



HAL
open science

Construction of extended topological quantum field theories

Marco de Renzi

► **To cite this version:**

Marco de Renzi. Construction of extended topological quantum field theories. Geometric Topology [math.GT]. Université Sorbonne Paris Cité, 2017. English. ⟨NNT : 2017USPCC114⟩. ⟨tel-02003025⟩

HAL Id: tel-02003025

<https://theses.hal.science/tel-02003025v1>

Submitted on 1 Feb 2019

HAL is a multi-disciplinary open access archive for the deposit and dissemination of scientific research documents, whether they are published or not. The documents may come from teaching and research institutions in France or abroad, or from public or private research centers.

L'archive ouverte pluridisciplinaire HAL, est destinée au dépôt et à la diffusion de documents scientifiques de niveau recherche, publiés ou non, émanant des établissements d'enseignement et de recherche français ou étrangers, des laboratoires publics ou privés.



HAL Authorization

Université Sorbonne Paris Cité

Université Paris Diderot – Paris 7

École Doctorale de Sciences Mathématiques de Paris Centre

Institut de Mathématiques de Jussieu – Paris Rive Gauche

THÈSE DE DOCTORAT

Discipline : Mathématiques

Présentée par

Marco DE RENZI

Construction of Extended Topological Quantum Field Theories

Dirigée par Christian BLANCHET

Soutenue le 27 octobre 2017 devant le jury composé de :

M ^{me} Anna BELIAKOVA	Universität Zürich	Examinatrice
M. Christian BLANCHET	Université Paris Diderot	Directeur
M. Francesco COSTANTINO	Université Toulouse III	Rapporteur
M. Louis FUNAR	Université Grenoble Alpes	Président
M. Azat GAINUTDINOV	LMPT	Examineur
M. Christoph SCHWEIGERT	Universität Hamburg	Examineur
M. Alexis VIRELIZIER	Université Lille 1	Examineur

Absent lors de la soutenance :

M. Vladimir TURAEV	Indiana University	Rapporteur
--------------------	--------------------	------------



Institut de Mathématiques de Jussieu – École Doctorale de Sciences Mathématiques de Paris Centre, ED 386
Paris Rive Gauche, UMR 7586
Université Paris Diderot – Paris 7
Bâtiment Sophie Germain
Boite Courrier 7012
75205 Paris Cedex 13

There is no royal road to geometry.

Euclid

Contents

Contents	v
Abstract	ix
Keywords	ix
Résumé	x
Mots-clés	x
Acknowledgements	xi
Introduction	xiii
Why are TQFTs interesting?	xiii
What is a TQFT?	xiv
A brief history of quantum topology	xv
Pleasures and pains of semisimple theories	xvi
Non-semisimple theories	xvii
What is an Extended TQFT?	xviii
Results	xix
Préface	xxi
Pourquoi les TQFTs sont-elles intéressantes ?	xxi
Qu'est-ce qu'une TQFT ?	xxii
Brève histoire de la topologie quantique	xxiii
Joies et douleurs des théories semi-simples	xxiv
Théories non semi-simples	xxv
Qu'est-ce qu'une TQFT Étendue ?	xxvi
Résultats	xxvii
Chapter 1. Semisimple Extended Topological Quantum Field Theories	1
1.1. Introduction	1
1.1.1. Main results	1
1.1.2. Outline of the construction	2
1.1.3. Structure of the exposition	2
1.2. Modular categories	2
1.2.1. Ribbon categories	3
1.2.2. Colored ribbon graphs	4
1.2.3. Main definitions	7
1.3. Decorated cobordisms	10
1.3.1. 2-Category of decorated cobordisms	10
1.3.2. Extended universal construction for decorated cobordisms	12
1.4. Surgery axioms	13

1.5.	Connection Lemma	16
1.6.	Witten-Reshetikhin-Turaev invariants	18
1.7.	Skein modules	19
1.8.	Morita reduction	21
1.9.	Monoidality	23
1.10.	TQFT	28
1.11.	Universal linear categories	33
1.12.	Universal linear functors	34
1.12.1.	2-Discs	34
1.12.2.	2-Pants	36
1.12.3.	Examples of computations	41
Chapter 2.	Non-Semisimple Extended Topological Quantum Field Theories	43
2.1.	Introduction	43
2.1.1.	Main results	44
2.1.2.	Outline of the construction	45
2.1.3.	Structure of the exposition	46
2.2.	Relative modular categories	47
2.2.1.	Group structures and homogeneous colored ribbon graphs	47
2.2.2.	Traces on ideals and ambidextrous objects	48
2.2.3.	Group realizations	49
2.2.4.	Main definitions	50
2.3.	Admissible cobordisms	53
2.3.1.	Group colorings on decorated cobordisms	53
2.3.2.	2-Category of decorated cobordisms	55
2.3.3.	2-Category of admissible cobordisms	59
2.3.4.	Extended universal construction for admissible cobordisms	60
2.4.	Surgery axioms	61
2.5.	Connection Lemma	68
2.6.	Costantino-Geer-Patureau invariants	74
2.7.	Admissible skein modules	76
2.8.	Morita reduction	78
2.9.	Graded extensions	82
2.9.1.	2-Spheres	82
2.9.2.	3-Discs	87
2.9.3.	3-Pants	88
2.9.4.	Suspension systems	95
2.9.5.	Graded quantization 2-functors	96
2.10.	Monoidality	98
2.11.	Symmetry	101
2.12.	Graded TQFT	102
2.13.	Universal graded linear categories	111
2.14.	Universal graded linear functors	116
2.14.1.	2-Discs	116
2.14.2.	2-Pants	119
2.14.3.	2-Cylinders	132
2.14.4.	Examples of computations	135
2.14.4.1.	Generic surfaces	136
2.14.4.2.	Critical tori	137

Appendix A. Algebraic appendices	139
A.1. Monoidal categories	139
A.2. Enriched categories	143
A.3. 2-Categories	146
A.4. Monoidal 2-categories	153
A.5. Complete linear categories	158
A.6. Complete graded linear categories	162
A.7. Extended universal construction	169
Appendix B. Topological appendices	173
B.1. Manifolds with corners	173
B.2. Collars	175
B.3. Gluing	176
B.4. Cobordisms	178
B.5. Ribbon graphs	183
B.6. Maslov index	186
Bibliography	195

Abstract

The central position held by *Topological Quantum Field Theories (TQFTs)* in the study of low dimensional topology is due to their extraordinarily rich structure, which allows for various interactions with and applications to questions of geometric nature. Ever since their first appearance, a great effort has been put into extending quantum invariants of 3-dimensional manifolds to TQFTs and *Extended TQFTs (ETQFTs)*. This thesis tackles this problem in two different general frameworks. The first one is the study of the *semisimple* quantum invariants of Witten, Reshetikhin and Turaev issued from *modular categories*. Although the corresponding ETQFTs were known to exist for a while, an explicit realization based on the universal construction of Blanchet, Habegger, Masbaum and Vogel appears here for the first time. The aim is to set a golden standard for the second part of the thesis, where the same procedure is applied to a new family of *non-semisimple* quantum invariants due to Costantino, Geer and Patureau. These invariants had been previously extended to graded TQFTs by Blanchet, Costantino, Geer and Patureau, but only for an explicit family of examples. We lay the first stone by introducing the definition of *relative modular category*, a non-semisimple analogue to modular categories. Then, we refine the universal construction to obtain graded ETQFTs extending both the quantum invariants of Costantino, Geer and Patureau and the graded TQFTs of Blanchet, Costantino, Geer and Patureau in this general setting.

Keywords

Extended TQFTs, Non-Semisimple Categories, Topological Quantum Field Theories, Quantum Invariants, Modular Categories, 2-Categories

Résumé

La position centrale occupée par les *Théories Quantiques des Champs Topologiques* (*TQFTs*) dans l'étude de la topologie en basse dimension est due à leur structure extraordinairement riche, qui permet différentes interactions et applications à des questions de nature géométrique. Depuis leur première apparition, un grand effort a été mis dans l'extension des invariants quantiques de 3-variétés en TQFTs et en *TQFT Étendues* (*ETQFTs*). Cette thèse s'attaque à ce problème dans deux cadres généraux différents. Le premier est l'étude des invariants quantiques *semi-simples* de Witten, Reshetikhin et Turaev issus de *catégories modulaires*. Bien que les ETQFTs correspondantes étaient connues depuis un certain temps, une réalisation explicite basée sur la construction universelle de Blanchet, Habegger, Masbaum et Vogel apparaît ici pour la première fois. L'objectif est de tracer la route à suivre dans la deuxième partie de la thèse, où la même procédure est appliquée à une nouvelle famille d'invariants quantiques *non semi-simples* due à Costantino, Geer et Patureau. Ces invariants avaient déjà été étendus en TQFTs graduées par Blanchet, Costantino, Geer and Patureau, mais seulement pour une famille explicite d'exemples. Nous posons la première pierre en introduisant la définition de *catégorie modulaire relative*, un analogue non semi-simple aux catégories modulaires. Ensuite, nous affinons la construction universelle pour obtenir des ETQFTs graduées étendant à la fois les invariants quantiques de Costantino, Geer et Patureau et les TQFTs graduées de Blanchet, Costantino, Geer et Patureau dans ce cadre général.

Mots-clés

TQFTs Étendues, Catégories Non Semi-Simples, Théories Quantiques des Champs Topologiques, Invariants Quantiques, Catégories Modulaires, 2-Catégories

Acknowledgements

I have a long list of people I would like to thank for all the support I received during the long preparation of this work.

First of all, I would like to thank my supervisor, Christian Blanchet. There are many things I am grateful to him for. To begin with, the subject he proposed me is fascinating, and it matches incredibly well my interests and abilities. During these three years, thanks to his broad vision and to his deep understanding of the mathematics I was using, he was always capable, with few words, to clearly show me the right perspective to take on my work. Many times he addressed fundamental problems of my research in advance, and it sufficed to go back to the notes I took during our meetings to find the ideas I was looking for. He also constantly encouraged me to step out of my comfort zone in order to broaden my knowledge and develop a more complete understanding. He was always very supportive, he made sure I could talk about my research in front of people who cared for it, and he made it possible for me to find the collaborations that constitute my present work. He was also extremely effective in providing me with the chance to come to Paris in the first place. For all of this, I am deeply thankful to him.

I would like to thank my rapporteurs, François Costantino and Vladimir Tu-raev. Their inspiring research literally provided the basis for all the constructions I developed during my thesis, so heartfelt thanks are due for introducing me to the theories and to the problems I am studying now. I am further grateful for their thorough work in reading my manuscript, for the useful discussions we had about its form and content, and for the helpful and encouraging comments they provided.

I would like to thank Anna Beliakova, Louis Funar, Azat Gainutdinov, Muriel Livernet, Christoph Schweigert, and Alexis Virelizier for accepting to take part in my PhD thesis defense as members of the jury. Their work was very important for my research, and I am honoured by their presence. I would like to warmly thank them for inviting me to Switzerland (many times), to Hamburg, and to Lille. I am also deeply grateful for the precious comments and advices they had for me during our discussions.

I would like to thank Nathan Geer and Bertrand Patureau, with whom I started a collaboration right after the completion of this thesis. They are extremely supportive, incredibly helpful, and extraordinarily nice, something which means a lot to me. I am learning a great deal from them, and at a much faster rate than ever before. I feel I am very lucky to have the chance to work with such accomplished researchers, whose constructions and discoveries I studied all along my PhD. I am also very grateful I got the chance to personally experience how much better it is to collaborate than to work on my own.

I would like to thank Jun Murakami for his support, for inviting me to Tokyo, for the time he dedicated to me while I was there, for the inspiring discussions we had and for his beautiful work in general.

I would like to thank Claire Lavollay, Sakina Madel-Kawami, Elodie Destrebecq, and Christine Le Sueur for assisting me countless times during these three years, always with a smile.

I would like to thank all the people that taught and organized the courses for which I was teaching assistant, for their guidance and help: Sami Abbes, Paul Laurain, Stéphane Vassout, Matteo Ruggiero, Jaouad Sahbani, Mathilde Herblot, and Patrick Simonetta. Thanks also to Hussein Mourtada for his work in the organisation of the PhD student seminar, for his kind comments and for his support.

I would like to thank my former academic siblings Catherine, Hoël, Louis-Hadrien, and Lukas for advising me, discussing with me, welcoming me, for inviting me to Montpellier and to Genève, and for being so nice. I would like to thank my present academic siblings too, Cristina and Daniel, for all the time we spent together at conferences and workshops, and for our mutual support in these challenging times.

I would like to thank all my mathematician friends Jules, Léo, Maÿlis, Xavier, Fathi, Renaud, Ramanujan, Delphine, as well as those I met less frequently: Anne, Damien, Guillem, Julien, Mounir, Anthony, Livio. They all welcomed me when I came to France for the first time, and they showed great endurance during my stuttering first dialogues. They were all friends and family to me, they made it fun to attend even the most terrible talks, and I am sure they will continue to do so in the future.

I would like to thank all the office mates I had through these three years: Rémi, Reda, Zhengfang, Kai, Ana, Alice, Riwan, Colin. Thanks also to all the students of Paris 7: Vito, Valerio, Mauro, Joël, Juan Pablo, Jean-Michel, Esther, Sacha, Marco, Kevin, Antoine, Léa, Alexandre, and all the others. Our office was always a nice place to be, to have discussions about music, movies, football, politics, and maths.

I would like to thank all my friends that contributed to bring Italy to Paris: Sara, Annina, Mauro, Leo, Cinzia, Cecilia, David, Giulia, Marche, Matthew, Paola, Aurora, Béatrice, Lorenzo, Michele, Mattia. Thanks also to all my friends who spread Italy across Europe, and to those who stayed in Pisa, making our come-backs always feel like coming home: Fabio, Chiara, Tommaso, Stefano, Veronica, Costanza, Pietro, Luca, Danny, Stefano, Enrico, Fra, Luca, Giani. Despite all the fear I had of leaving Pisa three years ago, it is thanks to them that moving to Paris was no shock at all, and now I know we will all grow old together.

All my love goes to my family: my parents, my sister, my grandparents, my aunts and uncles, and my cousins. Their caring presence keeps my footing firm and makes me feel I'm home, even when I'm far away. To my grandfather Ennio, whom I miss very much, I dedicate this thesis.

Finally, I would like to thank Eleonora, for making my life beautiful.

Introduction

The main purpose of this thesis is to develop a general theory for the construction of non-semisimple Extended Topological Quantum Field Theories for the Costantino-Geer-Patureau quantum invariants of closed 3-manifolds defined in [CGP14]. This short chapter is intended to provide motivation for this work by outlining a rough overview of the domain and a brief introduction to its main concepts.

Why are TQFTs interesting?

The study of *Topological Quantum Field Theories* represents a paramount example of the fruitful interaction between physics and mathematics, and a rather exceptional one too: it proves that the domains do not interact exclusively when mathematical theories are used as a tool in order to approach problems or to construct models of physical interest. Indeed, the converse happens as well: physics can be an outstanding propeller for new ideas in mathematics. This is exactly what happened with *quantum topology*, a mathematical discipline which stemmed from some groundbreaking discoveries in theoretical physics. By now Topological Quantum Field Theories, often abbreviated to the acronym *TQFT*, have taken a life of their own within the boundaries of pure mathematics. It is even possible to work on related research themes while knowing little or nothing of the physical concepts that brought the subject into being. It is however fascinating to think that this beautiful and elegant mathematical theory was inspired by physics, and that some of the deepest questions and conjectures in the field are still provided by physical insight.

Before setting out to explain what quantum topologists mean by TQFTs, which is often different, at least on the level of terminology, from what theoretical physicists mean, let us try to answer a more fundamental question: why should we care about them? We begin with what is arguably the most naïve motivation: TQFTs provide numerical invariants for closed manifolds, called *quantum invariants*, which enjoy good locality properties. In other words, in order to compute their global value on a complicated closed manifold we can cut the latter along codimension 1 submanifolds and we can then recombine the data assigned to the simpler pieces obtained. In particular, it is sufficient to understand quantum invariants in local settings where the topology is simpler. This is a highly valuable feature, as powerful topological invariants tend to be hard to explicitly compute in general. Now, to be honest, it should not be thought that people actually build TQFTs in order to obtain invariants for closed manifolds, at least not in dimension 3. Indeed, for what concerns all of the constructions treated in this thesis, this picture would be misleading. Most of the time we start with some numerical invariant of closed manifolds we already know, and then we try to extend it to a

TQFT, which is not necessarily an easy job. If we succeed in doing so, then we can understand how local behaviours determine global ones, thus highly improving the computability features of the invariant we started with. At any rate, the production of closed manifold invariants is probably not the real reason people try to construct TQFTs. Their true appeal lies in the richness of their structure, a feature which allows for a number of interactions with and applications to questions of geometric nature. The better known of them, at least in low dimensional topology, is the study of Mapping Class Groups of surfaces. These elementary algebraic structures are very easy to define and, at the same time, extraordinarily hard to understand, with many open questions about them being active research themes. One of the most famous conjectures in the field concerns their linearity, that is the existence of faithful representations. Since in general Mapping Class Group representations are quite hard to construct, every machinery that produces them is extremely helpful in the investigation. This makes 3-dimensional TQFTs highly attractive as they naturally induce representations of Mapping Class Groups of surfaces, called *quantum representations*, which are among the most effective tools at our disposal in order to tackle these kinds of problems.

What is a TQFT?

We have already mentioned Topological Quantum Field Theories in several places, but we have not yet given a precise definition. This is because the mathematical formalisation of the concept has a rather abstract flavor, and it is therefore natural, at first glance, to wonder why we should even consider such a notion.

In extremely concise terms, a TQFT is a symmetric monoidal functor from a cobordism category to a linear category. For the 3-dimensional theory, to which we will exclusively confine for this thesis, it involves associating a vector space with every closed surface in such a way that the topological operation of disjoint union of surfaces corresponds to the algebraic operation of tensor product of vector spaces. At the same time, a 3-dimensional TQFT associates with every 3-dimensional cobordism between closed surfaces a linear map between the corresponding vector spaces in such a way that the topological operation of gluing of cobordisms is translated to the algebraic operation of composition of linear maps. This means that by realizing a closed 3-manifold as the gluing of a finite family of cobordisms we can compute its invariant as the composition of the corresponding linear maps. It also means that TQFTs can be used for constructions which were completely out of the reach of numerical invariants of closed 3-manifolds. For instance, it is thanks to the rich structure provided by vector spaces and linear maps that quantum representations of Mapping Class Group can be obtained.

The definition of TQFT provided here is essentially due to Atiyah. It was first published in his 1988 paper [A88] and it was inspired by an analogue set of axioms for *Conformal Field Theories* which had been previously proposed by Segal in [S88]. However, as it often happens, the concept had already been considered before the scientific community agreed on its actual definition. It made its first appearance in a 1978 paper [S78] by Schwarz, where quantum field theories whose dynamics is independent of the metric were first discussed. The first family of examples was constructed only ten years later, and at the physical level of rigor, by Witten, but in order to understand its importance we first need to outline a rough historical overview of the events leading to this discovery.

A brief history of quantum topology

For a long time the only known polynomial invariant of knots was the *Alexander polynomial*. Its definition, which first appeared in the 1928 paper [A28] by Alexander, is derived from the homology of the infinite cyclic cover of the knot complement. In particular, its geometric interpretation is rather clear, as its construction allows for a concrete intuition of the topological properties it measures. This means its limits are also well understood: for instance, a knot and his mirror image always share the same Alexander polynomial. For more than sixty years all the polynomial invariants of knots that were discovered were systematically proven to boil down to some renormalization of the Alexander polynomial.

In 1985 a short paper [J85] by Jones introduced what is now known as the *Jones polynomial*. This discovery started a small revolution in knot theory. Indeed, an early computation by Jones and Birman shows that this invariant is not yet another version of the Alexander polynomial, as it distinguishes the left trefoil from the right trefoil. The definition, which is based on representations of braid groups in Von Neumann algebras, makes it hard to understand what topological properties of knots are detected, and to this day we are still missing a geometric interpretation. On the other hand, thanks to skein calculus, the Jones polynomial turns out to be rather easy to compute and quite a powerful invariant. For instance, whether or not it is capable of detecting the unknot is still an open question.

The mysterious nature of the Jones polynomial is the main reason topologists were so excited when in 1989 a theoretical physics paper [W89] by Witten showed the world an unexpected manifestation of this knot invariant in the context of quantum field theory. Indeed, the birth of the domain known today as quantum topology can probably be traced back to this event. Witten constructed a new family of invariants of closed 3-manifolds which recovered and generalized the Jones polynomial, and at the same time he predicted these invariants should be understood as part of a richer structure provided by a family of TQFTs. His construction made use of Feynman's path integral, a tool which has not yet been formalized on a mathematical level. More precisely, Witten's definition involves fixing a closed 3-manifold and integrating the Chern-Simons functional over the whole infinite-dimensional space of connections on its tangent bundle. Since it is not clear what sense should be made of a measure on such space, the mathematical foundations of this approach are rather shaky. The insight it provides however is remarkable, as many open conjectures about these 3-manifold invariants are inspired by the original construction. Witten remains to date the only physicist to have ever been awarded the Fields medal, a sign that his talents for mathematics are widely acknowledged.

This thrilling discovery sparked the interest of topologists in quantum field theory, and many of them set out to try and formalize Witten's results. Reshetikhin and Turaev were the first who managed to produce a rigorous, although completely different, construction of Witten's family of 3-manifold invariants. Shortly afterwards Turaev succeeded in completing Witten's program by extending these invariants through the construction, in a very general setting, of the family of TQFTs known today as Witten-Reshetikhin-Turaev. His work is what we call in this thesis the *semisimple theory*, and in Chapter 1 we entirely rephrase it in order to set the golden standard for its non-semisimple generalization.

Pleasures and pains of semisimple theories

Although, as we mentioned earlier, TQFTs are not that easy to build, the first and most famous family of examples comes in several different incarnations. The existence of various interpretations for it is an essential feature of the semisimple theory which ensure connections with many areas of mathematics. It allows indeed for the study of related questions under different perspectives and it makes room for the use of diverse techniques in order to reach deep results. Here is a non-exhaustive list of the main different realizations of the Witten-Reshetikhin-Turaev family of quantum invariants and TQFTs:

- (i) The original construction was performed by Witten in his 1988 paper [W88]. Although its mathematical basis is not firm, its main advantage lies in the unique insight it provides. An example of the deep open questions which are inspired by this approach is *Witten's asymptotic conjecture*, the prediction of a relation between a certain limit stated in terms of Witten-Reshetikhin-Turaev quantum invariants and some expression involving classical invariants such as Reidemeister torsions, Chern-Simons invariants and the spectral flow of representations of the fundamental group.
- (ii) The first rigorous construction was obtained by Reshetikhin and Turaev in their 1991 paper [RT91], for what concerns quantum invariants, and by Turaev in his 1994 book [T94], for what concerns TQFTs. Their approach is based on the semisimple representation theory of the *restricted* version of the quantum group of \mathfrak{sl}_2 at roots of unity. Its rather algebraic flavor makes it the best suited for generalizations. Indeed, all of the constructions which will be central to this thesis are derived from this version of the theory.
- (iii) In their 1992 paper [BHMV92] Blanchet, Habegger, Masbaum and Vogel delivered a completely combinatorial construction of these quantum invariants, which they extended to TQFTs in their 1995 paper [BHMV95]. Their definition relies on the bracket polynomial introduced by Kauffman in [K87]. The advantage of this approach is that it makes computations easier by translating them into a problem of skein calculus. They are also to be credited with the introduction of the universal construction, a very general machinery on which all of the results in this thesis will heavily rely.
- (iv) More recently, in a series of paper which culminated with [AU15], Andersen and Ueno gave a geometric interpretation of the previous constructions which allows for the use of analytic methods in order to approach a number of open questions like the *Andersen-Masbaum-Ueno conjecture* on the dynamics of diffeomorphisms of surfaces. An example of the deep results within the reach of geometric techniques is given by the asymptotic faithfulness of Mapping Class Group representations established by Andersen in [A06].

As it is witnessed by the previous list, Witten-Reshetikhin-Turaev quantum invariants and TQFTs have been studied extensively since their first appearance. In fact, they provide a very active research theme to this day. Although much more remains to be discovered, certain weaknesses of this family of examples are already known:

- (i) There exist infinite families of pairs of inequivalent closed 3-manifolds which cannot be distinguished by the Witten-Reshetikhin-Turaev quantum invariants. Examples are provided by pairs of lens spaces which are homotopically equivalent but not homeomorphic.
- (ii) Quantum representations of Mapping Class Groups induced by Witten-Reshetikhin-Turaev TQFTs are never faithful. In particular Dehn twists along simple closed curves always act on TQFT vector spaces of closed surfaces with finite order.
- (iii) In general the theory is not well-suited to treat certain fundamental questions. An example is provided by the *volume conjecture* first proposed by Kashaev in [K97] and later generalized by Murakami and Murakami in [MM01] and by Murakami, Murakami, Okamoto, Takata and Yokota in [MMOTY02]. In its complex form, it consists in the prediction of a relation between some expression involving the hyperbolic volume of the complement of a hyperbolic link, together with its Chern-Simons invariant, and a certain limit stated in terms of the Jones polynomials colored with the Steinberg representations of quantum \mathfrak{sl}_2 . Since the latter are not featured in the construction of Reshetikhin and Turaev, certain aspects of these questions are out of the reach of semisimple quantum invariants.

Non-semisimple theories

In the algebraic construction by Reshetikhin and Turaev there is substantial room for improvement, as only small semisimple quotients of representation categories of quantum \mathfrak{sl}_2 enter the picture. We could hope to obtain more powerful quantum invariants and TQFTs by adapting their machinery in order to take into account also non-semisimple parts of categories of representations. This has been done quite early, most notably in the 1996 paper [H96] by Hennings and in a series of publications by Kerler and Lyubashenko which culminated in their joint 2001 book [KL01]. These constructions of non-semisimple quantum invariants and TQFTs would deserve to be discussed at length, but we will not focus on them in this thesis. We just point out that non-semisimple Hennings invariants vanish on all closed 3-manifolds with positive first Betti number and that Kerler-Lyubashenko TQFTs are defined only for connected surfaces. In particular, though it is extremely interesting, this version of the non-semisimple theory still has some weaker points.

What was probably lacking from earlier attempts at producing powerful non-semisimple constructions is the theory of traces on ideals which was developed by Geer and Patureau through a number of collaborations with Turaev, Kujawa and Virelizier. This body of work constitutes the ground on which more recent non-semisimple constructions have been erected. In their 2014 paper [CGP14] Costantino, Geer and Patureau defined a new family of quantum invariants of closed 3-manifolds of Witten-Reshetikhin-Turaev type which are based on the non-semisimple representation theory of the *unrolled* version of quantum \mathfrak{sl}_2 . In their 2017 paper [BBG17] Beliakova, Blanchet and Geer defined, in the case of restricted quantum \mathfrak{sl}_2 , a logarithmic version of Hennings' invariants which integrates the new technology of traces on ideals into the construction.

This thesis builds on the first of these two works. Indeed, TQFTs extending the Costantino-Geer-Patureau invariants in the case of quantum \mathfrak{sl}_2 have already been

defined in [BCGP16] by Blanchet, Costantino, Geer and Patureau, and a series of remarkable properties, which mark a sharp contrast with the Witten-Reshetikhin-Turaev theory, have been established:

- (i) The Costantino-Geer-Patureau quantum invariants are strictly finer than the Witten-Reshetikhin-Turaev ones. Indeed, they recover various classical invariants such as the Reidemeister torsion, which naturally appears in a standard normalization. This allows to recover the whole classification of lens spaces.
- (ii) All of the quantum representations of Mapping Class Groups induced by the Blanchet-Costantino-Geer-Patureau TQFTs have unprecedented behaviours, with Dehn twists along non-separating simple closed curves always acting with infinite order. In particular, nothing is known to be in the kernels of these representations, as all diffeomorphisms which were there in the semisimple theory no longer are.
- (iii) The inclusion of Steinberg representations of quantum \mathfrak{sl}_2 , also known as Kashaev colors, into the construction makes it possible to use these quantum invariants and TQFTs in order to extend the volume conjecture to links in arbitrary manifolds and to prove it for an infinite family of examples.

What is an Extended TQFT?

What this thesis actually deals with is the construction of *Extended TQFTs*, which will be often abbreviated with the acronym *ETQFT*. The idea is that, just like invariants of closed manifolds, TQFTs may be hard to compute in general. One thing we could try to do then is to localize them also in their codimension 1 parts. This means extending their definition so to allow computations of vector spaces associated with codimension 1 submanifolds to be made by cutting the latter along codimension 2 submanifolds and then recombining the data assigned to the various simpler pieces obtained. In the same abstract terms used before, an ETQFT can then be defined as a symmetric monoidal 2-functor from a cobordism 2-category to a linear 2-category. The possible targets this time are many, and different choices can give rise to slightly different theories. For the purpose of this thesis we may think of a 3-dimensional ETQFT as associating a complete linear category with every closed 1-manifold, a linear functor with every 2-dimensional cobordism and a natural transformation with every 3-dimensional cobordism with corners.

In what sense does the above notion do the job we introduced it for in the first place? Well, exactly in the same way TQFTs provided the analogue service for quantum invariants. Indeed, computing the quantum invariant of a closed 3-manifold by means of a TQFT amounts to do the following: we start by interpreting the closed 3-manifold as a cobordism between two copies of the empty surface. Then the TQFT associates with it a linear endomorphism of a certain vector space which, as a consequence of monoidality, is isomorphic to the base field, the unit for the tensor product of vector spaces. Such a map is just a product with some fixed number, which we can interpret as the quantum invariant of the closed 3-manifold. This idea directly generalizes to the extended setting. Indeed, if we want to compute the TQFT vector space of a closed surface by means of an ETQFT, the procedure is the same: we start by interpreting the closed surface as a cobordism between two copies of the empty 1-manifold. Then the ETQFT associates with it a linear

endofunctor of a certain linear category which, as a consequence of monoidality, is equivalent to the category of finite-dimensional vector spaces, the unit for the tensor product of complete linear categories. Such a functor is equivalent to a tensor product with some fixed vector space, which we can interpret as the TQFT vector space of the closed surface. In particular, hidden behind the higher structure of a symmetric monoidal 2-functor, we still have a recipe which associates a complex number with every closed 3-manifold and a vector space with every closed surface.

Results

It has been known for a while that Witten-Reshetikhin-Turaev TQFTs extend to ETQFTs. In fact, all semisimple ETQFTs have been classified by Bartlett, Douglas, Schommer-Pries and Vicary in their 2015 paper [BDSV15]. Once again, there are several ways of constructing all of these ETQFTs. In Chapter 1 we present a completely general and explicit recipe for doing so which mixes two of the classical approaches: the algebraic formalism of Turaev, and the universal construction of Blanchet, Habegger, Masbaum and Vogel. None of the results contained in this first part of the thesis is original, but we provide a detailed construction all the same in order to chart a course we will later follow while trying to develop an analogous theory in the previously unexplored non-semisimple setting. The two key algebraic structures introduced by Turaev which allow for the implementation of the whole procedure are *non-degenerate pre-modular categories* and *modular categories*. A non-degenerate pre-modular category is precisely what is needed, in the most general version of the theory, in order to obtain an associated Witten-Reshetikhin-Turaev quantum invariant. A modular category is just a pre-modular category satisfying a strong non-degeneracy condition which implies the weaker one required to construct closed 3-manifold invariants. The main result then is that the Witten-Reshetikhin-Turaev quantum invariant associated with a modular category extends to an ETQFT. We can even give a combinatorial description of this ETQFT and a meaningful interpretation of its various components in terms of algebraic structures on the modular category at use.

In Chapter 2 we play the same game, but starting from the Costantino-Geer-Patureau quantum invariants. This time we implement the universal construction of Blanchet, Habegger, Masbaum and Vogel in the context of the algebraic formalism introduced by Costantino, Geer and Patureau. Results in this second half of the thesis are new, and they combine to provide a very general theory for the production of non-semisimple ETQFTs. The key algebraic structures underlying the construction of Costantino-Geer-Patureau quantum invariants are *non-degenerate relative pre-modular categories*. We should think of these categories as some sorts of non-semisimple analogues to the building blocks for Witten-Reshetikhin-Turaev quantum invariants. Our first contribution is the identification of the new concept of *relative modular category*, an algebraic structure which will play the role of modular categories in this non-semisimple setting. Our main result can be then stated as follows:

THEOREM. *The Costantino-Geer-Patureau quantum invariant associated with a relative modular category extends to a graded ETQFT.*

In order to build these graded ETQFTs we have to construct 2-categories of cobordisms whose decorations involve cohomology classes. We point out that this

time the theory is significantly more complicated, as the procedure we implemented in the semisimple setting does not directly produce an ETQFT. Indeed, we face obstructions to monoidality, and the strategy to tackle them will be to refine the universal construction by integrating them into its structure. This phenomenon is responsible for the appearance of gradings in this non-semisimple version of the theory. Finally, a combinatorial description and a meaningful interpretation of the various components can be derived for this graded ETQFT in complete analogy with the semisimple case, although some of the explicit characterizations this time are decidedly more complicated.

Préface

Le but principal de cette thèse est de développer une théorie générale pour la construction de Théories Quantiques des Champs Topologiques Étendus non semi-simples pour les invariants quantiques de Costantino-Geer-Patureau de 3-variétés fermées définis dans [CGP14]. Ce court chapitre est consacré à motiver ce travail en esquissant une vue d'ensemble du domaine et une brève introduction à ses principaux concepts.

Pourquoi les TQFTs sont-elles intéressantes ?

L'étude des *Théories Quantiques des Champs Topologiques* représente un éclatant exemple de l'interaction fructueuse entre la physique et les mathématiques qui est plutôt exceptionnel : il prouve que les domaines n'interagissent exclusivement lorsque des théories mathématiques sont utilisées comme outil pour aborder des problèmes ou pour construire des modèles d'intérêt physique. En effet, le phénomène inverse se produit aussi : la physique peut être un propulseur exceptionnel pour de nouvelles idées en mathématiques. C'est exactement ce qui s'est produit avec la *topologie quantique*, une discipline mathématique née à partir de découvertes révolutionnaires en physique théorique. Maintenant, les Théories Quantiques des Champs Topologiques, souvent abrégées par l'acronyme *TQFT*, ont évolué en des concepts autonomes en mathématiques fondamentales. Il est même possible de travailler sur des thèmes de recherche connexes tout en connaissant peu ou pas les concepts physiques qui ont amené à la naissance le sujet. C'est pourtant fascinant de penser que cette belle et élégante théorie mathématique a été inspirée de la physique et que certaines des questions les plus profondes et des conjectures les plus importantes du domaine sont toujours inspirées par une compréhension physique.

Avant d'expliquer ce que les topologues quantiques entendent par TQFT, qui est souvent différent, au moins sur le plan de la terminologie, de ce que les physiciens théoriciens entendent, essayons de répondre à une question plus fondamentale : pourquoi devrions-nous nous en préoccuper ? Nous commençons par ce qui est sans doute la motivation la plus naïve : les TQFTs produisent des invariants numériques pour les variétés fermées, appelés *invariants quantiques*, qui satisfont de bonnes propriétés de localité. En d'autres termes, afin de calculer leur valeur globale sur une variété fermée compliquée, nous pouvons couper cette dernière le long de sous-variétés de codimension 1 et nous pouvons ensuite recombinaison les données associées aux morceaux plus simples obtenues. En particulier, il suffit de comprendre les invariants quantiques dans des contextes locaux où la topologie est plus simple. Cette caractéristique est très précieuse, d'autant plus que les invariants topologiques puissants ont tendance à être difficiles à calculer explicitement en général. Or, pour dire vrai, il ne faut pas penser que les gens construisent des TQFTs afin d'obtenir des invariants pour les variétés fermées, au moins pas en dimension 3.

En effet, pour ce qui concerne toutes les constructions traitées dans cette thèse, cette image serait trompeuse. La plupart du temps, on commence avec un invariant numérique des variétés fermées qu'on connaît déjà, puis on essaie de l'étendre en une TQFT, ce qui n'est pas nécessairement facile. Si nous arrivons à le faire, nous pouvons comprendre comment les comportements locaux déterminent les comportements globaux, améliorant ainsi considérablement les propriétés de calculabilité de l'invariant de départ. En tout cas, la production d'invariants des variétés fermées n'est probablement pas la vraie raison pour laquelle les gens essaient de construire des TQFTs. Leur véritable attrait réside dans la richesse de leur structure, une caractéristique qui permet un certain nombre d'interactions et d'applications à des questions de nature géométrique. La plus connue d'entre elles, au moins en topologie en basse dimension, est l'étude des Mapping Class Groups de surfaces. Ces structures algébriques élémentaires sont très faciles à définir et, en même temps, extraordinairement difficiles à comprendre, avec beaucoup de questions ouvertes à ce sujet qui constituent des thèmes de recherche actifs. L'une des conjectures les plus célèbres dans le domaine concerne leur linéarité, c'est à dire l'existence de représentations fidèles. Puisque, en général, les représentations des Mapping Class Groups sont assez difficiles à construire, toutes les machines qui les produisent sont extrêmement utiles dans l'enquête. Cela rend les TQFTs de dimension 3 très intéressantes car elles produisent naturellement des représentations des Mapping Class Groups de surfaces, appelées *représentations quantiques*, qui sont parmi les outils les plus efficaces à notre disposition pour s'attaquer à ces types de problèmes.

Qu'est-ce qu'une TQFT ?

Nous avons déjà mentionné les Théories Quantiques des Champs Topologiques à plusieurs endroits, mais nous n'avons pas encore donné une définition précise. C'est parce que la formalisation mathématique du concept a une saveur plutôt abstraite, et il est donc naturel, à première vue, de se demander pourquoi on devrait même considérer une telle notion.

En termes extrêmement concis, une TQFT est un foncteur monoïdal symétrique d'une catégorie de cobordisme vers une catégorie linéaire. Pour ce qui concerne la théorie en dimension 3, à laquelle nous allons nous restreindre dans cette thèse, il s'agit d'associer un espace vectoriel à chaque surface fermée de telle sorte que l'opération topologique d'union disjointe de surfaces corresponde à l'opération algébrique de produit tensoriel d'espaces vectoriels. Au même temps, une TQFT en dimension 3 associe à chaque cobordisme de dimension 3 entre surfaces fermées une application linéaire entre les espaces vectoriels correspondants de telle sorte que l'opération topologique de recollement de cobordismes soit traduite dans l'opération algébrique de composition d'applications linéaires. Cela signifie que, en réalisant une 3-variété fermée comme le recollement d'une famille finie de cobordismes, nous pouvons calculer son invariant comme la composition des applications linéaires correspondantes. Cela signifie également que les TQFTs peuvent être utilisés pour des constructions qui étaient totalement hors de portée des invariants numériques de 3-variétés fermées. Par exemple, c'est grâce à la riche structure fournie par les espaces vectoriels et les applications linéaires que les représentations quantiques des Mapping Class Groups peuvent être obtenues.

La définition de TQFT fournie ici est essentiellement due à Atiyah. Elle a été publiée pour la première fois dans son article daté de 1988 [A88] et elle a été inspirée par un ensemble analogue d'axiomes pour les *Théories Conformées des Champs* qui avait déjà été proposé par Segal dans [S88]. Cependant, comme cela arrive souvent, le concept avait déjà été considéré avant que la communauté scientifique ne se mette d'accord sur sa définition. Il a fait sa première apparition en 1978 dans un article de Schwarz [S78], où des théories quantiques des champs dont la dynamique est indépendante de la métrique ont été discutées pour la première fois. La première famille d'exemples a été construite seulement dix ans plus tard, et au niveau physique de la rigueur, par Witten, mais pour comprendre son importance, il faut d'abord donner un aperçu historique des événements menant à cette découverte.

Brève histoire de la topologie quantique

Pendant longtemps, le seul invariant polynomial des nœuds connu était le *polynôme d'Alexander*. Sa définition, qui est apparue pour la première fois en 1928 dans l'article d'Alexandre [A28], est dérivé de l'homologie du revêtement cyclique infini du complément du nœud. En particulier, son interprétation géométrique est assez claire, car sa construction permet une intuition concrète des propriétés topologiques qu'il mesure. Cela signifie également que ses limites sont bien comprises : par exemple, un nœud et son image miroir partagent toujours le même polynôme d'Alexander. Pendant plus de soixante ans, chaque découverte d'un nouveau invariant polynomial des nœuds a été systématiquement démontré aboutir à une renormalisation du polynôme d'Alexander.

En 1985, un court article [J85] de Jones a introduit ce qu'on appelle maintenant le *polynôme de Jones*. Cette découverte a déclenché une petite révolution dans la théorie des nœuds. En effet, un calcul de Jones et Birman a montré tout de suite que cet invariant n'était pas une autre version du polynôme d'Alexander, car il arrive à distinguer le trèfle gauche du trèfle droit. La définition, qui est basé sur des représentations des groupes de tresses dans des algèbres de Von Neumann, rend difficile de comprendre quelles propriétés topologiques des nœuds sont détectées et, à ce jour, nous n'avons encore pas trouvé une interprétation géométrique. D'autre part, grâce aux relations d'écheveaux, le polynôme de Jones s'avère être plutôt facile à calculer et assez puissant comme invariant. Par exemple, la question de comprendre s'il est capable de détecter le nœud trivial reste encore ouverte.

La nature mystérieuse du polynôme de Jones est la raison principale de l'enthousiasme qui s'est diffusé parmi les topologues lorsque, en 1989, un article de physique théorique de Witten [W89] a montré au monde une manifestation inattendue de cet invariant des nœuds dans le contexte de la théorie quantique des champs. En effet, la naissance du domaine connu aujourd'hui sous le nom de topologie quantique peut être probablement remonté à cet événement. Witten a construit une nouvelle famille d'invariants des 3-variétés fermées qui retrouvent et généralisent le polynôme de Jones, et en même temps il a prédit que ces invariants devraient être compris comme faisant partie d'une structure plus riche fournie par une famille de TQFTs. Sa construction utilisait l'intégrale de chemin de Feynman, un outil qui n'a pas encore été formalisé au niveau mathématique. Plus précisément, la définition de Witten consiste à fixer une 3-variété fermée et à intégrer la fonctionnelle de Chern-Simons sur l'espace de dimension infinie des connexions sur son fibré tangent. Comme il n'est pas clair quel sens doit être fait d'une mesure sur un tel espace, les

fondements mathématiques de cette approche sont plutôt fragiles. Le point de vue qu'il fournit cependant est remarquable, car de nombreuses conjectures ouvertes à propos de ces invariants des 3-variétés s'inspirent de la construction originale. Witten reste à ce jour le seul physicien à avoir reçu la médaille Fields, signe que ses talents pour les mathématiques sont largement reconnus.

Cette découverte passionnante a suscité l'intérêt des topologues dans la théorie quantique des champs, et beaucoup d'entre eux ont entrepris d'essayer de formaliser les résultats de Witten. Reshetikhin et Turaev ont été les premiers qui ont réussi à produire une construction rigoureuse, bien que complètement différente, de la famille d'invariants des 3-variétés de Witten. Peu de temps après, Turaev a réussi à compléter le programme de Witten en étendant ces invariants à travers la construction, dans un cadre très général, de la famille de TQFTs connue aujourd'hui comme de Witten-Reshetikhin-Turaev. Son travail est ce que nous appelons dans cette thèse la *théorie semi-simple*. Dans le Chapitre 1 nous allons présenter une reformulation de ces résultats afin de tracer la route pour leur généralisation non semi-simple.

Joies et douleurs des théories semi-simples

Bien que, comme nous l'avons mentionné plus tôt, les TQFTs ne soient pas faciles à construire, la première et la plus célèbre famille d'exemples se présente dans plusieurs incarnations différentes. L'existence d'interprétations diverses est une caractéristique essentielle de la théorie semi-simple qui assure connexions avec de nombreux domaines des mathématiques. Elle permet en effet d'étudier des questions connexes sous différentes perspectives et elle permet de recourir à des techniques variées afin d'atteindre des résultats profonds. Voici une liste non exhaustive des principales réalisations différentes de la famille d'invariants quantiques et de TQFTs de Witten-Reshetikhin-Turaev :

- (i) La construction originale a été réalisée en 1988 par Witten dans son article [W88]. Bien que sa base mathématique ne soit pas ferme, son principal avantage réside dans la perspective unique qu'elle fournit. Un exemple des questions profondes ouvertes qui s'inspire de cette approche est la *conjecture asymptotique de Witten*, la prédiction d'une relation entre une limite exprimée en termes des invariants quantiques de Witten-Reshetikhin-Turaev et une certaine expression impliquant des invariants classiques tels que la torsion de Reidemeister, les invariants de Chern-Simons et le flot spectral des représentations du groupe fondamental.
- (ii) La première construction rigoureuse a été obtenue en 1991 par Reshetikhin et Turaev dans leur article [RT91], pour ce qui concerne les invariants quantiques, et en 1994 par Turaev dans son livre [T94], pour ce qui concerne les TQFTs. Leur approche est basée sur la théorie semi-simple de représentation de la version *restreinte* du groupe quantique de \mathfrak{sl}_2 aux racines de l'unité. Sa saveur plutôt algébrique le rend le mieux adapté aux généralisations. En effet, toutes les constructions au centre de cette thèse sont dérivées de cette version de la théorie.
- (iii) Dans leur article daté de 1992 [BHMV92] Blanchet, Habegger, Masbaum et Vogel ont livré une construction entièrement combinatoire de ces invariants quantiques, qu'ils ont étendus en TQFTs dans leur article

daté de 1995 [BHMV95]. Leur définition repose sur le polynôme du crochet introduit par Kauffman dans [K87]. L'avantage de cette approche est qu'il rend les calculs plus faciles en les traduisant en un problème de calcul d'écheveaux. Ils sont également à créditer pour l'introduction de la construction universelle, une procédure très générale de laquelle tous les résultats de cette thèse dépendront fortement.

- (iv) Plus récemment, dans une série d'articles qui ont abouti à [AU15], Andersen et Ueno ont donné une interprétation géométrique des constructions précédentes qui permet l'utilisation de méthodes analytiques pour aborder un certain nombre de questions ouvertes comme le *Conjecture Andersen-Masbaum-Ueno* sur la dynamique des difféomorphismes des surfaces. Un exemple des résultats profonds à la portée des techniques géométriques est donné par la fidélité asymptotique des représentations des Mapping Class Groups établie par Andersen dans [A06].

Comme le montre la liste précédente, les invariants quantiques et les TQFTs de Witten-Reshetikhin-Turaev ont été largement étudiés depuis leur première apparition. En fait, ils constituent un thème de recherche très actif à ce jour. Bien qu'il reste encore beaucoup à découvrir, certaines faiblesses de cette famille d'exemples sont déjà connues :

- (i) Il existe des familles infinies de paires de 3-variétés inéquivalentes qui ne peuvent pas être distingués par les invariants quantiques de Witten-Reshetikhin-Turaev. Des exemples sont fournis par des paires d'espaces lenticulaires qui sont homotopiquement équivalents, mais pas homéomorphes.
- (ii) Les représentations quantiques des Mapping Class Groups induites par les TQFTs de Witten-Reshetikhin-Turaev ne sont jamais fidèles. En particulier, les twists de Dehn le long de courbes fermées simples agissent toujours avec ordre fini sur les espaces vectoriels de TQFT des surfaces fermées.
- (iii) En général, la théorie n'est pas bien adaptée pour traiter certaines questions fondamentales. Un exemple est fourni par la *conjecture de volume* proposée d'abord par Kashaev dans [K97] et généralisée plus tard par Murakami et Murakami dans [MM01] et par Murakami, Murakami, Okamoto, Takata et Yokota dans [MMOTY02]. Dans sa forme complexe, elle consiste en la prédiction d'une relation entre une expression impliquant le volume hyperbolique du complément d'un entrelacs hyperbolique, ainsi que son invariant de Chern-Simons, et une certaine limite exprimée en termes des polynômes de Jones coloriés avec les représentations de Steinberg de \mathfrak{sl}_2 quantique. Comme ces dernières ne figurent pas dans la construction de Reshetikhin et Turaev, certains aspects de ces questions sont hors de portée des invariants quantiques semi-simples.

Théories non semi-simples

Dans la construction algébrique de Reshetikhin et Turaev, il existe une grande marge d'amélioration, car seuls des petits quotients semi-simples de catégories de représentations de \mathfrak{sl}_2 quantique interviennent. Nous pourrions espérer obtenir des invariants quantiques et des TQFTs plus puissants en adaptant leur construction afin de prendre en compte également des parties non semi-simples des catégories

de représentations. Cela a été fait assez tôt, notamment dans l'article de Hennings daté de 1996 [H96] et dans une série de publications de Kerler et Lyubashenko qui ont abouti à leur livre en collaboration [KL01] en 2001. Ces constructions d'invariants quantiques et de TQFTs non semi-simples mériteraient d'être discutés longuement, mais nous ne nous concentrerons pas sur eux dans cette thèse. Nous soulignons simplement que les invariants non semi-simples de Hennings s'annulent sur toutes les 3-variétés fermées avec premier nombre de Betti positif et que les TQFTs de Kerler-Lyubashenko sont définies uniquement pour les surfaces connexes. En particulier, bien qu'elle soit extrêmement intéressante, cette version de la théorie non semi-simple a encore des points faibles.

Ce qui manquait probablement dans les tentatives précédentes de produire des constructions non semi-simples puissantes, c'est la théorie des traces sur des idéaux développée par Geer et Patureau à travers un certain nombre de collaborations avec Turaev, Kujawa et Virelizier. Ce corps de travail constitue le terrain sur lequel des constructions non semi-simples plus récentes ont été érigées. Dans leur article daté de 2014 [CGP14] Costantino, Geer et Patureau ont défini une nouvelle famille d'invariants quantiques de 3-variétés fermées de type Witten-Reshetikhin-Turaev qui sont basés sur la théorie non semi-simple des représentations de la version *déroulé* de \mathfrak{sl}_2 quantique. Dans leur article daté de 2017 [BBG17] Beliakova, Blanchet et Geer définissent, dans le cas de \mathfrak{sl}_2 quantique restreint, une version logarithmique des invariants de Hennings qui intègre la nouvelle technologie des traces sur des idéaux dans la construction.

Cette thèse s'appuie sur la première de ces deux œuvres. En effet, des TQFTs étendant les invariants de Costantino-Geer-Patureau dans le cas de \mathfrak{sl}_2 quantique ont déjà été définies dans [BCGP16] par Blanchet, Costantino, Geer et Patureau, et une série de propriétés remarquables, qui marquent une nette différence avec la théorie de Witten-Reshetikhin-Turaev, ont été établies :

- (i) Les invariants quantiques de Costantino-Geer-Patureau sont strictement plus fins que les invariants de Witten-Reshetikhin-Turaev. En effet, ils retrouvent plusieurs invariants classiques comme la torsion de Reidemeister, qui apparaît dans une normalisation standard. Cela permet de récupérer la classification complète des espaces lenticulaires.
- (ii) Toutes les représentations quantiques des Mapping Class Groups induites par les TQFTs de Blanchet-Costantino-Geer-Patureau ont des comportements sans précédent, avec les twists de Dehn le long de courbes fermées simples non séparantes agissant toujours avec ordre infini. En particulier, on ne connaît rien dans les noyaux de ces représentations, car tous les difféomorphismes qui étaient là dans la théorie semi-simple n'y sont plus.
- (iii) L'inclusion dans la construction des représentations de Steinberg de \mathfrak{sl}_2 quantique, également connues sous le nom de couleurs de Kashaev, permet d'utiliser ces invariants quantiques et ces TQFTs pour étendre la conjecture de volume aux entrelacs dans des variantes arbitraires et pour la prouver pour une famille infinie d'exemples.

Qu'est-ce qu'une TQFT Étendue ?

Ce que cette thèse traite en réalité est la construction de *TQFTs Étendues*, qui seront souvent abrégé avec l'acronyme *ETQFT*. L'idée est que, tout comme les

invariants des variétés fermées, les TQFTs peuvent être difficiles à calculer en général. Une chose que nous pourrions tenter de faire alors est de les localiser également dans leurs parties de codimension 1. Cela signifie étendre leur définition de manière à permettre de réaliser les calculs d'espaces vectoriels associés aux sous-variétés de codimension 1 en coupant ces dernières le long de sous-variétés de codimension 2 et ensuite en recombinaut les données associées aux différents morceaux plus simples obtenues. Dans les mêmes termes abstraits utilisés précédemment, une ETQFT peut alors être définie comme un 2-foncteur monoïdal symétrique d'une 2-catégorie de cobordismes vers une 2-catégorie linéaire. Les cibles possibles cette fois sont nombreuses, et différents choix peuvent donner lieu à des théories légèrement différentes. Aux fins de cette thèse, nous pouvons penser qu'une ETQFT en dimension 3 associe une catégorie linéaire complète à chaque 1-variété fermée, un foncteur linéaire à chaque cobordisme de dimension 2 et une transformation naturelle à chaque cobordisme à coins de dimension 3.

Dans quel sens la notion ci-dessus fait-elle ce pour lequel nous l'avons introduite en premier lieu ? Exactement de la même manière que les TQFTs fournissent le service analogue pour les invariants quantiques. En effet, le calcul de l'invariant quantique d'une 3-variété fermée au moyen d'une TQFT se fait comme suit : on commence par interpréter la 3-variété fermée comme un cobordisme entre deux copies de la surface vide. Ensuite, la TQFT lui associe un endomorphisme linéaire d'un certain espace vectoriel qui, en conséquence de la monoïdalité, est isomorphe au corps de base, l'unité pour le produit tensoriel d'espaces vectoriels. Une telle application n'est qu'un produit avec un nombre fixe, ce que l'on peut interpréter comme l'invariant quantique de la 3-variété fermée. Cette idée se généralise directement au cas étendu. En effet, si nous voulons calculer l'espace vectoriel de TQFT d'une surface fermée au moyen d'une ETQFT, la procédure est la même : on commence par interpréter la surface fermée comme un cobordisme entre deux copies de la 1-variété vide. Ensuite, l'ETQFT lui associe un endofoncteur linéaire d'une certaine catégorie linéaire qui, en conséquence de la monoïdalité, équivaut à la catégorie des espaces vectoriels de dimension finie, l'unité pour le produit tensoriel de catégories linéaires complètes. Un tel foncteur équivaut à un produit tensoriel avec un espace vectoriel fixe, que l'on peut interpréter comme l'espace vectoriel de TQFT de la surface fermée. En particulier, cachée derrière la structure supérieure de 2-foncteur monoïdal symétrique, nous avons encore une recette qui associe un nombre complexe à chaque 3-variété fermée et un espace vectoriel à chaque surface fermée.

Résultats

On sait depuis un certain temps que les TQFTs de Witten-Reshetikhin-Turaev s'étendent en ETQFTs. En fait, toutes les ETQFTs semi-simples ont été classées par Bartlett, Douglas, Schommer-Pries et Vicary dans leur article daté de 2015 [BDSV15]. Encore une fois, il existe plusieurs façons de construire toutes ces ETQFTs. Dans le Chapitre 1, nous présentons une recette complètement générale et explicite pour faire cela, qui mélange deux des approches classiques : le formalisme algébrique de Turaev et la construction universelle de Blanchet, Habegger, Masbaum et Vogel. Aucun des résultats contenus dans cette première partie de la thèse n'est original, mais nous fournissons une construction détaillée tout de

même pour tracer une route que nous suivrons plus tard en essayant de développer une théorie analogue dans le cadre non semi-simple précédemment inexploré. Les deux structures algébriques clés introduites par Turaev qui permettent la mise en œuvre de la procédure sont les *catégories pré-modulaires non dégénérées* et les *catégories modulaires*. Une catégorie pré-modulaire non dégénérée est précisément ce qui est nécessaire, dans la version la plus générale de la théorie, afin d'obtenir un invariant quantique de Witten-Reshetikhin-Turaev. Une catégorie modulaire est juste une catégorie pré-modulaire satisfaisant une condition de non dégénérescence plus forte qui implique celle plus faible requise pour construire des invariants des 3-variétés fermées. Le résultat principal est alors que l'invariant quantique de Witten-Reshetikhin-Turaev associé à une catégorie modulaire s'étend en une ETQFT. Nous pouvons même donner une description combinatoire de cette ETQFT et une interprétation significative de ses différentes composantes en termes de structures algébriques sur la catégorie modulaire utilisée.

Dans le Chapitre 2, nous jouons le même jeu, mais à partir des invariants quantiques de Costantino-Geer-Patureau. Cette fois, nous mettons en œuvre la construction universelle de Blanchet, Habegger, Masbaum et Vogel dans le cadre du formalisme algébrique introduit par Costantino, Geer et Patureau. Les résultats de cette deuxième moitié de la thèse sont nouveaux et ils se combinent pour fournir une théorie très générale pour la production d'ETQFTs non semi-simples. Les structures algébriques clés sous-jacentes à la construction des invariants quantiques de Costantino-Geer-Patureau sont les *catégories pré-modulaires relatives non dégénérées*. Il faut penser à ces catégories comme à une sorte d'analogue non semi-simple aux briques fondamentales des invariants quantiques de Witten-Reshetikhin-Turaev. Notre première contribution est l'identification du nouveau concept de *catégorie modulaire relative*, une structure algébrique qui jouera le rôle des catégories modulaires dans ce cadre non semi-simple. Notre résultat principal peut alors être énoncé comme suit :

THÉORÈME. *L'invariant quantique de Costantino-Geer-Patureau associé à une catégorie modulaire relative s'étend en une ETQFT graduée.*

Afin de construire ces ETQFTs graduées, nous sommes obligés d'introduire des 2-catégories de cobordismes dont les décorations impliquent des classes de cohomologie. Nous soulignons que, cette fois, la théorie est beaucoup plus compliquée, car la procédure que nous avons mise en œuvre dans le cadre semi-simple ne produit pas directement une ETQFT. En effet, nous sommes confrontés à des obstacles à la monoïdalité, et la stratégie pour les franchir sera d'affiner la construction universelle en les intégrant dans sa structure. Ce phénomène est responsable de l'apparition des graduations dans cette version non semi-simple de la théorie. Enfin, une description combinatoire et une interprétation significative des différents composants peuvent être dérivées pour cette ETQFT graduée en parfaite analogie avec le cas précédent, bien que certaines des caractérisations explicites cette fois soient décidément plus compliquées.

Semisimple Extended Topological Quantum Field Theories

This chapter builds the general theory for the construction of 3-dimensional ETQFTs extending the Witten-Reshetikhin-Turaev quantum invariants defined in [T94]. As pointed out by Schommer-Pries in [S11], these ETQFTs have been well-known for some time, so the results we present here are by no means original. What we provide is a new explicit construction, whose main purpose is to set the golden standard for future non-semisimple generalizations. The approach we choose is based on the work of Turaev on modular categories, but it also exploits a 2-categorical version of the universal construction introduced by Blanchet, Habegger, Masbaum and Vogel. The 1+1+1 TQFTs thus obtained are realized by symmetric monoidal 2-functors defined over 2-categories of cobordisms decorated with colored ribbon graphs and taking values in 2-categories of complete linear categories.

1.1. Introduction

In his 1994 book [T94] Turaev developed the general theory for the construction of Witten-Reshetikhin-Turaev quantum invariants. His work is based on surgery presentations and it exploits some algebraic structures called *non-degenerate pre-modular categories*, which consist of semisimple ribbon linear categories featuring some finiteness properties. For every such category \mathcal{C} Turaev builds an invariant $\text{WRT}_{\mathcal{C}}$ of closed 3-manifolds M equipped with \mathcal{C} -colored ribbon graphs T^{φ} .

The original construction of [RT91] fits into this picture as follows: for every natural number $r \geq 2$ we can fix a primitive $2r$ -th root of unity q and we can consider the category $\bar{U}_q \mathfrak{sl}_2\text{-mod}$ of finite-dimensional integral-weight representations of the *restricted* version of quantum \mathfrak{sl}_2 . The category obtained from $\bar{U}_q \mathfrak{sl}_2\text{-mod}$ by quotienting negligible morphisms is then pre-modular and non-degenerate, and the induced Witten-Reshetikhin-Turaev invariant coincides with the corresponding invariant of [RT91].

1.1.1. Main results. The algebraic structures which allow for the construction of ETQFTs extending the Witten-Reshetikhin-Turaev quantum invariants are called *modular categories*. They consist of pre-modular categories satisfying a slightly stronger non-degeneracy condition with respect to the one which is needed in order to obtain invariants of closed 3-manifolds. The quotients of $\bar{U}_q \mathfrak{sl}_2\text{-mod}$ we mentioned earlier provide important examples of modular categories. We state here the main result of this chapter.

THEOREM 1.1.1. *If \mathcal{C} is a modular category then $\text{WRT}_{\mathcal{C}}$ extends to an ETQFT*

$$\hat{\mathbf{E}}_{\mathcal{C}} : \mathbf{Cob}_3^{\mathcal{C}} \rightarrow \hat{\mathbf{Cat}}_{\mathbb{C}}.$$

The 2-functor $\hat{\mathbf{E}}_{\mathcal{C}}$ can be described in terms of the modular category \mathcal{C} which is used as a building block: the generating object of $\mathbf{Cob}_3^{\mathcal{C}}$, the circle, is mapped to a linear category which is Morita equivalent to \mathcal{C} , and generating 1-morphisms of $\mathbf{Cob}_3^{\mathcal{C}}$, discs and pants, can be interpreted as algebraic structures on \mathcal{C} .

1.1.2. Outline of the construction. We will essentially follow the approach of Blanchet, Habegger, Masbaum and Vogel’s paper [BHMV95] in the context of the general formalism of Turaev’s book [T94]. The strategy will be to consider a non-degenerate pre-modular category \mathcal{C} and to plug the associated quantum invariant $\text{WRT}_{\mathcal{C}}$ into a machinery called the *extended universal construction*. This operation produces a 2-functor denoted

$$\hat{\mathbf{E}}_{\mathcal{C}} : \mathbf{Cob}_3^{\mathcal{C}} \rightarrow \hat{\mathbf{Cat}}_{\mathbb{C}}.$$

Here $\mathbf{Cob}_3^{\mathcal{C}}$ is a symmetric monoidal 2-category of \mathcal{C} -decorated cobordisms of dimension 1+1+1, $\hat{\mathbf{Cat}}_{\mathbb{C}}$ is the symmetric monoidal 2-category of complete linear categories and $\hat{\mathbf{E}}_{\mathcal{C}}$ is the completion of a 2-functor which is called the *covariant quantization 2-functor associated with* $\text{WRT}_{\mathcal{C}}$. If the category \mathcal{C} is modular then the monoidality of the 2-functor $\hat{\mathbf{E}}_{\mathcal{C}}$ can be shown thanks to a set of *surgery axioms* satisfied by $\text{WRT}_{\mathcal{C}}$. These properties allow for the reduction of the proof to a problem of skein calculus, which can be studied and solved in situations where the topology is simple. Once the result is established, the same techniques can be used to produce a more combinatorial description of the 2-functor $\hat{\mathbf{E}}_{\mathcal{C}}$ in terms of the modular category \mathcal{C} .

1.1.3. Structure of the exposition. The chapter is organized as follows: we begin by introducing the main ingredients of our construction, modular categories, in Section 1.2. We devote Section 1.3 to the detailed construction of the symmetric monoidal 2-categories of decorated cobordisms, which we will then use as the domains for our semisimple ETQFTs. In Section 1.4 we introduce a set of surgery axioms derived from [BHMV95] and in Section 1.5 we use them to dramatically simplify the study of vector spaces of morphisms by restricting to fixed connected cobordisms with corners. In Section 1.6 we recall the definition of the Witten-Reshetikhin-Turaev quantum invariants of closed 3-manifolds and we prove they satisfy the surgery axioms. Starting from Sections 1.7 and 1.8 we fix a modular category \mathcal{C} , we consider the associated Witten-Reshetikhin-Turaev quantum invariant and we study the associated quantization 2-functor. The main results are contained in Section 1.9, where we show that the 2-functor $\hat{\mathbf{E}}_{\mathcal{C}}$ is indeed symmetric monoidal. Section 1.10 contains a detailed discussion of the relationship between this ETQFT and the associated Witten-Reshetikhin-Turaev TQFT. Sections 1.11 and 1.12 are devoted to the explicit description, in terms of the relative modular category \mathcal{C} , of the linear categories and of the linear functors associated with generating objects and 1-morphisms of $\mathbf{Cob}_3^{\mathcal{C}}$ respectively.

1.2. Modular categories

This section is devoted to the definition of the algebraic structures which are going to play the leading role in the construction. We first set the ground by recalling classical concepts like ribbon categories and colored ribbon graphs.

1.2.1. Ribbon categories. Let us begin by recalling the basic notions for the whole construction. A *pivotal category* is given by:

- (i) a strict monoidal category \mathcal{C} ;
- (ii) a monoidal functor¹ $d : \mathcal{C}^{\text{op}} \rightarrow \mathcal{C}$ called the *duality functor*;
- (iii) a pair of dinatural transformations²

$$\text{ev} : \otimes \circ (d \times \text{id}_{\mathcal{C}}) \rightrightarrows \mathbb{1}, \quad \text{coev} : \mathbb{1} \circ \beta_{\mathcal{C}^{\text{op}}, \mathcal{C}} \rightrightarrows \otimes \circ (\text{id}_{\mathcal{C}} \times d),$$

called the *left evaluation* and the *left coevaluation* respectively, satisfying

$$\begin{aligned} (\text{id}_V \otimes \text{ev}_V) \circ (\text{coev}_V \otimes \text{id}_V) &= \text{id}_V, \\ (\text{ev}_V \otimes \text{id}_{V^*}) \circ (\text{id}_{V^*} \otimes \text{coev}_V) &= \text{id}_{V^*} \end{aligned}$$

for every object $V \in \text{Ob}(\mathcal{C})$;

- (iv) a monoidal natural isomorphism $\varphi : d \circ d \Rightarrow \text{id}_{\mathcal{C}}$.

REMARK 1.2.1. Our notation for pivotal categories, and more in general for all categories equipped with some specified structures, will be slightly abusive, as we will always drop all references to extra data and refer only to the underlying categories.

REMARK 1.2.2. If \mathcal{C} is a pivotal category then the image of an object $V \in \text{Ob}(\mathcal{C}^{\text{op}})$ under the duality functor d will be denoted by V^* and the image of a morphism $f \in \text{Hom}_{\mathcal{C}^{\text{op}}}(V, V')$ will be denoted by $f^* \in \text{Hom}_{\mathcal{C}}(V^*, V'^*)$.

If \mathcal{C} is a pivotal category we define the *right evaluation* and the *right coevaluation* to be the dinatural transformations

$$\tilde{\text{ev}} : \otimes \circ (\text{id}_{\mathcal{C}} \times d) \rightrightarrows \mathbb{1} \circ \beta_{\mathcal{C}, \mathcal{C}^{\text{op}}}, \quad \tilde{\text{coev}} : \mathbb{1} \rightrightarrows \otimes \circ (d \times \text{id}_{\mathcal{C}})$$

given by

$$\tilde{\text{ev}}_V := \text{ev}_{V^*} \circ (\varphi_V^{-1} \otimes \text{id}_{V^*}), \quad \tilde{\text{coev}}_V := (\text{id}_{V^*} \otimes \varphi_V) \circ \text{coev}_{V^*}.$$

If β is a braiding on a pivotal category \mathcal{C} then we define the *twist of \mathcal{C}* to be the natural isomorphism $\vartheta : \text{id}_{\mathcal{C}} \Rightarrow \text{id}_{\mathcal{C}}$ associating with every object $V \in \text{Ob}(\mathcal{C})$ the morphism

$$\vartheta_V := (\text{id}_V \otimes \tilde{\text{ev}}_V) \circ (\beta_{V, V} \otimes \text{id}_{V^*}) \circ (\text{id}_V \otimes \text{coev}_V).$$

REMARK 1.2.3. The twist satisfies

$$\vartheta_{V \otimes V'} = \beta_{V', V} \circ \beta_{V, V'} \circ (\vartheta_V \otimes \vartheta_{V'}).$$

If \mathcal{C} is a pivotal category then a braiding β on \mathcal{C} is *compatible with the pivotal structure* if the twist ϑ satisfies

$$(\vartheta_V)^* = \vartheta_{V^*}.$$

A *ribbon category* is then a pivotal category together with a compatible braiding.

¹If \mathcal{C} is a monoidal category then the standard monoidal structure on \mathcal{C}^{op} is determined by the opposite tensor product $\otimes \circ \beta_{\mathcal{C}^{\text{op}}, \mathcal{C}^{\text{op}}} : \mathcal{C}^{\text{op}} \times \mathcal{C}^{\text{op}} \rightarrow \mathcal{C}^{\text{op}}$ where $\beta_{\mathcal{C}, \mathcal{C}'} : \mathcal{C} \times \mathcal{C}' \rightarrow \mathcal{C}' \times \mathcal{C}$ denotes the standard braiding functor of categories \mathcal{C} and \mathcal{C}' .

²If \mathcal{C} is a monoidal category then the constant functor $\mathbb{1} : \mathcal{C}^{\text{op}} \times \mathcal{C} \rightarrow \mathcal{C}$ maps every object to $\mathbb{1}$ and every morphism to $\text{id}_{\mathbb{1}}$.

1.2.2. Colored ribbon graphs. In this subsection we recall the definition of the category of \mathcal{C} -colored ribbon graphs and of the associated Reshetikhin-Turaev functor. In order to do so we fix a ribbon category \mathcal{C} . If Σ is a 2-dimensional cobordism and if $P \subset \Sigma$ is a ribbon set³ then a \mathcal{C} -coloring of P , denoted $V : P \rightarrow \text{Ob}(\mathcal{C})$, is given by an object $V(p)$ of \mathcal{C} called the *color of p* for each vertex $p \in P$. A \mathcal{C} -colored ribbon set $P^V \subset \Sigma$ is given by a ribbon set $P \subset \Sigma$ together with a \mathcal{C} -coloring $V : P \rightarrow \text{Ob}(\mathcal{C})$.

REMARK 1.2.4. If Σ and Σ' are 2-dimensional cobordisms and if $P^V \subset \Sigma$ is a \mathcal{C} -colored ribbon set then every time we have a positive embedding of surfaces $f_\Sigma : \Sigma \hookrightarrow \Sigma'$ we obtain a \mathcal{C} -colored ribbon set $f_\Sigma(P^V) \subset \Sigma'$ given by $f_\Sigma(P)$ with color $V(p)$ on $f_\Sigma(p)$ for every vertex $p \in P$.

If M is a 3-dimensional cobordism with corners from Σ to Σ' , if $P^V \subset \Sigma$ and $P^{V'} \subset \Sigma'$ are \mathcal{C} -colored ribbon sets and if $T \subset M$ is a ribbon graph from P to P' then a \mathcal{C} -coloring of T extending V and V' , denoted $\varphi : T \rightarrow \mathcal{C}$, is given by:

- (i) an object $\varphi(e)$ of \mathcal{C} called the *color of e* for each edge $e \subset T$;
- (ii) a morphism $\varphi(C)$ of \mathcal{C} called the *color of C* for each coupon $C \subset T$.

These data satisfy:

- (i) The color $\varphi(e)$ of an edge $e \subset T$ intersecting $\partial_-^h M$ along a vertex $f_{M_-^h}(p)$ equals $V(p)$;
- (ii) The color $\varphi(e)$ of an edge $e \subset T$ intersecting $\partial_+^h M$ along a vertex $f_{M_+^h}(p')$ equals $V(p')$;
- (iii) The color $\varphi(C)$ of a coupon $C \subset T$ of type (k, k') belongs to

$$\text{Hom}_{\mathcal{C}}(\varphi(e_1)^{\varepsilon_1} \otimes \dots \otimes \varphi(e_k)^{\varepsilon_k}, \varphi(e'_1)^{\varepsilon'_1} \otimes \dots \otimes \varphi(e'_{k'})^{\varepsilon'_{k'}})$$

where e_i is the edge of T intersecting $\partial_-^h C$ along its i -th input point, where e'_i is the edge of T intersecting $\partial_+^h C$ along its i' -th output point, where ε_i is the sign given by the orientation of the i -th input point of C , where ε'_i is the sign given by the orientation of the i' -th output point of C and where $V^+ := V$ and $V^- := V^*$ for all $V \in \text{Ob}(\mathcal{C})$.

A \mathcal{C} -colored ribbon graph $T^\varphi \subset M$ from P^V to $P^{V'}$ is given by a ribbon graph $T \subset M$ from P to P' together with a \mathcal{C} -coloring $\varphi : T \rightarrow \mathcal{C}$ extending V and V' .

REMARK 1.2.5. For \mathcal{C} -colorings of ribbon tangles we will sometimes use the same notation V we use for \mathcal{C} -colorings of ribbon sets instead of φ , in order to stress the absence of coupons.

REMARK 1.2.6. If M is a 3-dimensional cobordism with corners from Σ to Σ'' , if M' is a 3-dimensional cobordism with corners from Σ' to Σ''' and if $T^\varphi \subset M$ is a \mathcal{C} -colored ribbon graph from $P^V \subset \Sigma$ to $P^{V'} \subset \Sigma'$ then every time we have positive embeddings of surfaces $f_\Sigma : \Sigma \hookrightarrow \Sigma'$ and $f_{\Sigma''} : \Sigma'' \hookrightarrow \Sigma'''$ and a positive embedding of manifolds with faces $f_M : M \hookrightarrow M'$ satisfying

$$f_{M_-^h} \circ f_\Sigma = f_M \circ f_{M_-^h}, \quad f_{M_+^h} \circ f_{\Sigma''} = f_M \circ f_{M_+^h}$$

we obtain a \mathcal{C} -colored ribbon graph $f_M(T^\varphi) \subset M'$ from $f_\Sigma(P^V)$ to $f_{\Sigma'}(P^{V'})$ given by $f_M(T)$ with color $\varphi(e)$ on $f_M(e)$ for every edge $e \subset T$ and with color $\varphi(C)$ on $f_M(C)$ for every coupon $C \subset T$.

³A reference for the notation and terminology used here for ribbon sets and ribbon graphs can be found in Appendix B.5.

REMARK 1.2.7. Every \mathcal{C} -coloring $V : P \rightarrow \text{Ob}(\mathcal{C})$ of a ribbon set $P \subset \Sigma$ determines a \mathcal{C} -colored ribbon tangle $(P \times I)^V \subset \Sigma \times I$.

We can now begin to define the *ribbon category* $\text{Rib}_{\mathcal{C}}$ of \mathcal{C} -colored ribbon graphs: an *object* $(\vec{\varepsilon}, \vec{V})$ of $\text{Rib}_{\mathcal{C}}^G$ is a finite sequence

$$((\varepsilon_1, V_1), \dots, (\varepsilon_k, V_k))$$

where ε_i is an element of $\{+, -\}$ and V_i is an object of \mathcal{C} for all $i = 1, \dots, k$. If $(\vec{\varepsilon}, \vec{V}) = ((\varepsilon_1, V_1), \dots, (\varepsilon_k, V_k))$ is an object of $\text{Rib}_{\mathcal{C}}$ then we denote with V^ε the object of \mathcal{C} given by

$$V_1^{\varepsilon_1} \otimes \dots \otimes V_k^{\varepsilon_k}.$$

REMARK 1.2.8. Let D^2 denote the 2-dimensional cobordism from \emptyset to S^1 given by⁴

$$\left(D^2, \emptyset, \text{id}_{S^1}, \emptyset, F_{D^2_+} \right)$$

where the collar $F_{D^2_+}$ is defined as

$$\begin{aligned} F_{D^2_+} : \mathbb{R}_- \times S^1 &\hookrightarrow D^2 \\ (t_-, (x, y)) &\mapsto F_{I_+}(t_-) \cdot (x, y) \end{aligned}$$

for the embedding $F_{I_+} : \mathbb{R}_- \hookrightarrow I$ specified in Remark B.4.2. Then with every object $(\vec{\varepsilon}, \vec{V}) = ((\varepsilon_1, V_1), \dots, (\varepsilon_k, V_k))$ of $\text{Rib}_{\mathcal{C}}$ we can associate the standard \mathcal{C} -colored ribbon set $P(\vec{\varepsilon})^{\vec{V}}$ inside D^2 whose oriented vertex set is given by

$$P(\vec{\varepsilon}) := \left\{ \left(\frac{2i - k - 1}{k}, 0 \right) \in D^2 \mid i = 1, \dots, k \right\}$$

with orientation specified by the sequence of signs $\varepsilon_1, \dots, \varepsilon_k$, with framing tangent to $\{(x, y) \in D^2 \mid y = 0\}$ and given by the positive unit vector at positive vertices and by the negative unit vector at negative vertices and with \mathcal{C} -coloring $\vec{V} : P(\vec{\varepsilon}) \rightarrow \text{Ob}(\mathcal{C})$ given by $\vec{V} \left(\frac{2i - k - 1}{k}, 0 \right) = V_i$ for all $i = 1, \dots, k$.

A *morphism* $T^\varphi : (\vec{\varepsilon}, \vec{V}) \rightarrow (\vec{\varepsilon}', \vec{V}')$ of $\text{Rib}_{\mathcal{C}}$ is an equivalence class of \mathcal{C} -colored ribbon graphs inside $D^2 \times I$ from $P(\vec{\varepsilon})^{\vec{V}}$ to $P(\vec{\varepsilon}')^{\vec{V}'}$. Two \mathcal{C} -colored ribbon graphs from $P(\vec{\varepsilon})^{\vec{V}}$ to $P(\vec{\varepsilon}')^{\vec{V}'}$ are equivalent if their oriented graphs are isotopic relative to $P(\vec{\varepsilon}) \times \{0\}$ and $P(\vec{\varepsilon}') \times \{1\}$ through an isotopy which preserves framings via pullback and colorings.

REMARK 1.2.9. The notation for morphisms of $\text{Rib}_{\mathcal{C}}$ will be a little abusive since we will not distinguish between an isotopy class of \mathcal{C} -colored ribbon graphs and any of its representatives.

REMARK 1.2.10. Morphisms of $\text{Rib}_{\mathcal{C}}$ will simply be represented by oriented diagrams in $\{(x, y, t) \in D^2 \times I \mid y = 0\}$. In particular we will always implicitly assume the framing to be the blackboard one, and coupons will always be depicted with their horizontal faces oriented from left to right and with their vertical faces oriented from bottom to top. When depicting ribbon graphs inside general cobordism with corners we will be more careful, always specifying framing of ribbon sets and of edges and orientations of coupons.

⁴See Definition B.4.1.

REMARK 1.2.11. We can always suppose that every morphism T^φ from $(\vec{\varepsilon}, \vec{V})$ to $(\vec{\varepsilon}', \vec{V}')$ is represented, up to isotopy, by a vertical graph in some neighborhood of $\partial_{\pm}^h(D^2 \times I)$. More precisely we can suppose that

$$\begin{aligned} T \cap N(\partial_-^h(D^2 \times I)) &= (P(\vec{\varepsilon}) \times I) \cap N(\partial_-^h(D^2 \times I)), \\ T \cap N(\partial_+^h(D^2 \times I)) &= (P(\vec{\varepsilon}') \times I) \cap N(\partial_+^h(D^2 \times I)) \end{aligned}$$

for some neighborhood $N(\partial_{\pm}^h(D^2 \times I))$ of $\partial_{\pm} \text{id}_{D^2}$.

Let us now describe the structure of the ribbon category $\text{Rib}_{\mathcal{C}}$: if we consider morphisms $T^\varphi : (\vec{\varepsilon}, \vec{V}) \rightarrow (\vec{\varepsilon}', \vec{V}')$ and $T'^{\varphi'} : (\vec{\varepsilon}', \vec{V}') \rightarrow (\vec{\varepsilon}'', \vec{V}'')$ in $\text{Rib}_{\mathcal{C}}$ then the vertical composition of id_{D^2} with itself determines a \mathcal{C} -colored ribbon graph inside $\text{id}_{D^2} * \text{id}_{D^2}$ which we denote $T^\varphi \cup_{P(\vec{\varepsilon}')V'} T'^{\varphi'}$. The *composition* $T'^{\varphi'} \circ T^\varphi : (\vec{\varepsilon}, \vec{V}) \rightarrow (\vec{\varepsilon}'', \vec{V}'')$ of $T'^{\varphi'}$ and T^φ is then defined as $f(T^\varphi \cup_{P(\vec{\varepsilon}')V'} T'^{\varphi'})$ for the isomorphism

$$\begin{aligned} f : (D^2 \times I) \cup_{D^2} (D^2 \times I) &\rightarrow D^2 \times I \\ [(x, y), t, i] &\mapsto \begin{cases} ((x, y), \frac{t}{2}) & i = 0 \\ ((x, y), \frac{t+1}{2}) & i = 1 \end{cases} \end{aligned}$$

The *tensor product* $(\vec{\varepsilon}, \vec{V}) \otimes (\vec{\varepsilon}', \vec{V}')$ of objects $(\vec{\varepsilon}, \vec{V})$ and $(\vec{\varepsilon}', \vec{V}')$ of $\text{Rib}_{\mathcal{C}}$ is given by

$$((\varepsilon_1, V_1), \dots, (\varepsilon_k, V_k), (\varepsilon'_1, V'_1), \dots, (\varepsilon'_{k'}, V'_{k'})).$$

The *tensor product* $T^\varphi \otimes T'^{\varphi'}$ of morphisms T^φ and $T'^{\varphi'}$ of $\text{Rib}_{\mathcal{C}}$ is given by

$$f_{k,k'}(T^\varphi) \cup f'_{k,k'}(T'^{\varphi'})$$

for the embeddings

$$\begin{aligned} f_{k,k'} : D^2 \times I &\hookrightarrow D^2 \times I \\ ((x, y), t) &\mapsto \left(\frac{k}{k+k'} \cdot (x, y) - \left(\frac{k'}{k+k'}, 0 \right) \right) \\ f'_{k,k'} : D^2 \times I &\hookrightarrow D^2 \times I \\ ((x, y), t) &\mapsto \left(\frac{k'}{k+k'} \cdot (x, y) + \left(\frac{k}{k+k'}, 0 \right) \right). \end{aligned}$$

The *dual* $(\vec{\varepsilon}, \vec{V})^*$ of an object $(\vec{\varepsilon}, \vec{V}) = ((\varepsilon_1, V_1), \dots, (\varepsilon_k, V_k))$ of $\text{Rib}_{\mathcal{C}}$ is given by

$$(-\vec{\varepsilon}, \vec{V}) = ((-\varepsilon_k, V_k), \dots, (-\varepsilon_1, V_1))$$

where $-+ := -$ and $-- := +$. The *braiding*, the *twist*, the *left evaluation* and *left coevaluation* of $\text{Rib}_{\mathcal{C}}$ are depicted in Figure 1.

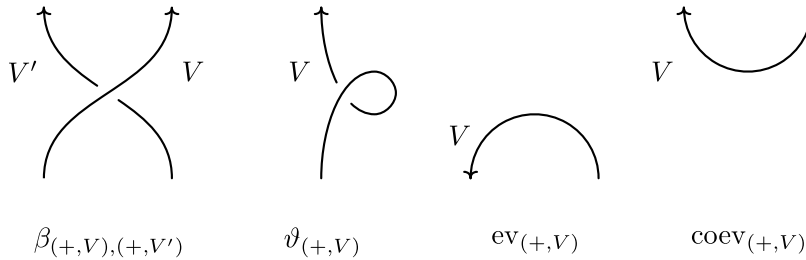

FIGURE 1. Braiding, twist, left evaluation and left coevaluation in $\text{Rib}_{\mathcal{C}}$.

REMARK 1.2.12. From now on the term \mathcal{C} -colored ribbon graph, if used without any reference to the ambient cobordism with corners, will denote morphisms of $\text{Rib}_{\mathcal{C}}$.

An elementary morphism $T^f : (\vec{\varepsilon}, \vec{V}) \rightarrow (\vec{\varepsilon}', \vec{V}')$ of $\text{Rib}_{\mathcal{C}}$ is a morphism of $\text{Rib}_{\mathcal{C}}$ which features a single coupon of color $f \in \text{Hom}_{\mathcal{C}}(V^{\varepsilon}, V'^{\varepsilon'})$ and whose oriented graph is contained in $\{(x, y, t) \in D^2 \times I \mid y = 0\}$.

THEOREM 1.2.1. *If \mathcal{C} is a ribbon category then there exists a unique braided monoidal functor $F_{\mathcal{C}} : \text{Rib}_{\mathcal{C}} \rightarrow \mathcal{C}$ mapping the object $(+, V)$ to V , the object $(-, V)$ to V^* , an elementary morphism to the color of its coupon and the braiding, the twist and the left evaluation and the left coevaluation of $\text{Rib}_{\mathcal{C}}$ to those of \mathcal{C} .*

The functor $F_{\mathcal{C}}$ is the *Reshetikhin-Turaev functor associated with \mathcal{C}* .

1.2.3. Main definitions. We are ready to recall the concepts of pre-modular and modular categories, which are semisimple ribbon categories featuring some finiteness and some non-degeneracy properties. All pivotal and ribbon categories we are going to consider from now on are going to be linear⁵.

REMARK 1.2.13. It is to be understood that a monoidal linear category is a linear category equipped with a monoidal structure whose unit is given by a simple object $\mathbb{1} \in \text{Ob}(\mathcal{C})$ and whose tensor product is given by a bilinear functor $\otimes : \mathcal{C} \times \mathcal{C} \rightarrow \mathcal{C}$. In particular, when considering some monoidal linear category \mathcal{C} we will always confuse $\text{End}_{\mathcal{C}}(\mathbb{1})$ with \mathbb{C} by identifying $\text{id}_{\mathbb{1}}$ with 1. A pivotal linear category will be a strict monoidal linear category equipped with a pivotal structure whose duality functor is linear. A ribbon linear category will simply be a pivotal linear category which is ribbon.

Let us start by fixing the terminology for semisimple categories. We say a dominating set⁶ D for a linear category \mathcal{C} is *reduced* if

$$\dim_{\mathbb{C}} \text{Hom}_{\mathcal{C}}(V, V') = \delta_{V, V'}$$

for all $V, V' \in D$. A *semisimple category* is then a linear category \mathcal{C} which admits a reduced dominating set.

LEMMA 1.2.1. *Let \mathcal{C} be a semisimple category, let V, V' be objects of \mathcal{C} and let D be an ordered reduced dominating set. Then:*

- (i) $\text{Hom}_{\mathcal{C}}(V, V')$ is finite-dimensional.
- (ii) $\text{Hom}_{\mathcal{C}}(V, W) = 0$ and $\text{Hom}_{\mathcal{C}}(W, V') = 0$ for all but a finite number of $W \in D$.
- (iii) The linear map

$$(c_{V, W, V'})_{W \in D} : \bigoplus_{W \in D} \text{Hom}_{\mathcal{C}}(W, V') \otimes \text{Hom}_{\mathcal{C}}(V, W) \rightarrow \text{Hom}_{\mathcal{C}}(V, V')$$

$$\bigoplus_{W \in D} g_W \otimes f_W \mapsto \sum_{W \in D} g_W \circ f_W$$

is an isomorphism.

This is proved in [T94].

⁵In this thesis the term *linear* will always stand for *linear over \mathbb{C}* .

⁶See Definition A.5.18.

LEMMA 1.2.2. *Let \mathcal{C} be a semisimple ribbon category. Then the pairing*

$$\begin{aligned} \mathrm{tr}_{\mathcal{C}} \circ c_{V',V} : \mathrm{Hom}_{\mathcal{C}}(V', V) \otimes \mathrm{Hom}_{\mathcal{C}}(V, V') &\rightarrow \mathbb{C} \\ g \otimes f &\mapsto \mathrm{tr}_{\mathcal{C}}(g \circ f) \end{aligned}$$

is non-degenerate for all $V, V' \in \mathrm{Ob}(\mathcal{C})$.

This result too is proved in [T94].

DEFINITION 1.2.1. A *pre-modular category* is a semisimple ribbon category \mathcal{C} together with a reduced dominating set $\Gamma(\mathcal{C}) = \{V_i \in \mathrm{Ob}(\mathcal{C}) \mid i \in \mathbf{I}\}$ for some ordered finite index set \mathbf{I} .

REMARK 1.2.14. If \mathcal{C} is a pre-modular category then we will always suppose there exists an index $0 \in \mathbf{I}$ such that $V_0 = \mathbb{1} \in \Gamma(\mathcal{C})$.

If \mathcal{C} is a pre-modular category then its *Kirby color* is the formal linear combination of objects

$$\Omega := \sum_{i \in \mathbf{I}} \dim_{\mathcal{C}}(V_i) \cdot V_i.$$

If T^φ is a \mathcal{C} -colored ribbon graph and if $K \subset \mathrm{id}_{\mathbb{D}^2}$ is a framed knot disjoint from T then we denote with $K^\Omega \cup T^\varphi$ the formal linear combination of \mathcal{C} -colored ribbon graphs

$$\sum_{i \in \mathbf{I}} \dim_{\mathcal{C}}(V_i) \cdot (K^{V_i} \cup T^\varphi)$$

where $V_i(K) = V_i$. Although $K^\Omega \cup T^\varphi$ is not actually a morphism of $\mathrm{Rib}_{\mathcal{C}}$, we can still define its image $F_{\mathcal{C}}(K^\Omega \cup T^\varphi)$ under the Reshetikhin-Turaev functor as

$$\sum_{i \in \mathbf{I}} \dim_{\mathcal{C}}(V_i) \cdot F_{\mathcal{C}}(K^{V_i} \cup T^\varphi).$$

REMARK 1.2.15. In fact the name Kirby color comes from the following property: the Reshetikhin-Turaev functor is invariant under the second Kirby move, the handle slide, over knot components colored with Ω . A proof of this fact is contained in [B03].

For a pre-modular category \mathcal{C} we denote with Δ_+ and Δ_- the evaluations of the Reshetikhin-Turaev functor $F_{\mathcal{C}}$ against the \mathcal{C} -colored framed unknots depicted in the left hand part and in the right hand part of Figure 2 respectively.

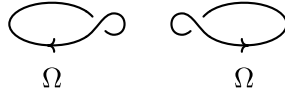

FIGURE 2. The \mathcal{C} -colored framed unknots representing Δ_+ and Δ_- .

DEFINITION 1.2.2. A *modular category* \mathcal{C} is a pre-modular category which admits a *modularity parameter* $\zeta \in \mathbb{C}^*$ such that

$$\dim_{\mathcal{C}}(V_i) \cdot f_{i,j} = \begin{cases} \zeta \cdot (\mathrm{co\tilde{e}v}_{V_i} \circ \mathrm{e}v_{V_i}) & \text{if } i = j \\ 0 & \text{if } i \neq j \end{cases}$$

for all $i, j \in \mathbf{I}$, where $f_{i,j}$ is the image under the Reshetikhin-Turaev functor $F_{\mathcal{C}}$ of the \mathcal{C} -colored ribbon tangle depicted in Figure 3.

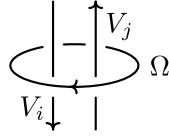

FIGURE 3. Modularity condition.

PROPOSITION 1.2.1. *If \mathcal{C} is a modular category then the modularity parameter ζ equals $\Delta_- \Delta_+$.*

PROOF. The proof of this fact follows from Remark 1.2.15 together with the modularity condition for \mathcal{C} applied to the evaluation of the Reshetikhin-Turaev functor $F_{\mathcal{C}}$ against the \mathcal{C} -colored ribbon tangle depicted in Figure 4. □

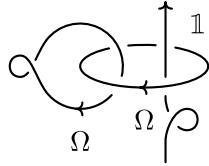

FIGURE 4. The \mathcal{C} -colored ribbon tangle witnessing $\zeta = \Delta_- \Delta_+$.

Our definition of modular categories is not the standard one of [T94], but it is in fact equivalent to it. The remainder of the section is devoted to the explanation of this equivalence. If \mathcal{C} is a pre-modular category then the *positive Hopf link matrix* of \mathcal{C} is the $I \times I$ matrix whose (i, j) -th entry S_{ij}^+ is defined as the evaluation of the Reshetikhin-Turaev functor $F_{\mathcal{C}}$ against the \mathcal{C} -colored framed link depicted in the left-hand part of Figure 5 for all $i, j \in I$.

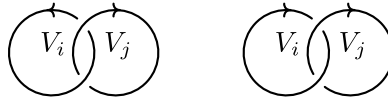

FIGURE 5. The \mathcal{C} -colored framed links representing the (i, j) -th entry of the positive and of the negative Hopf link matrix of \mathcal{C} respectively.

PROPOSITION 1.2.2. *A pre-modular category \mathcal{C} is modular if and only if its positive Hopf link matrix is invertible.*

PROOF. If the positive Hopf link matrix of \mathcal{C} is invertible than it is known that the modularity condition of Definition 1.2.2 holds⁷. Then let us suppose \mathcal{C} is modular and let us consider the negative Hopf link matrix of \mathcal{C} whose (i, j) -th entry S_{ij}^- is defined as the evaluation of the Reshetikhin-Turaev functor $F_{\mathcal{C}}$ against

⁷See Exercise 3.10.2 of [T94].

the \mathcal{C} -colored framed link depicted in the right-hand part of Figure 5 for all $i, j \in \mathbf{I}$. Now we have

$$S_{ij}^- = \text{tr}_{\mathcal{C}}(f_{ij}^-), \quad S_{jk}^+ = \text{tr}_{\mathcal{C}}(f_{jk}^+)$$

for the \mathcal{C} -colored ribbon tangles depicted in Figure 6 for all $i, j, k \in \mathbf{I}$.

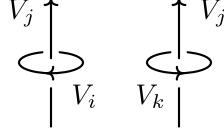

FIGURE 6. The \mathcal{C} -colored ribbon tangles representing f_{ij}^- and f_{jk}^+ .

Therefore we have

$$\sum_{j \in \mathbf{I}} S_{ij}^- S_{jk}^+ = \sum_{j \in \mathbf{I}} \text{tr}_{\mathcal{C}}(f_{ij}^-) \text{tr}_{\mathcal{C}}(f_{jk}^+) = \sum_{j \in \mathbf{I}} \dim_{\mathcal{C}}(V_j) \text{tr}_{\mathcal{C}}(f_{ij}^- \circ f_{jk}^+) = M_{ik}$$

where M_{ik} is given by the evaluation of the Reshetikhin-Turaev functor $F_{\mathcal{C}}$ against the \mathcal{C} -colored framed link depicted in Figure 7 for all $i, k \in \mathbf{I}$. As a consequence we get

$$M_{ik} = \zeta \delta_{ik} = \Delta_- \Delta_+ \delta_{ik}$$

and we can conclude.

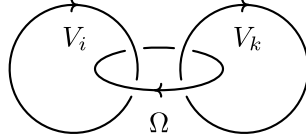

FIGURE 7. The \mathcal{C} -colored framed link representing M_{ik} .

□

1.3. Decorated cobordisms

This section is devoted to the definition of the domain 2-category for our extended TQFTs, the symmetric monoidal 2-category $\mathbf{Cob}_3^{\mathcal{C}}$ of decorated cobordisms of dimension $1+1+1$.

1.3.1. 2-Category of decorated cobordisms. In this subsection we fix a ribbon category \mathcal{C} and we define the symmetric monoidal 2-category $\mathbf{Cob}_3^{\mathcal{C}}$ of decorated cobordisms of dimension $1+1+1$ which will serve as the domain for our ETQFTs. The notation we use for cobordisms is introduced in Appendix B.4. Let us remark that the various decorations we will equip cobordisms with will play different roles. While \mathcal{C} -colored ribbon sets and graphs will be needed in the following in order to explicitly describe the ETQFTs we are building, the purpose of Lagrangian subspaces and signature defects is to fix the framing anomaly in the Witten-Reshetikhin-Turaev TQFTs. Appendix B.6 collects all the results we shall need about Lagrangian subspaces and Maslov indices.

DEFINITION 1.3.1. An *object* Γ of $\mathbf{Cob}_3^{\mathcal{C}}$ is given by a smooth oriented closed 1-dimensional manifold Γ .

DEFINITION 1.3.2. A *1-morphism* $\Sigma : \Gamma \rightarrow \Gamma'$ of $\mathbf{Cob}_3^{\mathcal{C}}$ is given by a triple $(\Sigma, P^V, \mathcal{L})$ where:

- (i) Σ is a 2-dimensional cobordism from Γ to Γ' ;
- (ii) $P^V \subset \Sigma$ is a \mathcal{C} -colored ribbon set;
- (iii) $\mathcal{L} \subset H_1(\Sigma; \mathbb{R})$ is a Lagrangian subspace with respect to the intersection pairing \cap_{Σ} .

DEFINITION 1.3.3. The *identity 1-morphism* $\text{id}_{\Gamma} : \Gamma \rightarrow \Gamma$ associated with an object Γ of $\mathbf{Cob}_3^{\mathcal{C}}$ is the triple

$$(\mathbf{I} \times \Gamma, \emptyset^{\emptyset}, H_1(\mathbf{I} \times \Gamma; \mathbb{R})).$$

DEFINITION 1.3.4. A *2-morphism* $\mathbb{M} : \Sigma \Rightarrow \Sigma'$ of $\mathbf{Cob}_3^{\mathcal{C}}$ between 1-morphisms $\Sigma, \Sigma' : \Gamma \rightarrow \Gamma'$ is given by an equivalence class of triples (M, T^{φ}, n) where:

- (i) M is a 3-dimensional cobordism with corners from Σ to Σ' ;
- (ii) $T^{\varphi} \subset M$ is a \mathcal{C} -colored ribbon graph from P^V to P'^V ;
- (iii) $n \in \mathbb{Z}$ is called the *signature defect*.

Two triples (M, T^{φ}, n) and $(M', T'^{\varphi'}, n')$ are equivalent if $n = n'$ and if there exists an isomorphism of cobordisms with corners $f : M \rightarrow M'$ satisfying $f(T^{\varphi}) = T'^{\varphi'}$.

DEFINITION 1.3.5. The *identity 2-morphism* $\text{id}_{\Sigma} : \Sigma \Rightarrow \Sigma$ associated with a 1-morphism $\Sigma = (\Sigma, P^V, \mathcal{L})$ of $\mathbf{Cob}_3^{\mathcal{C}}$ is the equivalence class of the triple

$$(\Sigma \times \mathbf{I}, P^V \times \mathbf{I}, 0).$$

REMARK 1.3.1. We will adopt the following abusive notation: whenever we will glue two topological spaces X and X' along a common subspace Y we will suppress all references to the natural embeddings of X and of X' into $X \cup_Y X'$. In particular we will consider both X and X' as submanifolds of $X \cup_Y X'$, the \mathcal{C} -colored ribbon sets and graphs inside X and inside X' as \mathcal{C} -colored ribbon sets and graphs inside $X \cup_Y X'$ and the homologies of X and of X' as subspaces of the homology of $X \cup_Y X'$.

DEFINITION 1.3.6. The *horizontal composition* $\Sigma' \circ \Sigma : \Gamma \rightarrow \Gamma''$ of 1-morphisms $\Sigma' : \Gamma' \rightarrow \Gamma''$ and $\Sigma : \Gamma \rightarrow \Gamma'$ of $\mathbf{Cob}_3^{\mathcal{C}}$ is given by the triple

$$(\Sigma \cup_{\Gamma'} \Sigma', P^V \cup P'^V, \mathcal{L} + \mathcal{L}').$$

DEFINITION 1.3.7. The *horizontal composition* $\mathbb{M}' \circ \mathbb{M} : \Sigma' \circ \Sigma \Rightarrow \Sigma''' \circ \Sigma''$ of 2-morphisms $\mathbb{M}' : \Sigma' \Rightarrow \Sigma'''$ and $\mathbb{M} : \Sigma \Rightarrow \Sigma''$ of $\mathbf{Cob}_3^{\mathcal{C}}$ for 1-morphisms $\Sigma, \Sigma'' : \Gamma \rightarrow \Gamma'$ and $\Sigma', \Sigma''' : \Gamma' \rightarrow \Gamma''$ is given by the equivalence class of the triple

$$(M \cup_{\Gamma' \times \mathbf{I}} M', T^{\varphi} \cup T'^{\varphi'}, n + n').$$

REMARK 1.3.2. If $\Sigma, \Sigma', \Sigma'' : \Gamma \rightarrow \Gamma'$ are 1-morphisms and if $\mathbb{M} : \Sigma \Rightarrow \Sigma'$ and $\mathbb{M}' : \Sigma' \Rightarrow \Sigma''$ are 2-morphisms of $\mathbf{Cob}_3^{\mathcal{C}}$ then the gluing $M \cup_{\Sigma'} M'$ determines, up to isotopy, a \mathcal{C} -colored ribbon graph which we denote $T^{\varphi} \cup_{P^V, P'^V} T'^{\varphi'}$. Indeed if

$$F_{M_+^h} : \Sigma' \times \mathbb{R}_- \hookrightarrow M, \quad F_{M_-^h} : \Sigma' \times \mathbb{R}_+ \hookrightarrow M'$$

is the pair of collars we choose in order to glue M to M' we can suppose, up to isotopy, that

$$\begin{aligned} T \cap N(\partial_+^h M) &= F_{M_+^h}(P' \times \mathbb{R}_-) \cap N(\partial_+^h M), \\ T' \cap N(\partial_-^h M') &= F_{M_-^h}(P' \times \mathbb{R}_+) \cap N(\partial_-^h M') \end{aligned}$$

for some neighborhoods $N(\partial_+^h M)$ and $N(\partial_-^h M')$ of $\partial_+^h M$ and $\partial_-^h M'$ inside M and M' respectively. The oriented graph of $T^\varphi \cup_{P, V'} T'^{\varphi'}$ will be denoted $T \cup_{P'} T'$

DEFINITION 1.3.8. The *vertical composition* $M' * M : \Sigma \Rightarrow \Sigma''$ of 2-morphisms $M' : \Sigma' \Rightarrow \Sigma''$ and $M : \Sigma \Rightarrow \Sigma'$ of $\mathbf{Cob}_3^{\mathcal{C}}$ for 1-morphisms $\Sigma, \Sigma', \Sigma'' : \Gamma \rightarrow \Gamma'$ is given by the equivalence class of the triple

$$\left(M \cup_{\Sigma'} M', T^\varphi \cup_{P, V'} T'^{\varphi'}, n + n' - \mu(M_* \mathcal{L}, \mathcal{L}', M'^* \mathcal{L}'') \right)$$

for the Lagrangian subspaces

$$\begin{aligned} M_* \mathcal{L} &:= \{x' \in H_1(\Sigma'; \mathbb{R}) \mid i_{M_+^h} x' \in i_{M_+^h}(\mathcal{L})\} \subset H_1(\Sigma'; \mathbb{R}) \\ M'^* \mathcal{L}'' &:= \{x' \in H_1(\Sigma'; \mathbb{R}) \mid i_{M_+^h} x' \in i_{M_+^h}(\mathcal{L}'')\} \subset H_1(\Sigma'; \mathbb{R}). \end{aligned}$$

where:

- (i) $i_{M_+^h} : \Sigma \hookrightarrow M$ denotes the embedding obtained by composing $f_{M_+^h}$ with the inclusion $\partial_+^h M \hookrightarrow M$;
- (ii) $i_{M_+^h} : \Sigma' \hookrightarrow M$ denotes the embedding obtained by composing $f_{M_+^h}$ with the inclusion $\partial_+^h M \hookrightarrow M$;
- (iii) $i_{M_+^h} : \Sigma' \hookrightarrow M'$ denotes the embedding obtained by composing $f_{M_+^h}$ with the inclusion $\partial_+^h M' \hookrightarrow M'$;
- (iv) $i_{M_+^h} : \Sigma'' \hookrightarrow M'$ denotes the embedding obtained by composing $f_{M_+^h}$ with the inclusion $\partial_+^h M' \hookrightarrow M'$.

DEFINITION 1.3.9. The *unit* of $\mathbf{Cob}_3^{\mathcal{C}}$ is the empty object \emptyset .

DEFINITION 1.3.10. The *tensor product* $\Gamma \otimes \Gamma'$ of objects Γ and Γ' of $\mathbf{Cob}_3^{\mathcal{C}}$ is given by $\Gamma \sqcup \Gamma'$

DEFINITION 1.3.11. The *tensor product* $\Sigma \otimes \Sigma' : \Gamma \otimes \Gamma' \rightarrow \Gamma'' \otimes \Gamma'''$ of 1-morphisms $\Sigma : \Gamma \rightarrow \Gamma''$ and $\Sigma' : \Gamma' \rightarrow \Gamma'''$ of $\mathbf{Cob}_3^{\mathcal{C}}$ is given by the triple

$$(\Sigma \sqcup \Sigma', P^V \sqcup P^{V'}, \mathcal{L} + \mathcal{L}')$$

DEFINITION 1.3.12. The *tensor product* $M \otimes M' : \Sigma \otimes \Sigma' \Rightarrow \Sigma'' \otimes \Sigma'''$ of 2-morphisms $M : \Sigma \Rightarrow \Sigma''$ and $M' : \Sigma' \Rightarrow \Sigma'''$ of $\mathbf{Cob}_3^{\mathcal{C}}$ is given by the equivalence class of the triple

$$(M \sqcup M', T^\varphi \sqcup T'^{\varphi'}, n + n').$$

1.3.2. Extended universal construction for decorated cobordisms.

In this subsection we fix the terminology for quantum invariants, TQFTs and ETQFTs in the context of decorated manifolds and cobordisms. We also recall the main ideas of the extended universal construction, the fundamental machinery our investigation is based on, postponing a detailed account to Appendix A.7.

REMARK 1.3.3. Morphisms of $\mathbf{Cob}_3^{\mathcal{C}}$ from \emptyset to itself are naturally arranged in a symmetric monoidal category with respect to the tensor product of 1-morphisms and 2-morphisms and with unit given by the empty 1-morphism id_\emptyset . This category will be denoted $\text{Cob}_3^{\mathcal{C}}$ for brevity. Analogously, the set of 2-morphisms of $\mathbf{Cob}_3^{\mathcal{C}}$ from id_\emptyset to itself forms a commutative monoid with respect to the tensor product of 2-morphisms and with unit given by the empty 2-morphism $\text{id}_{\text{id}_\emptyset}$. This monoid will be denoted $\text{Man}_3^{\mathcal{C}}$ for brevity.

An *invariant on $\text{Man}_3^{\mathcal{C}}$* is a function from $\text{Man}_3^{\mathcal{C}}$ to \mathbb{C} . A *covariant quantization functor on $\text{Cob}_3^{\mathcal{C}}$* is a functor from $\text{Cob}_3^{\mathcal{C}}$ to $\text{Vect}_{\mathbb{C}}$. A *contravariant quantization functor on $\text{Cob}_3^{\mathcal{C}}$* is a functor from $(\text{Cob}_3^{\mathcal{C}})^{\text{op}}$ to $\text{Vect}_{\mathbb{C}}$. A *covariant quantization 2-functor on $\mathbf{Cob}_3^{\mathcal{C}}$* is a 2-functor from $\mathbf{Cob}_3^{\mathcal{C}}$ to $\mathbf{Cat}_{\mathbb{C}}$. A *contravariant quantization 2-functor on $\mathbf{Cob}_3^{\mathcal{C}}$* is a 2-functor from $(\mathbf{Cob}_3^{\mathcal{C}})^{\text{op}}$ to $\mathbf{Cat}_{\mathbb{C}}$. A *quantum invariant on $\text{Man}_3^{\mathcal{C}}$* is a commutative monoid homomorphism from $\text{Man}_3^{\mathcal{C}}$ to \mathbb{C} . A *TQFT on $\text{Cob}_3^{\mathcal{C}}$* is a symmetric monoidal functor from $\text{Cob}_3^{\mathcal{C}}$ to $\text{Vect}_{\mathbb{C}}$. An *ETQFT on $\mathbf{Cob}_3^{\mathcal{C}}$* is a symmetric monoidal 2-functor from $\mathbf{Cob}_3^{\mathcal{C}}$ to $\hat{\mathbf{C}}\mathbf{at}_{\mathbb{C}}$.

The extended universal construction is a machinery which associates with every invariant Z on $\text{Man}_3^{\mathcal{C}}$ a covariant and a contravariant quantization 2-functors on $\mathbf{Cob}_3^{\mathcal{C}}$ denoted \mathbf{E}_Z and \mathbf{E}'_Z respectively. The image of an object Γ of $\mathbf{Cob}_3^{\mathcal{C}}$ under \mathbf{E}_Z is a linear category $\Lambda_Z(\Gamma)$ called the *covariant universal linear category of Γ* whose objects are 1-morphisms of $\mathbf{Cob}_3^{\mathcal{C}}$ of the form $\Sigma_{\Gamma} : \emptyset \rightarrow \Gamma$ and whose morphism vector spaces $\text{Hom}_{\Lambda_Z(\Gamma)}(\Sigma_{\Gamma}, \Sigma'_{\Gamma})$ are given by certain quotients, which are defined using Z , of the free complex vector spaces generated by 2-morphisms of $\mathbf{Cob}_3^{\mathcal{C}}$ of the form $\mathbb{M}_{\Gamma} : \Sigma_{\Gamma} \Rightarrow \Sigma'_{\Gamma}$. The image of a 1-morphism $\Sigma : \Gamma \rightarrow \Gamma'$ of $\mathbf{Cob}_3^{\mathcal{C}}$ under \mathbf{E}_Z is a covariant linear functor $F_Z(\Sigma) : \Lambda_Z(\Gamma) \rightarrow \Lambda_Z(\Gamma')$ called the *covariant universal linear functor of Σ* which maps every object Σ_{Γ} of $\Lambda_Z(\Gamma)$ to the object $\Sigma \circ \Sigma_{\Gamma}$ of $\Lambda_Z(\Gamma')$ and every morphism $[\mathbb{M}_{\Gamma}]$ of $\Lambda_Z(\Gamma)$ to the morphism $[\text{id}_{\Sigma} \circ \mathbb{M}_{\Gamma}]$ of $\Lambda_Z(\Gamma')$. The image of a 2-morphism $\mathbb{M} : \Sigma \Rightarrow \Sigma'$ of $\mathbf{Cob}_3^{\mathcal{C}}$ under \mathbf{E}_Z is a natural transformation $\eta_Z(\mathbb{M}) : F_Z(\Sigma) \Rightarrow F_Z(\Sigma')$ called the *covariant universal natural transformation of \mathbb{M}* which associates with every object Σ_{Γ} of $\Lambda_Z(\Gamma)$ the morphism $[\mathbb{M} \circ \text{id}_{\Sigma_{\Gamma}}]$ of $\Lambda_Z(\Gamma')$. The contravariant quantization 2-functor \mathbf{E}'_Z is defined similarly.

1.4. Surgery axioms

We move on to the study of the quantization 2-functors produced by the extended universal construction. We begin by introducing a set of axioms for quantum invariants on $\text{Man}_3^{\mathcal{C}}$ which, when satisfied, enable us to better handle universal linear categories, linear functors and natural transformations. This is much in the spirit of [BHMV95] and [BCGP16].

REMARK 1.4.1. From now until the end of the chapter \mathcal{C} will denote a fixed pre-modular category.

Let $\Sigma = (\Sigma, P^V, \mathcal{L})$, $\Sigma' = (\Sigma', P'^{V'}, \mathcal{L}')$ be 1-morphisms of $\mathbf{Cob}_3^{\mathcal{C}}$ from Γ to Γ' , let \mathbb{M} be a cobordism with corners from Σ to Σ' , let $T^{\varphi} \subset \mathbb{M}$ be a \mathcal{C} -colored ribbon graph from P^V to $P'^{V'}$ and let n be an integer. If $L = L_1 \cup \dots \cup L_k \subset \mathbb{M}$ is a framed link disjoint from T then we denote with

$$(\mathbb{M}, L_1^{\Omega} \cup \dots \cup L_k^{\Omega} \cup T^{\varphi}, n)$$

the formal linear combination of 2-morphisms of $\mathbf{Cob}_3^{\mathcal{C}}$

$$\sum_{i_1, \dots, i_k \in \mathbb{I}} \dim_{\mathcal{C}}(V_{i_1}) \cdots \dim_{\mathcal{C}}(V_{i_k}) \cdot (\mathbb{M}, L_1^{V_{i_1}} \cup \dots \cup L_k^{V_{i_k}} \cup T^{\varphi}, n).$$

REMARK 1.4.2. Although $(\mathbb{M}, L_1^{\Omega} \cup \dots \cup L_k^{\Omega} \cup T^{\varphi}, n)$ is not actually a 2-morphism of $\mathbf{Cob}_3^{\mathcal{C}}$, we will treat it as such by abuse of notation.

DEFINITION 1.4.1. The *index k surgery 1-morphism* $\Sigma_k : \emptyset \rightarrow \emptyset$ of $\mathbf{Cob}_3^{\mathcal{C}}$ for $k = 0, 1, 2$ is given by

$$\begin{aligned}\Sigma_0 &:= (S^{-1} \times S^3, \emptyset^{\emptyset}, \{0\}) = \text{id}_{\emptyset}, \\ \Sigma_1 &:= (S^0 \times S^2, \emptyset^{\emptyset}, \{0\}), \\ \Sigma_2 &:= (S^1 \times S^1, \emptyset^{\emptyset}, \mathcal{L}_2)\end{aligned}$$

where $S^{-1} := \emptyset$ and where the Lagrangian subspace $\mathcal{L}_2 \subset H^1(S^1 \times S^1; \mathbb{R})$ is generated by the homology class of the meridian $m := \{(1, 0)\} \times \overline{S^1} \subset S^1 \times S^1$.

DEFINITION 1.4.2. The *index k attaching 2-morphism* $\mathbb{A}_k : \text{id}_{\emptyset} \Rightarrow \Sigma_k$ of $\mathbf{Cob}_3^{\mathcal{C}}$ for $k = 0, 1, 2$ is given by

$$\begin{aligned}\mathbb{A}_0 &:= (S^{-1} \times \overline{D^4}, \emptyset^{\emptyset}, 0) = \text{id}_{\text{id}_{\emptyset}}, \\ \mathbb{A}_1 &:= (S^0 \times D^3, \emptyset^{\emptyset}, 0), \\ \mathbb{A}_2 &:= (S^1 \times \overline{D^2}, K_2^{\Omega}, 0)\end{aligned}$$

where the framed knot K_2 is given by

$$K_2 := S^1 \times \{(0, 0)\} \subset S^1 \times \overline{D^2}$$

with orientation induced by S^1 and with framing tangent to

$$S^1 \times \{(x, y) \in \overline{D^2} \mid y = 0\}.$$

DEFINITION 1.4.3. The *index k belt 2-morphism* $\mathbb{B}_k : \text{id}_{\emptyset} \Rightarrow \Sigma_k$ of $\mathbf{Cob}_3^{\mathcal{C}}$ for $k = 0, 1, 2$ is given by

$$\mathbb{B}_k := (D^k \times S^{3-k}, \emptyset^{\emptyset}, 0)$$

where $D^0 := \{0\}$.

A quantum invariant Z on $\text{Man}_3^{\mathcal{C}}$ satisfies the surgery axioms if there exist $\lambda_k \in \mathbb{C}^*$ such that for every 2-morphism $\mathbb{M} : \Sigma_k \Rightarrow \text{id}_{\emptyset}$ of $\mathbf{Cob}_3^{\mathcal{C}}$ we have

$$Z(\mathbb{M} * \mathbb{B}_k) = \lambda_k Z(\mathbb{M} * \mathbb{A}_k),$$

for $k = 0, 1, 2$.

REMARK 1.4.3. Let Z be a non-trivial quantum invariant on $\text{Man}_3^{\mathcal{C}}$ satisfying the surgery axioms. Then:

- (i) If $\mathbb{M} : \text{id}_{\emptyset} \Rightarrow \text{id}_{\emptyset}$ is a closed 2-morphism of $\mathbf{Cob}_3^{\mathcal{C}}$ satisfying $Z(\mathbb{M}) \neq 0$ then

$$Z(\mathbb{M})Z(\mathbb{B}_0) = Z(\mathbb{M} \otimes \mathbb{B}_0) = Z(\mathbb{M} * \mathbb{B}_0) = \lambda_0 Z(\mathbb{M} * \mathbb{A}_0) = \lambda_0 Z(\mathbb{M})$$

implies $Z(\mathbb{B}_0) = \lambda_0$;

- (ii) Let $\overline{\mathbb{A}}_1 : \Sigma_1 \Rightarrow \text{id}_{\emptyset}$ denote the 2-morphism of $\mathbf{Cob}_3^{\mathcal{C}}$ given by

$$(S^0 \times \overline{D^3}, \emptyset^{\emptyset}, 0).$$

Then the chain of equalities

$$\lambda_0 = Z(\mathbb{B}_0) = Z(\overline{\mathbb{A}}_1 * \mathbb{B}_1) = \lambda_1 Z(\overline{\mathbb{A}}_1 * \mathbb{A}_1) = \lambda_1 Z(\mathbb{B}_0 \otimes \mathbb{B}_0) = \lambda_1 Z(\mathbb{B}_0)^2$$

implies $\lambda_1 = \lambda_0^{-1}$;

(iii) Let $\overline{\mathbb{B}}_1 : \Sigma_1 \Rightarrow \text{id}_\emptyset$ denote the 2-morphism of $\mathbf{Cob}_3^{\mathcal{C}}$ given by

$$(\overline{\mathbb{D}}^1 \times S^2, \emptyset^\emptyset, 0).$$

Then we have

$$Z(\overline{\mathbb{B}}_1 * \mathbb{B}_1) = \lambda_1 Z(\overline{\mathbb{B}}_1 * \mathbb{A}_1) = \lambda_1 Z(\mathbb{B}_0) = 1.$$

REMARK 1.4.4. Let $U \subset S^3$ denote the \mathcal{C} -colored framed knot given by the unknot

$$U = \{(x, y, z, t) \in S^3 \mid x^2 + y^2 = 1, z = t = 0\}$$

with any orientation and with framing tangent to

$$\{(x, y, z, t) \in S^3 \mid z = t = 0\}.$$

If Z is a non-trivial quantum invariant on $\text{Man}_3^{\mathcal{C}}$ satisfying the surgery axioms then we have

$$\lambda_2 = Z(S^3, U^\Omega, 0)^{-1}.$$

Indeed if $\overline{\mathbb{B}}_2 : \Sigma_2 \Rightarrow \text{id}_\emptyset$ denotes the 2-morphism of $\mathbf{Cob}_3^{\mathcal{C}}$ given by

$$(\overline{\mathbb{D}}^2 \times S^1, \emptyset^\emptyset, 0)$$

then we have

$$1 = Z(\overline{\mathbb{B}}_1 * \mathbb{B}_1) = Z(\overline{\mathbb{B}}_2 * \mathbb{B}_2) = \lambda_2 Z(\overline{\mathbb{B}}_2 * \mathbb{A}_2) = \lambda_2 Z(S^3, U^\Omega, 0).$$

REMARK 1.4.5. Let Z be a non-trivial quantum invariant on $\text{Man}_3^{\mathcal{C}}$ satisfying the surgery axioms. Then

$$Z(M, T^\varphi, n) = \kappa^n Z(M, T^\varphi, 0)$$

with

$$\kappa := \lambda_1 Z(S^3, \emptyset^\emptyset, 1).$$

LEMMA 1.4.1. *Let Z be a quantum invariant on $\text{Man}_3^{\mathcal{C}}$, let Γ be an object of $\mathbf{Cob}_3^{\mathcal{C}}$, let $\Sigma_\Gamma, \Sigma_\Gamma''$ be objects of $\Lambda_Z(\Gamma)$ and let $M_\Gamma : \Sigma_k \otimes \Sigma_\Gamma \Rightarrow \Sigma_\Gamma''$ be a 2-morphism of $\mathbf{Cob}_3^{\mathcal{C}}$ with $k \in \{0, 1, 2\}$. If Z satisfies the surgery axioms then*

$$[M_\Gamma * (\mathbb{B}_k \otimes \text{id}_{\Sigma_\Gamma})] = \lambda_k \cdot [M_\Gamma * (\mathbb{A}_k \otimes \text{id}_{\Sigma_\Gamma})]$$

as vectors of $\text{Hom}_{\Lambda_Z(\Gamma)}(\Sigma_\Gamma, \Sigma_\Gamma'')$.

PROOF. We have to show that

$$Z_\Gamma(M_\Gamma * (\mathbb{B}_k \otimes \text{id}_{\Sigma_\Gamma})) = \lambda_k \cdot Z_\Gamma(M_\Gamma * (\mathbb{A}_k \otimes \text{id}_{\Sigma_\Gamma}))$$

where for every 2-morphism $M_\Gamma'' : \Sigma_\Gamma \Rightarrow \Sigma_\Gamma''$ of $\mathbf{Cob}_3^{\mathcal{C}}$ the natural transformation

$$Z_\Gamma(M_\Gamma'') : Z_\Gamma(\Sigma_\Gamma) \Rightarrow Z_\Gamma(\Sigma_\Gamma'')$$

comes from the extended universal construction⁸. But then the equality we have to prove is equivalent to

$$Z(M * \mathbb{B}_k) = \lambda_k Z(M * \mathbb{A}_k)$$

for every 2-morphism $M : \Sigma_k \Rightarrow \text{id}_\emptyset$ of $\mathbf{Cob}_3^{\mathcal{C}}$, which is precisely the index k surgery axiom. \square

⁸See Appendix A.7 for the definition.

1.5. Connection Lemma

In this section we derive the main consequences of surgery axioms: all morphisms between a fixed pair of objects of a universal linear category associated with a quantum invariant which satisfies the surgery axioms are generated by all possible decorations on a fixed connected cobordism with corners.

We fix our notation for surgery. If M is a 3-dimensional cobordism with corners from Σ to Σ' then every k -component framed link L inside M determines, up to isotopy, k disjoint positive embeddings $\iota_{L_i} : S^1 \times \overline{D^2} \hookrightarrow M$ such that:

- (i) $L_i := \iota_{L_i}(S^1 \times \{(0, 0)\})$ is the i -th component of the link L ;
- (ii) $m_{L_i} := \iota_{L_i}(\{(1, 0)\} \times \overline{S^1})$ is a meridian of L_i ;
- (iii) $\ell_{L_i} := \iota_{L_i}(S^1 \times \{(0, 1)\})$ is a longitude of L_i determined by the framing.

These embeddings determine a 3-dimensional cobordism with corners M_L from $\Sigma_L := (S^1 \times S^1) \sqcup \dots \sqcup (S^1 \times S^1) \sqcup \Sigma$ to Σ' called the *exterior of L in M* whose support M_L is given by M deprived of the interior of the image of $\iota_L = \iota_{L_1} \sqcup \dots \sqcup \iota_{L_k}$ and whose incoming horizontal boundary identification is given by

$$f_{(M_L)_\perp} := \iota_{L_1}|_{S^1 \times S^1} \sqcup \dots \sqcup \iota_{L_k}|_{S^1 \times S^1} \sqcup f_{M^\perp}.$$

Then M is isomorphic to

$$\left((S^1 \times \overline{D^2}) \sqcup \dots \sqcup (S^1 \times \overline{D^2}) \sqcup (\Sigma \times I) \right) \cup_{\Sigma_L} M_L$$

and we define $\chi_2(M, L)$ to be the 3-dimensional cobordism with corners

$$\left((D^2 \times S^1) \sqcup \dots \sqcup (D^2 \times S^1) \sqcup (\Sigma \times I) \right) \cup_{\Sigma_L} M_L.$$

REMARK 1.5.1. The 3-dimensional cobordism with corners $\chi_2(M, L)$ depends on the choice of the embedding ι_L , but its isomorphism class depends only on L .

Let M and M' be 3-dimensional cobordisms with corners from Σ to Σ' and let $L \subset M$ be a framed link. If there exists an isomorphism of cobordisms with corners $f : \chi_2(M, L) \rightarrow M'$ then we say that L gives a *surgery presentation for M' inside M* or equivalently that L is a *surgery framed link for M' inside M* . In this case the *identification of the exteriors of L* is the isomorphism $f_L : M_L \rightarrow M'_L$ induced by f between the exterior of L in M and the cobordism with corners M'_L from Σ_L to Σ' whose support is given by $f(M_L) \subset M'$ with boundary identifications induced by those of M_L via f . Therefore a surgery framed link L for M' inside M induces an isomorphism of cobordisms with corners between M' and

$$\left((S^1 \times \overline{D^2}) \sqcup \dots \sqcup (S^1 \times \overline{D^2}) \sqcup (\Sigma \times I) \right) \cup_{\Sigma_L} M'_L.$$

REMARK 1.5.2. If L is a surgery framed link for M' inside M we will call M'_L the *exterior of L in M'* even if L is not contained in M' .

The following result is a standard consequence of the Lickorish-Wallace Theorem.

LEMMA 1.5.1. *If M and M' are non-empty connected 3-dimensional cobordisms with corners from Σ to Σ' then there exists a surgery framed link for M' inside M .*

REMARK 1.5.3. If Z is a quantum invariant on $\text{Man}_3^{\mathcal{C}}$ which satisfies the surgery axioms, if Γ is an object of $\mathbf{Cob}_3^{\mathcal{C}}$, if

$$\Sigma_\Gamma = (\Sigma_\Gamma, P^V, \mathcal{L}), \quad \Sigma''_\Gamma = (\Sigma''_\Gamma, P''^{V''}, \mathcal{L}'')$$

are objects of $\Lambda_Z(\Gamma)$, if M_Γ is a non-empty connected cobordism with corners from Σ_Γ to Σ''_Γ and if $M''_\Gamma : \Sigma_\Gamma \Rightarrow \Sigma''_\Gamma$ is a non-empty connected 2-morphism of $\mathbf{Cob}_3^{\mathcal{C}}$ of the form $(M''_\Gamma, T''\varphi'', n'')$ then Lemmas 1.5.1 and 1.4.1 yield the equality

$$[M''_\Gamma] = \lambda_2^k \cdot [M_\Gamma, L^\Omega \cup f_L^{-1}(T''\varphi''), n]$$

between morphisms of $\text{Hom}_{\Lambda_Z(\Gamma)}(\Sigma_\Gamma, \Sigma''_\Gamma)$ where $L = L_1 \cup \dots \cup L_k$ is some surgery framed link for M''_Γ inside M_Γ , where T'' is contained inside M''_Γ up to isotopy and where $n \in \mathbb{Z}$ is determined via the Maslov index formula.

If M is a 3-dimensional cobordism with corners from Σ to Σ' and if $P^V \subset \Sigma$ and $P^{V'} \subset \Sigma'$ are \mathcal{C} -colored ribbon sets then a \mathcal{C} -skein inside M relative to P^V and $P^{V'}$ is an equivalence class of \mathcal{C} -colored ribbon graphs $T^\varphi \subset M$ from P^V to $P^{V'}$. Two \mathcal{C} -colored ribbon graphs T^φ and $T^{\varphi'}$ are equivalent if there exists an isomorphism of cobordism with corners $f : M \rightarrow M$ isotopic to the identity relative to ∂M satisfying $f(T^\varphi) = T^{\varphi'}$. We denote with $\mathcal{S}_{\mathcal{C}}(M; P^V, P^{V'})$ the free complex vector space generated by \mathcal{C} -skeins inside M relative to P^V and $P^{V'}$.

REMARK 1.5.4. Our notation for \mathcal{C} -skeins will be a little abusive since we will not distinguish between an equivalence class of \mathcal{C} -colored ribbon graphs and any of its representatives.

LEMMA 1.5.2. *Let Γ be an object of $\mathbf{Cob}_3^{\mathcal{C}}$, let*

$$\Sigma_\Gamma = (\Sigma_\Gamma, P^V, \mathcal{L}), \quad \Sigma''_\Gamma = (\Sigma''_\Gamma, P^{V''}, \mathcal{L}'')$$

be objects of $\Lambda_Z(\Gamma)$ and let M_Γ be a non-empty connected 3-dimensional cobordism with corners from Σ_Γ to Σ''_Γ . If Z is a quantum invariant on $\text{Man}_3^{\mathcal{C}}$ which satisfies the surgery axioms then the natural linear map

$$\begin{aligned} \rho_Z : \mathcal{S}_{\mathcal{C}}(M_\Gamma; P^V, P^{V''}) &\rightarrow \text{Hom}_{\Lambda_Z(\Gamma)}(\Sigma_\Gamma, \Sigma''_\Gamma) \\ T^\varphi &\mapsto [M_\Gamma, T^\varphi, 0] \end{aligned}$$

is surjective.

PROOF. We have to show that for every morphism

$$[M''_\Gamma, T''\varphi'', n''] \in \text{Hom}_{\Lambda_Z(\Gamma)}(\Sigma_\Gamma, \Sigma''_\Gamma)$$

there exist some \mathcal{C} -colored ribbon graphs $T_i^{\varphi^i} \subset M_\Gamma$ for $i = 1, \dots, k$ such that

$$\sum_{i=1}^k \lambda_i \cdot [M_\Gamma, T_i^{\varphi^i}, 0] = [M''_\Gamma, T''\varphi'', n''].$$

First of all we can suppose that M''_Γ is connected: indeed if it is not then, thanks to Lemma 1.4.1, a finite sequence of index 1 surgeries on M''_Γ connecting its components will determine a vector of $\text{Hom}_{\Lambda_Z(\Gamma)}(\Sigma_\Gamma, \Sigma''_\Gamma)$ which is a non-zero scalar multiple of $[M''_\Gamma, T''\varphi'', n'']$. Now thanks to Lemma 1.5.1 and to Remark 1.5.3 we know there exists some framed link $L = L_1 \cup \dots \cup L_k \subset M_\Gamma$ together with some integer $n \in \mathbb{Z}$ such that

$$[M''_\Gamma, T''\varphi'', n''] = \lambda_2^k \cdot [M_\Gamma, L^\Omega \cup f_L^{-1}(T''\varphi''), n] = \lambda_2^k \kappa^n \cdot [M_\Gamma, L^\Omega \cup f_L^{-1}(T''\varphi''), 0].$$

□

REMARK 1.5.5. It is possible to give the exact same description of the contravariant universal linear categories. In particular Lemma 1.4.1 can be directly translated into an analogous result for the corresponding contravariant universal linear categories.

LEMMA 1.5.3. *Let Γ be an object of $\mathbf{Cob}_3^{\mathcal{C}}$, let*

$$\Sigma'_\Gamma = (\Sigma'_\Gamma, P^{V'}, \mathcal{L}'), \quad \Sigma'''_\Gamma = (\Sigma'''_\Gamma, P^{V'''}, \mathcal{L}''')$$

be objects of $\Lambda'_Z(\Gamma)$ and let M'_Γ be a non-empty connected 3-dimensional cobordism with corners from Σ'_Γ to Σ'''_Γ . If Z is a quantum invariant on $\mathbf{Man}_3^{\mathcal{C}}$ which satisfies the surgery axioms then the natural linear map

$$\begin{aligned} \rho_Z : \mathcal{S}_{\mathcal{C}}(M'_\Gamma; P^{V'}, P^{V'''}) &\rightarrow \text{Hom}_{\Lambda'_Z(\Gamma)}(\Sigma'_\Gamma, \Sigma'''_\Gamma) \\ \mathbb{T}^{\varphi} &\mapsto [M'_\Gamma, \mathbb{T}^{\varphi}, 0] \end{aligned}$$

is surjective.

REMARK 1.5.6. The exact same proof that was given for Lemma 1.5.2 can be repeated here.

1.6. Witten-Reshetikhin-Turaev invariants

In this section we recall the definition of the Witten-Reshetikhin-Turaev quantum invariants of decorated closed 3-dimensional manifolds, which were first constructed in [RT91] and later generalized in [T94], and we show them to satisfy the surgery axioms introduced earlier.

If \mathcal{C} satisfies the non-degeneracy condition

$$\Delta_- \Delta_+ \neq 0$$

for the parameters Δ_+ and Δ_- given in Figure 2 then the *Witten-Reshetikhin-Turaev quantum invariant associated with \mathcal{C}* is the unique quantum invariant on $\mathbf{Man}_3^{\mathcal{C}}$ evaluating each closed connected 2-morphism $\mathbb{M} = (M, \mathbb{T}^{\varphi}, n)$ of $\mathbf{Cob}_3^{\mathcal{C}}$ to the complex number

$$\text{WRT}_{\mathcal{C}}(M, \mathbb{T}^{\varphi}, n) := \mathcal{D}^{-1-k} \delta^{n-\sigma(L)} F_{\mathcal{C}}(L^{\Omega} \cup f_L^{-1}(\mathbb{T}^{\varphi}))$$

where:

- (i) $L = L_1 \cup \dots \cup L_k \subset S^3$ is a surgery framed link for \mathbb{M} in S^3 ;
- (ii) $f_L : S_L^3 \rightarrow M_L$ is the identification of the exteriors of L ;
- (iii) $\sigma(L)$ is the signature of L ;
- (iv) \mathcal{D} is a choice of a square root of $\Delta_- \Delta_+$;
- (v) $\delta := \frac{\Delta_+}{\mathcal{D}} = \frac{\mathcal{D}}{\Delta_-}$.

REMARK 1.6.1. A proof of the fact that $\text{WRT}_{\mathcal{C}}$ is a well-defined invariant on $\mathbf{Man}_3^{\mathcal{C}}$ is contained in [T94].

PROPOSITION 1.6.1. *If \mathcal{C} is modular then the Witten-Reshetikhin-Turaev quantum invariant $\text{WRT}_{\mathcal{C}}$ satisfies the surgery axioms with $\lambda_0 = \lambda_1^{-1} = \lambda_2 = \mathcal{D}^{-1}$. Moreover $\kappa = \delta$.*

PROOF. The 0-surgery axiom holds with parameter $\lambda_0 = \mathcal{D}^{-1}$ thanks to the trivial computation

$$\text{WRT}_{\mathcal{C}}(\mathbb{B}_0) = \mathcal{D}^{-1-0} \delta^{0-0} F_{\mathcal{C}}(\emptyset^{\emptyset}) = \mathcal{D}^{-1}.$$

The 1-surgery axiom holds with parameter $\lambda_1 = \mathcal{D}$ thanks to two easy computations. First of all, using the notation of Remarks 1.4.3 and 1.4.4, we have

$$\text{WRT}_{\mathcal{C}}(\overline{\mathbb{B}_1} * \mathbb{B}_1) = \mathcal{D}^{-1-1} \delta^{0-0} F_{\mathcal{C}}(U^\Omega) = \mathcal{D}^{-2} \zeta = 1,$$

as follows from the modularity condition of Definition 1.2.2. Now the claim follows from the fact that if T^φ and $T'^{\varphi'}$ are closed morphisms of $\text{Rib}_{\mathcal{C}}$ then we have the equality

$$F_{\mathcal{C}}(T^\varphi \otimes T'^{\varphi'}) = F_{\mathcal{C}}(T^\varphi) F_{\mathcal{C}}(T'^{\varphi'}).$$

Finally the 2-surgery axiom holds with parameter $\lambda_2 = \mathcal{D}^{-1}$. Indeed if we consider a surgery framed link $L = L_1 \cup \dots \cup L_k \subset S^3$ for

$$\mathbb{M} * \mathbb{A}_2 = (\mathbb{M} \cup_{S^1 \times S^1} (S^1 \times \overline{D^2}), T^\varphi \cup K_2^\Omega, n)$$

and if we set $K_L := f_L^{-1}(K_2) \subset S^3$ then $L \cup K_L \subset S^3$ is a surgery framed link for

$$\mathbb{M} * \mathbb{B}_2 = (\mathbb{M} \cup_{S^1 \times S^1} (D^2 \times S^1), T^\varphi, n + \sigma(L \cup K_L) - \sigma(L)),$$

and we obtain equalities

$$\text{WRT}_{\mathcal{C}}(\mathbb{M} * \mathbb{A}_2) = \mathcal{D}^{-1-k} \delta^{n-\sigma(L)} F_{\mathcal{C}}(L^\Omega \cup K_L^\Omega),$$

$$\text{WRT}_{\mathcal{C}}(\mathbb{M} * \mathbb{B}_2) = \mathcal{D}^{-1-(k+1)} \delta^{(n+\sigma(L \cup K_L) - \sigma(L)) - \sigma(L \cup K_L)} F_{\mathcal{C}}(L^\Omega \cup K_L^\Omega).$$

□

REMARK 1.6.2. As a corollary Lemma 1.5.2 applies to $\text{WRT}_{\mathcal{C}}$ whenever \mathcal{C} is modular.

REMARK 1.6.3. The only quantum invariant we will consider from now on is $\text{WRT}_{\mathcal{C}}$. We will therefore adopt a lighter notation for the extended universal construction: instead of using the full subscript $\text{WRT}_{\mathcal{C}}$ for universal linear categories, linear functors and natural transformations we will simply refer to the modular category \mathcal{C} .

1.7. Skein modules

In this section we introduce skein modules and we explain how the study of the universal linear categories associated with $\text{WRT}_{\mathcal{C}}$ is related to the study of these vector spaces, much in the spirit of [BHMV95].

REMARK 1.7.1. From now we will suppose that the pre-modular category \mathcal{C} we fixed in Remark 1.4.1 is actually modular. In particular $\text{WRT}_{\mathcal{C}}$ satisfies the surgery axioms.

DEFINITION 1.7.1. The $(\vec{\varepsilon}, \vec{V})$ -colored 2-disc $\mathbb{D}_{(\vec{\varepsilon}, \vec{V})}^2 : \emptyset \rightarrow S^1$ for an object $(\vec{\varepsilon}, \vec{V})$ of $\text{Rib}_{\mathcal{C}}$ is the 1-morphism of $\mathbf{Cob}_3^{\mathcal{C}}$ given by

$$(D^2, P(\vec{\varepsilon})^V, \{0\}).$$

DEFINITION 1.7.2. The T^φ -colored 3-cylinder $(\mathbb{D}^2 \times \mathbb{I})_{T^\varphi} : \mathbb{D}_{(\vec{\varepsilon}, \vec{V})}^2 \Rightarrow \mathbb{D}_{(\vec{\varepsilon}', \vec{V}')}^2$ for a morphism $T^\varphi : (\vec{\varepsilon}, \vec{V}) \rightarrow (\vec{\varepsilon}', \vec{V}')$ of $\text{Rib}_{\mathcal{C}}$ is the 2-morphism of $\mathbf{Cob}_3^{\mathcal{C}}$ given by

$$(D^2 \times \mathbb{I}, T^\varphi, 0).$$

If $\Sigma, \Sigma' : \Gamma \rightarrow \Gamma'$ are 1-morphisms of $\mathbf{Cob}_3^{\mathcal{C}}$ then we denote with $\mathcal{V}(\Sigma, \Sigma')$ the complex vector space generated by the set of 2-morphisms $M : \Sigma \Rightarrow \Sigma'$ of $\mathbf{Cob}_3^{\mathcal{C}}$. Then we denote with $\mathcal{K}(\Sigma, \Sigma')$ the subspace of $\mathcal{V}(\Sigma, \Sigma')$ generated by vectors of the form

$$\sum_{i=1}^m \lambda_i \cdot \left(M' * \left(\text{id}_{\Sigma''} \circ \left((\mathbb{D}^2 \times \mathbb{I})_{\Gamma_i^{\varphi_i}} \otimes \text{id}_{\text{id}_{\Gamma}} \right) \right) * M \right)$$

for some 1-morphism $\Sigma'' : \mathbb{S}^1 \otimes \Gamma \rightarrow \Gamma'$ of $\mathbf{Cob}_3^{\mathcal{C}}$, for some 2-morphisms

$$M : \Sigma \Rightarrow \Sigma'' \circ (\mathbb{D}_{(\vec{\varepsilon}, \vec{V})}^2 \otimes \text{id}_{\Gamma}), \quad M' : \Sigma'' \circ (\mathbb{D}_{(\vec{\varepsilon}', \vec{V}')}^2 \otimes \text{id}_{\Gamma}) \Rightarrow \Sigma'$$

of $\mathbf{Cob}_3^{\mathcal{C}}$, for some objects $(\vec{\varepsilon}, \vec{V})$ and $(\vec{\varepsilon}', \vec{V}')$ of $\text{Rib}_{\mathcal{C}}$ and for some morphisms $T_1^{\varphi_1}, \dots, T_m^{\varphi_m} : (\vec{\varepsilon}, \vec{V}) \rightarrow (\vec{\varepsilon}', \vec{V}')$ of $\text{Rib}_{\mathcal{C}}$ satisfying the equality

$$\sum_{i=1}^m \lambda_i \cdot F_{\mathcal{C}}(T_i^{\varphi_i}) = 0$$

between vectors of $\text{Hom}_{\mathcal{C}}(V^{\varepsilon}, V^{\varepsilon'})$.

Let $\Sigma, \Sigma' : \Gamma \rightarrow \Gamma'$ be 1-morphisms of $\mathbf{Cob}_3^{\mathcal{C}}$ of the form

$$\Sigma = (\Sigma, P^V, \mathcal{L}), \quad \Sigma' = (\Sigma', P^{V'}, \mathcal{L}')$$

and let M be a 3-dimensional cobordism with corners from Σ to Σ' . Let

$$\mathcal{K}_{\mathcal{C}}(M; P^V, P^{V'})$$

denote the subspace of $\mathcal{S}_{\mathcal{C}}(M; P^V, P^{V'})$ given by the preimage of the subspace $\mathcal{K}(\Sigma, \Sigma')$ of $\mathcal{V}(\Sigma, \Sigma')$ under the natural linear map

$$\begin{aligned} \rho : \mathcal{S}_{\mathcal{C}}(M; P^V, P^{V'}) &\rightarrow \mathcal{V}(\Sigma, \Sigma') \\ T^{\varphi} &\mapsto (M, T^{\varphi}, 0). \end{aligned}$$

A vector of $\mathcal{K}_{\mathcal{C}}(M; P^V, P^{V'})$ will be called a \mathcal{C} -skein relation.

If M is a 3-dimensional cobordism with corners from Σ to Σ' and if $P^V \subset \Sigma$ and $P^{V'} \subset \Sigma'$ are \mathcal{C} -colored ribbon sets then the *skein module of M relative to P^V and $P^{V'}$* is the complex vector space

$$\mathcal{S}_{\mathcal{C}}(M; P^V, P^{V'}) := \mathcal{S}_{\mathcal{C}}(M; P^V, P^{V'}) / \mathcal{K}_{\mathcal{C}}(M; P^V, P^{V'}).$$

Two \mathcal{C} -skeins in $\mathcal{S}_{\mathcal{C}}(M; P^V, P^{V'})$ are said to be *skein equivalent* if their difference is a \mathcal{C} -skein relation.

LEMMA 1.7.1. *Let Γ be an object of $\mathbf{Cob}_3^{\mathcal{C}}$, let*

$$\Sigma_{\Gamma} = (\Sigma_{\Gamma}, P^V, \mathcal{L}), \quad \Sigma''_{\Gamma} = (\Sigma''_{\Gamma}, P^{V''}, \mathcal{L}'')$$

be objects of $\Lambda_{\mathcal{C}}(\Gamma)$ and let M_{Γ} be a cobordism with corners from Σ_{Γ} to Σ''_{Γ} . The linear map

$$\begin{aligned} \pi_{\mathcal{C}} : \mathcal{S}_{\mathcal{C}}(M_{\Gamma}; P^V, P^{V''}) &\rightarrow \text{Hom}_{\Lambda_{\mathcal{C}}(\Gamma)}(\Sigma_{\Gamma}, \Sigma''_{\Gamma}) \\ T^{\varphi} &\mapsto [M_{\Gamma}, T^{\varphi}, 0] \end{aligned}$$

is well-defined.

PROOF. First of all, if

$$\sum_{i=1}^k \lambda_i \cdot T_i^{\varphi_i}$$

is a \mathcal{C} -skein relation in $\mathcal{S}_{\mathcal{C}}(M_{\Gamma}; P^V, P''V'')$ then we have to show that

$$\sum_{i=1}^k \lambda_i \cdot (\text{WRT}_{\mathcal{C}})_{\Gamma}(M_{\Gamma}, T_i^{\varphi_i}, 0) = 0$$

for the natural transformations

$$(\text{WRT}_{\mathcal{C}})_{\Gamma}(M_{\Gamma}, T_i^{\varphi_i}, 0) : (\text{WRT}_{\mathcal{C}})_{\Gamma}(\Sigma_{\Gamma}) \Rightarrow (\text{WRT}_{\mathcal{C}})_{\Gamma}(\Sigma''_{\Gamma})$$

coming from the extended universal construction (see Appendix A.7 for a definition). In particular, it suffices to show that $\text{WRT}_{\mathcal{C}}$ vanishes on $\mathcal{X}(\text{id}_{\emptyset}, \text{id}_{\emptyset})$. This is true thanks to the very definition of $\text{WRT}_{\mathcal{C}}$ in terms of the Reshetikhin-Turaev functor $F_{\mathcal{C}}$. \square

REMARK 1.7.2. The same result holds also for the contravariant universal linear categories associated with $\text{WRT}_{\mathcal{C}}$. In other words, vectors in morphism spaces of contravariant universal linear categories are invariant under skein equivalence just like vectors in morphism spaces of covariant universal linear categories.

1.8. Morita reduction

We use here the results of the previous sections in order to give a better description for covariant universal linear categories associated with the Witten-Reshetikhin-Turaev invariant, to which we will confine from now on. In particular, we give for every covariant universal linear category both an explicit description of a dominating set and a triviality criterion for morphisms. This will allow for a proof in the following sections of the monoidality of the completion of the quantization 2-functor produced by the extended universal construction.

Let Σ_{Γ} be a cobordism from \emptyset to Γ . A *fundamental ribbon set* P for Σ_{Γ} is a ribbon set inside Σ_{Γ} given by a single positive ribbon vertex in every component of Σ_{Γ} . If P is a fundamental ribbon set for Σ_{Γ} then a *fundamental \mathcal{C} -coloring* V of P is a \mathcal{C} -coloring satisfying $V(p) \in \Gamma(\mathcal{C})$ for every $p \in P$. We denote with $\mathcal{F}(P)$ the set of fundamental \mathcal{C} -colorings of P .

REMARK 1.8.1. If P is a fundamental ribbon set for Σ_{Γ} and if we have a fixed choice for a Lagrangian $\mathcal{L} \subset H^1(\Sigma_{\Gamma}; \mathbb{R})$ then we denote with $(\Sigma_{\Gamma})_V$ the object of $\Lambda_{\mathcal{C}}(\Gamma)$ given by

$$(\Sigma_{\Gamma}, P^V, \mathcal{L})$$

for every fundamental \mathcal{C} -coloring V of P .

LEMMA 1.8.1. *Let Γ be an object of $\mathbf{Cob}_3^{\mathcal{C}}$, let Σ_{Γ} be a non-empty cobordism from \emptyset to Γ , let P be a fundamental ribbon set for Σ_{Γ} and let $\mathcal{L} \subset H^1(\Sigma_{\Gamma}; \mathbb{R})$ be a Lagrangian. Then*

$$D(\Sigma_{\Gamma}) := \{(\Sigma_{\Gamma})_V \mid V \in \mathcal{F}(P)\}$$

dominates $\Lambda_{\mathcal{C}}(\Gamma)$.

PROOF. Let $\Sigma''_{\Gamma} = (\Sigma''_{\Gamma}, P''V'', \mathcal{L}'')$ and $\Sigma'''_{\Gamma} = (\Sigma'''_{\Gamma}, P'''V''', \mathcal{L}''')$ be objects of $\Lambda_{\mathcal{C}}(\Gamma)$. If M_{Γ} is a connected cobordism with corners from Σ''_{Γ} to Σ_{Γ} and if M'_{Γ} is a connected cobordism with corners from Σ_{Γ} to Σ'''_{Γ} then, thanks to Lemma 1.5.2, every morphism of $\text{Hom}_{\Lambda_{\mathcal{C}}(\Gamma)}(\Sigma''_{\Gamma}, \Sigma'''_{\Gamma})$ can be described by some linear combination of \mathcal{C} -skeins inside $M_{\Gamma} \cup_{\Sigma_{\Gamma}} M'_{\Gamma}$ relative to $P''V''$ and $P'''V'''$. But thanks to the semisimplicity of \mathcal{C} every such \mathcal{C} -skein can be written, up to isotopy and skein equivalence, as a linear combination of \mathcal{C} -skeins whose \mathcal{C} -colored ribbon graphs

meet Σ_Γ transversely in P inducing a fundamental \mathcal{C} -coloring of P . In other words every morphism

$$[M_\Gamma \cup_{\Sigma_\Gamma} M''_\Gamma, T^\varphi, 0] \in \text{Hom}_{\Lambda_{\mathcal{C}}(\Gamma)}(\Sigma''_\Gamma, \Sigma''_\Gamma)$$

can be decomposed as

$$\sum_{i=1}^k \lambda_i \cdot \left[\left(M''_\Gamma, T_i^{\varphi''}, 0 \right) * \left(M_\Gamma, T_i^{\varphi}, \omega_i, 0 \right) \right]$$

for some fundamental \mathcal{C} -colorings V_i of P , for some \mathcal{C} -skein $T_i^{\varphi''}$ inside M''_Γ relative to $P''^{V''}$ and P^{V_i} and for some \mathcal{C} -skein T_i^{φ} inside M_Γ relative to P^{V_i} and $P''^{V''}$ for every $i = 1, \dots, k$. \square

If P is a ribbon graph inside a 2-dimensional cobordism Σ from Γ to Γ' then we will denote with \bar{P} the ribbon graph inside the cobordism $\bar{\Sigma}$ from Γ' to Γ whose oriented vertex set \bar{P} is obtained from P by reversing the orientation of every vertex and whose framing at \bar{p} is given by the framing of P at p for every $\bar{p} \in \bar{P}$.

If V is a \mathcal{C} -coloring of P then \bar{V} will denote the \mathcal{C} -coloring of \bar{P} defined by $\bar{V}(\bar{p}) = V(p)$ for every $\bar{p} \in \bar{P}$.

Let Σ'_Γ be a cobordism from Γ to \emptyset . A ribbon set $P' \subset \Sigma'_\Gamma$ is a *fundamental ribbon set* for Σ'_Γ if \bar{P}' is a fundamental ribbon set for $\bar{\Sigma}'_\Gamma$. Let P' be a fundamental ribbon set for Σ'_Γ . A *fundamental \mathcal{C} -coloring V' of P'* is a \mathcal{C} -coloring such that \bar{V}' is a fundamental \mathcal{C} -coloring of \bar{P}' . We denote with $\mathcal{F}(P')$ the set of fundamental \mathcal{C} -colorings of P' .

REMARK 1.8.2. If P' is a fundamental ribbon set for Σ'_Γ and if we have a fixed choice for a Lagrangian $\mathcal{L}' \subset H^1(\Sigma'_\Gamma; \mathbb{R})$ then we denote with $(\Sigma'_\Gamma)_{V'}$ the object of $\Lambda'_{\mathcal{C}}(\Gamma)$ the 1-morphism of $\mathbf{Cob}_3^{\mathcal{C}}$ given by

$$(\Sigma'_\Gamma, P'^{V'}, \mathcal{L}')$$

for every fundamental \mathcal{C} -coloring V' of P' .

LEMMA 1.8.2. *Let Γ be an object of $\mathbf{Cob}_3^{\mathcal{C}}$, let*

$$\Sigma_\Gamma = (\Sigma_\Gamma, P^V, \mathcal{L}), \quad \Sigma''_\Gamma = (\Sigma''_\Gamma, P''^{V''}, \mathcal{L}'')$$

be objects of $\Lambda_{\mathcal{C}}(\Gamma)$ and let $M_{1,\Gamma}, \dots, M_{k,\Gamma} : \Sigma_\Gamma \Rightarrow \Sigma''_\Gamma$ be 2-morphisms of $\mathbf{Cob}_3^{\mathcal{C}}$. Let Σ'_Γ be a non-empty cobordism from Γ to \emptyset , let P' be a fundamental ribbon set for Σ'_Γ , let $\mathcal{L}' \subset H^1(\Sigma'_\Gamma; \mathbb{R})$ be a Lagrangian, let M be a connected cobordism with corners from \emptyset to $\Sigma_\Gamma \cup_\Gamma \Sigma'_\Gamma$ and let M' be a connected cobordism with corners from $\Sigma''_\Gamma \cup_\Gamma \Sigma'_\Gamma$ to \emptyset . Then a linear combination $\sum_{i=1}^k \lambda_i \cdot [M_{i,\Gamma}]$ determines a trivial morphism in $\text{Hom}_{\Lambda_{\mathcal{C}}(\Gamma)}(\Sigma_\Gamma, \Sigma''_\Gamma)$ if and only if

$$\sum_{i=1}^k \lambda_i \text{WRT}_{\mathcal{C}} \left((M', T'^{\varphi'}, 0) * \left(\text{id}_{(\Sigma'_\Gamma)_{V'}} \circ M_{i,\Gamma} \right) * (M, T^\varphi, 0) \right) = 0$$

for all fundamental \mathcal{C} -colorings V' of P' , for all \mathcal{C} -skeins T^φ inside M relative to \emptyset^\emptyset and $P^V \cup P'^{V'}$ and for all \mathcal{C} -skeins $T'^{\varphi'}$ inside M' relative to $P''^{V''} \cup P'^{V'}$ and \emptyset^\emptyset .

PROOF. The vector

$$\sum_{i=1}^k \lambda_i \cdot [\mathbb{M}_{i,\Gamma}] \in \text{Hom}_{\Lambda_{\mathcal{E}}(\Gamma)}(\Sigma_{\Gamma}, \Sigma''_{\Gamma})$$

is trivial if and only if

$$\sum_{i=1}^k \lambda_i \cdot (\text{WRT}_{\mathcal{E}})_{\Gamma}(\mathbb{M}_{i,\Gamma}) = 0.$$

This happens if and only if we have the equality

$$\sum_{i=1}^k \lambda_i \text{WRT}_{\mathcal{E}}(\mathbb{M}''' * (\text{id}_{\Sigma''_{\Gamma}} \circ \mathbb{M}_{i,\Gamma}) * \mathbb{M}'') = 0$$

for every object

$$\Sigma'''_{\Gamma} = (\Sigma'''_{\Gamma}, \mathbb{P}'''V''', \mathcal{L}''')$$

of $\Lambda'_{\mathcal{E}}(\Gamma)$ and for all 2-morphisms $\mathbb{M}'' : \text{id}_{\emptyset} \Rightarrow \Sigma''_{\Gamma} \circ \Sigma_{\Gamma}$ and $\mathbb{M}''' : \Sigma''_{\Gamma} \circ \Sigma'_{\Gamma} \Rightarrow \text{id}_{\emptyset}$ of $\mathbf{Cob}_3^{\mathcal{E}}$ of the form

$$\mathbb{M}'' = (\mathbb{M}'', \mathbb{T}''\varphi'', n''), \quad \mathbb{M}''' = (\mathbb{M}''', \mathbb{T}'''\varphi''', n''').$$

But, just like in the proof of Lemma 1.8.1, we can use Lemma 1.5.3, isotopy and skein equivalence to obtain a decomposition

$$[\text{id}_{\Sigma''_{\Gamma}}] = \sum_{j=1}^{\ell} \mu_j \cdot [\mathbb{M}''_{\Gamma}, \mathbb{T}'''\varphi''', 0] * [\mathbb{M}'_{\Gamma}, \mathbb{T}''\varphi'_j, 0]$$

for some connected cobordisms with corners \mathbb{M}'_{Γ} from Σ''_{Γ} to Σ'_{Γ} and \mathbb{M}''_{Γ} from Σ'_{Γ} to Σ''_{Γ} , and for some \mathcal{E} -skeins $\mathbb{T}''\varphi'_j$ inside \mathbb{M}'_{Γ} relative to $\mathbb{P}'''V'''$ and $\mathbb{P}''V'_j$ and $\mathbb{T}'''\varphi'''$ inside \mathbb{M}''_{Γ} relative to $\mathbb{P}''V'_j$ and $\mathbb{P}'''V'''$ for all $j = 1, \dots, \ell$. Now we can apply Lemma 1.5.2 to

$$[(\mathbb{M}'_{\Gamma}, \mathbb{T}''\varphi'_j, 0) \circ \text{id}_{\Sigma_{\Gamma}}] * [\mathbb{M}'']$$

and to

$$[\mathbb{M}'''] * [(\mathbb{M}''_{\Gamma}, \mathbb{T}'''\varphi''', 0) \circ \text{id}_{\Sigma'_{\Gamma}}]$$

in order to conclude. \square

1.9. Monoidality

In this section we prove the main result: if \mathcal{E} is modular then the covariant quantization 2-functor $\mathbf{E}_{\mathcal{E}} : \mathbf{Cob}_3^{\mathcal{E}} \rightarrow \hat{\mathbf{Cat}}_{\mathbb{C}}$ is an ETQFT.

We begin by studying the universal linear category $\Lambda_{\mathcal{E}}(\emptyset)$.

Let P_{S^2} denote the fundamental ribbon set for S^2 given by

$$P_{S^2} = \{p\} = \{(0, 0, 1)\} \subset S^2$$

with framing tangent to

$$\{(x, y, z) \in S^2 \mid y = 0\}.$$

For every $i \in I$ we simply denote with i the fundamental \mathcal{E} -coloring of P_{S^2} determined by $i(p) = V_i$, and we denote with S_i^2 the object of $\Lambda_{\mathcal{E}}(\emptyset)$ given by

$$(S^2, P_{S^2}^i, \{0\}).$$

Such an object will be called an *i-colored 2-sphere*.

LEMMA 1.9.1. *For all $i, i'' \in I$ we have*

$$\dim_{\mathbb{C}} \text{Hom}_{\Lambda_{\mathcal{E}}(\emptyset)} (\mathbb{S}_i^2, \mathbb{S}_{i''}^2) = \delta_{i,0} \delta_{i'',0}.$$

PROOF. Thanks to Lemma 1.5.2 we know that every morphism in

$$\text{Hom}_{\Lambda_{\mathcal{E}}(\emptyset)} (\mathbb{S}_i^2, \mathbb{S}_{i''}^2)$$

can be represented by some linear combination of \mathcal{E} -skeins inside the trivial cobordism with corners $S^2 \times I$ relative to $P_{S^2}^i$ and $P_{S^2}^{i''}$. Up to isotopy and skein equivalence we can moreover restrict to \mathcal{E} -skeins T_C^f consisting of an oriented graph T_C contained in

$$\{(x, y, z), t) \in S^2 \times I \mid y = 0\}$$

featuring a single coupon C with color $f \in \text{Hom}_{\mathcal{E}}(V_i, V_{i''})$ like the one represented in Figure 8.

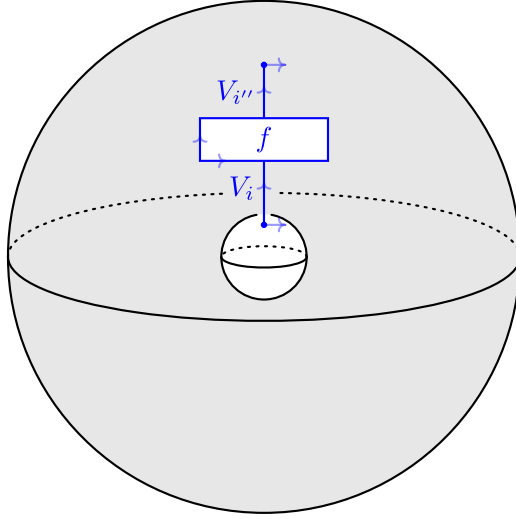

FIGURE 8. The \mathcal{E} -colored ribbon graph T_C^f inside $S^2 \times I$.

In other words, what we have is a surjective linear map from $\text{Hom}_{\mathcal{E}}(V_i, V_{i''})$ to $\text{Hom}_{\Lambda_{\mathcal{E}}(\emptyset)}(\mathbb{S}_i^2, \mathbb{S}_{i''}^2)$ whose kernel is to be determined. The semisimplicity of \mathcal{E} immediately implies

$$\dim_{\mathbb{C}} \text{Hom}_{\Lambda_{\mathcal{E}}(\emptyset)} (\mathbb{S}_i^2, \mathbb{S}_{i''}^2) \leq \delta_{i,i''}.$$

When $i = i''$ we can specify $\overline{S^2}$ as a non-empty 2-dimensional cobordism from \emptyset to \emptyset , we can specify $S^2 \times \overline{I}$ as a 3-dimensional cobordism with corners from \emptyset to $S^2 \sqcup \overline{S^2}$ and we can specify $S^2 \times I$ as a 3-dimensional cobordism with corners from $S^2 \sqcup \overline{S^2}$ to \emptyset . Then, thanks to Lemma 1.8.2, the triviality of the vector $[S^2 \times I, T_C^f, 0]$ in $\text{Hom}_{\Lambda_{\mathcal{E}}(\emptyset)}(\mathbb{S}_i^2, \mathbb{S}_{i''}^2)$ can be tested by choosing $P_{S^2}^i := \overline{P_{S^2}}$ as a fundamental ribbon set, by considering all fundamental \mathcal{E} -colorings i' of $P_{S^2}^i$, by considering all \mathcal{E} -skeins $T^{\varphi'}$ inside $S^2 \times \overline{I}$ relative to \emptyset^{\emptyset} and $P_{S^2}^i \sqcup P_{S^2}^{i'}$, by considering all \mathcal{E} -skeins $T^{\varphi''}$ inside $S^2 \times I$ relative to $P_{S^2}^{i''} \sqcup P_{S^2}^{i'}$ and \emptyset^{\emptyset} and by computing the Witten-Reshetikhin-Turaev invariant $\text{WRT}_{\mathcal{E}}$ on the resulting closed 2-morphism of $\mathbf{Cob}_3^{\mathcal{E}}$. Up to isotopy, skein equivalence and multiplication by some non-zero scalar this

amounts to evaluating the Reshetikhin-Turaev functor $F_{\mathcal{C}}$ against the \mathcal{C} -colored ribbon graph $T^{\varphi_{f,f'}}$ of Figure 9 for all

$$f \in \text{Hom}_{\mathcal{C}}(\mathbb{1}, V_i \otimes V_{i'}^*), \quad f' \in \text{Hom}_{\mathcal{C}}(V_i \otimes V_{i'}^*, \mathbb{1}).$$

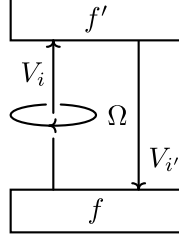

FIGURE 9. The \mathcal{C} -colored ribbon graph $T^{\varphi_{f,f'}}$.

Then the modularity condition for \mathcal{C} gives

$$\dim_{\mathbb{C}} \text{Hom}_{\Lambda_{\mathcal{C}}(\emptyset)}(\mathbb{S}_i^2, \mathbb{S}_i^2) \leq \delta_{i,0}.$$

The dimension of $\text{Hom}_{\Lambda_{\mathcal{C}}(\emptyset)}(\mathbb{S}_0^2, \mathbb{S}_0^2)$ is furthermore exactly equal to 1 because the non-triviality of $[\text{id}_{\mathbb{S}_0^2}]$ follows from the evaluation of $F_{\mathcal{C}}$ against $T^{\varphi_{f,f'}}$ for

$$f = \text{coev}_{\mathbb{1}} \in \text{Hom}_{\mathcal{C}}(\mathbb{1}, \mathbb{1} \otimes \mathbb{1}^*), \quad f' = \tilde{\text{ev}}_{\mathbb{1}} \in \text{Hom}_{\mathcal{C}}(\mathbb{1} \otimes \mathbb{1}^*, \mathbb{1}).$$

□

DEFINITION 1.9.1. The *0-colored 3-disc*

$$\mathbb{D}_0^3 : \text{id}_{\emptyset} \Rightarrow \mathbb{S}_0^2$$

is the 2-morphism of $\mathbf{Cob}_3^{\mathcal{C}}$ given by

$$(\mathbb{D}^3, (T_0^1)^{\text{id}_1}, 0)$$

where $(T_0^1)^{\text{id}_1}$ is the \mathcal{C} -colored ribbon graph contained in

$$\{(x, y, z) \in D^3 \mid y = 0\}$$

and represented in the left-hand part of Figure 19 whose only coupon is colored with $\text{id}_{\mathbb{1}}$.

DEFINITION 1.9.2. The *inverse 0-colored 3-disc*

$$\overline{\mathbb{D}}_0^3 : \mathbb{S}_0^2 \Rightarrow \text{id}_{\emptyset}$$

is the 2-morphism of $\mathbf{Cob}_3^{\mathcal{C}}$ given by

$$(\overline{\mathbb{D}}^3, (T_1^0)^{\text{id}_1}, 0)$$

where $(T_1^0)^{\text{id}_1}$ is the \mathcal{C} -colored ribbon graph contained in

$$\{(x, y, z) \in \overline{D}^3 \mid y = 0\}$$

and represented in the right-hand part of Figure 19 whose only coupon is colored with $\text{id}_{\mathbb{1}}$.

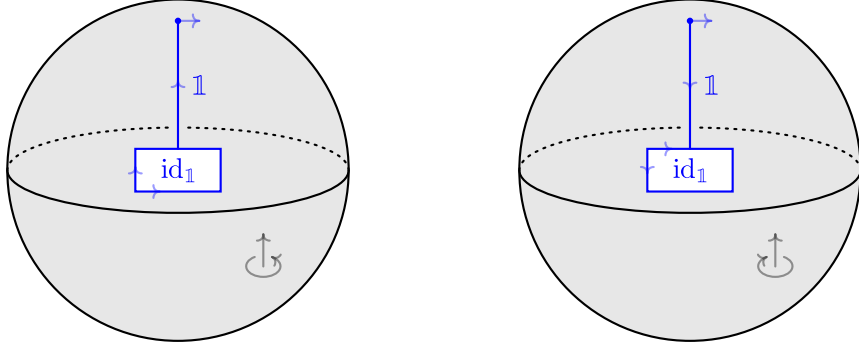

FIGURE 10. The 0-colored 3-disc \mathbb{D}_0^3 and the inverse 0-colored 3-disc $\overline{\mathbb{D}}_0^3$. The ribbon graphs T_0^1 and T_1^0 are represented in blue with blackboard framing. The arrows on the faces of the coupons specify the orientations of their horizontal boundaries and of their vertical boundaries.

LEMMA 1.9.2. *We have the equality*

$$\mathcal{D} \cdot [\mathbb{D}_0^3 * \overline{\mathbb{D}}_0^3] = [\text{id}_{\mathbb{S}_0^2}]$$

between vectors of $\text{Hom}_{\Lambda_{\mathcal{E}}(\emptyset)}(\mathbb{S}_0^2, \mathbb{S}_0^2)$.

PROOF. This result is an immediate consequence of the index 1 surgery axiom. \square

REMARK 1.9.1. Since the equality

$$\mathcal{D} \cdot [\overline{\mathbb{D}}_0^3 * \mathbb{D}_0^3] = [\text{id}_{\text{id}_{\emptyset}}]$$

follows immediately from the index 0 surgery axiom, we have

$$\mathcal{D} \cdot [\overline{\mathbb{D}}_0^3] = [\mathbb{D}_0^3]^{-1} \in \text{Hom}_{\Lambda_{\mathcal{E}}(\emptyset)}(\mathbb{S}_0^2, \text{id}_{\emptyset})$$

and the objects id_{\emptyset} and \mathbb{S}_0^2 of $\Lambda_{\mathcal{E}}(\emptyset)$ are isomorphic.

REMARK 1.9.2. If V is an object of a linear category Λ then we denote with $V : \mathbb{C} \rightarrow \Lambda$ the linear functor mapping the unique object of the unit linear category \mathbb{C} to V .

THEOREM 1.9.1. *The linear functor $\text{id}_{\emptyset} : \mathbb{C} \rightarrow \Lambda_{\mathcal{E}}(\emptyset)$ is a Morita equivalence.*

PROOF. $\Lambda_{\mathcal{E}}(\emptyset)$ is dominated by the set $\{\text{id}_{\emptyset}\}$, as follows immediately from Lemmas 1.8.1, 1.9.1 and 1.9.2 and from Theorem A.5.1. \square

Let us define the 2-transformation

$$\eta : \boxtimes \circ (\mathbf{E}_{\mathcal{E}} \times \mathbf{E}_{\mathcal{E}}) \Rightarrow \mathbf{E}_{\mathcal{E}} \circ \otimes$$

as follows: with every object (Γ, Γ') of $\mathbf{Cob}_3^{\mathcal{E}} \times \mathbf{Cob}_3^{\mathcal{E}}$ the 2-transformation η associates the linear functor

$$\eta_{\Gamma, \Gamma'} : \Lambda_{\mathcal{E}}(\Gamma) \boxtimes \Lambda_{\mathcal{E}}(\Gamma') \rightarrow \Lambda_{\mathcal{E}}(\Gamma \otimes \Gamma')$$

mapping every object $(\Sigma_\Gamma, \Sigma_{\Gamma'})$ of $\Lambda_{\mathcal{G}}(\Gamma) \boxtimes \Lambda_{\mathcal{G}}(\Gamma')$ to the object $\Sigma_\Gamma \otimes \Sigma_{\Gamma'}$ of $\Lambda_{\mathcal{G}}(\Gamma \otimes \Gamma')$ and mapping every morphism

$$[\mathbb{M}_\Gamma] \otimes [\mathbb{M}_{\Gamma'}]$$

of $\text{Hom}_{\Lambda_{\mathcal{G}}(\Gamma)}(\Sigma_\Gamma, \Sigma''_\Gamma) \otimes \text{Hom}_{\Lambda_{\mathcal{G}}(\Gamma')}(\Sigma_{\Gamma'}, \Sigma''_{\Gamma'})$ to the morphism

$$[\mathbb{M}_\Gamma \otimes \mathbb{M}_{\Gamma'}]$$

of $\text{Hom}_{\Lambda_{\mathcal{G}}(\Gamma \otimes \Gamma')}(\Sigma_\Gamma \otimes \Sigma_{\Gamma'}, \Sigma''_\Gamma \otimes \Sigma''_{\Gamma'})$. With every 1-morphism

$$(\Sigma, \Sigma') : (\Gamma, \Gamma') \rightarrow (\Gamma'', \Gamma''')$$

of $\mathbf{Cob}_3^{\mathcal{G}} \times \mathbf{Cob}_3^{\mathcal{G}}$ the 2-transformation $\boldsymbol{\eta}$ associates the natural transformation

$$\boldsymbol{\eta}_{\Sigma, \Sigma'} : F_{\mathcal{G}}(\Sigma \otimes \Sigma') \circ \boldsymbol{\eta}_{\Gamma, \Gamma'} \Rightarrow \boldsymbol{\eta}_{\Gamma'', \Gamma'''} \circ (F_{\mathcal{G}}(\Sigma) \boxtimes F_{\mathcal{G}}(\Sigma'))$$

associating with every object $(\Sigma_\Gamma, \Sigma_{\Gamma'})$ of $\Lambda_{\mathcal{G}}(\Gamma) \boxtimes \Lambda_{\mathcal{G}}(\Gamma')$ the morphism⁹

$$\text{id}_{(\Sigma \circ \Sigma_\Gamma) \otimes (\Sigma' \circ \Sigma_{\Gamma'})}$$

of $\text{Hom}_{\Lambda_{\mathcal{G}}(\Gamma'' \otimes \Gamma''')}((\Sigma \circ \Sigma_\Gamma) \otimes (\Sigma' \circ \Sigma_{\Gamma'}), (\Sigma \otimes \Sigma') \circ (\Sigma_\Gamma \otimes \Sigma_{\Gamma'}))$.

THEOREM 1.9.2. *For all objects Γ and Γ' of $\mathbf{Cob}_3^{\mathcal{G}}$ the linear functor*

$$\boldsymbol{\eta}_{\Gamma, \Gamma'} : \Lambda_{\mathcal{G}}(\Gamma) \boxtimes \Lambda_{\mathcal{G}}(\Gamma') \rightarrow \Lambda_{\mathcal{G}}(\Gamma \otimes \Gamma')$$

is a Morita equivalence.

PROOF. If $\Lambda_{\mathcal{G}}(\Gamma)$ is dominated by

$$D(\Sigma_\Gamma) = \{(\Sigma_\Gamma)_V \mid V \in \mathcal{F}(\mathbb{P})\}$$

and if $\Lambda_{\mathcal{G}}(\Gamma')$ is dominated by

$$D(\Sigma_{\Gamma'}) = \{(\Sigma_{\Gamma'})_{V'} \mid V' \in \mathcal{F}(\mathbb{P}')\}$$

then $\Lambda_{\mathcal{G}}(\Gamma \otimes \Gamma')$ is dominated by

$$D(\Sigma_\Gamma \sqcup \Sigma_{\Gamma'}) = \{(\Sigma_\Gamma)_V \otimes (\Sigma_{\Gamma'})_{V'} \mid V \in \mathcal{F}(\mathbb{P}), V' \in \mathcal{F}(\mathbb{P}')\}.$$

Therefore $\boldsymbol{\eta}_{\Gamma, \Gamma'}$ clearly defines a bijection between generators.

To see that it is faithful let us consider objects $\Sigma_\Gamma, \Sigma''_\Gamma$ of $\Lambda_{\mathcal{G}}(\Gamma)$, objects $\Sigma_{\Gamma'}, \Sigma''_{\Gamma'}$ of $\Lambda_{\mathcal{G}}(\Gamma')$, coefficients $\lambda_1, \dots, \lambda_k \in \mathbb{C}$ and morphisms

$$\begin{aligned} [\mathbb{M}_{1, \Gamma}], \dots, [\mathbb{M}_{k, \Gamma}] &\in \text{Hom}_{\Lambda_{\mathcal{G}}(\Gamma)}(\Sigma_\Gamma, \Sigma''_\Gamma), \\ [\mathbb{M}_{1, \Gamma'}], \dots, [\mathbb{M}_{k, \Gamma'}] &\in \text{Hom}_{\Lambda_{\mathcal{G}}(\Gamma')}(\Sigma_{\Gamma'}, \Sigma''_{\Gamma'}) \end{aligned}$$

satisfying

$$\sum_{i=1}^k \lambda_i \cdot \boldsymbol{\eta}_{\Gamma, \Gamma'}([\mathbb{M}_{i, \Gamma}] \otimes [\mathbb{M}_{i, \Gamma'}]) = 0.$$

Then for every object Σ'_Γ of $\Lambda'_{\mathcal{G}}(\Gamma)$, for every object $\Sigma'_{\Gamma'}$ of $\Lambda'_{\mathcal{G}}(\Gamma')$ and for all 2-morphisms

$$\begin{aligned} \mathbb{M} : \text{id}_\emptyset &\Rightarrow (\Sigma'_\Gamma \circ \Sigma_\Gamma), & \mathbb{M}' : \text{id}_\emptyset &\Rightarrow (\Sigma'_{\Gamma'} \circ \Sigma_{\Gamma'}), \\ \mathbb{M}'' : (\Sigma'_\Gamma \circ \Sigma''_\Gamma) &\Rightarrow \text{id}_\emptyset, & \mathbb{M}''' : (\Sigma'_{\Gamma'} \circ \Sigma''_{\Gamma'}) &\Rightarrow \text{id}_\emptyset \end{aligned}$$

⁹We simply confuse $(\Sigma \otimes \Sigma') \circ (\Sigma_\Gamma \otimes \Sigma_{\Gamma'})$ with $(\Sigma \circ \Sigma_\Gamma) \otimes (\Sigma' \circ \Sigma_{\Gamma'})$ by a very slight abuse of notation.

of $\mathbf{Cob}_3^{\mathcal{C}}$ we have the equality

$$\begin{aligned} & \text{WRT}_{\mathcal{C}} \left((\mathbb{M}'' \otimes \mathbb{M}''') * ((\text{id}_{\Sigma'_\Gamma} \otimes \text{id}_{\Sigma'_\Gamma}) \circ (\mathbb{M}_{i,\Gamma} \otimes \mathbb{M}_{i,\Gamma'})) * (\mathbb{M} \otimes \mathbb{M}') \right) \\ &= \text{WRT}_{\mathcal{C}} (\mathbb{M}'' * (\text{id}_{\Sigma'_\Gamma} \circ \mathbb{M}_{i,\Gamma}) * \mathbb{M}) \text{WRT}_{\mathcal{C}} (\mathbb{M}''' * (\text{id}_{\Sigma'_\Gamma} \circ \mathbb{M}_{i,\Gamma'}) * \mathbb{M}') \end{aligned}$$

for every $i = 1, \dots, k$. This implies

$$\sum_{i=1}^k \lambda_i \cdot ([\mathbb{M}_{i,\Gamma}] \otimes [\mathbb{M}_{i,\Gamma'}]) = 0.$$

To see that $\boldsymbol{\eta}_{\Gamma,\Gamma'}$ is also full we need to show that for all objects

$$\Sigma_\Gamma = (\Sigma_\Gamma, P^V, \mathcal{L}), \quad \Sigma''_\Gamma = (\Sigma''_\Gamma, P''^{V''}, \mathcal{L}'')$$

of $\Lambda_{\mathcal{C}}(\Gamma)$ and for all objects

$$\Sigma_{\Gamma'} = (\Sigma_{\Gamma'}, P^{V'}, \mathcal{L}'), \quad \Sigma''_{\Gamma'} = (\Sigma''_{\Gamma'}, P''^{V'''}, \mathcal{L}''')$$

of $\Lambda_{\mathcal{C}}(\Gamma')$ every morphism

$$[\mathbb{M}_{\Gamma \otimes \Gamma'}] \in \text{Hom}_{\Lambda_{\mathcal{C}}(\Gamma \otimes \Gamma')} (\Sigma_\Gamma \otimes \Sigma_{\Gamma'}, \Sigma''_\Gamma \otimes \Sigma''_{\Gamma'})$$

can be written as

$$\sum_{i=1}^k \lambda_i \cdot \boldsymbol{\eta}_{\Gamma,\Gamma'} ([\mathbb{M}_{i,\Gamma}] \otimes [\mathbb{M}_{i,\Gamma'}])$$

for some coefficients $\lambda_1, \dots, \lambda_k \in \mathbb{C}$, and for some morphisms

$$\begin{aligned} & [\mathbb{M}_{1,\Gamma}], \dots, [\mathbb{M}_{k,\Gamma}] \in \text{Hom}_{\Lambda_{\mathcal{C}}(\Gamma)} (\Sigma_\Gamma, \Sigma''_\Gamma), \\ & [\mathbb{M}_{1,\Gamma'}], \dots, [\mathbb{M}_{k,\Gamma'}] \in \text{Hom}_{\Lambda_{\mathcal{C}}(\Gamma')} (\Sigma_{\Gamma'}, \Sigma''_{\Gamma'}). \end{aligned}$$

To do so let us consider connected cobordisms with corners M_Γ from Σ_Γ to $\Sigma''_\Gamma \sqcup S^2$ and $M_{\Gamma'}$ from $S^2 \sqcup \Sigma_{\Gamma'}$ to $\Sigma''_{\Gamma'}$. Then $[\mathbb{M}_{\Gamma \otimes \Gamma'}]$ can be presented by some linear combination of \mathcal{C} -skeins inside

$$(M_\Gamma \sqcup (\Sigma_{\Gamma'} \times I)) \cup_{\Sigma'_\Gamma \sqcup S^2 \sqcup \Sigma_{\Gamma'}} ((\Sigma''_\Gamma \times I) \sqcup M_{\Gamma'}).$$

Up to isotopy and skein equivalence Lemmas 1.9.1 and 1.9.2 allow us to conclude. \square

1.10. TQFT

In this section we describe the TQFT produced by $\hat{\mathbf{E}}_{\mathcal{C}}$. Indeed, as it was explained in the introduction, every ETQFT on $\mathbf{Cob}_3^{\mathcal{C}}$ yields a TQFT on $\text{Cob}_3^{\mathcal{C}}$, and linear functors associated with closed 1-morphisms of $\mathbf{Cob}_3^{\mathcal{C}}$ determine vector spaces which we explicitly characterize. When the modular category \mathcal{C} is taken to be the modular quotient of the category $\bar{U}_q \mathfrak{sl}_2\text{-mod}$ of finite-dimensional representations of the restricted version of quantum \mathfrak{sl}_2 at $q = e^{\frac{\pi i}{r}}$, then our description recovers the TQFT associated with the quantum invariants of [RT91].

We recall that the universal construction associates with the quantum invariant $\text{WRT}_{\mathcal{C}}$ on $\text{Man}_3^{\mathcal{C}}$ a covariant and a contravariant quantization functors on $\text{Cob}_3^{\mathcal{C}}$ denoted $U_{\mathcal{C}}$ and $U'_{\mathcal{C}}$ respectively. The image of an object Σ of $\text{Cob}_3^{\mathcal{C}}$ under $U_{\mathcal{C}}$ is a vector space $V_{\mathcal{C}}(\Sigma)$ called the *covariant universal vector space* of Σ given by a certain quotient, which is defined using $\text{WRT}_{\mathcal{C}}$, of the free complex vector space generated by morphisms of $\text{Cob}_3^{\mathcal{C}}$ of the form $\mathbb{M}_\Sigma : \text{id}_\emptyset \Rightarrow \Sigma$. The image of a morphism $\mathbb{M} : \Sigma \Rightarrow \Sigma'$ of $\text{Cob}_3^{\mathcal{C}}$ under $U_{\mathcal{C}}$ is a linear map $f_{\mathcal{C}}(\mathbb{M}) : V_{\mathcal{C}}(\Sigma) \rightarrow V_{\mathcal{C}}(\Sigma')$

called the *covariant universal linear map* of \mathbb{M} which maps every vector $[M_\Sigma]$ of $V_{\mathcal{G}}(\Sigma)$ to the vector $[M * M_\Sigma]$ of $V_{\mathcal{G}}(\Sigma')$.

PROPOSITION 1.10.1. *For every 1-morphism $\Sigma : \emptyset \rightarrow \emptyset$ of $\mathbf{Cob}_3^{\mathcal{G}}$ we have $V_{\mathcal{G}}(\Sigma) = \text{Hom}_{\Lambda_{\mathcal{G}}(\emptyset)}(\text{id}_\emptyset, \Sigma)$.*

PROOF. The vector spaces $V_{\mathcal{G}}(\Sigma)$ and $\text{Hom}_{\Lambda_{\mathcal{G}}(\emptyset)}(\text{id}_\emptyset, \Sigma)$ are both quotients of the free vector space generated by the set of 2-morphisms $M_\emptyset : \text{id}_\emptyset \Rightarrow \Sigma$ of $\mathbf{Cob}_3^{\mathcal{G}}$. We have to show that they are the exact same quotient. It is clear that if

$$\sum_{i=1}^k \lambda_i \cdot [M_{i,\emptyset}] = 0 \in \text{Hom}_{\Lambda_{\mathcal{G}}(\emptyset)}(\text{id}_\emptyset, \Sigma)$$

then

$$\sum_{i=1}^k \lambda_i \cdot [M_{i,\emptyset}] = 0 \in V_{\mathcal{G}}(\Sigma)$$

because, using the notation of Appendix A.7, the kernel of the linear map

$$(\text{WRT}_{\mathcal{G}})_\Sigma$$

given by the universal construction contains the kernel of the linear map

$$((\text{WRT}_{\mathcal{G}})_\emptyset)_{\text{id}_\emptyset, \Sigma}$$

determined by the linear functor $(\text{WRT}_{\mathcal{G}})_\emptyset$ given by the extended universal construction. To show that the converse is also true, let us suppose

$$\sum_{i=1}^k \lambda_i \cdot [M_{i,\Sigma}] = 0 \in V_{\mathcal{G}}(\Sigma).$$

This means

$$\sum_{i=1}^k \lambda_i \text{WRT}_{\mathcal{G}}(M' * M_{i,\Sigma}) = 0$$

for every 2-morphism $M' : \Sigma \Rightarrow \text{id}_\emptyset$ of $\mathbf{Cob}_3^{\mathcal{G}}$. Such a linear combination determines a trivial vector in $\text{Hom}_{\Lambda_{\mathcal{G}}(\emptyset)}(\text{id}_\emptyset, \Sigma)$ if

$$\sum_{i=1}^k \lambda_i \text{WRT}_{\mathcal{G}}\left(M' * \left(\text{id}_{\Sigma'_\emptyset} \circ M_{i,\Sigma}\right) * M\right) = 0$$

for every object Σ'_\emptyset of $\Lambda'_{\mathcal{G}}(\emptyset)$ and for all 2-morphisms

$$M : \text{id}_\emptyset \Rightarrow \Sigma'_\emptyset \circ \text{id}_\emptyset, \quad M' : \Sigma'_\emptyset \circ \Sigma \Rightarrow \text{id}_\emptyset$$

of $\mathbf{Cob}_3^{\mathcal{G}}$. But since

$$M' * \left(\text{id}_{\Sigma'_\emptyset} \circ M_{i,\Sigma}\right) * M = \left(M' * \left(\left(\text{id}_{\Sigma'_\emptyset} * M\right) \circ \text{id}_\Sigma\right)\right) * M_{i,\Sigma}$$

for every $i = 1, \dots, k$ we can conclude. \square

COROLLARY 1.10.1. *The covariant quantization functor $U_{\mathcal{G}}$ is a TQFT on $\mathbf{Cob}_3^{\mathcal{G}}$.*

Let us consider the linear functor

$$F_{\emptyset} : \Lambda_{\mathcal{G}}(\emptyset) \rightarrow \text{Vect}_{\mathbb{C}}^{\text{fg}}$$

mapping every object Σ_{\emptyset} of $\Lambda_{\mathcal{G}}(\emptyset)$ to the covariant universal vector space $V_{\mathcal{G}}(\Sigma_{\emptyset})$ and mapping every morphism $[\mathbb{M}_{\emptyset}]$ of $\text{Hom}_{\Lambda_{\mathcal{G}}(\emptyset)}(\Sigma_{\emptyset}, \Sigma''_{\emptyset})$ to the covariant universal linear map

$$f_{\mathcal{G}}(\mathbb{M}_{\emptyset}) : V_{\mathcal{G}}(\Sigma_{\emptyset}) \rightarrow V_{\mathcal{G}}(\Sigma''_{\emptyset}).$$

PROPOSITION 1.10.2. *The linear functor*

$$F_{\emptyset} : \Lambda_{\mathcal{G}}(\emptyset) \rightarrow \text{Vect}_{\mathbb{C}}^{\text{fg}}$$

is a Morita equivalence.

PROOF. Since $\text{Vect}_{\mathbb{C}}^{\text{fg}}$ is dominated by the unit linear category \mathbb{C} and since $V_{\mathcal{G}}(\text{id}_{\emptyset})$ is isomorphic to it as an object of $\text{Vect}_{\mathbb{C}}^{\text{fg}}$ then, thanks to Theorem A.5.1, we just need to show that F_{\emptyset} is faithful and full. In order to do so, let us fix objects $\Sigma_{\emptyset} = (\Sigma_{\emptyset}, P^V, \mathcal{L})$ and $\Sigma''_{\emptyset} = (\Sigma''_{\emptyset}, P''^{V''}, \mathcal{L}'')$ of $\Lambda_{\mathcal{G}}(\emptyset)$. We begin by showing faithfulness, so let us consider a morphism

$$\sum_{i=1}^n \lambda_i \cdot [\mathbb{M}_{i,\emptyset}] \in \text{Hom}_{\Lambda_{\mathcal{G}}(\emptyset)}(\Sigma_{\emptyset}, \Sigma''_{\emptyset})$$

satisfying

$$\sum_{i=1}^n \lambda_i \cdot f_{\mathcal{G}}(\mathbb{M}_{i,\emptyset}) = 0.$$

This means that

$$\sum_{i=1}^n \lambda_i \text{WRT}_{\mathcal{G}}(\mathbb{M}' * \mathbb{M}_{i,\emptyset} * \mathbb{M}_{\Sigma_{\emptyset}}) = 0$$

for every vector $[\mathbb{M}_{\Sigma_{\emptyset}}]$ of $V_{\mathcal{G}}(\Sigma_{\emptyset})$ and for every 2-morphism $\mathbb{M}' : \Sigma''_{\emptyset} \Rightarrow \text{id}_{\emptyset}$ of $\mathbf{Cob}_{\mathcal{G}}^{\mathcal{C}}$. Therefore we can choose connected cobordisms M from \emptyset to $\Sigma_{\emptyset} \sqcup S^2$ and M' from $\Sigma''_{\emptyset} \sqcup S^2$ to \emptyset and, thanks to Lemma 1.8.2, we have

$$\sum_{i=1}^n \lambda_i \cdot [\mathbb{M}_{i,\emptyset}] = 0$$

in $\text{Hom}_{\Lambda_{\mathcal{G}}(\emptyset)}(\Sigma_{\emptyset}, \Sigma''_{\emptyset})$ if and only if

$$\sum_{i=1}^n \lambda_i \text{WRT}_{\mathcal{G}}\left((M', T'^{\varphi'}, 0) * \mathbb{M}_{i,\emptyset} * (M_{\Sigma_{\emptyset}}, T^{\varphi}, 0)\right) = 0$$

for every index $i' \in I$, for all \mathcal{G} -skeins T^{φ} inside $M_{\Sigma_{\emptyset}}$ relative to \emptyset^{\emptyset} and $P^V \sqcup P_{S^2}^{i'}$ and for all \mathcal{G} -skeins $T'^{\varphi'}$ inside M' relative to $P''^{V''} \sqcup P_{S^2}^{i'}$ and \emptyset^{\emptyset} . Therefore faithfulness follows from Lemmas 1.9.1 and 1.9.2. Finally, in order to show fullness of F_{\emptyset} , let us choose a basis

$$\{[\mathbb{M}_{1,\Sigma_{\emptyset}}], \dots, [\mathbb{M}_{k,\Sigma_{\emptyset}}]\}$$

of $V_{\mathcal{G}}(\Sigma_{\emptyset})$, its dual basis

$$\{[\mathbb{M}'_{1,\Sigma_{\emptyset}}], \dots, [\mathbb{M}'_{k,\Sigma_{\emptyset}}]\}$$

of $V'_{\mathcal{G}}(\Sigma_{\emptyset})$ with respect to the non-degenerate pairing $\langle \cdot, \cdot \rangle_{\Sigma_{\emptyset}}$ of Remark A.7.2 and a basis

$$\{[M_{1, \Sigma''_{\emptyset}}], \dots, [M_{k'', \Sigma''_{\emptyset}}]\}$$

of $V_{\mathcal{G}}(\Sigma''_{\emptyset})$. Then a basis for $\text{Hom}_{\mathbb{C}}(V_{\mathcal{G}}(\Sigma_{\emptyset}), V_{\mathcal{G}}(\Sigma''_{\emptyset}))$ is given by the linear maps

$$f_{\mathcal{G}} \left(M_{j, \Sigma''_{\emptyset}} * M'_{i, \Sigma_{\emptyset}} \right)$$

for all $i = 1, \dots, k$ and $j = 1, \dots, k''$. \square

We complete the picture with a standard linear algebra result. Let us consider a linear functor $F : \text{Vect}_{\mathbb{C}}^{\text{fg}} \rightarrow \text{Vect}_{\mathbb{C}}^{\text{fg}}$ and let $\eta_F : F \Rightarrow (\cdot \otimes F(\mathbb{C}))$ denote the natural transformation associating with every vector space V the linear map

$$\begin{aligned} (\eta_F)_V : F(V) &\rightarrow V \otimes F(\mathbb{C}) \\ w &\mapsto \sum_{i=1}^n v_i \otimes F(f_i)(w) \end{aligned}$$

where $\{v_1, \dots, v_n\}$ is a basis of V and where $\{f_1, \dots, f_n\}$ is its dual basis of V^* .

PROPOSITION 1.10.3. *The natural transformation $\eta_F : F \Rightarrow (\cdot \otimes F(\mathbb{C}))$ is a well-defined natural isomorphism.*

PROOF. We consider the linear map

$$\begin{aligned} (\eta_F^{-1})_V : V \otimes F(\mathbb{C}) &\rightarrow F(V) \\ v \otimes x &\mapsto F(f_v)(x), \end{aligned}$$

where, for every $v \in V$, the linear map $f_v : \mathbb{C} \rightarrow V$ is determined by $f_v(1) = v$. Then $(\eta_F^{-1})_V$ is the inverse of $(\eta_F)_V$ because

$$\sum_{i=1}^n F(f_{v_i})(F(f_i)(w)) = \sum_{i=1}^n F(f_{v_i} \circ f_i)(w) = F\left(\sum_{i=1}^n f_{v_i} \circ f_i\right)(w) = w$$

for every $w \in F(V)$ and

$$\sum_{i=1}^n v_i \otimes F(f_i)(F(f_v)(x)) = \sum_{i=1}^n v_i \otimes F(f_i \circ f_v)(x) = \sum_{i=1}^n f_i(v)v_i \otimes x = v \otimes x$$

for every $v \in V$ and every $x \in F(\mathbb{C})$.

Both linear maps $(\eta_F)_V$ and $(\eta_F^{-1})_V$ are independent of the choice of the basis, because another basis $\{v'_1, \dots, v'_n\}$ of V determines a dual basis $\{f'_1, \dots, f'_n\}$ of V^* , and there exist complex numbers $a_{ij}, b_{ij} \in \mathbb{C}$ for $i, j = 1, \dots, n$ such that

$$\sum_{j=1}^n a_{ij} b_{jk} = \delta_{jk}, \quad v'_j = \sum_{i=1}^n a_{ij} v_i, \quad f'_j = \sum_{k=1}^n b_{jk} f_k.$$

Then

$$\sum_{j=1}^n v'_j \otimes F(f'_j)(w) = \sum_{i,j,k=1}^n a_{ij} b_{jk} v_i \otimes F(f_k)(w) = \sum_{i=1}^n v_i \otimes F(f_i)(w)$$

for every $w \in F(V)$.

Moreover, we have

$$(\eta_F)_{V'} \circ F(f) = (f \otimes \text{id}_{F(\mathbb{C})}) \circ (\eta_F)_V$$

for every linear map $f : V \rightarrow V'$. Indeed if $\{v'_1, \dots, v'_{n'}\}$ is a basis of V' and if $\{f'_1, \dots, f'_{n'}\}$ is its dual basis of V'^* then there exist complex numbers $c_{ij} \in \mathbb{C}$ for $i = 1, \dots, n'$ and $j = 1, \dots, n$ such that

$$f(v_j) = \sum_{i=1}^{n'} c_{ij} v'_i, \quad f'_i \circ f = \sum_{j=1}^n c_{ij} f_j.$$

Therefore

$$\begin{aligned} \sum_{i=1}^{n'} v'_i \otimes F(f'_i)(F(f)(w)) &= \sum_{i=1}^{n'} v'_i \otimes F(f'_i \circ f)(w) \\ &= \sum_{i=1}^{n'} \sum_{j=1}^n v'_i \otimes c_{ij} F(f_j)(w) \\ &= \sum_{i=1}^{n'} \sum_{j=1}^n c_{ij} v'_i \otimes F(f_j)(w) \\ &= \sum_{j=1}^n f(v_j) \otimes F(f_j)(w) \end{aligned}$$

for every $w \in F(V)$. □

REMARK 1.10.1. Lemma 1.10.3 can be used to relate the universal vector space $V_{\mathcal{E}}(\Sigma)$ of a closed 1-morphism $\Sigma : \emptyset \rightarrow \emptyset$ of $\mathbf{Cob}_3^{\mathcal{E}}$ to its universal linear functor $F_{\mathcal{E}}(\Sigma) : \Lambda_{\mathcal{E}}(\emptyset) \rightarrow \Lambda_{\mathcal{E}}(\emptyset)$ as explained in the introduction.

REMARK 1.10.2. Our goal will be to produce computations of universal vector spaces associated with closed 1-morphisms of $\mathbf{Cob}_3^{\mathcal{E}}$ in terms of the modular category \mathcal{E} . We will think about this question as follows: if $\Sigma : \emptyset \rightarrow \emptyset$ is a 1-morphism of $\mathbf{Cob}_3^{\mathcal{E}}$ then we look for a linear functor $F_{\Sigma} : \mathbb{C} \rightarrow \mathbf{Vect}_{\mathbb{C}}^{\text{fg}}$ together with a natural isomorphism¹⁰

$$\begin{array}{ccc} \mathbb{C} & \xrightarrow{F_{\Sigma}} & \mathbf{Vect}_{\mathbb{C}}^{\text{fg}} \\ \text{id}_{\emptyset} \downarrow & & \downarrow \eta_{\Sigma} \\ \Lambda_{\mathcal{E}}(\emptyset) & \xrightarrow{F_{\mathcal{E}}(\Sigma)} & \Lambda_{\mathcal{E}}(\emptyset) \\ & & \uparrow F_{\emptyset} \end{array}$$

The idea is then to try and decompose the 1-morphism $\Sigma : \emptyset \rightarrow \emptyset$ as a composition of tensor products of elementary 1-morphisms which are easier to describe and compute.

¹⁰Since the linear category \mathbb{C} features a single object, every such linear functor and every such natural isomorphism are constant, so we are actually looking for a single finitely generated vector space together with a linear isomorphism from $V_{\mathcal{E}}(\Sigma)$ to it.

1.11. Universal linear categories

We describe here covariant universal linear categories in terms of \mathcal{C} .

Let

$$F : \mathcal{C} \rightarrow \Lambda_{\mathcal{C}}(\mathbb{S}^1)$$

be the linear functor mapping every object V of \mathcal{C} to the object $\mathbb{D}_{(+,V)}^2$ of $\Lambda_{\mathcal{C}}(\mathbb{S}^1)$ given by Definition 1.7.1 and mapping every morphism f of $\text{Hom}_{\mathcal{C}}(V, V'')$ to the morphism $[(\mathbb{D}^2 \times \mathbb{I})_{T_{\mathbb{C}}^f}]$ of $\text{Hom}_{\Lambda_{\mathcal{C}}(\mathbb{S}^1)}(\mathbb{D}_{(+,V)}^2, \mathbb{D}_{(+,V'')}^2)$ given by Definition 1.7.2 for the \mathcal{C} -colored ribbon graph $T_{\mathbb{D}^2 \times \mathbb{I}}^f$ inside $\mathbb{D}^2 \times \mathbb{I}$ consisting of the oriented graph $T_{\mathbb{D}^2 \times \mathbb{I}}$ contained in

$$\{(x, y, t) \in \mathbb{D}^2 \times \mathbb{I} \mid y = 0\}$$

featuring a single coupon with color f which is represented in Figure 11.

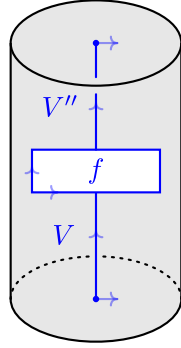

FIGURE 11. The \mathcal{C} -colored ribbon graph $T_{\mathbb{D}^2 \times \mathbb{I}}^f$ inside $\mathbb{D}^2 \times \mathbb{I}$.

THEOREM 1.11.1. *The linear functor $F : \mathcal{C} \rightarrow \Lambda_{\mathcal{C}}(\mathbb{S}^1)$ is a Morita equivalence.*

PROOF. The family of objects

$$\{\mathbb{D}_{(+,V)}^2 \mid V \in \text{Ob}(\mathcal{C})\}$$

dominates $\Lambda_{\mathcal{C}}(\mathbb{S}^1)$ thanks to Lemma 1.8.1. Therefore, thanks to Theorem A.5.1, we just need to show that F is faithful and full. In order to do so, let us fix objects V and V'' of \mathcal{C} .

To begin with, the linear map

$$F : \text{Hom}_{\mathcal{C}}(V, V'') \rightarrow \text{Hom}_{\Lambda_{\mathcal{C}}(\mathbb{S}^1)}(\mathbb{D}_{(+,V)}^2, \mathbb{D}_{(+,V'')}^2)$$

is surjective thanks to Lemmas 1.5.2 and 1.7.1.

Furthermore, in order to see that

$$F : \text{Hom}_{\mathcal{C}}(V, V'') \rightarrow \text{Hom}_{\Lambda_{\mathcal{C}}(\mathbb{S}^1)}(\mathbb{D}_{(+,V)}^2, \mathbb{D}_{(+,V'')}^2)$$

is also injective it is sufficient to use the non-degeneracy of the trace $\text{tr}_{\mathcal{C}}$ established in Lemma 1.2.2: indeed if $f \in \text{Hom}_{\mathcal{C}}(V, V'')$ is a non-trivial morphism then there exists some morphism $f' \in \text{Hom}_{\mathcal{C}}(V'', V)$ satisfying $\text{tr}_{\mathcal{C}}(f' \circ f) \neq 0$. \square

1.12. Universal linear functors

We describe covariant universal linear functors induced by a set of generating 1-morphisms of $\mathbf{Cob}_3^{\mathcal{C}}$ composed of 2-discs and 2-pants. This allows for the computation of the covariant universal vector spaces associated with closed 1-morphisms of $\mathbf{Cob}_3^{\mathcal{C}}$.

1.12.1. 2-Discs. The first family of universal linear functors we are going to analyse is equivalent to a collection of constant functors. Indeed, recall Definition 1.7.1 for the $(+, V)$ -colored 2-disc and Remark 1.9.2 for the notation we adopt for constant linear functors. For every object V of \mathcal{C} we have a commutative diagram of linear functors of the form¹¹

$$\begin{array}{ccc}
 \hat{\mathcal{C}} & \xrightarrow{\hat{V}} & \hat{\mathcal{C}} \\
 \hat{\text{id}}_{\emptyset} \downarrow & & \searrow \hat{F} \\
 \hat{\Lambda}_{\mathcal{C}}(\emptyset) & \xrightarrow{\hat{F}_{\mathcal{C}}(\mathbb{D}_{(+,V)}^2)} & \hat{\Lambda}_{\mathcal{C}}(\mathbb{S}^1)
 \end{array}$$

We move on to describe a family of universal linear functors which are equivalent to Hom functors. Indeed, let V be an object of \mathcal{C} .

DEFINITION 1.12.1. The *dual $(-, V)$ -colored 2-disc*

$$\overline{\mathbb{D}}_{(-,V)}^2 : \mathbb{S}^1 \rightarrow \emptyset$$

is the 1-morphism of $\mathbf{Cob}_3^{\mathcal{C}}$ given by

$$\left(\overline{\mathbb{D}}^2, \text{P}(-)^V, \{0\} \right).$$

We denote with B the 3-dimensional cobordism from \emptyset to $\mathbb{D}^2 \cup_{\mathbb{S}^1} \overline{\mathbb{D}}^2$ with support $B = D^3$ whose outgoing horizontal boundary identification is induced by the diffeomorphism

$$\begin{array}{ccc}
 D^2 \cup_{\mathbb{S}^1} \overline{D}^2 & \rightarrow & \partial D^3 \\
 [i, (x, y)] & \mapsto & \begin{cases} \left(-\sqrt{1-x^2-y^2}, x, y \right) & i = -1 \\ \left(\sqrt{1-x^2-y^2}, x, y \right) & i = +1 \end{cases}
 \end{array}$$

For object V in \mathcal{C} let

$$\text{Hom}_{\mathcal{C}}(V, \cdot) : \mathcal{C} \rightarrow \text{Vect}_{\mathbb{C}}^{\text{fg}}$$

be the linear functor mapping every object V' of \mathcal{C} to the vector space $\text{Hom}_{\mathcal{C}}(V, V')$ and mapping every morphism f' of $\text{Hom}_{\mathcal{C}}(V', V'')$ to the linear map

$$\begin{array}{ccc}
 \text{Hom}_{\mathcal{C}}(V, f') : \text{Hom}_{\mathcal{C}}(V, V') & \rightarrow & \text{Hom}_{\mathcal{C}}(V, V'') \\
 & f & \mapsto f' \circ f.
 \end{array}$$

¹¹The linear functor F was introduced in Theorem 1.11.1.

Then for every object V' of \mathcal{C} we define the linear map

$$\begin{aligned} (\eta_{(-, V)})_{V'} : \text{Hom}_{\mathcal{C}}(V, V') &\rightarrow V_{\mathcal{C}} \left(\overline{\mathbb{D}}_{(-, V)}^2 \circ \mathbb{D}_{(+, V')}^2 \right) \\ f &\mapsto [\mathbb{B}_f] := [\mathbb{B}, \mathbb{T}_{\mathbb{B}}^f, 0] \end{aligned}$$

where $\mathbb{T}_{\mathbb{B}}^f$ is the \mathcal{C} -colored ribbon graph contained in $\{(x, y, z) \in B \mid y = 0\}$ represented in Figure 12.

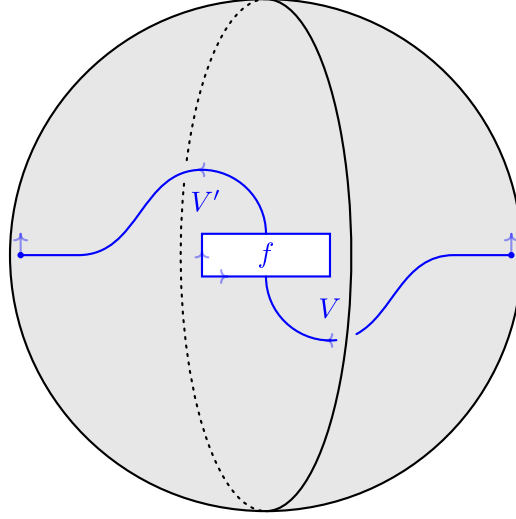

FIGURE 12. The vector $[\mathbb{B}_f]$. The ribbon graph $\mathbb{T}_{\mathbb{B}}$ is represented in blue with blackboard framing.

PROPOSITION 1.12.1. *For every object V of \mathcal{C} the collection of the linear maps $(\eta_{(-, V)})_{V'}$ defines a natural isomorphism¹²*

$$\begin{array}{ccc} \hat{\mathcal{C}} & \xrightarrow{\hat{\text{Hom}}_{\mathcal{C}}(V, \cdot)} & \hat{\text{Vect}}_{\mathbb{C}}^{\text{fg}} \\ & \searrow \hat{F} & \uparrow \hat{F}_{\emptyset} \\ & \hat{\Lambda}_{\mathcal{C}}(\mathbb{S}^1) & \hat{\Lambda}_{\mathcal{C}}(\emptyset) \\ & \hat{F}_{\mathcal{C}} \left(\overline{\mathbb{D}}_{(-, V)}^2 \right) & \end{array}$$

PROOF. The result is established by showing that the linear maps

$$(\eta_{(-, V)})_{V'} : \text{Hom}_{\mathcal{C}}(V, V') \rightarrow V_{\mathcal{C}} \left(\overline{\mathbb{D}}_{(-, V)}^2 \circ \mathbb{D}_{(+, V')}^2 \right)$$

¹²The linear functor F_{\emptyset} is given in Proposition 1.10.2.

are isomorphisms for every object V' of \mathcal{C} and that they are natural with respect to morphisms of \mathcal{C} . In order to do so, let us fix an object V' of \mathcal{C} .

To begin with, the linear map $(\eta_{(-,V)})_{V'}$ is surjective thanks to Lemmas 1.5.2 and 1.7.1.

Furthermore, in order to see that $(\eta_{(-,V)})_{V'}$ is also injective it is sufficient to use the non-degeneracy of the trace $\text{tr}_{\mathcal{C}}$ established in Lemma 1.2.2: indeed if $f \in \text{Hom}_{\mathcal{C}}(V, V')$ is a non-trivial morphism then there exists some morphism $f' \in \text{Hom}_{\mathcal{C}}(V', V)$ satisfying $\text{tr}_{\mathcal{C}}(f' \circ f) \neq 0$.

Finally, the naturality of $\eta_{(-,V)}$ is proved by checking that

$$F_{\varnothing} \left(\left[\text{id}_{\mathbb{D}_{(-,V)}^2} \circ (\mathbb{D}^2 \times \mathbb{I})_{f'} \right] \right) ([\mathbb{B}_f]) = [\mathbb{B}_{f' \circ f}]$$

for all objects V', V'' of \mathcal{C} , for every morphism f of $\text{Hom}_{\mathcal{C}}(V, V')$ and for every morphism f' of $\text{Hom}_{\mathcal{C}}(V', V'')$. \square

1.12.2. 2-Pants. We define the *2-pant cobordism* P^2 as the 2-dimensional cobordism from $S^1 \sqcup S^1$ to S^1 whose support P^2 is given by

$$D^2 \setminus \left(B \left(\left(-\frac{1}{2}, 0 \right), \frac{1}{4} \right) \cup B \left(\left(\frac{1}{2}, 0 \right), \frac{1}{4} \right) \right) \subset \mathbb{R}^2$$

where $B((x, y), \rho)$ is the open ball of center (x, y) and radius ρ in \mathbb{R}^2 , whose incoming boundary identification is given by

$$\begin{aligned} f_{P^2_-} : S^1 \sqcup S^1 &\rightarrow \partial B \left(\left(-\frac{1}{2}, 0 \right), \frac{1}{4} \right) \cup \partial B \left(\left(\frac{1}{2}, 0 \right), \frac{1}{4} \right) \\ (i, (x, y)) &\mapsto \begin{cases} \left(\frac{x-2}{4}, \frac{y}{4} \right) & i = -1 \\ \left(\frac{x+2}{4}, \frac{y}{4} \right) & i = +1 \end{cases} \end{aligned}$$

and whose outgoing boundary identification is given by id_{S^1} .

We also define the *dual 2-pant cobordism* \overline{P}^2 as the 2-dimensional cobordism from S^1 to $S^1 \sqcup S^1$ whose support is given by \overline{P}^2 , whose incoming boundary identification is given by id_{S^1} and whose outgoing boundary identification is given by $f_{P^2_-}$.

DEFINITION 1.12.2. The *2-pant*

$$\mathbb{P}^2 : S^1 \otimes S^1 \rightarrow S^1$$

is the 1-morphism of $\mathbf{Cob}_3^{\mathcal{C}}$ given by

$$(P^2, \varnothing^{\varnothing}, H_1(P^2; \mathbb{R})).$$

DEFINITION 1.12.3. The *dual 2-pant*

$$\overline{\mathbb{P}}^2 : S^1 \rightarrow S^1 \otimes S^1$$

is the 1-morphism of $\mathbf{Cob}_3^{\mathcal{C}}$ given by

$$(\overline{P}^2, \varnothing^{\varnothing}, H_1(\overline{P}^2; \mathbb{R})).$$

We begin with the study of the 2-pant cobordism, which induces a family of universal linear functors that are equivalent to tensor product functors. Let

$$\nabla : \mathcal{C} \boxtimes \mathcal{C} \rightarrow \mathcal{C}$$

be the linear functor mapping every object (V, V') of $\mathcal{C} \boxtimes \mathcal{C}$ to the object $V \otimes V'$ of \mathcal{C} and mapping every morphism of the form $f \otimes f'$ of $\text{Hom}_{\mathcal{C}}(V, V'') \otimes \text{Hom}_{\mathcal{C}}(V', V''')$ to the morphism $f \otimes f'$ of $\text{Hom}_{\mathcal{C}}(V \otimes V', V'' \otimes V''')$.

REMARK 1.12.1. For every object $(\vec{\varepsilon}, \vec{V})$ of $\text{Rib}_{\mathcal{E}}$ we have a 2-morphism

$$(\mathbb{D}^2 \times \mathbb{I})_{\text{Tid}_{V^\varepsilon}} : \mathbb{D}_{(+, V^\varepsilon)}^2 \Rightarrow \mathbb{D}_{(\vec{\varepsilon}, \vec{V})}^2$$

of $\text{Cob}_3^{\mathcal{E}}$ given by Definition 1.7.2 for the obvious morphism

$$\text{Tid}_{V^\varepsilon} : (+, V^\varepsilon) \rightarrow (\vec{\varepsilon}, \vec{V})$$

of $\text{Rib}_{\mathcal{E}}$.

For every object (V, V') of $\mathcal{E} \boxtimes \mathcal{E}$ we define $(\eta_{\nabla})_{(V, V')}$ to be the morphism

$$[(\mathbb{D}^2 \times \mathbb{I})_{\text{Tid}_{V \otimes V'}}]$$

of

$$\text{Hom}_{\Lambda_{\mathcal{E}}(\mathbb{S}^1)} \left(\mathbb{D}_{(+, V \otimes V')}^2, \mathbb{P}^2 \circ \left(\mathbb{D}_{(+, V)}^2 \otimes \mathbb{D}_{(+, V')}^2 \right) \right),$$

where we confuse the objects $\mathbb{D}_{((+, V), (+, V'))}^2$ and $\mathbb{P}^2 \circ \left(\mathbb{D}_{(+, V)}^2 \otimes \mathbb{D}_{(+, V')}^2 \right)$ of $\Lambda_{\mathcal{E}}(\mathbb{S}^1)$ by identifying them via the isomorphism induced by the obvious positive diffeomorphism from D^2 to $(D^2 \sqcup D^2) \cup_{S^1 \sqcup S^1} P^2$.

PROPOSITION 1.12.2. *The collection of the morphisms $(\eta_{\nabla})_{(V, V')}$ defines a natural isomorphism*

$$\begin{array}{ccc} \hat{\mathcal{E}} \hat{\boxtimes} \hat{\mathcal{E}} & \xrightarrow{\hat{\nabla}} & \hat{\mathcal{E}} \\ \hat{\eta}_{\mathbb{S}^1, \mathbb{S}^1} \circ (\hat{F} \hat{\boxtimes} \hat{F}) \searrow & & \downarrow \hat{F} \\ & & \hat{\eta}_{\nabla} \\ & & \hat{\Lambda}_{\mathcal{E}}(\mathbb{S}^1 \otimes \mathbb{S}^1) \xrightarrow{\hat{F}_{\mathcal{E}}(\mathbb{P}^2)} \hat{\Lambda}_{\mathcal{E}}(\mathbb{S}^1) \end{array}$$

PROOF. For every object (V, V') of $\mathcal{E} \boxtimes \mathcal{E}$ the morphism $(\eta_{\nabla})_{(V, V')}$ is clearly invertible.

In order to show the naturality of η_{∇} we have to check that

$$\begin{aligned} & (\hat{F}_{\mathcal{E}}(\mathbb{P}^2)) \left([(\mathbb{D}^2 \times \mathbb{I})_f \otimes (\mathbb{D}^2 \times \mathbb{I})_{f'}] \right) \circ [(\mathbb{D}^2 \times \mathbb{I})_{\text{Tid}_{V \otimes V'}}] \\ &= [(\mathbb{D}^2 \times \mathbb{I})_{\text{Tid}_{V'' \otimes V'''}}] \circ [(\mathbb{D}^2 \times \mathbb{I})_{f \otimes f'}] \end{aligned}$$

for every morphism of the form

$$f \otimes f' \in \text{Hom}_{\mathcal{E}}(V, V'') \otimes \text{Hom}_{\mathcal{E}}(V', V''').$$

□

Before going any further, we stop to introduce some notation which will be used in the following. We choose a fixed 3-dimensional cobordism with corners X from $D^2 \sqcup D^2$ to $D^2 \cup_{S^1} \overline{P^2}$ whose support X is given by

$$(I \times D^2) \setminus \left(B \left((0, 0, 0), \frac{1}{4} \right) \cup B \left((1, 0, 0), \frac{1}{4} \right) \right) \subset \mathbb{R}^3,$$

whose incoming horizontal boundary $\partial_{\text{h}}^{\text{b}} X$ is given by

$$\left(\partial B \left((0, 0, 0), \frac{1}{4} \right) \cup \partial B \left((1, 0, 0), \frac{1}{4} \right) \right) \cap X,$$

whose outgoing horizontal boundary $\partial_+^h X$ is given by $I \times \partial D^2$ and whose outgoing vertical boundary $\partial_+^v X$ is given by

$$(\partial I \times D^2) \setminus \left(B \left((0, 0, 0), \frac{1}{4} \right) \cup B \left((1, 0, 0), \frac{1}{4} \right) \right).$$

We can now begin with the study of the dual 2-pant cobordism, which gives rise to a family of universal linear functors that are equivalent to coproduct functors. Let

$$\Delta : \mathcal{C} \rightarrow \mathcal{C} \hat{\boxtimes} \mathcal{C}$$

be the linear functor mapping every object V of \mathcal{C} to the object¹³

$$\bigoplus_{i \in I} (V_i, V_i^* \otimes V)$$

of the completion of $\mathcal{C} \boxtimes \mathcal{C}$ and mapping every morphism f of $\text{Hom}_{\mathcal{C}}(V, V'')$ to the morphism

$$(\delta_{ij} \cdot (\text{id}_{V_i} \otimes (\text{id}_{V_i^*} \otimes f)))_{i,j \in I}$$

of

$$\text{Hom}_{\mathcal{C} \hat{\boxtimes} \mathcal{C}} \left(\bigoplus_{j \in I} (V_j, V_j^* \otimes V), \bigoplus_{i \in I} (V_i, V_i^* \otimes V'') \right).$$

Let us consider for every index j in I and for every object V of \mathcal{C} the 2-morphism

$$\mathbb{X}_{j,V} : \mathbb{D}_{(+, V_j)}^2 \otimes \mathbb{D}_{((- , V_j), (+, V))}^2 \Rightarrow \mathbb{P}^2 \circ \mathbb{D}_{(+, V)}^2$$

of $\mathbf{Cob}_3^{\mathcal{C}}$ given by

$$(X, T_X^{\varphi_{j,V}}, 0)$$

for the \mathcal{C} -skein $T_X^{\varphi_{j,V}}$ represented in Figure 13.

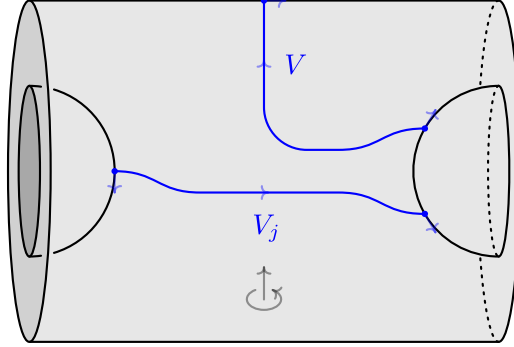

FIGURE 13. The 2-morphism $\mathbb{X}_{j,V}$ of $\mathbf{Cob}_3^{\mathcal{C}}$.

Then for every object V of \mathcal{C} we define $(\eta_{\Delta})_V$ to be the morphism

$$([\mathbb{X}_{j,V}])_{j \in I}$$

¹³See Appendix A.5 for the notation we use for completions of linear categories.

of

$$\mathrm{Hom}_{\hat{\Lambda}_{\mathcal{C}}(\mathbb{S}^1 \otimes \mathbb{S}^1)} \left(\bigoplus_{j \in I} \mathbb{D}_{(+, V_j)}^2 \otimes \mathbb{D}_{(+, V_j^* \otimes V)}^2, \bar{\mathbb{P}}^2 \circ \mathbb{D}_{(+, V)}^2 \right),$$

where we confuse the objects $\mathbb{D}_{(+, V_j^* \otimes V)}^2$ and $\mathbb{D}_{((-, V_j), (+, V)}^2$ of $\Lambda_{\mathcal{C}}(\mathbb{S}^1)$ by identifying them via the isomorphism

$$\left[(\mathbb{D}^2 \times \mathbb{I})_{\mathrm{T}^{\mathrm{id}_{V_j^* \otimes V}}} \right]$$

which was introduced in Remark 1.12.1.

PROPOSITION 1.12.3. *The collection of the morphisms $(\eta_{\Delta})_V$ defines a natural isomorphism*

$$\begin{array}{ccc} \hat{\mathcal{C}} & \xrightarrow{\hat{\Delta}} & \hat{\mathcal{C}} \hat{\boxtimes} \hat{\mathcal{C}} \\ \hat{F} \searrow & & \downarrow \hat{\eta}_{\Delta} \\ & & \hat{\Lambda}_{\mathcal{C}}(\mathbb{S}^1) \xrightarrow{\hat{F}_{\mathcal{C}}(\bar{\mathbb{P}}^2)} \hat{\Lambda}_{\mathcal{C}}(\mathbb{S}^1 \otimes \mathbb{S}^1) \\ & & \hat{\eta}_{\mathbb{S}^1, \mathbb{S}^1} \circ (\hat{F} \hat{\boxtimes} \hat{F}) \searrow \end{array}$$

PROOF. Let us consider the 2-morphisms

$$\overline{\mathbb{X}}_{i, V} : \bar{\mathbb{P}}^2 \circ \mathbb{D}_{(+, V)}^2 \Rightarrow \mathbb{D}_{(+, V_i)}^2 \otimes \mathbb{D}_{((-, V_i), (+, V)}^2)$$

of $\mathbf{Cob}_3^{\mathcal{C}}$ given by

$$\overline{\mathbb{X}}_{i, V} := (\overline{\mathbb{X}}, \mathrm{T}'_{\mathbb{X}}{}^{\varphi_{i, V}}, 0)$$

for the ribbon graph $\mathrm{T}'_{\mathbb{X}}$ represented in Figure 14.

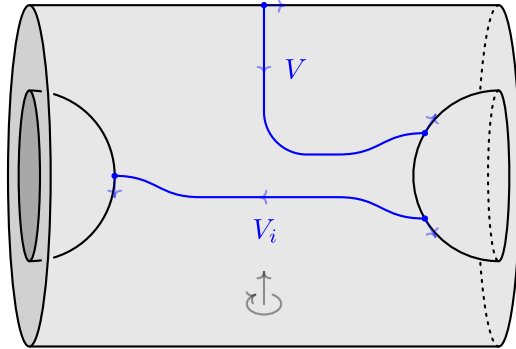

FIGURE 14. The 2-morphism $\overline{\mathbb{X}}_{i, V}$ of $\mathbf{Cob}_3^{\mathcal{C}}$.

Then the inverse of the morphism

$$([\mathbb{X}_j, V]_{j \in I})$$

of

$$\mathrm{Hom}_{\hat{\Lambda}_{\mathcal{C}}(\mathbb{S}^1 \otimes \mathbb{S}^1)} \left(\bigoplus_{j \in I} \mathbb{D}_{(+, V_j)}^2 \otimes \mathbb{D}_{(+, V_j^* \otimes V)}^2, \bar{\mathbb{P}}^2 \circ \mathbb{D}_{(+, V)}^2 \right)$$

is given by the morphism

$$\mathcal{D}^{-1} \cdot (\dim_{\mathcal{C}}(V_i) \cdot [\overline{\mathbb{X}_{i, V}}])_{i \in I}$$

of

$$\mathrm{Hom}_{\hat{\Lambda}_{\mathcal{C}}(\mathbb{S}^1 \otimes \mathbb{S}^1)} \left(\bar{\mathbb{P}}^2 \circ \mathbb{D}_{(+, V)}^2, \bigoplus_{i \in I} \mathbb{D}_{(+, V_i)}^2 \otimes \mathbb{D}_{(+, V_i^* \otimes V)}^2 \right).$$

Indeed a \mathcal{C} -skein inside $I \times S^1 \times I$ representing the composition

$$\mathcal{D} \cdot \sum_{i \in I} \dim_{\mathcal{C}}(V_i) \cdot [\mathbb{X}_{i, V} * \overline{\mathbb{X}_{i, V}}]$$

is represented in Figure 15, so that the modularity condition of Definition 1.2.2 yields the equality

$$\mathcal{D}^{-1} \cdot \sum_{i \in I} \dim_{\mathcal{C}}(V_i) \cdot [\mathbb{X}_{i, V} * \overline{\mathbb{X}_{i, V}}] = \left[\mathrm{id}_{\bar{\mathbb{P}}^2 \circ \mathbb{D}_{(+, V)}^2} \right].$$

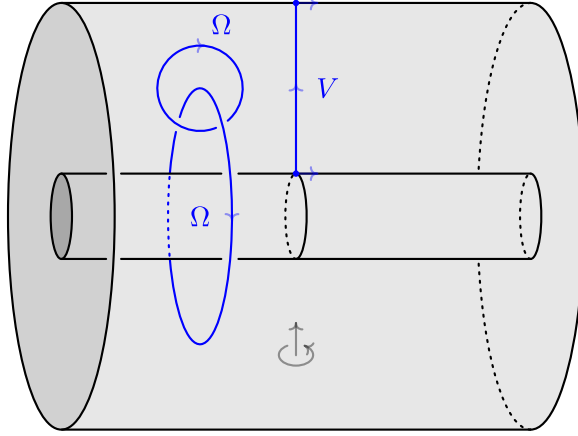

FIGURE 15. The morphism $\sum_{i \in I} \dim_{\mathcal{C}}(V_i) \cdot [\mathbb{X}_{i, V} * \overline{\mathbb{X}_{i, V}}]$.

The equality

$$\mathcal{D}^{-1} \dim_{\mathcal{C}}(V_i) \cdot [\overline{\mathbb{X}_{i, V}} * \mathbb{X}_{j, V}] = \delta_{ij} \cdot \left[\mathrm{id}_{\mathbb{D}_{(+, V_i)}^2} \otimes \mathrm{id}_{\mathbb{D}_{(+, V_i^* \otimes V)}^2} \right]$$

follows essentially from Lemma 1.8.2 and from the modularity condition of Definition 1.2.2.

In order to show the naturality of η_{Δ} we have to establish the equality

$$\left(\mathbb{F}_{\mathcal{C}}(\bar{\mathbb{P}}^2) \right) \left([(\mathbb{D}^2 \times \mathbb{I})_f] \right) \circ [\mathbb{X}_{j, V}] = [\mathbb{X}_{k, V''}] \circ \left[(\mathbb{D}^2 \times \mathbb{I})_{\mathrm{id}_{V_j}} \otimes (\mathbb{D}^2 \times \mathbb{I})_{\mathrm{id}_{V_j^* \otimes f}} \right]$$

of morphisms of

$$\mathrm{Hom}_{\tilde{\Lambda}_{\mathcal{E}}(\mathbb{S}^1 \otimes \mathbb{S}^1)} \left(\bigoplus_{j \in I} \mathbb{D}_{(+, V_j)}^2 \otimes \mathbb{D}_{(+, V_j^* \otimes V)}^2, \overline{\mathbb{P}}^2 \circ \mathbb{D}_{(+, V'')}^2 \right)$$

for every $j \in I$ and for every $f \in \mathrm{Hom}_{\mathcal{E}}(V, V'')$. This is done by using Lemma 1.8.2. \square

1.12.3. Examples of computations. For every $1 \leq n \in \mathbb{N}$ we fix an oriented trivalent graph Φ_n inside $\mathbb{R}^2 \times \{0\} \subset \mathbb{R}^3$ like the one represented in Figure 16.

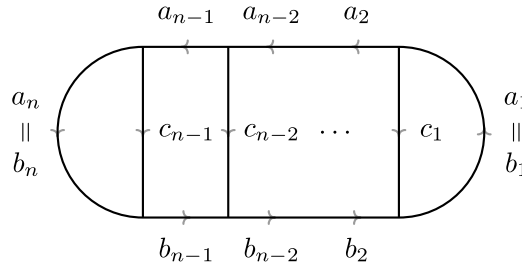

FIGURE 16. Trivalent graph of genus n . For $n = 1$ it has a unique edge a and no vertex, while for $n > 1$ it has $3n - 3$ edges, named according to the picture, and $2n - 2$ vertices.

Let Σ_n be a standard closed surface of genus n obtained as the boundary of a standard tubular neighborhood of Φ_n in \mathbb{R}^3 . We denote with $\Sigma_n : \emptyset \rightarrow \emptyset$ the 1-morphism of $\mathbf{Cob}_3^{\mathcal{E}}$ given by

$$(\Sigma_n, \emptyset^{\emptyset}, \mathcal{L}_{\Sigma_n})$$

where the Lagrangian subspace $\mathcal{L}_{\Sigma_n} \subset H_1(\Sigma_n; \mathbb{R})$ is generated by the homology classes of meridians of edges of Φ_n .

If $n = 1$ then the set $\mathrm{Col}(\Phi_1)$ of colorings of Φ_1 is defined to be the index set I .

REMARK 1.12.2. We should think of elements i of $\mathrm{Col}(\Phi_1)$ as labelings of the edge a of Φ_1 .

If $n > 1$ then we denote with I_n the finite set

$$\prod_{\ell=1}^n I \times \prod_{\ell=1}^n I \times \prod_{\ell=1}^{n-1} I.$$

An element of I_n is denoted

$$\left(\vec{i}, \vec{j}, \vec{k} \right) := (i_1, \dots, i_n, j_1, \dots, j_n, k_1, \dots, k_{n-1}).$$

The set $\mathrm{Col}(\Phi_n)$ of colorings of Φ_n is the subset of I_n given by

$$\left\{ \left(\vec{i}, \vec{j}, \vec{k} \right) \in I_n \mid i_1 = j_1, i_n = j_n \right\}.$$

REMARK 1.12.3. We should think of elements $\left(\vec{i}, \vec{j}, \vec{k} \right)$ of $\mathrm{Col}(\Phi_n)$ as labelings of edges of Φ_n , where the edge a_{ℓ} is labeled i_{ℓ} , the edge b_{ℓ} is labeled j_{ℓ} and the edge c_{ℓ} is labeled k_{ℓ} .

PROPOSITION 1.12.4. *If $n = 1$ then $V_{\mathcal{E}}(\Sigma_1)$ is isomorphic to*

$$\bigoplus_{i \in \text{Col}(\Phi_1)} \bigotimes_{\ell=1}^{n-1} \text{Hom}_{\mathcal{E}}(\mathbb{1}, V_i \otimes V_i^*).$$

If $n > 1$ then $V_{\mathcal{E}}(\Sigma_n)$ is isomorphic to

$$\bigoplus_{(\vec{i}, \vec{j}, \vec{k}) \in \text{Col}(\Phi_n)} \bigotimes_{\ell=1}^{n-1} \left(\text{Hom}_{\mathcal{E}}(\mathbb{1}, V_{i_\ell}^* \otimes V_{i_{\ell+1}} \otimes V_{k_\ell}) \otimes \text{Hom}_{\mathcal{E}}(\mathbb{1}, V_{j_\ell} \otimes V_{k_\ell}^* \otimes V_{j_{\ell+1}}^*) \right).$$

PROOF. If $n = 1$ then the 1-morphism $\Sigma_1 : \emptyset \rightarrow \emptyset$ of $\mathbf{Cob}_3^{\mathcal{E}}$ can be decomposed, up to isomorphism, as

$$\overline{\mathbb{D}^2} \circ \overline{\mathbb{P}^2} \circ \mathbb{P}^2 \circ \mathbb{D}^2.$$

If $n > 1$ then the 1-morphism $\Sigma_n : \emptyset \rightarrow \emptyset$ of $\mathbf{Cob}_3^{\mathcal{E}}$ can be decomposed, up to isomorphism, as

$$\overline{\mathbb{D}^2} \circ \overline{\mathbb{P}^2} \circ \Xi \circ \dots \circ \Xi \circ \mathbb{P}^2 \circ \mathbb{D}^2$$

for the 1-morphisms $\Xi : \mathbb{S}^1 \otimes \mathbb{S}^1 \rightarrow \mathbb{S}^1 \otimes \mathbb{S}^1$ of $\mathbf{Cob}_3^{\mathcal{E}}$ represented Figure 17.

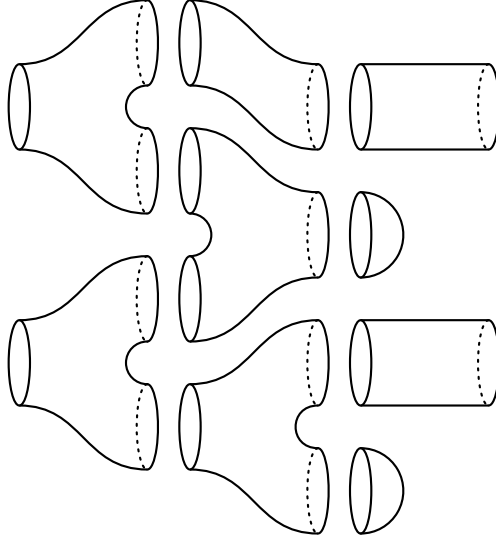

FIGURE 17. The 1-morphism Ξ of $\mathbf{Cob}_3^{\mathcal{E}}$.

Then thanks to Propositions 1.12.1, 1.12.2 and 1.12.3 we can conclude. \square

Non-Semisimple Extended Topological Quantum Field Theories

This chapter provides the general theory for the construction of 3-dimensional ETQFTs extending the Costantino-Geer-Patureau quantum invariants defined in [CGP14]. Our results rely on relative modular categories, a class of non-semisimple ribbon linear categories modeled on representations of unrolled quantum groups, and they exploit a 2-categorical version of the universal construction introduced by Blanchet, Habegger, Masbaum and Vogel. The 1+1+1 TQFTs thus obtained are realized by symmetric monoidal 2-functors defined over 2-categories of admissible cobordisms decorated with colored ribbon graphs and cohomology classes and taking values in 2-categories of complete graded linear categories. In particular our construction extends the family of graded TQFTs defined for unrolled quantum \mathfrak{sl}_2 by Blanchet, Costantino, Geer and Patureau in [BCGP16] to a new family of graded ETQFTs.

2.1. Introduction

In [CGP14] Costantino, Geer and Patureau developed the general theory for the construction of a new class of non-semisimple Witten-Reshetikhin-Turaev type quantum invariants of closed 3-manifolds. Their work is based on surgery presentations and it exploits some rather complicated algebraic structures: if G and Π are abelian groups called the *structure group* and the *periodicity group* respectively and if X is a “small” subset of G called the *critical set* then their machinery provides a quantum invariant¹ $\text{CGP}_{\mathcal{C}}$ of decorated closed 3-manifolds for every *pre-modular*² G -category \mathcal{C} relative to (Π, X) satisfying some non-degeneracy condition. Such relative pre-modular categories, introduced here in Definition 2.2.1, are ribbon categories with three important new features: they carry a G -structure, they have finiteness properties only up to the action of Π and, more importantly, they are not necessarily semisimple, with the deviation from semisimplicity being measured by $X \subset G$. The Costantino-Geer-Patureau invariants are evaluated against closed 3-manifolds M equipped with \mathcal{C} -colored ribbon graphs T^φ and cohomology classes ω with G -coefficients, but not arbitrary ones: T^φ and ω should satisfy a certain compatibility condition and, more importantly, a certain admissibility condition³,

¹The invariant defined in [CGP14] is actually called N .

²In [CGP14] the authors use the term modular instead of pre-modular. Our change of terminology is motivated by the semisimple theory, where quantum invariants are defined for any non-degenerate pre-modular category, and modularity is only needed in order to prove symmetric monoidality of functorial extensions.

³See Subsections 2.3.1 and 2.3.3.

the lack of which makes it impossible to even lay down the definition. A small survey of the construction is provided by [D15].

An explicit family of examples, which inspired the general theory in the first place, is obtained by considering certain non-degenerate relative pre-modular categories $\mathcal{C} = U_q^H \mathfrak{sl}_2\text{-mod}$ of finite-dimensional complex-weight representations of the so called *unrolled* version of quantum \mathfrak{sl}_2 when q is a primitive $2r$ -th root of unity for $r \geq 2$. These categories feature $G = \mathbb{C}/2\mathbb{Z}$ as their structure group with critical set $X = \mathbb{Z}/2\mathbb{Z}$ and periodicity group $\Pi = \mathbb{Z}$. This family of examples extends the multivariable Alexander polynomial, the Kashaev invariants and the Akutsu-Deguchi-Ohtsuki invariants to framed colored links in arbitrary 3-manifolds. An unexpected phenomenon is the appearance of the abelian Reidemeister torsion, which can be recovered by the \mathfrak{sl}_2 Costantino-Geer-Patureau invariants at the level $r = 2$. This distinguishes dramatically the non-semisimple theory from the semisimple one, as the relationship between the Reidemeister torsion and the Witten-Reshetikhin-Turaev invariants remains a great open question, part of Witten's asymptotic conjecture.

In [BCGP16] Blanchet, Costantino, Geer and Patureau extended this family of \mathfrak{sl}_2 quantum invariants to non-semisimple \mathbb{Z} -graded Topological Quantum Field Theories⁴. The latter are symmetric monoidal functors with sources given by categories of admissible decorated cobordisms and with targets given by categories of \mathbb{Z} -graded⁵ vector spaces. When the level r , which is half of the order of the root of unity q , is a multiple of 4 then the braiding on \mathbb{Z} -graded vector spaces is the super-symmetric one. This family of \mathbb{Z} -graded TQFTs has surprising new properties which produce unprecedented results: indeed, if we consider the induced representations for Mapping Class Groups of surfaces, the actions of Dehn twists along non-separating simple closed curves have infinite order.

2.1.1. Main results. Extended TQFTs, usually abbreviated as ETQFTs, are symmetric monoidal 2-functors from 2-categories of cobordisms to linear 2-categories. They provide localizations of TQFTs while further enriching their structure. Therefore it is natural to ask the following:

- (i) Is it possible to upgrade the family of \mathbb{Z} -graded TQFTs coming from unrolled quantum \mathfrak{sl}_2 to a new family of non-semisimple \mathbb{Z} -graded ETQFTs?
- (ii) Can we find conditions for a non-degenerate pre-modular G -category \mathcal{C} relative to (Π, X) under which $\text{CGP}_{\mathcal{C}}$ extends to a Π -graded ETQFT?

The goal of this chapter is to give a positive answer to both of these questions. Indeed we prove that if \mathcal{C} is a non-degenerate relative pre-modular category then we only need to make a small additional requirement in order to carry out the whole plan. We call this condition *relative modularity*, we introduce it in Definition 2.2.2 and we draw the analogies with the standard modularity condition coming from the semisimple theory. Since in particular this property is established for $U_q^H \mathfrak{sl}_2\text{-mod}$ in Lemma A.4 of [BCGP16], our construction applies to all of the Blanchet-Costantino-Geer-Patureau \mathbb{Z} -graded TQFTs. Our ETQFTs will then be given by

⁴The abbreviation TQFT is an acronym for this term.

⁵Remark that the periodicity group of the categories of representations of unrolled quantum \mathfrak{sl}_2 appears as the grading group for vector spaces.

symmetric monoidal 2-functors defined over 2-categories $\check{\mathbf{Cob}}_3^{\mathcal{C}}$ of decorated cobordisms satisfying admissibility conditions, and taking values in 2-categories $\hat{\mathbf{Cat}}_{\mathbb{C}}^{\Pi}$ of complete Π -graded linear categories. We state here our main result.

THEOREM 2.1.1. *If \mathcal{C} is a modular G -category relative to (Π, X) then $\text{CGP}_{\mathcal{C}}$ extends to a Π -graded ETQFT*

$$\hat{\mathbb{E}}_{\mathcal{C}} : \check{\mathbf{Cob}}_3^{\mathcal{C}} \rightarrow \hat{\mathbf{Cat}}_{\mathbb{C}}^{\Pi}.$$

Unlike the non-semisimple ETQFTs constructed by Kerler and Lyubashenko in [KL01], the 2-functor $\hat{\mathbb{E}}_{\mathcal{C}}$ is defined also for non-connected surfaces. It can be described in terms of the relative modular category \mathcal{C} which is used as a building block: connected objects of $\check{\mathbf{Cob}}_3^{\mathcal{C}}$ are mapped to complete Π -graded linear categories which, up to equivalence, are given by Π -graded extensions of homogeneous subcategories of projective objects of \mathcal{C} . Furthermore, generating 1-morphisms of $\check{\mathbf{Cob}}_3^{\mathcal{C}}$ can be translated into Π -graded linear functors between these Π -graded linear categories, and they can be interpreted as algebraic structures on them. This description presents us immediately with a new phenomenon: the 2-functor $\hat{\mathbb{E}}_{\mathcal{C}}$ is fully monoidal, but the images of certain objects of the domain 2-category are in general non-semisimple. This result may seem to contradict Theorem 3 of [BDSV15], which can roughly be stated as follows: not only every modular category \mathcal{C} determines a 3-dimensional ETQFT featuring \mathcal{C} as the image of S^1 , but these are essentially all of the possibilities. In particular, images of closed 1-dimensional manifolds under 3-dimensional ETQFTs are necessarily semisimple. This apparent incongruity can in fact be explained as follows: all of the objects of the cobordism 2-category considered in [BDSV15] are fully dualizable, and semisimplicity is a consequence of this property. On the other hand, in the definition of the admissible cobordism 2-category $\check{\mathbf{Cob}}_3^{\mathcal{C}}$ we forbid some non-admissible decorated cobordisms by removing them from the categories of morphisms. This makes some ‘‘critical’’ objects into non-dualizable ones, thus making room for non-semisimplicity.

We may ask again what it means, in this Π -graded version of the theory, for a TQFT to extend a quantum invariant, or for an ETQFT to extend a TQFT. The idea is exactly the same one we used to answer this question before the appearance of gradings. Indeed a Π -graded TQFT associates with a closed 3-manifold a Π -graded linear endomorphism of a certain Π -graded vector space which, as a consequence of monoidality, is 1-dimensional in degree 0 and 0-dimensional in all other degrees. Such a map is just a product with some fixed complex number which we can interpret as the quantum invariant of the closed 3-manifold. Analogously, a Π -graded ETQFT associates with a closed surface a Π -graded linear endofunctor of a certain Π -graded linear category which, as a consequence of monoidality, is equivalent to the category of Π -graded vector spaces. Such a functor is equivalent to a product with some fixed Π -graded vector space, which we can interpret as the Π -graded TQFT vector space of the closed surface. In particular a Π -graded ETQFT still essentially associates a complex number with every closed 3-manifold and a Π -graded vector space with every closed surface. In this sense our construction recovers the quantum invariants of [CGP14] and generalizes the TQFTs of [BCGP16] to all relative modular categories.

2.1.2. Outline of the construction. We will essentially try to reproduce the previous chapter in the non-semisimple setting of Costantino, Geer and Patureau.

The strategy will be to fix a non-degenerate pre-modular G -category \mathcal{C} relative to (H, X) and to apply the extended universal construction to the corresponding quantum invariant⁶ $\text{CGP}_{\mathcal{C}}$. This operation produces a 2-functor denoted

$$\hat{\mathbf{E}}_{\mathcal{C}} : \check{\mathbf{Cob}}_3^{\mathcal{C}} \rightarrow \hat{\mathbf{Cat}}_{\mathbb{C}}.$$

This time $\check{\mathbf{Cob}}_3^{\mathcal{C}}$ denotes a suitable symmetric monoidal 2-category of admissible cobordisms decorated with \mathcal{C} -colored ribbon graphs and cohomology classes with G -coefficients. However, unlike in the semisimple case, $\hat{\mathbf{E}}_{\mathcal{C}}$ is not an ETQFT on the nose, not even when the category \mathcal{C} is relative modular. Indeed, in this case a set of surgery axioms satisfied by $\text{CGP}_{\mathcal{C}}$ allows us to parametrize the deviation from monoidality of $\hat{\mathbf{E}}_{\mathcal{C}}$ by means of the periodicity group H . Nevertheless, we can define a H -graded extension

$$\hat{\mathbb{E}}_{\mathcal{C}} : \check{\mathbf{Cob}}_3^{\mathcal{C}} \rightarrow \hat{\mathbf{Cat}}_H^H$$

of $\hat{\mathbf{E}}_{\mathcal{C}}$ with target the symmetric monoidal 2-category of complete H -graded linear categories. The idea is to replace the image of an object of $\check{\mathbf{Cob}}_3^{\mathcal{C}}$ under $\hat{\mathbf{E}}_{\mathcal{C}}$, which is a complete linear category, with a suitably defined complete H -graded linear category obtained by integrating the obstruction to monoidality into its structure. We can then show that the resulting 2-functor $\hat{\mathbb{E}}_{\mathcal{C}}$ is indeed symmetric monoidal, and thus provides a H -graded ETQFT. Once again, skein calculus techniques can be used to produce a more combinatorial description of $\hat{\mathbf{E}}_{\mathcal{C}}$ in terms of the relative modular category \mathcal{C} , with images of generating 1-dimensional manifolds corresponding to natural subcategories of \mathcal{C} and with images of generating 2-dimensional cobordisms corresponding to meaningful functors between them.

2.1.3. Structure of the exposition. The chapter is organized as follows: we begin by introducing the main ingredients of our construction, relative modular categories, in Section 2.2. We devote Section 2.3 to the detailed construction of the symmetric monoidal 2-categories of admissible decorated cobordisms, which we will then use as the domains for our non-semisimple ETQFTs. In Section 2.4 we introduce a set of surgery axioms derived from [BCGP16] and in Section 2.5 we use them to dramatically simplify the study of vector spaces of morphisms by restricting to fixed connected cobordisms with corners, much in the spirit of [BHMV95]. In Section 2.6 we recall the definition of the Costantino-Geer-Patureau quantum invariants of closed 3-manifolds and we prove they satisfy the surgery axioms. Starting from Sections 2.7 and 2.8 we fix a relative modular category \mathcal{C} , we consider the associated Costantino-Geer-Patureau quantum invariant and we study the associated quantization 2-functor. In Section 2.9 we prove the failure of $\hat{\mathbf{E}}_{\mathcal{C}}$ to be an ETQFT, we carefully analyse its deviation from monoidality and we upgrade the construction by defining the H -graded quantization 2-functors $\hat{\mathbb{E}}_{\mathcal{C}}$ and $\hat{\mathbb{E}}'_{\mathcal{C}}$. Our main results are contained in Sections 2.10 and 2.11, where we show that the 2-functor $\hat{\mathbb{E}}_{\mathcal{C}}$ is indeed monoidal and symmetric. Section 2.12 contains a detailed discussion of the relationship between our ETQFT and the associated generalized version of the Blanchet-Costantino-Geer-Patureau TQFT. Sections 2.13 and 2.14 are devoted to the explicit description, in terms of the relative modular category \mathcal{C} , of the H -graded linear categories and of the H -graded linear functors associated with elementary objects and 1-morphisms of $\check{\mathbf{Cob}}_3^{\mathcal{C}}$ respectively.

⁶The invariant defined in [CGP14] is a different renormalization of the one considered here.

2.2. Relative modular categories

This section is devoted to the definition of the algebraic structures which are going to play the leading role in the construction, relative modular categories. They are a non-semisimple analogue of modular categories and, since their definition involves a lot of different ingredients, we first set the ground by recalling definitions for various concepts like group structures, traces on ideals induced by ambidextrous objects and group realizations.

2.2.1. Group structures and homogeneous colored ribbon graphs. We begin by introducing group structures on monoidal categories. In order to do so let us fix an abelian group G . If \mathcal{C} is a strict monoidal category then a G -structure on \mathcal{C} is given by a family of full subcategories $\{\mathcal{C}_g \mid g \in G\}$ of \mathcal{C} indexed by elements of G and satisfying $V \otimes V' \in \text{Ob}(\mathcal{C}_{g+g'})$ for all $V \in \text{Ob}(\mathcal{C}_g)$ and all $V' \in \text{Ob}(\mathcal{C}_{g'})$. A strict monoidal category \mathcal{C} equipped with a G -structure is called a G -category⁷ and G is called the *structure group* of \mathcal{C} . For every $g \in G$ the subcategory \mathcal{C}_g is called the *homogeneous subcategory of index g* . If an object V of \mathcal{C} belongs to the homogeneous subcategory of index g then we will write $i(V) = g$ and we will say V is a *homogeneous object of index g* . We say a G -structure on a pivotal category \mathcal{C} is *compatible with the pivotal structure* if $V^* \in \text{Ob}(\mathcal{C}_{-g})$ for all $V \in \text{Ob}(\mathcal{C}_g)$. A *pivotal G -category* is then a pivotal category equipped with a compatible G -structure, and a *ribbon G -category* is a pivotal G -category which is ribbon.

Let us fix for this subsection a ribbon G -category \mathcal{C} . If Σ is a 2-dimensional cobordism and if $P \subset \Sigma$ is a ribbon set⁸ then a \mathcal{C} -coloring $V : P \rightarrow \text{Ob}(\mathcal{C})$ is G -homogeneous if $V(p)$ is a homogeneous object of \mathcal{C} for every vertex $p \in P$. A \mathcal{C} -colored ribbon set $P^V \subset \Sigma$ is G -homogeneous if the \mathcal{C} -coloring $V : P \rightarrow \text{Ob}(\mathcal{C})$ is G -homogeneous.

If M is a 3-dimensional cobordism with corners from Σ to Σ' , if $P^V \subset \Sigma$ and $P'^{V'} \subset \Sigma'$ are G -homogeneous \mathcal{C} -colored ribbon sets and if $T \subset M$ is a ribbon graph from P to P' then a \mathcal{C} -coloring $\varphi : T \rightarrow \mathcal{C}$ extending V and V' is G -homogeneous, denoted φ , if $\varphi(e)$ is a homogeneous object of \mathcal{C} for every edge $e \subset T$. A \mathcal{C} -colored ribbon graph $T^\varphi \subset M$ from P^V to $P'^{V'}$ is G -homogeneous if the \mathcal{C} -coloring $\varphi : T \rightarrow \mathcal{C}$ extending V and V' is G -homogeneous.

The *ribbon G -category $\text{Rib}_{\mathcal{C}}^G$ of G -homogeneous \mathcal{C} -colored ribbon graphs* is the subcategory of⁹ $\text{Rib}_{\mathcal{C}}$ whose objects are objects

$$((\varepsilon_1, V_1), \dots, (\varepsilon_k, V_k))$$

of $\text{Rib}_{\mathcal{C}}$ such that V_i is a homogeneous object of \mathcal{C} for all $i = 1, \dots, k$, and whose morphisms are morphism $T^\varphi : (\vec{\varepsilon}, \vec{V}) \rightarrow (\vec{\varepsilon}', \vec{V}')$ of $\text{Rib}_{\mathcal{C}}$ such that $\varphi : T \rightarrow \mathcal{C}$ is a G -homogeneous \mathcal{C} -coloring.

REMARK 2.2.1. We still denote with $F_{\mathcal{C}}$ the restriction of the Reshetikhin-Turaev functor associated with \mathcal{C} to the subcategory $\text{Rib}_{\mathcal{C}}^G$ of $\text{Rib}_{\mathcal{C}}$.

⁷In literature a monoidal category with a G -structure is usually called a G -graded category, see [TV12], [GP13] and [CGP14]. We change terminology because we will use the term graded category in the enriched sense, with grading appearing on morphisms rather than on objects.

⁸We recall that a reference for the notation and terminology used for ribbon sets and ribbon graphs can be found in Appendix B.5, while \mathcal{C} -colorings are introduced in Section 1.2.

⁹The ribbon category $\text{Rib}_{\mathcal{C}}$ has been introduced in Section 1.2.

2.2.2. Traces on ideals and ambidextrous objects. In this subsection we recall the notions of ambidextrous objects and of traces on ideals in ribbon linear categories which are central in the theory of renormalized link invariant developed by Geer, Patureau and Turaev in [GPT09]. We say an object V of a category \mathcal{C} is a *retract* of another object V' of \mathcal{C} if there exist morphisms $f \in \text{Hom}_{\mathcal{C}}(V, V')$ and $f' \in \text{Hom}_{\mathcal{C}}(V', V)$ satisfying $f' \circ f = \text{id}_V$. A subcategory \mathcal{C}' of \mathcal{C} is said to be *closed under retraction* if every retract of every object of \mathcal{C}' is an object of \mathcal{C}' . Moreover a subcategory \mathcal{C}' of a monoidal category \mathcal{C} is said to be *absorbent* if for all objects V of \mathcal{C} and V' of \mathcal{C}' the tensor products $V \otimes V'$ and $V' \otimes V$ are objects of \mathcal{C}' . An *ideal* \mathcal{F} of a monoidal category \mathcal{C} is then a full subcategory of \mathcal{C} which is absorbent and closed under retraction.

LEMMA 2.2.1. *If \mathcal{C} is a pivotal category, if \mathcal{F} is an ideal of \mathcal{C} and if $V \in \text{Ob}(\mathcal{F})$ then $V^* \in \text{Ob}(\mathcal{F})$.*

A proof of this Lemma can be found in [GPV13]. The *ideal \mathcal{F}_V generated by an object V of a pivotal category \mathcal{C}* is the smallest among the ideals \mathcal{F} of \mathcal{C} satisfying $V \in \text{Ob}(\mathcal{F})$.

EXAMPLE 2.2.1. If \mathcal{C} is a pivotal category then the full subcategory $\text{Proj}(\mathcal{C})$ of projective objects of \mathcal{C} is an ideal of \mathcal{C} , and it coincides with the full subcategory $\text{Inj}(\mathcal{C})$ of injective objects. Moreover if V is a projective object of \mathcal{C} with epic evaluation then $\text{Proj}(\mathcal{C}) = \mathcal{F}_V$. Again this is proved in [GPV13].

We will consider from now on pivotal and ribbon categories which are linear.

REMARK 2.2.2. It is to be understood that a monoidal linear category is a linear category equipped with a monoidal structure whose unit is given by a simple object $\mathbb{1} \in \text{Ob}(\mathcal{C})$ and whose tensor product is given by a bilinear functor $\otimes : \mathcal{C} \times \mathcal{C} \rightarrow \mathcal{C}$. In particular, when considering some monoidal linear category \mathcal{C} we will always confuse $\text{End}_{\mathcal{C}}(\mathbb{1})$ with \mathbb{C} by identifying $\text{id}_{\mathbb{1}}$ with 1. A pivotal linear category will be a strict monoidal linear category equipped with a pivotal structure whose duality functor is linear. A ribbon linear category will simply be a pivotal linear category which is ribbon.

The *left partial trace of a morphism $f \in \text{End}_{\mathcal{C}}(V \otimes V')$ of a ribbon linear category \mathcal{C}* is the morphism $\text{tr}_l(f) \in \text{End}_{\mathcal{C}}(V')$ given by

$$\text{tr}_l(f) := (\text{ev}_V \otimes \text{id}_{V'}) \circ (\text{id}_{V^*} \otimes f) \circ (\text{coev}_V \otimes \text{id}_{V'})$$

and the *right partial trace of f* is the morphism $\text{tr}_r(f) \in \text{End}_{\mathcal{C}}(V)$ given by

$$\text{tr}_r(f) := (\text{id}_V \otimes \tilde{\text{ev}}_{V'}) \circ (f \otimes \text{id}_{V'^*}) \circ (\text{id}_V \otimes \text{coev}_{V'}).$$

See Figure 1 for a graphical representation.

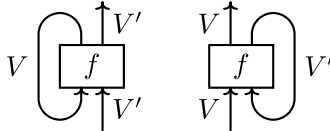

FIGURE 1. Partial traces of a morphism $f \in \text{End}_{\mathcal{C}}(V \otimes V')$.

A trace t on an ideal \mathcal{J} of a ribbon linear category \mathcal{C} is a family

$$t := \{t_V : \text{End}_{\mathcal{C}}(V) \rightarrow \mathbb{C} \mid V \in \text{Ob}(\mathcal{J})\}$$

of linear maps satisfying:

- (i) $t_{V \otimes V'} = t_{V'}(\text{tr}_l(f))$ for all objects V of \mathcal{C} and V' of \mathcal{J} and for all morphisms $f \in \text{End}_{\mathcal{C}}(V \otimes V')$;
- (ii) $t_{V \otimes V'} = t_V(\text{tr}_r(f))$ for all objects V of \mathcal{J} and V' of \mathcal{C} and for all morphisms $f \in \text{End}_{\mathcal{C}}(V \otimes V')$;
- (iii) $t_V(f' \circ f) = t_{V'}(f \circ f')$ for all objects V and V' of \mathcal{J} and for all morphisms $f \in \text{Hom}_{\mathcal{C}}(V, V')$ and $f' \in \text{Hom}_{\mathcal{C}}(V', V)$.

A trace t on an ideal \mathcal{J} of a ribbon linear category \mathcal{C} is *non-degenerate* if

$$t_V \circ c_{V, V', V} : \text{Hom}_{\mathcal{C}}(V', V) \otimes \text{Hom}_{\mathcal{C}}(V, V') \rightarrow \mathbb{C}$$

is a non-degenerate pairing for every $V \in \text{Ob}(\mathcal{J})$ and for every $V' \in \text{Ob}(\mathcal{C})$. The *dimension* d associated with a trace t on an ideal \mathcal{J} of a ribbon linear category \mathcal{C} is the function

$$\begin{aligned} d : \mathcal{J} &\rightarrow \mathbb{C} \\ V &\mapsto t_V(\text{id}_V) \end{aligned}$$

The main propeller for the theory of traces on ideals in ribbon linear categories is the existence of a special kind of object: a simple object V of a ribbon linear category \mathcal{C} is *ambidextrous* if for every $f \in \text{End}_{\mathcal{C}}(V \otimes V^*)$ we have

$$f \circ \text{coev}_V = (\varphi_V \otimes \text{id}_{V^*}) \circ \mu_{V^*, V} \circ f^* \circ \mu_{V^*, V}^{-1} \circ \tilde{\text{coev}}_{V^*},$$

where the isomorphisms $\mu_{V, V'} \in \text{Hom}_{\mathcal{C}}((V \otimes V')^*, V'^* \otimes V^*)$ are part of the structure of the monoidal linear functor $d : \mathcal{C}^{\text{op}} \rightarrow \mathcal{C}$. If \mathcal{C} is a ribbon linear category and if V is an ambidextrous object of \mathcal{C} then there exists a unique trace t on \mathcal{J}_V which satisfies¹⁰ $d(V) = 1$. Moreover if V is projective with epic evaluation then the unique trace t on $\text{Proj}(\mathcal{C})$ satisfying $d(V) = 1$ satisfies $d(V') \neq 0$ for every simple projective object V' of \mathcal{C} with epic evaluation¹¹.

2.2.3. Group realizations. The last ingredient we will need for the definition of relative modular categories is the action of an abelian group Π . If $\nu : \Pi \times \Pi \rightarrow \mathbb{Z}^*$ is a symmetric \mathbb{Z} -bilinear map then we denote with Π^ν the symmetric monoidal linear category with set of objects $\text{Ob}(\Pi) = \Pi$, with vector spaces of morphisms satisfying

$$\dim_{\mathbb{C}} \text{Hom}_{\Pi^\nu}(u, u') = \delta_{u, u'},$$

with unit $0 \in \Pi$, with tensor product mapping each pair of objects (u, u') of $\Pi \times \Pi$ to $u \otimes u' := u + u'$ and with braiding given by the morphisms $\beta_{u, u'} := \nu(u, u') \cdot \text{id}_{u+u'}$ for all $u, u' \in \Pi$. A *realization of Π in a braided monoidal category \mathcal{C}* is a braided monoidal functor $\sigma : \Pi^\nu \rightarrow \mathcal{C}$.

REMARK 2.2.3. For every realization σ of Π in \mathcal{C} and for all $u, u' \in \Pi$ we will denote with $\varepsilon \in \text{Hom}_{\mathcal{C}}(\mathbb{1}, \sigma(0))$ and with $\mu_{u, u'} \in \text{Hom}_{\mathcal{C}}(\sigma(u) \otimes \sigma(u'), \sigma(u + u'))$ the morphisms of \mathcal{C} coming from the structure of σ , and we denote with $\sigma(\Pi)$ the set of objects $\{\sigma(u) \in \text{Ob}(\mathcal{C}) \mid u \in \Pi\}$ of \mathcal{C} .

¹⁰See Theorem 3.3.2 of [GKP11] for this result.

¹¹See Section 5 of [GPV13] for this result. If we work with abelian categories then another condition ensuring the existence and uniqueness up to scalar of a trace on $\text{Proj}(\mathcal{C})$ is provided by Corollary 3.2.1 of [GKP13].

REMARK 2.2.4. If $\sigma : \Pi^\nu \rightarrow \mathcal{C}$ is a realization of Π in \mathcal{C} then all objects in $\sigma(\Pi) := \{\sigma(u) \mid u \in \Pi\}$ are simple and $\text{Hom}_{\mathcal{C}}(\sigma(u) \otimes V, \sigma(u) \otimes V')$ is isomorphic to $\text{Hom}_{\mathcal{C}}(V, V')$ for all $V, V' \in \text{Ob}(\mathcal{C})$ and for every $u \in \Pi$. In particular $\sigma(u) \otimes V$ is simple if and only if V is simple.

A *free realization of Π in a braided monoidal category \mathcal{C}* is a realization of Π in \mathcal{C} such that for every simple object V of \mathcal{C} the tensor product $\sigma(u) \otimes V$ is isomorphic to V if and only if $u = 0$.

2.2.4. Main definitions. Relative modular categories will provide a non-semisimple analogue to modular categories with group structure. However, for them to be manageable, we will need to be able to control their non-semisimplicity. In particular, like in [GP13] and in [CGP14], we will want their generic homogeneous subcategory to be semisimple, with the non-semisimple part of the category originating from a “small” set of critical indices. Before making precise what is the exact notion of smallness we will need, let us start by fixing the terminology for semisimple categories. We say a dominating set¹² D for a linear category \mathcal{C} is *reduced* if

$$\dim_{\mathbb{C}} \text{Hom}_{\mathcal{C}}(V, V') = \delta_{V, V'}$$

for all $V, V' \in D$. A *semisimple category* is then a linear category \mathcal{C} which admits a reduced dominating set.

A subset X of an abelian group G is *small symmetric* if:

- (i) $X = -X$;
- (ii) $G \not\subset \bigcup_{i=1}^k (g_i + X)$ for all $k \in \mathbb{N}$ and all $g_1, \dots, g_k \in G$.

If G is an abelian group and $X \subset G$ is a small symmetric subset then all elements in $G \setminus X$ are called *generic* and all elements in X are called *critical*. Let us fix such an abelian group G with a small symmetric subset $X \subset G$. We say a linear G -category \mathcal{C} is *semisimple relative to X* if:

- (i) \mathcal{C}_g is semisimple for all $g \in G \setminus X$;
- (ii) $V \in \text{Ob}(\mathcal{C}_g), V' \in \text{Ob}(\mathcal{C}_{g'}), g \neq g' \Rightarrow \text{Hom}_{\mathcal{C}}(V, V') = 0$.

If \mathcal{C} is a semisimple G -category relative to X then X is called the *set of critical indices* or simply the *critical set*.

REMARK 2.2.5. For a semisimple G -category relative to X we will use the term *relative semisimple category* every time there will be no need to explicitly mention the structure group G and the critical set $X \subset G$.

A *semisimple ribbon G -category relative to X* is just a ribbon linear G -category which is semisimple relative to X .

DEFINITION 2.2.1. If G and Π are abelian groups and if $X \subset G$ is a small symmetric subset then a *pre-modular G -category relative to (Π, X)* is given by:

- (i) a semisimple ribbon G -category \mathcal{C} relative to $X \subset G$;
- (ii) a set $\Theta(\mathcal{C}_g) = \{V_i \in \text{Ob}(\mathcal{C}_g) \mid i \in I_g\}$ of simple projective objects of \mathcal{C} with epic evaluation for all $g \in G \setminus X$ and for some ordered finite set I_g ;
- (iii) an ambidextrous projective object V_0 of \mathcal{C} with epic evaluation;
- (iv) a free realization $\sigma : \Pi^\nu \rightarrow \mathcal{C}_0$.

¹²See Definition A.5.18.

These data satisfy the following conditions:

- (i) $\sigma(\Pi) \otimes \Theta(\mathcal{E}_g) := \{\sigma(u) \otimes V_i \mid u \in \Pi, i \in I_g\}$ is a reduced dominating set for \mathcal{E}_g ;
- (ii) $\dim_{\mathbb{C}}(\sigma(u)) \neq 0$;
- (iii) $\beta_{V, \sigma(u)} = \psi(g, u) \cdot \beta_{\sigma(u), V}^{-1}$ for all $g \in G$, $V \in \text{Ob}(\mathcal{E}_g)$ and $u \in \Pi$ and for some \mathbb{Z} -bilinear homomorphism $\psi : G \times \Pi \rightarrow \mathbb{C}^*$.

The group Π is called the *periodicity group* of \mathcal{E} .

REMARK 2.2.6. If \mathcal{E} is a pre-modular G -category relative to (Π, X) then we denote with t the unique trace on $\text{Proj}(\mathcal{E})$ satisfying $d(V_0) = 1$ and we introduce the notation

$$\Theta(\mathcal{E}) := \bigcup_{g \in G \setminus X} \Theta(\mathcal{E}_g).$$

PROPOSITION 2.2.1. *If \mathcal{E} is a pre-modular G -category relative to (Π, X) then the trace t on $\text{Proj}(\mathcal{E})$ is non degenerate.*

PROOF. We begin with a remark. If U is a projective object of \mathcal{E} and if $V_i \in \Theta(\mathcal{E}_g)$ then the morphism $\text{ev}_{V_i} \otimes \text{id}_U$ is still epic because U is dualizable. Therefore, since U is projective, there exists a section s of $\text{ev}_{V_i} \otimes \text{id}_U$, which is a morphism in $\text{Hom}_{\mathcal{E}}(U, V_i^* \otimes V_i \otimes U)$ satisfying $(\text{ev}_{V_i} \otimes \text{id}_U) \circ s = \text{id}_U$.

Let us consider a homogeneous projective object U , a homogeneous object W of the same index and a non-zero morphism $f \in \text{Hom}_{\mathcal{E}}(U, W)$ between them. Then if $V_i \in \Theta(\mathcal{E}_g)$ the morphism

$$(\text{id}_{V_i} \otimes (f \circ (\text{ev}_{V_i} \otimes \text{id}_U))) \otimes \text{id}_{U^*} \circ (\text{coev}_{V_i} \otimes \text{id}_{V_i} \otimes \text{coev}_U)$$

is a non-zero morphism of \mathcal{E}_g because

$$f \circ (\text{ev}_{V_i} \otimes \text{id}_U) \circ s = f$$

for every section s of $\text{ev}_{V_i} \otimes \text{id}_U$. Then, since \mathcal{E}_g is semisimple and V_i is simple, there exists a retraction r of $\text{id}_{V_i} \otimes ((f \otimes \text{id}_{U^*}) \circ \text{coev}_U)$, which is a morphism in $\text{Hom}_{\mathcal{E}}(V_i \otimes W \otimes U^*, V_i)$ satisfying

$$r \circ (\text{id}_{V_i} \otimes ((f \otimes \text{id}_{U^*}) \circ \text{coev}_U)) = \text{id}_{V_i}.$$

Let $h \in \text{Hom}_{\mathcal{E}}(W, V_i^* \otimes V_i \otimes U)$ denote the morphism

$$(\text{id}_{V_i^*} \otimes r \otimes \text{id}_U) \circ (\text{c}\tilde{\text{e}}\text{v}_{V_i} \otimes \text{id}_W \otimes \text{c}\tilde{\text{e}}\text{v}_U)$$

and let $f' \in \text{Hom}_{\mathcal{E}}(W, U)$ denote the morphism

$$(\text{ev}_{V_i} \otimes \text{id}_U) \circ h.$$

Then

$$\begin{aligned} \text{t}_{V_i}(f' \circ f) &= \text{t}_{V_i}((\text{ev}_{V_i} \otimes \text{id}_U) \circ h \circ f) = \text{t}_{V_i^* \otimes V_i \otimes U}(h \circ f \circ (\text{ev}_{V_i} \otimes \text{id}_U)) \\ &= \text{t}_{V_i}(\text{tr}_1(\text{tr}_r(h \circ f \circ (\text{ev}_{V_i} \otimes \text{id}_U)))) \\ &= \text{t}_{V_i}(r \circ (\text{id}_{V_i} \otimes ((f \otimes \text{id}_{U^*}) \circ \text{coev}_U))) \\ &= \text{t}_{V_i}(\text{id}_{V_i}) \neq 0. \end{aligned}$$

□

If \mathcal{C} is a pre-modular G -category relative to (Π, X) then the *Kirby color of index* $g \in G \setminus X$ is the formal linear combination of objects

$$\Omega_g := \sum_{i \in I_g} d(V_i) \cdot V_i.$$

If T^φ is a G -homogeneous \mathcal{C} -colored ribbon graph, if $K \subset \text{id}_{\mathbb{D}^2}$ is a framed knot disjoint from T and if $g \in G \setminus X$ is a generic index then we denote with $K^{\Omega_g} \cup T^\varphi$ the formal linear combination of G -homogeneous \mathcal{C} -colored ribbon graphs

$$\sum_{i \in I_g} d(V_i) \cdot (K^{V_i} \cup T^\varphi)$$

where $V_i(K) = V_i$. Although $K^{\Omega_g} \cup T^\varphi$ is not actually a morphism of $\text{Rib}_{\mathcal{C}}^G$, we can still define its image $F_{\mathcal{C}}(K^{\Omega_g} \cup T^\varphi)$ under the Reshetikhin-Turaev functor as

$$\sum_{i \in I_g} d(V_i) \cdot F_{\mathcal{C}}(K^{V_i} \cup T^\varphi).$$

REMARK 2.2.7. For a pre-modular G -category \mathcal{C} relative to (Π, X) there exist constants $\Delta_+, \Delta_- \in \mathbb{C}$ satisfying

$$f_{+V} = \Delta_+ \cdot \text{id}_V, \quad f_{-V} = \Delta_- \cdot \text{id}_V$$

for every $V \in \text{Ob}(\mathcal{C}_g)$ with $g \in G \setminus X$, where f_{+V} and f_{-V} are the images under the Reshetikhin-Turaev functor $F_{\mathcal{C}}$ of the \mathcal{C} -colored ribbon tangles depicted in Figure 2. Observe that Δ_+ and Δ_- do not depend neither on $V \in \text{Ob}(\mathcal{C}_g)$ nor on $g \in G \setminus X$. This is proved in Lemma 5.10 of [CGP14].

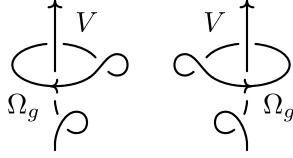

FIGURE 2. The \mathcal{C} -colored ribbon tangles representing f_{+V} and f_{-V} .

DEFINITION 2.2.2. A *modular G -category \mathcal{C} relative to (Π, X)* is a pre-modular G -category relative to (Π, X) which admits a *relative modularity parameter* $\zeta \in \mathbb{C}^*$ such that

$$d(V_i) \cdot f_{i,j}^g = \begin{cases} \zeta \cdot (\text{coev}_{V_i} \circ \text{ev}_{V_i}) & \text{if } i = j \\ 0 & \text{if } i \neq j \end{cases}$$

for all $g, h \in G \setminus X$ and all $i, j \in I_h$, where $f_{i,j}^g$ is the image under the Reshetikhin-Turaev functor $F_{\mathcal{C}}$ of the \mathcal{C} -colored ribbon tangle depicted in Figure 3.

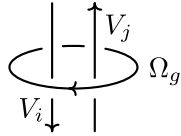

FIGURE 3. Relative modularity condition.

REMARK 2.2.8. Definition 2.2.2 is a direct generalization of Definition 1.2.2, which was shown in Proposition 1.2.2 to be equivalent to the standard definition of modular categories of [T94].

PROPOSITION 2.2.2. *If \mathcal{C} is a modular G -category relative to (Π, X) then the relative modularity parameter ζ equals $\Delta_- \Delta_+$.*

PROOF. The proof of this fact follows from the relative modularity condition for \mathcal{C} applied to the evaluation of the Reshetikhin-Turaev functor $F_{\mathcal{C}}$ against the \mathcal{C} -colored ribbon tangle depicted in Figure 4 for any $i \in I_g$. \square

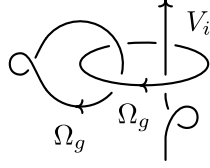

FIGURE 4. The \mathcal{C} -colored ribbon tangle witnessing $\zeta = \Delta_- \Delta_+$.

2.3. Admissible cobordisms

This section is devoted to the definition of the domain 2-category for our extended TQFTs, the symmetric monoidal 2-category $\check{\mathbf{Cob}}_3^{\mathcal{C}}$ of admissible decorated cobordisms of dimension 1+1+1. Since our goal is to extend the Costantino-Geer-Patureau quantum invariants, which require cohomology classes for their definition, decorations on cobordisms will be richer than usual.

2.3.1. Group colorings on decorated cobordisms. In this subsection we fix an abelian group G and we introduce a new piece of decoration for cobordisms: G -colorings. They consist of relative cohomology classes with coefficients in G together with discrete sets of specified base points which are needed in order to induce G -colorings on horizontal and vertical gluings. Their role will be to determine indices for surgery presentations of 3-dimensional manifolds. The notation we use for cobordisms is introduced in Appendix B.4.

DEFINITION 2.3.1. If Γ is a 1-dimensional smooth manifold without boundary then a G -coloring ξ_A of Γ is given by:

- (i) a finite set $A \subset \Gamma$ called the *base set*, whose elements are called *base points*;
- (ii) a cohomology class $\xi \in H^1(\Gamma, A; G)$.

These data satisfy the following condition: if Γ_i is a non-empty connected component of Γ then $A \cap \Gamma_i = \{a_i\}$ for exactly one point $a_i \in \Gamma_i$.

DEFINITION 2.3.2. If Σ is a 2-dimensional cobordism from Γ to Γ' , if P is a ribbon set inside Σ and if ξ_A and $\xi_{A'}$ are G -colorings of Γ and Γ' respectively then a G -coloring ϑ_B of (Σ, P) extending ξ_A and $\xi_{A'}$ is given by:

- (i) a finite set $B \subset (\Sigma \setminus (P \cup \partial\Sigma))$ called the *base set*, whose elements are called *base points*;
- (ii) a cohomology class $\vartheta \in H^1(\Sigma \setminus P, A_{\Sigma} \cup B \cup A'_{\Sigma}; G)$ where

$$A_{\Sigma} := f_{\Sigma^-}(A), \quad A'_{\Sigma} := f_{\Sigma^+}(A').$$

These data satisfy the following conditions:

(i) if Σ_i is a non-empty connected component of Σ then

$$(A_\Sigma \cup B) \cap \Sigma_i \neq \emptyset;$$

(ii) $j_\Gamma^* \vartheta = \xi$ and $j_{\Gamma'}^* \vartheta = \xi'$ for the embeddings

$$\begin{aligned} j_\Gamma &: (\Gamma, A) \hookrightarrow (\Sigma \setminus P, A_\Sigma \cup B \cup A'_\Sigma), \\ j_{\Gamma'} &: (\Gamma', A') \hookrightarrow (\Sigma \setminus P, A_\Sigma \cup B \cup A'_\Sigma) \end{aligned}$$

induced by f_{Σ_-} and f_{Σ_+} respectively.

REMARK 2.3.1. Every G -coloring ξ_A of Γ naturally determines a G -coloring $I \times \xi_A$ of $I \times \Gamma$ extending ξ_A and ξ_A whose base set is given by

$$\{0, 1\} \times A \subset I \times \Gamma$$

and whose cohomology class is given by $\pi_\Gamma^* \xi$ for the projection

$$\pi_\Gamma : (I \times \Gamma, \{0, 1\} \times A) \rightarrow (\Gamma, A)$$

induced by the natural projection onto the second factor of $I \times \Gamma$.

DEFINITION 2.3.3. If Σ and Σ' are 2-dimensional cobordisms from Γ to Γ' , if M is a 3-dimensional cobordism with corners from Σ to Σ' , if $T \subset M$ is a ribbon graph from $P \subset \Sigma$ to $P' \subset \Sigma'$, if ξ_A and $\xi'_{A'}$ are G -colorings of Γ and Γ' respectively, if ϑ_B and $\vartheta'_{B'}$ are G -colorings of (Σ, P) and (Σ', P') respectively which both extend ξ_A and $\xi'_{A'}$ then a G -coloring ω of (M, T) extending ϑ_B and $\vartheta'_{B'}$ is a cohomology class

$$\omega \in H^1(M \setminus T, A_M \cup B_M \cup B'_M \cup A'_M; G)$$

where

$$\begin{aligned} A_M &:= f_{M^\pm}(A_\Sigma) \cup f_{M^\pm}(A_{\Sigma'}), & B_M &:= f_{M^\pm}(B), \\ B'_M &:= f_{M^\pm}(B'), & A'_M &:= f_{M^\pm}(A'_\Sigma) \cup f_{M^\pm}(A'_{\Sigma'}). \end{aligned}$$

This data satisfies the following condition: $j_\Sigma^* \omega = \vartheta$, $j_{\Sigma'}^* \omega = \vartheta'$, $j_\Gamma^* \omega = \pi_\Gamma^* \xi$ and $j_{\Gamma'}^* \omega = \pi_{\Gamma'}^* \xi'$ for the embeddings

$$\begin{aligned} j_\Sigma &: (\Sigma \setminus P, A_\Sigma \cup B \cup A'_\Sigma) \hookrightarrow (M \setminus T, A_M \cup B_M \cup B'_M \cup A'_M), \\ j_{\Sigma'} &: (\Sigma' \setminus P', A_{\Sigma'} \cup B' \cup A'_{\Sigma'}) \hookrightarrow (M \setminus T, A_M \cup B_M \cup B'_M \cup A'_M), \\ j_\Gamma &: (\Gamma \times I, A \times \{0, 1\}) \hookrightarrow (M \setminus T, A_M \cup B_M \cup B'_M \cup A'_M), \\ j_{\Gamma'} &: (\Gamma' \times I, A' \times \{0, 1\}) \hookrightarrow (M \setminus T, A_M \cup B_M \cup B'_M \cup A'_M) \end{aligned}$$

induced by f_{M^\pm} , f_{M^\pm} , f_{M^\pm} , f_{M^\pm} respectively and for the projections

$$\begin{aligned} \pi_\Gamma &: (\Gamma \times I, A \times \{0, 1\}) \rightarrow (\Gamma, A), \\ \pi_{\Gamma'} &: (\Gamma' \times I, A' \times \{0, 1\}) \rightarrow (\Gamma', A') \end{aligned}$$

induced by the natural projections onto the first factors of $\Gamma \times I$ and $\Gamma' \times I$ respectively.

REMARK 2.3.2. If Σ and Σ' are 2-dimensional cobordisms from Γ to Γ' , if M and M' are 3-dimensional cobordisms with corners from Σ to Σ' , if $T' \subset M'$ is a ribbon graph from $P \subset \Sigma$ to $P' \subset \Sigma'$, if ξ_A and $\xi'_{A'}$ are G -colorings of Γ and Γ' respectively, if ϑ_B and $\vartheta'_{B'}$ are G -colorings of (Σ, P) and (Σ', P') respectively which both extend ξ_A and $\xi'_{A'}$ and if ω' is a G -coloring of (M', T') extending ϑ_B

and $\vartheta'_{B'}$, then every isomorphism of cobordisms with corners $f : M \rightarrow M'$ induces a G -coloring $f^*\omega'$ of $(M', f^{-1}(T'))$ extending ϑ_B and $\vartheta'_{B'}$, given by the cohomology class

$$f^*\omega' \in H^1(M \setminus f^{-1}(T'), A_M \cup B_M \cup B'_M \cup A'_M; G)$$

where the induced isomorphism of pairs

$$f : (M \setminus f^{-1}(T'), A_M \cup B_M \cup B'_M \cup A'_M) \rightarrow (M' \setminus T', A_{M'} \cup B_{M'} \cup B'_{M'} \cup A'_{M'})$$

is still denoted f by abuse of notation.

REMARK 2.3.3. If Σ is a 2-dimensional cobordism from Γ to Γ' , if ξ_A and $\xi'_{A'}$ are G -colorings of Γ and Γ' respectively and if $P \subset \Sigma$ is a ribbon set then very G -coloring ϑ_B of (Σ, P) naturally determines a G -coloring $\vartheta_B \times I$ of $(\Sigma \times I, P \times I)$ extending ϑ_B and ϑ_B whose base set is given by

$$B \times \{0, 1\} \subset \Sigma \times I$$

and whose cohomology class is given by $\pi_{\Sigma}^* \vartheta$ for the map of pairs

$$\pi_{\Sigma} : ((\Sigma \times I) \setminus (P \times I), (A_{\Sigma} \cup B \cup A'_{\Sigma}) \times \{0, 1\}) \rightarrow (\Sigma \setminus P, A_{\Sigma} \cup B \cup A'_{\Sigma})$$

induced by the natural projection onto the first factor of $(\Sigma \setminus P) \times I$.

Let us fix a ribbon G -category \mathcal{C} . If Σ is a 2-dimensional cobordism and if $P \subset \Sigma$ is a ribbon set then we say a G -homogeneous \mathcal{C} -coloring V of P and a G -coloring ϑ_B of (Σ, P) are *compatible* if for every oriented vertex $p \in P$ the homology class m_p of a positive meridian of p satisfies $\langle \vartheta, m_p \rangle = i(V(p))$. A (\mathcal{C}, G) -coloring (V, ϑ_B) of (Σ, P) is given by a \mathcal{C} -coloring V of P together with a compatible G -coloring ϑ_B of (Σ, P) . If M is a 3-dimensional cobordism with corners and if $T \subset M$ is a ribbon graph then we say a G -homogeneous \mathcal{C} -coloring φ of T and a G -coloring ω of (M, T) are *compatible* if for every oriented edge $e \in T$ the homology class m_e of a positive meridian of e satisfies $\langle \omega, m_e \rangle = i(\varphi(e))$. A (\mathcal{C}, G) -coloring (φ, ω) of (M, T) is given by a \mathcal{C} -coloring φ of T together with a compatible G -coloring ω of (M, T) .

2.3.2. 2-Category of decorated cobordisms. In this subsection we fix a ribbon G -category \mathcal{C} and we introduce the symmetric monoidal 2-category $\mathbf{Cob}_3^{\mathcal{C}}$ of decorated cobordisms of dimension 1+1+1.

DEFINITION 2.3.4. An *object* Γ of $\mathbf{Cob}_3^{\mathcal{C}}$ is given by a pair (Γ, ξ_A) where:

- (i) Γ is a smooth oriented closed 1-dimensional manifold;
- (ii) ξ_A is a G -coloring of Γ .

DEFINITION 2.3.5. A *1-morphism* $\Sigma : \Gamma \rightarrow \Gamma'$ of $\mathbf{Cob}_3^{\mathcal{C}}$ is given by a 4-tuple $(\Sigma, P^V, \vartheta_B, \mathcal{L})$ where:

- (i) Σ is a 2-dimensional cobordism from Γ to Γ' ;
- (ii) $P^V \subset \Sigma$ is a G -homogeneous \mathcal{C} -colored ribbon set;
- (iii) ϑ_B is a G -coloring of (Σ, P) extending ξ_A and $\xi'_{A'}$ which is compatible with the \mathcal{C} -coloring $V : P \rightarrow \text{Ob}(\mathcal{C})$;
- (iv) $\mathcal{L} \subset H_1(\Sigma; \mathbb{R})$ is a Lagrangian subspace¹³ with respect to the intersection pairing \cap_{Σ} .

¹³A subspace A of a finite dimensional real vector space H equipped with an antisymmetric bilinear form is Lagrangian if it satisfies $A = A^{\perp}$.

DEFINITION 2.3.6. The *identity 1-morphism* $\text{id}_\Gamma : \Gamma \rightarrow \Gamma$ associated with an object $\Gamma = (I, \xi_A)$ of $\mathbf{Cob}_3^{\mathcal{C}}$ is the 4-tuple

$$(I \times \Gamma, \emptyset^\emptyset, I \times \xi_A, H_1(I \times \Gamma; \mathbb{R})).$$

DEFINITION 2.3.7. A *2-morphism* $\mathbf{M} : \Sigma \Rightarrow \Sigma'$ of $\mathbf{Cob}_3^{\mathcal{C}}$ between 1-morphisms $\Sigma, \Sigma' : \Gamma \rightarrow \Gamma'$ is given by an equivalence class of 4-tuples $(M, T^\varphi, \omega, n)$ where:

- (i) M is a 3-dimensional cobordism with corners from Σ to Σ' ;
- (ii) $T^\varphi \subset M$ is a G -homogeneous \mathcal{C} -colored ribbon graph from P^V to $P^{V'}$;
- (iii) ω is a G -coloring of (M, T) extending (B, ϑ) and (B', ϑ') which is compatible with the \mathcal{C} -coloring $\varphi : T \rightarrow \mathcal{C}$;
- (iv) $n \in \mathbb{Z}$ is called the *signature defect*.

Two 4-tuples $(M, T^\varphi, \omega, n)$ and $(M', T'^{\varphi'}, \omega', n')$ are equivalent if $n = n'$ and if there exists an isomorphism of cobordisms with corners $f : M \rightarrow M'$ satisfying $f(T^\varphi) = T'^{\varphi'}$ and $f^*\omega' = \omega$.

DEFINITION 2.3.8. The *identity 2-morphism* $\text{id}_\Sigma : \Sigma \Rightarrow \Sigma$ associated with a 1-morphism $\Sigma = (\Sigma, P^V, \vartheta_B, \mathcal{L})$ of $\mathbf{Cob}_3^{\mathcal{C}}$ is the equivalence class of the 4-tuple

$$(\Sigma \times I, P^V \times I, \vartheta_B \times I, 0).$$

In order to define horizontal and vertical compositions of 1-morphisms and 2-morphisms we need to be able to induce uniquely determined G -colorings on horizontal and vertical gluings of \mathcal{C} -decorated cobordisms. The following observation will be repeatedly used for this purpose.

REMARK 2.3.4. Let X_-, X_+, Y be topological spaces, let $A_- \subset \partial X_-, A_+ \subset \partial X_+$ be subspaces and let $f_- : Y \rightarrow A_-, f_+ : Y \rightarrow A_+$ be homeomorphisms. If $E_- \subset X_-, E_+ \subset X_+, E \subset Y$ are subsets satisfying $f_-(E) = E_- \cap A_-$ and $f_+(E) = E_+ \cap A_+$ let us consider relative cohomology classes

$$\alpha_- \in H^1(X_-, E_-; G), \quad \alpha_+ \in H^1(X_+, E_+; G)$$

satisfying $j_{Y_-}^*(\alpha_-) = j_{Y_+}^*(\alpha_+)$ for the embeddings of pairs

$$j_{Y_-} : (Y, E) \hookrightarrow (X_-, E_-), \quad j_{Y_+} : (Y, E) \hookrightarrow (X_+, E_+)$$

induced by f_- and f_+ respectively. Then there exists a relative cohomology class $\alpha_- \cup_Y \alpha_+ \in H^1(X_- \cup_Y X_+, E_- \cup E_+; G)$ satisfying $j_{X_-}^*(\alpha_- \cup_Y \alpha_+) = \alpha_-$ and $j_{X_+}^*(\alpha_- \cup_Y \alpha_+) = \alpha_+$ for the natural embeddings of pairs

$$\begin{aligned} j_{X_-} : (X_-, E_-) &\hookrightarrow (X_- \cup_Y X_+, E_- \cup E_+), \\ j_{X_+} : (X_+, E_+) &\hookrightarrow (X_- \cup_Y X_+, E_- \cup E_+) \end{aligned}$$

as follows from the Mayer-Vietoris sequence

$$\begin{aligned} \dots &\longrightarrow H^0(Y, E; G) \longrightarrow H^1(X_- \cup_Y X_+, i_{X_-}(E_-) \cup i_{X_+}(E_+); G) \\ &\xrightarrow{(j_{X_-}^*, j_{X_+}^*)} H^1(X_-, E_-; G) \oplus H^1(X_+, E_+; G) \xrightarrow{j_{Y_-}^* - j_{Y_+}^*} H^1(Y, E; G) \longrightarrow \dots \end{aligned}$$

Such a cohomology class is furthermore unique if the map

$$H^0(Y, E; G) \rightarrow H^1(X_- \cup_Y X_+, E_- \cup E_+; G)$$

is zero. This happens, for instance, when $H^0(Y, E; G) = 0$.

REMARK 2.3.5. If $\Sigma : \Gamma \rightarrow \Gamma'$ and $\Sigma' : \Gamma' \rightarrow \Gamma''$ are 1-morphisms of $\mathbf{Cob}_3^{\mathcal{C}}$ then the horizontal composition of Σ' with Σ determines a unique G -coloring

$$\vartheta_B \cup_{\xi'_{A'}} \vartheta'_{B'}$$

of $(\Sigma \cup_{\Gamma'} \Sigma', P \cup P')$ extending ξ_A and $\xi''_{A''}$, defined as follows: its base set is given by $B \cup B'$ and its cohomology class is given by $j^*(\vartheta \cup_{\Gamma'} \vartheta')$ where $\vartheta \cup_{\Gamma'} \vartheta'$ is the unique cohomology class in

$$H^1((\Sigma \cup_{\Gamma'} \Sigma') \setminus (P \cup P'), A_{\Sigma} \cup B \cup A'_{\Sigma'} \cup A''_{\Sigma''} \cup B' \cup A''_{\Sigma''}; G)$$

given by Remark 2.3.4 and where j is the inclusion of the pair

$$\left((\Sigma \cup_{\Gamma'} \Sigma') \setminus (P \cup P'), A_{\Sigma \cup_{\Gamma'} \Sigma'} \cup B \cup B' \cup A''_{\Sigma \cup_{\Gamma'} \Sigma'} \right)$$

into the pair

$$\left((\Sigma \cup_{\Gamma'} \Sigma') \setminus (P \cup P'), A_{\Sigma} \cup B \cup A'_{\Sigma'} \cup A''_{\Sigma''} \cup B' \cup A''_{\Sigma''} \right)$$

with

$$A_{\Sigma \cup_{\Gamma'} \Sigma'} = A_{\Sigma} = f_{\Sigma_-}(A), \quad A''_{\Sigma \cup_{\Gamma'} \Sigma'} = A''_{\Sigma''} = f_{\Sigma''_+}(A'').$$

DEFINITION 2.3.9. The *horizontal composition* $\Sigma' \circ \Sigma : \Gamma \rightarrow \Gamma''$ of 1-morphisms $\Sigma' : \Gamma' \rightarrow \Gamma''$ and $\Sigma : \Gamma \rightarrow \Gamma'$ of $\mathbf{Cob}_3^{\mathcal{C}}$ is given by the 4-tuple

$$(\Sigma \cup_{\Gamma'} \Sigma', P^V \cup P'^V, \vartheta_B \cup_{\xi'_{A'}} \vartheta'_{B'}, \mathcal{L} + \mathcal{L}').$$

REMARK 2.3.6. If $\Sigma, \Sigma'' : \Gamma \rightarrow \Gamma'$ and $\Sigma', \Sigma''' : \Gamma' \rightarrow \Gamma''$ are 1-morphisms and if $M : \Sigma \Rightarrow \Sigma''$ and $M' : \Sigma' \Rightarrow \Sigma'''$ are 2-morphisms of $\mathbf{Cob}_3^{\mathcal{C}}$ then the horizontal composition of M' with M determines a unique G -coloring

$$\omega \cup_{\xi'_{A'} \times I} \omega'$$

of $(M \cup_{\Gamma' \times I} M', T \cup T')$ extending $\vartheta_B \cup_{\Gamma'} \vartheta'_{B'}$ and $\vartheta''_{B''} \cup_{\Gamma'} \vartheta'''_{B'''}$ given by $j^*(\vartheta \cup_{\Gamma'} \vartheta')$ where $\vartheta \cup_{\Gamma'} \vartheta'$ is the unique cohomology class in

$$H^1((\Sigma \cup_{\Gamma'} \Sigma') \setminus (P \cup P'), A_{\Sigma} \cup B \cup A'_{\Sigma'} \cup A''_{\Sigma''} \cup B' \cup A''_{\Sigma''}; G)$$

given by Remark 2.3.4 and where j is the inclusion of the pair

$$\left((\Sigma \cup_{\Gamma'} \Sigma') \setminus (P \cup P'), A_{\Sigma \cup_{\Gamma'} \Sigma'} \cup B \cup B' \cup A''_{\Sigma \cup_{\Gamma'} \Sigma'} \right)$$

into the pair

$$\left((\Sigma \cup_{\Gamma'} \Sigma') \setminus (P \cup P'), A_{\Sigma} \cup B \cup A'_{\Sigma'} \cup A''_{\Sigma''} \cup B' \cup A''_{\Sigma''} \right)$$

with

$$A_{\Sigma \cup_{\Gamma'} \Sigma'} = A_{\Sigma} = f_{\Sigma_-}(A), \quad A''_{\Sigma \cup_{\Gamma'} \Sigma'} = A''_{\Sigma''} = f_{\Sigma''_+}(A'').$$

DEFINITION 2.3.10. The *horizontal composition* $M' \circ M : \Sigma' \circ \Sigma \Rightarrow \Sigma''' \circ \Sigma''$ of 2-morphisms $M' : \Sigma' \Rightarrow \Sigma'''$ and $M : \Sigma \Rightarrow \Sigma''$ of $\mathbf{Cob}_3^{\mathcal{C}}$ for 1-morphisms $\Sigma, \Sigma'' : \Gamma \rightarrow \Gamma'$ and $\Sigma', \Sigma''' : \Gamma' \rightarrow \Gamma''$ is given by the equivalence class of the 4-tuple

$$(M \cup_{\Gamma' \times I} M', T^{\varphi} \cup T'^{\varphi'}, \omega \cup_{\xi'_{A'} \times I} \omega', n + n').$$

REMARK 2.3.7. If $\Sigma, \Sigma', \Sigma'' : \Gamma \rightarrow \Gamma'$ are 1-morphisms and if $M : \Sigma \rightarrow \Sigma'$ and $M' : \Sigma' \rightarrow \Sigma''$ are 2-morphisms of $\mathbf{Cob}_3^{\mathcal{G}}$ then the vertical composition of M' with M determines a G -coloring

$$\omega \cup_{\vartheta'_B} \omega'$$

of $(M \cup_{\Sigma'} M', T \cup_P T')$ extending ϑ_B and $\vartheta''_{B''}$ given by $j^*(\omega \cup_{\Sigma'} \omega')$ where $\omega \cup_{\Sigma'} \omega'$ is the unique class in

$$H^1((M \cup_{\Sigma'} M') \setminus (T \cup_{P'} T'), A_M \cup B_M \cup B'_M \cup A'_M \cup A_{M'} \cup B_{M'} \cup B''_{M'} \cup A'_{M'}; G)$$

given by Remark 2.3.4 and where j is the inclusion of the pair

$$\left((M \cup_{\Sigma'} M') \setminus (T \cup_{P'} T'), A_{M \cup_{\Sigma'} M'} \cup B_M \cup B''_{M'} \cup A'_{M \cup_{\Sigma'} M'} \right)$$

into the pair

$$\left((M \cup_{\Sigma'} M') \setminus (T \cup_{P'} T'), A_M \cup B_M \cup B'_M \cup A'_M \cup A_{M'} \cup B_{M'} \cup B''_{M'} \cup A'_{M'} \right)$$

with

$$\begin{aligned} A_{M \cup_{\Sigma'} M'} &= f_{M \perp} (A_{\Sigma}) \cup f_{M \perp} (A_{\Sigma''}), \\ A'_{M \cup_{\Sigma'} M'} &= f_{M \perp} (A'_{\Sigma}) \cup f_{M \perp} (A'_{\Sigma''}). \end{aligned}$$

DEFINITION 2.3.11. The *vertical composition* $M' * M : \Sigma \Rightarrow \Sigma''$ of 2-morphisms $M' : \Sigma' \Rightarrow \Sigma''$ and $M : \Sigma \Rightarrow \Sigma'$ of $\mathbf{Cob}_3^{\mathcal{G}}$ for 1-morphisms $\Sigma, \Sigma', \Sigma'' : \Gamma \rightarrow \Gamma'$ is given by the equivalence class of the 4-tuple

$$(M \cup_{\Sigma'} M', T^{\varphi} \cup_{P'V'} T'^{\varphi'}, \omega \cup_{\vartheta'_B} \omega', n + n' - \mu(M_* \mathcal{L}, \mathcal{L}', M'^* \mathcal{L}''))$$

where the correction term $\mu(M_* \mathcal{L}, \mathcal{L}', M'^* \mathcal{L}'')$ is the Maslov index of the Lagrangian subspaces $M_* \mathcal{L}, \mathcal{L}', M'^* \mathcal{L}'' \subset H_1(\Sigma'; \mathbb{R})$ introduced in Definition 1.3.8.

DEFINITION 2.3.12. The *unit of $\mathbf{Cob}_3^{\mathcal{G}}$* is the unique object whose manifold is empty and it will be denoted \emptyset .

REMARK 2.3.8. Let X, X' be topological spaces and let $E \subset X, E' \subset X'$ be subsets. If $\alpha \in H^k(X, E; G)$ and $\alpha' \in H^k(X', E'; G)$ are cohomology classes then we denote with $\alpha \sqcup \alpha'$ the cohomology class in $H^k(X \sqcup X', E \sqcup E'; G)$ defined as

$$\alpha \sqcup \alpha' := q_{X'}^* e_{X'}^{*-1} \alpha + q_X^* e_X^{*-1} \alpha'$$

for the natural inclusions

$$\begin{aligned} q_{X'} &: (X \sqcup X', E \sqcup E') \hookrightarrow (X \sqcup X', E \sqcup X'), \\ q_X &: (X \sqcup X', E \sqcup E') \hookrightarrow (X \sqcup X', X \sqcup E'), \\ e_{X'} &: (X, E) \hookrightarrow (X \sqcup X', E \sqcup X'), \\ e_X &: (X', E') \hookrightarrow (X \sqcup X', X \sqcup E'). \end{aligned}$$

DEFINITION 2.3.13. The *tensor product* $\Gamma \otimes \Gamma'$ of objects Γ and Γ' of $\mathbf{Cob}_3^{\mathcal{G}}$ is given by the pair $(\Gamma \sqcup \Gamma', (\xi \sqcup \xi')_{A \sqcup A'})$.

DEFINITION 2.3.14. The *tensor product* $\Sigma \otimes \Sigma' : \Gamma \otimes \Gamma' \rightarrow \Gamma'' \otimes \Gamma'''$ of 1-morphisms $\Sigma : \Gamma \rightarrow \Gamma''$ and $\Sigma' : \Gamma' \rightarrow \Gamma'''$ of $\mathbf{Cob}_3^{\mathcal{G}}$ is given by the 4-tuple

$$(\Sigma \sqcup \Sigma', P^V \sqcup P'^{V'}, (\vartheta \sqcup \vartheta')_{B \sqcup B'}, \mathcal{L} + \mathcal{L}')$$

DEFINITION 2.3.15. The *tensor product* $\mathbf{M} \otimes \mathbf{M}' : \Sigma \otimes \Sigma' \Rightarrow \Sigma'' \otimes \Sigma'''$ of 2-morphisms $\mathbf{M} : \Sigma \Rightarrow \Sigma''$ and $\mathbf{M}' : \Sigma' \Rightarrow \Sigma'''$ of $\mathbf{Cob}_3^{\mathcal{C}}$ is given by the equivalence class of the 4-tuple

$$(\mathbf{M} \sqcup \mathbf{M}', \mathbf{T}^\varphi \sqcup \mathbf{T}'^{\varphi'}, \omega \sqcup \omega', n + n').$$

DEFINITION 2.3.16. The *braiding 1-morphism* $\beta_{\Gamma, \Gamma'} : \Gamma \otimes \Gamma' \rightarrow \Gamma' \otimes \Gamma$ associated with objects Γ and Γ' of $\mathbf{Cob}_3^{\mathcal{C}}$ is given by the 4-tuple¹⁴

$$(\tilde{I} \times (\Gamma \sqcup \Gamma'), \emptyset^\emptyset, I \times (\xi \sqcup \xi')_{A \sqcup A'}, H_1(I \times (\Gamma \sqcup \Gamma'); \mathbb{R})).$$

DEFINITION 2.3.17. The *braiding 2-morphism*

$$(\beta_{(\Gamma, \Gamma'), (\Gamma'', \Gamma''')})_{\Sigma, \Sigma'} : \beta_{\Gamma'', \Gamma'''} \circ (\Sigma \otimes \Sigma') \Rightarrow (\Sigma' \otimes \Sigma) \circ \beta_{\Gamma, \Gamma'}$$

associated with 1-morphisms $\Sigma : \Gamma \rightarrow \Gamma''$ and $\Sigma' : \Gamma' \rightarrow \Gamma'''$ of $\mathbf{Cob}_3^{\mathcal{C}}$ is given by the 4-tuple¹⁵

$$((\Sigma \sqcup \Sigma') \tilde{\times} I, (P^V \sqcup P'^{V'}) \times I, (\vartheta_B \sqcup \vartheta'_{B'}) \times I, 0).$$

2.3.3. 2-Category of admissible cobordisms. In this subsection we fix a pre-modular G -category \mathcal{C} relative to (Π, X) and we define the symmetric monoidal 2-category $\check{\mathbf{Cob}}_3^{\mathcal{C}}$ of admissible decorated cobordisms of dimension 1+1+1.

If Σ is a connected 2-dimensional cobordism and if $P \subset \Sigma$ is a ribbon set then a vertex $p \in P$ is said to be *projective with respect to a \mathcal{C} -coloring V of P* if $V(p)$ is a projective object of \mathcal{C} . A \mathcal{C} -coloring $V : P \rightarrow \text{Ob}(\mathcal{C})$ is *projective* if there exists a projective vertex $p \in P$ with respect to V . If M is a connected 3-dimensional cobordism with corners and if $T \subset M$ is a ribbon graph then an edge $e \subset T$ is said to be *projective with respect to a \mathcal{C} -coloring φ of T* if $\varphi(e)$ is a projective object of \mathcal{C} . A \mathcal{C} -coloring $\varphi : T \rightarrow \mathcal{C}$ is *projective* if there exists a projective edge $e \subset T$ with respect to φ . If Σ is a connected 2-dimensional cobordism and if $P \subset \Sigma$ is a ribbon set then a simple closed oriented curve $\gamma \subset \Sigma \setminus P$ is *generic with respect to a G -coloring ϑ_B of (Σ, P)* if $\langle \vartheta, \gamma \rangle \in G \setminus X$ as a homology class. A G -coloring ϑ_B of (Σ, P) is *generic* if there exists a generic simple closed oriented curve $\gamma \subset \Sigma \setminus P$ with respect to ϑ_B . If M is a connected 3-dimensional cobordism with corners and if $T \subset M$ is a ribbon graph then an oriented knot $K \subset M \setminus T$ is *generic with respect to a G -coloring ω of (M, T)* if $\langle \omega, K \rangle \in G \setminus X$ as a homology class. A G -coloring ω of (M, T) is *generic* if there exists a generic oriented knot $K \subset M \setminus T$ with respect to ω .

REMARK 2.3.9. If $\Sigma = \Sigma_1 \cup \dots \cup \Sigma_n$ is a 2-dimensional cobordism with connected components Σ_i for $i = 1, \dots, n$ and if $P \subset \Sigma$ is a ribbon set which decomposes as $P = P_1 \cup \dots \cup P_n$ with $P_i \subset \Sigma_i$ then every (\mathcal{C}, G) -coloring (V, ϑ_B) of (Σ, P) naturally restricts to a (\mathcal{C}, G) -coloring of (Σ_i, P_i) for all $i = 1, \dots, n$ which will be denoted $(V_i, (\vartheta_i)_{B_i})$. Analogously if $M = M_1 \cup \dots \cup M_n$ is a 3-dimensional cobordism with corners with connected components M_i for $i = 1, \dots, n$ and if $T \subset M$ is a ribbon graph which decomposes as $T = T_1 \cup \dots \cup T_n$ with $T_i \subset M_i$ then every (\mathcal{C}, G) -coloring (φ, ω) of (M, T) naturally restricts to a (\mathcal{C}, G) -coloring of (M_i, T_i) for all $i = 1, \dots, n$ which will be denoted (φ_i, ω_i) .

If $\Sigma = \Sigma_1 \cup \dots \cup \Sigma_n$ is a 2-dimensional cobordism with connected components Σ_i for $i = 1, \dots, n$ and if $P \subset \Sigma$ is a ribbon set which decomposes as $P = P_1 \cup \dots \cup P_n$

¹⁴See Definition B.4.10 for the flip cobordism $\tilde{I} \times (\Gamma \sqcup \Gamma')$.

¹⁵See Definition B.4.11 for the flip cobordism with corners $(\Sigma \sqcup \Sigma') \tilde{\times} I$.

with $P_i \subset \Sigma_i$ then a (\mathcal{C}, G) -coloring (V, ϑ_B) of (Σ, P) is *admissible* if for every connected component Σ_i of Σ disjoint from the incoming boundary $\partial_- \Sigma$ either V_i is projective or $(\vartheta_i)_{B_i}$ is generic, and it is *strongly admissible* if for every connected component Σ_i of Σ either V_i is projective or $(\vartheta_i)_{B_i}$ is generic. If $M = M_1 \cup \dots \cup M_n$ is a 3-dimensional cobordism with corners with connected components M_i for $i = 1, \dots, n$ and if $T \subset M$ is a ribbon graph which decomposes as $T = T_1 \cup \dots \cup T_n$ with $T_i \subset M_i$ then a (\mathcal{C}, G) -coloring (φ, ω) of (M, T) is *admissible* if for every connected component M_i of M disjoint from the incoming horizontal boundary $\partial^h_- M$ either φ_i is projective or ω_i is generic, and it is *strongly admissible* if for every connected component M_i of M either φ_i is projective or ω_i is generic.

DEFINITION 2.3.18. A 1-morphism $\Sigma = (\Sigma, P^V, \vartheta_B, \mathcal{L})$ of $\mathbf{Cob}_3^{\mathcal{C}}$ is *admissible* if (V, ϑ_B) is an admissible (\mathcal{C}, G) -coloring for (Σ, P) , and it is *strongly admissible* if (V, ϑ_B) is a strongly admissible (\mathcal{C}, G) -coloring for (Σ, P) .

REMARK 2.3.10. The previous definition has the following direct consequences:

- (i) If Γ is an object of $\mathbf{Cob}_3^{\mathcal{C}}$ then id_Γ is an admissible 1-morphism.
- (ii) If $\Sigma' : \Gamma' \rightarrow \Gamma''$ and $\Sigma : \Gamma \rightarrow \Gamma'$ are admissible 1-morphisms of $\mathbf{Cob}_3^{\mathcal{C}}$ then $\Sigma' \circ \Sigma$ is an admissible 1-morphism.
- (iii) If Σ and Σ' are admissible 1-morphisms of $\mathbf{Cob}_3^{\mathcal{C}}$ then $\Sigma \otimes \Sigma'$ is an admissible 1-morphism.

DEFINITION 2.3.19. A 2-morphism $\mathbf{M} = (M, T^\varphi, \omega, n)$ of $\mathbf{Cob}_3^{\mathcal{C}}$ is *admissible* if (φ, ω) is an admissible (\mathcal{C}, G) -coloring for (M, T) .

REMARK 2.3.11. The previous definition has the following direct consequences:

- (i) If Σ is an admissible 1-morphism of $\mathbf{Cob}_3^{\mathcal{C}}$ then id_Σ is an admissible 2-morphism.
- (ii) If $\mathbf{M}' : \Sigma' \rightarrow \Sigma'''$ and $\mathbf{M} : \Sigma \rightarrow \Sigma''$ are admissible 2-morphisms of $\mathbf{Cob}_3^{\mathcal{C}}$ for 1-morphisms $\Sigma, \Sigma'' : \Gamma \rightarrow \Gamma'$ and $\Sigma', \Sigma''' : \Gamma' \rightarrow \Gamma''$ then $\mathbf{M}' \circ \mathbf{M}$ is an admissible 2-morphism.
- (iii) If $\mathbf{M}' : \Sigma' \rightarrow \Sigma''$ and $\mathbf{M} : \Sigma \rightarrow \Sigma'$ are admissible 2-morphisms of $\mathbf{Cob}_3^{\mathcal{C}}$ for 1-morphisms $\Sigma, \Sigma', \Sigma'' : \Gamma \rightarrow \Gamma'$ then $\mathbf{M}' * \mathbf{M}$ is an admissible 2-morphism.
- (iv) If \mathbf{M} and \mathbf{M}' are admissible 2-morphisms of $\mathbf{Cob}_3^{\mathcal{C}}$ then $\mathbf{M} \otimes \mathbf{M}'$ is an admissible 2-morphism.

DEFINITION 2.3.20. The symmetric monoidal 2-category $\check{\mathbf{Cob}}_3^{\mathcal{C}}$ of admissible 3-dimensional cobordisms is the symmetric monoidal 2-category whose objects are objects of $\mathbf{Cob}_3^{\mathcal{C}}$, whose morphisms are admissible morphisms of $\mathbf{Cob}_3^{\mathcal{C}}$ and whose symmetric monoidal structure is inherited by that of $\mathbf{Cob}_3^{\mathcal{C}}$.

2.3.4. Extended universal construction for admissible cobordisms.

In this subsection we consider a pre-modular G -category \mathcal{C} relative to (H, X) and we fix the terminology for quantum invariants, TQFTs and ETQFTs in the context of admissible decorated manifolds and cobordisms. We also recall the main ideas of the extended universal construction, the fundamental machinery our investigation is based on, postponing a detailed account to Appendix A.7.

REMARK 2.3.12. Morphisms of $\check{\mathbf{Cob}}_3^{\mathcal{C}}$ from \emptyset to itself are naturally arranged in a symmetric monoidal category with respect to the tensor product of 1-morphisms and 2-morphisms and with unit given by the empty 1-morphism id_\emptyset . This category

will be denoted $\check{\mathbf{Cob}}_3^{\mathcal{C}}$ for brevity. Analogously, the set of 2-morphisms of $\check{\mathbf{Cob}}_3^{\mathcal{C}}$ from id_{\emptyset} to itself forms a commutative monoid with respect to the tensor product of 2-morphisms and with unit given by the empty 2-morphism $\text{id}_{\text{id}_{\emptyset}}$. This monoid will be denoted $\check{\mathbf{Man}}_3^{\mathcal{C}}$ for brevity.

An *invariant on $\check{\mathbf{Man}}_3^{\mathcal{C}}$* is a function from $\check{\mathbf{Man}}_3^{\mathcal{C}}$ to \mathbb{C} . A *covariant quantization functor on $\check{\mathbf{Cob}}_3^{\mathcal{C}}$* is a functor from $\check{\mathbf{Cob}}_3^{\mathcal{C}}$ to $\text{Vect}_{\mathbb{C}}$. A *contravariant quantization functor on $\check{\mathbf{Cob}}_3^{\mathcal{C}}$* is a functor from $(\check{\mathbf{Cob}}_3^{\mathcal{C}})^{\text{op}}$ to $\text{Vect}_{\mathbb{C}}$. A *covariant quantization 2-functor on $\check{\mathbf{Cob}}_3^{\mathcal{C}}$* is a 2-functor from $\check{\mathbf{Cob}}_3^{\mathcal{C}}$ to $\mathbf{Cat}_{\mathbb{C}}$. A *contravariant quantization 2-functor on $\check{\mathbf{Cob}}_3^{\mathcal{C}}$* is a 2-functor from $(\check{\mathbf{Cob}}_3^{\mathcal{C}})^{\text{op}}$ to $\mathbf{Cat}_{\mathbb{C}}$. A *quantum invariant on $\check{\mathbf{Man}}_3^{\mathcal{C}}$* is an invariant on $\check{\mathbf{Man}}_3^{\mathcal{C}}$ which is a commutative monoid homomorphism. A *TQFT on $\check{\mathbf{Cob}}_3^{\mathcal{C}}$* is a covariant quantization functor on $\check{\mathbf{Cob}}_3^{\mathcal{C}}$ which is symmetric monoidal. An *ETQFT on $\check{\mathbf{Cob}}_3^{\mathcal{C}}$* is a symmetric monoidal 2-functor from $\check{\mathbf{Cob}}_3^{\mathcal{C}}$ to $\hat{\mathbf{Cat}}_{\mathbb{C}}$. A *Π -graded TQFT on $\check{\mathbf{Cob}}_3^{\mathcal{C}}$* is a symmetric monoidal functor from $\check{\mathbf{Cob}}_3^{\mathcal{C}}$ to $\text{Vect}_{\mathbb{C}}^{\Pi}$. A *Π -graded ETQFT on $\check{\mathbf{Cob}}_3^{\mathcal{C}}$* is a symmetric monoidal 2-functor from $\check{\mathbf{Cob}}_3^{\mathcal{C}}$ to $\hat{\mathbf{Cat}}_{\mathbb{C}}^{\Pi}$.

The extended universal construction is a machinery which associates with every invariant Z on $\check{\mathbf{Man}}_3^{\mathcal{C}}$ a covariant and a contravariant quantization 2-functors on $\check{\mathbf{Cob}}_3^{\mathcal{C}}$ denoted \mathbf{E}_Z and \mathbf{E}'_Z respectively. The image of an object Γ of $\check{\mathbf{Cob}}_3^{\mathcal{C}}$ under \mathbf{E}_Z is a linear category $\Lambda_Z(\Gamma)$ called the *covariant universal linear category of Γ* whose objects are 1-morphisms of $\check{\mathbf{Cob}}_3^{\mathcal{C}}$ of the form $\Sigma_{\Gamma} : \emptyset \rightarrow \Gamma$ and whose morphism vector spaces $\text{Hom}_{\Lambda_Z(\Gamma)}(\Sigma_{\Gamma}, \Sigma'_{\Gamma})$ are given by certain quotients, which are defined using Z , of the free complex vector spaces generated by 2-morphisms of $\check{\mathbf{Cob}}_3^{\mathcal{C}}$ of the form $\mathbf{M}_{\Gamma} : \Sigma_{\Gamma} \Rightarrow \Sigma'_{\Gamma}$. The image of a 1-morphism $\Sigma : \Gamma \rightarrow \Gamma'$ of $\check{\mathbf{Cob}}_3^{\mathcal{C}}$ under \mathbf{E}_Z is a covariant linear functor $F_Z(\Sigma) : \Lambda_Z(\Gamma) \rightarrow \Lambda_Z(\Gamma')$ called the *covariant universal linear functor of Σ* which maps every object Σ_{Γ} of $\Lambda_Z(\Gamma)$ to the object $\Sigma \circ \Sigma_{\Gamma}$ of $\Lambda_Z(\Gamma')$ and every morphism $[\mathbf{M}_{\Gamma}]$ of $\Lambda_Z(\Gamma)$ to the morphism $[\text{id}_{\Sigma} \circ \mathbf{M}_{\Gamma}]$ of $\Lambda_Z(\Gamma')$. The image of a 2-morphism $\mathbf{M} : \Sigma \Rightarrow \Sigma'$ of $\check{\mathbf{Cob}}_3^{\mathcal{C}}$ under \mathbf{E}_Z is a natural transformation $\eta_Z(\mathbf{M}) : F_Z(\Sigma) \Rightarrow F_Z(\Sigma')$ called the *covariant universal natural transformation of \mathbf{M}* which associates with every object Σ_{Γ} of $\Lambda_Z(\Gamma)$ the morphism $[\mathbf{M} \circ \text{id}_{\Sigma_{\Gamma}}]$ of $\Lambda_Z(\Gamma')$. The contravariant quantization 2-functor \mathbf{E}'_Z is defined similarly.

2.4. Surgery axioms

We move on to the study of the quantization 2-functors given by the extended universal construction. We begin by introducing a set of axioms for quantum invariants on $\check{\mathbf{Man}}_3^{\mathcal{C}}$ which, when satisfied, enable us to better handle universal linear categories, linear functors and natural transformations. This is much in the spirit of [BHMV95] and [BCGP16].

REMARK 2.4.1. From now on \mathcal{C} will denote a fixed pre-modular G -category relative to (Π, X) and i_g will denote a fixed index in I_g for every generic $g \in G \setminus X$. This choice specifies a fixed projective simple object $V_g := V_{i_g}$ of \mathcal{C}_g .

Let $\Sigma = (\Sigma, P^V, \vartheta_B, \mathcal{L})$, $\Sigma' = (\Sigma', P^{V'}, \vartheta'_{B'}, \mathcal{L}')$ be 1-morphisms of $\check{\mathbf{Cob}}_3^{\mathcal{C}}$ from Γ to Γ' , let \mathbf{M} be a cobordism with corners from Σ to Σ' , let $T^{\varphi} \subset \mathbf{M}$ be a G -homogeneous \mathcal{C} -colored ribbon graph from P^V to $P^{V'}$ and let n be an integer. If $L = L_1 \cup \dots \cup L_k \subset \mathbf{M}$ is a framed link disjoint from T and if ω is a G -coloring of $(\mathbf{M}, L \cup T)$ extending ϑ_B and $\vartheta'_{B'}$ which is compatible with $\varphi : T \rightarrow \mathcal{C}$ and which

satisfies $\langle \omega, m_{L_i} \rangle = g_i \in G \setminus X$ for a positive meridian m_{L_i} of L_i for all $i = 1, \dots, k$ then we denote with

$$(M, L_1^{\Omega_{g_1}} \cup \dots \cup L_1^{\Omega_{g_k}} \cup T^\varphi, \omega, n)$$

the formal linear combination of 2-morphisms of $\check{\mathbf{Cob}}_3^{\mathcal{C}}$

$$\sum_{i_1 \in I_{g_1}} \dots \sum_{i_k \in I_{g_k}} d(V_{i_1}) \dots d(V_{i_k}) \cdot (M, L_1^{V_{i_1}} \cup \dots \cup L_k^{V_{i_k}} \cup T^\varphi, \omega, n).$$

REMARK 2.4.2. Although $(M, L_1^{\Omega_{g_1}} \cup \dots \cup L_1^{\Omega_{g_k}} \cup T^\varphi, \omega, n)$ is not actually a 2-morphism of $\check{\mathbf{Cob}}_3^{\mathcal{C}}$, we will treat it as such by abuse of notation.

DEFINITION 2.4.1. For every generic $g \in G \setminus X$ the g -colored index 0 surgery 1-morphism $\Sigma_{0,g} : \emptyset \rightarrow \emptyset$ of $\check{\mathbf{Cob}}_3^{\mathcal{C}}$ is given by

$$\Sigma_{0,g} := (S^{-1} \times S^3, \emptyset^\emptyset, 0_\emptyset, \{0\}) = \text{id}_\emptyset.$$

DEFINITION 2.4.2. For every generic $g \in G \setminus X$ the g -colored index 1 surgery 1-morphism $\Sigma_{1,g} : \emptyset \rightarrow \emptyset$ of $\check{\mathbf{Cob}}_3^{\mathcal{C}}$ is given by

$$\Sigma_{1,g} := (S^0 \times S^2, P_1^{V_g}, (\vartheta_{1,g})_{B_1}, \{0\})$$

where the \mathcal{C} -colored ribbon set $P_1^{V_g}$ is given by

$$P_1 := S^0 \times \{p_S, p_N\} \subset S^0 \times S^2$$

for the poles $p_S = (0, 0, -1)$ and $p_N = (0, 0, 1)$, with orientation given by the sign $+$ on $(0, p_S)$ and $(1, p_N)$ and by the sign $-$ on $(0, p_N)$ and $(1, p_S)$, with framing tangent to

$$S^0 \times \{(x, y, z) \in S^2 \mid x \geq 0, z = 0\}$$

and with \mathcal{C} -coloring given by the object V_g for every point, where the base set $B_1 \subset S^0 \times S^2$ is given by $S^0 \times \{p_E\}$ for some equatorial point p_E and where $\vartheta_{1,g}$ is the only cohomology class yielding a G -coloring of $(S^0 \times S^2, P_1)$ which is compatible with the \mathcal{C} -coloring of P_1 . See Figure 5 for a graphical representation.

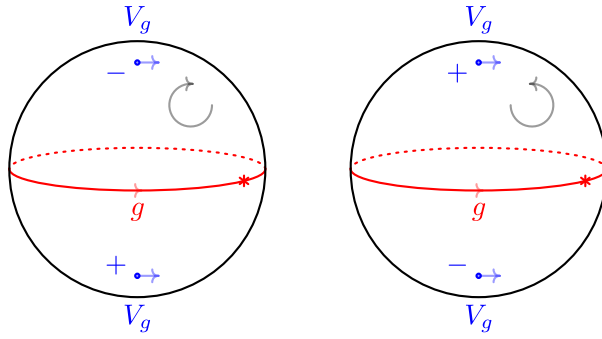

FIGURE 5. The 1-morphism $\Sigma_{1,g}$. The ribbon set P_1 is given by the four framed blue vertices. The base set B_1 is given by the two starred red equatorial points. The oriented red equators, which form a basis for the first homology group, are evaluated to g by $\vartheta_{1,g}$.

DEFINITION 2.4.3. For every generic $g \in G \setminus X$ the g -colored index 2 surgery 1-morphism $\Sigma_{2,g} : \emptyset \rightarrow \emptyset$ of $\check{\mathbf{Cob}}_3^{\mathcal{E}}$ is given by

$$\Sigma_{2,g} := (S^1 \times S^1, \emptyset^\emptyset, (\vartheta_{2,g})_{B_2}, \mathcal{L}_2)$$

where the base set $B_2 \subset S^1 \times S^1$ is given by $\{((1,0), (0,1))\}$, where $\vartheta_{2,g}$ is the cohomology class determined by $\langle \vartheta_{2,g}, m \rangle = g$ and $\langle \vartheta_{2,g}, \ell \rangle = 0$ for the positive meridian $m := \{(1,0)\} \times \overline{S^1}$ and for the positive longitude $\ell := S^1 \times \{(0,1)\}$ and where the Lagrangian subspace $\mathcal{L}_2 \subset H^1(S^1 \times S^1; \mathbb{R})$ is generated by m . See Figure 6 for a graphical representation.

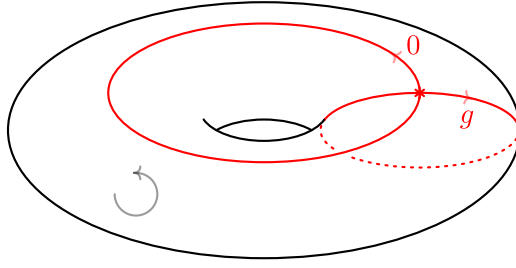

FIGURE 6. The 1-morphism $\Sigma_{2,g}$. The base set B_2 is given by the starred red intersection point between the meridian and the longitude. These two oriented red curves, which form a basis for the first homology group, are evaluated to g and to 0 respectively by $\vartheta_{2,g}$.

DEFINITION 2.4.4. For every generic $g \in G \setminus X$ the g -colored index 0 attaching 2-morphism $\mathbf{A}_{0,g} : \text{id}_\emptyset \Rightarrow \Sigma_{0,g}$ of $\check{\mathbf{Cob}}_3^{\mathcal{E}}$ is given by

$$\mathbf{A}_{0,g} := (S^{-1} \times \overline{D^4}, \emptyset^\emptyset, 0, 0) = \text{id}_{\text{id}_\emptyset}.$$

DEFINITION 2.4.5. For every generic $g \in G \setminus X$ the g -colored index 1 attaching 2-morphism $\mathbf{A}_{1,g} : \text{id}_\emptyset \Rightarrow \Sigma_{1,g}$ of $\check{\mathbf{Cob}}_3^{\mathcal{E}}$ is given by

$$\mathbf{A}_{1,g} := (S^0 \times D^3, T_{a_1}^{V_g}, \omega_{a_1,g}, 0)$$

where the \mathcal{E} -colored ribbon tangle $T_{a_1}^{V_g}$ is given by

$$T_{a_1} := S^0 \times \{(x, y, z) \in D^3 \mid x = y = 0\} \subset S^0 \times D^3$$

with orientation determined by that of P_1 , with framing tangent to

$$S^0 \times \{(x, y, z) \in D^3 \mid y = 0\}$$

and with \mathcal{E} -coloring uniquely determined by the \mathcal{E} -coloring already present on $P_1 \subset S^0 \times S^2$ and where $\omega_{a_1,g}$ is the only G -coloring of $(S^0 \times D^3, T_{a_1})$ extending $\vartheta_{1,g}$. See Figure 7 for a graphical representation.

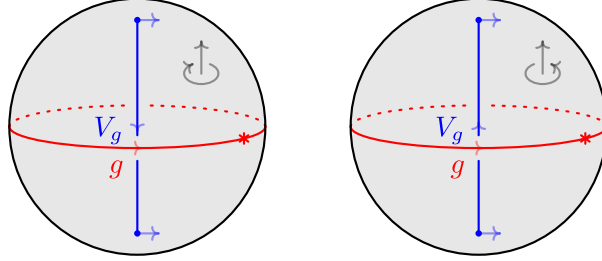

FIGURE 7. The 2-morphism $\mathbf{A}_{1,g}$. The ribbon tangle T_{a_1} is represented by the two vertical blue edges with blackboard framing. The cohomology class $\omega_{a_1,g}$ is completely determined by $\vartheta_{1,g}$.

DEFINITION 2.4.6. For every generic $g \in G \setminus X$ the g -colored index 2 attaching 2-morphism $\mathbf{A}_{2,g} : \text{id}_\emptyset \Rightarrow \Sigma_{2,g}$ of $\check{\mathbf{Cob}}_3^{\mathcal{G}}$ is given by

$$\mathbf{A}_{2,g} := \left(S^1 \times \overline{D^2}, K_2^{\Omega_g}, \omega_{a_2,g}, 0 \right)$$

where the framed knot K_2 is given by

$$K_2 := S^1 \times \{(0,0)\} \subset S^1 \times \overline{D^2}$$

with orientation induced by S^1 and with framing tangent to

$$S^1 \times \{(x,y) \in \overline{D^2} \mid y=0\}$$

and where $\omega_{a_2,g}$ is the only G -coloring of $(S^1 \times \overline{D^2}, K_2)$ extending $\vartheta_{2,g}$. See Figure 8 for a graphical representation.

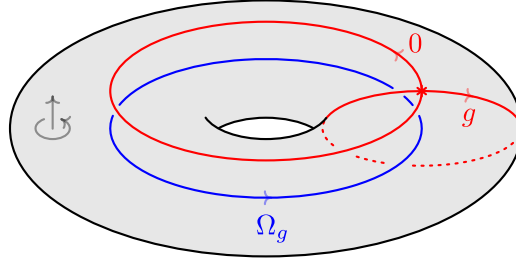

FIGURE 8. The 2-morphism $\mathbf{A}_{2,g}$. The framed knot K_2 is given by the oriented blue core of the solid torus with blackboard framing. The cohomology class $\omega_{a_2,g}$ is completely determined by $\vartheta_{2,g}$.

DEFINITION 2.4.7. For every generic $g \in G \setminus X$ the g -colored index 0 belt 2-morphism $\mathbf{B}_{0,g} : \text{id}_\emptyset \Rightarrow \Sigma_{0,g}$ of $\check{\mathbf{Cob}}_3^{\mathcal{G}}$ is given by

$$\mathbf{B}_{0,g} := \left(D^0 \times S^3, K_0^{V_g}, \omega_{0,g}, 0 \right)$$

where the \mathcal{C} -colored framed knot $K_0^{V_g}$ is given by the unknot

$$K_0 := D^0 \times \{(x, y, z, t) \in S^3 \mid x^2 + y^2 = 1, z = t = 0\} \subset D^0 \times S^3$$

with any orientation, with framing tangent to

$$D^0 \times \{(x, y, z, t) \in S^3 \mid z = t = 0\}$$

and with \mathcal{C} -coloring given by the object V_g and where $\omega_{0,g}$ is the only G -coloring of $(D^0 \times S^3, K_0)$ which is compatible with the \mathcal{C} -coloring of K_0 .

DEFINITION 2.4.8. For every generic $g \in G \setminus X$ the g -colored index 1 belt 2-morphism $\mathbf{B}_{1,g} : \text{id}_\emptyset \Rightarrow \Sigma_{1,g}$ of $\check{\mathbf{Cob}}_3^{\mathcal{C}}$ is given by

$$\mathbf{B}_{1,g} := (D^1 \times S^2, T_{b_1}^{V_g}, \omega_{b_1,g}, 0)$$

where the \mathcal{C} -colored ribbon tangle $T_{b_1}^{V_g}$ is given by

$$T_{b_1} := D^1 \times \{p_S, p_N\} \subset D^1 \times S^2$$

with orientation determined by that of P_1 , with framing tangent to

$$D^1 \times \{(x, y, z) \in S^2 \mid y = 0\}$$

and with \mathcal{C} -coloring uniquely determined by the \mathcal{C} -coloring already present on $P_1 \subset S^0 \times S^2$ and where $\omega_{b_1,g} = \pi^*(\vartheta_{1,g})$ for the natural projection

$$\pi : (D^1 \times (S^2 \setminus \{p_S, p_N\}), \partial D^1 \times \{p_E\}) \rightarrow (S^2 \setminus \{p_S, p_N\}, \{p_E\}).$$

See Figure 9 for a graphical representation.

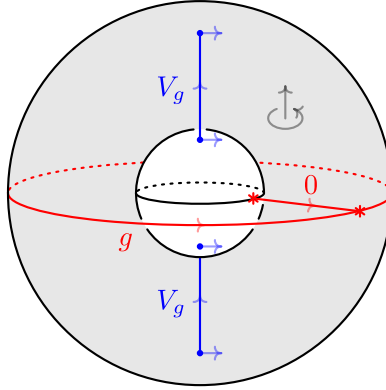

FIGURE 9. The 2-morphism $\mathbf{B}_{1,g}$. The ribbon tangle T_{b_1} is represented by the two vertical blue edges with blackboard framing. The red line joining the two starred red equatorial points, which, together with any oriented red equator, forms a basis for the first homology group, is evaluated to 0 by $\omega_{b_1,g}$.

DEFINITION 2.4.9. For every generic $g \in G \setminus X$ the g -colored index 2 belt 2-morphism $\mathbf{B}_{2,g} : \text{id}_\emptyset \Rightarrow \Sigma_{2,g}$ of $\check{\mathbf{Cob}}_3^{\mathcal{C}}$ is given by

$$\mathbf{B}_{2,g} := (D^2 \times S^1, \emptyset^\emptyset, \omega_{b_2,g}, 0)$$

where $\omega_{b_2,g}$ is the only G -coloring of $(D^2 \times S^1, \emptyset)$ extending $\vartheta_{2,g}$. See Figure 10 for a graphical representation.

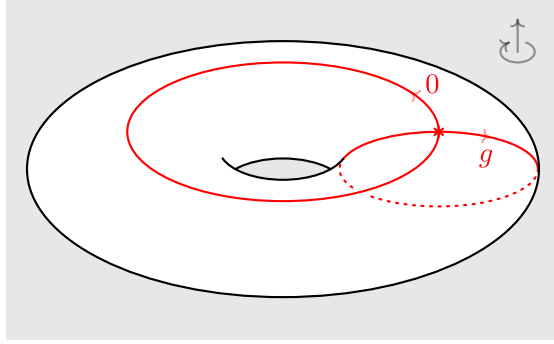

FIGURE 10. The 2-morphism $\mathbf{B}_{2,g}$. The cohomology class $\omega_{\mathbf{b}_{2,g}}$ is completely determined by $\vartheta_{2,g}$.

A quantum invariant Z on $\check{\mathbf{M}}\mathbf{an}_3^{\mathcal{G}}$ satisfies the surgery axioms if there exist $\lambda_{k,g} \in \mathbb{C}^*$ such that for every 2-morphism $\mathbf{M} : \Sigma_{k,g} \Rightarrow \text{id}_{\emptyset}$ of $\check{\mathbf{C}}\mathbf{ob}_3^{\mathcal{G}}$ we have

$$Z(\mathbf{M} * \mathbf{B}_{k,g}) = \lambda_{k,g} Z(\mathbf{M} * \mathbf{A}_{k,g}),$$

for $k = 0, 1, 2$ and for every $g \in G \setminus X$.

REMARK 2.4.3. Let Z be a non-trivial quantum invariant on $\check{\mathbf{M}}\mathbf{an}_3^{\mathcal{G}}$ satisfying the surgery axioms. Then:

- (i) If $\mathbf{M} : \text{id}_{\emptyset} \Rightarrow \text{id}_{\emptyset}$ is a closed 2-morphism of $\check{\mathbf{C}}\mathbf{ob}_3^{\mathcal{G}}$ satisfying $Z(\mathbf{M}) \neq 0$ then

$$\begin{aligned} Z(\mathbf{M})Z(\mathbf{B}_{0,g}) &= Z(\mathbf{M} \otimes \mathbf{B}_{0,g}) = Z(\mathbf{M} * \mathbf{B}_{0,g}) = \lambda_{0,g} Z(\mathbf{M} * \mathbf{A}_{0,g}) \\ &= \lambda_{0,g} Z(\mathbf{M}) \end{aligned}$$

implies $Z(\mathbf{B}_{0,g}) = \lambda_{0,g}$ for every $g \in G \setminus X$;

- (ii) For every $g \in G \setminus X$ let $\overline{\mathbf{A}}_{1,g} : \Sigma_{1,g} \Rightarrow \text{id}_{\emptyset}$ denote the 2-morphism of $\check{\mathbf{C}}\mathbf{ob}_3^{\mathcal{G}}$ given by

$$(\mathbb{S}^0 \times \overline{\mathbb{D}^3}, \overline{T_{\mathbf{a}_1}}^{V_g}, \omega_{\mathbf{a}_1,g}, 0)$$

where, using the notation of Definition 2.4.5, $\overline{T_{\mathbf{a}_1}}$ is obtained from $T_{\mathbf{a}_1}$ by reversing the orientation of the tangle $T_{\mathbf{a}_1}$. Then the chain of equalities

$$\begin{aligned} \lambda_{0,g} &= Z(\mathbf{B}_{0,g}) = Z(\overline{\mathbf{A}}_{1,g} * \mathbf{B}_{1,g}) = \lambda_{1,g} Z(\overline{\mathbf{A}}_{1,g} * \mathbf{A}_{1,g}) = \lambda_{1,g} Z(\mathbf{B}_{0,g} \otimes \mathbf{B}_{0,g}) \\ &= \lambda_{1,g} Z(\mathbf{B}_{0,g})^2 \end{aligned}$$

implies $\lambda_{1,g} = \lambda_{0,g}^{-1}$ for every $g \in G \setminus X$;

- (iii) For every $g \in G \setminus X$ and every $g' \in G$ let $\Sigma_{1,g} \times \mathbf{I}_{g'} : \Sigma_{1,g} \Rightarrow \Sigma_{1,g}$ denote the 2-morphism of $\check{\mathbf{C}}\mathbf{ob}_3^{\mathcal{G}}$ given by

$$(\mathbb{S}^0 \times \mathbb{S}^2 \times \mathbf{I}, \mathbf{P}_1^{V_g} \times \mathbf{I}, (\vartheta_{1,g})_{B_1} \times I_{g'}, 0)$$

where, using the notation of Definition 2.4.2, the G -coloring $(\vartheta_{1,g})_{B_1} \times I_{g'}$ satisfies

$$(\text{id}_{\mathbb{S}^0 \times \mathbb{S}^2}, 0)^*((\vartheta_{1,g})_{B_1} \times I_{g'}) = (\vartheta_{1,g})_{B_1}$$

for the incoming horizontal boundary identification $(\text{id}_{\mathbb{S}^0 \times \mathbb{S}^2}, 0)$ and

$$\langle (\vartheta_{1,g})_{B_1} \times I_{g'}, \{-1\} \times \{p_E\} \times \mathbf{I} \rangle = 0, \quad \langle (\vartheta_{1,g})_{B_1} \times I_{g'}, \{1\} \times \{p_E\} \times \mathbf{I} \rangle = g'.$$

Let also $\overline{\mathbf{B}}_{1,g} : \Sigma_{1,g} \Rightarrow \text{id}_\emptyset$ denote the 2-morphism of $\check{\mathbf{Cob}}_3^{\mathcal{C}}$ given by

$$(\overline{\mathbf{D}}^1 \times S^2, \overline{\mathbf{T}}_{b_1}^{V_g}, \omega_{b_1,g}, 0)$$

where, using the notation of Definition 2.4.8, $\overline{\mathbf{T}}_{b_1}$ is obtained from \mathbf{T}_{b_1} by reversing the orientation of the tangle \mathbf{T}_{b_1} . Then we have

$$\begin{aligned} Z(\overline{\mathbf{B}}_{1,g} * (\Sigma_{1,g} \times \mathbf{I}_{g'}) * \mathbf{B}_{1,g}) &= \lambda_{1,g} Z(\overline{\mathbf{B}}_{1,g} * (\Sigma_{1,g} \times \mathbf{I}_{g'}) * \mathbf{A}_{1,g}) \\ &= \lambda_{1,g} Z(\mathbf{B}_{0,g}) = 1 \end{aligned}$$

for every $g \in G \setminus X$ and every $g' \in G$.

REMARK 2.4.4. Let $L_1^{V_1} \subset S^3$ be the \mathcal{C} -colored framed link depicted in Figure 11. If Z is a non-trivial quantum invariant on $\check{\mathbf{Man}}_3^{\mathcal{C}}$ which satisfies the surgery axioms then we have

$$\lambda_2^g = Z(S^3, L_1^{V_1}, \omega_1, 0)^{-1}$$

for every $g \in G \setminus X$, where ω_1 is the only G -coloring of (S^3, L_1) which is compatible with the \mathcal{C} -coloring of L_1 . Indeed, for all $g, g' \in G \setminus X$, let $\overline{\mathbf{B}}_{2,g,g'} : \Sigma_{2,g} \Rightarrow \text{id}_\emptyset$ denote the 2-morphism of $\check{\mathbf{Cob}}_3^{\mathcal{C}}$ given by

$$(\overline{\mathbf{D}}^2 \times S^1, L_2^{V_2}, \omega_2, 0)$$

where the \mathcal{C} -colored ribbon graph $L_2^{V_2}$ is given by

$$L_2 := \left\{ \left(-\frac{1}{2}, 0 \right), \left(\frac{1}{2}, 0 \right) \right\} \times S^1 \subset \overline{\mathbf{D}}^2 \times S^1$$

with opposite orientations on the two components, with framing tangent to

$$\{(x, y) \in \overline{\mathbf{D}}^2 \mid y = 0\} \times S^1$$

and with constant \mathcal{C} -coloring given by the object $V_{g'}$ and where ω_2 is the only G -coloring of $(\overline{\mathbf{D}}^2 \times S^1, L_2)$ extending $(\vartheta_2^g)_{B_2}$ which is compatible with the \mathcal{C} -coloring of L_2 . Then we have

$$\begin{aligned} 1 &= Z(\overline{\mathbf{B}}_{1,g} * (\Sigma_{1,g} \times \mathbf{I}_{g'}) * \mathbf{B}_{1,g}) = Z(\overline{\mathbf{B}}_{2,g,g'} * \mathbf{B}_{2,g'}) = \lambda_{2,g'} Z(\overline{\mathbf{B}}_{2,g,g'} * \mathbf{A}_{2,g'}) \\ &= \lambda_{2,g'} Z(S^3, L_1^{V_1}, \omega_1, 0). \end{aligned}$$

for all $g, g' \in G \setminus X$.

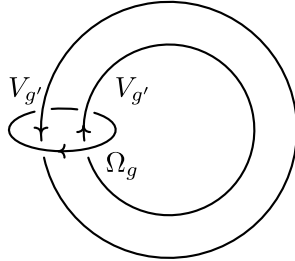

FIGURE 11. The \mathcal{C} -colored framed link $L_1^{V_1} \subset S^3$ with blackboard framing.

REMARK 2.4.5. Let Z be a non-trivial quantum invariant on $\check{\text{Man}}_3^{\mathcal{C}}$ satisfying the surgery axioms. Then

$$Z(\mathbb{M}, \mathbb{T}^\varphi, \omega, n) = \kappa^n Z(\mathbb{M}, \mathbb{T}^\varphi, \omega, 0)$$

with

$$\kappa := \lambda_{1,g} Z(\mathbb{S}^3, \mathbb{U}^{V_g}, \omega_g, 1)$$

where the \mathcal{C} -colored framed knot \mathbb{U}^{V_g} is given by the unknot

$$U = \{(x, y, z, t) \in \mathbb{S}^3 \mid x^2 + y^2 = 1, z = t = 0\}$$

with any orientation, with framing tangent to

$$\{(x, y, z, t) \in \mathbb{S}^3 \mid z = t = 0\}$$

and with \mathcal{C} -coloring given by the object V_g and where ω_g is the unique G -coloring of $(\mathbb{S}^3, \mathbb{U})$ which is compatible with the \mathcal{C} -coloring of \mathbb{U} .

LEMMA 2.4.1. *Let Z be a quantum invariant on $\check{\text{Man}}_3^{\mathcal{C}}$, let Γ be an object of $\check{\text{Cob}}_3^{\mathcal{C}}$, let $\Sigma_\Gamma, \Sigma_\Gamma''$ be objects of $\Lambda_Z(\Gamma)$ and let $\mathbf{M}_\Gamma : \Sigma_{k,g} \otimes \Sigma_\Gamma \Rightarrow \Sigma_\Gamma''$ be a 2-morphism of $\check{\text{Cob}}_3^{\mathcal{C}}$ with $k \in \{0, 1, 2\}$ and $g \in G \setminus X$. If Z satisfies the surgery axioms then*

$$[\mathbf{M}_\Gamma * (\mathbf{B}_{k,g} \otimes \text{id}_{\Sigma_\Gamma})] = \lambda_{k,g} \cdot [\mathbf{M}_\Gamma * (\mathbf{A}_{k,g} \otimes \text{id}_{\Sigma_\Gamma})]$$

as vectors of $\text{Hom}_{\Lambda_Z(\Gamma)}(\Sigma_\Gamma, \Sigma_\Gamma'')$.

PROOF. We have to show that

$$Z_\Gamma(\mathbf{M}_\Gamma * (\mathbf{B}_{k,g} \otimes \text{id}_{\Sigma_\Gamma})) = \lambda_{k,g} \cdot Z_\Gamma(\mathbf{M}_\Gamma * (\mathbf{A}_{k,g} \otimes \text{id}_{\Sigma_\Gamma}))$$

where for every 2-morphism $\mathbf{M}_\Gamma' : \Sigma_\Gamma \Rightarrow \Sigma_\Gamma''$ of $\check{\text{Cob}}_3^{\mathcal{C}}$ the natural transformation

$$Z_\Gamma(\mathbf{M}_\Gamma') : Z_\Gamma(\Sigma_\Gamma) \Rightarrow Z_\Gamma(\Sigma_\Gamma'')$$

comes from the extended universal construction¹⁶. But then the equality we have to prove is equivalent to

$$Z(\mathbb{M} * \mathbf{B}_{k,g}) = \lambda_{k,g} Z(\mathbb{M} * \mathbf{A}_{k,g})$$

for every 2-morphism $\mathbf{M} : \Sigma_{k,g} \Rightarrow \text{id}_\emptyset$ of $\check{\text{Cob}}_3^{\mathcal{C}}$, which is precisely the g -colored index k surgery axiom. \square

2.5. Connection Lemma

In this section we derive the main consequences of surgery axioms: all morphisms between a fixed pair of strongly admissible objects of a universal linear category associated with a quantum invariant which satisfies the surgery axioms are generated by all possible decorations on a fixed connected cobordism with corners.

We fix our notation for surgery. If \mathbb{M} and \mathbb{M}' are 3-dimensional cobordisms with corners from Σ to Σ' then a surgery framed link L for \mathbb{M}' inside \mathbb{M} determines, up to isomorphism, a cobordism with corners

$$\chi_2(\mathbb{M}, L) := \left((\mathbb{S}^1 \times \overline{\mathbb{D}^2}) \sqcup \dots \sqcup (\mathbb{S}^1 \times \overline{\mathbb{D}^2}) \sqcup (\Sigma \times \mathbb{I}) \right) \cup_{\Sigma_L} \mathbb{M}_L$$

where Σ_L denotes $(\mathbb{S}^1 \times \mathbb{S}^1) \sqcup \dots \sqcup (\mathbb{S}^1 \times \mathbb{S}^1) \sqcup \Sigma$ and where \mathbb{M}_L denotes the exterior of L in \mathbb{M} , together with an isomorphism $f : \chi_2(\mathbb{M}, L) \rightarrow \mathbb{M}'$ of cobordisms with

¹⁶See Appendix A.7 for the definition.

corners restricting to an identification $f_L : M_L \rightarrow M'_L$ of the exteriors of L . Here M'_L denotes the cobordism with corners from Σ_L to Σ' whose support is given by $f(M_L) \subset M'$ with boundary identifications induced by those of M_L via f . We also denote with m_{L_i} the simple closed curve inside the incoming horizontal boundary $\partial_-^h M_L$ of M_L corresponding to the positive meridian $\{(1, 0)\} \times \overline{S^1} \subset S^1 \times S^1$ of the i -th copy of $S^1 \times D^2$.

REMARK 2.5.1. Let $\Sigma, \Sigma' : \Gamma \rightarrow \Gamma'$ be 1-morphisms of $\check{\mathbf{Cob}}_3^{\mathcal{C}}$ and let M be a cobordism with corners from Σ to Σ' . If $L \subset M$ is a framed link then for every \mathcal{C} -colored ribbon graph $T^\varphi \subset M$ from P^V to $P^{V'}$ the inclusion

$$(M_L \setminus T, A_M \cup B_M \cup B'_M \cup A'_M) \hookrightarrow (M \setminus (L \cup T), A_M \cup B_M \cup B'_M \cup A'_M)$$

induces an isomorphism between the first homology groups of the two pairs. In particular if $\mathbf{M}' : \Sigma \Rightarrow \Sigma'$ is a 2-morphism of $\check{\mathbf{Cob}}_3^{\mathcal{C}}$ of the form $(M', T'^{\varphi'}, \omega', n')$ and if L gives a surgery presentation for M' inside M then we denote with $f_L^\# \omega'$ the unique G -coloring of $(M, L \cup f_L^{-1}(T'))$ satisfying

$$j^* f_L^\# \omega' = f_* j'^* \omega'$$

where j denotes the inclusion of the pair

$$(M_L \setminus f_L^{-1}(T'), A_M \cup B_M \cup B'_M \cup A'_M)$$

into the pair

$$(M \setminus (L \cup f_L^{-1}(T')), A_M \cup B_M \cup B'_M \cup A'_M),$$

where j' denotes the inclusion of the pair

$$(M'_L \setminus T, A_{M'} \cup B_{M'} \cup B'_{M'} \cup A'_{M'})$$

into the pair

$$(M' \setminus T', A_{M'} \cup B_{M'} \cup B'_{M'} \cup A'_{M'})$$

and where f_L also denotes, by abuse of notation, the isomorphism of pairs induced by f_L between

$$(M_L \setminus f_L^{-1}(T'), A_M \cup B_M \cup B'_M \cup A'_M)$$

and

$$(M'_L \setminus T', A_{M'} \cup B_{M'} \cup B'_{M'} \cup A'_{M'}).$$

Let $\Sigma, \Sigma' : \Gamma \rightarrow \Gamma'$ be 1-morphisms of $\check{\mathbf{Cob}}_3^{\mathcal{C}}$, let M be a non-empty connected cobordism with corners from Σ to Σ' , let $\mathbf{M}' : \Sigma \Rightarrow \Sigma'$ be a 2-morphism of $\check{\mathbf{Cob}}_3^{\mathcal{C}}$ of the form $(M', T'^{\varphi'}, \omega', n')$ for some non-empty connected cobordism with corners M' from Σ to Σ' , let $L = L_1 \cup \dots \cup L_k \subset M$ be a framed link giving a surgery presentation for M' and let $f : \chi_2(M, L) \rightarrow M'$ be an isomorphism of cobordisms with corners. We say that L gives a computable surgery presentation for \mathbf{M}' , or that L is a computable surgery framed link for \mathbf{M}' , if $\langle f_L^\# \omega', m_{L_i} \rangle = g_i \in G \setminus X$ for all $i = 1, \dots, k$, and in this case we denote with $L^{\omega'}$ the formal linear combination of \mathcal{C} -colored ribbon graphs inside M given by $L_1^{\Omega_{g_1}} \cup \dots \cup L_k^{\Omega_{g_k}}$.

LEMMA 2.5.1. *If $\Sigma, \Sigma' : \Gamma \rightarrow \Gamma'$ are 1-morphisms of $\check{\mathbf{Cob}}_3^{\mathcal{C}}$, if M is a non-empty connected cobordism with corners from Σ to Σ' and if $\mathbf{M}' : \Sigma \Rightarrow \Sigma'$ is a non-empty connected 2-morphism of $\check{\mathbf{Cob}}_3^{\mathcal{C}}$ then there exists a computable surgery framed link for \mathbf{M}' inside M .*

REMARK 2.5.2. A proof of this Lemma in the case where $M = S^3$ can be found in [CGP14]. The proof of the general case is completely analogous.

REMARK 2.5.3. If Z is a quantum invariant on $\check{\text{Man}}_3^{\mathcal{G}}$ which satisfies the surgery axioms, if Γ is an object of $\check{\text{Cob}}_3^{\mathcal{G}}$, if

$$\Sigma_{\Gamma} = (\Sigma_{\Gamma}, P^V, \vartheta_B, \mathcal{L}), \quad \Sigma_{\Gamma}'' = (\Sigma_{\Gamma}'', P''V'', \vartheta_{B''}, \mathcal{L}'')$$

are objects of $\Lambda_Z(\Gamma)$, if M_{Γ} is a non-empty connected cobordism with corners from Σ_{Γ} to Σ_{Γ}'' and if $\mathbf{M}_{\Gamma}'' : \Sigma_{\Gamma} \Rightarrow \Sigma_{\Gamma}''$ is a non-empty connected 2-morphism of $\check{\text{Cob}}_3^{\mathcal{G}}$ of the form $(M_{\Gamma}'', T''\varphi'', \omega'', n'')$ then Lemmas 2.5.1 and 2.4.1 yield the equality

$$[\mathbf{M}_{\Gamma}''] = \lambda_{2,g_1} \cdots \lambda_{2,g_k} \cdot [M_{\Gamma}, L^{\omega''} \cup f_L^{-1}(T''\varphi''), f_L^{\#}\omega'', n]$$

between morphisms of $\text{Hom}_{\Lambda_Z(\Gamma)}(\Sigma_{\Gamma}, \Sigma_{\Gamma}'')$, where $L = L_1 \cup \dots \cup L_k$ is some computable surgery framed link for \mathbf{M}_{Γ}'' inside M_{Γ} , where T'' is contained inside M_{Γ}'' up to isotopy and where $n \in \mathbb{Z}$ is determined via the Maslov index formula.

DEFINITION 2.5.1. The g -colored 1-sphere \mathbf{S}_g^1 for an index $g \in G$ is the object of $\text{Cob}_3^{\mathcal{G}}$ given by

$$(S^1, (\xi_g)_{A_{S^1}})$$

where A_{S^1} is the base set given by $\{(1, 0)\} \subset S^1$ and where ξ_g is the unique cohomology class satisfying $\langle \xi_g, S^1 \rangle = g$. If g is generic then \mathbf{S}_g^1 is said to be a *generic circle*, while if g is critical then \mathbf{S}_g^1 is said to be a *critical circle*.

DEFINITION 2.5.2. The $(\vec{\varepsilon}, \vec{V})$ -colored 2-disc $\mathbf{D}_{(\vec{\varepsilon}, \vec{V})}^2 : \emptyset \rightarrow \mathbf{S}_{i(V^{\varepsilon})}^1$ for an object $(\vec{\varepsilon}, \vec{V})$ of $\text{Rib}_{\mathcal{G}}^G$ is the 1-morphism of $\text{Cob}_3^{\mathcal{G}}$ given by

$$\left(D^2, P(\vec{\varepsilon})^V, \left(\vartheta_{(\vec{\varepsilon}, \vec{V})} \right)_{B_{D^2}}, \{0\} \right)$$

where B_{D^2} is the base set given by $\{(0, \frac{1}{2})\} \subset D^2$ and where $\vartheta_{(\vec{\varepsilon}, \vec{V})}$ is the unique cohomology class compatible with the \mathcal{G} -coloring of $P(\vec{\varepsilon})$ which evaluates to 0 every relative homology class that can be represented by some oriented arc contained in $\{(x, y) \in D^2 \mid y \geq 0\}$.

DEFINITION 2.5.3. The T^{φ} -colored 3-cylinder $(\mathbf{D}^2 \times \mathbf{I})_{T^{\varphi}} : \mathbf{D}_{(\vec{\varepsilon}, \vec{V})}^2 \Rightarrow \mathbf{D}_{(\vec{\varepsilon}', \vec{V}')}^2$ for a morphism $T^{\varphi} : (\vec{\varepsilon}, \vec{V}) \rightarrow (\vec{\varepsilon}', \vec{V}')$ of $\text{Rib}_{\mathcal{G}}^G$ with $i(V^{\varepsilon}) = i(V'^{\varepsilon'})$ is the 2-morphism of $\text{Cob}_3^{\mathcal{G}}$ given by

$$(D^2 \times I, T^{\varphi}, \omega_{T^{\varphi}}, 0)$$

where $\omega_{T^{\varphi}}$ is the unique G -coloring extending $(\vartheta_{(\vec{\varepsilon}, \vec{V})})_{B_{D^2}}$ and $(\vartheta_{(\vec{\varepsilon}', \vec{V}')})_{B_{D^2}}$ which is compatible with the \mathcal{G} -coloring of T and which evaluates to 0 the relative homology class of the oriented arc $B_{D^2} \times I$.

A quantum invariant Z on $\check{\text{Man}}_3^{\mathcal{G}}$ satisfies the *skein axiom* if for all objects $(\vec{\varepsilon}, \vec{V})$ and $(\vec{\varepsilon}', \vec{V}')$ of $\text{Rib}_{\mathcal{G}}^G$ satisfying $i(V^{\varepsilon}) = i(V'^{\varepsilon'}) = g$ and for all morphisms $T^{\varphi}, T'^{\varphi'} : (\vec{\varepsilon}, \vec{V}) \rightarrow (\vec{\varepsilon}', \vec{V}')$ of $\text{Rib}_{\mathcal{G}}^G$ satisfying $F_{\mathcal{G}}(T^{\varphi}) = F_{\mathcal{G}}(T'^{\varphi'})$ we have

$$Z(\mathbf{M}' * (\text{id}_{\Sigma} \circ (\mathbf{D}^2 \times \mathbf{I})_{T^{\varphi}}) * \mathbf{M}) = Z(\mathbf{M}' * (\text{id}_{\Sigma} \circ (\mathbf{D}^2 \times \mathbf{I})_{T'^{\varphi'}}) * \mathbf{M})$$

for every choice of a 1-morphism $\Sigma : \mathbf{S}_g^1 \rightarrow \emptyset$ of $\check{\text{Cob}}_3^{\mathcal{G}}$ and of 2-morphisms $\mathbf{M} : \text{id}_{\emptyset} \Rightarrow \Sigma \circ \mathbf{D}_{(\vec{\varepsilon}, \vec{V})}^2$ and $\mathbf{M}' : \Sigma \circ \mathbf{D}_{(\vec{\varepsilon}', \vec{V}')}^2 \Rightarrow \text{id}_{\emptyset}$ of $\check{\text{Cob}}_3^{\mathcal{G}}$.

LEMMA 2.5.2. Let Z be a quantum invariant on $\check{\text{Man}}_3^{\mathcal{G}}$, let $(\vec{\varepsilon}, \vec{V})$ and $(\vec{\varepsilon}', \vec{V}')$ be objects of $\text{Rib}_{\mathcal{G}}^G$ satisfying $i(V^{\varepsilon}) = i(V^{\varepsilon'}) = g$, let $T^{\varphi}, T^{\varphi'} : (\vec{\varepsilon}, \vec{V}) \rightarrow (\vec{\varepsilon}', \vec{V}')$ be morphisms of $\text{Rib}_{\mathcal{G}}^G$ satisfying $F_{\mathcal{G}}(T^{\varphi}) = F_{\mathcal{G}}(T^{\varphi'})$, let Γ be an object of $\check{\text{Cob}}_3^{\mathcal{G}}$, let $\Sigma_{\Gamma}, \Sigma_{\Gamma}''$ be objects of $\Lambda_Z(\Gamma)$, let $\Sigma' : \mathbf{S}_g^1 \rightarrow \Gamma$ be a 1-morphism of $\check{\text{Cob}}_3^{\mathcal{G}}$ and let $M_{\Gamma} : \Sigma_{\Gamma} \Rightarrow \Sigma' \circ \mathbf{D}_{(\vec{\varepsilon}, \vec{V})}^2$ and $M_{\Gamma}'' : \Sigma_{\Gamma}'' \Rightarrow \Sigma' \circ \mathbf{D}_{(\vec{\varepsilon}', \vec{V}')}^2$ be 2-morphisms of $\check{\text{Cob}}_3^{\mathcal{G}}$. If Z satisfies the skein axiom then

$$[M_{\Gamma}'' * (\text{id}_{\Sigma'} \circ (\mathbf{D}^2 \times \mathbf{I})_{T^{\varphi}}) * M_{\Gamma}] = [M_{\Gamma}'' * (\text{id}_{\Sigma'} \circ (\mathbf{D}^2 \times \mathbf{I})_{T^{\varphi'}}) * M_{\Gamma}]$$

as vectors of $\text{Hom}_{\Lambda_Z(\Gamma)}(\Sigma_{\Gamma}, \Sigma_{\Gamma}'')$.

REMARK 2.5.4. The proof of this Lemma is analogous to the proof of Lemma 2.4.1.

Let $(\mathbf{S}^1 \times \mathbf{S}^1)_g : \emptyset \rightarrow \emptyset$ be the 1-morphism of $\check{\text{Cob}}_3^{\mathcal{G}}$ given by

$$(\mathbf{S}^1 \times \mathbf{S}^1, \emptyset^{\emptyset}, (\overline{\vartheta_{2,g}})_{B_2}, \mathcal{L}_2)$$

where $B_2 \subset S^1 \times S^1$ is given by $\{((1,0), (0,1))\}$, where $\overline{\vartheta_{2,g}}$ is the cohomology class determined by $\langle \overline{\vartheta_{2,g}}, \ell \rangle = g$ and $\langle \overline{\vartheta_{2,g}}, m \rangle = 0$ for the oriented longitude $\ell := S^1 \times \{(0,1)\}$ and meridian $m := \{(1,0)\} \times S^1$ and where the Lagrangian $\mathcal{L}_2 \subset H^1(S^1 \times S^1; \mathbb{R})$ is generated by the homology class of m .

REMARK 2.5.5. The only difference between $(\mathbf{S}^1 \times \mathbf{S}^1)_g$ and the g -colored index 2 surgery 1-morphism $\Sigma_{2,g}$ is that the G -coloring $(\vartheta_{2,g})_{B_2}$ of $\Sigma_{2,g}$ is given by a cohomology class satisfying $\langle \vartheta_{2,g}, \ell \rangle = 0$ and $\langle \vartheta_{2,g}, m \rangle = g$.

Let $(\mathbf{S}^1 \times \overline{\mathbf{D}^2})_{\emptyset,g} : \text{id}_{\emptyset} \rightarrow (\mathbf{S}^1 \times \mathbf{S}^1)_g$ be the 2-morphism of $\check{\text{Cob}}_3^{\mathcal{G}}$ given by

$$(\mathbf{S}^1 \times \overline{\mathbf{D}^2}, \emptyset^{\emptyset}, \omega_{\emptyset,g}, 0)$$

where $\omega_{\emptyset,g}$ is the only G -coloring on $(\mathbf{S}^1 \times \overline{\mathbf{D}^2}, \emptyset)$ extending $(\overline{\vartheta_{2,g}})_{B_2}$.

Let $(\mathbf{S}^1 \times \overline{\mathbf{D}^2})_{L,g} : \text{id}_{\emptyset} \rightarrow (\mathbf{S}^1 \times \mathbf{S}^1)_g$ be the 2-morphism of $\check{\text{Cob}}_3^{\mathcal{G}}$ given by

$$(\mathbf{S}^1 \times \overline{\mathbf{D}^2}, K_-^{\Omega_g} \cup K_+^{\Omega_g - g}, \omega_{L,g}, 0)$$

where $L = K_- \cup K_+$ is the framed link depicted in Figure 12 and where $\omega_{L,g}$ is the only G -coloring on $(\mathbf{S}^1 \times \overline{\mathbf{D}^2}, L)$ extending $(\overline{\vartheta_{2,g}})_{B_2}$ which is compatible with the \mathcal{G} -coloring on L .

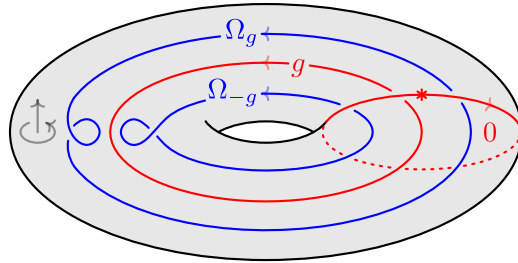

FIGURE 12. The 2-morphism $(\mathbf{S}^1 \times \overline{\mathbf{D}^2})_{L,g}$. The framed link L is represented by the two blue knots K_- and K_+ with blackboard framing. The cohomology class $\omega_{L,g}$ evaluates the oriented red longitude to g and the oriented red meridian to 0 .

LEMMA 2.5.3. *If Z is a quantum invariant on $\check{\text{Man}}_3^{\mathcal{C}}$ which satisfies the surgery axioms then*

$$\left[(\mathbf{S}^1 \times \overline{\mathbf{D}^2})_{\emptyset, g} \right] = \lambda_{2, g} \lambda_{2, -g} \cdot \left[(\mathbf{S}^1 \times \overline{\mathbf{D}^2})_{L, g} \right]$$

as vectors in $\text{Hom}_{\Lambda_Z(\emptyset)}(\text{id}_{\emptyset}, (\mathbf{S}^1 \times \mathbf{S}^1)_g)$.

PROOF. Surgery along L yields a cobordism with corners $\chi_2(\mathbf{S}^1 \times \overline{\mathbf{D}^2}, L)$ which is isomorphic to $\mathbf{S}^1 \times \overline{\mathbf{D}^2}$ because surgery along K_+ cancels the effects of surgery along K_- . \square

LEMMA 2.5.4. *Let Z be a quantum invariant on $\check{\text{Man}}_3^{\mathcal{C}}$ which satisfies the surgery axioms and the skein axiom. Let Γ be an object of $\check{\text{Cob}}_3^{\mathcal{C}}$, let $\Sigma_{\Gamma}, \Sigma''_{\Gamma}$ be objects of $\Lambda_Z(\Gamma)$, let $\mathbf{M}_{\Gamma} : \Sigma_{\Gamma} \Rightarrow \Sigma''_{\Gamma}$ be a 2-morphism of $\check{\text{Cob}}_3^{\mathcal{C}}$ of the form $(M_{\Gamma}, T^{\varphi}, \omega, n)$ and let $g \in G \setminus X$ be a generic index. Then the vector $[\mathbf{M}_{\Gamma}]$ of $\text{Hom}_{\Lambda_Z(\Gamma)}(\Sigma_{\Gamma}, \Sigma''_{\Gamma})$ can be represented by a linear combination*

$$\sum_{i=1}^k \lambda_i \cdot [M_{\Gamma}, T_i^{\varphi_i}, \omega_i, n]$$

where every \mathcal{C} -colored ribbon graph $T_i^{\varphi_i}$ contains an edge colored with V_g in every connected component of M_{Γ} .

PROOF. Since the following proof can be carried out in each connected component of M_{Γ} separately, let us assume that M_{Γ} is connected. Let us start by supposing that T^{φ} contains a projective edge e colored with a projective object U of \mathcal{C} . Then, thanks to the skein axiom, we can replace a small portion of e with an embedded copy of the \mathcal{C} -colored ribbon graph $T_{U, g}^{\varphi_{U, g}}$ represented in Figure 13 for any section¹⁷ $s \in \text{Hom}_{\mathcal{C}}(U, V_g^* \otimes V_g \otimes U)$ of $\text{ev}_{V_g} \otimes \text{id}_U$.

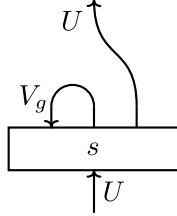

FIGURE 13. The \mathcal{C} -colored ribbon graph $T_{U, g}^{\varphi_{U, g}}$.

Let us now suppose that T^{φ} does not contain a projective edge. Then, thanks to the admissibility condition, there exists some generic oriented knot $K \subset M_{\Gamma} \setminus T$ satisfying $\langle \omega, K \rangle \in G \setminus X$. Now Lemma 2.5.3 enables us to produce a \mathcal{C} -colored framed link inside a tubular neighborhood of K whose every component is projective, and we reduce the previous case. \square

If M is a 3-dimensional cobordism with corners from Σ to Σ' , if $P^V \subset \Sigma$ and $P^{V'} \subset \Sigma'$ are G -homogeneous \mathcal{C} -colored ribbon sets and if ϑ_B and $\vartheta'_{B'}$ are G -colorings of (Σ, P) and (Σ', P') which are compatible with V and V' respectively then a \mathcal{C} -skein inside M relative to (P^V, ϑ_B) and $(P^{V'}, \vartheta'_{B'})$ is an equivalence class of pairs (T^{φ}, ω) where $T^{\varphi} \subset M$ is a G -homogeneous \mathcal{C} -colored ribbon graph from

¹⁷The existence of such a section is established in the proof of Proposition 2.2.1.

P^V to $P^{V'}$ and where ω is a G -coloring of (M, T) extending ϑ_B and $\vartheta'_{B'}$ which is compatible with φ . Two pairs (T^φ, ω) and $(T'^{\varphi'}, \omega')$ are equivalent if there exists an isomorphism of cobordisms with corners $f : M \rightarrow M$ isotopic to the identity relative to ∂M satisfying $f(T^\varphi) = T'^{\varphi'}$ and $f^*\omega' = \omega$. A \mathcal{C} -skein (T^φ, ω) inside M relative to (P^V, ϑ_B) and $(P^{V'}, \vartheta'_{B'})$ is *admissible* if (φ, ω) is an admissible (\mathcal{C}, G) -coloring of (M, T) . We denote with $\check{\mathcal{J}}_{\mathcal{C}}(M; (P^V, \vartheta_B), (P^{V'}, \vartheta'_{B'}))$ the free complex vector space generated by admissible \mathcal{C} -skeins inside M relative to (P^V, ϑ_B) and $(P^{V'}, \vartheta'_{B'})$.

REMARK 2.5.6. Our notation for \mathcal{C} -skeins will be a little abusive since we will not distinguish between an equivalence class of \mathcal{C} -colored ribbon graphs and any of its representatives.

LEMMA 2.5.5. *Let Γ be an object of $\check{\mathbf{Cob}}_3^{\mathcal{C}}$, let*

$$\Sigma_\Gamma = (\Sigma_\Gamma, P^V, \vartheta_B, \mathcal{L}), \quad \Sigma''_\Gamma = (\Sigma''_\Gamma, P^{V''}, \vartheta''_{B''}, \mathcal{L}'')$$

be objects of $\Lambda_Z(\Gamma)$ and let M_Γ be a non-empty connected 3-dimensional cobordism with corners from Σ_Γ to Σ''_Γ . If Z is a quantum invariant on $\text{Man}_3^{\mathcal{C}}$ which satisfies the surgery axioms and the skein axiom then the natural linear map

$$\begin{aligned} \rho_Z : \check{\mathcal{J}}_{\mathcal{C}}(M_\Gamma; (P^V, \vartheta_B), (P^{V''}, \vartheta''_{B''})) &\rightarrow \text{Hom}_{\Lambda_Z(\Gamma)}(\Sigma_\Gamma, \Sigma''_\Gamma) \\ (T^\varphi, \omega) &\mapsto [M_\Gamma, T^\varphi, \omega, 0] \end{aligned}$$

is surjective.

PROOF. We have to show that for every morphism

$$[M''_\Gamma, T''^{\varphi''}, \omega'', n''] \in \text{Hom}_{\Lambda_Z(\Gamma)}(\Sigma_\Gamma, \Sigma''_\Gamma)$$

there exist some ribbon graphs $T_i \subset M_\Gamma$ together with some admissible (\mathcal{C}, G) -colorings (φ_i, ω_i) of (M_Γ, T_i) for $i = 1, \dots, k$ such that

$$\sum_{i=1}^k \lambda_i \cdot [M_\Gamma, T_i^{\varphi_i}, \omega_i, 0] = [M''_\Gamma, T''^{\varphi''}, \omega'', n''].$$

First of all we can suppose that M''_Γ is connected: indeed if it is not then, thanks to Lemma 2.5.4, we can choose some $g \in G \setminus X$ and we can suppose that every connected component of M''_Γ contains an edge of $T''^{\varphi''}$ which is colored with V_g . Then, thanks to Lemma 2.4.1, a finite sequence of g -colored index 1 surgeries on M''_Γ connecting its components will determine a vector of $\text{Hom}_{\Lambda_Z(\Gamma)}(\Sigma_\Gamma, \Sigma''_\Gamma)$ which is a non-zero scalar multiple of $[M''_\Gamma, T''^{\varphi''}, \omega'', n'']$. Now thanks to Lemma 2.5.1 and to Remark 2.5.3 we know there exists a computable framed link $L = L_1 \cup \dots \cup L_k \subset M_\Gamma$ together with some integer $n \in \mathbb{Z}$ such that

$$\begin{aligned} [M''_\Gamma, T''^{\varphi''}, \omega'', n''] &= \lambda_{2, g_1} \cdots \lambda_{2, g_k} \cdot [M_\Gamma, L^{\omega''} \cup f_L^{-1}(T''^{\varphi''}), f_L^\# \omega'', n] \\ &= \lambda_{2, g_1} \cdots \lambda_{2, g_k} \kappa^n \cdot [M_\Gamma, L^{\omega''} \cup f_L^{-1}(T''^{\varphi''}), f_L^\# \omega'', 0]. \quad \square \end{aligned}$$

REMARK 2.5.7. At this point in the construction the contravariant universal linear categories divert from the covariant ones. Indeed the admissibility condition is equivalent to the strong admissibility condition for all objects and morphisms in covariant universal linear categories, while in the contravariant case the two properties differ. This discrepancy is not visible in Lemmas 2.4.1, 2.5.2 and 2.5.3,

which can be directly translated into analogous results for the corresponding contravariant universal linear categories. On the other hand, Lemmas 2.5.4 and 2.5.5 require stronger hypotheses. More precisely, Lemma 2.5.4 only applies to strongly admissible morphisms of $\Lambda'_Z(\Gamma)$ and Lemma 2.5.5 only applies to strongly admissible objects $\Lambda'_Z(\Gamma)$. These stronger hypotheses allow for the exact same proofs that were given in the covariant case.

2.6. Costantino-Geer-Patureau invariants

In this section we recall the definitions for the Geer-Patureau-Turaev renormalized invariants of admissible \mathcal{C} -colored closed ribbon graphs, which were first introduced in [GPT09], and for the Costantino-Geer-Patureau quantum invariants of admissible decorated closed 3-manifolds, which were first constructed in [CGP14], and we show that the latter satisfy the surgery axioms introduced earlier.

A closed morphism $T^\varphi : \emptyset \rightarrow \emptyset$ of $\text{Rib}_{\mathcal{C}}^G$ is *admissible* if the closed 2-morphism

$$(S^3, T^\varphi, \omega_{T^\varphi}, 0)$$

is admissible for the unique G -coloring ω_{T^φ} of (S^3, T) which is compatible with the \mathcal{C} -coloring φ of T . We denote with $\check{\text{Rib}}_{\mathcal{C}}^G(\emptyset, \emptyset)$ the set of admissible closed morphisms of $\text{Rib}_{\mathcal{C}}^G$.

REMARK 2.6.1. Recall we confuse closed ribbon graphs contained in $\text{id}_{\mathbb{D}^2}$ with ribbon graphs contained in S^3 .

If $T^\varphi : \emptyset \rightarrow \emptyset$ is an admissible closed morphism of $\text{Rib}_{\mathcal{C}}^G$ and if $e \subset T$ is a projective edge with respect to φ then a morphism

$$T_e^{\varphi_e} : (+, \varphi(e)) \rightarrow (+, \varphi(e))$$

of $\text{Rib}_{\mathcal{C}}^G$ is *obtained from T^φ by cutting it open at e* if

$$\text{tr}_{\text{Rib}_{\mathcal{C}}^G}(T_e^{\varphi_e}) = \tilde{e}v_{(+, \varphi(e))} \circ (T_e^{\varphi_e} \otimes \text{id}_{(-, V)}) \circ \text{coev}_{(+, \varphi(e))} = T^\varphi.$$

The *Geer-Patureau-Turaev renormalized invariant $F'_{\mathcal{C}}$ of admissible \mathcal{C} -colored closed ribbon graphs* is the function

$$\begin{array}{ccc} F'_{\mathcal{C}} : \check{\text{Rib}}_{\mathcal{C}}^G(\emptyset, \emptyset) & \rightarrow & \mathbb{C} \\ T^\varphi & \mapsto & \text{t}_{\varphi(e)}(F_{\mathcal{C}}(T_e^{\varphi_e})) \end{array}$$

where $e \subset T$ is any projective edge with respect to φ , where $T_e^{\varphi_e}$ is obtained from T^φ by cutting it open at e and where t is the unique trace on $\text{Proj}(\mathcal{C})$ satisfying $\text{t}_{V_0}(\text{id}_{V_0}) = 1$ for the specified ambidextrous projective object V_0 of \mathcal{C} .

THEOREM 2.6.1. *The Geer-Patureau-Turaev renormalized invariant $F'_{\mathcal{C}}$ of admissible \mathcal{C} -colored closed ribbon graphs is well-defined.*

REMARK 2.6.2. A proof of this result, which consists in showing that the definition of $F'_{\mathcal{C}}$ does not depend on the choice of the projective edge e where to cut open T , can be found in [GPT09].

If \mathcal{C} satisfies the non-degeneracy condition

$$\Delta_- \Delta_+ \neq 0$$

for the parameters Δ_+ and Δ_- given in Remark 2.2.7 then the *Costantino-Geer-Patureau quantum invariant associated with \mathcal{C}* is the unique quantum invariant on

$\check{\text{Man}}_3^{\mathcal{C}}$ evaluating each closed connected 2-morphism $\mathbf{M} = (M, T^\varphi, \omega, n)$ of $\check{\text{Cob}}_3^{\mathcal{C}}$ to the complex number

$$\text{CGP}_{\mathcal{C}}(\mathbf{M}, T^\varphi, \omega, n) := \mathcal{D}^{-1-k} \delta^{n-\sigma(L)} F'_{\mathcal{C}}(L^\omega \cup f_L^{-1}(T^\varphi))$$

where:

- (i) $L = L_1 \cup \dots \cup L_k \subset S^3$ is a computable surgery framed link for \mathbf{M} in S^3 ;
- (ii) $f_L : S_L^3 \rightarrow M_L$ is the identification of the exteriors of L ;
- (iii) $\sigma(L)$ is the signature of L ;
- (iv) \mathcal{D} is a choice of a square root of $\Delta_- \Delta_+$;
- (v) $\delta := \frac{\Delta_+}{\mathcal{D}} = \frac{\mathcal{D}}{\Delta_-}$.

REMARK 2.6.3. A proof of the fact that $\text{CGP}_{\mathcal{C}}$ is a well-defined invariant on $\check{\text{Man}}_3^{\mathcal{C}}$ is contained in [CGP14].

LEMMA 2.6.1. *The Costantino-Geer-Patureau quantum invariant $\text{CGP}_{\mathcal{C}}$ satisfies the skein axiom.*

PROOF. The result directly follows from the definition of the Geer-Patureau-Turaev renormalized invariant $F'_{\mathcal{C}}$ of admissible \mathcal{C} -colored closed ribbon graphs in terms of the Reshetikhin-Turaev functor $F_{\mathcal{C}}$. \square

PROPOSITION 2.6.1. *If \mathcal{C} is modular relative to (Π, X) then the Costantino-Geer-Patureau quantum invariant $\text{CGP}_{\mathcal{C}}$ satisfies the surgery axioms with parameters $\lambda_{0,g} = \lambda_{1,g}^{-1} = \mathcal{D}^{-1}d(V_g)$ and $\lambda_{2,g} = \mathcal{D}^{-1}$ for every $g \in G \setminus X$. Moreover $\kappa = \delta$.*

PROOF. The 0-surgery axiom holds for every generic $g \in G \setminus X$ with $\lambda_{0,g} = \mathcal{D}^{-1}d(V_g)$ thanks to the trivial computation

$$\text{CGP}_{\mathcal{C}}(\mathbf{B}_{0,g}) = \mathcal{D}^{-1-0} \delta^{0-0} F'_{\mathcal{C}}(K_0^{V_g}) = \mathcal{D}^{-1}d(V_g).$$

The 1-surgery axiom holds for every generic $g \in G \setminus X$ with $\lambda_{1,g} = \mathcal{D}d(V_g)^{-1}$ thanks to two easy computations. First of all, using the notation of Remark 2.4.3, we have

$$\text{CGP}_{\mathcal{C}}(\overline{\mathbf{B}}_{1,g} * \mathbf{B}_{1,g}) = \mathcal{D}^{-1-2} \delta^{0-1} F'_{\mathcal{C}}(L_0^{V_0}) = \mathcal{D}^{-3} \delta^{-1} \zeta \Delta_+ = 1,$$

as follows from the evaluation of the Geer-Patureau-Turaev renormalized invariant $F'_{\mathcal{C}}$ against the admissible \mathcal{C} -colored framed link $L_0^{V_0} \subset S^3$ depicted in Figure 14, which gives $\zeta \Delta_+ = \mathcal{D}^3 \delta$ thanks to the relative modularity condition of definition 2.2.2. Now the claim follows¹⁸ from the fact that if $T^\varphi, T^{\varphi'} : (+, V_g) \rightarrow (+, V_g)$ are morphisms of $\text{Rib}_{\mathcal{C}}^G$ such that both $\text{tr}_{\text{Rib}_{\mathcal{C}}^G}(T^\varphi)$ and $\text{tr}_{\text{Rib}_{\mathcal{C}}^G}(T^{\varphi'})$ are admissible \mathcal{C} -colored closed ribbon graphs then we have the equality

$$F'_{\mathcal{C}}(\text{tr}_{\text{Rib}_{\mathcal{C}}^G}(T^{\varphi'} \circ T^\varphi)) = d(V_g)^{-1} F'_{\mathcal{C}}(\text{tr}_{\text{Rib}_{\mathcal{C}}^G}(T^{\varphi'})) F'_{\mathcal{C}}(\text{tr}_{\text{Rib}_{\mathcal{C}}^G}(T^\varphi)).$$

Finally the 2-surgery axiom holds for every generic $g \in G \setminus X$ with $\lambda_{2,g} = \mathcal{D}^{-1}$. Indeed if $L = L_1 \cup \dots \cup L_k \subset S^3$ is a computable surgery framed link for

$$\mathbf{M} * \mathbf{A}_{2,g} = (M \cup_{S^1 \times S^1} (S^1 \times \overline{D^2}), T^\varphi \cup K_2^{\Omega_g}, \omega \cup_{(\emptyset_{2,g})_{B_2}} \omega_{a_{2,g}}, n)$$

¹⁸See axiom (N c) in the axiomatic definition of the Costantino-Geer-Patureau invariant contained in [CGP14].

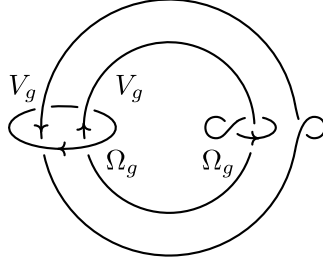

FIGURE 14. The admissible \mathcal{C} -colored framed link $L_0^{V_0} \subset S^3$. The two components colored with Ω_g form a computable surgery framed link for $\overline{\mathbf{B}}_{1,g} * \mathbf{B}_{1,g}$ inside S^3 whose signature is equal to 1, while the two components colored with V_g are decorations.

and if we set $K_L := f_L^{-1}(K_2) \subset S^3$ then $L \cup K_L \subset S^3$ is a computable surgery framed link for

$$\mathbf{M} * \mathbf{B}_{2,g} = (\mathbf{M} \cup_{S^1 \times S^1} (\mathbf{D}^2 \times S^1), \mathbf{T}^\varphi, \omega \cup_{(\vartheta_{2,g})_{B_2}} \omega_{b_{2,g}}, n + \sigma(L \cup K_L) - \sigma(L)),$$

and we obtain equalities

$$\begin{aligned} \text{CGP}_{\mathcal{C}}(\mathbf{M} * \mathbf{A}_{2,g}) &= \mathcal{D}^{-1-k} \delta^{n-\sigma(L)} F'_{\mathcal{C}}(L^\omega \cup K_L^{\Omega_g}), \\ \text{CGP}_{\mathcal{C}}(\mathbf{M} * \mathbf{B}_{2,g}) &= \mathcal{D}^{-1-(k+1)} \delta^{(n+\sigma(L \cup K_L))-\sigma(L)-\sigma(L \cup K_L)} F'_{\mathcal{C}}(L^\omega \cup K_L^{\Omega_g}). \end{aligned}$$

□

REMARK 2.6.4. As a corollary Lemma 2.5.5 applies to $\text{CGP}_{\mathcal{C}}$ whenever \mathcal{C} is relative modular.

REMARK 2.6.5. The only quantum invariant we will consider from now on is $\text{CGP}_{\mathcal{C}}$. We will therefore adopt a lighter notation for the extended universal construction: instead of using the full subscript $\text{CGP}_{\mathcal{C}}$ for universal linear categories, linear functors and natural transformations we will simply refer to the relative modular category \mathcal{C} .

2.7. Admissible skein modules

In this section we define admissible skein modules which project onto vector spaces of morphisms of universal linear categories associated with $\text{CGP}_{\mathcal{C}}$, much in the spirit of [BHMV95] and [BCGP16].

REMARK 2.7.1. From now on we will suppose that the pre-modular G -category \mathcal{C} relative to (H, X) we fixed in Remark 2.4.1 is actually modular relative to (H, X) . In particular $\text{CGP}_{\mathcal{C}}$ satisfies the surgery axioms.

If $\Sigma, \Sigma' : \Gamma \rightarrow \Gamma'$ are 1-morphisms of $\check{\mathbf{Cob}}_3^{\mathcal{C}}$ then we denote with $\check{\mathcal{V}}(\Sigma, \Sigma')$ the complex vector space generated by the set of 2-morphisms $\mathbf{M} : \Sigma \Rightarrow \Sigma'$ of $\check{\mathbf{Cob}}_3^{\mathcal{C}}$. Then we denote with $\check{\mathcal{X}}(\Sigma, \Sigma')$ the subspace of $\check{\mathcal{V}}(\Sigma, \Sigma')$ generated by vectors of the form

$$\sum_{i=1}^m \lambda_i \cdot \left(\mathbf{M}' * \left(\text{id}_{\Sigma''} \circ \left((\mathbf{D}^2 \times \mathbf{I})_{\mathbf{T}^{\varphi_i}} \otimes \text{id}_{\text{id}_{\Gamma}} \right) \right) * \mathbf{M} \right)$$

for some 1-morphism $\Sigma'' : \mathbf{S}_{i(V^\varepsilon)}^1 \otimes \Gamma \rightarrow \Gamma'$ of $\check{\mathbf{Cob}}_3^{\mathcal{G}}$, for some 2-morphisms

$$\mathbf{M} : \Sigma \Rightarrow \Sigma'' \circ (\mathbf{D}_{(\vec{\varepsilon}, \vec{V})}^2 \otimes \text{id}_\Gamma), \quad \mathbf{M}' : \Sigma'' \circ (\mathbf{D}_{(\vec{\varepsilon}', \vec{V}')}^2 \otimes \text{id}_\Gamma) \Rightarrow \Sigma'$$

of $\check{\mathbf{Cob}}_3^{\mathcal{G}}$, for some objects $(\vec{\varepsilon}, \vec{V}), (\vec{\varepsilon}', \vec{V}')$ of $\text{Rib}_{\mathcal{G}}^G$ satisfying $i(V^\varepsilon) = i(V'^{\varepsilon'})$ and for some morphisms $T_1^{\varphi_1}, \dots, T_m^{\varphi_m} : (\vec{\varepsilon}, \vec{V}) \rightarrow (\vec{\varepsilon}', \vec{V}')$ of $\text{Rib}_{\mathcal{G}}^G$ satisfying the equality

$$\sum_{i=1}^m \lambda_i \cdot F_{\mathcal{G}}(T_i^{\varphi_i}) = 0$$

between vectors of $\text{Hom}_{\mathcal{G}}(V^\varepsilon, V'^{\varepsilon'})$.

REMARK 2.7.2. The 2-morphisms $(\mathbf{D}^2 \times \mathbf{I})_{T_i^{\varphi_i}}$ are not required to be admissible.

Let $\Sigma, \Sigma' : \Gamma \rightarrow \Gamma'$ be 1-morphisms of $\check{\mathbf{Cob}}_3^{\mathcal{G}}$ of the form

$$\Sigma = (\Sigma, P^V, \vartheta_B, \mathcal{L}), \quad \Sigma' = (\Sigma', P^{V'}, \vartheta'_{B'}, \mathcal{L}')$$

and let M be a 3-dimensional cobordism with corners from Σ to Σ' . Let

$$\check{\mathcal{K}}_{\mathcal{G}}(M; (P^V, \vartheta_B), (P^{V'}, \vartheta'_{B'}))$$

denote the subspace of $\check{\mathcal{J}}_{\mathcal{G}}(M; (P^V, \vartheta_B), (P^{V'}, \vartheta'_{B'}))$ given by the preimage of the subspace $\check{\mathcal{K}}(\Sigma, \Sigma')$ of $\check{\mathcal{Y}}(\Sigma, \Sigma')$ under the natural linear map

$$\begin{aligned} \rho : \check{\mathcal{J}}_{\mathcal{G}}(M; (P^V, \vartheta_B), (P^{V'}, \vartheta'_{B'})) &\rightarrow \check{\mathcal{Y}}(\Sigma, \Sigma') \\ (T^\varphi, \omega) &\mapsto (M, T^\varphi, \omega, 0). \end{aligned}$$

A vector of $\check{\mathcal{K}}_{\mathcal{G}}(M; (P^V, \vartheta_B), (P^{V'}, \vartheta'_{B'}))$ will be called a \mathcal{G} -skein relation. We also denote with

$$\check{\mathcal{K}}_\sigma(M; (P^V, \vartheta_B), (P^{V'}, \vartheta'_{B'}))$$

the subspace of $\check{\mathcal{J}}_{\mathcal{G}}(M; (P^V, \vartheta_B), (P^{V'}, \vartheta'_{B'}))$ generated by vectors of the form

$$(M, T^\varphi \cup K^{\sigma(u)}, j^* \omega, 0) - \psi(\langle \omega, K_{//} \rangle, u) \cdot (M, T^\varphi, \omega, 0)$$

for some $u \in \Pi$ and some framed knot $K \subset M$ disjoint from T and colored with $\sigma(u)$, where $K_{//}$ is a parallel copy of K determined by the framing and where j is the inclusion of pairs

$$j : (M \setminus (T \cup K), A_M \cup B_M \cup B'_M \cup A'_M) \hookrightarrow (M \setminus T, A_M \cup B_M \cup B'_M \cup A'_M).$$

A vector of $\check{\mathcal{K}}_\sigma(M; (P^V, \vartheta_B), (P^{V'}, \vartheta'_{B'}))$ will be called a σ -skein relation.

If M is a 3-dimensional cobordism with corners from Σ to Σ' , if $P^V \subset \Sigma$ and $P^{V'} \subset \Sigma'$ are G -homogeneous \mathcal{G} -colored ribbon sets and if ϑ_B and $\vartheta'_{B'}$ are G -colorings of (Σ, P) and (Σ', P') which are compatible with V and V' respectively then the *admissible skein module of M relative to (P^V, ϑ_B) and $(P^{V'}, \vartheta'_{B'})$* is the complex vector space

$$\check{\mathcal{S}}_{\mathcal{G}}(M; (P^V, \vartheta_B), (P^{V'}, \vartheta'_{B'}))$$

defined as the quotient of

$$\check{\mathcal{J}}_{\mathcal{G}}(M; (P^V, \vartheta_B), (P^{V'}, \vartheta'_{B'}))$$

with respect to

$$\check{\mathcal{K}}_{\mathcal{G}}(M; (P^V, \vartheta_B), (P^{V'}, \vartheta'_{B'})) + \check{\mathcal{K}}_\sigma(M; (P^V, \vartheta_B), (P^{V'}, \vartheta'_{B'})).$$

Two \mathcal{G} -skeins in $\check{\mathcal{J}}_{\mathcal{G}}(M; (P^V, \vartheta_B), (P^{V'}, \vartheta'_{B'}))$ are said to be *skein equivalent* if their difference is a sum of a \mathcal{G} -skein relation with a σ -skein relation.

LEMMA 2.7.1. *Let Γ be an object of $\check{\mathbf{Cob}}_3^{\mathcal{C}}$, let*

$$\Sigma_{\Gamma} = (\Sigma_{\Gamma}, P^V, \vartheta_B, \mathcal{L}), \quad \Sigma''_{\Gamma} = (\Sigma''_{\Gamma}, P''^{V''}, \vartheta''_{B''}, \mathcal{L}'')$$

be objects of $\Lambda_{\mathcal{C}}(\Gamma)$ and let M_{Γ} be a cobordism with corners from Σ_{Γ} to Σ''_{Γ} . The linear map

$$\begin{aligned} \pi_{\mathcal{C}} : \check{\mathcal{S}}_{\mathcal{C}}(M_{\Gamma}; (P^V, \vartheta_B), (P''^{V''}, \vartheta''_{B''})) &\rightarrow \text{Hom}_{\Lambda_{\mathcal{C}}(\Gamma)}(\Sigma_{\Gamma}, \Sigma''_{\Gamma}) \\ (T^{\varphi}, \omega) &\mapsto [M_{\Gamma}, T^{\varphi}, \omega, 0] \end{aligned}$$

is well-defined.

PROOF. First of all, if

$$\sum_{i=1}^k \lambda_i \cdot (T_i^{\varphi_i}, \omega_i)$$

is a \mathcal{C} -skein relation in $\check{\mathcal{S}}_{\mathcal{C}}(M_{\Gamma}; (P^V, \vartheta_B), (P''^{V''}, \vartheta''_{B''}))$ then we have to show that

$$\sum_{i=1}^k \lambda_i \cdot (\text{CGP}_{\mathcal{C}})_{\Gamma}(M_{\Gamma}, T_i^{\varphi_i}, \omega_i, 0) = 0$$

for the natural transformations

$$(\text{CGP}_{\mathcal{C}})_{\Gamma}(M_{\Gamma}, T_i^{\varphi_i}, \omega_i, 0) : (\text{CGP}_{\mathcal{C}})_{\Gamma}(\Sigma_{\Gamma}) \Rightarrow (\text{CGP}_{\mathcal{C}})_{\Gamma}(\Sigma''_{\Gamma})$$

coming from the extended universal construction (see Appendix A.7 for a definition). In particular, it suffices to show that $\text{CGP}_{\mathcal{C}}$ vanishes on $\check{\mathcal{K}}(\text{id}_{\emptyset}, \text{id}_{\emptyset})$. This is true thanks to the very definition of $\text{CGP}_{\mathcal{C}}$ in terms of the Geer-Patureau-Turaev renormalized invariant $F'_{\mathcal{C}}$ of admissible closed \mathcal{C} -colored ribbon graphs, which is itself defined in terms of the Reshetikhin-Turaev functor $F_{\mathcal{C}}$.

Now if (T^{φ}, ω) is an admissible \mathcal{C} -skein in M_{Γ} and if $K \subset M_{\Gamma}$ is a framed knot disjoint from T then we have to show that

$$(\text{CGP}_{\mathcal{C}})_{\Gamma}(M_{\Gamma}, T^{\varphi} \cup K^{\sigma(u)}, j^* \omega, 0) = \psi(\langle \omega, K \rangle, u) \cdot (\text{CGP}_{\mathcal{C}})_{\Gamma}(M_{\Gamma}, T^{\varphi}, \omega, 0).$$

This follows from the definition of $F'_{\mathcal{C}}$ in terms of $F_{\mathcal{C}}$ and from the second and third condition in Definition 2.2.1. \square

REMARK 2.7.3. The same result holds also for the contravariant universal linear categories associated with $\text{CGP}_{\mathcal{C}}$. In other words, vectors in morphism spaces of contravariant universal linear categories are invariant under skein equivalence just like vectors in morphism spaces of covariant universal linear categories.

2.8. Morita reduction

We use here the results of the previous sections in order to give a better description for covariant universal linear categories associated with the Costantino-Geer-Patureau invariant, to which we will confine from now on. In particular, we give for every covariant universal linear category an explicit description of a dominating set. This will allow for a careful analysis in the following sections of the obstruction for the monoidality of the completion of the quantization 2-functor produced by the extended universal construction.

REMARK 2.8.1. From now on we will fix a choice, for every critical $x \in X$, of a generic index $g_x \in G \setminus X$ satisfying $g_x + x \in G \setminus X$. Such a choice exists because X is small symmetric in G . We also introduce the short notation d_x for $d(V_{g_x}) \in \mathbb{C}^*$, where V_{g_x} is the fixed projective simple object of index g_x specified in Remark 2.4.1.

REMARK 2.8.2. If $x \in X$ then $\text{Proj}(\mathcal{C}_x)$ is dominated by the set

$$\{V_{g_x}^*\} \otimes \sigma(\Pi) \otimes \Theta(\mathcal{C}_{g_x+x}) := \{V_{g_x}^* \otimes \sigma(u) \otimes V_i \mid u \in \Pi, i \in I_{g_x+x}\}.$$

In other words if V is a projective object of \mathcal{C}_x then we can always find objects $V_{i_1}, \dots, V_{i_n} \in \Theta(\mathcal{C}_{g_x+x})$, elements $u_1, \dots, u_n \in \Pi$ and morphisms

$$s_j \in \text{Hom}_{\mathcal{C}}(V, V_{g_x}^* \otimes \sigma(u_j) \otimes V_{i_j}), \quad r_j \in \text{Hom}_{\mathcal{C}}(V_{g_x}^* \otimes \sigma(u_j) \otimes V_{i_j}, V)$$

satisfying $\text{id}_V = \sum_{j=1}^n r_j \circ s_j$. Indeed, since V is projective, there exists¹⁹ a section $s \in \text{Hom}_{\mathcal{C}}(V, V_{g_x}^* \otimes V_{g_x} \otimes V)$ of $\text{ev}_{V_{g_x}} \otimes \text{id}_V$. Then, since $V_{g_x} \otimes V$ has index $g_x + x$ and since \mathcal{C}_{g_x+x} is semisimple and dominated by $\sigma(\Pi) \otimes \Theta(\mathcal{C}_{g_x+x})$, we can conclude.

Let us fix an object $\mathbf{\Gamma} = (\Gamma, \xi_A)$ of $\check{\mathbf{Cob}}_3^{\mathcal{C}}$. Every cobordism

$$\Sigma_{\Gamma} = \Sigma_{\Gamma_1} \cup \dots \cup \Sigma_{\Gamma_n}$$

from \emptyset to Γ whose i -th connected component Σ_{Γ_i} is given by a cobordism from \emptyset to Γ_i induces a decomposition $\Gamma = \Gamma_1 \cup \dots \cup \Gamma_n$ and the *index* $i(\Sigma_{\Gamma_i})$ of Σ_{Γ_i} with respect to $\mathbf{\Gamma}$ is defined as the element of G given by $\langle \xi, j_{i*}[\Gamma_i] \rangle$ for the fundamental class $[\Gamma_i]$ of Γ_i and for the inclusion

$$j_i : (\Gamma_i, \emptyset) \hookrightarrow (\Gamma, A).$$

If $i(\Sigma_{\Gamma_i}) \in G \setminus X$ then Σ_{Γ_i} is said to be a *generic component* of Σ_{Γ} with respect to $\mathbf{\Gamma}$ while if $i(\Sigma_{\Gamma_i}) \in X$ then Σ_{Γ_i} is said to be a *critical component* of Σ_{Γ} with respect to $\mathbf{\Gamma}$.

Let Σ_{Γ} be a cobordism from \emptyset to Γ . A *fundamental ribbon set* P for Σ_{Γ} with respect to $\mathbf{\Gamma}$ is a ribbon set inside Σ_{Γ} decomposed as a disjoint union

$$P = P_- \cup P_0 \cup P_+$$

where:

- (i) P_- is given by a single negative ribbon vertex in every critical component of Σ_{Γ} with respect to $\mathbf{\Gamma}$;
- (ii) P_0 is given by a single positive ribbon vertex in every component of Σ_{Γ} ;
- (iii) P_+ is given by a single positive ribbon vertex in every component of Σ_{Γ} .

Let P be a fundamental ribbon set for Σ_{Γ} with respect to $\mathbf{\Gamma}$. If $p_- \in P_-$ is contained in the connected component Σ_{Γ_i} of Σ_{Γ} then the *index* $x(p_-)$ of p_- with respect to $\mathbf{\Gamma}$ is defined as the element of X given by $i(\Sigma_{\Gamma_i}) \in X$. A *fundamental* (\mathcal{C}, G) -coloring (V, ϑ_B) of (Σ_{Γ}, P) extending ξ_A is a (\mathcal{C}, G) -coloring satisfying:

- (i) $V(p_-) = V_{g_{x(p_-)}}$ for every $p_- \in P_-$;
- (ii) $V(p_0) \in \sigma(\Pi)$ for every $p_0 \in P_0$;
- (iii) $V(p_+) \in \Theta(\mathcal{C})$ for every $p_+ \in P_+$.

REMARK 2.8.3. The compatibility between V and ϑ_B together with the assumption that $g_x + x \in G \setminus X$ for every $x \in X$ guarantees the genericity of the index of $V(p_+)$ for every $p_+ \in P_+$.

¹⁹See the beginning of the proof of Proposition 2.2.1.

We denote with $\mathcal{F}(\Sigma_\Gamma, P)$ the set of fundamental (\mathcal{C}, G) -colorings of (Σ_Γ, P) extending ξ_A .

REMARK 2.8.4. If P is a fundamental ribbon set for Σ_Γ with respect to $\mathbf{\Gamma}$ and if we have a fixed choice for a base set $B \subset (\Sigma_\Gamma \setminus (P \cup \partial\Sigma_\Gamma))$ and for a Lagrangian $\mathcal{L} \subset H^1(\Sigma_\Gamma; \mathbb{R})$ then we denote with $(\mathbf{\Sigma}_\Gamma)_{(V, \vartheta)}$ the object of $\Lambda_{\mathcal{C}}(\mathbf{\Gamma})$ given by

$$(\Sigma_\Gamma, P^V, \vartheta_B, \mathcal{L})$$

for every fundamental (\mathcal{C}, G) -coloring (V, ϑ_B) of (Σ_Γ, P) extending ξ_A .

LEMMA 2.8.1. *Let $\mathbf{\Gamma} = (\Gamma, \xi_A)$ be an object of $\check{\mathbf{Cob}}_3^{\mathcal{C}}$, let Σ_Γ be a non-empty cobordism from \emptyset to Γ , let P be a fundamental ribbon set for Σ_Γ with respect to $\mathbf{\Gamma}$, let B be a base set for Σ_Γ and let $\mathcal{L} \subset H^1(\Sigma_\Gamma; \mathbb{R})$ be a Lagrangian. Then*

$$D(\Sigma_\Gamma) := \{ (\mathbf{\Sigma}_\Gamma)_{(V, \vartheta)} \mid (V, \vartheta_B) \in \mathcal{F}(\Sigma_\Gamma, P) \}$$

dominates $\Lambda_{\mathcal{C}}(\mathbf{\Gamma})$.

PROOF. Let $\mathbf{\Sigma}_\Gamma'' = (\Sigma_\Gamma'', P''^{V''}, \vartheta''_{B''}, \mathcal{L}'')$ and $\mathbf{\Sigma}_\Gamma'' = (\Sigma_\Gamma'', P''^{V''}, \vartheta''_{B''}, \mathcal{L}'')$ be objects of $\Lambda_{\mathcal{C}}(\mathbf{\Gamma})$. If M_Γ is a connected cobordism with corners from Σ_Γ'' to Σ_Γ and if M_Γ'' is a connected cobordism with corners from Σ_Γ to Σ_Γ'' then, thanks to Lemma 2.5.5, every morphism inside $\text{Hom}_{\Lambda_{\mathcal{C}}(\mathbf{\Gamma})}(\mathbf{\Sigma}_\Gamma'', \mathbf{\Sigma}_\Gamma'')$ can be described by some linear combination of admissible \mathcal{C} -skeins inside $M_\Gamma \cup_{\Sigma_\Gamma} M_\Gamma''$ relative to

$$(P''^{V''}, \vartheta''_{B''}), \quad (P''^{V''}, \vartheta''_{B''}).$$

But every such \mathcal{C} -skein can be written, up to isotopy and skein equivalence, as a linear combination of admissible \mathcal{C} -skeins whose \mathcal{C} -colored ribbon graphs meet Σ_Γ transversely in P inducing a fundamental (\mathcal{C}, G) -coloring of (Σ_Γ, P) . This follows from the semisimplicity of $\mathcal{C}_{i(\Sigma_\Gamma)}$ for generic components Σ_{Γ_i} of Σ_Γ with respect to $\mathbf{\Gamma}$, and it follows from Remark 2.8.2 for critical components Σ_{Γ_j} of Σ_Γ with respect to $\mathbf{\Gamma}$. In other words every morphism

$$[M_\Gamma \cup_{\Sigma_\Gamma} M_\Gamma'', T^\varphi, \omega, 0] \in \text{Hom}_{\Lambda_{\mathcal{C}}(\mathbf{\Gamma})}(\mathbf{\Sigma}_\Gamma'', \mathbf{\Sigma}_\Gamma'')$$

can be decomposed as

$$\sum_{i=1}^k \lambda_i \cdot \left[\left(M_\Gamma'', T_i''^{\varphi_i''}, \omega_i'', 0 \right) * \left(M_\Gamma, T_i^{\varphi_i}, \omega_i, 0 \right) \right]$$

for some fundamental (\mathcal{C}, G) -colorings $(V_i, (\vartheta_i)_B)$ of (Σ_Γ, P) , for some admissible \mathcal{C} -skein $(T_i^{\varphi_i}, \omega_i)$ inside M_Γ relative to

$$(P''^{V''}, \vartheta''_{B''}), \quad (P^{V_i}, (\vartheta_i)_B)$$

and for some admissible \mathcal{C} -skein $(T_i''^{\varphi_i''}, \omega_i'')$ inside M_Γ'' relative to

$$(P^{V_i}, (\vartheta_i)_B), \quad (P''^{V''}, \vartheta''_{B''})$$

for every $i = 1, \dots, k$. □

If P is a ribbon graph inside a 2-dimensional cobordism Σ from Γ to Γ' then we will denote with \bar{P} the ribbon graph inside the cobordism $\bar{\Sigma}$ from Γ' to Γ whose oriented vertex set \bar{P} is obtained from P by reversing the orientation of every vertex and whose framing at \bar{p} is given by the framing of P at p for every $\bar{p} \in \bar{P}$.

If (V, ϑ_B) is a (\mathcal{C}, G) -coloring of (Σ, P) then $(\bar{V}, \bar{\vartheta}_B)$ will denote the (\mathcal{C}, G) -coloring of $(\bar{\Sigma}, \bar{P})$ defined by $\bar{V}(\bar{p}) = V(p)$ for every $\bar{p} \in \bar{P}$ and by $\bar{\vartheta} = \vartheta$.

Let $\mathbf{\Gamma} = (\Gamma, \xi_A)$ be an object of $\check{\mathbf{Cob}}_3^{\mathcal{C}}$ and let Σ'_Γ be a cobordism from Γ to \emptyset . A connected component Σ'_{Γ_i} of Σ'_Γ is *generic with respect to $\mathbf{\Gamma}$* if $\overline{\Sigma'_{\Gamma_i}}$ is generic with respect to $\mathbf{\Gamma}$ and it is *critical with respect to $\mathbf{\Gamma}$* if $\overline{\Sigma'_{\Gamma_i}}$ is critical with respect to $\mathbf{\Gamma}$. A ribbon set $P' \subset \Sigma'_\Gamma$ is a *fundamental ribbon set for Σ'_Γ with respect to $\mathbf{\Gamma}$* if $\overline{P'}$ is a fundamental ribbon set for $\overline{\Sigma'_\Gamma}$ with respect to $\mathbf{\Gamma}$. Let P' be a fundamental ribbon set for Σ'_Γ with respect to $\mathbf{\Gamma}$. A *fundamental (\mathcal{C}, G) -coloring $(V', \vartheta'_{B'})$ of (Σ'_Γ, P') extending ξ_A* is a (\mathcal{C}, G) -coloring such that $(\overline{V'}, (\vartheta')_{B'})$ is a fundamental (\mathcal{C}, G) -coloring of $(\overline{\Sigma'_\Gamma}, \overline{P'})$. We denote with $\mathcal{F}(\Sigma'_\Gamma, P')$ the set of fundamental (\mathcal{C}, G) -colorings of (Σ'_Γ, P') extending ξ_A .

REMARK 2.8.5. If P' is a fundamental ribbon set for Σ'_Γ and if we have a fixed choice for a base set $B' \subset (\Sigma'_\Gamma \setminus (P' \cup \partial \Sigma'_\Gamma))$ and for a Lagrangian $\mathcal{L}' \subset H^1(\Sigma'_\Gamma; \mathbb{R})$ then we denote with $(\Sigma'_\Gamma)_{(V', \vartheta')}$ the object of $\Lambda_{\mathcal{C}}(\mathbf{\Gamma})$ the 1-morphism of $\check{\mathbf{Cob}}_3^{\mathcal{C}}$ given by

$$(\Sigma'_\Gamma, P'^{V'}, \vartheta'_{B'}, \mathcal{L}')$$

for every fundamental (\mathcal{C}, G) -coloring $(V', \vartheta'_{B'})$ of (Σ'_Γ, P') extending ξ_A .

LEMMA 2.8.2. *Let $\mathbf{\Gamma}$ be an object of $\check{\mathbf{Cob}}_3^{\mathcal{C}}$, let*

$$\Sigma_\Gamma = (\Sigma_\Gamma, P^V, \vartheta_B, \mathcal{L}), \quad \Sigma''_\Gamma = (\Sigma''_\Gamma, P''^{V''}, \vartheta''_{B''}, \mathcal{L}'')$$

be objects of $\Lambda_{\mathcal{C}}(\mathbf{\Gamma})$ and let $\mathbf{M}_{1, \Gamma}, \dots, \mathbf{M}_{k, \Gamma} : \Sigma_\Gamma \Rightarrow \Sigma''_\Gamma$ be 2-morphisms of $\check{\mathbf{Cob}}_3^{\mathcal{C}}$. Let Σ'_Γ be a non-empty cobordism from Γ to \emptyset , let P' be a fundamental ribbon set for Σ'_Γ with respect to $\mathbf{\Gamma}$, let B' be a base set for Σ'_Γ , let $\mathcal{L}' \subset H^1(\Sigma'_\Gamma; \mathbb{R})$ be a Lagrangian, let M be a connected cobordism with corners from \emptyset to $\Sigma_\Gamma \cup_\Gamma \Sigma'_\Gamma$ and let M' be a connected cobordism with corners from $\Sigma''_\Gamma \cup_\Gamma \Sigma'_\Gamma$ to \emptyset . Then a linear combination $\sum_{i=1}^k \lambda_i \cdot [\mathbf{M}_{i, \Gamma}]$ determines a trivial morphism in $\text{Hom}_{\Lambda_{\mathcal{C}}(\mathbf{\Gamma})}(\Sigma_\Gamma, \Sigma''_\Gamma)$ if and only if

$$\sum_{i=1}^k \lambda_i \text{CGP}_{\mathcal{C}} \left((M', T'^{\varphi'}, \omega', 0) * \left(\text{id}_{(\Sigma'_\Gamma)_{(V', \vartheta')}} \circ \mathbf{M}_{i, \Gamma} \right) * (M, T^\varphi, \omega, 0) \right) = 0$$

for all fundamental (\mathcal{C}, G) -colorings $(V', \vartheta'_{B'})$ of (Σ'_Γ, P') extending ξ_A , for all admissible \mathcal{C} -skeins (T^φ, ω) inside M relative to

$$(\emptyset^\emptyset, \emptyset_\emptyset), \quad \left(P^V \cup P'^{V'}, \vartheta_B \cup_{\xi_A} \vartheta'_{B'} \right)$$

and for all \mathcal{C} -skeins $(T'^{\varphi'}, \omega')$ inside M' relative to

$$\left(P''^{V''} \cup P'^{V'}, \vartheta''_{B''} \cup_{\xi_A} \vartheta'_{B'} \right), \quad (\emptyset^\emptyset, \emptyset_\emptyset).$$

PROOF. The vector

$$\sum_{i=1}^k \lambda_i \cdot [\mathbf{M}_{i, \Gamma}] \in \text{Hom}_{\Lambda_{\mathcal{C}}(\mathbf{\Gamma})}(\Sigma_\Gamma, \Sigma''_\Gamma)$$

is trivial if and only if

$$\sum_{i=1}^k \lambda_i \cdot (\text{CGP}_{\mathcal{C}})_\Gamma(\mathbf{M}_{i, \Gamma}) = 0.$$

This happens if and only if we have the equality

$$\sum_{i=1}^k \lambda_i \text{CGP}_{\mathcal{C}} \left(\mathbf{M}''' * (\text{id}_{\Sigma''_\Gamma} \circ \mathbf{M}_{i, \Gamma}) * \mathbf{M}'' \right) = 0$$

for every object

$$\Sigma_{\Gamma}''' = (\Sigma_{\Gamma}''', P'''V''', \vartheta_{B'''}''', \mathcal{L}''')$$

of $\Lambda'_{\mathcal{C}}(\Gamma)$ and for all 2-morphisms $\mathbf{M}'' : \text{id}_{\emptyset} \Rightarrow \Sigma_{\Gamma}''' \circ \Sigma_{\Gamma}$ and $\mathbf{M}''' : \Sigma_{\Gamma}''' \circ \Sigma_{\Gamma}'' \Rightarrow \text{id}_{\emptyset}$ of $\check{\mathbf{Cob}}_3^{\mathcal{C}}$ of the form

$$\mathbf{M}'' = (M'', T''\varphi'', \omega'', n''), \quad \mathbf{M}''' = (M''', T'''\varphi''', \omega''', n''').$$

Thanks to Lemma 2.5.4 we can suppose that $T''\varphi''$ restricts to an admissible \mathcal{C} -colored ribbon graph in every connected component of M'' . Therefore, up to sliding projective arcs of $T'''\varphi'''$ through all connected components of $\Sigma_{\Gamma}''' \times I$, we can suppose that $\text{id}_{\Sigma_{\Gamma}''}$ is strongly admissible. Then, just like in the proof of Lemma 2.8.1, we can use the contravariant version of Lemma 2.5.5 discussed in Remark 2.5.7, isotopy and skein equivalence to obtain a decomposition

$$[\text{id}_{\Sigma_{\Gamma}''}] = \sum_{j=1}^{\ell} \mu_j \cdot [M_{\Gamma}''', T_j'''\varphi_j''', \omega_j''', 0] * [M'_{\Gamma}, T_j'\varphi_j', \omega_j', 0]$$

for some connected cobordisms with corners M'_{Γ} from Σ_{Γ}'''' to Σ'_{Γ} and M_{Γ}''' from Σ'_{Γ} to Σ_{Γ}'' , and for some admissible \mathcal{C} -skeins $(T_j'\varphi_j', \omega_j')$ inside M'_{Γ} relative to

$$(P'''V''', \vartheta_{B'''}'''), \quad (P'^{V'_j}, (\vartheta'_j)_{B'})$$

and $(T_j'''\varphi_j''', \omega_j''')$ inside M_{Γ}''' relative to

$$(P'^{V'_j}, (\vartheta'_j)_{B'}), \quad (P'''V''', \vartheta_{B'''}''')$$

for all $j = 1, \dots, \ell$. Now we can apply Lemma 2.5.5 to

$$[(M'_{\Gamma}, T_j'\varphi_j', \omega_j', 0) \circ \text{id}_{\Sigma_{\Gamma}}] * [\mathbf{M}'']$$

and to

$$[\mathbf{M}'''] * [(M_{\Gamma}''', T_j'''\varphi_j''', \omega_j''', 0) \circ \text{id}_{\Sigma_{\Gamma}''}]$$

in order to conclude. \square

2.9. Graded extensions

In this section we analyse the failure of $\hat{\mathbf{E}}_{\mathcal{C}}$ at being an ETQFT. We describe the obstruction to monoidality as \mathbb{I} -suspension systems on universal linear categories. This allows for the construction of suitable \mathbb{I} -graded extensions which lead to the definition of the \mathbb{I} -graded quantization 2-functors $\mathbb{E}_{\mathcal{C}}$ and $\mathbb{E}'_{\mathcal{C}}$.

2.9.1. 2-Spheres. We begin by studying the universal linear category $\Lambda_{\mathcal{C}}(\emptyset)$, which measures the obstruction to monoidality for $\hat{\mathbf{E}}_{\mathcal{C}}$.

REMARK 2.9.1. We suppose from now on that the element $0 \in G$ is critical. Indeed, should 0 be generic, we could choose $\mathbb{1}$ as the specified projective ambidextrous object of \mathcal{C} . Then we would have $\text{Proj}(\mathcal{C}) = \mathcal{C}$ and, since $\dim_{\mathcal{C}}(\mathbb{1}) = 1$, the Geer-Patureau-Turaev renormalized invariant $F'_{\mathcal{C}}$ would be equivalent to $F_{\mathcal{C}}$ thanks to Corollary 17 of [GPT09]. Then $\text{CGP}_{\mathcal{C}}$ would boil down to Witten-Reshetikhin-Turaev with G -structure. In particular the construction could be carried on also without this assumption, but since it would force us to use two different notations for the rest of the exposition while producing just a very mild generalization of what was already well-known, we prefer to directly concentrate on the new situation.

Let $P_{S^2} = (P_{S^2})_- \cup (P_{S^2})_0 \cup (P_{S^2})_+$ denote the fundamental ribbon set for S^2 given by $(P_{S^2})_- = \{p_-\} = \{(-1, 0, 0)\} \subset S^2$, by $(P_{S^2})_0 = \{p_0\} = \{(0, 0, 1)\} \subset S^2$ and by $(P_{S^2})_+ = \{p_+\} = \{(1, 0, 0)\} \subset S^2$ with framing given by

$$v_{p_-} = -\frac{d\gamma}{dt} \left(-\frac{\pi}{2} \right), \quad v_{p_0} = \frac{d\gamma}{dt} (0), \quad v_{p_+} = \frac{d\gamma}{dt} \left(\frac{\pi}{2} \right)$$

for the curve

$$\begin{aligned} \gamma: \mathbb{R} &\rightarrow S^2 \\ t &\mapsto (\sin t, 0, \cos t) \end{aligned}$$

Consider the base set $B_{S^2} = \{(0, 0, -1)\} \subset S^2$ and let ϑ_{S^2} be the cohomology class in $H^1(S^2 \setminus P_{S^2}, B_{S^2}; G)$ given by

$$\langle \vartheta_{S^2}, m_{p_-} \rangle = \langle \vartheta_{S^2}, m_{p_+} \rangle = g_0, \quad \langle \vartheta_{S^2}, m_{p_0} \rangle = 0$$

for positive meridians m_{p_ε} of p_ε for $\varepsilon \in \{-, 0, +\}$. For every $u \in \Pi$ and for every $i \in I_{g_0}$ we denote with $((u, i), (\vartheta_{S^2})_{B_{S^2}})$ the fundamental (\mathcal{C}, G) -coloring of (S^2, P_{S^2}) determined by $(u, i)(p_0) = \sigma(u)$ and by $(u, i)(p_+) = V_i$, and we will simply denote with $\mathbf{S}_{u,i}^2$ the object of $\Lambda_{\mathcal{C}}(\emptyset)$ given by

$$(S^2, \mathbf{P}_{S^2}^{u,i}, (\vartheta_{S^2})_{B_{S^2}}, \{0\}).$$

Such an object will be called a (u, i) -colored 2-sphere.

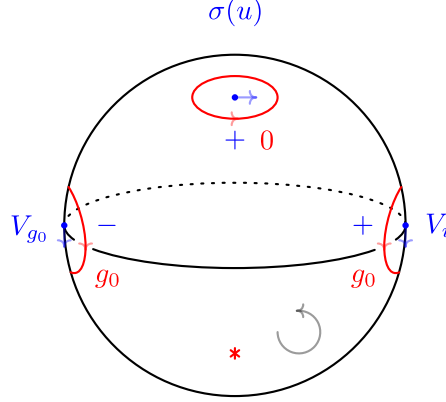

FIGURE 15. The (u, i) -colored 2-sphere $\mathbf{S}_{u,i}^2$.

LEMMA 2.9.1. *For all $u, u'' \in \Pi$ and for all $i, i'' \in I_{g_0}$ we have*

$$\dim_{\mathbb{C}} \text{Hom}_{\Lambda_{\mathcal{C}}(\emptyset)} (\mathbf{S}_{u,i}^2, \mathbf{S}_{u'',i''}^2) = \delta_{i,i_{g_0}} \delta_{i'',i_{g_0}} \delta_{u,u''}.$$

PROOF. Thanks to Lemma 2.5.5 we know that every morphism in

$$\text{Hom}_{\Lambda_{\mathcal{C}}(\emptyset)} (\mathbf{S}_{u,i}^2, \mathbf{S}_{u'',i''}^2)$$

can be represented by some linear combination of admissible \mathcal{C} -skeins inside the trivial cobordism with corners $S^2 \times I$ relative to

$$(\mathbf{P}_{S^2}^{u,i}, (\vartheta_{S^2})_{B_{S^2}}), \quad (\mathbf{P}_{S^2}^{u'',i''}, (\vartheta_{S^2})_{B_{S^2}}).$$

Up to isotopy and skein equivalence we can moreover restrict to admissible \mathcal{C} -skeins of the form (T_C^f, ω_f) where T_C^f consists of an oriented graph T_C contained in

$$\{(x, y, z, t) \in S^2 \times I \mid y = 0\}$$

featuring a single coupon C with color $f \in \text{Hom}_{\mathcal{E}}(V_{g_0}^* \otimes \sigma(u) \otimes V_i, V_{g_0}^* \otimes \sigma(u'') \otimes V_{i''})$ like the one represented in Figure 16.

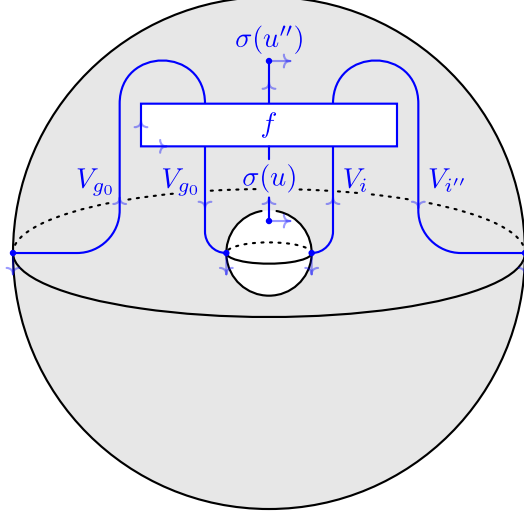

FIGURE 16. The \mathcal{E} -colored ribbon graph T_C^f inside $S^2 \times I$.

In other words, what we have is a surjective linear map from

$$\text{Hom}_{\mathcal{E}}(V_{g_0}^* \otimes \sigma(u) \otimes V_i, V_{g_0}^* \otimes \sigma(u'') \otimes V_{i''})$$

to

$$\text{Hom}_{\Lambda_{\mathcal{E}}(\emptyset)}(\mathbf{S}_{u,i}^2, \mathbf{S}_{u'',i''}^2)$$

whose kernel is to be determined. In order to do so we can specify $\overline{S^2}$ as a non-empty 2-dimensional cobordism from \emptyset to \emptyset , we can specify $S^2 \times \overline{I}$ as a 3-dimensional cobordism with corners from \emptyset to $S^2 \sqcup \overline{S^2}$ and we can specify $S^2 \times I$ as a 3-dimensional cobordism with corners from $S^2 \sqcup \overline{S^2}$ to \emptyset . Then, thanks to Lemma 2.8.2, the triviality of the vector $[S^2 \times I, T_C^f, \omega_f, 0]$ in $\text{Hom}_{\Lambda_{\mathcal{E}}(\emptyset)}(\mathbf{S}_{u,i}^2, \mathbf{S}_{u'',i''}^2)$ can be tested by choosing $P'_{\overline{S^2}} := \overline{P}_{S^2}$ as a fundamental ribbon set, $B_{\overline{S^2}} := B_{S^2}$ as a base set, $\vartheta'_{\overline{S^2}} := \vartheta_{S^2}$ as a cohomology class, by considering all fundamental (\mathcal{E}, G) -colorings $((u', i'), (\vartheta'_{\overline{S^2}})_{B_{\overline{S^2}}})$ of $(\overline{S^2}, P'_{\overline{S^2}})$, by considering all admissible \mathcal{E} -skeins $(T'^{\varphi'}, \omega')$ inside $S^2 \times \overline{I}$ relative to

$$(\emptyset^{\emptyset}, \emptyset^{\emptyset}), \quad (P_{S^2}^{u,i} \sqcup P_{S^2}^{u',i'}, (\vartheta_{S^2})_{B_{S^2}} \sqcup (\vartheta'_{S^2})_{B_{\overline{S^2}}}),$$

by considering all admissible \mathcal{E} -skeins $(T''^{\varphi''}, \omega'')$ inside $S^2 \times I$ relative to

$$(P_{S^2}^{u'',i''} \sqcup P_{S^2}^{u',i'}, (\vartheta_{S^2})_{B_{S^2}} \sqcup (\vartheta'_{S^2})_{B_{\overline{S^2}}}), \quad (\emptyset^{\emptyset}, \emptyset^{\emptyset})$$

and by computing the Costantino-Geer-Patureau invariant $\text{CGP}_{\mathcal{E}}$ on the resulting closed 2-morphism of $\check{\mathbf{Cob}}_3^{\mathcal{E}}$. Up to isotopy, skein equivalence and multiplication by some non-zero scalar this amounts²⁰ to evaluating the Geer-Patureau-Turaev

²⁰See Remark 2.9.2.

renormalized invariant $F'_{\mathcal{E}}$ against the admissible \mathcal{E} -colored closed ribbon graph $\mathbb{T}_g^{\varphi_{f,f',f''}}$ of Figure 17 for all $g \in G \setminus X$ and for all

$$\begin{aligned} f' &\in \text{Hom}_{\mathcal{E}}(\mathbb{1}, V_{g_0}^* \otimes \sigma(u) \otimes V_i \otimes V_{i'}^* \otimes \sigma(u')^* \otimes V_{g_0}), \\ f'' &\in \text{Hom}_{\mathcal{E}}(V_{g_0}^* \otimes \sigma(u'') \otimes V_{i''} \otimes V_{i'}^* \otimes \sigma(u')^* \otimes V_{g_0}, \mathbb{1}). \end{aligned}$$

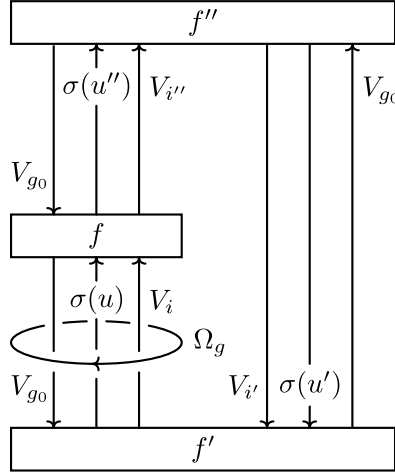

FIGURE 17. The admissible \mathcal{E} -colored closed ribbon graph $\mathbb{T}_g^{\varphi_{f,f',f''}}$.

The middle $\sigma(u)$ -colored strand can be pulled out on top of the closed component encircling it at the cost of a multiplicative factor $\psi(g, -u)$. Then, thanks to the relative modularity condition for \mathcal{E} , we get

$$F'_{\mathcal{E}}(\mathbb{T}_g^{\varphi_{f,f',f''}}) = \delta_{i,i_{g_0}} d_0^{-1} \zeta \psi(g, -u) F'_{\mathcal{E}}(\mathbb{T}^{\varphi_{f,f',f''}})$$

for the admissible \mathcal{E} -colored closed ribbon graph $\mathbb{T}^{\varphi_{f,f',f''}}$ depicted in Figure 18.

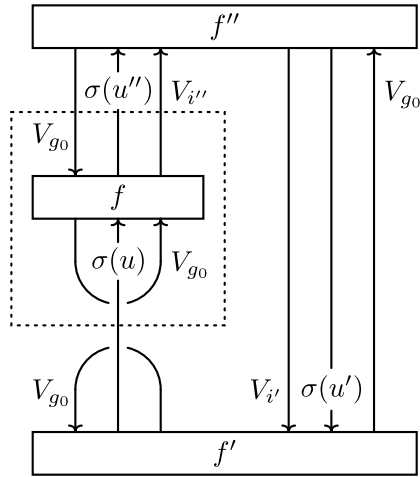

FIGURE 18. The admissible \mathcal{E} -colored closed ribbon graph $\mathbb{T}^{\varphi_{f,f',f''}}$.

The region enclosed by the dotted rectangle represents a morphism in

$$\mathrm{Hom}_{\mathcal{E}}(\sigma(u), V_{g_0}^* \otimes \sigma(u'') \otimes V_{i''}).$$

Since this vector space is naturally isomorphic to $\mathrm{Hom}_{\mathcal{E}}(\sigma(u) \otimes V_{g_0}, \sigma(u'') \otimes V_{i''})$ then the semisimplicity of \mathcal{E}_{g_0} implies

$$\dim_{\mathbb{C}} \mathrm{Hom}_{\Lambda_{\mathcal{E}}(\emptyset)}(\mathbf{S}_{u,i}^2, \mathbf{S}_{u'',i''}^2) \leq \delta_{i,i_{g_0}} \delta_{i'',i_{g_0}} \delta_{u,u''}.$$

The dimension of $\mathrm{Hom}_{\Lambda_{\mathcal{E}}(\emptyset)}(\mathbf{S}_{u,i_{g_0}}^2, \mathbf{S}_{u,i_{g_0}}^2)$ is furthermore exactly equal to 1 because the non-triviality of $[\mathrm{id}_{\mathbf{S}_{u,i_{g_0}}^2}]$ follows from the evaluation of $F'_{\mathcal{E}}$ against $\mathrm{T}^{\varphi_{f,f',f''}}$ for $i' = i_{g_0}$, for $u' = u$ and for

$$\begin{aligned} f &= \mathrm{id}_{V_{g_0}^* \otimes \sigma(u) \otimes V_{g_0}} \in \mathrm{Hom}_{\mathcal{E}}(V_{g_0}^* \otimes \sigma(u) \otimes V_{g_0}, V_{g_0}^* \otimes \sigma(u) \otimes V_{g_0}), \\ f' &= \mathrm{coev}_{V_{g_0}^* \otimes \sigma(u) \otimes V_{g_0}} \in \mathrm{Hom}_{\mathcal{E}}(\mathbb{1}, V_{g_0}^* \otimes \sigma(u) \otimes V_{g_0} \otimes V_{g_0}^* \otimes \sigma(u)^* \otimes V_{g_0}), \\ f'' &= \tilde{\mathrm{ev}}_{V_{g_0}^* \otimes \sigma(u) \otimes V_{g_0}} \in \mathrm{Hom}_{\mathcal{E}}(V_{g_0}^* \otimes \sigma(u) \otimes V_{g_0} \otimes V_{g_0}^* \otimes \sigma(u)^* \otimes V_{g_0}, \mathbb{1}). \quad \square \end{aligned}$$

REMARK 2.9.2. In order to give a complete proof, we would also have to consider the case of a critical index $x \in X$ for the closed component of the ribbon graph in Figure 17, which of course would determine a Kirby color which is not defined. The problem is that the chosen surgery presentation would no longer be computable, and this is a recurring phenomenon with relative pre-modular categories which makes arguments a little cumbersome, like in [CGP14]. We will explain here how to adapt the proof given above to the critical case by passing to a computable surgery presentation, and this can be done every time an analogous situation shows up, so we will not give details again. By using the skein axiom we can produce a strand with color V_{g_x} in a small region of the graph along the bottom left edge colored with V_{g_0} . Then we can change the index of the critical component by sliding the new arc over it. If we take care of doing this by subtraction we obtain a computable surgery presentation because the index of the surgery knot is changed from x to $g_x + x$, which is generic. We can then pull the middle $\sigma(u)$ -colored strand out on top of the diagram and the cost of doing this, in terms of multiplicative factors, is equal to $\psi(g_x + x, -u)\psi(g_x, -u)^{-1} = \psi(x, -u)$. We can then use the relative modularity condition just like in the generic case, and remark that now the V_{g_x} -colored strand can be returned to its original position, so that the modification we performed on $\mathrm{T}_x^{\varphi_{f,f',f''}}$ can in fact be undone. The rest of the proof is unchanged.

REMARK 2.9.3. Since we established that for every $i \neq i_{g_0}$ and for every $u \in \Pi$ the (u, i) -colored 2-sphere $\mathbf{S}_{u,i}^2$ is a zero object of $\Lambda_{\mathcal{E}}(\emptyset)$, we will switch from now on to the simpler notations

$$\mathbf{S}_u^2 := \mathbf{S}_{u,i_{g_0}}^2, \quad \mathrm{P}_{\mathbb{S}^2}^u := \mathrm{P}_{\mathbb{S}^2}^{u,i_{g_0}}$$

and we will refer to \mathbf{S}_u^2 as the u -colored 2-sphere.

REMARK 2.9.4. Lemmas 2.8.1 and 2.9.1 immediately imply that $\Lambda_{\mathcal{E}}(\emptyset)$ is Morita equivalent to its full linear subcategory with set of objects $\{\mathbf{S}_u^2 \mid u \in \Pi\}$. This is of course not Morita equivalent to the unit linear category \mathbb{C} unless $\Pi = \{0\}$, in which case we can prove that $\mathbf{E}_{\mathcal{E}}$ is monoidal. Therefore, as in Remark 2.9.1, we will suppose from now on that Π is not trivial, and thus that $\hat{\mathbf{E}}_{\mathcal{E}}$ is not an ETQFT.

2.9.2. 3-Discs. The next subsections are dedicated to the study of vector spaces of morphisms between tensor products of fundamental spheres in $\Lambda_{\mathcal{C}}(\emptyset)$.

DEFINITION 2.9.1. The *0-colored 3-disc*

$$\mathbf{D}_0^3 : \text{id}_{\emptyset} \Rightarrow \mathbf{S}_0^2$$

is the 2-morphism of $\check{\mathbf{Cob}}_3^{\mathcal{C}}$ given by

$$(\mathbf{D}^3, (\mathbf{T}_0^1)^{\varepsilon}, \omega_{\varepsilon}, 0)$$

where $(\mathbf{T}_0^1)^{\varepsilon}$ is the \mathcal{C} -colored ribbon graph contained in

$$\{(x, y, z) \in D^3 \mid y = 0\}$$

and represented in the left-hand part of Figure 19 whose only coupon is colored with the invertible morphism $\varepsilon \in \text{Hom}_{\mathcal{C}}(\mathbb{1}, \sigma(0))$ given by the braided monoidal functor $\sigma : \Pi \rightarrow \mathcal{C}$ and where ω_{ε} is the only G -coloring of $(\mathbf{D}^3, \mathbf{T}_0^1)$ which is compatible with the \mathcal{C} -coloring on \mathbf{T}_0^1 .

DEFINITION 2.9.2. The *inverse 0-colored 3-disc*

$$\overline{\mathbf{D}}_0^3 : \mathbf{S}_0^2 \Rightarrow \text{id}_{\emptyset}$$

is the 2-morphism of $\check{\mathbf{Cob}}_3^{\mathcal{C}}$ given by

$$(\overline{\mathbf{D}}^3, (\mathbf{T}_1^0)^{\varepsilon^{-1}}, \omega_{\varepsilon^{-1}}, 0)$$

where $(\mathbf{T}_1^0)^{\varepsilon^{-1}}$ is the \mathcal{C} -colored ribbon graph contained in

$$\{(x, y, z) \in \overline{D}^3 \mid y = 0\}$$

and represented in the right-hand part of Figure 19 whose only coupon is colored with the invertible morphism $\varepsilon^{-1} \in \text{Hom}_{\mathcal{C}}(\sigma(0), \mathbb{1})$ given by the braided monoidal functor $\sigma : \Pi \rightarrow \mathcal{C}$ and where $\omega_{\varepsilon^{-1}}$ is the only G -coloring of $(\overline{\mathbf{D}}^3, \mathbf{T}_1^0)$ which is compatible with the \mathcal{C} -coloring on \mathbf{T}_1^0 .

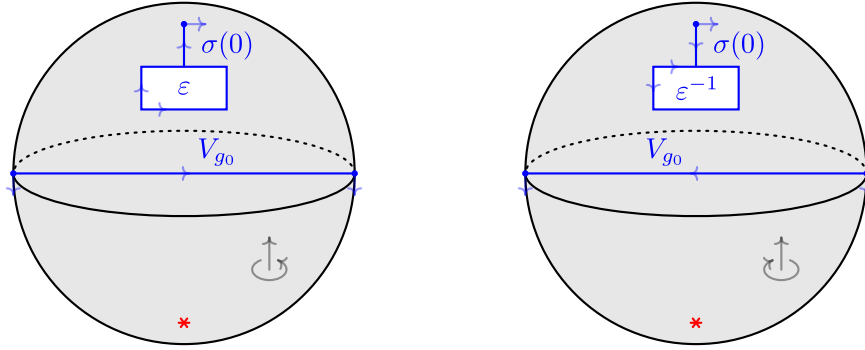

FIGURE 19. The 0-colored 3-disc \mathbf{D}_0^3 and the inverse 0-colored 3-disc $\overline{\mathbf{D}}_0^3$. The ribbon graphs \mathbf{T}_0^1 and \mathbf{T}_1^0 are represented in blue with blackboard framing. The arrows on the faces of the coupons specify the orientations of their horizontal boundaries and of their vertical boundaries. The cohomology classes ω_{ε} and $\omega_{\varepsilon^{-1}}$ are completely determined by the \mathcal{C} -colorings on \mathbf{T}_0^1 and on \mathbf{T}_1^0 respectively.

LEMMA 2.9.2. *We have the equality*

$$\mathcal{D}d_0^{-1} \cdot [\mathbf{D}_0^3 * \overline{\mathbf{D}}_0^3] = [\text{id}_{\mathbf{S}_0^2}]$$

between vectors of $\text{Hom}_{\Lambda_{\mathcal{E}}(\emptyset)}(\mathbf{S}_0^2, \mathbf{S}_0^2)$.

PROOF. This result is an immediate consequence of the g_0 -colored index 1 surgery axiom. \square

REMARK 2.9.5. Since the equality

$$\mathcal{D}d_0^{-1} \cdot [\overline{\mathbf{D}}_0^3 * \mathbf{D}_0^3] = [\text{id}_{\text{id}_{\emptyset}}]$$

follows immediately from the g_0 -colored index 0 surgery axiom, we have

$$\mathcal{D}d_0^{-1} \cdot [\overline{\mathbf{D}}_0^3] = [\mathbf{D}_0^3]^{-1} \in \text{Hom}_{\Lambda_{\mathcal{E}}(\emptyset)}(\mathbf{S}_0^2, \text{id}_{\emptyset})$$

and the objects id_{\emptyset} and \mathbf{S}_0^2 of $\Lambda_{\mathcal{E}}(\emptyset)$ are isomorphic.

2.9.3. 3-Pants. We define the *3-pant cobordism*²¹ \mathbf{P}^3 as the 3-dimensional cobordism from $\mathbf{S}^2 \sqcup \mathbf{S}^2$ to \mathbf{S}^2 whose support P^3 is given by

$$D^3 \setminus \left(B \left(\left(-\frac{1}{2}, 0, 0 \right), \frac{1}{4} \right) \cup B \left(\left(\frac{1}{2}, 0, 0 \right), \frac{1}{4} \right) \right) \subset \mathbb{R}^3$$

where $B((x, y, z), \rho)$ is the open ball of center (x, y, z) and radius ρ in \mathbb{R}^3 , whose incoming horizontal boundary identification is given by

$$\begin{aligned} f_{(P^3)_{\text{h}}} : \quad \mathbf{S}^2 \sqcup \mathbf{S}^2 &\rightarrow \partial B \left(\left(-\frac{1}{2}, 0, 0 \right), \frac{1}{4} \right) \cup \partial B \left(\left(\frac{1}{2}, 0, 0 \right), \frac{1}{4} \right) \\ (i, (x, y, z)) &\mapsto \begin{cases} \left(\frac{x-2}{4}, \frac{y}{4}, \frac{z}{4} \right) & i = -1 \\ \left(\frac{x+2}{4}, \frac{y}{4}, \frac{z}{4} \right) & i = +1 \end{cases} \end{aligned}$$

and whose outgoing horizontal boundary identification is given by $\text{id}_{\mathbf{S}^2}$.

We define the *inverse 3-pant cobordism* $\overline{\mathbf{P}^3}$ as the 3-dimensional cobordism from \mathbf{S}^2 to $\mathbf{S}^2 \sqcup \mathbf{S}^2$ whose support is given by $\overline{P^3}$, whose incoming horizontal boundary identification is given by $\text{id}_{\mathbf{S}^2}$ and whose outgoing horizontal boundary identification is given by $f_{(P^3)_{\text{h}}}$.

Let us consider $u, u' \in H$.

DEFINITION 2.9.3. The (u, u') -colored 3-pant

$$\mathbf{P}_{u, u'}^3 : \mathbf{S}_u^2 \otimes \mathbf{S}_{u'}^2 \Rightarrow \mathbf{S}_{u+u'}^2$$

is the 2-morphism of $\check{\mathbf{Cob}}_3^{\mathcal{E}}$ given by

$$\left(\mathbf{P}^3, (\mathbf{T}_2^1)^{\mu_{u, u'}}, \omega_{\mu_{u, u'}}, 0 \right)$$

where $(\mathbf{T}_2^1)^{\mu_{u, u'}}$ is the \mathcal{E} -colored ribbon graph contained in

$$\{(x, y, z) \in P^3 \mid y = 0\}$$

and represented in Figure 20, whose only coupon is colored with the invertible morphism $\mu_{u, u'} \in \text{Hom}_{\mathcal{E}}(\sigma(u) \otimes \sigma(u'), \sigma(u+u'))$ given by the braided monoidal functor $\sigma : \Pi \rightarrow \mathcal{E}$, and where $\omega_{\mu_{u, u'}}$ is the unique G -coloring of $(\mathbf{P}^3, \mathbf{T}_2^1)$ which is compatible with the \mathcal{E} -coloring of \mathbf{T}_2^1 and which evaluates to 0 every relative homology class that can be represented by some oriented arc contained in $\{(x, y, z) \in P^3 \mid z \geq 0\}$.

²¹The name comes from the analogy with the 2-dimensional pants cobordism, which can similarly be defined as the complement of two small discs inside the unit disc in \mathbb{R}^2 .

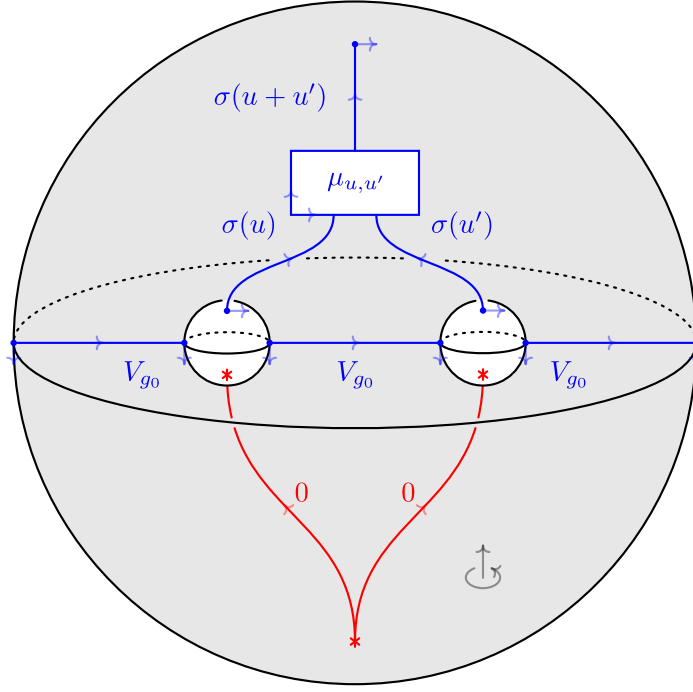

FIGURE 20. The (u, u') -colored 3-pant $\mathbf{P}_{u, u'}^3$. The ribbon graph \mathbb{T}_2^1 is given by the three blue edges together with the middle blue trivalent graph with blackboard framing. The arrows on the faces of the coupon specify the orientation of its horizontal boundary and of its vertical boundary. The cohomology class $\omega_{\mu_{u, u'}}$ is completely determined by the \mathcal{C} -coloring on \mathbb{T}_2^1 and by the vanishing condition for the evaluations against relative homology classes contained in the lower hemisphere.

DEFINITION 2.9.4. The *inverse* (u, u') -colored 3-pant

$$\overline{\mathbf{P}}_{u, u'}^3 : \mathbf{S}_{u+u'}^2 \Rightarrow \mathbf{S}_u^2 \otimes \mathbf{S}_{u'}^2$$

is the 2-morphism of $\check{\mathbf{Cob}}_3^{\mathcal{C}}$ given by

$$\left(\overline{\mathbf{P}}^3, (\mathbb{T}_1^2)^{\mu_{u, u'}^{-1}}, \omega_{\mu_{u, u'}^{-1}}, 0 \right)$$

where $(\mathbb{T}_1^2)^{\mu_{u, u'}^{-1}}$ is the \mathcal{C} -colored ribbon graph contained in

$$\{(x, y, z) \in \overline{\mathbf{P}}^3 \mid y = 0\}$$

and represented in Figure 21, whose only coupon is colored with the invertible morphism $\mu_{u, u'}^{-1} \in \text{Hom}_{\mathcal{C}}(\sigma(u+u'), \sigma(u) \otimes \sigma(u'))$ given by the braided monoidal functor $\sigma : \Pi \rightarrow \mathcal{C}$, and where $\omega_{\mu_{u, u'}^{-1}}$ is the only G -coloring of $(\overline{\mathbf{P}}^3, \mathbb{T}_1^2)$ which is compatible with the \mathcal{C} -coloring on \mathbb{T}_1^2 and which evaluates to 0 every relative homology class that can be represented by some oriented arc contained in $\{(x, y, z) \in \overline{\mathbf{P}}^3 \mid z \geq 0\}$.

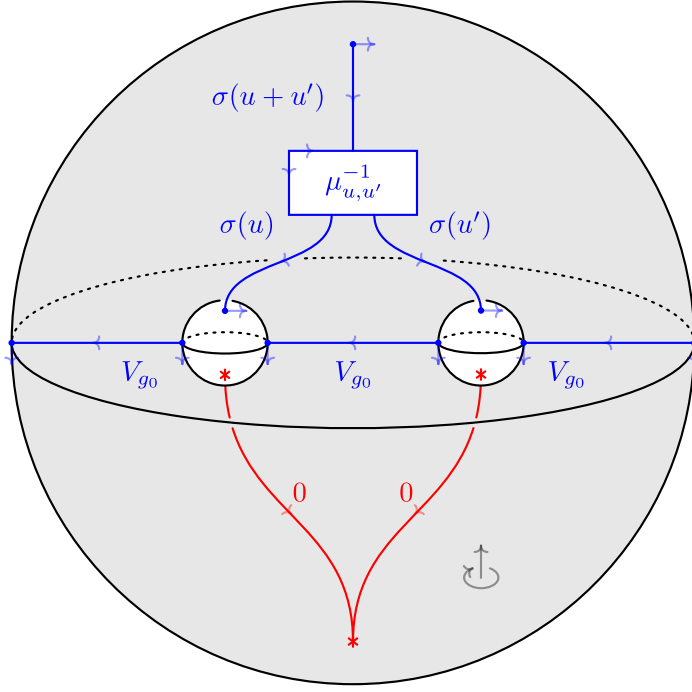

FIGURE 21. The inverse (u, u') -colored 3-pant $\bar{\mathbf{P}}_{u,u'}^3$. The ribbon graph \mathbf{T}_1^2 is given by the three blue edges together with the middle blue trivalent graph with blackboard framing. The arrows on the faces of the coupon specify the orientation of its horizontal boundary and of its vertical boundary. The cohomology class $\omega_{\mu_{u,u'}^{-1}}$ is completely determined by the \mathcal{C} -coloring on \mathbf{T}_1^2 and by the vanishing condition for the evaluations against relative homology classes contained in the lower hemisphere.

LEMMA 2.9.3. *For all $u, u', u'', u''' \in \Pi$ we have*

$$\begin{aligned} \dim_{\mathbb{C}} \text{Hom}_{\Lambda_{\mathcal{C}}(\emptyset)} (\mathbf{S}_u^2 \otimes \mathbf{S}_{u'}^2, \mathbf{S}_{u''}^2) &= \delta_{u+u', u''} \\ \dim_{\mathbb{C}} \text{Hom}_{\Lambda_{\mathcal{C}}(\emptyset)} (\mathbf{S}_u^2, \mathbf{S}_{u''}^2 \otimes \mathbf{S}_{u'''}^2) &= \delta_{u, u''+u'''} \end{aligned}$$

PROOF. We will only prove the first statement as the proof of the second one is completely analogous. Thanks to Lemma 2.5.5 every morphism in

$$\text{Hom}_{\Lambda_{\mathcal{C}}(\emptyset)} (\mathbf{S}_u^2 \otimes \mathbf{S}_{u'}^2, \mathbf{S}_{u''}^2)$$

can be represented by some linear combination of admissible \mathcal{C} -skeins inside the 3-pant cobordism \mathbf{P}^3 relative to $(\mathbf{P}_{\mathbb{S}^2}^u \sqcup \mathbf{P}_{\mathbb{S}^2}^{u'}, (\vartheta_{\mathbb{S}^2})_{B_{\mathbb{S}^2}} \sqcup (\vartheta_{\mathbb{S}^2})_{B_{\mathbb{S}^2}})$ and $(\mathbf{P}_{\mathbb{S}^2}^{u''}, (\vartheta_{\mathbb{S}^2})_{B_{\mathbb{S}^2}})$. Up to isotopy and skein equivalence, just like for Lemma 2.9.1, we have a surjective linear map from

$$\text{Hom}_{\mathcal{C}} (V_{g_0}^* \otimes \sigma(u) \otimes V_{g_0} \otimes V_{g_0}^* \otimes \sigma(u') \otimes V_{g_0}, V_{g_0}^* \otimes \sigma(u'') \otimes V_{g_0})$$

to

$$\text{Hom}_{\Lambda_{\mathcal{C}}(\emptyset)} (\mathbf{S}_u^2 \otimes \mathbf{S}_{u'}^2, \mathbf{S}_{u''}^2)$$

and we have to study its kernel. In order to do so we can specify $\overline{S^2}$ as a non-empty 2-dimensional cobordism from \emptyset to \emptyset , we can specify $\overline{P^3}$ as a 3-dimensional cobordism from \emptyset to $S^2 \sqcup S^2 \sqcup \overline{S^2}$ and we can specify $S^2 \times I$ as a 3-dimensional cobordism from $S^2 \sqcup \overline{S^2}$ to \emptyset . Then the triviality of the image of a morphism

$$f \in \text{Hom}_{\mathcal{E}} (V_{g_0}^* \otimes \sigma(u) \otimes V_{g_0} \otimes V_{g_0}^* \otimes \sigma(u') \otimes V_{g_0}, V_{g_0}^* \otimes \sigma(u'') \otimes V_{g_0})$$

in $\text{Hom}_{\Lambda_{\mathcal{E}}(\emptyset)}(\mathbf{S}_u^2 \otimes \mathbf{S}_{u'}^2, \mathbf{S}_{u''}^2)$ can be tested by evaluating the Geer-Patureau-Turaev renormalized invariant $F'_{\mathcal{E}}$ against the admissible \mathcal{E} -colored closed ribbon graph $T^{\varphi_{f,f',f''}}$ depicted in Figure 22 for every $u''' \in \Pi$ and for all

$$\begin{aligned} f' &\in \text{Hom}_{\mathcal{E}} (\mathbb{1}, V_{g_0}^* \otimes \sigma(u) \otimes V_{g_0} \otimes V_{g_0}^* \otimes \sigma(u') \otimes V_{g_0} \otimes V_{i'''}^* \otimes \sigma(u''')^* \otimes V_{g_0}), \\ f'' &\in \text{Hom}_{\mathcal{E}} (V_{g_0}^* \otimes \sigma(u'') \otimes V_{g_0} \otimes V_{i'''}^* \otimes \sigma(u''')^* \otimes V_{g_0}, \mathbb{1}). \end{aligned}$$

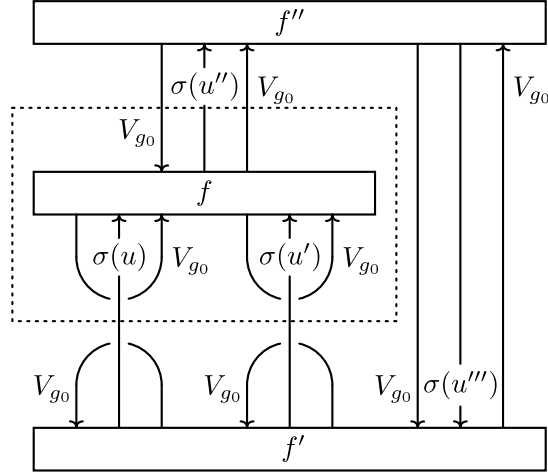

FIGURE 22. The admissible \mathcal{E} -colored closed ribbon graph $T^{\varphi_{f,f',f''}}$.

As before, the region enclosed by the dotted rectangle represents a morphism in $\text{Hom}_{\mathcal{E}}(\sigma(u) \otimes \sigma(u'), V_{g_0}^* \otimes \sigma(u'') \otimes V_{g_0})$. Since this vector space is naturally isomorphic to $\text{Hom}_{\mathcal{E}}(\sigma(u+u') \otimes V_{g_0}, \sigma(u'') \otimes V_{g_0})$ the semisimplicity of \mathcal{E}_{g_0} implies

$$\dim_{\mathbb{C}} \text{Hom}_{\Lambda_{\mathcal{E}}(\emptyset)}(\mathbf{S}_u^2 \otimes \mathbf{S}_{u'}^2, \mathbf{S}_{u''}^2) \leq \delta_{u+u', u''}.$$

The dimension of $\text{Hom}_{\Lambda_{\mathcal{E}}(\emptyset)}(\mathbf{S}_u^2 \otimes \mathbf{S}_{u'}^2, \mathbf{S}_{u+u'}^2)$ is furthermore exactly 1 because the non-triviality of $[\mathbf{P}_{u,u'}^3]$ follows from the evaluation of $F'_{\mathcal{E}}$ against $T^{\varphi_{f,f',f''}}$ where $u''' = u + u'$ and where

$$\begin{aligned} f &\in \text{Hom}_{\mathcal{E}}(V_{g_0}^* \otimes \sigma(u) \otimes V_{g_0} \otimes V_{g_0}^* \otimes \sigma(u') \otimes V_{g_0}, V_{g_0}^* \otimes \sigma(u+u') \otimes V_{g_0}), \\ f' &\in \text{Hom}_{\mathcal{E}}(\mathbb{1}, V_{g_0}^* \otimes \sigma(u) \otimes V_{g_0} \otimes V_{g_0}^* \otimes \sigma(u') \otimes V_{g_0} \otimes V_{g_0}^* \otimes \sigma(u+u')^* \otimes V_{g_0}), \\ f'' &\in \text{Hom}_{\mathcal{E}}(V_{g_0}^* \otimes \sigma(u+u') \otimes V_{g_0} \otimes V_{g_0}^* \otimes \sigma(u+u')^* \otimes V_{g_0}, \mathbb{1}) \end{aligned}$$

are given by the images under the Reshetikhin-Turaev functor $F_{\mathcal{E}}$ of the \mathcal{E} -colored ribbon graphs depicted in Figure 23. \square

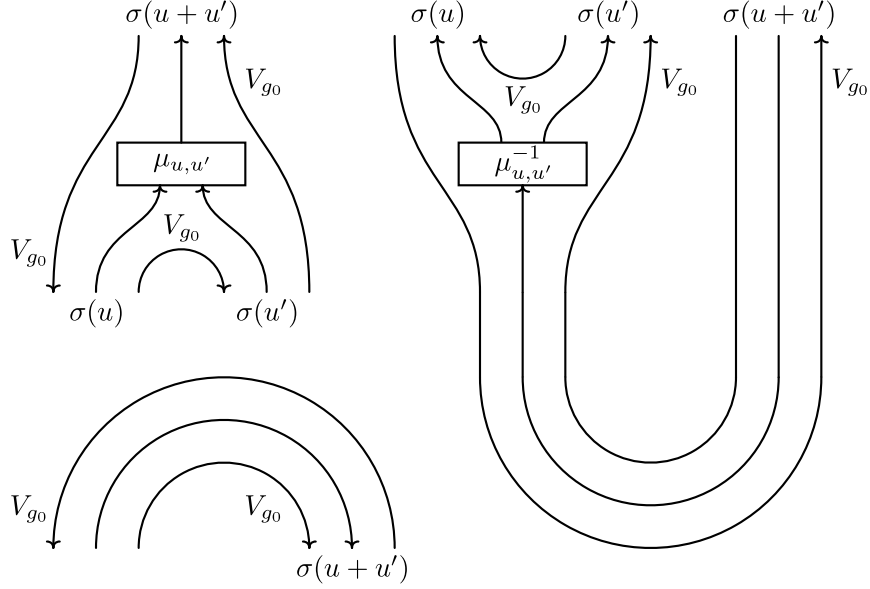
FIGURE 23. The \mathcal{C} -colored ribbon graphs representing f , f' and f'' .

LEMMA 2.9.4. *For every $u \in \Pi$ we have the equalities*

$$[\mathbf{P}_{0,u}^3 * (\mathbf{D}_0^3 \otimes \text{id}_{\mathbf{S}_u^2})] = [\mathbf{P}_{u,0}^3 * (\text{id}_{\mathbf{S}_u^2} \otimes \mathbf{D}_0^3)] = [\text{id}_{\mathbf{S}_u^2}]$$

between vectors of $\text{Hom}_{\Lambda_{\mathcal{C}}(\emptyset)}(\mathbf{S}_u^2, \mathbf{S}_u^2)$ and

$$[(\overline{\mathbf{D}}_0^3 \otimes \text{id}_{\mathbf{S}_u^2}) * \overline{\mathbf{P}}_{0,u}^3] = [(\text{id}_{\mathbf{S}_u^2} \otimes \overline{\mathbf{D}}_0^3) * \overline{\mathbf{P}}_{u,0}^3] = [\text{id}_{\mathbf{S}_u^2}]$$

between vectors of $\text{Hom}_{\Lambda_{\mathcal{C}}(\emptyset)}(\mathbf{S}_u^2, \mathbf{S}_u^2)$.

PROOF. Once again, we will only prove the first statement as the proof of the second one is completely analogous. The equality

$$\mu_{0,u} \circ (\varepsilon \otimes \text{id}_{\sigma(u)}) = \mu_{u,0} \circ (\text{id}_{\sigma(u)} \otimes \varepsilon) = \text{id}_{\sigma(u)}$$

follows from the definition of σ , which is a braided monoidal functor between braided monoidal categories. The result then follows from the existence of isomorphisms between the cobordisms

$$(\mathbf{D}^3 \sqcup (\mathbf{S}^2 \times \mathbf{I})) \cup_{\mathbf{S}^2 \sqcup \mathbf{S}^2} \mathbf{P}^3, \quad ((\mathbf{S}^2 \times \mathbf{I}) \sqcup \mathbf{D}^3) \cup_{\mathbf{S}^2 \sqcup \mathbf{S}^2} \mathbf{P}^3, \quad \mathbf{S}^2 \times \mathbf{I}. \quad \square$$

LEMMA 2.9.5. *For all $u, u', u'' \in \Pi$ we have the equalities*

$$\left[\mathbf{P}_{u+u',u''}^3 * \left(\mathbf{P}_{u,u'}^3 \otimes \text{id}_{\mathbf{S}_{u''}^2} \right) \right] = \left[\mathbf{P}_{u,u'+u''}^3 * (\text{id}_{\mathbf{S}_u^2} \otimes \mathbf{P}_{u',u''}^3) \right]$$

between vectors of $\text{Hom}_{\Lambda_{\mathcal{C}}(\emptyset)}(\mathbf{S}_u^2 \otimes \mathbf{S}_{u'}^2 \otimes \mathbf{S}_{u''}^2, \mathbf{S}_{u+u'+u''}^2)$ and

$$\left[\left(\overline{\mathbf{P}}_{u,u'}^3 \otimes \text{id}_{\mathbf{S}_{u''}^2} \right) * \overline{\mathbf{P}}_{u+u',u''}^3 \right] = \left[(\text{id}_{\mathbf{S}_u^2} \otimes \overline{\mathbf{P}}_{u',u''}^3) * \overline{\mathbf{P}}_{u,u'+u''}^3 \right]$$

between vectors of $\text{Hom}_{\Lambda_{\mathcal{C}}(\emptyset)}(\mathbf{S}_{u+u'+u''}^2, \mathbf{S}_u^2 \otimes \mathbf{S}_{u'}^2 \otimes \mathbf{S}_{u''}^2)$.

PROOF. As usual, we will only prove the first statement as the proof of the second one is completely analogous. The equality

$$\mu_{u+u',u''} \circ (\mu_{u,u'} \otimes \text{id}_{\sigma(u'')}) = \mu_{u,u'+u''} \circ (\text{id}_{\sigma(u)} \otimes \mu_{u',u''})$$

follows from the definition of σ , which is a braided monoidal functor between braided monoidal categories. The result then follows from the existence of isomorphisms between the cobordisms

$$(\mathbf{P}^3 \sqcup (\mathbf{S}^2 \times \mathbf{I})) \cup_{\mathbf{S}^2 \sqcup \mathbf{S}^2} \mathbf{P}^3, \quad ((\mathbf{S}^2 \times \mathbf{I}) \sqcup \mathbf{P}^3) \cup_{\mathbf{S}^2 \sqcup \mathbf{S}^2} \mathbf{P}^3. \quad \square$$

REMARK 2.9.6. The morphism space

$$\text{Hom}_{\Lambda_{\mathcal{E}}(\emptyset)}(\mathbf{S}_u^2 \otimes \mathbf{S}_{u'}^2, \mathbf{S}_{u+u'}^2)$$

is generated by $[\mathbf{P}_{u,u'}^3]$ for all $u, u' \in \mathcal{H}$ and

$$\text{Hom}_{\Lambda_{\mathcal{E}}(\emptyset)}(\mathbf{S}_{u''+u'''}^2, \mathbf{S}_{u''}^2 \otimes \mathbf{S}_{u'''}^2)$$

is generated by $[\overline{\mathbf{P}}_{u'',u'''}^3]$ for all $u'', u''' \in \mathcal{H}$.

LEMMA 2.9.6. *For all $u, u' \in \mathcal{H}$ we have the equality*

$$[\overline{\mathbf{P}}_{u,u'}^3 * \mathbf{P}_{u,u'}^3] = \mathcal{D}d_0^{-1} \cdot [\text{id}_{\mathbf{S}_u^2} \otimes \text{id}_{\mathbf{S}_{u'}^2}]$$

between vectors of $\text{Hom}_{\Lambda_{\mathcal{E}}(\emptyset)}(\mathbf{S}_u^2 \otimes \mathbf{S}_{u'}^2, \mathbf{S}_u^2 \otimes \mathbf{S}_{u'}^2)$.

PROOF. The equality

$$\mu_{u,u'}^{-1} \circ \mu_{u,u'} = ((\text{id}_{\sigma(u)} \otimes \varepsilon^{-1}) \circ \mu_{u,0}^{-1}) \otimes (\mu_{0,u'} \circ (\varepsilon \otimes \text{id}_{\sigma(u')}))$$

follows from the definition of σ , which is a braided monoidal functor between braided monoidal categories. The existence of isomorphisms between the cobordisms

$$\overline{\mathbf{P}}^3 \cup_{\mathbf{S}^2} \mathbf{P}^3, \quad ((\mathbf{S}^2 \times \mathbf{I}) \sqcup \mathbf{P}^3) \cup_{\mathbf{S}^2 \sqcup \mathbf{S}^2 \sqcup \mathbf{S}^2} (\overline{\mathbf{P}}^3 \sqcup (\mathbf{S}^2 \times \mathbf{I}))$$

implies the equality

$$[\overline{\mathbf{P}}_{u,u'}^3 * \mathbf{P}_{u,u'}^3] = [(\text{id}_{\mathbf{S}_u^2} \otimes \mathbf{P}_{0,u'}^3) * (\overline{\mathbf{P}}_{u,0}^3 \otimes \text{id}_{\mathbf{S}_{u'}^2})]$$

between vectors of $\text{Hom}_{\Lambda_{\mathcal{E}}(\emptyset)}(\mathbf{S}_u^2 \otimes \mathbf{S}_{u'}^2, \mathbf{S}_u^2 \otimes \mathbf{S}_{u'}^2)$. The result now follows from Lemmas 2.9.2 and 2.9.4. \square

LEMMA 2.9.7. *For all $u, u' \in \mathcal{H}$ we have the equality*

$$[\mathbf{P}_{u,u'}^3 * \overline{\mathbf{P}}_{u,u'}^3] = \mathcal{D}d_0^{-1} \cdot [\text{id}_{\mathbf{S}_{u+u'}^2}]$$

between vectors of $\text{Hom}_{\Lambda_{\mathcal{E}}(\emptyset)}(\mathbf{S}_{u+u'}^2, \mathbf{S}_{u+u'}^2)$.

PROOF. Thanks to Remark 2.9.4 we have $\dim_{\mathbb{C}} \text{Hom}_{\Lambda_{\mathcal{E}}(\emptyset)}(\mathbf{S}_{u+u'}^2, \mathbf{S}_{u+u'}^2) = 1$.

In particular $[\mathbf{P}_{u,u'}^3 * \overline{\mathbf{P}}_{u,u'}^3]$ must be of the form $\lambda \cdot [\text{id}_{\mathbf{S}_{u+u'}^2}]$ for some $\lambda \in \mathbb{C}$.

Thanks to Lemma 2.9.6 we have the chain of equalities

$$\begin{aligned} [\text{id}_{\mathbf{S}_u^2} \otimes \text{id}_{\mathbf{S}_{u'}^2}] &= \mathcal{D}^{-2} d_0^2 \cdot [\overline{\mathbf{P}}_{u,u'}^3 * \mathbf{P}_{u,u'}^3 * \overline{\mathbf{P}}_{u,u'}^3 * \mathbf{P}_{u,u'}^3] \\ &= \mathcal{D}^{-2} d_0^2 \lambda \cdot [\overline{\mathbf{P}}_{u,u'}^3 * \mathbf{P}_{u,u'}^3] \\ &= \mathcal{D}^{-1} d_0 \lambda \cdot [\text{id}_{\mathbf{S}_u^2} \otimes \text{id}_{\mathbf{S}_{u'}^2}] \end{aligned}$$

which implies $\lambda = \mathcal{D}d_0^{-1}$. \square

REMARK 2.9.7. Lemmas 2.9.6 and 2.9.7 combine to give the equality

$$\mathcal{D}d_0^{-1} \cdot [\overline{\mathbf{P}}_{u,u'}^3] = [\mathbf{P}_{u,u'}^3]^{-1}$$

between vectors of $\text{Hom}_{\Lambda_{\mathcal{G}}(\emptyset)}(\mathbf{S}_{u+u'}^2, \mathbf{S}_{u+u'}^2)$.

DEFINITION 2.9.5. For all $u, u' \in \Pi$ the *twisted (u, u') -colored 3-pant*

$$\tilde{\mathbf{P}}_{u,u'}^3 : \mathbf{S}_u^2 \otimes \mathbf{S}_{u'}^2 \Rightarrow \mathbf{S}_{u+u'}^2$$

is the 2-morphism of $\check{\mathbf{Cob}}_3^{\mathcal{G}}$ given by

$$\mathbf{P}_{u',u}^3 * \beta_{\mathbf{S}_u^2, \mathbf{S}_{u'}^2}.$$

LEMMA 2.9.8. For all $u, u' \in \Pi$ we have the equality

$$[\tilde{\mathbf{P}}_{u,u'}^3] = \nu(u, u') \cdot [\mathbf{P}_{u,u'}^3]$$

between vectors of $\text{Hom}_{\Lambda_{\mathcal{G}}(\emptyset)}(\mathbf{S}_u^2 \otimes \mathbf{S}_{u'}^2, \mathbf{S}_{u+u'}^2)$.

PROOF. For the proof of this Lemma we adopt the notation used in the proof of Lemma 2.9.3. We know that $[\mathbf{P}_{u,u'}^3]$ generates the vector space

$$\text{Hom}_{\Lambda_{\mathcal{G}}(\emptyset)}(\mathbf{S}_u^2 \otimes \mathbf{S}_{u'}^2, \mathbf{S}_{u+u'}^2),$$

so there have to exist coefficients $\lambda_{u,u'} \in \mathbb{C}$ for all $u, u' \in \Pi$ satisfying

$$[\tilde{\mathbf{P}}_{u,u'}^3] = \lambda_{u,u'} \cdot [\mathbf{P}_{u,u'}^3].$$

In order to compute $\lambda_{u,u'}$ we choose $\overline{\mathbf{P}}^3$ as a cobordism from \emptyset to $\mathbf{S}^2 \sqcup \mathbf{S}^2 \sqcup \overline{\mathbf{S}^2}$ and $\mathbf{S}^2 \times \mathbf{I}$ as a cobordism from $\mathbf{S}^2 \sqcup \overline{\mathbf{S}^2}$ to \emptyset . Now it is sufficient to compare the evaluations of the Geer-Patureau-Turaev renormalized invariant $F'_{\mathcal{G}}$ against the admissible \mathcal{G} -colored closed ribbon graphs $\mathbf{T}^{\varphi_{f,f',f''}}$ and $\mathbf{T}^{\varphi_{\tilde{f},f',f''}}$ depicted in Figure 22 for $i''' = i_{g_0}$, for $u''' = u + u'$ and for

$$\begin{aligned} f &\in \text{Hom}_{\mathcal{G}}(V_{g_0}^* \otimes \sigma(u) \otimes V_{g_0} \otimes V_{g_0}^* \otimes \sigma(u') \otimes V_{g_0}, V_{g_0}^* \otimes \sigma(u + u') \otimes V_{g_0}), \\ f' &\in \text{Hom}_{\mathcal{G}}(\mathbb{1}, V_{g_0}^* \otimes \sigma(u) \otimes V_{g_0} \otimes V_{g_0}^* \otimes \sigma(u') \otimes V_{g_0} \otimes V_{g_0}^* \otimes \sigma(u + u')^* \otimes V_{g_0}), \\ f'' &\in \text{Hom}_{\mathcal{G}}(V_{g_0}^* \otimes \sigma(u + u') \otimes V_{g_0} \otimes V_{g_0}^* \otimes \sigma(u + u') \otimes V_{g_0}, \mathbb{1}), \\ \tilde{f} &\in \text{Hom}_{\mathcal{G}}(V_{g_0}^* \otimes \sigma(u) \otimes V_{g_0} \otimes V_{g_0}^* \otimes \sigma(u') \otimes V_{g_0}, V_{g_0}^* \otimes \sigma(u + u')^* \otimes V_{g_0}) \end{aligned}$$

given by the images under the Reshetikhin-Turaev functor $F_{\mathcal{G}}$ of the ribbon graphs depicted in Figure 23 and 24.

By applying twice the skein condition for relative modular categories we can pull the $\sigma(u)$ -colored strand in Figure 24 on top of all the V_{g_0} -colored strands. Then the equality

$$\mu_{u',u} \circ \beta_{\sigma(u), \sigma(u')} = \nu(u, u') \cdot \mu_{u,u'}$$

coming from the definition of braided monoidal functor leads to the equality

$$F'_{\mathcal{G}}(\mathbf{T}^{\varphi_{\tilde{f},f',f''}}) = \nu(u, u') \cdot F'_{\mathcal{G}}(\mathbf{T}^{\varphi_{f,f',f''}}),$$

which proves the assertion. \square

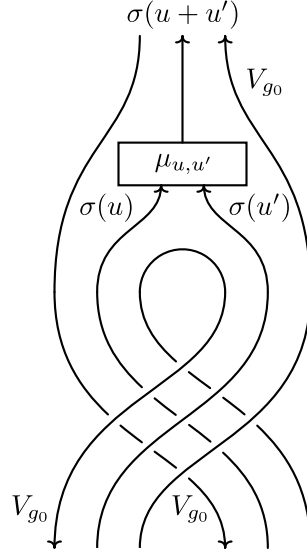
FIGURE 24. \mathcal{C} -colored ribbon graph representing \tilde{f} .

2.9.4. Suspension systems. We sidetrack for a moment in order to define an operation we will apply to our quantization 2-functors $\mathbf{E}_{\mathcal{C}}$ and $\mathbf{E}'_{\mathcal{C}}$. This will allow for the definition of a symmetric monoidal 2-functor at the cost of changing the target symmetric monoidal 2-category.

REMARK 2.9.8. If Λ is a linear category then the category $\text{Cat}_{\mathbb{C}}(\Lambda, \Lambda)$ of linear functors from Λ to Λ together with their natural transformations is monoidal with unit given by id_{Λ} and with tensor product given by composition.

DEFINITION 2.9.6. A Π -suspension system on a linear category Λ is a monoidal functor $S : \Pi \rightarrow \text{Cat}_{\mathbb{C}}(\Lambda, \Lambda)$.

REMARK 2.9.9. If S is a Π -suspension system on a linear category Λ then we denote with

$$\varepsilon \in \text{Hom}_{\text{Cat}_{\mathbb{C}}(\Lambda, \Lambda)}(\mathbb{1}, S(0)), \quad \mu_{u, u'} \in \text{Hom}_{\text{Cat}_{\mathbb{C}}(\Lambda, \Lambda)}(S(u) \otimes S(u'), S(u + u'))$$

the natural transformations coming from the structure of S and we denote with S^u the functor $S(u)$, which is called the u -suspension functor.

DEFINITION 2.9.7. If Λ is a linear category and if S is a Π -suspension system on Λ then the Π -graded extension of Λ along S is the Π -graded linear category Λ with set of objects

$$\text{Ob}(\Lambda) := \text{Ob}(\Lambda),$$

with vector spaces of degree u morphisms

$$\text{Hom}_{\Lambda}^u(V, V') := \text{Hom}_{\Lambda}(V, S^{-u}(V'))$$

for all objects V and V' of Λ and for every degree $u \in \Pi$, with identities

$$\text{id}_V^0 := \varepsilon_V \in \text{Hom}_{\Lambda}(V, S^0(V))$$

for every object V of Λ and with compositions

$$f'^{u'} \star f^u := (\mu_{-u, -u'})_{V''} \circ S^{-u}(f'^{u'}) \circ f^u \in \text{Hom}_{\Lambda}(V, S^{-u-u'}(V''))$$

for all $f^u \in \text{Hom}_\Lambda(V, S^{-u}(V'))$ and $f^{u'} \in \text{Hom}_\Lambda(V', S^{-u'}(V''))$.

EXAMPLE 2.9.1. The *standard Π -suspension system* on $\text{Vect}_{\mathbb{C}}^{\Pi, \text{fg}}$ is the Π -suspension system S on $\text{Vect}_{\mathbb{C}}^{\Pi, \text{fg}}$ defined by $S^u(\mathbb{V}) := \mathbb{V} \circ L_{-u}$ for every Π -graded vector space \mathbb{V} and every $u \in \Pi$, where $L_u : \Pi \rightarrow \Pi$ is the functor defined by $L_u(u') := u + u'$. We denote with $\text{Vect}_{\mathbb{C}}^{\Pi, \text{fg}}$ the Π -graded extension of $\text{Vect}_{\mathbb{C}}^{\Pi, \text{fg}}$ along the standard Π -suspension system S , and for every $u \in \Pi$ and all objects \mathbb{V}, \mathbb{V}' of $\text{Vect}_{\mathbb{C}}^{\Pi, \text{fg}}$ we denote with $\text{Hom}_{\mathbb{C}}^u(\mathbb{V}, \mathbb{V}')$ the vector space of degree u morphisms of $\text{Vect}_{\mathbb{C}}^{\Pi, \text{fg}}$ from \mathbb{V} to \mathbb{V}' .

The results of the previous subsections can now be summarized as follows. For every object Γ of $\check{\mathbf{Cob}}_3^{\mathcal{E}}$ and for every $u \in \Pi$ we have a functor

$$S^u : \Lambda_{\mathcal{E}}(\Gamma) \rightarrow \Lambda_{\mathcal{E}}(\Gamma)$$

mapping each object Σ_{Γ} of $\Lambda_{\mathcal{E}}(\Gamma)$ to $\mathbf{S}_u^2 \otimes \Sigma_{\Gamma}$ and each morphism $[\mathbf{M}_{\Gamma}]$ of $\Lambda_{\mathcal{E}}(\Gamma)$ to $[\text{id}_{\mathbf{S}_u^2} \otimes \mathbf{M}_{\Gamma}]$. We have a natural isomorphism

$$\varepsilon : \text{id}_{\Lambda_{\mathcal{E}}(\Gamma)} \Rightarrow S^0$$

associating with each object Σ_{Γ} of $\Lambda_{\mathcal{E}}(\Gamma)$ the morphism $[\mathbf{D}_0^3 \otimes \text{id}_{\Sigma_{\Gamma}}]$. We also have for each $u, u' \in \Pi$ natural isomorphisms

$$\mu_{u, u'} : S^u \circ S^{u'} \rightarrow S^{u+u'}$$

associating with each object Σ_{Γ} of $\Lambda_{\mathcal{E}}(\Gamma)$ the morphism $[\mathbf{P}_{u, u'}^3 \otimes \text{id}_{\Sigma_{\Gamma}}]$. Analogously, for every object Γ of $\check{\mathbf{Cob}}_3^{\mathcal{E}}$ and for every $u \in \Pi$ we have a functor

$$S^u : \Lambda'_{\mathcal{E}}(\Gamma) \rightarrow \Lambda'_{\mathcal{E}}(\Gamma)$$

mapping each object Σ'_{Γ} of $\Lambda'_{\mathcal{E}}(\Gamma)$ to $\mathbf{S}_u^2 \otimes \Sigma'_{\Gamma}$ and each morphism $[\mathbf{M}'_{\Gamma}]$ of $\Lambda'_{\mathcal{E}}(\Gamma)$ to $[\text{id}_{\mathbf{S}_u^2} \otimes \mathbf{M}'_{\Gamma}]$. We have a natural isomorphism

$$\varepsilon : \text{id}_{\Lambda'_{\mathcal{E}}(\Gamma)} \Rightarrow S^0$$

associating with each object Σ'_{Γ} of $\Lambda'_{\mathcal{E}}(\Gamma)$ the morphism $[\mathbf{D}_0^3 \otimes \text{id}_{\Sigma'_{\Gamma}}]$. We also have for each $u, u' \in \Pi$ natural isomorphisms

$$\mu_{u, u'} : S^u \circ S^{u'} \rightarrow S^{u+u'}$$

associating with each object Σ'_{Γ} of $\Lambda'_{\mathcal{E}}(\Gamma)$ the morphism $[\mathbf{P}_{u, u'}^3 \otimes \text{id}_{\Sigma'_{\Gamma}}]$.

PROPOSITION 2.9.1. *For every object Γ of $\check{\mathbf{Cob}}_3^{\mathcal{E}}$ the functors S^u together with the natural transformations ε and $\mu_{u, u'}$ for $u, u' \in \Pi$ form a Π -suspension system on $\Lambda_{\mathcal{E}}(\Gamma)$ and on $\Lambda'_{\mathcal{E}}(\Gamma)$.*

2.9.5. Graded quantization 2-functors. We are now ready to improve the extended universal construction by defining a Π -graded version of the quantization 2-functors $\mathbf{E}_{\mathcal{E}}$ and $\mathbf{E}'_{\mathcal{E}}$.

DEFINITION 2.9.8. The *covariant universal Π -graded linear category* $\Lambda_{\mathcal{E}}(\Gamma)$ associated with an object Γ of $\check{\mathbf{Cob}}_3^{\mathcal{E}}$ is the Π -graded extension of $\Lambda_{\mathcal{E}}(\Gamma)$ along the Π -suspension system S given by Proposition 2.9.1.

The *contravariant universal Π -graded linear category* $\Lambda'_{\mathcal{E}}(\Gamma)$ associated with an object Γ of $\check{\mathbf{Cob}}_3^{\mathcal{E}}$ is the Π -graded extension of $\Lambda'_{\mathcal{E}}(\Gamma)$ along the Π -suspension system S given by Proposition 2.9.1.

DEFINITION 2.9.9. The *covariant universal Π -graded linear functor*

$$\mathbb{F}_{\mathcal{E}}(\Sigma) : \Lambda_{\mathcal{E}}(\Gamma) \rightarrow \Lambda_{\mathcal{E}}(\Gamma')$$

associated with a 1-morphism $\Sigma : \Gamma \rightarrow \Gamma'$ of $\check{\mathbf{Cob}}_3^{\mathcal{E}}$ is the Π -graded linear functor mapping every object Σ_{Γ} of $\Lambda_{\mathcal{E}}(\Gamma)$ to the object $\Sigma \circ \Sigma_{\Gamma}$ of $\Lambda_{\mathcal{E}}(\Gamma')$ and mapping every degree u morphism $[\mathbf{M}_{\Gamma}^u] \in \text{Hom}_{\Lambda_{\mathcal{E}}(\Gamma)}^u(\Sigma_{\Gamma}, \Sigma_{\Gamma}')$ to the degree u morphism

$$[\text{id}_{\Sigma} \circ \mathbf{M}_{\Gamma}^u] \in \text{Hom}_{\Lambda_{\mathcal{E}}(\Gamma')}^u(\Sigma \circ \Sigma_{\Gamma}, \Sigma \circ \Sigma_{\Gamma}').$$

The *contravariant universal Π -graded linear functor*

$$\mathbb{F}'_{\mathcal{E}}(\Sigma) : \Lambda'_{\mathcal{E}}(\Gamma') \rightarrow \Lambda'_{\mathcal{E}}(\Gamma)$$

associated with a 1-morphism $\Sigma : \Gamma \rightarrow \Gamma'$ of $\check{\mathbf{Cob}}_3^{\mathcal{E}}$ is the Π -graded linear functor mapping every object $\Sigma'_{\Gamma'}$ of $\Lambda'_{\mathcal{E}}(\Gamma')$ to the object $\Sigma'_{\Gamma'} \circ \Sigma$ of $\Lambda'_{\mathcal{E}}(\Gamma)$ and mapping every degree u morphism $[\mathbf{M}'_{\Gamma'}]^u \in \text{Hom}_{\Lambda'_{\mathcal{E}}(\Gamma')}^u(\Sigma'_{\Gamma'}, \Sigma'_{\Gamma'}')$ to the degree u morphism

$$[\mathbf{M}'_{\Gamma'}]^u \circ \text{id}_{\Sigma} \in \text{Hom}_{\Lambda'_{\mathcal{E}}(\Gamma)}^u(\Sigma'_{\Gamma'} \circ \Sigma, \Sigma'_{\Gamma'}' \circ \Sigma).$$

DEFINITION 2.9.10. The *covariant universal Π -graded natural transformation*

$$\eta_{\mathcal{E}}(\mathbf{M}) : \mathbb{F}_{\mathcal{E}}(\Sigma) \Rightarrow \mathbb{F}_{\mathcal{E}}(\Sigma')$$

associated with a 2-morphism $\mathbf{M} : \Sigma \Rightarrow \Sigma'$ of $\check{\mathbf{Cob}}_3^{\mathcal{E}}$ is the Π -graded natural transformation associating with every object Σ_{Γ} of $\Lambda_{\mathcal{E}}(\Gamma)$ the degree 0 morphism

$$[\mathbf{D}_0^3 \otimes (\mathbf{M} \circ \text{id}_{\Sigma_{\Gamma}})] \in \text{Hom}_{\Lambda_{\mathcal{E}}(\Gamma')}^0(\Sigma \circ \Sigma_{\Gamma}, \Sigma' \circ \Sigma_{\Gamma}).$$

The *contravariant universal Π -graded natural transformation*

$$\eta'_{\mathcal{E}}(\mathbf{M}) : \mathbb{F}'_{\mathcal{E}}(\Sigma) \Rightarrow \mathbb{F}'_{\mathcal{E}}(\Sigma')$$

associated with a 2-morphism $\mathbf{M} : \Sigma \Rightarrow \Sigma'$ of $\check{\mathbf{Cob}}_3^{\mathcal{E}}$ is the Π -graded natural transformation associating with every object $\Sigma'_{\Gamma'}$ of $\Lambda'_{\mathcal{E}}(\Gamma')$ the degree 0 morphism

$$\left[\mathbf{D}_0^3 \otimes (\text{id}_{\Sigma'_{\Gamma'}} \circ \mathbf{M}) \right] \in \text{Hom}_{\Lambda'_{\mathcal{E}}(\Gamma)}^0(\Sigma'_{\Gamma'} \circ \Sigma, \Sigma'_{\Gamma'}' \circ \Sigma').$$

DEFINITION 2.9.11. The *covariant Π -graded quantization 2-functor*

$$\mathbb{E}_{\mathcal{E}} : \check{\mathbf{Cob}}_3^{\mathcal{E}} \rightarrow \mathbf{Cat}_{\mathbb{C}}^{\Pi}$$

associated with $\text{CGP}_{\mathcal{E}}$ is the 2-functor mapping each object Γ of $\check{\mathbf{Cob}}_3^{\mathcal{E}}$ to $\Lambda_{\mathcal{E}}(\Gamma)$, each 1-morphism Σ of $\check{\mathbf{Cob}}_3^{\mathcal{E}}$ to $\mathbb{F}_{\mathcal{E}}(\Sigma)$ and each 2-morphism \mathbf{M} of $\check{\mathbf{Cob}}_3^{\mathcal{E}}$ to $\eta_{\mathcal{E}}(\mathbf{M})$.

The *contravariant Π -graded quantization 2-functor*

$$\mathbb{E}'_{\mathcal{E}} : \left(\check{\mathbf{Cob}}_3^{\mathcal{E}} \right)^{\text{op}} \rightarrow \mathbf{Cat}_{\mathbb{C}}^{\Pi}$$

associated with $\text{CGP}_{\mathcal{E}}$ is the 2-functor mapping each object Γ of $\check{\mathbf{Cob}}_3^{\mathcal{E}}$ to $\Lambda'_{\mathcal{E}}(\Gamma)$, each 1-morphism Σ of $\check{\mathbf{Cob}}_3^{\mathcal{E}}$ to $\mathbb{F}'_{\mathcal{E}}(\Sigma)$ and each 2-morphism \mathbf{M} of $\check{\mathbf{Cob}}_3^{\mathcal{E}}$ to $\eta'_{\mathcal{E}}(\mathbf{M})$.

LEMMA 2.9.9. *Let $\Gamma = (\Gamma, \xi_A)$ be an object of $\check{\mathbf{Cob}}_3^{\mathcal{E}}$, let Σ_{Γ} be a cobordism from \emptyset to Γ , let \mathbf{P} be a fundamental ribbon set for Σ_{Γ} with respect to Γ , let B be a base set for Σ_{Γ} and let $\mathcal{L} \subset H^1(\Sigma_{\Gamma}; \mathbb{R})$ be a Lagrangian. Then the set*

$$D(\Sigma_{\Gamma}) := \{ (\Sigma_{\Gamma})_{(V, \vartheta)} \mid (V, \vartheta_B) \in \mathcal{F}(\Sigma_{\Gamma}, \mathbf{P}) \}$$

dominates $\Lambda_{\mathcal{E}}(\Gamma)$.

PROOF. Let $\Sigma_{\Gamma}'' = (\Sigma_{\Gamma}'', P''^{V''}, \vartheta''_{B''}, \mathcal{L}'')$ and $\Sigma_{\Gamma}'' = (\Sigma_{\Gamma}'', P''^{V''}, \vartheta''_{B''}, \mathcal{L}'')$ be objects of $\Lambda_{\mathcal{E}}(\Gamma)$. If M_{Γ} is a connected cobordism with corners from Σ_{Γ}'' to $S^2 \sqcup \Sigma_{\Gamma}''$ and if M_{Γ}'' is a connected cobordism with corners from Σ_{Γ}'' to $S^2 \sqcup \Sigma_{\Gamma}''$ then, thanks to the Connection Lemma 2.5.5, every morphism inside

$$\mathrm{Hom}_{\Lambda_{\mathcal{E}}(\Gamma)}^u(\Sigma_{\Gamma}'', \Sigma_{\Gamma}'') = \mathrm{Hom}_{\Lambda_{\mathcal{E}}(\Gamma)}(\Sigma_{\Gamma}'', \mathbf{S}_{-u}^2 \otimes \Sigma_{\Gamma}'')$$

can be described by some linear combination of admissible \mathcal{E} -skeins inside

$$M_{\Gamma}'' := M_{\Gamma} \cup_{S^2 \sqcup \Sigma_{\Gamma}''} ((S^2 \times I) \sqcup M_{\Gamma}'') \cup_{S^2 \sqcup S^2 \sqcup \Sigma_{\Gamma}''} (P^3 \sqcup (\Sigma_{\Gamma}'' \times I))$$

relative to

$$\left(P''^{V''}, \vartheta''_{B''} \right), \quad \left(P_{S^2}^{-u} \sqcup P''^{V''}, (\vartheta_{S^2})_{B_{S^2}} \sqcup \vartheta''_{B''} \right).$$

But, just like in the proof of Lemma 2.8.1, and thanks to Lemmas 2.9.1 and 2.9.3, every such admissible \mathcal{E} -skein (T^{φ}, ω) can be written, up to isotopy and skein equivalence, as a linear combination of admissible \mathcal{E} -skeins inducing a decomposition of $[M_{\Gamma}'', T^{\varphi}, \omega, 0]$ into a linear combination of morphisms of the form

$$\left([P_{-v_i, -u+v_i}^3] \otimes \mathrm{id}_{\Sigma_{\Gamma}''} \right) * \left([\mathrm{id}_{S^2_{-v_i}}] \otimes [M_{\Gamma}'', T_i''^{\varphi''}, \omega_i'', 0] \right) * [M_{\Gamma}, T_i^{\varphi_i}, \omega_i, 0]$$

for some fundamental (\mathcal{E}, G) -colorings $(V_i, (\vartheta_i)_B)$ of (Σ_{Γ}, P) and for some fundamental (\mathcal{E}, G) -colorings $(-v_i, (\vartheta_{S^2})_{B_{S^2}})$ of (S^2, P_{S^2}) with $i = 1, \dots, k$, for some \mathcal{E} -skein $(T_i^{\varphi_i}, \omega_i)$ inside M_{Γ} relative to

$$\left(P^{V''}, \vartheta''_{B''} \right), \quad \left(P_{S^2}^{-v_i} \sqcup P^{V_i}, (\vartheta_{S^2})_{B_{S^2}} \sqcup (\vartheta_i)_B \right)$$

and for some \mathcal{E} -skein $(T_i''^{\varphi''}, \omega_i'')$ inside M_{Γ}'' relative to

$$\left(P^{V_i}, (\vartheta_i)_B \right), \quad \left(P_{S^2}^{-u+v_i} \sqcup P''^{V''}, (\vartheta_{S^2})_{B_{S^2}} \sqcup \vartheta''_{B''} \right)$$

for every $i = 1, \dots, k$. \square

2.10. Monoidality

This section contains the first part of the proof of our main result, which is the monoidality of the 2-functor $\tilde{\mathbb{E}}_{\mathcal{E}}$.

REMARK 2.10.1. If V is an object of a \mathbb{I} -graded linear category Λ then we denote with $V : \mathbb{C} \rightarrow \Lambda$ the \mathbb{I} -graded linear functor mapping the unique object of the unit \mathbb{I} -graded linear category \mathbb{C} to V .

THEOREM 2.10.1. *The \mathbb{I} -graded linear functor $\mathrm{id}_{\emptyset} : \mathbb{C} \rightarrow \Lambda_{\mathcal{E}}(\emptyset)$ is a \mathbb{I} -Morita equivalence.*

PROOF. $\Lambda_{\mathcal{E}}(\emptyset)$ is dominated by the set $\{\mathrm{id}_{\emptyset}\}$, as follows immediately from Lemma 2.9.9 and from Theorem A.6.1. \square

REMARK 2.10.2. We will constantly confuse $\emptyset \otimes \Gamma'$ with Γ' and $\Gamma \otimes \emptyset$ with Γ for all objects Γ and Γ' of $\check{\mathbf{Cob}}_3^{\mathcal{E}}$ by a very slight abuse of notation. This means that the braiding 1-morphisms $\beta_{\emptyset, \Gamma'}$ and $\beta_{\Gamma, \emptyset}$ of $\check{\mathbf{Cob}}_3^{\mathcal{E}}$ given by definition 2.3.16 will be confused with $\mathrm{id}_{\Gamma'}$ and with id_{Γ} respectively. Then for all 1-morphisms

$$\Sigma : \emptyset \rightarrow \emptyset, \quad \Sigma' : \Gamma' \rightarrow \Gamma''', \quad \Sigma'' : \Gamma \rightarrow \Gamma'', \quad \Sigma''' : \emptyset \rightarrow \emptyset$$

of $\check{\mathbf{Cob}}_3^{\mathcal{E}}$ we will use the notation $\beta_{\Sigma, \Sigma'}$ and $\beta_{\Sigma'', \Sigma'''}$ for the braiding 2-morphisms $(\beta_{(\emptyset, \Gamma'), (\emptyset, \Gamma''')})_{\Sigma, \Sigma'}$ and $(\beta_{(\Gamma, \emptyset), (\Gamma'', \emptyset)})_{\Sigma'', \Sigma'''}$ and we will consider them as a 2-morphisms from $\Sigma \otimes \Sigma'$ to $\Sigma' \otimes \Sigma$ and from $\Sigma'' \otimes \Sigma'''$ to $\Sigma''' \otimes \Sigma''$ respectively.

REMARK 2.10.3. We introduce a short notation which will be useful for the statement and the proof of the next result: consider objects $\Gamma, \Gamma', \Gamma'', \Gamma'''$, 1-morphisms $\Sigma, \Sigma'' : \Gamma \rightarrow \Gamma'', \Sigma', \Sigma''' : \Gamma' \rightarrow \Gamma'''$ and 2-morphisms

$$\begin{aligned} \mathbf{M} : \Sigma &\Rightarrow \mathbf{S}_u^2 \otimes \Sigma'', & \mathbf{M}' : \Sigma' &\Rightarrow \mathbf{S}_{u'}^2 \otimes \Sigma''', \\ \mathbf{M}'' : \mathbf{S}_u^2 \otimes \Sigma &\Rightarrow \Sigma'', & \mathbf{M}''' : \mathbf{S}_{u'}^2 \otimes \Sigma' &\Rightarrow \Sigma''' \end{aligned}$$

of $\check{\mathbf{Cob}}_3^{\mathcal{E}}$. Then we denote with

$$\mathbf{P}_{u,u'}(\mathbf{M} \otimes \mathbf{M}') : \Sigma \otimes \Sigma' \Rightarrow \mathbf{S}_{u+u'}^2 \otimes \Sigma'' \otimes \Sigma'''$$

the 2-morphism of $\check{\mathbf{Cob}}_3^{\mathcal{E}}$ given by

$$(\mathbf{P}_{u,u'}^3 \otimes \text{id}_{\Sigma'' \otimes \Sigma'''}) * (\text{id}_{\mathbf{S}_u^2} \otimes \beta_{\Sigma'', \mathbf{S}_{u'}^2} \otimes \text{id}_{\Sigma'''}) * (\mathbf{M} \otimes \mathbf{M}'),$$

we denote with

$$\bar{\mathbf{P}}_{u,u'}(\mathbf{M}'' \otimes \mathbf{M}''') : \mathbf{S}_{u+u'}^2 \otimes \Sigma \otimes \Sigma' \Rightarrow \Sigma'' \otimes \Sigma'''$$

the 2-morphism of $\check{\mathbf{Cob}}_3^{\mathcal{E}}$ given by

$$(\mathbf{M}'' \otimes \mathbf{M}''') * (\text{id}_{\mathbf{S}_u^2} \otimes \beta_{\mathbf{S}_{u'}^2, \Sigma} \otimes \text{id}_{\Sigma'}) * (\bar{\mathbf{P}}_{u,u'}^3 \otimes \text{id}_{\Sigma \otimes \Sigma'}).$$

Let us define the 2-transformation

$$\eta : \boxtimes \circ (\mathbb{E}_{\mathcal{E}} \times \mathbb{E}_{\mathcal{E}}) \Rightarrow \mathbb{E}_{\mathcal{E}} \circ \boxtimes$$

as follows: with every object (Γ, Γ') of $\check{\mathbf{Cob}}_3^{\mathcal{E}} \times \check{\mathbf{Cob}}_3^{\mathcal{E}}$ the 2-transformation η associates the \mathbb{I} -graded linear functor

$$\eta_{\Gamma, \Gamma'} : \Lambda_{\mathcal{E}}(\Gamma) \boxtimes \Lambda_{\mathcal{E}}(\Gamma') \rightarrow \Lambda_{\mathcal{E}}(\Gamma \otimes \Gamma')$$

mapping every object $(\Sigma_{\Gamma}, \Sigma_{\Gamma'})$ of $\Lambda_{\mathcal{E}}(\Gamma) \boxtimes \Lambda_{\mathcal{E}}(\Gamma')$ to the object $\Sigma_{\Gamma} \otimes \Sigma_{\Gamma'}$ of $\Lambda_{\mathcal{E}}(\Gamma \otimes \Gamma')$ and mapping every degree $u + u'$ morphism

$$[\mathbf{M}_{\Gamma}^u] \otimes [\mathbf{M}_{\Gamma'}^{u'}]$$

of $\text{Hom}_{\Lambda_{\mathcal{E}}(\Gamma)}^u(\Sigma_{\Gamma}, \Sigma_{\Gamma}'') \otimes \text{Hom}_{\Lambda_{\mathcal{E}}(\Gamma')}^{u'}(\Sigma_{\Gamma'}, \Sigma_{\Gamma}''')$ to the degree $u + u'$ morphism

$$[\mathbf{P}_{-u, -u'}(\mathbf{M}_{\Gamma}^u \otimes \mathbf{M}_{\Gamma'}^{u'})]$$

of $\text{Hom}_{\Lambda_{\mathcal{E}}(\Gamma \otimes \Gamma')}^{u+u'}(\Sigma_{\Gamma} \otimes \Sigma_{\Gamma'}, \Sigma_{\Gamma}'' \otimes \Sigma_{\Gamma}''')$. With every 1-morphism

$$(\Sigma, \Sigma') : (\Gamma, \Gamma') \rightarrow (\Gamma'', \Gamma''')$$

of $\check{\mathbf{Cob}}_3^{\mathcal{E}} \times \check{\mathbf{Cob}}_3^{\mathcal{E}}$ the 2-transformation η associates the \mathbb{I} -graded natural transformation

$$\eta_{\Sigma, \Sigma'} : \mathbb{F}_{\mathcal{E}}(\Sigma \otimes \Sigma') \circ \eta_{\Gamma, \Gamma'} \Rightarrow \eta_{\Gamma'', \Gamma'''} \circ (\mathbb{F}_{\mathcal{E}}(\Sigma) \boxtimes \mathbb{F}_{\mathcal{E}}(\Sigma'))$$

associating with every object $(\Sigma_{\Gamma}, \Sigma_{\Gamma'})$ of $\Lambda_{\mathcal{E}}(\Gamma) \boxtimes \Lambda_{\mathcal{E}}(\Gamma')$ the degree 0 morphism²²

$$\text{id}_{(\Sigma \circ \Sigma_{\Gamma}) \otimes (\Sigma' \circ \Sigma_{\Gamma'})}^0$$

of $\text{Hom}_{\Lambda_{\mathcal{E}}(\Gamma'' \otimes \Gamma''')}^0((\Sigma \circ \Sigma_{\Gamma}) \otimes (\Sigma' \circ \Sigma_{\Gamma'}), (\Sigma \otimes \Sigma') \circ (\Sigma_{\Gamma} \otimes \Sigma_{\Gamma'}))$.

²²We simply confuse $(\Sigma \otimes \Sigma') \circ (\Sigma_{\Gamma} \otimes \Sigma_{\Gamma'})$ with $(\Sigma \circ \Sigma_{\Gamma}) \otimes (\Sigma' \circ \Sigma_{\Gamma'})$ by a very slight abuse of notation.

REMARK 2.10.4. To actually check that η is a 2-transformation we need to go through some very lengthy but also very standard applications of structural properties of the symmetric monoidal 2-category $\check{\mathbf{Cob}}_3^{\mathcal{E}}$. We will not report them here as they are not very enlightening. We just stress one fact: the proof that $\eta_{\Gamma, \Gamma'}$ is a Π -graded linear functor uses the naturality of the braiding of $\check{\mathbf{Cob}}_3^{\mathcal{E}}$ together with the identity

$$\begin{aligned} & \left[\mathbf{P}_{v+v', v''+v'''}^3 * (\mathbf{P}_{v, v'}^3 \otimes \mathbf{P}_{v'', v'''}^3) * (\text{id}_{\mathbf{S}_v^2} \otimes \beta_{\mathbf{S}_{v''}^2, \mathbf{S}_{v'''}^2} \otimes \text{id}_{\mathbf{S}_{v'''}^2}) \right] \\ &= \nu(v', v'') \cdot \left[\mathbf{P}_{v+v'', v'+v'''}^3 * (\mathbf{P}_{v, v''}^3 \otimes \mathbf{P}_{v', v'''}^3) \right] \end{aligned}$$

which holds for all $v, v', v'', v''' \in \Pi$ and which itself follows from Lemmas 2.9.5 and 2.9.8. This is used to prove the equality²³

$$\begin{aligned} & \eta_{\Gamma, \Gamma'}^{u''+u'''} \left([\mathbf{M}_{\Gamma}^{u''}] \otimes [\mathbf{M}_{\Gamma'}^{u'''}] \right) \circ \eta_{\Gamma, \Gamma'}^{u+u'} \left([\mathbf{M}_{\Gamma}^u] \otimes [\mathbf{M}_{\Gamma'}^{u'}] \right) \\ &= \nu(u', u'') \cdot \eta_{\Gamma, \Gamma'}^{u+u'+u''+u'''} \left(\left([\mathbf{M}_{\Gamma}^{u''}] \star [\mathbf{M}_{\Gamma}^u] \right) \otimes \left([\mathbf{M}_{\Gamma'}^{u'''}] \star [\mathbf{M}_{\Gamma'}^{u'}] \right) \right). \end{aligned}$$

THEOREM 2.10.2. For all objects Γ and Γ' of $\check{\mathbf{Cob}}_3^{\mathcal{E}}$ the Π -graded linear functor

$$\eta_{\Gamma, \Gamma'} : \Lambda_{\mathcal{E}}(\Gamma) \boxtimes \Lambda_{\mathcal{E}}(\Gamma') \rightarrow \Lambda_{\mathcal{E}}(\Gamma \otimes \Gamma')$$

is a Π -Morita equivalence.

PROOF. If $\Lambda_{\mathcal{E}}(\Gamma)$ is dominated by

$$D(\Sigma_{\Gamma}) = \{ (\Sigma_{\Gamma})_{(V, \vartheta)} \mid (V, \vartheta_B) \in \mathcal{F}(\Sigma_{\Gamma}, \mathbf{P}) \}$$

and if $\Lambda_{\mathcal{E}}(\Gamma')$ is dominated by

$$D(\Sigma_{\Gamma'}) = \{ (\Sigma_{\Gamma'})_{(V', \vartheta')} \mid (V', \vartheta'_{B'}) \in \mathcal{F}(\Sigma_{\Gamma'}, \mathbf{P}') \}$$

then $\Lambda_{\mathcal{E}}(\Gamma \otimes \Gamma')$ is dominated by

$$D(\Sigma_{\Gamma} \sqcup \Sigma_{\Gamma'}) = \left\{ (\Sigma_{\Gamma})_{(V, \vartheta)} \otimes (\Sigma_{\Gamma'})_{(V', \vartheta')} \mid \begin{array}{l} (V, \vartheta_B) \in \mathcal{F}(\Sigma_{\Gamma}, \mathbf{P}), \\ (V', \vartheta'_{B'}) \in \mathcal{F}(\Sigma_{\Gamma'}, \mathbf{P}') \end{array} \right\}.$$

Therefore $\eta_{\Gamma, \Gamma'}$ clearly defines a bijection between generators.

To see that it is faithful let us consider objects $\Sigma_{\Gamma}, \Sigma_{\Gamma}''$ of $\Lambda_{\mathcal{E}}(\Gamma)$, objects $\Sigma_{\Gamma'}, \Sigma_{\Gamma'}''$ of $\Lambda_{\mathcal{E}}(\Gamma')$, coefficients $\lambda_i \in \mathbb{C}$, degree $u - u_i$ morphisms

$$[\mathbf{M}_{i, \Gamma}^{u-u_i}] \in \text{Hom}_{\Lambda_{\mathcal{E}}(\Gamma)}^{u-u_i}(\Sigma_{\Gamma}, \Sigma_{\Gamma}'')$$

and degree u_i morphisms

$$[\mathbf{M}_{i, \Gamma'}^{u_i}] \in \text{Hom}_{\Lambda_{\mathcal{E}}(\Gamma')}^{u_i}(\Sigma_{\Gamma'}, \Sigma_{\Gamma'}'')$$

with $i = 1, \dots, k$ satisfying

$$\sum_{i=1}^k \lambda_i \cdot \eta_{\Gamma, \Gamma'}^u \left([\mathbf{M}_{i, \Gamma}^{u-u_i}] \otimes [\mathbf{M}_{i, \Gamma'}^{u_i}] \right) = 0.$$

Then for every object Σ_{Γ}' of $\Lambda_{\mathcal{E}}(\Gamma)$, for every object $\Sigma_{\Gamma'}''$ of $\Lambda_{\mathcal{E}}(\Gamma')$ and for all 2-morphisms

$$\begin{aligned} \mathbf{M} : \text{id}_{\emptyset} &\Rightarrow (\Sigma_{\Gamma}' \circ \Sigma_{\Gamma}), & \mathbf{M}' : \text{id}_{\emptyset} &\Rightarrow (\Sigma_{\Gamma'}'' \circ \Sigma_{\Gamma'}), \\ \mathbf{M}'' : (\mathbf{S}_{-u+u_i}^2 \otimes (\Sigma_{\Gamma}' \circ \Sigma_{\Gamma}'')) &\Rightarrow \text{id}_{\emptyset}, & \mathbf{M}''' : (\mathbf{S}_{-u_i}^2 \otimes (\Sigma_{\Gamma'}'' \circ \Sigma_{\Gamma'}'')) &\Rightarrow \text{id}_{\emptyset} \end{aligned}$$

²³See Remark A.6.3.

of $\check{\mathbf{Cob}}_3^{\mathcal{C}}$ the evaluation of $\text{CGP}_{\mathcal{C}}$ against

$\bar{\mathbf{P}}_{-u+u_i, -u_i}(\mathbf{M}'' \otimes \mathbf{M}''') * \mathbf{P}_{-u+u_i, -u_i}((\text{id}_{\Sigma_{\Gamma}'} \otimes \text{id}_{\Sigma_{\Gamma'}'}) \circ (\mathbf{M}_{i, \Gamma}^{u-u_i} \otimes \mathbf{M}_{i, \Gamma'}^{u_i})) * (\mathbf{M} \otimes \mathbf{M}')$
equals

$$\mathcal{D}d_0^{-1} \text{CGP}_{\mathcal{C}} \left(\mathbf{M}'' * \left(\text{id}_{\Sigma_{\Gamma}'} \circ \mathbf{M}_{i, \Gamma}^{u-u_i} \right) * \mathbf{M} \right) \text{CGP}_{\mathcal{C}} \left(\mathbf{M}''' * \left(\text{id}_{\Sigma_{\Gamma'}'} \circ \mathbf{M}_{i, \Gamma'}^{u_i} \right) * \mathbf{M}' \right)$$

for every $i = 1, \dots, k$. This implies

$$\sum_{i=1}^k \lambda_i \cdot \left([\mathbf{M}_{i, \Gamma}^{u-u_i}] \otimes [\mathbf{M}_{i, \Gamma'}^{u_i}] \right) = 0.$$

To see that $\eta_{\Gamma, \Gamma'}$ is also full we need to show that for all objects

$$\Sigma_{\Gamma} = (\Sigma_{\Gamma}, \mathbf{P}^V, \vartheta_B, \mathcal{L}), \quad \Sigma_{\Gamma}'' = (\Sigma_{\Gamma}'', \mathbf{P}''V'', \vartheta_{B''}, \mathcal{L}'')$$

of $\Lambda_{\mathcal{C}}(\Gamma)$ and for all objects

$$\Sigma_{\Gamma'} = (\Sigma_{\Gamma'}, \mathbf{P}'V', \vartheta_{B'}', \mathcal{L}'), \quad \Sigma_{\Gamma'}'' = (\Sigma_{\Gamma'}'', \mathbf{P}'''V''', \vartheta_{B'''}, \mathcal{L}''')$$

of $\Lambda_{\mathcal{C}}(\Gamma')$ every degree u morphism

$$[\mathbf{M}_{\Gamma \otimes \Gamma'}^u] \in \text{Hom}_{\Lambda_{\mathcal{C}}(\Gamma \otimes \Gamma')}^u(\Sigma_{\Gamma} \otimes \Sigma_{\Gamma'}, \Sigma_{\Gamma}'' \otimes \Sigma_{\Gamma'}'')$$

can be written as

$$\sum_{i=1}^k \lambda_i \cdot \eta_{\Gamma, \Gamma'}^u \left([\mathbf{M}_{i, \Gamma}^{u-u_i}] \otimes [\mathbf{M}_{i, \Gamma'}^{u_i}] \right)$$

for some coefficients $\lambda_i \in \mathbb{C}$, for some degree $u - u_i$ morphisms

$$[\mathbf{M}_{i, \Gamma}^{u-u_i}] \in \text{Hom}_{\Lambda_{\mathcal{C}}(\Gamma)}^{u-u_i}(\Sigma_{\Gamma}, \Sigma_{\Gamma}'')$$

and for some degree u_i morphisms

$$[\mathbf{M}_{i, \Gamma'}^{u_i}] \in \text{Hom}_{\Lambda_{\mathcal{C}}(\Gamma')}^{u_i}(\Sigma_{\Gamma'}, \Sigma_{\Gamma'}'')$$

with $i = 1, \dots, k$. To do so let us consider connected cobordisms with corners M_{Γ} from Σ_{Γ} to $\mathbb{S}^2 \sqcup \Sigma_{\Gamma}''$ and $M_{\Gamma'}$ from $\Sigma_{\Gamma'}$ to $\mathbb{S}^2 \sqcup \Sigma_{\Gamma'}''$. Then $[\mathbf{M}_{\Gamma \otimes \Gamma'}^u]$ can be presented by some linear combination of \mathcal{C} -skeins inside the connected cobordism with corners obtained by gluing $M_{\Gamma} \sqcup M_{\Gamma'}$ to

$$((\mathbb{S}^2 \times \mathbf{I}) \sqcup ((\Sigma_{\Gamma}'' \sqcup \mathbb{S}^2) \tilde{\times} \mathbf{I}) \sqcup (\Sigma_{\Gamma'}'' \times \mathbf{I})) \cup_{\mathbb{S}^2 \sqcup \mathbb{S}^2 \sqcup \Sigma_{\Gamma}'' \sqcup \Sigma_{\Gamma'}''} \mathbf{P}^3 \sqcup (\Sigma_{\Gamma}'' \times \mathbf{I}) \sqcup (\Sigma_{\Gamma'}'' \times \mathbf{I})$$

along $\mathbb{S}^2 \sqcup \Sigma_{\Gamma}'' \sqcup \mathbb{S}^2 \sqcup \Sigma_{\Gamma'}''$. Up to isotopy and skein equivalence Lemmas 2.9.1 and 2.9.3 allow us to conclude. \square

2.11. Symmetry

In this section we complete the proof of Theorem 2.1.1 by establishing the symmetry of the monoidal 2-functor $\hat{\mathbb{E}}_{\mathcal{C}}$.

DEFINITION 2.11.1. The *flip morphism*

$$\left[\beta_{\Sigma_{\Gamma}, \Sigma_{\Gamma'}}^0 \right] \in \text{Hom}_{\Lambda_{\mathcal{C}}(\Gamma' \otimes \Gamma)}^0(\Sigma_{\Gamma'} \otimes \Sigma_{\Gamma}, \beta_{\Gamma, \Gamma'} \circ (\Sigma_{\Gamma} \otimes \Sigma_{\Gamma'}))$$

associated with objects Σ_{Γ} of $\Lambda_{\mathcal{C}}(\Gamma)$ and $\Sigma_{\Gamma'}$ of $\Lambda_{\mathcal{C}}(\Gamma')$ is the degree 0 morphism of $\Lambda_{\mathcal{C}}(\Gamma' \otimes \Gamma)$ given by

$$\left[\mathbf{D}_0^3 \otimes (\beta_{(\emptyset, \emptyset), (\Gamma, \Gamma')})_{\Sigma_{\Gamma}, \Sigma_{\Gamma'}} \right].$$

THEOREM 2.11.1. *For all objects Γ, Γ' of $\check{\mathbf{Cob}}_3^{\mathcal{E}}$, $\Sigma_\Gamma, \Sigma_\Gamma''$ of $\Lambda_{\mathcal{E}}(\Gamma)$ and $\Sigma_{\Gamma'}, \Sigma_{\Gamma'}''$ of $\Lambda_{\mathcal{E}}(\Gamma')$ and for every morphism*

$$[\mathbf{M}_\Gamma^u] \otimes [\mathbf{M}_{\Gamma'}^{u'}] \in \text{Hom}_{\Lambda_{\mathcal{E}}(\Gamma)}^u(\Sigma_\Gamma, \Sigma_\Gamma'') \otimes \text{Hom}_{\Lambda_{\mathcal{E}}(\Gamma')}^{u'}(\Sigma_{\Gamma'}, \Sigma_{\Gamma'}'')$$

the diagram

$$\begin{array}{ccc}
 & \beta_{\Gamma, \Gamma'} \circ (\Sigma_\Gamma \otimes \Sigma_{\Gamma'}) & \\
 & \nearrow & \searrow \\
 [\beta_{\Sigma_\Gamma, \Sigma_{\Gamma'}}^0] & & [\text{id}_{\beta_{\Gamma, \Gamma'}}] \circ \eta_{\Gamma, \Gamma'}^{u+u'}([\mathbf{M}_\Gamma^u] \otimes [\mathbf{M}_{\Gamma'}^{u'}]) \\
 \nearrow & & \searrow \\
 \Sigma_{\Gamma'} \otimes \Sigma_\Gamma & & \beta_{\Gamma, \Gamma'} \circ (\Sigma_{\Gamma'}'' \otimes \Sigma_{\Gamma}'') \\
 \searrow & & \nearrow \\
 \nu(u, u') \cdot \eta_{\Gamma', \Gamma}^{u'+u}([\mathbf{M}_{\Gamma'}^{u'}] \otimes [\mathbf{M}_\Gamma^u]) & & [\beta_{\Sigma_{\Gamma'}'', \Sigma_{\Gamma}''}^0] \\
 \searrow & & \nearrow \\
 & \Sigma_{\Gamma'}'' \otimes \Sigma_{\Gamma}'' &
 \end{array}$$

of morphisms of $\Lambda_{\mathcal{E}}(\Gamma' \otimes \Gamma)$ is commutative.

PROOF. The proof of this Theorem is a rather lengthy application of the naturality property of the braiding β of $\check{\mathbf{Cob}}_3^{\mathcal{E}}$, so we will not write it in detail. The only additional ingredient which is needed is the following equality

$$\begin{aligned}
 & \nu(u, u') \cdot [\mathbf{P}_{-u'-u, 0}^3 * (\mathbf{P}_{-u', -u}^3 \otimes \mathbf{D}_0^3)] \\
 &= \nu(u, u') \cdot [\mathbf{P}_{0, -u'-u}^3 * (\mathbf{D}_0^3 \otimes \mathbf{P}_{-u', -u}^3)] \\
 &= [\mathbf{P}_{0, -u'-u}^3 * (\mathbf{D}_0^3 \otimes \tilde{\mathbf{P}}_{-u', -u}^3)]
 \end{aligned}$$

between morphisms of $\text{Hom}_{\Lambda_{\mathcal{E}}(\emptyset)}(\mathbf{S}_{-u'}^2 \otimes \mathbf{S}_{-u}^2, \mathbf{S}_{-u'-u}^2)$, which is a consequence of Lemmas 2.9.4, 2.9.5 and 2.9.8 and of the equality $\nu(-u', -u) = \nu(u, u')$ which obviously holds for all $u, u' \in \mathbb{H}$. \square

2.12. Graded TQFT

In this section we describe the \mathbb{H} -graded TQFT produced by $\hat{\mathbb{E}}_{\mathcal{E}}$. Indeed, as it was explained in the introduction, every \mathbb{H} -graded ETQFT on $\check{\mathbf{Cob}}_3^{\mathcal{E}}$ yields a \mathbb{H} -graded TQFT on $\check{\mathbf{Cob}}_3^{\mathcal{E}}$, and \mathbb{H} -graded linear functors associated with closed 1-morphisms of $\check{\mathbf{Cob}}_3^{\mathcal{E}}$ determine \mathbb{H} -graded vector spaces which we explicitly characterize. When the relative modular category \mathcal{C} is taken to be the category $U_q^H \mathfrak{sl}_2\text{-mod}$ of finite-dimensional complex-weight representations of the unrolled version of quantum \mathfrak{sl}_2 at $q = e^{\frac{\pi i}{r}}$ then our description recovers the \mathbb{Z} -graded TQFT defined in [BCGP16].

DEFINITION 2.12.1. The *covariant universal Π -graded vector space* $\mathbb{V}_{\mathcal{G}}(\Sigma)$ associated with a 1-morphism $\Sigma : \emptyset \rightarrow \emptyset$ of $\check{\mathbf{Cob}}_3^{\mathcal{G}}$ is the Π -graded vector space whose space of degree u vectors $\mathbb{V}_{\mathcal{G}}^u(\Sigma)$ is given by²⁴ $\mathbb{V}_{\mathcal{G}}(\mathbf{S}_{-u}^2 \otimes \Sigma)$ for every $u \in \Pi$.

The *contravariant universal Π -graded vector space* $\mathbb{V}'_{\mathcal{G}}(\Sigma)$ associated with a 1-morphism $\Sigma : \emptyset \rightarrow \emptyset$ of $\check{\mathbf{Cob}}_3^{\mathcal{G}}$ is the Π -graded vector space whose space of degree u vectors $\mathbb{V}'_{\mathcal{G}}^u(\Sigma)$ is given by $\mathbb{V}'_{\mathcal{G}}(\mathbf{S}_u^2 \otimes \Sigma)$ for every $u \in \Pi$.

DEFINITION 2.12.2. The *covariant universal Π -graded linear map*

$$\mathbb{f}_{\mathcal{G}}(\mathbf{M}) : \mathbb{V}_{\mathcal{G}}(\Sigma) \rightarrow \mathbb{V}_{\mathcal{G}}(\Sigma')$$

associated with a 2-morphism $\mathbf{M} : \Sigma \Rightarrow \Sigma'$ between 1-morphisms $\Sigma, \Sigma' : \emptyset \rightarrow \emptyset$ of $\check{\mathbf{Cob}}_3^{\mathcal{G}}$ is the Π -graded linear map whose degree u component $\mathbb{f}_{\mathcal{G}}^u(\mathbf{M})$ is given by²⁵

$$\mathbb{f}_{\mathcal{G}}(\text{id}_{\mathbf{S}_{-u}^2} \otimes \mathbf{M}) : \mathbb{V}_{\mathcal{G}}(\mathbf{S}_{-u}^2 \otimes \Sigma) \rightarrow \mathbb{V}_{\mathcal{G}}(\mathbf{S}_{-u}^2 \otimes \Sigma').$$

for every $u \in \Pi$.

The *contravariant universal Π -graded linear map*

$$\mathbb{f}'_{\mathcal{G}}(\mathbf{M}) : \mathbb{V}'_{\mathcal{G}}(\Sigma') \rightarrow \mathbb{V}'_{\mathcal{G}}(\Sigma)$$

associated with a 2-morphism $\mathbf{M} : \Sigma \Rightarrow \Sigma'$ between 1-morphisms $\Sigma, \Sigma' : \emptyset \rightarrow \emptyset$ of $\check{\mathbf{Cob}}_3^{\mathcal{G}}$ is the Π -graded linear map whose degree u component $\mathbb{f}'_{\mathcal{G}}^u(\mathbf{M})$ is given by

$$\mathbb{f}'_{\mathcal{G}}(\text{id}_{\mathbf{S}_u^2} \otimes \mathbf{M}) : \mathbb{V}'_{\mathcal{G}}(\mathbf{S}_u^2 \otimes \Sigma') \rightarrow \mathbb{V}'_{\mathcal{G}}(\mathbf{S}_u^2 \otimes \Sigma).$$

for every $u \in \Pi$.

DEFINITION 2.12.3. The *covariant Π -graded quantization functor*

$$\mathbb{U}_{\mathcal{G}} : \check{\mathbf{Cob}}_3^{\mathcal{G}} \rightarrow \text{Vect}_{\mathbb{C}}^{\Pi}$$

associated with $\text{CGP}_{\mathcal{G}}$ is the functor mapping each object Σ of $\check{\mathbf{Cob}}_3^{\mathcal{G}}$ to $\mathbb{V}_{\mathcal{G}}(\Sigma)$ and each morphism \mathbf{M} of $\check{\mathbf{Cob}}_3^{\mathcal{G}}$ to $\mathbb{f}_{\mathcal{G}}(\mathbf{M})$.

The *contravariant Π -graded quantization functor*

$$\mathbb{U}'_{\mathcal{G}} : \left(\check{\mathbf{Cob}}_3^{\mathcal{G}}\right)^{\text{op}} \rightarrow \text{Vect}_{\mathbb{C}}^{\Pi}$$

associated with $\text{CGP}_{\mathcal{G}}$ is the functor mapping each object Σ of $\check{\mathbf{Cob}}_3^{\mathcal{G}}$ to $\mathbb{V}'_{\mathcal{G}}(\Sigma)$ and each morphism \mathbf{M} of $\check{\mathbf{Cob}}_3^{\mathcal{G}}$ to $\mathbb{f}'_{\mathcal{G}}(\mathbf{M})$.

REMARK 2.12.1. For every object Σ of $\check{\mathbf{Cob}}_3^{\mathcal{G}}$ the Π -graded pairing

$$\langle \cdot, \cdot \rangle_{\Sigma} : \mathbb{V}'_{\mathcal{G}}(\Sigma) \otimes \mathbb{V}_{\mathcal{G}}(\Sigma) \rightarrow \mathbb{C}$$

whose degree 0 component

$$\langle \cdot, \cdot \rangle_{\Sigma}^0 : \bigoplus_{u \in \Pi} \mathbb{V}'_{\mathcal{G}}^{-u}(\Sigma) \otimes \mathbb{V}_{\mathcal{G}}^u(\Sigma) \rightarrow \mathbb{C}$$

maps every vector

$$[\mathbf{M}'_{\Sigma}{}^{-u}] \otimes [\mathbf{M}_{\Sigma}^u] \in \mathbb{V}'_{\mathcal{G}}^{-u}(\Sigma) \otimes \mathbb{V}_{\mathcal{G}}^u(\Sigma)$$

to

$$\text{CGP}_{\mathcal{G}}(\mathbf{M}'_{\Sigma}{}^{-u} * \mathbf{M}_{\Sigma}^u) \in \mathbb{C}$$

is non-degenerate thanks to Remark A.7.2.

²⁴See Definition A.7.3.

²⁵See Definition A.7.4.

PROPOSITION 2.12.1. *For every 1-morphism $\Sigma : \emptyset \rightarrow \emptyset$ of $\check{\mathbf{Cob}}_3^{\mathcal{G}}$ we have $\mathbb{V}_{\mathcal{G}}(\Sigma) = \text{Hom}_{\Lambda_{\mathcal{G}}(\emptyset)}(\text{id}_{\emptyset}, \Sigma)$.*

PROOF. For every degree u in \mathbb{I} the spaces of degree u vectors $\mathbb{V}_{\mathcal{G}}^u(\Sigma)$ and $\text{Hom}_{\Lambda_{\mathcal{G}}(\emptyset)}^u(\text{id}_{\emptyset}, \Sigma)$ are both quotients of the free vector space generated by the set of 2-morphisms $\mathbf{M}_{\emptyset}^u : \text{id}_{\emptyset} \Rightarrow \mathbf{S}_{-u}^2 \otimes \Sigma$ of $\check{\mathbf{Cob}}_3^{\mathcal{G}}$. We have to show that they are the exact same quotient. It is clear that if

$$\sum_{i=1}^k \lambda_i \cdot [\mathbf{M}_{i,\emptyset}^u] = 0 \in \text{Hom}_{\Lambda_{\mathcal{G}}(\emptyset)}^u(\text{id}_{\emptyset}, \Sigma)$$

then

$$\sum_{i=1}^k \lambda_i \cdot [\mathbf{M}_{i,\emptyset}^u] = 0 \in \mathbb{V}_{\mathcal{G}}^u(\Sigma)$$

because, using the notation of Appendix A.7, the kernel of the linear map

$$(\text{CGP}_{\mathcal{G}})_{\mathbf{S}_{-u}^2 \otimes \Sigma}$$

given by the universal construction contains the kernel of the linear map

$$((\text{CGP}_{\mathcal{G}})_{\emptyset})_{\text{id}_{\emptyset}, \mathbf{S}_{-u}^2 \otimes \Sigma}$$

determined by the linear functor $(\text{CGP}_{\mathcal{G}})_{\emptyset}$ given by the extended universal construction. To show that the converse is also true, let us suppose

$$\sum_{i=1}^k \lambda_i \cdot [\mathbf{M}_{i,\Sigma}^u] = 0 \in \mathbb{V}_{\mathcal{G}}^u(\Sigma).$$

This means

$$\sum_{i=1}^k \lambda_i \text{CGP}_{\mathcal{G}}(\mathbf{M}' * \mathbf{M}_{i,\Sigma}^u) = 0$$

for every 2-morphism $\mathbf{M}' : \mathbf{S}_{-u}^2 \otimes \Sigma \Rightarrow \text{id}_{\emptyset}$ of $\check{\mathbf{Cob}}_3^{\mathcal{G}}$. Such a linear combination determines a trivial vector in $\text{Hom}_{\Lambda_{\mathcal{G}}(\emptyset)}^u(\text{id}_{\emptyset}, \Sigma)$ if

$$\sum_{i=1}^k \lambda_i \text{CGP}_{\mathcal{G}}(\mathbf{M}' * (\text{id}_{\Sigma'_\emptyset} \circ \mathbf{M}_{i,\Sigma}^u) * \mathbf{M}) = 0$$

for every object Σ'_\emptyset of $\Lambda_{\mathcal{G}}(\emptyset)$ and for all 2-morphisms

$$\mathbf{M} : \text{id}_{\emptyset} \Rightarrow \Sigma'_\emptyset \circ \text{id}_{\emptyset}, \quad \mathbf{M}' : \Sigma'_\emptyset \circ (\mathbf{S}_{-u}^2 \otimes \Sigma) \Rightarrow \text{id}_{\emptyset}$$

of $\check{\mathbf{Cob}}_3^{\mathcal{G}}$. But since

$$\mathbf{M}' * (\text{id}_{\Sigma'_\emptyset} \circ \mathbf{M}_{i,\Sigma}^u) * \mathbf{M} = \left(\mathbf{M}' * \left((\text{id}_{\Sigma'_\emptyset} * \mathbf{M}) \circ \text{id}_{\Sigma} \right) \right) * \mathbf{M}_{i,\Sigma}^u$$

for every $i = 1, \dots, k$ we can conclude. \square

COROLLARY 2.12.1. *The covariant \mathbb{I} -graded quantization functor $\mathbb{U}_{\mathcal{G}}$ is a \mathbb{I} -graded TQFT on $\check{\mathbf{Cob}}_3^{\mathcal{G}}$.*

The proofs of Lemmas 2.5.5 and 2.8.2 can be directly adapted to the simpler context of the universal construction in order to obtain the following analogue results, which we state for the convenience of the reader.

LEMMA 2.12.1. Let $\Sigma : \emptyset \rightarrow \emptyset$ be a 1-morphism of $\check{\mathbf{Cob}}_3^{\mathcal{C}}$ of the form

$$(\Sigma, P^V, \vartheta_B, \mathcal{L})$$

and let M_Σ be a non-empty connected 3-dimensional cobordism from \emptyset to Σ . If Z is a quantum invariant on $\check{\mathbf{Man}}_3^{\mathcal{C}}$ which satisfies the surgery axioms and the skein axiom then the natural linear maps

$$\begin{aligned} \rho_Z : \text{ad } \mathcal{S} (M_\Sigma; (\emptyset^\emptyset, \emptyset_\emptyset), (P^V, \vartheta_B)) &\rightarrow V_Z(\Sigma) \\ (\mathbb{T}^\varphi, \omega) &\mapsto [M_\Sigma, \mathbb{T}^\varphi, \omega, 0] \end{aligned}$$

and

$$\begin{aligned} \rho'_Z : \text{ad } \mathcal{S} (M'_\Sigma; (P^{V'}, \vartheta_{B'}), (\emptyset^\emptyset, \emptyset_\emptyset)) &\rightarrow V'_Z(\Sigma) \\ (\mathbb{T}'^{\varphi'}, \omega') &\mapsto [M'_\Sigma, \mathbb{T}'^{\varphi'}, \omega', 0] \end{aligned}$$

are surjective.

LEMMA 2.12.2. Let $\Sigma : \emptyset \rightarrow \emptyset$ be a 1-morphism of $\check{\mathbf{Cob}}_3^{\mathcal{C}}$ of the form

$$(\Sigma, P^V, \vartheta_B, \mathcal{L}),$$

let $M_{i,\Sigma} : \text{id}_\emptyset \Rightarrow \Sigma$ be 2-morphisms of $\check{\mathbf{Cob}}_3^{\mathcal{C}}$ for $i = 1, \dots, k$ and let M'_Σ be a connected cobordism with corners from Σ to \emptyset . If Z is a quantum invariant on $\check{\mathbf{Man}}_3^{\mathcal{C}}$ which satisfies the surgery axioms and the skein axiom then a linear combination $\sum_{i=1}^k \lambda_i \cdot [M_{i,\Sigma}]$ determines a trivial vector of $V_Z(\Sigma)$ if and only if the expression

$$\sum_{i=1}^k \lambda_i Z \left((M'_\Sigma, \mathbb{T}'^{\varphi'}, \omega', 0) * M_{i,\Sigma} \right)$$

vanishes for all \mathcal{C} -skeins $(\mathbb{T}'^{\varphi'}, \omega')$ inside M'_Σ relative to (P^V, ϑ_B) and $(\emptyset^\emptyset, \emptyset_\emptyset)$.

Let us consider for every object Σ_\emptyset of $\Lambda_{\mathcal{C}}(\emptyset)$ the Π -graded pairing

$$H_{\Sigma_\emptyset}(\cdot, \cdot) : \text{Hom}_{\Lambda_{\mathcal{C}}(\emptyset)}(\Sigma_\emptyset, \text{id}_\emptyset) \otimes \text{Hom}_{\Lambda_{\mathcal{C}}(\emptyset)}(\text{id}_\emptyset, \Sigma_\emptyset) \rightarrow \mathbb{C}$$

whose degree 0 component

$$H_{\Sigma_\emptyset}^0(\cdot, \cdot) : \bigoplus_{u \in \Pi} \text{Hom}_{\Lambda_{\mathcal{C}}(\emptyset)}^{-u}(\Sigma_\emptyset, \text{id}_\emptyset) \otimes \text{Hom}_{\Lambda_{\mathcal{C}}(\emptyset)}^u(\text{id}_\emptyset, \Sigma_\emptyset) \rightarrow \mathbb{C}$$

maps every vector

$$[M_\emptyset'^{-u}] \otimes [M_\emptyset^u] \in \text{Hom}_{\Lambda_{\mathcal{C}}(\emptyset)}^{-u}(\Sigma_\emptyset, \text{id}_\emptyset) \otimes \text{Hom}_{\Lambda_{\mathcal{C}}(\emptyset)}^u(\text{id}_\emptyset, \Sigma_\emptyset)$$

to

$$\text{CGP}_{\mathcal{C}} \left(\overline{\mathbf{D}}_0^3 * \mathbf{P}_{-u,u}^3 * \left(\text{id}_{\mathbf{S}^2_{-u}} \otimes M_\emptyset'^{-u} \right) * M_\emptyset^u \right) \in \mathbb{C}.$$

PROPOSITION 2.12.2. For every object $\Sigma_\emptyset = (\Sigma_\emptyset, P^V, \vartheta_B, \mathcal{L})$ of $\Lambda_{\mathcal{C}}(\emptyset)$ the Π -graded pairing $H_{\Sigma_\emptyset}(\cdot, \cdot)$ is non-degenerate.

PROOF. Let us fix a connected cobordism M' from Σ_\emptyset to \mathbf{S}^2 and let \hat{M}' denote the connected cobordism

$$((\mathbf{S}^2 \times \mathbf{I}) \sqcup M') \cup_{\mathbf{S}^2 \sqcup \mathbf{S}^2} \mathbf{P}^3 \cup_{\mathbf{S}^2} \overline{\mathbf{D}}^3$$

from $\mathbf{S}^2 \sqcup \Sigma_\emptyset$ to \emptyset . Then, thanks to Lemmas 2.9.1, 2.9.2 and 2.9.3, every \mathcal{C} -skein $(\hat{\mathbb{T}}^{\varphi'}, \hat{\omega}')$ inside \hat{M}' relative to

$$(\mathbf{P}_{\mathbf{S}^2}^{-u} \sqcup \mathbf{P}^V, (\vartheta_{\mathbf{S}^2})_{B_{\mathbf{S}^2}} \sqcup \vartheta_B), \quad (\emptyset^\emptyset, \emptyset_\emptyset)$$

satisfies

$$\left[\left(\hat{\mathbf{M}}', \hat{\mathbf{T}}'^{\varphi'}, \hat{\omega}', 0 \right) \right] = \left[\overline{\mathbf{D}}_0^3 * \mathbf{P}_{-u,u}^3 * \left(\text{id}_{\mathbf{S}^2_{-u}} \otimes \mathbf{M}' \right) \right]$$

for some 2-morphisms $\mathbf{M}' : \Sigma_{\emptyset} \Rightarrow \mathbf{S}^2_u$ of $\check{\mathbf{Cob}}_3^{\mathcal{E}}$. Therefore, thanks to Lemmas 2.12.1 and 2.12.2, the only vector of $\text{Hom}_{\Lambda_{\mathcal{E}}(\emptyset)}^u(\text{id}_{\emptyset}, \Sigma_{\emptyset})$ which is annihilated by the whole of $\text{Hom}_{\Lambda_{\mathcal{E}}(\emptyset)}^{-u}(\Sigma_{\emptyset}, \text{id}_{\emptyset})$ under $\mathbf{H}_{\Sigma_{\emptyset}}(\cdot, \cdot)$ is 0.

Let us fix now a connected cobordism \mathbf{M} from \emptyset to $\mathbf{S}^2 \sqcup \Sigma_{\emptyset}$ and let $\tilde{\mathbf{M}}$ denote the connected cobordism

$$\mathbf{M} \cup_{\mathbf{S}^2 \sqcup \Sigma_{\emptyset}} \left((\mathbf{S}^2 \sqcup \Sigma_{\emptyset}) \tilde{\times} \mathbf{I} \right)$$

from \emptyset to $\Sigma_{\emptyset} \sqcup \mathbf{S}^2$. Then, thanks to Lemmas 2.9.1, 2.9.2 and 2.9.3, every \mathcal{E} -skein $(\tilde{\mathbf{T}}^{\varphi}, \tilde{\omega})$ inside $\tilde{\mathbf{M}}$ relative to

$$(\emptyset^{\emptyset}, \emptyset^{\emptyset}), \quad \left(\mathbf{P}^V \sqcup \mathbf{P}_{\mathbf{S}^2}^u, \vartheta_B \sqcup (\vartheta_{\mathbf{S}^2})_{B_{\mathbf{S}^2}} \right)$$

satisfies

$$\left[\left(\tilde{\mathbf{M}}, \tilde{\mathbf{T}}^{\varphi}, \tilde{\omega}, 0 \right) \right] = \left[\beta_{\mathbf{S}^2_{-u}, \Sigma_{\emptyset}} * \mathbf{M} \right]$$

for some 2-morphism $\mathbf{M} : \text{id}_{\emptyset} \Rightarrow \mathbf{S}^2_{-u} \otimes \Sigma_{\emptyset}$ of $\check{\mathbf{Cob}}_3^{\mathcal{E}}$ and, thanks to Lemma 2.9.1, every \mathcal{E} -skein $(\tilde{\mathbf{T}}'^{\varphi'}, \tilde{\omega}')$ inside

$$\tilde{\mathbf{P}}^3 := \left((\mathbf{S}^2 \sqcup \mathbf{S}^2) \tilde{\times} \mathbf{I} \right) \cup_{\mathbf{S}^2 \sqcup \mathbf{S}^2} \mathbf{P}^3 \cup_{\mathbf{S}^2} \overline{\mathbf{D}}^3$$

relative to

$$\left(\mathbf{P}_{\mathbf{S}^2}^u \sqcup \mathbf{P}_{\mathbf{S}^2}^u, (\vartheta_{\mathbf{S}^2})_{B_{\mathbf{S}^2}} \sqcup (\vartheta_{\mathbf{S}^2})_{B_{\mathbf{S}^2}} \right), \quad (\emptyset^{\emptyset}, \emptyset^{\emptyset})$$

satisfies

$$\left[\left(\tilde{\mathbf{P}}^3, \tilde{\mathbf{T}}'^{\varphi'}, \omega', 0 \right) \right] = \delta_{-u, u'} \lambda \cdot \left[\overline{\mathbf{D}}_0^3 * \mathbf{P}_{-u, u'}^3 * \beta_{\mathbf{S}^2_u, \mathbf{S}^2_{-u}} \right]$$

for some non-zero $\lambda \in \mathbb{C}$. This means that the only vector of $\text{Hom}_{\Lambda_{\mathcal{E}}(\emptyset)}^{-u}(\Sigma_{\emptyset}, \text{id}_{\emptyset})$ which is annihilated by the whole of $\text{Hom}_{\Lambda_{\mathcal{E}}(\emptyset)}^u(\text{id}_{\emptyset}, \Sigma_{\emptyset})$ under $\mathbf{H}_{\Sigma_{\emptyset}}(\cdot, \cdot)$ is 0. \square

Let us consider the \mathbb{I} -graded linear functor

$$\mathbb{F}_{\emptyset} : \Lambda_{\mathcal{E}}(\emptyset) \rightarrow \text{Vect}_{\mathbb{C}}^{\mathbb{I}, \text{fg}}$$

mapping every object Σ_{\emptyset} of $\Lambda_{\mathcal{E}}(\emptyset)$ to the \mathbb{I} -graded vector space $\mathbb{V}_{\mathcal{E}}(\Sigma_{\emptyset})$ and mapping every degree u morphism $[\mathbf{M}_{\emptyset}^u]$ of $\text{Hom}_{\Lambda_{\mathcal{E}}(\emptyset)}^u(\Sigma_{\emptyset}, \Sigma''_{\emptyset})$ to the \mathbb{I} -graded linear map

$$\mathbb{F}_{\emptyset}^u([\mathbf{M}_{\emptyset}^u]) : \mathbb{V}_{\mathcal{E}}(\Sigma_{\emptyset}) \rightarrow S^{-u}(\mathbb{V}_{\mathcal{E}}(\Sigma''_{\emptyset}))$$

whose degree v component is given by

$$\begin{aligned} \mathbb{F}_{\emptyset}^u([\mathbf{M}_{\emptyset}^u])^v : \mathbb{V}_{\mathcal{E}}^v(\Sigma_{\emptyset}) &\rightarrow \mathbb{V}_{\mathcal{E}}^{u+v}(\Sigma''_{\emptyset}) \\ \left[\mathbf{M}_{\Sigma_{\emptyset}}^v \right] &\mapsto \left[\left(\mathbf{P}_{-v, -u}^3 \otimes \text{id}_{\Sigma''_{\emptyset}} \right) * \left(\text{id}_{\mathbf{S}^2_{-v}} \otimes \mathbf{M}_{\emptyset}^u \right) * \mathbf{M}_{\Sigma_{\emptyset}}^v \right] \end{aligned}$$

PROPOSITION 2.12.3. *The \mathbb{I} -graded linear functor*

$$\mathbb{F}_{\emptyset} : \Lambda_{\mathcal{E}}(\emptyset) \rightarrow \text{Vect}_{\mathbb{C}}^{\mathbb{I}, \text{fg}}$$

is a \mathbb{I} -Morita equivalence.

PROOF. Since $\text{Vect}_{\mathbb{C}}^{\Pi, \text{fg}}$ is dominated by the unit Π -graded linear category \mathbb{C} and since $\mathbb{V}_{\mathcal{E}}(\text{id}_{\emptyset})$ is isomorphic to it as an object of $\text{Vect}_{\mathbb{C}}^{\Pi, \text{fg}}$ then, thanks to Theorem A.6.1, we just need to show that \mathbb{F}_{\emptyset} is faithful and full. In order to do so, let us fix objects $\Sigma_{\emptyset} = (\Sigma_{\emptyset}, \mathbf{P}^V, \vartheta_B, \mathcal{L})$ and $\Sigma''_{\emptyset} = (\Sigma''_{\emptyset}, \mathbf{P}''^{V''}, \vartheta''_{B''}, \mathcal{L}'')$ of $\Lambda_{\mathcal{E}}(\emptyset)$. We begin by showing faithfulness, so let us consider a degree u morphism

$$\sum_{i=1}^n \lambda_i \cdot [\mathbf{M}_{i, \emptyset}^u] \in \text{Hom}_{\Lambda_{\mathcal{E}}(\emptyset)}^u(\Sigma_{\emptyset}, \Sigma''_{\emptyset})$$

satisfying

$$\sum_{i=1}^n \lambda_i \cdot \mathbb{F}_{\emptyset}^u([\mathbf{M}_{i, \emptyset}^u]) = 0.$$

This means that

$$\sum_{i=1}^n \lambda_i \text{CGP}_{\mathcal{E}} \left(\mathbf{M}' * \left(\mathbf{P}_{-v, -u}^3 \otimes \text{id}_{\Sigma''_{\emptyset}} \right) * \left(\text{id}_{\mathbf{S}_{-v}^2} \otimes \mathbf{M}_{i, \emptyset}^u \right) * \mathbf{M}_{\Sigma_{\emptyset}}^v \right) = 0$$

for every degree v of Π , for every degree v vector $[\mathbf{M}_{\Sigma_{\emptyset}}^v]$ of $\mathbb{V}_{\mathcal{E}}(\Sigma_{\emptyset})$ and for every 2-morphism $\mathbf{M}' : \mathbf{S}_{-v, -u}^2 \otimes \Sigma''_{\emptyset} \Rightarrow \text{id}_{\emptyset}$ of $\check{\mathbf{Cob}}_3^{\mathcal{E}}$. Therefore we can choose connected cobordisms $\mathbf{M}_{\Sigma_{\emptyset}}$ from \emptyset to $\mathbf{S}^2 \sqcup \Sigma_{\emptyset}$ and \mathbf{M}' from $\mathbf{S}^2 \sqcup \Sigma''_{\emptyset}$ to \emptyset , and then we can specify

$$\tilde{\mathbf{M}}_{\Sigma_{\emptyset}} := \mathbf{M}_{\Sigma_{\emptyset}} \cup_{\mathbf{S}^2 \sqcup \Sigma_{\emptyset}} ((\mathbf{S}^2 \sqcup \Sigma_{\emptyset}) \tilde{\times} \mathbf{I})$$

as a connected cobordism from \emptyset to $\Sigma_{\emptyset} \sqcup \mathbf{S}^2$ and

$$\tilde{\mathbf{M}}' := ((\mathbf{S}^2 \times \mathbf{I}) \sqcup ((\Sigma''_{\emptyset} \sqcup \mathbf{S}^2) \tilde{\times} \mathbf{I})) \cup_{\mathbf{S}^2 \sqcup \Sigma''_{\emptyset}} (\mathbf{P}^3 \sqcup (\Sigma''_{\emptyset} \times \mathbf{I})) \cup_{\mathbf{S}^2 \sqcup \Sigma''_{\emptyset}} \mathbf{M}'$$

as a connected cobordism from $\mathbf{S}^2 \sqcup \Sigma''_{\emptyset} \sqcup \mathbf{S}^2$ to \emptyset . This means that, thanks to Lemma 2.12.2, we have

$$\sum_{i=1}^n \lambda_i \cdot [\mathbf{M}_{i, \emptyset}^u] = 0$$

in $\text{Hom}_{\Lambda_{\mathcal{E}}(\emptyset)}^u(\Sigma_{\emptyset}, \Sigma''_{\emptyset})$ if and only if

$$\sum_{i=1}^n \lambda_i \text{CGP}_{\mathcal{E}} \left((\tilde{\mathbf{M}}', \tilde{\mathbf{T}}'^{\tilde{\varphi}'}, \tilde{\omega}', 0) * \left(\text{id}_{\mathbf{S}_{u'}^2} \circ \mathbf{M}_{i, \emptyset}^u \right) * (\tilde{\mathbf{M}}_{\Sigma_{\emptyset}}, \tilde{\mathbf{T}}^{\tilde{\varphi}}, \tilde{\omega}, 0) \right) = 0$$

for every $u' \in \Pi$, for all admissible \mathcal{E} -skeins $(\tilde{\mathbf{T}}^{\tilde{\varphi}}, \tilde{\omega})$ inside $\tilde{\mathbf{M}}_{\Sigma_{\emptyset}}$ relative to

$$(\emptyset^{\emptyset}, \emptyset^{\emptyset}), \quad \left(\mathbf{P}^V \sqcup \mathbf{P}_{\mathbf{S}^2}^{u'}, \vartheta_B \sqcup (\vartheta_{\mathbf{S}^2})_{B_{\mathbf{S}^2}} \right)$$

and for all \mathcal{E} -skeins $(\tilde{\mathbf{T}}'^{\tilde{\varphi}'}, \tilde{\omega}')$ inside $\tilde{\mathbf{M}}'$ relative to

$$\left(\mathbf{P}_{\mathbf{S}^2}^{-u} \sqcup \mathbf{P}''^{V''} \sqcup \mathbf{P}_{\mathbf{S}^2}^{u'}, (\vartheta_{\mathbf{S}^2})_{B_{\mathbf{S}^2}} \sqcup \vartheta''_{B''} \sqcup (\vartheta_{\mathbf{S}^2})_{B_{\mathbf{S}^2}} \right), \quad (\emptyset^{\emptyset}, \emptyset^{\emptyset}).$$

Therefore faithfulness follows from Lemmas 2.9.1 and 2.9.3. Finally, in order to show fullness of \mathbb{F}_{\emptyset} , let us fix some $v \in \Pi$ and let us choose a basis

$$\{[\mathbf{M}_{1, \Sigma_{\emptyset}}^v], \dots, [\mathbf{M}_{k, \Sigma_{\emptyset}}^v]\}$$

of $\mathbb{V}_{\mathcal{E}}^v(\Sigma_{\emptyset})$, its dual basis

$$\{[\mathbf{M}'_{1, \emptyset}^{-v}], \dots, [\mathbf{M}'_{k, \emptyset}^{-v}]\}$$

of $\text{Hom}_{\Lambda_{\mathbb{C}}(\emptyset)}^{-v}(\Sigma_{\emptyset}, \text{id}_{\emptyset})$ with respect to the non-degenerate pairing induced by Propositions 2.12.1 and 2.12.2 and a basis

$$\{[\mathbf{M}_{1,\emptyset}^{u+v}], \dots, [\mathbf{M}_{k'',\emptyset}^{u+v}]\}$$

of $\text{Hom}_{\Lambda_{\mathbb{C}}(\emptyset)}^{u+v}(\text{id}_{\emptyset}, \Sigma''_{\emptyset})$. Then a basis for $\text{Hom}_{\mathbb{C}}(\mathbb{V}_{\mathbb{C}}^v(\Sigma_{\emptyset}), \mathbb{V}_{\mathbb{C}}^{u+v}(\Sigma''_{\emptyset}))$ is given by the linear maps

$$(\mathbb{F}_{\emptyset}^u([\mathbf{M}_{j,\emptyset}^{u+v}] \star [\mathbf{M}_{i,\emptyset}^{u-v}]))^v$$

for all $i = 1, \dots, k$ and $j = 1, \dots, k''$. \square

We complete the picture with a standard linear algebra result.

REMARK 2.12.2. If \mathbb{V} is a finitely generated Π -graded vector space then its *dual Π -graded vector space* \mathbb{V}^* is the Π -graded vector space $\text{Hom}_{\mathbb{C}}(\mathbb{V}, \mathbb{C})$. In particular, for every $u \in \Pi$ the space of degree u vectors $(\mathbb{V}^*)^u$ is naturally isomorphic to $(\mathbb{V}^{-u})^*$.

If $\mathbb{F} : \text{Vect}_{\mathbb{C}}^{\Pi, \text{fg}} \rightarrow \text{Vect}_{\mathbb{C}}^{\Pi, \text{fg}}$ is a Π -graded linear functor let $\eta_{\mathbb{F}} : \mathbb{F} \Rightarrow (\cdot \otimes \mathbb{F}(\mathbb{C}))$ denote the Π -graded natural transformation associating with every Π -graded vector space \mathbb{V} the Π -graded linear map $(\eta_{\mathbb{F}})_{\mathbb{V}}$ with degree u component

$$\begin{aligned} (\eta_{\mathbb{F}})_{\mathbb{V}}^u : (\mathbb{F}(\mathbb{V}))^u &\rightarrow \bigoplus_{u' \in \Pi} \mathbb{V}^{u-u'} \otimes (\mathbb{F}(\mathbb{C}))^{u'} \\ w^u &\mapsto \sum_{u' \in \Pi} \sum_{i=1}^{n_{u-u'}} v_i^{u-u'} \otimes \mathbb{F}^u \left((\mathbb{f}_i^{-u+u'})^u \right) (w^u), \end{aligned}$$

where $\{v_1^{u-u'}, \dots, v_{n_{u-u'}}^{u-u'}\}$ is a basis of $\mathbb{V}^{u-u'}$ and where $\{\mathbb{f}_1^{-u+u'}, \dots, \mathbb{f}_{n_{u-u'}}^{-u+u'}\}$ is its dual basis of $(\mathbb{V}^*)^{-u+u'}$ for every $u' \in \Pi$.

PROPOSITION 2.12.4. *The Π -graded natural transformation $\eta_{\mathbb{F}} : \mathbb{F} \Rightarrow (\cdot \otimes \mathbb{F}(\mathbb{C}))$ is a well-defined Π -graded natural isomorphism.*

PROOF. For every $u \in \Pi$ we consider the linear map

$$\begin{aligned} (\eta_{\mathbb{F}}^{-1})_{\mathbb{V}}^u : \bigoplus_{u' \in \Pi} \mathbb{V}^{u-u'} \otimes (\mathbb{F}(\mathbb{C}))^{u'} &\rightarrow (\mathbb{F}(\mathbb{V}))^u \\ v^{u-u'} \otimes x^{u'} &\mapsto \mathbb{F}^{u'} \left((\mathbb{f}_{v^{u-u'}}^{u-u'})^{u'} \right) (x^{u'}), \end{aligned}$$

where for every $v^{u-u'} \in \mathbb{V}^{u-u'}$ the degree $u-u'$ morphism $\mathbb{f}_{v^{u-u'}}^{u-u'} \in \text{Hom}_{\mathbb{C}}^{u-u'}(\mathbb{C}, \mathbb{V})$ is determined by $(\mathbb{f}_{v^{u-u'}}^{u-u'})^0(1^0) = v^{u-u'}$. Then $(\eta_{\mathbb{F}}^{-1})_{\mathbb{V}}$ is the inverse of $(\eta_{\mathbb{F}})_{\mathbb{V}}$ because

$$\begin{aligned} &\sum_{u' \in \Pi} \sum_{i=1}^{n_{u-u'}} \mathbb{F}^{u'} \left((\mathbb{f}_{v_i^{u-u'}}^{u-u'})^{u'} \right) \left(\mathbb{F}^u \left((\mathbb{f}_i^{-u+u'})^u \right) (w^u) \right) \\ &= \sum_{u' \in \Pi} \sum_{i=1}^{n_{u-u'}} \mathbb{F}^u \left((\mathbb{f}_{v_i^{u-u'}}^{u-u'} \circ \mathbb{f}_i^{-u+u'})^u \right) (w^u) \\ &= \mathbb{F}^u \left(\sum_{u' \in \Pi} \sum_{i=1}^{n_{u-u'}} (\mathbb{f}_{v_i^{u-u'}}^{u-u'} \circ \mathbb{f}_i^{-u+u'})^u \right) (w^u) = w^u \end{aligned}$$

for every $u \in \Pi$ and every $w^u \in (\mathbb{F}(\mathbb{V}))^u$ and

$$\begin{aligned} & \sum_{u' \in \Pi} \sum_{i=1}^{n_{u-u'}} v_i^{u-u'} \otimes \mathbb{F}^u \left((\mathbb{f}_i^{-u+u'})^u \right) \left(\mathbb{F}^{u'} \left((\mathbb{f}_{v^{u-u'}}^{u-u'})^{u'} \right) (x^{u'}) \right) \\ &= \sum_{u' \in \Pi} \sum_{i=1}^{n_{u-u'}} v_i^{u-u'} \otimes \mathbb{F}^{u'} \left((\mathbb{f}_i^{-u+u'} \circ \mathbb{f}_{v^{u-u'}}^{u-u'})^{u'} \right) (x^{u'}) \\ &= \sum_{u' \in \Pi} \sum_{i=1}^{n_{u-u'}} (\mathbb{f}_i^{-u+u'})^{u-u'} (v^{u-u'}) v_i^{u-u'} \otimes x^{u'} = v^{u-u'} \otimes x^{u'} \end{aligned}$$

for every $u \in \Pi$, every $v^{u-u'} \in \mathbb{V}^{u-u'}$ and every $x^{u'} \in (\mathbb{F}(\mathbb{C}))^{u'}$.

For every $u \in \Pi$ both degree u components $(\eta_{\mathbb{F}}^u)_{\mathbb{V}}$ and $(\eta_{\mathbb{F}}^{-1})_{\mathbb{V}}^u$ are independent of the choices of the bases, because for every $u' \in \Pi$ another basis

$$\{v_1^{u'}, \dots, v_{n_{u'}}^{u'}\}$$

of $\mathbb{V}^{u'}$ determines a dual basis

$$\{\mathbb{f}_1^{-u'}, \dots, \mathbb{f}_{n_{u'}}^{-u'}\}$$

of $(\mathbb{V}^*)^{-u'}$, and there exist complex numbers $a_{ij}^{u'}, b_{jk}^{-u'} \in \mathbb{C}$ for $i, j = 1, \dots, n_{u'}$ such that

$$\sum_{j=1}^{n_{u'}} a_{ij}^{u'} b_{jk}^{-u'} = \delta_{jk}, \quad v_j^{u'} = \sum_{i=1}^{n_{u'}} a_{ij}^{u'} v_i^{u'}, \quad \mathbb{f}_j^{-u'} = \sum_{k=1}^{n_{u'}} b_{jk}^{-u'} \mathbb{f}_k^{-u'}.$$

Then

$$\begin{aligned} & \sum_{u' \in \Pi} \sum_{j=1}^{n_{u-u'}} v_j^{u-u'} \otimes \mathbb{F}^u \left((\mathbb{f}_j^{-u+u'})^u \right) (w^u) \\ &= \sum_{u' \in \Pi} \sum_{i,j,k=1}^{n_{u-u'}} a_{ij}^{u-u'} b_{jk}^{-u+u'} v_i^{u-u'} \otimes \mathbb{F}^u \left((\mathbb{f}_k^{-u+u'})^u \right) (w^u) \\ &= \sum_{u' \in \Pi} \sum_{i=1}^{n_{u-u'}} v_i^{u-u'} \otimes \mathbb{F}^u \left((\mathbb{f}_i^{-u+u'})^u \right) (w^u) \end{aligned}$$

for every $u \in \Pi$ and every $w^u \in (\mathbb{F}(\mathbb{V}))^u$.

Moreover, we have

$$(\eta_{\mathbb{F}}^u)_{\mathbb{V}'}^{u+u'} \circ \mathbb{F}^{u'} \left((\mathbb{f}^u)^{u'} \right) = (\mathbb{f}^u \otimes \text{id}_{\mathbb{F}(\mathbb{C})}^0)^{u'} \circ (\eta_{\mathbb{F}}^u)_{\mathbb{V}}^{u'}$$

for every degree u morphism $\mathbb{f}^u \in \text{Hom}_{\mathbb{C}}^u(\mathbb{V}, \mathbb{V}')$. Indeed, for every $u' \in \Pi$, if

$$\{v_1^{u+u'}, \dots, v_{n_{u+u'}}^{u+u'}\}$$

is a basis of $\mathbb{V}^{u+u'}$ and if

$$\{\mathbb{f}_1^{-u-u'}, \dots, \mathbb{f}_{n_{u+u'}}^{-u-u'}\}$$

is the dual basis of $(\mathbb{V}'^*)^{-u-u'}$ then there exist complex numbers $c_{ij}^{u,u'} \in \mathbb{C}$ for $i = 1, \dots, n'_{u+u'}$, $j = 1, \dots, n_{u'}$ such that

$$\mathbb{f}^u(v_j^{u'}) = \sum_{i=1}^{n'_{u+u'}} c_{ij}^{u,u'} v_i^{u+u'}, \quad \mathbb{f}'^{-u-u'} \circ \mathbb{f}^u = \sum_{j=1}^{n_{u'}} c_{ij}^{u,u'} \mathbb{f}_j^{-u'}.$$

Therefore

$$\begin{aligned} & \sum_{u'' \in \Pi} \sum_{i=1}^{n'_{u+u'-u''}} v_i^{u+u'-u''} \otimes \mathbb{F}^{u+u'} \left((\mathbb{f}'^{-u-u'+u''})^{u+u'} \right) \left(\mathbb{F}^{u'} \left((\mathbb{f}^u)^{u'} \right) (w^{u'}) \right) \\ &= \sum_{u'' \in \Pi} \sum_{i=1}^{n'_{u+u'-u''}} v_i^{u+u'-u''} \otimes \mathbb{F}^{u'} \left((\mathbb{f}'^{-u-u'+u''} \circ \mathbb{f}^u)^{u'} \right) (w^{u'}) \\ &= \sum_{u'' \in \Pi} \sum_{i=1}^{n'_{u+u'-u''}} \sum_{j=1}^{n_{u'-u''}} v_i^{u+u'-u''} \otimes c_{ij}^{u,u'-u''} \mathbb{F}^{u'} (\mathbb{f}_j^{-u'+u''}) (w^{u'}) \\ &= \sum_{u'' \in \Pi} \sum_{i=1}^{n'_{u+u'-u''}} \sum_{j=1}^{n_{u'-u''}} c_{ij}^{u,u'-u''} v_i^{u+u'-u''} \otimes \mathbb{F}^{u'} (\mathbb{f}_j^{-u'+u''}) (w^{u'}) \\ &= \sum_{u'' \in \Pi} \sum_{j=1}^{n_{u'-u''}} \mathbb{f}^u(v_j^{u'-u''}) \otimes \mathbb{F}^{u'} (\mathbb{f}_j^{-u'+u''}) (w^{u'}) \end{aligned}$$

for every $u' \in \Pi$ and every $w^{u'} \in (\mathbb{F}(\mathbb{V}))^{u'}$. \square

REMARK 2.12.3. Lemma 2.12.4 can be used to relate the universal Π -graded vector space $\mathbb{V}_{\mathcal{E}}(\Sigma)$ of a closed 1-morphism $\Sigma : \emptyset \rightarrow \emptyset$ of $\check{\mathbf{Cob}}_3^{\mathcal{E}}$ to its universal Π -graded linear functor $\mathbb{F}_{\mathcal{E}}(\Sigma) : \Lambda_{\mathcal{E}}(\emptyset) \rightarrow \Lambda_{\mathcal{E}}(\emptyset)$ as explained in the introduction.

REMARK 2.12.4. Our goal will be to produce computations of universal Π -graded vector spaces associated with certain closed 1-morphisms of $\check{\mathbf{Cob}}_3^{\mathcal{E}}$ in terms of the relative modular category \mathcal{E} . We will think about this problem as follows: if $\Sigma : \emptyset \rightarrow \emptyset$ is a 1-morphism of $\check{\mathbf{Cob}}_3^{\mathcal{E}}$ then we look for a Π -graded linear functor $\mathbb{F}_{\Sigma} : \mathbb{C} \rightarrow \mathbf{Vect}_{\mathbb{C}}^{\Pi, \text{fg}}$ together with a Π -graded natural isomorphism²⁶

$$\begin{array}{ccc} \mathbb{C} & \xrightarrow{\mathbb{F}_{\Sigma}} & \mathbf{Vect}_{\mathbb{C}}^{\Pi, \text{fg}} \\ \text{id}_{\emptyset} \downarrow & & \uparrow \mathbb{F}_{\emptyset} \\ & \downarrow \eta_{\Sigma} & \\ \Lambda_{\mathcal{E}}(\emptyset) & \xrightarrow{\mathbb{F}_{\mathcal{E}}(\Sigma)} & \Lambda_{\mathcal{E}}(\emptyset) \end{array}$$

²⁶Since the Π -graded linear category \mathbb{C} features a single object, every such Π -graded linear functor and every such Π -graded natural isomorphism are constant, so we are actually looking for a single finitely generated Π -graded vector space together with a Π -graded linear isomorphism from $\mathbb{V}_{\mathcal{E}}(\Sigma)$ to it.

The idea is then to try and decompose the 1-morphism $\Sigma : \mathcal{O} \rightarrow \mathcal{O}$ as a composition of tensor products of elementary 1-morphisms which are easier to describe and compute.

2.13. Universal graded linear categories

We describe here covariant universal Π -graded linear categories in terms of Π -graded extensions of ideals of projective homogeneous objects of \mathcal{E} .

REMARK 2.13.1. For every index $g \in G$ there exists a standard Π -suspension system on $\text{Proj}(\mathcal{E}_g)$ given by the linear functors $S^u : \text{Proj}(\mathcal{E}_g) \rightarrow \text{Proj}(\mathcal{E}_g)$ mapping every object V to $\sigma(u) \otimes V$ and every morphism f to $\text{id}_{\sigma(u)} \otimes f$. We denote with $\mathbb{P}\text{roj}(\mathcal{E}_g)$ the Π -graded extension of $\text{Proj}(\mathcal{E}_g)$ along this standard Π -suspension system.

We begin with some preliminary results. The following is a key technical result which is needed in order to relate the Π -suspension systems we are considering on universal Π -graded linear categories to those we just introduced on ideals of projective homogeneous objects of \mathcal{E} .

LEMMA 2.13.1. *For all $u, u' \in \Pi$ we have the equality*

$$d_0 \cdot f_{S^2, u, u'} = \zeta \cdot f_{\sigma, u, u'}$$

where $f_{S^2, u, u'}$ and $f_{\sigma, u, u'}$ are the images under the Reshetikhin-Turaev functor $F_{\mathcal{E}}$ of the \mathcal{E} -colored ribbon graphs represented in Figure 25.

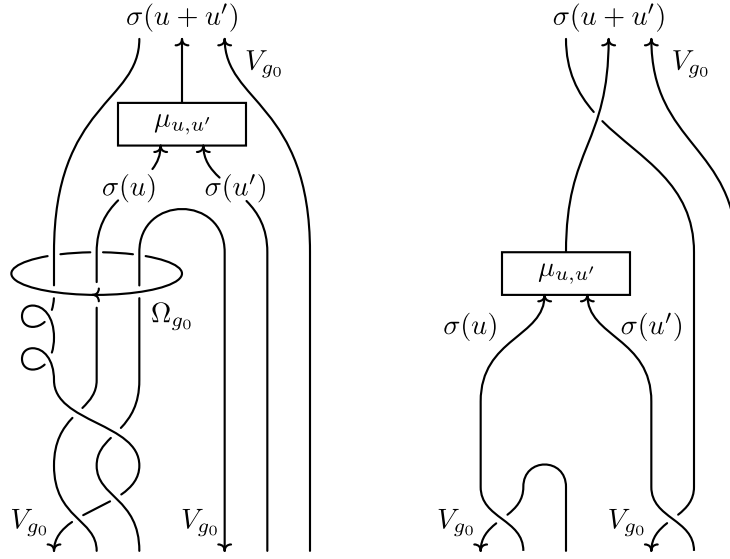

FIGURE 25. The \mathcal{E} -colored ribbon graphs representing $f_{S^2, u, u'}$ and $f_{\sigma, u, u'}$.

PROOF. The equality follows immediately from the properties of the \mathbb{Z} -bilinear homomorphism $\psi : G \times \Pi \rightarrow \mathbb{C}^*$ of Definition 2.2.1 and from the relative modularity condition of Definition 2.2.2. □

REMARK 2.13.2. Let us consider for all indices $g, g' \in G$ and for every object V of $\mathbb{P}\text{roj}(\mathcal{C}_g)$ the object²⁷ $\mathbf{D}_{(+,V),g'}^2 := (D^2, P(+)^V, (\vartheta_{(+,V),g'})_{B_{D^2}}, \{0\})$ of $\Lambda_{\mathcal{C}}(\mathbf{S}_g^1)$ determined by the unique cohomology class $\vartheta_{(+,V),g'}$ which is compatible with the \mathcal{C} -coloring of $P(+)$ and which evaluates to g' every relative homology class that can be represented by some oriented arc from B_{D^2} to $(A_{S^1})_{D^2}$ contained in $\{(x, y) \in D^2 \mid y \geq 0\}$. Let $\mathbf{D}_{(+,V)}^2 \times \mathbf{I}_{g'} : \mathbf{D}_{(+,V),0}^2 \Rightarrow \mathbf{D}_{(+,V),g'}^2$ denote the 2-morphism $(D^2 \times I, P(+)^V \times I, \omega_{g'}, 0)$ of $\check{\mathbf{Cob}}_3^{\mathcal{C}}$ determined by the unique G -coloring $\omega_{g'}$ extending $(\vartheta_{(+,V),0})_{B_{D^2}}$ and $(\vartheta_{(+,V),g'})_{B_{D^2}}$. Then $[\mathbf{D}_0^3 \otimes (\mathbf{D}_{(+,V)}^2 \times \mathbf{I}_{g'})]$ is a degree 0 isomorphism from $\mathbf{D}_{(+,V),0}^2$ to $\mathbf{D}_{(+,V),g'}^2$. See Figure 26 for a graphical representation of $\mathbf{D}_{(+,V)}^2 \times \mathbf{I}_{g'}$.

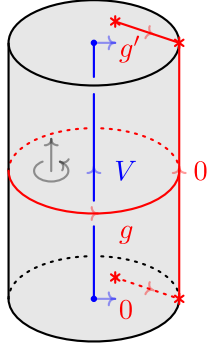

FIGURE 26. The 2-morphism $\mathbf{D}_{(+,V)}^2 \times \mathbf{I}_{g'}$ of $\check{\mathbf{Cob}}_3^{\mathcal{C}}$.

We denote with Y the 3-dimensional cobordism with corners from D^2 to $S^2 \sqcup D^2$ whose support Y is given by²⁸

$$(D^2 \times I) \setminus B\left(\left(0, 0, \frac{1}{2}\right), \frac{1}{8}\right) \subset \mathbb{R}^3,$$

whose incoming horizontal boundary $\partial_-^h Y$ is given by $D^2 \times \{0\}$ with identification given by $(\text{id}_{D^2}, 0) : D^2 \rightarrow D^2 \times \{0\}$, whose outgoing horizontal boundary $\partial_+^h Y$ is given by $\overline{\partial B((0, 0, \frac{1}{2}), \frac{1}{8})} \cup D^2 \times \{1\}$ with identification induced by the diffeomorphisms

$$\begin{aligned} S^2 &\rightarrow \overline{\partial B((0, 0, \frac{1}{2}), \frac{1}{8})} \\ (x, y, z) &\mapsto \left(\frac{x}{8}, \frac{y}{8}, \frac{4-z}{8}\right) \end{aligned}$$

and $(\text{id}_{D^2}, 1) : D^2 \rightarrow D^2 \times \{1\}$ and whose outgoing vertical boundary identification is given by $\text{id}_{S^1 \times I}$.

REMARK 2.13.3. From now on we adopt the following notation: for every generic index g in $G \setminus X$ and for every projective homogeneous object V of \mathcal{C} we choose a fixed section $s_{g,V} \in \text{Hom}_{\mathcal{C}}(V, V_g^* \otimes V_g \otimes V)$ of the epimorphism $\text{ev}_{V_g} \otimes \text{id}_V$.

²⁷Recall that for every object $(\vec{\varepsilon}, \vec{V})$ of $\text{Rib}_{\mathcal{C}}^G$ and for every morphism T^φ of $\text{Rib}_{\mathcal{C}}^G$ we introduced the g -colored 1-sphere \mathbf{S}_g^1 of Definition 2.5.1 and the $(\vec{\varepsilon}, \vec{V})$ -colored 2-disc $\mathbf{D}_{(\vec{\varepsilon}, \vec{V})}^2$ of Definition 2.5.2.

²⁸ $B((x, y, z), \rho)$ is the open ball of center (x, y, z) and radius ρ in \mathbb{R}^3 .

Then for every degree u in Π , for every index g in G and for every object V of $\text{Proj}(\mathcal{C}_g)$ we denote with $r_{u,g,V} \in \text{Hom}_{\mathcal{C}}(V_g^* \otimes \sigma(u) \otimes V_g \otimes V, \sigma(u) \otimes V)$ the retraction

$$\left((\text{id}_{\sigma(u)} \otimes \text{ev}_{V_g}) \circ (\beta_{\sigma(u), V_g}^{-1} \otimes \text{id}_{V_g}) \right) \otimes \text{id}_V$$

of the map $s_{u,g,V} \in \text{Hom}_{\mathcal{C}}(\sigma(u) \otimes V, V_g^* \otimes \sigma(u) \otimes V_g \otimes V)$ given by

$$\left(\beta_{\sigma(u), V_g} \otimes \text{id}_{V_g} \otimes \text{id}_V \right) \circ (\text{id}_{\sigma(u)} \otimes s_{g,V})$$

and we denote with $p_{u,g,V} \in \text{End}_{\mathcal{C}}(V_g^* \otimes \sigma(u) \otimes V_g \otimes V)$ the idempotent

$$s_{u,g,V} \circ r_{u,g,V}.$$

Finally, for every degree u in Π , for every index g in G , for all objects V, V'' of $\text{Proj}(\mathcal{C}_g)$ and for every degree u morphism f^u of $\text{Hom}_{\text{Proj}(\mathcal{C}_g)}^u(V, V'')$ we denote with $f_{g_0}^u \in \text{Hom}_{\mathcal{C}}(V, V_{g_0}^* \otimes \sigma(-u) \otimes V_{g_0} \otimes V'')$ the morphism

$$\mathcal{D}^{-1} \text{d}_0 \cdot (s_{-u, g_0, V''} \circ f^u),$$

so that we have the equality $r_{-u, g_0, V''} \circ f_{g_0}^u = f^u$.

Let

$$\mathbb{F}_g : \text{Proj}(\mathcal{C}_g) \rightarrow \Lambda_{\mathcal{C}}(\mathbf{S}_g^1)$$

be the Π -graded linear functor mapping every object V of $\text{Proj}(\mathcal{C}_g)$ to the object $\mathbf{D}_{(+, V)}^2$ of $\Lambda_{\mathcal{C}}(\mathbf{S}_g^1)$ and mapping every degree u morphism f^u of $\text{Hom}_{\text{Proj}(\mathcal{C}_g)}^u(V, V'')$ to the degree u morphism

$$\left[\mathbf{Y}_{f_{g_0}^u}^u \right] := \left[\mathbf{Y}, \text{T}_Y^{f_{g_0}^u}, \omega_{f_{g_0}^u}, 0 \right]$$

of $\text{Hom}_{\Lambda_{\mathcal{C}}(\mathbf{S}_g^1)}^u(\mathbf{D}_{(+, V)}^2, \mathbf{D}_{(+, V'')}^2)$, where $\text{T}_Y^{f_{g_0}^u}$ is the \mathcal{C} -colored ribbon graph contained in $\{(x, y, z) \in Y \mid y = 0\}$ represented in Figure 27 and where $\omega_{f_{g_0}^u}$ is the unique cohomology class which is compatible with the \mathcal{C} -coloring of T_Y and which evaluates to 0 every relative homology class that can be represented by some oriented arc contained in $\{(x, y, z) \in Y \mid y \geq 0\}$.

THEOREM 2.13.1. *The Π -graded linear functor $\mathbb{F}_g : \text{Proj}(\mathcal{C}_g) \rightarrow \Lambda_{\mathcal{C}}(\mathbf{S}_g^1)$ is a well-defined Π -Morita equivalence.*

PROOF. The first property we have to establish is the functoriality of \mathbb{F}_g . The identity

$$\left[\mathbf{D}_0^3 \otimes \text{id}_{\mathbf{D}_{(+, V)}^2} \right] = \left[\mathbf{Y}_{(\text{id}_V)_{g_0}}^0 \right]$$

follows from Lemma 2.9.2. Furthermore, the identity

$$\left[\mathbf{Y}_{(f'^{u'} \star f^u)_{g_0}}^{u+u'} \right] = \left[\mathbf{Y}_{f'^{u'}}^{u'} \right] \star \left[\mathbf{Y}_{f^u}^u \right]$$

follows from Lemma 2.13.1: indeed, thanks to Lemma 2.8.2, we can reduce ourselves to study two closed admissible \mathcal{C} -colored ribbon graphs $\text{T}_{S^2}^{\varphi_{S^2}}$ and $\text{T}_{\sigma}^{\varphi_{\sigma}}$ whose diagrams differ only in some small region where they look like the \mathcal{C} -colored ribbon graphs represented in the left-hand part and in the right-hand part of Figure 25 respectively. Therefore in order to conclude we just need to notice that $\text{T}_{S^2}^{\varphi_{S^2}}$ features an additional component of the surgery link which leaves the signature unchanged, so that²⁹

$$\mathcal{D}^{-1} \text{d}_0 \cdot F'_{\mathcal{C}}(\text{T}_{S^2}^{\varphi_{S^2}}) = \zeta \cdot F'_{\mathcal{C}}(\text{T}_{\sigma}^{\varphi_{\sigma}}).$$

²⁹Compare with the definition of the Costantino-Geer-Patureau invariant of Section 2.6.

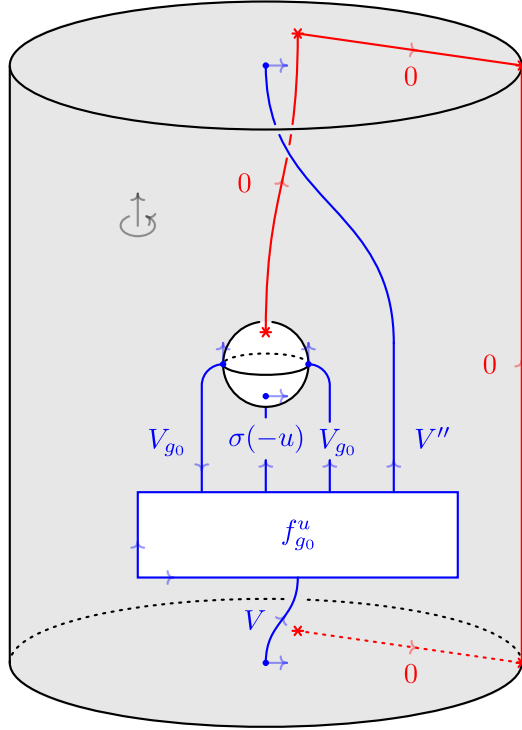

FIGURE 27. The degree u morphism $[\mathbf{Y}_{f_{g_0}}^u]$. The ribbon graph \mathbf{T}_Y is represented in blue with blackboard framing. The cohomology class $\omega_{f_{g_0}}^u$ is completely determined by the \mathcal{C} -coloring on \mathbf{T}_Y and by the specified evaluations against the relative homology classes represented by the oriented red curves.

Now, for what concerns the Morita equivalence, the family of objects

$$\{\mathbf{D}_{(+,V)}^2 \mid V \in \text{Ob}(\text{Proj}(\mathcal{C}_g))\}$$

dominates $\Lambda_{\mathcal{C}}(\mathbf{S}_g^1)$ thanks to Remark 2.13.2. Therefore, thanks to Theorem A.6.1, we just need to show that \mathbb{F}_g is faithful and full. In order to do so, let us fix objects V and V'' of $\text{Proj}(\mathcal{C}_g)$.

Let us begin by showing that the degree u component

$$\mathbb{F}_g^u : \text{Hom}_{\text{Proj}(\mathcal{C}_g)}^u(V, V'') \rightarrow \text{Hom}_{\Lambda_{\mathcal{C}}(\mathbf{S}_g^1)}^u(\mathbf{D}_{(+,V)}^2, \mathbf{D}_{(+,V'')}^2)$$

is surjective for every $u \in \Pi$. Thanks to Lemma 2.5.5 we know that every morphism in $\text{Hom}_{\Lambda_{\mathcal{C}}(\mathbf{S}_g^1)}^u(\mathbf{D}_{(+,V)}^2, \mathbf{D}_{(+,V'')}^2)$ can be represented by some admissible \mathcal{C} -skein inside \mathbf{Y} relative to

$$(\mathbf{P}(+)^V, (\vartheta_{(+,V)})_{B_{D^2}}), \quad (\mathbf{P}_{S^2}^{-u} \sqcup \mathbf{P}(+)^{V''}, (\vartheta_{S^2})_{B_{S^2}} \sqcup (\vartheta_{(+,V'')})_{B_{D^2}}).$$

Up to isotopy and skein equivalence we can moreover restrict to admissible \mathcal{C} -skeins of the form $(\mathbf{T}_Y^f, \omega_f)$ where f is a morphism in $\text{Hom}_{\mathcal{C}}(V, V_{g_0}^* \otimes \sigma(-u) \otimes V_{g_0} \otimes V'')$. Remark that we can suppose that the G -coloring ω_f evaluates to 0 every relative

homology class that can be represented by some oriented arc contained in

$$\{(x, y, z) \in Y \mid y \geq 0\}$$

because if $\omega_{f,g'}$ is the unique G -coloring of (Y, T_Y) extending $(\vartheta_{(+,V)})_{B_{D^2}}$ and $(\vartheta_{S^2})_{B_{S^2}} \sqcup (\vartheta_{(+,V'')})_{B_{D^2}}$ which is compatible with the \mathcal{C} -coloring of T_Y and which evaluates to g' the relative homology class of the oriented arc between the two different components of $\partial_+^h Y$ which is represented in red in Figure 27 then we have the equality³⁰

$$[Y, T_Y^f, \omega_{f,g'}, 0] = \psi(g', u) \cdot [Y, T_Y^f, \omega_f, 0]$$

between vectors of $\text{Hom}_{\mathbb{A}_{\mathcal{C}}(\mathbf{S}_g^1)}^u(\mathbf{D}_{(+,V)}^2, \mathbf{D}_{(+,V'')}^2)$. Therefore every degree u morphism of $\text{Hom}_{\mathbb{A}_{\mathcal{C}}(\mathbf{S}_g^1)}^u(\mathbf{D}_{(+,V)}^2, \mathbf{D}_{(+,V'')}^2)$ is of the form $[Y_f^u]$ for some morphism f of $\text{Hom}_{\mathcal{C}}(V, V_{g_0}^* \otimes \sigma(-u) \otimes V_{g_0} \otimes V'')$. Now it is enough to show that

$$[Y_f^u] = [Y_{p_{-u, g_0, V''} \circ f}^u] = \mathcal{D}d_0^{-1} \cdot \mathbb{F}_g^u(r_{-u, g_0, V''} \circ f)$$

for every $f \in \text{Hom}_{\mathcal{C}}(V, V_{g_0}^* \otimes \sigma(-u) \otimes V_{g_0} \otimes V'')$. In order to do so we can apply Lemma 2.8.2 and, since the critical case is completely analogous, we will suppose for the rest of the proof that $g \in G \setminus X$. It is readily checked that the evaluation of the Geer-Patureau-Turaev renormalized invariant $F'_{\mathcal{C}}$ against the admissible \mathcal{C} -colored closed ribbon graph $T_Y^{\varphi_{f, f', f''}}$ represented in Figure 28 is unchanged if we replace f with $p_{V'', -u} \circ f$, and that this holds for every $i' \in I_g$, for every $u' \in \Pi$ and for all

$$f' \in \text{Hom}_{\mathcal{C}}(\mathbb{1}, V \otimes V_{i'}^* \otimes \sigma(u')^*),$$

$$f'' \in \text{Hom}_{\mathcal{C}}(V_{g_0}^* \otimes \sigma(-u) \otimes V_{g_0} \otimes V'' \otimes V_{i'}^* \otimes \sigma(u')^*, \mathbb{1}).$$

This is enough to show the surjectivity of \mathbb{F}_g^u and it also proves that for every $f^u \in \text{Hom}_{\text{Proj}(\mathcal{C}_g)}^u(V, V'')$ the definition of $\mathbb{F}_g^u(f^u)$ is actually independent of the choice of the section $s_{g_0, V''}$ of $\text{ev}_{V_{g_0}} \otimes \text{id}_{V''}$ which was made in Remark 2.13.3.

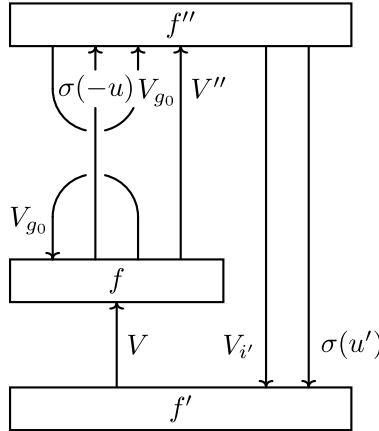

FIGURE 28. The admissible \mathcal{C} -colored closed ribbon graph $T_Y^{\varphi_{f, f', f''}}$.

³⁰It can be proven as usual by appealing to Lemma 2.8.2.

Finally, in order to see that

$$\mathbb{F}_g^u : \text{Hom}_{\mathbb{P}\text{roj}(\mathcal{E}_g)}^u(V, V'') \rightarrow \text{Hom}_{\hat{\Lambda}_{\mathcal{E}}(\mathbf{S}_g^1)}^u(\mathbf{D}_{(+,V)}^2, \mathbf{D}_{(+,V'')}^2)$$

is also injective it is sufficient to use the non-degeneracy of the trace t on $\text{Proj}(\mathcal{E}_g)$: indeed if we consider some non-trivial degree u morphism $f^u \in \text{Hom}_{\mathbb{P}\text{roj}(\mathcal{E}_g)}^u(V, V'')$ then there exists some morphism $f'_{-u} \in \text{Hom}_{\mathcal{E}}(\sigma(-u) \otimes V'', V)$ satisfying

$$t_V(f'_{-u} \circ f^u) \neq 0.$$

Now let us choose a retraction $\tilde{r}_{-u, g_0, V''}$ of the monomorphism

$$\left((\beta_{\sigma(-u), V_{g_0}^*} \otimes \text{id}_{V_{g_0}}) \circ (\text{id}_{\sigma(-u)} \otimes \text{c}\tilde{\text{e}}\text{v}_{V_{g_0}}) \right) \otimes \text{id}_{V''},$$

whose existence is ensured by the injectivity of V'' . Then the evaluation of the Geer-Patureau-Turaev renormalized invariant $F'_{\mathcal{E}}$ against the admissible \mathcal{E} -colored closed ribbon graph $\Gamma_{\hat{Y}}^{\varphi, f', f''}$ when $V'_i = V$, when $u' = 0 \in \Pi$ and when

$$\begin{aligned} f &= f_{g_0}^u, & f' &= (\text{id}_V \otimes \text{id}_{V^*} \otimes (\varepsilon^{-1})^*) \circ \text{coev}_V, \\ f'' &= \tilde{\text{e}}\text{v}_V \circ ((f'_{-u} \circ \tilde{r}_{-u, g_0, V''}) \otimes \text{id}_{V^*} \otimes \varepsilon^*) \end{aligned}$$

is exactly

$$\begin{aligned} t_V(f'_{-u} \circ \tilde{r}_{-u, g_0, V''} \circ \left((\beta_{\sigma(-u), V_{g_0}^*} \otimes \text{id}_{V_{g_0}}) \circ (\text{id}_{\sigma(-u)} \otimes \text{c}\tilde{\text{e}}\text{v}_{V_{g_0}}) \right) \otimes \text{id}_{V''}) \circ f^u) \\ = t_V(f'_{-u} \circ f^u) \neq 0. \quad \square \end{aligned}$$

2.14. Universal graded linear functors

We describe covariant universal Π -graded linear functors induced by a set of generating 1-morphisms of $\check{\mathbf{Cob}}_3^{\mathcal{E}}$ composed of 2-discs, 2-pants and 2-cylinders. This allows for the computation of the covariant universal Π -graded vector spaces associated with some elementary closed 1-morphisms of $\check{\mathbf{Cob}}_3^{\mathcal{E}}$.

2.14.1. 2-Discs. The first family of universal Π -graded linear functors we are going to analyse is equivalent to a collection of constant Π -graded linear functors. Indeed, recall Definition 2.5.2 for the $(+, V)$ -colored 2-disc and Remark 2.10.1 for the notation we adopt for constant Π -graded linear functors. For every index $g \in G$ and for every object V of $\mathbb{P}\text{roj}(\mathcal{E}_g)$ we have a commutative diagram of Π -graded linear functors of the form³¹

$$\begin{array}{ccc} \hat{\mathbf{C}} & \xrightarrow{\hat{V}} & \hat{\mathbb{P}\text{roj}}(\mathcal{E}_g) \\ \hat{\text{id}}_{\emptyset} \downarrow & & \searrow \hat{\mathbb{F}}_g \\ \hat{\Lambda}_{\mathcal{E}}(\emptyset) & \xrightarrow{\hat{\mathbb{F}}_{\mathcal{E}}(\mathbf{D}_{(+,V)}^2)} & \hat{\Lambda}_{\mathcal{E}}(\mathbf{S}_g^1) \end{array}$$

³¹The Π -graded linear functor \mathbb{F}_g was introduced in Theorem 2.13.1.

We move on to describe a family of universal \mathbb{I} -graded linear functors which are equivalent to \mathbb{I} -graded Hom functors. Indeed, g be an index in G and let V be an object of \mathcal{C}_g .

DEFINITION 2.14.1. The *dual $(-, V)$ -colored 2-disc*

$$\overline{\mathbf{D}}_{(-, V)}^2 : \mathbf{S}_g^1 \rightarrow \emptyset$$

is the 1-morphism of $\check{\mathbf{Cob}}_3^{\mathcal{C}}$ given by

$$\left(\overline{\mathbf{D}}^2, \mathbf{P}(-)^V, (\vartheta_{(-, V)})_{\emptyset}, \{0\} \right).$$

We denote with Z the 3-dimensional cobordism from \emptyset to $\mathbf{S}^2 \sqcup (\mathbf{D}^2 \cup_{\mathbf{S}^1} \overline{\mathbf{D}}^2)$ whose support Z is given by

$$D^3 \setminus B \left((0, 0, 0), \frac{1}{4} \right) \subset \mathbb{R}^3,$$

whose outgoing horizontal boundary identification is induced by the diffeomorphisms

$$\begin{aligned} S^2 &\rightarrow \overline{\partial B \left((0, 0, 0), \frac{1}{4} \right)} \\ (x, y, z) &\mapsto \left(\frac{x}{4}, \frac{y}{4}, \frac{-z}{4} \right) \end{aligned}$$

and

$$\begin{aligned} D^2 \cup_{\mathbf{S}^1} \overline{\mathbf{D}}^2 &\rightarrow \partial D^3 \\ [i, (x, y)] &\mapsto \begin{cases} \left(-\sqrt{1-x^2-y^2}, x, y \right) & i = -1 \\ \left(\sqrt{1-x^2-y^2}, x, y \right) & i = +1 \end{cases} \end{aligned}$$

For every index $g \in G$ and for every object V of \mathcal{C}_g let

$$\mathbb{H}\mathrm{om}_{\mathcal{C}}(V, \cdot) : \mathbb{P}\mathrm{roj}(\mathcal{C}_g) \rightarrow \mathbb{V}\mathrm{ect}_{\mathbb{C}}^{\mathbb{I}, \mathrm{fg}}$$

be the \mathbb{I} -graded linear functor mapping every object V' of $\mathbb{P}\mathrm{roj}(\mathcal{C}_g)$ to the \mathbb{I} -graded vector space $\mathbb{H}\mathrm{om}_{\mathcal{C}}(V, V')$ whose space of degree u vectors is given by

$$\mathbb{H}\mathrm{om}_{\mathcal{C}}^u(V, V') := \mathrm{Hom}_{\mathcal{C}}(V, \sigma(-u) \otimes V')$$

and mapping every degree u' morphism $f'^{u'}$ of $\mathrm{Hom}_{\mathbb{P}\mathrm{roj}(\mathcal{C}_g)}^{u'}(V', V'')$ to the \mathbb{I} -graded linear map

$$\mathbb{H}\mathrm{om}_{\mathcal{C}}(V, f'^{u'}) : \mathbb{H}\mathrm{om}_{\mathcal{C}}(V, V') \rightarrow S^{-u'}(\mathbb{H}\mathrm{om}_{\mathcal{C}}(V, V''))$$

whose degree u component $\mathbb{H}\mathrm{om}_{\mathcal{C}}^u(V, f'^{u'})$ maps every vector f^u of $\mathbb{H}\mathrm{om}_{\mathcal{C}}^u(V, V')$ to the vector $f'^{u'} \star f^u := (\mu_{-u, -u'} \otimes \mathrm{id}_{V''}) \circ (\mathrm{id}_{\sigma(-u)} \otimes f'^{u'}) \circ f^u$ of $\mathbb{H}\mathrm{om}_{\mathcal{C}}^{u+u'}(V, V'')$.

Then for every object V' of $\mathbb{P}\mathrm{roj}(\mathcal{C}_g)$ we define the \mathbb{I} -graded linear map

$$\left(\eta_{(-, V)} \right)_{V'} : \mathbb{H}\mathrm{om}_{\mathcal{C}}(V, V') \rightarrow \mathbb{V}_{\mathcal{C}} \left(\overline{\mathbf{D}}_{(-, V)}^2 \circ \mathbf{D}_{(+, V')}^2 \right)$$

whose degree u component $(\eta_{(-, V)})_{V'}^u$ maps every vector f^u of $\mathbb{H}\mathrm{om}_{\mathcal{C}}^u(V, V')$ to the vector³²

$$\left[\mathbf{Z}_{f_{g_0}^u}^u \right] := \left[\mathbf{Z}, \mathbf{T}_{\mathbf{Z}}^{f_{g_0}^u}, \omega_{f_{g_0}^u}, 0 \right]$$

of $\mathbb{V}_{\mathcal{C}}^u(\overline{\mathbf{D}}_{(-, V)}^2 \circ \mathbf{D}_{(+, V')}^2)$, where $\mathbf{T}_{\mathbf{Z}}^{f_{g_0}^u}$ is the \mathcal{C} -colored ribbon graph contained in $\{(x, y, z) \in Z \mid y = 0\}$ represented in Figure 29 and where $\omega_{f_{g_0}^u}$ is the unique cohomology class which is compatible with the \mathcal{C} -coloring of $\mathbf{T}_{\mathbf{Z}}$ and which evaluates

³²We use the notation introduced in Remark 2.13.3.

to 0 every relative homology class that can be represented by some oriented arc contained in $\{(x, y, z) \in Z \mid y \geq 0\}$.

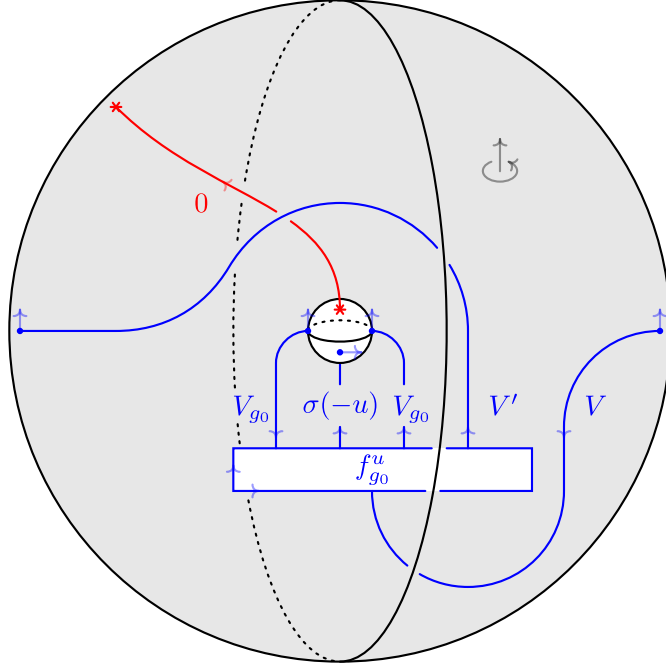

FIGURE 29. The degree u vector $[\mathbf{Z}_{f_{g_0}^u}^u]$. The ribbon graph T_Z is represented in blue with blackboard framing. The cohomology class $\omega_{f_{g_0}^u}$ is completely determined by the \mathcal{E} -coloring on T_Z and by the specified evaluation against the relative homology class represented by the oriented red curve.

PROPOSITION 2.14.1. *For every index $g \in G$ and for every object V of $\text{Proj}(\mathcal{E}_g)$ the \mathbb{H} -graded linear maps $(\eta_{(-,V)})_{V'}$ define a \mathbb{H} -graded natural isomorphism³³*

$$\begin{array}{ccc}
 \hat{\text{Proj}}(\mathcal{E}_g) & \xrightarrow{\hat{\text{Hom}}_{\mathcal{E}}(V, \cdot)} & \hat{\text{Vect}}_{\mathbb{C}}^{\mathbb{H}, \text{fg}} \\
 \searrow \hat{\mathbb{F}}_g & \downarrow \eta_{(-,V)} & \uparrow \hat{\mathbb{F}}_{\emptyset} \\
 & \hat{\mathbb{A}}_{\mathcal{E}}(\mathbf{S}_g^1) & \hat{\mathbb{A}}_{\mathcal{E}}(\emptyset) \\
 & \xrightarrow{\hat{\mathbb{F}}_{\mathcal{E}}(\mathbf{D}_{(-,V)}^2)} &
 \end{array}$$

³³The \mathbb{H} -graded linear functor \mathbb{F}_{\emptyset} is given in Proposition 2.12.3.

PROOF. The result is established by showing that the linear maps

$$\left(\eta_{(-,V)}\right)_{V'}^u : \mathbb{H}\text{om}_{\mathcal{C}}^u(V, V') \rightarrow \mathbb{V}_{\mathcal{C}}^u \left(\overline{\mathbf{D}}_{(-,V)}^2 \circ \mathbf{D}_{(+,V')}^2 \right)$$

are isomorphisms for every degree u in Π and for every object V' of $\mathbb{P}\text{roj}(\mathcal{C}_g)$ and that they are natural with respect to morphisms of $\mathbb{P}\text{roj}(\mathcal{C}_g)$. Both properties are checked by reproducing the proof of Theorem 2.13.1.

The surjectivity and injectivity of $(\eta_{(-,V)})_{V'}^u$, is shown just like the fullness and faithfulness of \mathbb{F}_g^u . Indeed every degree u vector of $\mathbb{V}_{\mathcal{C}}^u(\overline{\mathbf{D}}_{(-,V)}^2 \circ \mathbf{D}_{(+,V')}^2)$ is of the form $[\mathbf{Z}_f^u]$ for some morphism

$$f \in \text{Hom}_{\mathcal{C}}(V, V_{g_0}^* \otimes \sigma(-u) \otimes V_{g_0} \otimes V'),$$

and we have

$$[\mathbf{Z}_f^u] = \left[\mathbf{Z}_{p_{-u, g_0, V'} \circ f}^u \right] = \mathcal{D}d_0^{-1} \cdot \left(\eta_{(-,V)} \right)_{V'}^u (r_{-u, g_0, V'} \circ f).$$

Moreover, if $f^u \in \mathbb{H}\text{om}_{\mathcal{C}}^u(V, V')$ is non-zero then the non-degeneracy of the trace t on $\text{Proj}(\mathcal{C})$ guarantees the existence of some morphism

$$f'_{-u} \in \text{Hom}_{\mathcal{C}}(\sigma(-u) \otimes V', V)$$

satisfying $t_V(f'_{-u} \circ f^u) \neq 0$. This allows us to deduce the non-triviality of $[\mathbf{Z}_{f'_{g_0}}^u]$.

Finally, the naturality of $\eta_{(-,V)}$ is proved by establishing the equality

$$\mathbb{F}_{\mathcal{C}}^{u'} \left(\left[\text{id}_{\overline{\mathbf{D}}_{(-,V)}^2} \circ \mathbf{Y}_{f'_{g_0}^{u'}} \right] \right) \left(\left[\mathbf{Z}_{f'_{g_0}}^u \right] \right) = \left[\mathbf{Z}_{(f'^{u'} \star f^u)_{g_0}}^{u+u'} \right]$$

of degree $u + u'$ vectors of $\mathbb{V}_{\mathcal{C}}^u(\overline{\mathbf{D}}_{(-,V)}^2 \circ \mathbf{D}_{(+,V'')}^2)$ for all degrees u, u' of Π , for all objects V', V'' of $\mathbb{P}\text{roj}(\mathcal{C}_g)$, for every degree u vector f^u of $\mathbb{H}\text{om}_{\mathcal{C}}(V, V')$ and for every degree u' morphism $f'^{u'}$ of $\text{Hom}_{\mathbb{P}\text{roj}(\mathcal{C}_g)}(V', V'')$. The result follows from Lemma 2.13.1, and the proof is completely analogous to the proof of the functoriality of \mathbb{F}_g : thanks to Lemma 2.12.2 we reduce ourselves to compare two admissible \mathcal{C} -colored closed ribbon graphs whose diagrams differ only in some small region where they look like the \mathcal{C} -colored ribbon graphs represented in the left-hand part and in the right-hand part of Figure 25 respectively. The evaluation of the Geer-Patureau-Turaev renormalized invariant $F'_{\mathcal{C}}$ against the first admissible \mathcal{C} -colored closed ribbon graph has then to be corrected with a \mathcal{D}^{-1} factor which takes into account the additional surgery component, and we can conclude. \square

2.14.2. 2-Pants. We define the *2-pant cobordism* P^2 as the 2-dimensional cobordism from $S^1 \sqcup S^1$ to S^1 whose support P^2 is given by

$$D^2 \setminus \left(B \left(\left(-\frac{1}{2}, 0 \right), \frac{1}{4} \right) \cup B \left(\left(\frac{1}{2}, 0 \right), \frac{1}{4} \right) \right) \subset \mathbb{R}^2$$

where $B((x, y), \rho)$ is the open ball of center (x, y) and radius ρ in \mathbb{R}^2 , whose incoming boundary identification is given by

$$\begin{aligned} f_{P^2} : S^1 \sqcup S^1 &\rightarrow \partial B \left(\left(-\frac{1}{2}, 0 \right), \frac{1}{4} \right) \cup \partial B \left(\left(\frac{1}{2}, 0 \right), \frac{1}{4} \right) \\ (i, (x, y)) &\mapsto \begin{cases} \left(\frac{x-2}{4}, \frac{y}{4} \right) & i = -1 \\ \left(\frac{x+2}{4}, \frac{y}{4} \right) & i = +1 \end{cases} \end{aligned}$$

and whose outgoing boundary identification is given by id_{S^1} .

We also define the *dual 2-pant cobordism* $\overline{P^2}$ as the 2-dimensional cobordism from S^1 to $S^1 \sqcup S^1$ whose support is given by $\overline{P^2}$, whose incoming boundary identification is given by id_{S^1} and whose outgoing boundary identification is given by f_{P^2} . Let us consider indices $g, g' \in G$.

DEFINITION 2.14.2. The (g, g') -colored 2-pant

$$\mathbf{P}_{g, g'}^2 : \mathbf{S}_g^1 \otimes \mathbf{S}_{g'}^1 \rightarrow \mathbf{S}_{g+g'}^1$$

is the 1-morphism of $\check{\mathbf{Cob}}_3^{\mathcal{G}}$ given by

$$(\mathbf{P}^2, \emptyset^\emptyset, (\vartheta_{g, g'})_\emptyset, H_1(P^2; \mathbb{R}))$$

where $\vartheta_{g, g'}$ is the unique G -coloring of $(\mathbf{P}^2, \emptyset)$ extending $(\xi_g)_{A_{S^1}} \sqcup (\xi_{g'})_{A_{S^1}}$ and $(\xi_{g+g'})_{A_{S^1}}$ which evaluates to 0 every relative homology class that can be represented by some oriented arc contained in $\{(x, y) \in P^2 \mid y \leq 0\}$. See the left-hand part of Figure 30 for a graphical representation.

DEFINITION 2.14.3. The *dual* (g, g') -colored 2-pant

$$\overline{\mathbf{P}}_{g, g'}^2 : \mathbf{S}_{g+g'}^1 \rightarrow \mathbf{S}_g^1 \otimes \mathbf{S}_{g'}^1$$

is the 1-morphism of $\check{\mathbf{Cob}}_3^{\mathcal{G}}$ given by

$$(\overline{\mathbf{P}}^2, \emptyset^\emptyset, (\vartheta_{g, g'})_\emptyset, H_1(P^2; \mathbb{R})).$$

See the right-hand part of Figure 30 for a graphical representation.

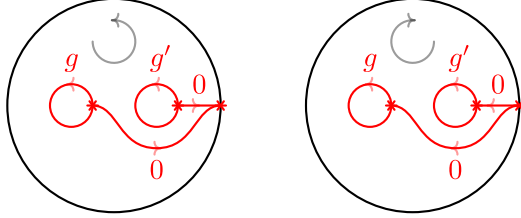

FIGURE 30. The (g, g') -colored 2-pant $\mathbf{P}_{g, g'}^2$ and the dual (g, g') -colored 2-pant $\overline{\mathbf{P}}_{g, g'}^2$. The G -coloring $(\vartheta_{g, g'})_\emptyset$ is uniquely determined by the specified evaluations against the homology classes represented by the oriented red curves.

We begin with the study of the 2-pant cobordism, which induces a family of universal \mathbb{H} -graded linear functors that are equivalent to \mathbb{H} -graded tensor product functors. For all indices $g, g' \in G$ let

$$\nabla_{g, g'} : \text{Proj}(\mathcal{C}_g) \boxtimes \text{Proj}(\mathcal{C}_{g'}) \rightarrow \text{Proj}(\mathcal{C}_{g+g'})$$

be the \mathbb{H} -graded linear functor mapping every object (V, V') of $\text{Proj}(\mathcal{C}_g) \boxtimes \text{Proj}(\mathcal{C}_{g'})$ to the object $V \otimes V'$ of $\text{Proj}(\mathcal{C}_{g+g'})$ and mapping every degree $u + u'$ morphism of the form $f^u \otimes f'^{u'}$ of $\text{Hom}_{\text{Proj}(\mathcal{C}_g)}^u(V, V'') \otimes \text{Hom}_{\text{Proj}(\mathcal{C}_{g'})}^{u'}(V', V''')$ to the degree $u + u'$ morphism

$$(\mu_{-u, -u'} \otimes \text{id}_{V'' \otimes V'''}) \circ \left(\text{id}_{\sigma(-u)} \otimes \beta_{\sigma(-u'), V''}^{-1} \otimes \text{id}_{V'''} \right) \circ (f^u \otimes f'^{u'})$$

of $\text{Hom}_{\text{Proj}(\mathcal{C}_{g+g'})}^{u+u'}(V \otimes V', V'' \otimes V''')$.

REMARK 2.14.1. For every object $(\vec{\varepsilon}, \vec{V})$ of $\text{Rib}_{\mathcal{C}}^G$ we have a 2-morphism

$$(\mathbf{D}^2 \times \mathbf{I})_{\text{Tid}_{V^\varepsilon}} : \mathbf{D}_{(+, V^\varepsilon)}^2 \Rightarrow \mathbf{D}_{(\vec{\varepsilon}, \vec{V})}^2$$

of $\check{\mathbf{Cob}}_3^{\mathcal{C}}$ given by Definition 2.5.3 for the obvious morphism

$$\text{Tid}_{V^\varepsilon} : (+, V^\varepsilon) \rightarrow (\vec{\varepsilon}, \vec{V})$$

of $\text{Rib}_{\mathcal{C}}^G$.

For every object (V, V') of $\text{Proj}(\mathcal{C}_g) \boxtimes \text{Proj}(\mathcal{C}_{g'})$ we define $(\eta_{\nabla_{g, g'}})_{(V, V')}^0$ to be the degree 0 morphism

$$[\mathbf{D}_0^3 \otimes (\mathbf{D}^2 \times \mathbf{I})_{\text{Tid}_{V \otimes V'}}]$$

of

$$\text{Hom}_{\mathbb{A}_{\mathcal{C}}(\mathbf{S}_{g+g'}^1)}^0 \left(\mathbf{D}_{(+, V \otimes V')}^2, \mathbf{P}_{g, g'}^2 \circ \left(\mathbf{D}_{(+, V)}^2 \otimes \mathbf{D}_{(+, V')}^2 \right) \right),$$

where we confuse the objects $\mathbf{D}_{((+, V), (+, V'))}^2$ and $\mathbf{P}_{g, g'}^2 \circ \left(\mathbf{D}_{(+, V)}^2 \otimes \mathbf{D}_{(+, V')}^2 \right)$ of $\mathbb{A}_{\mathcal{C}}(\mathbf{S}_{g+g'}^1)$ by identifying them via the degree 0 isomorphism induced by the obvious positive diffeomorphism from D^2 to $(D^2 \sqcup D^2) \cup_{S^1 \sqcup S^1} P^2$.

PROPOSITION 2.14.2. For all indices $g, g' \in G$ the collection of the degree 0 morphisms $(\eta_{\nabla_{g, g'}})_{(V, V')}^0$ defines a \mathbb{I} -graded natural isomorphism³⁴

$$\begin{array}{ccc} \hat{\mathbb{P}}\text{roj}(\mathcal{C}_g) \boxtimes \hat{\mathbb{P}}\text{roj}(\mathcal{C}_{g'}) & \xrightarrow{\hat{\nabla}_{g, g'}} & \hat{\mathbb{P}}\text{roj}(\mathcal{C}_{g+g'}) \\ \hat{\eta}_{\mathbf{S}_g^1, \mathbf{S}_{g'}^1} \circ (\hat{\mathbb{F}}_g \boxtimes \hat{\mathbb{F}}_{g'}) & \searrow & \downarrow \hat{\eta}_{\nabla_{g, g'}} \\ & & \hat{\mathbb{A}}_{\mathcal{C}}(\mathbf{S}_g^1 \otimes \mathbf{S}_{g'}^1) \xrightarrow{\hat{\mathbb{F}}_{\mathcal{C}}(\mathbf{P}_{g, g'}^2)} \hat{\mathbb{A}}_{\mathcal{C}}(\mathbf{S}_{g+g'}^1) \\ & & \hat{\mathbb{F}}_{g+g'} \swarrow & \searrow \end{array}$$

PROOF. For every object (V, V') of $\text{Proj}(\mathcal{C}_g) \boxtimes \text{Proj}(\mathcal{C}_{g'})$ the degree 0 morphism $(\eta_{\nabla_{g, g'}})_{(V, V')}^0$ is clearly invertible.

In order to show the naturality of $\eta_{\nabla_{g, g'}}$ we have to establish the equality

$$\begin{aligned} & (\mathbb{F}_{\mathcal{C}}(\mathbf{P}_{g, g'}^2)) \left(\eta_{\mathbf{S}_g^1, \mathbf{S}_{g'}^1}^{u+u'} \left(\left[\mathbf{Y}_{f_{g_0}^u} \right] \otimes \left[\mathbf{Y}_{f_{g_0}^{u'}} \right] \right) \right) \star [\mathbf{D}_0^3 \otimes (\mathbf{D}^2 \times \mathbf{I})_{\text{Tid}_{V \otimes V'}}] \\ &= [\mathbf{D}_0^3 \otimes (\mathbf{D}^2 \times \mathbf{I})_{\text{Tid}_{V'' \otimes V'''}}] \star \left[\mathbf{Y}_{\left(\nabla_{g, g'}^{u+u'}(f^u \otimes f^{u'}) \right)_{g_0}} \right] \end{aligned}$$

of degree $u + u'$ morphisms of

$$\text{Hom}_{\mathbb{A}_{\mathcal{C}}(\mathbf{S}_{g+g'}^1)}^{u+u'} \left(\mathbf{D}_{(+, V \otimes V')}^2, \mathbf{P}_{g, g'}^2 \circ \left(\mathbf{D}_{(+, V''')}^2 \otimes \mathbf{D}_{(+, V''')}^2 \right) \right)$$

for every degree $u + u'$ morphism of the form

$$f^u \otimes f^{u'} \in \text{Hom}_{\text{Proj}(\mathcal{C}_g)}^u(V, V'') \otimes \text{Hom}_{\text{Proj}(\mathcal{C}_{g'})}^{u'}(V', V''').$$

³⁴The \mathbb{I} -graded linear functor $\eta_{\mathbf{S}_g^1, \mathbf{S}_{g'}^1}$ is given in Theorem 2.10.2.

The proof essentially follows the proof of Theorem 2.13.1: thanks to Lemma 2.8.2 we can reduce to compare two admissible \mathcal{C} -colored closed ribbon graphs whose diagrams differ only in some small region. Then, since the definition of the H -graded linear functor $\mathbb{F}_g : \mathbb{P}\text{roj}(\mathcal{C}_g) \rightarrow \hat{\Lambda}_{\mathcal{C}}(\mathbf{S}_g^1)$ is actually independent of the choice of the section $s_{g_0, V'' \otimes V'''}$ of the epimorphism $\text{ev}_{V_{g_0}} \otimes \text{id}_{V'' \otimes V'''}$ which was made in Remark 2.13.3, we can make sure the region where they differ contains \mathcal{C} -colored ribbon graphs which look like the ones represented in the left-hand part and in the right-hand part of Figure 25 respectively. This allows us to conclude. \square

We choose now some fixed 3-dimensional cobordism with corners X from $D^2 \sqcup D^2$ to $D^2 \cup_{S^1} \overline{P^2}$ whose support X is given by

$$(I \times D^2) \setminus \left(B \left((0, 0, 0), \frac{1}{4} \right) \cup B \left((1, 0, 0), \frac{1}{4} \right) \right) \subset \mathbb{R}^3,$$

whose incoming horizontal boundary $\partial_-^h X$ is given by

$$\left(\partial B \left((0, 0, 0), \frac{1}{4} \right) \cup \partial B \left((1, 0, 0), \frac{1}{4} \right) \right) \cap X,$$

whose outgoing horizontal boundary $\partial_+^h X$ is given by $I \times \partial D^2$ and whose outgoing vertical boundary $\partial_+^v X$ is given by

$$(\partial I \times D^2) \setminus \left(B \left((0, 0, 0), \frac{1}{4} \right) \cup B \left((1, 0, 0), \frac{1}{4} \right) \right).$$

We move on to the study of the dual 2-pant cobordism, which gives rise to a family of universal H -graded linear functors that are equivalent to H -graded coproduct functors. We have to distinguish two cases: either one of the two colors is generic or both of them are critical. The two situations can be treated similarly, although the second one is much more complicated. We begin by analysing the generic case, and the structure of the exposition is meant to highlight the analogies with the critical case.

For all generic indices $g, h \in G \setminus X$, for every arbitrary index $g' \in G$, for all $i, j \in I_g$ and for every object V of $\mathbb{P}\text{roj}(\mathcal{C}_{g+g'})$ we denote with $T_{g, g'}^{\varphi_{i, j, V, h}}$ the \mathcal{C} -colored ribbon graph represented in Figure 31.

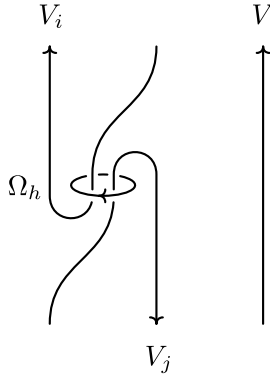

FIGURE 31. The \mathcal{C} -colored ribbon graph $T_{g, g'}^{\varphi_{i, j, V, h}}$.

LEMMA 2.14.1. *For all generic indices $g, h \in G \setminus X$, for every arbitrary index $g' \in G$, for all $i, j \in I_g$ and for every object V of $\mathbb{P}\text{roj}(\mathcal{C}_{g+g'})$ we have the equality*

$$\zeta^{-1}d(V_i) \cdot \left(\varepsilon \otimes F_{\mathcal{C}} \left(\mathbf{T}_{g,g'}^{\varphi_{i,j,V,h}} \right) \right) = \delta_{ij} \cdot \nabla_{g,g'}^0(\text{id}_{V_i}^0 \otimes \text{id}_{V_i^* \otimes V}^0)$$

between degree 0 morphisms of

$$\text{Hom}_{\mathbb{P}\text{roj}(\mathcal{C}_{g+g'})}^0(V_j \otimes V_j^* \otimes V, V_i \otimes V_i^* \otimes V).$$

REMARK 2.14.2. Let us consider the object

$$\bigoplus_{i \in I_g} (V_i, V_i^* \otimes V)$$

of $\mathbb{P}\text{roj}(\mathcal{C}_g) \hat{\boxtimes} \mathbb{P}\text{roj}(\mathcal{C}_{g'})$. Then the degree 0 morphism

$$\left(\delta_{ij} \cdot (\text{id}_{V_i}^0 \otimes \text{id}_{V_i^* \otimes V}^0) \right)_{i,j \in I_g}$$

of $\text{End}_{\mathbb{P}\text{roj}(\mathcal{C}_g) \hat{\boxtimes} \mathbb{P}\text{roj}(\mathcal{C}_{g'})}^0 \left(\bigoplus_{i \in I_g} (V_i, V_i^* \otimes V) \right)$ is the identity.

For every generic index $g \in G \setminus X$ and for every arbitrary index $g' \in G$ let

$$\Delta_{g,g'} : \mathbb{P}\text{roj}(\mathcal{C}_{g+g'}) \rightarrow \mathbb{P}\text{roj}(\mathcal{C}_g) \hat{\boxtimes} \mathbb{P}\text{roj}(\mathcal{C}_{g'})$$

be the \mathbb{H} -graded linear functor mapping every object V of $\mathbb{P}\text{roj}(\mathcal{C}_{g+g'})$ to the object

$$\bigoplus_{i \in I_g} (V_i, V_i^* \otimes V)$$

of the completion of $\mathbb{P}\text{roj}(\mathcal{C}_g) \boxtimes \mathbb{P}\text{roj}(\mathcal{C}_{g'})$ and mapping every degree u morphism f^u of $\text{Hom}_{\mathbb{P}\text{roj}(\mathcal{C}_{g+g'})}^u(V, V'')$ to the degree u morphism

$$\left(\delta_{ij} \cdot (\text{id}_{V_i}^0 \otimes \nabla_{-g,g+g'}^u(\text{id}_{V_i^*}^0 \otimes f^u)) \right)_{i,j \in I_g}$$

of

$$\text{Hom}_{\mathbb{P}\text{roj}(\mathcal{C}_g) \hat{\boxtimes} \mathbb{P}\text{roj}(\mathcal{C}_{g'})}^u \left(\bigoplus_{j \in I_g} (V_j, V_j^* \otimes V), \bigoplus_{i \in I_g} (V_i, V_i^* \otimes V'') \right).$$

Let us consider for every index j in I_g and for every object V of $\mathbb{P}\text{roj}(\mathcal{C}_{g+g'})$ the 2-morphism

$$\mathbf{X}_{j,V} : \mathbf{D}_{(+,V_j)}^2 \otimes \mathbf{D}_{((- ,V_j), (+,V))}^2 \Rightarrow \bar{\mathbf{P}}_{g,g'}^2 \circ \mathbf{D}_{(+,V)}^2$$

of $\check{\mathbf{Cob}}_3^{\mathcal{C}}$ given by

$$(\mathbf{X}, \mathbf{T}_{\mathbf{X},g,g'}^{\varphi_{j,V}}, \omega_{\mathbf{X},g,g',j,V}, 0)$$

for the admissible \mathcal{C} -skein $(\mathbf{T}_{\mathbf{X},g,g'}^{\varphi_{j,V}}, \omega_{\mathbf{X},g,g',j,V})$ represented in Figure 32.

Then for every object V of $\mathbb{P}\text{roj}(\mathcal{C}_{g+g'})$ we define $(\eta_{\Delta_{g,g'}}^0)_V$ to be the degree 0 morphism

$$\left([\mathbf{D}_0^3 \otimes \mathbf{X}_{j,V}] \right)_{j \in I_g}$$

of

$$\text{Hom}_{\mathbb{A}_{\mathcal{C}}(\mathbf{S}_g^1 \otimes \mathbf{S}_{g'}^1)}^0 \left(\bigoplus_{j \in I_g} \mathbf{D}_{(+,V_j)}^2 \otimes \mathbf{D}_{(+,V_j^* \otimes V)}^2, \bar{\mathbf{P}}_{g,g'}^2 \circ \mathbf{D}_{(+,V)}^2 \right),$$

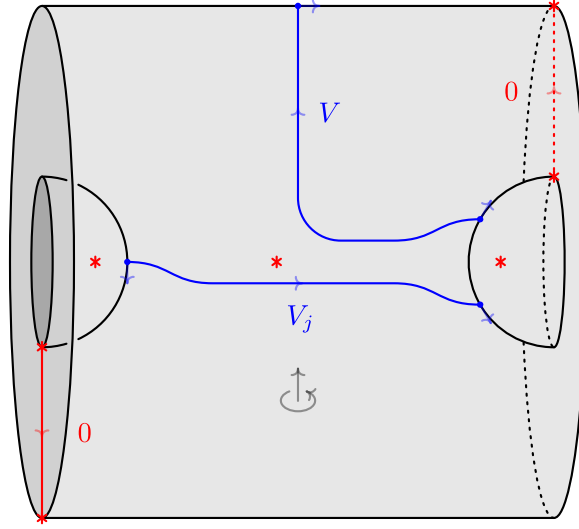
FIGURE 32. The 2-morphism $\mathbf{X}_{j,V}$ of $\check{\mathbf{Cob}}_3^{\mathcal{E}}$.

where we confuse the objects $\mathbf{D}_{(+,V_j^* \otimes V)}^2$ and $\mathbf{D}_{((- ,V_j),(+,V))}^2$ of $\Lambda_{\mathcal{E}}(\mathbf{S}_{g+g'}^1)$ by identifying them via the degree 0 isomorphism

$$\left[\mathbf{D}_0^3 \otimes (\mathbf{D}^2 \times \mathbf{I})_{\mathbb{T}^{\text{id}_{V_j^* \otimes V}}} \right]$$

which was introduced in Remark 2.14.1.

PROPOSITION 2.14.3. *For every generic index $g \in G \setminus X$ and for every arbitrary index $g' \in G$ the collection of the degree 0 morphisms $(\eta_{\Delta_{g,g'}})_V^0$ defines a Π -graded natural isomorphism*

$$\begin{array}{ccc} \hat{\mathbb{P}}\text{roj}(\mathcal{E}_{g+g'}) & \xrightarrow{\hat{\Delta}_{g,g'}} & \hat{\mathbb{P}}\text{roj}(\mathcal{E}_g) \hat{\boxtimes} \hat{\mathbb{P}}\text{roj}(\mathcal{E}_{g'}) \\ \hat{\mathbb{F}}_{g+g'} \searrow & & \downarrow \hat{\eta}_{\Delta_{g,g'}} \\ & & \hat{\Lambda}_{\mathcal{E}}(\mathbf{S}_{g+g'}^1) \xrightarrow{\hat{\mathbb{F}}_{\mathcal{E}}(\overline{\mathbf{P}}_{g,g'}^2)} \hat{\Lambda}_{\mathcal{E}}(\mathbf{S}_g^1 \otimes \mathbf{S}_{g'}^1) \\ & & \hat{\eta}_{\mathbf{S}_g^1, \mathbf{S}_{g'}^1} \circ (\hat{\mathbb{F}}_g \hat{\boxtimes} \hat{\mathbb{F}}_{g'}) \searrow \end{array}$$

PROOF. Let us consider the 2-morphisms

$$\overline{\mathbf{X}}_{i,V} : \overline{\mathbf{P}}_{g,g'}^2 \circ \mathbf{D}_{(+,V)}^2 \Rightarrow \mathbf{D}_{(+,V_i)}^2 \otimes \mathbf{D}_{((- ,V_i),(+,V))}^2$$

of $\check{\mathbf{Cob}}_3^{\mathcal{E}}$ given by

$$\overline{\mathbf{X}}_{i,V} := \left(\overline{\mathbf{X}}, \mathbb{T}'_{\mathbf{X},g,g'}^{\varphi_{i,V}}, \omega'_{g,g',i,V}, 0 \right)$$

for the ribbon graph $T'_{X,g,g'}$ represented in Figure 33.

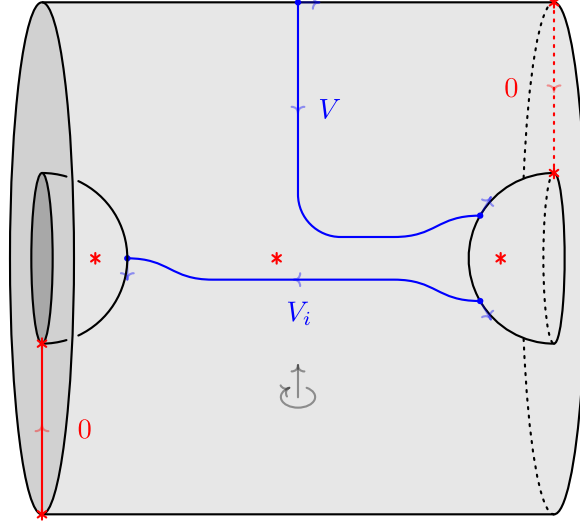

FIGURE 33. The 2-morphism $\overline{\mathbf{X}}_{i,V}$ of $\check{\mathbf{Cob}}_3^{\mathcal{C}}$.

Then the inverse of the degree 0 morphism

$$([\mathbf{D}_0^3 \otimes \mathbf{X}_{j,V}])_{j \in I_g}$$

of

$$\mathrm{Hom}_{\hat{\mathbb{A}}^{\mathcal{C}}}^0(\mathbf{s}_j^1 \otimes \mathbf{s}_{g'}^1) \left(\bigoplus_{j \in I_g} \mathbf{D}_{(+,V_j)}^2 \otimes \mathbf{D}_{(+,V_j^* \otimes V)}^2, \overline{\mathbf{P}}_{g,g'}^2 \circ \mathbf{D}_{(+,V)}^2 \right)$$

is given by the degree 0 morphism

$$\mathcal{D}^{-1} \cdot (d(V_i) \cdot [\mathbf{D}_0^3 \otimes \overline{\mathbf{X}}_{i,V}])_{i \in I_g}$$

of

$$\mathrm{Hom}_{\hat{\mathbb{A}}^{\mathcal{C}}}^0(\mathbf{s}_j^1 \otimes \mathbf{s}_{g'}^1) \left(\overline{\mathbf{P}}_{g,g'}^2 \circ \mathbf{D}_{(+,V)}^2, \bigoplus_{i \in I_g} \mathbf{D}_{(+,V_i)}^2 \otimes \mathbf{D}_{(+,V_i^* \otimes V)}^2 \right).$$

Indeed an admissible \mathcal{C} -skein inside $I \times S^1 \times I$ yielding the composition

$$\sum_{i \in I_g} d(V_i) \cdot [\mathbf{X}_{i,V} * \overline{\mathbf{X}}_{i,V}]$$

is represented in Figure 34, so that the relative modularity condition of Definition 2.2.2 yields the equality

$$\mathcal{D}^{-1} \cdot \sum_{i \in I_g} d(V_i) \cdot [\mathbf{D}_0^3 \otimes (\mathbf{X}_{i,V} * \overline{\mathbf{X}}_{i,V})] = \left[\mathbf{D}_0^3 \otimes \mathrm{id}_{\overline{\mathbf{P}}_{g,g'}^2 \circ \mathbf{D}_{(+,V)}^2} \right].$$

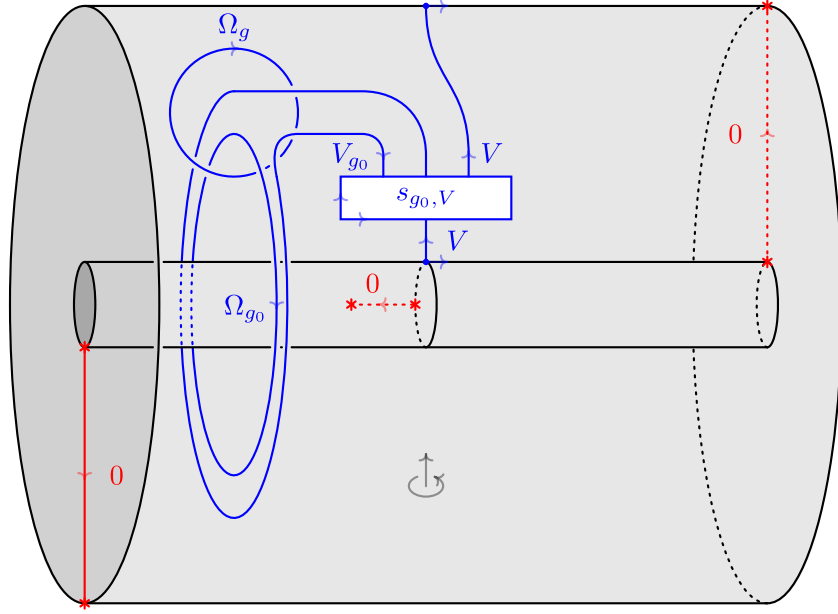

FIGURE 34. The morphism $\sum_{i \in I_g} d(V_i) \cdot [\mathbf{X}_{i,V} * \overline{\mathbf{X}_{i,V}}]$.

The equality

$$\begin{aligned} & \mathcal{D}^{-1} d(V_i) \cdot [\mathbf{D}_0^3 \otimes (\overline{\mathbf{X}_{i,V}} * \mathbf{X}_{j,V})] \\ &= \delta_{ij} \cdot \eta_{\mathbf{S}_g^1, \mathbf{S}_{g'}^1}^0 \left(\left[\mathbf{Y}^0_{(\text{id}_{V_i}^0)_{g_0}} \right] \otimes \left[\mathbf{Y}^0_{(\text{id}_{V_i^* \otimes V}^0)_{g_0}} \right] \right) \\ &= \delta_{ij} \cdot \left[\mathbf{D}_0^3 \otimes \text{id}_{\mathbf{D}_{(+, V_i)}^2} \otimes \text{id}_{\mathbf{D}_{(+, V_i^* \otimes V)}^2} \right] \end{aligned}$$

follows essentially from Lemma 2.14.1, and it boils down to the study of the \mathcal{E} -colored ribbon graph $\mathbb{T}_{g, g'}^{\varphi^{i,j,V,h}}$ of Figure 31 for every $h \in G \setminus X$ thanks to Lemma 2.8.2.

In order to show the naturality of $\eta_{\Delta_{g, g'}}$ we have to establish the equality

$$\begin{aligned} & \left(\mathbb{F}_{\mathcal{E}}(\overline{\mathbf{P}}_{g, g'}^2) \right) \left(\left[\mathbf{Y}_{f_{g_0}^u}^u \right] \right) \star [\mathbf{D}_0^3 \otimes \mathbf{X}_{j,V}] \\ &= [\mathbf{D}_0^3 \otimes \mathbf{X}_{k, V''}] \star \eta_{\mathbf{S}_g^1, \mathbf{S}_{g'}^1}^u \left(\left[\mathbf{Y}^0_{(\text{id}_{V_j}^0)_{g_0}} \right] \otimes \left[\mathbf{Y}^u_{(\nabla_{-g, g+g'}^u(\text{id}_{V_j^*}^0 \otimes f^u))_{g_0}} \right] \right) \end{aligned}$$

of degree u morphisms of

$$\text{Hom}_{\mathbb{A}_{\mathcal{E}}(\mathbf{S}_g^1 \otimes \mathbf{S}_{g'}^1)}^0 \left(\bigoplus_{j \in I_g} \mathbf{D}_{(+, V_j)}^2 \otimes \mathbf{D}_{(+, V_j^* \otimes V)}^2 \cdot \overline{\mathbf{P}}_{g, g'}^2 \circ \mathbf{D}_{(+, V'')}^2 \right)$$

for every $j \in I_g$, for every $u \in \Pi$ and for every $f^u \in \text{Hom}_{\text{Proj}(\mathcal{E}_{g+g'})}^u(V, V'')$. This is done by using Lemmas 2.8.2 and 2.13.1. \square

We move on to analyse the critical case. Since the statements are much heavier, we should bear in mind the analogue but simpler generic situation in order to interpret them.

For all critical indices $x, x' \in X$, for every generic index $h \in G \setminus X$, for all $i, j \in \mathbf{I}_{g_x+x}$ and for every object V of $\mathbb{P}\text{roj}(\mathcal{C}_{x+x'})$ we denote with $\mathbf{T}_{x,x'}^{\varphi_{i,j,V,h}}$ the \mathcal{C} -colored ribbon graph represented in Figure 31.

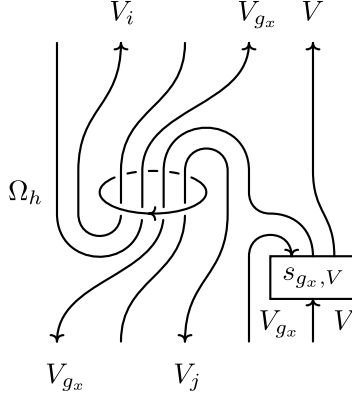

FIGURE 35. The \mathcal{C} -colored ribbon graph $\mathbf{T}_{x,x'}^{\varphi_{i,j,V,h}}$.

LEMMA 2.14.2. *For all critical indices $x, x' \in X$, for every generic index $h \in G \setminus X$, for all $i, j \in \mathbf{I}_{g_x+x}$ and for every object V of $\mathbb{P}\text{roj}(\mathcal{C}_{x+x'})$ there exist degree $-u_n$ morphisms*

$$s_{n,i,j}^{-u_n} \in \text{Hom}_{\mathbb{P}\text{roj}(\mathcal{C}_x)}^{-u_n}(V_{g_x}^* \otimes V_j, V_{g_x}^* \otimes V_i)$$

and degree u_n morphisms

$$r_{n,i,j,V}^{u_n} \in \text{Hom}_{\mathbb{P}\text{roj}(\mathcal{C}_{x'})}^{u_n}(V_j^* \otimes V_{g_x} \otimes V, V_i^* \otimes V_{g_x} \otimes V)$$

for $n = 1, \dots, N$ that yield the equality

$$\zeta^{-1}d(V_i) \cdot \left(\varepsilon \otimes F_{\mathcal{C}} \left(\mathbf{T}_{x,x'}^{\varphi_{i,j,V,h}} \right) \right) = \sum_{n=1}^N \psi(h, -u_n) \cdot \nabla_{x,x'}^0(s_{n,i,j}^{-u_n} \otimes r_{n,i,j,V}^{u_n})$$

between degree 0 morphisms of

$$\text{Hom}_{\mathbb{P}\text{roj}(\mathcal{C}_{x+x'})}^0(V_{g_x}^* \otimes V_j \otimes V_j^* \otimes V_{g_x} \otimes V, V_{g_x}^* \otimes V_i \otimes V_i^* \otimes V_{g_x} \otimes V).$$

REMARK 2.14.3. Let us consider the object

$$\bigoplus_{i \in \mathbf{I}_{g_x+x}} (V_{g_x}^* \otimes V_i, V_i^* \otimes V_{g_x} \otimes V)$$

of $\mathbb{P}\text{roj}(\mathcal{C}_x) \hat{\boxtimes} \mathbb{P}\text{roj}(\mathcal{C}_{x'})$. Then the morphism

$$\left(\sum_{n=1}^N s_{n,i,j}^{-u_n} \otimes r_{n,i,j,V}^{u_n} \right)_{i,j \in \mathbf{I}_{g_x+x}}$$

of $\text{End}_{\mathbb{P}\text{roj}(\mathcal{E}_x) \hat{\boxtimes} \mathbb{P}\text{roj}(\mathcal{E}_{x'})}^0 \left(\bigoplus_{i \in \mathbb{I}_{g_x+x}} (V_{g_x}^* \otimes V_i, V_i^* \otimes V_{g_x} \otimes V) \right)$ is an idempotent. Indeed for every $h \in G \setminus X$ the degree 0 morphism

$$\zeta^{-1} \cdot \left(d(V_i) \cdot \left(\varepsilon \otimes F_{\mathcal{E}} \left(\mathbb{T}_{x,x'}^{\varphi_{i,j,V,h}} \right) \right) \right)_{i,j \in \mathbb{I}_{g_x+x}}$$

of $\text{End}_{\mathbb{P}\text{roj}(\mathcal{E}_{x+x'})}^0 \left(\bigoplus_{i \in \mathbb{I}_{g_x+x}} (V_{g_x}^* \otimes V_i \otimes V_i^* \otimes V_{g_x} \otimes V) \right)$ is clearly an idempotent thanks to the relative modularity condition of Definition 2.2.2. This means

$$\begin{aligned} & \sum_{\substack{1 \leq \ell, m \leq N \\ k \in \mathbb{I}_{g_x+x}}} \psi(h, -u_\ell) \psi(h, -u_m) \cdot \left(\left(s_{\ell,i,k}^{-u_\ell} \star s_{m,k,j}^{-u_m} \right) \otimes \left(r_{\ell,i,k,V}^{u_\ell} \star r_{m,k,j,V}^{u_m} \right) \right) \\ &= \sum_{n=1}^N \psi(h, -u_n) \cdot \left(s_{n,i,j}^{-u_n} \otimes r_{n,i,j,V}^{u_n} \right) \end{aligned}$$

for all $i, j \in \mathbb{I}_{g_x+x}$. But this implies

$$\begin{aligned} & \sum_{\substack{1 \leq \ell, m \leq N \\ k \in \mathbb{I}_{g_x+x}}} \delta_{u_m+u_\ell, u} \psi(h, -u_\ell) \psi(h, -u_m) \cdot \left(\left(s_{\ell,i,k}^{-u_\ell} \star s_{m,k,j}^{-u_m} \right) \otimes \left(r_{\ell,i,k,V}^{u_\ell} \star r_{m,k,j,V}^{u_m} \right) \right) \\ &= \sum_{n=1}^N \delta_{u_n, u} \psi(h, -u_n) \cdot \left(s_{n,i,j}^{-u_n} \otimes r_{n,i,j,V}^{u_n} \right) \end{aligned}$$

for every $u \in \Pi$, so that the claim follows from the properties of ψ .

It will be useful to introduce the following notation: for all $\ell, m \in \{1, \dots, N\}$, for all $i, j \in \mathbb{I}_{g_x+x}$ and for every $f^u \in \text{Hom}_{\mathbb{P}\text{roj}(\mathcal{E}_{x+x'})}^u(V, V'')$ we denote with

$$s_{\ell,m,i,j}^{-u_\ell-u_m} \in \text{Hom}_{\mathbb{P}\text{roj}(\mathcal{E}_x)}^{-u_\ell-u_m} (V_{g_x}^* \otimes V_j, V_{g_x}^* \otimes V_i)$$

the degree $-u_\ell - u_m$ morphism

$$\sum_{k \in \mathbb{I}_{g_x+x}} s_{\ell,i,k}^{-u_\ell} \star s_{m,k,j}^{-u_m}$$

and we denote with

$$r_{\ell,m,i,j,f^u}^{u_\ell+u+u_m} \in \text{Hom}_{\mathbb{P}\text{roj}(\mathcal{E}_{x'})}^{u_\ell+u+u_m} (V_j^* \otimes V_{g_x} \otimes V, V_i^* \otimes V_{g_x} \otimes V)$$

the degree $u_\ell + u + u_m$ morphism

$$\sum_{k \in \mathbb{I}_{g_x+x}} r_{\ell,i,k,V''}^{u_\ell} \star \nabla_{-x,x+x'}^u \left(\text{id}_{V_k^* \otimes V_{g_x}}^0 \otimes f^u \right) \star r_{m,k,i,V}^{u_m}$$

For all critical indices x, x' in X let

$$\Delta_{x,x'} : \mathbb{P}\text{roj}(\mathcal{E}_{x+x'}) \rightarrow \mathbb{P}\text{roj}(\mathcal{E}_x) \hat{\boxtimes} \mathbb{P}\text{roj}(\mathcal{E}_{x'})$$

be the Π -graded linear functor mapping every object V of $\mathbb{P}\text{roj}(\mathcal{E}_{x+x'})$ to the object

$$\text{im} \left(\sum_{n=1}^N s_{n,i,j}^{-u_n} \otimes r_{n,i,j,V}^{u_n} \right)_{i,j \in \mathbb{I}_{g_x+x}}$$

of

$$\mathrm{Hom}_{\hat{\Lambda}_{\mathcal{G}}(\mathbf{S}_x^1 \otimes \mathbf{S}_{x'}^1)}^0 \left(\mathrm{im} \left(\eta_{\mathbf{S}_x^1, \mathbf{S}_{x'}^1}^0 \left(\left[\mathbf{Y}_{\left(\begin{smallmatrix} -u_n \\ s_{i,j} \end{smallmatrix} \right)_{g_0}} \right] \otimes \left[\mathbf{Y}_{\left(\begin{smallmatrix} u_n \\ r_{i,j,V} \end{smallmatrix} \right)_{g_0}} \right] \right) \right), \bar{\mathbf{P}}_{x,x'}^2 \circ \mathbf{D}_{(+,V)}^2 \right),$$

where we confuse the objects $\mathbf{D}_{(+,V_{g_x}^* \otimes V_i)}^2$ and $\mathbf{D}_{((- , V_{g_x}), (+, V_i))}^2$ of $\Lambda_{\mathcal{G}}(\mathbf{S}_{x+x'}^1)$ by identifying them via the degree 0 isomorphism

$$\left[\mathbf{D}_0^3 \otimes (\mathbf{D}^2 \times \mathbf{I})_{\mathrm{T}^{\mathrm{id}_{V_{g_x}^* \otimes V_i}}} \right]$$

and where we confuse the objects $\mathbf{D}_{(+, V_i^* \otimes V_{g_x} \otimes V)}^2$ and $\mathbf{D}_{((- , V_i), (+, V_{g_x}), (+, V))}^2$ of $\Lambda_{\mathcal{G}}(\mathbf{S}_{x+x'}^1)$ by identifying them via the degree 0 isomorphism

$$\left[\mathbf{D}_0^3 \otimes (\mathbf{D}^2 \times \mathbf{I})_{\mathrm{T}^{\mathrm{id}_{V_i^* \otimes V_{g_x} \otimes V}}} \right].$$

PROPOSITION 2.14.4. *For all critical indices $x, x' \in X$ the collection of the degree 0 morphisms $(\eta_{\Delta_{x,x'}})_V^0$ defines a Π -graded natural isomorphism*

$$\begin{array}{ccc} \hat{\mathbb{P}}\mathrm{roj}(\mathcal{E}_{x+x'}) & \xrightarrow{\hat{\Delta}_{x,x'}} & \hat{\mathbb{P}}\mathrm{roj}(\mathcal{E}_x) \hat{\boxtimes} \hat{\mathbb{P}}\mathrm{roj}(\mathcal{E}_{x'}) \\ & \searrow \hat{\mathbb{F}}_{x+x'} & \downarrow \hat{\eta}_{\Delta_{x,x'}} \\ & & \hat{\eta}_{\mathbf{S}_x^1, \mathbf{S}_{x'}^1} \circ (\hat{\mathbb{F}}_x \hat{\boxtimes} \hat{\mathbb{F}}_{x'}) \\ & & \searrow \\ & \hat{\Lambda}_{\mathcal{G}}(\mathbf{S}_{x+x'}^1) & \xrightarrow{\hat{\mathbb{F}}_{\mathcal{G}}(\bar{\mathbf{P}}_{x,x'}^2)} \hat{\Lambda}_{\mathcal{G}}(\mathbf{S}_x^1 \otimes \mathbf{S}_{x'}^1) \end{array}$$

PROOF. Let us consider the 2-morphisms

$$\overline{\mathbf{X}}_{i,V} : \bar{\mathbf{P}}_{x,x'}^2 \circ \mathbf{D}_{(+,V)}^2 \Rightarrow \mathbf{D}_{((- , V_{g_x}), (+, V_i))}^2 \otimes \mathbf{D}_{((- , V_i), (+, V_{g_x}), (+, V))}^2$$

of $\check{\mathbf{Cob}}_3^{\mathcal{G}}$ given by

$$\overline{\mathbf{X}}_{i,V} := \left(\bar{\mathbf{X}}, \mathrm{T}_{X,x,x'}^{\prime \varphi_{i,V}}, \omega'_{x,x',i,V}, 0 \right)$$

for the ribbon graph $\mathrm{T}_{X,x,x'}^{\prime}$ represented in Figure 37.

Then the inverse of the degree 0 morphism

$$\left(\sum_{\substack{1 \leq n \leq N \\ k \in I_{g_x+x}}} \left[\mathrm{id}_{\mathbf{S}_0^2} \otimes \mathbf{X}_{k,V} \right] * \eta_{\mathbf{S}_x^1, \mathbf{S}_{x'}^1}^0 \left(\left[\mathbf{Y}_{\left(\begin{smallmatrix} -u_n \\ s_{k,j} \end{smallmatrix} \right)_{g_0}} \right] \otimes \left[\mathbf{Y}_{\left(\begin{smallmatrix} u_n \\ r_{k,j,V} \end{smallmatrix} \right)_{g_0}} \right] \right) \right)_{\substack{j=1 \\ j \in I_{g_x+x}}}$$

of

$$\mathrm{Hom}_{\hat{\Lambda}_{\mathcal{G}}(\mathbf{S}_x^1 \otimes \mathbf{S}_{x'}^1)}^0 \left(\mathrm{im} \left(\eta_{\mathbf{S}_x^1, \mathbf{S}_{x'}^1}^0 \left(\left[\mathbf{Y}_{\left(\begin{smallmatrix} -u_n \\ s_{i,j} \end{smallmatrix} \right)_{g_0}} \right] \otimes \left[\mathbf{Y}_{\left(\begin{smallmatrix} u_n \\ r_{i,j,V} \end{smallmatrix} \right)_{g_0}} \right] \right) \right), \bar{\mathbf{P}}_{x,x'}^2 \circ \mathbf{D}_{(+,V)}^2 \right),$$

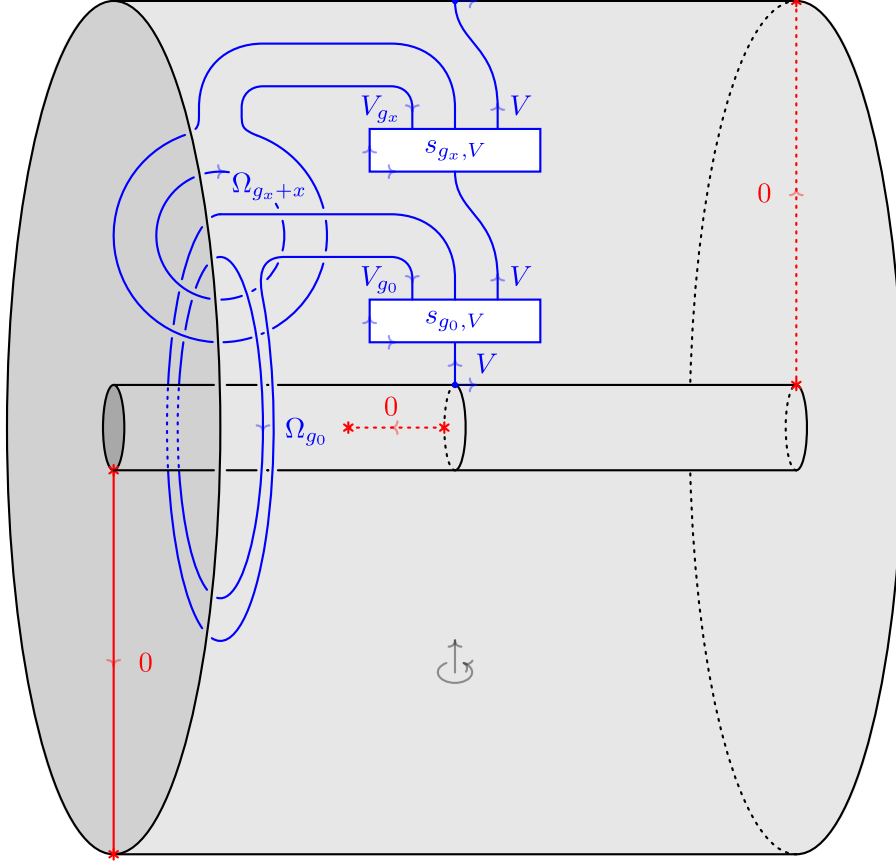

FIGURE 38. The morphism $\sum_{i \in I_{g_x+x}} d(V_i) \cdot [\mathbf{X}_{i,V} * \overline{\mathbf{X}}_{i,V}]$.

In order to show the naturality of $\eta_{\Delta_{x,x'}}$ we have to establish the equality

$$\begin{aligned} & \left(\mathbb{F}_{\mathcal{G}}(\overline{\mathbf{P}}_{x,x'}^2) \right) \left(\left[\mathbf{Y}_{f_{g_0}^u}^u \right] \right) \star \left[\mathbf{D}_0^3 \otimes \mathbf{X}_{j,V} \right] \\ &= \sum_{\substack{1 \leq \ell, m \leq N \\ k \in I_{g_x+x}}} \left[\mathbf{D}_0^3 \otimes \mathbf{X}_{k,V''} \right] \star \eta_{\mathbf{S}_x^1, \mathbf{S}_{x'}^1}^u \left(\left[\mathbf{Y}_{\left(\begin{smallmatrix} -u_\ell - u_m \\ s_{\ell,m,k,j} \end{smallmatrix} \right)_{g_0}} \right] \otimes \left[\mathbf{Y}_{\left(\begin{smallmatrix} u_\ell + u + u_m \\ r_{\ell,m,k,j,f^u} \end{smallmatrix} \right)_{g_0}} \right] \right) \end{aligned}$$

of degree u morphisms of

$$\text{Hom}_{\Delta_{\mathcal{G}}(\mathbf{S}_x^1 \otimes \mathbf{S}_{x'}^1)}^0 \left(\text{im} \left(\eta_{\mathbf{S}_x^1, \mathbf{S}_{x'}^1}^0 \left(\left[\mathbf{Y}_{\left(\begin{smallmatrix} -u_n \\ s_{i,j} \end{smallmatrix} \right)_{g_0}} \right] \otimes \left[\mathbf{Y}_{\left(\begin{smallmatrix} u_n \\ r_{i,j,V} \end{smallmatrix} \right)_{g_0}} \right] \right) \right), \overline{\mathbf{P}}_{x,x'}^2 \circ \mathbf{D}_{(+, V'')}^2 \right)$$

for every $j \in I_{g_x+x}$, for every $u \in \Pi$ and for every $f^u \in \text{Hom}_{\text{Proj}(\mathcal{G}_{x+x'})}^u(V, V'')$. This is done by using Lemmas 2.8.2 and 2.13.1. \square

2.14.3. 2-Cylinders. The last cobordisms we are left to analyse are somewhat simpler than the preceding ones. Let us consider indices $g, g' \in G$.

DEFINITION 2.14.4. The (g, g') -colored 2-cylinder

$$\mathbf{I}_{g'} \times \mathbf{S}_g^1 : \mathbf{S}_g^1 \rightarrow \mathbf{S}_g^1$$

is the 1-morphism of $\check{\mathbf{Cob}}_3^{\mathcal{E}}$ given by

$$(\mathbf{I} \times \mathbf{S}^1, \varnothing^{\varnothing}, I_{g'} \times (\xi_g)_{A_{S^1}}, H_1(I \times S^1; \mathbb{R}))$$

where $I_{g'} \times (\xi_g)_{A_{S^1}} := (I_{g'} \times \xi_g)_{\varnothing}$ is the unique G -coloring of $(\mathbf{I} \times \mathbf{S}^1, \varnothing)$ extending $(\xi_g)_{A_{S^1}}$ and $(\xi_g)_{A_{S^1}}$ which satisfies $\langle I_{g'} \times \xi_g, I \times \{A_{S^1}\} \rangle = g'$. See Figure 39 for a graphical representation.

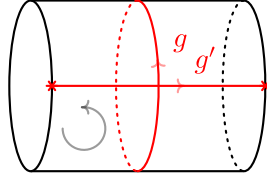

FIGURE 39. The 1-morphism $\mathbf{I}_{g'} \times \mathbf{S}_g^1$.

For all indices $g, g' \in G$ let

$$\mathbb{I}_{g, g'} : \text{Proj}(\mathcal{E}_g) \rightarrow \text{Proj}(\mathcal{E}_g)$$

be the Π -graded linear functor given by the identity on objects of $\text{Proj}(\mathcal{E}_g)$ and by a factor $\psi(-g', u)$ rescaling on degree u morphism vector spaces of $\text{Proj}(\mathcal{E}_g)$.

For all indices $g, g' \in G$ and for every object V of $\text{Proj}(\mathcal{E}_g)$ we define $(\eta_{I_{g, g'}})_V^0$ to be the degree 0 morphism

$$\left[\mathbf{D}_0^3 \otimes \left(\mathbf{D}_{(+, V)}^2 \times \mathbf{I}_{g'} \right) \right] \in \text{Hom}_{\hat{\Lambda}_{\mathcal{E}}(\mathbf{S}_g^1)}^0 \left(\mathbf{D}_{(+, V)}^2, (\mathbf{I}_{g'} \times \mathbf{S}_g^1) \circ \mathbf{D}_{(+, V)}^2 \right)$$

determined by the 2-morphism $\mathbf{D}_{(+, V)}^2 \times \mathbf{I}_{g'}$ of $\check{\mathbf{Cob}}_3^{\mathcal{E}}$ which was introduced in Remark 2.13.2 and which is represented in Figure 2.13.2, where we confuse the objects $\mathbf{D}_{(+, V), g'}^2$ and $(\mathbf{I}_{g'} \times \mathbf{S}_g^1) \circ \mathbf{D}_{(+, V)}^2$ of $\Lambda_{\mathcal{E}}(\mathbf{S}_g^1)$ by identifying them via the degree 0 isomorphism induced by any positive diffeomorphism from D^2 to $D^2 \cup_{S^1} (I \times S^1)$.

PROPOSITION 2.14.5. For all indices $g, g' \in G$ the collection of the degree 0 morphisms $(\eta_{I_{g, g'}})_V^0$ defines a Π -graded natural isomorphism

$$\begin{array}{ccc} \hat{\text{Proj}}(\mathcal{E}_g) & \xrightarrow{\mathbb{I}_{g, g'}} & \hat{\text{Proj}}(\mathcal{E}_g) \\ & \searrow \hat{\mathbb{F}}_g & \downarrow \hat{\eta}_{I_{g, g'}} \\ & & \hat{\Lambda}_{\mathcal{E}}(\mathbf{S}_g^1) \\ & & \xrightarrow{\hat{\mathbb{F}}_{\mathcal{E}}(\mathbf{I}_{g'} \times \mathbf{S}_g^1)} \hat{\Lambda}_{\mathcal{E}}(\mathbf{S}_g^1) \end{array}$$

PROOF. The degree 0 morphism $(\eta_{I_{g,g'}})_V^0$ is clearly invertible for every object V of $\mathbb{P}\text{roj}(\mathcal{C}_g)$ and the equality

$$\begin{aligned} & \left[\left((\text{id}_{\mathbf{I}_{g'}} \times \mathbf{s}_g^1) \circ \mathbf{Y}_{f_{g_0}^u}^u \right) * \left(\mathbf{D}_{(+,V)}^2 \times \mathbf{I}_{g'} \right) \right] \\ &= \psi(-g', u) \cdot \left[\left(\text{id}_{\mathbf{S}_{-u}^2} \otimes \left(\mathbf{D}_{(+,V)}^2 \times \mathbf{I}_{g'} \right) \right) * \mathbf{Y}_{f_{g_0}^u}^u \right] \end{aligned}$$

of degree u morphisms of $\text{Hom}_{\Lambda(\mathbf{S}_g^1)}(\mathbf{D}_{(+,V)}^2, \mathbf{D}_{(+,V'')}^2)$, which holds for every degree u morphism f^u of $\text{Hom}_{\mathbb{P}\text{roj}(\mathcal{C}_g)}(V, V'')$, follows from remarks which were made during the proof of Theorem 2.13.1. \square

We are missing one last family of generating 1-morphisms of $\check{\mathbf{Cob}}_3^{\mathcal{C}}$ from our description: indeed for every generic index $g \in G \setminus X$ the g -colored 1-sphere \mathbf{S}_g^1 of $\check{\mathbf{Cob}}_3^{\mathcal{C}}$ is dualizable, but the left counit given by the g -colored 2-cylinder $\bar{\mathbf{P}}_{g,-g}^2 \circ \mathbf{D}^2$, which is admissible, cannot be obtained from the previous 1-morphisms because \mathbf{D}^2 is not admissible. However we do not need any extra work in order to figure out the covariant universal \mathbb{Z} -graded linear functor $\mathbb{F}_{\mathcal{C}}(\bar{\mathbf{P}}_{g,-g}^2 \circ \mathbf{D}^2)$.

Let us consider the object

$$\Delta_{g,-g}(\mathbb{1}) := \bigoplus_{i \in I_g} (V_i, V_i^*)$$

of $\mathbb{P}\text{roj}(\mathcal{C}_g) \hat{\boxtimes} \mathbb{P}\text{roj}(\mathcal{C}_{-g})$.

For every index j in I_g , let us consider the 2-morphism

$$\mathbf{X}_j : \mathbf{D}_{(+,V_j)}^2 \otimes \mathbf{D}_{(-,V_j)}^2 \Rightarrow \bar{\mathbf{P}}_{g,g'}^2 \circ \mathbf{D}^2$$

of $\check{\mathbf{Cob}}_3^{\mathcal{C}}$ given by

$$(X, \mathbb{T}_{X,g}^{\varphi_j}, \omega_{X,g,j}, 0)$$

for the admissible \mathcal{C} -skein $(\mathbb{T}_{X,g}^{\varphi_j}, \omega_{X,g,j})$ represented in Figure 40.

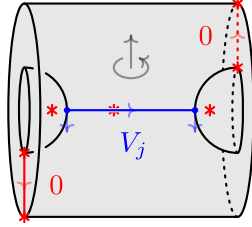

FIGURE 40. The 2-morphism \mathbf{X}_j of $\check{\mathbf{Cob}}_3^{\mathcal{C}}$.

Then we define $\eta_{\Delta_{g,-g}(\mathbb{1})}^0$ to be the degree 0 morphism

$$([\mathbf{D}_0^3 \otimes \mathbf{X}_j])_{j \in I_g}^1$$

of

$$\text{Hom}_{\hat{\Lambda}_{\mathcal{C}}(\mathbf{S}_g^1 \otimes \mathbf{S}_{-g}^1)}^0 \left(\bigoplus_{j \in I_g} \mathbf{D}_{(+,V_j)}^2 \otimes \mathbf{D}_{(+,V_j)}^2, \bar{\mathbf{P}}_{g,-g}^2 \circ \mathbf{D}^2 \right),$$

where we confuse the objects $\mathbf{D}_{(+, V_j^*)}^2$ of $\Lambda_{\mathcal{C}}(\mathbf{S}_{-g}^1)$ and $\mathbf{D}_{(-, V_j)}^2$ by identifying them via the degree 0 isomorphism

$$\left[\mathbf{D}_0^3 \otimes (\mathbf{D}^2 \times \mathbf{I})_{\mathbb{T}^{\text{id}_{V_j^*}}} \right]$$

which was introduced in Remark 2.14.1.

For every generic index $g \in G \setminus X$ we get a \mathbb{H} -graded natural isomorphism

$$\begin{array}{ccc} \mathbb{C} & \xrightarrow{\hat{\Delta}_{g, g'}(\mathbb{1})} & \hat{\mathbb{P}}\text{roj}(\mathcal{C}_g) \hat{\boxtimes} \hat{\mathbb{P}}\text{roj}(\mathcal{C}_{-g}) \\ & \searrow \text{id}_{\emptyset} & \downarrow \hat{\eta}_{\Delta_{g, -g}(\mathbb{1})} \\ & & \hat{\Lambda}_{\mathcal{C}}(\emptyset) \xrightarrow{\hat{\mathbb{F}}_{\mathcal{C}}(\overline{\mathbf{P}}_{g, -g}^2 \circ \mathbf{D}^2)} \hat{\Lambda}_{\mathcal{C}}(\mathbf{S}_g^1 \otimes \mathbf{S}_{-g}^1) \\ & & \hat{\eta}_{\mathbf{S}_g^1, \mathbf{S}_{-g}^1} \circ (\hat{\mathbb{F}}_g \hat{\boxtimes} \hat{\mathbb{F}}_{-g}) \end{array}$$

2.14.4. Examples of computations. For every $1 \leq n \in \mathbb{N}$ we fix an oriented trivalent graph Φ_n inside $\mathbb{R}^2 \times \{0\} \subset \mathbb{R}^3$ like the one represented in Figure 41.

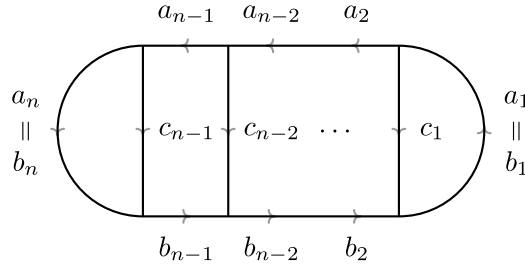

FIGURE 41. Trivalent graph of genus n . For $n = 1$ it has a unique edge a and no vertex, while for $n > 1$ it has $3n - 3$ edges, named according to the picture, and $2n - 2$ vertices.

Let Σ_n be a standard closed surface of genus n obtained as the boundary of a standard tubular neighborhood of Φ_n in \mathbb{R}^3 . Let us consider the ordered basis $\{\alpha_1, \dots, \alpha_n, \alpha'_1, \dots, \alpha'_n\}$ of $H_1(\Sigma_n; \mathbb{Z})$ defined as follows: for $n = 1$ we take α to be the homology class determined by a positive meridian of a and α' to be homology class determined by the cycle a , which has to be pushed into Σ_n using the vertical framing. For $n > 1$ we take α_ℓ to be the homology class determined by a positive meridian of the edge a_ℓ and we take α'_ℓ to be the homology class determined as before by a certain cycle in Φ_n , where α'_1 corresponds to $a_1 + c_1$, where α'_ℓ corresponds to $a_\ell + c_\ell + b_\ell - c_{\ell-1}$ for all $1 < \ell < n$ and where α'_n corresponds to $a_n - c_{n-1}$.

We will adopt the notation $\vec{g} = (g_1, \dots, g_n)$ for elements of G^n . For all $\vec{g}, \vec{g}' \in G^n$ we denote with $\Sigma_{n, \vec{g}, \vec{g}'} : \emptyset \rightarrow \emptyset$ the 1-morphism of $\mathbf{Cob}_3^{\mathcal{E}}$ given by

$$(\Sigma_n, \emptyset^{\emptyset}, (\vartheta_{\vec{g}, \vec{g}'})_{B_{\Sigma_n}}, \mathcal{L}_{\Sigma_n})$$

where the base set B_{Σ_n} is composed of a single point, where the cohomology class $\vartheta_{\vec{g}, \vec{g}'}$ is determined by the evaluations $\langle \vartheta_{\vec{g}, \vec{g}'}, \alpha_{\ell} \rangle = g_{\ell}$ and $\langle \vartheta_{\vec{g}, \vec{g}'}, \alpha'_{\ell} \rangle = g'_{\ell}$ for every $\ell = 1, \dots, n$ and where the Lagrangian subspace \mathcal{L}_{Σ_n} is generated by the homology classes $\alpha_1, \dots, \alpha_n$. See Figure 42 for a graphical representation.

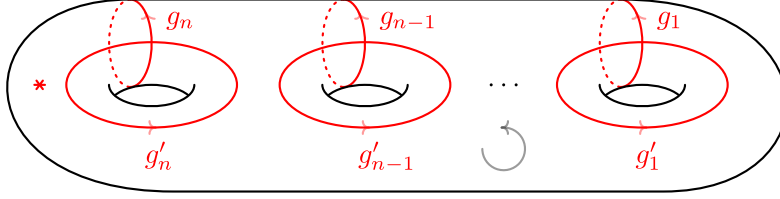

FIGURE 42. The 1-morphism $\Sigma_{n, \vec{g}, \vec{g}'}$ of $\mathbf{Cob}_3^{\mathcal{E}}$.

2.14.4.1. *Generic surfaces.* If $n = 1$ and $g \in G \setminus X$ then the set $\text{Col}(\Phi_1, g)$ of colorings of Φ_1 which are compatible with $\vartheta_{g, g'}$ is defined to be the index set I_g .

REMARK 2.14.4. We should think of elements i of $\text{Col}(\Phi_1, g)$ as labelings of the edge a of Φ_1 which are compatible with $\vartheta_{g, g'}$.

If $n > 1$ and $\vec{g} = (g_1, \dots, g_n)$ is an element of G^n then we denote with $d(\vec{g})$ the element of G^{n-1} given by $(g_2 - g_1, g_3 - g_2, \dots, g_n - g_{n-1})$. If $\vec{g} \in (G \setminus X)^n$ and $d(\vec{g}) \in (G \setminus X)^{n-1}$ then we denote with $I_{\vec{g}}$ the finite set

$$\prod_{\ell=1}^n I_{g_{\ell}} \times \prod_{\ell=1}^n I_{g_{\ell}} \times \prod_{\ell=1}^{n-1} I_{g_{\ell+1} - g_{\ell}}.$$

An element of $I_{\vec{g}}$ is denoted

$$(\vec{i}, \vec{j}, \vec{k}) := (i_1, \dots, i_n, j_1, \dots, j_n, k_1, \dots, k_{n-1}).$$

The set $\text{Col}(\Phi_n, \vec{g})$ of colorings of Φ_n which are compatible with $\vartheta_{\vec{g}, \vec{g}'}$ is the subset of $I_{\vec{g}}$ given by

$$\left\{ (\vec{i}, \vec{j}, \vec{k}) \in I_{\vec{g}} \mid i_1 = j_1, i_n = j_n \right\}.$$

REMARK 2.14.5. We should think of elements $(\vec{i}, \vec{j}, \vec{k})$ of $\text{Col}(\Phi_n, \vec{g})$ as labelings of edges of Φ_n which are compatible with $\vartheta_{\vec{g}, \vec{g}'}$, where the edge a_{ℓ} is labeled i_{ℓ} , the edge b_{ℓ} is labeled j_{ℓ} and the edge c_{ℓ} is labeled k_{ℓ} .

PROPOSITION 2.14.6. *If $n = 1$ with $g \in G \setminus X$ then $\mathbb{V}_{\mathcal{E}}(\Sigma_{1, g, g'})$ is isomorphic to*

$$\bigoplus_{i \in \text{Col}(\Phi_1, g)} \bigotimes_{\ell=1}^{n-1} \mathbb{H}\text{om}_{\mathcal{E}}(\mathbb{1}, V_i \otimes V_i^*).$$

If $n > 1$ with $\vec{g} \in (G \setminus X)^n$ and $d(\vec{g}) \in (G \setminus X)^{n-1}$ then $\mathbb{V}_{\mathcal{C}}(\Sigma_{n,\vec{g},\vec{g}'})$ is isomorphic to

$$\bigoplus_{(\vec{i},\vec{j},\vec{k}) \in \text{Col}(\Phi_n,\vec{g})} \bigotimes_{\ell=1}^{n-1} \left(\text{Hom}_{\mathcal{C}}(\mathbb{1}, V_{i_\ell}^* \otimes V_{i_{\ell+1}} \otimes V_{k_\ell}) \otimes \text{Hom}_{\mathcal{C}}(\mathbb{1}, V_{j_\ell} \otimes V_{k_\ell}^* \otimes V_{j_{\ell+1}}^*) \right).$$

PROOF. If $n = 1$ then the 1-morphism $\Sigma_{n,g,g'} : \emptyset \rightarrow \emptyset$ of $\check{\mathbf{Cob}}_3^{\mathcal{C}}$ can be decomposed, up to isomorphism, as

$$\overline{\mathbf{D}}^2 \circ \overline{\mathbf{P}}_{g,-g}^2 \circ ((\mathbf{I}_0 \times \mathbf{S}_g^1) \otimes (\mathbf{I}_{g'} \times \mathbf{S}_{-g}^1)) \circ \mathbf{P}_{g,-g}^2 \circ \mathbf{D}^2.$$

If $n > 1$ then the 1-morphism $\Sigma_{n,\vec{g},\vec{g}'} : \emptyset \rightarrow \emptyset$ of $\check{\mathbf{Cob}}_3^{\mathcal{C}}$ can be decomposed, up to isomorphism, as

$$\overline{\mathbf{D}}^2 \circ \overline{\mathbf{P}}_{g_1,-g_1}^2 \circ \Xi_{1,2} \circ \dots \circ \Xi_{n-1,n} \circ \mathbf{P}_{g_n,-g_n}^2 \circ \mathbf{D}^2$$

for the 1-morphisms $\Xi_{\ell,\ell+1} : \mathbf{S}_{g_{\ell+1}}^1 \otimes \mathbf{S}_{-g_{\ell+1}}^1 \rightarrow \mathbf{S}_{g_\ell}^1 \otimes \mathbf{S}_{-g_\ell}^1$ of $\check{\mathbf{Cob}}_3^{\mathcal{C}}$ represented Figure 43.

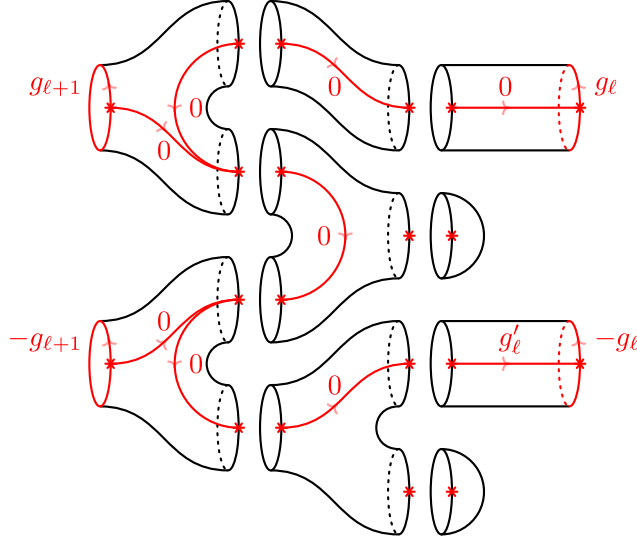

FIGURE 43. The 1-morphism $\Xi_{\ell,\ell+1}$ of $\check{\mathbf{Cob}}_3^{\mathcal{C}}$.

Then thanks to Propositions 2.14.1, 2.14.2, 2.14.3 and 2.14.5 we can conclude. \square

2.14.4.2. *Critical tori.* We will give a description also for the universal Π -graded vector space associated with a critical torus. This time, instead of colorings of trivalent graphs, we will state our result in terms of subspaces of Hom spaces.

Let V be an object of $\text{Proj}(\mathcal{C}_0)$ and let $\Sigma_{1,x,x',V} : \emptyset \rightarrow \emptyset$ denote the 1-morphism of $\check{\mathbf{Cob}}_3^{\mathcal{C}}$ given by

$$(\Sigma_1, \mathbf{P}_{\Sigma_1}^V, (\vartheta_{g,g'})_{B_{\Sigma_1}}, \mathcal{L}_{\Sigma_1})$$

where the \mathcal{C} -colored ribbon set $\mathbf{P}_{\Sigma_1}^V$ is given by a single positive point with color V .

If x is a critical index in X , if h is an arbitrary index in G and if V is an object of $\text{Proj}(\mathcal{C}_0)$ then for all indices $i, j \in I_{g_x+x}$ we denote with

$$p_{i,j,V,h} : \mathbb{H}\text{om}_{\mathcal{C}}(\mathbb{1}, V_{g_x}^* \otimes V_j \otimes V_j^* \otimes V_{g_x} \otimes V) \rightarrow \mathbb{H}\text{om}_{\mathcal{C}}(\mathbb{1}, V_{g_x}^* \otimes V_i \otimes V_i^* \otimes V_{g_x} \otimes V)$$

the \mathbb{H} -graded linear map whose degree u component $p_{i,j,V,h}^u$ maps every vector $f_{j,V}^u$ of $\mathbb{H}\text{om}_{\mathcal{C}}^u(\mathbb{1}, V_{g_x}^* \otimes V_j \otimes V_j^* \otimes V_{g_x} \otimes V)$ to the vector

$$\sum_{n=1}^N \psi(h, -u_n) \cdot \left(\nabla_{x,-x}^0 (s_{n,i,j}^{-u_n} \otimes r_{n,i,j,V}^{u_n}) \star f_{j,V}^u \right)$$

of $\mathbb{H}\text{om}_{\mathcal{C}}^u(\mathbb{1}, V_{g_x}^* \otimes V_i \otimes V_i^* \otimes V_{g_x} \otimes V)$ where, if $h \in G \setminus X$, we have

$$\zeta^{-1} d(V_i) \cdot \left(\varepsilon \otimes F_{\mathcal{C}} \left(\mathbb{T}_{x,x'}^{\varphi_{i,j,V,h}} \right) \right) = \sum_{n=1}^N \psi(h, -u_n) \cdot \nabla_{x,x'}^0 (s_{n,i,j}^{-u_n} \otimes r_{n,i,j,V}^{u_n})$$

for the \mathcal{C} -colored ribbon graph $\mathbb{T}_{x,x'}^{\varphi_{i,j,V,h}}$ represented in Figure 35.

PROPOSITION 2.14.7. *If x, x' are critical indices in X and if V is an object of $\text{Proj}(\mathcal{C}_0)$ then $\mathbb{V}_{\mathcal{C}}(\Sigma_{1,x,x',V})$ is isomorphic to*

$$\text{im} (p_{i,j,V,x'})_{i,j \in I_{g_x+x}} \subset \bigoplus_{i \in I_{g_x+x}} \mathbb{H}\text{om}_{\mathcal{C}}(\mathbb{1}, V_{g_x}^* \otimes V_i \otimes V_i^* \otimes V_{g_x} \otimes V).$$

PROOF. The 1-morphism $\Sigma_{1,x,x',V} : \emptyset \rightarrow \emptyset$ of $\check{\mathbf{C}}\text{ob}_3^{\mathcal{C}}$ can be decomposed, up to isomorphism, as

$$\overline{\mathbf{D}}^2 \circ \overline{\mathbf{P}}_{x,-x}^2 \circ \left((\mathbf{I}_0 \times \mathbf{S}_x^1) \otimes (\mathbf{I}_{x'} \times \mathbf{S}_{-x}^1) \right) \circ \mathbf{P}_{x,-x}^2 \circ \mathbf{D}_{(+,V)}^2.$$

Then thanks to Propositions 2.14.1, 2.14.2, 2.14.4 and 2.14.5 we can conclude. \square

Algebraic appendices

We recall the concepts of symmetric monoidal category and of symmetric monoidal 2-category, we introduce complete linear categories and complete graded linear categories and we present in detail a generalized version of the universal construction of Blanchet, Habegger, Masbaum and Vogel which provides an essential piece of machinery for the production of Extended Topological Quantum Field Theories.

A.1. Monoidal categories

We begin with some classical definitions. Comprehensive references are given by [EK66] and by [EGNO15].

DEFINITION A.1.1. A *monoidal category* is given by:

- (i) a category \mathcal{C} ;
- (ii) a distinguished object $\mathbb{1} \in \text{Ob}(\mathcal{C})$ called the *unit*;
- (iii) a functor $\otimes : \mathcal{C} \times \mathcal{C} \rightarrow \mathcal{C}$ called the *tensor product*;
- (iv) a family of natural isomorphisms

$$\lambda : \otimes \circ (\mathbb{1} \times \text{id}_{\mathcal{C}}) \circ \Delta_{\mathcal{C}} \Rightarrow \text{id}_{\mathcal{C}}, \quad \rho : \otimes \circ (\text{id}_{\mathcal{C}} \times \mathbb{1}) \circ \Delta_{\mathcal{C}} \Rightarrow \text{id}_{\mathcal{C}},$$

$$\alpha : \otimes \circ (\otimes \times \text{id}_{\mathcal{C}}) \Rightarrow \otimes \circ (\text{id}_{\mathcal{C}} \times \otimes)$$

called the *left unitor*, the *right unitor* and the *associator* respectively, where $\Delta_{\mathcal{C}} : \mathcal{C} \rightarrow \mathcal{C} \times \mathcal{C}$ is the diagonal functor and where $\mathbb{1} : \mathcal{C} \rightarrow \mathcal{C}$ is the constant functor mapping each object to $\mathbb{1}$ and each morphism to $\text{id}_{\mathbb{1}}$.

These data must satisfy the following conditions:

- (i) The diagram

$$\begin{array}{ccc}
 & x \otimes (\mathbb{1} \otimes y) & \\
 & \nearrow & \searrow \\
 \alpha_{x, \mathbb{1}, y} & & \text{id}_x \otimes \lambda_y \\
 \nearrow & & \searrow \\
 (x \otimes \mathbb{1}) \otimes y & \xrightarrow{\rho_x \otimes \text{id}_y} & x \otimes y
 \end{array}$$

is commutative for all objects $x, y \in \text{Ob}(\mathcal{C})$.

(ii) The diagram

$$\begin{array}{ccc}
 & \alpha_{x,y \otimes z,w} & \\
 & (x \otimes (y \otimes z)) \otimes w \longrightarrow x \otimes ((y \otimes z) \otimes w) & \\
 \nearrow & & \searrow \\
 \alpha_{x,y,z} \otimes \text{id}_w & & \text{id}_x \otimes \alpha_{y,z,w} \\
 \nearrow & & \searrow \\
 ((x \otimes y) \otimes z) \otimes w & & x \otimes (y \otimes (z \otimes w)) \\
 \searrow & & \nearrow \\
 \alpha_{x \otimes y,z,w} & & \alpha_{x,y,z \otimes w} \\
 & (x \otimes y) \otimes (z \otimes w) &
 \end{array}$$

is commutative for all objects $x, y, z \in \text{Ob}(\mathcal{C})$.

Monoidal categories were first introduced as *categories with multiplication* by Bénabou in [B63].

LEMMA A.1.1. *If \mathcal{C} is a monoidal category then $\lambda_{\mathbb{1}} = \rho_{\mathbb{1}}$, $\lambda_x \otimes \text{id}_y = \lambda_{x \otimes y} \circ \alpha_{\mathbb{1},x,y}$ and $\rho_{x \otimes y} = (\text{id}_x \otimes \rho_y) \circ \alpha_{x,y,\mathbb{1}}$ for all objects $x, y \in \text{Ob}(\mathcal{C})$.*

A proof of this result can be found in [K64].

DEFINITION A.1.2. A monoidal category \mathcal{C} is *strict* if the natural isomorphisms λ, ρ and α are identity natural isomorphisms.

DEFINITION A.1.3. A *braided monoidal category* is given by:

- (i) a monoidal category \mathcal{C} ;
- (ii) a natural isomorphism

$$\beta : \otimes \Rightarrow \otimes \circ \tau$$

called the *braiding*, where $\tau : \mathcal{C} \times \mathcal{C} \rightarrow \mathcal{C} \times \mathcal{C}$ denotes the functor switching the two factors.

These data must makes the following diagrams

$$\begin{array}{ccc}
 & \beta_{x,y \otimes z} & \\
 & x \otimes (y \otimes z) \longrightarrow (y \otimes z) \otimes x & \\
 \nearrow & & \searrow \\
 \alpha_{x,y,z} & & \alpha_{y,z,x} \\
 \nearrow & & \searrow \\
 (x \otimes y) \otimes z & & y \otimes (z \otimes x) \\
 \searrow & & \nearrow \\
 \beta_{x,y} \otimes \text{id}_z & & \text{id}_y \otimes \beta_{x,z} \\
 \searrow & & \nearrow \\
 (y \otimes x) \otimes z \longrightarrow y \otimes (x \otimes z) & & \\
 \alpha_{y,x,z} & &
 \end{array}$$

$$\begin{array}{ccc}
& \beta_{x \otimes y, z} & \\
& (x \otimes y) \otimes z \longrightarrow z \otimes (x \otimes y) & \\
& \nearrow & \searrow \\
\alpha_{x,y,z}^{-1} & & \alpha_{z,x,y}^{-1} \\
x \otimes (y \otimes z) & & (z \otimes x) \otimes y \\
& \searrow & \nearrow \\
\text{id}_x \otimes \beta_{y,z} & & \beta_{x,z} \otimes \text{id}_y \\
& \searrow & \nearrow \\
x \otimes (z \otimes y) & \longrightarrow & (x \otimes z) \otimes y \\
& \alpha_{x,z,y}^{-1} &
\end{array}$$

into commutative ones for all objects $x, y, z \in \text{Ob}(\mathcal{C})$.

See [JS93] for a reference on braided monoidal categories.

DEFINITION A.1.4. A braided monoidal category \mathcal{C} is *symmetric* if the diagram

$$\begin{array}{ccc}
& y \otimes x & \\
& \nearrow & \searrow \\
\beta_{x,y} & & \beta_{y,x} \\
& \nearrow & \searrow \\
x \otimes y & \xrightarrow{\text{id}_{x \otimes y}} & x \otimes y
\end{array}$$

is commutative for all objects $x, y \in \text{Ob}(\mathcal{C})$.

EXAMPLE A.1.1. The category Cat whose objects are categories and whose morphisms are functors, with monoidal structure given by the cartesian product \times of categories and with unit given by the discrete category $\mathbb{1}$ with a single object $*$ is a symmetric monoidal category.

EXAMPLE A.1.2. The category $\text{Vect}_{\mathbb{C}}$ whose objects are vector spaces and whose morphisms are linear maps, with monoidal structure given by the standard tensor product \otimes of vector spaces and with unit given by 1-dimensional vector space \mathbb{C} is a symmetric monoidal category.

DEFINITION A.1.5. A *monoidal functor* $F : \mathcal{C} \rightarrow \mathcal{C}'$ between monoidal categories \mathcal{C} and \mathcal{C}' is given by:

- (i) a functor $F : \mathcal{C} \rightarrow \mathcal{C}'$;
- (ii) an isomorphism $\varepsilon : \mathbb{1}' \rightarrow F(\mathbb{1})$;
- (iii) a natural isomorphism $\mu : \otimes' \circ (F \times F) \Rightarrow F \circ \otimes$.

These data must satisfy the following conditions:

(i) The diagrams

$$\begin{array}{ccc}
 & \mu_{\mathbb{1},x} & \\
 F(\mathbb{1}) \otimes' F(x) & \longrightarrow & F(\mathbb{1} \otimes x) \\
 \uparrow & & \downarrow \\
 \varepsilon \otimes' \text{id}_{F(x)} & & (\text{id}_F \circ \lambda)_x \\
 \downarrow & & \downarrow \\
 \mathbb{1}' \otimes' F(x) & \longrightarrow & F(x) \\
 & \lambda'_{F(x)} & \\
 & \mu_{x,\mathbb{1}} & \\
 F(x) \otimes' F(\mathbb{1}) & \longrightarrow & F(x \otimes \mathbb{1}) \\
 \uparrow & & \downarrow \\
 \text{id}_{F(x)} \otimes' \varepsilon & & (\text{id}_F \circ \rho)_x \\
 \downarrow & & \downarrow \\
 F(x) \otimes' \mathbb{1}' & \longrightarrow & F(x) \\
 & \rho'_{F(x)} &
 \end{array}$$

are commutative for every object $x \in \text{Ob}(\mathcal{C})$.

(ii) The diagram

$$\begin{array}{ccc}
 & \text{id}_{F(x)} \otimes' \mu_{y,z} & \\
 F(x) \otimes' (F(y) \otimes' F(z)) & \longrightarrow & F(x) \otimes' F(y \otimes z) \\
 \uparrow & & \downarrow \\
 \alpha'_{F(x),F(y),F(z)} & & \mu_{x,y \otimes z} \\
 (F(x) \otimes' F(y)) \otimes' F(z) & & F(x \otimes (y \otimes z)) \\
 \downarrow & & \uparrow \\
 \mu_{x,y} \otimes' \text{id}_{F(z)} & & (\text{id}_F \circ \alpha)_{x,y,z} \\
 \downarrow & & \downarrow \\
 F(x \otimes y) \otimes' F(z) & \longrightarrow & F((x \otimes y) \otimes z) \\
 & \mu_{x \otimes y, z} &
 \end{array}$$

is commutative for all objects $x, y, z \in \text{Ob}(\mathcal{C})$.

DEFINITION A.1.6. A *braided monoidal functor* $F : \mathcal{C} \rightarrow \mathcal{C}'$ between braided monoidal categories \mathcal{C} and \mathcal{C}' is a monoidal functor which makes the diagram

$$\begin{array}{ccc}
 & F(y) \otimes' F(x) & \\
 & \nearrow & \searrow \\
 F(x) \otimes' F(y) & & F(y \otimes x) \\
 & \nwarrow & \nearrow \\
 & F(x \otimes y) &
 \end{array}$$

$\beta'_{F(x), F(y)}$ (left arrow), $\mu_{y,x}$ (top-right arrow), $\mu_{x,y}$ (bottom-left arrow), $(\text{id}_F \circ \beta)_{x,y}$ (bottom-right arrow)

into a commutative one for all objects $x, y \in \text{Ob}(\mathcal{C})$.

A braided monoidal functor between symmetric monoidal categories will be called a *symmetric monoidal functor*.

A.2. Enriched categories

The standard reference for the material introduced in this section is [K82]. Let us fix a monoidal category \mathcal{K} .

DEFINITION A.2.1. A \mathcal{K} -enriched category \mathcal{C} given by:

- (i) a class $\text{Ob}(\mathcal{C})$ whose elements are called *objects*;
- (ii) an object $\text{Hom}_{\mathcal{C}}(x, y)$ of \mathcal{K} for all $x, y \in \text{Ob}(\mathcal{C})$ which is called the \mathcal{K} -object of morphisms;
- (iii) a morphism 1_x in $\text{Hom}_{\mathcal{K}}(\mathbb{1}, \text{Hom}_{\mathcal{C}}(x, x))$ for all $x \in \text{Ob}(\mathcal{C})$ called the *identity \mathcal{K} -morphism*;
- (iv) a morphism $c_{x,y,z}$ in $\text{Hom}_{\mathcal{K}}(\text{Hom}_{\mathcal{C}}(y, z) \otimes \text{Hom}_{\mathcal{C}}(x, y), \text{Hom}_{\mathcal{C}}(x, z))$ for all $x, y, z \in \text{Ob}(\mathcal{C})$ called the *composition \mathcal{K} -morphism*;

These data must satisfy the following conditions:

- (i) The diagrams of morphisms of \mathcal{K}

$$\begin{array}{ccc}
 & \text{Hom}_{\mathcal{C}}(y, y) \otimes \text{Hom}_{\mathcal{C}}(x, y) & \\
 & \nearrow & \searrow \\
 1_y \otimes \text{id}_{\text{Hom}_{\mathcal{C}}(x, y)} & & c_{x,y,y} \\
 & \nwarrow & \nearrow \\
 \mathbb{1} \otimes \text{Hom}_{\mathcal{C}}(x, y) & \xrightarrow{\quad \quad \quad} & \text{Hom}_{\mathcal{C}}(x, y) \\
 & \lambda_{\text{Hom}_{\mathcal{C}}(x, y)} &
 \end{array}$$

$$\begin{array}{ccc}
& \text{Hom}_{\mathcal{C}}(x, y) \otimes \text{Hom}_{\mathcal{C}}(x, x) & \\
& \nearrow & \searrow \\
& \text{id}_{\text{Hom}_{\mathcal{C}}(x, y)} \otimes 1_x & c_{x, x, y} \\
& \swarrow & \searrow \\
\text{Hom}_{\mathcal{C}}(x, y) \otimes \mathbb{1} & \xrightarrow{\rho_{\text{Hom}_{\mathcal{C}}(x, y)}} & \text{Hom}_{\mathcal{C}}(x, y)
\end{array}$$

are commutative for all objects $x, y \in \text{Ob}(\mathcal{C})$.

(ii) The diagram of morphisms of \mathcal{K}

$$\begin{array}{ccccc}
& & \text{Hom}_{\mathcal{C}}(y, w) \otimes \text{Hom}_{\mathcal{C}}(x, y) & & \\
& & \nearrow & & \searrow \\
& & c_{y, z, w} \otimes \text{id}_{\text{Hom}_{\mathcal{C}}(x, y)} & & c_{x, y, w} \\
& & \swarrow & & \searrow \\
\text{Hom}_{\mathcal{C}}(z, w) \otimes \text{Hom}_{\mathcal{C}}(y, z) \otimes \text{Hom}_{\mathcal{C}}(x, y) & & & & \text{Hom}_{\mathcal{C}}(x, w) \\
& & \swarrow & & \searrow \\
& & \text{id}_{\text{Hom}_{\mathcal{C}}(z, w)} \otimes c_{x, y, z} & & c_{x, z, w} \\
& & \searrow & & \swarrow \\
& & \text{Hom}_{\mathcal{C}}(z, w) \otimes \text{Hom}_{\mathcal{C}}(x, z) & &
\end{array}$$

is commutative for all objects $x, y, z, w \in \text{Ob}(\mathcal{C})$.

DEFINITION A.2.2. A \mathcal{K} -enriched functor $F : \mathcal{C} \rightarrow \mathcal{C}'$ between \mathcal{K} -enriched categories \mathcal{C} and \mathcal{C}' is given by:

- (i) a function $F : \text{Ob}(\mathcal{C}) \rightarrow \text{Ob}(\mathcal{C}')$;
- (ii) a morphism $F_{x, y}$ in $\text{Hom}_{\mathcal{K}}(\text{Hom}_{\mathcal{C}}(x, y), \text{Hom}_{\mathcal{C}'}(F(x), F(y)))$ for all $x, y \in \text{Ob}(\mathcal{C})$;

These data must satisfy the following conditions:

(i) The diagram of morphisms of \mathcal{K}

$$\begin{array}{ccc}
& \mathbb{1}_{F(x)} & \\
& \nearrow & \searrow \\
\mathbb{1} & \xrightarrow{\quad} & \text{Hom}_{\mathcal{C}'}(F(x), F(x)) \\
& \swarrow & \searrow \\
& 1_x & F_{x, x} \\
& \searrow & \swarrow \\
& \text{Hom}_{\mathcal{C}}(x, x) &
\end{array}$$

is commutative for every object $x \in \text{Ob}(\mathcal{C})$.

(ii) The diagram of morphisms of \mathcal{K}

$$\begin{array}{ccc}
 & \text{Hom}_{\mathcal{E}'}(F(y), F(z)) \otimes \text{Hom}_{\mathcal{E}'}(F(x), F(y)) & \\
 & \nearrow \quad \quad \quad \searrow & \\
 F_{y,z} \otimes F_{x,y} & & c_{F(x), F(y), F(z)} \\
 \nearrow \quad \quad \quad \searrow & & \\
 \text{Hom}_{\mathcal{E}}(y, z) \otimes \text{Hom}_{\mathcal{E}}(x, y) & & \text{Hom}_{\mathcal{E}'}(F(x), F(z)) \\
 \searrow \quad \quad \quad \nearrow & & \\
 c_{x,y,z} & & F_{x,z} \\
 \searrow \quad \quad \quad \nearrow & & \\
 & \text{Hom}_{\mathcal{E}}(x, z) &
 \end{array}$$

is commutative for all objects $x, y, z \in \text{Ob}(\mathcal{E})$.

DEFINITION A.2.3. A \mathcal{K} -enriched functor $F : \mathcal{E} \rightarrow \mathcal{E}'$ is fully faithful if $F_{x,y}$ is an isomorphism for all objects $x, y \in \text{Ob}(\mathcal{E})$.

DEFINITION A.2.4. A \mathcal{K} -enriched natural transformation $\eta : F \Rightarrow G$ between \mathcal{K} -enriched functors $F : \mathcal{E} \rightarrow \mathcal{E}'$ and $G : \mathcal{E} \rightarrow \mathcal{E}'$ is given by a \mathcal{K} -morphism $\eta_x \in \text{Hom}_{\mathcal{K}}(\mathbb{1}, \text{Hom}_{\mathcal{E}'}(F(x), G(x)))$ for all $x \in \text{Ob}(\mathcal{E})$ making the diagram of \mathcal{K} -morphisms

$$\begin{array}{ccc}
 & \text{Hom}_{\mathcal{E}}(x, y) \otimes \mathbb{1} & \\
 & \nearrow \quad \quad \quad \searrow & \\
 \rho_{\text{Hom}_{\mathcal{E}}(x,y)}^{-1} & & G_{x,y} \otimes \eta_x \\
 \nearrow \quad \quad \quad \searrow & & \\
 \text{Hom}_{\mathcal{E}}(x, y) & & \text{Hom}_{\mathcal{E}'}(G(x), G(y)) \otimes \text{Hom}_{\mathcal{E}'}(F(x), G(x)) \\
 \uparrow \quad \quad \quad \downarrow & & \\
 \lambda_{\text{Hom}_{\mathcal{E}}(x,y)} & & c_{F(x), G(x), G(y)} \\
 \downarrow & & \downarrow \\
 \mathbb{1} \otimes \text{Hom}_{\mathcal{E}}(x, y) & & \text{Hom}_{\mathcal{E}'}(F(x), G(y)) \\
 \searrow \quad \quad \quad \nearrow & & \\
 \eta_y \otimes F_{x,y} & & c_{F(x), F(y), G(y)} \\
 \searrow \quad \quad \quad \nearrow & & \\
 & \text{Hom}_{\mathcal{E}'}(F(y), G(y)) \otimes \text{Hom}_{\mathcal{E}'}(F(x), F(y)) &
 \end{array}$$

into a commutative one for all objects $x, y \in \text{Ob}(\mathcal{E})$.

DEFINITION A.2.5. The *vertical composition* $\vartheta * \eta : F \Rightarrow H$ for \mathcal{K} -enriched natural transformations $\eta : F \Rightarrow G$ and $\vartheta : G \Rightarrow H$ is the \mathcal{K} -enriched natural transformation defined by

$$(\vartheta * \eta)_x := c_{F(x), G(x), H(x)} \circ (\vartheta_x \otimes \eta_x) \circ \lambda_{\mathbb{1}}^{-1}.$$

REMARK A.2.1. If \mathcal{C} and \mathcal{C}' are \mathcal{K} -enriched categories then we can arrange \mathcal{K} -enriched functors and \mathcal{K} -enriched natural transformations between them into a category $\text{Cat}_{\mathcal{K}}(\mathcal{C}, \mathcal{C}')$.

DEFINITION A.2.6. The *underlying category* \mathcal{C}_0 of a \mathcal{K} -enriched category \mathcal{C} is the category $\text{Cat}_{\mathcal{K}}(\mathbb{1}, \mathcal{C})$ where $\mathbb{1}$ denotes the \mathcal{K} -enriched category with a single object $*$ with a single \mathcal{K} -object of morphisms $\text{Hom}_{\mathbb{1}}(*, *) = \mathbb{1} \in \text{Ob}(\mathcal{K})$.

DEFINITION A.2.7. The *\mathcal{K} -enriched unit category* $\mathbb{1}$ is the \mathcal{K} -enriched category with a single object $*$ and with \mathcal{K} -object of morphisms $\text{Hom}_{\mathbb{1}}(*, *) := \mathbb{1} \in \text{Ob}(\mathcal{K})$.

DEFINITION A.2.8. The *\mathcal{K} -enriched tensor product* $\mathcal{C} \boxtimes \mathcal{C}'$ of \mathcal{K} -enriched categories \mathcal{C} and \mathcal{C}' is the \mathcal{K} -enriched category with $\text{Ob}(\mathcal{C} \boxtimes \mathcal{C}')$ given by

$$\text{Ob}(\mathcal{C}) \times \text{Ob}(\mathcal{C}')$$

and with $\text{Hom}_{\mathcal{C} \boxtimes \mathcal{C}'}((x, x'), (y, y'))$ given by

$$\text{Hom}_{\mathcal{C}}(x, y) \otimes \text{Hom}_{\mathcal{C}'}(x', y') \in \text{Ob}(\mathcal{K})$$

for all objects $x, y \in \text{Ob}(\mathcal{C})$ and $x', y' \in \text{Ob}(\mathcal{C}')$.

A.3. 2-Categories

Standard references for this section are provided by [B67], [KS74] and [G74].

DEFINITION A.3.1. A *2-category* \mathcal{C} (sometimes called a *weak 2-category* or a *bicategory*) is given by:

- (i) a class $\text{Ob}(\mathcal{C})$ whose elements are called *objects*;
- (ii) a category $\mathcal{C}(x, y)$ for all $x, y \in \text{Ob}(\mathcal{C})$ whose objects are called *1-morphisms*, whose morphisms are called *2-morphisms* and whose composition is called the *vertical composition* (1-morphisms will be represented by arrows $f : x \rightarrow y$, 2-morphisms will be represented by double-struck arrows $\alpha : f \Rightarrow g$ and the vertical composition of $\beta : g \Rightarrow h$ and $\alpha : f \Rightarrow g$ will be denoted $\beta * \alpha : f \Rightarrow h$);
- (iii) a functor $1_x : \mathbb{1} \rightarrow \mathcal{C}(x, x)$ for all $x \in \text{Ob}(\mathcal{C})$ called the *identity* (here $\mathbb{1}$ stands for the unity with respect to the cartesian product of categories, and the image under 1_x of the unique object of $\mathbb{1}$ will be denoted id_x);
- (iv) a functor $c_{x,y,z} : \mathcal{C}(y, z) \times \mathcal{C}(x, y) \rightarrow \mathcal{C}(x, z)$ for all $x, y, z \in \text{Ob}(\mathcal{C})$ called the *horizontal composition* (the horizontal composition of $g : y \rightarrow z$ and $f : x \rightarrow y$ will be denoted $g \circ f : x \rightarrow z$ and the horizontal composition of $\beta : h \Rightarrow k$ and $\alpha : f \Rightarrow g$ will be denoted $\beta \circ \alpha : h \circ f \Rightarrow k \circ g$);
- (v) natural isomorphisms $\ell_{x,y}$ and $r_{x,y}$ for all $x, y \in \text{Ob}(\mathcal{C})$ of the form

$$\begin{array}{ccc}
 & \mathcal{C}(y, y) \times \mathcal{C}(x, y) & \\
 & \swarrow \quad \searrow & \\
 1_y \times \text{id}_{\mathcal{C}(x, y)} & & c_{x, y, y} \\
 \swarrow \quad \searrow & \Downarrow & \\
 \mathbb{1} \times \mathcal{C}(x, y) & \xrightarrow{\quad} & \mathcal{C}(x, y) \\
 & \lambda_{\mathcal{C}(x, y)} &
 \end{array}$$

$$\begin{array}{ccc}
& \mathcal{C}(x, y) \times \mathcal{C}(x, x) & \\
& \nearrow & \searrow \\
\text{id}_{\mathcal{C}(x, y)} \times 1_x & & c_{x, x, y} \\
& \Downarrow & \\
& r_{x, y} & \\
\mathcal{C}(x, y) \times \mathbb{1} & \xrightarrow{\quad} & \mathcal{C}(x, y) \\
& \rho_{\mathcal{C}(x, y)} &
\end{array}$$

called the *left unitor* and the *right unitor* respectively, where

$$\lambda : \otimes \circ (\mathbb{1} \times \text{id}_{\text{Cat}}) \circ \Delta_{\text{Cat}} \Rightarrow \text{id}_{\text{Cat}}, \quad \rho : \otimes \circ (\text{id}_{\text{Cat}} \times \mathbb{1}) \circ \Delta_{\text{Cat}} \Rightarrow \text{id}_{\text{Cat}},$$

are the left and the right unitors of the symmetric monoidal category Cat ;

(vi) a natural isomorphism $a_{x, y, z, w}$ for all $x, y, z, w \in \text{Ob}(\mathcal{C})$ of the form

$$\begin{array}{ccccc}
& & \mathcal{C}(y, w) \times \mathcal{C}(x, y) & & \\
& & \nearrow & & \searrow \\
& & c_{y, z, w} \times \text{id}_{\mathcal{C}(x, y)} & & c_{x, y, w} \\
& & \nearrow & & \searrow \\
\mathcal{C}(z, w) \times \mathcal{C}(y, z) \times \mathcal{C}(x, y) & & \Downarrow & & \mathcal{C}(x, w) \\
& & a_{x, y, z, w} & & \\
& & \text{id}_{\mathcal{C}(z, w)} \times c_{x, y, z} & & c_{x, z, w} \\
& & \searrow & & \nearrow \\
& & \mathcal{C}(z, w) \times \mathcal{C}(x, z) & &
\end{array}$$

called the *associator*.

These data must satisfy the following conditions:

(i) The diagram of 2-morphisms

$$\begin{array}{ccc}
& g \circ (\text{id}_y \circ f) & \\
& \nearrow & \searrow \\
(a_{x, y, y, z})_{g, \text{id}_y, f} & & \text{id}_g \circ (\ell_{x, y})_f \\
& \nearrow & \searrow \\
(g \circ \text{id}_y) \circ f & \xrightarrow{\quad} & g \circ f \\
& (r_{x, y})_g \circ \text{id}_f &
\end{array}$$

is commutative for all objects $x, y \in \text{Ob}(\mathcal{C})$ and for all 1-morphisms $f : x \rightarrow y, g : y \rightarrow z$.

(ii) The diagram of 2-morphisms

$$\begin{array}{ccc}
 & (a_{x,y,w,t})_{k,h \circ g, f} & \\
 & (k \circ (h \circ g)) \circ f \Longrightarrow k \circ ((h \circ g) \circ f) & \\
 \nearrow & & \searrow \\
 (a_{y,z,w,t})_{k,h,g} \circ \text{id}_f & & \text{id}_k \circ (a_{x,y,z,w})_{h,g,f} \\
 \nearrow & & \searrow \\
 ((k \circ h) \circ g) \circ f & & k \circ (h \circ (g \circ f)) \\
 \searrow & & \nearrow \\
 (a_{x,y,z,t})_{k \circ h, g, f} & & (a_{x,z,w,t})_{k,h,g \circ f} \\
 \searrow & & \nearrow \\
 & (k \circ h) \circ (g \circ f) &
 \end{array}$$

is commutative for all objects $x, y, z, w, t \in \text{Ob}(\mathcal{C})$ and all 1-morphisms $f : x \rightarrow y, g : y \rightarrow z, h : z \rightarrow w, k : w \rightarrow t$.

EXAMPLE A.3.1. The 2-category **Ring** is defined as follows: objects are rings R with unit; the category **Ring** (R, R') is the category whose objects are (R', R) -bimodules and whose morphisms are (R', R) -bimodule homomorphisms, with vertical composition given by composition of (R', R) -bimodule homomorphism; the horizontal composition functor

$$c_{R,R',R''} : \mathbf{Ring}(R', R'') \times \mathbf{Ring}(R, R') \rightarrow \mathbf{Ring}(R, R'')$$

maps (M', M) to the (R'', R) -bimodule $M' \otimes_{R'} M$.

DEFINITION A.3.2. If \mathcal{C} is a 2-category then its *opposite 2-category* \mathcal{C}^{op} is the 2-category defined by $\text{Ob}(\mathcal{C}^{\text{op}}) := \text{Ob}(\mathcal{C})$ and by $\mathcal{C}^{\text{op}}(x, y) := \mathcal{C}(y, x)$ for all $x, y \in \text{Ob}(\mathcal{C})$.

DEFINITION A.3.3. A *2-functor* $\mathbf{F} : \mathcal{C} \rightarrow \mathcal{C}'$ between 2-categories \mathcal{C} and \mathcal{C}' is given by:

- (i) a function $\mathbf{F} : \text{Ob}(\mathcal{C}) \rightarrow \text{Ob}(\mathcal{C}')$;
- (ii) a functor $\mathbf{F}_{x,y} : \mathcal{C}(x, y) \rightarrow \mathcal{C}'(\mathbf{F}(x), \mathbf{F}(y))$ for all $x, y \in \text{Ob}(\mathcal{C})$;
- (iii) a natural isomorphism \mathbf{F}_x for all $x \in \text{Ob}(\mathcal{C})$ of the form

$$\begin{array}{ccc}
 & \mathbb{1}_{\mathbf{F}(x)} & \\
 \mathbb{1} & \xrightarrow{\quad} & \mathcal{C}'(\mathbf{F}(x), \mathbf{F}(x)) \\
 & \searrow & \nearrow \\
 & \mathbb{1}_x & \mathbf{F}_{x,x} \\
 & \searrow & \nearrow \\
 & \mathcal{C}(x, x) &
 \end{array}$$

(we will use the abusive notation $\mathbf{F}_x : \text{id}_{\mathbf{F}(x)} \Rightarrow \mathbf{F}_{x,x}(\text{id}_x)$ for the associated invertible 2-morphism);

(iv) a natural isomorphism $\mathbf{F}_{x,y,z}$ for all $x, y, z \in \text{Ob}(\mathcal{C})$ of the form

$$\begin{array}{ccccc}
 & & \mathcal{C}'(\mathbf{F}(y), \mathbf{F}(z)) \times \mathcal{C}'(\mathbf{F}(x), \mathbf{F}(y)) & & \\
 & \nearrow & & \nwarrow & \\
 & \mathbf{F}_{y,z} \times \mathbf{F}_{x,y} & & c_{\mathbf{F}(x), \mathbf{F}(y), \mathbf{F}(z)} & \\
 & \nearrow & & \searrow & \\
 \mathcal{C}(y, z) \times \mathcal{C}(x, y) & & \Downarrow & & \mathcal{C}'(\mathbf{F}(x), \mathbf{F}(z)) \\
 & \searrow & \mathbf{F}_{x,y,z} & \nearrow & \\
 & c_{x,y,z} & & \mathbf{F}_{x,z} & \\
 & \searrow & & \nearrow & \\
 & & \mathcal{C}(x, z) & &
 \end{array}$$

These data must satisfy the following conditions:

(i) the diagrams of 2-morphisms

$$\begin{array}{ccc}
 & (\mathbf{F}_{x,y,y})_{\text{id}_y, f} & \\
 \mathbf{F}_{y,y}(\text{id}_y) \circ \mathbf{F}_{x,y}(f) & \Longrightarrow & \mathbf{F}_{x,y}(\text{id}_y \circ f) \\
 \uparrow \parallel & & \parallel \downarrow \\
 \mathbf{F}_y \circ \text{id}_{\mathbf{F}_{x,y}(f)} & & \mathbf{F}_{x,y}((\ell_{x,y})_f) \\
 \parallel \downarrow & & \parallel \downarrow \\
 \text{id}_{\mathbf{F}(y)} \circ \mathbf{F}_{x,y}(f) & \Longrightarrow & \mathbf{F}_{x,y}(f) \\
 & (\ell_{\mathbf{F}(x), \mathbf{F}(y)})_{\mathbf{F}_{x,y}(f)} & \\
 & (\mathbf{F}_{x,x,y})_{f, \text{id}_x} & \\
 (\mathbf{F}_{x,y})(f) \circ \mathbf{F}_{x,x}(\text{id}_x) & \Longrightarrow & \mathbf{F}_{x,y}(f \circ \text{id}_x) \\
 \uparrow \parallel & & \parallel \downarrow \\
 \text{id}_{\mathbf{F}_{x,y}(f)} \circ \mathbf{F}_x & & \mathbf{F}_{x,y}((r_{x,y})_f) \\
 \parallel \downarrow & & \parallel \downarrow \\
 \mathbf{F}_{x,y}(f) \circ \text{id}_{\mathbf{F}(x)} & \Longrightarrow & \mathbf{F}_{x,y}(f) \\
 & (r_{\mathbf{F}(x), \mathbf{F}(y)})_{\mathbf{F}_{x,y}(f)} &
 \end{array}$$

are commutative for all objects $x, y \in \text{Ob}(\mathcal{C})$ and for all 1-morphisms $f : x \rightarrow y$;

(ii) The diagram of 2-morphisms

$$\begin{array}{ccc}
& (\mathbf{F}_{z,w}(h) \circ \mathbf{F}_{y,z}(g)) \circ \mathbf{F}_{x,y}(f) & \\
& \swarrow \quad \searrow & \\
\mathbf{F}_{z,w}(h) \circ (\mathbf{F}_{y,z}(g) \circ \mathbf{F}_{x,y}(f)) & & (\mathbf{F}_{y,z,x})_{h,g} \circ \text{id}_{\mathbf{F}_{x,y}(f)} \\
\parallel & & \searrow \\
\text{id}_{\mathbf{F}_{z,w}(h)} \circ (\mathbf{F}_{x,y,z})_{g,f} & & \mathbf{F}_{y,w}(h \circ g) \circ \mathbf{F}_{x,y}(f) \\
\parallel & & \parallel \\
\mathbf{F}_{z,w}(h) \circ \mathbf{F}_{x,z}(g \circ f) & & \mathbf{F}_{x,w}((h \circ g) \circ f) \\
\searrow & & \swarrow \\
& (\mathbf{F}_{x,z,w})_{h,g \circ f} & \mathbf{F}_{x,w}((a_{x,y,z,w})_{h,g,f}) \\
& \searrow & \swarrow \\
& \mathbf{F}_{x,w}(h \circ (g \circ f)) &
\end{array}$$

is commutative for all objects $x, y, z, w \in \text{Ob}(\mathcal{C})$ and all 1-morphisms $f : x \rightarrow y$, $g : y \rightarrow z$, $h : z \rightarrow w$ and where the unlabeled arrow is

$$(a_{\mathbf{F}(x), \mathbf{F}(y), \mathbf{F}(z), \mathbf{F}(w)})_{\mathbf{F}_{z,w}(h), \mathbf{F}_{y,z}(g), \mathbf{F}_{x,y}(f)}.$$

DEFINITION A.3.4. A 2-transformation $\sigma : \mathbf{F} \Rightarrow \mathbf{G}$ between a pair of 2-functors $\mathbf{F} : \mathcal{C} \rightarrow \mathcal{C}'$ and $\mathbf{G} : \mathcal{C} \rightarrow \mathcal{C}'$ is given by:

- (i) a 1-morphism $\sigma_x : \mathbf{F}(x) \rightarrow \mathbf{G}(x)$ for all $x \in \text{Ob}(\mathcal{C})$;
- (ii) a natural isomorphism $\sigma_{x,y}$ for all $x, y \in \text{Ob}(\mathcal{C})$ of the form

$$\begin{array}{ccccc}
& & \mathcal{C}'(\mathbf{G}(x), \mathbf{G}(y)) & & \\
& & \nearrow & & \searrow \\
& \mathbf{G}_{x,y} & & & (\sigma_x)^* \\
& \nearrow & & & \searrow \\
\mathcal{C}(x, y) & & & & \mathcal{C}'(\mathbf{F}(x), \mathbf{G}(y)) \\
& \searrow & \Downarrow & & \nearrow \\
& \mathbf{F}_{x,y} & \sigma_{x,y} & & (\sigma_y)_* \\
& \searrow & & & \nearrow \\
& & \mathcal{C}'(\mathbf{F}(x), \mathbf{F}(y)) & &
\end{array}$$

where $(\sigma_x)^*$ is the functor horizontally pre-composing 1-morphisms of $\mathcal{C}'(\mathbf{G}(x), \mathbf{G}(y))$ with σ_x and $(\sigma_y)_*$ is the functor horizontally post-composing 1-morphisms of $\mathcal{C}'(\mathbf{F}(x), \mathbf{F}(y))$ with σ_y .

These data must satisfy the following conditions:

(i) The diagram of 2-morphisms

$$\begin{array}{ccc}
 & & r_{\mathbf{F}(x), \mathbf{G}(x)}^{-1} \\
 & & \sigma_x \rightleftarrows \sigma_x \circ \text{id}_{\mathbf{F}(x)} \\
 & \nearrow \ell_{\mathbf{F}(x), \mathbf{G}(x)} & \searrow \text{id}_{\sigma_x} \circ \mathbf{F}_x \\
 \text{id}_{\mathbf{G}(x)} \circ \sigma_x & & \sigma_x \circ \mathbf{F}_{x,x}(\text{id}_x) \\
 \searrow \mathbf{G}_x \circ \text{id}_{\sigma_x} & & \nearrow (\sigma_{x,x})\text{id}_x \\
 & \mathbf{G}_{x,x}(\text{id}_x) \circ \sigma_x &
 \end{array}$$

is commutative for all objects $x \in \text{Ob}(\mathcal{B})$.

(ii) The diagram of 2-morphisms

$$\begin{array}{ccc}
 & & (\mathbf{G}_{y,z}(g) \circ \sigma_y) \circ \mathbf{F}_{x,y}(f) \\
 & \nearrow & \searrow \\
 \mathbf{G}_{y,z}(g) \circ (\sigma_y \circ \mathbf{F}_{x,y}(f)) & & (\sigma_z \circ \mathbf{F}_{y,z}(g)) \circ \mathbf{F}_{x,y}(f) \\
 \nearrow (2) & & \searrow (5) \\
 \mathbf{G}_{y,z}(g) \circ (\mathbf{G}_{x,y}(f) \circ \sigma_x) & & \sigma_z \circ (\mathbf{F}_{y,z}(g) \circ \mathbf{F}_{x,y}(f)) \\
 \nearrow (1) & & \searrow (6) \\
 (\mathbf{G}_{y,z}(g) \circ \mathbf{G}_{x,y}(f)) \circ \sigma_x & & \sigma_z \circ \mathbf{F}_{x,z}(g \circ f) \\
 \searrow & & \nearrow \\
 & \mathbf{G}_{x,z}(g \circ f) \circ \sigma_x &
 \end{array}$$

is commutative for all objects $x, y, z \in \text{Ob}(\mathcal{B})$ and for all 1-morphisms $f : x \rightarrow y$, $g : y \rightarrow z$ with respect to the following labeling of the unlabeled arrows (starting from (1) and moving clockwise):

$$\begin{array}{ll}
 (1) = (a_{\mathbf{F}(x), \mathbf{G}(x), \mathbf{G}(y), \mathbf{G}(z)})_{\mathbf{G}_{y,z}(g), \mathbf{G}_{x,y}(f), \sigma_x})^{-1} & (2) = \text{id}_{\mathbf{G}_{y,z}(g)} \circ (\sigma_{x,y})f \\
 (3) = (a_{\mathbf{F}(x), \mathbf{F}(y), \mathbf{G}(y), \mathbf{G}(z)})_{\mathbf{G}_{y,z}(g), \sigma_y, \mathbf{F}_{x,y}(f)})^{-1} & (4) = (\sigma_{y,z})g \circ \text{id}_{\mathbf{F}_{x,y}(f)} \\
 (5) = (a_{\mathbf{F}(x), \mathbf{F}(y), \mathbf{F}(z), \mathbf{G}(z)})_{\sigma_z, \mathbf{F}_{y,z}(g), \mathbf{F}_{x,y}(f)}) & (6) = \text{id}_{\sigma_z} \circ (\mathbf{F}_{x,y,z})g, f \\
 (7) = (\sigma_{x,z})g \circ f & (8) = (\mathbf{G}_{x,y,z})g, f \circ \text{id}_{\sigma_x}
 \end{array}$$

DEFINITION A.3.5. A *2-modification* $\Gamma : \sigma \Rightarrow \vartheta$ between 2-transformations $\sigma : \mathbf{F} \Rightarrow \mathbf{G}$ and $\vartheta : \mathbf{F} \Rightarrow \mathbf{G}$ is given by a 2-morphism $\Gamma_x : \sigma_x \Rightarrow \vartheta_x$ for all $x \in \text{Ob}(\mathcal{C})$ making the following diagram of 2-morphisms

$$\begin{array}{ccc}
 & \mathbf{G}_{x,y}(f) \circ \vartheta_x & \\
 & \swarrow \text{id}_{\mathbf{G}_{x,y}(f)} \circ \Gamma_x & \searrow (\vartheta_{x,y})_f \\
 \mathbf{G}_{x,y}(f) \circ \sigma_x & & \vartheta_y \circ \mathbf{F}_{x,y}(f) \\
 \searrow (\sigma_{x,y})_f & & \swarrow \Gamma_y \circ \text{id}_{\mathbf{F}_{x,y}(f)} \\
 & \sigma_y \circ \mathbf{F}_{x,y}(f) &
 \end{array}$$

into a commutative one for all objects $x, y \in \text{Ob}(\mathcal{C})$ and all 1-morphisms $f : x \rightarrow y$.

EXAMPLE A.3.2. If we fix a pair 2-categories \mathcal{C} and \mathcal{C}' then 2-functors from \mathcal{C} to \mathcal{C}' , together with 2-transformations and 2-modifications between them, can be arranged into a 2-category which will be denoted $\mathbf{2Cat}(\mathcal{C}, \mathcal{C}')$.

DEFINITION A.3.6. Two objects x, y of a 2-category \mathcal{C} are *equivalent* if there exist 1-morphisms $f : x \rightarrow y$, $g : y \rightarrow x$ and invertible 2-morphisms $\eta : \text{id}_x \Rightarrow g \circ f$, $\varepsilon : f \circ g \Rightarrow \text{id}_y$. The 1-morphisms f and g are called *equivalences* between x and y . If further η and ε satisfy

$$(\text{id}_g \circ \varepsilon) * (\eta \circ \text{id}_g) = \text{id}_g, \quad (\varepsilon \circ \text{id}_f) * (\text{id}_f \circ \eta) = \text{id}_f$$

then $(f, g, \eta, \varepsilon)$ is called an *equivalence adjunction system*, f is called the *left adjoint* of g , g is called the *right adjoint* of f , η is called the *unit of the adjunction* and ε is called the *counit of the adjunction*.

REMARK A.3.1. For every pair of equivalent objects $x, y \in \text{Ob}(\mathcal{C})$ there exists an equivalence adjunction system $(f, g, \eta, \varepsilon)$.

Let $\mathbf{F} : \mathcal{C} \rightarrow \mathcal{C}'$ and $\mathbf{G} : \mathcal{C} \rightarrow \mathcal{C}'$ be 2-functors between 2-categories \mathcal{C} and \mathcal{C}' . A 2-transformation $\sigma : \mathbf{F} \Rightarrow \mathbf{G}$ is called an *equivalence 2-transformation* if it can be completed to an equivalence adjunction system $(\sigma, \sigma^*, \mathbf{H}_\sigma, \mathbf{E}_\sigma)$ inside $\mathbf{2Cat}(\mathcal{C}, \mathcal{C}')$ for some 2-transformation $\sigma^* : \mathbf{G} \Rightarrow \mathbf{F}$ and for some invertible 2-modifications $\mathbf{H}_\sigma : \text{id}_{\mathbf{F}} \Rightarrow \sigma^* \circ \sigma$, $\mathbf{E}_\sigma : \sigma \circ \sigma^* \Rightarrow \text{id}_{\mathbf{G}}$.

DEFINITION A.3.7. A *strict 2-category* \mathcal{C} is a 2-category whose unitors and associators are identities. It can be equivalently defined as a Cat -enriched category.

EXAMPLE A.3.3. The strict 2-category \mathbf{Cat} is defined as follows: objects are categories \mathcal{C} ; the category of morphisms $\mathbf{Cat}(\mathcal{C}, \mathcal{C}')$ is the category whose objects are functors from \mathcal{C} to \mathcal{C}' and whose morphisms are natural transformations.

EXAMPLE A.3.4. The strict 2-category $\mathbf{Cat}_{\mathcal{K}}$ is defined as follows: objects are \mathcal{K} -enriched categories \mathcal{C} ; the category of morphisms $\mathbf{Cat}_{\mathcal{K}}(\mathcal{C}, \mathcal{C}')$ is the category whose objects are \mathcal{K} -enriched functors from \mathcal{C} to \mathcal{C}' and whose morphisms are \mathcal{K} -enriched natural transformations.

Two categories are said to be *equivalent* if they are equivalent as objects of the strict 2-category \mathbf{Cat} . Two \mathcal{K} -enriched categories are said to be *equivalent* if they are equivalent as objects of the strict 2-category $\mathbf{Cat}_{\mathcal{K}}$.

A.4. Monoidal 2-categories

References for this section are provided by [M00], [S16] and [S11].

DEFINITION A.4.1. A *monoidal 2-category* is given by:

- (i) a 2-category \mathcal{C} ;
- (ii) a distinguished object $\mathbb{1} \in \text{Ob}(\mathcal{C})$ called the *unit*;
- (iii) a 2-functor $\otimes : \mathcal{C} \times \mathcal{C} \rightarrow \mathcal{C}$ called the *tensor product*;
- (iv) a family of equivalence 2-transformations

$$\lambda : \otimes \circ (\mathbb{1} \times \text{id}_{\mathcal{C}}) \circ \Delta_{\mathcal{C}} \Rightarrow \text{id}_{\mathcal{C}}, \quad \rho : \otimes \circ (\text{id}_{\mathcal{C}} \times \mathbb{1}) \circ \Delta_{\mathcal{C}} \Rightarrow \text{id}_{\mathcal{C}},$$

$$\alpha : \otimes \circ (\otimes \times \text{id}_{\mathcal{C}}) \Rightarrow \otimes \circ (\text{id}_{\mathcal{C}} \times \otimes)$$

called the *left unitor*, the *right unitor* and the *associator* respectively, where $\Delta_{\mathcal{C}} : \mathcal{C} \rightarrow \mathcal{C} \times \mathcal{C}$ is the diagonal 2-functor and where $\mathbb{1} : \mathcal{C} \rightarrow \mathcal{C}$ denotes the constant 2-functor mapping each object to $\mathbb{1}$, together with specified equivalence adjunction systems

$$(\lambda, \lambda^*, \mathbf{H}_{\lambda}, \mathbf{E}_{\lambda}), \quad (\rho, \rho^*, \mathbf{H}_{\rho}, \mathbf{E}_{\rho}), \quad (\alpha, \alpha^*, \mathbf{H}_{\alpha}, \mathbf{E}_{\alpha});$$

- (v) invertible 2-modifications \mathbf{A} , \mathbf{P} , \mathbf{M} and $\mathbf{\Pi}$ of the form

$$\begin{array}{ccc} \begin{array}{c} \mathbb{1} \otimes (x \otimes y) \\ \swarrow \quad \searrow \\ \alpha_{\mathbb{1}, x, y} \quad \lambda_{x \otimes y} \\ \swarrow \quad \searrow \\ (\mathbb{1} \otimes x) \otimes y \quad \xrightarrow{\lambda_x \otimes \text{id}_y} \quad x \otimes y \end{array} & & \begin{array}{c} x \otimes (y \otimes \mathbb{1}) \\ \swarrow \quad \searrow \\ \alpha_{x, y, \mathbb{1}} \quad \text{id}_x \otimes \rho_y \\ \swarrow \quad \searrow \\ (x \otimes y) \otimes \mathbb{1} \quad \xrightarrow{\rho_{x \otimes y}} \quad x \otimes y \end{array} \\ \downarrow \mathbf{A}_{x, y} & & \downarrow \mathbf{P}_{x, y} \\ \begin{array}{c} x \otimes (\mathbb{1} \otimes y) \\ \swarrow \quad \searrow \\ \alpha_{x, \mathbb{1}, y} \quad \text{id}_x \otimes \lambda_y \\ \swarrow \quad \searrow \\ (x \otimes \mathbb{1}) \otimes y \quad \xrightarrow{\rho_x \otimes \text{id}_y} \quad x \otimes y \end{array} \end{array}$$

$$\begin{array}{ccc}
& \alpha_{x,y \otimes z,w} & \\
(x \otimes (y \otimes z)) \otimes w & \longrightarrow & x \otimes ((y \otimes z) \otimes w) \\
& \nearrow & \searrow \\
\alpha_{x,y,z} \otimes \text{id}_w & & \text{id}_x \otimes \alpha_{y,z,w} \\
& \downarrow & \downarrow \\
((x \otimes y) \otimes z) \otimes w & \xrightarrow{\Pi_{x,y,z,w}} & x \otimes (y \otimes (z \otimes w)) \\
& \searrow & \nearrow \\
& \alpha_{x \otimes y,z,w} & \alpha_{x,y,z \otimes w} \\
& \searrow & \nearrow \\
& (x \otimes y) \otimes (z \otimes w) &
\end{array}$$

These data must satisfy five conditions in the form of commuting polytopes of 2-modifications which can be found in Definition 4.4 of [S16].

EXAMPLE A.4.1. The strict 2-category $\mathbf{Cat}_{\mathcal{K}}$ can be made into a monoidal 2-category by specifying the \mathcal{K} -enriched unit category as a unit object and by specifying the \mathcal{K} -enriched tensor product as a tensor product 2-functor.

DEFINITION A.4.2. A *symmetric monoidal 2-category* is given by:

- (i) a monoidal 2-category \mathcal{C} ;
- (ii) an equivalence 2-transformation

$$\beta : \otimes \Rightarrow \otimes \circ \tau$$

called the *braiding*, where $\tau : \mathcal{C} \times \mathcal{C} \rightarrow \mathcal{C} \times \mathcal{C}$ denotes the 2-functor switching the two factors, together with a specified equivalence adjunction system

$$(\beta, \beta^*, \mathbf{H}_\beta, \mathbf{E}_\beta);$$

- (iii) invertible 2-modifications \mathbf{A} , \mathbf{B} and Σ of the form

$$\begin{array}{ccc}
& \beta_{x,y \otimes z} & \\
x \otimes (y \otimes z) & \longrightarrow & (y \otimes z) \otimes x \\
& \nearrow & \searrow \\
\alpha_{x,y,z} & & \alpha_{y,z,x} \\
(x \otimes y) \otimes z & & y \otimes (z \otimes x) \\
& \downarrow & \downarrow \\
& \mathbf{A}_{x,y,z} & \\
\beta_{x,y} \otimes \text{id}_z & & \text{id}_y \otimes \beta_{x,z} \\
& \searrow & \nearrow \\
(y \otimes x) \otimes z & \longrightarrow & y \otimes (x \otimes z) \\
& \alpha_{y,x,z} &
\end{array}$$

$$\begin{array}{ccc}
& \beta_{x \otimes y, z} & \\
& (x \otimes y) \otimes z \longrightarrow z \otimes (x \otimes y) & \\
& \nearrow \alpha_{x,y,z}^* & \searrow \alpha_{z,x,y}^* \\
x \otimes (y \otimes z) & \Downarrow \mathbf{B}_{x,y,z} & (z \otimes x) \otimes y \\
& \text{id}_x \otimes \beta_{y,z} & \beta_{x,z} \otimes \text{id}_y \\
& \searrow & \nearrow \\
x \otimes (z \otimes y) & \longrightarrow & (x \otimes z) \otimes y \\
& \alpha_{y,z,x}^* &
\end{array}$$

$$\begin{array}{ccc}
& y \otimes x & \\
& \nearrow \beta_{x,y} & \searrow \beta_{y,x} \\
x \otimes y & \xrightarrow{\text{id}_{x \otimes y}} & x \otimes y \\
& \Downarrow \Sigma_{x,y} &
\end{array}$$

These data must satisfy seven conditions in the form of commuting polytopes of 2-modifications which can be found in Definitions from 4.5 to 4.8 of [S16].

EXAMPLE A.4.2. Every symmetric braiding β on a monoidal category \mathcal{K} induces a symmetric braiding β on the monoidal 2-category $\mathbf{Cat}_{\mathcal{K}}$ given by the 2-transformation which associates with each pair of \mathcal{K} -enriched categories \mathcal{C} and \mathcal{C}' the \mathcal{K} -enriched functor

$$\beta_{\mathcal{C}, \mathcal{C}'} : \mathcal{C} \boxtimes \mathcal{C}' \rightarrow \mathcal{C}' \boxtimes \mathcal{C}$$

given by the function mapping every object (x, x') of $\mathcal{C} \boxtimes \mathcal{C}'$ to the object (x', x) of $\mathcal{C}' \boxtimes \mathcal{C}$ and by the \mathcal{K} -morphisms $\beta_{\text{Hom}_{\mathcal{C}}(x,y), \text{Hom}_{\mathcal{C}'}(x',y')}$ from

$$\text{Hom}_{\mathcal{C} \boxtimes \mathcal{C}'}((x, x'), (y, y')) = \text{Hom}_{\mathcal{C}}(x, y) \otimes \text{Hom}_{\mathcal{C}'}(x', y')$$

to

$$\text{Hom}_{\mathcal{C}' \boxtimes \mathcal{C}}((x', x), (y', y)) = \text{Hom}_{\mathcal{C}'}(x', y') \otimes \text{Hom}_{\mathcal{C}}(x, y).$$

Therefore when \mathcal{K} is symmetric monoidal with braiding β then $\mathbf{Cat}_{\mathcal{K}}$ can be made into a symmetric monoidal 2-category denoted $\mathbf{Cat}_{\mathcal{K}}^{\beta}$.

REMARK A.4.1. If \mathcal{C} is a symmetric monoidal 2-category then $\mathcal{C}(\mathbb{1}, \mathbb{1})$ is a symmetric monoidal category.

DEFINITION A.4.3. A *monoidal 2-functor* is given by:

- (i) a 2-functor $\mathbf{F} : \mathcal{C} \rightarrow \mathcal{C}'$;
- (ii) an equivalence $\iota : \mathbb{1}' \rightarrow \mathbf{F}(\mathbb{1})$ together with a specified equivalence adjunction system $(\iota, \iota^*, \eta_\iota, \varepsilon_\iota)$;
- (iii) an equivalence 2-transformation $\chi : \otimes' \circ (\mathbf{F} \times \mathbf{F}) \Rightarrow \mathbf{F} \circ \otimes$ together with a specified equivalence adjunction system $(\chi, \chi^*, \mathbf{H}_\chi, \mathbf{E}_\chi)$;
- (iv) invertible 2-modifications $\mathbf{\Gamma}$, $\mathbf{\Delta}$ and $\mathbf{\Omega}$ of the form

$$\begin{array}{ccc}
 & \mathbf{\chi}_{\mathbb{1},x} & \\
 \mathbf{F}(\mathbb{1}) \otimes' \mathbf{F}(x) & \xrightarrow{\quad\quad\quad} & \mathbf{F}(\mathbb{1} \otimes x) \\
 \uparrow \iota \otimes' \text{id}_{\mathbf{F}(x)} & \Downarrow \mathbf{\Gamma}_x & \downarrow (\text{id}_{\mathbf{F}} \circ \boldsymbol{\lambda})_x \\
 \mathbb{1}' \otimes' \mathbf{F}(x) & \xrightarrow{\quad\quad\quad} & \mathbf{F}(x) \\
 & \mathbf{\lambda}'_{\mathbf{F}(x)} & \\
 & \mathbf{\chi}_{x,\mathbb{1}} & \\
 \mathbf{F}(x) \otimes' \mathbf{F}(\mathbb{1}) & \xrightarrow{\quad\quad\quad} & \mathbf{F}(x \otimes \mathbb{1}) \\
 \uparrow \text{id}_{\mathbf{F}(x)} \otimes' \iota & \Downarrow \mathbf{\Delta}_x & \downarrow (\text{id}_{\mathbf{F}} \circ \boldsymbol{\rho})_x \\
 \mathbf{F}(x) \otimes' \mathbb{1}' & \xrightarrow{\quad\quad\quad} & \mathbf{F}(x) \\
 & \boldsymbol{\rho}'_{\mathbf{F}(x)} &
 \end{array}$$

$$\begin{array}{ccc}
& \text{id}_{\mathbf{F}(x)} \otimes' \chi_{y,z} & \\
& \mathbf{F}(x) \otimes' (\mathbf{F}(y) \otimes' \mathbf{F}(z)) \longrightarrow \mathbf{F}(x) \otimes' \mathbf{F}(y \otimes z) & \\
& \nearrow \alpha'_{\mathbf{F}(x), \mathbf{F}(y), \mathbf{F}(z)} & \searrow \chi_{x, y \otimes z} \\
(\mathbf{F}(x) \otimes' \mathbf{F}(y)) \otimes' \mathbf{F}(z) & \Downarrow \Omega_{x, y, z} & \mathbf{F}(x \otimes (y \otimes z)) \\
& \searrow \chi_{x, y} \otimes' \text{id}_{\mathbf{F}(z)} & \nearrow (\text{id}_{\mathbf{F}} \circ \alpha)_{x, y, z} \\
& \mathbf{F}(x \otimes y) \otimes' \mathbf{F}(z) \longrightarrow \mathbf{F}((x \otimes y) \otimes z) & \\
& \chi_{x \otimes y, z} &
\end{array}$$

These data must satisfy two conditions in the form of commuting polytopes of 2-modifications which can be obtained from Equations (HTA1) and (HTA2) of [GPS95] as explained in Definition 2.5 of [S11].

DEFINITION A.4.4. A *symmetric monoidal 2-functor* is given by:

- (i) a monoidal 2-functor $\mathbf{F} : \mathcal{C} \rightarrow \mathcal{C}'$;
- (ii) an invertible 2-modification Θ of the form

$$\begin{array}{ccc}
& \mathbf{F}(y) \otimes' \mathbf{F}(x) & \\
& \nearrow \beta'_{\mathbf{F}(x), \mathbf{F}(y)} & \searrow \chi_{y, x} \\
\mathbf{F}(x) \otimes' \mathbf{F}(y) & \Downarrow \Theta_{x, y} & \mathbf{F}(y \otimes x) \\
& \searrow \chi_{x, y} & \nearrow (\text{id}_{\mathbf{F}} \circ \beta)_{x, y} \\
& \mathbf{F}(x \otimes y) &
\end{array}$$

These data must satisfy three conditions in the form of commuting polytopes of 2-modifications which can be obtained from Equations (BHA1), (BHA2) and (SHA1) of [M00] as explained in Definition 2.5 of [S11].

A.5. Complete linear categories

Let $\text{Vect}_{\mathbb{C}}$ denote the monoidal category of complex vector spaces and complex linear maps.

DEFINITION A.5.1. A *linear category* is a $\text{Vect}_{\mathbb{C}}$ -enriched category Λ .

DEFINITION A.5.2. A *linear functor* is a $\text{Vect}_{\mathbb{C}}$ -enriched functor F between linear categories.

EXAMPLE A.5.1. If Λ and Λ' are linear categories then the category $\text{Cat}_{\mathbb{C}}(\Lambda, \Lambda')$ whose objects are linear functors $F : \Lambda \rightarrow \Lambda'$ and whose morphisms are natural transformations $\eta : F \Rightarrow F'$ naturally admits the structure of a linear category.

EXAMPLE A.5.2. If \mathcal{C} is a category then the *free linear category generated by \mathcal{C}* is defined as the linear category having the same set of objects as \mathcal{C} and having the free complex vector space generated by the set $\text{Hom}_{\mathcal{C}}(x, y)$ as vector space of morphisms between objects x and y .

EXAMPLE A.5.3. If $F : \Lambda \rightarrow \Lambda'$ is a linear functor between linear categories Λ and Λ' then the *quotient linear category $\Lambda/\ker F$* is defined as the linear category whose set of objects is given by

$$\text{Ob}(\Lambda/\ker F) := \text{Ob}(\Lambda)$$

and whose vector spaces of morphisms are given by¹

$$\text{Hom}_{\Lambda/\ker F}(x, y) := \text{Hom}_{\Lambda}(x, y)/\ker F_{x,y}$$

for all $x, y \in \text{Ob}(\Lambda)$.

DEFINITION A.5.3. The *unit linear category \mathbb{C}* is the $\text{Vect}_{\mathbb{C}}$ -enriched unit category².

DEFINITION A.5.4. The *tensor product $\Lambda \boxtimes \Lambda'$ of linear categories Λ and Λ'* is the $\text{Vect}_{\mathbb{C}}$ -enriched tensor product of linear categories.

DEFINITION A.5.5. The *trivial braiding functor $\beta_{\Lambda, \Lambda'}$ associated with linear categories Λ and Λ'* is the linear functor

$$\beta_{\Lambda, \Lambda'} : \Lambda \boxtimes \Lambda' \Rightarrow \Lambda' \boxtimes \Lambda$$

induced by the trivial braiding of vector spaces.

DEFINITION A.5.6. The symmetric monoidal 2-category $\mathbf{Cat}_{\mathbb{C}}$ of linear categories is the 2-category whose objects Λ are linear categories, whose 1-morphisms $F : \Lambda \rightarrow \Lambda'$ are linear functors and whose 2-morphisms $\eta : F \Rightarrow F'$ are natural transformations, with monoidal structure given by the unit linear category \mathbb{C} , by the tensor product of linear categories \boxtimes and by the trivial braiding β of linear categories.

DEFINITION A.5.7. A linear category is *complete* if it is closed under finite direct sums and if all its idempotents split.

¹Here $F_{x,y} : \text{Hom}_{\Lambda}(x, y) \rightarrow \text{Hom}_{\Lambda'}(F(x), F(y))$ is the linear map determined by the linear functor F .

²If \mathcal{K} is a monoidal category then the \mathcal{K} -enriched unit category is the \mathcal{K} -enriched category having a single object with \mathcal{K} -object of morphisms given by the unit object 1 of \mathcal{K} .

REMARK A.5.1. Sometimes complete linear categories are called Cauchy complete, as in [BDSV15].

DEFINITION A.5.8. The *additive completion* $\text{Mat}(\Lambda)$ of a linear category Λ is the linear category whose set of objects $\text{Ob}(\text{Mat}(\Lambda))$ is given by

$$\left\{ \bigoplus_{i=1}^{\ell} x_i := \begin{pmatrix} x_1 \\ \vdots \\ x_\ell \end{pmatrix} \middle| x_i \in \text{Ob}(\Lambda), \ell \in \mathbb{N} \right\}$$

and whose morphism vector spaces

$$\text{Hom}_{\text{Mat}(\Lambda)} \left(\bigoplus_{j=1}^{\ell} x_j, \bigoplus_{i=1}^m y_i \right)$$

are given by

$$\left\{ (f_{ij})_{\substack{1 \leq i \leq m \\ 1 \leq j \leq \ell}} := \begin{pmatrix} f_{11} & \cdots & f_{1\ell} \\ \vdots & \ddots & \vdots \\ f_{m1} & \cdots & f_{m\ell} \end{pmatrix} \middle| f_{ij} \in \text{Hom}_{\Lambda}(x_j, y_i) \right\}$$

for all $x_j, y_i \in \text{Ob}(\Lambda)$ with $i = 1, \dots, m$ and $j = 1, \dots, \ell$. The identity morphism of an object $\bigoplus_{i=1}^{\ell} x_i \in \text{Ob}(\text{Mat}(\Lambda))$ is given by the morphism

$$(\delta_{ij} \cdot \text{id}_{x_i})_{1 \leq i, j \leq \ell} \in \text{End}_{\text{Mat}(\Lambda)} \left(\bigoplus_{i=1}^{\ell} x_i \right)$$

and the composition of a morphism

$$(f_{ij})_{\substack{1 \leq i \leq m \\ 1 \leq j \leq \ell}} \in \text{Hom}_{\text{Mat}(\Lambda)} \left(\bigoplus_{j=1}^{\ell} x_j, \bigoplus_{i=1}^m y_i \right)$$

with a morphism

$$(g_{ij})_{\substack{1 \leq i \leq n \\ 1 \leq j \leq m}} \in \text{Hom}_{\text{Mat}(\Lambda)} \left(\bigoplus_{j=1}^m y_j, \bigoplus_{i=1}^n z_i \right)$$

is given by the morphism

$$\left(\sum_{k=1}^m g_{ik} \circ f_{kj} \right)_{\substack{1 \leq i \leq n \\ 1 \leq j \leq \ell}} \in \text{Hom}_{\text{Mat}(\Lambda)} \left(\bigoplus_{j=1}^{\ell} x_j, \bigoplus_{i=1}^n z_i \right)$$

REMARK A.5.2. If x is an object of a linear category Λ then we will denote with x the object $\bigoplus_{i=1} x$ of $\text{Mat}(\Lambda)$ too.

DEFINITION A.5.9. The *idempotent completion* $\text{Kar}(\Lambda)$ of a linear category Λ is the linear category whose set of objects $\text{Ob}(\text{Kar}(\Lambda))$ is given by

$$\{(x, p) \mid x \in \text{Ob}(\Lambda), p \in \text{End}_{\Lambda}(x), p \circ p = p\}$$

and whose morphism vector spaces $\text{Hom}_{\text{Kar}(\Lambda)}((x, p), (y, q))$ are given by

$$\{f \in \text{Hom}_{\Lambda}(x, y) \mid f \circ p = f = q \circ f\}$$

for all $(x, p), (y, q) \in \text{Ob}(\text{Kar}(\Lambda))$. The identity of an object (x, p) is given by the idempotent morphism p and compositions are directly inherited from compositions in Λ .

REMARK A.5.3. If x is an object of a linear category Λ then we will denote with x the object (x, id_x) of $\text{Kar}(\Lambda)$ too.

DEFINITION A.5.10. The *completion* $\hat{\Lambda}$ of a linear category Λ is defined as the linear category $\text{Kar}(\text{Mat}(\Lambda))$.

REMARK A.5.4. Every object of the completion $\hat{\Lambda}$ of a linear category Λ is of the form

$$\text{im}(p_{ij})_{1 \leq i, j \leq \ell} := \left(\left(\begin{array}{c} x_1 \\ \vdots \\ x_\ell \end{array} \right), \left(\begin{array}{ccc} p_{11} & \cdots & p_{1\ell} \\ \vdots & \ddots & \vdots \\ p_{\ell 1} & \cdots & p_{\ell\ell} \end{array} \right) \right)$$

for some natural number ℓ , for some objects x_1, \dots, x_ℓ of Λ and for some morphisms $p_{ij} \in \text{Hom}_\Lambda(x_j, x_i)$ satisfying

$$\sum_{k=1}^{\ell} p_{ik} \circ p_{kj} = p_{ij}$$

for all $i, j = 1, \dots, \ell$. Analogously every morphism of

$$\text{Hom}_{\hat{\Lambda}} \left(\text{im}(p_{ij})_{1 \leq i, j \leq \ell}, \text{im}(q_{ij})_{1 \leq i, j \leq m} \right)$$

is of the form

$$(f_{ij})_{\substack{1 \leq i \leq \ell \\ 1 \leq j \leq m}} := \left(\begin{array}{ccc} f_{11} & \cdots & f_{1\ell} \\ \vdots & \ddots & \vdots \\ f_{m1} & \cdots & f_{m\ell} \end{array} \right)$$

for some morphisms $f_{ij} \in \text{Hom}_\Lambda(x_j, y_i)$ satisfying

$$\sum_{k=1}^{\ell} f_{ik} \circ p_{kj} = f_{ij} = \sum_{k=1}^m q_{ik} \circ f_{kj}$$

for all $i = 1, \dots, m$ and $j = 1, \dots, \ell$. In practice most of the time we will drop all references to the sets of indices, either because they can be clearly deduced from the context or because it is unnecessary to choose name for them, so that objects will often simply be denoted by

$$\text{im}(p_{ij}) \in \text{Ob}(\hat{\Lambda})$$

and morphisms will often simply be denoted by

$$(f_{ij}) \in \text{Hom}_{\hat{\Lambda}}(\text{im}(p_{ij}), \text{im}(q_{ij})).$$

REMARK A.5.5. Every linear functor $F : \Lambda \rightarrow \Lambda'$ admits an extension $\hat{F} : \hat{\Lambda} \rightarrow \hat{\Lambda}'$, called the *completion of F* , mapping every object $\text{im}(p_{ij}) \in \text{Ob}(\hat{\Lambda})$ to the object

$$\text{im}(F(p_{ij})) \in \text{Ob}(\hat{\Lambda}')$$

and mapping every morphism $(f_{ij}) \in \text{Hom}_{\hat{\Lambda}}(\text{im}(p_{ij}), \text{im}(q_{ij}))$ to the morphism

$$(F(f_{ij})) \in \text{Hom}_{\hat{\Lambda}'}(\text{im}(F(p_{ij})), \text{im}(F(q_{ij})))$$

Analogously every natural transformation $\eta : F \Rightarrow G$ admits a natural extension $\hat{\eta} : \hat{F} \Rightarrow \hat{G}$, called the *completion of η* , associating with every object

$$\text{im}(p_{ij})_{1 \leq i, j \leq \ell}$$

of $\hat{\Lambda}$ the morphism

$$\left(\sum_{k=1}^{\ell} G(p_{ik}) \circ \eta_{x_k} \circ F(p_{kj}) \right)_{1 \leq i, j \leq \ell}$$

of

$$\text{Hom}_{\hat{\Lambda}'} \left(\text{im}(F(p_{ij}))_{1 \leq i, j \leq \ell}, \text{im}(G(p_{ij}))_{1 \leq i, j \leq \ell} \right).$$

DEFINITION A.5.11. The *complete unit linear category* $\hat{\mathbb{C}}$ is the completion of the unit linear category \mathbb{C} .

DEFINITION A.5.12. The *complete tensor product* $\Lambda \hat{\boxtimes} \Lambda'$ of linear categories Λ and Λ' is defined as

$$\widehat{\Lambda \boxtimes \Lambda'}.$$

DEFINITION A.5.13. The *complete braiding functor* $\hat{\beta}_{\Lambda, \Lambda'}$ associated with linear categories Λ and Λ' is the completion of the braiding functor $\beta_{\Lambda, \Lambda'}$ associated with Λ and Λ' .

DEFINITION A.5.14. The symmetric monoidal 2-category³ $\hat{\mathbf{Cat}}_{\mathbb{C}}$ of complete linear categories is the 2-category whose objects Λ are complete linear categories, whose 1-morphisms $F : \Lambda \rightarrow \Lambda'$ are linear functors and whose 2-morphisms $\eta : F \Rightarrow F'$ are natural transformations, with identities and compositions inherited by $\mathbf{Cat}_{\mathbb{C}}$ and with monoidal structure given by the complete unit linear category $\hat{\mathbb{C}}$, by the complete tensor product of linear categories $\hat{\boxtimes}$ and by the complete braiding $\hat{\beta}$ of linear categories.

DEFINITION A.5.15. The *completion* $\hat{\mathbf{F}} : \mathcal{E} \rightarrow \hat{\mathbf{Cat}}_{\mathbb{C}}$ of a 2-functor $\mathbf{F} : \mathcal{E} \rightarrow \mathbf{Cat}_{\mathbb{C}}$ is the 2-functor mapping every object x of \mathcal{E} to the completion $\hat{\mathbf{F}}(x)$ of the linear category $\mathbf{F}(x)$, mapping every 1-morphism f of \mathcal{E} to the completion $\hat{\mathbf{F}}(f)$ of the linear functor $\mathbf{F}(f)$ and mapping every 2-morphism α of \mathcal{E} to the completion $\hat{\mathbf{F}}(\alpha)$ of the natural transformation $\mathbf{F}(\alpha)$.

DEFINITION A.5.16. Two linear categories Λ and Λ' are *Morita equivalent* if their completions are equivalent as objects of $\hat{\mathbf{Cat}}_{\mathbb{C}}$.

DEFINITION A.5.17. A *Morita equivalence between linear categories* Λ and Λ' is a linear functor $F : \Lambda \rightarrow \Lambda'$ whose completion \hat{F} is part of an equivalence adjunction system in $\hat{\mathbf{Cat}}_{\mathbb{C}}$.

DEFINITION A.5.18. A set D of objects of a linear category Λ is a *dominating set for Λ* if for every object x of Λ there exist objects x_1, \dots, x_n in D and morphisms $r_i \in \text{Hom}_{\Lambda}(x_i, x)$ and $s_i \in \text{Hom}_{\Lambda}(x, x_i)$ with $i = 1, \dots, n$ satisfying

$$\text{id}_x = \sum_{i=1}^n r_i \circ s_i.$$

If D is a dominating set for Λ we say that D *dominates* Λ .

³The notation used in [BDSV15] is $\mathbf{2Vect}_{\mathbb{k}}$.

THEOREM A.5.1. *Let Λ and Λ' be linear categories and let $F : \Lambda \rightarrow \Lambda'$ be a fully faithful linear functor. If $F(\text{Ob}(\Lambda))$ dominates Λ' then F is a Morita equivalence.*

PROOF. For every object x' of Λ' we have a decomposition

$$\text{id}_{x'} = \sum_{i=1}^n r'_i \circ s'_i$$

with $r'_i \in \text{Hom}_{\Lambda'}(F(x_i), x')$, with $s'_i \in \text{Hom}_{\Lambda'}(x', F(x_i))$ and with $x_i \in \text{Ob}(\Lambda)$ for $i = 1, \dots, n$. Then let us consider the object

$$\text{im}(s'_i \circ r'_j)_{1 \leq i, j \leq n}$$

of $\hat{\Lambda}'$. This is indeed an object of the completion of Λ' because

$$\sum_{k=1}^n s'_i \circ r'_k \circ s'_k \circ r'_j = s'_i \circ \text{id}_x \circ r'_j.$$

Then x is isomorphic to $\text{im}(s'_i \circ r'_j)_{1 \leq i, j \leq n}$ as objects of $\hat{\Lambda}'$ via the invertible morphisms

$$\begin{aligned} (s'_i)_{\substack{1 \leq i \leq n \\ j=1}} &\in \text{Hom}_{\hat{\Lambda}'}(x, \text{im}(s'_i \circ r'_j)_{1 \leq i, j \leq n}), \\ (r'_j)_{\substack{i=1 \\ 1 \leq j \leq n}} &\in \text{Hom}_{\hat{\Lambda}'}(\text{im}(s'_i \circ r'_j)_{1 \leq i, j \leq n}, x). \end{aligned}$$

Indeed we have equalities

$$\begin{aligned} (s'_i \circ r'_k)_{1 \leq i, k \leq n} \circ (s'_k)_{1 \leq k \leq n} &= (s'_i)_{1 \leq i \leq n}, \\ (r'_k)_{\substack{i=1 \\ 1 \leq k \leq n}} \circ (s'_k \circ r'_j)_{1 \leq k, j \leq n} &= (r'_j)_{\substack{i=1 \\ 1 \leq j \leq n}}, \\ (r'_k)_{\substack{i=1 \\ 1 \leq k \leq n}} \circ (s'_k)_{1 \leq k \leq n} &= \text{id}_x, \\ (s'_i)_{1 \leq i \leq n} \circ (r'_j)_{\substack{k=1 \\ 1 \leq j \leq n}} &= (s'_i \circ r'_j)_{1 \leq i, j \leq n}. \end{aligned}$$

This means x is isomorphic to the image of the object

$$\text{im}(F^{-1}(s'_i \circ r'_j))_{1 \leq i, j \leq n}$$

of $\hat{\Lambda}$ under the functor \hat{F} . □

A.6. Complete graded linear categories

Let Π be an abelian group, let $\nu : \Pi \times \Pi \rightarrow \mathbb{Z}^*$ be a symmetric \mathbb{Z} -bilinear map and let Π denote the discrete category whose set of objects is given by the set of elements of Π .

DEFINITION A.6.1. A Π -graded vector space \mathbb{V} is a functor

$$\mathbb{V} : \Pi \rightarrow \text{Vect}_{\mathbb{C}}.$$

If \mathbb{V} is a Π -graded vector space then for every $u \in \Pi$ the vector space $\mathbb{V}^u := \mathbb{V}(u)$ is called the *space of degree u vectors*.

DEFINITION A.6.2. A Π -graded vector space \mathbb{V} is *locally finitely generated* if \mathbb{V}^u is finite dimensional for every $u \in \Pi$.

DEFINITION A.6.3. The *dimension of a locally finitely generated Π -graded vector space* \mathbb{V} is the function

$$\begin{aligned} \dim \mathbb{V} : \Pi &\rightarrow \mathbb{N} \\ u &\mapsto \dim \mathbb{V}^u. \end{aligned}$$

DEFINITION A.6.4. A locally finitely generated Π -graded vector space \mathbb{V} is *finitely generated* if

$$\sum_{u \in \Pi} \dim \mathbb{V}^u < +\infty.$$

DEFINITION A.6.5. A Π -graded linear map $\mathbb{f} : \mathbb{V} \rightarrow \mathbb{V}'$ for Π -graded vector spaces \mathbb{V} and \mathbb{V}' is a natural transformation

$$\mathbb{f} : \mathbb{V} \Rightarrow \mathbb{V}'.$$

If $\mathbb{f} : \mathbb{V} \rightarrow \mathbb{V}'$ is a Π -graded linear map then for every $u \in \Pi$ the vector space linear map $\mathbb{f}^u := \mathbb{f}_u \in \text{Hom}_{\mathbb{C}}(\mathbb{V}^u, \mathbb{V}'^u)$ is called the *degree u component of \mathbb{f}* .

REMARK A.6.1. If $\mathbb{f} : \mathbb{V} \rightarrow \mathbb{V}'$ is a Π -graded linear map then we can define Π -graded vector spaces $\ker \mathbb{f}$ and $\text{im } \mathbb{f}$ as

$$(\ker \mathbb{f})^u := \ker(\mathbb{f}^u), \quad (\text{im } \mathbb{f})^u := \text{im}(\mathbb{f}^u)$$

respectively.

DEFINITION A.6.6. The *unit Π -graded vector space* \mathbb{C} is the Π -graded vector space defined by

$$\mathbb{C}^u := \begin{cases} \mathbb{C} & u = 0 \\ \{0\} & u \neq 0 \end{cases}$$

DEFINITION A.6.7. The *tensor product $\mathbb{V} \otimes \mathbb{V}'$ of Π -graded vector spaces* \mathbb{V} and \mathbb{V}' is the Π -graded vector space defined by

$$(\mathbb{V} \otimes \mathbb{V}')^u := \bigoplus_{u' \in \Pi} \mathbb{V}^{u-u'} \otimes \mathbb{V}'^{u'}.$$

DEFINITION A.6.8. The ν -*braiding morphism* $\beta_{\mathbb{V}, \mathbb{V}'}^{\nu}$ associated with Π -graded vector spaces \mathbb{V} and \mathbb{V}' is the degree 0 linear map

$$\beta_{\mathbb{V}, \mathbb{V}'}^{\nu} : \mathbb{V} \otimes \mathbb{V}' \Rightarrow \mathbb{V}' \otimes \mathbb{V}$$

defined by

$$\begin{aligned} (\beta_{\mathbb{V}, \mathbb{V}'}^{\nu})_u : \bigoplus_{u' \in \Pi} \mathbb{V}^{u-u'} \otimes \mathbb{V}'^{u'} &\rightarrow \bigoplus_{u' \in \Pi} \mathbb{V}'^{u'} \otimes \mathbb{V}^{u-u'} \\ v^{u-u'} \otimes v'^{u'} &\mapsto \nu(u', u-u') \cdot v'^{u'} \otimes v^{u-u'} \end{aligned}$$

DEFINITION A.6.9. The monoidal category $\text{Vect}_{\mathbb{C}}^{\Pi}$ of Π -graded vector spaces is the category whose objects are Π -graded vector spaces, whose morphisms are Π -graded linear maps, whose identities are given by identity natural transformations, whose compositions are given by vertical compositions of natural transformations, whose unit is the unit Π -graded vector space and whose tensor product is given by the tensor product of Π -graded vector spaces. It can be made into a symmetric monoidal category by equipping it with the braiding $\beta^{\nu} : \otimes \Rightarrow \otimes \circ \tau$ defined by the ν -braiding morphism $\beta_{\mathbb{V}, \mathbb{V}'}^{\nu}$ for every pair of Π -graded vector spaces \mathbb{V} and \mathbb{V}' .

DEFINITION A.6.10. A Π -graded linear category, also called Π -graded linear category, is a $\text{Vect}_{\mathbb{C}}^{\Pi}$ -enriched category Λ .

DEFINITION A.6.11. A Π -graded linear functor is a $\text{Vect}_{\mathbb{C}}^{\Pi}$ -enriched functor \mathbb{F} between Π -graded linear categories.

DEFINITION A.6.12. A Π -graded natural transformation is a $\text{Vect}_{\mathbb{C}}^{\Pi}$ -enriched natural transformation η between Π -graded linear functors.

REMARK A.6.2. If \mathbb{A} is a Π -graded linear category, if x, y are objects of \mathbb{A} and if u is an element of Π then the vector space $(\text{Hom}_{\mathbb{A}}(x, y))^u$ will be called the *vector space of degree u morphism of \mathbb{A} from x to y* and it will be denoted $\text{Hom}_{\mathbb{A}}^u(x, y)$. The underlying category \mathbb{A}_0 of a Π -graded linear category \mathbb{A} is the linear category having $\text{Ob}(\mathbb{A})$ as set of objects and having $\text{Hom}_{\mathbb{A}}^0(x, y)$ as vector space of morphisms from x to y for all $x, y \in \text{Ob}(\mathbb{A})$.

DEFINITION A.6.13. The *unit Π -graded linear category* \mathbb{C} is the $\text{Vect}_{\mathbb{C}}^{\Pi}$ -enriched unit category.

DEFINITION A.6.14. The *tensor product $\mathbb{A} \boxtimes \mathbb{A}'$ of Π -graded linear categories \mathbb{A} and \mathbb{A}'* is the $\text{Vect}_{\mathbb{C}}^{\Pi}$ -enriched tensor product of Π -graded linear categories.

REMARK A.6.3. If \mathbb{A} and \mathbb{A}' are Π -graded linear categories then

$$\text{Hom}_{\mathbb{A} \boxtimes \mathbb{A}'}((x, x'), (y, y')) := \text{Hom}_{\mathbb{A}}(x, y) \otimes \text{Hom}_{\mathbb{A}'}(x', y')$$

for all objects x, y of \mathbb{A} and x', y' of \mathbb{A}' . If $f^u \in \text{Hom}_{\mathbb{A}}^u(x, y)$, $g^v \in \text{Hom}_{\mathbb{A}}^v(y, z)$ are morphisms of \mathbb{A} and if $f'^{u'} \in \text{Hom}_{\mathbb{A}'}^{u'}(x', y')$, $g'^{v'} \in \text{Hom}_{\mathbb{A}'}^{v'}(y', z')$ are morphisms of \mathbb{A}' then

$$f^u \otimes f'^{u'} \in \text{Hom}_{\mathbb{A} \boxtimes \mathbb{A}'}^{u+u'}((x, x'), (y, y')), \quad g^v \otimes g'^{v'} \in \text{Hom}_{\mathbb{A} \boxtimes \mathbb{A}'}^{v+v'}((y, y'), (z, z'))$$

are morphisms of $\mathbb{A} \boxtimes \mathbb{A}'$ and their composition is defined as

$$(g^v \otimes g'^{v'}) \circ (f^u \otimes f'^{u'}) := \nu(u', v) \cdot (g^v \circ f^u) \otimes (g'^{v'} \circ f'^{u'}).$$

Remark we are actually using a non-standard convention, as the standard choice would have been to use $\nu(u, v')$ as a multiplying factor instead of $\nu(u', v)$. Of course both choices produce a coherent composition laws on $\mathbb{A} \boxtimes \mathbb{A}'$.

DEFINITION A.6.15. The ν -braiding functor $\beta_{\mathbb{A}, \mathbb{A}'}^{\nu}$, associated with Π -graded linear categories \mathbb{A} and \mathbb{A}' is the Π -graded linear functor

$$\beta_{\mathbb{A}, \mathbb{A}'}^{\nu} : \mathbb{A} \boxtimes \mathbb{A}' \Rightarrow \mathbb{A}' \boxtimes \mathbb{A}$$

induced by the ν -braiding of Π -graded vector spaces.

DEFINITION A.6.16. The symmetric monoidal 2-category $\mathbf{Cat}_{\mathbb{C}}^{\Pi}$ of Π -graded linear categories with ν -braiding is the 2-category whose objects \mathbb{A} are complete Π -graded linear categories, whose 1-morphisms $\mathbb{F} : \mathbb{A} \rightarrow \mathbb{A}'$ are Π -graded linear functors and whose 2-morphisms $\eta : \mathbb{F} \Rightarrow \mathbb{F}'$ are Π -graded natural transformations, with monoidal structure given by the unit Π -graded linear category \mathbb{C} , by the tensor product of Π -graded linear categories \boxtimes and by the ν -braiding β^{ν} of Π -graded linear categories.

DEFINITION A.6.17. An object x of a Π -graded linear category \mathbb{A} is said to be the u -suspension of an object y of \mathbb{A} for some $u \in \Pi$ if there exists a degree u invertible morphism $f^u \in \text{Hom}_{\mathbb{A}}^u(x, y)$.

DEFINITION A.6.18. An object x of a Π -graded linear category \mathbb{A} is said to be the *direct sum in \mathbb{A} of a family of objects x_i of \mathbb{A} for $i \in I$* if it is the direct sum of x_i for $i \in I$ in the underlying category \mathbb{A}_0 of \mathbb{A} .

DEFINITION A.6.19. A degree 0 morphism of a Π -graded linear category Λ is said to be an *idempotent* of Λ if it is an idempotent morphism of the underlying category Λ_0 .

DEFINITION A.6.20. A Π -graded linear category Λ is *complete* if it is closed under suspensions and finite direct sums and if all of its idempotents split.

DEFINITION A.6.21. The *suspension completion* $\text{Deg}(\Lambda)$ of a Π -graded linear category Λ is the Π -graded linear category whose set of objects $\text{Ob}(\text{Deg}(\Lambda))$ is given by

$$\{(x, v) \mid x \in \text{Ob}(\Lambda), v \in \Pi\}$$

and whose degree u morphism vector spaces $\text{Hom}_{\text{Deg}(\Lambda)}^u((x, v), (y, w))$ are given by $\text{Hom}_{\Lambda}^{u+v-w}(x, y)$ for all $u \in \Pi$ and all $(x, v), (y, w) \in \text{Ob}(\text{Deg}(\Lambda))$. Identities and compositions are directly inherited from Λ .

REMARK A.6.4. If x is an object of a Π -graded linear category Λ then we will denote with x the object $(x, 0)$ of $\text{Deg}(\Lambda)$ too.

DEFINITION A.6.22. The *additive completion* $\text{Mat}(\Lambda)$ of a Π -graded linear category Λ is the Π -graded linear category whose set of objects $\text{Ob}(\text{Mat}(\Lambda))$ is given by

$$\left\{ \bigoplus_{i=1}^{\ell} x_i := \begin{pmatrix} x_1 \\ \vdots \\ x_{\ell} \end{pmatrix} \mid x_i \in \text{Ob}(\Lambda), \ell \in \mathbb{N} \right\}$$

and whose degree u morphism vector spaces

$$\text{Hom}_{\text{Mat}(\Lambda)}^u \left(\bigoplus_{j=1}^{\ell} x_j, \bigoplus_{i=1}^m y_i \right)$$

are given by

$$\left\{ (f_{ij}^u)_{\substack{1 \leq i \leq m \\ 1 \leq j \leq \ell}} := \begin{pmatrix} f_{11}^u & \cdots & f_{1\ell}^u \\ \vdots & \ddots & \vdots \\ f_{m1}^u & \cdots & f_{m\ell}^u \end{pmatrix} \mid f_{ij}^u \in \text{Hom}_{\Lambda}^u(x_j, y_i) \right\}$$

for every $u \in \Pi$ and for all $x_j, y_i \in \text{Ob}(\Lambda)$ with $i = 1, \dots, m$ and $j = 1, \dots, \ell$. The identity morphism of an object $\bigoplus_{i=1}^{\ell} x_i \in \text{Ob}(\text{Mat}(\Lambda))$ is given by the degree 0 morphism

$$(\delta_{ij} \cdot \text{id}_{x_i}^0)_{1 \leq i, j \leq \ell} \in \text{End}_{\text{Mat}(\Lambda)}^0 \left(\bigoplus_{i=1}^{\ell} x_i \right)$$

and the composition of a degree u morphism

$$(f_{ij}^u)_{\substack{1 \leq i \leq m \\ 1 \leq j \leq \ell}} \in \text{Hom}_{\text{Mat}(\Lambda)}^u \left(\bigoplus_{j=1}^{\ell} x_j, \bigoplus_{i=1}^m y_i \right)$$

with a degree v morphism

$$(g_{ij}^v)_{\substack{1 \leq i \leq n \\ 1 \leq j \leq m}} \in \text{Hom}_{\text{Mat}(\Lambda)}^v \left(\bigoplus_{j=1}^m y_j, \bigoplus_{i=1}^n z_i \right)$$

is given by the degree $u + v$ morphism

$$\left(\sum_{k=1}^m g_{ik}^v \circ f_{kj}^u \right)_{\substack{1 \leq i \leq n \\ 1 \leq j \leq \ell}} \in \text{Hom}_{\text{Mat}(\Lambda)}^{u+v} \left(\bigoplus_{j=1}^{\ell} x_j, \bigoplus_{i=1}^n z_i \right)$$

REMARK A.6.5. If x is an object of a Π -graded linear category Λ then we will denote with x the object $\bigoplus_{i=1} x$ of $\text{Mat}(\Lambda)$ too.

DEFINITION A.6.23. The *idempotent completion* $\text{Kar}(\Lambda)$ of a Π -graded linear category Λ is the Π -graded linear category whose set of objects $\text{Ob}(\text{Kar}(\Lambda))$ is given by

$$\{(x, p^0) \mid x \in \text{Ob}(\Lambda), p^0 \in \text{End}_{\Lambda}^0(x), p^0 \circ p^0 = p^0\}$$

and whose degree u morphism vector spaces $\text{Hom}_{\text{Kar}(\Lambda)}^u((x, p^0), (y, q^0))$ are given by

$$\{f^u \in \text{Hom}_{\Lambda}^u(x, y) \mid f^u \circ p^0 = f^u = q^0 \circ f^u\}$$

for all $u \in \Pi$ and all $(x, p^0), (y, q^0) \in \text{Ob}(\text{Kar}(\Lambda))$. The identity of an object (x, p^0) is given by the idempotent morphism p and compositions are directly inherited from compositions in Λ .

REMARK A.6.6. If x is an object of a Π -graded linear category Λ then we will denote with x the object (x, id_x^0) of $\text{Kar}(\Lambda)$ too.

DEFINITION A.6.24. The *completion* $\hat{\Lambda}$ of a Π -graded linear category Λ is defined as the Π -graded linear category $\text{Kar}(\text{Mat}(\text{Deg}(\Lambda)))$.

REMARK A.6.7. Every object of the completion $\hat{\Lambda}$ of a Π -graded linear category Λ is of the form

$$\text{im} \left(p_{ij}^{v_j - v_i} \right)_{1 \leq i, j \leq \ell} := \left(\left(\begin{array}{c} (x_1, v_1) \\ \vdots \\ (x_\ell, v_\ell) \end{array} \right), \left(\begin{array}{ccc} p_{11}^0 & \cdots & p_{1\ell}^{v_\ell - v_1} \\ \vdots & \ddots & \vdots \\ p_{\ell 1}^{v_1 - v_\ell} & \cdots & p_{\ell\ell}^0 \end{array} \right) \right)$$

for some natural number ℓ , for some objects x_1, \dots, x_ℓ of Λ , for some degrees $v_1, \dots, v_\ell \in \Pi$ and for some morphisms $p_{ij}^{v_j - v_i} \in \text{Hom}_{\Lambda}^{v_j - v_i}(x_j, x_i)$ satisfying

$$\sum_{k=1}^{\ell} p_{ik}^{v_k - v_i} \circ p_{kj}^{v_j - v_k} = p_{ij}^{v_j - v_i}$$

for all $i, j = 1, \dots, \ell$. Analogously every degree u morphism of

$$\text{Hom}_{\hat{\Lambda}}^u \left(\text{im} \left(p_{ij}^{v_j - v_i} \right)_{1 \leq i, j \leq \ell}, \text{im} \left(q_{ij}^{w_j - w_i} \right)_{1 \leq i, j \leq m} \right)$$

is of the form

$$\left(f_{ij}^{u+v_j-w_i} \right)_{\substack{1 \leq i \leq \ell \\ 1 \leq j \leq m}} := \left(\begin{array}{ccc} f_{11}^{u+v_1-w_1} & \cdots & f_{1\ell}^{u+v_\ell-w_1} \\ \vdots & \ddots & \vdots \\ f_{m1}^{u+v_1-w_m} & \cdots & f_{m\ell}^{u+v_\ell-w_m} \end{array} \right)$$

for some morphisms $f_{ij}^{u+v_j-w_i} \in \text{Hom}_{\Lambda}^{u+v_j-w_i}(x_j, y_i)$ satisfying

$$\sum_{k=1}^{\ell} f_{ik}^{u+v_k-w_i} \circ p_{kj}^{v_j - v_k} = f_{ij}^{u+v_j-w_i} = \sum_{k=1}^m q_{ik}^{w_k - w_i} \circ f_{kj}^{u+v_j-w_k}$$

for all $i = 1, \dots, m$ and $j = 1, \dots, \ell$. In practice most of the time we will drop all references to the sets of indices, either because they can be clearly deduced from the context or because it is unnecessary to choose name for them, so that objects will often simply be denoted by

$$\mathrm{im} \left(p_{ij}^{v_j - v_i} \right) \in \mathrm{Ob}(\hat{\Lambda})$$

and degree u morphisms will often simply be denoted by

$$\left(f_{ij}^{u+v_j-w_i} \right) \in \mathrm{Hom}_{\hat{\Lambda}}^u \left(\mathrm{im} \left(p_{ij}^{v_j - v_i} \right), \mathrm{im} \left(q_{ij}^{w_j - w_i} \right) \right).$$

REMARK A.6.8. Every Π -graded linear functor $\mathbb{F} : \Lambda \rightarrow \Lambda'$ admits an extension $\hat{\mathbb{F}} : \hat{\Lambda} \rightarrow \hat{\Lambda}'$, called the *completion of \mathbb{F}* , mapping every object $\mathrm{im}(p_{ij}^{v_j - v_i}) \in \mathrm{Ob}(\hat{\Lambda})$ to the object

$$\mathrm{im} \left(\mathbb{F}^{v_j - v_i} \left(p_{ij}^{v_j - v_i} \right) \right) \in \mathrm{Ob}(\hat{\Lambda}')$$

and mapping every degree u morphism $(f_{ij}^{u+v_j-w_i}) \in \mathrm{Hom}_{\hat{\Lambda}}^u(\mathrm{im}(p_{ij}^{v_j - v_i}), \mathrm{im}(q_{ij}^{w_j - w_i}))$ to the degree u morphism

$$\left(\mathbb{F}^{u+v_j-w_i} \left(f_{ij}^{u+v_j-w_i} \right) \right) \in \mathrm{Hom}_{\hat{\Lambda}'}^u \left(\mathrm{im} \left(\mathbb{F}^{v_j - v_i} \left(p_{ij}^{v_j - v_i} \right) \right), \mathrm{im} \left(\mathbb{F}^{w_j - w_i} \left(q_{ij}^{w_j - w_i} \right) \right) \right)$$

Analogously every Π -graded natural transformation $\eta : \mathbb{F} \Rightarrow \mathbb{G}$ admits a natural extension $\hat{\eta} : \hat{\mathbb{F}} \Rightarrow \hat{\mathbb{G}}$, called the *completion of η* , associating with every object

$$\mathrm{im} \left(p_{ij}^{v_j - v_i} \right)_{1 \leq i, j \leq \ell}$$

of $\hat{\Lambda}$ the degree 0 morphism

$$\left(\sum_{k=1}^{\ell} \mathbb{G}^{v_k - v_i} (p_{ik}^{v_k - v_i}) \circ \eta_{x_k}^0 \circ \mathbb{F}^{v_j - v_k} (p_{kj}^{v_j - v_k}) \right)_{1 \leq i, j \leq \ell}$$

of

$$\mathrm{Hom}_{\hat{\Lambda}'}^0 \left(\mathrm{im} \left(\mathbb{F}^{v_j - v_i} \left(p_{ij}^{v_j - v_i} \right) \right)_{1 \leq i, j \leq \ell}, \mathrm{im} \left(\mathbb{G}^{v_j - v_i} \left(p_{ij}^{v_j - v_i} \right) \right)_{1 \leq i, j \leq \ell} \right).$$

DEFINITION A.6.25. The *complete unit Π -graded linear category $\hat{\mathbb{C}}$* is the completion of the unit Π -graded linear category \mathbb{C} .

DEFINITION A.6.26. The *complete tensor product $\Lambda \hat{\boxtimes} \Lambda'$ of Π -graded linear categories Λ and Λ'* is defined as

$$\widehat{\Lambda \boxtimes \Lambda'}.$$

DEFINITION A.6.27. The *complete ν -braiding functor $\hat{\beta}_{\Lambda, \Lambda'}^{\nu}$, associated with Π -graded linear categories Λ and Λ'* is the completion of the ν -braiding functor $\beta_{\Lambda, \Lambda'}^{\nu}$ associated with Λ and Λ' .

DEFINITION A.6.28. The symmetric monoidal 2-category $\hat{\mathbf{Cat}}_{\mathbb{C}}^{\Pi}$ of complete Π -graded linear categories with ν -braiding is the 2-category whose objects Λ are complete Π -graded linear categories, whose 1-morphisms $\mathbb{F} : \Lambda \rightarrow \Lambda'$ are Π -graded linear functors and whose 2-morphisms $\eta : \mathbb{F} \Rightarrow \mathbb{F}'$ are Π -graded natural transformations, with monoidal structure given by the complete unit Π -graded linear category $\hat{\mathbb{C}}$, by the complete tensor product of Π -graded linear categories $\hat{\boxtimes}$ and by the complete ν -braiding $\hat{\beta}^{\nu}$ of Π -graded linear categories.

DEFINITION A.6.29. The *completion* $\hat{\mathbf{F}} : \mathcal{C} \rightarrow \hat{\mathbf{Cat}}_{\mathbb{C}}^{\Pi}$ of a 2-functor $\mathbf{F} : \mathcal{C} \rightarrow \mathbf{Cat}_{\mathbb{C}}^{\Pi}$ is the 2-functor mapping every object x of \mathcal{C} to the completion $\hat{\mathbf{F}}(x)$ of the Π -graded linear category $\mathbf{F}(x)$, mapping every 1-morphism f of \mathcal{C} to the completion $\hat{\mathbf{F}}(f)$ of the Π -graded linear functor $\mathbf{F}(f)$ and mapping every 2-morphism α of \mathcal{C} to the completion $\hat{\mathbf{F}}(\alpha)$ of the Π -graded natural transformation $\mathbf{F}(\alpha)$.

DEFINITION A.6.30. Two Π -graded linear categories \mathbb{A} and \mathbb{A}' are *Π -Morita equivalent* if their completions are equivalent as objects of $\hat{\mathbf{Cat}}_{\mathbb{C}}^{\Pi}$.

DEFINITION A.6.31. A *Π -Morita equivalence between Π -graded linear categories* \mathbb{A} and \mathbb{A}' is a Π -graded linear functor $\mathbb{F} : \mathbb{A} \rightarrow \mathbb{A}'$ whose completion $\hat{\mathbb{F}}$ is part of an equivalence adjunction system in $\hat{\mathbf{Cat}}_{\mathbb{C}}^{\Pi}$.

DEFINITION A.6.32. A set D of objects of a Π -graded linear category \mathbb{A} is a *dominating set* for \mathbb{A} if for every object x of \mathbb{A} there exist objects x_1, \dots, x_n in D , elements $u_1, \dots, u_n \in \Pi$, degree u_i morphisms $r_i^{u_i} \in \text{Hom}_{\mathbb{A}}^{u_i}(x_i, x)$ and degree $-u_i$ morphisms $s_i^{-u_i} \in \text{Hom}_{\mathbb{A}}^{-u_i}(x, x_i)$ with $i = 1, \dots, n$ satisfying

$$\text{id}_x^0 = \sum_{i=1}^n r_i^{u_i} \circ s_i^{-u_i}.$$

If D is a dominating set for \mathbb{A} we say that D *dominates* \mathbb{A} .

THEOREM A.6.1. *Let \mathbb{A} and \mathbb{A}' be Π -graded linear categories and let $\mathbb{F} : \mathbb{A} \rightarrow \mathbb{A}'$ be a fully faithful Π -graded linear functor. If $\mathbb{F}(\text{Ob}(\mathbb{A}))$ dominates \mathbb{A}' then \mathbb{F} is a Π -Morita equivalence.*

PROOF. For every object x' of \mathbb{A}' we have a decomposition

$$\text{id}_{x'}^0 = \sum_{i=1}^n r_i'^{u_i} \circ s_i'^{-u_i}$$

with $u_i \in \Pi$, with $r_i'^{u_i} \in \text{Hom}_{\mathbb{A}'}^{u_i}(\mathbb{F}(x_i), x')$, with $s_i'^{-u_i} \in \text{Hom}_{\mathbb{A}'}^{-u_i}(x', \mathbb{F}(x_i))$ and with $x_i \in \text{Ob}(\mathbb{A})$ for $i = 1, \dots, n$. Then let us consider the object

$$\text{im}(s_i'^{-u_i} \circ r_j'^{u_j})_{1 \leq i, j \leq n}$$

of $\hat{\mathbb{A}}'$. This is indeed an object of the completion of \mathbb{A}' because

$$\sum_{k=1}^n s_i'^{-u_i} \circ r_k'^{u_k} \circ s_k'^{-u_k} \circ r_j'^{u_j} = s_i'^{-u_i} \circ \text{id}_x^0 \circ r_j'^{u_j}.$$

Then x is isomorphic to $\text{im}(s_i'^{-u_i} \circ r_j'^{u_j})_{1 \leq i, j \leq n}$ as objects of $\hat{\mathbb{A}}'$ via the invertible degree 0 morphisms

$$\begin{aligned} (s_i'^{-u_i})_{\substack{1 \leq i \leq n \\ j=1}} &\in \text{Hom}_{\hat{\mathbb{A}}'}^0 \left(x, \text{im}(s_i'^{-u_i} \circ r_j'^{u_j})_{1 \leq i, j \leq n} \right), \\ (r_j'^{u_j})_{\substack{i=1 \\ 1 \leq j \leq n}} &\in \text{Hom}_{\hat{\mathbb{A}}'}^0 \left(\text{im}(s_i'^{-u_i} \circ r_j'^{u_j})_{1 \leq i, j \leq n}, x \right). \end{aligned}$$

Indeed we have equalities

$$\begin{aligned}
& (s_i'^{-u_i} \circ r_k'^{u_k})_{1 \leq i, k \leq n} \circ (s_k'^{-u_k})_{1 \leq k \leq n} = (s_i'^{-u_i})_{1 \leq i \leq n}, \\
& (r_k'^{u_k})_{1 \leq k \leq n} \circ (s_k'^{-u_k} \circ r_j'^{u_j})_{1 \leq k, j \leq n} = (r_j'^{u_j})_{1 \leq j \leq n}, \\
& (r_k'^{u_k})_{1 \leq k \leq n} \circ (s_k'^{-u_k})_{1 \leq k \leq n} = \text{id}_x^0, \\
& (s_i'^{-u_i})_{1 \leq i \leq n} \circ (r_j'^{u_j})_{1 \leq j \leq n} = (s_i'^{-u_i} \circ r_j'^{u_j})_{1 \leq i, j \leq n}.
\end{aligned}$$

This means x is isomorphic to the image of the object

$$\text{im}((\mathbb{F}^{u_j - u_i})^{-1} (s_i'^{-u_i} \circ r_j'^{u_j}))_{1 \leq i, j \leq n}$$

of $\hat{\mathbb{A}}$ under the functor $\hat{\mathbb{F}}$. □

A.7. Extended universal construction

This section presents a 2-categorical version of the construction of [BHMV95].

DEFINITION A.7.1. Let C be a set, let \mathcal{C} be a category and let \mathcal{E} be a 2-category.

- (i) An *invariant* on C is a function from C to \mathbb{C} .
- (ii) A *covariant quantization functor* on \mathcal{C} is a functor from \mathcal{C} to $\text{Vect}_{\mathbb{C}}$.
- (iii) A *contravariant quantization functor* on \mathcal{C} is a functor from \mathcal{C}^{op} to $\text{Vect}_{\mathbb{C}}$.
- (iv) A *covariant quantization 2-functor* on \mathcal{C} is a 2-functor from \mathcal{C} to $\mathbf{Cat}_{\mathbb{C}}$.
- (v) A *contravariant quantization 2-functor* on \mathcal{C} is a 2-functor from \mathcal{C}^{op} to $\mathbf{Cat}_{\mathbb{C}}$.

DEFINITION A.7.2. A *pointed category* is given by a category \mathcal{C} together with a specified object called the *base point*. A *pointed 2-category* is given by a 2-category \mathcal{E} together with a specified object called the *base point*.

REMARK A.7.1. By abuse of notation we will often denote pointed categories and pointed 2-categories without specifying base points, especially when we have natural choices for base points, as it is the case with monoidal categories and monoidal 2-categories, for which the base point will always be tacitly taken to be the unit for the tensor product.

Let us start by recalling the universal construction, which was introduced in [BHMV95]. In order to do so let us fix a pointed category \mathcal{C} with base point $x_0 \in \text{Ob}(\mathcal{C})$, let us consider the set $C := \text{Hom}_{\mathcal{C}}(x_0, x_0)$ and an invariant ψ on C .

Let x be an object of \mathcal{C} , let $\mathcal{V}(x)$ be the free complex vector space generated by the set $\text{Hom}_{\mathcal{C}}(x_0, x)$ and let $\mathcal{V}'(x)$ be the free complex vector space generated by the set $\text{Hom}_{\mathcal{C}}(x, x_0)$. We define the linear map

$$\psi_x : \mathcal{V}(x) \rightarrow \text{Hom}_{\mathbb{C}}(\mathcal{V}'(x), \mathbb{C})$$

which maps every vector $f_x : x_0 \rightarrow x$ in the basis of $\mathcal{V}(x)$ to the linear map

$$\psi_x(f_x) : \mathcal{V}'(x) \rightarrow \mathbb{C}$$

mapping every vector $f'_x : x \rightarrow x_0$ in the basis of $\mathcal{V}'(x)$ to the evaluation $\psi(f'_x \circ f_x)$. Analogously we define the linear map

$$\psi'_x : \mathcal{V}'(x) \rightarrow \text{Hom}_{\mathbb{C}}(\mathcal{V}(x), \mathbb{C})$$

which maps every vector $f'_x : x \rightarrow x_0$ in the basis of $\mathcal{V}'(x)$ to the linear map

$$\psi'_x(f'_x) : \mathcal{V}'(x) \rightarrow \mathbb{C}$$

mapping every vector $f_x : x_0 \rightarrow x$ in the basis of $\mathcal{V}(x)$ to the evaluation $\psi(f'_x \circ f_x)$.

DEFINITION A.7.3. The *covariant universal vector space of x with respect to ψ* is the complex vector space

$$V_\psi(x) := \mathcal{V}(x) / \ker \psi_x.$$

The *contravariant universal vector space of x with respect to ψ* is the complex vector space

$$V'_\psi(x) := \mathcal{V}'(x) / \ker \psi'_x$$

Let f be a morphism of \mathcal{C} from x to x' .

DEFINITION A.7.4. The *covariant universal linear map of f with respect to ψ* is the linear map

$$\begin{aligned} \mathfrak{f}_\psi(f) : \quad V_\psi(x) &\rightarrow V_\psi(x') \\ [f_x : x_0 \rightarrow x] &\mapsto [f \circ f_x : x_0 \rightarrow x'] \end{aligned}$$

The *contravariant universal linear map of f with respect to ψ* is the linear map

$$\begin{aligned} \mathfrak{f}'_\psi(f) : \quad V'_\psi(x') &\rightarrow V'_\psi(x) \\ [f'_{x'} : x' \rightarrow x_0] &\mapsto [f'_{x'} \circ f : x \rightarrow x_0] \end{aligned}$$

DEFINITION A.7.5. The *universal construction* associates with an invariant ψ on \mathbb{C} the following data:

- (i) a covariant quantization functor $U_\psi : \mathcal{C} \rightarrow \text{Vect}_{\mathbb{C}}$ mapping each object x of \mathcal{C} to $V_\psi(x)$ and each morphism f of \mathcal{C} to $\mathfrak{f}_\psi(f)$;
- (ii) a contravariant quantization functor $U'_\psi : \mathcal{C}^{\text{op}} \rightarrow \text{Vect}_{\mathbb{C}}$ mapping each object x of \mathcal{C}^{op} to $V'_\psi(x)$ and each morphism f of \mathcal{C}^{op} to $\mathfrak{f}'_\psi(f)$.

REMARK A.7.2. For every object x of \mathcal{C} the pairing

$$\begin{aligned} \langle \cdot, \cdot \rangle_x : \quad V'_\psi(x) \otimes V_\psi(x) &\rightarrow \mathbb{C} \\ [f'_x] \otimes [f_x] &\mapsto \psi(f'_x \circ f_x) \end{aligned}$$

is non-degenerate.

Let us now describe the extended universal construction, which builds on the universal construction we just introduced. In order to do so let us fix a pointed 2-category \mathcal{E} with base point $x_0 \in \text{Ob}(\mathcal{E})$, let us consider the pointed category $\mathcal{C} := \mathcal{E}(x_0, x_0)$ with base point $\text{id}_{x_0} \in \text{Ob}(\mathcal{C})$, the set $\mathbb{C} := \text{Hom}_{\mathcal{E}}(\text{id}_{x_0}, \text{id}_{x_0})$ and an invariant ψ on \mathbb{C} . Then the universal construction extends ψ to a covariant quantization functor $U_\psi : \mathcal{E} \rightarrow \text{Vect}_{\mathbb{C}}$ and to a contravariant quantization functor $U'_\psi : \mathcal{E}^{\text{op}} \rightarrow \text{Vect}_{\mathbb{C}}$.

Let x be an object of \mathcal{E} , let $\mathcal{L}(x)$ be the free linear category generated by $\mathcal{E}(x_0, x)$ and let $\mathcal{L}'(x)$ be the free linear category generated by $\mathcal{E}(x, x_0)$. We define the linear functor

$$\psi_x : \mathcal{L}(x) \rightarrow \mathbf{Cat}_{\mathbb{C}}(\mathcal{L}'(x), \text{Vect}_{\mathbb{C}})$$

which maps every object $f_x : x_0 \rightarrow x$ of $\mathcal{L}(x)$ to the linear functor

$$\psi_x(f_x) : \mathcal{L}'(x) \rightarrow \text{Vect}_{\mathbb{C}}$$

mapping every object $f'_x : x \rightarrow x_0$ of $\mathcal{L}'(x)$ to the universal vector space

$$V_\psi(f'_x \circ f_x)$$

and every vector $\alpha'_x : f'_x \Rightarrow f'''_x$ in the basis of $\text{Hom}_{\mathcal{L}'(x)}(f'_x, f'''_x)$ to the universal linear map

$$f_\psi(\alpha'_x \circ \text{id}_{f_x}) : V_\psi(f'_x \circ f_x) \rightarrow V_\psi(f'''_x \circ f_x),$$

and which maps every vector $\alpha_x : f_x \Rightarrow f''_x$ in the basis of $\text{Hom}_{\mathcal{L}(x)}(f_x, f''_x)$ to the natural transformation

$$\psi_x(\alpha_x) : \psi_x(f_x) \Rightarrow \psi_x(f''_x)$$

associating with every object $f'_x : x \rightarrow x_0$ of $\mathcal{L}'(x)$ the linear map

$$f_\psi(\text{id}_{f'_x} \circ \alpha_x) : V_\psi(f'_x \circ f_x) \rightarrow V_\psi(f'_x \circ f''_x).$$

Analogously we define the linear functor

$$\psi'_x : \mathcal{L}'(x) \rightarrow \mathbf{Cat}_{\mathbb{C}}(\mathcal{L}(x), \mathbf{Vect}_{\mathbb{C}})$$

which maps every object $f'_x : x \rightarrow x_0$ of $\mathcal{L}'(x)$ to the linear functor

$$\psi'_x(f'_x) : \mathcal{L}(x) \rightarrow \mathbf{Vect}_{\mathbb{C}}$$

mapping every object $f_x : x_0 \rightarrow x$ of $\mathcal{L}(x)$ to the universal vector space

$$V_\psi(f'_x \circ f_x)$$

and every vector $\alpha_x : f_x \Rightarrow f''_x$ in the basis of $\text{Hom}_{\mathcal{L}(x)}(f_x, f''_x)$ to the universal linear map

$$f_\psi(\text{id}_{f'_x} \circ \alpha_x) : V_\psi(f'_x \circ f_x) \rightarrow V_\psi(f'_x \circ f''_x),$$

and which maps every vector $\alpha'_x : f'_x \Rightarrow f'''_x$ in the basis of $\text{Hom}_{\mathcal{L}'(x)}(f'_x, f'''_x)$ to the natural transformation

$$\psi'_x(\alpha'_x) : \psi'_x(f'_x) \Rightarrow \psi'_x(f'''_x)$$

associating with every object $f_x : x_0 \rightarrow x$ of $\mathcal{L}(x)$ the linear map

$$f_\psi(\alpha'_x \circ \text{id}_{f_x}) : V_\psi(f'_x \circ f_x) \rightarrow V_\psi(f'''_x \circ f_x).$$

DEFINITION A.7.6. The *covariant universal linear category of x with respect to ψ* is the linear category

$$\Lambda_\psi(x) := \mathcal{L}(x) / \ker \psi_x.$$

The *contravariant universal linear category of x with respect to ψ* is the linear category

$$\Lambda'_\psi(x) := \mathcal{L}'(x) / \ker \psi'_x.$$

Let f be a 1-morphism of \mathcal{E} from x to x' .

DEFINITION A.7.7. The *covariant universal linear functor of f with respect to ψ* is the linear functor

$$F_\psi(f) : \Lambda_\psi(x) \rightarrow \Lambda_\psi(x')$$

mapping every object $f_x : x_0 \rightarrow x$ of $\Lambda_\psi(x)$ to the object $f \circ f_x : x_0 \rightarrow x'$ of $\Lambda_\psi(x')$ and mapping every morphism $[\alpha_x : f_x \Rightarrow f''_x]$ of $\Lambda_\psi(x)$ to the morphism $[\text{id}_f \circ \alpha_x : f \circ f_x \Rightarrow f \circ f''_x]$ of $\Lambda_\psi(x')$.

The *contravariant universal linear functor of f with respect to ψ* is the linear functor

$$F'_\psi(f) : \Lambda'_\psi(x') \rightarrow \Lambda'_\psi(x)$$

mapping every object $f'_{x'} : x' \rightarrow x_0$ of $\Lambda'_\psi(x')$ to the object $f'_{x'} \circ f : x' \rightarrow x_0$ of $\Lambda'_\psi(x)$ and mapping every morphism $[\alpha'_{x'} : f'_{x'} \Rightarrow f''_{x'}]$ of $\Lambda'_\psi(x')$ to the morphism $[\alpha'_{x'} \circ \text{id}_f : f'_{x'} \circ f \Rightarrow f''_{x'} \circ f]$ of $\Lambda'_\psi(x)$.

Let α be a 2-morphism of \mathcal{C} from $f : x \rightarrow x'$ to $f' : x \rightarrow x'$.

DEFINITION A.7.8. The *covariant universal natural transformation of α with respect to ψ* is the natural transformation

$$\eta_\psi(\alpha) : F_\psi(f) \Rightarrow F_\psi(f')$$

which associates with every object $f_x : x_0 \rightarrow x$ of $\Lambda_\psi(x)$ the morphism

$$[\alpha \circ \text{id}_{f_x} : f \circ f_x \Rightarrow f' \circ f_x]$$

of $\Lambda_\psi(x')$.

The *contravariant universal natural transformation of α with respect to ψ* is the natural transformation

$$\eta'_\psi(\alpha) : F'_\psi(f) \Rightarrow F'_\psi(f')$$

which associates with every object $f'_{x'} : x' \rightarrow x_0$ of $\Lambda'_\psi(x')$ the morphism

$$[\text{id}_{f'_{x'}} \circ \alpha : f'_{x'} \circ f \Rightarrow f'_{x'} \circ f']$$

of $\Lambda'_\psi(x)$.

DEFINITION A.7.9. The *extended universal construction* associates with an invariant ψ on \mathbf{C} the following data:

- (i) a covariant quantization 2-functor $\mathbf{E}_\psi : \mathcal{C} \rightarrow \mathbf{Cat}_{\mathbf{C}}$ mapping each object x of \mathcal{C} to $\Lambda_\psi(x)$, each 1-morphism f of \mathcal{C} to $F_\psi(f)$ and each 2-morphism α of \mathcal{C} to $\eta_\psi(\alpha)$;
- (ii) a contravariant quantization 2-functor $\mathbf{E}'_\psi : \mathcal{C}^{\text{op}} \rightarrow \mathbf{Cat}_{\mathbf{C}}$ mapping each object x of \mathcal{C}^{op} to $\Lambda'_\psi(x)$, each 1-morphism f of \mathcal{C}^{op} to $F'_\psi(f)$ and each 2-morphism α of \mathcal{C}^{op} to $\eta'_\psi(\alpha)$.

REMARK A.7.3. For every object x of \mathcal{C} we will denote with $\hat{\Lambda}_\psi(x)$ the completion of the universal linear category $\Lambda_\psi(x)$, for every 1-morphism f of \mathcal{C} we will denote with $\hat{F}_\psi(f)$ the completion of the universal linear functor $F_\psi(f)$ and for every 2-morphism α of \mathcal{C} we will denote with $\hat{\eta}_\psi(\alpha)$ the completion of the universal linear functor $\eta_\psi(\alpha)$.

Topological appendices

We introduce the right concepts of manifolds with corners, of collars and of gluings which are needed for our construction. We also fix the notation for cobordisms and ribbon graphs. The last section contains details about Lagrangian subspaces and Maslov indices.

REMARK B.0.1. We adopt the convention that there exists a unique orientation on the empty set \emptyset and that an orientation for a connected 0-dimensional manifold is a sign, $+$ or $-$. The convention we use to induce an orientation on the boundary is the “outward normal first” convention.

B.1. Manifolds with corners

This section follows [J68]. Consider the manifolds with boundary

$$\mathbb{R}_+ := \{x \in \mathbb{R} \mid x \geq 0\}, \quad \mathbb{R}_- := \{x \in \mathbb{R} \mid x \leq 0\}$$

oriented as submanifolds of \mathbb{R} . A map f from $V \subset \mathbb{R}_+^m$ to \mathbb{R}^n is *smooth* if there exists an open neighborhood W of V in \mathbb{R}^m and a smooth map $g : W \rightarrow \mathbb{R}^n$ such that

$$g|_V = f.$$

Let X be an orientable m -dimensional topological manifold with boundary. A *chart at* $x \in X$ is a pair (U, φ) where U is an open subset of X containing x and $\varphi : U \rightarrow \mathbb{R}_+^m$ is a homeomorphism onto its image. Two charts (U, φ) and (U', φ') are *compatible* if the transition function

$$\varphi' \circ \varphi^{-1}|_{\varphi(U \cap U')} : \varphi(U \cap U') \rightarrow \varphi'(U \cap U')$$

is a diffeomorphism, and they are *co-oriented* if the Jacobian determinant of the transition function is positive. An *(oriented) atlas with corners* for X is a collection of compatible (co-oriented) charts containing a chart at x for every $x \in X$. An *(oriented) smooth structure with corners* on an (orientable) topological manifold with boundary is an (oriented) atlas with corners which is maximal under inclusion. Given an (oriented) atlas with corners \mathcal{A} for X there exists a unique maximal (oriented) smooth structure with corners containing \mathcal{A} .

DEFINITION B.1.1. An *(oriented) manifold with corners* is an (orientable) topological manifold with boundary X equipped with an (oriented) smooth structure with corners.

If X is an oriented manifold with corners and \mathcal{A} is its oriented smooth structure with corners then \bar{X} denotes the *opposite oriented manifold with corners* obtained by replacing \mathcal{A} with the opposite oriented smooth structure with corners $\bar{\mathcal{A}}$ which is composed of all charts outside of \mathcal{A} which are compatible with charts in \mathcal{A} . Other

notations we will sometimes use for \overline{X} are $-X$ and $(-1)X$, with $+X$ and $(+1)X$ denoting X .

REMARK B.1.1. If X is an (orientable) topological manifold and Y is an (oriented) manifold with corners then every homeomorphism $f : X \rightarrow Y$ induces via pull-back an (oriented) smooth structure with corners which makes X into an (oriented) m -dimensional manifold with corners. Given an oriented smooth atlas with corners \mathcal{A} for Y the pull-back $f^*\mathcal{A}$ is composed of charts

$$\left(f^{-1}(U), \varphi \circ f|_{f^{-1}(U)} \right)$$

with $(U, \varphi) \in \mathcal{A}$.

A map $f : X \rightarrow Y$ between manifolds with corners is *smooth at* $x \in X$ if it is smooth when read in any pair of charts at x and at $f(x)$ respectively.

DEFINITION B.1.2. A *smooth map* $f : X \rightarrow Y$ between manifolds with corners is a map which is smooth at x for all $x \in X$.

The *tangent space at* $x \in X$ is defined as usual as the vector space $T_x X$ of derivations on the algebra $\mathcal{C}^\infty(x)$ of germs of smooth functions at x , and the *differential* $d_x f : T_x X \rightarrow T_{f(x)} Y$ at $x \in X$ of a smooth map $f : X \rightarrow Y$ between manifolds with corners is defined using the algebra homomorphism $f^* : \mathcal{C}^\infty(f(x)) \rightarrow \mathcal{C}^\infty(x)$. A smooth map $f : X \rightarrow Y$ between manifolds with corners is an *immersion* if $d_x f$ is injective for all $x \in X$, and it is an *embedding* if it is also a homeomorphism. If X and Y are oriented manifolds with corners of the same dimension then an embedding $f : X \hookrightarrow Y$ is *positive* if it preserves the orientations, and it is *negative* otherwise.

DEFINITION B.1.3. A *submanifold with corners* of a manifold with corners X is a topological submanifold Y of X together with a smooth structure with corners making the inclusion $i : Y \hookrightarrow X$ into a smooth embedding.

The *index* $i(x)$ of a point $x \in X$ is the number of vanishing coordinates of $\varphi(x)$ for any chart (U, φ) at x . A *connected face* of a manifold with corners X is the closure of a component of $\{x \in X \mid i(x) = 1\}$.

DEFINITION B.1.4. A *manifold with faces* X is a manifold with corners whose every point $x \in X$ belongs to exactly $i(x)$ different connected faces.

A *face* of a manifold with faces X is a disjoint union of connected faces and is itself an manifold with faces, which is oriented if X is oriented.

REMARK B.1.2. If X and Y are (oriented) manifolds with faces, then so is $X \times Y$.

DEFINITION B.1.5. An *(oriented) m -dimensional (2)-manifold* is given by an (oriented) m -dimensional manifold with faces X together with a decomposition of its boundary into a union of (oriented) faces

$$\partial X = \partial^h X \cup \partial^v X$$

such that $\partial^h X \cap \partial^v X$ is a possibly empty (oriented) face of both $\partial^h X$ and $\partial^v X$. The face $\partial^h X$ is called the *horizontal boundary* and the face $\partial^v X$ is called the *vertical boundary* of X .

REMARK B.1.3. Our abusive notation for $\langle 2 \rangle$ -manifolds will be the same used for manifolds with faces.

A face of a $\langle 2 \rangle$ -manifold X contained in $\partial^h X$ is a *horizontal face*, or a face of *horizontal type*, and a face contained in $\partial^v X$ is a *vertical face*, or a face of *vertical type*.

DEFINITION B.1.6. An *isomorphism of (oriented) $\langle 2 \rangle$ -manifolds* is a (positive) diffeomorphism of manifolds with faces which preserves the vertical and the horizontal boundaries.

REMARK B.1.4. A face of an (oriented) $\langle 2 \rangle$ -manifold is an (oriented) manifold with boundary and two faces of a $\langle 2 \rangle$ -manifold intersect along unions of connected components of their boundaries. A horizontal face of an (oriented) $\langle 2 \rangle$ -manifold is naturally an (oriented) $\langle 2 \rangle$ -manifold with empty horizontal boundary and a vertical face of an (oriented) $\langle 2 \rangle$ -manifold is naturally an (oriented) $\langle 2 \rangle$ -manifold with empty vertical boundary. The boundary of a horizontal face coincides with its vertical boundary and the boundary of a vertical face coincides with its horizontal boundary.

REMARK B.1.5. If X is an (oriented) n -dimensional manifold with boundary and Y is an (oriented) $m - n$ -dimensional manifold with boundary, then $X \times Y$ is naturally an (oriented) m -dimensional $\langle 2 \rangle$ -manifold. Indeed we can define

$$\partial^h(X \times Y) := (-1)^n (X \times \partial Y), \quad \partial^v(X \times Y) := \partial X \times Y.$$

B.2. Collars

This section is adapted from Section 2 of [L00]. Let X be an oriented m -dimensional $\langle 2 \rangle$ -manifold and let $\varepsilon^v A^v$ and $(-1)^{m-1} \varepsilon^h A^h$ be a vertical and a horizontal face of X respectively with $\varepsilon^v, \varepsilon^h \in \{+, -\}$. Let Y^v and Y^h be oriented $m-1$ -dimensional manifolds with boundary and let $f^v : Y^v \rightarrow A^v$ and $f^h : Y^h \rightarrow A^h$ be positive diffeomorphisms. A (*horizontal*) *collar for the identification f^v inside X* is a positive embedding

$$F^v : \mathbb{R}_{-\varepsilon^v} \times Y^v \hookrightarrow X$$

whose image is an open neighborhood of A^v inside X satisfying $F^v(0, y^v) = f^v(y^v)$ for every $y^v \in Y^v$. A (*vertical*) *collar for f^h inside X* is a positive embedding

$$F^h : Y^h \times \mathbb{R}_{-\varepsilon^h} \hookrightarrow X$$

whose image is an open neighborhood of A^h inside X satisfying $F^h(y^h, 0) = f^h(y^h)$ for every $y^h \in Y^h$.

PROPOSITION B.2.1. *If X is an oriented $\langle 2 \rangle$ -manifold, if Y^v and Y^h are oriented $m - 1$ -dimensional manifolds with boundary, if $\varepsilon^v A^v$ and $(-1)^{m-1} \varepsilon^h A^h$ are faces of X and if $f^v : Y^v \rightarrow A^v$ and $f^h : Y^h \rightarrow A^h$ are positive diffeomorphisms then there exist collars F^v and F^h for f^v and f^h inside X .*

In the above situation suppose that Z is an oriented $m-2$ -dimensional manifold without boundary and that $g^h : Z \rightarrow B^h, g^v : Z \rightarrow B^v$ are positive diffeomorphisms satisfying $f^h \circ g^h = f^v \circ g^v$, where $\varepsilon^v B^v$ is the manifold $(f^h)^{-1}(A^h \cap A^v)$ oriented as a face of Y^h and $(-1)^{m-1} \varepsilon^h B^h$ is the manifold $(f^v)^{-1}(A^h \cap A^v)$ oriented as a face of Y^v . Then we say (f^h, f^v, g^h, g^v) is a *positive compatible system around $A^h \cap A^v$* , and a *collar for $f^h \circ g^h = f^v \circ g^v$ inside X* is a positive embedding $G : \mathbb{R}_{-\varepsilon^v} \times Z \times \mathbb{R}_{-\varepsilon^h} \hookrightarrow X$ whose image is an open neighborhood of $A^h \cap A^v$ inside X satisfying $G(0, z, 0) = f^h \circ g^h(z) = f^v \circ g^v(z)$ for every $z \in Z$.

PROPOSITION B.2.2. *If X is an oriented m -dimensional $\langle 2 \rangle$ -manifold, if $\varepsilon^v A^v$ and $(-1)^{m-1} \varepsilon^h A^h$ are a vertical and a horizontal face of X respectively and if (f^h, f^v, g^h, g^v) is a positive compatible system around $A^h \cap A^v$ then there exists a collar G for $f^h \circ g^h = f^v \circ g^v$ inside X .*

REMARK B.2.1. Each collar G for $f^h \circ g^h = f^v \circ g^v$ inside X induces a horizontal collar G^h for g^h inside Y^h defined as

$$\begin{aligned} G^h : \mathbb{R}_{-\varepsilon^v} \times Z &\rightarrow Y^h \\ (t^h, z) &\mapsto (f^h)^{-1}(G(t^h, z, 0)) \end{aligned}$$

and a vertical collar G^v for g^v inside Y^v defined as

$$\begin{aligned} G^v : Z \times \mathbb{R}_{-\varepsilon^h} &\rightarrow Y^v \\ (z, t^v) &\mapsto (f^v)^{-1}(G(0, z, t^v)). \end{aligned}$$

PROPOSITION B.2.3. *Let X be an oriented m -dimensional $\langle 2 \rangle$ -manifold, let $\varepsilon^v A^v$ and $(-1)^{m-1} \varepsilon^h A^h$ be a vertical and a horizontal face of X respectively and let (f^h, f^v, g^h, g^v) be a positive compatible system around $A^h \cap A^v$.*

- (i) *For all collars $G^h : \mathbb{R}_{-\varepsilon^v} \times Z \hookrightarrow Y^h$ and $G^v : Z \times \mathbb{R}_{-\varepsilon^h} \hookrightarrow Y^v$ for g^h inside Y^h and for g^v inside Y^v respectively there exists a collar G for $f^h \circ g^h = f^v \circ g^v$ inside X agreeing with G^h and G^v in a neighborhood of $\{0\} \times Z \times \{0\}$, i.e. satisfying*

$$f^h(G^h(t^h, z)) = G(t^h, z, 0)$$

for all (t^h, z) in some neighborhood of $\{0\} \times Z \subset \mathbb{R}_{-\varepsilon^v} \times Z$ and

$$f^v(G^v(z, t^v)) = G(0, z, t^v)$$

for all (z, t^v) in some neighborhood of $Z \times \{0\} \subset Z \times \mathbb{R}_{-\varepsilon^h}$. Moreover any two such collars are isotopic through an isotopy which fixes some neighborhood of $\{0\} \times Z \times \{0\} \subset \partial(\mathbb{R}_{-\varepsilon^v} \times Z \times \mathbb{R}_{-\varepsilon^h})$.

- (ii) *For all collars $G : \mathbb{R}_{-\varepsilon^v} \times Z \times \mathbb{R}_{-\varepsilon^h} \hookrightarrow X$ for $f^h \circ g^h = f^v \circ g^v$ inside X there exist a vertical collar F^h for f^h inside X and a horizontal collar F^v for f^v inside X agreeing with G in a neighborhood of $\{0\} \times Z \times \{0\}$, i.e. satisfying*

$$F^h(G^h(t^h, z), t^v) = G(t^h, z, t^v)$$

for all (t^h, z, t^v) in some neighborhood of $\{0\} \times Z \times \{0\} \subset \mathbb{R}_{-\varepsilon^v} \times Z \times \mathbb{R}_{-\varepsilon^h}$ and

$$F^v(t^h, G^v(z, t^v)) = G(t^h, z, t^v)$$

for all (t^h, z, t^v) in some neighborhood of $\{0\} \times Z \times \{0\} \subset \mathbb{R}_{-\varepsilon^v} \times Z \times \mathbb{R}_{-\varepsilon^h}$, where the collars G^h and G^v are those given by Remark B.2.1. Moreover any two such collars are isotopic through an isotopy which fixes some neighborhood of $\{0\} \times Z \times \{0\} \subset \mathbb{R}_{-\varepsilon^v} \times Z \times \mathbb{R}_{-\varepsilon^h}$.

B.3. Gluing

Let X and X' be oriented m -dimensional $\langle 2 \rangle$ -manifolds, let A^v and $\overline{A'^v}$ be vertical faces of X and of X' respectively, and let $(-1)^{m-1} A^h$ and $(-1)^{m-1} A'^h$ be horizontal faces of X and of X' respectively. Let Y^v and Y^h be oriented $m-1$ -dimensional manifolds with boundary, let

$$f^v : Y^v \rightarrow A^v, \quad f'^v : Y^v \rightarrow \overline{A'^v}, \quad f^h : Y^h \rightarrow A^h, \quad f'^h : Y^h \rightarrow \overline{A'^h}$$

be positive diffeomorphisms. Let $F^v : \mathbb{R}_- \times Y^v \hookrightarrow X$ and $F'^v : \mathbb{R}_+ \times Y^v \hookrightarrow X'$ be a pair of horizontal collars for f^v and f'^v inside X and X' respectively, and let $F^h : Y^h \times \mathbb{R}_- \hookrightarrow X$ and $F'^h : Y^h \times \mathbb{R}_+ \hookrightarrow X'$ be a pair of vertical collars for f^h and f'^h inside X and X' respectively. We denote with $X \cup_{Y^v} X'$ and with $X \cup_{Y^h} X'$ the oriented m -dimensional $\langle 2 \rangle$ -manifolds obtained by gluing horizontally X to X' along the (*horizontal*) *gluing data* $(Y^v, f^v, f'^v, F^v, F'^v)$ and by gluing vertically X to X' along the (*vertical*) *gluing data* $(Y^h, f^h, f'^h, F^h, F'^h)$ respectively. More precisely $X \cup_{Y^v} X'$ and $X \cup_{Y^h} X'$ are obtained as topological manifolds from the disjoint union $X \sqcup X' := (\{-1\} \times X) \cup (\{+1\} \times X_+)$ by identifying $\{-1\} \times A^v$ to $\{+1\} \times A'^v$ using $f'^v \circ (f^v)^{-1}$ and by identifying $\{-1\} \times A^h$ to $\{+1\} \times A'^h$ using $f'^h \circ (f^h)^{-1}$ respectively. These quotient spaces come with natural (topological) embeddings

$$\begin{aligned} i_X^v : X &\hookrightarrow X \cup_{Y^v} X', & i_{X'}^v : X' &\hookrightarrow X \cup_{Y^v} X', \\ i_X^h : X &\hookrightarrow X \cup_{Y^h} X', & i_{X'}^h : X' &\hookrightarrow X \cup_{Y^h} X'. \end{aligned}$$

Their smooth structures are the only ones making the restrictions

$$\begin{aligned} i_X^v|_{X \setminus A^v} : X \setminus A^v &\hookrightarrow X \cup_{Y^v} X', & i_{X'}^v|_{X' \setminus A'^v} : X' \setminus A'^v &\hookrightarrow X \cup_{Y^v} X', \\ i_X^h|_{X \setminus A^h} : X \setminus A^h &\hookrightarrow X \cup_{Y^h} X', & i_{X'}^h|_{X' \setminus A'^h} : X' \setminus A'^h &\hookrightarrow X \cup_{Y^h} X' \end{aligned}$$

and the maps

$$\begin{aligned} F^v \cup_{Y^v} F'^v : \mathbb{R} \times Y^v &\rightarrow X \cup_{Y^v} X' \\ (t, y^v) &\rightarrow \begin{cases} [F^v(t, y^v), 0] & t \leq 0 \\ [F'^v(t, y^v), 1] & t \geq 0 \end{cases} \\ F^h \cup_{Y^h} F'^h : Y^h \times \mathbb{R} &\rightarrow X \cup_{Y^h} X' \\ (y^h, t) &\rightarrow \begin{cases} [F^h(y^h, t), 0] & t \leq 0 \\ [F'^h(y^h, t), 1] & t \geq 0 \end{cases} \end{aligned}$$

into smooth embeddings. The boundary of $X \cup_{Y^v} X'$ is decomposed as

$$\begin{aligned} \partial^h(X \cup_{Y^v} X') &:= \partial^h X \cup_{\partial Y^v} \partial^h X', \\ \partial^v(X \cup_{Y^v} X') &:= i_X^v(\partial^v X \setminus A^v) \cup i_{X'}^v(\partial^v X' \setminus A'^v) \end{aligned}$$

and the boundary of $X \cup_{Y^h} X'$ is decomposed as

$$\begin{aligned} \partial^h(X \cup_{Y^h} X') &:= i_X^h(\partial^h X \setminus A^h) \cup i_{X'}^h(\partial^h X' \setminus A'^h), \\ \partial^v(X \cup_{Y^h} X') &:= \partial^v X \cup_{\partial Y^h} \partial^v X'. \end{aligned}$$

REMARK B.3.1. Let us consider oriented $\langle 2 \rangle$ -manifolds X, X', X'' and X''' , let (Y, f, f', F, F') be a gluing data for X and X' and let $g : X \rightarrow X''$ and $g' : X' \rightarrow X'''$ positive diffeomorphisms. If $X'' \cup_Y X'''$ denotes the $\langle 2 \rangle$ -manifold determined by the gluing data

$$(Y, g \circ f, g \circ f', g \circ F', g' \circ F')$$

we get a natural positive diffeomorphism $g \cup_Y g' : X \cup_Y X' \rightarrow X'' \cup_Y X'''$ induced by g and g' .

B.4. Cobordisms

DEFINITION B.4.1. If Γ and Γ' are oriented $d-2$ -dimensional closed manifolds a $d-1$ -dimensional cobordism Σ from Γ to Γ' is a 5-tuple

$$(\Sigma, f_{\Sigma_-}, f_{\Sigma_+}, F_{\Sigma_-}, F_{\Sigma_+})$$

where:

- (i) Σ is a smooth oriented $d-1$ -dimensional compact manifold with boundary called the *support* whose boundary is decomposed as

$$\partial\Sigma = \overline{\partial_- \Sigma} \cup \partial_+ \Sigma$$

with $\overline{\partial_- \Sigma} \cap \partial_+ \Sigma = \emptyset$;

- (ii) $f_{\Sigma_-} : \Gamma \rightarrow \partial_- \Sigma$ is a positive diffeomorphism called the *incoming boundary identification* and $f_{\Sigma_+} : \Gamma' \rightarrow \partial_+ \Sigma$ is a positive diffeomorphisms called the *outgoing boundary identification*;
- (iii) $F_{\Sigma_-} : \mathbb{R}_+ \times \Gamma \hookrightarrow \Sigma$ is a collar for f_{Σ_-} ;
- (iv) $F_{\Sigma_+} : \mathbb{R}_- \times \Gamma' \hookrightarrow \Sigma$ is a collar for f_{Σ_+} .

Two cobordisms Σ and Σ' from Γ to Γ' are *isomorphic* if there exists a positive diffeomorphism $f : \Sigma \rightarrow \Sigma'$ such that:

- (i) $f \circ f_{\Sigma_{\pm}} = f_{\Sigma'_{\pm}}$;
- (ii) $f \circ F_{\Sigma_-}$ agrees with $F_{\Sigma'_-}$ in a neighborhood of $0 \times \Gamma$;
- (iii) $f \circ F_{\Sigma_+}$ agrees with $F_{\Sigma'_+}$ in a neighborhood of $0 \times \Gamma'$.

Such a diffeomorphism f is called an *isomorphism of cobordisms* and is denoted $f : \Sigma \rightarrow \Sigma'$.

REMARK B.4.1. If Σ is a $d-1$ -dimensional cobordism from Γ to Γ' and Σ' is a smooth oriented $d-1$ -dimensional compact manifold with boundary then every positive diffeomorphism $f : \Sigma \rightarrow \Sigma'$ induces an isomorphism of cobordisms between Σ and

$$\Sigma' := (\Sigma', f \circ f_{\Sigma_-}, f \circ f_{\Sigma_+}, f \circ F_{\Sigma_-}, f \circ F_{\Sigma_+}).$$

REMARK B.4.2. Every oriented smooth $d-2$ -dimensional closed manifold Γ determines a $d-1$ -dimensional cobordism $I \times \Gamma$ from Γ to itself called the *trivial cobordism of Γ* and given by

$$(I \times \Gamma, (0, \text{id}_{\Gamma}), (1, \text{id}_{\Gamma}), F_{I_-} \times \text{id}_{\Gamma}, F_{I_+} \times \text{id}_{\Gamma})$$

where $(0, \text{id}_{\Gamma}) : \Gamma \rightarrow \{0\} \times \Gamma$ and $(1, \text{id}_{\Gamma}) : \Gamma \rightarrow \{1\} \times \Gamma$ project to the identity on the second component and where $F_{I_-} : \mathbb{R}_+ \hookrightarrow I$ and $F_{I_+} : \mathbb{R}_- \hookrightarrow I$ are some fixed embeddings satisfying $F_{I_-}(t_+) = t_+$ for every $t_+ \leq \frac{1}{3}$ and $F_{I_+}(t_-) = 1 + t_-$ for every $t_- \geq -\frac{1}{3}$.

REMARK B.4.3. If Σ is a $d-1$ -dimensional cobordism from Γ to Γ' then we will always denote with $\overline{\Sigma}$ the *opposite* cobordism from Γ' to Γ given by

$$(\overline{\Sigma}, f_{\Sigma_+}, f_{\Sigma_-}, F_{\overline{\Sigma}_-}, F_{\overline{\Sigma}_+})$$

where:

- (i) $\partial_- \overline{\Sigma} = \partial_+ \Sigma$ and $\partial_+ \overline{\Sigma} = \partial_- \Sigma$;
- (ii) $F_{\overline{\Sigma}_-}(t_+, x') = F_{\Sigma_+}(-t_+, x')$ for all $t_+ \in \mathbb{R}_+$ and all $x' \in \Gamma'$;
- (iii) $F_{\overline{\Sigma}_+}(t_-, x) = F_{\Sigma_-}(-t_-, x)$ for all $t_- \in \mathbb{R}_-$ and all $x \in \Gamma$.

REMARK B.4.4. Whenever we have an oriented $d - 1$ -dimensional closed manifold Σ we will denote with Σ the only $d - 1$ -dimensional cobordism from \emptyset to \emptyset whose support is given by Σ .

REMARK B.4.5. If Σ is a cobordism then we will speak of topological properties of its support Σ as if they were properties of Σ itself. For instance if Σ is connected then we will say Σ is connected.

DEFINITION B.4.2. If Γ and Γ' are oriented $d - 2$ -dimensional closed manifolds and Σ and Σ' are $d - 1$ -dimensional cobordisms from Γ to Γ' a d -dimensional cobordism with corners M from Σ to Σ' is a 9-tuple

$$(M, f_{M_-^h}, f_{M_+^h}, f_{M_-^v}, f_{M_+^v}, F_{M_-}, F_{M_r}, F_{M_-}, F_{M_r})$$

where:

- (i) M is an oriented d -dimensional compact $\langle 2 \rangle$ -manifold whose underlying manifold with faces is called the *support*, whose horizontal boundary is decomposed as

$$\partial^h M = (-1)^{d-1} \left(\overline{\partial_-^h M} \cup \partial_+^h M \right)$$

with $\overline{\partial_-^h M} \cup \partial_+^h M = \emptyset$ and whose vertical boundary is decomposed as

$$\partial^v M = \overline{\partial_-^v M} \cup \partial_+^v M$$

with $\overline{\partial_-^v M} \cap \partial_+^v M = \emptyset$;

- (ii) $f_{M_-^h} : \Sigma \rightarrow \partial_-^h M$ is a positive diffeomorphism called the *incoming horizontal boundary identification*, $f_{M_+^h} : \Sigma' \rightarrow \partial_+^h M$ is a positive diffeomorphism called the *outgoing horizontal boundary identification*, $f_{M_-^v} : \Gamma \times I \rightarrow \partial_-^v M$ is a positive diffeomorphism called the *incoming vertical boundary identification*, $f_{M_+^v} : \Gamma' \times I \rightarrow \partial_+^v M$ is a positive diffeomorphism called the *outgoing vertical boundary identification* such that

$$f_{M_-^h}(f_{\Sigma_-}(x)) = f_{M_-^v}(x, 0), \quad f_{M_+^h}(f_{\Sigma'_-}(x)) = f_{M_+^v}(x, 1)$$

for all $x \in \Gamma$ and

$$f_{M_-^h}(f_{\Sigma_+}(x')) = f_{M_+^v}(x', 0), \quad f_{M_+^h}(f_{\Sigma'_+}(x')) = f_{M_+^v}(x', 1)$$

for all $x' \in \Gamma'$;

- (iii) $F_{M_-} : \mathbb{R}_+ \times \Gamma \times \mathbb{R}_+ \hookrightarrow M$ is a collar for $f_{M_-^h} \circ f_{\Sigma_-}$ agreeing with F_{Σ_-} and $\text{id}_\Gamma \times F_{I_-}$ in a neighborhood of $\{0\} \times \Gamma \times \{0\}$;
- (iv) $F_{M_r} : \mathbb{R}_+ \times \Gamma \times \mathbb{R}_- \hookrightarrow M$ is a collar for $f_{M_+^h} \circ f_{\Sigma'_-}$ agreeing with $F_{\Sigma'_-}$ and $\text{id}_\Gamma \times F_{I_+}$ in a neighborhood of $\{0\} \times \Gamma \times \{0\}$;
- (v) $F_{M_-} : \mathbb{R}_- \times \Gamma' \times \mathbb{R}_+ \hookrightarrow M$ is a collar for $f_{M_-^h} \circ f_{\Sigma_+}$ agreeing with F_{Σ_+} and $\text{id}_{\Gamma'} \times F_{I_-}$ in a neighborhood of $\{0\} \times \Gamma' \times \{0\}$;
- (vi) $F_{M_r} : \mathbb{R}_- \times \Gamma' \times \mathbb{R}_- \hookrightarrow M$ is a collar for $f_{M_+^h} \circ f_{\Sigma'_+}$ agreeing with $F_{\Sigma'_+}$ and $\text{id}_{\Gamma'} \times F_{I_+}$ in a neighborhood of $\{0\} \times \Gamma' \times \{0\}$.

Two cobordisms with corners M and M' from Σ to Σ' are *isomorphic* if there exists an isomorphism of oriented $\langle 2 \rangle$ -manifolds $f : M \rightarrow M'$ such that:

- (i) $f \circ f_{M_-^h} = f_{M'^h_-}$, $f \circ f_{M_+^h} = f_{M'^h_+}$;
- (ii) $f \circ f_{M_-^v} = f_{M'^v_-}$, $f \circ f_{M_+^v} = f_{M'^v_+}$;

- (iii) $f \circ F_{M_\perp}, f \circ F_{M_\top}$ agree with $F_{M'_\perp}, F_{M'_\top}$ in a neighborhood of $\{0\} \times \Gamma \times \{0\}$;
- (iv) $f \circ F_{M_\downarrow}, f \circ F_{M_\uparrow}$ agree with $F_{M'_\downarrow}, F_{M'_\uparrow}$ in a neighborhood of $\{0\} \times \Gamma' \times \{0\}$;

Such an f is called an *isomorphism of cobordisms with corners* and is denoted $f : M \rightarrow M'$.

REMARK B.4.6. If M is a d -dimensional cobordism with corners from Σ to Σ' and M' is an oriented d -dimensional compact $\langle 2 \rangle$ -manifold then every isomorphism of oriented $\langle 2 \rangle$ -manifolds $f : M \rightarrow M'$ induces an isomorphism of cobordisms with corners between M and the cobordism with corners M' given by

$$(M', f \circ f_{M_\perp}, f \circ f_{M_\top}, f \circ f_{M_\downarrow}, f \circ f_{M_\uparrow}, f \circ F_{M_\perp}, f \circ F_{M_\top}, f \circ F_{M_\downarrow}, f \circ F_{M_\uparrow}).$$

REMARK B.4.7. Every $d-1$ -dimensional cobordism Σ from Γ to Γ' determines a d -dimensional cobordism with corners $\Sigma \times I$ from Σ to itself called the *trivial cobordism with corners of Σ* and given by

$$(\Sigma \times I, (\text{id}_\Sigma, 0), (\text{id}_\Sigma, 1), f_{\Sigma_-} \times \text{id}_I, f_{\Sigma_+} \times \text{id}_I, \\ F_{\Sigma_-} \times F_{I_-}, F_{\Sigma_-} \times F_{I_+}, F_{\Sigma_+} \times F_{I_-}, F_{\Sigma_+} \times F_{I_+}).$$

REMARK B.4.8. Whenever we have a d -dimensional compact manifold M with boundary $\partial M = \overline{\partial_- M} \cup \partial_+ M$ where $\overline{\partial_- M} \cap \partial_+ M = \emptyset$ we denote with M the only d -dimensional cobordism with corners from $\partial_- M$ to $\partial_+ M$ whose support is given by M with incoming horizontal boundary identification given by $\text{id}_{\partial_- M}$ and with outgoing horizontal boundary identification given by $\text{id}_{\partial_+ M}$. Since we use the same notation for all possible decompositions of the boundary, we will specify incoming and outgoing horizontal boundaries whenever our choice will not be evident.

REMARK B.4.9. If M is a cobordism with corners then we will speak of topological properties of its support M as if they were properties of M itself. For instance if M is connected then we will say M is connected.

DEFINITION B.4.3. If Σ is a $d-1$ -dimensional cobordism from Γ to Γ' and if Σ' is a $d-1$ -dimensional cobordism from Γ' to Γ'' then we denote with $\Sigma \cup_{\Gamma'} \Sigma'$ the $d-1$ -dimensional cobordism from Γ to Γ'' given by

$$(\Sigma \cup_{\Gamma'} \Sigma', f_{\Sigma_-}, f_{\Sigma'_+}, F_{\Sigma_-}, F_{\Sigma'_+})$$

with gluing data $(\Gamma', f_{\Sigma_+}, f_{\Sigma'_-}, F_{\Sigma_+}, F_{\Sigma'_-})$.

DEFINITION B.4.4. If Σ and Σ'' are $d-1$ -dimensional cobordisms from Γ to Γ' , if Σ' and Σ''' are $d-1$ -dimensional cobordisms from Γ' to Γ'' , if M is a d -dimensional cobordism with corners from Σ to Σ'' and if M' is a d -dimensional cobordism with corners from Σ' to Σ''' then we denote with $M \cup_{\Gamma' \times I} M'$ the d -dimensional cobordism with corners from $\Sigma \cup_{\Gamma'} \Sigma'$ to $\Sigma'' \cup_{\Gamma'} \Sigma'''$ given by

$$(M \cup_{\Gamma' \times I} M', f_{M_\perp} \cup_{\Gamma' \times I} f_{M'_\perp}, f_{M_\top} \cup_{\Gamma' \times I} f_{M'_\top}, f_{M_\downarrow}, f_{M'_\downarrow}, F_{M_\perp}, F_{M_\top}, F_{M_\downarrow}, F_{M'_\downarrow})$$

where:

- (i) the gluing data is given by the $d-1$ -dimensional manifold with boundary $\Gamma' \times I$ together with the diffeomorphisms f_{M_\downarrow} and $f_{M'_\downarrow}$ and with any pair of collars

$$F_{M_\downarrow} : \mathbb{R}_- \times \Gamma' \times I \hookrightarrow M, \quad F_{M'_\downarrow} : \mathbb{R}_+ \times \Gamma' \times I \hookrightarrow M'$$

for f_{M_\downarrow} and $f_{M'_\downarrow}$ respectively such that F_{M_\downarrow} agrees with F_{M_\downarrow} in a neighborhood of $\{0\} \times \Gamma' \times \{0\} \subset \mathbb{R}_- \times \Gamma' \times \mathbb{R}_+$ and with F_{M_\uparrow} in a neighborhood

of $\{0\} \times I' \times \{0\} \subset \mathbb{R}_- \times I' \times \mathbb{R}_-$ and such that $F_{M'_-}$ agrees with $F_{M'_-}$ in a neighborhood of $\{0\} \times I' \times \{0\} \subset \mathbb{R}_+ \times I' \times \mathbb{R}_+$ and with $F_{M'_-}$ in a neighborhood of $\{0\} \times I' \times \{0\} \subset \mathbb{R}_+ \times I' \times \mathbb{R}_-$;

(ii) the boundary of $M \cup_{\Gamma' \times I} M'$ is decomposed as

$$\begin{aligned}\partial_-^h(M \cup_{\Gamma' \times I} M') &= \partial_-^h M \cup_{\Gamma' \times \{0\}} \partial_-^h M', \\ \partial_+^h(M \cup_{\Gamma' \times I} M') &= \partial_+^h M \cup_{\Gamma' \times \{1\}} \partial_+^h M', \\ \partial_-^v(M \cup_{\Gamma' \times I} M') &= i_M(\partial_-^v M), \\ \partial_+^v(M \cup_{\Gamma' \times I} M') &= i_{M'}(\partial_+^v M').\end{aligned}$$

DEFINITION B.4.5. If Σ, Σ' and Σ'' are $d-1$ -dimensional cobordisms from Γ to Γ' , if M is a d -dimensional cobordism with corners from Σ to Σ' and if M' is a d -dimensional cobordism with corners from Σ' to Σ'' then we denote with $M \cup_{\Sigma'} M'$ the d -dimensional cobordism with corners from Σ to Σ'' given by

$$\begin{aligned}(M \cup_{\Sigma'} M', f_{M_-^h}, f_{M_+^h}, (f_{M_-^v} \cup_{\Sigma'} f_{M_-^v}) \circ u_{\Gamma \times I}, (f_{M_+^v} \cup_{\Sigma'} f_{M_+^v}) \circ u_{\Gamma' \times I}, \\ F_{M_-}, F_{M_+}, F_{M_-}, F_{M_+})\end{aligned}$$

where:

(i) the gluing data is given by the $d-1$ -dimensional manifold with boundary Σ' together with the diffeomorphisms $f_{M_+^h}$ and $f_{M_-^h}$ and with any pair of collars

$$F_{M_+^h} : \Sigma' \times \mathbb{R}_- \hookrightarrow M, \quad F_{M_-^h} : \Sigma' \times \mathbb{R}_+ \hookrightarrow M'$$

for $f_{M_+^h}$ and $f_{M_-^h}$ respectively such that $F_{M_+^h}$ agrees with F_{M_-} in a neighborhood of $\{0\} \times I' \times \{0\} \subset \mathbb{R}_+ \times I' \times \mathbb{R}_-$ and with F_{M_+} in a neighborhood of $\{0\} \times I' \times \{0\} \subset \mathbb{R}_- \times I' \times \mathbb{R}_-$ and such that $F_{M_-^h}$ agrees with F_{M_-} in a neighborhood of $\{0\} \times I' \times \{0\} \subset \mathbb{R}_+ \times I' \times \mathbb{R}_+$ and with F_{M_+} in a neighborhood of $\{0\} \times I' \times \{0\} \subset \mathbb{R}_- \times I' \times \mathbb{R}_+$;

(ii) the boundary of $M \cup_{\Sigma'} M'$ is decomposed as

$$\begin{aligned}\partial_-^h(M \cup_{\Sigma'} M') &= i_M(\partial_-^h M), \\ \partial_+^h(M \cup_{\Sigma'} M') &= i_{M'}(\partial_+^h M'), \\ \partial_-^v(M \cup_{\Sigma'} M') &= \partial_-^v M \cup_{\Gamma} \partial_-^v M', \\ \partial_+^v(M \cup_{\Sigma'} M') &= \partial_+^v M \cup_{\Gamma'} \partial_+^v M';\end{aligned}$$

(iii) the diffeomorphisms $u_{\Gamma \times I}$ and $u_{\Gamma' \times I}$ are defined as

$$\begin{aligned}u_{\Gamma \times I} : \Gamma \times I &\rightarrow (\Gamma \times I) \cup_{\Gamma} (\Gamma \times I) \\ (x, t) &\mapsto \begin{cases} [-1, (x, 2\psi(t))] & t \leq \frac{1}{2} \\ [+1, (x, 2\psi(t) - 1)] & t \geq \frac{1}{2} \end{cases} \\ u_{\Gamma' \times I} : \Gamma' \times I &\rightarrow (\Gamma' \times I) \cup_{\Gamma'} (\Gamma' \times I) \\ (x', t) &\mapsto \begin{cases} [-1, (x', 2\psi(t))] & t \leq \frac{1}{2} \\ [+1, (x', 2\psi(t) - 1)] & t \geq \frac{1}{2} \end{cases}\end{aligned}$$

where $\psi : I \rightarrow I$ is a diffeomorphism satisfying $\psi(t) = \frac{t}{2}$ for all $t \leq \frac{1}{4}$, $\psi(t) = \frac{t+1}{2}$ for all $t \geq \frac{3}{4}$ and $\psi(\frac{1}{2}) = \frac{1}{2}$.

DEFINITION B.4.6. If Σ is a $d-1$ -dimensional cobordism from Γ to Γ' then the *left wedge cobordism with corners* $(\Sigma \times \mathbb{I})_{\Gamma_-}$ is the d -dimensional cobordism with corners from $(\mathbb{I} \times \Gamma) \cup_{\Gamma} \Sigma$ to Σ given by

$$(\Sigma \times \mathbb{I}, (\ell_{\Sigma}, 0), (\text{id}_{\Sigma}, 1), f_{\Sigma_-} \times \text{id}_{\mathbb{I}}, f_{\Sigma_+} \times \text{id}_{\mathbb{I}}, \\ F_{I_-} \times \text{id}_{\Gamma} \times F_{I_-}, F_{\Sigma_-} \times F_{I_+}, F_{\Sigma_+} \times F_{I_-}, F_{\Sigma_+} \times F_{I_+})$$

where $\ell_{\Sigma} : (\mathbb{I} \times \Gamma) \cup_{\Gamma} \Sigma \rightarrow \Sigma$ coincides with id_{Σ} on $\Sigma \setminus F_{\Sigma_-}(\mathbb{R}_+ \times \Gamma)$ and with

$$(F_{\Sigma})_{\Gamma_-} : (\mathbb{I} \times \Gamma) \cup_{\Gamma} F_{\Sigma_-}(\mathbb{R}_+ \times \Gamma) \rightarrow \Sigma \\ [-1, (t, x)] \mapsto F_{\Sigma_-}(t, x) \\ [+1, F_{\Sigma_-}(t_+, x)] \mapsto F_{\Sigma_-}(\psi_+(t_+), x),$$

elsewhere for some fixed embedding $\psi_+ : \mathbb{R}_+ \hookrightarrow \mathbb{R}_+$ satisfying $\psi_+(t_+) = t_+ + 1$ for all $t_+ \leq 1$ and $\psi_+(t_+) = t_+$ for all $t_+ \geq 3$.

DEFINITION B.4.7. If Σ is a $d-1$ -dimensional cobordism from Γ to Γ' then the *right wedge cobordism with corners* $(\Sigma \times \mathbb{I})_{\Gamma'_+}$ is the d -dimensional cobordism with corners from $\Sigma \cup_{\Gamma'} (\mathbb{I} \times \Gamma')$ to Σ given by

$$(\Sigma \times \mathbb{I}, (r_{\Sigma}, 0), (\text{id}_{\Sigma}, 1), f_{\Sigma_-} \times \text{id}_{\mathbb{I}}, f_{\Sigma_+} \times \text{id}_{\mathbb{I}}, \\ F_{\Sigma_-} \times F_{I_-}, F_{\Sigma_-} \times F_{I_+}, F_{I_+} \times \text{id}_{\Gamma'} \times F_{I_-}, F_{\Sigma_+} \times F_{I_+})$$

where $r_{\Sigma} : \Sigma \cup_{\Gamma'} (\mathbb{I} \times \Gamma') \rightarrow \Sigma$ coincides with id_{Σ} on $\Sigma \setminus F_{\Sigma_+}(\mathbb{R}_- \times \Gamma')$ and with

$$(F_{\Sigma})_{\Gamma'_+} : F_{\Sigma_+}(\mathbb{R}_- \times \Gamma') \cup_{\Gamma'} (\mathbb{I} \times \Gamma') \rightarrow \Sigma \\ [-1, F_{\Sigma_+}(t_-, x')] \mapsto F_{\Sigma_+}(\psi_-(t_-), x') \\ [+1, (t, x')] \mapsto F_{\Sigma_+}(t-1, x'),$$

elsewhere for some fixed embedding $\psi_- : \mathbb{R}_- \hookrightarrow \mathbb{R}_-$ satisfying $\psi_-(t_-) = t_- - 1$ for all $t_- \geq -1$ and $\psi_-(t_-) = t_-$ for all $t_- \leq -3$.

DEFINITION B.4.8. If Σ is a $d-1$ -dimensional cobordism from Γ to Γ'' and if Σ' is a $d-1$ -dimensional cobordism from Γ' to Γ''' then we denote with $\Sigma \sqcup \Sigma'$ the $d-1$ -dimensional cobordism¹ from $\Gamma \sqcup \Gamma'$ to $\Gamma'' \sqcup \Gamma'''$ given by

$$(\Sigma \sqcup \Sigma', f_{\Sigma_-} \sqcup f_{\Sigma'_-}, f_{\Sigma_+} \sqcup f_{\Sigma'_+}, F_{\Sigma_-} \sqcup F_{\Sigma'_-}, F_{\Sigma_+} \sqcup F_{\Sigma'_+}).$$

DEFINITION B.4.9. If M is a d -dimensional cobordism with corners from Σ to Σ'' and if M' is a d -dimensional cobordism from Σ' to Σ''' then we denote with $M \sqcup M'$ the d -dimensional cobordism with corners from $\Sigma \sqcup \Sigma'$ to $\Sigma'' \sqcup \Sigma'''$ given by

$$(M \sqcup M', f_{M^{\text{h}}} \sqcup f_{M'^{\text{h}}}, f_{M^{\text{b}}} \sqcup f_{M'^{\text{b}}}, f_{M^{\text{v}}} \sqcup f_{M'^{\text{v}}}, f_{M^{\text{v}}} \sqcup f_{M'^{\text{v}}}, \\ F_{M^{\text{l}}} \sqcup F_{M'^{\text{l}}}, F_{M^{\text{r}}} \sqcup F_{M'^{\text{r}}}, F_{M^{\text{j}}} \sqcup F_{M'^{\text{j}}}, F_{M^{\text{r}}} \sqcup F_{M'^{\text{r}}}).$$

DEFINITION B.4.10. If Γ and Γ' are oriented smooth $d-2$ -dimensional closed manifolds then the *flip cobordism* $\text{I}\tilde{\times}(\Gamma \sqcup \Gamma')$ of Γ and Γ' is the $d-1$ -dimensional cobordism from $\Gamma \sqcup \Gamma'$ to $\Gamma' \sqcup \Gamma$ given by

$$(\mathbb{I} \times (\Gamma \sqcup \Gamma'), (0, \text{id}_{\Gamma \sqcup \Gamma'}), (1, \tau_{\Gamma, \Gamma'}), F_{I_-} \times \text{id}_{\Gamma \sqcup \Gamma'}, F_{I_+} \times \tau_{\Gamma, \Gamma'})$$

where we use the notation of Remark B.4.2 and

$$\tau_{\Gamma, \Gamma'} : \Gamma' \sqcup \Gamma \rightarrow \Gamma \sqcup \Gamma' \\ (-1, x') \mapsto (+1, x') \\ (+1, x) \mapsto (-1, x).$$

¹If X and X' are sets then we denote with $X \sqcup X'$ the set $(\{-1\} \times X) \cup (\{+1\} \times X')$, although most of the time we will suppress references to the first coordinate.

DEFINITION B.4.11. If Σ is a $d - 1$ -dimensional cobordism from Γ to Γ'' and if Σ' is a $d - 1$ -dimensional cobordism from Γ' to Γ''' then the *flip cobordism with corners* $(\Sigma \sqcup \Sigma') \tilde{\times} I$ of Σ and Σ' is the d -dimensional cobordism from

$$(\Sigma \sqcup \Sigma') \cup_{(\Gamma'' \sqcup \Gamma''')} (\tilde{I} \tilde{\times} (\Gamma'' \sqcup \Gamma'''))$$

to

$$(\tilde{I} \tilde{\times} (\Gamma \sqcup \Gamma')) \cup_{(\Gamma' \sqcup \Gamma)} (\Sigma' \sqcup \Sigma)$$

given by

$$\begin{aligned} & ((\Sigma \sqcup \Sigma') \times I, (r_{\Sigma \sqcup \Sigma'}, 0), (\ell_{\Sigma \sqcup \Sigma'} \circ (\text{id}_{I \times (\Gamma \sqcup \Gamma')} \cup_{\Gamma' \sqcup \Gamma} \tau_{\Sigma', \Sigma}), 1), \\ & (f_{\Sigma_-} \sqcup f_{\Sigma'_-}) \times \text{id}_I, (f_{\Sigma'_+} \sqcup f_{\Sigma_+}) \times \text{id}_I, \\ & (F_{\Sigma_-} \sqcup F_{\Sigma'_-}) \times F_{I_-}, F_{I_-} \times (\text{id}_{\Gamma \sqcup \Gamma'}) \times F_{I_+}, \\ & F_{I_+} \times (\text{id}_{\Gamma'' \sqcup \Gamma'''}) \times F_{I_-}, (F_{\Sigma'_+} \sqcup F_{\Sigma_+}) \times F_{I_+} \end{aligned}$$

where we use the notation of Definitions B.4.6, B.4.7 and B.4.10.

B.5. Ribbon graphs

REMARK B.5.1. Our notation will differ from the one used in [T94] for what concerns the orientations of edges. This is done in order to have a coherent notation for the orientation induced on the boundary throughout the exposition.

DEFINITION B.5.1. If Σ is a 2-dimensional cobordism then an *oriented vertex set* P inside Σ , denoted $P \subset \Sigma$, is an embedded oriented discrete set inside Σ disjoint from $\partial\Sigma$ whose points are called *vertices*.

REMARK B.5.2. The empty set is admitted as an oriented vertex set.

Let $I \times \{0\}$ denote the trivial cobordism of the oriented 0-dimensional manifold given by the set $\{0\}$ with positive orientation and let $I \times \{0\} \times I$ denote the trivial cobordism with corners of $I \times \{0\}$.

DEFINITION B.5.2. If M is a 3-dimensional manifold with corners then a *coupon* C inside M of type (k, k') is given by:

- (i) an embedded oriented 2-dimensional manifold with faces C inside M disjoint from ∂M ;
- (ii) a diffeomorphism of manifolds with faces $f_C : I \times \{0\} \times I \rightarrow C$ specifying an orientation for C and a structure C of cobordism with corners from $I \times \{0\}$ to $I \times \{0\}$ on C distinguishing an incoming horizontal boundary

$$\partial_-^h C := f_C(I \times \{0\} \times \{0\})$$

and an outgoing horizontal boundary

$$\partial_+^h C := f_C(I \times \{0\} \times \{1\})$$

called the *bottom base of C* and the *top base of C* respectively;

- (iii) a set In_C of k oriented points lying along the bottom base at

$$\left\{ f_C \left(\frac{i}{k+1}, 0, 0 \right) \in \partial_-^h C \mid i = 1, \dots, k \right\}$$

called the *input set*;

(iv) a set Out_C of k' oriented points lying along the top base at

$$\left\{ f_C \left(\frac{i'}{k'+1}, 0, 1 \right) \in \partial_+^h C \mid i' = 1, \dots, k' \right\}$$

called the *output set*.

REMARK B.5.3. The empty set is admitted both as an input and as an output set.

REMARK B.5.4. If M and M' are 3-dimensional manifolds with faces and if C is a coupon of type (k, k') inside M then every positive embedding $f_M : M \hookrightarrow M'$ naturally induces a coupon of type (k, k') inside M' which will be denoted $f_M(C)$.

REMARK B.5.5. If M is a 3-dimensional manifold with faces we will say an embedded 1-dimensional manifold with boundary $X \subset M$ intersects nicely an embedded 2-dimensional manifold with faces $Y \subset M$ if $X \cap Y = \partial X \cap \partial Y$ and if for every point in this intersection the tangent vector to X is also tangent to Y but not to ∂Y .

DEFINITION B.5.3. If M is a 3-dimensional cobordism with corners from Σ to Σ' and if $P \subset \Sigma$ and $P' \subset \Sigma'$ are oriented vertex sets then an *oriented graph T inside M from P to P'* , denoted $T \subset M$, is given by:

- (i) a finite set of oriented embedded smooth arcs inside M called the *edges of T* ;
- (ii) a finite set of coupons inside M .

These data satisfy:

- (i) The union of all edges E intersects ∂M transversely along the union of $f_{M_-^h}(P)$ and $f_{M_+^h}(P')$;
- (ii) The union of all edges E intersects C nicely along the union of In_C and Out_C for every coupon C ;
- (iii) The orientation obtained by placing a positive tangent vector to E before a positive frame of $\partial_\pm^h M$ agrees with the orientation of M at positive vertices and disagrees at negative vertices of $f_{M_-^h}(P)$ and $f_{M_+^h}(P')$.
- (iv) The orientation obtained by placing a positive tangent vector to E before a positive tangent vector to $\partial_\pm^h C$ agrees with the orientation of C at positive points and disagrees at negative points of In_C and Out_C for every coupon C .

REMARK B.5.6. We will use the notation $e \subset T$ for edges of T and $C \subset T$ for coupons of T .

REMARK B.5.7. If M is a 3-dimensional cobordism with corners from Σ to Σ'' , if M' is a 3-dimensional cobordism with corners from Σ' to Σ''' and if $T \subset M$ is an oriented graph from $P \subset \Sigma$ to $P' \subset \Sigma'$ then every time we have positive embedding of surfaces $f_\Sigma : \Sigma \hookrightarrow \Sigma'$ and $f_{\Sigma''} : \Sigma'' \hookrightarrow \Sigma'''$ and a positive embedding of manifolds with faces $f_M : M \hookrightarrow M'$ satisfying

$$f_{M_-^h} \circ f_\Sigma = f_M \circ f_{M_-^h}, \quad f_{M_+^h} \circ f_{\Sigma''} = f_M \circ f_{M_+^h}$$

we obtain an oriented graph $f_M(T) \subset M'$ from $f_\Sigma(P)$ to $f_{\Sigma''}(P')$ with an edge $f_M(e)$ for every edge $e \subset T$ and with a coupon $f_M(C)$ for every coupon $C \subset T$.

REMARK B.5.8. Every oriented vertex set $P \subset \Sigma$ naturally determines an oriented graph $P \times I$ from P to itself inside $\Sigma \times I$ called the *trivial oriented graph on P* which features an edge $\{p\} \times I \subset P \times I$ for every vertex $p \in P$ with orientation determined by the orientation of p .

DEFINITION B.5.4. If Σ is a 2-dimensional cobordism then a *ribbon set P inside Σ* , denoted $P \subset \Sigma$, is given by:

- (i) an oriented vertex set $P \subset \Sigma$;
- (ii) a framing given by a non-zero tangent vector $v_p \in T_p \Sigma$ for all $p \in P$.

A vertex together with its framing is called a *ribbon vertex*.

REMARK B.5.9. The empty set is admitted as a ribbon set.

REMARK B.5.10. If Σ and Σ' are 2-dimensional cobordisms and if $P \subset \Sigma$ is a ribbon set then every positive embedding of surfaces $f_\Sigma : \Sigma \hookrightarrow \Sigma'$ induces a ribbon set $f_\Sigma(P) \subset \Sigma'$ given by $f_\Sigma(P)$ with framing $d_p f_\Sigma(v_p)$ at $f_\Sigma(p)$ for every vertex $p \in P$.

DEFINITION B.5.5. If M is a 3-dimensional cobordism with corners from Σ to Σ' and if $P \subset \Sigma$ and $P' \subset \Sigma'$ are ribbon sets then a *ribbon graph T inside M from P to P'* , denoted $T \subset M$, is given by:

- (i) an oriented graph $T \subset M$;
- (ii) a framing given by a nowhere-vanishing normal vector field X_e along every edge $e \subset T$.

These data satisfy:

- (i) The framing of T equals the framing of $f_{M_-^h}(P)$ and $f_{M_+^h}(P')$ at their intersection.
- (ii) The framing of T equals the positive unit tangent vector of $\partial_\pm^h C$ at positive input and output points and equals the negative unit tangent vector of $\partial_\pm^h C$ at negative input and output points of C for every coupon C .

REMARK B.5.11. The empty set is considered to be a ribbon graph.

A ribbon graph between empty ribbon sets will be called a *closed ribbon graph*, a ribbon graph without coupons will be called a *ribbon tangle*, a ribbon tangle between empty ribbon sets will be called a *framed link* and a connected framed link will be called a *framed knot*.

REMARK B.5.12. If M is a 3-dimensional cobordism with corners from Σ to Σ'' , if M' is a 3-dimensional cobordism with corners from Σ' to Σ''' and if $T \subset M$ is a ribbon graph from $P \subset \Sigma$ to $P' \subset \Sigma'$ then every time we have positive embedding of surfaces $f_\Sigma : \Sigma \hookrightarrow \Sigma'$ and $f_{\Sigma''} : \Sigma'' \hookrightarrow \Sigma'''$ and a positive embedding of manifolds with faces $f_M : M \hookrightarrow M'$ satisfying

$$f_{M_-^h} \circ f_\Sigma = f_M \circ f_{M_-^h}, \quad f_{M_+^h} \circ f_{\Sigma''} = f_M \circ f_{M_+^h}$$

we obtain a ribbon graph $f_M(T) \subset M'$ from $f_\Sigma(P)$ to $f_{\Sigma''}(P')$ given by $f_M(T)$ with framing $d f_M(X_e)$ along $f_M(e)$ for every edge $e \subset T$.

REMARK B.5.13. Every ribbon set $P \subset \Sigma$ naturally determines a ribbon tangle $P \times I$ from P to itself inside $\Sigma \times I$ called the *trivial ribbon tangle on P* whose oriented graph is given by $P \times I \subset \Sigma \times I$ with framing $X_{\{p\} \times I} = \pi_\Sigma^*(v_p)$ along each edge $\{p\} \times I \subset P \times I$ for the natural projection $\pi_\Sigma : \Sigma \times I \rightarrow \Sigma$.

B.6. Maslov index

This section contains details on Lagrangian subspaces and Maslov indices. Standard references are provided by [W69] and [T94]. Coefficients for homology and cohomology groups will always be in \mathbb{R} .

If X is a compact oriented n -dimensional manifold then for every $k = 0, \dots, n$ we have natural *intersection pairings* $\frown_X: H_k(X) \times H_{n-k}(X) \rightarrow \mathbb{R}$ defined by

$$a \frown_X b := \langle D_X^{-1} a \smile D_X^{-1} b, [X] \rangle$$

for all $a \in H_k(X)$ and $b \in H_{n-k}(X)$, where D_X denotes the Poincaré duality isomorphism. The properties of the cup product imply

$$b \frown_X a = (-1)^{k(n-k)} a \frown_X b$$

for all $a \in H_k(X)$ and $b \in H_{n-k}(X)$.

DEFINITION B.6.1. If X is a compact oriented n -dimensional manifold a *boundary pair* (A, B) for X is given by compact oriented $n-1$ -dimensional submanifolds A and B of ∂X satisfying $\partial X = A \cup B$ and $A \cap B = \partial A = \overline{\partial B}$.

REMARK B.6.1. We admit both $(\emptyset, \partial X)$ and $(\partial X, \emptyset)$ as boundary pairs.

If X is a compact oriented n -dimensional manifold and (A, B) is a boundary pair for X then for every $k = 0, \dots, n$ we have natural *relative intersection pairings* $\frown_X^{A,B}: H_k(X, A) \times H_{n-k}(X, B) \rightarrow \mathbb{R}$ defined again by the formula

$$a \frown_X^{A,B} b := \langle D_X^{-1} a \smile D_X^{-1} b, [X] \rangle$$

for all $a \in H_k(X, A)$ and $b \in H_{n-k}(X, B)$. Again, we have

$$b \frown_X^{B,A} a = (-1)^{k(n-k)} a \frown_X^{A,B} b$$

for all $a \in H_k(X, A)$ and $b \in H_{n-k}(X, B)$.

REMARK B.6.2. Let (A, B) be a boundary pair for an n -dimensional compact manifold X . If $\mathcal{B} = \{a_1, \dots, a_m\}$ is a basis of $H_k(X, A)$ then let us denote with $\mathcal{U} = \{\varphi^1, \dots, \varphi^m\}$ the basis of $H^k(X, A)$ which is dual to \mathcal{B} under the Universal Coefficient isomorphism and let us denote with $\mathcal{P} = \{b_1, \dots, b_m\}$ the basis of $H_{n-k}(X, B)$ which is dual to \mathcal{U} under the Poincaré Duality isomorphism. Then for all $a \in H_k(X, A)$ we have

$$a = \sum_{i=1}^m \langle \varphi^i, a \rangle \cdot a_i = \sum_{i=1}^m (a \frown_X^{A,B} b_i) \cdot a_i.$$

In particular these relative pairings are always non-degenerate.

REMARK B.6.3. It follows directly from the naturality of cup and cap products that absolute and relative pairings agree where they are both defined. More precisely, if (A, B) is a boundary pair for an n -dimensional compact manifold X and if $q_A: (X, \emptyset) \hookrightarrow (X, A)$, $q_B: (X, \emptyset) \hookrightarrow (X, B)$ are inclusions then

$$q_{A*} a \frown_X^{A,B} q_{B*} b = a \frown_X b$$

for all $a \in H_k(X)$ and $b \in H_{n-k}(X)$. In particular for every $k = 0, \dots, n$ we can characterize the annihilator $\text{Ann}_{\frown_X}(H_{n-k}(X)) \subset H_k(X)$ as the kernel of the homomorphism $q_{\partial X*}: H_k(X) \rightarrow H_k(X, \partial X)$ induced by inclusion.

REMARK B.6.4. Another consequence of naturality is that compatible relative pairings agree where they are both defined. More precisely, if (A, B) and (A', B') are boundary pairs for an n -dimensional compact manifold X satisfying $A \subset A'$ and if $q_{A'} : (X, A) \hookrightarrow (X, A')$, $q_B : (X, B') \hookrightarrow (X, B)$ are inclusions then

$$q_{A'*} a \frown_X^{A', B'} b = a \frown_X^{A, B} q_{B*} b$$

for all $a \in H_k(X, A)$ and $b \in H_{n-k}(X, B')$.

PROPOSITION B.6.1. *Let (A, B) be a boundary pair for an n -dimensional compact manifold X , let*

$$j_{A*} : H_{n-k}(A, \partial A) \rightarrow H_{n-k}(X, B)$$

be induced by inclusion and let

$$\partial_* : H_k(X, A) \rightarrow H_{k-1}(A)$$

be the homomorphism coming from the long exact sequence of the pair (X, A) . Then

$$a \frown_X^{A, B} j_{A*} b = \partial_* a \frown_A^{\emptyset, \partial A} b$$

for all $a \in H_k(X, A)$ and $b \in H_{n-k}(A, \partial A)$.

The proof essentially follows from the proof of Theorem 3.43 of Hatcher's book [H02].

Now let X be a compact oriented n -dimensional manifold and let Y_0 be a compact oriented separating $n-1$ -dimensional submanifold of X with boundary $\partial Y_0 = Y_0 \cap \partial X$. Then Y_0 induces a decomposition $X = X_- \cup X_+$ with X_- and X_+ being codimension-0 submanifolds of X having boundaries $\partial X_- = \overline{Y_-} \cup Y_0$ and $\partial X_+ = \overline{Y_0} \cup Y_+$ respectively, where Y_- and Y_+ satisfy $\partial X = \overline{Y_-} \cup Y_+$ and $\overline{Y_-} \cap Y_+ = \partial Y_- = \partial Y_0 = \partial Y_+ =: Z$. We do not exclude the case $\partial X = \emptyset$, nor the case $\partial Y_0 = \emptyset$, and so Y_- and Y_+ may be empty, even simultaneously.

PROPOSITION B.6.2. *Let $X, X_-, X_+, Y_-, Y_0, Y_+$ and Z be as above and let $\partial X = A \cup B$ be a decomposition satisfying either $A \subset Y_-$ or $Y_- \subset A$. Set*

$$A_- := A \cap \partial X_-, \quad B_- := \partial X_- \setminus A_-$$

and let

$$\begin{aligned} j_{X-*} &: H_k(X_-, A_-) \rightarrow H_k(X, A), \\ q_{X+*} &: H_{n-k}(X, B) \rightarrow H_{n-k}(X, B \cup X_+), \\ e_{X+*} &: H_{n-k}(X_-, B_-) \rightarrow H_{n-k}(X, B \cup X_+) \end{aligned}$$

be induced by inclusions. Then

$$j_{X-*} a \frown_X^{A, B} b = a \frown_{X_-}^{A_-, B_-} e_{X+*}^{-1} q_{X+*} b$$

for all $a \in H_k(X_-, A_-)$ and $b \in H_{n-k}(X, B)$.

The proof essentially follows from the naturality of the cup product.

When a manifold X decomposes into two pieces X_- and X_+ as above it is useful to study intersection pairings on X in terms of their restrictions to X_- and X_+ . The following is a crucial technical result in this direction. Consider the subspaces $XY_{\pm} := X_{\pm} \cup Y_{\mp}$ and $Y := Y_- \cup Y_0 \cup Y_+$ of X . Let $i_{X_{\pm}} : X_{\pm} \hookrightarrow X$, $i_{\partial X_{\pm}} : \partial X_{\pm} \hookrightarrow X$, $i_{XY_{\pm}} : XY_{\pm} \hookrightarrow X$ and $i_Y : Y \hookrightarrow X$ denote inclusions.

PROPOSITION B.6.3. *Let X , X_- , X_+ , Y_- , Y_0 , Y_+ and Z be as above and let $\text{im } i_{X_{\pm}^*}$ and $\text{im } i_{\partial X_{\pm}^*}$ be subspaces of $H_{n-k}(X)$. Then we have the following equalities:*

$$\begin{aligned} \text{Ann}_{\cap_X}(\text{im } i_{X_{\pm}^*}) &= \text{im } i_{XY_{\pm}^*} \subset H_k(X), \\ \text{Ann}_{\cap_X}(\text{im } i_{X_{-}^*} + \text{im } i_{X_{+}^*}) &= \text{im } i_{Y^*} \subset H_k(X), \\ \text{Ann}_{\cap_X}(\text{im } i_{\partial X_{\pm}^*}) &= \text{im } i_{X_{\pm}^*} + \text{im } i_{XY_{\mp}^*} \subset H_k(X), \\ \text{Ann}_{\cap_X}(\text{im } i_{\partial X_{-}^*} + \text{im } i_{\partial X_{+}^*}) &= \text{im } i_{X_{-}^*} + \text{im } i_{X_{+}^*} + \text{im } i_{Y^*} \subset H_k(X) \end{aligned}$$

PROOF. Remark B.6.3 and Proposition B.6.2 combine to give the equality

$$a \cap_X i_{X_{\pm}^*} b_{\pm} = e_{X_{\mp}^*}^{-1} q_{XY_{\mp}^*} a \cap_{X_{\pm}^*}^{\partial X_{\pm}^*, \emptyset} b_{\pm},$$

for all $a \in H_k(X)$ and $b_{\mp} \in H_{n-k}(X_{\pm})$, where $q_{X_{\mp}^*} : H_k(X) \rightarrow H_k(X, XY_{\mp}^*)$ and $e_{X_{\mp}^*} : H_k(X_{\pm}, \partial X_{\pm}) \rightarrow H_k(X, XY_{\mp}^*)$ are induced by inclusions. Therefore, since $\cap_{X_{\pm}^*}^{\partial X_{\pm}^*, \emptyset}$ is non-degenerate, the exact sequence of the pair (X, XY_{\mp}^*) gives the first annihilator.

The second annihilator equals $\text{im } i_{XY_{-}^*} \cap \text{im } i_{XY_{+}^*}$ which, thanks to the Mayer-Vietoris sequence associated with XY_- and XY_+ , equals $\text{im } i_{Y^*}$.

The previous equality and Proposition B.6.1 combine to give the equality

$$a \cap_X i_{\partial X_{\pm}^*} b_{\pm} = \partial_* q_{\partial X^*} a \cap_{\partial X_{\pm}^*} b_{\pm}$$

for all $a \in H_k(X)$ and $b_{\mp} \in H_{n-k}(\partial X_{\pm})$, where $q_{\partial X^*} : H_k(X) \rightarrow H_k(X, \partial X)$ is induced by inclusion and where $\partial_* : H_k(X, \partial X) \rightarrow H_{k-1}(\partial X_{\pm})$ comes from the relative Mayer-Vietoris sequence associated with (X_{\pm}, \emptyset) and $(XY_{\mp}^*, \partial X)$. Therefore, since $\cap_{\partial X_{\pm}^*}$ is non-degenerate, the third annihilator equals $q_{\partial X^*}^{-1}(\ker \partial_*)$. Now the exactness of the relative Mayer-Vietoris sequence above gives the equality

$$\ker \partial_* = \text{im } p_{X_{\pm}^*} + \text{im } j_{XY_{\mp}^*}$$

where $p_{X_{\pm}^*} : H_k(X_{\pm}) \rightarrow H_k(X, \partial X)$ and $j_{XY_{\mp}^*} : H_k(XY_{\mp}^*, \partial X) \rightarrow H_k(X, \partial X)$ are induced by inclusions. But since $p_{X_{\pm}^*}$ factors through $q_{\partial X^*}$ we get

$$q_{\partial X^*}^{-1}(\text{im } p_{X_{\pm}^*} + \text{im } j_{XY_{\mp}^*}) = \text{im } i_{X_{\pm}^*} + \text{im } i_{XY_{\mp}^*}.$$

Finally the last annihilator equals

$$(\text{im } i_{X_{-}^*} + \text{im } i_{XY_{+}^*}) \cap (\text{im } i_{X_{+}^*} + \text{im } i_{XY_{-}^*}) = \text{im } i_{X_{-}^*} + \text{im } i_{X_{+}^*} + \text{im } i_{Y^*},$$

thanks to inclusions $\text{im } i_{X_{-}^*} \subset \text{im } i_{XY_{-}^*}$ and $\text{im } i_{X_{+}^*} \subset \text{im } i_{XY_{+}^*}$, and thanks to the Mayer-Vietoris sequence associated with XY_- and XY_+ . \square

Another technical result which will be fundamental in the following is the following characterization of the intersection pairing restricted to the subspace Y .

PROPOSITION B.6.4. *Let X , X_- , X_+ , Y_- , Y_0 , Y_+ and Z be as above and let*

$$\begin{aligned} \partial_{Y_0^*} : H_k(Y) &\rightarrow H_{k-1}(Z), \\ \partial_{Y_{-}^*} : H_{n-k}(Y) &\rightarrow H_{n-k-1}(Z) \end{aligned}$$

be the homomorphisms coming from the Mayer-Vietoris sequences associated with Y_0 and ∂X and with Y_- and ∂X_+ respectively. Then

$$i_{Y^*} a \cap_X i_{Y^*} b = (-1)^k \cdot \partial_{Y_0^*} a \cap_Z \partial_{Y_{-}^*} b$$

for all $a \in H_k(Y)$ and $b \in H_{n-k}(Y)$.

PROOF. We have the commutative diagrams

$$\begin{array}{ccccc}
H_k(Y, \partial X) & \xrightarrow{e_{\partial X^*}^{-1}} & H_k(Y_0, Z) & \xrightarrow{\partial_{Y_0^*}} & H_{k-1}(Z) \\
\uparrow q_{\partial X^*} & & \downarrow j_{Y_0^*} & & \downarrow i_{Z_*} \\
H_k(Y) & & & & \\
\downarrow p_{\partial X^*} & & \downarrow & & \downarrow \\
H_k(X, \partial X) & \xleftarrow{j_{X_*}} & H_k(X_-, Y_-) & \xrightarrow{\partial_{X_*}} & H_{k-1}(Y_-)
\end{array}$$

$$\begin{array}{ccccc}
H_{n-k}(Y, \partial X_+) & \xrightarrow{e_{\partial X_+^*}^{-1}} & H_{n-k}(Y_-, Z) & \xrightarrow{\partial_{Y_*}} & H_{n-k-1}(Z) \\
\uparrow q_{\partial X_+^*} & & \downarrow j_{Y_*} & & \downarrow i_{Z_0^*} \\
H_{n-k}(Y) & & & & \\
\downarrow p_{X_+^*} & & \downarrow & & \downarrow \\
H_{n-k}(X, X_+) & \xrightarrow{e_{X_+^*}^{-1}} & H_{n-k}(X_-, Y_0) & \xrightarrow{\partial_{X_*}} & H_{n-k-1}(Y_0)
\end{array}$$

where all dimension-preserving homomorphisms are induced by inclusions and all other homomorphisms come from long exact sequences of pairs. Therefore let us fix $a \in H_k(Y)$ and $b \in H_{n-k}(Y)$ and let us set $a_0 := e_{\partial X_*}^{-1} q_{\partial X_*} a \in H_k(Y_0, Z)$ and $b_- := e_{\partial X_+^*}^{-1} q_{\partial X_+^*} b \in H_k(Y_-, Z)$. Then we have

$$\begin{aligned}
i_{Y_*} a \frown_X i_{Y_*} b &= p_{\partial X_*} a \frown_X^{\partial X, \emptyset} i_{Y_*} b \\
&= j_{X_*} j_{Y_0^*} a_0 \frown_X^{\partial X, \emptyset} i_{Y_*} b \\
&= j_{Y_0^*} a_0 \frown_{X_-}^{Y_-, Y_0} e_{X_+^*}^{-1} p_{X_+^*} b \\
&= j_{Y_0^*} a_0 \frown_{X_-}^{Y_-, Y_0} j_{Y_*} b_- \\
&= (-1)^{k(n-k)} \cdot j_{Y_*} b_- \frown_{X_-}^{Y_0, Y_-} j_{Y_0^*} a_0 \\
&= (-1)^{k(n-k)} \cdot \partial_{X_*} j_{Y_*} b_- \frown_{Y_0}^{\emptyset, Z} a_0 \\
&= (-1)^{k(n-k)+k(n-k-1)} \cdot a_0 \frown_{Y_0}^{Z, \emptyset} \partial_{X_*} j_{Y_*} b_- \\
&= (-1)^k \cdot a_0 \frown_{Y_0}^{Z, \emptyset} i_{Z_0^*} \partial_{Y_*} b_- \\
&= (-1)^k \cdot \partial_{Y_0^*} a_0 \frown_Z \partial_{Y_*} b_-
\end{aligned}$$

where the first equality follows from Remark B.6.3, where the second, the fourth and the eighth equality follow from the commutativity of the previous diagrams, where the third equality follows from Proposition B.6.2 and where the sixth and the ninth equality follow from Proposition B.6.1. \square

Let H be a finite dimensional real vector space equipped with an antisymmetric bilinear form ω . A subspace $A \subset H$ is *isotropic* if it satisfies $A \subset A^\perp$. An isotropic subspace \mathcal{L} of H is *Lagrangian* if $\mathcal{L} = \mathcal{L}^\perp$. The pair (H, ω) is called a *symplectic space* if ω is non-degenerate.

EXAMPLE B.6.1. If Σ is a $4m + 2$ -dimensional closed oriented manifold then its middle homology $H_{2m+1}(\Sigma)$ equipped with the intersection pairing \cap_Σ is a symplectic space.

PROPOSITION B.6.5. *Let M be a compact oriented $(4m + 3)$ -dimensional manifold and let $i_{\partial M} : \partial M \hookrightarrow M$ denote the inclusion of ∂M inside M . Then $\ker i_{\partial M*} \subset H_{2m+1}(\partial M)$ is a Lagrangian subspace of $(H_{2m+1}(\partial M), \cap_{\partial M})$.*

PROOF. Proposition B.6.1 gives for all $a \in H_{2m+2}(M, \partial M)$, $b \in H_{2m+1}(\partial M)$ the equality

$$a \cap_M^{\partial M, \emptyset} i_{\partial M*} b = \partial_* a \cap_{\partial M} b$$

where $\partial_* : H_{2m+2}(M, \partial M) \rightarrow H_{2m+1}(\partial M)$ is the homomorphism coming from the long exact sequence of the pair $(M, \partial M)$. From the non-degeneracy of $\cap_M^{\emptyset, \partial M}$ we derive $\ker i_{\partial M*} = (\text{im } \partial_*)^\perp$ and the equality $\ker i_{\partial M*} = \text{im } \partial_*$ gives the result. \square

Now let Σ be a compact oriented $4m + 2$ -dimensional manifold and let Γ_0 be a closed oriented separating $4m + 1$ -dimensional submanifold of Σ disjoint from $\partial\Sigma$. Then Γ_0 induces a decomposition $\Sigma = \Sigma_- \cup \Sigma_+$ for codimension-0 submanifolds Σ_- and Σ_+ of Σ with boundaries

$$\partial\Sigma_- = \overline{\Gamma_-} \sqcup \Gamma_0, \quad \partial\Sigma_+ = \overline{\Gamma_0} \sqcup \Gamma_+,$$

where Γ_- and Γ_+ satisfy $\partial\Sigma = \overline{\Gamma_-} \sqcup \Gamma_+$. Let

$$\mathcal{L}_- \subset H_{2m+1}(\Sigma_-), \quad \mathcal{L}_+ \subset H_{2m+1}(\Sigma_+)$$

be Lagrangian subspaces and consider inclusions $i_{\Sigma_\pm} : \Sigma_\pm \hookrightarrow \Sigma$.

PROPOSITION B.6.6. *Let Σ , Σ_- , Σ_+ , Γ_- , Γ_0 and Γ_+ be as above. Then the subspace $\mathcal{L} := i_{\Sigma_-*}(\mathcal{L}_-) + i_{\Sigma_+*}(\mathcal{L}_+)$ is a Lagrangian subspace of $H_{2m+1}(\Sigma)$.*

PROOF. Consider inclusions $i_{\Gamma_\pm} : \Gamma_\pm \hookrightarrow \Sigma$ and set

$$L_\pm := i_{\Sigma_\pm*}(\mathcal{L}_\pm) + \text{im } i_{\Gamma_\pm*} \subset H_{2m+1}(\Sigma).$$

Remark that $\text{im } i_{\Gamma_\pm*} \subset i_{\Sigma_\pm*}(\mathcal{L}_\pm)$, so that $L_- + L_+ = \mathcal{L}$. Now if we set

$$\Gamma := \Gamma_- \sqcup \Gamma_0 \sqcup \Gamma_+$$

and we let $i_\Gamma : \Gamma \hookrightarrow \Sigma$ denote the inclusion of Γ inside Σ , we have $\text{im } i_{\Gamma*} \subset L_- \cap L_+$. Therefore $(L_\pm)^\perp \subset (\text{im } i_{\Gamma*})^\perp$ and, thanks to Proposition B.6.3, we get

$$(\text{im } i_{\Gamma*})^\perp = \text{im } i_{\Sigma_-*} + \text{im } i_{\Sigma_+*} + H_{2m+1}(\Sigma)^\perp = \text{im } i_{\Sigma_-*} + \text{im } i_{\Sigma_+*}.$$

Now it is easy to study $(L_\pm)^\perp$: indeed, since both i_{Σ_-*} and i_{Σ_+*} preserve intersection pairings, Proposition B.6.3 gives $(L_\pm)^\perp = i_{\Sigma_\pm*}(\mathcal{L}_\pm) + \text{im } i_{\Sigma_\mp*}$. Therefore

$$\mathcal{L}^\perp = (L_-)^\perp \cap (L_+)^\perp = i_{\Sigma_-*}(\mathcal{L}_-) + i_{\Sigma_+*}(\mathcal{L}_+) = \mathcal{L}.$$

\square

Let (H, ω) be a symplectic space and let $A \subset H$ be an isotropic subspace. If $H|A$ denotes the space A^\perp/A and $\omega|A$ denotes the antisymmetric form induced by ω on $H|A$ then $(H|A, \omega|A)$ is a symplectic space. For all subspaces $B \subset H$ let $B|A$ denote the subspace of $H|A$ given by $[(B + A) \cap A^\perp]/A$. We say $B|A$ is obtained by *contraction along A* .

LEMMA B.6.1. *If \mathcal{L} is a Lagrangian subspace of the symplectic space (H, ω) then for all isotropic subspaces $A \subset H$ the contraction $\mathcal{L}|A$ is a Lagrangian subspace of $(H|A, \omega|A)$.*

PROOF. For all $x, x', a, a' \in H$ we have

$$\omega(x + a, x' + a') = \omega(x, x') + \omega(x + a, a') + \omega(a, x' + a') - \omega(a, a').$$

If $x, x' \in \mathcal{L}$, $a, a' \in A$ and $x + a, x' + a' \in A^\perp$ then all terms on the right-hand side are equal to 0. Therefore $\mathcal{L}|A \subset (\mathcal{L}|A)^\perp$ in $(H|A, \omega|A)$. For the opposite inclusion we have

$$[(\mathcal{L} + A) \cap A^\perp]^\perp = (\mathcal{L}^\perp \cap A^\perp) + A \subset \mathcal{L}^\perp + A = \mathcal{L} + A$$

Therefore $[(\mathcal{L} + A) \cap A^\perp]^\perp \cap A^\perp \subset (\mathcal{L} + A) \cap A^\perp$ and $(\mathcal{L}|A)^\perp \subset \mathcal{L}|A$. \square

Let M be a compact oriented $4m + 3$ -dimensional manifold and let Σ_- and Σ_+ be compact oriented $4m + 2$ -dimensional submanifolds of its boundary ∂M satisfying $\partial M = \Sigma_- \cup \Sigma_+$ and $\Sigma_- \cap \Sigma_+ = \partial \Sigma_- = \overline{\partial \Sigma_+} = \Gamma$. Let

$$i_{\Sigma_\pm} : \Sigma_\pm \hookrightarrow \partial M, \quad i_{\partial M} : \partial M \hookrightarrow M, \quad i_{\Gamma_\pm} : \Gamma \hookrightarrow \Sigma_\pm, \quad i_\Gamma : \Gamma \hookrightarrow \partial M$$

denote inclusions. If \mathcal{L}_- is a Lagrangian subspace of $H_{2m+1}(\Sigma_-)$ and \mathcal{L}_+ is a Lagrangian subspace of $H_{2m+1}(\Sigma_+)$ then set

$$\begin{aligned} M_* \mathcal{L}_- &:= \{y \in H_{2m+1}(\Sigma_+) \mid i_{\partial M*} i_{\Sigma_+*} y \in i_{\partial M*} i_{\Sigma_-*}(\mathcal{L}_-)\} \subset H_{2m+1}(\Sigma_+), \\ M^* \mathcal{L}_+ &:= \{x \in H_{2m+1}(\Sigma_-) \mid i_{\partial M*} i_{\Sigma_-*} x \in i_{\partial M*} i_{\Sigma_+*}(\mathcal{L}_+)\} \subset H_{2m+1}(\Sigma_-). \end{aligned}$$

PROPOSITION B.6.7. *Let M , Σ_- , Σ_+ and Γ be as above. Then for all Lagrangian subspaces $\mathcal{L}_- \subset H_{2m+1}(\Sigma_-)$ and $\mathcal{L}_+ \subset H_{2m+1}(\Sigma_+)$ we have that $M_* \mathcal{L}_-$ is a Lagrangian subspace of $H_{2m+1}(\Sigma_+)$ and $M^* \mathcal{L}_+$ is a Lagrangian subspace of $H_{2m+1}(\Sigma_-)$.*

PROOF. The kernel of the homomorphism $i_{\partial M*} : H_{2m+1}(\partial M) \rightarrow H_{2m+1}(M)$ is a Lagrangian subspace thanks to Proposition B.6.5. Moreover, since homomorphisms $i_{\Sigma_\pm*} : H_{2m+1}(\Sigma_\pm) \rightarrow H_{2m+1}(\partial M)$ preserve intersection pairings, we also know that $i_{\Sigma_-*}(\mathcal{L}_-)$ and $i_{\Sigma_+*}(\mathcal{L}_+)$ are isotropic subspaces of $H_{2m+1}(\partial M)$. Therefore we have that the contraction $\ker i_{\partial M*} | i_{\Sigma_\pm*}(\mathcal{L}_\pm)$ is a Lagrangian subspace of $H_{2m+1}(\partial M) | i_{\Sigma_\pm*}(\mathcal{L}_\pm)$ thanks to Lemma B.6.1. Now we claim that the space $H_{2m+1}(\partial M) | i_{\Sigma_\pm*}(\mathcal{L}_\pm)$ is isomorphic to $\text{im } i_{\Sigma_\mp*} / \text{im } i_{\Gamma*}$ and that, under these isomorphisms, the subspace $\ker i_{\partial M*} | i_{\Sigma_-*}(\mathcal{L}_-)$ corresponds to $i_{\Sigma_+*}(M_* \mathcal{L}_-) / \text{im } i_{\Gamma*}$ and the subspace $\ker i_{\partial M*} | i_{\Sigma_+*}(\mathcal{L}_+)$ corresponds to $i_{\Sigma_-*}(M^* \mathcal{L}_+) / \text{im } i_{\Gamma*}$. Then, since $M_* \mathcal{L}_- \supset \text{im } i_{\Gamma_*}$ and $M^* \mathcal{L}_+ \supset \text{im } i_{\Gamma_*}$, we can conclude. To show the claim we remark that, since $\text{im } i_{\Gamma_*} \subset i_{\Sigma_\pm*}(\mathcal{L}_\pm)$, we have $(i_{\Sigma_\pm*}(\mathcal{L}_\pm))^\perp \subset (\text{im } i_{\Gamma_*})^\perp$. But now, thanks to Proposition B.6.3, we have $(\text{im } i_{\Gamma_*})^\perp = \text{im } i_{\Sigma_-*} + \text{im } i_{\Sigma_+*}$. Therefore $(i_{\Sigma_\pm*}(\mathcal{L}_\pm))^\perp = i_{\Sigma_\pm*}(\mathcal{L}_\pm) + \text{im } i_{\Sigma_\mp*}$ and $H_{2m+1}(\partial M) | i_{\Sigma_\pm*}(\mathcal{L}_\pm) \simeq \text{im } i_{\Sigma_\mp*} / \text{im } i_{\Gamma_*}$. \square

Let (H, ω) be a symplectic space and let $\mathcal{L}_1, \mathcal{L}_2, \mathcal{L}_3$ be three Lagrangian subspaces of H . Every element of the vector space

$$W(\mathcal{L}_1, \mathcal{L}_2, \mathcal{L}_3) := \frac{\mathcal{L}_1 \cap (\mathcal{L}_2 + \mathcal{L}_3)}{(\mathcal{L}_1 \cap \mathcal{L}_2) + (\mathcal{L}_1 \cap \mathcal{L}_3)}$$

is represented by some $a_1 \in \mathcal{L}_1$ which is equal to a sum $a_2 + a_3$ for $a_2 \in \mathcal{L}_2$ and $a_3 \in \mathcal{L}_3$. Now consider the bilinear form

$$\begin{aligned} \langle \cdot, \cdot \rangle : W(\mathcal{L}_1, \mathcal{L}_2, \mathcal{L}_3) \times W(\mathcal{L}_1, \mathcal{L}_2, \mathcal{L}_3) &\rightarrow \mathbb{R} \\ ([a_1], [b_2 + b_3]) &\mapsto \omega(a_1, b_2) \end{aligned}$$

where $a_1 \in \mathcal{L}_1, b_2 \in \mathcal{L}_2, b_3 \in \mathcal{L}_3$. This map is well-defined: indeed suppose that $a_1 = a_2 + a_3$ with $a_i \in \mathcal{L}_1 \cap \mathcal{L}_i$ and $b_1 = b_2 + b_3$ with $b_i \in \mathcal{L}_i$. Then we have $\omega(a_1, b_2) = \omega(a_3, b_2) = \omega(a_3, b_1) = 0$. Analogously for $a_i \in \mathcal{L}_i$ and $b_i \in \mathcal{L}_1 \cap \mathcal{L}_i$ we have $\omega(a_1, b_2) = 0$. Moreover this map is symmetric: indeed the equality $\omega(a_1, b_1) = 0$ implies $0 = \omega(a_3, b_2) + \omega(a_2, b_3) = \omega(a_3, b_2) - \omega(b_3, a_2)$, which gives

$$\omega(a_1, b_2) = \omega(a_3, b_2) = \omega(b_3, a_2) = \omega(b_1, a_2)$$

for all $a_i, b_i \in \mathcal{L}_i$. The symmetric form $\langle \cdot, \cdot \rangle$ is called the *Maslov form associated with the Lagrangian spaces $\mathcal{L}_1, \mathcal{L}_2, \mathcal{L}_3$* , and its signature, which is denoted $\mu(\mathcal{L}_1, \mathcal{L}_2, \mathcal{L}_3)$, is the *Maslov index* of $\mathcal{L}_1, \mathcal{L}_2, \mathcal{L}_3$.

PROPOSITION B.6.8. *If (H, ω) is a symplectic space and if $\mathcal{L}_1, \mathcal{L}_2, \mathcal{L}_3$ are three Lagrangian subspaces of H then*

$$\mu(\mathcal{L}_1, \mathcal{L}_2, \mathcal{L}_3) = -\mu(\mathcal{L}_2, \mathcal{L}_1, \mathcal{L}_3) = -\mu(\mathcal{L}_1, \mathcal{L}_3, \mathcal{L}_2).$$

If Φ is a symmetric bilinear form on a finite-dimensional real vector space V then we denote with $\sigma(\Phi)$ its signature.

LEMMA B.6.2. *Let V be a finite dimensional real vector space equipped with a symmetric bilinear form Φ and let $W \subset V$ be a linear subspace. If W is isotropic then*

$$\sigma(\Phi) = \sigma\left(\Phi|_{W^\perp \times W^\perp}\right).$$

The signature of a compact oriented $4k$ -dimensional manifold X is the signature of the symmetric intersection form $\cap_X: H_{2k}(X) \times H_{2k}(X) \rightarrow \mathbb{R}$ and is denoted $\sigma(X)$. Let W be a compact oriented $4k$ -dimensional manifold, let M_0 be a compact oriented separating $4k - 1$ -dimensional submanifold of W with $\partial M_0 = M_0 \cap \partial W$ inducing a decomposition $W = W_- \cup W_+$ for codimension-0 submanifolds W_- and W_+ having boundaries $\partial W_- = \overline{M_-} \cup M_0$ and $\partial W_+ = \overline{M_0} \cup M_+$ respectively, where M_- and M_+ satisfy $\partial W = \overline{M_-} \cup M_+$ and $\overline{M_-} \cap M_+ = \partial M_- = \partial M_0 = \partial M_+ = \Sigma$.

THEOREM B.6.1. *Let W, M_-, M_0, M_+ and Σ be as above, let*

$$\begin{aligned} i_{\Sigma_0*} : H_1(\Sigma) &\rightarrow H_1(M_0), \\ i_{\Sigma_\pm*} : H_1(\Sigma) &\hookrightarrow H_1(M_\pm) \end{aligned}$$

be induced by inclusions and set $\mathcal{L}_0 := \ker i_{\Sigma_0}$ and $\mathcal{L}_\pm := \ker i_{\Sigma_\pm*}$. Then*

$$\sigma(W) = \sigma(W_-) + \sigma(W_+) + \mu(\mathcal{L}_-, \mathcal{L}_0, \mathcal{L}_+).$$

PROOF. Let us consider the subspace $M := M_- \cup M_0 \cup M_+$ and inclusions $i_{W_\pm} : W_\pm \hookrightarrow W$, $i_{\partial W_\pm} : \partial W_\pm \hookrightarrow W$ and $i_M : M \hookrightarrow W$. Then thanks to Proposition B.6.3 we have

$$(\operatorname{im} i_{\partial W_-} + \operatorname{im} i_{\partial W_+})^\perp = \operatorname{im} i_{W_-} + \operatorname{im} i_{W_+} + \operatorname{im} i_{M^*} \subset H_{2k}(W)$$

and so $\operatorname{im} i_{\partial W_-} + \operatorname{im} i_{\partial W_+}$ is an isotropic subspace of $H_{2k}(W)$. Therefore, thanks to Lemma B.6.2, $\sigma(W)$ equals the signature of $\operatorname{im} i_{W_-} + \operatorname{im} i_{W_+} + \operatorname{im} i_{M^*}$. Now if we choose complements V_\pm for $\operatorname{im} i_{\partial W_\pm}$ inside $\operatorname{im} i_{W_\pm}$ we get an orthogonal decomposition

$$\operatorname{im} i_{W_-} + \operatorname{im} i_{W_+} + \operatorname{im} i_{M^*} = V_- \oplus V_+ \oplus \operatorname{im} i_{M^*}.$$

Since V_- and V_+ carry the signature of W_- and W_+ respectively we get

$$\sigma(W) = \sigma(W_-) + \sigma(W_+) + \sigma(\operatorname{im} i_{M^*}).$$

Let us consider the homomorphism $\partial_{0^*} : H_{2k}(M) \rightarrow H_{2k-1}(\Sigma)$ coming from the Mayer-Vietoris sequence associated with M_0 and ∂W and let us define the map

$$\begin{aligned} \Psi : \operatorname{im} i_{M^*} / (\operatorname{im} i_{\partial W_-} + \operatorname{im} i_{\partial W_+}) &\rightarrow W(\mathcal{L}_0, \mathcal{L}_-, \mathcal{L}_+) \\ [i_{M^*}a] &\mapsto [\partial_{0^*}a]. \end{aligned}$$

The image of ∂_{0^*} equals $\ker i_{\Sigma_0^*} \cap \ker i_{\Sigma_\partial}$ where $i_{\Sigma_\partial} : \Sigma \hookrightarrow \partial W$ denotes the inclusion of Σ inside ∂W . Now $\ker i_{\Sigma_\partial}$ equals the image of the connection homomorphism in the exact sequence of the pair $(\partial W, \Sigma)$, which in turn equals the image of

$$\partial_{-*} + \partial_{+*} : H_{2k}(M_-, \Sigma) \oplus H_{2k}(M_+, \Sigma) \rightarrow H_{2k-1}(\Sigma),$$

where $\partial_{\pm*} : H_{2k}(M_\pm, \Sigma) \rightarrow H_{2k-1}(\Sigma)$ comes from the exact sequence of the pair (M_\pm, Σ) . In other words $\operatorname{im} \partial_{0^*} = \mathcal{L}_0 \cap (\mathcal{L}_- + \mathcal{L}_+)$. Moreover

$$\partial_{0^*}(\operatorname{im} i_{\partial W_-} + \operatorname{im} i_{\partial W_+}) = (\mathcal{L}_0 \cap \mathcal{L}_-) + (\mathcal{L}_0 \cap \mathcal{L}_+)$$

because $\partial_{0^*} \circ i_{\partial W_\pm}$ coincides with the homomorphism coming from the Mayer-Vietoris sequence associated with M_0 and M_\pm . Therefore Ψ is an isomorphism. Moreover we have $\partial_{0^*} = -\partial_{-*} - \partial_{+*}$ because $\partial_{-*} + \partial_{+*}$ coincides with the homomorphism coming from the Mayer-Vietoris sequence associated with ∂W and M_0 (the order here is reversed with respect to the sequence which yields ∂_{0^*}). Therefore, thanks to Proposition B.6.4, we get

$$\begin{aligned} i_{M^*}a \frown_W i_{M^*}b &= (-1)^{2k} \partial_{0^*}a \frown_\Sigma \partial_{-*}b \\ &= -(\partial_{0^*}a \frown_\Sigma - \partial_{-*}b) \\ &= -\langle \Psi[i_{M^*}a], \Psi[i_{M^*}b] \rangle. \end{aligned}$$

□

Bibliography

- [A28] J. Alexander – *Topological Invariants of Knots and Links* – Transactions of the American Mathematical Society, Volume 30, Issue 2, April 1928, Pages 275-306
- [A06] J. Andersen – *Asymptotic Faithfulness of the Quantum $SU(n)$ Representations of the Mapping Class Groups* – Annals of Mathematics, Volume 163, Issue 1, 2006, Pages 347-368
- [AU15] J. Andersen, K. Ueno – *Construction of the Witten-Reshetikhin-Turaev TQFT from Conformal Field Theory* – Inventiones Mathematicae, August 2015, Volume 201, Issue 2, Pages 519-559
- [A88] M. Atiyah – *Topological Quantum Field Theory* – Publications Mathématiques de l’IHÉS, Volume 68, 1988, Pages 175-186
- [BDSV15] B. Bartlett, C. Douglas, C. Schommer-Pries, J. Vicary – *Modular Categories as Representations of the 3-Dimensional Bordism 2-Category* – [arXiv:1509.06811](#) [math.AT]
- [BBG17] A. Beliakova, C. Blanchet, N. Geer – *Logarithmic Hennings Invariants for Restricted Quantum $\mathfrak{sl}(2)$* – [arXiv:1705.03083](#) [math.GT]
- [B63] J. Bénabou – *Catégories avec Multiplication* – Comptes Rendus Hebdomadaires des Séances de l’Académie des Sciences, Tome 256, Paris, Janvier-Février 1963, Pages 1887-1890
- [B67] J. Bénabou – *Introduction to Bicategories* – Reports of the Midwest Category Seminar I, Lecture Notes in Mathematics, Volume 47, Springer-Verlag Berlin Heidelberg, 1967
- [B03] C. Blanchet – *Introduction to Quantum Invariants of 3-Manifolds, Topological Quantum Field Theories and Modular Categories* – Geometric and Topological Methods for Quantum Field Theory, Proceedings of the Summer School, Villa de Leyva, Colombia, 9–27 July 2001, World Scientific Publishing, March 2003, Pages 228–264
- [BCGP16] C. Blanchet, F. Costantino, N. Geer, B. Patureau-Mirand – *Non-Semisimple TQFTs, Reidemeister Torsion and Kashaev’s Invariants* – Advances in Mathematics, Volume 301, 1 October 2016, Pages 1-78
- [BHMV92] C. Blanchet, N. Habegger, G. Masbaum, P. Vogel – *Three-Manifold Invariants Derived from the Kauffman Bracket* – Topology, Volume 31, Issue 4, October 1992, Pages 685-699
- [BHMV95] C. Blanchet, N. Habegger, G. Masbaum, P. Vogel – *Topological Quantum Field Theories Derived from the Kauffman Bracket* – Topology, Volume 34, Issue 4, 1995, Pages 883-927
- [CGP14] F. Costantino, N. Geer, B. Patureau-Mirand – *Quantum Invariants of 3-Manifolds via Link Surgery Presentations and Non-Semi-Simple Categories* – Journal of Topology, Volume 7, Number 4, 2014, Pages 1005-1053
- [D15] M. De Renzi – *Quantum Invariants of 3-Manifolds Arising from Non-Semisimple Categories* – Bulletin of the Chelyabinsk State University, Mathematics, Mechanics, Informatics, Volume 17, Number 3 (358), 2015, Pages 26-40 – [arXiv:1703.07319](#) [math.GT]
- [EK66] S. Eilenberg, M. Kelly – *Closed Categories* – Proceedings of the Conference on Categorical Algebra – La Jolla 1965, Springer-Verlag Berlin Heidelberg, 1966, Pages 421-562
- [EGNO15] P. Etingof, S. Gelaki, D. Nikshych, V. Ostrik – *Tensor Categories* – Mathematical Surveys and Monographs, Volume 205, American Mathematical Society, 2015
- [GKP11] N. Geer, J. Kujawa, B. Patureau-Mirand – *Generalized Trace and Modified Dimension Functions on Ribbon Categories* – Selecta Mathematica, Volume 17, Number 2, 2011, Pages 435-504
- [GKP13] N. Geer, J. Kujawa, B. Patureau-Mirand – *Ambidextrous Objects and Trace Functions for Nonsemisimple Categories* – Proceedings of the American Mathematical Society, Volume 141, 2013, 2963-2978
- [GP13] N. Geer, B. Patureau-Mirand – *Topological Invariants from Non-Restricted Quantum Groups* – Algebraic & Geometric Topology, Volume 13, Issue 6, 2013, 3305-3363

- [GPT09] N. Geer, B. Patureau-Mirand, V. Turaev – *Modified Quantum Dimensions and Re-Normalized Link Invariants* – *Compositio Mathematica*, Volume 145, Issue 1, January 2009, Pages 196-212
- [GPV13] N. Geer, B. Patureau-Mirand, A. Virelizier – *Traces on Ideals in Pivotal Categories* – *Quantum Topology*, Volume 4, Issue 1, 2013, Pages 91-124
- [GPS95] R. Gordon, A. Power, R. Street – *Coherence for Tricategories* – *Memoirs of the American Mathematical Society*, American Mathematical Society, 1995
- [G74] J. Gray – *Formal Category Theory : Adjointness for 2-Categories* – *Lecture Notes in Mathematics*, Volume 391, Springer-Verlag Berlin Heidelberg, 1974
- [H02] A. Hatcher – *Algebraic Topology* – Cambridge University Press, 2002
- [H96] M. Hennings – *Invariants of Links and 3-Manifolds Obtained from Hopf Algebras* – *Journal of the London Mathematical Society*, Volume 54, Issue 3, 1996, Pages 594-624
- [J68] K. Jänich – *On the Classification of $O(n)$ -Manifolds* – *Mathematische Annalen*, Volume 176, Issue 1, January 1968, Pages 53-76
- [J85] V. Jones – *A Polynomial Invariant for Knots via Von Neumann Algebras* – *Bulletin of the American Mathematical Society*, Volume 12, Number 1, 1985, Pages 103-111
- [JS93] A. Joyal, R. Street – *Braided Tensor Categories* – *Advances in Mathematics*, Volume 102, Issue 1, November 1993, Pages 20-78
- [K97] R. Kashaev – *The Hyperbolic Volume of Knots from the Quantum Dilogarithm* – *Letters in Mathematical Physics*, Volume 39, Issue 3, February 1997, Pages 269-275
- [K87] L. Kauffman – *State Models and the Jones Polynomial* – *Topology*, Volume 26, Issue 3, 1987, Pages 395-407
- [K64] M. Kelly – *On MacLane's Conditions for Coherence of Natural Associativities, Commutativities, etc.* – *Journal of Algebra*, Volume 1, Issue 4, December 1964, Pages 397-402
- [K82] M. Kelly – *Basic Concepts of Enriched Category Theory* – *London Mathematical Society Lecture Note Series*, Number 64, Cambridge University Press, New York, 1982
- [KS74] M. Kelly, R. Street – *Review of the Elements of 2-Categories* – *Category Seminar, Proceedings Sydney Category Theory Seminar 1972/1973*, *Lecture Notes in Mathematics*, Volume 420, Springer-Verlag Berlin Heidelberg, Pages 75-103
- [KL01] T. Kerler, V. Lyubashenko – *Non-Semisimple Topological Quantum Field Theories for 3-Manifolds with Corners* – *Lecture Notes in Mathematics*, Volume 1765, Springer-Verlag Berlin Heidelberg, 2001
- [L00] G. Laures – *On Cobordism of Manifolds with Corners* – *Transactions of the American Mathematical Society*, Volume 352, Number 12, 2000, Pages 5667-5688
- [M00] P. McCrudden – *Balanced Coalgebroids* – *Theory and Applications of Categories*, Volume 7, Number 6, 2000, Pages 71-147
- [MM01] H. Murakami, J. Murakami – *The Colored Jones Polynomials and the Simplicial Volume of a Knot* – *Acta Mathematica*, Volume 186, Issue 1, March 2001, Pages 85-104
- [MMOTY02] H. Murakami, J. Murakami, M. Okamoto, T. Takata, Y. Yokota – *Kashaev's Conjecture and the Chern-Simons Invariants of Knots and Links* – *Experimental Mathematics*, Volume 11, Issue 3, 2002, Pages 427-435
- [RT91] N. Reshetikhin, V. Turaev – *Invariants of 3-Manifolds via Link Polynomials and Quantum Groups* – *Inventiones Mathematicae*, Volume 103, Issue 1, 1991, Pages 547-597
- [S11] C. Schommer-Pries – *The Classification of Two-Dimensional Extended Topological Field Theories* – [arXiv:1112.1000](https://arxiv.org/abs/1112.1000) [math.AT]
- [S78] A. Schwarz – *The Partition Function of Degenerate Quadratic Functional and Ray-Singer Invariants* – *Letters in Mathematical Physics*, Volume 2, Issue 3, January 1978, Pages 247-252
- [S88] G. Segal – *The Definition of Conformal Field Theory* – *Differential Geometrical Methods in Theoretical Physics*, Volume 250, 1988, Pages 165-171
- [S16] M. Stay – *Compact Closed Bicategories* – *Theory & Applications of Categories*, Volume 31, Issue 24-28, 2016, Pages 755-798
- [T94] V. Turaev – *Quantum Invariants of Knots and 3-Manifolds* – Berlin, Boston: De Gruyter, 1994
- [TV12] V. Turaev, A. Virelizier – *On 3-Dimensional Homotopy Quantum Field Theory I* – *International Journal of Mathematics*, Volume 23, Number 9, 2012, Pages 1250094
- [W69] C. Wall – *Non-Additivity of the Signature* – *Inventiones Mathematicae*, Volume 7, 1969, Pages 269-274

- [W88] E. Witten – *Topological Quantum Field Theory* – Communications in Mathematical Physics, Volume 117, Number 3, 1988, Pages 353-386
- [W89] E. Witten – *Quantum Field Theory and the Jones Polynomial* – Communications in Mathematical Physics, Volume 121, Number 3, 1989, Pages 351-399