



HAL
open science

Neuroprotective effects of voluntary exercise and monoaminergic modulators in stressed male rats

Sarawut Lapmanee

► **To cite this version:**

Sarawut Lapmanee. Neuroprotective effects of voluntary exercise and monoaminergic modulators in stressed male rats. Neurobiology. Université de Strasbourg; Mahidol University (Bangkok, Thaïlande), 2017. English. NNT : 2017STRAJ058 . tel-02003607

HAL Id: tel-02003607

<https://theses.hal.science/tel-02003607>

Submitted on 1 Feb 2019

HAL is a multi-disciplinary open access archive for the deposit and dissemination of scientific research documents, whether they are published or not. The documents may come from teaching and research institutions in France or abroad, or from public or private research centers.

L'archive ouverte pluridisciplinaire **HAL**, est destinée au dépôt et à la diffusion de documents scientifiques de niveau recherche, publiés ou non, émanant des établissements d'enseignement et de recherche français ou étrangers, des laboratoires publics ou privés.

ÉCOLE DOCTORALE DES SCIENCES DE LA VIE ET DE LA SANTÉ

**Institut des Neurosciences Cellulaires et Intégrées CNRS UMR 3212
Université de Strasbourg**

**Center of Calcium and Bone Research, Department of Physiology, Faculty of
Sciences, Mahidol University (Bangkok, Thailand)**

THÈSE présentée par :

Sarawut LAPMANEE

soutenue le : 7 Juin 2017

pour obtenir le grade de : **Docteur de l'université de Strasbourg**

Discipline/ Spécialité : Neurosciences

**Effets neuroprotecteurs de l'exercice
volontaire et de modulateurs
monoaminergiques chez le rat mâle
stressé**

THÈSE dirigée par :

**Mr KLOSEN Paul
Mme KRISHNAMRA Nateetip**

Maître de Conférences (HDR), Université de Strasbourg
Professeur, Mahidol University, Thailand

RAPPORTEURS :

**Mme CHATTIPAKORN Siriporn
Mme KALANDAKANOND Sarinee**

Professeur, Chiang Mai University, Thailand
Professeur Associé, Chulalongkorn University, Thailand

AUTRES MEMBRES DU JURY :

**Mr LELIÈVRE Vincent
Mr CHAROENPHANDHU Narattaphol**

Professeur, Université de Strasbourg
Professeur, Mahidol University, Thailand

ACKNOWLEDGMENTS

I would like to express my deepest gratitude and sincere appreciation to my major advisors, Prof. Dr. Nateetip Krishnamra and Assoc. Prof. Dr. Paul Klosen for their valuable advice and encouragement during my doctoral studies.

My sincere gratitude and respect are expressed to my co-advisors, Prof. Dr. Narattaphol Charoenphandhu and Asst. Prof. Dr. Jantarima Charoenphandhu as well as the chair of my thesis examination committee, Prof. Vincent Lelièvre, and external committees, Prof. Dr. Siriporn Chattipakorn and Assoc. Prof. Dr. Sarinee Kalandakanond-Thongsong for their valuable criticisms, scientific guidance and suggestions for my research work.

I would like to extend my thanks to Asst. Prof. Dr. Pritsana Piyabhan, Dr. Marie-Paule Felder-Schmittbuhl, Dr. Apron Nuntapornsak for guidance in the study of recognition memory, genotyping, and microdissection techniques. I am also thankful Dr. Panan Suntornsaratoon, Dr. Jarinthorn Teerapornpuntakit, and Miss Nithipak Thammayon for their technical assistance.

I am thankful for the scholarships and co-funding institutions from the Institutional Strengthening Program, Faculty of Science, Mahidol University, the Royal Golden Jubilee Ph.D. Program, Thailand Research Fund, the Embassy of France in Thailand, the Graduate Studies of Mahidol University Alumni Association, Mahidol University, Dr. Paul Pévet, and Dr. Valérie Simonneaux, Department of Neurobiology of Rhythms, Institute of Cellular and Integrative Neurosciences, University of Strasbourg, France.

Furthermore, I would like to express my gratitude to the experimental animals, my appreciation to the staffs at the Animal Facility and the Research Unit of the Faculty of Medicine, Thammasat University, and at the Chronobiotron Animal Facility of the Institute of Cellular and Integrative Neurosciences, University of Strasbourg, France, for animal care and laboratory equipments.

I thank all members of the Department of Physiology, Faculty of Science, Mahidol University and the Melatonin and Seasonal Rhythms team of the Institute of Cellular and Integrative Neurosciences, University of Strasbourg, France and my friends for their moral supports. Finally, I am grateful to my parents and family members for their love and continuous encouragement throughout my study. I dedicate this thesis to my parents, all of my teachers, and the experimental animals.

Sarawut Lapmanee

CONTENTS

	Page
ACKNOWLEDGMENTS	ii
LIST OF TABLES	iv
LIST OF FIGURES	v
LIST OF ABBREVIATIONS	xix
CHAPTER I INTRODUCTION	1
CHAPTER II LITERATURE REVIEW	5
CHAPTER III MATERIALS AND METHODS	38
CHAPTER IV RESULTS	66
CHAPTER V DISCUSSION	125
CHAPTER VI CONCLUSIONS	139
SUMMARY (FRENCH)	142
REFERENCES	166
APPENDIX	196
BIOGRAPHY	201

LIST OF TABLES

Table	Page
2.1 Functional anatomy and physiology of brain regions in stress responses.	8
2.2 Summary of localization of selected target proteins in the present study.	18
3.1 Descriptions of animal groups in the experiment 1.	40
3.2 Descriptions of animal groups in the experiment 2.	41
3.3 Descriptions of animal groups in the experiment 3.	42
3.4 Summarizes the parameters and interpretations of behavioral evaluations.	44
3.5 Primary antibodies used in Western blotting analysis.	55
3.6 The MT1-/MT2-LacZ genotyping and primer designs.	59
3.7 Mouse primers in the PCR experiments for cloning probe.	62
3.8 Summary of parameters and techniques in this study.	65
4.1 Changes in bio-behavioral parameters of time dependent effects of the 1-, 4-, and 8-week restraint stress induction in male rats.	80
4.2 Changes in bio-behavioral parameters of effects of the 4-week voluntary wheel running under non-stressed condition and/or after the 4-week restraint stress induction in male rats.	92
4.3 Changes in bio-behavioral parameters of preventive effects of the 4-week agomelatine, venlafaxine, and voluntary wheel running in stressed male rats.	107
4.4 Localization of MT1 and MT2 melatonin receptors in transgenic MT1-/MT2-LacZ knock-in mouse brains.	124

LIST OF FIGURES

Figure	Page
2.1 The hypothalamic-pituitary-adrenal (HPA) axis in stress responses showing positive feedbacks (+) and negative feedbacks (-). Elevated glucocorticoids (GCs) are induced by the release of corticotropin-releasing hormone (CRH) and adrenocorticotrophic hormone (ACTH) from the hypothalamic paraventricular nucleus (PVN) and anterior pituitary, respectively. Negative feedback inhibition by GCs acts on the pituitary gland and the hypothalamus. The release of GCs is also regulated by circadian signals (~) from the suprachiasmatic nucleus (SCN) in the hypothalamus.	6
2.2 Neuroanatomical organization of stress responses consist of three levels, i.e., the cortico-limbic system, the hypothalamus-brain stem system, and brain-to-adrenal gland system. ACTH, adrenocorticotrophic hormone; ACH, acetylcholine; BNST, bed nucleus of the stria terminalis; CRH, corticotropin releasing hormone; EPI, epinephrine; GC, glucocorticoids; NE, norepinephrine; PFC, prefrontal cortex; and subcortical structures, amygdala (Gunnar and Quevedo, 2007).	7
2.3 Effects of MT1 and MT2 melatonin receptor agonists and antagonists in mammals. FSH: follicle-stimulating hormone; GnRH: gonadotropin-releasing hormone; KLH: Keyhole limpet hemocyanin; LH: luteinizing hormone; PGE: prostaglandin; PRL: Prolactin (Modified from Dubocovich and Markowska, 2005).	17
2.4 Chemical structures of monoamine modulators used in the present study.	27

LIST OF FIGURES (cont.)

Figure	Page
2.5 Physiological effects of physical exercise: Adaptive mechanisms are responsible for a decreased perception of chronic stress. BDNF: Brain-derived neurotrophic factor; DA: Dopamine; HPA axis: hypothalamic-pituitary-adrenal axis; iNOS: Inducible nitric oxide synthase; IL-1 β : Interleukin 1 β ; IL-6: Interleukin 6; IL-10: Interleukin 10; NE; Norepinephrine; ROS: Reactive oxygen species; TNF- α : Tumor necrosis factor; 5-HT: Serotonin; VEGF: Vascular endothelial growth factor (Modified from Sanches et al., 2016).	30
3.1 Schematic diagram showing the time-course of restraint stress induction and sample collections in the experimental protocol 1.	39
3.2 Schematic diagram showing the time-course of restraint stress induction, voluntary wheel running, and sample collections in the experimental protocol 2.	41
3.3 Schematic diagram showing the time-course of treatments and sample collections in the experimental protocol 3.	42
3.4 Schematic showing, the EPM apparatus that consisted of two open arms (50 cm long \times 10 cm wide) at right angles to two closed arms (50 cm long \times 10 cm wide \times 40 cm high). The whole apparatus was elevated to 50 cm above the floor.	45
3.5 Schematic showing, the ETM apparatus that consisted of three arms of equal dimensions (50 cm long \times 10 cm wide) and elevated 50 cm above the floor. One arm, enclosed by walls (40 cm high) was perpendicular to the two opposed open arms.	46

LIST OF FIGURES (cont.)

Figure	Page
3.6 Schematic showing, A. The OFT was made from a black painted wooden box (76 cm long × 57 cm wide × 35 cm high) with a 48 square grid floor (6 × 8 squares, 9.5 cm per side). B. The arena of maze was divided into two zones, i.e., inner (white area) and outer zones (gray area).	47
3.7 Schematic showing the MWM pool that consisted of a circular aluminum pool (150 cm diameter and 60 cm deep) that was filled with water (25 °C temperature) up to 31 cm. The pool was divided into four quadrants of equal area. An aluminum platform (10 diameter and 30 cm high) was submerged 1 cm below the water surface.	49
3.8 Brain cutting block illustrating orientation of brain and placement of razor blades to obtain coronal brain sections. The numbers on the right refer to brain sections. Coronal brain sections from which brain regions were dissected. Dotted lines indicate borders of brain regions. FC, frontal cortex; S, septum; aH, anterior hypothalamus; pH, posterior hypothalamus; A, amygdala; VTA, ventral tegmentum area; and H, hippocampus (Heffner et al., 1980).	54
3.9 Coronal brain sections at the levels of periaqueductal grey and dorsal raphe nuclei (A) and locus coeruleus (B) (Paxinos and Watson, 2005).	54
3.10 Schematic diagram showing the experimental protocols in the study of part 2.	58

LIST OF FIGURES (cont.)

Figure	Page
4.1 Time-dependent effects of the 1-, 4-, and 8-week restraint stress induction on (A) starting body weight, (B) final body weight, (C) body weight gain, (D) daily food intake, (E) wet adrenal gland weight, (F) dry adrenal gland weight, (G) relative wet adrenal gland weights, and (H) relative dry adrenal gland weights. Numbers of animals are noted in parentheses. * $P < 0.05$, ** $P < 0.01$, *** $P < 0.001$ compared to non-stress control group.	67
4.2 Time-dependent effects of the 4-week restraint stress induction on (A) basal serum and (B) urinary corticosterone levels. Numbers of animals are noted in parentheses. * $P < 0.05$ compared to non-stress control group.	68
4.3 Time-dependent effects of the 1-, 4-, and 8-week restraint stress-induced anxiety-like behavior as evaluated by EPM, (A) percent open arm entry, (B) percent open arm time, (C) percent closed arm entry, (D) percent closed arm time, (E) percent center of arm time, (F) total arm entry, (G) numbers of rearing, and (H) numbers of grooming. Numbers of animals are noted in parentheses. * $P < 0.05$ and ** $P < 0.01$ compared to non-stressed control group.	70
4.4 Time-dependent effects of the 1-, 4-, and 8-week restraint stress-induced anxiety/learned and innate fear-like behavior as evaluated by ETM, (A) baseline latency, (B) avoidance latency 1, (C) avoidance latency 2, and (E) one-way escape latency. Numbers of animals are noted in parentheses. * $P < 0.05$ and *** $P < 0.001$ compared to non-stressed control group.	71

LIST OF FIGURES (cont.)

Figure	Page
4.5 Time-dependent effects of the 1-, 4-, and 8-week restraint stress-induced anxiety-like behavior as evaluated by OFT, (A) number of lines crossed in the first 30 seconds, (B) total lines crossed, (C) inner zone time, (D) outer zone time, (E) number of rearing, and (F) number of grooming. Numbers of animals are noted in parentheses. * $P < 0.05$ compared to non-stressed control group.	72
4.6 Time-dependent effects of the 1-, 4-, and 8-week restraint stress-induced depression-like behaviors as evaluated by forced swimming and sucrose preference, (A) swimming duration, (B) climbing duration, (C) immobility duration, (D) number of fecal pellets, and (E) weekly percent sucrose preference. Numbers of animals are noted in parentheses. ^a $P < 0.05$ and ^{aa} $P < 0.01$ compared to percent sucrose preference in baseline period. * $P < 0.05$ and ** $P < 0.01$ compared to non-stressed control group.	73
4.7 Time-dependent effects of the 1-, 4-, and 8-week restraint stress-induced learning and memory impairment-like behavior as evaluated by MWM and NOR, (A) escape latency, (B) correct quadrant time, (C) percent correct quadrant time, and (D) discrimination ratio. Numbers of animals are noted in parentheses. * $P < 0.05$, ** $P < 0.01$, and *** $P < 0.001$ compared to non-stressed control group.	74
4.8 Time-dependent effects of the 1-, 4-, and 8-week stress induction on the BDNF protein levels. Numbers of animals are noted in parentheses. * $P < 0.05$ compared to non-stressed control group.	76

LIST OF FIGURES (cont.)

Figure	Page
4.9 Time-dependent effects of 1-, 4-, and 8-week restraint stress induction on the hypothalamic and hippocampal GR protein levels. Numbers of animals are noted in parentheses. * $P < 0.05$ and *** $P < 0.001$ compared to non-stressed control group.	76
4.10 Time-dependent effects of the 1-, 4-, and 8-week restraint stress induction on the NET protein levels. Numbers of animals are noted in parentheses. * $P < 0.05$ compared to non-stressed control group.	77
4.11 Time-dependent effects of the 1-, 4-, and 8-week restraint stress induction on the SERT protein levels. Numbers of animals are noted in parentheses. * $P < 0.05$ compared to non-stressed control group.	78
4.12 Time-dependent effects of the 1-, 4-, and 8-week restraint stress induction on the 5-HT _{2C} R protein levels. Numbers of animals are noted in parentheses. * $P < 0.05$, and ** $P < 0.01$ compared to non-stressed control group.	79
4.13 The effects of the 4-week voluntary wheel running on (A) starting body weight, (B) final body weight, (C) body weight gain, and (D) daily food intake. Numbers of animals are noted in parentheses. ** $P < 0.01$, *** $P < 0.001$ exercise group compared to non-stressed sedentary control. # $P < 0.05$ sedentary stressed group compared to non-stressed sedentary control group. † $P < 0.05$ combined stressed and exercised group compared to sedentary stressed group.	82

LIST OF FIGURES (cont.)

Figure		Page
4.14	The effects of the 4-week voluntary wheel running on (A) running distance per day, (B) total running distance, (C) wet heart weight, (D) dry heart weight, (E) relative wet heart weight, and (F) relative dry heart weight. Numbers of animals are noted in parentheses. ** $P < 0.01$, *** $P < 0.001$ exercise group compared to non-stressed sedentary control. † $P < 0.05$, †† $P < 0.001$ combined stressed and exercised group compared to sedentary stressed group.	83
4.15	The effects of the 4-week voluntary wheel running on (A) wet adrenal weight, (B) dry adrenal weight, (C) relative wet adrenal weight, (D) relative dry adrenal gland weight, and (E) serum corticosterone levels. Numbers of animals are noted in parentheses. ** $P < 0.01$ exercised group compared to non-stressed control sedentary group. ## $P < 0.05$, ### $P < 0.01$ sedentary stressed group compared to non-stressed sedentary control group. † $P < 0.05$ combined stressed and exercised group compared to sedentary stressed group.	84
4.16	Effects of the 4-week voluntary wheel running on restraint stress-induced depression-like behavior as determined by sucrose preference test. Numbers of animals are noted in parentheses. ### $P < 0.001$ sedentary stressed group compared to non-stressed sedentary control group. † $P < 0.05$ combined stressed and exercised group compared to sedentary stressed group.	85

LIST OF FIGURES (cont.)

Figure	Page
<p>4.17 Effects of the 4-week voluntary wheel running on BDNF protein levels. Numbers of animals are noted in parentheses. *$P < 0.05$ exercised group compared to non-stressed control sedentary group. #$P < 0.05$ sedentary stressed group compared to non-stressed sedentary control group. †$P < 0.05$ combined stressed and exercised group compared to sedentary stressed group.</p>	86
<p>4.18 Effects of the 4-week voluntary wheel running on the hypothalamic and hippocampal GR and adrenal MC2R protein levels. Numbers of animals are noted in parentheses. #$P < 0.05$ sedentary stressed group compared to non-stressed sedentary control group. †$P < 0.05$ combined stressed and exercised group compared to sedentary stressed group.</p>	88
<p>4.19 Effects of the 4-week voluntary wheel running on NET protein levels. Numbers of animals are noted in parentheses. *$P < 0.05$, **$P < 0.01$ exercised group compared to non-stressed control sedentary group. #$P < 0.05$ sedentary stressed group compared to non-stressed sedentary control group. †$P < 0.05$ combined stressed and exercised group compared to sedentary stressed group.</p>	89
<p>4.20 Effects of the 4-week voluntary wheel running on SERT protein levels. Numbers of animals are noted in parentheses. **$P < 0.01$ exercised group compared to non-stressed control sedentary group. #$P < 0.05$, ###$P < 0.01$ sedentary stressed group compared to non-stressed sedentary control group. †$P < 0.01$ combined stressed and exercised group compared to sedentary stressed group.</p>	90

LIST OF FIGURES (cont.)

Figure	Page
<p>4.21 Effects of the 4-week voluntary wheel running on the 5-HT_{2C}R protein levels. Numbers of animals are noted in parentheses. *<i>P</i> < 0.05 exercised group compared to non-stressed control sedentary group. #<i>P</i> < 0.05 sedentary stressed group compared to non-stressed sedentary control group. †<i>P</i> < 0.01 combined stressed and exercised group compared to sedentary stressed group.</p>	91
<p>4.22 Protective effects of agomelatine (Ago), venlafaxine (Vlx) and voluntary wheel running (Rw) on (A) starting body weight, (B) running distance, (C) body weight, (D) final body weight, (E) daily weight gain in pre-treatment, (F) daily weight gain in stress induction, (G) daily food intake in pre-treatment, and (H) daily weight gain in stress induction. Numbers of animals are noted in parentheses. †<i>P</i> < 0.05, ††<i>P</i> < 0.01, and †††<i>P</i> < 0.001 compared to vehicle (Veh)-treated group</p>	94
<p>4.23 Protective effects of agomelatine (Ago), venlafaxine (Vlx) and voluntary wheel running (Rw) on (A) wet adrenal weight (B) dry adrenal weight, (C) relative wet adrenal weight, (D) relative dry adrenal weight, (E) serum corticosterone levels in stressed male rats. Numbers of animals are noted in parentheses.</p>	95

LIST OF FIGURES (cont.)

Figure	Page
4.24 Protective effects of agomelatine (Ago), venlafaxine (Vlx) and voluntary wheel running (Rw) on stress-induced anxiety-like behavior as determined by EPM, (A) percent open arm entry, (B) percent open arm time, (C) percent closed arm entry, (D) percent closed arm time, (E) percent center of arm time, (F) total arm entries, (G) numbers of grooming, and (H) numbers of rearing. Numbers of animals are noted in parentheses. [†] <i>P</i> < 0.05 compared to vehicle (Veh)-treated group.	97
4.25 Protective effects of agomelatine (Ago), venlafaxine (Vlx) and voluntary wheel running (Rw) on stress-induced anxiety/learned and innate fear-like behavior as determined by ETM, (A) baseline latency, (B) avoidance latency 1, (C) avoidance latency 2, and (D) one-way escape latency. Numbers of animals are noted in parentheses. ^{†††} <i>P</i> < 0.001 compared to vehicle (Veh)-treated group.	98
4.26 Protective effects of agomelatine (Ago), venlafaxine (Vlx) and voluntary wheel running (Rw) on stress-induced anxiety-like behavior as determined by OFT, (A) inner zone time, (B) outer zone time, (C) number of lines crossed in the first 30 seconds, (D) total lines crossed, (E) numbers of rearing, and (F) numbers of grooming. Numbers of animals are noted in parentheses. ^{††} <i>P</i> < 0.01, ^{†††} <i>P</i> < 0.001 compared to vehicle (Veh)-treated group.	99

LIST OF FIGURES (cont.)

Figure	Page
<p>4.27 Protective effects of agomelatine (Ago), venlafaxine (Vlx) and voluntary wheel running (Rw) on stress-induced depression-like behavior as determined by FST and sucrose preference test, (A) swimming duration, (B) climbing duration, (C) immobility duration, (D) numbers of fecal pellets, and (E) weekly sucrose preference. Numbers of animals are noted in parentheses. $^{\dagger\dagger}P < 0.01$, $^{\dagger\dagger\dagger}P < 0.001$ compared to vehicle (Veh)-treated group. $^{aaa}P < 0.001$ compared to percent sucrose preference after completing 4-week pre-treatment period.</p>	100
<p>4.28 Protective effects of agomelatine (Ago), venlafaxine (Vlx) and voluntary wheel running (Rw) on stress-induced learning and memory impairment-like behavior as determined by MWM and NOR, (A) escape latency, (B) correct quadrant time, (C) percent correct quadrant time, and (D) discrimination ratio. Numbers of animals are noted in parentheses. $^{\dagger}P < 0.05$, $^{\dagger\dagger}P < 0.01$, $^{\dagger\dagger\dagger}P < 0.001$ compared to vehicle (Veh)-treated group.</p>	101
<p>4.29 Protective effects of agomelatine (Ago), venlafaxine (Vlx) and voluntary wheel running (Rw) on the BDNF protein levels. Numbers of animals are noted in parentheses. $^{\dagger}P < 0.05$, $^{\dagger\dagger}P < 0.01$, and $^{\dagger\dagger\dagger}P < 0.001$ compared to vehicle (Veh)-treated group.</p>	103
<p>4.30 Protective effects of agomelatine (Ago), venlafaxine (Vlx) and voluntary wheel running (Rw) on the hypothalamic and hippocampal GR protein levels. Numbers of animals are noted in parentheses. $^{\dagger}P < 0.05$ compared to vehicle (Veh)-treated group.</p>	103

LIST OF FIGURES (cont.)

Figure		Page
4.31	Protective effects of agomelatine (Ago), venlafaxine (Vlx) and voluntary wheel running (Rw) on the NET protein levels. Numbers of animals are noted in parentheses. $^{\dagger\dagger}P < 0.01$ compared to vehicle (Veh)-treated group.	104
4.32	Protective effects of agomelatine (Ago), venlafaxine (Vlx) and voluntary wheel running (Rw) on the SERT protein levels. Numbers of animals are noted in parentheses. $^{\dagger}P < 0.05$ and $^{\dagger\dagger}P < 0.01$ compared to vehicle (Veh)-treated group.	105
4.33	Protective effects of agomelatine (Ago), venlafaxine (Vlx) and voluntary wheel running (Rw) on the 5-HT _{2c} R protein levels. Numbers of animals are noted in parentheses. Veh; vehicle treatment.	106
4.34	Generation of the MT1/MT2-LacZ knock-in mice. (A) The MT1 or MT2 receptor gene locus organization before and after site-specific insertion. (B) Mouse genotyping by PCR for MT1/MT2-LacZ transgenic knock-in mice.	109
4.35	Comparison MT1-LacZ staining between immunocytochemistry (<i>A and C</i>) and X-gal histochemistry (<i>B and D</i>) in the suprachiasmatic nucleus (<i>upper</i>) and <i>pars tuberalis</i> of anterior pituitary (<i>lower</i>) of transgenic knock-in mice.	111
4.36	MT1-LacZ expressions in neurons as detected by X-gal histochemical staining compared to ¹²⁵ I- iodomelatonin binding autoradiography by Liu et al., 1997.	112
4.37	X-gal histochemical mapping of MT1- and MT2-LacZ expression.	113

LIST OF FIGURES (cont.)

Figure		Page
4.38	Immunocytochemical staining of MT1-LacZ expression in (A) the suprachiasmatic nucleus; SCN and (B) <i>pars tuberalis</i> of anterior pituitary; PT. Nuclear LacZ staining and lysosomal accumulation of LacZ can be seen in the SCN (C). In the PT (D), the cytoplasmic staining is very strong, but sometimes the lysosomal accumulation can also be seen (arrows).	116
4.39	Immunocytochemical staining of MT2-LacZ expressing neurons in (A) the paraventricular nucleus of the hypothalamus, (B) the arcuate nucleus of the hypothalamus, (C) the dorsal hippocampus, (D) the ventral hippocampus, (E) the CA2 of the hippocampus, and (F) the molecular layer of the dentate gyrus. DG; dentate gyrus of hippocampus.	117
4.40	Double-labeling with MT1-LacZ-Immunohistochemistry (green) and non-radioactive <i>in situ</i> hybridization for neuropeptides (red). Diagram representing of the cell and fiber distributions of neuropeptides in the SCN (Abrahamson and Moore, 2001) (A) AVP, (B), GRP, and (C) VIP. For AVP, the green dots of the MT1-LacZ cells are clearly located outside of the area of the AVP cells (D). For VIP (E) and GRP (F) some red neuropeptide cells contain the green dot indicating co-expression of the MT1-LacZ transgene (arrows/arrowheads).	120
4.41	Double-labeling with LacZ-immunohistochemistry for MT2 (green) and non-radioactive <i>in situ</i> hybridization for CRH (red) in the paraventricular nucleus (PVN) of the hypothalamus. Inset shows a group of CRH cells that are MT2 positive. Asterisk shows CRH neurons without MT2 label. Most GRP cells are MT2 positive.	121

LIST OF FIGURES (cont.)

Figure		Page
4.42	Double-labeling with LacZ-Immunohistochemistry and non-radioactive <i>in situ</i> hybridization for MT2 (green) and GAD (red) colocalization in the hippocampus (A). Most small horizontal MT2 positive neurons in the external molecular layer (B) are GAD negative (C). Only a few of these horizontal cells are GAD positive (arrow in D). Many GAD positive neurons in the dentate gyrus hilus are also MT2 positive (arrowheads in E).	122
4.43	Double-labeling with LacZ-Immunohistochemistry and non-radioactive <i>in situ</i> hybridization for MT2 (green) and GAD (red) colocalization. The MT2 positive cells in the CA2 of the hippocampus are GAD negative. A few non-pyramidal cells of the CA2 are MT2 + GAD positive (arrowheads).	123
6.1	Diagram showing the summary results in this present study.	141
A.1	Generation of MT1-/MT2-LacZ knock-in mice. The mutant MT1 (Mtnr1a) or MT2 (Mtnr1b) alleles contain a loxP-hUbc-Neomycin-polyA stop cassette. This Neomycin resistance cassette used for the selection of recombinant embryonic stem cells is then deleted from the mutant locus using Cre-mediated recombination to avoid interference of these sequences with the expression profile of the LacZ reporter gene.	199

LIST OF ABBREVIATIONS

A	Amygdala
Ach	Acetylcholine
ACC	Anterior cingulate
ACTH	Adrenocorticotrophic hormone
AG	Adrenal gland
Ago	Agomelatine
aH	Anterior hypothalamus
AMPA	α -amino-3-hydroxy- 5-methyl-4-isoxazolepropionic acid
ANOVA	Analysis of variance
AR	Adrenergic receptor
AVP	Arginine Vasopressin
BCA	Bicinchoninic acid
BCIP	Bromo-chloro-indolyl phosphate
BDNF	Brain-derived neurotrophic factor
BLA	Basolateral Amygdala
BNST	Bed Nucleus of the Stria Terminalis
BSA	Bovine Serum Albumin
BW	Body weight
BDZ	Benzodiazepine
CA	Cornu Ammonis
cDNA	Complementary DNA
cGMP	cyclic guanosine monophosphate
cm	Centimeter
cm ³	Cubic centimeter
CO ₂	Carbon dioxide
COMT	Catechol-O-methyltransferase
CRH	Corticotropin-releasing hormone

LIST OF ABBRIVATIONS (cont.)

CREB	Cyclic adenosine monophosphate response element-binding protein
CYP	Cytochrome P450
DA	Dopamine
DAB	3,3'-diaminobenzidine
DAG	Diacylglycerol
DNA	Deoxyribonucleic acid
df	Degree of freedom
DFI	Daily food intake
DG	Dentate gyrus
DHBA	3, 4-dihydroxy-benzyl-amine hydrobromide
DI	Discrimination index
DMPC	Dimethylpyrocarbonate
DMSO	Dimethyl sulfoxide
DNA	Deoxyribonucleic acid
dNTP	Deoxynucleotide
DR	Dorsal Raphe
DSM	Diagnostic and Statistical Manual of Mental Disorder
DWG	Daily weight gain
DWI	Daily water intake
EDTA	Ethylenediaminetetraacetic acid
EGF	Epidermal growth factor (EGF)
ELISA	Enzyme-linked immunosorbent assay
EPI	Epinephrine
EPM	Elevated plus-maze
ETM	Elevated T-maze
FSH	Follicle-stimulating hormone
FST	Forced swimming test

LIST OF ABBRIVATIONS (cont.)

g	Gram
x g	centrifugal force in multiples of the gravitational acceleration
GABA	Gamma-aminobutyric acid
GAD	Glutamic acid decarboxylase
GC	Glucocorticoid
GnRH	Gonadotropin-releasing hormone
GR	Glucocorticoid receptor
GRP	Gastrin releasing peptide
h	Hour
H	Hippocampus
HCl	Hydrochloric acid
H ₂ O ₂	Hydrogen peroxide
HPA	Hypothalamic-pituitary-adrenal
HRP	Horseradish peroxidase
ICC	Immunocytochemistry
IGF-I	Insulin-like growth factor-1
IL	Interleukin
iNOS	Inducible nitric oxide synthase
ipRGC	Intrinsically photosensitive retinal ganglion cell
ISH	<i>In situ</i> hybridization
IU	International units
K ₃ Fe(CN) ₆	Potassium hexacyanoferrate
K ₄ Fe(CN) ₆	Potassium ferrocyanide
kg	Kilogram
K _i	The inhibitory constant
KLH	Keyhole limpet hemocyanin
L	Liter
LacZ	Beta-galactosidase
LB	Luria-Bertani medium

LIST OF ABBRIVATIONS (cont.)

LC	Locus coeruleus
LH	Luteinizing hormone
LTD	Long-term depression
LTP	Long-term potentiation
M	Molar
MC2R	Melanocortin type 2 receptor
MgCl ₂	Magnesium chloride
MHPG	3-methoxy-4-hydroxyphenylglycol
min	Minute
mL	Milliliter
mm	Millimeter
MOA	Monoamine oxidase enzyme
MOAI	Monoamine oxidase inhibitor
mol	Mole
MR	Mineralocorticoid receptor
mRNA	Messenger ribonucleic acid
MT	Melatonin
MWM	Morris water maze
NA	Nucleus accumbens
NaCl	Sodium chloride
NaIO ₄	Sodium periodate
NaOH	Sodium hydroxide
NBT	Nitroblue tetrazolium
NDRI	Norepinephrine-dopamine reuptake inhibitor
NE	Norepinephrine
NET	Norepinephrine transporter
ng	nanogram
NGF	Nerve growth factor (NGF)

LIST OF ABBRIVATIONS (cont.)

NOR	Novel objective recognition
NOS	Nitric oxide synthase
NRI	Norepinephrine reuptake inhibitor
OFC	Orbital frontal cortex
OFT	Open field test
PAG	Periaqueductal grey
PBS	Phosphate buffered saline
PCR	Polymerase chain reaction
PD	Panic disorder
PEG	Polyethylene glycol
PGE	Prostaglandin
PFC	Prefrontal cortex
p75NR	Pan- neurotrophin receptors
pH	Posterior hypothalamus
PLP	Periodate-lysine-paraformaldehyde
pmol	Picomole
p.o.	Per os (Oral administration)
PRL	Prolactin
PT	The <i>pars tuberalis</i> of pituitary
PVN	Paraventricular nucleus of hypothalamus
PVT	Paraventricular nucleus of thalamus
RIPA	Radioimmunoprecipitation assay buffer
ROS	Reactive oxygen species
RPM	Revolutions per minute of centrifuge rotor speed
s	Second
S	Septum
SCN	Suprachiasmatic nucleus
SDS	Sodium dodecyl sulfate

LIST OF ABBRIVATIONS (cont.)

SE	The standard error
SERT	Serotonin reuptake transporter
SN	Substantial nigra
SNDR1	Serotonin-norepinephrine-dopamine reuptake inhibitor
SNRI	Serotonin-norepinephrine reuptake inhibitor
SP	Sucrose preference
SSC	Saline sodium citrate
SSRI	Selective serotonin reuptake inhibitor
TBE	Tris-borate-EDTA buffer
TBST	Tris buffer saline with Tween 20
TCA	Tricyclic antidepressant
TH	Tyrosine hydroxylase
TNF	Tumor necrosis factor
TPH	Tryptophan hydroxylase
TrkB	Tyrosine kinase type B receptor
V	Volt
VEGF	Vascular endothelial growth factor
VIP	Vasoactive intestinal polypeptide
Vlx	Venlafaxine
VTA	Ventral tegmental area
X-gal	5-bromo-4-chloro-3-indolyl- β -d-galactoside
5-HIAA	5-hydroxyindoleacetic acid
5-HT	5-hydroxytryptamine, serotonin
5-HTP	5-hydroxytryptophan
5-HT _{2C} R	5-HT _{2C} receptor
°C	Degree Celsius
μ g	Microgram
μ l	Microliter

CHAPTER I

INTRODUCTION

Stress-related mood disorders are common psychiatric illness and are becoming a global burden of disability and comorbidity (Kessler et al., 2009). Severe and chronic stress exposures are believed to cause anxiety, depression, and memory impairment later in life (Sareen et al., 2007; Li et al., 2014; Ikeda et al., 2017), and therefore, preventive intervention for these stress complications is worth exploring. In many situations, such as extreme military combat or war, infectious disease outbreak, and natural disaster, preventive strategies become more important in reducing incidence of stress-related psychiatric problems in veterans or victims.

The underlying mechanisms of mood disorders in stressed individuals are associated with deregulation of the hypothalamic-pituitary adrenal (HPA) axis and an imbalance of the monoamines serotonin (5-HT) and norepinephrine (NE) (Charney, 1998; Bowman et al., 2003; Belmaker and Agam, 2008). Chronic stress increases the glucocorticoid stress hormones, that glucocorticoids can pass the blood–brain barrier and induce deleterious changes in the neuronal function in brain regions regulating memory formation and behavior. Sustained high levels of glucocorticoids decrease glucocorticoid receptor (GR), brain-derived neurotrophic factor (BDNF), and neurogenesis in the hippocampus leading to anxiety, depression and memory impairment (McEwen, 2007; Schmidt and Duman, 2007).

Besides the aberrant HPA axis, stress could disturb the circadian rhythms and the pineal-adrenal secretory response (Konakchieva et al., 1997; McClung, 2011). Melatonin (MT) plays a crucial role in the synchronization of circadian rhythmicity. Actions of MT are mediated by membrane MT receptor subtypes, MT1 and MT2. Despite the finding that MT levels were decreased in depressed patients (Claustrat et al., 1984), it is still important to know where MT1 and MT2 are localized because they are targets for the development of novel antidepressants and MT derivatives in the HPA axis and hippocampus. So far, the cellular localization of MT1 and MT2 has not

been visualized clearly despite the use of ^{125}I -iodomelatonin binding, *in situ* hybridization, and some developed antibody for immunocytochemistry (Liu et al., 1997; Fugieda et al., 1999; Poirel et al., 2002). MT1 has been identified in the suprachiasmatic nucleus (SCN), but site of MT2 remain elusive. Therefore, a genetic modified rodent model has been generated for mapping and phenotyping MT receptor expression.

The use of animal models in the stress-related studies provides useful insights into the behavioral and physiological mechanisms involved in the stress response. Restraint stress is a simple but effective method that produces both physical and behavioral changes in mouse and rats. However, the variations of the procedures such as the intensity and duration of restraint stress have so far failed to produce a consensus in the results for stress-induced anxiety, depression, and memory impairment (Buynitsky and Mostofsky, 2009). Although chronic restraint stress could produce anxiety-and depression-like behavior in male rats (Lapmanee et al., 2012, 2013), but whether total durations of stress induced learning and memory impairment is still unclear. In addition, the mechanisms triggering the restraint stress-related behaviors are still not known

The involvement of the dysregulation of 5-HT and NE system in stress-related mood disorders has been primarily supported by the enhancing effects of antidepressants on the binding of 5-HT to the serotonin transporter (SERT) and NE to the noradrenaline transporter (NET), thus increasing storage and release of these neurotransmitters into the synaptic cleft. A recent study showed that a serotonin-norepinephrine-dopamine reuptake inhibitor (SNDRI), venlafaxine, showed a greater potency in the treatment of anxiety-like behavior in stressed male rats than a selective serotonin reuptake inhibitor (SSRI), fluoxetine or a norepinephrine reuptake inhibitor (NRI), reboxetine (Lapmanee et al., 2012). However, it is not known whether venlafaxine can prevent stress-induced anxiety, depression, and memory impairments.

Interestingly, due to the anxiolytic and antidepressant effects (Papp et al., 2003; Millan et al., 2005; Taylor et al., 2014) of the melatonergic antidepressant agomelatine, the a melatonin MT1 and MT2 receptor agonist and 5-HT_{2C} receptor (5-HT_{2C}R) antagonist could be a candidate drug for the prevention of stress-induced behavioral change. Unlike venlafaxine, agomelatine is without side effects, such as

nausea, diarrhea, or sexual dysfunctions, which can be attributed to excessive stimulation of some peripheral and central 5-HT receptors (Kennedy and Emsley, 2007). Furthermore, there are no discontinuation symptoms after cessation of agomelatine treatment compared to paroxetine (Montgomery et al., 2004). However, it is unclear whether agomelatine acts directly on brain region responsible for stress responses. Since localization of MT receptors in the rodent central nervous system is not completely understood, and there is limitation in the use of immunolocalization for MT1 and MT2 (Wu et al., 2013; Lacoste et al., 2015), the present study attempted to use transgenic mice with β -galactosidase (LacZ) reporter gene in the study of MT receptor distribution in brain regions associated with stress responses.

Since the pharmacological intervention in mood disorders are time-consuming and might cause side effects, it is better to search for a novel medication in parallel with alternative interventions. Therefore, non-pharmacological intervention such as physical exercise has recently become popular, and could be a low cost-stress-relieving therapy with no side effects for stressed individuals. Exercise has been reported to be an alternative treatment for a variety of mood disorders. Compared to forced exercise, e.g., treadmill running and swimming, voluntary exercise such as voluntary wheel running in rodents should be a motivational exercise with less associated stress. Moreover, voluntary exercise was found to have both antidepressant and anxiolytic effects in rodents and human studies (Burghardt et al., 2004; Ströhle, 2009; Lapmanee et al., 2013). Voluntary exercise is a potent stimulator of the HPA axis (Stranahan et al., 2008). Voluntary wheel running increases hippocampal BDNF and neurogenesis (Cotman and Berchtold, 2002) and also enhances brain function by altering monoaminergic neurotransmission (Dishman, 1997). However, the modulating effects of voluntary wheel running exercise on the chronic stress response are not well understood, and its preventive effect on stress-induced mood and memory deficits remains unclear.

Therefore, the objectives of thesis research were:

1. To examine the time-dependent effects of the 1-, 4- and 8-week stress induction on anxiety-, depression-, and memory impairment-like behaviors and changes in the expression of selected target proteins in brain regions associated with stress responses.

2. To determine the effects of the 4 week-voluntary wheel running on the HPA axis under two conditions, non-stress condition or after the 4-week exposure to restraint stress, and changes in the expression of selected target proteins in brain regions associated with stress responses.

3. To evaluate the effectiveness of agomelatine, venlafaxine, and voluntary wheel running exercise in the prevention of stress-induced anxiety-, depression-, and memory impairment-like behaviors and changes in the expression of selected target proteins in brain regions associated with stress responses.

4. To characterize the phenotype of MT1-/MT2-LacZ expressing neurons in knock-in mice by analyzing co-expressed neuropeptides and neuronal markers.

The hypothesizes of this study were:

1. Monoaminergic modulators and voluntary wheel running could prevent stress-related behaviors in male rats by modulating hippocampal neurogenesis and altering the expression of target proteins of central monoamine neurotransmission in the brain regions associate with stress response.

2. MT1/MT2-LacZ expressing neurons in brain regions associated with stress responses were characterized in knock-in mice and might be the sites action of pharmacological treatment.

CHAPTER II

LITERATURE REVIEW

2.1 The basics of the stress response

1. Neurophysiology of stress

Stress is a state of threat exposure that can disturb homeostasis and thus induces physiological and behavioral adaptations. Both sympathetic and parasympathetic activities are responsible for the rapid acute stress response via neural innervation. The hypothalamic-pituitary-adrenal (HPA) axis also plays a role in the stress response (Figure 2.1). After HPA axis activation, corticotropin-releasing hormone (CRH) and arginine vasopressin (AVP) synthesized by hypophysiotropic neurons in the hypothalamic paraventricular nucleus (PVN), are secreted into the hypophyseal portal circulation in the median eminence. CRH activates the anterior pituitary corticotrope cells to release adrenocorticotrophic hormone (ACTH), while AVP provides a synergistic effect on ACTH release. ACTH binds to the melanocortin type 2 receptor (MC2R) in the zona fasciculata of the adrenal cortex to stimulate synthesis and secretion of stress hormones, i.e., glucocorticoids (GCs) (cortisol in humans, or corticosterone in rodents) and catecholamines, i.e., norepinephrine (NE) and epinephrine (Epi). GCs affect the structure and excitability of neurons by binding to the GC receptor (GR) and the mineralocorticoid receptor (MR), whereas catecholamines promote vigilance, arousal, and attention. Positive and negative feedbacks involved in the regulation of the HPA axis act at various brain regions depending on the levels of stress. Therefore, the sympathoadrenal system and HPA axis are important centers for maintaining homeostasis during stress. Changes in hormonal responses to stress (i.e., CRH, ACTH, and GR) affect physiological processes and behavior that can be used to indicate clinical status and therapeutic targets (as reviewed by Ulrich-Lai and Herman, 2009).

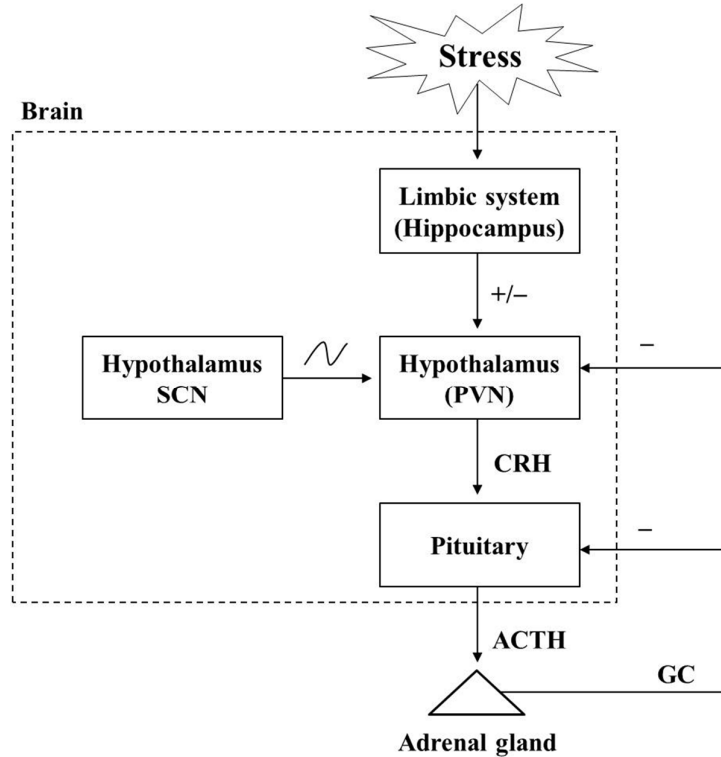

Figure 2.1 The hypothalamic-pituitary-adrenal (HPA) axis in stress responses showing positive feedbacks (+) and negative feedbacks (-). Elevated glucocorticoids (GCs) are induced by the release of corticotropin-releasing hormone (CRH) and adrenocorticotrophic hormone (ACTH) from the hypothalamic paraventricular nucleus (PVN) and anterior pituitary, respectively. Negative feedback inhibition by GCs acts on the pituitary gland and the hypothalamus. The release of GCs is also regulated by circadian signals (~) from the suprachiasmatic nucleus (SCN) in the hypothalamus.

2. Neuroanatomy of stress

Various brain regions involved in stress responses can be described at three levels (Figure 2.2), i.e., the cortico-limbic system, the hypothalamus-brain stem system, and brain-to-adrenal gland system (as reviewed by Gunnar and Quevedo, 2007). At the level of the cortico-limbic system, the anterior cingulate (ACC) and orbital frontal cortex (OFC) are connected to the amygdala, which in turn connects with the hippocampus and bed nucleus of the stria terminalis (BNST). The BNST signals to the PVN to stimulate the release of CRH and AVP, whereas the

hippocampus, prefrontal cortex (PFC) and ACC control the feedback regulation of the PVN. This limbic structure restrains HPA activity indirectly via stimulation of inhibitory gamma-aminobutyric acid (GABA)ergic neurons located in the ventrolateral septal region and the BNST. These neurons project to CRH-containing parvocellular neurons of the PVN. At the level of hypothalamus–brain stem system, the hippocampus stimulates the locus coeruleus (LC) in the brain stem to release NE to produce alertness. For, the brain-to-adrenal gland system, the hypothalamic nuclei, the parabrachial nuclei in the brain stem control both the sympathetic (NE and Epi) and parasympathetic (acetylcholine, Ach) nervous systems via the spinal cord to preganglionic neurons or to the adrenal glands.

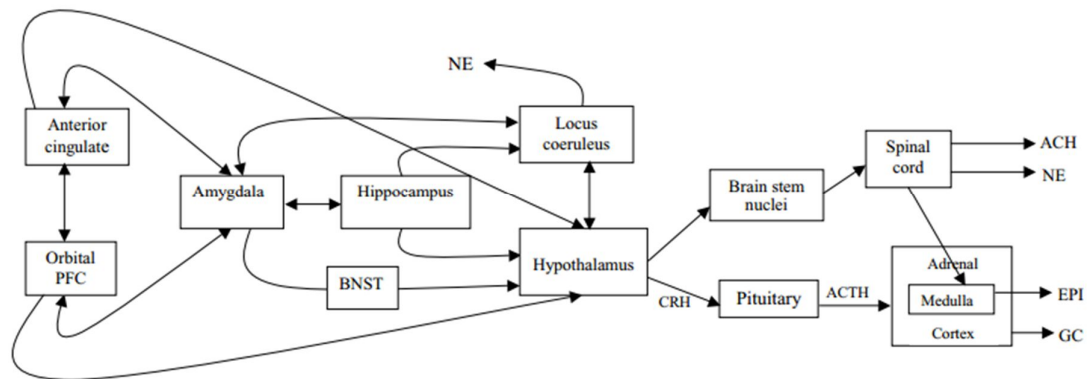

Figure 2.2 Neuroanatomical organization of stress responses consist of three levels, i.e., the cortico-limbic system, the hypothalamus-brain stem system, and brain-to-adrenal gland system. ACTH, adrenocorticotrophic hormone; ACH, acetylcholine; BNST, bed nucleus of the stria terminalis; CRH, corticotropin releasing hormone; EPI, epinephrine; GC, glucocorticoids; NE, norepinephrine; PFC, prefrontal cortex; and subcortical structures, amygdala (Gunnar and Quevedo, 2007).

The PFC, hippocampus, and amygdala are the key regions responsible for GC feedback in the regulation of the HPA axis (Sairanen et al., 2007). The hippocampus and PFC are involved with depression, while subcortical regions, i.e., nucleus accumbens (NA), amygdala, and hypothalamus are involved with reward, fear, and motivation. The brain regions responsible for stress responses are summarized in Table 2.1 (Drevets, 2001; Liotti and Mayberg, 2001).

Table 2.1 Functional anatomy and physiology of brain regions in stress responses.

Brain region	Physiological roles in stress responses
Amygdala	Triggers the fear response, aggressive behaviors, memory, and acts as an emotion center.
Hippocampus	Forms conscious memories of emotional events.
Hypothalamus	Controls body homeostasis, detects and responds to stress through the HPA axis via PVN, and generates defensive behaviors.
Thalamus	Integrates and relays sensory inputs, modulates motivation and emotion, and regulates motor programs.
Prefrontal cortex (PFC)	Supports learning and memory processes, and expresses subjective feelings (e.g., nausea and anxiety).
Caudate putamen	Provides a feedback loop to the cortex, and voluntary motor movement.
Globus pallidus	Consists of inhibitory GABAergic projection neurons, controls coordinate/fine movement, and processes learning and memory.
Nucleus accumbens (NA)	Receives stress-responsive DA projection neurons from the VTA, mediates by interfacing limbic, cognitive and motor circuitry and processes rewarding and reinforcing, exploratory, and spontaneous activity.
Septal nuclei	Plays a role in reward and reinforcement along with the NA and promotes active stress coping behavior involved in a HPA-inhibitory mechanism.
Raphe nuclei	Produces serotonin (5-HT) in dorsal raphe nuclei, promotes attention, vigilance, alertness, arousal and attention.
Locus coeruleus (LC)	Produces NE, modulates emotion, attention, pain, autonomic, respiratory, and cardiovascular functions.
Ventra tegmental area (VTA)	Produces DA, processes for reinforcement, reward, memory, and attention.
Periaqueductal gray (PAG)	Generates defensive responses and strong feeling of fear in panic attacks and promotes fear and defensive behaviors, arousal, hypoalgesia
Substantial nigra (SN)	Contains nigrostriatal dopaminergic neurons and regulates movement and coordination. Its dysfunction is implicated in Parkinson's disease.

3. Neurochemistry of stress

3.1 Corticotropin-releasing hormone (CRH)

CRH is an amino acid neuropeptide, which plays a major role in the adaptation to stress (Vale et al., 1981). Release of CRH depends on circulating GC and ACTH, which are associated with circadian patterns of the HPA axis. CRH is required for the activation of anterior pituitary ACTH gene expression. CRH is present throughout the central nervous system, adrenal and sympathetic ganglion of autonomic nervous system and some fetal organs such as lung and gastrointestinal tract. Regarding localization of CRH receptors, CRH 1 and CRH 2 are expressed in the brain. About 50% of CRH neurons colocalize with AVP in the the dorsomedial parvocellular part of the PVN (Smith and Vale, 2006). CRH neurons directly synapse with glutamatergic and GABAergic neurons in the PVN and the cerebral cortex, i.e., the layers 2–3 of the rat brain (Yan et al., 1998; Kubota et al., 2011). In addition, CRH neurons and CRH receptors are expressed in the hippocampus, stria terminalis, solitary nucleus of hypothalamus, amygdala, locus coeruleus, cerebellum and spinal cord (Aguilera and Liu, 2012). CRH is not only responsible for metabolic, endocrine and autonomic responses in the perceived acute stress, but CRH also leads to psychological problems in the perceived chronic stress (Korosi and Baram, 2008). Therefore, CRH can mediate behavioral responses such as anxiety, arousal, depression, and learning and memory (Binder and Nemeroff, 2010).

3.2 Glucocorticoid (GC)

GCs are essential for life. Normally, the release of GC is driven by a circadian rhythm originating in the SCN of the hypothalamus. Signal inputs from SCN result CRH release, which activates the HPA axis and releases GCs (Figure 2.1). In addition, sympathetic nerve fibers directly connect the SCN to the HPA axis; therefore GC release exhibits a circadian pattern. GC promotes energy mobilization, i.e., increase in blood glucose and free-fatty acids in the fight to flight response, and also disturbs the functions of the immune, digestive, and reproductive systems in long-term stress exposure. GRs and MRs are nuclear receptors with transcription factor activity, which is activated by the binding of GCs to the GR and MR. GR is highly expressed throughout the whole brain, whereas MR is expressed in

specific restricted brain regions such as the amygdala, the hippocampus, the LC, the PFC, the solitary nucleus and the PVN (de Kloet et al., 2005; McEwen, 2007). GC mediates the negative feedback to inhibit the secretion of CRH and ACTH.

Hyperactivity or dysregulation of the HPA axis leads to hypercortisolism contributing to metabolic, cardiovascular, and mental diseases. It has been well established that chronic stress is a risk factor for mood disorders (e.g. anxiety disorders and depression). Particularly, GCs cause impaired learning and memory formation, changes in the distribution pattern of GR and MR, atrophy of hippocampal cells, reduced hippocampal neurogenesis, reduced synaptic plasticity and impaired learning ability, resulting in memory problems in stressed individuals (Sapolsky et al., 1986).

3.3 GABAergic neurotransmission

GABA plays a role in the modulation of emotional behaviors. GABAergic neurons synthesize GABAs to inhibit neuronal excitability. GABA is synthesized by glutamic acid decarboxylase (GAD), which exists as two isoforms based on the protein size of glutamic acid decarboxylase (GAD), i.e., 67 kDa (GAD1) and 65 kDa (GAD2). In the mouse brain, 80–90% of GAD activity is produced by GAD1 (Asada et al. 1997, Condie et al. 1997). Changes in GABA, GABA receptor, and GAD expression can occur in stress exposure. Stress can inhibit the GABAergic plasticity, which contributes to the development of stress-related disorders (reviewed by Maguire, 2014).

During stress, increased levels of GCs lead to increased GABA levels in the hippocampus of rats (de Groote and Linthorst, 2007). Alteration of GAD expression causes marked inhibitory effects on postsynaptic neurons in the hippocampus (Stone et al., 2001; Maggio and Segal, 2009). Both GAD1 and GAD2 expressions are increased in the bed nucleus of the stria terminalis, preoptic area of hypothalamus, PVN and CA3 of the hippocampus after chronic intermittent stress (Bowers et al., 1998). Moreover, chronic immobilization stress increases the expression of GABA_A receptors in the PFC as indicated by greater binding of ³H-flunitrazepam (Braestrup et al., 1979). In contrast, the reduction of GAD was reported in the striatum and olfactory bulb in chronic cold stress (Acosta et al., 1993) leading to

reduced levels of GABA. These results indicate that the GABAergic inhibitory control over glutamatergic cells is reduced (Kalkman and Loetscher, 2003). Therefore, the reduction of GABAergic inhibitory control in these areas could be implicated in the pathophysiology of fear, anxiety, and depression.

3.4 Monoaminergic neurotransmission

Monoamines, organic compounds with one amino group, are associated with mood stabilization. Imbalance of monoaminergic neurotransmitters contributes to the impairments of structural plasticity and changes in the size of specific limbic areas. The members of monoamine neurotransmitters include catecholamines (dopamine, DA and NE) and 5-hydroxytryptamine (serotonin; 5-HT). Therefore, dysregulation of monoaminergic neurotransmission has been implicated in mood disorders such as depression, anxiety, and schizophrenia (Kandel et al., 2000, Sieglä et al., 2006)

3.4.1 Catecholamines

The dopaminergic system plays a role in emotional reward, motivation, desire, addiction, pleasure, learning and motor fine tuning. The central component of the dopaminergic system is the ventral tegmental area (VTA). DA is synthesized in the nigrostriatal neurons that are involved in body movement and mood. In rats, dopaminergic neurons are present in the midbrain, i.e., the substantia nigra (SN), VTA and related nuclei. DA and the limbic system are essential in forming behavior, sensory and environmental/emotional-memory connections. The VTA forms a connection with a key pleasure center known as NA. DA release into the NA is responsible for rewarding and addictive behaviors. In addition, the NE system plays a role in wakefulness, alertness, energy, arousal and motivation. The LC, a nucleus located in the pons of the brainstem, is the central norepinephrine system. The LC produces NE and sends projections to areas of the hindbrain, forebrain, and spinal cord through a system of noradrenergic projections. Terminals in the cerebellum and cortex could be derived from collateral branches of a single neuron's axon. It plays a major role in the function of the sympathetic nervous system, during states of agitation or stress. The LC and the adrenergic projections are known as the LC-noradrenergic system. Activation of the LC induces the fight or flight reaction in the stress response.

NE is synthesized by adrenergic neurons in LC in the brain stem while the major site of Epi synthesis is adrenal medulla.

The catecholamine neurotransmitters are synthesized from tyrosine. The biosynthetic pathways of catecholamines involve several enzymes, i.e., tyrosine hydroxylase (TH), pteridine reductase, aromatic amino acid decarboxylase, dopamine β -hydroxylase, and phenylethanolamine-N-methyl transferase. TH in the LC is upregulated in response to depletion of NE in normal and stressed rats. Therefore, elevated TH levels could be an indicator of the stressed status in the NE system (Melia et al., 1992). Moreover, high NE may facilitate long-term potential (LTP) induction in the hippocampus by decreasing the threshold to LTP generation, facilitating memory formation (Hu et al., 2007). DA and NE are stored in the storage vesicles that are located in the nerve terminal. Since the metabolizing enzyme monoamine oxidase (MAO) is present in the cytosol, concentrations of both catecholamines in the cytosol are low. Catecholamines are released by exocytosis from the nerve terminal. Both DA and NE are inactivated by MOA and catechol-O-methyltransferase (COMT) after binding to the receptors. Some catecholamines are transported back into the presynaptic nerve terminal via their respective selective reuptake transporters such as the DA reuptake transporter or the norepinephrine transporter (NET).

NETs are located on the presynaptic membrane of NE nerve terminals. NET expression has not been found in serotonergic and dopaminergic neurons, but the NET is located on the presynaptic part of an NE terminal (Barker and Blakely, 1995). Moreover, alterations of NET expression could contribute to the pathophysiology of depressive symptoms (Klimek et al., 1997; Haenisch et al., 2009; Haller et al., 2002). Although the role of the NET in NE signaling is well known, its regulation in response to treatment with NET inhibiting antidepressants remains uninvestigated. Moreover, reports of effects of stress on NET expression are inconsistent. Either membrane trafficking or degradation of NET proteins may contribute to the loss of NET ligand binding and protein levels. Altered expression of the NET gene may contribute to the loss of NET proteins in response to antidepressant treatment (Zhu et al., 2002; Chen et al., 2012).

3.4.2 Serotonin (5-hydroxytryptamine, 5-HT)

The 5-HT system plays a role in mood, emotion, social disposition, sleep cycle, wakefulness, dreaming, appetite, spinal pain modulation and the modulation of the endogenous opioidergic system. The raphe nuclei are located in the brainstem, and are the primary source of 5-HT in the brain. 5-HT is a hydrophilic substance and that can pass the blood-brain barrier. Ascending serotonergic projections innervating the cerebral cortex and other regions of the forebrain arise from the dorsal raphe (DR) and the median raphe. The median raphe projects to the hippocampus, the septum and the hypothalamus, whereas the striatum is innervated predominantly by the DR. Raphe neurons send collateral axons to brain areas that are functional related, i.e., the amygdala and hippocampus or the SN and caudate putamen. The serotonergic pathways project to areas of the cerebral cortex, and the spinal cord. When activated, the ascending projections of the 5-HT neurons in the DR facilitate neuronal activity in the amygdala and suppress neurons commanding flight in the periaqueductal grey (PAG). Neurons in the median raphe nucleus could be stimulated by uncontrollable stress. In order to prevent the occurrence of depression, 5-HT would promote a disconnecting mechanism that results in tolerance to stress that takes place in the hippocampus. Abnormalities of 5-HT function in the brain can lead to psychiatric disorders such as schizophrenia, anxiety, panic and depression (Graeff et al., 1996).

5-HT is synthesized from the amino acid tryptophan by the rate limiting enzymes tryptophan hydroxylase (TPH) and 5-hydroxytryptophan (5-HTP) decarboxylase. TPH is similar to TH in term of catalytic mechanism and the amino acid sequences. 5-HT is taken up from the cytoplasm into the storage vesicle by active transport. The 5-HT receptors are divided into 5-HT₁, 5-HT₂, and 5-HT₃ receptors. The 5-HT₁ and 5-HT₂ receptor families are G-protein coupled receptor, while the 5-HT₃ receptor is a ligand-gated sodium and potassium ion channel (Mohammad-Zadeh et al., 2008).

Among the 5-HT receptor families, the 5-HT_{2C} receptor (5-HT_{2C}R) is a prominent serotonin receptor that is distributed throughout the central nervous system. 5-HT_{2C}Rs are widely distributed in the choroid plexus, frontal cortex, hippocampus, hypothalamus, ventral tegmental area and amygdala (Xu et al.,

2008; Greenwood et al., 2012). Activation of 5-HT_{2C}R induces a decrease in food intake and increases anxiety (Dryden et al., 1996; Gatch, 2003) because 5-HT_{2C}R is expressed on CRF neurons that regulate ACTH and corticosterone secretion (Heisler et al., 2007a). Furthermore, 5-HT_{2C}R knockout mice display reduced anxiety when exposed to novel environments and show decreased neuronal activities, specifically in the amygdala (Heisler et al., 2007b). In addition, altered RNA editing of the 5-HT_{2C}R was observed in the PFC of suicide victims with major depressive disorder as well as in stressed rats (Niswender et al., 2001; Iwamoto et al., 2005). Therefore, the activation of this receptor could be involved in anxiety and fear responses and could be a target for anxiolytic drugs, i.e., agomelatine.

3.4.3 Serotonin reuptake transporter (SERT)

In order to regulate the availability of 5-HT in the synaptic cleft, both binding of 5-HT to its autoreceptor and the activity of the SERT located on the presynaptic membrane are required. Stimulation of the 5-HT autoreceptor decreases further release of 5-HT, while the SERT removes 5-HT from the synaptic cleft back into the presynaptic neuron. Changes in SERT expression and function are correlated with the pathophysiology of depression and anxiety disorders. Effects of stress on SERT expression in the raphe nuclei have been studied but the results are still controversial. For example, single immobilization reduced SERT mRNA in the raphe pontis (Vollmayr et al. 2000). Single social defeat reduced the SERT densities in hippocampus, but did not change those in the midbrain where the DR nuclei are located (Berton et al., 1999). In contrast, chronic restraint plus cold stress resulted in an increase in SERT mRNA levels in the DR of both male and female rats (Pare et al., 1999). These studies with inconsistent results clearly emphasize the need for further studies on the effects of chronic stress on the SERT in serotonergic neurons. SERT is the primary target of the clinically successful class of antidepressant and anxiolytic drugs known as the selective serotonin reuptake inhibitors (SSRIs). Although the action of the SSRIs is generally understood to involve an increase in 5-HT concentrations in the synapse, resulting in increased postsynaptic receptor binding, this has not been clearly established (Schloss and Williams, 1998).

The complex neural pathways of the serotonergic system allow this transmitter substance to broadly affect behavior and mood. Changes in the serotonergic system have been shown to be strongly correlated with mental disorders. At the cellular level, abnormalities may include abnormal regulation of 5-HT synthesis, release and/or reuptake or abnormal responsiveness to the 5-HT signal. In addition, alteration of this neurotransmission involves the presynaptic autoreceptors (5-HT_{1A}), the SERT site, and the postsynaptic 5-HT_{2C}R, in several brain regions, that are believed to be potentially important in mood and memory disorders.

3.4.4 Melatonin

Melatonin (MT) is an important regulator of circadian rhythms and seasonal physiology. MT was first isolated and identified by Lerner and co-workers (1958). MT synthesis in the pineal gland is modulated by the light/dark information that is detected by the retina. The relative contributions of the intrinsically photosensitive retinal ganglion cells (ipRGCs) and the classical photoreceptors in the control of MT synthesis are subject to discussion. IpRGCs alone are sufficient in photoreceptor deficient animals, but that does not mean that in animals with functional retinal photoreceptors only the ipRGC control melatonin production. MT production in the pineal gland and locally in the retina follows a circadian rhythm, with the highest levels produced during the dark phase. In mammals, the light/dark information is sent through the retino-hypothalamic tract and the SCN to the pineal gland, where MT is synthesized and secreted by pinealocytes. Glutamate released from the retinohypothalamic tract stimulates the SCN GABAergic neurons, which in turn inhibit the stimulatory action of the PVN on MT secretion by the pineal gland through its sympathetic innervation at the intermediolateral nucleus of the spinal cord and the superior cervical ganglion. MT binds to the MT₁ and/or MT₂ receptors on the target cells (reviewed by Liu et al, 2016).

Stress-induced activation of the HPA axis can modulate the MT rhythm, and thus the MT production and secretion pattern (McClung, 2011). There is a reduction in MT secretion in the dark phase after stress exposure, which probably results from a reduction in tryptophan precursor for MT synthesis. However, nocturnal illumination did not further suppress MT production in stressed animals (Persengiev et al., 1991). Corticosterone apparently alters 5-HT and

MT synthesis by modulating the mRNA levels of TH (Clark and Russo, 1997). Although corticosterone reportedly inhibited nuclear factor- κ B translocation, thereby enhancing the NE-induced synthesis of MT in the pineal gland (Ferreira et al., 2005), chronic stress indirectly impaired sympathetic inputs to the pineal gland, leading to disruption of MT rhythm (Dagnino-Subiabre et al., 2006). It is therefore possible that derangement of the melatonergic system in stressed rats may stem from inappropriate MT production and its irregular rhythm. Also, MT levels are decreased in depressed patients (Claustrat et al., 1984). However, the cellular localization of MT1 and MT2 is still not fully established and subject to controversies. This localization is important because MT1 and MT2 receptors are targets for the development of novel antidepressants and MT derivatives

MT receptors belong to the family of G protein coupled receptors or the seven-transmembrane domain receptors. In mammals, there are two types of MT receptors, melatonin receptor 1 (MT1; MTNR1A) and melatonin receptor 2 (MT2; MTNR1B). The MT1 receptor mediates the acute inhibitory action on the SCN firing, whereas the MT2 receptor mediates the phase shifting effect on the SCN activity (Pandi-Perumal et al., 2007). When MT binds to MT receptors, it activates Gi and Gq proteins, which in turn inhibit the adenylate cyclase/cAMP pathway and activate the protein kinase C pathway. As a result of the phosphorylating activity of protein kinases, cAMP response element-binding protein (CREB) and mitogen-activated protein kinase (MAPK or MAP kinase) regulate the expression of clock genes and modulate clock gene rhythms (phase advances and delays) (Sharma et al., 2015). MT actions were mediated via MT1 and MT2 receptors as summarized in the Figure 2.3. MT receptors are the target for development of pharmacological agents. However, there is variation in the density and location of MT receptor expression between species. Radioactive ligand binding, especially 125 I-iodomelatonin receptor binding remains the “gold standard” for the detection of MT receptors (Vanecek et al., 1987). Although the tissue distribution of MT1 can be detected by receptor binding, there is no specific mapping for MT2 and this technique does not allow the study of cellular receptor localization. In situ hybridization has proven not sensitive enough for the mapping and phenotyping of MT receptor expressing cells (Poirel et al., 2002).

In addition, MT receptor protein localization using the immunocytochemistry in rodents is controversial because reliable antibodies with high sensitivity are not available (Fujieda et al., 1999). Therefore, a genetically modified rodent model has been generated for mapping and phenotyping MT receptor expression. Tissues characterized functional MT1 and/or MT2 melatonin receptors, e.g., retina, SCN, *pars tuberalis*, cerebral, arteries, kidney, pancreas, adrenal cortex, testes and immune cells (Dubocovich and Markowska, 2005). However, MT receptor localization is not clearly and controversial finding.

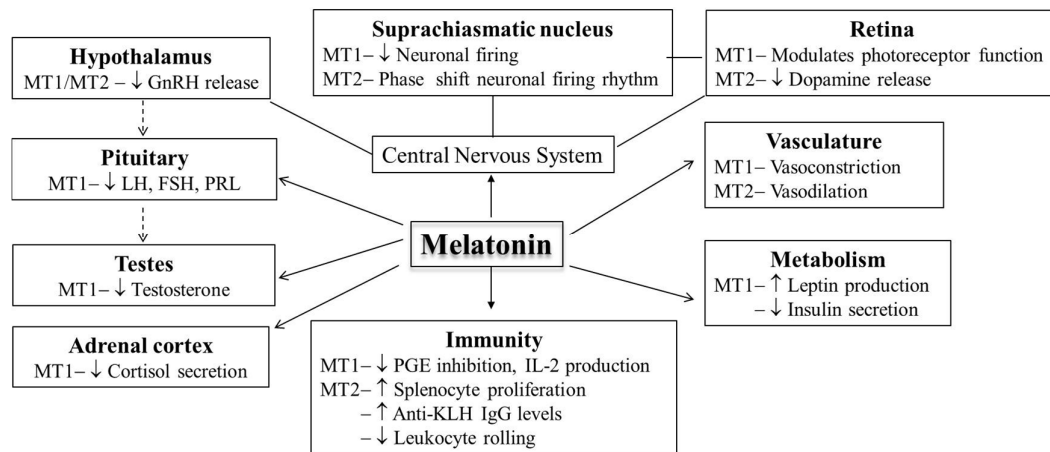

Figure 2.3 Effects of MT1 and MT2 melatonin receptor agonists and antagonists in mammals. FSH: follicle-stimulating hormone; GnRH: gonadotropin-releasing hormone; KLH: Keyhole limpet hemocyanin; LH: luteinizing hormone; PGE: prostaglandin; PRL: Prolactin (Modified from Dubocovich and Markowska, 2005).

3.5. Brain-derived neurotrophic factor (BDNF)

Besides affecting neurotransmitter levels underlying the regulation of neurogenesis such as GABA, 5-HT, DA, and NE, cannabinoids, opioids and nitric oxide (Balu and Lucki, 2009), stress also decreases the expression of growth factors, such as BDNF, insulin-like growth factor-1 (IGF-1), nerve growth factor (NGF), epidermal growth factor (EGF) and vascular endothelial growth factor (VEGF) that also influence neurogenesis (Schmidt and Duman, 2007).

BDNF is a member of the nerve growth factor family and is expressed in the hippocampus and the cortex where it modulates neuronal plasticity, inhibits cell death cascades and increases the cell survival proteins that are responsible for the proliferation and maintenance of central nervous system neurons (Duman, 2004, Murakami et al., 2005). BDNF mRNA was transcribed and regulated by 8 various promoters containing untranslated exons (I to VIII). Especially, promoter IV is mediated by calcium and regulatory components, leading to protein translation (Zheng and Wang et al., 2009). The function of BDNF is mediated by its binding to specific receptors, i.e., tropomyosin receptor kinase B (TrkB) receptors and p75 neurotrophin receptor (p75NTR). TrkB signaling promotes neurogenesis while p75NTR activation mediates proteolytic mechanisms in survival and apoptosis inducing mechanisms (Lee and Kim, 2010). BDNF is involved in the pathophysiology of mood disorders and plays an important role in the mechanism of action of antidepressant drugs (Duman and Monteggia, 2006). Clinical studies have found a decreased BDNF level in the blood of depressed patients (Aydemir et al., 2005).

Taken together, these proteins involved in neuronal remodeling of the noradrenergic and serotonergic systems and which were among the primary targets of the effects of stress, pharmacological treatment, and voluntary wheel running were brain-derived neurotrophic factor (BDNF), glucocorticoid receptor (GR), norepinephrine transporter (NET), serotonin transporter (SERT), and 5-HT type 2C receptor (5-HT_{2C}R).

Table 2.2 Summary of localization of selected target proteins in the present study

Target protein	Study model/Methods	Brain regions	References
Brain-derived neurotrophic factor (BDNF)	Rat/Western blotting, Immunocytochemistry, <i>In situ</i> hybridization	Cerebral cortex, hippocampus, forebrain, striatum, hypothalamus, brainstem, cerebellum, amygdala, claustrum, substantia nigra, septum, bed nucleus of the stria terminalis, preoptic nucleus, olivary pretectal nucleus, lateral paragigantocellular nucleus, trigeminal nuclei, nuclei tractus solitarius, superior colliculus, geniculate nucleus, and olivary pretectal nucleus.	Kawamoto et al., 1996; Yan et al., 1997; Zhou et al., 2004; Avwenagha et al., 2006

Table 2.2 Summary of localization of selected target proteins in the present study (cont.).

Target protein	Study model/Methods	Brain regions	References
Norepinephrine transporter (NET)	Rat/(3)H-nisoxetine binding, Western blotting, <i>In situ</i> hybridization	Cerebral cortex, hippocampus, locus coeruleus, amygdala	Zhao et al., 2008; Zhu et al., 2002; Chen et al., 2012; Fan et al., 2014
Serotonin reuptake transporter (SERT)	Rat/ Western blotting, Immunocytochemistry,	Raphe nuclei, olfactory bulb, frontal cortex, locus ceruleus, hypothalamus, frontal cortex, striatal neuroepithelia, sensory thalamic pathways, thalamocortical bundles, reticular nucleus, internal capsule bundle and form barrels in somatosensory cortices, hippocampus, cerebellum, hippocampus, and amygdala	Zhou et al., 1996; 2000, Zhang et al., 2012
Glucocorticoid receptor (GR)	Human/Northern blot, <i>In situ</i> hybridization Rats/ Western blotting <i>In situ</i> hybridization	Prefrontal cortex, cerebellum, medulla, putamen, hippocampus Choroid plexus, hippocampus, paraventricular and periventricular hypothalamic nuclei, dorsal thalamic nuclei, layers II and VI of the cerebral cortex, olfactory nucleus, olfactory cortex, olfactory bulb. mammillary nuclei, subthalamus, basal ganglia, rhinencephalon, pons, cerebellum, amygdala, subiculum, and pituitary gland	Sousa et al., 1989 Kitraki et al., 1996
Serotonin type 2C receptor (5-HT_{2C}R)	Human / RT-PCR, Editing efficiency analyses Rats/microdialysis, <i>In situ</i> hybridization, Immunocytochemistry	Cerebral cortex, substantia nigra, and cerebellum Striatum, prefrontal cortex, nucleus accumbens, amygdala, hippocampus, hypothalamus, choroid plexus. retrosplenial, piriform and entorhinal cortex, olfactory nucleus, septal nucleus, subthalamic nucleus, subiculum and ventral part of CA3, lateral habenula, substantia nigra pars compacta, brainstem nuclei, geniculate thalamic nuclei, caudate-putamen, and dorsal raphe.	Niswender et al., 2001 Pompeiano et al., 1994; Clemett et al., 2000; Alex et al., 2005

2.2 Stress-induced mood and memory disorders

1 Stress induced-anxiety disorders

Kim and Gorman (2005) explained that anxiety is a normal response to threat or stress, and it is an unpleasant emotional state consisting of psychophysiological responses to the anticipation of an unreal event. According to the classification system of the American Psychiatric Association's modified fifth edition of the Diagnostic and Statistical manual of Mental Disorder (DSM-5), anxiety disorders are divided into 5 subtypes i.e., panic disorder, generalized anxiety disorder, social anxiety disorder, post-traumatic stress disorder, and obsessive-compulsive disorder (American Psychiatric Association, 2013).

Anxiety involves multiple brain regions, namely the BNST, the LC and the PFC. The activation and regulation of neuroendocrine pathways in fear and anxiety involve the stress response in the HPA axis and its related pathways, i.e., the CRH-ACTH-cortisol axis and the LC-axis. Anxiety disorders may result from genetic factors, threatening environmental factors, life experiences or imbalanced neurotransmitters, especially, monoamine neurotransmission. Stress-induced changes in monoamines (5-HT and NE) by anxiety such as immobilization could produce negative emotions such as anxiety and/or fear and emotional responses such as defecation, vocalization and struggling (Charney and Drevets, 2002).

Dysregulation of 5-HT release and reuptake or decreased responsiveness to the 5-HT signal lead to anxiety and mood disorders (Graeff et al., 1996). It was reported that stress caused a reduction of 5-HT and/or 5-hydroxyindoleacetic acid (5-HIAA)—metabolite of 5-HT in the brain of rats exposed to electrical foot shock (Malyszko et al., 1994). Maternal deprivation and uncontrollable stress induced the reductions in the 5-HT_{1A} autoreceptor and 5-HT_{2C}R in the hippocampus and the basolateral amygdala of rats (Christianson et al., 2010, Maniam and Morris, 2010). Apart from the serotonergic system, the central noradrenergic system has been implicated in both anxiety and regulation of the HPA axis (Sullivan et al., 1999). After being activated by stress, this system modulates the activity of forebrain regions involved in behavioral and neuroendocrine responses to stress, such as the BNST that receives dense noradrenergic innervations. Tanaka and co-workers (2000)

demonstrated that immobilization stress led to a marked increase in NE release in several brain regions. In addition, stressed rats exhibited increased anxiety in the elevated plus-maze (EPM) and a high dendritic arborization in the basolateral amygdala neurons (Mitra et al., 2005). They also displayed aggressive behaviors and an increase learned fear in elevated T-maze (ETM) (Wood et al., 2008, Lapmanee et al., 2012, 2013).

2. Stress induced-depression

Depression is a common feeling that disturbs daily life if present for long periods. The risk factors for depression include personal or family history, physical illness and stress exposure. Besides the genetic background, dysfunction of HPA axis can also cause depression. Maladaptive responses to stress and GC hypersecretion can induce extreme emotional imbalance, mood dysfunction and cognitive impairments in depressed patients. PFC and hippocampus mediate memory impairments and feelings of worthlessness, helplessness, guilt and suicidal thoughts. The volume of these brain structures was reduced in severe depression (Cerqueira et al., 2008, Kempton et al., 2011). In addition, the striatum and amygdala control the emotional memory and could be the cause of anhedonia. The CRH expressing neurons and the amount of CRH-mRNA in the PVN are increased and disrupted CRH signaling by CRH1 receptors promotes stress-related depressive conditions (Raadsheer et al., 1995).

Concerning the monoamine deficiency hypothesis, many studies suggested that there is a decrease in 5-HT, as indicated by its metabolite (5-HIAA) in the cerebrospinal fluid of depressed suicide victims (Fisher et al., 2001). Moreover, SERT mRNA levels were upregulated in PFC, hippocampus, amygdala, and PGA of ovariectomized rats subjected to chronic mild stress (Charoenphandhu et al., 2013). Alteration of the noradrenergic system in depression is associated with a synaptic deficiency of NE that is consistent with up-regulation of TH and down-regulation of the NET observed in postmortem studies (Klimek et al., 1997). Therefore, monoamine modulators, such as monoamine oxidase inhibitor (MAOI), SSRIs, norepinephrine reuptake inhibitors (NRIs) and selective norepinephrine reuptake inhibitors (SNRIs), are widely used to alleviate the symptoms by elevating the levels of monoamines in

the synaptic cleft. This suggests that availability of 5-HT and NE plays an important role in the pathogenesis of depression.

3. Stress induced-memory impairment

Memory is ability to recall or recognize that can be divided into declarative and non-declarative memory. Declarative memory processes consciously recollect events and facts, whereas non-declarative memory processes implicitly through performance and skill without consciousness (Squire, 1992). The hippocampus consolidates information while the amygdala plays a role in emotional declarative memory. The basal ganglia and cerebellum are associated with non-declarative memory, such as procedural or habit learning and motor skill learning (Foerde and Shohamy, 2011). Declarative memory is associated with the storage of consciously learned facts, and includes both general knowledge (e.g., figures, word meanings, object uses, scientific facts) and episodic knowledge in the specific events. The hippocampus, amygdala, entorhinal cortex, and areas of the cerebral cortex participate in declarative (explicit) memory. Non-declarative memory also includes new skills through repeated trials and learning (Searleman and Herrmann, 1994). Learning refers to the encoding of information. For example, learning new words is defined as one type of non-declarative memory. The formation and storage of long-term memory are derived from transient changes in neuronal efficiency followed by long-lasting functional and morphological modifications in the hippocampus, related cortical regions and different nuclei of the amygdala (Izquierdo et al., 2006). The cellular and molecular cascade of memory involves glutamate release from presynaptic neurons and activation of the postsynaptic α -amino-3-hydroxy-5-methyl-4-isoxazolepropionic acid (AMPA) and the N-Methyl-D-aspartic acid (NMDA) receptors. These events are associated with increased protein levels of BDNF and activation of TrkB which is coupled to mitogen-activated protein kinases (MAPK/ERK/Ark), which in turn regulate the phosphorylation of the CREB (Yamada and Nabeshima, 2003, Izquierdo et al., 2008).

A study on physiological stress responses demonstrated that GCs potentially act on the hippocampus to exert their effect on memory (Sadni, 1996). High levels of GCs from stress exposure affect LTP processes, facilitate long-term

depression (LTD) and also induce cognitive impairment (Sapolsky et al., 1986). Studies in rats with hippocampal damage showed impairment in learning the location of the hidden platform in the radial arm water maze, whereas chronic restraint stress caused object-recognition memory defects. Similarly, the infusion of NMDA receptor antagonists, which block hippocampal LTP, impaired object-recognition memory in rats (Beck and Luine, 1999; Dimond et al., 1999). Memory impairment may also occur in the onset and progression of Alzheimer's disease (Huang et al., 2009).

2.3 Pharmacological treatment of mood and memory disorders

Current treatments involve pharmacological approaches and psychological interventions. However, pharmacological treatments are largely alleviative and may potentially offer superior benefits in the management of patients with mood and memory disorders (Garner et al., 2009; Li et al., 2012).

1. GABA receptor agonist

Benzodiazepines (BDZs) are the most widely used anxiolytic drugs. The target for BDZs actions is GABA neurotransmission, an inhibitory neurotransmitter in central nervous system). BDZs, such as flurazepam, temazepam, triazolam, alprazolam, clonazepam and diazepam are usually considered as a second line treatment because of their side effects, risk of dependence and withdrawal problems. BDZs are frequently used for the treatment of anxiety associated with panic disorder and generalized anxiety disorder. Since anxiety co-exists with depression, combinations of BDZs and antidepressant drugs are more effective than antidepressants alone. The side effects of BDZs are related to their sedating action, i.e., cognitive impairment, impaired coordination of muscle movement, and muscle relaxation.

2. Antidepressants

MAOIs and tricyclic antidepressants (TCAs) were the effective first-line antidepressants in clinical use during the early period of psychotropic drug discovery (Youdim and Bakhle, 2006). Recently SSRIs, SNRIs, and other antidepressants, such

as mirtazapine and nefazodone, have improved side-effect profiles but are no more effective than MAOIs and TCAs. All of these drugs share similar mechanisms of enhancing or modulating 5-HT and NE neurotransmission in order to alleviate the symptoms.

2.1 Monoamine oxidase inhibitors (MAOI)

These drugs inhibit the MAO, which destroys excessive monoamine within the axon terminals. MAOs are a group of enzymes that metabolize and subsequently inactivate monoamine and indolamine neurotransmitters, i.e., DA, NE, and 5-HT (Amsterdam and Chopra, 2001). The precursor amine, similar to catecholamines, stimulates the sympathetic nervous system. Thus a depressed patient who is treated with MAOI may develop a serious sympathetic reaction after eating food containing the precursor amine. MAOIs, such as phenelzine, isocarboxazid, and tranylcypromine show effectiveness in anxiety disorders, e.g., panic disorder and social anxiety disorder in cases in which no success was found with BDZs. Phenelzine prevents degradation and accumulation of neurotransmitters. Hypotension, dizziness, drowsiness, insomnia, nausea, weight gain, edema, muscle soreness, paresthesias, sexual dysfunction and abnormal sensation such as tingling, tickling, pricking, numbness have been reported as the side effects of MAOIs (Evans et al., 1982; Fiedorowicz and Swartz, 2004).

2.2 Tricyclic antidepressants (TCA)

TCAs are antidepressant drugs that increase the availability of 5-HT and NE in the post-synaptic cleft by inhibiting reuptake of these neurotransmitters. TCAs mediate nonselective interaction between 5-HT and NE neurotransmitter systems, anticholinergic action, direct alpha-adrenergic blockade and membrane-stabilizing effects on the myocardium resulting from over-dosage (Biggs et al., 1977). TCAs such as imipramine also have beneficial effects in depression, panic attack, generalized anxiety disorder and obsessive-compulsive disorder.

2.3 Selective antidepressants

Selective reuptake inhibitor-antidepressants promote availability of monoamines in the synaptic cleft by inhibiting the specific reuptake transporters. SSRIs and SNRIs cause adverse effects resulting from drug-induced spillover of 5-HT and NE. SNRIs block central α_2 -AR, hetero-, 5-HT₂ and 5-HT₃ receptors. NE/DA reuptake inhibitors (NDRIs) are effective in bipolar depression. However, these antidepressant drugs are effective only after several weeks of continued administration.

2.3.1 SSRIs selectively block the reuptake of 5-HT, leading to increased 5-HT levels in the synaptic cleft and thus greater postsynaptic neuronal activity. SSRIs such as fluoxetine, sertraline, paroxetine, and escitalopram are generally recommended as first line agents. SSRIs are also used in the acute and long-term treatment of patients with major depression, anxiety disorders. SSRIs have less risk of overdose with fewer side effects when compared with TCAs and MAOIs. But SSRIs can cause gastrointestinal discomfort, weakness and sleep disturbances (Isbister et al., 2004).

2.3.2 NRIs such as atomoxetine, daledalin, edivoxetine, mazindol, and viloxazine have a positive effect on concentration and motivation. Reboxetine, in particular, is efficacious in the acute treatment of manic disorder and panic disorder (Eyding et al., 2010).

2.3.3 SNRIs selectively inhibit the reuptake of both 5-HT and NE. SNRIs are used in the treatment of depressions, and anxiety disorders (i.e., obsessive-compulsive disorder), neuropathic pain, menopausal-related symptoms, and are also used as an appetite suppressant for body weight control (Spina et al., 2008). SNRIs in general use are venlafaxine, sibutramine, duloxetine, desvenlafaxine, milnacipran, and levomilnacipran.

Interestingly, venlafaxine inhibits 5-HT reuptake at a low dose. And at high dose, it inhibits both, 5-HT and NE reuptake. Venlafaxine was the first to be introduced in this class and has been estimated to be more effective than the SSRIs (Bauer et al., 2010). Venlafaxine and duloxetine are effective in panic disorder, generalized anxiety disorder, and social phobia. Their adverse effects include nausea, dizziness, insomnia, sedation and constipation. After oral administration, this

drug is absorbed from the gut and undergoes hepatic first-pass metabolism. The peak plasma concentration is obtained within 2 h. The oral bioavailability of venlafaxine is 45%, and its biotransformation pathway is mediated by cytochrome P450 (CYP) 2D6. The active metabolite is o-desmethylvenlafaxine. The elimination half-life of venlafaxine is at least 4 h. Both venlafaxine and its metabolites have little affinity for muscarinic, cholinergic, H₁-histaminergic or α -adrenergic receptors (AR), and have no MAOA or B inhibitory activity. Venlafaxine is available in both immediate-release and extended release formulations, and its metabolites are effective in depression, panic disorder, generalized anxiety disorder, and social anxiety disorder. Its adverse effects include nausea, dizziness, insomnia, sedation and constipation (Dell'Osso et al., 2010). Therefore, venlafaxine has a greater potency in the treatment of anxiety-like behavior in stressed male rats than fluoxetine or reboxetine (Lapmanee et al., 2012). However, further investigation is required to demonstrate whether venlafaxine could protect and directly modulate neurotransmission in the stress circuit of male rats.

2.4 Melatonergic antidepressants

Agomelatine (N-[2-(7-methoxy-1-naphthyl)ethyl] acetamide) is the first melatonergic antidepressant in an alternative new pharmacological approach for depression with no side effects. Even though the role of the different melatonin (MT) receptors in the treatment of depression is still unknown, it is suggested that the antidepressant action of agomelatine is caused by its agonistic action at MT receptors and antagonistic action at 5-HT_{2c}Rs. It shows a high affinity for the cloned human MT1 and MT2 subtypes ($K_i = 6.15 \times 10^{-11}$ mol/L and 2.68×10^{-10} mol/L, respectively) and displaces iodomelatonin from its binding sites in the central SCN and peripheral organs, the biological clock (Bonfond et al., 1993). This drug is more than 80% absorbed after oral administration. The peak plasma concentration is obtained within 1–2 hours. It is metabolized by the CYP1A2, CYP2C9, and CYP2C19 isoenzymes. The elimination is rapid as the mean plasma half-life is 1–2 hours and clearance is about 1,100 mL/min with excretion of 80% in urine. Previous studies reported that agomelatine had antidepressant-like effects in the learned helplessness test, chronic mild stress and in a transgenic mouse model of depression, as well as anxiety. Agomelatine-treated rats showed reduced duration of

immobility in the forced swimming test (FST) and tail suspension (Bourin et al., 2004, Paizanis et al., 2006). Agomelatine also increased the capacity of rats to wait for a delayed but larger reward in ETM and EPM (Loiseau et al., 2005, Morley-Fletcher et al., 2011). Moreover, treatment with agomelatine reversed stress affected dentate gyrus neurogenesis and proliferating progenitor cells deficits (Dagytè et al., 2011, Morley-Fletcher et al., 2011). Taken together, these data show that agomelatine has beneficial effects on hippocampal neurogenesis in stress. However, it is still not clearly known whether agomelatine can prevent stress-induced changes in behavior and monoamine secretion.

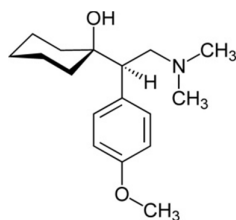

Venlafaxine

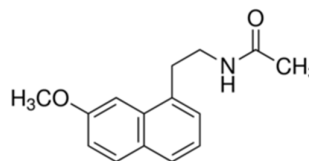

Agomelatine

Figure 2.4 Chemical structures of monoamine modulators used in the present study.

3. Anti-manic and mood-stabilizing agents

Lithium is an anti-manic drug which freely penetrates into neurons and interacts with multiple intracellular molecules, e.g., inositol phosphatases and glycogen synthase kinase-3 associated with the neurotrophic effects (Berridge et al., 1982; Klein and Melton, 1996).

4. Other drugs

Buspirone, the action of which appears to be mediated by the serotonin receptor 5HT_{1A}, is particularly useful in the treatment of generalized anxiety disorders and elderly patients. Buspirone is also used to augment antidepressants in the treatment of depression (Howland et al., 2015). Its side effects include dizziness, nausea, headache, but not sedation or loss of coordination.

2.4 Beneficial effects of exercise on stress-induced mood and memory disorders

It is generally accepted that physical activity and exercise have positive effects on mental health reducing the incidence and severity of psychiatric disorders such as anxiety and depression. These interventions could relieve symptoms and are as effective as meditation or psychotherapy.

Physical exercise is cost-efficient and also provides protection against harmful consequences of stress in healthy people and patients (Salmon, 2001). Light-to-moderate intensity of aerobic exercise produces antidepressant- and anxiety-like action (de Moor et al., 2006). In human studies, aerobic exercise training shows a comparable effect when compared to antidepressant drugs or placebo in middle-age and older adults with major depression disorder (Blumenthal et al., 2007). Carta and co-workers (2008) showed that long term-exercise provided better physical quality of life in depressed patients who received antidepressant and/or physical exercise as evaluated by self-report survey questionnaire. In addition, both high and low exercise intensities could reduce anxiety sensitivity as indicated by an anxiety sensitivity index. On the other hand, exercise may paradoxically induce anxiety in some groups of patients, e.g., inducing acute panic attacks or increasing the anxiety levels in patients with panic disorder (Ströhle, 2009). The aforementioned human studies indicate the strong effects of aerobic exercise on the emotional states, such as anxiety, depression and mood disorders. Although, the mechanism responsible for the exercise-induced anxiolytic-like effect is not completely understood, the improvement could result from the released endorphins and some monoamines.

Benefits of physical exercise as an alternative to psychological interventions have been demonstrated in several animal models. The mechanisms of action of exercise probably involve increased expression of neurotrophic factors, increased neurogenesis and increased monoamine neurotransmission in various brain regions. The possible mechanism underlying of beneficial effects of physical exercise are summarized in Figure 2.5. However, some investigators found controversial results, presumably due to the use of different exercise programs and intensities. Leasure and Jones (2008) reported that the increased emotional state (as indicated by anxiety-like behaviors, defecation and increased circulating levels of corticosterone)

were found in forced exercising rats as compared to those subjected to wheel running. Indeed, most exercise models, such as treadmill and swimming may be considered as forced exercise. Swimming might induce additional stress on animals since the swimming tank represents an inescapable environment (Charoenphandhu et al., 2011). Therefore, voluntary exercise is better for the study of behavioral and neuroendocrine changes.

The effects of voluntary wheel running on brain NE and its metabolites in male rats have been previously investigated. Two major metabolites of NE, 3,4-dihydroxyphenylglycol (DHPG) and 3-methoxy-4-hydroxyphenylglycol (MHPG), as indicators of neuronal NE release (Scheinin et al., 1991). For example, during running, there was an increase in NE in the cell bodies of the pons, the LC, the DR and the spinal cord MHPG, whereas DHPG levels were unaltered in spinal cord, pons medulla, hippocampus, and PFC, which was correlated with increased freezing in contextual fear conditioning (Dunn et al., 1996; Dishman, 1997). The enhancement of α -1B adrenoceptor mRNA expression in DR depended on exercise duration, but not the distance ran (Greenwood et al., 2005). Moreover, previous studies also reported that wheel running exercise increased 5-HT release and metabolism. The effects of exercise on the 5-HT system appeared to be highly dependent on the receptor subtypes and brain regions investigated, and exercise effects may not be as immediate as in the NE system (Garcia et al., 2008). The levels of 5-HIAA were reduced in the amygdala and CA1 only after uncontrollable stress. The ratio of 5-HIAA to 5-HT was also reduced in the PVN (Dishman et al., 1997). SERT mRNA in the MR and DRN subregions was reduced but this effect was not correlated with the distance ran. Furthermore, the increase in 5-HT_{1A} receptor in the MR and in DR was dependent on the duration of exercise (Greenwood et al., 2003, 2005). Voluntary exercise reversed maternal deprivation induced reductions in 5-HT_{1A} mRNA in the hippocampus (Maniam and Morris, 2010). On other hand, 5-HT_{1B} receptor mRNA in the DR was decreased by exercise and this decrease was dependent on exercise length (Greenwood et al., 2005).

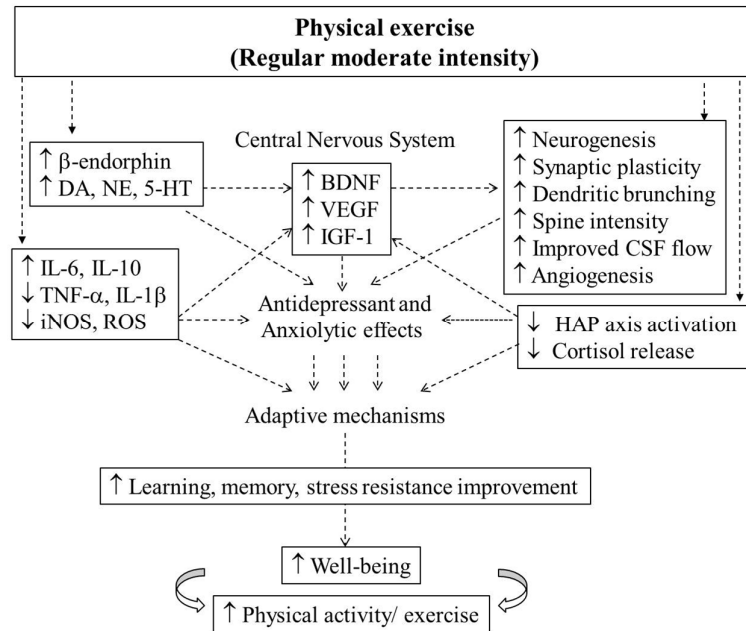

Figure 2.5 Physiological effects of physical exercise: Adaptive mechanisms are responsible for a decreased perception of chronic stress. BDNF: Brain-derived neurotrophic factor; DA: Dopamine; HPA axis: hypothalamic-pituitary-adrenal axis; iNOS: Inducible nitric oxide synthase; IL-1 β : Interleukin 1 β ; IL-6: Interleukin 6; IL-10: Interleukin 10; NE; Norepinephrine; ROS: Reactive oxygen species; TNF- α : Tumor necrosis factor; 5-HT: Serotonin; VEGF: Vascular endothelial growth factor (Modified from Sanches et al., 2016).

As mentioned before, NE and 5-HT, the two classical central monoamine neurotransmitters, can regulate synaptic plasticity, enhance neuronal survival, promote neurogenesis and improve mental health. Therefore, NE and/or 5-HT could be important in the exercise-induced protective effects on the brain, and may participate in the up-regulation of BDNF in the response to voluntary exercise.

The effects of exercise on depressive behavior and spatial performance in stressed rats were examined by determining the alterations of corticosterone, hippocampal BDNF mRNA expression and hippocampal GRs. Voluntary wheel running should reverse the adverse effects of variable stressors on both behavior and hippocampal BDNF mRNA level. Although, exercise alone increased corticosterone, exercise did not affect the hippocampal GR mRNA expression, whereas stress showed

increased corticosterone and decreased hippocampal GR mRNA. These results suggested that exercise had beneficial effect on depressive behavior that might be associated with corticosterone and BDNF mRNA levels (Zheng et al., 2006). In hyperactive rats, there were higher extracellular NE levels and $\alpha 2$ -ARs but lower MAOA activity. Wheel running activity reduced the level of depression (as indicated by immobility time in FST) by increasing the number of $\alpha 2$ -ARs and elevating the extracellular NE via a reduction of MAOA (Morishima et al., 2006).

The anxiolytic effects of voluntary wheel running associated with adaptation of mental and physiological effects on brain and behavior in laboratory rodents and their implications to humans have been well studied (Pietropaolo et al., 2008). After being trained with a running wheel for 4 weeks, mice spent more time in the open arm, had a higher percentage of open arm entries in the EPM test and increased open-field locomotion. Furthermore, chronic wheel running exercise resulted in antidepressant-like behavior, which was associated with increased BDNF levels (Duman et al., 2008). van Praag and co-workers (2005) reported that voluntary wheel running enhanced the number of hippocampal DG cells and LTP, thus improving performance of mice in the Morris water maze (MWM). This result suggested a close relationship between neurogenesis and the hippocampal function involved in the behavioral performance. Voluntary exercise also led to a reduction in anxiety-like behaviors in mice, and the experimental outcome was consistent with those measured with acoustic startle, stress-induced hyperthermia, social interaction and light-enhanced startle (Salam et al., 2009).

Therefore, it is possible that voluntary exercise can be an alternative treatment for mood and memory disorders in humans or animals. However, little is known regarding the preventive effect of exercise on behavior and brain neurochemical changes in stressed individuals.

2.5 Behavioral testing of depression, anxiety, cognition, and memory

1. Experimental models of anxiety

van der Staay (2006) grouped animal models of anxiety into the conditioned response test or conflict test (e.g., exposure to electric foot shock, punished drinking, defensive burying tests) and the unconditional response test (e.g. exploration test or social test) that includes ethologically based paradigms and involves the animal's natural reactions such as fight, avoidance and freezing. The behavioral paradigms are generally probed as the influencing parameter of anxiety. The methods such as, open field can simultaneously measure locomotion, exploration, and anxiety when exposed to an open field arena, while the EPM test is based upon the conflict between an innate fear to exposed spaces and the elevation of the maze. These studies are designed to indicate anxiety related behaviors that parallel anxiety behavior in humans.

1.1 Elevated plus-maze (EPM) test

The EPM test has become one of the most popular behavioral tests for investigations on anxiety (Hogg, 1996; Belzung and Griebel, 2001). The EPM test is based on the conflict between an innate fear to exposed spaces and the elevation of the maze. This test is typically used for the investigation of anxiolytic drugs. The EPM consists of 4 arms in a crossed arrangement, where 2 open arms represent the unsafe places and the 2 closed arms represent the safer places. Anxiety related behaviors include increases in closed arm activity, grooming, rearing, freezing, defecation and urination. A greater number of these behaviors indicate a greater level of anxiety or fear. Risk assessment behaviors, e.g., stretches-attend postures-forward elongation of the head and shoulders followed by retraction to the normal position, are an index of a greater level of anxiety. Decreased open arm activities and increased risk assessment behaviors in locomotion and exploration indicate increased anxiety in the EPM test. Behavioral and pharmacological validation of the EPM has reported that BDZs and 5-HT_{2A/C}R antagonist (e.g., mianserin, ritanserin, and ketanserin) increase the open arm activities (Pinheiro et al., 2007).

1.2. Elevated T-maze (ETM) test

The ETM test is developed to discriminate between conditioned and unconditioned fear in animals. It is derived from the elevated X- or plus-maze by closing the entrance to one of the enclosed arms (Graeff et al., 1993; 1998). Based on 2 strategies—avoidance of open arms when the rat is in one of the closed arms, and escape from an open arm to enter a safer (closed arm)—the constructing ETM has been succeeded. The maze consists of 2 elevated arms that are 1 enclosed arm and 2 open with equal dimensional arms. Conditioned fear results from inhibitory avoidance that is measured by recording the time taken to leave the enclosed arm, whereas unconditioned fear is measured by recording the time to escape from the open arm. An open arm seems to generate an unpleasant feeling with its elevation and the openness of the maze, such that an animal has an innate or unconditioned fear. This will allow the rats to learn inhibitory avoidance if frequently placed within the enclosed arm to explore the maze. Therefore, learning is indicated by the increase of the withdrawal latency along the trials. When the rat is placed at the end of the enclosed arm, it does not see the open arms until it extends its head further from the walls of the closed arm. On the other hand, when the rat is placed at the end of one of the open arms, it can shift to the closed arm, which is like performing an escape response. Behavioral and pharmacological validation of the ETM has reported that TCAs (e.g., imipramine), SSRIs (e.g., sibutramine, fenfluramine, and paroxetine), 5-HT_{1A}R partial agonist (e.g., buspirone, and isapirone), 5-HT_{2A/B/C}R antagonist (e.g., SR46349B, SER082, and SB200646A) impaired inhibitory avoidance and one-way escape latencies (Pinheiro et al., 2007).

1.3 Open field test (OFT)

The OFT test is used to determine locomotion, exploration, and anxiety by exposure to an open area (Prut and Belzung, 2003). The number of crossed lines and the frequency of rearing (i.e. lifting the forepaws from the floor) are used as measures of locomotor activity. A high frequency of these behaviors indicates increased locomotion, while the duration of time spent in the inner zone are a measure of exploration and anxiety. A high frequency or duration of these behaviors indicates high exploratory behavior and low anxiety levels. Behavioral and pharmacological

validation of the OFT has reported that BDZs but not SSRIs or 5-HT_{1A}R partial agonist enhanced time spent in the inner zone (Prut and Belzung, 2003).

1.4 Assessment of emotionality in the anxiety of the animal

In the assessment of changes in emotion, the number of fecal pellet is related to the affective or anxiety state of the animal. An increased number of fecal pellets are correlated with other measures of anxiety. The excretion of corticosteroid metabolites in fecal pellets is correlated with serum corticosterone levels. The validity of defecation as a measure of anxiety remains clear, i.e., increased defecation indicates increased anxiety. Risk assessment behavior seems to be defensive behavior and is indicative of anxiety when the animal faces an unknown or threatening situation. Animals express stretched-attend postures which when occurring a high frequency indicate a higher level of anxiety. Grooming includes licking the fur, beginning from the muzzle, going to the ears, and down to the rest of the body. Rearing and grooming behaviors are a displacement response and are expected to be displayed in a novel environment (Thanos et al., 2009).

2. Experimental models of depression

Preclinical studies in experimental animals have been an important part of the development of antidepressants. Equipments used to assess the behavior of rodents include swimming tanks, drinking tubes and an open field apparatus. Forced swimming test and the sucrose preference test are used to evaluate helplessness, anhedonia, behavioral despair and other neurovegetative changes such as changes in sleep and appetite patterns. The use of animal models for behavioral tests can reveal depression-like behavioral profiles.

2.1 Forced swimming test (FST)

The FST is high the predictive validity models of depression that is most commonly used to evaluate antidepressant-like action. The FST described by Porsolt and co-workers (1979), aimed to measure the effects of antidepressant compounds in mice. This procedure involves placing an animal in a water-filled cylinder which it is unable to exit. At the beginning, the animal will try to escape, and then it adopts a posture of immobility defined by a lack of movements except for keeping the body afloat in the water. The test for rats consists of 2 swimming sessions.

The first session lasts 15 minutes and the second is performed 24 h after the first session, with a test period of 5 minutes. The FST is used for the selection of new antidepressant drugs. Various antidepressants reduce immobility time by increasing the swimming and/or climbing time. Antidepressant drugs affecting noradrenergic neurotransmission such as imipramine and reboxetine increase the climbing behavior, whereas antidepressant drugs affecting serotonergic neurotransmission such as fluoxetine, sertraline, paroxetine and citalopram increase swimming time (Castagné et al., 2011, Lapmanee et al., 2013). The swimming time is measured by the horizontal and vertical movements as animals try to scale the cylinder walls with their paws. The effects of antidepressants on FST behavior are relatively specific, since they do not increase spontaneous motor activity, unlike stimulants such as amphetamine and cocaine (Kang et al., 2010). Besides the effects of antidepressant drugs, the FST can also be used to evaluate the type of depressive behavior; for example, it has been demonstrated that animals subjected to a protocol of maternal deprivation and chronic restraint stress exhibit increased immobility time in the FST (Reus et al., 2011, Lapmanee et al., 2013).

2.2 Sucrose preference test

The sucrose preference test is used for the assessment of hedonic sensitivity whereby animals learn to associate an environment with a rewarding experience. Measurement of consumption of sweetened fluids (sucrose or saccharin) is commonly conducted for assessing stress-induced anhedonia in depression models. Rats habituated to sucrose are typically given a choice of drinks between sucrose and water in a two-bottle test. While control rats typically show a preference for drinking weak sucrose solutions, rats exposed to chronic stress such as chronic mild stress lose this preference. The effects of an antidepressant treatment could reverse this symptom in a time dependent manner. However, the factors affecting sucrose consumption or preference include sucrose concentration, temperature, test duration and body weight. Anhedonic measures after chronic mild stress are sensitive to strain effects for both rats and mice (Willner et al., 1996, Pothion et al., 2004). In addition, Strekalova and co-workers (2011) have reported that a four week chronic stress paradigm resulted in a decrease in the preference for sucrose

solutions by $\leq 65\%$ in 50–70% of mice and rats without any changes at the beginning of the stress paradigm.

3. Experimental models of learning and memory

Animal models have been widely used to study the physiology and the cellular and molecular mechanisms of learning and memory and human cognition. Spatial memory involves processes such as encoding, retaining and retrieving information in the hippocampus, whereas non-spatial memory (implicit) relies on the cerebellum and the amygdala.

3.1 Morris water maze (MWM) test

The MWM test is one of the most commonly used methods in assessing hippocampal-dependent spatial memory in rodents (Morris et al., 1981, 1984). Spatial learning is assessed across repeated trials and reference memory is determined by preference for the platform area when the platform is absent. The test includes a pool of water that is made opaque, and surrounded by a wall with different patterns at various directions. The principle of the test is that rodents can learn to swim towards a hidden escape platform from any starting position. They do this using distal extra-maze cues that are remote from the actual place in the pool to which the animal is heading. Therefore, the room containing the tank should have permanently positioned distinctive objects such as posters placed outside of the pool and/or on the walls. Animals are expected to find the hidden platform under the water using these visual cues. After several trials, the platform is removed, and experimenter further measures the time spent by animals in the corrected quadrant to evaluate their spatial memories (Paul et al., 2009).

3.2 Novel objective recognition (NOR) test

The NOR test has a large field of application not only to test the pharmacological effects of a drug, but also to characterize which brain regions are involved in memory and learning, as well as to understand Alzheimer's disease (e.g., hippocampus and perirhinal cortex). In 1988, Ennaceur and Delacour developed the NOR test to evaluate the differences in the exploration time of novel and familiar objects. The NOR test is a simple behavioral assessment of memory that relies primarily on a rodent's innate exploratory behavior in the absence of externally

applied rules or reinforcement, motivation, reward, or punishment (Antunes and Biala, 2012). However, training or habituation is required. The exploration is the orientation of animal's snout toward the object, sniffing or touching with the snout. Running around the object, sitting or climbing on it is not included as exploration. If animals showed a lack of exploration activity, they are excluded from the test. The NOR test consists of the habituation phase (exploring the empty open field arena), the familiarization phase (exploring only one object) and finally the test phase (exploring the familiar object and a novel one). The objects used in this test vary in shape, size, texture, material, color and appearance. From the familiarization to the test phase, object features change when a novel object that is different from the familiar one is presented. The discrimination index (DI) indicates discrimination between the novel and familiar objects as the difference in exploration time for familiar objects divided by the total amount of exploration of the novel and familiar objects. A positive score indicates more time spent with the novel object, a negative score indicates more time spent with the familiar object, and a zero score indicates a no preference (Redrobe et al., 2010; 2012; Antunes and Biala, 2012).

CHAPTER III

MATERIALS AND METHODS

Part I: Effects of restraint stress induction, monoamine modulators (i.e., agomelatine and venlafaxine), and voluntary wheel running in male rats.

3.1 Animals

Eight-week-old Wistar male rats, weighing 180–220 g, were obtained from the National Animal Center of Thailand, Mahidol University. Rats were individually housed in standard stainless steel shoe box at 25 ± 2 °C in a humidity-controlled room at $55 \pm 5\%$ humidity with a 12-h (06:00–18:00) light/dark cycle (average illuminance of 200 lux). Rats were acclimatized for 1 week with food (CP Co., Ltd., Thailand) and water available *ad libitum* before the start of the experiments. Body weight (BW) and food intake were measured daily. All procedures were approved by the Animal Care and Use Committee of the Faculty of Medicine, Thammasat University, Thailand.

3.2 Experimental protocols

Experiment 1. To examine the time-dependent effect of the 1-, 4- and 8-week stress induction on anxiety-, depression-, and memory impairment-like behaviors and changes in the expression of selected target proteins in the brain regions associated with stress responses.

Rats were subdivided into 2 groups as follows.

1. Non-stress control group (16 rats/group)

2. Stressed group were divided into 3 subgroups

- 1-week restraint stress induction (16 rats/group)
- 4-week restraint stress induction (16 rats/group)
- 8-week restraint stress induction (16 rats/group)

In the 1- and 4-week stressed groups, there was a preceding stress-free period of 7 and 4 weeks (5-min of gentle handling to reduce stress), respectively, in order to commence the behavioral tests at the same age.

At the end of the restraint stress induction, rats were evaluated for behavioral changes. The anxiety-like behavior was evaluated by elevated plus-maze (EPM), elevated T-maze (ETM), and open-field (OFT) tests, while the depressant-like behavior was evaluated by weekly sucrose preference and forced swimming tests (FST). In addition, novel object recognition (NOR) and Morris water maze (MWM) tests were used to evaluate learning and memory. Urine samples were collected from metabolic cages between 11:00 a.m. and 17:00 p.m., prior to the last day of restraint stress induction to determine urinary corticosterone levels. Rats were sacrificed 24 h after the last behavioral test. Blood and adrenal glands were collected for measurement of serum corticosterone levels and adrenal weights, respectively. Brains were removed and the target proteins were analysed in the regions associated with stress responses by Western blot analysis. The experimental protocol and the descriptions of animal groups are presented in Figure 3.1 and Table 3.1.

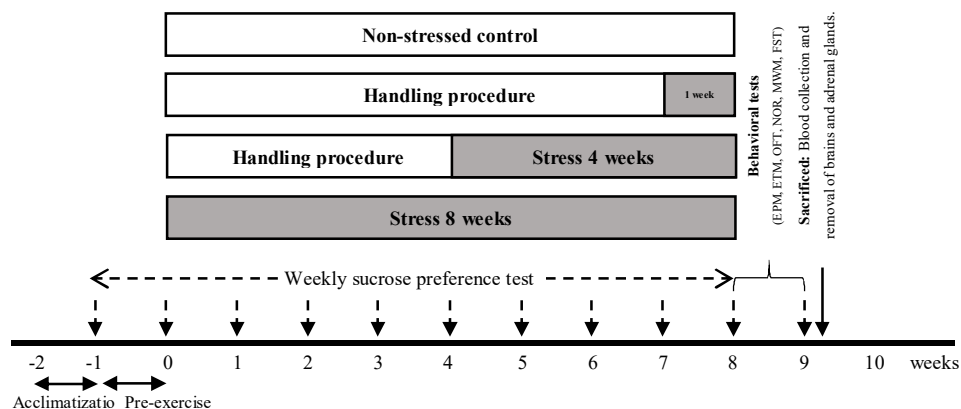

Figure 3.1 Schematic diagram showing the time-course of restraint stress induction and sample collections in the experimental protocol 1.

Table 3.1 Descriptions of animal groups in the experiment 1.

Experimental group	Definition
Control	Rats were subjected to regular handling for 8 weeks.
1-week stress	Rats were subjected to regular handling for 7 weeks and exposed to restraint stress for 1 week.
4-week stress	Rats were subjected to regular handling for 4 weeks and exposed to restraint stress for 4 weeks.
8-week stress	Rats were exposed to restraint stress for 8 weeks.

Experiment 2. To determine the effect of the 4 weeks of voluntary wheel running on the hypothalamic-pituitary-adrenal (HPA) axis under non-stress condition or after the 4-week exposure to restraint stress and changes in the expression of selected target proteins in brain regions associated with stress responses.

Rats were subdivided into 2 groups as follows.

1. Non-stressed control group was divided into 2 subgroups
 - Non-stressed sedentary (10 rats/group)
 - Non-stressed voluntary wheel running (10 rats/group)
2. Stressed group was divided into 2 subgroups
 - Stressed sedentary (10 rats/group)
 - Stressed and voluntary wheel running (10 rats/group)

All rats were weekly subjected to a sucrose preference test for the evaluation of stress-induced anhedonia. After the last stress or exercise sessions, rats were euthanized immediately. Blood was collected in the following morning (8:00–11:00 a.m.) for basal serum corticosterone levels by cardiac puncture. Heart and adrenal glands were collected and weighed. Brains were removed and analyzed for target proteins in the brain regions associated with stress responses by Western blot analysis. Adrenal glands were also analyzed for melanocortin receptor 2 (MC2R; ATCH receptor) protein. The experimental protocol and descriptions of animal groups are presented in Figure 3.2 and Table 3.2.

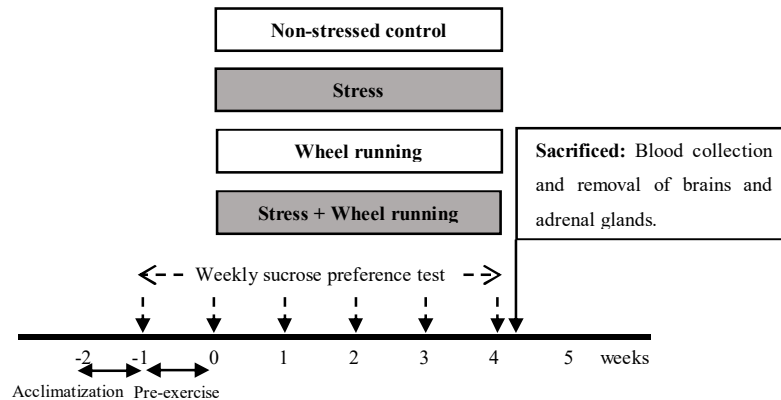

Figure 3.2 Schematic diagram showing the time-course of restraint stress induction, voluntary wheel running, and sample collections in the experimental protocol 2.

Table 3.2 Descriptions of animal groups in the experiment 2.

Experimental group	Definition
Sedentary control	Rats were kept undisturbed and subjected to regular handling for 4 weeks.
Exercise	Rats were subjected to voluntary wheel running for 4 weeks.
Stress control	Rats were exposed to restraint stress for 4 weeks.
Stress + Exercise	Rats were exposed to restraint stress and subjected to voluntary wheel running for 4 weeks.

Experiment 3. To evaluate the effectiveness of agomelatine, venlafaxine, and voluntary wheel running exercise in the prevention of stress-induced anxiety-, depression-, and memory impairment-like behaviors and changes in the expression of selected target proteins in brain regions associated with stress responses.

Rats were subdivided into 2 groups as follows.

1. Monoamine modulators-treated group were divided into 3 subgroups

- Vehicle (Veh, 5 mL/kgBW, p.o., 16 rats/group)
- Agomelatine (Ago, 10 mg/kgBW, p.o., 16 rats/group)
- Venlafaxine (Vlx, 10 mg/kgBW, p.o., 16 rats/group)

2. Voluntary wheel running group (16 rats/group)

Rats were pre-treated for 4 weeks with agomelatine and venlafaxine, or underwent voluntary wheel running, followed by 4-week restraint stress induction (2 h/day, 5 days/week). During the restraint stress induction, rats received neither pharmacological treatment nor voluntary wheel running. Anhedonic-like behavior was evaluated by a weekly sucrose preference test. At the end of the restraint stress induction, all rats were evaluated for anxiety-, depression-, and memory-like behaviors using EPM, ETM, OFT, FST, NOR, and MWM. Twenty-four hours after the last behavioral test, rats were sacrificed. Blood was collected for the serum corticosterone measurement. Adrenal glands were collected and weighed. Brains were removed and analyzed for target proteins in brain regions associated with stress responses by Western blot analysis. The experimental protocol and the descriptions of animal groups are presented in Figure 3.3 and Table 3.3.

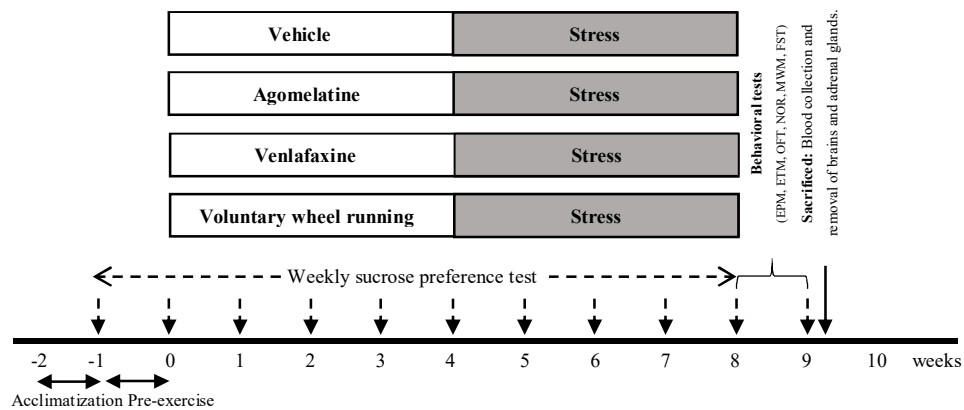

Figure 3.3 Schematic diagram showing the time-course of treatments and sample collections in the experimental protocol 3.

Table 3.3 Descriptions of animal groups in the experiment 3.

Experimental group	Definition
Sedentary	Rats were administered a 4-week vehicle treatment before exposure to restraint stress for 4 weeks.
Monoamine modulators	Rats were administered a 4-week monoamine modulator treatment (i.e., agomelatine and venlafaxine) before exposure to restraint stress for 4 weeks.
Voluntary exercise	Rats were administered a 4-week combined vehicle treatment and voluntary wheel running before exposure to restraint stress for 4 weeks.

3.3 Experimental procedures

1. Restraint stress induction

The stress protocol was followed from the methods of Lapmanee et al., 2013. Briefly, stressed rats were immobilized 2 h/day (8:00–10:00 a.m.) in a quiet room, 5 days/week for 1-, 4-, or 8-weeks. Restraint technique involved placing the rat in a transparent plastic cylinder (24 cm long × 6 cm wide) with a 1-cm hole at the end of the cylinder for breathing. Rat was fixed with plastic tape. The restraint procedure was performed after 4-weeks of pharmacological treatments or voluntary wheel running.

2. Monoamine modulator administration

Drugs were daily administrated orally by gavage between 15:00 p.m. and 16:00 p.m. every day for 4 weeks. The dosage was based on those reported previously (Bourin et al., 2004; Lapmanee et al., 2012). Drugs used were agomelatine (10 mg/kgBW, Les Laboratoires Servier Industrie, GidyServier, Paris, France) and venlafaxine (10 mg/kgBW, venlafaxine hydrochloride; Pfizer Ireland pharmaceuticals, Newbridge, Co. Kildare, Ireland). Sterile saline (5 mL/kg/day) was used as vehicle.

3. Voluntary wheel running

Mild to moderate intensity aerobic voluntary exercise provides beneficial effects on both physical and psychological health. The voluntary exercise protocol was adapted from the methods of Droste et al., 2007 and Lapmanee et al., 2013. Rats were individually housed in polycarbonate living chamber (50 cm long × 40 cm wide × 20 cm high) with a running wheel system. The running distance was calculated by the number of turns multiplied by the circumference (144 cm) of the running wheel (model 86060; Lafayette Instrument Company, Lafayette, IN, USA). The number of turns was automatically recorded by an electronic counter. In preparation for wheel running, rats were housed in cages with a running wheel for 1 week to familiarize them with the running wheel. Exercise on the running wheel was voluntary (7 days/week for 4 weeks). Rats not completely familiarized with the running wheel were

excluded from the study. As for the sedentary control groups, rats remained in their cages without a wheel for the duration of the experiment.

4. Behavioral tests

In all experiments, rats were subjected to a weekly sucrose preference test and evaluated for anxiety-, depression-, and memory impairment-like behaviors at the end of the restraint stress induction (8:00–12:00 a.m.). Each rat was brought to the behavioral testing room with average illuminance of 20 lux, and left undisturbed in a quiet environment for at least 5 min. Behavioral profiles were recorded by an infrared video camera (model HDR-XR200E; Sony, Tokyo, Japan). The behavioral test apparatus and the surrounding area were cleaned after each test with a wet towel and 70% ethanol to eliminate odorants, feces and urine. Each rat was subjected to one test at a time without the presence of other rats in the room. The EPM, ETM, OFT, NOR, MWM, and FST tests were performed, respectively as described in the following section. All measured parameters and interpretation are noted in Table 3.4.

Table 3.4 Summarizes the parameters and interpretations of behavioral evaluations.

Test	Parameter	Interpretation Definition	References
EPM	↑ Opened arm time/entry	↓ Anxiety-like behavior	Hogg, 1996; Rodgers et al., 1997; Pandaranandaka et al., 2006
	Closed arm entry	Locomotor activity	
	Total arm entry		
ETM	↓ Inhibitory avoidance latency	↓ Conditioned fear/ Generalized anxiety	Graeff et al., 1998; Pandaranandaka et al., 2009
	↑ Escape latency	↓ Unconditioned fear/ Panic-like symptom	
OFT	↑ Inner zone time	↓ Anxiety-like behavior	Treit and Fundytus, 1988; McCarthy et al., 1995; Pandaranandaka et al., 2009
	↑ The first 30 s line crossings	↑ fear reaction-thigmotaxis, hyperarousal	
	Total line crossings	Locomotor activity	
NOR	↓ Discrimination ratio	↑ Cognitive and memory impairment	Antunes and Biala, 2012; Redrobe et al., 2010; 2012
MWM	↑ Escape latency	↓ Spatial learning	Morris et al., 1981, 1984
	↑ Time reach to correct quadrant	↓ Spatial memory	

EPM: elevated plus-maze; ETM: elevated T- maze; NOR: novel objective recognition; MWM: Morris water maze; OFT: open-field test.

Table 3.4 Summarizes the parameters and interpretations of behavioral evaluations (Cont.).

Test	Parameter	Interpretation Definition	References
FST	↑ Swimming time	↓ Depression-like behavior	Porsolt et al., 1978
	↓ Immobility time		
	↑ Climbing time		
Sucrose preference	↓ % sucrose preference	↑ Depression-like behavior	Willner et al., 1987; Papp et al. 1991
Stress-related behaviors		Depression-like behavior Depression-like behavior ↑ Stress/Hyperarousal	Ramos and Mormède, 1998
↓ Grooming ↓ Rearing ↑ Grooming/Rearing/Defecation + Urinary			

FST: forced swimming test.

4.1 Elevated plus-maze test (EPM)

The EPM was made of black painted wood and consisted of two open arms (50 cm long × 10 cm wide) at right angles to two closed arms (50 cm long × 10 cm wide × 40 cm high). The maze was elevated to 50 cm above the floor. To prevent the rats from falling, the open arms were surrounded by a 1 cm high Plexiglas rim (Figure 3.4).

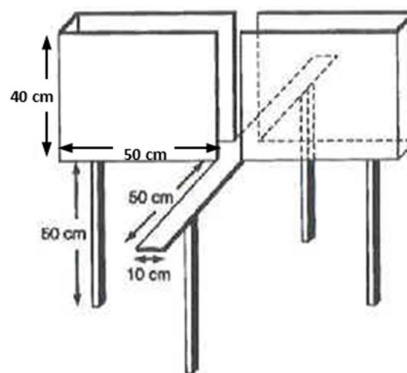

Figure 3.4 Schematic showing, the EPM apparatus that consisted of two open arms (50 cm long × 10 cm wide) at right angles to two closed arms (50 cm long × 10 cm wide × 40 cm high). The whole apparatus was elevated to 50 cm above the floor.

Each rat was gently placed in the center square of the EPM facing between an open arms or close arms, and allowed to explore the EPM for 5 min. The time spent, and number of entries into the open arms and closed arms, and the exploratory behaviors including the frequency of rearing and grooming were recorded by an infrared video camera. The EPM was fully cleaned with a wet towel between each rat. Increased open arm activities and decreased exploratory behaviors indicated decreased anxiety, whereas the numbers of closed and total arm entries were indices of locomotor activity (Hogg, 1996, Rodgers et al., 1997; Pandaranandaka et al., 2006).

4.2 Elevated T-maze test (ETM)

The ETM was made of black painted wood and consisted of three arms of equal dimensions (50 cm long \times 10 cm wide) and was elevated 50 cm above the floor. One arm, enclosed by walls (40 cm high) was perpendicular to the two opposed open arms. These three arms were connected by a square (10 cm long \times 10 cm wide). To prevent rats falling, the open arms were surrounded by a 1 cm high Plexiglas rim (Figure 3.5).

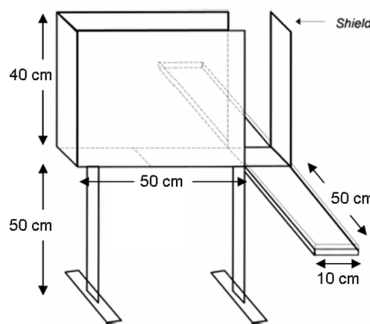

Figure 3.5 Schematic showing, the ETM apparatus that consisted of three arms of equal dimensions (50 cm long \times 10 cm wide) and elevated 50 cm above the floor. One arm, enclosed by walls (40 cm high) was perpendicular to the two opposed open arms.

The ETM test consisted of three inhibitory avoidance trials (i.e., baseline, avoidance 1, and 2) and one escape trial held at 30 s intervals. In the first three inhibitory avoidance trials, the rat was gently placed at the terminal end of the enclosed arm facing the center of the maze. The same measurement was repeated in two subsequent trials. One escape trial was performed by placing rat at the end of

the right open arm facing the center of the maze and recording the latent time the rats took to exit this arm with all four paws. The ETM was fully cleaned with a wet towel after each test. Increased inhibitory avoidance latency represented learned or conditioned fear, whereas one-way escape latency represented innate or unconditioned fear (Graeff et al., 1998; Pandaranandaka et al., 2009).

4.3 Open-field test (OFT)

The OFT was used to evaluate both locomotor activity and anxiety-like behavior. The apparatus was made of black painted wood (76 cm long \times 57 cm wide \times 35 cm high) with a 48-square grid floor (6 \times 8 squares, 9.5 cm per side). The arena was divided into two zones, i.e., inner and outer zones (24 peripheral squares) as shown in Figure 3.6.

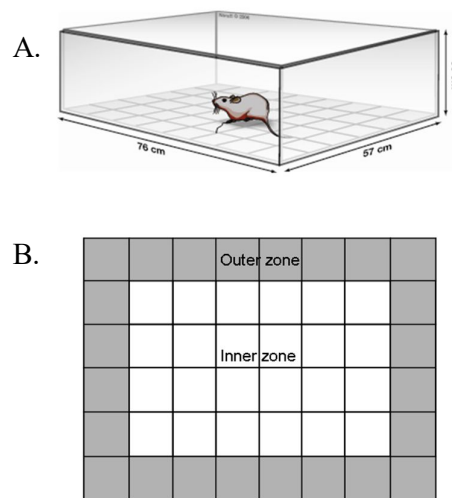

Figure 3.6 Schematic showing, A. The OFT was made from a black painted wooden box (76 cm long \times 57 cm wide \times 35 cm high) with a 48 square grid floor (6 \times 8 squares, 9.5 cm per side). B. The arena of maze was divided into two zones, i.e., inner (white area) and outer zones (gray area).

Each rat was subjected to OFT after EPM and ETM tests. The rat was gently placed in one of the four corner squares facing the wall and allowed 5 min to explore the apparatus. The time spent in each zone, the number of lines crossed in the 1st 30-s and 5-min test, and numbers of rearing, grooming, and fecal pellets were recorded by an infrared video camera. The OFT was fully cleaned with a wet

towel between tests. An increase in time spent in the inner zone or a decrease in time spent in the outer zone indicated anxiolysis or increased exploration. A change in the number of lines crossed represented change in locomotor activity (McCarthy et al., 1995; Treit and Fundytus, 1988; Pandaranandaka et al., 2009).

4.4 Novel object recognition test (NOR)

NOR was performed in a black rectangular plastic box (63 cm long × 63 cm wide × 45 cm high) in 360 lux room light. The procedure was modified from the method of Redrobe et al., 2010; 2012. A video camera was installed on a movable trolley above the box to record behaviors. The objects to be discriminated were made of glass or ceramic. On the day before the NOR test, each rat was allowed to habituate the empty box (2 sessions, 10 min/session). During the test, each rat was gently placed in the box and exposed for 3 min to an acquisition session with identical objects (two ceramic pepper bottles; 3 cm long × 3 cm wide × 7 cm high) placed, approximately 10 cm apart at the center of the box. Rats were then transferred to their home cages for a 1 h inter-trial interval. Meanwhile, the box and objects were cleaned. One object in the box was replaced with a novel object (glass paperweight; 5 cm long × 5 cm wide × 12 cm high). The same rat was then returned to the box and allowed to explore the new object for 3 min. Object-exploring behaviors included sniffing, licking, or touching each object. Rats that did not reach a total exploration time of 15 s, after exploring both objects for a minimum of 2 s, were excluded from the data analysis. The discrimination ratio was calculated from the following equation:

$$\frac{\text{Time exploring novel object (s)} - \text{Time exploring familiar object (s)}}{\text{Total exploration time (s)}}$$

A decrease in discrimination ratio indicated cognitive and memory impairment in stressed rats (Redrobe et al., 2010, 2012; Antunes and Biala, 2012;).

4.5 Morris water maze (MWM)

Learning and memory were evaluated by using the MWM, which was modified from the methods of Morris et al., 1981 and Carman and Mactutus, 2001. The water was made opaque with 200 ml of milk. Each rat was gently placed in one of the four quadrants (North, South, East, and West) at the start of each trial. A stainless steel platform (10 cm diameter and 30 cm high) was placed 1 cm beneath the surface of the water. Lighting in the room was arranged to provide even illumination in all quadrants. The spatial visual cues consisting of different shapes and colors (i.e., black/white circle and cross and black grid) were visible on each wall of the room to provide orientation during the navigational learning trials and memory probe test.

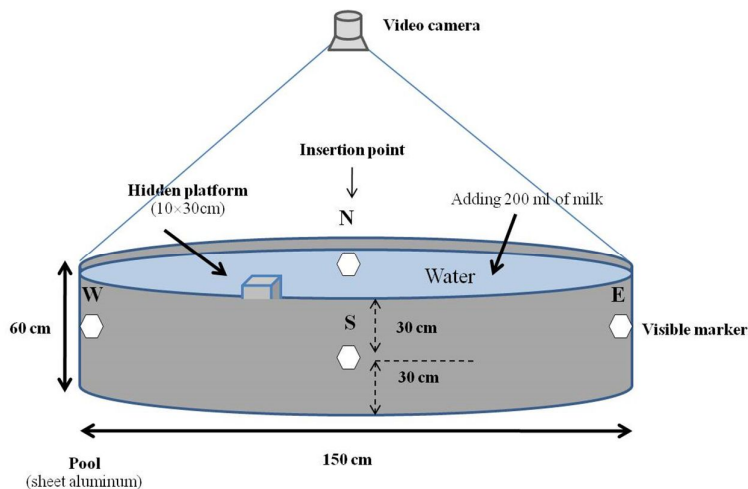

Figure 3.7 Schematic showing the MWM pool that consisted of a circular aluminum pool (150 cm diameter and 60 cm deep) that was filled with water (25 °C temperature) up to 31 cm. The pool was divided into four quadrants of equal area. An aluminum platform (10 cm diameter and 30 cm high) was submerged 1 cm below the water surface.

Prior to learning trials, a rat was individually placed on the platform for 10 s to familiarize it to the task. When the rat moved away from the platform before the end of 10 s, it was placed back onto the platform. This orientation procedure was repeated 3 times, and the learning trials were performed immediately thereafter. Each rat was placed in different location (North, South, East, or West) near

the edge of the pool with its front paws first touching the wall. Then, it was allowed to find the hidden platform, and time spent for locating the platform (escape latency) was recorded. The hidden platform was placed at a fixed location, i.e., in the Southeast quadrant. When the rat was unable to locate the platform within 60 s, it was placed on the platform and an escape latency of 60 s was recorded. Finally, the rat was given 10 s to remain on the platform to familiarize itself with the surrounding visual cues. Rats performed 8 trials on day 1 and 2, and 4 trials on day 3 (total 20 trials). There was a 5-min inter-trial interval, during which each rat was kept warm in a cage under a heating lamp. Spatial memory was evaluated by a probe test 1 h after the last learning trial on day 3. The rat was individually placed in the North quadrant in the absence of a platform. Each rat was allowed to swim for 60 s, and time spent in each quadrant was recorded by a video camera. Percentage time spent in the correct quadrant was calculated as follows.

$$\frac{\text{Time in correct quadrant (s)}}{\text{Total time in all four quadrants (s)}} \times 100$$

An increase in escape latency indicated poor spatial learning, whereas an increase in correct quadrant time (i.e., time to reach the correct quadrant) or a decrease in percentage time spent in the correct quadrant indicated spatial memory impairment. To eliminate confounding factors (e.g., urine, fecal pellets, stress odors, and pheromones), the pool was drained and refilled with fresh tap water before the training of each group of rats. Finally, all learning trials and memory probes were recorded by an experimenter unaware of the grouping of the animals.

4.6 Forced swimming test (FST)

All rats were individually forced to swim in a cylindrical container (25 cm diameter and 45 cm high) filled with 25 °C tap water up to 35 cm. In the first session, rats were placed in water for a 15-min assessment. Then, they were removed from water, dried and cleaned with towel before returning to their cages. Twenty-four hours later, the second session was performed in which rats were put back into the swimming tank for 5 min. Duration of immobility behavior (floating in water with only movement necessary to keep the head above water), swimming

behavior (active movement of the forepaws with goal-directed horizontal actions, such as crossing between quadrants of the cylinder and turning), climbing (upward goal-directed movements of the forepaws along the side of the cylindrical container), and number of fecal pellets were recorded. An increase in immobility duration or decreases in swimming duration and climbing duration indicated depression-like behaviors in rats (Porsolt et al., 1979).

4.7. Sucrose preference test

The sucrose preference test was modified from the methods of Charoenphandhu et al., 2013 and performed once weekly throughout the experimental periods. To confirm that sucrose neophobia was not a confounding factor in this behavioral test (Strekalova and Steinbusch, 2010), rats were given free access to the sucrose preference test prior to the start of the experiment to make sure that baseline sucrose intake did not differ among groups. For the determination of sucrose preference, rats were deprived of water and food for 4 h (08:00–12:00 h). Then rats were presented for 1 h with two bottles, one containing water and the other containing 2% sucrose with the density of 1.0098 g/cm³ (Ajax Finechem, NSW, Australia). The volumes of liquid were measured by weighing pre-weighed bottles before and after testing. To prevent possible effects of side-preference in drinking behavior, the position of the bottle in the cage was switched weekly. The amount of water and sucrose intake was measured. The relative sucrose intake per body weight (BW) (g/kgBW) was the absolute sucrose intake per gram of rat body weight, whereas sucrose preference was calculated according to the following ratio:

$$\frac{\text{Sucrose intake (g)}}{\text{Sucrose intake (g) + Water intake (g)}} \times 100$$

Decreased sucrose preference represents anhedonia-like behavior in rodents (Willner et al., 1987; Papp et al., 1991).

5. Measurement of body, organ weights, and food intake

Body weights (BW), food intake and water intake were measured daily. Pre-weighed food or water was provided and 24 h later the amount of remaining food

was recorded. The daily mean weight gain (DWG) and the daily mean food intake (DFI) were calculated, as follow:

$$\text{DWG} = \text{final BW} - \text{initial BW} / 28 \text{ (4weeks) or } 56 \text{ (8 weeks)}$$

$$\text{DFI} = \text{summation of food intake} / 28 \text{ (4weeks) or } 56 \text{ (8 weeks)}$$

At the end of the experiment, the heart and adrenal glands were removed, washed with ice-cold normal saline solution, and blotted dry with filter paper. The wet weights of the heart (experiment 2) and adrenal glands (experiment 1–3) were recorded. Thereafter, the tissues were dried in an incubator at 80 °C for 3 days to obtain dry weights. The heart and adrenal weights were used to indicate the effectiveness of exercise protocol and stress induction, respectively. The heart-to-body weight ratio (% Heart/BW) and percentage of adrenal gland (% AG/BW) were calculated, as follow:

$$\% \text{ AG/BW} = [\text{adrenal gland (g) / BW (g)}] \times 100$$

$$\% \text{ Heart/BW} = [\text{heart (g) / BW (g)}] \times 100$$

6. Euthanasia

At the end of the experiment, rats were humanely euthanized with an overdose of inhaled isoflurane (Minrad Inc., NY, USA).

7. Analyses of serum and urinary corticosterone levels

Serum supernatant was collected from blood samples after refrigeration for 24 h at 4°C and centrifugation (1,500×g for 10 min at room temperature). Urine samples were filtered and diluted 1:5 with water then stored –80°C until corticosterone analysis. Corticosterone levels (ng/mL) were indicators of stress response. Serum and urinary corticosterone levels were determined by a competitive enzyme immunoassay (EIA) commercial kit (catalog no. AC-14F1; Immunodiagnostic Systems Ltd, Tyne and Wear, UK), according to the manufacturer's instruction, with a detection limit of 0.23 ng/mL with inter- and intra-assay coefficients of variation of <8 and <4 %, respectively (Lertsinthalai et al., 2015).

8. Brain dissection

Brain was rapidly removed after decapitation, frozen in liquid nitrogen, and stored at -80°C . On the analysis day, the brain regions associated with stress responses (i.e., frontal cortex, septum, amygdala, hippocampus, periaqueductal gray, dorsal raphe, locus coeruleus, and ventral tegmental area) were microscopically dissected according to the methods of Heffner et al., 1980 and the atlas of Paxinos and Watson, 2005 (Figure 3.8–3.9). The isolation procedure was done on an ice-cold plate. Razor blades were carefully inserted through the cutting channels slicing the brain at right angles to the sagittal axis. The initial razor blade sliced through the coronal plane of the brain at the level of the anterior commissure. The position of the initial razor blade served as a reference point for other brain sections. A total of eight razor blades were inserted anteriorly or posteriorly to the first blade and thus divided the brains into 8 sections. The razor blades were removed from the block leaving coronal brain slices adhere to their surfaces. Brain sections were placed on a glass plate on ice. Brain regions were then bilaterally dissected from these slices. Besides the frontal cortex, hippocampus, and amygdala, two independent samples from relatively tiny brain areas (i.e., septum, periaqueductal gray, dorsal raphe, locus coeruleus, and ventral tegmental) were pooled together before protein extraction (Charoenphandhu et al., 2013).

9. Western blot analysis

The brain regions under study were separately lysed and homogenized with a handheld pestle and mortar in the radioimmunoprecipitation assay (RIPA) buffer containing 150 mM NaCl, 1.0% IGEPAL® CA-630, 0.5% sodium deoxycholate, 0.1% sodium dodecyl sulfate (SDS), 50 mM Tris, pH 8.0 supplemented with protease inhibitors and a phosphatase inhibitor cocktail (sodium pyrophosphate and sodium orthovanadate) (Sigma, St. Louis, MO, USA). Therefore, membrane-bound proteins should thus be in the supernatant. Brain tissues were then sonicated at power 6 for 25-s pulses (60-s pause between pulses) at 4°C and centrifuged (13,000 rpm for 15 min) at 4°C .

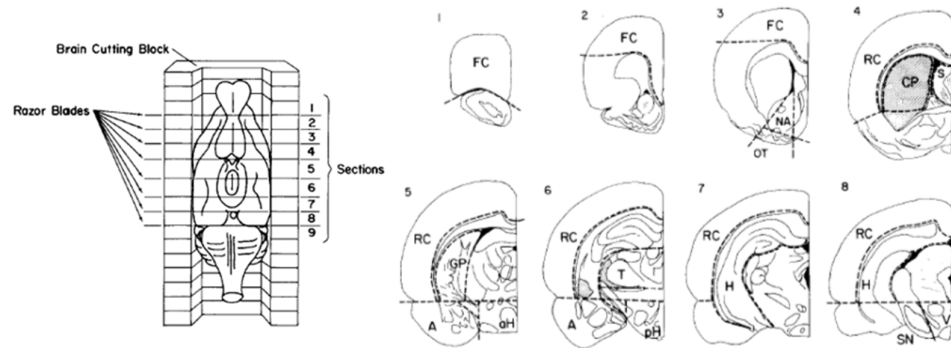

Figure 3.8 Brain cutting block illustrating orientation of brain and placement of razor blades to obtain coronal brain sections. The numbers on the right refer to brain sections. Coronal brain sections from which brain regions were dissected. Dotted lines indicate borders of brain regions. FC, frontal cortex; S, septum; aH, anterior hypothalamus; pH, posterior hypothalamus; A, amygdala; VTA, ventral tegmentum area; and H, hippocampus (Heffner et al., 1980).

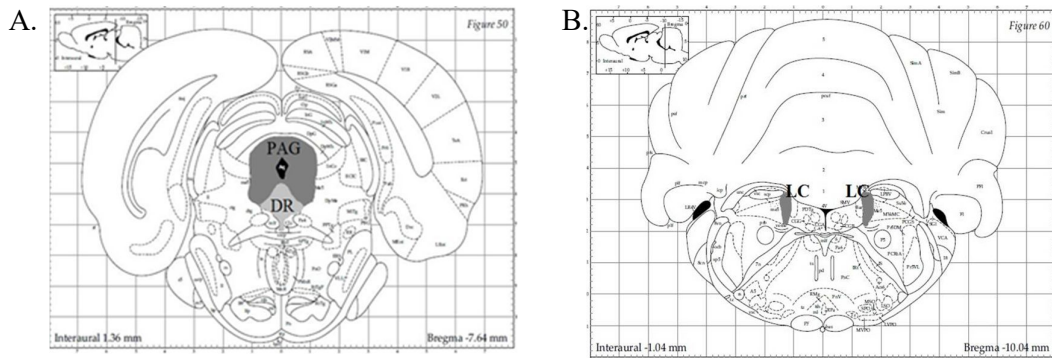

Figure 3.9 Coronal brain sections at the levels of periaqueductal grey and dorsal raphe nuclei (A) and locus coeruleus (B) (Paxinos and Watson, 2005).

The supernatants and pellets were stored at $-80\text{ }^{\circ}\text{C}$. Total amount of protein was quantified by the bicinchoninic acid assay (BCA; Sigma) and NanoDrop 2000 spectrophotometer (Thermo Scientific, Wilmington, DE, USA) according to manufacturer's instructions. Samples ($75\text{ }\mu\text{g}$ protein/lane) were resolved by 8–10% SDS-polyacrylamide gel electrophoresis using vertical minigel system (Bio-Rad Laboratories, Inc., Hercules, USA). Each sample was separated in triplicate.

After electrophoresis, proteins were electrophoretically transferred to nitrocellulose membranes (Amersham Biosciences, Freiburg, Germany) in Tris-glycine transfer buffer. Blotted membranes were then blocked with 5% non-fat powdered milk (Sigma) in Tris buffered saline with Tween 20 (TBST) for 2 h at room temperature. For identification of proteins, membranes were incubated overnight at 4 °C with the primary antibodies diluted in 5% bovine serum albumin (BSA) (Sigma). The primary antibodies were summarized in Table 3.5.

Table 3.5 Primary antibodies used in Western blotting analysis.

Antibody	Manufacturer	Catalog #	Host/clonality	Dilution	Reference
Brain-derived neurotrophic factor (BDNF)	Santa Cruz Biotechnology	SC546	Rabbit polyclonal	1:1,000	Seo et al., 2015
Glucocorticoid receptor (GR)	Abcam	AB2768	Mouse monoclonal	1:1,000	Taylor et al., 2011
Norepinephrine transporter (NET)	Alpha Diagnostic Intl. Inc	NET11-A	Rabbit, polyclonal	1:330	Chen et al., 2012
Serotonin transporter (SERT)	Santa Cruz Biotechnology	SC33724	Mouse monoclonal	1:2,000	Zhang et al., 2012
Serotonin type 2C receptor (5-HT _{2C} R)	Abcam	AB133570	Rabbit monoclonal	1:500	Anastasio et al., 2011
Melanocortin type 2 receptor (MC2R)	Millipore (Chemicon)	AB5128	Rabbit, polyclonal	1:1,000	Campbell et al., 2009
β-actin	Santa Cruz Biotechnology	SC47778	Mouse monoclonal	1:2,000	Tan et al., 2015

Following the primary antibody incubation, membranes were washed for 10 min with TBST, 3 times and incubated with anti-mouse or rabbit secondary antibodies horseradish peroxidase (HRP) conjugates (1:2,000; Santa Cruz Biotechnology, CA, USA) for 2 h at room temperature. Membranes were washed 3 times for 10 min with TBST, then the immunoreactive protein bands were visualized using Luminata Classico Western HRP substrate (Millipore Corporation, Billerica, MA, USA). Membranes were exposed to film (Hyperfilm-ECL; Amersham Biosciences) long enough to visualize the chemiluminescent bands. Blots were

reprobed with mouse monoclonal anti- β -actin (1:2,000; Santa Cruz) and normalized to verify equivalent protein loading. Comparisons were made with known molecular weight standards using prestained protein ladder (Thermo Scientific, Waltham, MA, USA). Blots were scanned and band density was quantified using ImageJ (Rasband, 1997–2016). The area of the curve in each gel band were quantified and normalized relative to the β -actin levels of control or vehicle-treated groups.

3.4 Statistical analysis

Results were expressed as means \pm SE. Statistical analyses for comparisons of two sets of data were performed by unpaired Student's *t*-test. Multiple comparisons were made by one-way analysis of variance (ANOVA) with Dunnett post-test. The *t*-value, *F*-value and degree of freedom (df) values are presented. The level of significance for all statistical tests was $P < 0.05$. Data were analyzed by GraphPad Prism 6.0 for Windows XP (GraphPad Software, San Diego, CA, USA).

Part II: Characterization of melatonin receptor expressing cells in the rodent brain using MT1 and MT2 melatonin receptor LacZ knock-in reporter mice: Identification of potential action sites of agomelatine on brain structures involved in stress.

3.5 Animals

Adult male and female wild-type and transgenic mice with knocked-in β -galactosidase (LacZ) reporter into melatonin (MT) receptor 1A (MTNR1A, MT1) and 1B (MTNR1B, MT2) gene locus of MT-proficient C3H mice and MT-deficient C57BL/6 mice (1.5–18 months, 20–60 g) were obtained from the Institute of Cellular and Integrative Neurosciences, University of Strasbourg, France. Mice were housed in the control room of the conventional zone of the Chronobiotron, UMS3415 with 12:12-h light:dark cycle with food and water *ad libitum*. All efforts were made to minimize the number of animals used. Experimental procedures were approved by the Animal Care and Use Committee of Institute of Cellular and Integrative Neurosciences, University of Strasbourg, France (Figure 3.10).

3.6 Experimental protocols

Experiment 1. To validate and map MT1/MT2-LacZ expressing neurons in transgenic knock-in mice.

Both MT1 and MT2 transgenic knock-in mice had their genotypes confirmed by polymerase chain reaction (PCR) technique. Wild-type and transgenic mice of different age groups were euthanized by CO₂ inhalation and intracardially perfused with fixative solutions. The free-floating sections were stained either for immunocytochemistry or LacZ enzymatic activity detection.

Experiment 2. To characterize the phenotype of MT1/MT2-LacZ expressing neurons in transgenic knock-in mice by determination of co-expressed neuropeptides and neuronal markers.

Polyethylene glycol (PEG)-embed brains were cut and subjected to double staining with LacZ immunocytochemistry and non-radioactive *in situ* hybridization using a digoxigenin-labeled neuropeptide or neuronal markers i.e., arginine vasopressin (AVP), corticotropin-releasing hormone (CRH), gastrin releasing peptide (GRP), glutamate decarboxylase (GAD1/2), LacZ and vasoactive intestinal polypeptide (VIP).

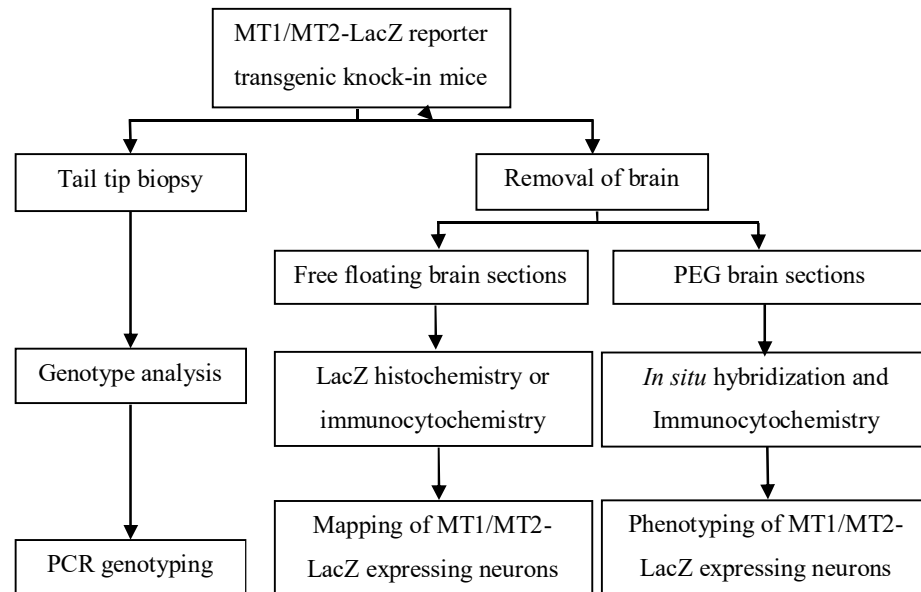

Figure 3.10 Schematic diagram showing the experimental protocols in the study of part 2.

3.7 Experimental procedures

1. PCR genotyping MT1/MT2-LacZ transgenic mice

Tail tips (2–3 mm) from new born transgenic mice (four to seven-day-old) were collected and stored frozen at -20°C for DNA extraction. Tissue samples were digested in 0.5 M NaOH, 200 mM EDTA, and H_2O for 1 h at 95°C . The samples were mixed with 1 M Tris HCL, pH 5 and centrifuged at 13,000 rpm for 3 min at room

temperature, and the supernatants were used for PCR genotyping. One (1) μ L supernatant was transferred to 15- μ L PCR reaction mixture containing 1.5 μ L Taq DNA polymerase 10X buffer without $MgCl_2$ and detergent (Euromedex, Souffelweyersheim, France), 1.5 μ L 25 mM $MgCl_2$, 0.75 μ L DMSO (Hybri-Max, Sigma D2650), 0.5 μ L 10 mM dNTP, 0.25 μ L 50 μ M forward primers, 0.25 μ L 50 μ M reverse primers, 0.2 μ L Taq DNA polymerase (Euromedex), and 9.05 μ L molecular biology grade H_2O . The corresponding primers are shown in Table 3.6.

Table 3.6 The MT1-/MT2-LacZ genotyping and primer designs.

Genotyping		Primer sequence 5'–3' (Forward/Reverse)
MT1-LacZ	Wild-type	CAAGTTGCTGGGCAGTGGACAGCAG CTTCTTGTTGCGGTACACAGACAGG
	Knock-in	CTAGTCTGTTTCAGCTGTGTCCACACC GCGGGAGGGCCATAAAAAGTGGC
MT2-LacZ	Wild-type	AAGCACCAGCAATTTCCCATTCTCC TCTTGCCTGAGGAAGGTCAGAATCC
	Knock-in	ACTTGCTTTAAAAAACCTCCCACA ATGGGTCCCTGGAAGTCACTCACC

Each PCR reaction was performed as follows: cycling touchdown PCR program, 94 °C for a 5-min initial strand separation, 94 °C for 30 s, 58°C for 30 s, at 72 °C for 45 min (repeat for a total of 35 cycles) , and a 5-min final elongation step at 72°C. Five μ L of each PCR product and mass ruler DNA ladder Mix (Euromedex) was electrophoresed through a 1.5% agarose gel in Tris-borate-EDTA buffer (TBE) that was then stained with 1 μ g/ml ethidium bromide. DNA fragments were visualized under ultraviolet light and photographed (Sony camera). DNA fragment phenotypes were identified by 425 bp (wild-type) or 196 bp (MT1-LacZ transgene), whereas MT2-LacZ DNA fragment phenotypes were identified by 143 bp (wild-type) or 666 bp (MT2-LacZ transgene).

2. Euthanasia

Mice were euthanized during the light phase (9.00–12.00 a.m.) by CO_2 inhalation. Heparin (500 IU, Héparine Choay; Sanofi, Gentilly, France) was injected into the heart before transcatheter perfusion first with PBS, and then with fixative

solution (4% phosphate-buffered formaldehyde for LacZ histochemistry or periodate-lysine-paraformaldehyde (PLP) fixative for immunocytochemistry and *in situ* hybridization).

3. Preparation of brain tissues

For LacZ histochemistry, the brains were removed from the skulls and post-fixed with 4% paraformaldehyde in 100 mM phosphate buffer, pH 7.4, cryoprotected in 30% sucrose solution at 4 °C for at least 24 hours. After sinking in the 30% sucrose cryoprotectant, the brains were frozen in isopentane, chilled to -78°C with mixed dry ice and 95% ethanol. The brains which were cut on a cryo-microtome (Microm HM 560, Thermo Scientific) into 40- μm -thick slices. Free floating sections were collected in PBS with 0.1% sodium azide (PBS-azide) and processed for detection of LacZ activity by X-gal staining.

For immunohistochemistry and *in situ* hybridization, we used PLP fixative (4% formaldehyde, 10 mM NaIO_4 in 75 mM phosphate-lysine buffer, pH 7.4). After transcardial perfusion, the brains were removed from the skulls and post-fixed in PLP fixative for 10 hours. Then the brains were rinsed in 50% ethanol and dehydrated with ethanol (70% for 2 times 1 hour, 95% for 2 times 1 hour), ethoxyethanol for 2 times 1 hour and finally n-butanol overnight. Thereafter, brains were embedded in PEG as described by Klosen et al., 1993. PEG-embedded brains were cut by microtome (Leica, Germany) into 8- μm -thick coronal sections and mounted onto slides.

4. LacZ histochemistry

The expression of the LacZ reporter can be detected by enzyme histochemical staining using the chromogenic substrate, 5-bromo-4-chloro-3-indolyl- β -d-galactoside (X-gal). The free-floating sections were washed for 3 times 15 min each in LacZ wash buffer (PBS, 2 mM MgCl_2 , 0.01% sodium deoxycholate, 0.02% nonidet-P40) at room temperature. The sections were stained overnight at 37 °C with an X-gal development solution ($\text{K}_4\text{Fe}(\text{CN})_6$, $\text{K}_3\text{Fe}(\text{CN})_6$, and X-gal in LacZ wash buffer). On the next day, the sections were washed for 3 times 5 min each in LacZ wash buffer and the floating sections were mounted on gelatinized slides from 0.5X PBS and 0.5% polyvinylalcohol. Slides were dehydrated by 5 min incubations in 70%,

95%, and 100% (twice) ethanol and cleared in toluene (twice). Coverslips were mounted using Eukitt (Chem Lab) and allowed to dry. Blue LacZ expressing cells were examined on a Leica DMRB microscope (Leica Microsystems, Rueil-Malmaison, France) equipped with an Olympus DP50 digital camera (Olympus France, Rungis, France).

5. Riboprobe synthesis for *in situ* hybridization

5.1 Preparation of plasmid DNA

For cloning probe sequences into plasmid, mouse brain complementary DNAs (cDNA) were amplified with target primers (Table 3.7) in PCR reaction mixtures. The 1 μ L cDNA was transferred to 20- μ L PCR reaction mixtures containing 2 μ l AmpliTaq® 360 DNA polymerase 10X buffer (Applied Biosystems, CA, USA), 0.1 μ l Taq DNA polymerase, 1.6 μ l 20 mM MgCl₂, 0.4 μ l 10 mM dNTP, 1.6 μ l 20 μ M forward primers, 1.6 μ l 20 μ M reverse primers, and 11.7 μ l molecular biology grade H₂O. Touchdown PCR cycling program was selected that the annealing temperature was gradually reduced. The PCR products were kept at 4 °C after amplification. Ten μ l of each PCR product and mass ruler DNA ladder Mix (Euromedex) was electrophoresed through a 1.5% agarose gel in TBE that was then stained with 1 μ g/ml ethidium bromide. DNA fragments were visualized and extracted the correct band using a Zymoclean™ gel DNA recovery kit (Zymo Research Corp, CA, USA). DNA quantity and quality were measured OD260/OD280 ratio by NanoDrop 2000 spectrophotometer. DNA fragments were ligated and cloned into the pT7-Blue 1 vector (Perfectly Blunt™ Cloning Kits, Novagen, Germany). The ligation products were transformed into bacteria (*E. coli* strains) and colonies were grown overnight at 37 °C. Bacterial colonies containing DNA fragments were screened and performed colony PCR. The primer sets of 5'TTTTCCCAGTCACGACGTT3' (primer U19) and 5'ATGACCATGATTACGC3' (primer R20) were used to determine the size and orientation of the inserted cDNA. The expected sizes of PCR products for pT7-Blue 1 vector in both the presence and absence of the 212 bp positive control insert were 468 bp and 256 bp, respectively. The selected colony was then dropped it into Luria-Bertani (LB) broth medium in a 10 mL tube and incubated overnight with shaking at 37 °C. Liquid cultures were collected and processed for

plasmid DNA isolation (Qiagen Miniprep kit, Qiagen, Valencia, CA, USA). Bacteria containing the correct plasmid were stored in glycerol stocks and frozen at -80°C . Plasmid DNA was digested by restricted enzymes (e.g., BamH I, EcoR I, and Hind III) and its examined sequence by AGOWA Sequencing Service, Germany, in order to confirm the orientation and identity of the plasmid DNA fragments.

5.2 Preparation of probes

The transcribed messenger RNA (mRNAs) coded for LacZ, neuropeptides (i.e., AVP, CRH, VIP, and GRP), or enzymes GAD1/2 in neuronal cells that express the corresponding genes were detected. Brain sections were incubated with labeled cDNA probes that form hybrids with the cellular mRNA, and the location of labeled cells was then determined by hapten labeled probes with alkaline phosphatase detection. Neuropeptides AVP and VIP probes were the gifts from Assoc. Prof. Paul Klosen, Team Melatonin and Seasonal Rhythms, Department of Neurobiology of Rhythms, Institute of Cellular and Integrative Neurosciences, University of Strasbourg, France. In the probe synthesis, mouse CRH, GRP, GAD1, GAD2, and LacZ cDNA primers (Sigma-Aldrich, France) underwent PCR amplification using the following oligonucleotides (Table 3.7).

Table 3.7 Mouse primers in the PCR experiments for cloning probe.

Gene Name (Abbreviated)	Primer sequence 5'-3' (Forward/Reverse)	Product Length, bp
Corticotropin-releasing hormone (CRH)	AGAAACTCAGAGCCCAAGTACG GATGACTCCCATCTGCTTTTC	1,062
Gastrin-releasing peptide (GRP)	CTGAGAACCGTCTCCGTC GGAAAAAGCGTTCATTGGAA	766
Glutamic acid decarboxylase 1 (GAD1)	TGTGCCCAAACCTGGTCCT TGGCCGATGATTCTGGTT	982
Glutamic acid decarboxylase 2 (GAD2)	TCTTTTCTCTGGTGGCG TTGAGAGCGGCTCATT	869
β -galactosidas (LacZ)	CCAACGTGACCTATCCCATTAC CAAAGACCAGACCGTTCATACA	1,524

The plasmids were fully linearized with suitable restriction enzymes overnight and the restriction mixtures were phenol–chloroform extracted and ethanol-precipitated. Probe labeling and hybridization were performed using digoxigenin (Roche Biochemicals, Germany). DNA templated RNA transcription was

carried out in a reaction mixture containing templates and RNA polymerase [e.g., SP6 (2,000–10,000 units), T7 (5,000–25,000 units), or T3 (5,000 units)]. These promoters recognized the 5' end of the reverse primer (Anti-sense RNA). The size of the probes was confirmed by formaldehyde-(*N*-2-morpholino) propane sulfonic acid agarose gel electrophoresis and Northern blotting, respectively. Non-hydrolyzed (full-length) probes were used. Specificity controls for single *in situ* hybridizations were performed using sense riboprobes transcribed from the same vectors.

6. Non-radioactive *in situ* hybridization (ISH)

ISH was performed as described by Klosien et al., 2002. PEG brain sections were postfixed in 4% phosphate-buffered formaldehyde for 10 min at room temperature, washed in PBS, and then digested with 0.5 µg/ml proteinase K (Roche; Meylan, France) in PBS for 30 min at 37 °C. Proteinase K digestion was stopped incubating in 2% cold phosphate-buffered formaldehyde for 5 min. After the sections were washed for 3 times 5 min with PBS and 0.2% dimethylpyrocarbonate (DMPC), the sections were acetylated twice for 10 min each in 100 mM triethanolamine with 0.25% acetic anhydride. After they were rinsed for 5 min in PBS and 0.2% DMPC twice, the sections were rinsed in 5X saline sodium citrate (SSC), 0.05% Tween-20, and 0.02% DMPC before hybridization.

Both sense and antisense probes were denatured for 5 min at 90 °C. The sections were then incubated with 200 ng/ml (1:100 dilution) labeled probes in hybridization buffer (50% formamide, 5X SSC, 5X Denhardt's solution, and 500 µg/ml salmon sperm DNA) and placed in the incubator at 62 °C for 40 h. After hybridization, the sections were washed in 5X SSC for 10 min at room temperature. Stringency rinses with 0.1X SSC were performed for 6 times 10 min at 72°C followed by A-Dig buffer rinses for 5 min, twice. After 1 h incubation in blocking buffer, hapten-labeled bound probes in the sections were detected with alkaline phosphatase-labeled sheep anti-digoxigenin antibodies (Roche). Alkaline phosphatase activity was visualized by bromo-chloro-indolyl phosphate (BCIP) and nitroblue tetrazolium (NBT).

7. Immunocytochemistry

For antigen retrieval, the slide-mounted brain sections were incubated in Tris-Citrate buffer, pH 8.0 for 1 h at 95°C, followed by a tap water rinse. After blocking with 3% dry skimmed milk and 0.02% NaN₃ in Tris-buffered saline, 0.05% Tween 20 (TBST) buffer for 2 h, brain sections were incubated with chicken anti-LacZ (1:5,000; ab9361, Abcam, UK) in antibody diluting buffer (TBS, 0.05% Tween 20, 0.02% NaN₃, and 1% fetal calf serum) overnight at room temperature. After 3 times 10 min TBST rinses, the brain sections were incubated with the secondary antibody, biotinylated donkey anti-chicken (1:2,000; Jackson ImmunoResearch, PA, USA) in antibody dilution buffer. After a further 3 times 10 min TBST rinses, the slides were finally incubated with a streptavidin-peroxidase conjugate (Pierce) in diluting buffer (TBS, 0.05% Tween 20, and 0.2% cold water fish skin gelatin) for 1 h. Peroxidase activity was detected using 0.5 mg/ml diaminobenzidine (DAB, Sigma) in 50 mM Tris buffer (pH 7.60) with 10 mM imidazole, and 0.003% H₂O₂ for 15 min. The slides were dehydrated and cover-slipped with Eukitt (Chem Lab, Zedelgem, Belgium). The peroxidase-immunostained sections were photographed with a Leica DMRB microscope (Leica Microsystems, Rueil-Malmaison, France) equipped with an Olympus DP50 digital camera (Olympus France, Rungis, France).

8. Combined ISH with ICC

The brain sections were first hybridized. After visualization of phosphatase activity with NBT/BCIP, the slides were washed with TBST for 3 times for 5 min and then selected for double labeling. These slides were rinsed in 95% ethanol for 5 min to elute background deposits and to change the color of the *in situ* labeling from dark purple to blue color. Brain sections were then immunolabeled using the standard protocol described above, but with fluorescein, green fluorescent tyramide substrate in PBS-Imidazole buffer instead of DAB. The absence of interactions between the ISH and the ICC was verified by omission of the primary antibody in the ICC detection. Further tests included ICC on sections that were mock-hybridized to check for antigen inactivation or decloaking by the hybridization procedure. Slides were visualized under bright field or green fluorescence filters. Images were processed using Adobe Photoshop 6 (Adobe Systems, Mountain View, CA, USA).

Table 3.8 Summary of parameters and techniques in this study.

Parameter	Technique	Brief objectives
Anxiety-like behaviors	EPM ETM OFT	To evaluate stress-induced anxiety.
Depression-like behaviors	Sucrose preference FST	To evaluate stress-induced depression.
Learning and memory impairment-like behaviors	NOR MWM	To evaluate stress-induced learning and memory impairment.
Serum and urinary CORT	ELISA	To confirm successful stress induction.
Protein expression	Western blotting	To examine protein expression in the brain region and stress-related organs contributing to stress responses.
Riboprobe synthesis for <i>in situ</i> hybridization	PCR cloning	To prepare probes for <i>in situ</i> hybridization.
MT1/ MT2-LacZ localization	Immunocytochemistry, <i>in situ</i> hybridization, X-gal histochemistry	To map and phenotype melatonin receptor MT1 and MT2 expressing neurons in transgenic mice

CORT: corticosterone; ELISA: enzyme-linked immunosorbent assay; EPM: elevated-plus maze; ETM: elevated T-maze; FST: forced swimming test; NOR: novel objective recognition; MT: melatonin receptor; MWM: Morris water maze; OFT: open-field test; PCR: polymerase chain reaction; X-gal: 5-bromo-4-chloro-3-indolyl- β -d-galactoside.

CHAPTER IV

RESULTS

Part I: Effects of restraint stress induction, monoamine modulators (i.e., agomelatine and venlafaxine), and voluntary wheel running in male rats.

Experiment 1. To examine the time-dependent effect of the 1-, 4- and 8-week stress induction on anxiety-, depression-, and memory impairment-like behaviors and changes in the expression of selected target proteins in the brain regions associated with stress responses.

1. Restraint stress induced a change in body weight, adrenal gland weight, food intake, and corticosterone levels.

There was no difference in the starting body weight (Figure 4.1A). Following the 1-, 4-, and 8-week restraint stress induction, the final body weights of stressed rats were decreased (Figure 4.1B), resulting from less body weight gain when compared to non-stress control rats (Figure 4.1C). Daily food intake was decreased in the 4-week stressed rats (Figure 4.1D). In addition, the adrenal gland weights (dry weight and dry weight-body weight ratio) in the 4- and 8-week stressed rats were increased when compared with non-stress control rats (Figure 4.1F and 4.1H). In addition, the results from experimental 2 showed that the 4-week stressed rats had increased serum and urinary corticosterone levels (Figure 4.2A–B). These could be correlated with adrenal hypertrophy. Therefore, the 4-weeks restraint stress induction effectively activated the HPA axis in male rats.

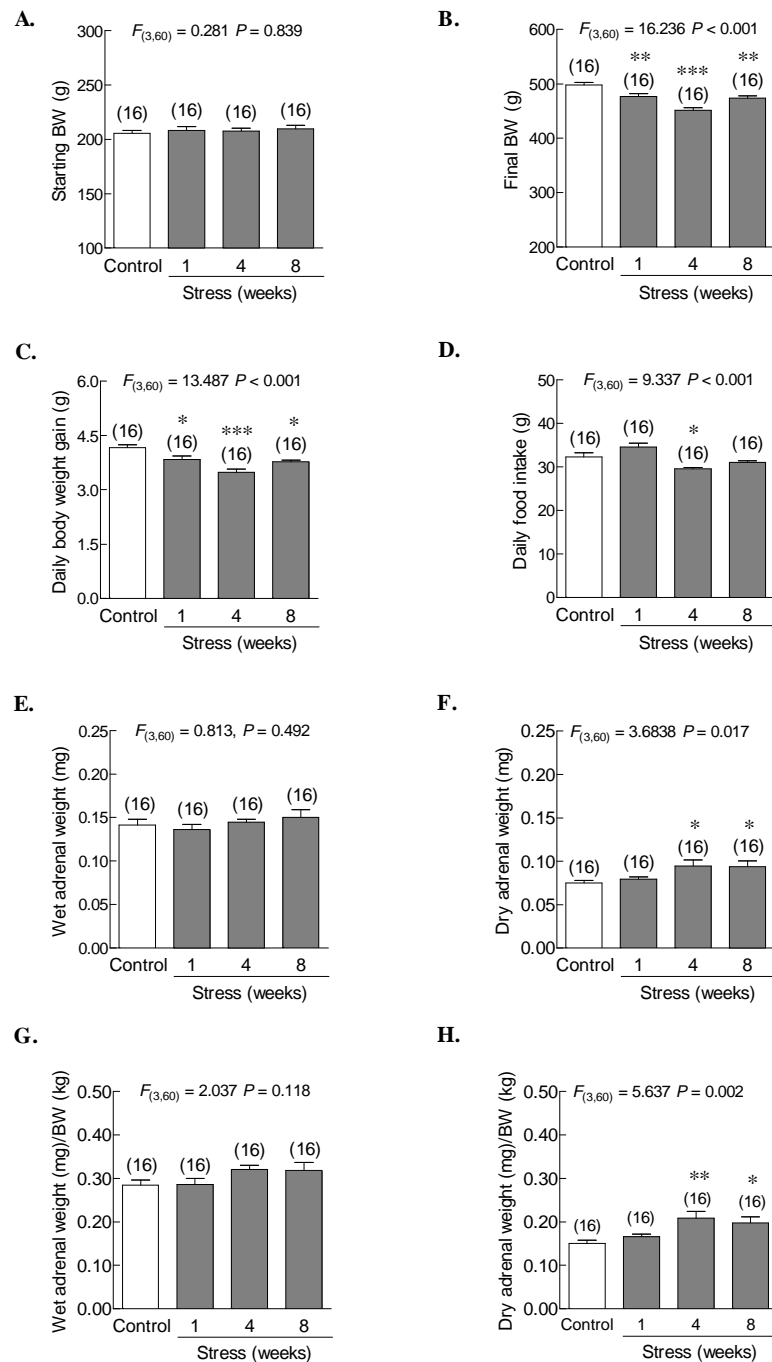

Figure 4.1 Time-dependent effects of the 1-, 4-, and 8-week restraint stress induction on (A) starting body weight, (B) final body weight, (C) body weight gain, (D) daily food intake, (E) wet adrenal gland weight, (F) dry adrenal gland weight, (G) relative wet adrenal gland weights, and (H) relative dry adrenal gland weights. Numbers of animals are noted in parentheses. * $P < 0.05$, ** $P < 0.01$, *** $P < 0.001$ compared to non-stress control group.

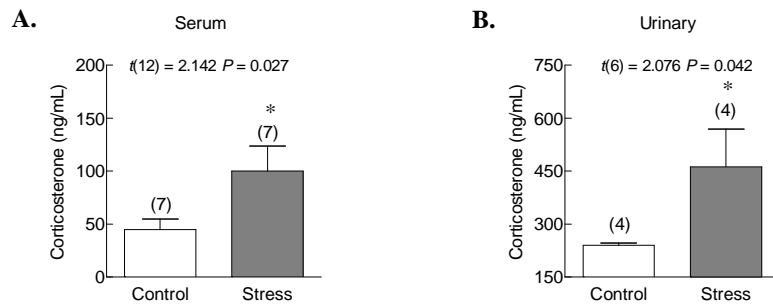

Figure 4.2 Time-dependent effects of the 4-week restraint stress induction on (A) basal serum and (B) urinary corticosterone levels. Numbers of animals are noted in parentheses. * $P < 0.05$ compared to non-stress control group.

2. Restraint stress-induced the changes in behavioral responses.

2.1 Anxiety-like behavior

In the EPM test, the 1-, 4-, and 8-week restraint stress resulted in decreased open arm entry and had a tendency to decrease open arm time (Figure 4.3A–B). Stressed rats increased closed arm entry and closed arm time without changes in center of arm time, total number of entries, or exploration (i.e., rearing and grooming) (Figure 4.3C–H). In the ETM test, there was no difference in baseline latency in the inhibitory avoidance test (Figure 4.4A). The 4-week stressed rats had prolonged latency in inhibitory avoidance 1, while 1- and 4-week, but not 8-week stress, showed prolonged latencies in inhibitory avoidance 2 (Figure 4.4B–C). However, the restraint stress induction did not alter the one-way escape latency (Figure 4.4D). In the OFT test, the 1- and 4-week stressed rats were hyperarousal to the sudden change from a familiar environment to an open area as shown by an increase in the number of lines crossed in the first 30 seconds but no changes in total lines crossed in 5 min (Figure 4.5A–B). Stressed rats spent less time in the inner zone and more time in the outer zone (Figure 4.5C–D). Increased numbers of grooming and rearing were observed in the 1- and 4-week stressed rats (Figure 4.5E–F). Therefore, the 1-, 4-, and 8-week restraint stress induction could induce anxiety-like behavior and did not alter the locomotor activities, i.e., no change in total arm entry in the EPM and total lines crossed in the OFT.

In the stressed group, the 1- and 4-week restraint stress induction could produce high anxiety rather than the 8-week stress induction as evaluated by EPM, ETM, and OFT tests.

2.2 Depression-like behavior

There were depression-like symptoms in the 4-week stress group, i.e. decreased swimming duration and increased immobility duration without change in climbing duration in the FST (Figure 4.6A–C). Stressed rats showed high emotionality and then presented anhedonia-like behavior during restraint stress induction. As compared to percent preference in the baseline period, the 1-week stressed rats had increased sucrose preference. Similarly, the 4- or 8-week stressed rats had increased sucrose preference on the 2nd of the 4-week stress and the 3rd of the 8-week stress. In addition, 8-week stress had decreased sucrose preference at weeks 5, 6, and 8 when compared to non-stressed control rats (Figure 4.6D).

2.3 Learning and memory impairment-like behavior

In the MWM test, the 4-week stressed rats spent more time finding the platform in escape latency on day 2 of the test, and on day 3, only 1-week stressed rats showed lower time spent in escape latency. Meanwhile latencies of the 4- and 8-week stressed rats were not different from non-stressed control rats (Figure 4.7A). The 1- and 4-week stressed rats had spatial memory impairment as shown by an increased time in the correct quadrant (Figure 4.7B). Percent correct quadrant was similar among stressed rats and non-stressed control rats (Figure 4.7C). Moreover, the 4-week stressed rats showed a lower discrimination ratio than non-stressed control rats in the NOR study (Figure 4.7D). Therefore, the 1-week restraint stress induction produced memory impairment and paradoxical effects on learning in MWM test, whereas the 4-week restraint stress produced learning and memory impairment as evaluated by MWM and NOR tests.

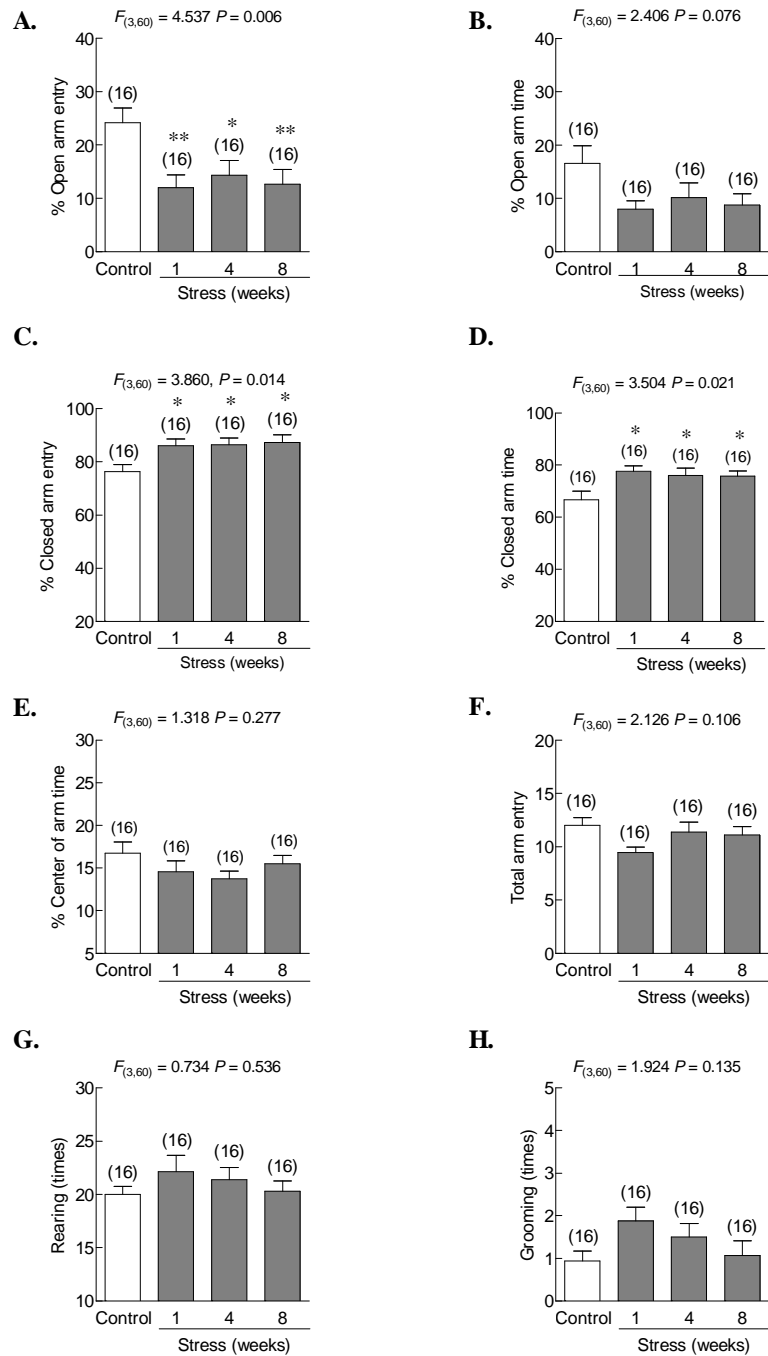

Figure 4.3 Time-dependent effects of the 1-, 4-, and 8-week restraint stress-induced anxiety-like behavior as evaluated by EPM, (A) percent open arm entry, (B) percent open arm time, (C) percent closed arm entry, (D) percent closed arm time, (E) percent center of arm time, (F) total arm entry, (G) numbers of rearing, and (H) numbers of grooming. Numbers of animals are noted in parentheses. * $P < 0.05$ and ** $P < 0.01$ compared to non-stressed control group.

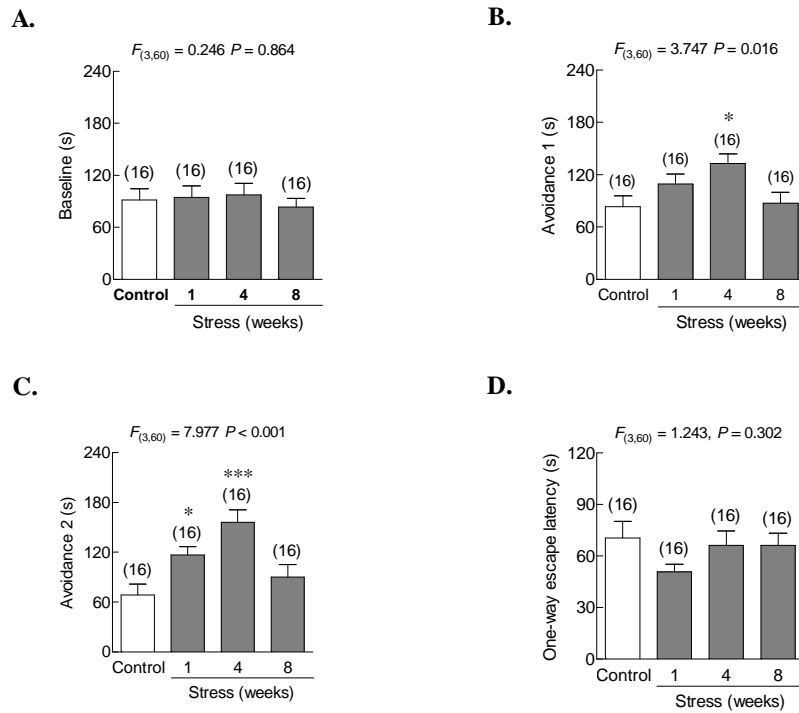

Figure 4.4 Time-dependent effects of the 1-, 4-, and 8-week restraint stress-induced anxiety/learned and innate fear-like behavior as evaluated by ETM, (A) baseline latency, (B) avoidance latency 1, (C) avoidance latency 2, and (E) one-way escape latency. Numbers of animals are noted in parentheses. * $P < 0.05$ and *** $P < 0.001$ compared to non-stressed control group.

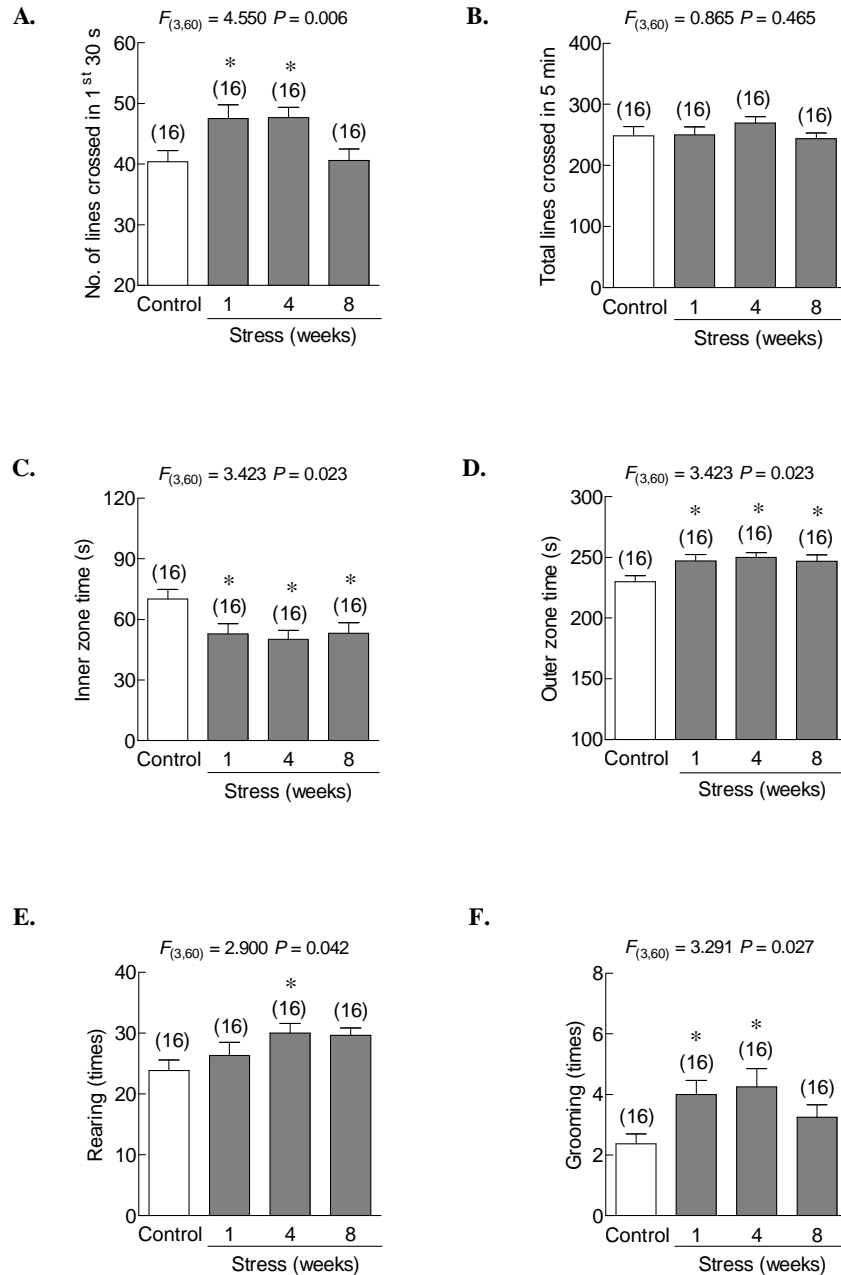

Figure 4.5 Time-dependent effects of the 1-, 4-, and 8-week restraint stress-induced anxiety-like behavior as evaluated by OFT, (A) number of lines crossed in the first 30 seconds, (B) total lines crossed, (C) inner zone time, (D) outer zone time, (E) number of rearing, and (F) number of grooming. Numbers of animals are noted in parentheses. * $P < 0.05$ compared to non-stressed control group.

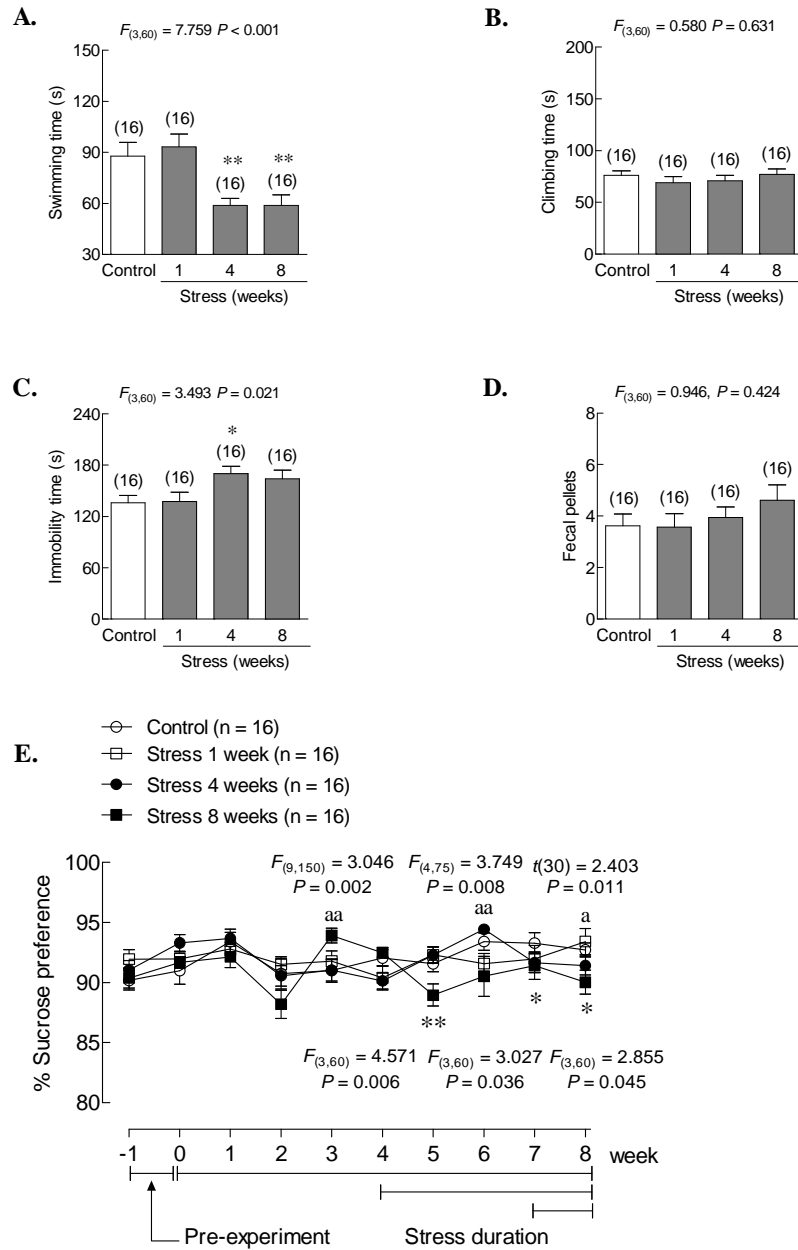

Figure 4.6 Time-dependent effects of the 1-, 4-, and 8-week restraint stress-induced depression-like behaviors as evaluated by forced swimming and sucrose preference, (A) swimming duration, (B) climbing duration, (C) immobility duration, (D) number of fecal pellets, and (E) weekly percent sucrose preference. Numbers of animals are noted in parentheses. ^a $P < 0.05$ and ^{aa} $P < 0.01$ compared to percent sucrose preference in baseline period. * $P < 0.05$ and ** $P < 0.01$ compared to non-stressed control group.

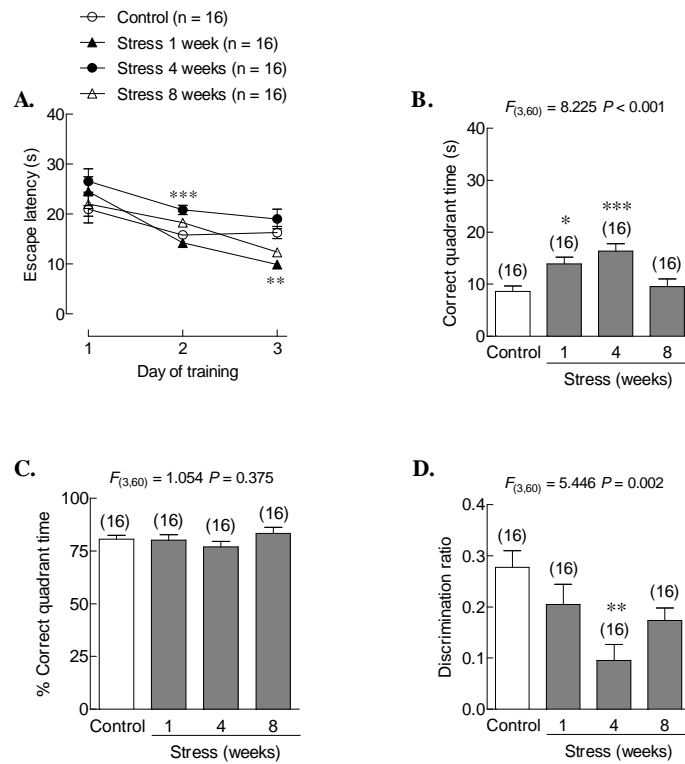

Figure 4.7 Time-dependent effects of the 1-, 4-, and 8-week restraint stress-induced learning and memory impairment-like behavior as evaluated by MWM and NOR, (A) escape latency, (B) correct quadrant time, (C) percent correct quadrant time, and (D) discrimination ratio. Numbers of animals are noted in parentheses. * $P < 0.05$, ** $P < 0.01$, and *** $P < 0.001$ compared to non-stressed control group.

3. Restraint stress induced changes in target protein expression in brain regions associated with stress responses.

3.1 Levels of BDNF

The 1- and 8-week restraint stress induction decreased BDNF protein levels in periaqueductal gray and ventral tegmentum area (Figure 4.8*F* and *G*).

3.2 Levels of GR in the hypothalamus and hippocampus

Hypothalamic GR protein was increased in the 1-week restraint stress induction, whereas hippocampal GR protein was decreased in the 4-week stress induction (Figure 4.9). These results suggest stress responses of GR proteins, resulting from hyperactivity of the HPA axis. GR could act back on the hippocampus to exert GR-mediated negative feedback inhibition on the HPA axis

3.3 Levels of NET

The 4-week restraint stress induction increased NET proteins in the locus coeruleus when compared to non-stressed controls (Figure 4.10*D*).

3.4 Levels of SERT

The 1- and 8-week restraint induction decreased SERT protein in the ventral tegmental area and hippocampus, respectively (Figure 4.11*B* and *F*).

3.5 Levels of 5-HT_{2C}R

The 1-, 4-, and 8-week restraint stress induction increased 5-HT_{2C}R protein levels in the amygdala and locus coeruleus (Figure 4.12*A* and *E*). In contrast, the 4- or 8-week stress induction decreased 5-HT_{2C}R protein expression in periaqueductal gray and the ventral tegmental area when compared to non-stressed control rats (Figure 4.12*G*).

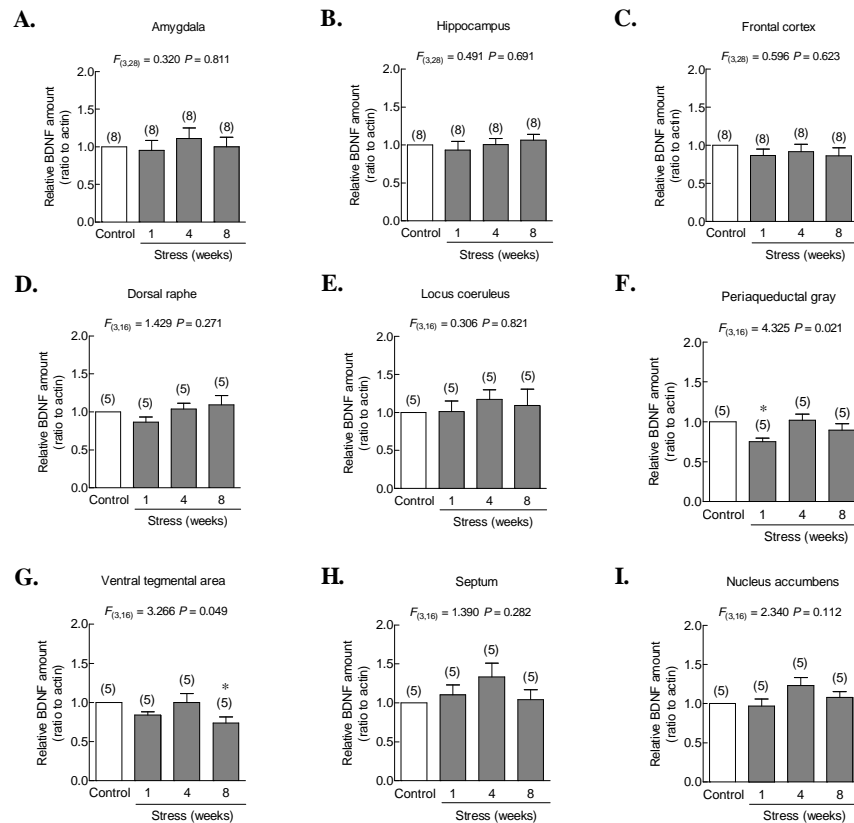

Figure 4.8 Time-dependent effects of the 1-, 4-, and 8-week stress induction on the BDNF protein levels. Numbers of animals are noted in parentheses. * $P < 0.05$ compared to non-stressed control group.

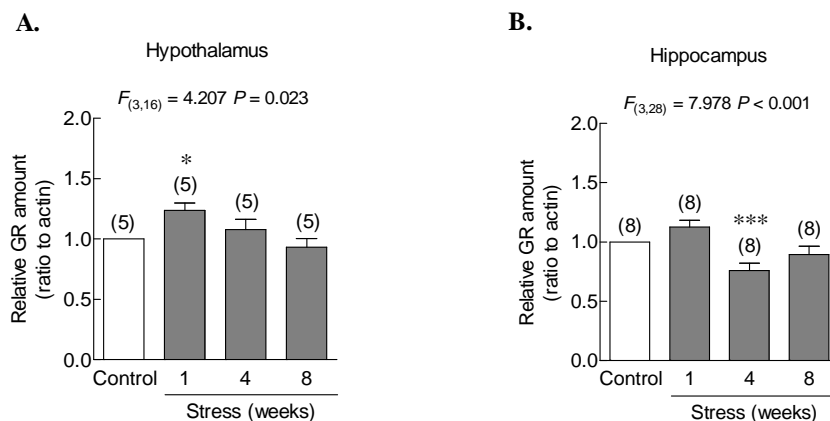

Figure 4.9 Time-dependent effects of 1-, 4-, and 8-week restraint stress induction on the hypothalamic and hippocampal GR protein levels. Numbers of animals are noted in parentheses. * $P < 0.05$ and *** $P < 0.001$ compared to non-stressed control group.

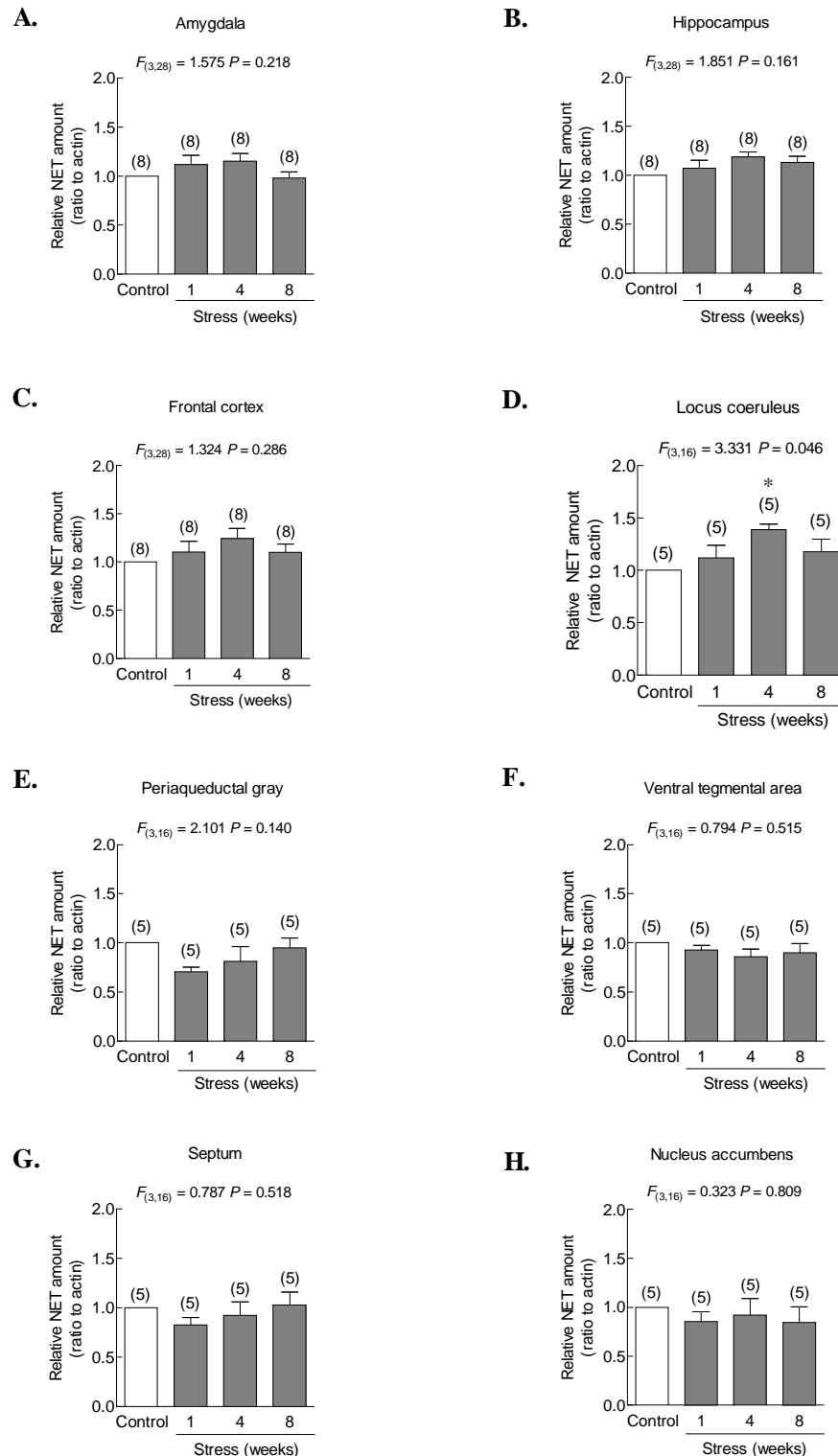

Figure 4.10 Time-dependent effects of the 1-, 4-, and 8-week restraint stress induction on the NET protein levels. Numbers of animals are noted in parentheses. * $P < 0.05$ compared to non-stressed control group.

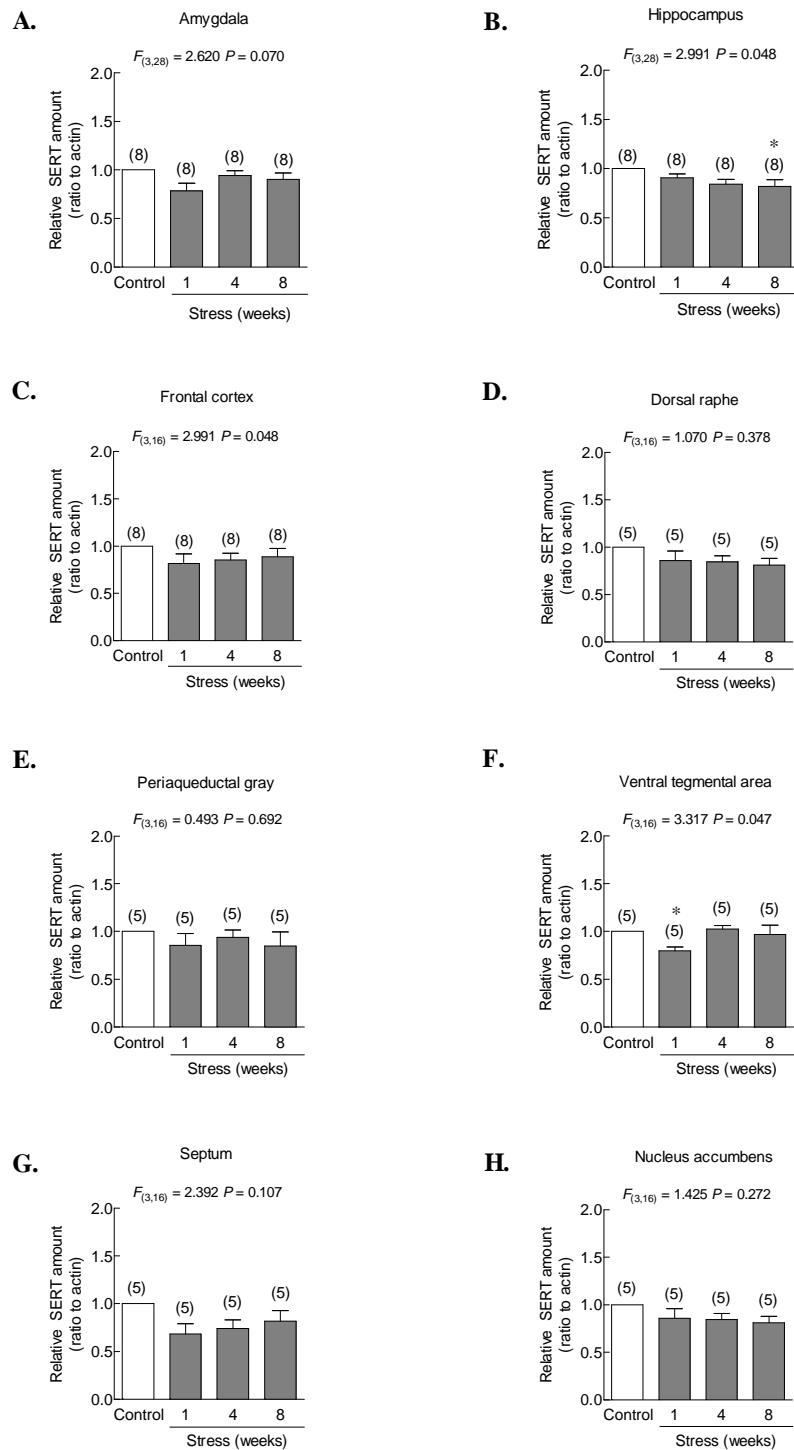

Figure 4.11 Time-dependent effects of the 1-, 4-, and 8-week restraint stress induction on the SERT protein levels. Numbers of animals are noted in parentheses. * $P < 0.05$ compared to non-stressed control group.

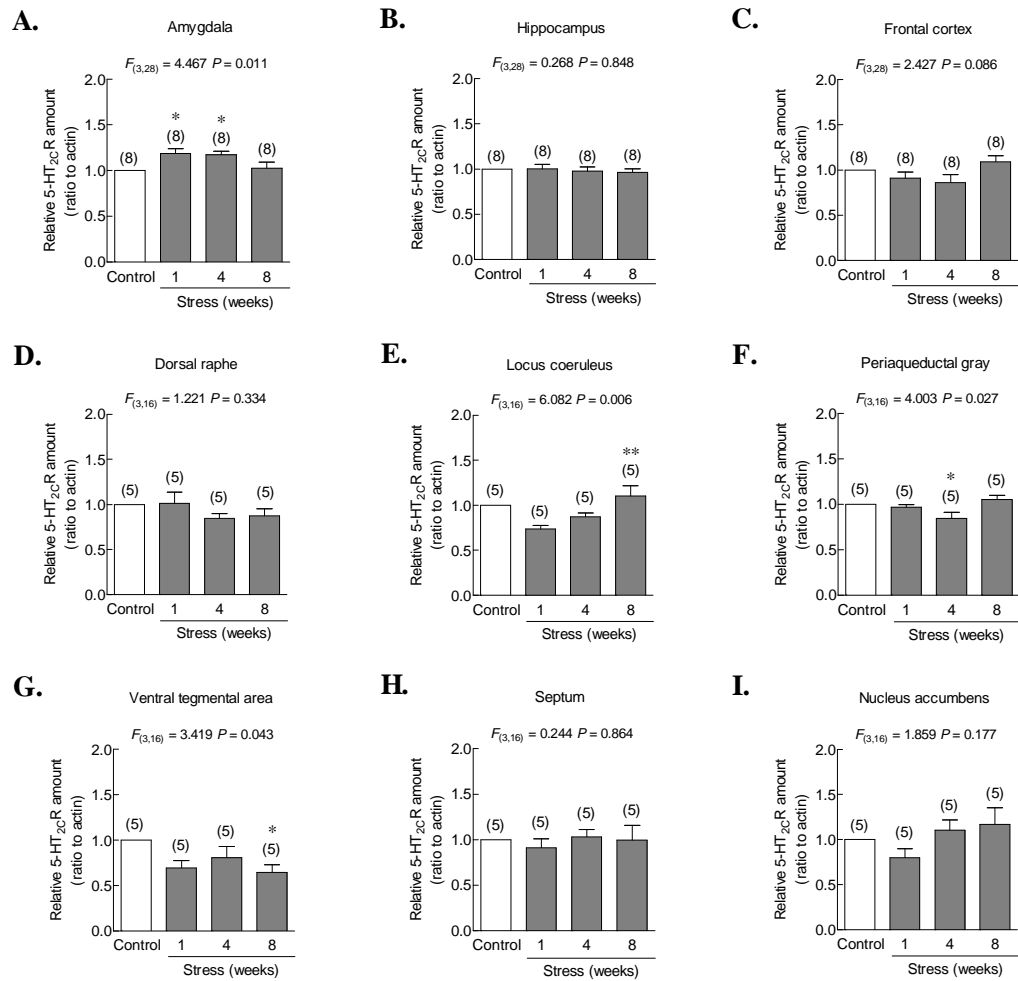

Figure 4.12 Time-dependent effects of the 1-, 4-, and 8-week restraint stress induction on the 5-HT_{2C}R protein levels. Numbers of animals are noted in parentheses. * $P < 0.05$, and ** $P < 0.01$ compared to non-stressed control group.

Table 4.1 Changes in bio-behavioral parameters of time dependent effects of the 1-, 4, and 8-week restraint stress induction in male rats.

Parameter		Stress 1 week	Stress 4 weeks	Stress 8 weeks
Anxiety	EPM	↑↑	↑	↑
	ETM	↑	↑↑↑	↔
	OFT	↑	↑	↑
Depression	% SP	↑	↑ at the 2 nd week of stress induction	↑ at the 2 nd week ↓ at the 5 th to 8 th week of stress induction
	FST	↔	↑	↔
Learning	MWM	↓↓	↑↑↑	↔
Memory	MWM/NOR	↑	↑↑↑	↔
Locomotion	EPM/OFT	↔	↔	↔
BDNF		↓ in the PAG	↔	↓ in the VTA
GR		↑ in the hypothalamus	↓↓↓ in the hippocampus	↔
NET		↔	↑ in the LC	↔
SERT		↓ in the VTA	↔	↓ in the hippocampus
5-HT _{2C} R		↑ in the amygdala	↑ in the amygdala, ↓ in the PAG	↑↑ in the LC, ↓ in the VTA

BDNF: Brain-derived neurotrophic factor; EPM: elevated-plus maze; ETM: elevated-T maze; FST: forced swimming test; GR: glucocorticoid receptor; LC: locus coeruleus; MWM: Morris water maze; NET: norepinephrine transporter; NOR: novel objective recognition; OFT: open-field test; PAG: periaqueductal gray; SERT: serotonin reuptake transporter; VTA: ventral tegmental area; SP: sucrose preference; 5-HT_{2C}R: serotonin type 2C receptor.

Experiment 2. To determine the effect of 4 weeks of voluntary wheel running on the hypothalamic-pituitary-adrenal (HPA) axis under non-stressed conditions, or after a 4-week exposure to restraint stress, and changes in the expression of selected target proteins in brain regions associated with stress responses.

1. The 4-week voluntary wheel running induced changes in body weight, heart weight, adrenal gland weight, food intake, corticosterone levels, and running distance.

There was no difference in starting body weight (Figure 4.13A). The sedentary stressed rats decreased body weight when compared to the non-stressed sedentary control rats. Both non-stressed exercised rats and the combined stressed and exercised rats had decreased body weight when compared to the non-stressed sedentary rats and stressed sedentary rats, respectively (Figure 4.13B). While the non-stressed sedentary rats had gained weight, non-stressed exercised and sedentary stressed rats had less weight gain. The combined stressed and exercised rats also displayed less weight gain when compared to sedentary stressed rats (Figure 4.13C). Sedentary stressed rats decreased daily food intake when compared to non-stressed control rats (Figure 4.13D). Therefore, the 4-week voluntary wheel running exercise could alter the energy balance including body weight and food intake.

In the exercise group, there was a similar running distance between non-stressed and stressed groups (Figure 4.14A–B). Both non-stressed and stressed rats gradually increased running distance through experimental period suggesting that stress did not affect the general locomotor activity in exercise training. Voluntary wheel running increased wet and dry heart weights in both non-stressed sedentary control and stressed rats (Figure 4.14C–F) indicating that the aerobic exercise protocol induced cardiac hypertrophy.

In addition, only the non-stressed exercised control rats, but not stressed exercised rats, had an increase in dry adrenal gland weight when compared with non-stressed sedentary control rats (Figure 4.15A–D). Therefore, voluntary wheel running-induced increase in adrenal weights might represent a modulation of sympatho-adrenal systems. Sedentary stressed rats had increased serum corticosterone levels when compared with non-stressed sedentary control rats. The combined stressed and

exercised rats had a tendency to decrease corticosterone levels when compared to sedentary stressed rats (Figure 4.15E). These results suggest that voluntary exercise could partially alleviate and prevent stress-induced increase in serum corticosterone.

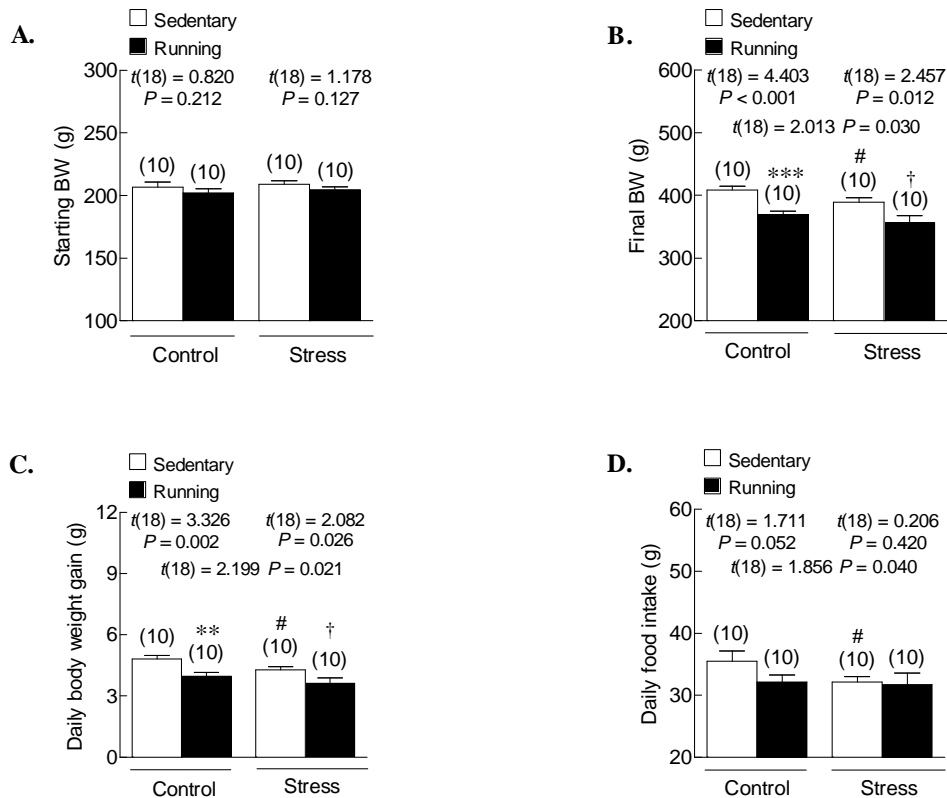

Figure 4.13 The effects of the 4-week voluntary wheel running on (A) starting body weight, (B) final body weight, (C) body weight gain, and (D) daily food intake. Numbers of animals are noted in parentheses. ** $P < 0.01$, *** $P < 0.001$ exercise group compared to non-stressed sedentary control. # $P < 0.05$ sedentary stressed group compared to non-stressed sedentary control group. † $P < 0.05$ combined stressed and exercised group compared to sedentary stressed group.

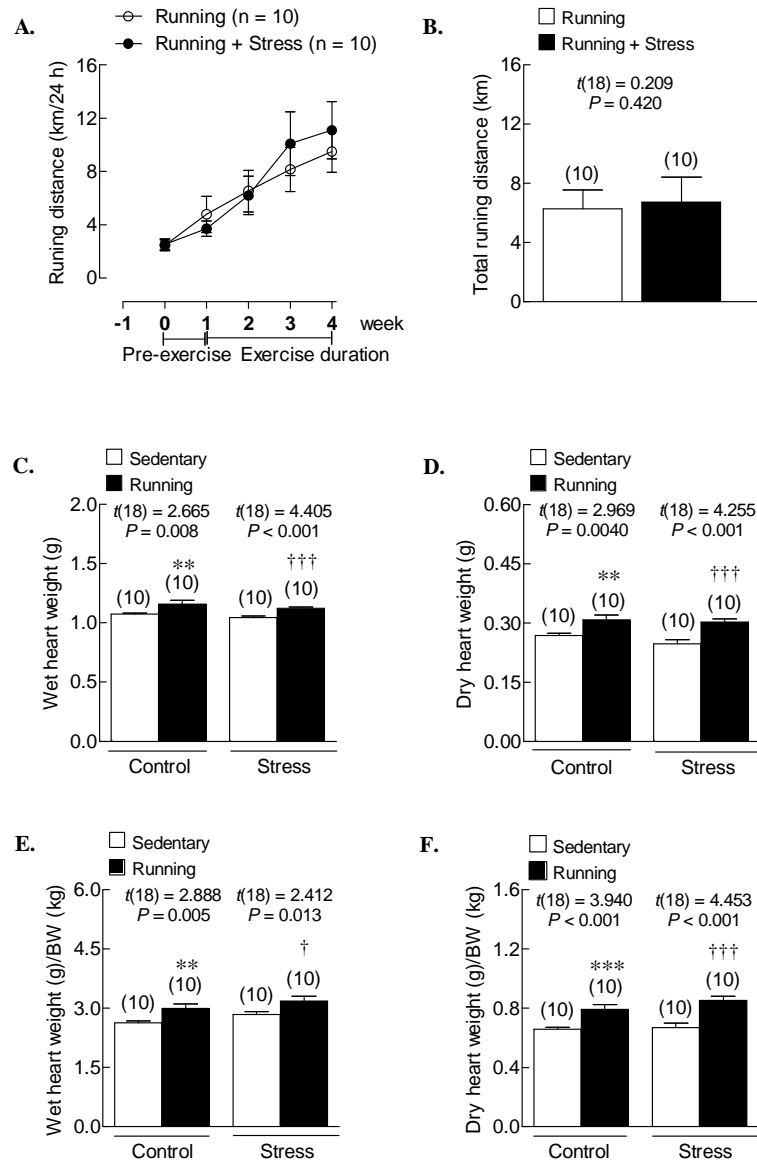

Figure 4.14 The effects of the 4-week voluntary wheel running on (A) running distance per day, (B) total running distance, (C) wet heart weight, (D) dry heart weight, (E) relative wet heart weight, and (F) relative dry heart weight. Numbers of animals are noted in parentheses. ** $P < 0.01$, *** $P < 0.001$ exercise group compared to non-stressed sedentary control. † $P < 0.05$, ††† $P < 0.001$ combined stressed and exercised group compared to sedentary stressed group.

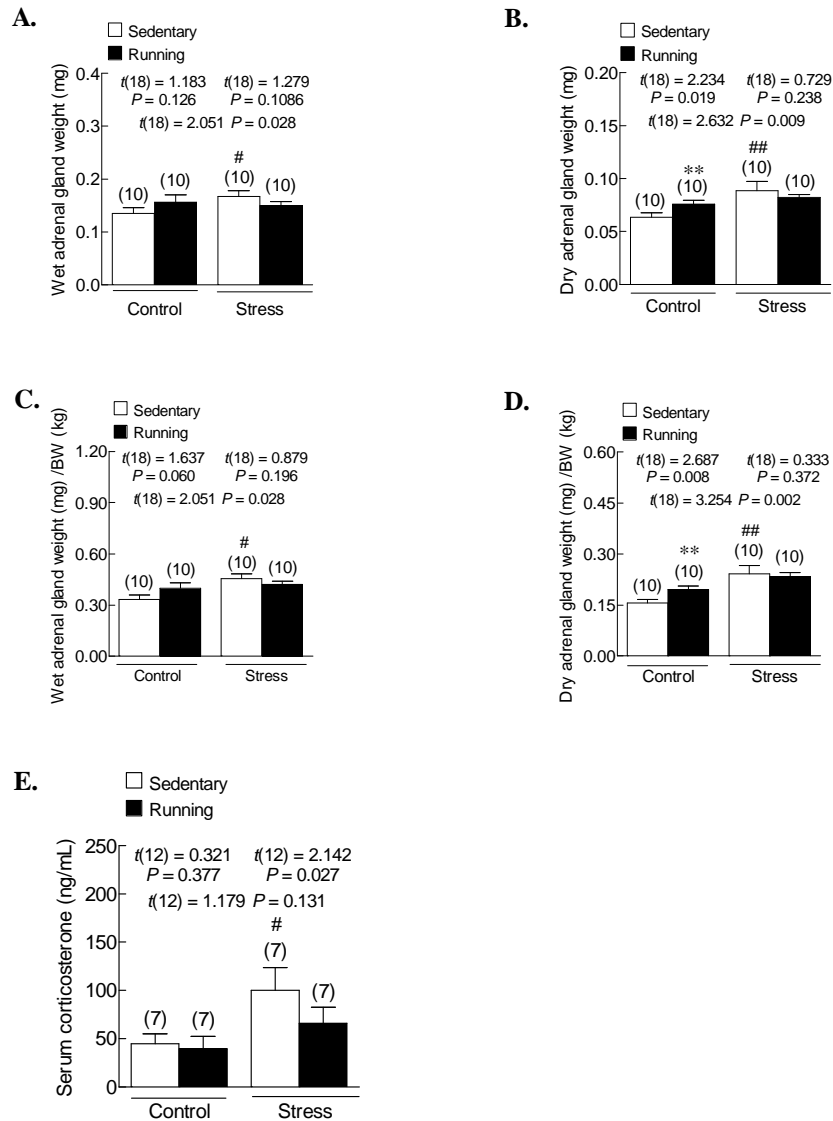

Figure 4.15 The effects of the 4-week voluntary wheel running on (A) wet adrenal weight, (B) dry adrenal weight, (C) relative wet adrenal weight, (D) relative dry adrenal gland weight, and (E) serum corticosterone levels. Numbers of animals are noted in parentheses. ** $P < 0.01$ exercised group compared to non-stressed control sedentary group. ## $P < 0.05$, ### $P < 0.01$ sedentary stressed group compared to non-stressed sedentary control group. † $P < 0.05$ combined stressed and exercised group compared to sedentary stressed group.

2. The 4-week voluntary wheel running induced the changes in behavioral responses

All groups of rats had increased sucrose preference as compared to the baseline period. There were no significant differences between groups as analyzed by one-way ANOVA. When compared to non-stress sedentary control by using unpaired *t*-test, stressed rats exhibited reduced sucrose preference in the 4th week of stress induction. Interestingly, the combined stress and voluntary exercise could prevent stress-induced decrease in sucrose preference in stressed male rats (Figure 4.16).

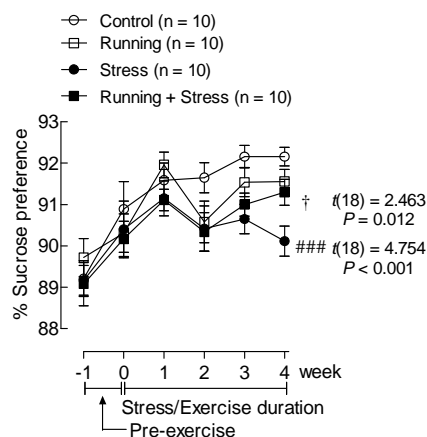

Figure 4.16 Effects of the 4-week voluntary wheel running on restraint stress-induced depression-like behavior as determined by sucrose preference test. Numbers of animals are noted in parentheses. ### $P < 0.001$ sedentary stressed group compared to non-stressed sedentary control group. † $P < 0.05$ combined stressed and exercised group compared to sedentary stressed group.

3. The 4-week wheel running induced changes in target protein expression in the brain regions associated with stress responses.

3.1 Levels of BDNF

Decreased hippocampal and septal BDNF protein expression in male rats was observed following the 4-week restraint stress induction (Figure 4.17B and H). The protein levels of BDNF in the nucleus accumbens were decreased in the exercise group. In the combined stressed and exercised rats BDNF protein was increased in the hippocampus and septum but decreased in the nucleus accumbens (Figure 4.17H-I).

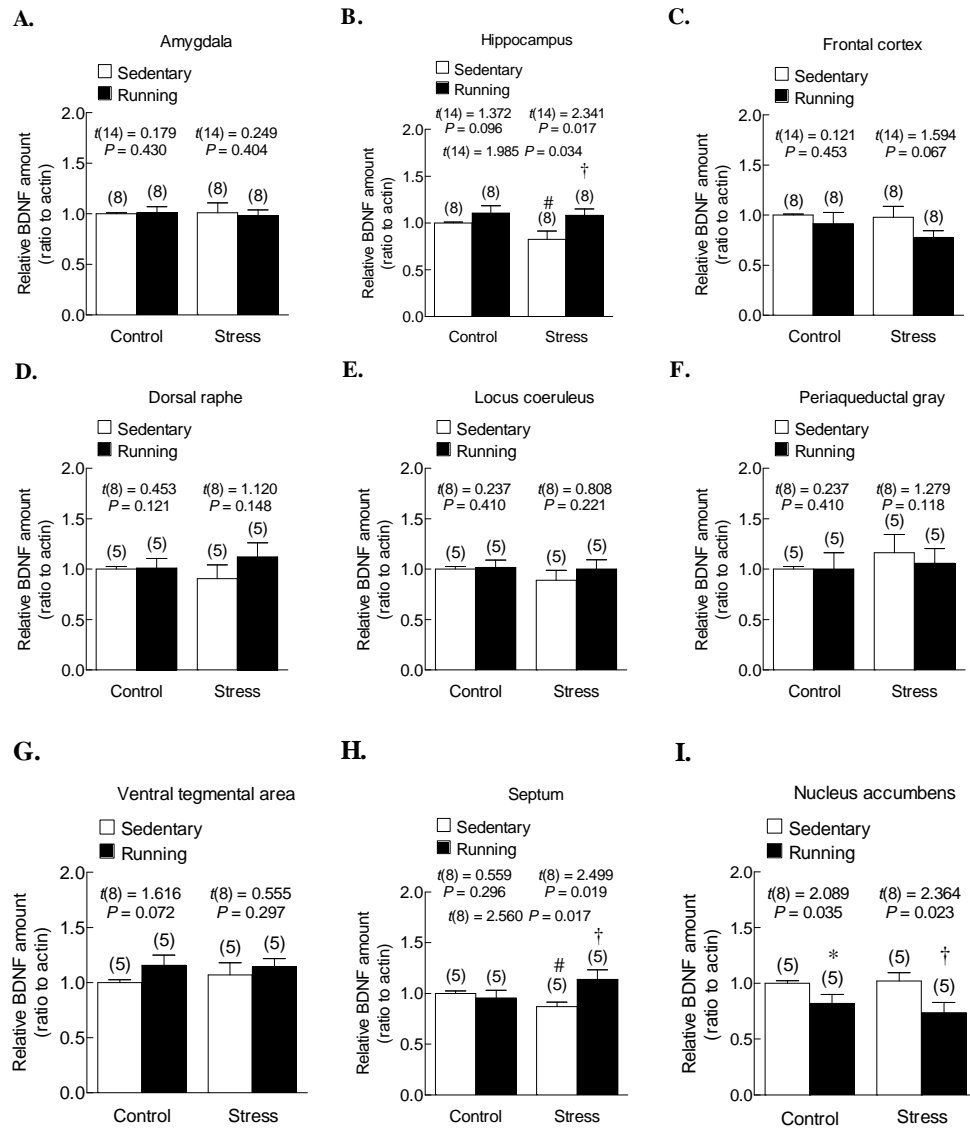

Figure 4.17 Effects of the 4-week voluntary wheel running on BDNF protein levels. Numbers of animals are noted in parentheses. * $P < 0.05$ exercised group compared to non-stressed control sedentary group. # $P < 0.05$ sedentary stressed group compared to non-stressed sedentary control group. † $P < 0.05$ combined stressed and exercised group compared to sedentary stressed group.

3.2 Levels of GR in the hypothalamus and the hippocampus and MC2R (ACTH receptor) in the adrenal gland.

Expression of proteins related to the HPA axis in the stressed male rats showed decreased GR protein levels in the hippocampus but not in the hypothalamus (Figure 4.18A–B). In addition, the presence of ACTH receptor in the adrenal cortex was downregulated in the combined stressed and exercised group than in the sedentary stressed group (Figure 4.18C). These results suggest that stress exposure and voluntary wheel running can modulate both central and peripheral HPA regulations.

3.3 Levels of NET

Stress decrease in NET protein levels in the locus coeruleus but decreased in the periaqueductal gray. Voluntary wheel running decreased NET protein levels in the locus coeruleus and the ventral tegmental area. Similarly, NET protein levels were decreased in the locus coeruleus in the combined stressed and exercised group (Figure 4.19D–F).

3.4 Levels of SERT

Stressed rats had decreased in SERT protein levels in the hippocampus and dorsal raphe (Figure 4.20B and D). Voluntary wheel running increased SERT protein expression in the septum when compared to non-stressed sedentary controls. The combined stressed and exercised rats had reduced SERT protein levels in the ventral tegmentum area when compared to sedentary stressed rats (Figure 4.20F–G).

3.5 Levels of 5-HT_{2C}R

The 5-HT_{2C}R protein levels in the amygdala of stressed rats were higher than non-stress sedentary control rats (Figure 4.21A). Apparently, voluntary wheel running decreased 5-HT_{2C}R protein expression in the dorsal raphe, periaqueductal gray, and nucleus accumbens when compared to non-stress sedentary control rats (Figure 4.21D, F, and I). In addition, the combined stressed and exercised group showed less 5-HT_{2C}R protein expression in the frontal cortex more than the sedentary stressed group (Figure 4.21C).

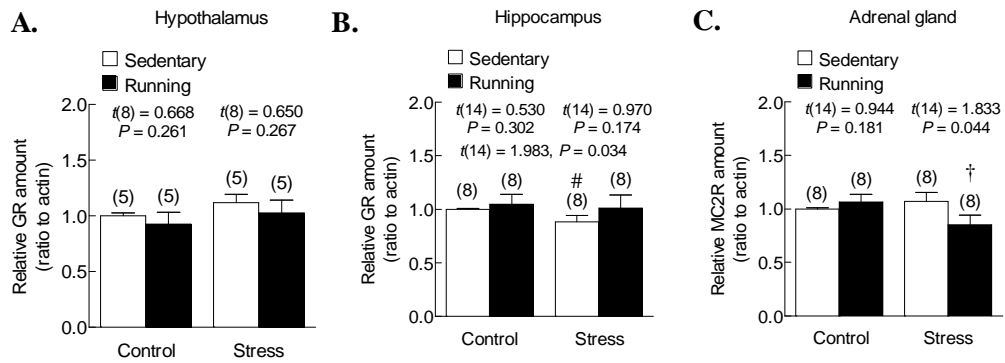

Figure 4.18 Effects of the 4-week voluntary wheel running on the hypothalamic and hippocampal GR and adrenal MC2R protein levels. Numbers of animals are noted in parentheses. [#] $P < 0.05$ sedentary stressed group compared to non-stressed sedentary control group. [†] $P < 0.05$ combined stressed and exercised group compared to sedentary stressed group.

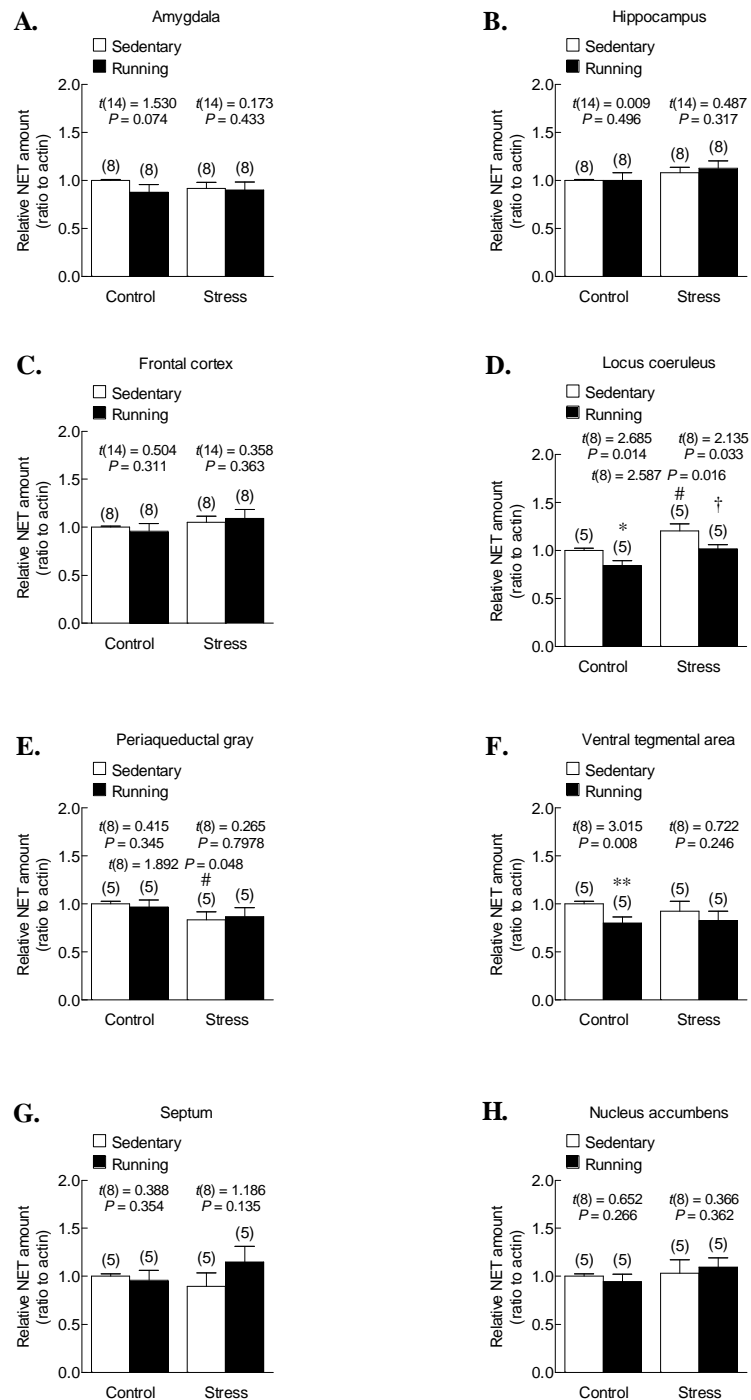

Figure 4.19 Effects of the 4-week voluntary wheel running on NET protein levels. Numbers of animals are noted in parentheses. * $P < 0.05$, ** $P < 0.01$ exercised group compared to non-stressed control sedentary group. # $P < 0.05$ sedentary stressed group compared to non-stressed sedentary control group. † $P < 0.05$ combined stressed and exercised group compared to sedentary stressed group.

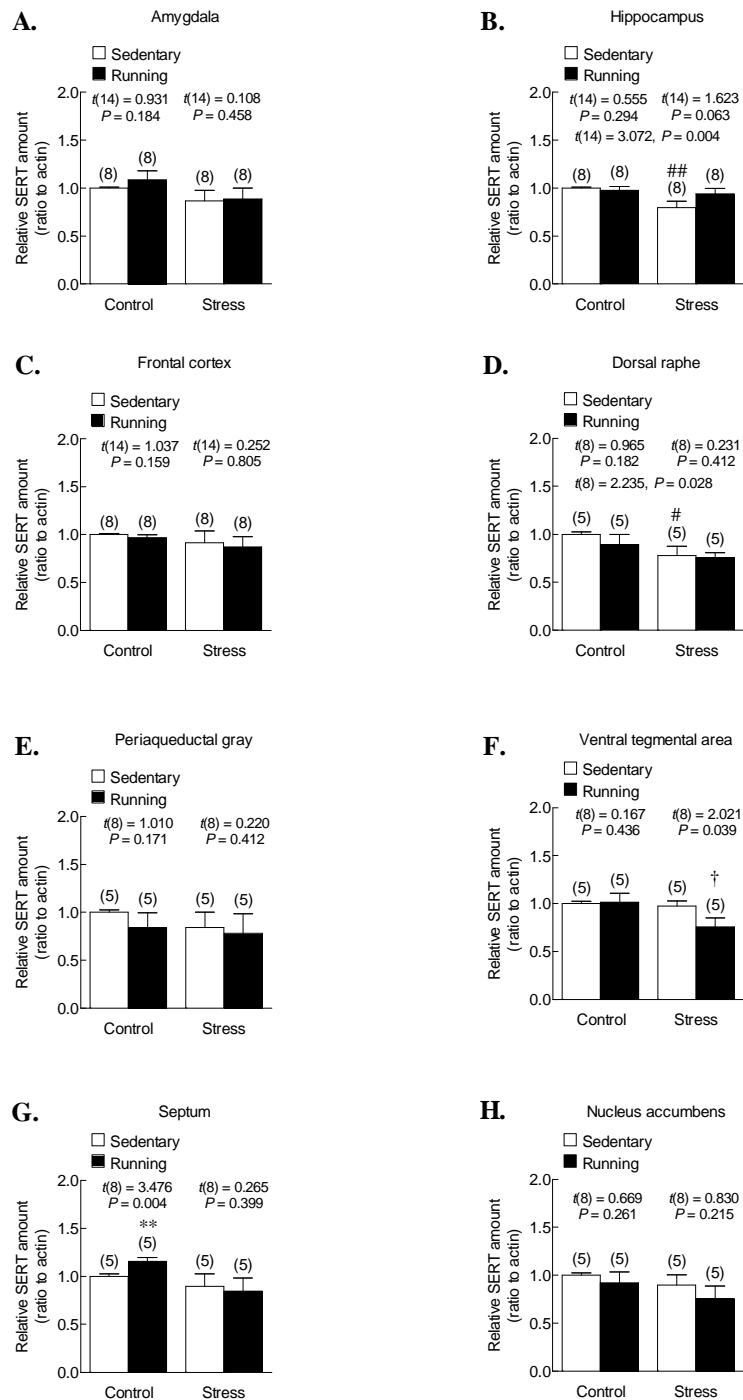

Figure 4.20 Effects of the 4-week voluntary wheel running on SERT protein levels. Numbers of animals are noted in parentheses. $**P < 0.01$ exercised group compared to non-stressed control sedentary group. $\#P < 0.05$, $\#\#P < 0.01$ sedentary stressed group compared to non-stressed sedentary control group. $\dagger P < 0.01$ combined stressed and exercised group compared to sedentary stressed group.

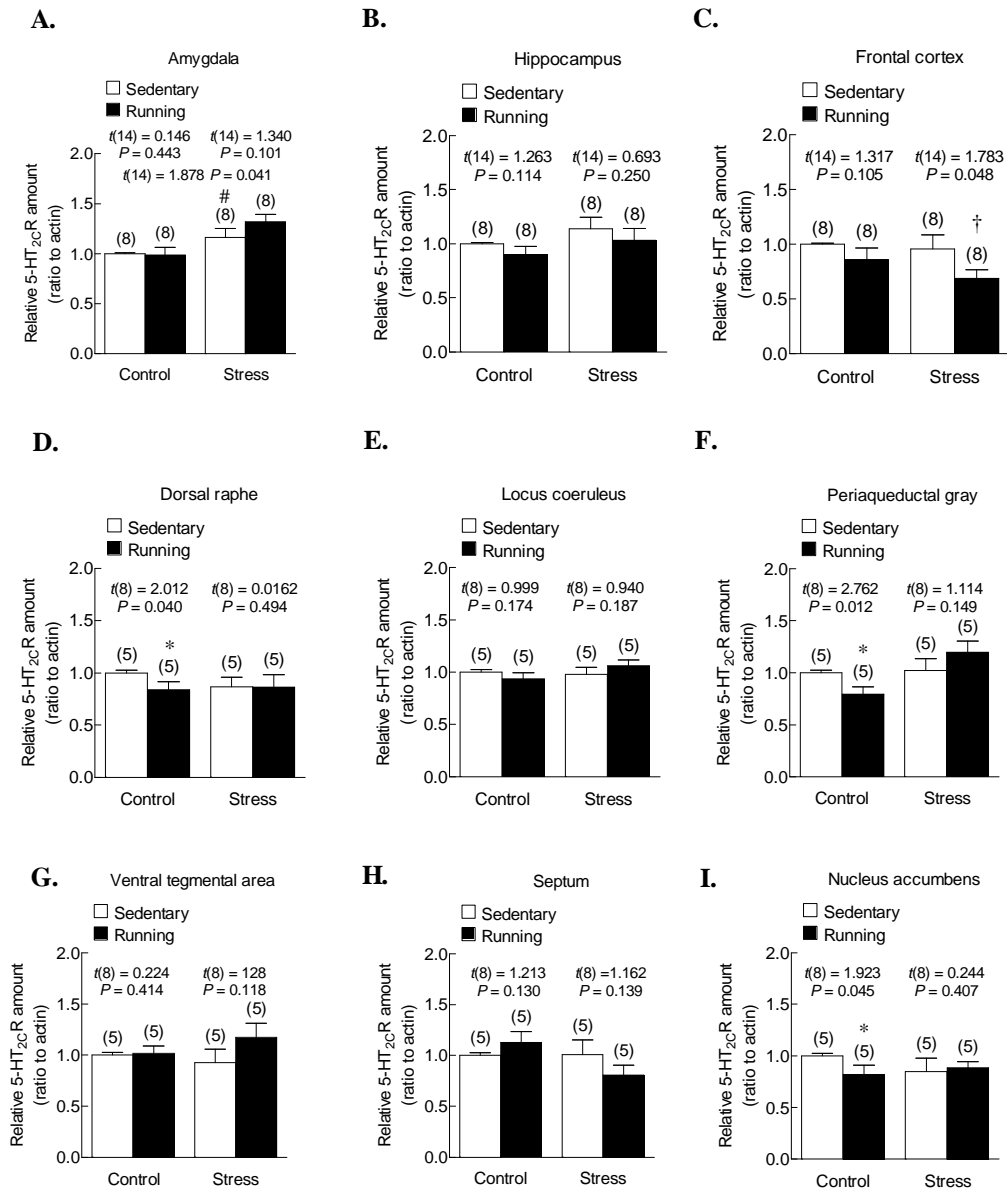

Figure 4.21 Effects of the 4-week voluntary wheel running on the 5-HT_{2c}R protein levels. Numbers of animals are noted in parentheses. * $P < 0.05$ exercised group compared to non-stressed control sedentary group. # $P < 0.05$ sedentary stressed group compared to non-stressed sedentary control group. † $P < 0.01$ combined stressed and exercised group compared to sedentary stressed group.

Table 4.2 Changes in bio-behavioral parameters of effects of the 4-week voluntary wheel running under non-stressed condition and/or after the 4-week restraint stress induction in male rats.

Parameter		Ex vs control	Stress vs control	Stress + Ex vs stress
Depression	% SP	↔	↓↓↓	↑
Serum corticosterone		↔	↑	↔
BDNF		↓ in the NA	↓↓ in the hippocampus and the septum	↑ in the hippocampus and the septum, ↓ in the NA
GR		↔	↓ in the hippocampus	↔
Adrenal MC2R		↔	↔	↓
NET		↓↓ in the LC and the VTA	↑ in the LC, ↓ in the PAG	↓ in the LC
SERT		↑↑ in the septum	↓↓ in the hippocampus and the DR	↓ in the VTA
5-HT_{2C}R		↓ in the DR, the PAG, and the NA	↑ in the amygdala	↓ in the PFC

BDNF: Brain-derived neurotrophic factor; DR: dorsal raphe; EPM: elevated-plus maze; ETM: elevated-T maze; FST: forced swimming test; GR: glucocorticoid receptor; LC: locus coeruleus; MWM: Morris water maze; NA: nucleus accumbens; NET: norepinephrine transporter; NOR: novel objective recognition; OFT: open-field test; PAG: periaqueductal gray; SERT: serotonin reuptake transporter; VTA: Ventral tegmental area; SP: sucrose preference; 5-HT_{2C}R: serotonin type 2C receptor.

Experiment 3. To evaluate the effectiveness of agomelatine, venlafaxine, and voluntary wheel running exercise in the prevention of stress-induced anxiety-, depression-, and memory impairment-like behaviors and changes in the expression of selected target proteins in brain regions associated with stress responses.

1. The 4-week pre-treatment of agomelatine, venlafaxine, and voluntary wheel running induced changes in body weight, adrenal gland weight, food intake, and corticosterone levels.

There was no difference in the starting body weight. Following the 4-week pre-treatments, voluntary wheel running animals had lower body weight gain and food intake. Exercising rats gradually increased their running distance throughout the exercise training (Figure 4.22A–D). Agomelatine- and venlafaxine-treated rats did not exhibit changes in their body weight gain but their food intake was higher than that of the vehicle-treated sedentary stressed rats (Figure 4.22C). Despite gaining body weight after stopping voluntary wheel running (Figure 4.22F), exercising rats subjected to stress induction had a decrease in the final body weight (Figure 4.22D), thus, demonstrating detraining effects of exercise. Therefore, pre-treatments with monoamine modulators and voluntary exercise could prevent the stress-induced decrease in body weight and food intake. Pre-treatment of agomelatine, venlafaxine or voluntary wheel running did not alter adrenal weights (Figure 4.23A–D) but serum corticosterone levels of agomelatine-treated rats was higher than non-stressed controls and vehicle-treated sedentary stressed rats (Figure 4.23E).

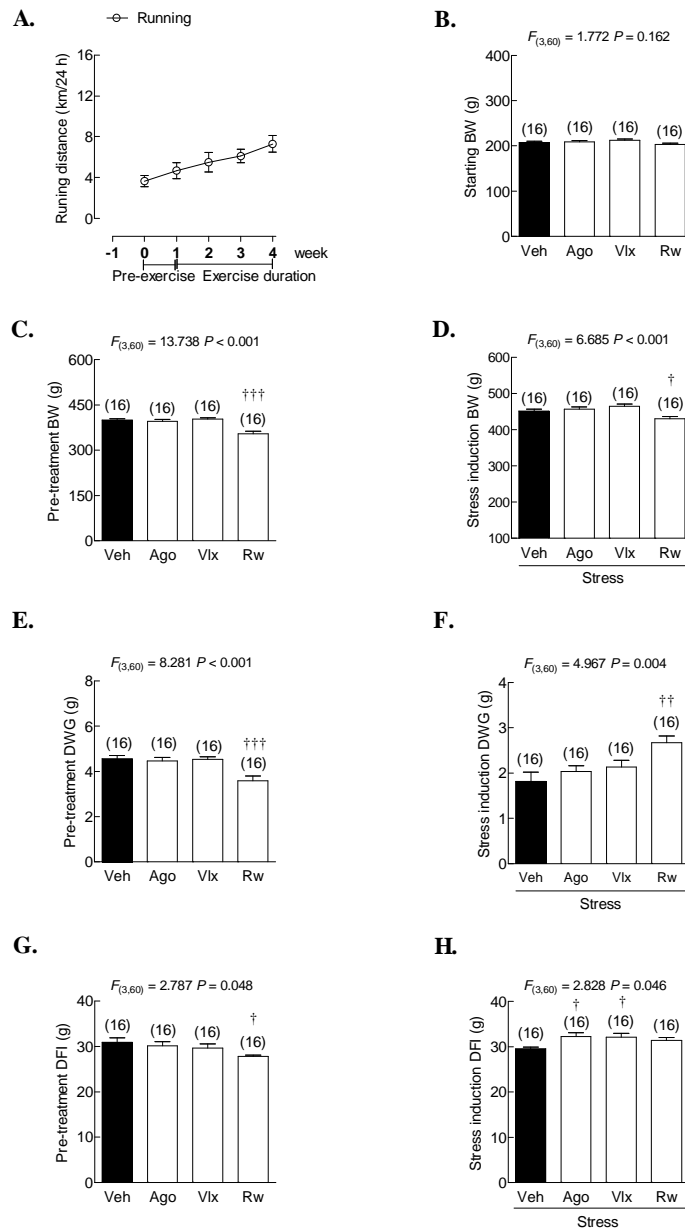

Figure 4.22 Protective effects of agomelatine (Ago), venlafaxine (Vlx) and voluntary wheel running (Rw) on (A) starting body weight, (B) running distance, (C) body weight, (D) final body weight, (E) daily weight gain in pre-treatment, (F) daily weight gain in stress induction, (G) daily food intake in pre-treatment, and (H) daily weight gain in stress induction. Numbers of animals are noted in parentheses. † $P < 0.05$, †† $P < 0.01$, and ††† $P < 0.001$ compared to vehicle (Veh)-treated group

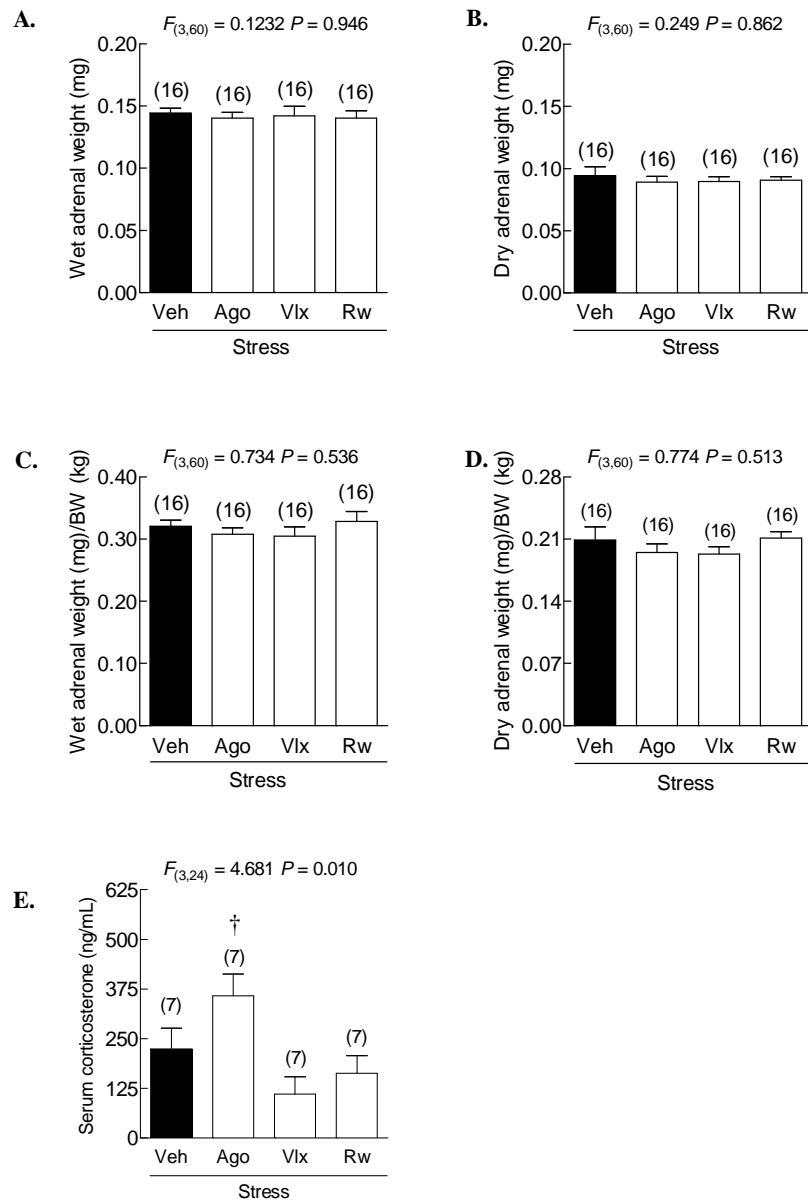

Figure 4.23 Protective effects of agomelatine (Ago), venlafaxine (Vlx) and voluntary wheel running (Rw) on (A) wet adrenal weight (B) dry adrenal weight, (C) relative wet adrenal weight, (D) relative dry adrenal weight, (E) serum corticosterone levels in stressed male rats. Numbers of animals are noted in parentheses.

2. The 4-week pre-treatment of agomelatine, venlafaxine, and voluntary wheel running induced changes in behavioral responses.

2.1 Anxiety-like behaviors

In the EPM test, pre-treatment with venlafaxine, but not agomelatine, or voluntary wheel running, increased the percent open arm time in stressed rats when compared to vehicle-treated stressed rats (Figure 4.24B). However, both pharmacological treatments and voluntary wheel running did not alter the percent open arm entry, percent closed arm entry, percent closed arm time, total arm entries or stress-related behaviors, i.e., rearing and grooming (Figure 4.24A and C–H). In the ETM test, pre-treatment with agomelatine, venlafaxine or voluntary wheel running decreased latencies in the inhibitory avoidance 1 and 2 in stressed rats when compared to vehicle-treated stressed rats (Figure 4.25B–C), while having no effect on baseline latency (Figure 4.25A) or one-way escape latency (Figure 4.25D). In the OFT test, agomelatine and voluntary wheel running, but not venlafaxine increased time spent in the inner zone and decreased time spent in the outer zone (Figure 4.26A–B). No change in the number of lines crossed in the first 30 seconds or total lines crossed in 5 min were observed in agomelatine-, venlafaxine-, and exercise-treated rats (Figure 4.26C–D). In addition, stress-increased grooming behavior was reduced by pre-treatment with agomelatine, venlafaxine, or with voluntary wheel running (Figure 4.26F).

2.2 Depression-like behaviors

Both agomelatine- and venlafaxine-treated stressed rats but not exercised rats showed longer swimming duration and less immobility duration than vehicle-treated stressed rats (Figure 4.27A–C). The number of fecal pellets could be used as an index of the stress in the forced swimming test; however, there were no difference among these groups (Figure 4.27D). No change in weekly sucrose preference was also observed in pre-treatment or exercise period. When comparing percent sucrose preference after completing the pre-treatment section, vehicle-treated rats increased sucrose preference at the 2nd week of stress. However, pre-treatment did not alter percent sucrose preference in stressed rats compared to the baseline period and to the vehicle-treated group (Figure 4.27E).

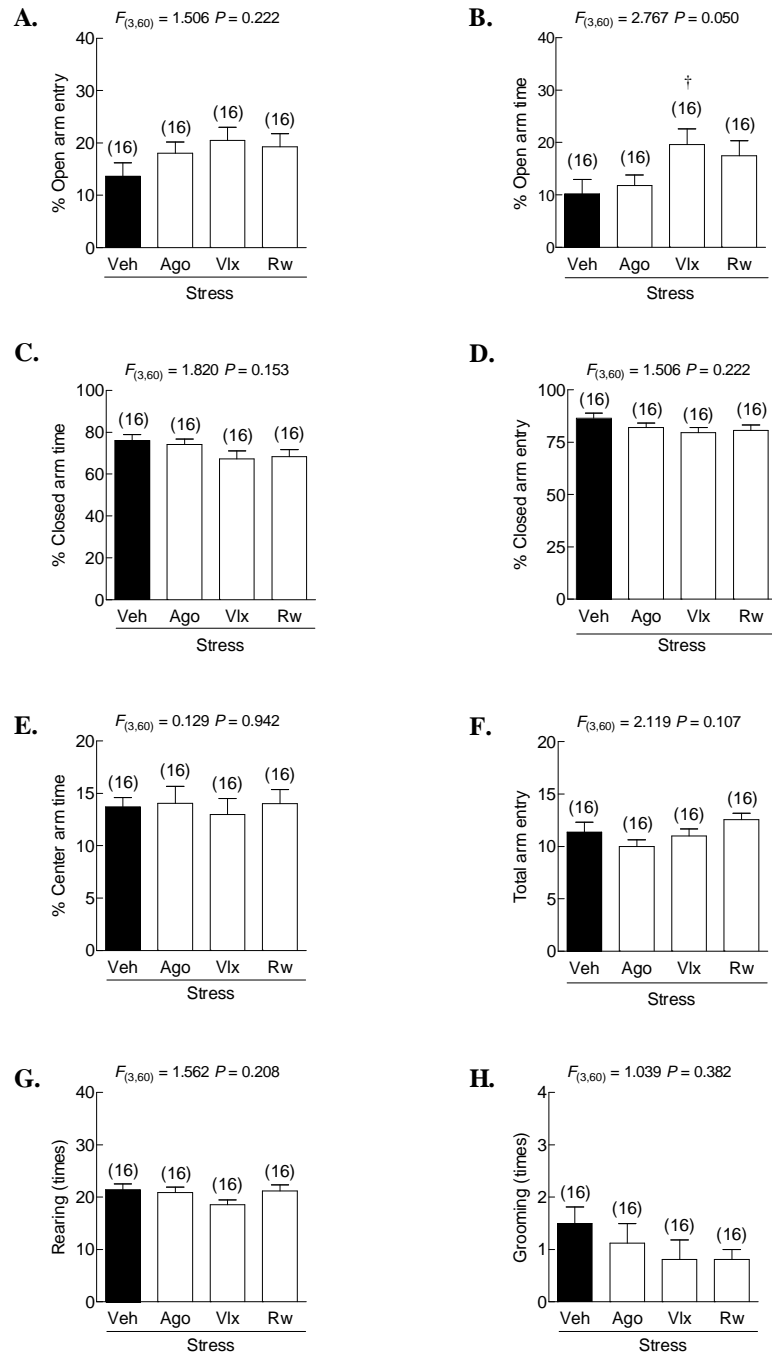

Figure 4.24 Protective effects of agomelatine (Ago), venlafaxine (Vlx) and voluntary wheel running (Rw) on stress-induced anxiety-like behavior as determined by EPM, (A) percent open arm entry, (B) percent open arm time, (C) percent closed arm entry, (D) percent closed arm time, (E) percent center of arm time, (F) total arm entries, (G) numbers of grooming, and (H) numbers of rearing. Numbers of animals are noted in parentheses. [†] $P < 0.05$ compared to vehicle (Veh)-treated group.

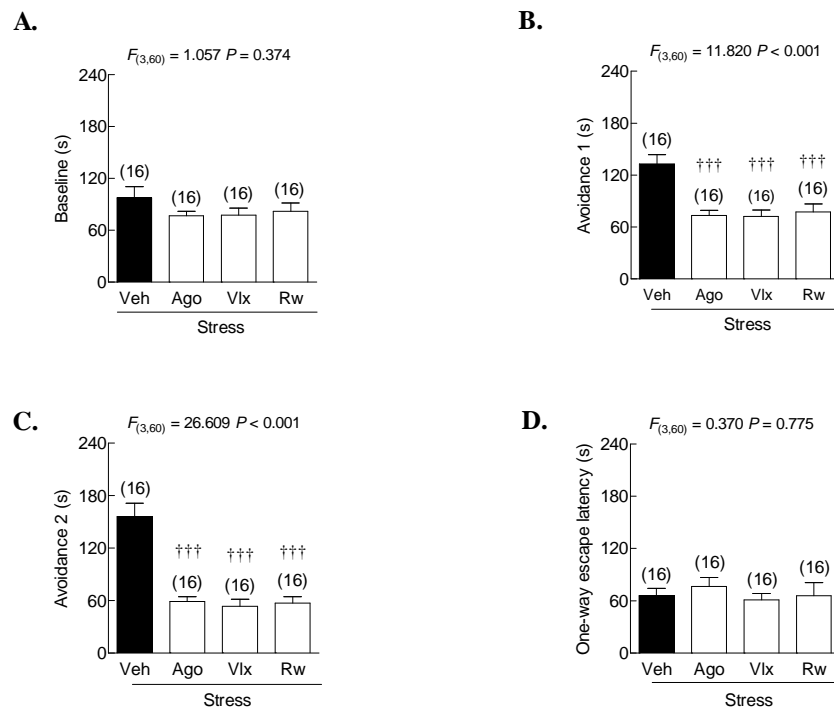

Figure 4.25 Protective effects of agomelatine (Ago), venlafaxine (Vlx) and voluntary wheel running (Rw) on stress-induced anxiety/learned and innate fear-like behavior as determined by ETM, (A) baseline latency, (B) avoidance latency 1, (C) avoidance latency 2, and (D) one-way escape latency. Numbers of animals are noted in parentheses. ^{†††} $P < 0.001$ compared to vehicle (Veh)-treated group.

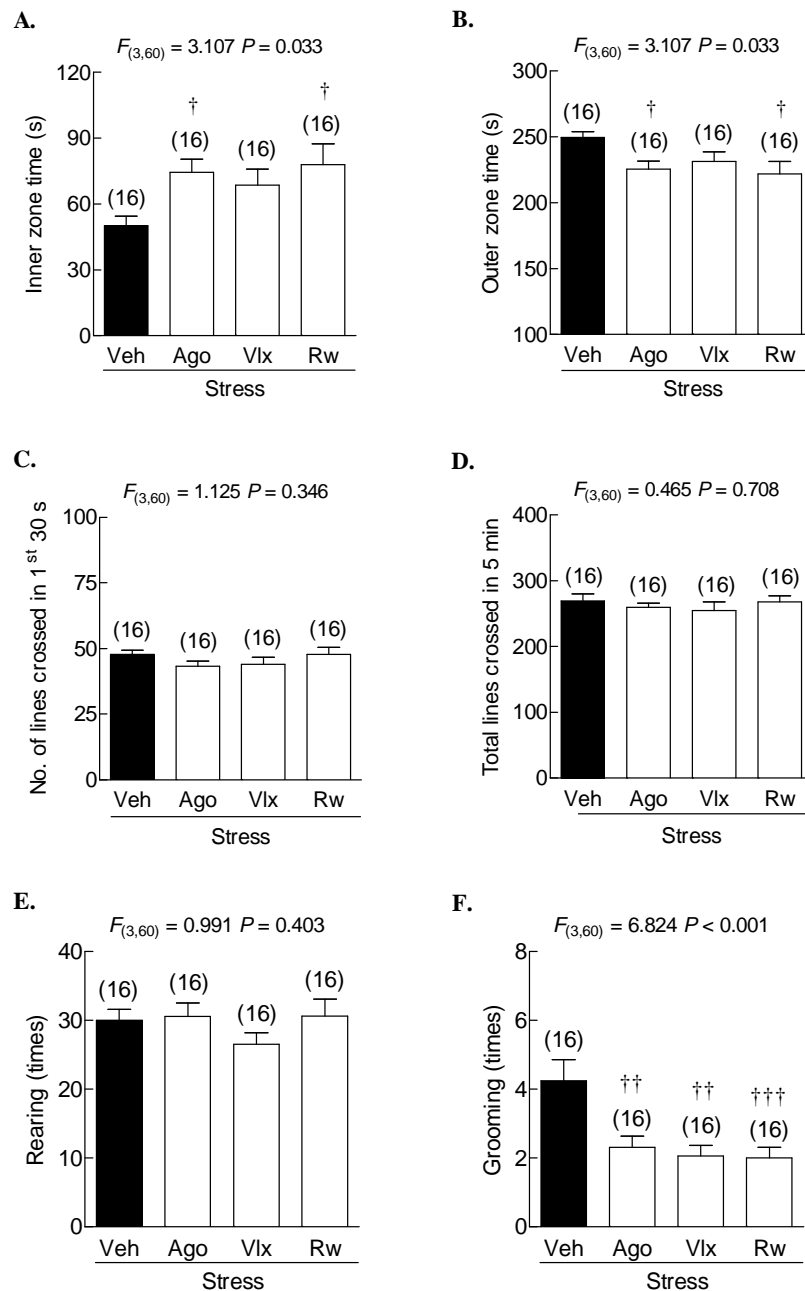

Figure 4.26 Protective effects of agomelatine (Ago), venlafaxine (Vlx) and voluntary wheel running (Rw) on stress-induced anxiety-like behavior as determined by OFT, (A) inner zone time, (B) outer zone time, (C) number of lines crossed in the first 30 seconds, (D) total lines crossed, (E) numbers of rearing, and (F) numbers of grooming. Numbers of animals are noted in parentheses. ^{††} $P < 0.01$, ^{†††} $P < 0.001$ compared to vehicle (Veh)-treated group.

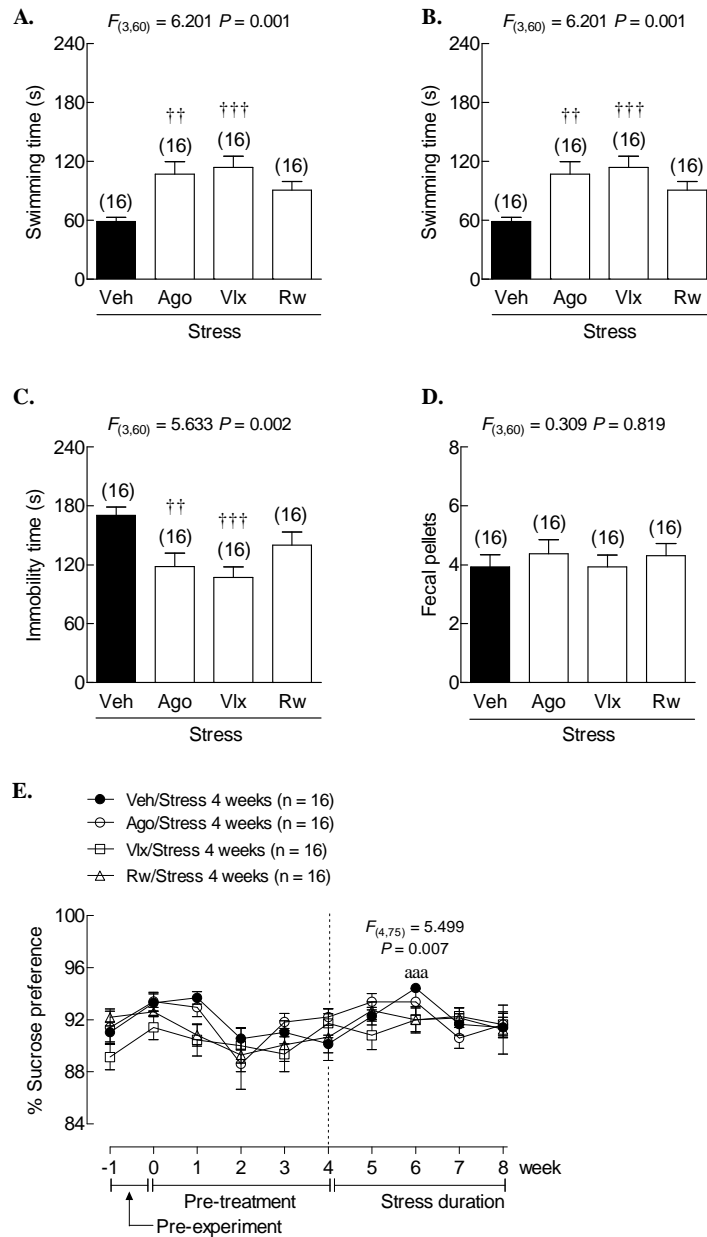

Figure 4.27 Protective effects of agomelatine (Ago), venlafaxine (Vlx) and voluntary wheel running (Rw) on stress-induced depression-like behavior as determined by FST and sucrose preference test, (A) swimming duration, (B) climbing duration, (C) immobility duration, (D) numbers of fecal pellets, and (E) weekly sucrose preference. Numbers of animals are noted in parentheses. ^{††} $P < 0.01$, ^{†††} $P < 0.001$ compared to vehicle (Veh)-treated group. ^{aaa} $P < 0.001$ compared to percent sucrose preference after completing 4-week pre-treatment period.

2.3 Learning and memory impairment-like behaviors

The MWM test showed that the agomelatine-, venlafaxine-, and exercise-treated stressed rats exhibited less escape latencies (on day 1, 2 and 3) and correct quadrant time than vehicle-treated stressed rats (Figure 4.28A–B), but percent correct quadrant was not different among these groups (Figure 4.28C). In the NOR, there was an improvement in the discrimination ratio in agomelatine- and venlafaxine-treated rats when compared to vehicle-treated stressed rats. However, the exercise-treated rats and vehicle-treated rats showed similar discrimination ratios (Figure 4.28D). These results suggest that pre-treatment of agomelatine, venlafaxine, and voluntary wheel running could improve learning and memory in stressed rats.

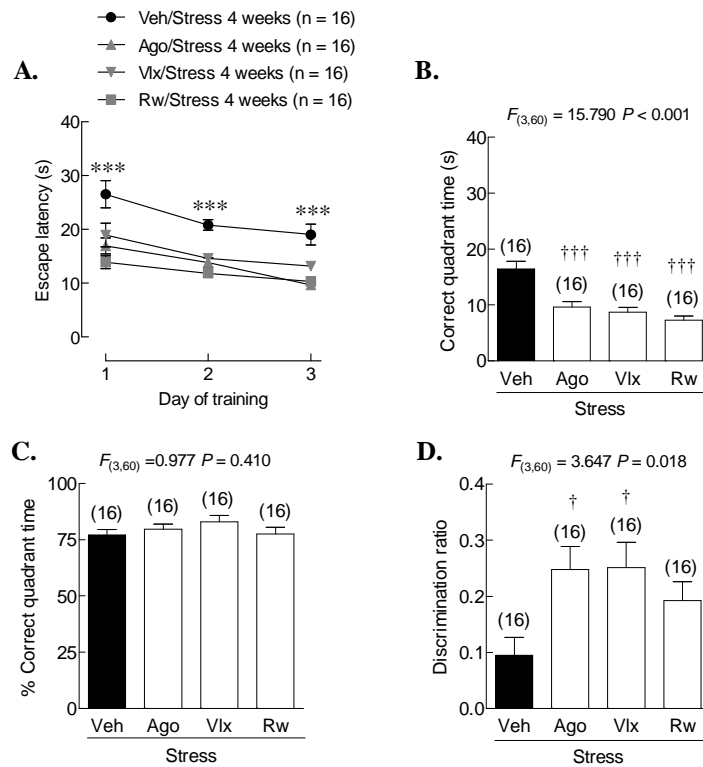

Figure 4.28 Protective effects of agomelatine (Ago), venlafaxine (Vlx) and voluntary wheel running (Rw) on stress-induced learning and memory impairment-like behavior as determined by MWM and NOR, (A) escape latency, (B) correct quadrant time, (C) percent correct quadrant time, and (D) discrimination ratio. Numbers of animals are noted in parentheses. † $P < 0.05$, †† $P < 0.01$, ††† $P < 0.001$ compared to vehicle (Veh)-treated group.

3. The 4-week pre-treatment of agomelatine, venlafaxine, and voluntary wheel running induced changes in target protein expression in the brain regions associated with stress responses.

3.1 Levels of BDNF

Venlafaxine and voluntary wheel running resulted in higher levels of hippocampal BDNF as compared to vehicle-treated rats. In contrast, agomelatine or venlafaxine pre-treatment decreased BDNF protein levels in the locus coeruleus and the septum (Figure 4.29*B, E, and H*).

3.2 Levels of GR in hypothalamus and hippocampus

The hypothalamic GR protein expression levels did not change in any of the groups. The hippocampal GR protein levels were increased in venlafaxine-treated stressed rats (Figure 4.30*B*).

3.3 Levels of NET

When compared to vehicle-treated stressed rats, NET protein levels in the locus coeruleus were increased in exercise treated-stressed rats. However, NET protein levels were decreased in the hippocampus and the hippocampus and periaqueductal gray in agomelatine- and venlafaxine-treated rats (Figure 4.31*B and E*).

3.4 Levels of SERT

Pre-treatment of agomelatine and venlafaxine decreased the septal SERT protein levels when compared to vehicle-treated rats (Figure 4.32*G*).

3.5 Levels of 5-HT_{2C}R

No significant differences in the 5-HT_{2C}R protein expression were observed among these groups (Figure 4.33). However, there was a tendency towards a downregulation of the 5-HT_{2C}R in the amygdala of the exercise group. This result might suggest partially anxiolytic effects of voluntary exercise on stress-induced 5-HT_{2C}R upregulation in stressed rats.

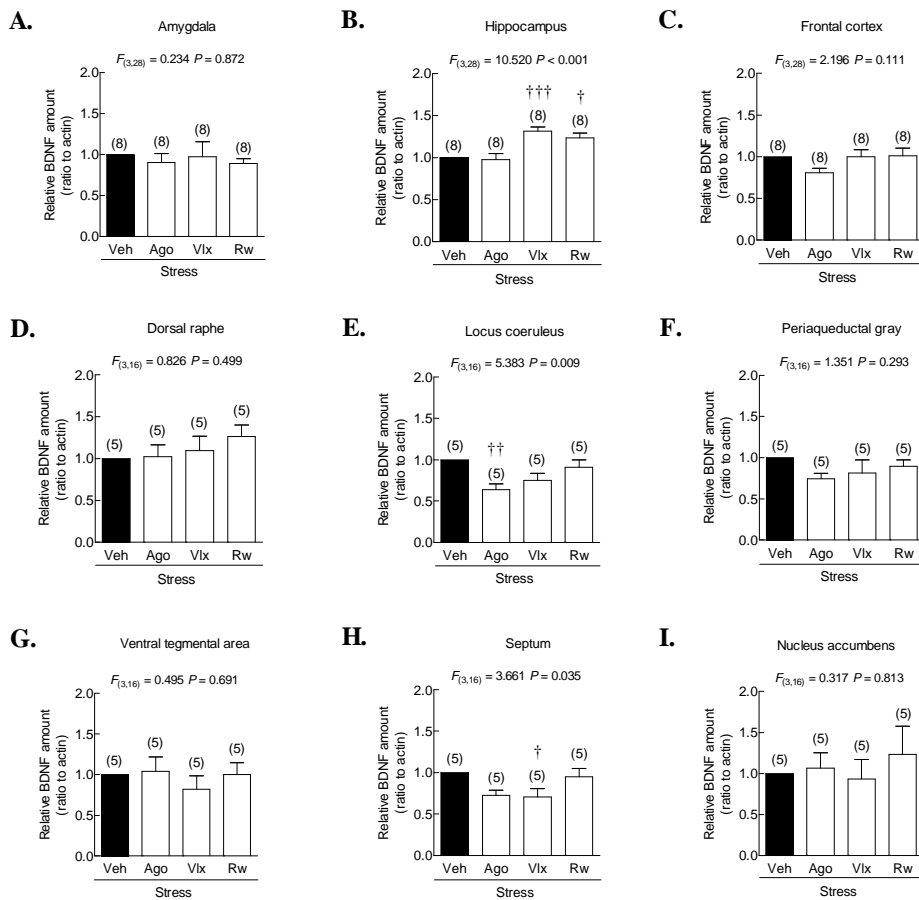

Figure 4.29 Protective effects of agomelatine (Ago), venlafaxine (Vlx) and voluntary wheel running (Rw) on the BDNF protein levels. Numbers of animals are noted in parentheses. $^{\dagger}P < 0.05$, $^{\dagger\dagger}P < 0.01$, and $^{\dagger\dagger\dagger}P < 0.001$ compared to vehicle (Veh)-treated group.

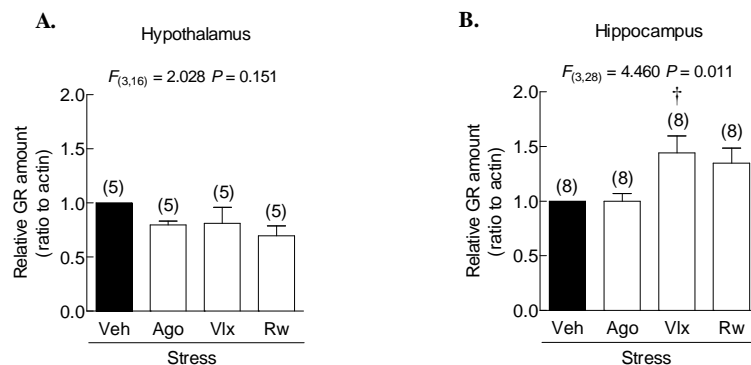

Figure 4.30 Protective effects of agomelatine (Ago), venlafaxine (Vlx) and voluntary wheel running (Rw) on the hypothalamic and hippocampal GR protein levels. Numbers of animals are noted in parentheses. $^{\dagger}P < 0.05$ compared to vehicle (Veh)-treated group.

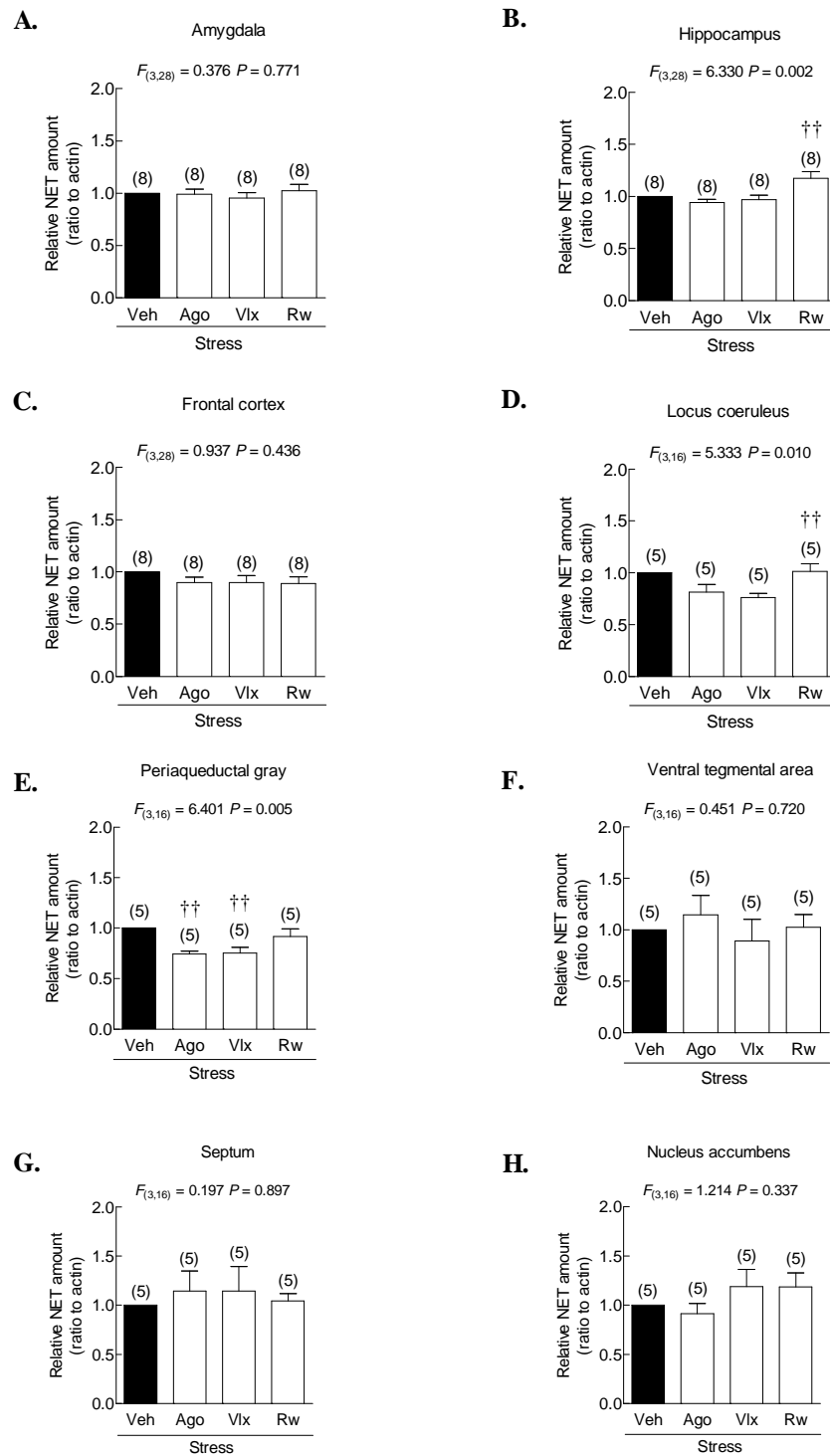

Figure 4.31 Protective effects of agomelatine (Ago), venlafaxine (Vlx) and voluntary wheel running (Rw) on the NET protein levels. Numbers of animals are noted in parentheses. $^{\dagger\dagger}P < 0.01$ compared to vehicle (Veh)-treated group.

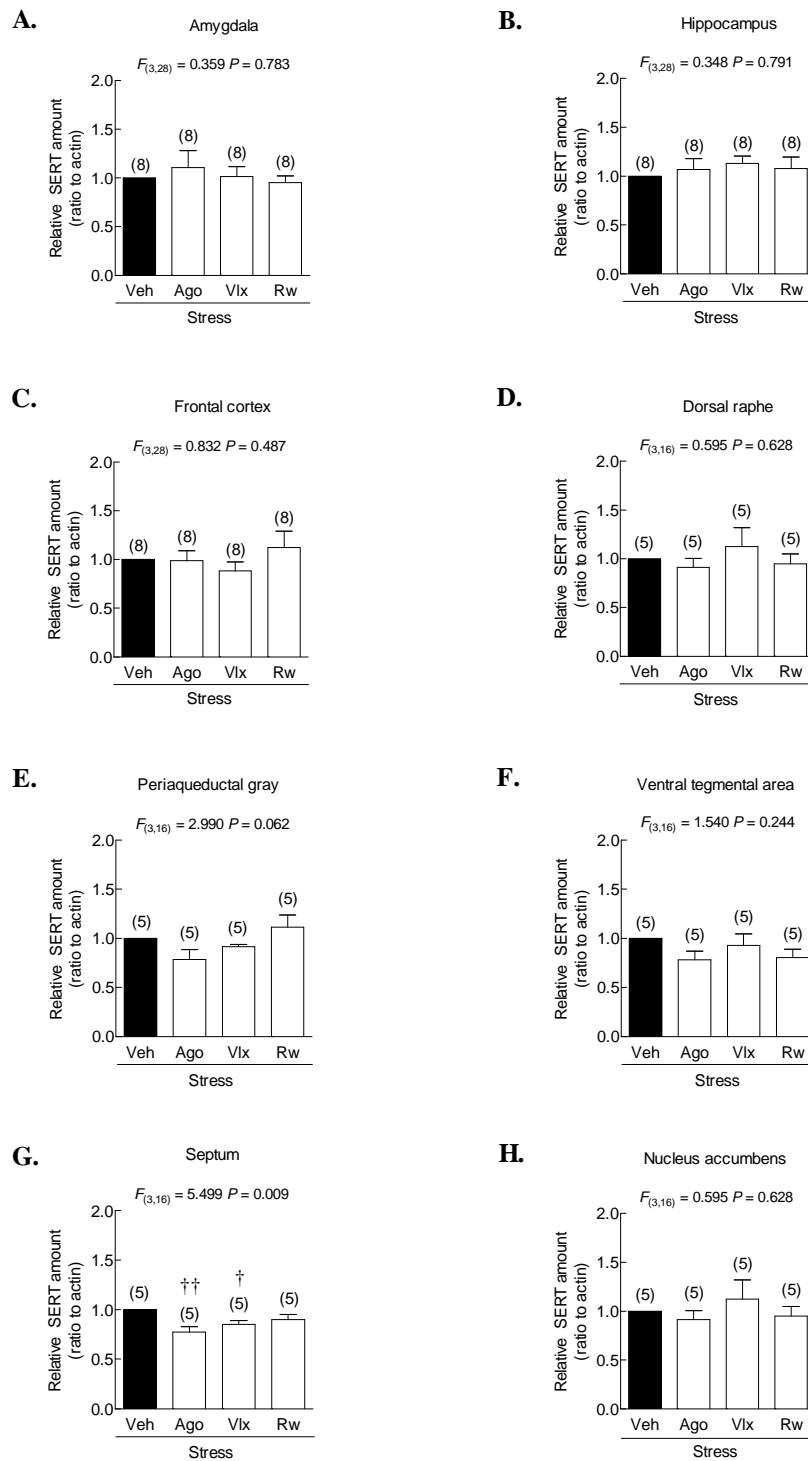

Figure 4.32 Protective effects of agomelatine (Ago), venlafaxine (Vlx) and voluntary wheel running (Rw) on the SERT protein levels. Numbers of animals are noted in parentheses. † $P < 0.05$ and †† $P < 0.01$ compared to vehicle (Veh)-treated group.

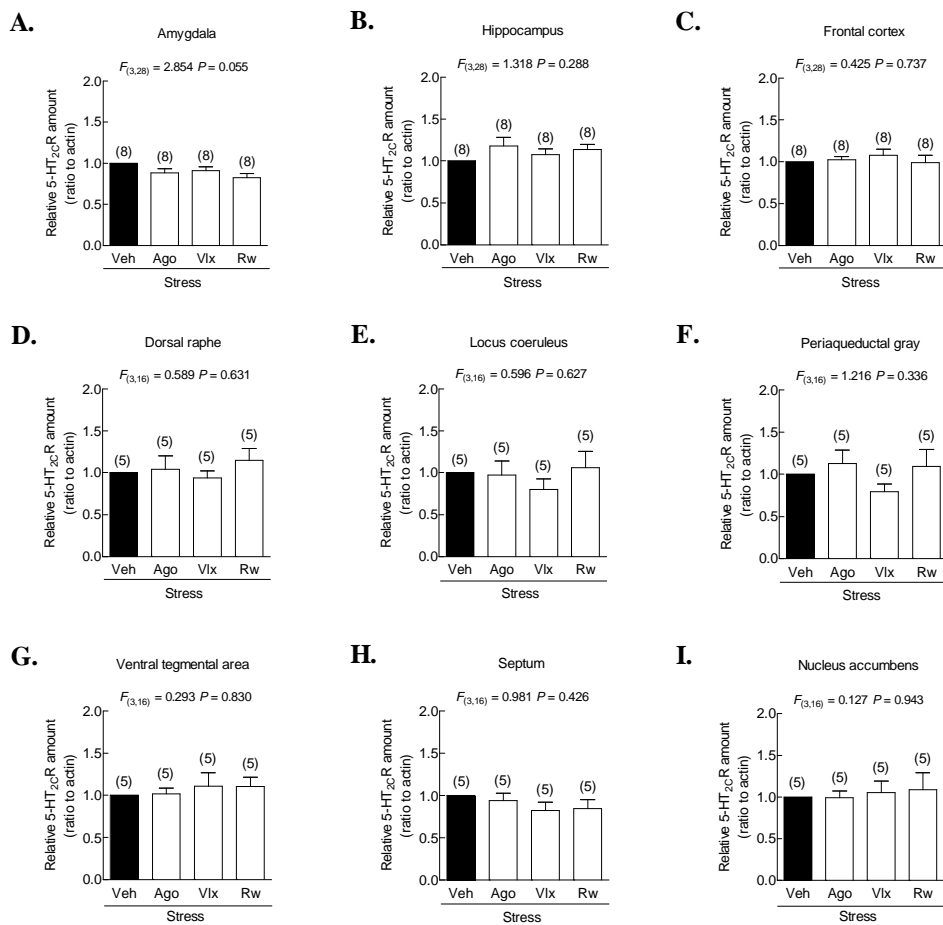

Figure 4.33 Protective effects of agomelatine (Ago), venlafaxine (Vlx) and voluntary wheel running (Rw) on the 5-HT_{2c}R protein levels. Numbers of animals are noted in parentheses. Veh; vehicle treatment.

Table 4.3 Changes in bio-behavioral parameters of preventive effects of the 4-week agomelatine, venlafaxine, and voluntary wheel running in stressed male rats.

Parameter		Ago	Vlx	Rw
Anxiety	EPM	↔	↓	↔
	ETM	↓↓↓	↓↓↓	↓↓↓
	OFT	↓	↔	↓
Depression	% SP	↔	↔	↔
	FST	↓↓	↓↓	↔
Learning	MWM	↑↑↑	↑↑	↑↑↑
Memory	MWM/NOR	↑↑↑	↑↑↑	↑↑↑
Locomotion	EPM/OFT	↔	↔	↔
Serum corticosterone		↑	↔	↔
BDNF		↓↓ in the LC	↑↑↑ in the hippocampus, ↓ in the septum	↑ in the hippocampus
GR		↔	↑ in the hippocampus	↔
NET		↓↓ in the PAG	↓↓ in the hippocampus and the PAG	↑↑ in the hippocampus and the LC
SERT		↓↓ in the septum	↓↓ in the septum	↔
5-HT _{2C} R		↔	↔	↔

Ago: agomelatine; BDNF: Brain-derived neurotrophic factor; EPM: elevated-plus maze; ETM: elevated-T maze; FST: forced swimming test; GR: glucocorticoid receptor; LC: locus coeruleus; MWM: Morris water maze; NET: norepinephrine transporter; NOR: novel objective recognition; OFT: open-field test; PAG: periaqueductal gray; SERT: serotonin reuptake transporter; SP: sucrose preference; Vlx: venlafaxine; Rw: wheel running; 5-HT_{2C}R: serotonin type 2C receptor.

Part II: Characterization of melatonin receptor expressing cells in the rodent brain using MT1 and MT2 melatonin receptor LacZ knock-in reporter mice: Identification of potential action sites of agomelatine on brain structures involved in stress.

Experiment 1. To validate and map MT1/MT2-LacZ expressing neurons in transgenic knock-in mice.

1. Genotyping of MT1/MT2-LacZ knock-in mice

The knock-in strategy is shown in the Figure 4.34A. The LacZ reporter gene was inserted at the MT1 or MT2 locus in order to investigate the expression pattern of MT1/MT2 gene. For both MT1 and MT2 loci, the LacZ transgene was inserted starting at the original ATG start codon, thus retaining all upstream and downstream regulatory sequences. Only potential regulatory elements contained in the intron of either the MT1 or the MT2 gene have been deleted by this strategy. Therefore, MT1/MT2-LacZ reporter knock-in mice were considered ideal tools to investigate the sites of expression of MT1/MT2 melatonin receptors in the absence of reliable specific antibodies for the immunocytochemical localization of these receptors.

We first selected heterozygous (MT1- or MT2-LacZ^{KI+}) for the initial investigations. These heterozygous animals have one intact MT1 or MT2 allele, thus reducing the risk of loss of the expression of the MT1/2 locus, or ectopic expression of the MT1/2 locus, because of the absence of functional MT1/2 receptors. Heterozygous carriers were also interbred to produce homozygous (MT1- or MT2-LacZ^{KIKI}) offsprings that were identified by genotyping PCR (Figure 4.34B).

In the genotyping of MT1-LacZ knock-in mice, a product of ~425 bp indicated the wild-type MT1 allele and a product of ~196 bp indicated the recombinant MT1-LacZ allele. Similarly, in the genotyping of MT2-LacZ knock-in mice, a product of ~143 bp indicated the wide-type allele and a product of ~666 bp indicated the recombinant allele.

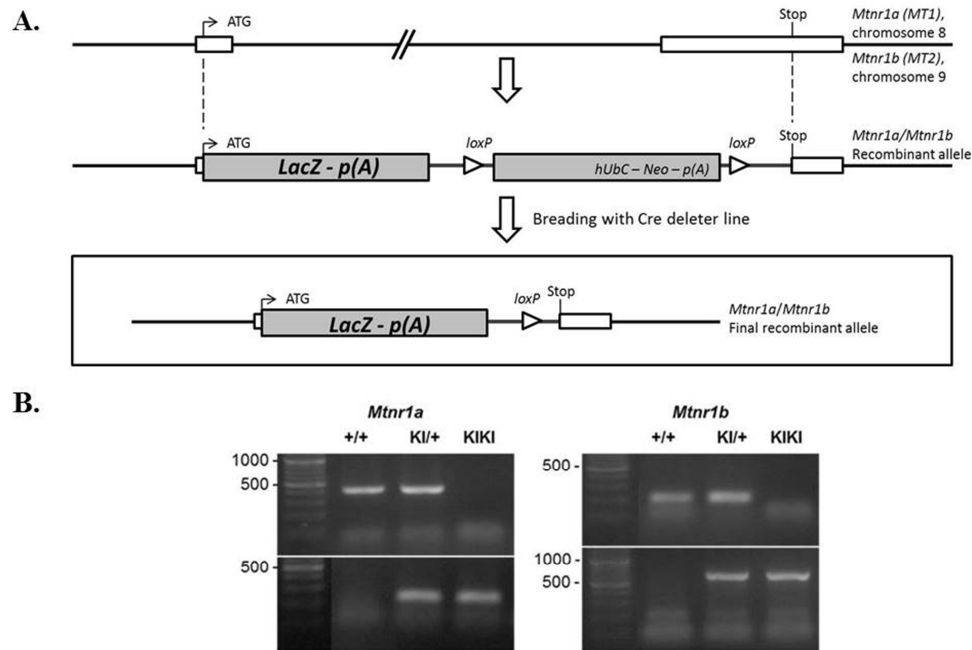

Figure 4.34 Generation of the MT1-/MT2-LacZ knock-in mice. (A) The MT1 or MT2 receptor gene locus organization before and after site-specific insertion. (B) Mouse genotyping by PCR for MT1-/MT2-LacZ transgenic knock-in mice.

2. LacZ mapping of MT1 and MT2 gene expression in the brain

Detection of LacZ enzymatic activity and LacZ protein expressing neurons were examined by X-gal histochemistry and immunocytochemistry respectively. Immunocytochemistry detected LacZ protein mostly in lysosomal accumulations as strongly stained dot-like structures, but also in the nucleus and sometimes in the cytoplasm (Figure 4.35A and C). There was also some diffuse background staining in immunocytochemistry that reduced the signal to noise ratio. X-gal histochemistry only stained the lysosomal accumulations of LacZ, and the absence of background resulted in a highly contrasted image (Figure 4.35B and D). Therefore, the staining of LacZ enzymatic activity was selected to map the patterns of MT1 and MT2 expression in these transgenic mice. Immunocytochemical detection of LacZ was used for the fine characterization of the MT1 and MT2 expressing cells by colabeling for phenotypic markers either by immunocytochemistry or by *in situ* hybridization.

No LacZ reporter activity was observed in the wild-type control mice. In MT1-LacZ heterozygous and homozygous mice, LacZ enzymatic activity was mainly restricted to the suprachiasmatic nucleus (SCN), the paraventricular nucleus of the thalamus (PVT), the *pars tuberalis* (PT) of anterior pituitary, and the supragenulate nucleus of the dorsal thalamus which were consistency with ¹²⁵I-iodomelatonin binding in in vitro autoradiography by Liu et al., 1997 (Figure 4.36). Other structures contained only isolated cells expressing the MT1-LacZ transgene (Figure 4.37).

The expression of the MT2-LacZ transgene in heterozygous and homozygous mice was much more wide-spread than that of the MT1-LacZ transgene. Large numbers of MT2-LacZ positive cells were seen in the olfactory bulb, the islands of Calleja, layer 3 of the cortical cortex, the superior colliculus, the amygdale and the arcuate nucleus of the hypothalamus. The MT2-LacZ was also expressed in the SCN, but much less intensely than the MT1-LacZ transgene. Interestingly in the context of our study, MT2-LacZ knock-in mice had a strong staining in the paraventricular nucleus of the hypothalamus (PVN), the cornu amonis 2 (CA2) of the hippocampus and in a population of small horizontal cells of the molecular layer of the dentate gyrus. In addition, there were low expression levels of both MT1 and MT2 in the cerebellum (Figure 4.37).

The pattern of expression of the MT1-LacZ and MT2-LacZ transgenes was confirmed by immunocytochemistry for the LacZ protein. The results of immunocytochemistry were similar to X-gal histochemistry. These results confirmed that LacZ expression in the mutant mice was faithful to the endogenous MT1 or MT2 protein expression (Figure 4.38–4.39).

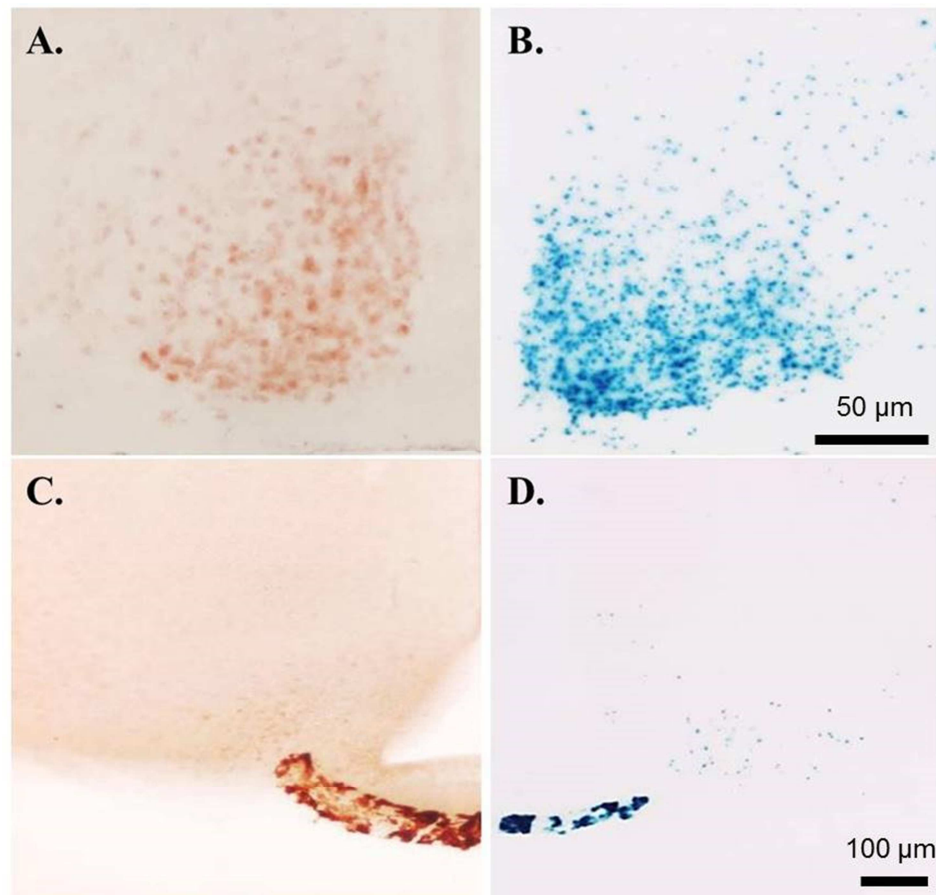

Figure 4.35 Comparison MT1-LacZ staining between immunocytochemistry (*A and C*) and X-gal histochemistry (*B and D*) in the suprachiasmatic nucleus (*upper*) and *pars tuberalis* of anterior pituitary (*lower*) of transgenic knock-in mice.

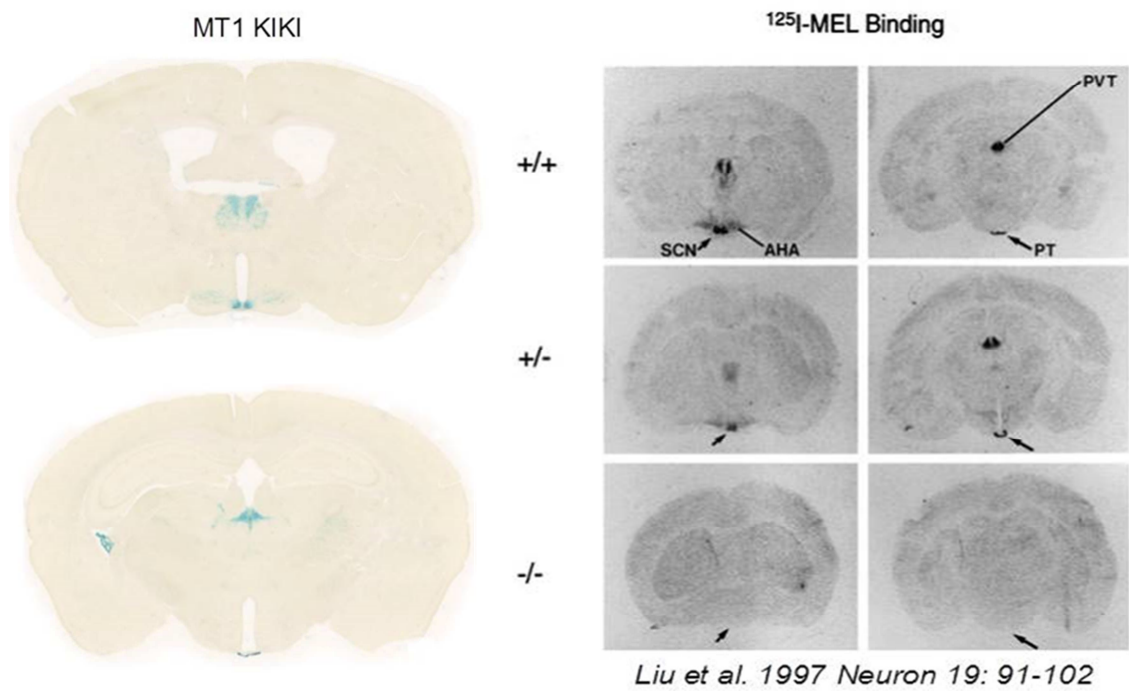

Figure 4.36 MT1-LacZ expressions in neurons as detected by X-gal histochemical staining compared to ^{125}I -iodomelatonin binding autoradiography by Liu et al., 1997.

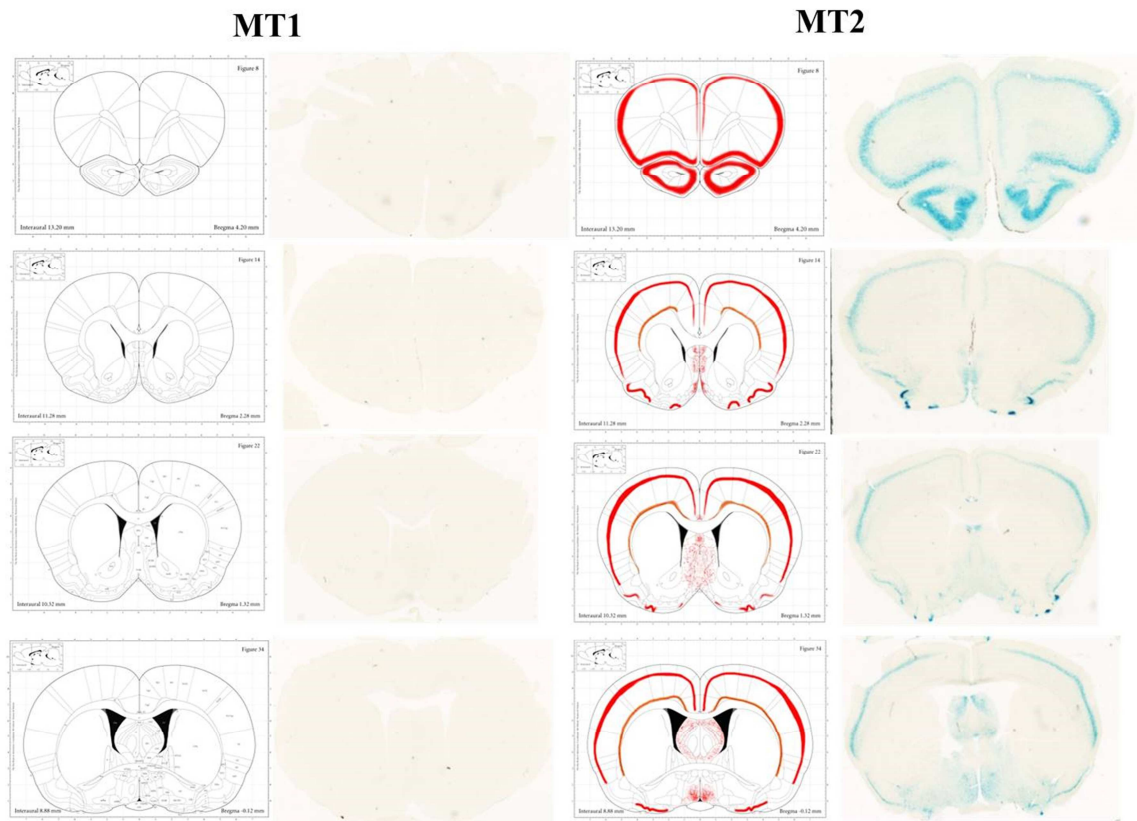

Figure 4.37 X-gal histochemical mapping of MT1- and MT2-LacZ expression.

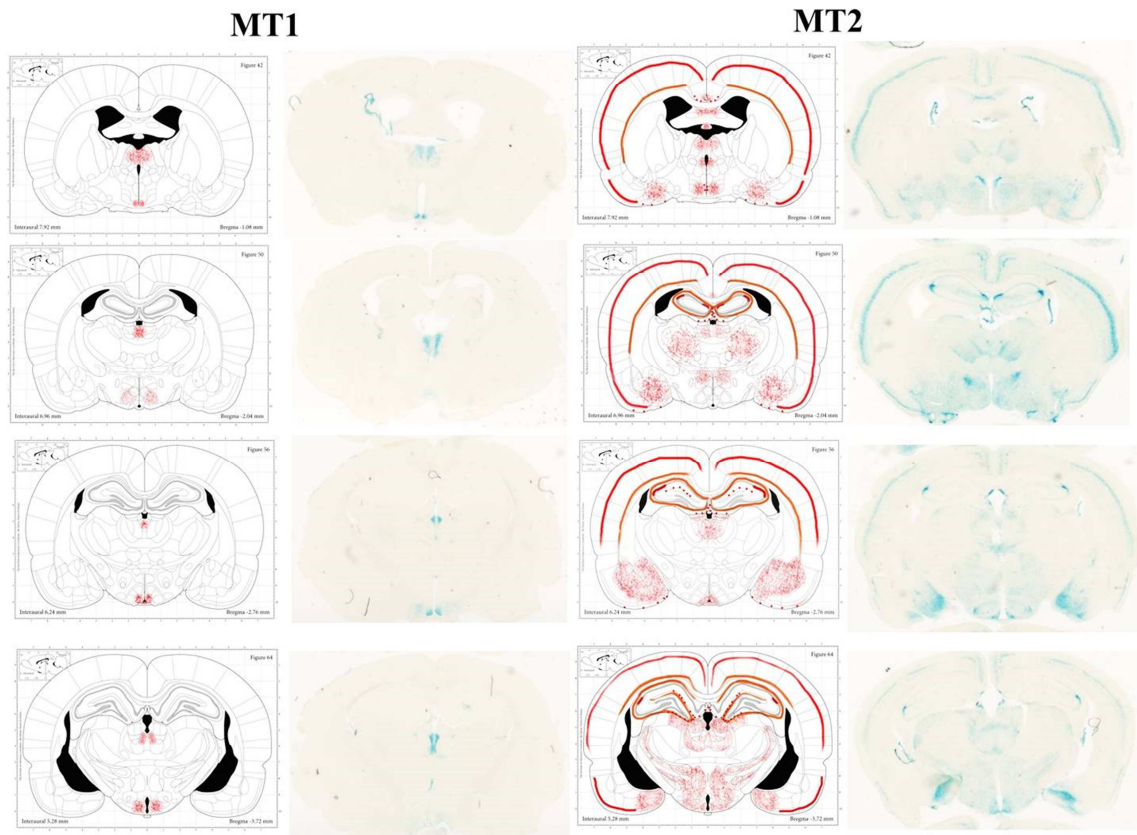

Figure 4.37 X-gal histochemical mapping of MT1- and MT2-LacZ expression (cont.).

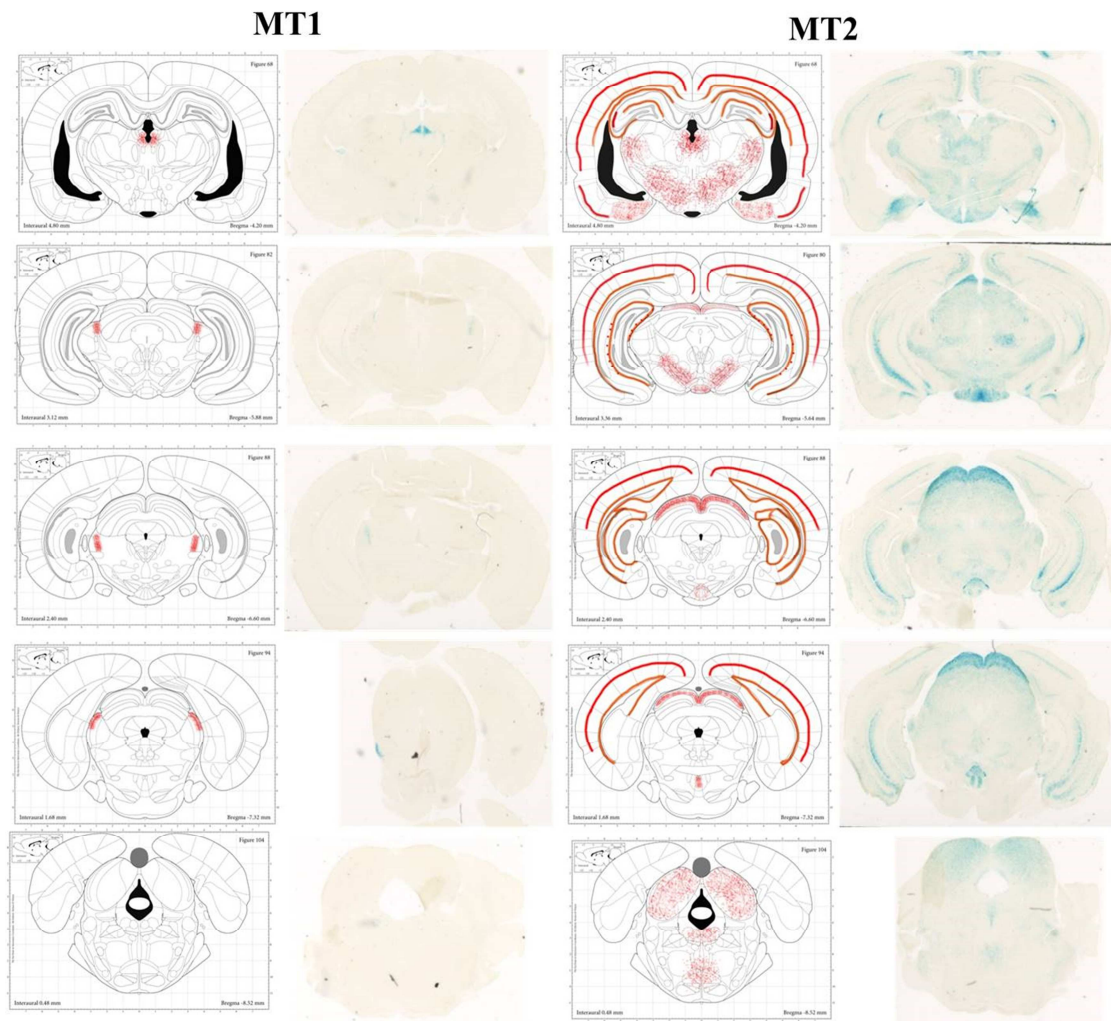

Figure 4.37 X-gal histochemical mapping of MT1- and MT2-LacZ expression (cont.).

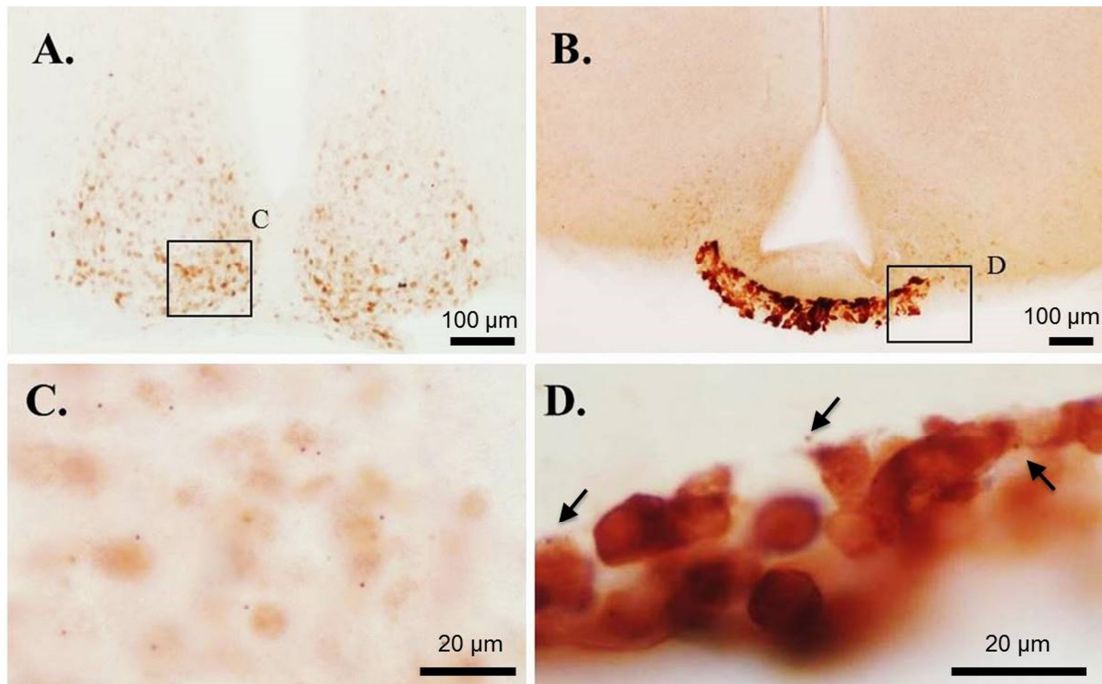

Figure 4.38 Immunocytochemical staining of MT1-LacZ expression in (A) the suprachiasmatic nucleus; SCN and (B) *pars tuberalis* of anterior pituitary; PT. Nuclear LacZ staining and lysosomal accumulation of LacZ can be seen in the SCN (C). In the PT (D), the cytoplasmic staining is very strong, but sometimes the lysosomal accumulation can also be seen (arrows).

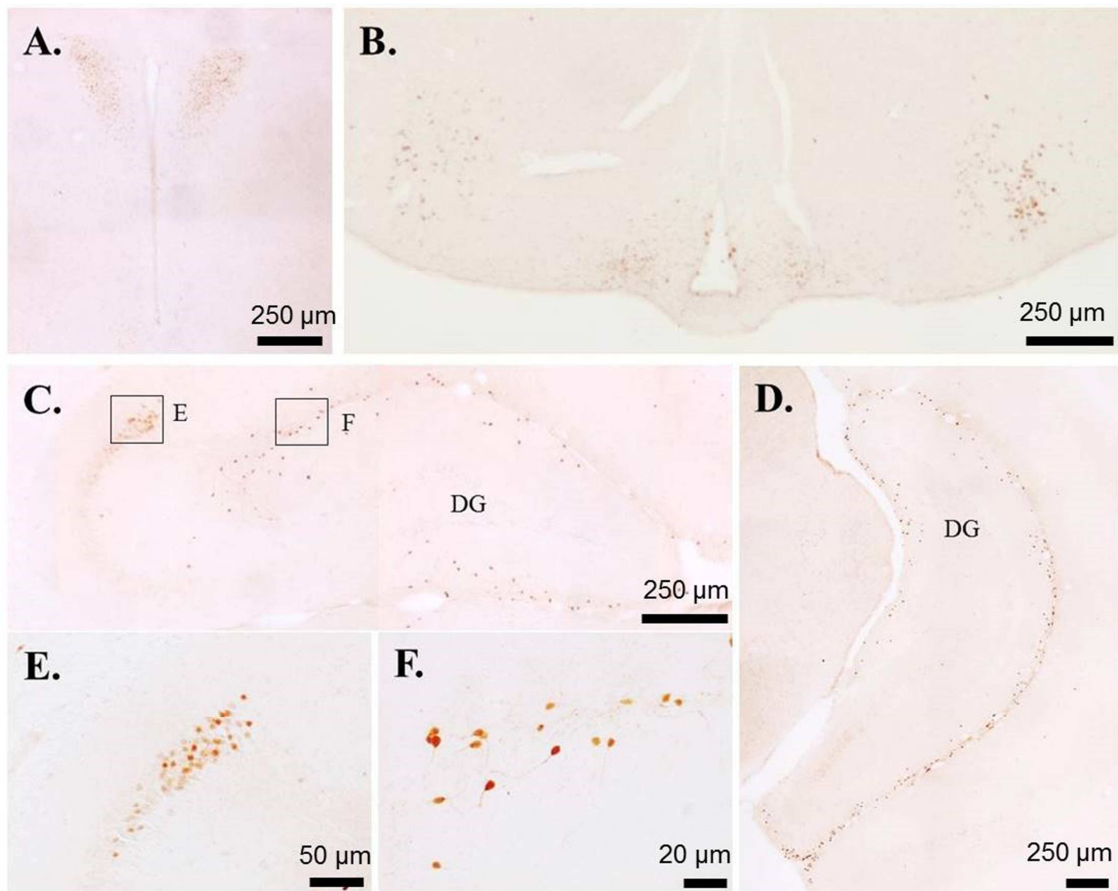

Figure 4.39 Immunocytochemical staining of MT2-LacZ expressing neurons in (A) the paraventricular nucleus of the hypothalamus, (B) the arcuate nucleus of the hypothalamus, (C) the dorsal hippocampus, (D) the ventral hippocampus, (E) the CA2 of the hippocampus, and (F) the molecular layer of the dentate gyrus. DG; dentate gyrus of hippocampus.

Experiment 2. To characterize the phenotype of MT1/MT2-LacZ expressing neurons in transgenic knock-in mice by determination of co-expressed neuropeptides and neuronal markers.

2.1 Co-localization of MT1-LacZ expressing neurons

Both X-gal histochemical and immunocytochemical staining in the previous experiment showed expression of the MT1-LacZ transgene in the SCN. Generally, neurons in the SCN subregions are distinguished by their neuropeptide contents. The SCN contains neurons containing AVP, GRP, and VIP in specific subregions. Therefore, these neuropeptides were selected for identifying MT1 expression in the SCN. Combined staining showed that MT1-LacZ expressing neurons co-localized with some, but not all, GRP and VIP neurons in the SCN, but did not co-localize with AVP neurons (Figure 4.40).

2.2 Co-localization of MT2-LacZ expressing neurons

MT2-LacZ expression was much more widespread than that of MT1-LacZ. We did not attempt to identify the phenotype of all MT2-LacZ expressing cells, but concentrated on those structures that are involved in the modulation of stress responses, in this case the PVN and the hippocampus.

The PVN contains CRH neurons, which are an important component of the HPA axis. CRH probes were cloned and applied on brain sections. MT2-LacZ expressing neurons co-localized with CRH in the PVN (Figure 4.41). Furthermore, MT2-LacZ expressing neurons co-localized with CRH in the layer III of cerebral cortex. Therefore, the co-localization of MT1 and CRH suggests that melatonin and agomelatine might directly modulate the HPA axis in the PVN, which may have implications for stress conditions such as depression.

Hippocampal interneurons express both the GAD1 and the GAD2 isoforms which synthesize GABA. Both isoforms are co-localized in 95% of GABA cells in hippocampus. Therefore, GAD 1 and 2 probes were cloned and double staining was performed with *in situ* hybridization and LacZ immunocytochemistry. MT2-LacZ expression was present in some GAD2 neurons in the hippocampus (Figure 4.42). GABAergic interneurons are inhibitory neurons. Melatonin signaling

through MT1 or MT2 receptors is mostly inhibitory. Thus MT action (and agomelatine action) should result in the inhibition of these inhibitory interneurons, and thus an activation of hippocampal activity. But in the CA2, MT2-LacZ expression is seen in the pyramidal neurons, which are excitatory glutamatergic neurons (Figure 4.43). Thus melatonin (and agomelatine) action should result in the selective inhibition of these CA2 neurons and thus an inhibition of CA2-mediated hippocampal action. The neurons staining most intensely for MT2-LacZ were small horizontal neurons located in the outer molecular layer of the dentate gyrus. No description of this population could be found in the literature and we could not colocalize these neurons with any of the neuropeptide markers we tested (i.e., calbindin, choline acetyltransferase, galanin, neuropeptide Y, and somatostatin). Only a very few of these cells colocalized with GAD.

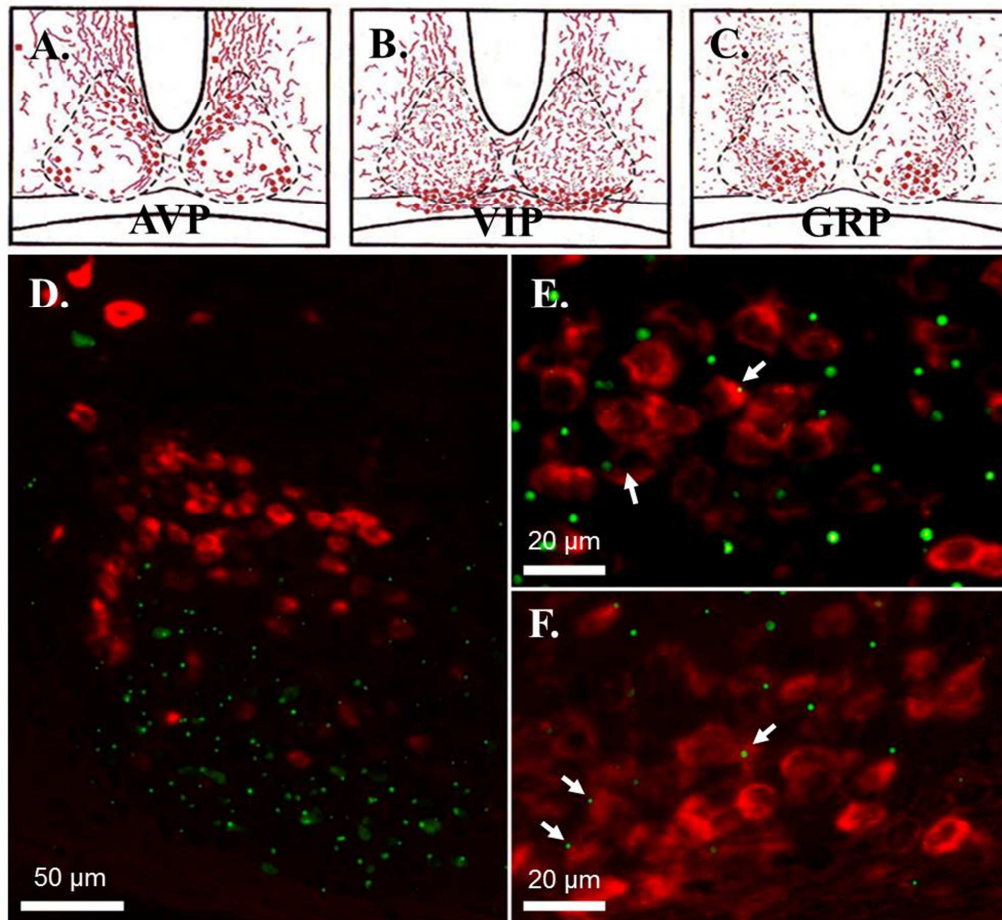

Figure 4.40 Double-labeling with MT1-LacZ-Immunohistochemistry (green) and non-radioactive *in situ* hybridization for neuropeptides (red). Diagram representing of the cell and fiber distributions of neuropeptides in the SCN (Abrahamson and Moore, 2001) (A) AVP, (B), GRP, and (C) VIP. For AVP, the green dots of the MT1-LacZ cells are clearly located outside of the area of the AVP cells (D). For VIP (E) and GRP (F) some red neuropeptide cells contain the green dot indicating co-expression of the MT1-LacZ transgene (arrows/arrowheads).

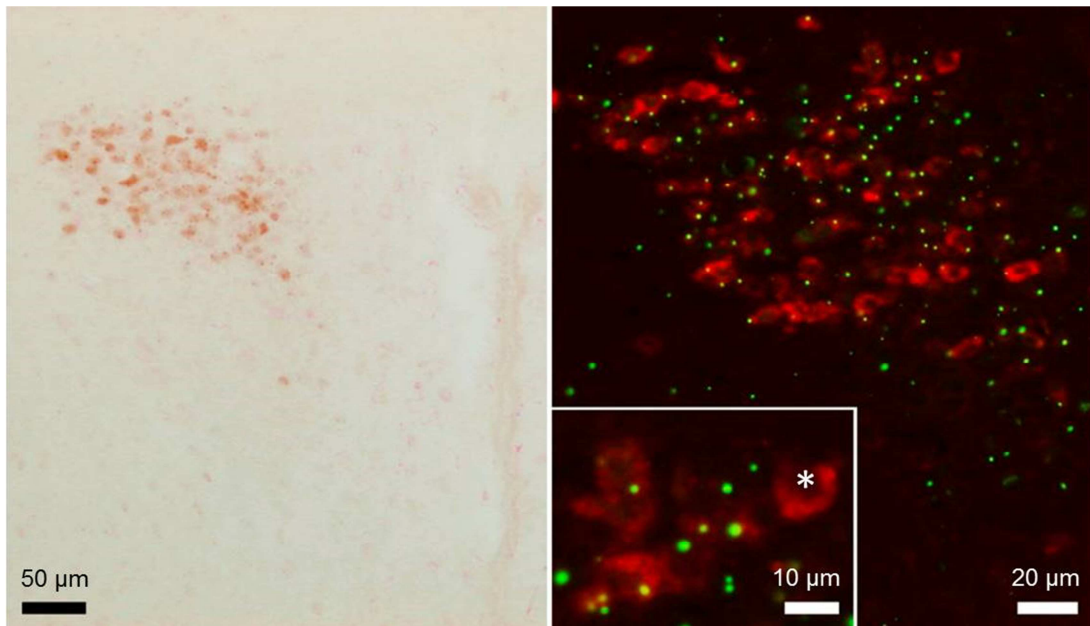

Figure 4.41 Double-labeling with LacZ-immunohistochemistry for MT2 (green) and non-radioactive *in situ* hybridization for CRH (red) in the paraventricular nucleus (PVN) of the hypothalamus. Inset shows a group of CRH cells that are MT2 positive. Asterisk shows CRH neurons without MT2 label. Most GRP cells are MT2 positive.

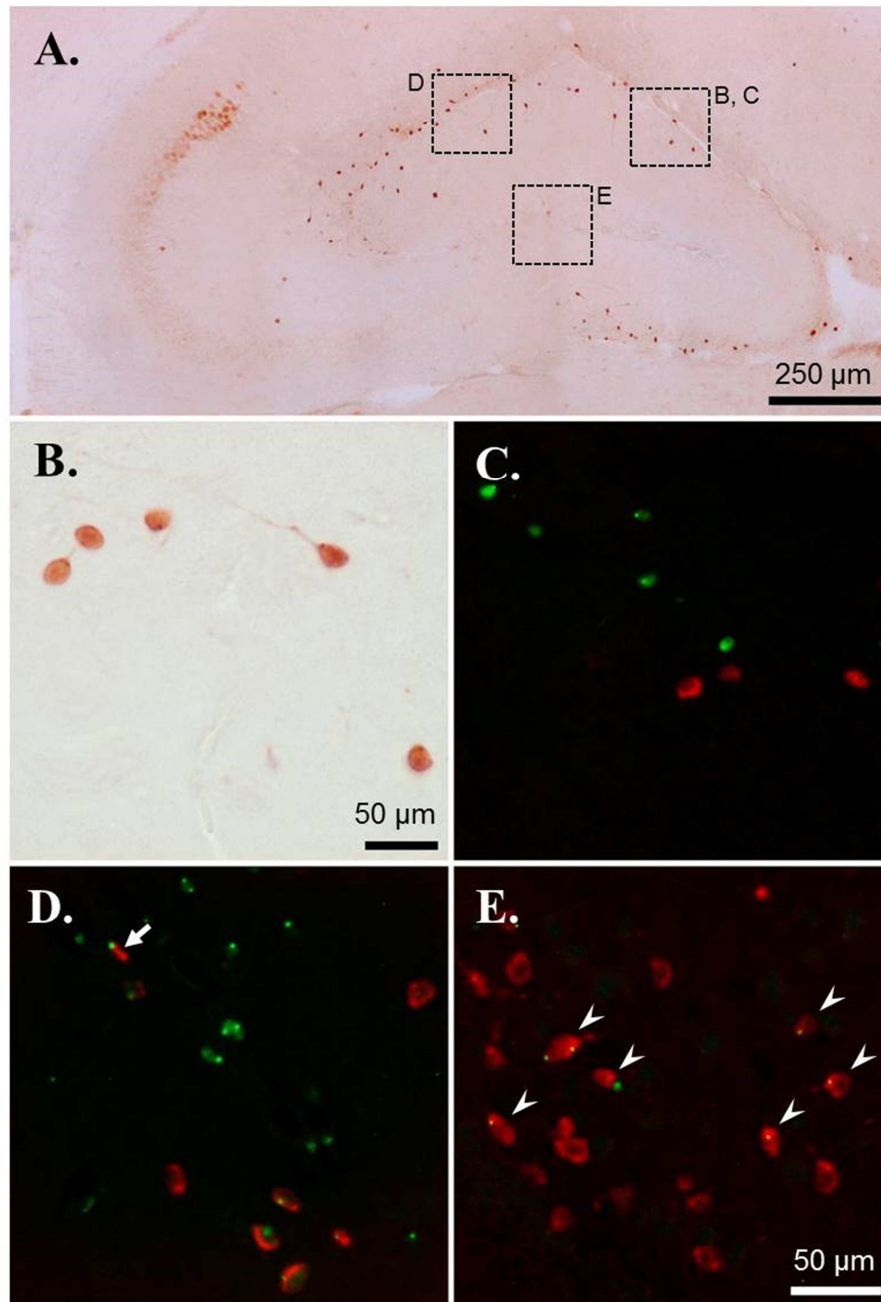

Figure 4.42 Double-labeling with LacZ-Immunohistochemistry and non-radioactive *in situ* hybridization for MT2 (green) and GAD (red) co-localization in the hippocampus (A). Most small horizontal MT2 positive neurons in the external molecular layer (B) are GAD negative (C). Only a few of these horizontal cells are GAD positive (arrow in D). Many GAD positive neurons in the dentate gyrus hilus are also MT2 positive (arrowheads in E).

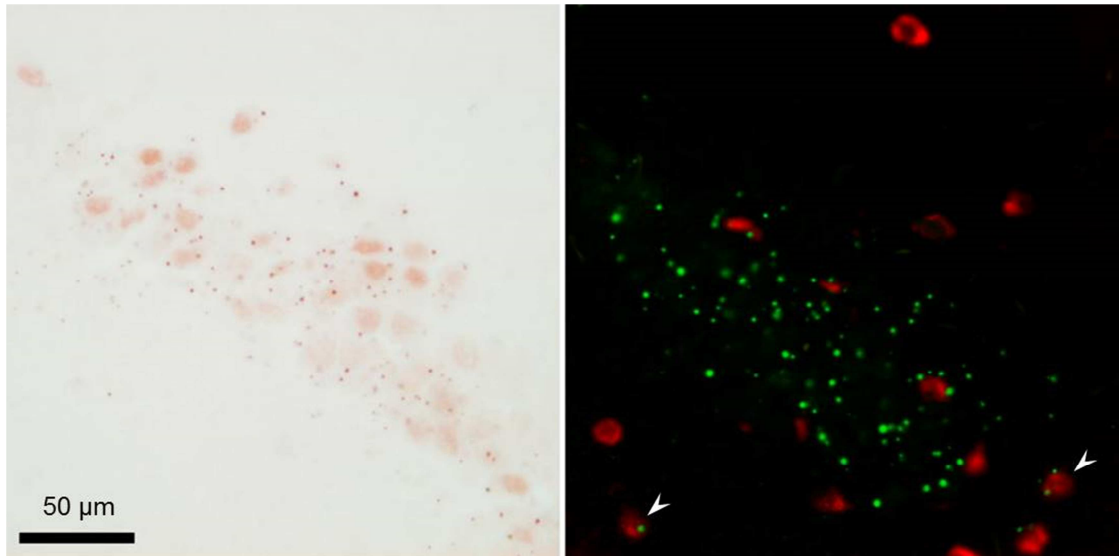

Figure 4.43 Double-labeling with LacZ-Immunohistochemistry and non-radioactive *in situ* hybridization for MT2 (green) and GAD (red) co-localization. The MT2 positive cells in the CA2 of the hippocampus are GAD negative. A few non-pyramidal cells of the CA2 are MT2 + GAD positive (arrowheads).

Table 4.4 Localization of MT1 and MT2 melatonin receptors in transgenic MT1-/MT2-LacZ knock-in mouse brains.

Brain regions	MT1	MT2
Cerebral cortex	isolated cells	✓✓ in layer III
Basal forebrain - Olfactory tubercle - Islands of Calleja	–	✓✓
Hypothalamus - Pre-optic area - SCN - PVN - Arcuate nucleus - Tuberal nucleus	– ✓✓ (Co-localized with GRP and VIP) – a few isolated cells – –	✓ ✓ ✓✓ (Co-localized with CRH) ✓ ✓
Thalamus - PVT - Posterior limiting nucleus - Dorsal anteromedial nucleus - Lateral habenula - Intermediodorsal nucleus - Ventral medial nucleus	✓ ✓	✓ ✓ ✓ ✓
Hippocampus - CA2 - Dentate gyrus – outer molecular layer - Dentate gyrus – hilus	–	✓✓ ✓✓ ✓ (Co-localized with GAD)
Amygdala	–	✓
Midbrain - Superior colliculus (optic tectum) - Inferior colliculus - Interpeduncular nucleus - Dorsal raphe	–	✓✓ ✓ ✓✓ ✓
Hindbrain - Nucleus incertus - Parabrachial nucleus		✓ ✓
Cerebellum	–	–
Pituitary gland - <i>pars tuberalis</i>	✓✓	–

CA2: *Cornu Ammonis*; CRH: Corticotropin-releasing hormone; GAD: glutamic acid decarboxylase; GRP: gastrin-releasing peptide; MT: melatonin receptor; PVN: paraventricular nucleus of hypothalamus; PVT: paraventricular nucleus of the thalamus; SCN: suprachiasmatic nucleus; VIP: vasoactive intestinal peptide.

CHAPTER V

DISCUSSION

5.1 Validation of restraint stress induction

Because restraint stress induces both physical and behavioral changes in animals, and it is often used to model mental illness in human (Keim and Sigg, 1977; Buynitsky and Mostofsky, 2009). The sustained circulating level of corticosterone induces a negative feedback that diminishes the release of CRH in the hypothalamus and ACTH from the pituitary gland. Restraint stress induction increases heart rate and blood pressure in rats (Irvine et al., 1997; McDougall et al., 2005). Stress-induced hyperactivation of HPA axis leads to adrenal hyperplasia and elevated serum and urine corticosterone levels (Ulrich-Lai et al., 2006).

In the present study, 4- and 8-week chronic restraint stress (2 h/day, 5 days/week) induced an increase in the adrenal gland weight in male rats. However, the absence of increased adrenal gland weight in the 1-week restraint stressed rats suggested that the 1-week duration was too short to produce long-lasting effects. Elevated corticosterone levels have been shown to cause a catabolic state and muscle wasting via lipolysis and glycogenolysis (Hasselgren et al., 1999; Adam and Epel, 2007). Corticosterone was reported to reduce appetite and body weight by downregulating hypothalamic neuropeptide Y/agouti gene-related protein and amphetamine-regulated transcript peptide mRNA expression levels resulting in a reduction in food intake and body weight gain (Liu et al., 2011). In addition, the intensity and duration of restraint stress on the body weight in stressed rats were associated with decreased levels of central monoamines and opioid peptides (Ely et al., 1997). Therefore, a decrease in food intake and an increase in adrenal gland weight could be used as appropriate indicators of physical change in stress induction.

5.2 Behavioral response to different durations of restraint induction

It has been shown that acute stress exposure led to anxiety in human and animal studies. Intense fear is present in posttraumatic stress disorders (Garner et al., 2009). However, behavioral responses in male rats were found to depend on the intensity of the stressors (Mercier et al., 2003). Apart from the acute stress reaction, chronic stress-induced increase in corticosterone levels disturbed the balance of monoamine neurotransmitters and neuronal function in several brain regions, thus contributing to the development of mood disorders and memory problems (Jezova and Hlavacova, 2008; Christoffel et al., 2011).

Herein, the study of different durations of restraint stress induction that stressed rats exhibited anxiety-, depression-, and memory impairment-like behaviors. Stressed rats had high anxiety as indicated by decreased open arm activity in the EPM test and decreased time spent in the inner zone of open arena with hyperarousal in the first 30s and stress-related behaviors (i.e., rearing and grooming) in the OFT test. The 1- and 4-week stressed rats further showed learned (conditioned) fear as indicated by increased avoidance latency, but not innate fear in one-way escape latency of the ETM test, suggesting that the subchronic and chronic restraint stress could produce a generalized anxiety disorder-like condition in rats without panic which was similar in human (Treit and Fundytus, 1988; Wood et al., 2008; Lapmanee et al., 2012; 2013).

Besides the anxiety-like behavior, the 4- and 8-week stressed rats showed strong emotionality and depression-like behavior as indicated by increased immobility time in the FST and altered sucrose preference. Reduction of sucrose preference in stressed rats indicated a decreased sensitivity to reward and may be homologous to anhedonia (Willner et al., 1996). These results were consistent with previous reports (Lapmanee et al., 2012; 2013). These changes are related to the hopelessness and anhedonic-like symptoms (a decreased ability to experience pleasures) in major depression (Strekalova et al., 2004; Cryan and Holmes, 2005). In addition, chronic stress in rats and mice has been shown to display several physiological changes that are also observed in patients with depression such as abnormal sleep cycle, reduced sexual function, and a disturbed circadian clock (Strekalova et al., 2004)

Changes in learning and memory were more complicated to apprehend. As shown in the MWM test, an increase in escape latency (an indicator of impaired spatial learning) was observed in the 4-week stressed rats (day 2), but the spatial learning was apparently improved in the 1-week stressed rats (day 3). These results suggest that the transitional period of stress promotes memory formation, but the memory does not last long. This was consistent with a previous finding that acute exposure to mild-to-moderate stress led to better learning in radial arm maze test (Luine et al., 1996). These results imply that the first role of stress is to improve the response to a stressful situation. The spatial memory or ability to retrieve previous consolidated information, as indicated by an increase in the time spent to reach the correct quadrant, was found to be impaired in the 1- and 4-week stressed rats. Furthermore, the NOR test showed that the 4-week stressed rats had poor ability to discriminate a previously explored object from a new object, a sign of cognitive or memory impairment (Redrobe et al., 2010, 2012; Antunes and Biala, 2012). Such stress on a short timescale is supposed to be “beneficial” because it improves the responsiveness to stressors, thus increasing the chance of the organism’s survival in dangerous situations. But this “reprogramming” of the physiological phenomena by stress does not last long. That is why long term stress becomes detrimental.

However, there was no alteration of motor skills or locomotor activities following chronic stress induction in the present study as suggested by the absence of change in total arm entries in the EPM, total lines crossed in OFT, or climbing duration in FST. Regarding approximately 80% change in the correct quadrant in all studied group, this means that both control and stressed rats spent a similar time in the correct quadrant (i.e., quadrant with a platform). Nevertheless, stressed rats required more time swimming around the correct quadrant before reaching the platform, as indicated by increased in the correct quadrant time. In other words, stressed rats remembered where the correct quadrant was, but required additional time to actually reach the platform.

Interestingly, it was not clear why some behavioral responses observed in the 1- or 4-week stressed groups were absent in the 8-week stressed group. However, it might be explained by habituation to prolonged restraining (Stamp and Herbert, 2001). The process of habituation involves the reduction of HPA axis activity and

deleterious actions of prolonged glucocorticoid (GC) secretion (de Kloet et al., 1998; Herman, 2013). The relationship between GC levels and behavioral adaptation has been reported as an “inverted-U” shaped curve, wherein an optimal level of GC signaling is required to produce the organismal response (Herman, 2013). GCs affect behavioral profiles that cause changes in learning task. For example, mice switch from spatial learning to stimulus-response learning by stress or corticosterone administration (Schwabe et al., 2010).

5.3 Differential target protein expression in the brain regions associated with stress responses

The underlying mechanisms of the restraint stress-induced led to aberrant behaviors and memory impairment are not completely understood. In the present study, the expressions of several target proteins, i.e., BDNF, GR, NET, SERT, 5-HT_{2C}R which are related to anxiety, depression, memory and/or stress, were investigated.

BDNF is an important regulator of the formation and plasticity of neuronal connectivity. BDNF is produced as a precursor (proBDNF), which is subsequently cleaved to become mature (m)BDNF. The proBDNF binds to p75^{NTR} receptors, whereas mBDNF binds to TrkB receptors. proBDNF-p75^{NTR} promotes hippocampal long-term depression (LTD) and apoptosis while mBDNF-TrkB promotes LTP and cell proliferation (Chao and Bothwell, 2002; Ibáñez, 2002). Restraint stress provides contrasting effects on the expression of BDNF mRNA and protein levels. Both intermittent restraint and chronic cold stress upregulated hippocampal BDNF protein levels (Adlard et al., 2004). Downregulation of BDNF expression was observed in depressed patients and a chronic mild stress model of depression in rodents (Gonul et al., 2005; Molteni et al, 2016). The present study found a downregulation of BDNF in the periaqueductal gray of the 1-week stressed rats and in the ventral tegmental area (VTA) of the 8-week stressed rats. Four-week restraint stress also downregulated BDNF in the hippocampus and the septum. It was

reported that stress-induced inflammatory cytokine production downregulated BDNF in the hippocampus and the prefrontal cortex, but upregulated BDNF in the nucleus accumbens (NA) leading to depression-like behavior in stressed male rats (Zhang et al., 2014). BDNF expression in the VTA–NA pathway plays a crucial role in resilience to social defeat stress (Krishnan et al. 2007). Antidepressant treatment for at least 4 weeks can restore the decreased BDNF levels to normal levels in stressed rats (Lee and Kim, 2010).

Prolonged high GC levels also down-regulate GR expression in the hippocampus and the prefrontal cortex controlling negative feedback (Chiba et al., 2012) leading to an impaired ability to regulate GC homeostasis. GR expression is another indicator of stress response (Boyle et al., 2005; de Kloet et al., 2005). There was the hyperactivity of the HPA axis in the 1-week stressed rats as shown by increased hypothalamic GR protein levels. On the other hand, the 4-week stressed rats had decreased levels of hippocampal GR indicating hyperactivity HPA axis in depression (de Kloet et al., 1998; Zhu et al., 2014). Moreover, the 4-week restraint stress markedly increased the MC2R protein levels suggesting an increased adrenal sensitivity to ACTH (Liu et al., 2013).

NET is a key protein regulating noradrenergic transmission and a site of action of TCA and NRIs. The 4-week stress induction upregulated NET protein levels in the LC similar to chronic social defeat (Chen et al., 2012; Fan et al., 2015). However, the upregulated NET in the locus should reduce noradrenergic transmission in the LC, but the reduction of NET in the PAG should act in this structure much like antidepressants, and thus stimulated noradrenergic transmission. Therefore, NET of the 4-week stressed rats showed adaptive change by downregulating its projections PAG (van Bockstaele and Aston-Jones, 1992). These results indicated that chronic stress activated the LC–noradrenergic system and caused depression-like behaviors.

Serotonergic transmission is critically regulated by serotonin reuptake via the SERT. Dysfunction of the SERT causes depression and anxiety disorders (Owens and Nemeroff, 1994). The 1- and 8-week restraint stress induction downregulated SERT protein levels in the VTA and the hippocampus. The 4-week restraint stress tended to downregulate SERT in the dorsal raphe. Acute restraint stress and social defeat decreased SERT in the raphe pontis and hippocampus (Berton et al., 1999;

Vollmayr et al., 2000). Where SERT is downregulated, less serotonin is reuptaken and thus longer 5-HT action is observed in the synaptic cleft. In contrast, upregulated SERT protein levels were observed in the chronic social defeat and ovariectomized rats exposed to chronic aversive stimuli (Zhang et al., 2012; Charoenphandhu et al., 2013).

The 5-HT_{2C}R regulates mood, anxiety, feeding, and reproductive behavior (Heisler et al., 2007). The 1- and 4-week restraint stress upregulated 5-HT_{2C}R protein expression in the amygdala while the 8-week restraint stress downregulated it in VTA. Changes in 5-HT_{2C}R RNA site editing were observed in the PFC of suicide patients with major depressive disorder and stressed rats (Niswender et al., 2001; Iwamoto et al., 2005). Activation of the 5-HT_{2C}R by serotonin inhibits DA and NE release in striatal and PFC rats (Alex et al., 2005) leading to depressive- and anxiety-like symptoms. In addition, isolation-reared rats showed high anxiety-like behavior and locomotor activities in EPM and OFT due to increased 5-HT_{2C}R protein levels and responsiveness (Fone et al., 1996).

Based on the physical and behavioral response to stress, the procedure of stress induction 2h/day, 5day/week for 4 weeks showed the most marked anxiety-, depression-, and memory impairment-like behaviors in male rats. These behavioral changes resulted from increased corticosterone levels, which altered target protein expression in various brain areas of stressed rats, especially BDNF and GR in the hippocampus. Therefore, the 4-week stress induction procedure was used to study the preventive effects of pharmacological and exercise interventions.

5.4 Validation of the voluntary exercise protocol

Physical exercise is known to provide several beneficial effects on physical and mental health. Moderate intensity aerobic exercise can prevent development of metabolic syndrome including obesity, diabetes mellitus, dyslipidemia, hypertension and cardiovascular diseases (McArdle et al., 2007; Booth et al., 2008). Regular aerobic exercise also reduces body fat accommodation, increases muscle growth and heart weight in both athletes and exercising animals

(Douglas et al., 1997; Wang et al., 2010; Lapmanee et al., 2013). The 4-week voluntary wheel running preserved cardiac performance as determined by an isolated working heart preparation (Kuczmarski et al., 2014). Voluntary wheel running alters the energy balance, body weight and composition, food intake and energy expenditure (Novak et al., 2012). Indeed, the results of voluntary wheel running in rodents are similar to the results of exercise in humans, i.e., increased muscle insulin sensitivity, increased skeletal muscle citrate synthase, and decreased visceral fat (Davidson et al., 2006; Henriksen and Halseth, 1995). Therefore, the physiological responses to voluntary wheel running can be considered a model of aerobic exercise. In this study, 4-week voluntary wheel running exercise resulted in body weight reduction and cardiac hypertrophy in both non-stressed rats and stressed rats. Therefore, the presence of body weight reduction and cardiac hypertrophy were used as indicator of the effective aerobic exercise protocol.

5.5 Modulating and protective effects of 4-week voluntary exercise on HPA axis dysregulation and stress-related behaviors in male rats.

Unlike forced exercise (e.g., treadmill running and swimming), voluntary exercise provides minimal physical and emotional stress (Leasure and Jones, 2008; Charoenphandhu et al., 2011). Four week voluntary wheel running increased the adrenal gland weight without a change in corticosterone levels in non-stressed male rats. This was consistent with a previous finding in which the 4-week voluntary wheel running had no effect on corticosterone concentrations, either the basal level or the peak level of the circadian rhythm in male Sprague-Dawley rats (Fediuc et al., 2006). But other studies reported elevated basal corticosterone levels after 3 weeks of wheel running in male Lewis rats (Makatsori et al. 2003) and C57BL/6 mice (Droste et al., 2003). These finding suggests that duration of voluntary exercise, strain of rats, animal species, and the timing of the circadian cycle can affect hormone levels and are important factors for basal HPA-axis activity.

Moreover, voluntary wheel running increases hippocampal BDNF and neurogenesis, and also enhances brain function by altering monoaminergic neurotransmission (Dishman, 1997; Cotman and Berchtold, 2002). In non-stressed rats, wheel running increased the quantity of 5-HT_{1A} receptor, while decreasing SERT mRNA level in the dorsal raphe, an area responsible for anxiety-like behavior (Greenwood et al., 2003, 2005). Voluntary wheel running also activated the dentate gyrus granule neurons and increased hippocampal neurogenesis through the upregulation of BDNF mRNA expression (van Praag et al., 1999). It is already well established that regular exercise provides several physiological and psychological advantages. Voluntary wheel exercise promotes brain health and has both antidepressant and anxiolytic effects in rodents and human (Burghardt et al., 2004; Ströhle, 2009; Greenwood et al., 2012).

Anti-stress effects of voluntary exercise possibly involve decreased perception of chronic stress by modulating neurotransmitters, growth factors, cytokines, and HPA axis (Sanches et al., 2016). In the present study, 4-week voluntary wheel running prevented the stress-induced decrease in sucrose preference in experiment 2. Previous reports showed that 4-week voluntary wheel running exerted anxiolytic- and antidepressant-like action as evaluated by the ETM, EPM, FST, and shuttle box escape deficit (Zheng et al., 2006; Duman et al., 2008; Greenwood and Fleshner, 2008; Lapmanee et al., 2013). In addition, increased BDNF protein and mRNA was observed after 4 weeks of voluntary wheel running, and thus responses enhanced learning and memory on MWM task (Adlard and Cotman, 2004).

Furthermore, voluntary wheel running decreased the central NET, SERT, and 5-HT_{2C}R in brain circuits of the reward system (i.e., LC, VTA, DR, PAG, and NA). Stress promoted activity of HPA axis as indicated by increase in corticosterone, which in turn feedbacked to decrease GR in the hippocampus. Exercise tended to reduce corticosterone possibly by decreasing ACTH (MC2R) receptors in the adrenal glands. The combined exercise and stress partially decreased the basal serum corticosterone levels, upregulated hippocampal BDNF, and downregulated adrenal MC2R and 5-HT_{2C}R in the PFC. BDNF plays a role in regulating hippocampal functions related to the reward system or the HPA axis activity (Gasic et al., 2009; Taliaz et al., 2011). These results thus suggest that voluntary exercise could reduce

the negative effect of chronic stress by modulating sympathetic activity and the HPA axis, which subsequently results in decreased corticosterone secretion (Droste et al., 2007; Patki et al., 2014).

Therefore, the sympathoadrenomedullary input is likely to play a role in glucocorticoid responses to the 4-week restraint stress. Four-week voluntary wheel running was thus effective in preventing the stress-induced anhedonia by modulating central target proteins in the brain structures and neural pathway of the reward systems.

5.6 Effectiveness of monoamine modulators and voluntary exercise in the prevention of stress-induced anxiety-, depression-, and memory impairment in male rats

Both pharmacological treatments (i.e., agomelatine and venlafaxine) and voluntary wheel running successfully prevented anxiety-like behavior, especially the learned fear (i.e., generalized anxiety disorder-like), as well as the impairment of spatial learning and memory in restraint stressed rats. Drugs and exercise had no impact on locomotor activity in the EPM and OFT. However, only pharmacological treatments, but not voluntary wheel running in rats showed a protective action against depression-like behavior and impaired memory in FST and NOR test, even though running concurrently with stress could reduce depression-like behaviors (Lapmanee et al., 2013). The finding of agomelatine-induced reduction in depression-like behavior was consistent with the previous reports using other behavioral tests. For example, Païzani and co-workers (2010) reported that, after agomelatine treatment, immobility was significantly reduced in mice subjected to the tail suspension test.

The corticosterone levels were above basal non-stressed levels in all 4 groups (even worse for the Ago group), thus indeed they all had high corticosterone levels. At the cellular level, stressed rats pre-treated with agomelatine or venlafaxine seemed to be sensitive to sustained high corticosterone levels, which resulted in a downregulation of BDNF through stress in the hippocampus and the septum, and in

both locations, this was counteracted and improved by wheel running. The GR was also downregulated but only in the hippocampus. As for SERT and NET, significant changes by stress are solely limited to the hippocampus and dorsal raphe for SERT and to the LC and the PAG for NET. Furthermore, venlafaxine and voluntary wheel running increased the levels of hippocampal BDNF protein in stressed male rats. Thus, the present findings demonstrate that both venlafaxine and exercise exert a protective effect against anxiety, depression, and memory impairment by restoring hippocampal GR and upregulating BDNF expression in stressed rats. These results suggest that change in corticosterone levels is not associated with the preventive effects of agomelatine treatments. Presumably, the blockade of 5-HT_{2C}R receptors causes enhanced release of both NE and DA at the fronto-cortical dopaminergic and noradrenergic pathways and promotes hippocampal cell proliferation, which in turn could be the underlying mechanism of the preventive action against stress-induced behavioral abnormality (Millan et al., 2000; 2003; Dagytė et al., 2010). Although pre-treatment did not alter 5-HT_{2C}R protein levels, there was a tendency towards a downregulation of the 5-HT_{2C}R in the amygdala of the exercise group. This result might suggest anxiolytic effects of voluntary exercise on stress-induced 5-HT_{2C}R upregulation in stressed rats (Greenwood et al., 2012).

Since the beneficial effects of the studied drugs and exercise were observed without changes in serum corticosterone levels, it is plausible that agomelatine, venlafaxine, and exercise might have already induced a long-lasting adaptation in monoaminergic neurotransmission or even neurogenesis in the brain, which lasted throughout the entire stress periods. For instance, agomelatine is known to stimulate cell proliferation within the dentate gyrus of rodents (Banasr et al., 2006). Venlafaxine also enduringly modulated monoaminergic neurotransmission by increasing 5-HT, DA and NE levels in the PFC and striatum (Higashino et al., 2014), and increasing the expression of BDNF protein in rat hippocampus (Cooke et al., 2009). BDNF possibly promoted the function and survival of dopaminergic, GABAergic, noradrenergic, and serotonergic neurons (Connor and Dragunow, 1998). Improvement of memory by venlafaxine and running exercise could be explained by increased BDNF expression in the hippocampus (Li et al., 2011; Liu et al., 2009), which is one of the utmost important brain structures for learning and memory.

Furthermore, voluntary wheel running exhibited SSRI and/or NRI-like actions (Engesser-Cesar et al., 2007; Lapmanee et al., 2013). During exercise, NE in the cell body and its metabolites were also increased in the pons, medulla oblongata, and spinal cord of rats (Dunn et al., 1996). The mRNA expression of 5-HT_{1B} and α 1 β adrenergic receptors was upregulated in the locus coeruleus and dorsal raphe (Greenwood et al., 2005), which could in turn alter adrenergic and serotonergic activities, respectively.

As aforementioned, it is possible that agomelatine, venlafaxine and voluntary wheel running can normalize and coordinate the balance of glucocorticoids and neurotransmitter metabolism, and induce long-lasting adaptations in monoaminergic neurotransmission or neurogenesis in the brain (Cotman and Berchtold, 2002; Dągystę et al., 2010; Huang et al., 2015), throughout the entire stress period.

Finally, the present findings suggest that, in a situation in which future exposure to stress is anticipated such as extreme military combat or war, infectious disease outbreak, and natural disaster, administration of melatonergic modulator (agomelatine), SNDRI (venlafaxine), and voluntary moderate-intensity exercise could be useful in the prevention against the posttraumatic development of mood disorders and memory impairment.

5.7 Mapping and characterization of MT1-/MT2-LacZ expressing neurons in transgenic knock-in mouse models

Melatonin (MT) not only plays a role in the mammalian circadian rhythm but also modulates mood, emotion, and memory. It also acts as a neuromodulator by interacting with its central and peripheral MT receptors (Dubocovich, 2007; Pévet, 2016). Thus, it is important to demonstrate the localization of MT receptor in the central nervous system. In the present study, the mouse brain was examined for the expression of the MT gene at the cellular level, using the LacZ reporter gene to the

targeting on MT1 or MT2 receptor gene locus downstream of the endogenous MT receptor regulatory elements.

Previous studies described the distribution of high-affinity binding sites for ^{125}I -iodomelatonin or localized the mRNA expression of MT receptors (Dubocovich et al., 2010). These investigations identified numerous structures containing neurons expressing MT receptor genes (Masson-Pévet et al., 1994). Unfortunately, there are no reliable specific antibodies for MT1 and MT2 immunocytochemical detection. Therefore, we used X-gal histochemistry and immunohistochemistry to map the distribution of both MT1 and MT2 receptors in these transgenic reporter mice. MT1-LacZ positive cells were restricted to a few structures such as the SCN, the paraventricular nucleus of the thalamus, the posterior limiting nucleus of the thalamus and the *pars tuberalis* (PT) of the adenohypophysis. This MT1-LacZ labeling is perfectly superposable to the ^{125}I -iodomelatonin binding sites, thus validating our approach (Liu et al., 1997). On the other hand, MT2-LacZ positive cells were detected in many structures throughout the brain such as the olfactory bulb, the islands of Calleja, the SCN, the cerebral cortex, the superior colliculus, the amygdala and the arcuate nucleus of the hypothalamus. MT2-LacZ knock-in mice also had a strong staining in the PVN, the CA2 and a population of small horizontal cells in the outer molecular layer of dentate gyrus of the hippocampus.

MT1 and/or MT2 receptors are present in the SCN and PT which have high concentration of MT binding sites (Vaněček, 1987; Morgan et al., 1989; Weaver et al., 1989). The distinct presence of MT1 and MT2 receptors in different brain areas suggests distinctive functions for each receptor in neurophysiology and neuropathology (Comai and Gobbi, 2014; Lacoste et al., 2015). MT binding sites are found predominantly in the median eminence, SCN, area postrema, paraventricular thalamic nucleus, hypothalamus, hippocampus, parietal cortex, striatum, PT, medial region of the lateral habenula, arcuate nucleus, and amygdala of the rats and mice (Laudon et al., 1988; Weaver et al., 1989; Masson-Pévet et al., 1994; Williams et al., 1995). MT1 and MT2 receptors are localized in regions known to contribute to anxiety and stress, e.g., the septal area, the habenula, and the dentate gyrus of hippocampus (Yadin et al., 1993; Karakaş et al., 2011). Regarding MT receptor

mRNA expression in rodent brain, MT1 receptor mRNA was detected in the rodent dorsal striatum, NA, olfactory tubercle, substantia nigra, and VTA. Also, MT1 and MT2 receptor mRNA expressions have been found in the SCN and vestibular nuclei (Us et al., 2005; Imbesi et al., 2008; Ahn et al., 2012). In human studies, MT1 mRNA and protein were detected in the hypothalamus, the cerebellum, the PFC, the NA, the amygdala, and hippocampus (Weaver et al., 1993; Mazzucchelli et al., 1996; Wu et al., 2006), and MT2 receptor transcripts were detected in the hippocampus (Musshoff et al., 2002).

The SCN is the master circadian clock and a target the drug discovery in circadian-dependent pathogenesis. Neurons in the SCN subregions are distinguished by their neuropeptide contents, i.e., AVP, GRP, and VIP, while AVP cells are the output of the SCN central clock, VIP cells are the input and GRP cells the core of the clock (Abrahamson and Moore, 2001; Welsh et al., 2010). MT1-LacZ expressing neurons co-localized with some GRP and VIP neurons in order to synchronize the endogenous circadian rhythms. Therefore, MT can act through MT1 receptors on the input and the inner working of the clock. MT2-LacZ expressing neurons were located more diffusely throughout the SCN and around it.

MT2-LacZ expressing neurons were also located in brain regions associated with stress responses, particularly the PVN and the hippocampus, both of which are important components of the HPA axis (Smith and Vale, 2006). The present study found that MT2-LacZ expressing neurons co-localized with CRH in the PVN, suggesting that melatonin and agomelatine might directly modulate the HPA axis at the PVN. As MT2 receptor signaling is mostly inhibitory, agomelatine action on the CRH neurons should thus reduce the activity of these neurons and reduce the secretion of CRH. Reduced secretion of CRH should result in a decrease in corticosterone levels. We observed however higher levels of corticosterone in the agomelatine-treated animals. Agomelatine being a combined MT1/M2 agonist and 5-HT_{2C} receptor antagonist, further studies of this complex pharmacological profile might help us to understand this apparently contradictory result.

Furthermore, MT2-LacZ expressing neurons were co-localized with GAD2 in the hippocampus (Stone et al., 1999). These results could imply that the actions of MT and agomelatine result in the inhibition of these inhibitory

interneurons, and thus an activation of hippocampal activity (Chamberland and Topolnik, 2012). However, MT2 receptors also seem to be very selectively placed on pyramidal neurons of the CA2. These pyramidal neurons are known to be glutamatergic, and thus MT or agomelatine action on these neurons should result in the selective inhibition of CA2 mediated functions. Thus MT and agomelatine should activate the hippocampus, but selectively inhibit CA2. How this dual action impacts hippocampal tasks and the hippocampal action on the HPA axis remains to be established.

In addition, MT2-LacZ expressing cells were observed in the dorsal raphe. This brain region apparently does not contain 5-HT_{2C}R, but the 5-HT_{2C}R is involved in negative serotonin feedback to the dorsal raphe through GABAergic neurons around the dorsal raphe, which express 5-HT_{2C}R (Serrats et al., 2005). Thus agomelatine might act directly on dorsal raphe and indirectly through this GABAergic 5-HT_{2C} feedback. As an agonist on MT2 receptors in the dorsal raphe, it might inhibit these serotonergic neurons. As a 5-HT_{2C} antagonist, it could block 5-HT negative feedback, which in turn could therefore stimulate the dorsal raphe. Thus this action is probably quite complex because it would both directly inhibit the dorsal raphe and indirectly stimulate the same structure. Therefore, the dorsal raphe is another target of interest for agomelatine.

CHAPTER VI

CONCLUSIONS

The aims of the present study were first, to examine the effects of restraint stress on anxiety-, depression-, and memory impairment-like behaviors at different time points, and second, to determine the preventive therapeutic effects of monoamine modulators (agomelatine and venlafaxine) and voluntary exercise in stressed male rats. Changes in the physical and behavioral parameters and protein expression levels in the brain regions associated with stress responses were investigated. In addition, possible sites of action for agomelatine administration were identified in melatonin (MT) MT1- and MT2-LacZ knocked-in mouse.

The conclusions are as follow with a summary in the Figure 6.1.

Four week restraint stress in male rats resulted in decreases in food intake and body weight gain, adrenal hypertrophy, and increased serum and urine levels of corticosterone. Increased levels of corticosterone could alter central the target proteins, i.e., brain-derived neurotrophic factor (BDNF), glucocorticoid receptor (GR), norepinephrine transporter (NET), and serotonin type 2C receptor (5-HT_{2C}R) in the amygdala, hippocampus, locus coeruleus, and periaqueductal gray (PAG) leading to manifestation of anxiety-, depression-, and memory impairment-like behaviors.

Four week voluntary aerobic wheel running exercise protocol were found to partly prevent the stress-induced increase in serum corticosterone levels and anhedonia-like behavior, most probably by deregulating adrenal adrenocorticotrophic hormone (ACTH) receptors, and altering target protein expression levels (i.e., BDNF and NET) in the brain structures specially involved in stress response, i.e., hippocampus, septum nuclei, locus coeruleus, and periaqueductal gray. Therefore, voluntary exercise could reduce the negative effect of chronic stress by modulating sympathetic activity in the central and peripheral hypothalamic-pituitary-adrenal (HPA) axis.

The study also revealed that agomelatine, venlafaxine as well as voluntary wheel running prevented the restraint stress-induced anxiety/depression-like behaviors and memory impairment in male rats. Upregulation of hippocampal BDNF protein levels might be a possible mechanism underlying the protective effects of venlafaxine and voluntary exercise in stressed male rats.

Regarding the applications of the present findings for clinical use, voluntary exercise should be recommended as an alternative treatment or used in concert with pharmacological treatments (i.e., agomelatine or venlafaxine) for the treatment of anxiety-, depression-, and memory impairment-like symptoms in patients and stressed individuals.

Indeed, mapping and phenotyping of MT1 and MT2 receptors expressing neurons indicate possible sites of action for melatonin or melatonin derivatives. MT1-LacZ expressing neurons were found in some studied areas, i.e., suprachiasmatic nucleus (SCN), paraventricular nucleus of thalamus (PVT), and *pars tuberalis* (PT) of anterior pituitary gland, whereas MT2-LacZ expressing neurons were more widely distributed throughout the whole brain, e.g., SCN, paraventricular nucleus of hypothalamus (PVN), dorsal raphe (DR), amygdala, and CA2 of hippocampus. Further studies are required to clarify the mode of action of agomelatine.

Taken together, the 4-week stress caused hyperactivity of HPA axis and increased glucocorticoid/corticosterone levels leading to hippocampal GR and BDNF downregulation. Four-week voluntary wheel running modulated the HPA axis and partially decreased corticosterone levels by downregulating adrenal ACTH receptor and also promoted hippocampal BDNF upregulation resulting in decreased anhedonic-like behaviors in stressed male rats. Furthermore, voluntary exercise prevented stress-induced anxiety, depression, and memory impairment. Pre-treatment with venlafaxine directly inhibited NET to increase norepinephrine (NE) in the synaptic cleft and mediated antidepressant and anxiolytic effects via hippocampal BDNF production. In addition, pre-treatment with agomelatine, a MT receptor agonist, effectively prevented stress-related behaviors. Potential sites of action for these effects through MT1 and MT2 receptors are the SCN, the PVN, the dorsal raphe (DR), and the hippocampus.

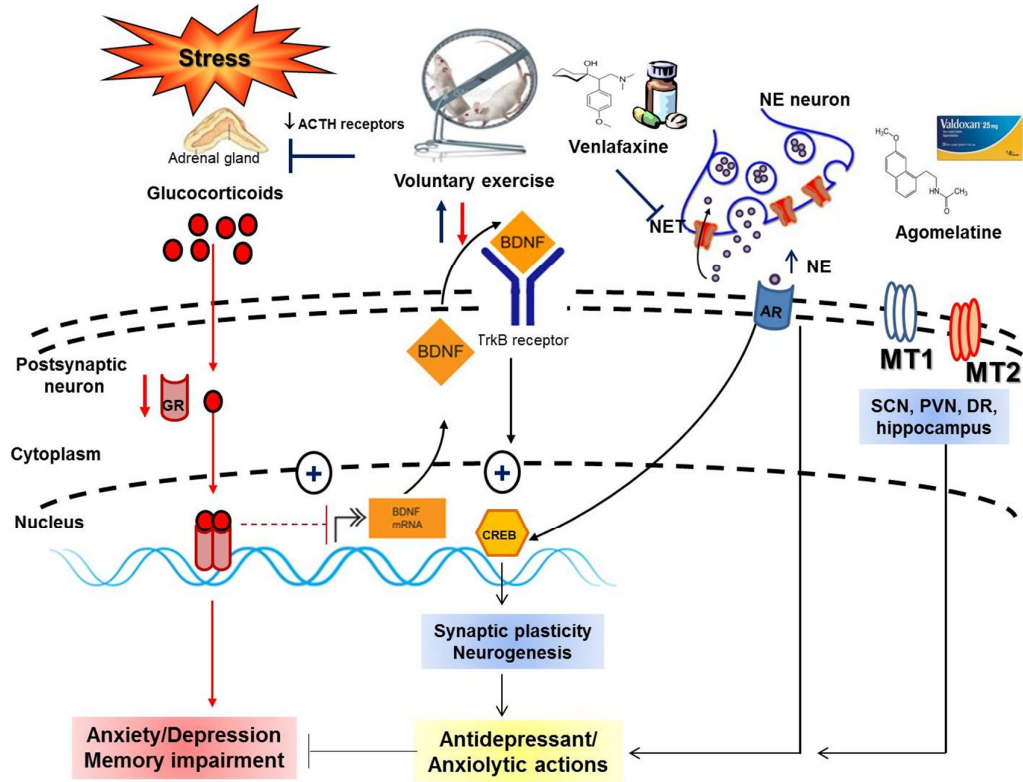

Figure 6.1 Diagram showing the summary results in this present study.

Effets neuroprotecteurs de l'exercice volontaire et de modulateurs monoaminergiques chez le rat mâle stressé

A. Introduction et objectifs

Le stress est un facteur important dans le développement de troubles de l'humeur tels que l'anxiété, la dépression et des troubles de la mémoire. Les troubles de l'humeur liés au stress sont des maladies psychiatriques en train de devenir un fardeau mondial d'invalidité et de comorbidité (Kessler et al. 2009). Les mécanismes sous-tendant les troubles de l'humeur chez l'individu stressé sont supposés être un dérèglement de l'axe hypothalamus-pituitaire-surrénalien (HPS) et un déséquilibre des monoamines sérotonine (5-HT) et noradrénaline (NA) (Bowman et al. 2003, Belmaker & Agam 2008). L'implication de 5-HT et NA dans la dépression est confirmée par l'action antidépresseur d'inhibiteurs de la recapture de ces molécules par les transporteurs de la sérotonine (SERT) et de la noradrénaline (NET). Ces inhibiteurs de recapture augmentent la concentration et la durée d'action de 5-HT et de NA dans la fente synaptique (Charney 1998, Bowman et al. 2003, Belmaker & Agam 2008). Outre la dérégulation de l'axe HPS, le stress perturbe aussi les rythmes circadiens et la sécrétion de mélatonine par la pinéale (Konakchieva et al. 1997, McClung 2011). Aussi, des niveaux réduits de mélatonine (MT) ont été rapportés chez des patients dépressifs (Claustrat et al. 1984). De ce fait, les deux types de récepteurs de la mélatonine, MT1 et MT2, sont devenus des cibles thérapeutiques pour le développement de nouveaux antidépresseurs. Cependant, la localisation cellulaire précise des récepteurs MT1 et MT2 n'est pas encore bien connue du fait de l'absence d'anticorps bien caractérisés et parfaitement spécifiques pour l'immunocytochimie. Basé sur ses effets anxiolytiques et antidépresseurs (Milan et al. 2005, Papp et al. 2006, Taylor et al. 2014), l'agomélatine, un agoniste MT1/MT2 et antagoniste 5-HT_{2C} pourrait être un candidat nouveau pour la prévention de changements comportementaux induits par le stress.

Outre les perturbations de l'axe HPS et des systèmes monoaminergiques, le stress chronique augmente les glucocorticoïdes, ce qui décroît la production de

récepteur aux glucocorticoïdes (GR) et de facteur neurotrophique dérivé du cerveau (Brain Derived Neurotropic Factor, BDNF) dans l'hippocampe, ainsi qu'une réduction de la neurogenèse dans cette structure, le tout conduisant à des troubles de l'humeur tels que l'anxiété et la dépression, ainsi que des perturbations de la mémoire (Schmidt & Duncan 2007, Autry & Monteggia 2012).

A côté de ces agents pharmacologiques, l'exercice physique est connu pour stimuler la neurotransmission monoaminergique et la production de BDNF (Cotman & Berchtold 2002). L'exercice physique volontaire possède des propriétés antidépressives et anxiolytiques chez les rongeurs et chez l'homme (Burghardt et al. 2004, Ströhle et al. 2009, Lapmanee et al. 2013). L'activité locomotrice volontaire dans une roue augmente la production de BDNF et la neurogenèse dans l'hippocampe (Cotman & Berchtold 2002), et améliore le fonctionnement cérébral en modifiant la neurotransmission monoaminergique (Dishman 1997). Certains patients ne répondent pas ou peu aux traitements pharmacologiques ou présentent une longue phase de latence avant de présenter des effets anxiolytiques ou antidépresseurs. L'exercice physique ou d'autres interventions pourraient donc s'avérer bénéfiques pour ces individus. Précédemment, nous avons montré qu'un inhibiteur de la recapture sérotonine-noradrénaline-dopamine, la venlafaxine, ainsi que l'activité locomotrice volontaire dans une roue pouvaient réduire des comportements de type anxiété et dépression chez des rats stressés (Lapmanee et al. 2012, 2013).

Cependant, les effets modulateurs de l'exercice de roue volontaire sur la réponse à un stress chronique ne sont pas encore bien compris, et les effets *préventifs* de cet exercice sur les troubles de l'humeur et les perturbations de la mémoire induits par le stress restent à préciser. Enfin, les mécanismes cellulaires des effets protecteurs de l'agomélatine, de la venlafaxine et de l'exercice physique dans les neurones 5-HT et NA vis-à-vis des changements comportementaux induits par le stress ne sont pas encore connus.

Ainsi, les objectifs de ce travail étaient

1. d'établir un modèle de stress de contention chronique chez le rat pour des études comportementales et des analyses biochimiques des changements d'expression de protéines cibles dans le cerveau.

2. de déterminer les bénéfices de l'activité de roue volontaire sur l'axe hypothalamo-pituitaire-surrénalien (HPS) et sur l'expression de protéines cibles dans diverses régions cérébrales chez le rat.

3. de comparer l'efficacité de l'Agomélatine (Ago), d'un inhibiteur de la recapture de la 5-HT et de la NA (Venlafaxine, Vlx) et de l'exercice physique volontaire dans la prévention de l'anxiété et de la dépression, ainsi que des perturbations de la mémoire induits par le stress.

4. de déterminer la localisation des récepteurs MT1 et MT2 chez des souris transgéniques rapportrices afin d'identifier des sites potentiels d'action de l'Agomélatine, en particulier dans le contexte du stress.

Les hypothèses centrales de ce travail étaient :

1. Les modulateurs de la neurotransmission monoaminergique et l'activité de roue volontaire peuvent prévenir les comportements induits par le stress chez le rat mâle en modulant la neurogenèse hippocampique et en altérant l'expression de protéines cibles de la neurotransmission monoaminergique centrale dans des régions associées avec la réponse au stress.

2. Des neurones exprimant les récepteurs de la mélatonine MT1 et MT2 localisées dans des régions associées à la réponse au stress pourraient être des cibles de l'action antidépressive et anxiolytique du traitement pharmacologique par l'Agomélatine.

B. Matériel et Méthodes

Partie 1 : Effets du stress de contention, des modulateurs pharmacologiques (Agomélatine, Venlafaxine) et de l'activité de roue volontaire chez des rats mâles

Animaux

Des rats mâles de souche Wistar (âgés de 8 semaines, 180–200 g) étaient obtenus du Centre National d'Animaux de Thaïlande (Université Mahidol, Thaïlande). A la fin des expériences, tous les rats étaient évalués pour des comportements de type anxiété, dépression ou perturbations de la mémoire. Après, le sang et des urines ont été collectés pour des mesures de la corticostérone. Le cœur, les surrénales et le cerveau

ont été prélevés dans toutes les expériences. Des régions cérébrales ont été microdisséquées pour étudier l'expression de protéines cibles : BDNF, récepteur au glucocorticoïdes (GR), transporteur de la NA (NET), transporteur de la 5-HT (SERT) et le récepteur de la sérotonine 5-HT_{2c}. Les niveaux d'expression des protéines ont été évalués par Western blotting dans des régions cérébrales contribuant à la réponse au stress : cortex frontal, amygdale, hypothalamus, hippocampe, raphé dorsal, locus coeruleus, gris périacquéducal, septum, noyau accumbens et aire tegmentale ventrale. Toutes les procédures animales ont été validées par le Comité de Soins et d'Utilisation d'Animaux de la Faculté de Médecine de l'Université Thammasat, Thaïlande.

Stress de contention

Les rats ont été placés dans des tubes de contention modifiés pendant 2 heures/jour, 5 jours/semaine pendant 1, 4 ou 8 semaines. Les tubes de contention avaient une ouverture d'1 cm de diamètre à un bout pour permettre aux animaux de respirer.

Études comportementales

Les comportements anxieux ont été évalués par le labyrinthe élevé en croix (elevated plus maze EPM), le labyrinthe élevé en T (elevated T maze ETM) et le test « Open Field » (OFT). Les comportements dépressifs ont été évalués par des tests hebdomadaires de préférence pour le sucrose et de nage forcée (forced swimming test FST). La piscine de Morris (Morris water maze MWM) et le test de reconnaissance d'objets nouveaux (novel object recognition NOR) ont été utilisés pour évaluer l'apprentissage et la mémoire.

Protocoles expérimentaux

Expérience 1 : Cinétique de l'induction par le stress de contention de comportements anxieux ou dépressifs, et de perturbations de la mémoire.

Les rats ont été séparés en 4 groupes : 1 groupe contrôle (non stressé) et 3 groupes de rats soumis au stress de contention pendant 1, 4 ou 8 semaines

Expérience 2 : Effets de 4 semaines d'activité locomotrice volontaire sur l'axe HPS en conditions basales et après 4 semaines d'exposition à un stress de contention.

Les rats ont été séparés en 4 groupes : 1 groupe non-stressé sans roue, 1 groupe non-stressé avec exercice de roue, 1 groupe stressé sans roue et 1 groupe stressé avec exercice de roue. Tous les rats ont été évalués pour des comportements anhédoniques par le test de préférence pour le sucrose. Le sang et les urines ont été collectés pour la détermination du niveau de corticostérone. Le cœur et les glandes surrénales ont été prélevés et pesés. Les cerveaux ont été prélevés et analysés pour les protéines cibles. Les glandes surrénales ont aussi analysées pour le niveau d'expression protéique du récepteur aux mélanocortines 2 (MC2R, récepteur de l'ACTH).

Expérience 3 : Effets de l'agomélatine, de la venlafaxine et de l'activité locomotrice volontaire dans la prévention de perturbations de la mémoire et de comportements de type anxiété et dépression.

Les rats ont été séparés en 4 groupes : 1 groupe contrôle recevant la solution véhicule (5 ml/kg de saline 9‰ per os), 1 groupe Agomélatine (10 mg/kg per os), Venlafaxine (10 mg/kg per os) et 1 groupe avec exercice de roue volontaire. Les animaux ont été soumis à ces traitements pendant 4 semaines (administrations per os tous les jours). Ensuite, ces traitements ont été arrêtés et les animaux ont été soumis pendant 4 semaines au stress de contention (2 h/jour, 5 jours/semaine). Les comportements anhédoniques ont été évalués par un test hebdomadaire de préférence pour le sucrose. A la fin des 4 semaines de soumission au stress, tous les rats ont été évalués pour des comportements anxieux ou dépressifs, ainsi que pour l'apprentissage et la mémoire.

Partie 2 : Caractérisation des cellules exprimant les récepteurs MT1 ou MT2 dans le cerveau de souris rapportrices LacZ knock-in : Identification de sites d'action potentiels de l'Agomélatine dans des structures impliquées dans le stress

Animaux

Des souris (1,5 à 18 mois d'âge, 20-60 g) mâles et femelles adultes transgéniques avec le rapporteur LacZ introduit dans le locus MT1 (MTNR1A) ou MT2 (MTNR2A) ont été obtenues à la plateforme Chronobiotron (CNRS UMS 3415) de l'Institut des Neurosciences Cellulaires et Intégratives (INCI CNRS UPR 3212) de l'Université de Strasbourg. Ces mutations étaient introduites dans la lignée C57/BL6, qui ne produit pas de mélatonine. Nous avons utilisé des souris hétérozygotes (KI/+) et des souris homozygotes (KI/KI) pour nos études. Des souris non-mutantes (+/+) des mêmes portées ont été utilisées comme contrôles. Pour obtenir des souris mutantes produisant de la mélatonine, nous avons utilisé des souris hétérozygotes (KI/+) issues d'un croisement F1 avec la lignée C3H, qui produit de la mélatonine. L'euthanasie des souris a été effectuée selon les protocoles agréments pour la plateforme « Chronobiotron » (UMS 3415) par le Comité Régional d'Ethique en Matière d'Expérimentation Animale de Strasbourg.

Analyses histologiques :

Les souris ont été euthanasiées par inhalation de CO₂ et perfusées par des solutions de fixateur à travers le cœur. Nous avons utilisé le fixateur Periodate-Lysine-Paraformaldéhyde (PLP) pour les analyses par immunocytochimie et par hybridation *in situ*. Pour la détection histoenzymologique de l'activité LacZ, les animaux ont été fixés par du formaldéhyde 4% dans du tampon phosphate 100 mM. Après dissection, le cerveau a été postfixé par immersion dans le fixateur et soit préparé pour des coupes flottantes en congélation après cryoprotection au sucrose (Histoenzymologie LacZ) ou enrobé en Polyéthylène Glycol (PEG) (immunocytochimie et hybridation *in situ*). Des coupes flottantes (30-40 µm d'épaisseur) ont été colorés pour l'activité beta-galactosidase (LacZ) en utilisant un substrat chromogénique (5-bromo-4-chloro-3-indolyl-beta-D-galactopyranoside, X-Gal).

Pour la détection immunocytochimique de la protéine LacZ, des coupes en PEG ont été pratiquées à 10 µm d'épaisseur et montées sur lames. Après une réactivation antigénique, la présence de la protéine LacZ a été révélée par un anticorps anti-LacZ (Abcam), suivi d'une amplification immunoperoxidase.

Pour phénotyper les cellules exprimant le LacZ-MT1 ou LacZ-MT2, nous avons pratiqué des doubles immunomarquages, ou combiné la détection immunocytochimique de LacZ avec une détection par hybridation *in situ* de marqueurs cellulaires. Comme marqueurs cellulaires nous avons utilisé des neuropeptides ou des enzymes impliqués dans la synthèse de neurotransmetteurs.

Tableau 1. Résumé des paramètres analyses et des techniques utilisées

Paramètre	Technique	Objectif
Comportements anxieux	EPM ETM OFT	Evaluation de l'anxiété induite par le stress
Comportements dépressifs	Préférence Sucrose FST	Evaluation de la dépression induite par le stress
Apprentissage et mémoire	NOR MWM	Evaluation des perturbations de l'apprentissage et de la mémoire induits par le stress
Corticostérone sérique et urinaire	ELISA	Confirmer l'induction du stress
Expression protéique	Western blot	Examiner l'expression de protéines cibles dans les organes et les structures cérébrales impliquées dans le stress
Localisation MT1-LacZ / MT2-LacZ	Histochimie X-Gal, Immunocytochimie, Hybridation <i>in situ</i>	Cartographier et phénotyper les neurones exprimant les récepteurs MT1 et MT2 dans des souris transgéniques

C. Résultats et Discussion

Partie 1 : Effets du stress de contention, des modulateurs pharmacologiques (Agomélatine, Venlafaxine) et de l'activité de roue volontaire chez des rats mâles

Expérience 1 :

Dans le groupe des animaux stressés, un stress de contention pendant 1 et 4 semaines induisait une anxiété plus élevée qu'un stress de contention pendant 8 semaines dans les tests EPM, ETM et OFT. Les animaux soumis pendant 1 semaine au stress exhibaient des comportements anxieux forts. Cependant, un stress d'une semaine stimulait la mémoire spatiale dans le test MWM. Les rats stressés pendant 4 semaines présentaient des comportements anxieux et dépressifs, ainsi que des perturbations de la mémoire, en parallèle avec une augmentation des taux de corticostérone dans le sang et les urines. De plus, le stress pendant 4 semaines

augmentait l'expression du NET et du 5-HT_{2c} dans le locus coeruleus et dans l'amygdale, et diminuait l'expression hypothalamique du GR. Ces résultats indiquent une perturbation du rétrocontrôle de l'axe HPS (Smith & Vale 2006). L'augmentation de l'expression du NET et du 5-HT_{2C} dans le cerveau antérieur et le locus coeruleus pourrait causer des comportements liés au stress (Kimura et al. 2009, Chen et al. 2012). Cependant, un stress de 8 semaines induisait moins de comportements liés au stress dans les tests comportementaux. Un stress d'une telle durée pourrait induire des adaptations compensatoires (Dhabar et al. 1997). Ces résultats montrent qu'un stress de 4 semaines est suffisant pour induire de l'anxiété et de la dépression, ainsi que des perturbations de la mémoire. Nous avons donc utilisé ce protocole de stress de 4 semaines pour la suite de nos études.

Tableau 2. Cinétique des changements comportementaux et biochimiques après un stress de contention pendant 1, 4 ou 8 semaines chez le rat male.

Paramètre		Stress 1 semaine	Stress 4 semaines	Stress 8 semaines
Anxiété	EPM	↑↑	↑	↑
	ETM	↑	↑↑↑	↔
	OFT	↑	↑	↑
Dépression	% Préférence Sucrose	↑	↑ à la deuxième semaine de stress	↑ à la deuxième semaine de stress ↓ de la 5 ^{ème} à la 8 ^{ème} semaine de stress
	FST	↔	↑	↔
Apprentissage	MWM	↓↓	↑↑↑	↔
Mémoire	MWM/NOR	↑	↑↑↑	↔
Locomotion	EPM/OFT	↔	↔	↔
BDNF		↓ dans le PAG	↔	↓ dans la VTA
GR		↑ dans l'hypothalamus	↓↓↓ dans l'hippocampe	↔
NET		↔	↑ dans le LC	↔
SERT		↓ dans la VTA	↔	↓ dans l'hippocampe
5-HT _{2c}		↑ dans l'amygdale	↑ dans l'amygdale, ↓ dans le PAG	↑↑ dans le LC, ↓ dans la VTA

LC locus coeruleus, PAG gris périaqueducal, VTA aire tegmentale ventrale

Expérience 2 :

L'activité de roue volontaire a induit une réduction du poids corporel et une augmentation du poids sec du cœur autant chez les rats contrôles que chez les rats stressés. La présence d'une hypertrophie cardiaque indique le succès du protocole d'exercice physique aérobique comme montré précédemment par Wang et al. (2010) et Lapmanee et al. (2013). L'exercice physique volontaire a aussi augmenté le poids des glandes surrénales sans changement des niveaux de corticostérone sériques chez les rats non-stressés. Ceci est en accord avec une étude précédente qui a montrée que 4 semaines d'activité de roue volontaire n'avaient aucun effet sur les niveaux de corticostérone circulante, que ce soit au niveau basal ou au niveau maximal du rythme circadien chez le rat mâle (Fedicu et al. 2006). De plus, l'activité de roue volontaire a diminué les niveaux du NET, du SERT et du 5-HT_{2C} dans le circuit de la récompense dans le système nerveux central (p.ex. locus coeruleus, aire tegmentale ventrale, raphé dorsal, gris périaqueducal et noyau accumbens). La combinaison du stress avec l'exercice physique volontaire a partiellement diminué le niveau basal de corticostérone, a augmenté le niveau de BDNF dans l'hippocampe et réduit le récepteur MC2R dans la surrénale et le récepteur 5-HT_{2C} dans le cortex frontal. Ces résultats suggèrent que l'exercice physique volontaire peut réduire l'effet négatif du stress chronique en modulant l'activité sympathique de l'axe HPS tant au niveau central qu'au niveau périphérique, ce qui par conséquent a réduit la sécrétion de corticostérone (Droste et al. 2007, Patki et al. 2014).

Tableau 3. Changements comportementaux et biochimiques chez des rats mâles contrôles ou après 4 semaines d'activité de roue volontaire et / ou soumis pendant 4 semaines à un stress de contention.

Paramètre		Exercice vs contrôle	Stress vs contrôle	Stress + Exercice vs stress
Dépression	% Préférence Sucrose	↔	↓↓↓	↑
Corticostérone sérique		↔	↑	↔
BDNF		↓ dans le NA	↓↓ dans l'hippocampe et le septum	↑ dans l'hippocampe et le septum, ↓ dans le NA
GR		↔	↓ dans l'hippocampe	↔

Paramètre	Exercice vs contrôle	Stress vs contrôle	Stress + Exercice vs stress
NET	↓↓ dans le LC et la VTA	↑ dans le LC, ↓ dans le PAG	↓ dans le LC
SERT	↑↑ dans le septum	↓↓ dans l'hippocampe et le DR	↓ dans la VTA
5-HT _{2c} R	↓ dans le DR, le PAG, et le NA	↑ dans l'amygdale	↓ dans le PFC

DR raphé dorsal, LC locus coeruleus, NA noyau accumbens, PAG gris périaqueducal, PFC cortex préfrontal, VTA aire tegmentale ventrale

Expérience 3 :

L'agomélatine, la venlafaxine et l'exercice volontaire de roue peuvent prévenir les comportements anxieux et les perturbations de la mémoire. Les prétraitements par l'agomélatine, la venlafaxine ou l'exercice volontaire n'ont pas changé le poids des surrénales, mais les niveaux de corticostérone sérique chez les animaux traités à l'agomélatine étaient plus élevés que ceux d'animaux contrôles sans exercice de roue et traités uniquement avec le véhicule. Les rats traités par l'agomélatine et la venlafaxine étaient sensible aux niveaux élevés de corticostérone de manière prolongée, ce qui a résulté en une diminution du SERT, du NET, du BDNF et du GR dans les régions contribuant aux réponses autonomiques et comportementales, p.ex. le septum, le locus coeruleus, le gris périaqueducal et l'hippocampe. La venlafaxine et l'activité volontaire de roue ont significativement augmenté les niveaux de BDNF chez des rats stressés. Il est donc possible que les prétraitements par l'agomélatine, la venlafaxine et l'exercice physique volontaire puissent normaliser et coordonner la balance des glucocorticoïdes et du métabolisme des neurotransmetteurs, et induire des adaptations au long terme de la neurotransmission monoaminergique et même de la neurogenèse dans le cerveau (Cotman & Berchtold 2002, Dągys et al. 2010, Huang et al. 2014), adaptations qui ont été maintenues pendant l'intégralité de la période de stress.

Table 4. Changements comportementaux et biochimiques chez des rats *prétraités* pendant 4 semaines avec de l'agomélatine, de la venlafaxine ou de l'exercice volontaire de roue, et soumis après pendant 4 semaines à un stress de contention.

Paramètre		Agomélatine	Venlafaxine	Exercice
Anxiété	EPM	↔	↓	↔
	ETM	↓↓↓	↓↓↓	↓↓↓
	OFT	↓	↔	↓
Dépression	% Préférence sucrose	↔	↔	↔
	FST	↓↓	↓↓	↔
Apprentissage	MWM	↑↑↑	↑↑	↑↑↑
Mémoire	MWM/NOR	↑↑↑	↑↑↑	↑↑↑
Locomotion	EPM/OFT	↔	↔	↔
Corticostérone sérique		↑	↔	↔
BDNF		↓↓ dans le LC	↑↑↑ dans l'hippocampe, ↓ dans le septum	↑ dans l'hippocampe
GR		↔	↑ dans l'hippocampe	↔
NET		↓↓ dans le PAG	↓↓ dans l'hippocampe et le PAG	↑↑ dans l'hippocampe et le LC
SERT		↓↓ dans le septum	↓↓ dans le septum	↔
5-HT _{2c} R		↔	↔	↔

LC locus coeruleus, PAG gris périaqueducal

Partie II : Caractérisation des cellules exprimant les récepteurs MT1 ou MT2 dans le cerveau de souris rapportrices LacZ knock-in : Identification de sites d'action potentiels de l'Agomélatine dans des structures impliquées dans le stress

Expérience 1 : Validation du modèle transgénique et cartographie des cellules exprimant le MT1-LacZ ou le MT2-LacZ chez des souris transgéniques knock-in

Génotypage des souris MT1-LacZ et MT-LacZ

Le rapporteur LacZ (beta-galactosidase) a été introduit dans le locus MT1 ou MT2 pour analyser l'expression de ces deux gènes. Pour les deux loci, le transgène LacZ a été inséré en phase avec le codon start ATG original, retenant ainsi toutes les séquences régulatrices en amont et en aval du locus. Seul des séquences régulatrices

potentielles situées dans l'intron unique des gènes MT1 ou MT2 ont été délétées par cette stratégie. Ainsi ces souris rapportrices knock-in MT1-LacZ ou MT2-LacZ sont considérées un outil idéal pour investiguer les sites d'expression des récepteurs de la mélatonine MT1 et MT2 en absence d'anticorps spécifiques fiables pour la détection immunocytochimique de ces récepteurs.

Nous avons d'abord sélectionné des animaux hétérozygotes MT1-LacZ^{KI+} ou MT2-LacZ^{KI+} pour les études initiales. Ces animaux hétérozygotes disposent d'un allèle MT1 ou MT2 intact, réduisant ainsi les risques d'expression ectopique du transgène du fait d'une perte de fonction complète du récepteur MT1 ou MT2. L'étude de Liu et al. (1997) a montré que la délétion d'un allèle du locus MT1 réduisait effectivement le niveau de liaison de la ¹²⁵I-iodomélatonine de 50%, mais n'affectait en rien le patron d'expression. Les animaux hétérozygotes ont aussi été croisés entre eux pour produire des animaux homozygotes MT1-LacZ^{KIKI} et MT2-LacZ^{KIKI}, qui sont de fait des animaux invalidés (knockout KO) soit pour le MT1 ou le MT2 comme alors les deux allèles sont remplacés par LacZ.

Les animaux transgéniques ont été génotypés par PCR. Chez les animaux MT1-LacZ, un produit de 425 bp indique un allèle MT1 sauvage, donc intact, et un produit de 196 bp indique un allèle MT1-LacZ recombinant. Chez les animaux MT2-LacZ un produit de 143 bp indique l'allèle sauvage intact, tandis qu'un produit de 666 bp indique l'allèle MT2-LacZ recombinant.

Cartographie de l'expression MT1-LacZ et MT2-LacZ dans le cerveau

Nous avons utilisé deux techniques pour visualiser l'expression de LacZ sous le contrôle du promoteur MT1 ou du promoteur MT2. La première technique est la visualisation histoenzymologique de l'activité enzymatique LacZ en utilisant le substrat chromogénique X-Gal (5-bromo-4-chloro-3-indolyl-beta-D-galactopyranoside) pour cette enzyme. La deuxième technique est la détection immunocytochimique de LacZ à l'aide d'un anticorps spécifique pour cette enzyme. Dans les deux cas, des animaux sauvages non-transgéniques ont été utilisés comme contrôles négatifs. Les deux techniques ont toujours fourni des résultats identiques quant à la localisation de LacZ, même si l'apparence du signal n'était pas toujours identique.

Le signal enzymatique LacZ se présentait sous forme de points très fortement colorés contre un fond pratiquement sans signal. Le signal immunocytochimique présentait aussi les mêmes points très fortement marqués, mais aussi du signal dans le noyau et parfois dans diffus dans le cytoplasme des cellules exprimant MT1-LacZ ou MT2-LacZ. Les points fortement marqués à l'intérieur des cellules par les deux techniques sont probablement des accumulations lysosomiales de LacZ. La détection immunocytochimique présentait aussi plus de bruit de fonds que la détection enzymologique. Nous avons utilisé la détection enzymologique pour la cartographie de l'expression MT1-LacZ et MT2-LacZ du fait du rapport signal/bruit très élevé. Tous les résultats obtenus par détection enzymologique ont été confirmés par détection immunocytochimique. Malheureusement, la détection enzymologique ne permet pas une combinaison avec une détection par hybridation *in situ* pour le phénotypage des cellules marquées. Nous avons donc utilisé l'immunocytochimie LacZ pour le phénotypage des cellules exprimant MT1-LacZ ou MT2-LacZ en le combinant avec un autre signal immunocytochimique ou d'hybridation *in situ*.

Les cellules MT1-LacZ étaient restreintes à quelques structures bien distinctes : le noyau suprachiasmatique (SCN), le noyau paraventriculaire du thalamus (PVT), le noyau postérieur limitant du thalamus et la *pars tuberalis* de l'adénohypophyse (PT). Ce marquage est parfaitement superposable à la liaison de la ^{125}I -iodomélatonine décrite entre autres par Liu et al. (1997), validant ainsi la spécificité de notre modèle transgénique (Figure 1 & 2).

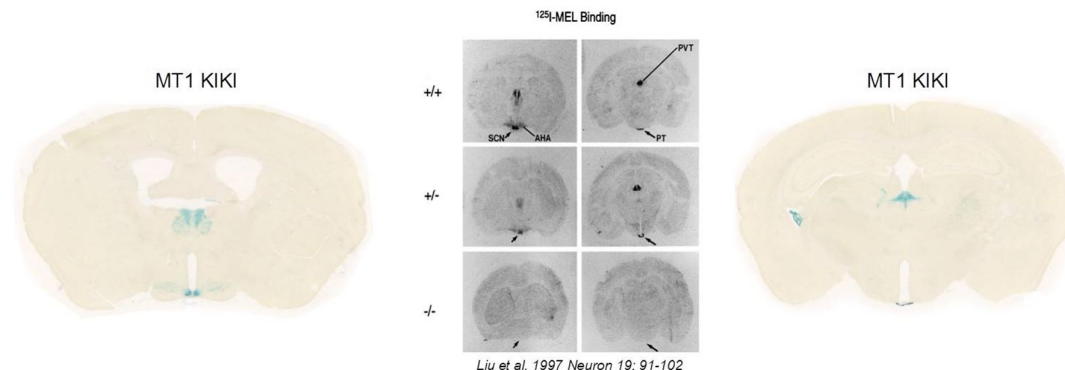

Figure 1 Expression MT1-LacZ détectée par coloration histoenzymologique utilisant le X-gal comme substrat, comparé à la liaison ^{125}I -iodomélatonine rapportée par Liu et al. (1997).

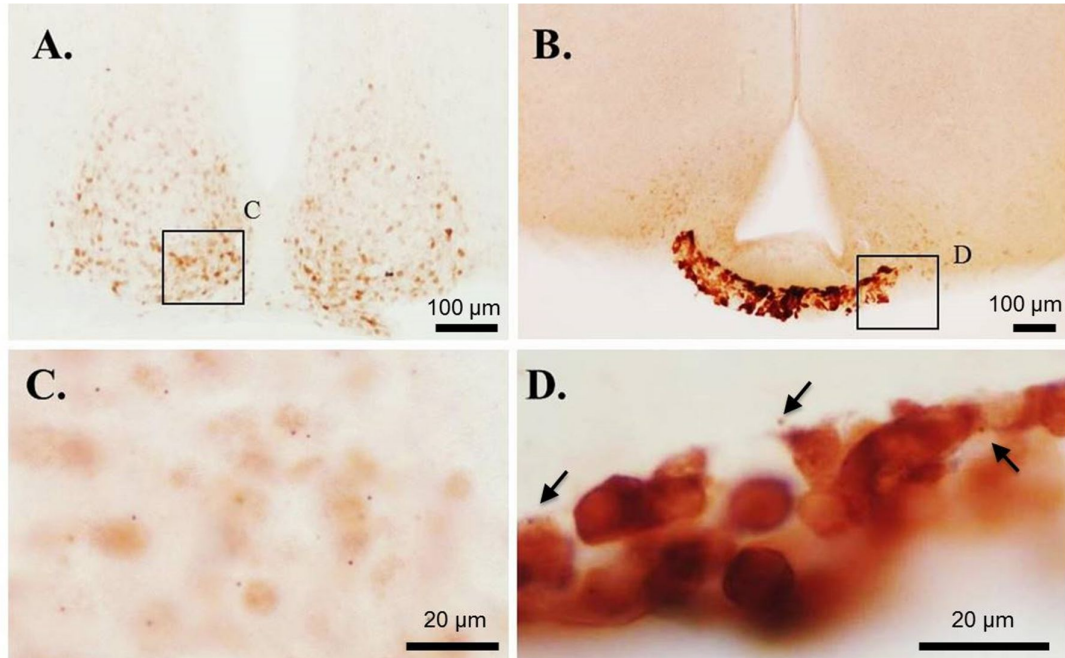

Figure 2. Détection immunocytochimique de l'expression MT1-LacZ dans le noyau suprachiasmatique (SCN, A) et la *pars tuberalis* de l'adénohypophyse (PT, B). Marquage LacZ dans le noyau et dans des accumulations lysosomiales dans le SCN (C). Dans la PT (D), le signal cytoplasmique est très fort, mais parfois des accumulations lysosomiales peuvent aussi être détectées (flèches).

Le signal MT2-LacZ pouvait être détecté dans de multiples structures à travers le cerveau telles que le bulbe olfactif, les ilots de Calleja, le SCN, le noyau paraventriculaire de l'hypothalamus (PVN), le cortex cérébral, l'hippocampe, le tectum optique, l'amygdale et le noyau arqué de l'hypothalamus. Les marquages les plus forts ont été observés surtout dans le PVN, la CA2 de l'hippocampe et une population de petits interneurons horizontaux dans la couche moléculaire externe du gyrus dentelé de l'hippocampe (Figure 3).

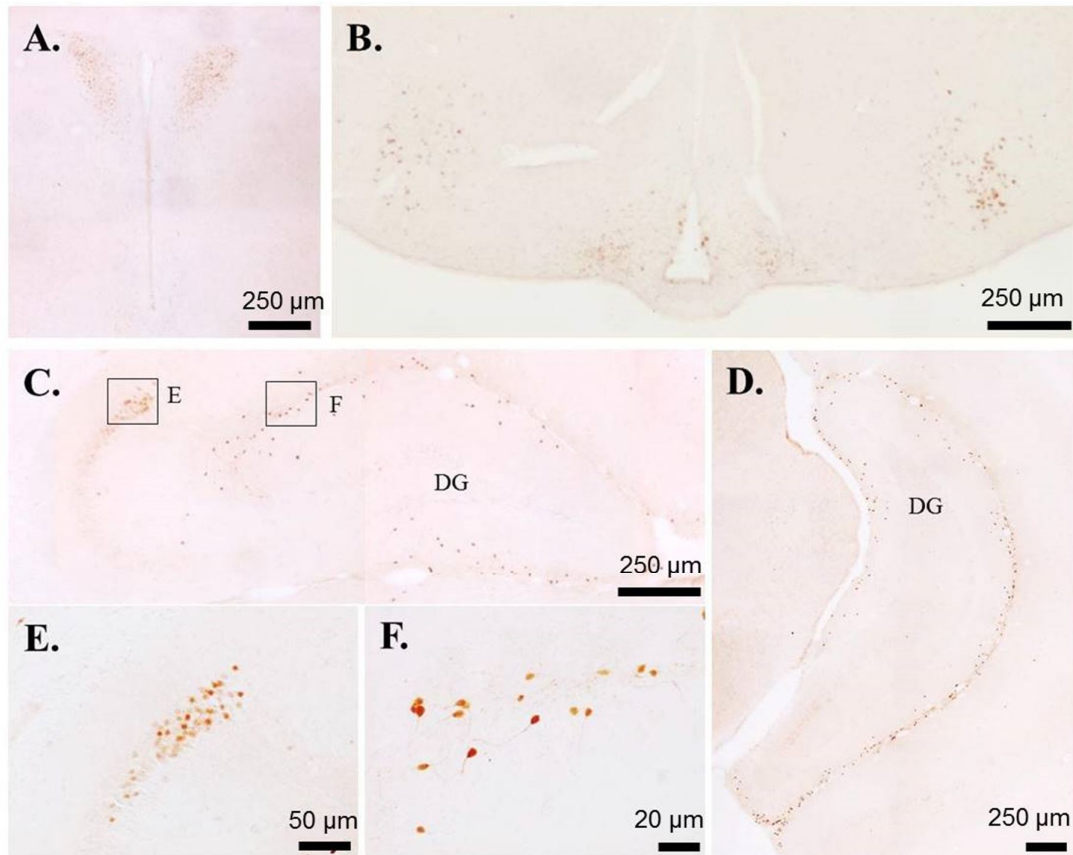

Figure 3. Détection immunocytochimique du MT2-LacZ dans le noyau paraventriculaire de l'hypothalamus (PVN, A), le noyau arqué de l'hypothalamus (B), l'hippocampe dorsal (C), l'hippocampe ventral (D), la CA2 de l'hippocampe (E) et la couche moléculaire du gyrus dentelé de l'hippocampe (F).

Expérience 2 :

Caractérisation du phénotype des neurones exprimant le MT1-LacZ ou le MT2-LacZ dans des souris transgéniques par détermination de la co-expression de neuropeptides ou de marqueurs neuronaux

Co-localisations dans des neurones MT1-LacZ

Autant la détection enzymatique que la détection immunohistochimique a montré la présence de MT1-LacZ dans des neurones du SCN. Le SCN est subdivisé dans des sous-régions anatomiques qui peuvent être distinguées par leur contenu de neuropeptides tels que la vasopressine (AVP), le gastrin-releasing peptide (GRP) et le vasoactive intestinal peptide (VIP). Nous avons donc sélectionné ces neuropeptides pour le phénotypage des neurones MT1-LacZ. Nous avons pu obtenir des

colocalisations pour le GRP et le VIP, mais pas du tout pour l'AVP. Dans le cas du GRP et du VIP, seules certaines cellules GRP ou VIP positives contenaient aussi le MT1-LacZ (Figure 4).

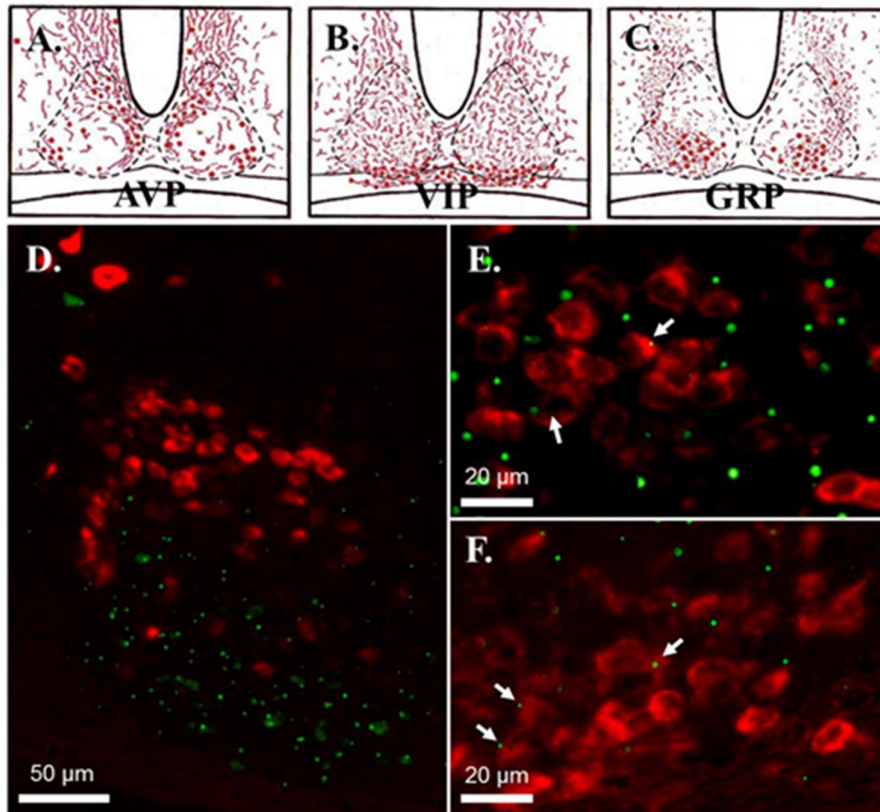

Figure 4. Double marquages avec du MT1-LacZ par immunocytochimie (fluorescence verte) et de l'hybridation *in situ* pour des neuropeptides (fluorescence rouge) dans le SCN. Diagrammes représentant la distribution des corps cellulaires et des fibres des neuropeptides dans le SCN (Abrahamson and Moore, 2001) AVP (A), GRP (B) et VIP (C). Les accumulations lysosomiales du MT1-LacZ (points verts) sont clairement situées en-dehors de la zone des neurones à AVP (D). Pour les colocalisations avec le VIP (E) ou le GRP (F), quelques neurones peptidergiques rouges contiennent les points verts des accumulations lysosomiales du MT1-LacZ (flèches).

Les neurones vasopressinergiques de l'SCN sont considérés être la principale voie de sortie de cette structure qui est l'horloge biologique centrale de l'organisme. Les neurones à VIP reçoivent les afférences en provenance de la rétine et les neurones à GRP sont considérés faire partie du mécanisme central de l'horloge biologique. Par le récepteur MT1, la mélatonine peut donc moduler les afférences rétiniennes et le fonctionnement central de l'horloge, mais pas directement les voies efférentes de l'SCN.

Co-localisations dans des neurones MT2-LacZ

Des neurones exprimant le MT2-LacZ ont pu être localisés dans des structures associées aux réponses au stress, en particulier le noyau paraventriculaire de l'hypothalamus (PVN) et l'hippocampe, tous les deux étant des composants essentiels de l'axe HPS (Smith & Vale 2006). Dans le PVN, nous avons pu colocaliser l'expression du MT2-LacZ dans des neurones produisant aussi de la corticotropin-releasing hormone (CRH, Figure 5), suggérant que la mélatonine et l'agomélatine peuvent directement moduler l'HPS au niveau du PVN. Comme la signalisation par le récepteur MT2 est généralement inhibitrice, l'action de l'agomélatine sur les neurones du PVN devrait réduire la sécrétion du CRH. Une réduction de la sécrétion du CRH devrait réduire les niveaux circulants de corticostérone. Nous avons cependant observé des niveaux élevés de corticostérone chez des animaux *prétraités* à l'agomélatine. Comme les animaux ne recevaient plus d'agomélatine pendant la phase de stress, ceci suggère que l'action de l'agomélatine sur les neurones à CRH pourrait être de courte durée. Aussi, l'agomélatine est un agoniste MT1/MT2, mais aussi un antagoniste 5-HT_{2C}, et des études plus poussées de ce profil pharmacologique complexe permettront peut-être de comprendre cette réponse apparemment contradictoire.

Dans le hile du gyrus dentelé de l'hippocampe (Figure 6), le MT2-LacZ est colocalisé avec des neurones à Glutamate Decarboxylase (GAD), l'enzyme de synthèse du GABA. Seul quelques rares petits interneurons MT2-LacZ horizontaux de la couche moléculaire du gyrus dentelé sont colocalisés avec de la GAD. Aucun autre marqueur testé n'a pu être colocalisé dans ces neurones. Le GABA étant un neurotransmetteur inhibiteur, et la signalisation MT2 étant en général inhibitrice aussi, la mélatonine ou l'agomélatine devraient donc inhiber l'action inhibitrice de ces neurones, aboutissant donc à une activation du gyrus dentelé (Stone et al. 1999, Chamberland & Topolnik 2012). Cependant, dans la CA2, le MT2-LacZ est présent dans des neurones pyramidaux de cette structure (Figure 7). Ces neurones pyramidaux sont connus pour être glutamatergiques et donc excitateurs. L'action inhibitrice de la mélatonine et de l'agomélatine devrait donc aboutir aussi à une inhibition sélective des fonctions de la CA2. L'hypothèse d'une telle action double de la mélatonine et de l'agomélatine sur l'hippocampe devrait maintenant être testée et validée en

électrophysiologie et par des études comportementales. Comme un telle action impacterait en particulier le fonctionnement de l'HPS reste à déterminer.

De plus, des neurones à MT2-LacZ sont aussi observés dans le raphé dorsal, qui contient une des principales populations de neurones à 5-HT. Le raphé dorsal ne contient apparemment pas de 5-HT_{2C}, mais le 5-HT_{2C} est impliqué dans le rétrocontrôle négatif de la 5-HT sur le raphé dorsal par l'intermédiaire de neurones GABAergiques localisés autour du raphé dorsale et qui eux expriment le 5-HT_{2C} (Serrats et al. 2005). Ainsi, l'agomélatine pourrait agir directement sur le raphé dorsal par le MT2 et indirectement par le 5-HT_{2C} par l'intermédiaire de ces neurones GABAergiques. En tant qu'agoniste MT1/MT2, l'agomélatine pourrait inhiber les neurones sérotoninergiques du raphé dorsal. En tant qu'antagoniste 5-HT_{2C}, l'agomélatine pourrait bloquer le rétrocontrôle négatif des neurones GABAergiques. Ainsi l'action de l'agomélatine sur le raphé dorsal est probablement très complexe parce qu'elle inhiberait directement le raphé dorsal tout en le stimulant de manière indirecte. Néanmoins, le raphé dorsal est donc certainement une cible d'intérêt pour l'agomélatine.

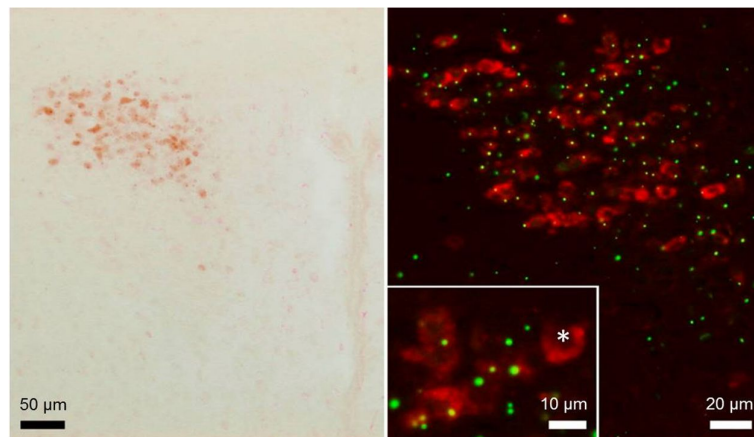

Figure 5. Double marquages avec de l'immunomarquage pour le MT2-LacZ (brun à gauche, fluorescence verte à droite) et de l'hybridation *in situ* non-radioactive pour le CRH (fluorescence rouge) dans le noyau paraventriculaire de l'hypothalamus (PVN). L'agrandissement montre un groupe de neurones à CRH (rouge) dont la majeure partie exprime aussi le MT2-LacZ (vert). L'astérisque montre un neurone à CRH ne contenant pas de MT2-LacZ.

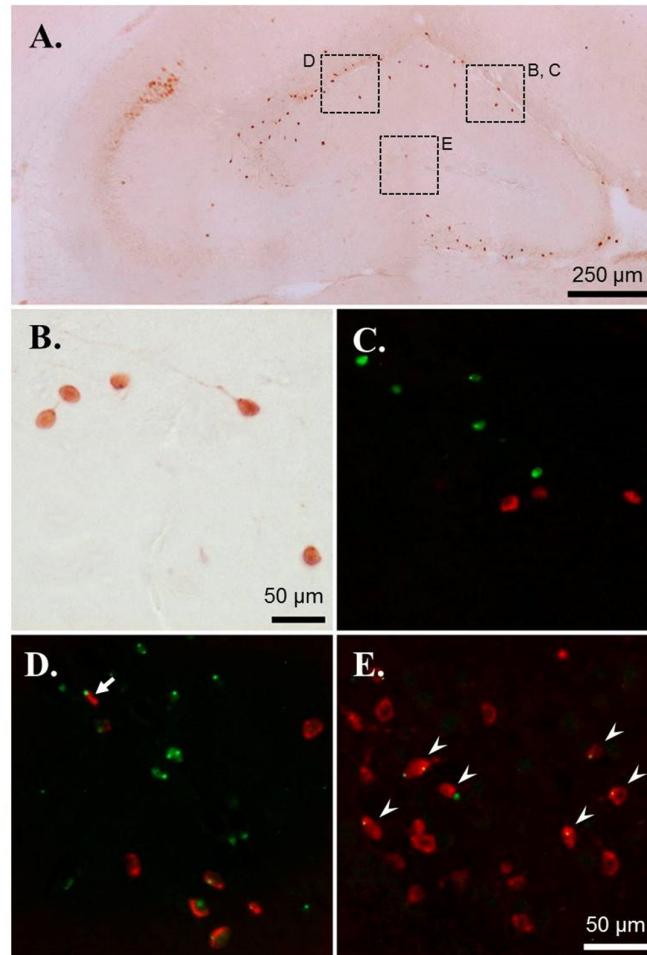

Figure 6. Double marquages avec de l'immunocytochimie pour le MT2-LacZ (brun en A et B, fluorescence verte en C, D et E) et de l'hybridation in situ non-radioactive pour la GAD (fluorescence rouge) dans l'hippocampe. (A) vue générale du marquage MT2-LacZ dans l'hippocampe dorsal. (B) Aspect des petits interneurons horizontaux situés dans la couche moléculaire externe du gyrus dentelé. (C) La plupart de ces petits interneurons n'est pas colocalisés avec la GAD. (D) Seuls quelques rares petits interneurons présentent une colocalisation avec la GAD. (E) Par contre, beaucoup de neurones à GAD dans le hile du gyrus dentelé co-expriment aussi de la GAD.

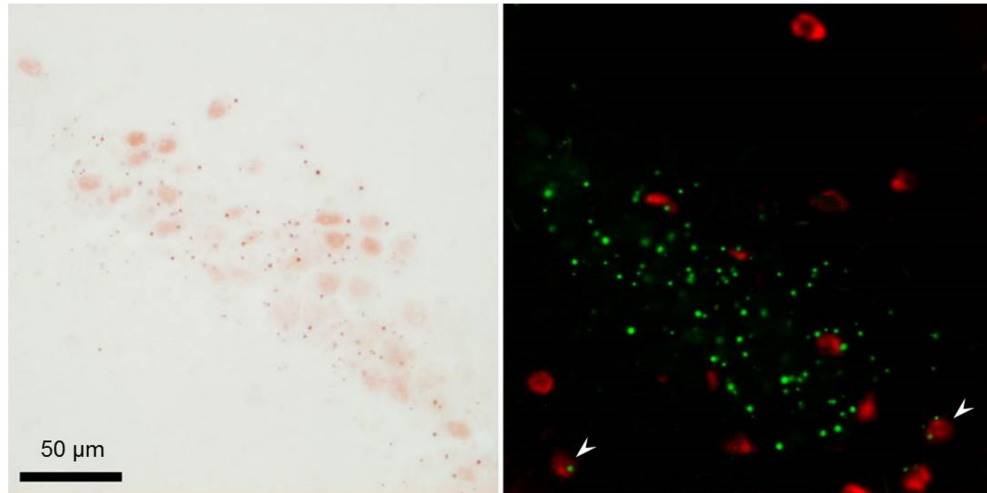

Figure 7. Double marquages avec de l'immunocytochimie pour le MT2-LacZ (brun à gauche, fluorescence verte à droite) et de l'hybridation *in situ* non-radioactive pour la GAD (fluorescence rouge) dans la CA2 de l'hippocampe. La majorité des cellules exprimant le MT2-LacZ dans la CA2 ne contiennent pas de GAD. Quelques rares cellules non-pyramidales de la CA2 (têtes de flèches) co-expriment le MT2-LacZ avec la GAD.

Table 5. Localisation des récepteurs MT1 and MT2 dans le cerveau de la souris d'après l'expression des transgènes MT1-LacZ et MT2-LacZ

Région cérébrale	MT1	MT2
Cortex cérébral	quelques cellules isolées	✓✓ dans la couche III
Cerveau basal antérieur - tubercule olfactif - Ilots de Calleja	–	✓✓
Hypothalamus - Aire pré-optique - SCN - PVN - Noyau arqué - Noyau tubéral	– ✓✓ (colocalisé avec GRP et VIP) – quelques rares cellules isolées – –	✓ ✓ ✓✓ (Colocalisé avec CRH) ✓ ✓
Thalamus - PVT - Noyau limitant postérieur - Noyau dorsal antéromédian - Habenula latérale - Noyau intermédiodorsal - Noyau ventromédian	✓ ✓	✓ ✓ ✓ ✓
Hippocampe - CA2 - Gyrus dentelé – couche moléculaire externe - Gyrus dentelé – hile	–	✓✓ ✓✓ ✓ (colocalisé avec GAD)
Amygdale	–	✓
Cerveau moyen - Tectum optique - Colliculus inférieur - Noyau interpédonculaire - Raphé dorsal	–	✓✓ ✓ ✓✓ ✓
Cerveau postérieur - Nucleus incertus - Noyau parabrachial		✓ ✓
Cervelet	–	–
Glande pituitaire - <i>pars tuberalis</i>	✓✓	–

D. Conclusions

Les buts de ce travail étaient d'abord d'examiner la cinétique des effets d'un stress de contention sur les comportements d'anxiété et de dépression, ainsi que les perturbations de la mémoire chez des rats mâles. En deuxième lieu, nous voulions déterminer les effets thérapeutiques préventifs d'un traitement pharmacologique par des modulateurs monoaminergiques (agomélatine ou venlafaxine) ou d'un exercice physique volontaire sur ces comportements. Outre des paramètres comportementaux, nous avons aussi investigué des paramètres physiques et physiologiques, ainsi que l'expression de protéines cibles dans les régions associées aux réponses de stress. Enfin, nous avons identifié des sites d'action potentiels pour l'agomélatine dans des souris transgéniques rapportrices MT1-LacZ et MT2-LacZ.

Les conclusions sont les suivantes, résumées dans la Figure 8 :

Un stress de contention de 4 semaines chez le rat mâle réduit la prise de nourriture et le poids corporel, induit une hypertrophie des surrénales et augmente les niveaux sériques et urinaires de la corticostérone. Ces niveaux élevés de corticostérone pourraient altérer l'expression des protéines cibles, telles que le facteur neurotrophique dérivé du cerveau (BDNF), le récepteur aux glucocorticoïdes (GR), le transporteur de la noradrénaline (NET) et le récepteur 5-HT_{2C} de la sérotonine dans l'amygdale, l'hippocampe, le locus coeruleus et le gris périaqueducal menant à des manifestations d'anxiété, de dépression et des troubles de la mémoire.

Un exercice volontaire d'activité de roue de 4 semaines peut partiellement prévenir l'élévation de la corticostérone sérique et les comportements anhédoniques induits par le stress, probablement par une modulation des récepteurs surrénaux pour l'hormone adrénocorticotrope (ACTH) et en altérant l'expression de protéines cibles (BDNF et NET) dans des structures impliquées dans la réponse au stress telles que l'hippocampe, le septum, le locus coeruleus et le gris périaqueducal. Ainsi, l'exercice physique volontaire pourrait réduire les effets néfastes d'un stress chronique en modulant l'activité sympathique tant au niveau central qu'au niveau périphérique de l'axe HPS.

L'agomélatine, la venlafaxine et l'activité volontaire dans une roue peuvent prévenir les comportements anxieux et dépressifs, ainsi que les perturbations

de la mémoire, induits par un stress de contention. L'augmentation de l'expression du BDNF dans l'hippocampe pourrait être un mécanisme des effets protecteurs de la venlafaxine et de l'exercice physique chez le rat mâle stressé.

Concernant les applications cliniques de nos observations, l'exercice physique volontaire peut être recommandé comme traitement alternatif ou de concert avec un traitement pharmacologique (p.ex. agomélatine ou venlafaxine) pour le traitement des symptômes d'anxiété, de dépression et de perturbation de la mémoire chez des patients et des individus stressés.

La cartographie et le phénotypage des neurones exprimant les récepteurs de la mélatonine MT1 et M2 indique des sites d'action potentiels pour la mélatonine et des agents mélatoninergiques tels que l'agomélatine. L'expression du MT1 est restreinte à quelques structures clés, en particulier le noyau suprachiasmatique (SCN), le noyau paraventriculaire du thalamus (PVT) et la *pars tuberalis* de la glande pituitaire. Le récepteur MT2 quant à lui est beaucoup plus largement exprimé dans le cerveau, avec notamment le noyau suprachiasmatique (SCN), le noyau paraventriculaire de l'hypothalamus (PVN), l'hippocampe, l'amygdale et le raphé dorsal (DR). Des études supplémentaires seront nécessaires pour clarifier le mode d'action de l'agomélatine.

En résumé, un stress de contention de 4 semaines cause une hyperactivité de l'axe HPS et augmente le niveau des glucocorticoïdes menant à une réduction d'expression du récepteur aux glucocorticoïdes et du BDNF dans l'hippocampe. Quatre semaines d'activité de roue volontaire module l'activité de l'axe HPS et diminue partiellement les niveaux de glucocorticoïdes en diminuant l'expression du récepteur surrénalien de l'ACTH. Cette activité augmente aussi l'expression du BDNF réduisant les comportements anhédoniques chez le rat mâle stressé. De plus, l'exercice physique volontaire est capable de prévenir l'anxiété, la dépression et les troubles de la mémoire induits par le stress. Un prétraitement par la venlafaxine inhibe directement le NET pour augmenter la noradrénaline dans la fente synaptique et exerce des effets antidépresseurs et anxiolytiques en promouvant la production de BDNF par l'hippocampe. Un prétraitement par l'agomélatine, un agoniste MT1/MT2, peut prévenir les comportements liés au stress en agissant par les récepteurs MT1 et MT2 dans le SCN, le PVN, le raphé dorsal et l'hippocampe.

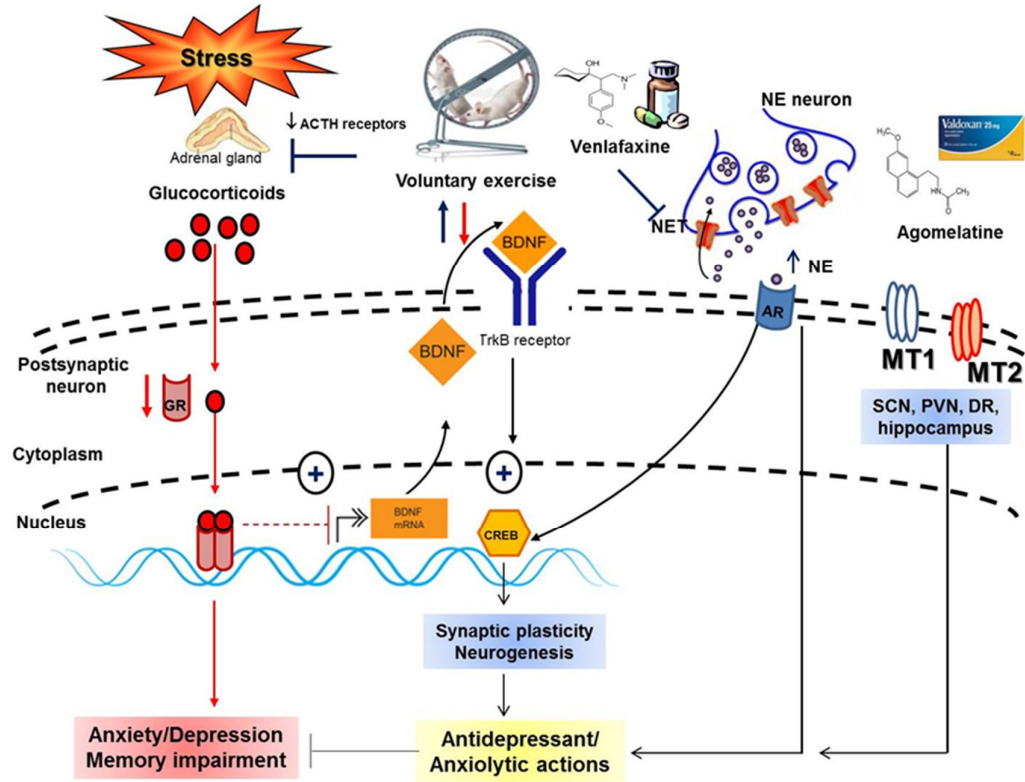

Figure 8. Résumé graphique des résultats de cette étude.

REFERENCES

- Abrahamson EE, Moore RY. Suprachiasmatic nucleus in the mouse: retinal innervation, intrinsic organization and efferent projections. *Brain Res.* 2001;916(1-2):172-91.
- Acosta GB, Otero Losada ME, Rubio MC. Area-dependent changes in GABAergic function after acute and chronic cold stress. *Neurosci Lett.* 1993;154, 175-8.
- Adam TC, Epel ES. Stress, eating and the reward system. *Physiol Behav.* 2007;91(4):449-58.
- Adlard PA, Cotman CW. Voluntary exercise protects against stress-induced decreases in brain-derived neurotrophic factor protein expression. *Neuroscience.* 2004;124(4):985-92.
- Adlard PA, Perreau VM, Engesser-Cesar C, Cotman CW. The timecourse of induction of brain-derived neurotrophic factor mRNA and protein in the rat hippocampus following voluntary exercise. *Neurosci Lett.* 2004;363(1):43-8.
- Aguilera G, Liu Y. The molecular physiology of CRH neurons. *Front Neuroendocrinol.* 2012;33(1):67-84.
- Ahn SK, Khalmuratova R, Hah YS, Jeon SY, Hur DG, Kang HS, Balaban CD. Immunohistochemical and biomolecular identification of melatonin 1a and 1b receptors in rat vestibular nuclei. *Auris Nasus Larynx.* 2012;39(5):479-83.
- Alex KD, Yavarian GJ, McFarlane HG, Pluto CP, Pehk EA. Modulation of dopamine release by striatal 5-HT_{2C} receptors. *Synapse.* 2005;55(4):242-51.
- American Psychiatric Association: DSM-5 (the Diagnostic and Statistical manual of Mental Disorders, 5th edition). American Psychiatric Association, 2013.
- Amsterdam JD, Chopra M. Monoamine oxidase inhibitors revisited. *Psychiatric Annals.* 2001;31:361-70.

- Anastasio NC, Lanfranco MF, Bubar MJ, Seitz PK, Stutz SJ, McGinnis AG, Watson CS, Cunningham KA. Serotonin 5-HT_{2C} receptor protein expression is enriched in synaptosomal and post-synaptic compartments of rat cortex. *J Neurochem.* 2010;113(6):1504–15.
- Antunes M, Biala G. The novel object recognition memory: neurobiology, test procedure, and its modifications. *Cogn Process* 2012;13(2):93–110.
- Asada H, Kawamura Y, Maruyama K, Kume H, Ding RG, Kanbara N, Kuzume H, Sanbo M, Yagi T, Obata K. Cleft palate and decreased brain gamma-aminobutyric acid in mice lacking the 67-kDa isoform of glutamic acid decarboxylase. *Proc Natl Acad Sci U S A.* 1997;94(12):6496–9.
- Avwenagha O, Bird MM, Lieberman AR, Yan Q, Campbell G. Patterns of expression of brain-derived neurotrophic factor and tyrosine kinase B mRNAs and distribution and ultrastructural localization of their proteins in the visual pathway of the adult rat. *Neuroscience.* 2006;140(3):913–28.
- Aydemir C, Deveci A, Taneli F. The effect of chronic antidepressant treatment of serum brain-derived neurotrophic factor levels in depressed patients: a preliminary study. *Prog Neuropsychopharmacol Biol Psychiatry.* 2005;29:261–5.
- Balu DT, Lucki I. Adult hippocampal neurogenesis: regulation, functional implications, and contribution to disease pathology. *Neurosci Biobehav Rev.* 2009;33:232–52.
- Banasr M, Soumier A, Hery M, Mocaër E, Daszuta A. Agomelatine, a new antidepressant, induces regional changes in hippocampal neurogenesis. *Biol Psychiatry.* 2006;59(11):1087–96.
- Barker EL, Blakely RD. Norepinephrine and serotonin transporters: molecular targets of antidepressant drugs. *J Biol Chem.* 1995; 264:2195–8.
- Bauer M, El-Khalili N, Datto C, Szamosi J, Eriksson H. A pooled analysis of two randomised, placebo-controlled studies of extended release quetiapine fumarate adjunctive to antidepressant therapy in patients with major depressive disorder. *J Affect Disord.* 2010;127(1–3):19–30.

- Beck KD, Luine VN. Food deprivation modulates chronic stress effects on object recognition in male rats: Role of monoamines and amino acids. *Brain Res.* 1999;830:56–71.
- Belmaker RH, Agam G. Major depressive disorder. *N Engl J Med.* 2008;358(1):55–68.
- Belzung C, Griebel G. Measuring normal and pathological anxiety-like behaviour in mice: a review. *Behav Brain Res.* 2001;125(1–2):141–9.
- Berridge MJ, Downes CP, Hanley MR. Lithium amplifies agonist-dependent phosphatidylinositol responses in brain and salivary glands. *Biochem J.* 1982;206(3):587–95.
- Berton O, Durand M, Aguerre S, Mormede P, Chaouloff F. Behavioral, neuroendocrine and serotonergic consequences of single social defeat and repeated fluoxetine pretreatment in the Lewis rat strain. *Neuroscience.* 1999;92:327–41.
- Biggs JT, Spiker DG, Petit JM, Ziegler VE. Tricyclic antidepressant overdose: incidence of symptoms. *JAMA.* 1977;238(2):135–8.
- Binder EB, Nemeroff CB. The CRF system, stress, depression and anxiety-insights from human genetic studies. *Mol Psychiatry.* 2010;15(6):574–88.
- Blumenthal JA, Babyak MA, Doraiswamy PM, Watkins L, Hoffman BM, Barbour KA, Herman S, Craighead WE, Brosse AL, Waugh R, Hinderliter A, Sherwood A. Exercise and pharmacotherapy in the treatment of major depressive disorder. *Psychosom Med.* 2007;69(7):587–96.
- Bonnefond C, Monnerie R, Richard JP, Martinet L. Melatonin and the circadian clock in mink: effects of daily injections of melatonin on circadian rhythm of locomotor activity and autoradiographic localization of melatonin binding sites. *J Neuroendocrinol.* 1993;5(3):241–6.
- Booth FW, Laye MJ, Lees SJ, Rector RS, Thyfault JP. Reduced physical activity and risk of chronic disease: the biology behind the consequences. *Eur. J. Appl. Physiol.* 2008;102(4):381–90.
- Bourin M, Mocaër E, Porsolt R. Antidepressant-like activity of S20098 (agomelatine) in the forced swimming test in rodents: involvement of melatonin and serotonin receptors. *J Psychiatry Neurosci.* 2004;29(2):126–33.

- Bowers G, Cullinan WE, Herman JP. Region-specific regulation of glutamic acid decarboxylase (GAD) mRNA expression in central stress circuits. *J Neurosci*. 1998;18(15):5938–47.
- Bowman RE, Beck KD, Luine VN. Chronic stress effects on memory: sex differences in performance and monoaminergic activity. *Horm Behav*. 2003;43(1):48–59.
- Boyle MP, Brewer JA, Funatsu M, Wozniak DF, Tsien JZ, Izumi Y, Muglia LJ. Acquired deficit of forebrain glucocorticoid receptor produces depression-like changes in adrenal axis regulation and behavior. *Proc Natl Acad Sci U S A*. 2005;102(2):473–8.
- Braestrup C, Nielsen M, Nielsen EB, Lyon M. Benzodiazepine receptors in the brain as affected by different experimental stresses: the changes are small and not unidirectional. *Psychopharmacology (Berl)*. 1979;65(3):273–7.
- Burghardt PR, Fulk LJ, Hand GA, Wilson MA. The effects of chronic treadmill and wheel running on behavior in rats. *Brain Res*. 2004;1019(1–2):84–96.
- Buynitsky T, Mostofsky DI. Restraint stress in biobehavioral research: Recent developments. *Neurosci Biobehav Rev*. 2009;33(7):1089–98.
- Campbell JE, Rakhshani N, Fediuc S, Bruni S, Riddell MC. Voluntary wheel running initially increases adrenal sensitivity to adrenocorticotrophic hormone, which is attenuated with long-term training. *J Appl Physiol* (1985). 2009;106(1):66–72.
- Carman HM, Mactutus CF. Proximal versus distal cue utilization in spatial navigation: the role of visual acuity? *Neurobiol Learn Mem*. 2002;78(2):332–46.
- Carta MG, Hardoy MC, Pilu A, Sorba M, Floris AL, Mannu FA, Baum A, Cappai A, Velluti C, Salvi M. Improving physical quality of life with group physical activity in the adjunctive treatment of major depression disorder. *Clin Pract Epidemiol Ment Health*. 2008;4:1–6.
- Castagné V, Moser P, Roux S, Porsolt RD. Rodent models of depression: forced swim and tail suspension behavioral despair tests in rats and mice. *Curr Protoc Neurosci*. 2011;55:8.10A.

- Cerqueira JJ, Almeida OF, Sousa N. The stressed prefrontal cortex. Left? Right! *Brain Behav Immun.* 2008;22(5):630–8.
- Chamberland S, Topolnik L. Inhibitory control of hippocampal inhibitory neurons. *Front Neurosci.* 2012;165(6):1–13.
- Chao MV, Bothwell M. Neurotrophins: To cleave or not to cleave. *Neuron.* 2002;33:9–12.
- Charney DS, Drevets WC. The neurobiological basis of anxiety disorders. In: Davis KL, Charney DS, Coyle JT, Nemeroff C, editors. *Neuropsychopharmacology: The fifth generation of progress.* Philadelphia: Lippincott Williams and Wilkins; 2002.
- Charney DS. Monoamine dysfunction and the pathophysiology and treatment of depression. *J Clin Psychiatry.* 1998;59 Suppl 14:11–4.
- Charoenphandhu N, Nuntapornsak A, Wongdee K, Krishnamra N, Charoenphandhu J. Upregulated mRNA levels of SERT, NET, MAOB, and BDNF in various brain regions of ovariectomized rats exposed to chronic aversive stimuli. *Mol Cell Biochem.* 2013;375(1–2):49–58.
- Charoenphandhu N, Teerapornpantakit J, Lapmanee S, Dorkkam N, Krishnamra N, Charoenphandhu J. Long-term swimming in an inescapable stressful environment attenuates the stimulatory effect of endurance swimming on duodenal calcium absorption in rats. *J Physiol Sci.* 2011;61(6):473–86.
- Chen P, Fan Y, Li Y, Sun Z, Bissette G, Zhu MY. Chronic social defeat up-regulates expression of norepinephrine transporter in rat brains. *Neurochem Int.* 2012;60:9–20.
- Chiba S, Numakawa T, Ninomiya M, Richards MC, Wakabayashi C, Kunugi H. Chronic restraint stress causes anxiety- and depression-like behaviors, downregulates glucocorticoid receptor expression, and attenuates glutamate release induced by brain-derived neurotrophic factor in the prefrontal cortex. *Prog Neuropsychopharmacol Biol Psychiatry.* 2012;39(1):112–9.
- Christianson JP, Ragole T, Amat J, Greenwood BN, Strong PV, Paul ED, Fleshner M, Watkins LR, Maier SF. 5-hydroxytryptamine 2C receptors in the

- basolateral amygdala are involved in the expression of anxiety after uncontrollable traumatic stress. *Biol Psychiatry*. 2010;67:339–45.
- Christoffel DJ, Golden SA, Russo SJ. Structural and synaptic plasticity in stress-related disorders. *Rev Neurosci*. 2011;22(5):535–49.
- Clark MS, Russo AF. Tissue-specific glucocorticoid regulation of tryptophan hydroxylase mRNA levels. *Brain Res Mol Brain Res*. 1997;48:346–54.
- Claustrat B, Chazot G, Brun J, Jordan D, Sassolas G. A chronobiological study of melatonin and cortisol secretion in depressed subjects: plasma melatonin, a biochemical marker in major depression. *Biol Psychiatry*. 1984;19(8):1215–28.
- Clemett DA, Punhani T, Duxon MS, Blackburn TP, Fone KC. Immunohistochemical localisation of the 5-HT_{2C} receptor protein in the rat CNS. *Neuropharmacology*. 2000;39(1):123–32.
- Comai S, Gobbi G. Unveiling the role of melatonin MT₂ receptors in sleep, anxiety and other neuropsychiatric diseases: a novel target in psychopharmacology. *J Psychiatry Neurosci*. 2014;39(1):6–21.
- Condie BG, Bain G, Gottlieb DI, Capecchi MR. Cleft palate in mice with a targeted mutation in the gamma-aminobutyric acid-producing enzyme glutamic acid decarboxylase 67. *Proc Natl Acad Sci U S A*. 1997;94(21):11451–5.
- Connor B, Dragunow M. The role of neuronal growth factors in neurodegenerative disorders of the human brain. *Brain Res Brain Res Rev*. 1998;27(1):1–39.
- Cooke JD, Grover LM, Spangler PR. Venlafaxine treatment stimulates expression of brain-derived neurotrophic factor protein in frontal cortex and inhibits long-term potentiation in hippocampus. *Neuroscience*. 2009;162(4):1411–9.
- Cotman CW, Berchtold NC. Exercise: a behavioral intervention to enhance brain health and plasticity. *Trends Neurosci*. 2002;25(6):295–301
- Cryan JF, Holmes A. The ascent of mouse: advances in modelling human depression and anxiety. *Nat Rev Drug Discov*. 2005;4(9):775–90.
- Dagnino-Subiabre A, Orellana JA, Carmona-Fontaine C, Montiel J, Díaz-Velíz G, Serón-Ferré M, Wyneken U, Concha ML, Aboitiz F. Chronic stress

- decreases the expression of sympathetic markers in the pineal gland and increases plasma melatonin concentration in rats. *J Neurochem.* 2006;97:1279–87.
- Dagytè G, Crescente I, Postema F, Seguin L, Gabriel C, Mocaër E, Boer JA, Koolhaas JM. Agomelatine reverses the decrease in hippocampal cell survival induced by chronic mild stress. *Behav Brain Res.* 2011;218(1):121–8.
- Dagytè G, Trentani A, Postema F, Luiten PG, Den Boer JA, Gabriel C, Mocaër E, Meerlo P, Van der Zee EA. The novel antidepressant agomelatine normalizes hippocampal neuronal activity and promotes neurogenesis in chronically stressed rats. *CNS Neurosci Ther.* 2010;16(4):195–207.
- Davidson SR, Burnett M, Hoffman-Goetz L. Training effects in mice after long-term voluntary exercise. *Med. Sci. Sports Exerc.* 2006;38(2):250–5.
- de Groote L, Linthorst AC. Exposure to novelty and forced swimming evoke stressor-dependent changes in extracellular GABA in the rat hippocampus. *Neuroscience.* 2007;148(3):794–805.
- de Kloet ER, Joëls M, Holsboer F. Stress and the brain: from adaptation to disease. *Nat Rev Neurosci.* 2005;6(6):463–75.
- de Kloet ER, Vreugdenhil E, Oitzl MS, Joëls M. Brain corticosteroid receptor balance in health and disease. *Endocr Rev.* 1998;19(3):269–301.
- de Moor MH, Beem AL, Stubbe JH, Boomsma DI, De Geus EJ. Regular exercise, anxiety, depression and personality: a population-based study. *Prev Med.* 2006;42(4):273–9.
- Dell’Osso B, Buoli M, Baldwin DS, Altamura AC. Serotonin norepinephrine reuptake inhibitors (SNRIs) in anxiety disorders: a comprehensive review of their clinical efficacy. *Hum Psychopharmacol.* 2010;25(1):17–29.
- Diamond DM, Park CR, Heman KL, Rose GM. Exposing rats to a predator impairs spatial working memory in the radial arm water maze. *Hippocampus.* 1999;9:542–52.
- Dishman RK, Renner KJ, Youngstedt SD, Reigle TG, Bunnell BN, Burke KA, Yoo HS, Mougey EH, Meyerhoff JL. Activity wheel running reduces escape latency and alters brain monoamine levels after footshock. *Brain Res Bull.* 1997;42(5):399–406.

- Dishman RK. Brain monoamines, exercise, and behavioral stress: animal models. *Med Sci Sports Exerc.* 1997;29(1):63–74.
- Douglas PS, O'Toole ML, Katz SE, Ginsburg GS, Hiller WD, Laird RH. Left ventricular hypertrophy in athletes. *Am J Cardiol.* 1997;80(10):1384–8.
- Drevets WC. Neuroimaging and neuropathological studies of depression: implications for the cognitive-emotional features of mood disorders. *Curr Opin Neurobiol.* 2001;11(2):240–9.
- Droste SK, Chandramohan Y, Hill LE, Linthorst AC, Reul JM. Voluntary exercise impacts on the rat hypothalamic-pituitary-adrenocortical axis mainly at the adrenal level. *Neuroendocrinology.* 2007;86(1):26–37.
- Droste SK, Gesing A, Ulbricht S, Muller MB, Linthorst ACE, Reul JM. Effects of long-term voluntary exercise on the mouse hypothalamic-pituitary-adrenocortical axis. *Endocrinology.* 2003;144(7):3012–23.
- Dryden S, Wang Q, Frankish HM, Williams G. Differential effects of the 5-HT 1B/2C receptor agonist mCPP and the 5-HT1A agonist flesinoxan on hypothalamic neuropeptide Y in the rat: evidence that NPY may mediate serotonin's effects on food intake. *Peptides.* 1996;17(6):943–9.
- Dubocovich ML, Delagrangé P, Krause DN, Sugden D, Cardinali DP, Olcese J. International Union of Basic and Clinical Pharmacology. LXXV. Nomenclature, classification, and pharmacology of G protein-coupled melatonin receptors. *Pharmacol Rev.* 2010;62(3):343–80.
- Dubocovich ML, Markowska M. Functional MT1 and MT2 melatonin receptors in mammals. *Endocrine.* 2005;27(2):101–10.
- Dubocovich ML. Melatonin receptors: role on sleep and circadian rhythm regulation. *Sleep Med.* 2007;8 Suppl 3:34–42.
- Duman CH, Schlesinger L, Russell DS, Duman RS. Voluntary exercise produces antidepressant and anxiolytic behavioral effects in mice. *Brain Res.* 2008;1199:148–58.
- Duman RS, Monteggia LM. A neurotrophic model for stress-related mood disorders. *Biol Psychiatry.* 2006;59(12):1116–27.
- Duman RS. Role of neurotrophic factors in the etiology and treatment of mood disorders. *Neuromolecular Med.* 2004;5(1):11–25.

- Dunn AL, Reigle TG, Youngstedt SD, Armstrong RB, Dishman RK. Brain norepinephrine and metabolites after treadmill training and wheel running in rats. *Med Sci Sports Exerc.* 1996;28(2):204–9.
- Ely DR, Dapper V, Marasca J, Corrêa JB, Gamaro GD, Xavier MH, Michalowski MB, Catelli D, Rosat R, Ferreira MB, Dalmaz C. Effect of restraint stress on feeding behavior of rats. *Physiol Behav.* 1997;61:395–8.
- Engesser-Cesar C, Anderson AJ, Cotman CW. Wheel running and fluoxetine antidepressant treatment have differential effects in the hippocampus and the spinal cord. *Neuroscience.* 2007;144(3):1033–44.
- Ennaceur A, Delacour J. A new one-trial test for neurobiological studies of memory in rats. 1: Behavioral data. *Behav Brain Res.* 1988;31(1):47–59.
- Evans DL, Davidson J, Raft T. Early and late side-effects of phenelzine. *J Clin Psychopharmacol.* 1982;2:208–10.
- Eyding D, Lelgemann M, Grouven U, Härter M, Kromp M, Kaiser T, Kerekes MF, Gerken M, Wieseler B. Reboxetine for acute treatment of major depression: systematic review and meta-analysis of published and unpublished placebo and selective serotonin reuptake inhibitor controlled trials. *BMJ.* 2010;341(c4737):1–14.
- Fan Y, Chen P, Li Y, Cui K, Noel DM, Cummins ED, Peterson DJ, Brown RW, Zhu MY. Corticosterone administration up-regulated expression of norepinephrine transporter and dopamine β -hydroxylase in rat locus coeruleus and its terminal regions. *J Neurochem.* 2014;128(3):445–58.
- Fan Y, Chen P, Li Y, Ordway GA, Zhu MY. Effects of desipramine treatment on stress-induced up-regulation of norepinephrine transporter expression in rat brains. *Psychopharmacology (Berl).* 2015;232(2):379–90.
- Fediuc S, Campbell JE, Riddell MC. Effect of voluntary wheel running on circadian corticosterone release and on HPA axis responsiveness to restraint stress in Sprague-Dawley rats. *J Appl Physiol.* 2006;100:1867–75.
- Ferreira ZS, Fernandes PA, Duma D, Assreuy J, Avellar MC, Markus RP. Corticosterone modulates noradrenaline-induced melatonin synthesis through inhibition of nuclear factor kappa B. *J Pineal Res.* 2005;38:182–8.

- Fiedorowicz JG, Swartz KL. The role of monoamine oxidase inhibitors in current psychiatric practice. *J Psychiatr Pract.* 2004;10(4):239–48.
- Fisher L, Chesla CA, Mullan JT, Skaff MM, Kanter RA. Contributors to depression in Latino and European-American patients with type 2 diabetes. *Diabetes Care.* 2001;24(10):1751–57.
- Foerde K, Shohamy D. Feedback timing modulates brain systems for learning in humans. *J Neurosci.* 2011;31(37):13157–67
- Fone KC, Shalders K, Fox ZD, Arthur R, Marsden CA. Increased 5-HT_{2C} receptor responsiveness occurs on rearing rats in social isolation. *Psychopharmacology (Berl).* 1996;123(4):346–52.
- Fujieda H, Hamadanizadeh SA, Wankiewicz E, Pang SF, Brown GM. Expression of m₁ melatonin receptor in rat retina: evidence for multiple cell targets for melatonin. *Neuroscience.* 1999;93(2):793–9.
- Garcia R, Spennato G, Nilsson-Todd L, Moreau JL, Deschaux O. Hippocampal low-frequency stimulation and chronic mild stress similarly disrupt fear extinction memory in rats. *Neurobiol Learn Mem.* 2008;89(4):560–6.
- Garner M, Möhler H, Stein DJ, Mueggler T, Baldwin DS. Research in anxiety disorders: from the bench to the bedside. *Eur Neuropsychopharmacol.* 2009;19(6):381–90.
- Gasic GP, Smoller JW, Perlis RH, Sun M, Lee S, Kim BW, Lee MJ, Holt DJ, Blood AJ, Makris N, Kennedy DK, Hoge RD, Calhoun J, Fava M, Gusella JF, Breiter HC. BDNF, relative preference, and reward circuitry responses to emotional communication. *Am J Med Genet B Neuropsychiatr Genet.* 2009;150B(6):762–81.
- Gatch MB. Discriminative stimulus effects of m-chlorophenylpiperazine as a model of the role of serotonin receptors in anxiety. *Life Sci.* 2003;73(11):1347–67.
- Gonul AS, Akdeniz F, Taneli F, Donat O, Eker C, Vahip S. Effect of treatment on serum brain-derived neurotrophic factor levels in depressed patients. *Eur Arch Psychiatry Clin Neurosci.* 2005;255:381–6.
- Graeff FG, Guimarães FS, De Andrade TG, Deakin JF. Role of 5-HT in stress, anxiety, and depression. *Pharmacol Biochem Behav.* 1996;54(1):129–41.

- Graeff FG, Netto CF, Zangrossi H Jr. The elevated T-maze as an experimental model of anxiety. *Neurosci Biobehav Rev.* 1998;23(2):237–46.
- Graeff FG, Viana MB, Tomaz C. The elevated T maze, a new experimental model of anxiety and memory: effect of diazepam. *Braz J Med Biol Res.* 1993;26(1):67–70.
- Greenwood BN, Fleshner M. Exercise, learned helplessness, and the stress-resistant brain. *Neuromolecular Med.* 2008;10(2):81–98.
- Greenwood BN, Foley TE, Day HE, Burhans D, Brooks L, Campeau S, Fleshner M. Wheel running alters serotonin (5-HT) transporter, 5-HT1A, 5-HT1B, and alpha 1b-adrenergic receptor mRNA in the rat raphe nuclei. *Biol Psychiatry.* 2005;57(5):559–68.
- Greenwood BN, Foley TE, Day HE, Campisi J, Hammack SH, Campeau S, Maier SF, Fleshner M. Freewheel running prevents learned helplessness/behavioral depression: role of dorsal raphe serotonergic neurons. *J Neurosci.* 2003;23(7):2889–98.
- Greenwood BN, Strong PV, Loughridge AB, Day HE, Clark PJ, Mika A, Hellwinkel JE, Spence KG, Fleshner M. 5-HT2C receptors in the basolateral amygdala and dorsal striatum are a novel target for the anxiolytic and antidepressant effects of exercise. *PLoS One.* 2012;7(9):1–10.
- Gunnar M, Quevedo K. The neurobiology of stress and development. *Annu Rev Psychol.* 2007;58:145–73.
- Haenisch B, Bilkei-Gorzo A, Caron MG, Bönisch H. Knockout of the norepinephrine transporter and pharmacologically diverse antidepressants prevent behavioral and brain neurotrophin alterations in two chronic stress models of depression. *J Neurochem.* 2009;111(2):403–16.
- Haller J, Bakos N, Rodriguiz RM, Caron MG, Wetsel WC, Liposits Z. Behavioral responses to social stress in noradrenaline transporter knockout mice: effects on social behavior and depression. *Brain Res Bull.* 2002;58:279–84.
- Hasselgren PO. Glucocorticoids and muscle catabolism. *Curr Opin Clin Nutr Metab Care.* 1999;2(3):201–5.

- Heffner TG, Hartman JA, Seiden LS. A rapid method for the regional dissection of the rat brain. *Pharmac Biochem Behav.* 1980;13:453–6.
- Heisler LK, Pronchuk N, Nonogaki K, Zhou L, Raber J, Tung L, Yeo GS, O'Rahilly S, Colmers WF, Elmquist JK, Tecott LH. Serotonin activates the hypothalamic-pituitary-adrenal axis via serotonin 2C receptor stimulation. *J Neurosci.* 2007;27(26):6956–64.
- Heisler LK, Zhou L, Bajwa P, Hsu J, Tecott LH. Serotonin 5-HT(2C) receptors regulate anxiety-like behavior. *Genes Brain Behav.* 2007;6(5):491–6.
- Henriksen EJ, Halseth AE. Adaptive responses of GLUT-4 and citrate synthase in fast-twitch muscle of voluntary running rats. *Am J Physiol.* 1995;268(1 Pt 2):R130–4.
- Herman JP. Neural control of chronic stress adaptation. *Front Behav Neurosci.* 2013;61(7):1–12.
- Higashino K, Ago Y, Umehara M, Kita Y, Fujita K, Takuma K, Matsuda T. Effects of acute and chronic administration of venlafaxine and desipramine on extracellular monoamine levels in the mouse prefrontal cortex and striatum. *Eur J Pharmacol.* 2014;729:86–93.
- Hogg S. A review of the validity and variability of the elevated plus-maze as an animal model of anxiety. *Pharmacol Biochem Behav.* 1996;54(1):21–30.
- Howland RH. Buspirone: Back to the Future. *J Psychosoc Nurs Ment Health Serv.* 2015;53(11):21–4.
- Hu H, Real E, Takamiya K, Kang M, Ledoux JE, Huganir RL, Malinow R. Emotion enhances learning via norepinephrine regulation of AMPA-receptor trafficking. *Cell* 2007;131(1):160–73.
- Huang CW, Lui CC, Chang WN, Lu CH, Wang YL, Chang CC. Elevated basal cortisol level predicts lower hippocampal volume and cognitive decline in Alzheimer's disease. *J Clin Neurosci* 2009;16:1283–6.
- Huang RR, Hu W, Yin YY, Wang YC, Li WP, Li WZ. Chronic restraint stress promotes learning and memory impairment due to enhanced neuronal endoplasmic reticulum stress in the frontal cortex and hippocampus in male mice. *Int J Mol Med.* 2015;35(2):553–9.

- Ibáñez CF. Jekyll-Hyde neurotrophins: The story of proNGF. *Trends Neurosci.* 2002;25:284–6.
- Ikeda A, Tanigawa T, Charvat H, Wada H, Shigemura J, Kawachi I. Longitudinal effects of disaster-related experiences on mental health among Fukushima nuclear plant workers: The Fukushima NEWS Project Study. *Psychol Med.* 2017;4:1–11.
- Imbesi M, Uz T, Dzitoyeva S, Giusti P, Manev H. Melatonin signaling in mouse cerebellar granule cells with variable native MT1 and MT2 melatonin receptors. *Brain Res.* 2008;1227:19–25.
- Irvine RJ, White J, Chan R. The influence of restraint on blood pressure in the rat. *J Pharmacol Toxicol Methods.* 1997;38(3):157–62.
- Isbister GK, Bowe SJ, Dawson A, Whyte IM. Relative toxicity of selective serotonin reuptake inhibitors (SSRIs) in overdose. *J Toxicol Clin Toxicol.* 2004;42(3):277–85.
- Iwamoto K, Nakatani N, Bundo M, Yoshikawa T, Kato T. Altered RNA editing of serotonin 2C receptor in a rat model of depression. *Neurosci Res.* 2005;53(1):69–76.
- Izquierdo I, Bevilaqua LR, Rossato JI, Bonini JS, Medina JH, Cammarota M. Different molecular cascades in different sites of the brain control memory consolidation. *Trends Neurosci.* 2006;29(9):496–505.
- Izquierdo I, Bevilaqua LR, Rossato JI, da Silva WC, Bonini J, Medina JH, Cammarota M. The molecular cascades of long-term potentiation underlie memory consolidation of one-trial avoidance in the CA1 region of the dorsal hippocampus, but not in the basolateral amygdala or the neocortex. *Neurotox Res.* 2008;14(2–3):273–94.
- Jezova D, Hlavacova N. Endocrine factors in stress and psychiatric disorders: focus on anxiety and salivary steroids. *Ann N Y Acad Sci.* 2008;1148:495–503.
- Kalkman HO, Loetscher E. GAD(67): the link between the GABA-deficit hypothesis and the dopaminergic- and glutamatergic theories of psychosis. *J Neural Transm (Vienna).* 2003;110(7):803–12.

- Kandel ER, Schwartz J, Jessell TM. Principles of neural science. 4th ed. USA: McGraw-Hill companies;2000.
- Kang S, Kim HJ, Kim HJ, Shin SK, Choi SH, Lee MS, et al. Effects of reboxetine and citalopram pretreatment on changes in cocaine and amphetamine regulated transcript (CART) expression in rat brain induced by the forced swimming test. *Eur J Pharmacol.* 2010; 647:110–6.
- Karakaş A, Coşkun H, Kaya A, Küçük A, Gündüz B. The effects of the intraamygdalar melatonin injections on the anxiety like behavior and the spatial memory performance in male Wistar rats. *Behav Brain Res.* 2011;222(1):141–50.
- Kawamoto Y, Nakamura S, Nakano S, Oka N, Akiguchi I, Kimura J. Immunohistochemical localization of brain-derived neurotrophic factor in adult rat brain. *Neuroscience.* 1996;74(4):1209–26.
- Keim KL, Sigg EB. Plasma corticosterone and brain catecholamines in stress: Effect of psychotropic drugs. *Pharmacol Biochem Behav.* 1977;6(1):79–85.
- Kempton MJ, Salvador Z, Munafò MR, Geddes JR, Simmons A, Frangou S, Williams SC. Structural neuroimaging studies in major depressive disorder: meta-analysis and comparison with bipolar disorder. *Arch Gen Psychiatry.* 2011;68(7):675–90.
- Kennedy SH, Eisfeld BS. Agomelatine and its therapeutic potential in the depressed patient. *Neuropsychiatr Dis Treat.* 2007;3(4):423–8.
- Kessler RC, Aguilar-Gaxiola S, Alonso J, Chatterji S, Lee S, Ormel J, Ustün TB, Wang PS. The global burden of mental disorders: an update from the WHO World Mental Health (WMH) surveys. *Epidemiol Psichiatr Soc.* 2009;18(1):23–33.
- Kim J, Gorman J. The psychobiology of anxiety. *Clin Neurosci Res.* 2005;4:335–47.
- Kitraki E, Alexis MN, Papalopoulou M, Stylianopoulou F. Glucocorticoid receptor gene expression in the embryonic rat brain. *Neuroendocrinology.* 1996;63: 305–17.
- Klein PS, Melton DA. A molecular mechanism for the effect of lithium on development. *Proc Natl Acad Sci U S A.* 1996;93(16):8455–9.

- Klimek V, Stockmeier C, Overholser J, Meltzer HY, Kalka S, Dilley G, Ordway GA. Reduced levels of norepinephrine transporters in the locus coeruleus in major depression. *J Neurosci*. 1997;17(21):8451–8.
- Klosen P, Bienvenu C, Demarteau O, Dardente H, Guerrero H, Pévet P, Masson-Pévet M. The mt1 melatonin receptor and RORbeta receptor are co-localized in specific TSH-immunoreactive cells in the pars tuberalis of the rat pituitary. *J Histochem Cytochem*. 2002;50(12):1647–57.
- Klosen P, Maessen X, van den Bosch de Aguilar P. PEG embedding for immunocytochemistry: application to the analysis of immunoreactivity loss during histological processing. *J Histochem Cytochem*. 1993;41(3):455–63.
- Konakchieva R, Mitev Y, Almeida OF, Patchev VK. Chronic melatonin treatment and the hypothalamo-pituitary-adrenal axis in the rat: attenuation of the secretory response to stress and effects on hypothalamic neuropeptide content and release. *Biol Cell*. 1997;89(9):587–96.
- Korosi A, Baram TZ. The central corticotropin releasing factor system during development and adulthood. *Eur J Pharmacol*. 2008;583(2–3):204–14.
- Krishnan V, Han MH, Graham DL, Berton O, Renthal W, Russo SJ, Laplant Q, Graham A, Lutter M, Lagace DC, Ghose S, Reister R, Tannous P, Green TA, Neve RL, Chakravarty S, Kumar A, Eisch AJ, Self DW, Lee FS, Tamminga CA, Cooper DC, Gershenfeld HK, Nestler EJ. Molecular adaptations underlying susceptibility and resistance to social defeat in brain reward regions. *Cell*. 2007;131:391–404.
- Kubota Y, Shigematsu N, Karube F, Sekigawa A, Kato S, Yamaguchi N, Hirai Y, Morishima M, Kawaguchi Y. Selective coexpression of multiple chemical markers defines discrete populations of neocortical GABAergic neurons. *Cereb Cortex*. 2011;21(8):1803–17.
- Kuczmarski JM, Martens CR, Kim J, Lennon-Edwards SL, Edwards DG. Cardiac function is preserved following 4 weeks of voluntary wheel running in a rodent model of chronic kidney disease. *J Appl Physiol* (1985). 2014;117(5):482–91.

- Lacoste B, Angeloni D, Dominguez-Lopez S, Calderoni S, Mauro A, Fraschini F, Descarries L, Gobbi G. Anatomical and cellular localization of melatonin MT1 and MT2 receptors in the adult rat brain. *J Pineal Res.* 2015;58(4):397–417.
- Lapmanee S, Charoenphandhu J, Charoenphandhu N. Beneficial effects of fluoxetine, reboxetine, venlafaxine, and voluntary running exercise in stressed male rats with anxiety- and depression-like behaviors. *Behav Brain Res.* 2013;250:316–25.
- Lapmanee S, Charoenphandhu N, Krishnamra N, Charoenphandhu J. Anxiolytic-like actions of reboxetine, venlafaxine and endurance swimming in stressed male rats. *Behav Brain Res.* 2012;231(1):20–8.
- Laudon M, Nir I, Zisapel N. Melatonin receptors in discrete brain areas of the male rat. Impact of aging on density and on circadian rhythmicity. *Neuroendocrinology.* 1988;48(6):577–83.
- Leasure JL, Jones M. Forced and voluntary exercise differentially affect brain and behavior. *Neuroscience.* 2008;156(3):456–65.
- Lee BH, Kim YK. The roles of BDNF in the pathophysiology of major depression and in antidepressant treatment. *Psychiatry Investig.* 2010;7(4):231–5.
- Lerner AB, Case JD, Takahashi Y, Lee TH, Mori W. Isolation of melatonin, the pineal gland factor that lightens melanocytes. *J Am Chem Soc.* 1958;80:2587.
- Lertsinthal P, Charoenphandhu J, Suntornsaratoon P, Krishnamra N, Charoenphandhu N. Voluntary wheel running mitigates the stress-induced bone loss in ovariectomized rats. *J Bone Miner Metab.* 2015;33(3):261–9.
- Li JJ, Yuan YG, Hou G, Zhang XR. Dose-related effects of venlafaxine on pCREB and brain-derived neurotrophic factor (BDNF) in the hippocampus of the rat by chronic unpredictable stress. *Acta Neuropsychiatr.* 2011;23(1):20–30.
- Li WY, Chang YC, Lee LJ, Lee LJ. Prenatal infection affects the neuronal architecture and cognitive function in adult mice. *Dev Neurosci.* 2014;36(5):359–70.

- Li X, Frye MA, Shelton RC. Review of pharmacological treatment in mood disorders and future directions for drug development. *Neuropsychopharmacology*. 2012;37(1):77–101.
- Liotti M, Mayberg HS. The role of functional neuroimaging in the neuropsychology of depression. *J Clin Exp Neuropsychol* 2001;23(1):121–36.
- Liu C, Weaver DR, Jin X, Shearman LP, Pieschl RL, Gribkoff VK, Reppert SM. Molecular dissection of two distinct actions of melatonin on the suprachiasmatic circadian clock. *Neuron*. 1997;19(1):91–102.
- Liu J, Clough SJ, Hutchinson AJ, Adamah-Biassi EB, Popovska-Gorevski M, Dubocovich ML. MT1 and MT2 Melatonin Receptors: A Therapeutic Perspective. *Annu Rev Pharmacol Toxicol*. 2016;56:361–83.
- Liu XY, Shi JH, DU WH, Fan YP, Hu XL, Zhang CC, Xu HB, Miao YJ, Zhou HY, Xiang P, Chen FL. Glucocorticoids decrease body weight and food intake and inhibit appetite regulatory peptide expression in the hypothalamus of rats. *Exp Ther Med*. 2011;2(5):977–84.
- Liu Y, Smith LI, Huang V, Poon V, Coello A, Olah M, Spiga F, Lightman SL, Aguilera G. Transcriptional regulation of episodic glucocorticoid secretion. *Mol Cell Endocrinol*. 2013;371(1–2):62–70.
- Liu YF, Chen HI, Wu CL, Kuo YM, Yu L, Huang AM, Wu FS, Chuang JI, Jen CJ. Differential effects of treadmill running and wheel running on spatial or aversive learning and memory: roles of amygdalar brain-derived neurotrophic factor and synaptotagmin I. *J Physiol*. 2009;587(Pt 13): 3221–31.
- Loiseau F, Le Bihan C, Hamon M, Thiébot MH. Antidepressant-like effects of agomelatine, melatonin and the NK1 receptor antagonist GR205171 in impulsive-related behaviour in rats. *Psychopharmacology (Berl)*. 2005;182(1):24–32.
- Luine V, Martinez C, Villegas M, Magariños AM, McEwen BS. Restraint stress reversibly enhances spatial memory performance. *Physiol Behav*. 1996;59(1):27–32.

- Maggio N, Segal M. Differential corticosteroid modulation of inhibitory synaptic currents in the dorsal and ventral hippocampus. *J Neurosci.* 2009;29(9):2857–66.
- Maguire J. Stress-induced plasticity of GABAergic inhibition. *Front Cell Neurosci.* 2014;157(8):1–8.
- Makatsori A, Duncko R, Schwendt M, Moncek F, Johansson BB, Jezova D. Voluntary wheel running modulates glutamate receptor subunit gene expression and stress hormone release in Lewis rats. *Psychoneuroendocrinology.* 2003;28:702–14.
- Malyszko J, Urano T, Takada Y, Takada A. Stress-dependent changes in fibrinolysis, serotonin and platelet aggregation in rats. *Life Sci.* 1994;54(17):1275–80.
- Maniam J, Morris MJ. Voluntary exercise and palatable high-fat diet both improve behavioural profile and stress responses in male rats exposed to early life stress: role of hippocampus. *Psychoneuroendocrinology.* 2010;35(10):1553–64.
- Masson-Pévet M, Naimi F, Canguilhem B, Saboureau M, Bonn D, Pévet P. Are the annual reproductive and body weight rhythms in the male European hamster (*Cricetus cricetus*) dependent upon a photoperiodically entrained circannual clock? *J Pineal Res.* 1994;17(4):151–63.
- Mazzucchelli C, Pannacci M, Nonno R, Lucini V, Fraschini F, Stankov BM. The melatonin receptor in the human brain: cloning experiments and distribution studies. *Brain Res Mol Brain Res.* 1996;39(1–2):117–26.
- McArdle WD, Katch FI, Katch VL. Training for anaerobic and aerobic power. In: McArdle WD, Katch FI, Katch VL, editors. *Exercise Physiology: Energy, Nutrition and Human Performance.* Philadelphia: Lippincott Williams and Wilkins; 2007. p. 469–507.
- McCarthy MM, Felzenberg E, Robbins A, Pfaff DW, Schwartz-Giblin S. Infusions of diazepam and allopregnanolone into the midbrain central gray facilitate open-field behavior and sexual receptivity in female rats. *Horm Behav.* 1995;29(3):279–95.
- McClung CA. Circadian rhythms and mood regulation: insights from pre-clinical models. *Eur Neuropsychopharmacol.* 2011;21 Suppl 4:S683–93.

- McDougall SJ, Lawrence AJ, Widdop RE. Differential cardiovascular responses to stressors in hypertensive and normotensive rats. *Exp Physiol.* 2005;90(1):141–50.
- McEwen BS. Physiology and neurobiology of stress and adaptation: central role of the brain. *Physiol Rev.* 2007;87(3):873–904.
- Melia KR, Rasmussen K, Terwilliger RZ, Haycock JW, Nestler EJ, Duman RS. Coordinate regulation of the cyclic AMP system with firing rate and expression of tyrosine hydroxylase in the rat locus coeruleus: effects of chronic stress and drug treatments. *J Neurochem.* 1992;58(2):494–502.
- Mercier S, Frédéric, Canini, Buguet A, Cespuglio R, Martin S, Bourdon L. Behavioural changes after an acute stress: stressor and test types influences. *Behav Brain Res.* 2003;139(1–2):167–75.
- Millan MJ, Brocco M, Gobert A, Dekeyne A. Anxiolytic properties of agomelatine, an antidepressant with melatonergic and serotonergic properties: role of 5-HT_{2C} receptor blockade. *Psychopharmacology (Berl).* 2005;177(4):448–58.
- Millan MJ, Gobert A, Lejeune F, Dekeyne A, Newman-Tancredi A, Pasteau V, Rivet JM, Cussac D. The novel melatonin agonist agomelatine (S20098) is an antagonist at 5-hydroxytryptamine 2C receptors, blockade of which enhances the activity of frontocortical dopaminergic and adrenergic pathways. *J Pharmacol Exp Ther.* 2003;306(3):954–64.
- Millan MJ, Gobert A, Rivet JM, Adhumeau-Auclair A, Cussac D, Newman-Tancredi A, Dekeyne A, Nicolas JP, Lejeune F. Mirtazapine enhances frontocortical dopaminergic and corticolimbic adrenergic, but not serotonergic, transmission by blockade of alpha₂-adrenergic and serotonin 2C receptors: a comparison with citalopram. *Eur J Neurosci.* 2000;12(3):1079–95.
- Mitra R, Jadhav S, McEwen BS, Vyas A, Chattarji S. Stress duration modulates the spatiotemporal patterns of spine formation in the basolateral amygdala. *Proc Natl Acad Sci USA.* 2005;102:9371–76.
- Mohammad-Zadeh LF, Moses L, Gwaltney-Brant SM. Serotonin: a review. *J Vet Pharmacol Ther.* 2008;31(3):187–99.

- Molteni R, Rossetti AC, Savino E, Racagni G, Calabrese F. Chronic Mild Stress Modulates Activity-Dependent Transcription of BDNF in Rat Hippocampal Slices. *Neural Plast.* 2016;2016:2592319.
- Montgomery SA, Kennedy SH, Burrows GD, Lejoyeux M, Hindmarch I. Absence of discontinuation symptoms with agomelatine and occurrence of discontinuation symptoms with paroxetine: a randomized, double-blind, placebo-controlled discontinuation study. *Int Clin Psychopharmacol.* 2004;19(5):271–80.
- Morgan PJ, Williams LM, Davidson G, Lawson W, Howell E. Melatonin receptors on ovine pars tuberalis: characterization and autoradiographical localization. *J Neuroendocrinol.* 1989;1(1):1–4.
- Morishima M, Harada N, Hara S, Sano A, Seno H, Takahashi A, Morita Y, Nakaya Y. Monoamine oxidase A activity and norepinephrine level in hippocampus determine hyperwheel running in SPORTS rats. *Neuropsychopharmacology.* 2006;31(12):2627–38.
- Morley-Fletcher S, Mairesse J, Soumier A, Banasr M, Fagioli F, Gabriel C, Mocaer E, Daszuta A, McEwen B, Nicoletti F, Maccari S. Chronic agomelatine treatment corrects behavioral, cellular, and biochemical abnormalities induced by prenatal stress in rats. *Psychopharmacology (Berl).* 2011;217(3):301–13.
- Morris R. Developments of a water-maze procedure for studying spatial-learning in the rat. *J of Neurosci Methods.* 1984;11:47–60.
- Morris R. Spatial localization does not require the presence of local cues. *Learning and Motivation.* 1981;12:239–60.
- Murakami S, Imbe H, Morikawa Y, Kubo C, Senba E. Chronic stress, as well as acute stress, reduces BDNF mRNA expression in the rat hippocampus but less robustly. *Neurosci Res.* 2005;53:129–39.
- Musshoff U, Riewenherm D, Berger E, Fauteck JD, Speckmann EJ. Melatonin receptors in rat hippocampus: molecular and functional investigations. *Hippocampus.* 2002;12(2):165–73.
- Niswender CM, Herrick-Davis K, Dilley GE, Meltzer HY, Overholser JC, Stockmeier CA, Emeson RB, Sanders-Bush E. RNA editing of the human serotonin 5-

- HT2C receptor: alterations in suicide and implications for serotonergic pharmacotherapy. *Neuropsychopharmacology*. 2001;24(5):478–91.
- Novak CM, Burghardt PR, Levine JA. The use of a running wheel to measure activity in rodents: relationship to energy balance, general activity, and reward. *Neurosci Biobehav Rev*. 2012;36(3):1001–14.
- Owens MJ, Nemeroff CB. Role of serotonin in the pathophysiology of depression: focus on the serotonin transporter. *Clin Chem*. 1994;40:288–95.
- Païzani E, Renoir T, Lelievre V, Saurini F, Melfort M, Gabriel C, Barden N, Mocaër E, Hamon M, Lanfumey L. Behavioural and neuroplastic effects of the new-generation antidepressant agomelatine compared to fluoxetine in glucocorticoid receptor-impaired mice. *Int J Neuropsychopharmacol*. 2010;13(6):759–74.
- Pandaranandaka J, Poonyachoti S, Kalandakanond-Thongsong S. Anxiolytic property of estrogen related to the changes of the monoamine levels in various brain regions of ovariectomized rats. *Physiol Behav*. 2006;87(4):828–35.
- Pandaranandaka J, Poonyachoti S, Kalandakanond-Thongsong S. Differential effects of exogenous and endogenous estrogen on anxiety as measured by elevated T-maze in relation to the serotonergic system. *Behav Brain Res*. 2009;198(1):142–8.
- Pandi-Perumal SR, Srinivasan V, Poeggeler B, Hardeland R, Cardinali DP. Drug Insight: the use of melatonergic agonists for the treatment of insomnia—focus on ramelteon. *Nat Clin Pract Neurol*. 2007;3(4):221–8.
- Papp M, Gruca P, Boyer PA, Mocaër E. Effect of agomelatine in the chronic mild stress model of depression in the rat. *Neuropsychopharmacology*. 2003;28(4):694–703.
- Papp M, Willner P, Muscat R. An animal model of anhedonia: attenuation of sucrose consumption and place preference conditioning by chronic unpredictable mild stress. *Psychopharmacology (Berl)*. 1991;104:255–9.
- Pare WP, Blair GR, Kluczynski J, Tejani-Butt S. Gender differences in acute and chronic stress in Wistar Kyoto (WKY) rats. *Integr Physiol Behav Sci*. 1999;34:227–41.

- Patki G, Solanki N, Atrooz F, Ansari A, Allam F, Jannise B, Maturi J, Salim S. Novel mechanistic insights into treadmill exercise based rescue of social defeat-induced anxiety-like behavior and memory impairment in rats. *Physiol Behav.* 2014;130:135–44.
- Paul C, Magda G, Abel S. Spatial memory: theoretical basis and comparative review on experimental methods in rodents. *Behav Brain Res.* 2009;203:151–164.
- Paxinos G, Watson C. *The rat brain in stereotaxic coordinates.* San Diego (CA): Elsevier Academic Press. 2005.
- Persengiev S, Kanchev L, Vezenkova G. Circadian patterns of melatonin, corticosterone, and progesterone in male rats subjected to chronic stress: effect of constant illumination. *J Pineal Res.* 1991;11:57–62.
- Pévet P. Melatonin receptors as therapeutic targets in the suprachiasmatic nucleus. *Expert Opin Ther Targets.* 2016;20(10):1209–18.
- Pietropaolo S, Sun Y, Li R, Brana C, Feldon J, Yee BK. The impact of voluntary exercise on mental health in rodents: a neuroplasticity perspective. *Behav Brain Res.* 2008;192(1):42–60.
- Pinheiro SH1, Zangrossi H Jr, Del-Ben CM, Graeff FG. Elevated mazes as animal models of anxiety: effects of serotonergic agents. *An Acad Bras Cienc.* 2007;79(1):71–85.
- Poirel VJ, Masson-Pévet M, Pevét P, Gauer F. MT1 melatonin receptor mRNA expression exhibits a circadian variation in the rat suprachiasmatic nuclei. *Brain Res.* 2002;946(1):64–71.
- Pompeiano M, Palacios JM, Mengod G. Distribution of the serotonin 5-HT2 receptor family mRNAs: comparison between 5-HT2A and 5-HT2C receptors. *Brain Res Mol Brain Res.* 1994;23(1–2):163–78.
- Porsolt RD, Bertin A, Blavet N, Deniel M, Jalfre M. Immobility induced by forced swimming in rats: effects of agents which modify central catecholamine and serotonin activity. *Eur J Pharmacol.* 1979;57(2–3):201–10.
- Pothion S, Bizot JC, Trovero F, Belzung C. Strain differences in sucrose preference and in the consequences of unpredictable chronic mild stress. *Behav Brain Res.* 2004;155(1):135–46.

- Prut L, Belzung C. The open field as a paradigm to measure the effects of drugs on anxiety-like behaviors: a review. *Eur J Pharmacol* 2003;463(1–3):3–33.
- Raadsheer FC, van Heerikhuize JJ, Lucassen PJ, Hoogendijk WJ, Tilders FJ, Swaab DF. Corticotropin-releasing hormone mRNA levels in the paraventricular nucleus of patients with Alzheimer's disease and depression. *Am J Psychiatry*. 1995;152(9):1372–6.
- Ramos A, Mormède P. Stress and emotionality: a multidimensional and genetic approach. *Neurosci Biobehav Rev*. 1998;22(1):33–57.
- Rasband, WS., ImageJ, U. S. National Institutes of Health, Bethesda, Maryland, USA, <http://imagej.nih.gov/ij/>, 1997–2016. [Accessed: 09/02/2016].
- Redrobe JP, Bull S, Plath N. Translational Aspects of the Novel Object Recognition Task in Rats Abstinent Following Sub-Chronic Treatment with Phencyclidine (PCP): Effects of Modafinil and Relevance to Cognitive Deficits in Schizophrenia. *Front Psychiatry*. 2010;146(1):1–7.
- Redrobe JP, Elster L, Frederiksen K, Bundgaard C, de Jong IE, Smith GP, Bruun AT, Larsen PH, Didriksen M. Negative modulation of GABAA $\alpha 5$ receptors by RO4938581 attenuates discrete sub-chronic and early postnatal phencyclidine (PCP)-induced cognitive deficits in rats. *Psychopharmacology (Berl)*. 2012;221(3):451–68.
- Reus GZ, Stringari RB, Ribeiro KF, Cipriano AL, Panizzutti BS, Stertz L, et al. Maternal deprivation induces depressive-like behaviour and alters neurotrophin levels in the rat brain. *Neurochem Res*. 2011;36:460–6.
- Rodgers RJ, Cao BJ, Dalvi A, Holmes A. Animal models of anxiety: an ethological perspective. *Braz J Med Biol Res*. 1997;30(3):289–304.
- Sairanen M, O'Leary OF, Knuutila JE, Castrén E. Chronic antidepressant treatment selectively increases expression of plasticity-related proteins in the hippocampus and medial prefrontal cortex of the rat. *Neuroscience*. 2007;144(1):368–74.
- Salam JN, Fox JH, Detroy EM, Guignon MH, Wohl DF, Falls WA. Voluntary exercise in C57 mice is anxiolytic across several measures of anxiety. *Behav Brain Res*. 2009;197(1):31–40.

- Salmon P. Effects of physical exercise on anxiety, depression, and sensitivity to stress: a unifying theory. *Clin Psychol Rev.* 2001;21(1):33–61.
- Sanches A, Costa R, Marcondes FK, Cunha TS. Relationship among stress, depression, cardiovascular and metabolic changes and physical exercise. *Fisioter mov.* 2016;29(1):23–36.
- Sandi C, Venero C, Guaza C. Novelty-related rapid locomotor effects of corticosterone in rats. *Eur J Neurosci.* 1996;8:794–800.
- Sapolsky RM, Krey LC, McEwen BS. The neuroendocrinology of stress and aging: the glucocorticoid cascade hypothesis. *Endocr Rev.* 1986;7(3):284–301.
- Sareen J, Cox BJ, Afifi TO, Stein MB, Belik SL, Meadows G, Asmundson GJ. Combat and peacekeeping operations in relation to prevalence of mental disorders and perceived need for mental health care: findings from a large representative sample of military personnel. *Arch Gen Psychiatry.* 2007;64(7):843–52.
- Scheinin M, Karhuvaara S, Ojala-Karlsson P, Kallio A, Koulu M. Plasma 3,4-dihydroxyphenylglycol (DHPG) and 3-methoxy-4-hydroxyphenylglycol (MHPG) are insensitive indicators of alpha 2-adrenoceptor mediated regulation of norepinephrine release in healthy human volunteers. *Life Sci.* 1991;49(1):75–84.
- Schloss P, Williams DC. The serotonin transporter: a primary target for antidepressant drugs. *J Psychopharmacol.* 1998;12(2):115–21.
- Schmidt HD, Duman RS. The role of neurotrophic factors in adult hippocampal neurogenesis, antidepressant treatments and animal models of depressive-like behavior. *Behav Pharmacol.* 2007;18:391–418.
- Schwabe L, Schächinger H, de Kloet ER, Oitzl MS. Corticosteroids operate as a switch between memory systems. *J Cogn Neurosci.* 2010;22(7):1362–72.
- Searleman A, Herrmann, D. *Memory from a broader perspective.* New York:McGraw-Hill, Inc. 1994.
- Seo MK, Lee CH, Cho HY, You YS, Lee BJ, Lee JG, Park SW, Kim YH. Effects of antipsychotic drugs on the expression of synapse-associated proteins in the frontal cortex of rats subjected to immobilization stress. *Psychiatry Res.* 2015;229(3):968–74.

- Serrats J, Mengod G, Cortés R. Expression of serotonin 5-HT_{2C} receptors in GABAergic cells of the anterior raphe nuclei. *J Chem Neuroanat.* 2005;29(2):83–91.
- Sharma S, Singh H, Ahmad N, Mishra P, Tiwari A. The role of melatonin in diabetes: therapeutic implications. *Arch Endocrinol Metab.* 2015;59(5):391–9.
- Sieglar GJ, Albers RW, Brady ST, Price DL. Basic neurochemistry molecular, cellular, and medical aspects. 7th ed. London: Elsevier Academic press; 2006.
- Smith SM, Vale WW. The role of the hypothalamic-pituitary-adrenal axis in neuroendocrine responses to stress. *Dialogues Clin Neurosci.* 2006;8(4):383–95.
- Sousa RJ, Tannery NH, Lafer EM. In situ hybridization mapping of glucocorticoid receptor messenger ribonucleic acid in rat brain. *Mol Endocrinol.* 1989;3:481–94.
- Spina E, Santoro V, D'Arrigo C. Clinically relevant pharmacokinetic drug interactions with second-generation antidepressants: an update. *Clin Ther.* 2008;30(7):1206–27.
- Squire LR. Declarative and nondeclarative memory: multiple brain systems supporting learning and memory. *J Cogn Neurosci.* 1992;4(3):232–43.
- Stamp J, Herbert J. Corticosterone modulates autonomic responses and adaptation of central immediate-early gene expression to repeated restraint stress. *Neuroscience.* 2001;107:465–79.
- Stone DJ, Walsh JP, Benes FM. Localization of cells preferentially expressing GAD(67) with negligible GAD(65) transcripts in the rat hippocampus. A double in situ hybridization study. *Brain Res Mol Brain Res.* 1999;71(2):201–9.
- Stone DJ, Walsh JP, Sebro R, Stevens R, Pantazopoulos H, Benes FM. Effects of pre- and postnatal corticosterone exposure on the rat hippocampal GABA system. *Hippocampus.* 2001;11(5):492–507.
- Stranahan AM, Lee K, Mattson MP. Central mechanisms of HPA axis regulation by voluntary exercise. *Neuromolecular Med.* 2008;10(2):118–27.

- Strekalova T, Couch Y, Kholod N, Boyks M, Malin D, Leprince P, Steinbusch HM. Update in the methodology of the chronic stress paradigm: internal control matters. *Behav Brain Funct.* 2011;9(7):1–18.
- Strekalova T, Spanagel R, Bartsch D, Henn FA, Gass P. Stress-induced anhedonia in mice is associated with deficits in forced swimming and exploration. *Neuropsychopharmacology.* 2004;29(11):2007–17.
- Strekalova T, Steinbusch HW. Measuring behavior in mice with chronic stress depression paradigm. *Prog Neuropsychopharmacol Biol Psychiatry.* 2010;34(2):348–61.
- Ströhle A. Physical activity, exercise, depression and anxiety disorders. *J Neural Transm.* 2009;116(6):777–84.
- Sullivan GM, Coplan JD, Kent JM, Gorman JM. The noradrenergic system in pathological anxiety: a focus on panic with relevance to generalized anxiety and phobias. *Biol Psychiatry.* 1999;46(9):1205–18.
- Taliaz D, Loya A, Gersner R, Haramati S, Chen A, Zangen A. Resilience to chronic stress is mediated by hippocampal brain-derived neurotrophic factor. *J Neurosci.* 2011;31(12):4475–83.
- Tan F, Fu W, Cheng N, Meng D, Gu Y. Ligustrazine reduces blood-brain barrier permeability in a rat model of focal cerebral ischemia and reperfusion. *Exp Ther Med.* 2015;9:1757–62.
- Tanaka M, Yoshida M, Emoto H, Ishii H. Noradrenaline systems in the hypothalamus, amygdala and locus coeruleus are involved in the provocation of anxiety: basic studies. *Eur J Pharmacol.* 2000;405(1–3):397–406.
- Taylor D, Sparshatt A, Varma S, Olofinjana O. Antidepressant efficacy of agomelatine: meta-analysis of published and unpublished studies. *BMJ.* 2014;348(g1888):1–19.
- Taylor SB, Markham JA, Taylor AR, Kanaskie BZ, Koenig JI. Sex-specific neuroendocrine and behavioral phenotypes in hypomorphic Type II Neuregulin 1 rats. *Behav Brain Res.* 2011;224(2):223–32.
- Thanos PK, Cavigelli SA, Michaelides M, Olvet DM, Patel U, Diep MN, et al. A non-invasive method for detecting the metabolic stress response in rodents:

- Characterization and disruption of the circadian corticosterone rhythm. *Physiol Res.* 2009;58(2):219–28.
- Treit D, Fundytus M. Thigmotaxis as a test for anxiolytic activity in rats. *Pharmacol Biochem Behav.* 1988;31(4):959–62.
- Ulrich-Lai YM, Figueiredo HF, Ostrander MM, Choi DC, Engeland WC, Herman JP. Chronic stress induces adrenal hyperplasia and hypertrophy in a subregion-specific manner. *Am J Physiol Endocrinol Metab.* 2006;291(5):E965–73.
- Ulrich-Lai YM, Herman JP. Neural regulation of endocrine and autonomic stress responses. *Nat Rev Neurosci.* 2009;10(6):397–409.
- Uz T, Arslan AD, Kurtuncu M, Imbesi M, Akhisaroglu M, Dwivedi Y, Pandey GN, Manev H. The regional and cellular expression profile of the melatonin receptor MT1 in the central dopaminergic system. *Brain Res Mol Brain Res.* 2005;136(1–2):45–53.
- Vale W, Spiess J, Rivier C, Rivier J. Characterization of a 41-residue ovine hypothalamic peptide that stimulates secretion of corticotropin and beta-endorphin. *Science.* 1981;213(4514):1394–7.
- van Bockstaele EJ, Aston-Jones G. Collateralized projections from neurons in the rostral medulla to the nucleus locus coeruleus, the nucleus of the solitary tract and the periaqueductal gray. *Neuroscience.* 1992;49:653–68
- van der Staay FJ. Animal models of behavioral dysfunctions: basic concepts and classifications, and an evaluation strategy. *Brain Res Rev.* 2006;52(1):131–59.
- van Praag H, Kempermann G, Gage FH. Running increases cell proliferation and neurogenesis in the adult mouse dentate gyrus. *Nat Neurosci.* 1999;2(3):266–70.
- van Praag H, Shubert T, Zhao C, Gage FH. Exercise enhances learning and hippocampal neurogenesis in aged mice. *J Neurosci.* 2005;25(38):8680–85.
- Vaněček J, Pavlík A, Illnerová H. Hypothalamic melatonin receptor sites revealed by autoradiography. *Brain Res.* 1987;435(1–2):359–62.

- Vollmayr B, Keck S, Henn FA, Schloss P. Acute stress decreases serotonin transporter mRNA in the raphe pontis but not in other raphe nuclei of the rat. *Neurosci Lett.* 2000;290:109–12.
- Wang Y, Wisloff U, Kemi OJ. Animal models in the study of exercise-induced cardiac hypertrophy. *Physiol Res.* 2010;59(5):633–44.
- Weaver DR, Rivkees SA, Reppert SM. Localization and characterization of melatonin receptors in rodent brain by in vitro autoradiography. *J Neurosci.* 1989;9(7):2581–90.
- Weaver DR, Stehle JH, Stopa EG, Reppert SM. Melatonin receptors in human hypothalamus and pituitary: implications for circadian and reproductive responses to melatonin. *J Clin Endocrinol Metab.* 1993;76(2):295–301.
- Welsh DK, Takahashi JS, Kay SA. Suprachiasmatic nucleus: cell autonomy and network properties. *Annu Rev Physiol.* 2010;72:551–77.
- Williams LM, Hannah LT, Hastings MH, Maywood ES. Melatonin receptors in the rat brain and pituitary. *J Pineal Res.* 1995;19(4):173–7.
- Willner P, Moreau JL, Nielsen CK, Papp M, Sluzewska A. Decreased hedonic responsiveness following chronic mild stress is not secondary to loss of body weight. *Physiol Behav.* 1996;60(1):129–34.
- Willner P, Towell A, Sampson D, Sophokleous S, Muscat R. Reduction of sucrose preference by chronic unpredictable mild stress, and its restoration by a tricyclic antidepressant. *Psychopharmacology (Berl).* 1987;93(3):358–64.
- Wood GE, Norris EH, Waters E, Stoldt JT, McEwen BS. Chronic immobilization stress alters aspects of emotionality and associative learning in the rat. *Behav Neurosci.* 2008;122(2):282–92.
- Wu YH, Ursinus J, Zhou JN, Scheer FA, Ai-Min B, Jockers R, van Heerikhuizen J, Swaab DF. Alterations of melatonin receptors MT1 and MT2 in the hypothalamic suprachiasmatic nucleus during depression. *J Affect Disord.* 2013;148(2–3):357–67.
- Wu YH, Zhou JN, Balesar R, Unmehopa U, Bao A, Jockers R, Van Heerikhuizen J, Swaab DF. Distribution of MT1 melatonin receptor immunoreactivity in the human hypothalamus and pituitary gland: colocalization of MT1 with

- vasopressin, oxytocin, and corticotropin-releasing hormone. *J Comp Neurol.* 2006;499(6):897–910.
- Xu Y, Jones JE, Kohno D, Williams KW, Lee CE, Choi MJ, Anderson JG, Heisler LK, Zigman JM, Lowell BB, Elmquist JK. 5-HT₂CRs expressed by pro-opiomelanocortin neurons regulate energy homeostasis. *Neuron.* 2008;60(4):582–9.
- Yadin E, Thomas E, Grishkat HL, Strickland CE. The role of the lateral septum in anxiolysis. *Physiol Behav.* 1993;53(6):1077–83.
- Yamada K, Nabeshima T. Brain-derived neurotrophic factor/TrkB signaling in memory processes. *J Pharmacol Sci.* 2003;91(4):267–70.
- Yan Q, Rosenfeld RD, Matheson CR, Hawkins N, Lopez OT, Bennett L, Welcher AA. Expression of brain-derived neurotrophic factor protein in the adult rat central nervous system. *Neuroscience.* 1997;78(2):431–48.
- Yan XX, Baram TZ, Gerth A, Schultz L, Ribak CE. Co-localization of corticotropin-releasing hormone with glutamate decarboxylase and calcium-binding proteins in infant rat neocortical interneurons. *Exp Brain Res.* 1998;123(3):334–40.
- Youdim MB, Bakhle YS. Monoamine oxidase: isoforms and inhibitors in Parkinson's disease and depressive illness. *Br J Pharmacol.* 2006;147 Suppl 1:S287–96.
- Zhang J, Fan Y, Li Y, Zhu H, Wang L, Zhu MY. Chronic social defeat up-regulates expression of the serotonin transporter in rat dorsal raphe nucleus and projection regions in a glucocorticoid-dependent manner. *J Neurochem.* 2012;123(6):1054–68.
- Zhang JC, Wu J, Fujita Y, Yao W, Ren Q, Yang C, Li SX, Shirayama Y, Hashimoto K. Antidepressant effects of TrkB ligands on depression-like behavior and dendritic changes in mice after inflammation. *Int J Neuropsychopharmacol.* 2014;18(4):1–12.
- Zhao Z, Baros AM, Zhang HT, Lapid MD, Bondi CO, Morilak DA, O'Donnell JM. Norepinephrine transporter regulation mediates the long-term behavioral

effects of the antidepressant desipramine. *Neuropsychopharmacology*. 2008;33(13):3190–200.

Zheng F, Wang H. NMDA-mediated and self-induced bdnf exon IV transcriptions are differentially regulated in cultured cortical neurons. *Neurochem Int*. 2009;54(5–6):385–92.

Zheng H, Liu Y, Li W, Yang B, Chen D, Wang W, Jiang Z, Wang Z, Cornelisson G, Halberg F. Beneficial effects of exercise and its molecular mechanism on depression in rats. *Behav Brain Res*. 2006;168:47–55.

Zhou FC, Sari Y, Zhang JK. Expression of serotonin transporter protein in developing rat brain. *Brain Res Dev Brain Res*. 2000;119(1):33–45.

Zhou FC, Xu Y, Bledsoe S, Lin R, Kelley MR. Serotonin transporter antibodies: production, characterization, and localization in the brain. *Brain Res Mol Brain Res*. 1996;43(1–2):267–78.

Zhou XF, Song XY, Zhong JH, Barati S, Zhou FH, Johnson SM. Distribution and localization of pro-brain-derived neurotrophic factor-like immunoreactivity in the peripheral and central nervous system of the adult rat. *J Neurochem*. 2004;91(3):704–15.

Zhu LJ, Liu MY, Li H, Liu X, Chen C, Han Z, Wu HY, Jing X, Zhou HH, Suh H, Zhu DY, Zhou QG. The different roles of glucocorticoids in the hippocampus and hypothalamus in chronic stress-induced HPA axis hyperactivity. *PLoS One*. 2014;9(5):1–14.

Zhu MY, Kim CH, Hwang DY, Baldessarini RJ, Kim KS. Effects of desipramine treatment on norepinephrine transporter gene expression in the cultured SK-N-BE(2)M17 cells and rat brain tissue. *J Neurochem*. 2002;82(1):146–53.

APPENDIX

TRANSGENIC MOUSE MODELS

Strategies for gene transfer into early embryonic stages have been developed to generate animal models to study human physiology and the pathophysiology of diseases. Technically, the process of generating transgenic mice consists in the purification of a transgenic construct, harvesting donor zygotes, microinjection of the transgenic construct into these zygotes, implantation of the microinjected zygotes into pseudo-pregnant recipient mice, and genotyping and analysis of transgene expression in founder mice (Cho et al., 2009).

Such transgenic models also include knock-out models, where genes are inactivated by the deletion of all or only parts of the coding sequence of a gene to be studied. Similarly, knock-in models allow the introduction of either specific mutations or foreign coding sequences into the locus of a gene. For these knock-in and knock-out models, the transgenic constructs are introduced directly into the locus of the gene of interest by homologous recombination in embryonic stem cells. These modified embryonic stem cells are then introduced into blastocysts, which then generate chimeric animals. These chimeric animals are then bred to generate first heterozygous founder mice, and further into homozygous mutant knock-in or knock-out mice if desired. Classical transgenic animals, knock-in and knock-out animals are tools to study the underlying mechanisms of candidate genes at cellular and molecular levels.

The *Cre/LoxP* system is an additional tool to generate mutant mice. Briefly, the *Cre* recombinase enzyme deletes a part of DNA located between two loxP sites (locus of crossing over of the P1 bacteriophage). The loxP sites can be introduced around an essential exon in a gene by the knock-in technique described above. The mouse strain containing the floxed allele is phenotypically identical to wild type animals. However, when these mice are then crossed with a transgenic mouse line expressing the enzyme *Cre* recombinase, the *Cre* recombinase will delete the sequence between the two loxP sites, but only in the cells that express the *Cre* recombinase.

Thus the *Cre/LoxP* system allows the targeting of gene deletions to selective cell types, according to the regulatory sequences that drive the expression of the *Cre* recombinase (reviewed by Kos, 2004; Hall et al., 2009).

In the transgenic animals used in this study, the *LacZ* reporter gene was introduced into either the MT1 or the MT2 receptor gene locus in such a way that the ATG start codon of *LacZ* is located at the position of the original ATG start codon of the MT1 or MT2 coding sequence. The MT1 or MT2 coding sequences are deleted in this process, while leaving intact all upstream and downstream regulatory elements driving the expression of the MT1 or MT2 gene (Figure A.1). Only potential regulatory sequences located in the intron of the MT1 or MT2 sequence are lost in this process. Thus the expression pattern of the reporter *LacZ* beta-galactosidase (from the bacterium *Escherichia coli*) should reflect the expression pattern of the original MT1 or MT2 genes. *LacZ* beta-galactosidase (encoded by the *lacZ* gene in the *lacZ* operon) is an enzyme converting lactose into glucose and galactose. When presented with the substrate analog X-gal (5-bromo-4-chloro-3-indolyl-beta-D-galactopyranoside), the *LacZ* enzyme activity results in the formation of a blue precipitate.

Heterogeneous ($KI^{+/-}$) MT1 or MT2 knock-in mice conserve one intact MT1 or MT2 allele. Thus these $KI^{+/-}$ mice still express this one intact allele. Liu and co-workers (1997) reported that the expression of MT1 in $Mtnr1a^{+/-}$ mice is about half that of wild-type animals, as assessed by ^{125}I -iodomelatonin binding. Except for this reduction in the quantity of ^{125}I -iodomelatonin binding, the qualitative pattern of ^{125}I -iodomelatonin binding in the $Mtnr1a^{+/-}$ animals is identical to that of wild type $Mtnr1a^{+/+}$ animals. Thus deletion of one *Mtnr1a* allele does not seem to affect the expression pattern of the MT1 receptor, and replacing one of the *Mtnr1a* alleles with a reporter gene construct should not modify the expression pattern due to the regulatory elements. Deletion of both *Mtnr1a* alleles in $Mtnr1a^{-/-}$ knockout animals resulted in the complete abolishment of ^{125}I -iodomelatonin binding, indicating that this ^{125}I -iodomelatonin binding on tissue sections was entirely due to the MT1 receptor (Liu et al., 1997).

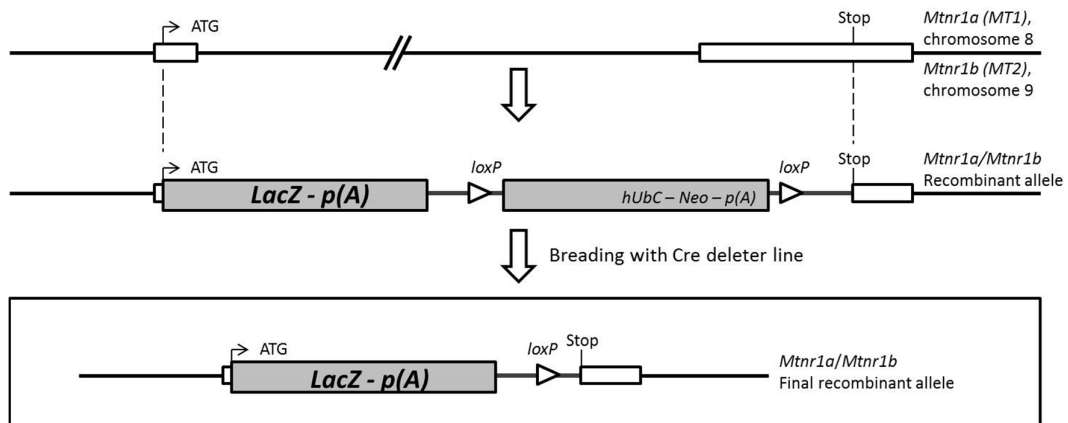

Figure A.1 Generation of MT1-/MT2-LacZ knock-in mice. The mutant MT1 (*Mtnr1a*) or MT2 (*Mtnr1b*) alleles contain a *loxP*-*hUbC*-Neomycin-polyA stop cassette. This Neomycin resistance cassette used for the selection of recombinant embryonic stem cells is then deleted from the mutant locus using *Cre*-mediated recombination to avoid interference of these sequences with the expression profile of the *LacZ* reporter gene.

Most mouse strains (including the C57BL/6 strain) do not produce MT due to loss of function mutations in the N-acetyltransferase (NAT) and the hydroxyindole O-methyltransferase (HIOMT) genes (Kasahara et al., 2010). Both of these enzymes are necessary to produce MT from its precursor 5-HT. The MT1-LacZ and MT2-LacZ reporter constructs were initially introduced into C57BL/6 mice that do not produce MT. To test whether the presence or the absence of MT influences the expression pattern of MT1 or MT2 receptors, we crossed the MT1-LacZ or MT2-LacZ C57BL/6 mice with a MT-proficient mouse strain, the C3H strain. In the F1 generation of this cross, animals possess 1 set of chromosomes from the C57BL/6 parent, with mutated non-functional NAT and HIOMT alleles, but potentially with the recombinant MT1-LacZ or MT2-LacZ allele. The second set of chromosomes comes from the C3H parent, thus containing intact NAT and HIOMT alleles. Because of these intact NAT and HIOMT alleles, the C57BL/6 x C3H F1 mice are able to synthesize MT. Among this F1 offspring, we then selected animals containing the recombinant MT1-LacZ and MT2-LacZ alleles to obtain reporter mice able to produce MT.

References

- Cho A, Haruyama N, Kulkarni AB. Generation of transgenic mice. *Curr Protoc Cell Biol.* 2009;Chapter 19:Unit 19.11.
- Hall B, Limaye A, Kulkarni AB. Overview: generation of gene knockout mice. *Curr Protoc Cell Biol.* 2009 Sep;Chapter 19:Unit 19.12 19.12.1–17.
- Kasahara T, Abe K, Mekada K, Yoshiki A, Kato T. Genetic variation of melatonin productivity in laboratory mice under domestication. *Proc Natl Acad Sci U S A.* 2010;107(14):6412–7.
- Kos CH. Cre/loxP system for generating tissue-specific knockout mouse models. *Nutr Rev.* 2004;62(6 Pt 1):243–6.
- Liu C, Weaver DR, Jin X, Shearman LP, Pieschl RL, Gribkoff VK, Reppert SM. Molecular dissection of two distinct actions of melatonin on the suprachiasmatic circadian clock. *Neuron.* 1997;19(1):91–102.

BIOGRAPHY

NAME	Mr. Sarawut Lapmanee
DATE OF BIRTH	June 7, 1985
PLACE OF BIRTH	Nakhon Si Thammarat, Thailand
INSTITUTIONS ATTENDED	Mahidol University, 2004–2007 Bachelor of Science (Physiotherapy) Mahidol University, 2008–2011 Master of Science (Exercise Physiology) Mahidol University, 2012–2017 Doctor of Philosophy (Neurosciences & Physiology)
SCHOLARSHIPS	2012–2013 Institutional Strengthening Program Scholarship, Faculty of Science, Mahidol University 2013–2015 Royal Golden Jubilee Ph.D. Program, Thailand Research Fund 2015–2016 - Embassy of France, Thailand - Graduate Studies of Mahidol University Alumni Association, Mahidol University
HOME ADDRESS	79/105 moo22, Robwiang, Muang , Chiang Rai, Thailand, 57000 Tel. 097–935–5055 E-mail: sarawut_lapmanee@outlook.com

PUBLICATIONS

Lapmanee S, Charoenphandhu J, Teerapornpantakit J, Krishnamra N, Charoenphandhu N. (2017): Agomelatine, venlafaxine, and running exercise effectively prevent anxiety- and depression-like behaviors and memory impairment in restraint stressed rats. (Edited and submitted to PLoS ONE)

Kraidith K, Svasti S, Teerapornpantakit J, Vadolas J, Chaimana R, **Lapmanee S**, Suntornsaratoon P, Krishnamra N, Fucharoen S, Charoenphandhu N. Hepcidin and 1,25(OH)₂D₃ effectively restore Ca²⁺ transport in β thalassemic mice: reciprocal phenomenon of Fe²⁺ and Ca²⁺ absorption. *Am J Physiol Endocrinol Metab.* 2016;311(1):E214–23.

Lapmanee S, Charoenphandhu N, Aeimlapa R, Suntornsaratoon P, Wongdee K, Tiyasatkulkovit W, Kengkoom K, Chaimongkolnukul K, Seriwatanachai D, Krishnamra N. High dietary cholesterol masks type 2 diabetes-induced osteopenia and changes in bone microstructure in rats. *Lipids.* 2014;49(10):975–86.

POSTER PRESENTATIONS

Lapmanee S, Charoenphandhu J, Krishnamra N, Charoenphandhu N. “Neuroprotective effects of venlafaxine and voluntary wheel running against stress-induced anxiety, depression and cognitive impairment in male rats” at Royal Golden Jubilee (RGJ)-Ph.D. Congress 18, Nonthaburi, Thailand, June 8–10, 2017.

Lapmanee S, Felder-Schmittbuhl MP, Schuster-Klein C, Guardiola B, Pévet P, Klosen P. “Transgenic reporter mice as a tool to identify MT1 and MT2 melatonin receptor expressing cells” at 45ème Congrès de la Société Francophone de Chronobiologie, Strasbourg, France, September 14–16, 2016.

Résumé

L'excès de glucocorticoïdes lors d'un stress prolongé perturbe la neurotransmission monoaminergique et mène à des troubles de l'humeur et de la mémoire. La Venlafaxine (Vlx) et l'Agomelatine (Ago) sont utilisés pour traiter ces troubles. L'exercice physique volontaire est aussi bénéfique pour la santé mentale. Nous avons analysé 1. les changements de l'humeur induits par le stress en fonction du temps, 2. l'effet de l'exercice volontaire sur l'axe hypothalamo-pituitaire, 3. l'efficacité de l'Ago, de la Vlx et de l'exercice à prévenir les perturbations liées au stress et 4. la localisation des récepteurs MT1 et MT2 chez des souris rapportrices transgéniques. Nous démontrons que le stress induit des dérèglements physiques, émotionnels et comportementaux chez des rats stressés. Le prétraitement par l'Ago, la Vlx et l'exercice préviennent l'anxiété, la dépression et les déficits de mémoire. La cartographie des récepteurs MT1 et MT2 a identifié des sites d'action potentiels de l'Ago.

Mots clés :

Agomelatine, Venlafaxine, Exercice volontaire, Anxiété, Dépression, Mémoire, Récepteurs de la mélatonine

Résumé en anglais

In long-term stress exposure, excess glucocorticoids disturb the balance of monoamine neurotransmitters leading to mood disorders and memory impairment. Venlafaxine and Agomelatin are currently used to treat these disorders. Voluntary exercise also has beneficial effects on mental health. In this work, we analyzed 1. the time-dependent changes in stress-induced mood disorders, 2. the modulating effect of voluntary exercise on the hypothalamic pituitary adrenal axis, 3. the effectiveness of Agomelatin, Venlafaxine and exercise to prevent stress-related behaviors and 4. the localization of MT1 and MT2 receptors in transgenic reporter mice. We demonstrate that stress caused physical, emotional and behavioral abnormalities in stressed rats. Pre-treatment with Agomelatin, Venlafaxine and exercise reduced the chronic stress-related behaviors and prevented anxiety, depression and memory deficits. The mapping of MT1 and MT2 receptors identified potential sites of action of Agomelatin.

Key words :

Agomelatin, Venlafaxine, Voluntary wheel running, Anxiety, Depression, Memory, Melatonin receptor