



HAL
open science

From Deterioration Modeling to Remaining Useful Life Control: a comprehensive framework for post-prognosis decision-making applied to friction drive systems

Diego Jair Rodriguez Obando

► **To cite this version:**

Diego Jair Rodriguez Obando. From Deterioration Modeling to Remaining Useful Life Control: a comprehensive framework for post-prognosis decision-making applied to friction drive systems. Automatic. Université Grenoble Alpes, 2018. English. NNT : 2018GREAT086 . tel-02019101v2

HAL Id: tel-02019101

<https://theses.hal.science/tel-02019101v2>

Submitted on 16 Apr 2019

HAL is a multi-disciplinary open access archive for the deposit and dissemination of scientific research documents, whether they are published or not. The documents may come from teaching and research institutions in France or abroad, or from public or private research centers.

L'archive ouverte pluridisciplinaire **HAL**, est destinée au dépôt et à la diffusion de documents scientifiques de niveau recherche, publiés ou non, émanant des établissements d'enseignement et de recherche français ou étrangers, des laboratoires publics ou privés.

THÈSE

pour obtenir le grade de

**DOCTEUR DE LA COMMUNAUTÉ
UNIVERSITÉ GRENOBLE ALPES**

Spécialité : **Automatique-Productique**

Arrêté ministériel : 25 mai 2016

Présentée par

Diego Jair RODRIGUEZ OBANDO

Thèse dirigée par **John Jairo MARTINEZ MOLINA** et
codirigée par **Christophe BERENGUER**

préparée au sein du **GIPSA-Lab** dans l'École Doctorale **EEATS**

From Deterioration Modeling to Remaining Useful Life Control: a comprehensive framework for post-prognosis decision-making applied to friction drive systems

Thèse soutenue publiquement le **13 Novembre 2018**,
devant le jury composé de :

M. Vincent COCQUEMPOT

Professeur, Université de Lille 1, Rapporteur

M. Antoine GRALL

Professeur, Université de Technologie de Troyes, Rapporteur

M. Philippe WEBER

Professeur, Université de Lorraine, Examineur

Mme. Anne BARROS

Professeur, Norwegian University of Science and Technology, Examinatrice

M. Olivier SENAME

Professeur, Grenoble INP, Président

M. John Jairo MARTINEZ MOLINA

Maître de conférences, HDR, Grenoble INP, Directeur de thèse

M. Christophe BERENGUER

Professeur, Grenoble INP, Co-Directeur de thèse



To Nadia, Jacobo and my family...

Acknowledgements

Special thanks to my advisors for their work and dedication in the development of this thesis. Thank you John for your great kindness, for your support, your teachings and for having accepted the challenge of advising this thesis. Thank you Christophe for your valuable questions and for your sincere interest in my family.

Thanks to the members of the jury Mr. Cocquempot, Mr. Grall, Mr. Weber and Mrs. Barros, for having accepted to evaluate this thesis, for their valuable contributions, and for having shared their professional and personal experience for the enrichment of my career.

Thank you Nadia, my love... for having encouraged me to assume this challenge, for supporting me and teaching me with your love. Thank you for being part of my life, even in the issues involved in academia. Thanks to God for your life.

Thanks to my family, Nelly, Jose Luis, Sebas, Lilian, Andrea, Teresa, Gloria y Wilson, for the value that you represent as support in my life. You are a blessing! Thanks to my wife's family also.

Thanks to my friends Cristhian and Jenny for your cheers and fraternal love.

Thanks in a special way to my partners on this journey: to Jorge, Firas, Sandra, Insaf, Sebin, Kaouther, Ronak, Chhay, Christian C. and Olivier S., for their fruitful contributions and comments in the development of this thesis. Thanks to them and also to François, Maëlle, Kazusa, Bruno, Swann, Alina and Gildas, Alain, Raouia, Nassim, Aida, Mohammad, Juan, Raúl, Nancy and Jonatan, Dulce and Josué, Noelia, Alejandra, Luisa, Andrés L., Andrés R., Andrés B., Ricardo, Mariam and José, Patty, Chiara, Gaby, Magda, Van Tan, Patricia, Jodie, Nicolás, Yorché, Lara, Miguel G., Miguel, Peter and Nieves for all the talks and good times shared with a cup of coffee or in the lunch. Thanks to Alex S. and Débora, Alicia and Alex, Luciana and Antonio, Michèle M., Stéphane, Raphael, Daniel and Rolly for their fraternal support, to the sisters and brothers in the faith for their love and their prayers. To Alex I. and Christelle for the walks and reflections. To Andrea del Mar, Marcela and Mauricio, Laura and Julián, Lorena y César, Oscar and his family for their collaboration and friendship.

Thanks to Gipsa-Lab's academic, technical and administrative teams. Especially to the DAUTO department and SLR and SAIGA teams.

Thanks God for the magnificent experience of what I lived in the fascinating France! During this time I was able to deepen in myself the value of scientific discussion and cultural exchange and the value of "learning by being more aware of my own ignorance ... fortunately". I will always remember the lessons that confirm to me that science is a door to peace among nations.

Merci, thank you, muchas gracias...

Diego

Notations

Mathematical notations

\mathbb{R}	Real values set
\mathbf{x}^\top	Transpose of vector \mathbf{x}
\mathbf{M}^T	Transpose of matrix $\mathbf{M} \in \mathbb{R}$
$\mathbf{M} \succ (\succeq) 0$	\mathbf{M} is symmetric and positive definite (semi definite) matrix

Acronyms

CBM	Condition Based Maintenance
CCEB	Current-condition-evaluation-based Decision-making
CM	Condition Monitoring
DC	Direct Current
EKF	Extended Kalman Filter
FCPB	Future-condition-prediction-based Decision-making
FTC	Fault Tolerant Control
LPV	Linear Parameter Varying
LQR	Linear Quadratic Regulator
MPC	Model Predictive Control
PHM	Prognostics and Health Management
RAS	Reliability-Adaptive Systems
RPI set	Robustly Positive Invariant Set
RUL	Remaining Useful Lifetime

From Deterioration Modeling to Remaining Useful Life Control: a comprehensive framework for post-prognosis decision-making applied to friction drive systems

Abstract — Remaining Useful Lifetime (RUL) can be simply defined as a prediction of the remaining time that a system is able to perform its intended function, from the current time to the final failure. In general, the purpose for predicting the RUL is to influence decision-making for the system. This thesis deals with the development of a comprehensive framework for controlling the RUL of a system, as a strategy to use the post-prognostic information and act dynamically over the decision-making during operation. Prediction of RUL mostly depends on the state of deterioration of the system components and their assumed future operating conditions. RUL prediction is an uncertain process and its control is not a trivial task. Model uncertainties as well as system disturbances have been considered into the proposed framework. Friction drive systems are used for illustrating the usefulness of the aforementioned framework. For this kind of system, the friction is the source of mechanical motion and simultaneously the source of deterioration. This double characteristic is a motivation for controlling automatically the deterioration of the system by keeping a trade-off, between motion requirements and desired RUL values. Firstly, a new control-oriented dynamical model of the deterioration is proposed. The amount of deterioration has been considered as a function of the dissipated energy at the contact surfaces, during the mechanical power transmission. An approach for estimating the current deterioration condition of a friction drive system is proposed. The approach is based on an Extended Kalman Filter (EKF), which uses an augmented model including the mechanical dynamical system and the deterioration dynamics. At every time instant, the EKF also provides intervals which surely includes the actual deterioration value with a given probability. A new architecture for controlling the RUL is proposed and includes: a) a deterioration condition monitoring system (for instance the proposed EKF), b) a system operating condition estimator, c) a RUL controller system, and d) a RUL-actuating-principle. The operating condition estimator is based on the assumption that it is possible to quantify certain characteristics of the motion requirements, for instance the duty cycle of motor torques. The RUL controller uses a cost function that weights the motion requirements and the desired RUL values to modify a varying-parameter filter, used here as the RUL-actuating-principle. This RUL-actuating-principle is based on a modification of the demanded torques, coming from a possible motion controller system. Results show that the RUL can be controlled according to the proposed theoretical framework.

Keywords: Automatic control, Deterioration - Mathematical modeling,, Diagnostics, Service life (Engineering), Prognostics Reliability, Fault tolerance (Engineering), Friction gearing.

De la Modélisation de la Détérioration au Contrôle de la Durée de Vie Utile Résiduelle : proposition d'un cadre pour la prise de décision post-pronostic appliquée aux systèmes de transmission par friction

Résumé — La durée de vie utile résiduelle (RUL) peut être simplement définie comme une prédiction du temps restant pendant lequel un système est capable d'exécuter sa fonction prévue ; elle est mesurée à partir de l'instant présent jusqu'à la défaillance finale. En général, le but de la prévision de la RUL est d'influencer la prise de décision pour le système. Dans cette thèse, on a présenté un cadre pour le contrôle de la RUL d'un système, en tant que stratégie pour utiliser les informations post-pronostiques et agir dynamiquement sur la prise de décision pendant le fonctionnement. Cette durée prévue dépend principalement de l'état de détérioration des composants du système et de leurs conditions de fonctionnement futures prévues. Ainsi, la prédiction de la RUL est un processus incertain et son contrôle n'est pas une tâche triviale. Les incertitudes du modèle ainsi que les perturbations du système ont été prises en compte dans le cadre proposé. Les systèmes d'entraînement par friction sont utilisés pour illustrer l'utilité du cadre susmentionnée. Pour ce type de système, le frottement est à la fois source du mouvement et source de la détérioration. Ce double caractère de frottement est une motivation pour contrôler automatiquement la détérioration du système en gardant un compromis entre les exigences de mouvement et les valeurs RUL souhaitées. Dans cette thèse, un nouveau modèle dynamique de la détérioration orienté au contrôle est proposé. Le degré de détérioration est considéré en fonction de l'énergie dissipée, à la surface de contact, pendant la transmission mécanique de puissance. Une approche est proposée pour estimer l'état actuel de la détérioration d'un système d'entraînement par friction. L'approche est basée sur un Filtre de Kalman Étendu (EKF en anglais) qui utilise un modèle augmenté incluant le système mécanique dynamique et la dynamique de détérioration. L'EKF fournit également des intervalles qui incluent sûrement la valeur de détérioration réelle avec une valeur de probabilité. Une nouvelle architecture de commande de la RUL est proposée, elle comprend : a) un système de surveillance de l'état de détérioration (par exemple l'EKF proposé), b) un estimateur de l'état de fonctionnement du système, c) un système de contrôle de la RUL et d) un principe actionneur de la RUL. L'estimateur des conditions de fonctionnement est basé sur l'hypothèse qu'il est possible de quantifier certaines caractéristiques des exigences de mouvement, par exemple le rapport cyclique des couples moteur. Le contrôleur RUL utilise une fonction de coût qui pondère les exigences de mouvement et les valeurs RUL souhaitées pour modifier un filtre à paramètres variables, utilisé ici comme principe actionneur RUL. Le principe actionneur RUL est basé sur une modification des couples exigés, provenant d'un éventuel système de contrôle de mouvement. Les résultats montrent qu'il est possible de contrôler la RUL, selon le cadre théorique proposé.

Mots clés: Commande automatique, Détérioration - Modèles mathématiques, Diagnostic, Durée de vie (ingénierie), Pronostic, Fiabilité, Tolérance aux fautes (ingénierie), Entraînement par frottement.

Contents

I	Main Introduction	1
I.1	About this thesis	1
I.2	General problem and motivations	2
I.2.1	The Remaining Useful Life	2
I.2.2	Motivation: Towards Post-Prognosis Decision-Making	3
I.2.3	Application Case: Friction-based Mechanisms	4
I.3	Organization of the document	6
I.4	Main contributions	8
II	From Background and State of the Art to Problem Statement	11
II.1	Introduction	11
II.2	Background	12
II.2.1	Prognostics and Health Management (PHM)	12
II.2.2	Diagnosis and Prognosis Stages	12
II.2.3	The Prediction of RUL: Definition and usefulness	13
II.2.4	Deterioration	14
II.2.5	Decision-making	15
II.2.6	The Proactive sense of PHM actions	16
II.2.7	Post-prognosis Activities	17
II.2.8	Reliability-Adaptive Systems (RAS)	17
II.2.9	The Uncertainty in PHM	19
II.2.10	Application for Illustrating the Developed Approaches	20
II.3	State of the art	22
II.3.1	Deterioration Modeling Process.	22
II.3.2	Control-oriented RUL Prediction Methods	22
II.3.3	Proactive Diagnostics and Prognostics	23
II.4	Introducing the problem statement	26
II.5	Conclusion	28
III	Deterioration Modeling of a Friction Drive System	31
III.1	Introduction	31
III.2	Friction drive system modelling	32
III.2.1	System description	32
III.2.2	Analytical physics-based modeling of the friction drive	33
III.2.3	Modeling the friction drive as an Uncertain Linear System	36
III.3	Dynamical model of deterioration	36
III.3.1	Dissipated-Energy-based model	36
III.3.2	State-space model for the friction drive system	41
III.3.3	Estimating the dynamic efficiency of the friction drive	41
III.3.4	Introducing randomness in the model	42

III.4 Case study analysis	42
III.4.1 Deterministic operational mode	43
III.4.2 Stochastic operational mode	49
III.4.3 Invariant sets for detecting deterioration	50
III.5 Conclusions	51
IV Deterioration Estimation for RUL Prognosis	55
IV.1 Introduction	55
IV.2 On condition monitoring and prognosis for a friction drive	57
IV.3 Estimation of current condition of the friction drive	58
IV.3.1 Analysis of the observability of the system	58
IV.3.2 Synthesis of an Extended Kalman Filter	59
IV.3.3 Checking the consistence of the innovations	61
IV.3.4 Stochastic bounds for the state estimation	62
IV.4 Integration of the observer into the prognostic of Remaining Useful Lifetime	63
IV.4.1 Current condition D and prognostic of the RUL	63
IV.4.2 Tuning of the EKF observer	66
IV.4.3 Evaluation of the observer performance	67
IV.4.4 Prognostic of Remaining Useful Lifetime	71
IV.5 Numerical examples	72
IV.5.1 Case 1. RUL prognosis with endogenous changes of the system	73
IV.5.2 Case 2. RUL prognosis with exogenous changes of the system	73
IV.6 RUL prediction evaluation	74
IV.6.1 The RUL estimation problem	75
IV.6.2 Uncertain input case	75
IV.6.3 Uncertain parameter case	76
IV.7 Conclusions	76
V Proposed Architecture for Controlling the RUL	83
V.1 Introduction	83
V.2 System description	84
V.3 Problem statement	85
V.4 Proposed RUL control architecture	87
V.4.1 The RUL actuating principle	87
V.4.2 The RUL predictor	88
V.4.3 The RUL controller	88
V.5 Numerical example	89
V.5.1 Chosen scenario	89
V.5.2 Chosen parametric varying filter	90
V.5.3 Used RUL predictor	91
V.5.4 Implemented RUL controller	92
V.6 Conclusions	93

VI Conclusions and Perspectives	97
VI.1 General conclusions	97
VI.2 Perspectives	99
VI.2.1 On modeling	99
VI.2.2 On estimation	99
VI.2.3 On control of RUL	100
A Annexe	103
A.1 Test rig for studying surfaces wear	103
A.1.1 Abstract	103
A.1.2 Summarized description of the test rig	103
A.1.3 Advances	104
Bibliography	105

List of Figures

I.1	Remaining Useful Lifetime: concept and use.	2
I.2	Examples of Friction-based mechanisms	5
II.1	Prognostics and Health Management: Towards a proactive management strategy	12
II.2	Remaining Useful Lifetime.	14
II.3	From data acquisition for monitoring the deterioration, towards decision-making	15
II.4	Using prognosis information for decision-making	17
II.5	A post-prognosis set of actions for the system.	20
II.6	Assumption II.2	27
II.7	Assumption II.4	28
III.1	Losses of power in contact	32
III.2	Basic roller-on-tire motor system	33
III.3	Contact quality coefficient α as a function of D for m within a given interval. .	38
III.4	Behavior of power in roller-on-tire system	44
III.5	Loss between P_L and P_L^* for given values of α	44
III.6	Deterioration for given values of α for the <i>sharp stage</i> of motion.	44
III.7	Step response of Deterioration, tangential speed of motor and tangential speed of wheel	45
III.8	Efficiency η for sharp stage and failure stage. Step response.	45
III.9	Normalized deterioration with respect to time.	46
III.10	Efficiency of the actuator in the study case.	47
III.11	Sliding $p(\mathbf{x})$ with respect to time.	47
III.12	Normalized deterioration \bar{D} and tangential speeds. Square wave response. . . .	48
III.13	Contact-quality coefficient α . Rectangular waveform response.	49
III.14	Internal mode of randomness.	50
III.15	External mode of randomness	51
III.16	Robustly positive invariant sets for a bounded electrical current	52
IV.1	Condition monitoring and RUL prognosis architecture.	63
IV.2	Prognostic of the RUL at a given time t_c	64
IV.3	Time diagram of a prognostic of the RUL at a given time t_c	65
IV.4	Prediction output error $\tilde{\mathbf{e}}_k$ for ω_1 and ω_2	68
IV.5	Estimation of $\hat{\alpha}$	69
IV.6	Estimation of \hat{m}	70
IV.7	Distribution of $\hat{\alpha}$ and \hat{m} for multiple simulations of the EKF.	71
IV.8	Predicted deterioration \tilde{D} for prognostic of RUL.	72
IV.9	Probability density function for a normal distribution fitting.	72
IV.10	Prognosis of RUL with an endogenous change in the system.	78
IV.11	Prognosis of RUL with an exogenous change in the system.	79
IV.12	Estimated deterioration for random input $I(t)$	79

IV.13	Predicted deterioration trajectory at the very beginning and in future time, for random inputs I	80
IV.14	Deterioration obtained with different maximal electrical currents for a predefined sequence of $u(t)$	80
IV.15	Pseudo-random activation sequence of signal $u = I(t)$	81
IV.16	Deterioration obtained with multiple random simulations	81
V.1	Illustration of the obtained <i>RUL</i> for two different sequences of the motor torque.	86
V.2	Architecture for an optimal control of the <i>RUL</i>	87
V.3	Examples of applied motor torque T_m compared to the desired one T^{ref}	88
V.4	Obtained motion satisfaction S as a function of the parameter θ_2	90
V.5	Predicted RUL as function of the parameter θ_2 , the estimated contact quality coefficient $\hat{\alpha}$, and the operating conditions \hat{d}	91
V.6	Predicted RUL along the useful lifetime: 1) by using the mean value of the estimated α (solid line), 2) by using extreme values of the estimated α (dotted line). Both compared to the obtained RUL (dashed line). The symbol * represents the desired RUL.	92
V.7	System behavior under the effect of the RUL controller.	94
V.8	The desired torque T^{ref} and the applied motor torque T_m	95
V.9	Estimated contact quality coefficient $\hat{\alpha}$ in presence of operating conditions changes and for three different cases.	95
A.1	Test Rig for Study of Surfaces Wear	104

List of Tables

III.1 Notation	34
III.2 Terms of power equations	35
III.3 Used values for the mechanical parameters	43
IV.1 Possible model for the dynamics of m	66
IV.2 Comparison between EKF estimates and fitting of simulated data	70
V.1 Nomenclature and used values	91

Main Introduction

Contents

I.1	About this thesis	1
I.2	General problem and motivations	2
I.2.1	The Remaining Useful Life	2
I.2.2	Motivation: Towards Post-Prognosis Decision-Making	3
I.2.3	Application Case: Friction-based Mechanisms	4
I.3	Organization of the document	6
I.4	Main contributions	8

I.1 About this thesis

This thesis was:

- developed between March 2015 and June 2018, within the SLR¹ and SAIGA² research teams, at the Control Systems Department of the laboratory GIPSA-Lab³, which is a joint research unit of the CNRS⁴, Grenoble-Inp⁵, and the *Université Grenoble Alpes* (UGA)⁶.
- developed in the specialty of Automatic Control and Production Systems⁷ of the doctoral school EEATS⁸, which is part of the College of doctoral schools of the UGA.
- partially supported by the Colombian government through the: “ COLCIENCIAS⁹ scholarship for developing international doctoral studies”.
- also partially supported by the French CNRS PEPS 2017 in the context of the IMPROVED project.

¹ *Systèmes Linéaires et Robustesse* (Linear Systems and Robustness)

² *Signal et Automatique pour la surveillance, le diagnostic et la biomécanique* (Signal and Automatics for Monitoring, Diagnosis, and Biomechanics)

³ *Grenoble Images Parole Signal Automatique* (Grenoble Images Speech Signal and Control Laboratory), France.

⁴ *Centre National de la Recherche Scientifique* (National Center for Scientific Research), France.

⁵ *Institut Polytechnique de Grenoble* (Grenoble Institute of Technology), France.

⁶ *Université Grenoble Alpes* (UGA), France.

⁷ *Automatique-Productique* (AP)

⁸ *Ecole Doctorale Electronique, Electrotechnique, Automatique et Traitement du Signal*

⁹ *Departamento Administrativo de Ciencia, Tecnología e Innovación*, (Administrative Department of Science, Technology and Innovation), Colombia.

I.2 General problem and motivations

I.2.1 The Remaining Useful Life

The Remaining Useful Life (RUL) of an asset or a system is defined as the time left from the current time to the end of its useful life [Si 2011]. The meaning of this “useful life” and its management vary according to the studied field, and they can generally be defined by the designer, engineers and users of the asset. For illustrating the general concept of RUL, in Figure I.1 the evolution of the *deterioration* of a given system is shown. There, the evolution of the deterioration is assumed as known. In that case, the RUL is the time between the current time, which corresponds to the condition A, and the time in which a maximum acceptable condition of deterioration B is reached. The latter can correspond to the time of failure (i.e. for 100% of the deterioration) or to a predefined threshold in a lower value. Consequently, one can define a “useful life” from the beginning of the lifetime until the failure or until the time of condition B. In general, a proper RUL prediction in A is useful to perform maintenance activities from A to B saving resources and improving the processes.

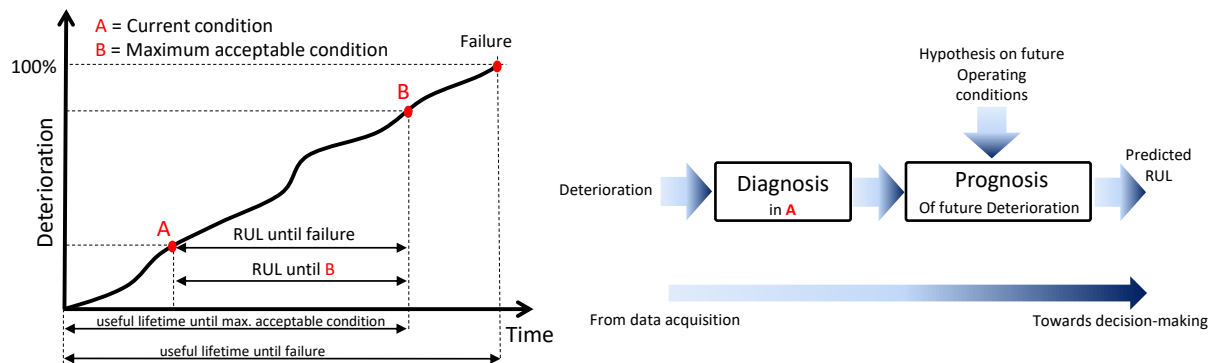

Figure I.1 – Remaining Useful Lifetime, its concept and its use.

Since prognostics deals with predicting the future behavior of engineering systems, there are several sources of uncertainty which influence such prediction. A suitable prediction of the RUL is the one that includes accuracy and precision, following the same criteria to evaluate a measure. However, unlike a physical magnitude, which can be quantified with an uncertainty level in the present time, the RUL prediction must include additional assumptions about the future *operating conditions* as illustrated in Figure I.1. *Prognosis* of RUL projects the *diagnosis* of current system condition (here, the deterioration in A) in the time by using a model. Of course, in the absence of “future measurements”, it necessarily entails propagated uncertainty [Tang 2009].

Even if a given mechanical system model is widely known, there are several sources of uncertainties that affect the RUL prediction. In fact, it is not even meaningful to make such predictions without computing the uncertainty associated with their RUL. Here, one can identify uncertainties which can be consider as *endogenous* to the system, for instance, the initial condition of its deterioration and its dynamical behavior; others can be considered

exogenous to the system, as measurement noise and process disturbances; and others can be considered as uncertainties on the *future of the system*, for instance, the changes in the operating conditions. Therefore, accurately predicting the RUL is still (and will remain) an open problem. Several statistical and probabilistic approaches have been developed for years to tackle the problem; a proper review on statistical data driven approaches can be seen in [Si 2011]. Also in [Jardine 2006], model based approaches, which are based on a model representing the physics of the degradation process built with specific experiments, and data based approaches, which use monitored data in order to construct the model, can be identified.

I.2.2 Motivation: Towards Post-Prognosis Decision-Making

One of the main aspects to take into account for performing reliable predictions of the RUL is the knowledge of the current *state of health* of the asset or the system. Wear and degradation of components, among others causes, affect directly the lifetime of assets, and consequently their usability and/or productivity. This is why, wear or degradation indicators are intended to be obtained from sensor signals of the systems to start suitable predictions of the RUL. Thus, management of the health state of a component needs an acceptable and efficient diagnosis of the current state of deterioration, nevertheless this is often difficult due to the stochastic nature of deterioration phenomena. Existent solutions demand high computational costs and sometimes historical information, which increase the difficulty to implement condition monitoring in real time with high accuracy [Ahmad 2012, Lee 2014].

On the other hand, *resources consumption* (for instance energy consumption) is another critical variable that needs to be managed with respect to the deterioration behavior. Here, RUL prognostics has an important role in the management of energy resources, for instance, in autonomous devices. Nowadays manufacturers or end users have a greater incentive to manage the complete life cycle of an asset, for optimizing the production process and its energy consumption, using *proactive* strategies [Muller 2008, Exner 2017]. Thus, an optimal management between health state of components and use of energy resources is required, and a “*RUL-aware*” operation of system is needed.

For some systems, for example in the friction-based ones, the failure is imminent because of deterioration of materials in contact, and the main goal is trying to optimize the use of functioning resources until the failure. In other words, planned actions which tend to *initiate changes* of behavior of the component, rather than *reacting to failures* are needed. This kind of maintenance strategies are in the *proactive level*.

In this context, Prognostics and Health Management (PHM) has become a field of engineering activities dedicated to develop methods that permits the reliability of a system to be evaluated in its actual life-cycle conditions [Vichare 2006, Lee 2014, Rakowsky 2015]. In the framework of PHM modern approaches, the proactive actions are focused either on system-level or on component-level. Then, combination of experienced-based, data-driven and model-based approaches [Byington 2003], seems to be an appropriate way for improving the efficiency of management proactive actions according to [Muller 2008]. In this context, common goals for the proactive actions are: a) the reduction of the probability of unexpected component failures in a reliable way, and/or b) the feasible on-line implementation (for instance, for embedded systems).

PHM methods are intended to use the prognosis stage results, namely the predicted RUL, for affecting in some useful sense the *decision-making*, for influencing system operation [Rakowsky 2015]. In other words, information about reliability properties should be implemented in a closed-loop way. To achieve that, either to lower work load and/or wear by adapting the operating conditions (derating actions), or selecting appropriate optimal system configurations (reconfiguration actions) of components are required according to [Meyer 2014]; [Rakowsky 2015] adds also maintenance optimisation and system control actions. Systems which possess these capabilities are called Reliability-Adaptive Systems (RAS) [Rakowsky 2006]. In other words a “reliability control” could allow to manage the deterioration of components like in the self-optimizing mechatronic systems, which are, according to [Gausemeier 2014], a class of intelligent technical systems able to autonomously adapt their behavior if user requirements or operating conditions change.

The motion control actions are seen as a source of stress deteriorating the actuator, see, for instance, [Langeron 2017], [Rakowsky 2006] and [Meyer 2014]. In [Grosso 2012] and [Pereira 2010], the authors assume a deterministic relationship between the degradation and the motion control input. In this sense, component-level proactive strategies continue being explored (See, for example [Nguyen 2014]). Physics-based models can explain the phenomena of deterioration in a deterministic way, which can be useful for managing the useful lifetime of a component in a control loop. This closed-loop management, could help in getting systems type RAS with feasible implementation. This could be especially useful in embedded systems due the computational restrictions.

Consequently, the development of a global approach for performing control actions, taking the prognosis information, namely the prediction of RUL, is one of the main motivations of this thesis. The design of a new control-oriented method of deterioration-estimation to implement post-prognosis decision-making in the proactive level is needed. In this dissertation, the *estimation* is considered as a process itself of reconstructing the states of the system from observed information. In automation we consider an *observation* as an *internal* information of a system obtained from *external* (directly available) *measurements* [Besançon 2007].

I.2.3 Application Case: Friction-based Mechanisms

Friction-based systems are the application used in this thesis to illustrate the developed methodology. Friction-based mechanisms are ubiquitous in mechanical systems. Clutch, frictional belt-pulley system, disc-brakes, tire-road contact and friction-drive motor, among others, are examples of this kind of mechanisms that use direct friction, instead of a chain and sprockets, to transfer power to a load. Figure I.2 shows some real friction-based mechanisms. However, one of the problems of these mechanisms is that this “useful friction” phenomena causes at the same time the wear of the surfaces in contact. This wear causes, in turn, deterioration and eventually faults or the final failure of the actuator. Thus, deterioration of this kind of actuators, notably their contact surfaces, is unavoidable, and therefore optimal control actions are needed to manage the actuators during their useful lifetime. Moreover, these control actions must provide a trade-off between efficiency and maintenance.

This thesis takes a look at the study of the deterioration of the contact of a friction drive

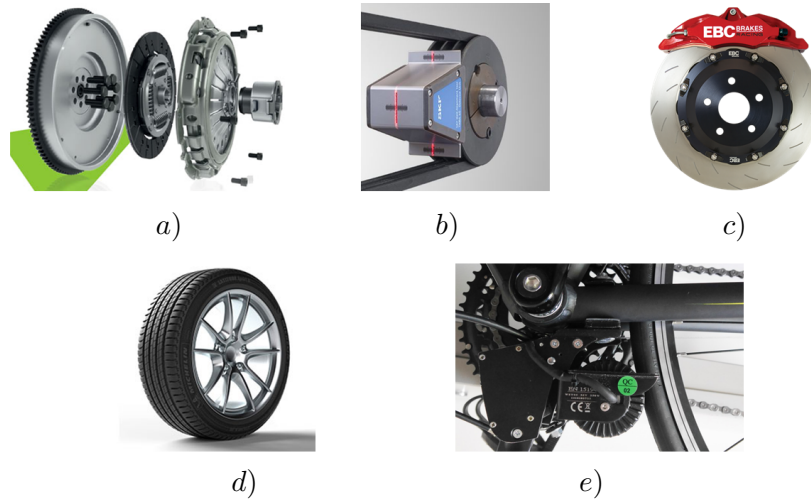

Figure I.2 – Examples of Friction-based mechanisms: a) clutch, b) frictional belt-pulley, c) disc-brakes, d) tire-road contact, e) friction-drive motor ¹⁰

composed by two rotational devices: a driver device which provides the power, and a driven device which acts as a load. In practice, the surfaces of the driver and the driven device are worn away with time, which in turn causes the deterioration of the contact quality. Thus, it is useful to estimate, with an enough degree of confidence, the current condition of the contact (*diagnosis*), which in turn helps in making suitable predictions about its future condition (*prognosis*). This could be eventually used to control the current state of health of the friction drive.

Moreover, in a general way, the study of the friction drive allows to appreciate possible uses of the modeling of the deterioration in various mechanical issues, such as Prognostics and Health Management, the characterization of materials, fault detection, and fault estimation among others.

Summarizing, let us define the following *general postulates* for this thesis:

- P1** Deterioration modeling and estimation of electromechanical devices represents a key issue for their condition-based, predictive and proactive maintenance.
- P2** A suitable control-oriented RUL-prediction method must be linked with a proper on-line deterioration estimation method, thereby allowing the development of more feasible proactive maintenance strategies.
- P3** A proper control-oriented modeling of current state of deterioration (and in turn, a proper predictor of RUL) must include deterministic and stochastic assumptions on the current and future operating conditions, which are intended to increase the reliability of the system.

¹⁰Sources of Figures I.2: a) clutch www.valeo.com, b) frictional belt-pulley www.skf.com/us, c) disc-brakes ebcbrakes.com, d) tire-road contact www.michelinman.com/US, e) friction-drive motor boost.bike/.

P4 Controlling dynamically the RUL of a component could be achieved by modifying, in a suitable way, the motion control laws.

According to the general postulates P1 to P4, the *General Objective* of this thesis is defined as follows:

GO *To develop an approach for controlling dynamically the RUL of a system whose deterioration is affected for their command inputs.*

and the *Specific Objectives* as follows:

SO1 *To develop a control-oriented model for deterioration*

SO2 *To develop a method to for estimating the deterioration during operation.*

SO3 *To integrate the deterioration model into its RUL prediction.*

SO4 *To propose an architecture for using the prognosis information for a post-prognosis dynamical making-decisions.*

These objectives are developed around friction-drive systems to illustrate the developed theory. In that sense, another postulate is:

P5 In friction-based mechanisms, the friction is, simultaneously the cause of the deterioration and the useful (and in turn unavoidable) mechanical phenomenon. Thus, proactive control actions are needed to manage the friction-based applications during their useful lifetime. This control must respect a trade-off between desired operation and maintenance.

I.3 Organization of the document

This thesis is organized in five chapters, namely:

Chapter II [*From Background and State of the Art to Problem Statement*] starts with brief introduction of the fundamentals of RUL prediction. An overview of control concepts that are applied in this thesis or under consideration for future works are presented. A brief look at friction drive applications, the application used to illustrate the developed approaches in this thesis, is also included. Chapter II finishes with the introduction of a general problem statement.

Chapter III [*Deterioration Modeling of a Friction Drive System*] deals with the development of an analytical dissipated-energy-based model for the deterioration estimation of an actuator with a monotonically increasing deterioration. This control-oriented model integrates the deterioration as one of the states of the system, thus it allows: *a)* to link the deterioration evolution to the inputs and operating modes of the system, *b)* to assess the behavior of deterioration in critical defined stages of motion, and *c)* to predict analytically an interval of useful lifetime before the total-failure-time of actuator, taking into account stochastic perturbations. A special case of a friction drive system: a

roller-on-tire system, is used to illustrate the model. Section III.2 presents the design and analysis of the deterioration modeling of the considered friction drive system, and provides the general definitions for the studied system. In a first step, the physics of the system, and in particular the link between deterioration dynamics and energy transfer at the friction surfaces, is modeled in a deterministic way in Section III.3 and a useful state space representation is presented. Then, considering either random system parameters or random system inputs and usage, a complete stochastic model for the system deterioration is proposed and illustrated by means of a case study in Section III.4. The contact quality coefficient proposed in Chapter III allows the modeling of the actuator as a (polytopic) Linear Parameter Varying model. Robustly Positive Invariant Sets are explored to characterize the nominal and the admissible degraded behavior of the system.

Chapter IV [*Deterioration Estimation for RUL Prognosis*] presents a method for condition monitoring and prognosis of Remaining Useful Lifetime (RUL). The method is based on the estimation of mainly two deterioration-parameters: contact quality coefficient and the quality-deterioration ratio. Toward this end, we start with the deterioration model presented in Chapter III, considering the deterioration model for a friction drive system, as a numerical application example. The relation between condition monitoring and the prognosis process is introduced in Section IV.2. An augmented non-linear model and a condition monitoring method based on an Extended Kalman Filter (EKF) are proposed in Section IV.3 for simultaneously: *a*) estimating the mechanical system states from a deterministic model based on mechanical motion equations; *b*) estimating the current state of deterioration and/or the contact quality coefficient from a dynamical model of deterioration, and *c*) estimating the quality-deterioration ratio, which in turn can be used to monitor changes in the conditions of the surfaces. A complementary stage of the method to prognosticate the RUL from the deterioration estimation is also proposed in Section IV.4. Since the model uses a few number of unknown parameters describing the macroscopic deterioration phenomena, the state estimation process can be performed with low computational cost. In Section IV.5 simulated examples for RUL prognosis with respect to endogenous and exogenous changes are used to illustrate the potential use of the method. In Section IV.6 an evaluation of the RUL prognosis is explored and discussed. This chapter shows that it is feasible to obtain an estimation of an interval of possible RUL, with a certain confidence percentage based on the presented deterioration model.

Chapter V [*Proposed Architecture for Controlling the RUL*], deals with the study of a system, to which control of the RUL can be applied in a manner that yields significant benefits from an engineering and operational viewpoint. This chapter presents a global framework for controlling the RUL of systems, for which their deterioration is assumed to be influenced by the command inputs. The control actions have short-term objectives that have to be modified to be compatible with the required/desired RUL. The control problem is defined in Section V.3. In Section V.4 the architecture is formally defined. Here, a RUL actuating principle is proposed in order to control the RUL. The proposed RUL actuating principle is based on a parametric varying filter which modifies the motion control realization based on the available information about the expected RUL. The total RUL control architecture also includes an operating condition estimator, a system

state estimator, and a RUL predictor. The RUL controller determines the parameters of the actuating filter by solving an on-line optimization problem. The RUL controller has to solve the RUL control problem by considering a trade-off between desired motion control actions and desired RUL. In Section V.5 a numerical example, applied to friction drive applications is used to illustrate the use of the proposed global architecture.

Chapter VI: [*Conclusions and Perspectives*] aims to summarize the main theoretical contributions of the thesis according to the defined general and specific objectives. At the same time, perspectives on suggested new methods and future work are presented; some of them includes the areas of fault detection, diagnosis, fault tolerant control, and instrumentation for analysis of contact materials.

I.4 Main contributions

Summary

- In this thesis a new model for friction drive systems which includes a dynamical model of the deterioration is proposed. The deterioration has been related as the dissipated energy, at the contact surface, during the mechanical power transmission.
- In this thesis an approach to estimate the current deterioration condition of the friction drive system is proposed. The approach is based on an Extended Kalman Filter (EKF) which uses an augmented model including the mechanical dynamical system and the deterioration dynamics. At every time instant, the EKF also provides intervals which includes the current deterioration value with a given probability.
- A new architecture for controlling the RUL has been proposed. This architecture includes a deterioration condition monitoring system (for instance the proposed EKF), a system operating condition estimator, a RUL controller system and a RUL actuation principle. The latter based on a modification of the demanded torques (coming from a possible motion controller system).

Collaboration

During the development of this thesis, there was the opportunity to establish an academic collaboration that was aimed at the development of one of the raised [perspectives](#). As a result of this academic link, the author of this thesis supervised the student Danilo Burbano for eight months, for the development of his final research work of the Electronic Engineering program (BACH + 5) of the *Universidad de Nariño*¹¹, Colombia.

Mr. Burbano worked mainly at the *Universidad de Nariño* and visited GIPSA-Lab for a short internship (France), financed by the project “*Robótica UDENAR*”.

¹¹ *Universidad de Nariño* is located in Pasto, Colombia. The Electronic Engineering program is part of its Faculty of Engineering.

Journal papers

- J1** Rodriguez Obando, Diego J., John J. Martinez, Christophe Berenguer. *RUL prognosis for a friction drive system using a degradation estimator*. In preparation.

International conference papers

- C1** Rodriguez Obando, Diego J., John J. Martinez, Christophe Berenguer. *Deterioration modelling of contact surfaces for a friction drive system*. In Proc. of the 26th European Safety and Reliability Conference (ESREL 2016), Sep. 2016. Glasgow, Scotland, pages 1961–1968.
- C2** Rodriguez Obando, Diego J., John J. Martinez, Christophe Berenguer. *Set-invariance analysis for deterioration prediction on a roller-on-tire actuator*. In Proc. of 3rd Conference on Control and Fault-Tolerant Systems (SysTol2016), Sep. 2016. Barcelona, Spain, pages 87–92.
- C3** Rodriguez Obando, Diego J., John J. Martinez, Christophe Berenguer. *Deterioration estimation for remaining useful lifetime prognosis in a friction drive system*. In Proc. of 20th IFAC World Congress, July 2017. Toulouse, France, pages 13324–13329.
- C4** Rodriguez Obando, Diego J., John J. Martinez, Christophe Berenguer. *Condition Monitoring of a Friction Drive System*. In Proc. of 3rd IEEE Colombian Conference on Automatic Control, Oct. 2017. Cartagena, Colombia, pages 1–6.
- C5** Rodriguez Obando, Diego J., John J. Martinez, Christophe Berenguer. *An architecture for controlling the remaining useful lifetime of a friction drive system*. In Proc. of 10th IFAC Symposium on Fault Detection, Supervision and Safety for Technical Processes (SAFEPROCESS), Aug. 2018. Warsaw, Poland, pages 1–6.

From Background and State of the Art to Problem Statement

Contents

II.1 Introduction	11
II.2 Background	12
II.2.1 Prognostics and Health Management (PHM)	12
II.2.2 Diagnosis and Prognosis Stages	12
II.2.3 The Prediction of RUL: Definition and usefulness	13
II.2.4 Deterioration	14
II.2.5 Decision-making	15
II.2.6 The Proactive sense of PHM actions	16
II.2.7 Post-prognosis Activities	17
II.2.8 Reliability-Adaptive Systems (RAS)	17
II.2.9 The Uncertainty in PHM	19
II.2.10 Application for Illustrating the Developed Approaches	20
II.3 State of the art	22
II.3.1 Deterioration Modeling Process.	22
II.3.2 Control-oriented RUL Prediction Methods	22
II.3.3 Proactive Diagnostics and Prognostics	23
II.4 Introducing the problem statement	26
II.5 Conclusion	28

II.1 Introduction

The purpose of this chapter is to provide the basis for a definition of the general problem addressed in the thesis. Chapter II provides key concepts for the definition of the problem and supports the motivations for the development of the thesis. This chapter begins with an overview of the PHM area, and take a look to the link between diagnosis and prognosis, the deterioration and the Remaining Useful Lifetime (RUL), the decision-making, the proactive actions and the uncertainty. An overview on friction drive systems is presented. This kind of systems are used to illustrate the developed concepts in this thesis.

This is followed by a state of the art used for defining general postulates and the objectives of the thesis. The state of the art includes key concepts such as *estimation* of deterioration, Remaining Useful Lifetime (RUL) prediction, and Proactive Diagnostics and Prognostics. Finally, the general problem statement is presented in a structured way.

II.2 Background

II.2.1 Prognostics and Health Management (PHM)

This thesis can be located theoretically in the area of Prognostics and Health Management (PHM) of systems. A proper definition of PHM is given [Zio 2013] as: “a field of research and application which aims at making use of *past, present, and future information* on the *environmental, operational, and usage conditions* of an *equipment* in order to *detect its degradation, diagnose its faults, and predict and proactively manage its failures*”. In this definition, some concepts have been highlighted because they are needed for making a conceptual relation and in turn, for defining the *general objective* of the thesis and the general problem statement in this chapter. Figure II.1 illustrates the conceptual relations for introducing the PHM.

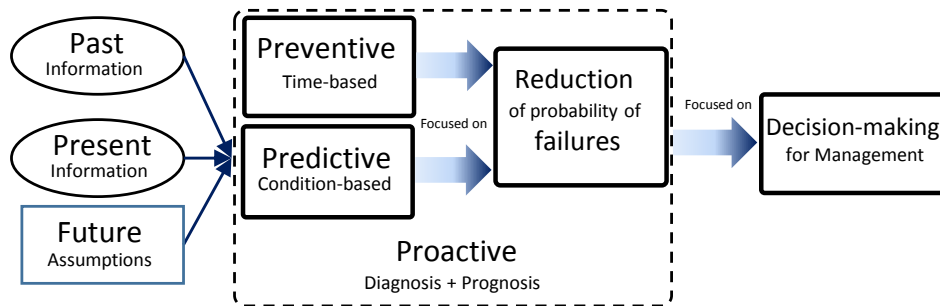

Figure II.1 – Prognostics and Health Management: Towards a proactive decision-making for a management strategy.

In [Zeng 2005], potential historical benefits of PHM are presented, various *diagnostics* and *prognostics* methods are classified and analyzed; definition, quantitative assessment and verification methodologies on uncertainty are discussed; and finally, key issues of implementation, status and perspectives on PHM are discussed. A categorization and a summary of the prognostic types can be read in [Coble 2008, Ramasso 2014, Rakowsky 2015]. In addition, [Javed 2017] contributes to state of the art and taxonomy of prognostics approaches and their actual application perspectives. Complementary perspectives, methods and history can be seen in [Vichare 2006, Pecht 2008].

II.2.2 Diagnosis and Prognosis Stages

Diagnostics and Prognostics, are the fields of engineering and science that deals with *diagnosis* and *prognosis* approaches. Diagnosis is an assessment stage (or assessment process) about the current and past health state of a system, based on observed symptoms, and prognosis is an assessment stage (or assessment process) of the future health state [Mathur 2001, Muller 2008].

Diagnosis is the process of performing activities such as: identification of the external or internal cause(s) of a problem, the isolation of a faulty component, a failure mode, or a failure condition. These activities can be present or not, depending on the application or the defined level of activity. Prognosis can be seen as a subsequent stage to diagnosis [Mathur 2001].

In this way the two main general elements of PHM are defined by [Javed 2017] as: 1. Prognostics refers to prediction/extrapolation/forecasting of process behavior, based on current health state assessment and future operating conditions, and 2. *Health management* is a decision process to intelligently perform decision-making activities on the basis of diagnosis and prognosis stages.

For PHM, sharing a certain vocabulary with the field of *medicine* is not fortuitous; see [Mathur 2001] and [Lee 2014] for a complementary look at this perspective. Hence, an analogy can be useful to put into context this thesis. In this thesis, we study the *health* condition monitoring of a system to perform suitable *diagnosis*. Complementary, we focus the study in the development of a *proactive* management technique, which can be seen as a “treatment” of the system. As in medicine, this treatment is conceived as a *post-prognosis* set of actions (here called as *activity*) intended to affect *decision-making*, for improving the *real* state of health of a system, thereby getting a predefined relation between *duration* and *quality* of “remaining-life”

II.2.3 The Prediction of RUL: Definition and usefulness

Prediction of Remaining Useful Lifetime (RUL), also known as RUL *prognosis*, is a widely studied topic in PHM of resources for automation and mechanics [Cremona 2016]. It can be defined as an estimation of the time left from the current time until the failure time (or a threshold of a maximum acceptable condition); this prediction is usually given in terms of probability. The Remaining Useful Life (RUL) of an asset or a system is defined as the time left from the current time to the end of its useful life [Si 2011]. The meaning of this “useful life” and its management vary according to the studied field, and they can generally be defined by the designer, engineers and users of the asset.

For illustrating the general concept of RUL, in Figure II.2 the evolution of the *deterioration* of a given system is shown. There, the evolution of the deterioration is assumed as known. In that case, the RUL is the time between the current time t , which corresponds to the condition **A**, and the time in which a maximum acceptable condition of deterioration **B** is reached. The latter can correspond to the time of failure t_f (i.e. for 100% of the deterioration) or to a predefined threshold in a lower value. Consequently, one can define a “useful life” from the beginning of the lifetime until the failure or until the time of condition **B**. In general, a proper RUL prediction in **A** is useful to perform maintenance activities from **A** to **B** saving resources and improving the processes.

The RUL is defined as a conditional random variable in [Jardine 2006]:

$$RUL = t_f - t \mid t_f > t; Z(t) \quad (\text{II.1})$$

where t_f is a random variable representing the time of failure which is intended to be characterized, t is the current time, and $Z(t)$ is the past condition profile (including environment data) and/or existing knowledge on the future use of the system up to t . In this thesis we characterize the random variable t_f from the modeling of deterioration.

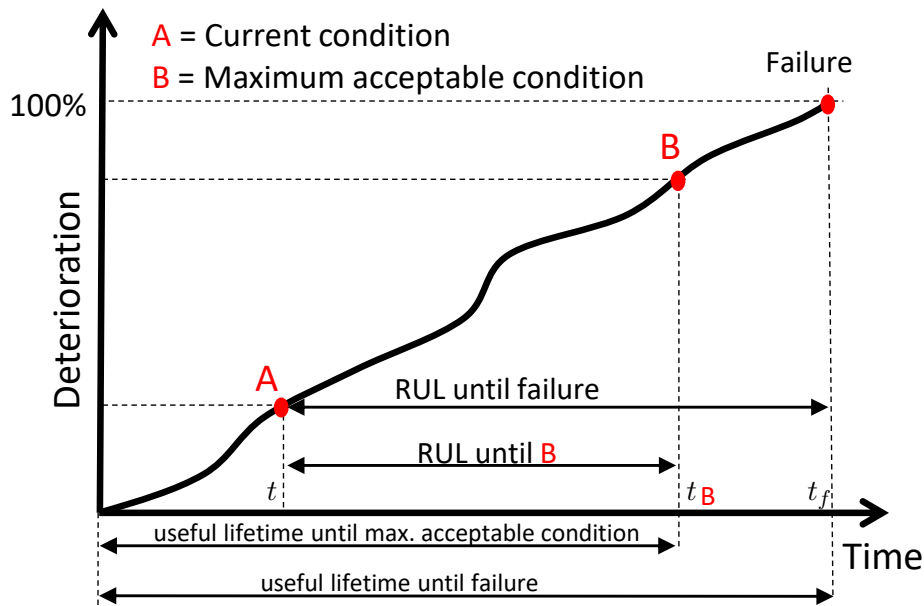

Figure II.2 – Remaining Useful Lifetime.

From now on, in this thesis we use the term *prediction* of RUL to emphasize the sense of a “future” estimation value, in the meaning of RUL. The RUL prediction is not only necessary to verify if the mission goal of a system can be accomplished (for instance reducing the probability of failures), but is also important to aid in on-line decision-making activities such as fault mitigation, mission re-planning, maintenance, etc. [Sankararaman 2013].

II.2.4 Deterioration

The deterioration the process or fact of becoming worse [Cambridge Dictionary 2018] in a given condition. Deterioration of an asset can be caused by input operating conditions and/or environmental conditions affecting a system. In this thesis, the state of deterioration is considered a health indicator of the system.

There is not an universal estimator of deterioration. In mechanics, many of the sensing methods to assess the deterioration are capacitive sensing, eddy current, infrared, optical/laser, micro/millimeter wave, acoustic emission and fatigue cycle measurement, piezoelectric sensing, among others. These mechanisms either give an image (estimate from observation) of the current deterioration or in most cases are used to detect an acceptable deterioration threshold [Vichare 2006, Nandi 2005].

As depicted in Figure II.2, developing a method to estimate the deterioration is needed to define the RUL in a given context. For instance, when the current deterioration measures of a system/equipment show that it has already exceeded or reached the predetermined failure threshold, there might no longer be enough time to plan for a proper maintenance activity.

Therefore, for this thesis two premises are defined to develop the estimator of deterioration: 1) evaluate a sensing mechanism that allows the estimation of the deterioration as simply as possible (in the form of a “virtual sensor”), and 2) consider that detecting a threshold is not enough; hence, a proper on-line-oriented estimation of deterioration must be performed. Consequently, a more “continuous” strategy is needed [Vichare 2006]. Precisely, these premises are addressed in rotatory machinery in [Lee 2014]. There, it is considered that a detected incipient change in the state of health should be monitored (from a small one as it progresses to a larger one), until it warrants some post-prognosis action. By employing such a system, the health of a machine, component or system can be known at “any” time instant, and the eventual occurrence of a failure can be predicted and prevented, or *proactively controlled* in the best of cases. It is worth mentioning that in maintenance this could be useful to enabling the achievement of near-zero downtime performance.

The deterioration measure does not have to be a directly measured parameter. It could be a function of several measured variables that provide a quantitative measure (an *estimation*) of deterioration. In this case the degradation parameter is not a directly measurable parameter but a function of several measurable parameters [Coble 2008].

Note also that the “on-line” and “off-line” terms can be also applied in a similar sense to the Condition Monitoring (CM) [Ahmad 2012]; on-line CM is performed when the equipment is in *operating state*, whereas off-line CM is performed when the equipment is not in operating state.

II.2.5 Decision-making

According to the definition of PHM in [Zio 2013] cited in II.2.1, the goal of PHM is proactively managing the system. For obtaining such a behavior, the proactive actions must affect the decision-making stage as depicted in Figure II.1. Figure II.3 illustrates the flow of information from the data acquisition for monitoring the deterioration, towards the decision-making.

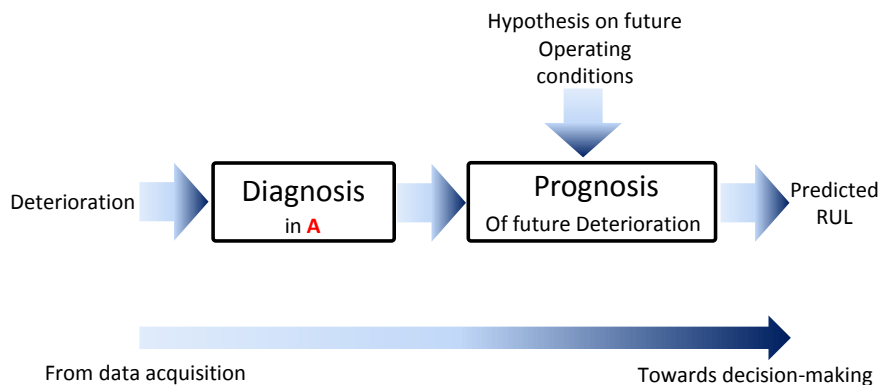

Figure II.3 – From data acquisition for monitoring the deterioration, towards decision-making

In prognostics, feature extraction and a knowledge base of faults are needed as in diagnostics; in addition, in prognostics other steps are required such as deterioration modeling including assumptions on future, performance assessment and prediction [Lee 2014]. A proper combination between deterioration modeling and performance assessment can be used to de-

scribe the state of health of a system. Thus, this thesis deals with the developing of a suitable deterioration modeling for allowing an on-line estimation of the state of health of the system, and for enabling an on-line prediction of its RUL.

Here we can use some concepts inspired on maintenance. Condition-Based Maintenance (CBM) decision-making can be classified into two methods: current-condition-evaluation-based (CCEB) and future-condition-prediction-based (FCPB) [Ahmad 2012]. CCEB focus on two main issues: i) dealing with the *deterioration modeling* process to evaluate current equipment conditions, and ii) integrating the deterioration modeling process and decision-making. Deterioration modeling towards predicting the future of equipment conditions is one of the most popular issues discussed in FCPB application, many of them for mechanical applications (e.g. rotary equipment) [Xie 2004, Ahmad 2012].

II.2.6 The Proactive sense of PHM actions

As outlined in Figure II.1, a proactive strategy is considered as the one that utilizes *preventive* and *predictive* activities for reducing the probability of failure of a given system, thereby increasing its reliability [Swanson 2001]. The “proactive sense” of the actions are nowadays widely-used in industry framework, mainly linked to maintenance [Muller 2008, Exner 2017].

Preventive actions are used to decrease probability of equipment breakdowns and extension of equipment useful life, but need to interrupt the process at scheduled intervals. In contrast, predictive actions are initiated in response to a specific *measured* or *observed* equipment condition¹; i.e. equipment is taken out of service only when direct evidence exists that deterioration has taken place. Therefore, preventive and predictive actions use different criterion for determining the need for specific maintenance activities, and are intended to reduce the probability of equipment breakdowns. Nevertheless, a more suitable meaning of the term “proactive” is *creating, controlling, or taking action by causing* a situation rather than just responding to it after it has happened [Cambridge Dictionary 2018, Oxford Living Dictionaries 2018]. The developing of this proactive sense is a motivation for this thesis.

In this sense, proactive actions should focus on management-oriented decision-making. This management is post-prognosis because it goes beyond prevention and prediction, as it involves not only trying to avoid failures, but also a complete management of the life-cycle of a system or a resource as much as possible. It should be noted that in the maintenance framework for industrial or higher levels, advanced techniques that go beyond the predictive level as Total Productive Maintenance (TPM), are highlighted to have significant positive relationships with the measures of performance [Swanson 2001]. In these levels, there are a need of more and more intelligent computer-based strategies to manage the system, a need to optimize preventive actions, and a need to carry out the actions in a more “continuous” manner [Waeyenbergh 2002], particularly in applications as embedded systems.

¹ In automation we consider an *observation* as an *internal* information of a system obtained from *external* (directly available) *measurements* [Besançon 2007]. Estimation is the process itself of reconstructing the states of the system from observed information.⁴

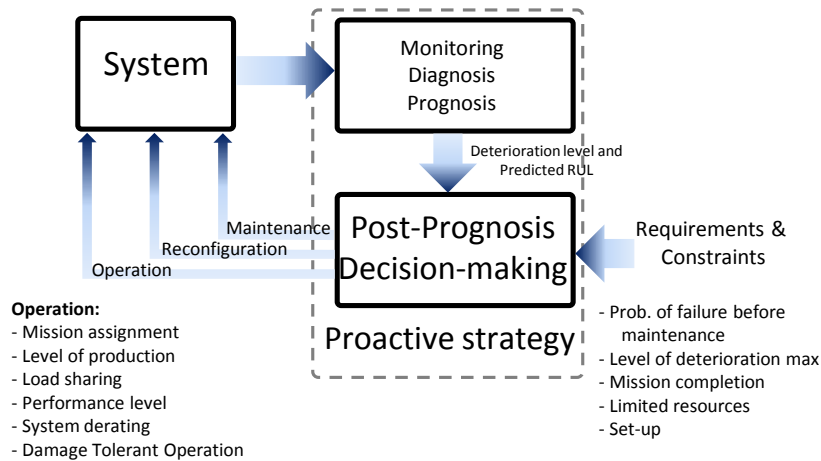

Figure II.4 – Using prognosis information for decision-Making. Types of actions to perform decision-making.

II.2.7 Post-prognosis Activities

Even if prognosis it is a key enabling step for the maintenance performance improvement on systems and structures, the issue of post-prognosis maintenance decision-making (i.e., how to use prognosis results to eventually make maintenance decisions) remains open [Huynh 2018].

PHM methods are intended to use the prognosis stage results, namely the predicted RUL, for affecting in some useful sense the *decision-making*, for influencing system operation [Rakowsky 2015]. In other words, information about reliability properties should be implemented in a closed-loop way. The latter can be grouped into three phases: 1) observe (data acquisition and data processing), 2) analyze (condition monitoring, diagnosis, prognosis), and 3) act [Javed 2017].

To achieve such closed-loop actions, either to lower work load and/or wear by adapting the operating conditions (derating actions), or selecting appropriate optimal system configurations (reconfiguration actions) of components are required according to [Meyer 2014]; [Rakowsky 2015] adds also maintenance optimization and system control actions. In general the concept of activity implies the process in which the actions are performed.

Post-prognosis activities can be classified in a general way in: maintenance, reconfiguration and operation [Berenguer 2018] and every class of these activities has been and is widely studied in PHM. Figure II.4 illustrates the different activities and their relation with the system. These activities are subject to requirements and constraints such as: probability of failure before the maintenance, level of maximal deterioration, mission completion, limited resources and set-up.

II.2.8 Reliability-Adaptive Systems (RAS)

For the case of control actions, systems which possess the capability to adapt their reliability behavior, including the control system, are called Reliability-Adaptive Systems (RAS) [Rakowsky 2006]. In other words a “reliability control” could allow to manage the deterioration of components like in the self-optimizing mechatronic systems, which are, according

to [Gausemeier 2014], a class of intelligent technical systems able to autonomously adapt their behavior if user requirements or operating conditions change.

Maintenance, reconfiguration and operation have similar purposes but we can cite differences in their process. Maintenance is defined as a set of activities serving the purpose of retaining the production units in, or restoring them to, the state considered necessary for fulfillment of their function [Gits 1984]. Reconfiguration is considered as a set of reactive activities, mainly used in fault tolerant approaches that seeks to change an initial configuration to fulfill the goal of the system or to avoid damage of the system after a failure; see for instance [Chen 2015]. Operation activities are intended to manage the nominal behavior even under the emergence of new conditions in a “more continuous” manner; some of these activities include the management of: mission assignment, level of production, load sharing, performance level, system derating, damage tolerant operation.

A common characteristic between maintenance, reconfiguration and operation activities is the need of performing the activities in a more automatic way as far as possible. In the sense of this thesis, we are focused on the developing of a control approach, for which it is intended to provide comprehensive framework for post-prognosis decision-making. Nevertheless, the conceptual relation with maintenance and reconfiguration is also developed in some parts of the document.

Thus, this thesis includes the relation between modeling, monitoring, diagnosis, prognosis, and *control* of RUL. The goal is making a contribution for a developing more intelligent management techniques during the useful life of a system.

The prognostic approaches can be classified into three main categories: experience-based approaches, data-driven approaches and model-based approaches [Jardine 2006]. Usually, the prediction of the RUL of an asset or a system has a complicated relationship with available observable “health” information. Most of sources of uncertainty are either not defined or not modeled. Moreover, prognostics is always associated with unavoidable inaccuracy. That makes that most of modeling developments rely on available past observed data and/or statistical models, and most research works about RUL focus on *preventive* maintenance applications [Si 2011]. This kind of estimation often requires to shutoff the systems; for which the term “off-line” in automation field for simulation, measurement and observation; see for instance, this sense in [Davis 1998, Bastin 2013].

Nowadays manufacturers are becoming increasingly motivated to manage the complete life-cycle of a system and to optimize the production process and its energy consumption using proactive maintenance strategies and “RUL-aware” operation of their system². Thus, models which rely on current health information, to enhance the feasibility of more intelligent management of the lifetime of the systems, are more and more interesting in literature. For instance, the optimization of service and minimization of risks/life cycle costs demands continuous monitoring of degrading behavior, and accurate prediction of lifetime at which the equipment will be unable to perform required function [Javed 2017]. For this, on-line prediction of RUL based on current health information of the system could be needed. Consequently, the design of new prognostic models of deterioration (as an indicator of the current state of health of a system), which ease the on-line implementation, is mostly necessary to implement decision-making on

²This kind of philosophy is also analyzed in industry from more general points of view in the framework of sustainability and management, see for instance [Jørgensen 2008].

a proactive level. This could be particularly useful, for instance, for embedded systems. Such need motivates the development of this thesis.

II.2.9 The Uncertainty in PHM

Thus, a suitable treatment for a system takes into account its current inputs, state of health and environmental conditions, and assumptions on the future of them. In automation, and in engineering related fields, we accept that the estimation of this current information has an *uncertainty* level, which is intended to be firstly quantified and then reduced as much as possible.

Since prognostics deals with predicting the future behavior of engineering systems, there are several sources of uncertainty which influence such prediction. A suitable prediction of the RUL is the one that includes accuracy and precision, following the same criteria to evaluate a measure. However, unlike a physical magnitude, which can be quantified with an uncertainty level in the present time, the RUL prediction must include additional assumptions about the future *operating conditions* as illustrated in Figure II.2. Prognosis of RUL projects in time the diagnosis of current system condition. At the same time, this uncertainty on the present propagates into the future as in a “chain reaction”, and of course, this uncertainty on the future depends also on assumptions with their own uncertainty level. Of course, in the absence of future measurements, it necessarily entails propagated uncertainty [Tang 2009, Javed 2017]. As a result, in prognosis one obtain predictions with higher uncertainty levels with respect to the present. However, these predictions are intended to be used to properly “close the loop” for affecting the current state of health and in turn the RUL. Hence, we define a first research question as follows:

How to perform post-prognosis decision-making on a system from a suitable modeling of the current state of health taking into account different kind of uncertainties? .

Figure II.5 illustrate the link between the main studied concepts in this thesis, to perform such a closed-loop decision-making process.

There are several sources of uncertainties that affect the the RUL prediction. In fact, it is not even meaningful to make such predictions without computing the uncertainty associated with their RUL [Sankararaman 2013]. Here, one can identify uncertainties which can be consider as *endogenous* to the system, for instance, the initial condition of its deterioration and its dynamical behavior; others can be considered *exogenous* to the system, as measurement noise and process disturbances; and others can be considered as uncertainties on the *future of the system*, for instance, the changes in the operation conditions. Therefore, accurately predicting the RUL is still (and will remain) an open problem. Several statistical and probabilistic approaches have been developed for years to tackle the problem; a proper review on statistical data driven approaches can be seen in [Si 2011]. Also in [Jardine 2006], model based approaches, which are based on a model representing the physics of the degradation process built with specific experiments, and data based approaches, which use monitored data in order to construct the model, can be identified.

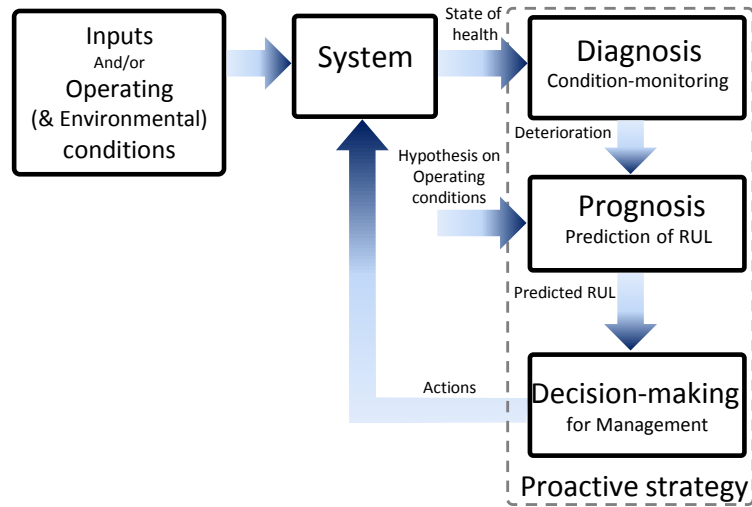

Figure II.5 – A post-prognosis set of actions for the system. The proactive actions include reaction to the failures, model of the deterioration, environmental conditions and response to a external inputs.

II.2.10 Application for Illustrating the Developed Approaches

This thesis presents a comprehensive framework for post-prognosis decision-making applied to systems whose deterioration is influenced by the command inputs. The developed concepts are illustrated, by using the application of friction drive systems. Thus, we mainly focus on the actuator level for illustration purposes; nevertheless, other systems are envisaged to be studied in perspective. This actuator-focused approaches also motivates, for instance, the work of [Nguyen 2014]. Of course, the study of a single unit system helps also in establishing the extent of the problem.

Some examples of friction-based systems are, among others, clutch, frictional belt-pulley system, disc-breaks, tire-road contact, and friction-drive-motor. This type of mechanism uses direct friction between the contact surfaces (usually made of rough materials), instead of a chain and sprockets, to transfer energy to a load.

Nowadays, the term *friction drive* is commonly used to call the basic *mechanism* and also to particular friction-based actuator including a motor. In this thesis, from now on, we adopt the following general definition of friction drive as a mechanism:

Definition II.1

A friction drive is a transmission mechanism used to transfer mechanical power by means of direct friction between two mating devices: from a driver device to a driven device.

In this thesis we focus on the friction drive following to two main points of view: one theoretical and the other practical.

From the theoretical point of view, we can consider friction drive as a basic mechanism that facilitates the study of the friction-deterioration link that is present in various friction-based systems. For example, consider a frictional brake system, which is designed to stop the movement instead of generating it; however, the definition of friction drive also includes the

brake mechanism, as the latter also involves power transfer by friction between two devices. Consider also the tire-road contact in a car, where there exist the aforementioned transfer of power from the motor to the complete body of the car by means of friction.

Note that for a friction drive, the friction is simultaneously the *useful phenomenon*, which causes the mechanical motion, and the *cause of deterioration* of the contact surfaces. This behavior implicitly leads to the problem of management of the useful life of the surfaces in contact. The failure of these surfaces is unavoidable, and in most cases it is intended to “use them well” until the moment of failure. Since surfaces are generally replacement parts, it is assumed that the improvement of a on-line-oriented use strategy is favored over, for example, the influence of their replacement on maintenance (as also discussed in PHM). Therefore, in this thesis we focus on improving the estimation of deterioration as an indicator of the state of health of the mechanism.

From the practical point of view, friction drive is an interesting mechanism for electric vehicles, given its low-cost, wide variety, ease of implementation or installation, and popular uses in machinery. In this case, the vision of the friction drive as an *actuator device* (with the driver and the driven devices mounted in an arrangement) is commonly used and remains in continuous development. Since the first patents, friction drives mechanisms are intended to be used in automotive and machinery applications. For instance the patent [Grau 1910] which describes a friction drive to change the speed and direction of a car; or the patent [Jacques 1920] where a friction drive is used for transmitting without shocks a uniform movement of rotation to large fly-wheels which have to rotate very slowly (for instance two rotations in an hour). Constraints of output power and the need of a housing lubrication motivated inventions of planetary friction drives such as [Hewko 1966] and [Hewko 1971]. The latter present additional advantage for keeping noise and vibration to a minimum. For years, friction drives were after dedicated to small-power machinery but nowadays they are also used for new applications; see for instance, a modern electric oil pump application in [Ai 2005], and popular uses of direct friction drives in electric bicycles³. In general, modern friction drives are considered to have consistent smooth and quiet performance over a wide range of operating conditions, avoiding phenomena as backlash which is common in gears and sprockets⁴.

For the friction-drive applications, an on-line-oriented Condition Monitoring approach could be useful to get closed-loop proactive post-prognosis actions (for configuring post-prognosis activities). From modeling to the control of the RUL, this thesis is focused on managing the reliability of a system during their lifetime (on-line approach). Reliability describes the ability of a system or component to function under stated conditions for a specified period of time [Geraci 1991]. Hence, this thesis can be seen also as a “Reliability-centered” use of the systems, because there are some failures which cannot be prevented by overhaul or preventive replacement action [Tsang 1995] and one of the best ways to manage the system is trying to control its reliability during the useful lifetime operation. This is particularly true for friction drive systems as seen in the premises defined for the deterioration modeling adopted in this thesis in Section II.2.4.

³See also [here](#), for instance, interesting applications in electric bicycles.

⁴For instance, observe a CVT transmission which uses rotating balls, instead of a layer of rough material, for transferring the power; therefore a CVT can be considered as kind of a friction drive.

II.3 State of the art

II.3.1 Deterioration Modeling Process.

Most of the CBM studies are focused on the deterioration modeling process. Although it is an important process in the CBM, follow-up action toward maintenance decision-making is just as important. In this sense [Mathur 2001] and [Ahmad 2012] recommend make an especial emphasis in the use of post-prognostic information for decision-making. As a solution, the following articles have considered this issue by integrating equipment deterioration modeling with maintenance decision-making:

For instance, [Percy 1998] explores how to improve the performance and the flexibility to model deterioration of a given system and/or improvement over time, thereby improving the accuracy of decisions. This work is focused on complex systems when data have been collected on failure times and PM interventions along with down times and man-hours expended on each. In [Mathur 2001] the impact of diagnostic and prognostic goals on modeling and reasoning system requirements are explored; in particular, the role of failure-dependency modeling in the overall decision. The work is developed with the purpose of developing a common software framework that can be applied to a large class of systems; however it is focused on the role of failure-dependency and uses dependency modeling which is not in the framework of this thesis. In [Lu 2007] a condition-based maintenance approach that links the concepts of modeling, monitoring, and predicting the deterioration of a system is presented. The approach can be applied on-line to maximize the profit of a system. To achieve this, the approach predict *recursively* the deterioration condition in the future for decision-making. This work is focused on improving maintenance in a general and wide range of systems. Industrial application of CBM decision-making is carried out by [Jardine 1999] for optimizing CBM decisions for equipment. There, the issue of minimizing total cost (or another appropriate goal such as profit maximization or availability maximization) can be systematically addressed.

A predictive-maintenance structure for a gradually deteriorating single-unit system (continuous time/continuous state) is presented in [Grall 2002]. The proposed decision model enables optimal inspection and replacement decision in order to balance the cost engaged by failure and unavailability on an infinite horizon. Using the proposed maintenance structure, a well-adapted strategy can *automatically* be selected for the maintenance decision-maker depending on the characteristics of the wear process and on the different unit costs. In a more general way, the proposed maintenance structure shows its adaptability to different possible characteristics of the maintained single-unit system.

II.3.2 Control-oriented RUL Prediction Methods

However, [Ahmad 2012] explain the need of additional research on CBM decision-making, particularly on how CBM can be effectively applied and implemented based on current industrial needs. The cited works in Section II.3.1 show the potential usefulness of intelligent strategies. In this thesis we are particularly interested in the control theory, mainly linked to the optimization, for the improvement of the decision-making activities during work. Of course, we adopt this premise in the context of friction drive systems.

According to [Amari 2006], several independent studies across various industries reveal that

only 15% to 20% of equipment failures are age-related. The other 80% to 85% of equipment failures are based on the effects of random events that happen in the machine or system. This leads to the fact that any method used to model the deterioration and in turn its useful life must also take into account the uncertainties of the model in a dynamic way, according to the on-line approach proposed in this thesis.

Thus the question is:

How a method for estimating the deterioration current-state, can be used to enhance the existing methods of RUL prediction? Below, some works related to the present thesis are discussed under the framework of the proactive approach that has been defined.

II.3.3 Proactive Diagnostics and Prognostics

So far, we have argued the need to model the deterioration of the treated systems in an appropriate way, to enable an appropriate prognosis of their RUL and a consequent decision making. We have seen that this process should be as continuous as possible and that in any case, whatever the chosen model of deterioration, it should systematically take into account the uncertainties in the process of evaluating the current state of health. In this way, as it was shown in Figure II.5, decisions could be made to manage the deterioration of a system from the current state of health of the system, to close the loop, acting on new decisions that ensure a desired performance of the system, and simultaneously, restrictions linked to its deterioration.

We organize the related work in the following topics:

T1. Prognosis in decision-making

In [Huynh 2018] the relation of the precision, and not only on e.g. a “mean value” of the prognosis with the predictive maintenance, is studied. They are focused on studying how to use prognosis precision results to eventually make maintenance decisions, and propose a parametric predictive maintenance decision framework that can take into account properly the system remaining life in maintenance decisions. There, the proposed framework is developed for a single-unit stochastically deteriorating system as we do in the present thesis. Results on increase of performance and the robustness of the new framework, confirm the benefit of basing maintenance decisions explicitly on the precision of the system health prognosis.

In this thesis, the relation of the precision on the estimation of the current state of deterioration is also studied. This analysis is intended to be done with respect the RUL prediction method by using a control-based model of the system. Since in Condition Based Maintenance (CBM), maintenance decisions are based on the on-line gathered system health prognosis information, rather than on the current diagnostic information [Ahmad 2012, Swanson 2001]. Thus, this thesis can be seen also as a future-condition-prediction-based (FCPB) decision-making contribution.

Recently, in [Rozas 2018], a prognosis decision-Making methodology for calculating the best route for an Electric Vehicle (EV) is presented. This is an example of how post prognosis actions can be performed trying to choose the best route. In this thesis we are interested in developing a control approach for a given kind of system by trying to modify the conditions of use, namely in systems whose deterioration is affected for their operating inputs.

T2. Focus on the actuator

A RUL estimation approach for deteriorating feedback control systems under random operating conditions, is presented also in [Nguyen 2014]. This work is focused also on evaluating the impact of prognosis result on the maintenance process. An integrated model is proposed which jointly describes the states of the controlled process and the actuators deterioration. The system state regarding the available information is estimated on-line by Particle Filtering method. Then, the RUL of the system is estimated by Monte Carlo simulation. This approach is interesting because, it shows the impact of the RUL estimation in a closed-loop control system, and because it mainly takes into account the actuator as the component that degrades through time.

In [Skima 2014] a hybrid PHM method based on physical and data-driven models and applied to a microgripper is presented. The method is applied to assess the health state of Microelectromechanical systems (MEMS) and estimate its RUL. Since, the model of the application has been developed and validated, following an structured approach, it seems a suitable candidate for application of a closed-loop control of RUL.

Also in [Javed 2015] a contribution is presented for feature extraction/selection deterioration in cutting tools and bearing, based on vibration data for prognostics. In this case, the feature extraction for prognosis is data-driven. The authors suggest as future perspectives, the integration of a dynamic failure thresholds assignment. This approach seems to be also a suitable candidate for application of closed-loop control of RUL.

In [Langeron 2017], a framework to model the deterioration of control systems is presented focusing on the actuator. The main idea is that the way an actuator is controlled is the root cause of its degradation. The control input related to the controller setting plays a central role in the actuator degradation process. The degradation is assumed observable and measurable with a dedicated monitoring equipment. Complementary, this thesis go further dealing with the development of a system that allows the condition monitoring for a given kind of systems.

T3. Model of uncertainties

In [Si 2014] the authors describe an approach for estimating the RUL taking into account three sources of variability in deterioration modeling: 1) temporal variability, 2) unit-to-unit variability, and 3) measurement variability. In that work, a relatively general deterioration model based on a Wiener process is presented. By constructing a state space model, the posterior distributions of the underlying deterioration state and random effect parameter, which are correlated, are estimated by employing the Kalman filtering technique. Further, the analytical forms of not only the probability distribution but also the mean and variance of the estimated RUL are derived, and can be on-line updated with the arrivals of new deterioration observations. This work is interesting because it provides a general theoretical framework for supporting the found results in this thesis, in particular, for the analysis of the distribution and the mean values of the estimations face to the prediction of RUL.

In [Tang 2009] the authors analyzes the source of uncertainties in typical Integrated Vehicle Health Management (IVHM) systems. Effective approaches for handling diagnostic uncertainty and the aggregation of component level uncertainty to system level are also addressed. The authors argue that managing and reducing prognostic uncertainty is of significant importance

to the success of PHM applications. A systematic analysis of the sources of uncertainty can help to reveal both reducible and irreducible uncertainties in the prognosis process and how significantly each uncertain factor affects the prognostic result.

T4. Control of Remaining Useful Lifetime

As it has been shown in this dissertation, the concept of management of systems by using post-prognosis actions for performing closed-loop decision-making has been widely envisaged and used in automation. In this context, maintenance, reconfiguration and operation actions are common goals for systems; nevertheless, sometimes the conceptual link between the developed approaches in these kind of actions is not comprehensive and it does not allow easily to share, adapt and or explore solutions. Moreover, most of work on PHM is mainly focused until prognosis stage. As a solution focused on friction drive systems, this thesis is located under the framework of the operation activities. For them, the on-line oriented modeling, monitoring, diagnosis, prognosis and post-prognosis actions are privileged. In that sense, as a general assumption for this thesis, the control theory is potentially interesting for the management of the systems under study.

A contribution for comprehension of the general concept of closed-loop actions applied to a single-unit system is developed in [Meyer 2014]. Self-optimizing mechatronic systems are a class of intelligent technical systems that are able to autonomously adapt their behavior if user requirements or operating conditions change [Gausemeier 2014, Kaul 2017]. A system must be able to sustain the intended dynamic operation, changes in operating conditions, non-desired conditions as faults and failures, *Reliable control* can be achieved using dedicated methods to make the system fault tolerant. However, the approach of fault tolerant, reliable or robust control do not allow control of the reliability of the whole system including the control system itself [Meyer 2014] as intended in terms of useful lifetime. To achieve that, a *reliability control* is required, which could be defined as the behavior adaptation to lower work load or wear on critical components for sustaining a predefined reliability (or by analogy, a predefined RUL). Systems that possess this capability are called Reliability-Adaptive Systems (RAS) by [Rakowsky 2006]. Consequently, this behavior adaptation implies the control of the RUL. A Reliability-Adaptive System is defined by the fulfillment of two characteristic requirements. First, quantitative reliability properties of a system are estimated during operation (it implies an on-line method), i.e. after a system has been put into service, but before an item under consideration fails, and second, achieved results influence system operation.

In [Gokdere 2005] an approach for RUL control of an electromechanical single-unit actuator is presented. Nevertheless the work relies only on extending its useful lifetime. Moreover, even though the concept of control is used, the approach is based on heuristics which complicate the inclusion of the uncertainties in the modeling and in turn the analysis of performance. The application of that work is the framework of RUL of motor bearing, which makes it interesting to clarify some concepts in this dissertation.

In [Garcia 2006] a maintenance approach of a windturbine gearbox was based on equipment conditions. The process of maintenance decision-making was controlled through the case-based and rule-based approaches. However, this approach and the related ones, do not take into account a formalized strategy of control which includes explicitly objectives of RUL.

Another complementary work is presented in [Meyer 2013] for Controlling the RUL using self-optimization for a single-unit system. Nevertheless, this interesting work is limited in its effectiveness since it did not take the inherent non-linearities and deviations between multiobjective optimization model and real system into account. In this thesis we propose to take into account such aspects firstly from the modeling of the deterioration.

In the same way, in [Meyer 2014] the concept of closed-loop control system for the reliability of intelligent mechatronic systems is presented. This is a remarkable alternative from the point of view of preventive and corrective maintenance. In that work, a simple relation between energy and degradation is supposed. In this thesis we propose to go further with the analysis of the uncertainties from modeling to control.

The PhD thesis [Langeron 2015] illustrates a stochastic modeling for working safety of controlled systems. A stochastic modeling framework is proposed combining the use of the system and various modes of deterioration. RUL is then used as a reconfiguration tool of the LQR (Linear Quadratic Regulator) control law. Complementary, in this thesis we propose the use of control techniques for obtaining, for instance, a predefined RUL.

T5. Potential applications

The work in [Bevan 2013] focuses on the development of a damage model to predict the deterioration rates of the wheel tread damage in terms of wear and rolling contact fatigue (RCF). In that work, the used damage models have been validated using observation data. The developed model uses a description of a fleet's service diagram to determine a simulation environment (accounting for the distribution of curvature, cant deficiency, traction braking, etc.) that represents the duty cycle of the vehicle. Vehicle dynamic simulations are then conducted to predict the wheel-rail contact forces on each wheel in the vehicle for each of the combination of operating conditions in the simulation environment. That work is also related with this thesis in terms of the used relation between energy and wear material as cause of deterioration. Nevertheless, we propose to go further in development of strategies that could be applied, for instance in perspective, for controlling the causes of wear dynamically.

In [Salazar 2016] a general framework for taking into account system and components reliability in a Model Predictive Control (MPC) algorithm is presented. The effectiveness and benefits of the proposed control framework are presented through a Drinking Water Network (DWN) simulation. One of the used premises in that work is that component health monitoring should be considered in a controlled system. In other words, reliability theory should be part in the studied control problem. Complementary, in this thesis we are particularly interested in applying control techniques to improve, in perspective, the reliability of a given kind of systems.

II.4 Introducing the problem statement

In this section, the Problem statement is presented in a structured way, taking into account the following postulates in its definition:

- P1** Deterioration modeling and estimation on electromechanical devices represents a key issue for their condition-based, predictive and proactive maintenance.

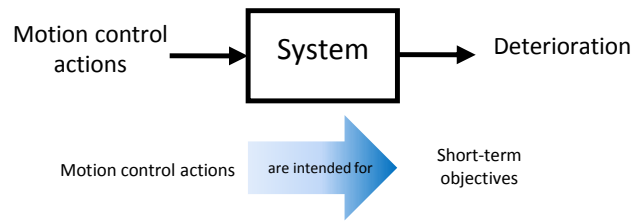

Figure II.6 – Assumption II.2: the system deterioration is a consequence of the motion control actions

- P2** A suitable control-oriented RUL-prediction method must be linked with a proper on-line deterioration estimation method, thereby allowing the development of more feasible proactive maintenance strategies.
- P3** A proper control-oriented modeling of current state of deterioration (and in turn, a proper predictor of RUL) must include deterministic and stochastic assumptions on the current and future operating conditions, which are intended to increase the reliability of the system.
- P4** Controlling dynamically the RUL of a component could be achieved by modifying, in a suitable way, the motion control laws.

Thus, let us assume:

Assumption II.1 : There exist a method which gives a metric of the current state of deterioration taking into account various sources of uncertainties.

and

Assumption II.2 : There exist a control-oriented dynamical model which links the motion control laws of friction drive and the current state of deterioration, i.e. the system deterioration is a consequence of the motion control actions, as depicted in Figure II.6.

and

Assumption II.3 : Estimation of RUL is possible at every time instant from the estimation of the current state of deterioration and assumptions on the future of the system.

and

Assumption II.4 : Controlling the RUL of a component could be achieved by modifying, in a suitable way, the motion control laws, as depicted in Figure II.7.

Let us define also:

Definition II.2

At a given time t , the desired RUL, denoted RUL^{ref} , is the desired remaining period of time before the friction drive system can no longer perform its intended function. Where this function, is measured or observed by using a predefined metric.

and

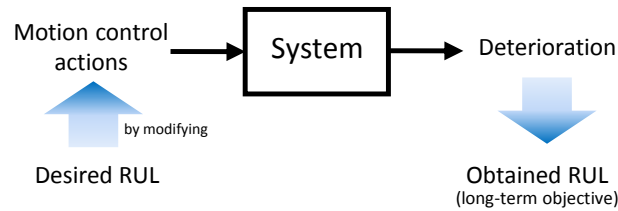

Figure II.7 – Assumption II.4: Controlling the RUL of a component could be achieved by modifying, in a suitable way, the motion control laws.

Definition II.3

At a given time t , the predicted RUL, denoted \hat{RUL} , is the predicted remaining period of time before the friction drive system can no longer perform its intended function. The predicted RUL is a random variable, which can be characterized by e.g. a probability distribution or a confidence metrics.

Given a mechanical friction drive system defined in II.1 and the general definitions II.2 and II.3, if assumptions II.1, II.2, II.3 and II.4 hold, then the *general problem statement* for this thesis is defined as:

Problem II.1

Find, at every time-instant, the manipulable input of the system which guarantees that the predicted RUL follows the desired one.

II.5 Conclusion

Taking postulates **P1** to **P4**, the general objective of this thesis is:

GO To develop an approach for controlling dynamically the Remaining Useful Lifetime (RUL) of systems whose deterioration is influenced by the command inputs.

and the *Specific Objectives* as follows:

SO1 To develop a control-oriented model for deterioration.

Chapter III deals with this objective.

SO2 To develop a method to for estimating the deterioration during operation.

Chapter IV deals with this objective.

SO3 To integrate the deterioration model into its RUL prediction.

Chapter IV deals with this objective.

SO4 *To propose an architecture for using the prognosis information for dynamical post-prognosis making-decisions.*

ChapterV deals with this objective.

These objectives are developed around friction-drive systems to illustrate the developed theory. In that sense, an additional postulate for taking into account is:

P5 In friction-based mechanisms, the friction is, simultaneously the cause of the deterioration and the useful (and in turn unavoidable) mechanical phenomenon. Thus, proactive control actions are needed to manage the friction-based applications during their useful lifetime. This control must respect a trade-off between desired operation and maintenance.

Deterioration Modeling of a Friction Drive System

Contents

III.1 Introduction	31
III.2 Friction drive system modelling	32
III.2.1 System description	32
III.2.2 Analytical physics-based modeling of the friction drive	33
III.2.3 Modeling the friction drive as an Uncertain Linear System	36
III.3 Dynamical model of deterioration	36
III.3.1 Dissipated-Energy-based model	36
III.3.2 State-space model for the friction drive system	41
III.3.3 Estimating the dynamic efficiency of the friction drive	41
III.3.4 Introducing randomness in the model	42
III.4 Case study analysis	42
III.4.1 Deterministic operational mode	43
III.4.2 Stochastic operational mode	49
III.4.3 Invariant sets for detecting deterioration	50
III.5 Conclusions	51

III.1 Introduction

The aim of this chapter is to illustrate the development of a mathematical model for a system whose deterioration is affected by the command input. As established in Chapter II, one of the motivations for this thesis is the study of management techniques of the deterioration and in turn the RUL. Thus, the model of deterioration must be control-oriented.

For this purpose, it is used a basic friction drive system, which is a type of transmission consisting of a driver device which transfers the power by friction to a driven device. The basic model of friction drive transmission relies on the assumption of equal tangential speeds of wheel and motor surfaces. However, in this chapter we start assuming that the difference between speeds can not be always neglected, because in fact this is linked with the production of the contact force and the efficiency of the mechanical transmission [Popov 2010]. Moreover, the contact force is associated with a transfer of energy that also deteriorates the contact

surfaces. Therefore, the energy transfer is simultaneously, the useful phenomenon (production of motion) and the source of deterioration; a double effect that must be properly modeled.

In this chapter, we develop an analytical physics-based model for the deterioration of the actuator, and we consider a special case of a friction drive system: a roller-on-tire system. The developed model integrates the deterioration as one of the states of the system, thus it allows: a) to link the deterioration evolution to the inputs and operating modes of the system, b) to assess the behavior of deterioration in critical stages, such as sharp motion and smooth motion, and c) to predict analytically an interval of useful lifetime before the total-failure-time of actuator, taking into account stochastic perturbations.

The remainder of this chapter is organized as follows. Section III.2 presents the design and analysis of the deterioration model of the considered friction drive system, and shows the general definition of the particular friction drive. In a first step, the physics of the system, and in particular the link between deterioration dynamics and energy transfer at the friction surfaces, is modeled in a deterministic way in Section III.3. A useful state space representation is presented, which contains the deterioration as one of the states. Then, considering either random system parameters or random system inputs and usage, a complete stochastic model for the system deterioration is proposed and illustrated by means of a case study in Section III.4. The contact quality coefficient proposed in this chapter allows to model the actuator as a (polytopic) Linear Parameter Varying model.

III.2 Friction drive system modelling

Figure III.1 presents the basic principles of the mechanical devices considered in this work: a power transmitted from the source to the load, P_L , is higher than the power which actually causes the motion, P_L^* . This phenomenon is modeled under the general hypothesis that the loss of efficiency in the conversion from energy to motion can be an estimable image of the deterioration of contact.

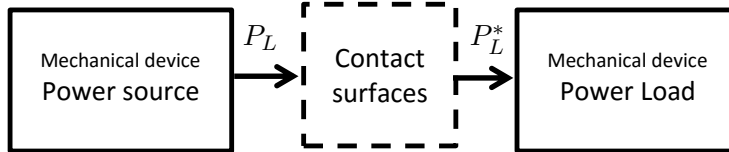

Figure III.1 – Losses of power in contact

III.2.1 System description

Let us assume a friction drive composed by a *driven device* and a *driver device*, as depicted in figure III.2, for which it is assumed that: a) both contact surfaces wear monotonically, and b) the contact joint reaches eventually a threshold above which the system is considered a failed system. Symbols of the equations and units are shown in Table V.1 ¹.

¹Note that in this thesis we are assuming non-squeezable surfaces. For this reason r_1 and r_2 are assumed as constant. As explained in Section III.2.2, the focus of the further modeling is the macroscopic phenomena.

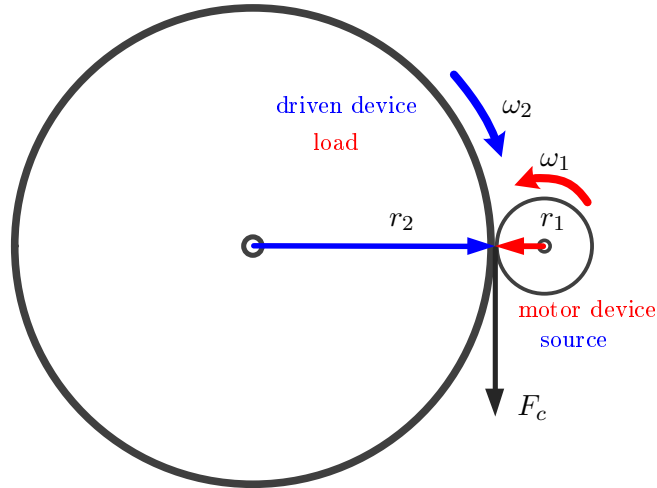

Figure III.2 – Basic roller-on-tire motor system

III.2.2 Analytical physics-based modeling of the friction drive

The following mechanical analysis is based on the Dahl model and LuGre model of friction, which are widely studied in the literature of mechanics. A good overview about those models can be read in [Geffen 2009] and [Armstrong-Helouvy 1996]. These models represent the friction force with three main components: i) the Stribeck friction effect taking place at low velocities, for which the friction force has an inverse relation with respect to the speed; ii) the Coulomb friction, for which the force remains as constant with respect to the speed at the beginning of motion; and iii) the viscous friction, for which the friction force is proportional to the speed.

The contact force $F_c(t)$ can be characterized by using dynamic friction models, see for instance [Canudas-de Wit 2003] and [Martinez 2004]. Due to the fact that this thesis work is focused on the analysis for long periods of time, only macroscopic friction phenomena will be kept for modeling a simpler contact model. In the present chapter, Stribeck friction effect and Coulomb friction are considered negligible; that is, only the viscous friction is taken into account.

Here F_c is assumed as a frictional force, tangential to both the driver and the driven devices, which is produced by the driver device and causes a rotational torque over the driven device. A similar approximation of the law of friction by a continuous function of velocity is analysed in [Popov 2010]. Consequently, the friction force component depicted in Equation (III.1), depends on the difference Δ_v between the tangential speeds of the driver and driven device, v_1 and v_2 respectively,

$$F_c = \alpha(v_1 - v_2) = \alpha(r_1\omega_1 - r_2\omega_2) = \alpha\Delta_v \quad (\text{III.1})$$

where $\alpha \geq 0$ is the proportionality coefficient, which in this chapter is called *contact quality coefficient* and considered as an uncertain parameter.

In some sense, this α stands for a measure about the *quality of contact* between both rolling devices at every time of the motion. Then, we assume that the condition of this contact-quality depends on the deterioration of the joint and varies with time because of the frictional phenomena.

Table III.1 – Notation

Symbol	Units	Physical meaning
v_1	$[m/s]$	Tangential speed of the driver device
v_2	$[m/s]$	Tangential speed of the driven device
ω_1	$[rad/s]$	Angular speed of the driver device
ω_2	$[rad/s]$	Angular speed of the driven device
$\dot{\omega}_1$	$[rad/s^2]$	Angular acceleration of the driver device
$\dot{\omega}_2$	$[rad/s^2]$	Angular acceleration of the driven device
r_1	$[m]$	External radius of the driver device ¹
r_2	$[m]$	External radius of the driven device ¹
b_1	$[N\ m/(rad/s)]$	Viscous damping coefficient of the driver device
b_2	$[N\ m/(rad/s)]$	Viscous damping coefficient of the driven device
J_1	$[Kg\ m^2]$	Moment of inertia of the driver device
J_2	$[Kg\ m^2]$	Moment of inertia of the driven device
T_m	$[N\ m]$	Torque of the driver device
T_L	$[N\ m]$	Load torque seen by the motor
T_L^*	$[N\ m]$	Source torque observed by the driven device
K_m	$[V\ s/rad]$	Motor back electromotive force constant
I	$[A]$	Electrical current of the motor
α	$[N\ s/m]$	Contact quality coefficient

In this thesis α is treated as a time-varying parameter. This is represented as:

$$\alpha = f(Deterioration, t) \succ 0 \quad (III.2)$$

The parameter α (defined as positive with $\succ 0$) corresponds to the viscous friction coefficient in the classic context of friction components modeling; this parameter is usually considered to be constant. Nevertheless, we assume that treating α as a time-varying parameter allows further conclusions on the study of the deterioration during the lifetime of the system. The parameter α can be used to characterize the quality of the contact (e.g. the inter-surface adhesion and the surface roughness) between both rotational devices. In addition, in this work, we consider that this parameter will *monotonically decrease* in time for modeling the deterioration of the friction drive.

The torque produced by the driver device and transferred to the load $T_L(t)$ and the torque observed by the driven device $T_L^*(t)$ depend on $F_c(t)$ according to equations (III.3) and (III.4).

$$T_L = F_c r_1 \quad (III.3)$$

$$T_L^* = F_c r_2 \quad (III.4)$$

The system dynamics using Newton's laws of motion can be written as follows:

$$J_1 \dot{\omega}_1 = T_m - T_L - b_1 \omega_1 \quad (III.5)$$

$$\dot{\omega}_1 = \frac{1}{J_1} (T_m - r_1 \alpha (r_1 \omega_1 - r_2 \omega_2) - b_1 \omega_1) \quad (III.6)$$

Table III.2 – Terms of power equations

Term	Physical meaning	Symbol
$J_1\dot{\omega}_1\omega_1$	Total power in the driver device	P_{TM}
$T_m\omega_1$	Power produced for the driver device	P_{motor}
$T_L\omega_1$	Power transferred to the load	P_L
$b_1\omega_1^2$	Power caused by the viscous damping b_1	P_{b1}
$J_2\dot{\omega}_2\omega_2$	Total power for the driven device	P_{TW}
$T_L^*\omega_2$	Power caused by contact observed by the driven device	P_L^*
$b_2\omega_2^2$	Power caused by viscous damping b_2	P_{b2}

and

$$J_2\dot{\omega}_2 = T_L^* - b_2\omega_2 \quad (\text{III.7})$$

$$\dot{\omega}_2 = \frac{1}{J_2}(r_2\alpha(r_1\omega_1 - r_2\omega_2) - b_2\omega_2) \quad (\text{III.8})$$

where, $T_m(t)$ is the input torque, and $b_1\omega_1$ and $b_2\omega_2$ are torques caused by the viscous damping of the driver device and the driven device, respectively.

$T_L(t)$ is a torque seen from the driver side, that reflects the load effect of the driven device. For this reason, $T_L(t)$ is assumed as a load in (III.5). In addition, $T_L^*(t)$ is the torque observed from the driven side. For this reason, $T_L^*(t)$ is assumed as a source in (III.7). Both torques can be written in terms of the contact force $F_c(t)$ as follows²:

Remark III.1

For the case of an electro-mechanical friction drive, $T_m(t)$ can be produced for instance by a dc motor. In that case, $T_m(t) = K_m I(t)$, where $I(t)$ is the electrical motor current and K_m the motor back-electromotive force constant.

Equations (III.6) and (III.8) can be rewritten in terms of power multiplying them by ω_1 and ω_2 respectively as follows:

$$J_1\dot{\omega}_1\omega_1 = T_m\omega_1 - T_L\omega_1 - b_1\omega_1^2 \quad (\text{III.9})$$

$$J_2\dot{\omega}_2\omega_2 = T_L^*\omega_2 - b_2\omega_2^2 \quad (\text{III.10})$$

where terms in equations (III.9) and (III.10) are shown in Table III.2:

Let P_c the contact power. Taking into account Equations (III.9) and (III.10), P_c can be expressed as follows:

$$\begin{aligned} P_c &= P_L - P_L^* = T_L\omega_1 - T_L^*\omega_2 \\ P_c &= F_c(r_1\omega_1 - r_2\omega_2) = F_c\Delta_v \end{aligned} \quad (\text{III.11})$$

Using Equation (III.1) this takes the form:

$$P_c = \alpha(r_1\omega_1 - r_2\omega_2)^2 = \alpha\Delta_v^2 \quad (\text{III.12})$$

²Note that in this Thesis, in some parts, dependence on time "(t)" is not written for simplicity.

III.2.3 Modeling the friction drive as an Uncertain Linear System

Let us represent the friction drive dynamics as an uncertain linear system in the state space representation:

$$\dot{\mathbf{x}} = \mathbf{A}(\alpha)\mathbf{x} + \mathbf{B}u \quad (\text{III.13})$$

$$\mathbf{y} = \mathbf{C}\mathbf{x} \quad (\text{III.14})$$

where $\mathbf{x} := [\omega_1(t) \ \omega_2(t)]^\top$ is the system state, $u = T_m(t)$ (in this case the electrical current) is the input, α is the uncertain parameter, or the scheduling parameter in the case of a linear parameter varying model interpretation, i.e. α is assumed either measured, estimated or known. In addition:

$$\mathbf{A}(\alpha) = \begin{bmatrix} (-\alpha r_1^2 - b_1)/J_1 & \alpha r_1 r_2/J_1 \\ \alpha r_2 r_1/J_2 & (-\alpha r_2^2 - b_2)/J_2 \end{bmatrix}, \quad (\text{III.15})$$

$$\mathbf{B} = \begin{bmatrix} 1/J_1 \\ 0 \end{bmatrix} \quad (\text{III.16})$$

$$\mathbf{C} = \begin{bmatrix} 1 & 0 \\ 0 & 1 \end{bmatrix} \quad (\text{III.17})$$

where \mathbf{C} means that both: angular speed of the driver device and angular speed of the driven device are measured, i.e. $\mathbf{y} = [\omega_1(t) \ \omega_2(t)]^\top$.

III.3 Dynamical model of deterioration

III.3.1 Dissipated-Energy-based model

The parameter α characterizes the quality of the contact (e.g. the inter-surface adhesion and the surface roughness) between both rotational devices. Hence, one can consider that the parameter α decreases monotonically over time, while the deterioration of the contact increases monotonically over time (As defined in assumptions of Section III.2.1). In this thesis the main assumption on this deterioration is that:

Assumption III.1 : Deterioration can be quantified and calculated from the estimation of the dissipated energy in the joint (the contact between external surfaces of the driver device and the driven device).

Hence, a deterioration index D is defined:

Definition III.1

The deterioration index D is defined as a measure of the loss in the actuator ability to transfer mechanical power to the load device.

The energy dissipated in the contact E_c between the surfaces in the friction drive system can be obtained from (III.12).

$$E_c = \int_{t_0}^t P_c dt = \int_{t_0}^t \alpha \Delta_v^2 dt \quad (\text{III.18})$$

where t_0 stands for the time instant in which the systems starts the motion, and t the current time instant.

Note, that E_c depends on the speed between the surfaces, which seems logical as more sliding between surfaces, implies more energy dissipated.

The resulting dissipated energy could be considered as an image of the heat and the material worn at the contact level during traction. This assumption is very similar to the Archard's equation that is commonly used in railway industry for wear prediction (see for instance [Bevan 2013] and [Cremona 2016]). Similar conclusion were found by [Meyer 2014] in the automatic control framework.

Since energy dissipation leads to entropy generation in materials, it has been shown and experimentally demonstrated that the use of the total entropy generated in any degradation process is measurable and can ultimately be used to represent the time of failure of components [Imanian 2016].

Thus, deterioration index D can be considered as proportional to the dissipated energy in the contact:

Remark III.2

The deterioration index D could be also directly linked to the worn material in the joint as:

$$D(t) := cE_c = c \int_{t_0}^t P_c dt = c \int_{t_0}^t \alpha \Delta_v^2 dt \quad (\text{III.19})$$

where c is a proportionality factor that relates deteriorated material because of friction with the energy dissipated. For simplicity, $c = 1$ is used from now on.

which follows:

$$D(t) := \int_{t_0}^t P_c(t) dt = \int_{t_0}^t \alpha (r_1 \omega_1 - r_2 \omega_2)^2 dt \quad (\text{III.20})$$

From Remark III.2, the estimated coefficient $\hat{\alpha}$ can be linked as an indicator of the loss of material, i.e. the material that allows the contact (or the existence of mechanical transmission), or the modification of the surface properties at the contact level. At the same time, $\hat{\alpha}$ establishes a relation between material of contact and energy of contact.

Equation (III.20) shows that the dynamics of the system and the contact surfaces deterioration are linked through α . From Equation (III.20), and since $\alpha = f(D)$, a nonlinear variation of the deterioration with respect to time can be obtained:

$$\dot{D} = \alpha \Delta_v^2 \quad (\text{III.21})$$

From Section III.2.1, let us rewrite the general assumptions in this chapter as: a) the evolution of α depends on the monotonically evolution of the deterioration D i.e. the higher D , the lower α , and b) the friction drive system reaches a value $D = D_{max}$, for which it is considered as a failed system, at a given *failure time* t_f .

By assumption, the contact quality coefficient $\alpha(t)$ monotonically decreases as $D(t)$ increases, following a first order linear variation of α with respect to D as depicted in Figure III.3, with initial value $\alpha(0)$:

$$\alpha(t) = -mD(t) + \alpha(0) \quad (\text{III.22})$$

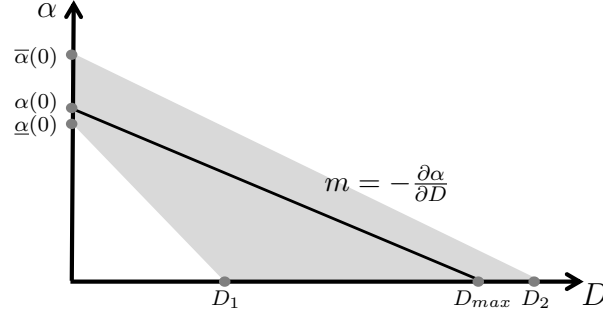

Figure III.3 – Contact quality coefficient α as a function of D for m within a given interval $\underline{m} \leq m \leq \bar{m}$.

where $\alpha(0)$ is considered as an unknown parameter, but belonging to a known interval in such a way that $0 \leq \underline{\alpha}(0) \leq \alpha(0) \leq \bar{\alpha}(0)$, where in turn $\underline{\alpha}(0)$ and $\bar{\alpha}(0)$ stands for the lower and the upper bound of the interval, respectively.

Let us call m (the slope of the assumed linear variation), the *quality-deterioration ratio*, which is:

$$m = -\frac{\partial \alpha}{\partial D} \quad (\text{III.23})$$

where m is considered as an unknown parameter, but belonging to a known interval $\underline{m} \leq m \leq \bar{m}$, where $\underline{m} := \inf\{m\}$ and $\bar{m} := \sup\{m\}$.

The shaded area in Fig. III.3 illustrates the domain of possible trajectories of the parameter α with respect to D , which configures an uncertainty interval on the knowledge of m . As an example, the bold line corresponds to a particular case where m is considered to be constant during the whole lifetime of the system.

From equations (III.21) and (III.22), we obtain:

$$\dot{D} = (-mD + \alpha(0))(r_1\omega_1 - r_2\omega_2)^2 \quad (\text{III.24})$$

Equation (III.24) can be rewritten as follows:

$$\dot{D} = -m \Delta_v^2 D + \alpha(0) \Delta_v^2 \quad (\text{III.25})$$

We can compute the maximum value of the deterioration with respect to time D_{max} as:

$$D_{max} := \lim_{t \rightarrow +\infty} D(t) \quad (\text{III.26})$$

This can be calculated by using Equation (III.25) with $\dot{D} = 0$, thus:

$$0 = -mD_{max} + \alpha(0) \quad (\text{III.27})$$

$$D_{max} = \alpha(0)/m \quad (\text{III.28})$$

In a complementary way, we define the *normalized deterioration* as:

$$\bar{D} := D(t)/D_{max} = (m/\alpha(0))D(t) \quad (\text{III.29})$$

where $0 \leq \bar{D}(t) \leq 1$.

From Equation (III.22), we get the special form:

$$D(t, \alpha) = (\alpha(0) - \alpha)/m \quad (\text{III.30})$$

Also from (III.22), (III.28), and (III.29), for a given initial condition $\alpha(0)$ and under the assumption of a constant m , $\bar{D}(t)$ can be computed at every time-instant as function of $\alpha(t)$, as follows:

$$\bar{D}(t) = 1 - \frac{\alpha(t)}{\alpha(0)} \quad (\text{III.31})$$

Since $\Delta_v = v_1 - v_2 = r_1\omega_1 - r_2\omega_2$ and using (III.6) and (III.8):

$$\dot{\Delta}_v = (r_1/J_1)(K_m I - \alpha r_1 \Delta_v - B_1 \omega_1) - (r_2/J_2)(\alpha r_2 \Delta_v - B_2 \omega_2) \quad (\text{III.32})$$

Remark III.3

Equation (III.32) shows that it is possible to estimate the value of α from the measured speeds (recall that measuring the speeds is considered feasible in this kind of mechanisms), and assuming the other parameters of the systems as constant.

From Remark III.3, let us denote with $\hat{\alpha}$ the *estimated value of α* , and \hat{D} the *estimated value of D* . Therefore, from Equation (III.30), the estimate of the deterioration index D is given by:

$$\hat{D} = \frac{\alpha(0) - \hat{\alpha}(t)}{m} \quad (\text{III.33})$$

Consequently, from (III.31) and considering m as constant, it is obtained the *normalized estimation of deterioration $\hat{\hat{D}}$* :

$$\hat{\hat{D}} = \frac{\hat{D}}{D_{max}} = \frac{\alpha(0) - \hat{\alpha}(t)}{\alpha(0)} = 1 - \frac{\hat{\alpha}(t)}{\alpha(0)} \quad (\text{III.34})$$

Remark III.4

Remark that the deterioration $\bar{D}(t)$ tends to 1 as the quality coefficient $\alpha(t)$ tends to 0. This normalized deterioration has the advantage that it depends only on $\alpha(t)$ and $\alpha(0)$, under the assumption of a constant m . The normalized deterioration can be obtained at every time-instant, by using III.34, the estimation of $\hat{\alpha}(t)$, and the estimation or assumption of $\alpha(0)$. In turn, if m is not constant, then Equation III.29 can be used. A suitable state-observer can be designed for this goal. Chapter IV establishes the main aspects for designing this observer.

Now, from (III.22) one can compute the time-derivative of the parameter α (for m not necessarily constant), as follows:

$$\dot{\alpha}(t) = -m\dot{D} - \dot{m}D \quad (\text{III.35})$$

Let us assume that \dot{m} (the time-derivative of m), is small enough in such a way that the second term can be neglected. Hence:

$$\dot{\alpha}(t) = -m \Delta_v^2 \alpha(t) \quad (\text{III.36})$$

Equation (III.36) can be rewritten to show explicitly the dependence of $\dot{\alpha}$ on the state vector \mathbf{x} of the system representation (III.13)-(III.14). In this case, \mathbf{x} contains the angular speeds of the driver device and the driven device, respectively as follows:

$$\dot{\alpha}(t) = -m p(\mathbf{x}) \alpha(t) \quad (\text{III.37})$$

where:

Definition III.2

$p(\mathbf{x}) = (r_1\omega_1 - r_2\omega_2)^2$ and is defined here as the sliding factor, which depends on the state vector \mathbf{x} and in turn, on the input $u(t)$ (the only input of the system). In other words, $p(\mathbf{x})$ depends on the input operating conditions.

Remark III.5

The equation (III.37) summarizes that one can calculate the time-derivative of $\alpha(t)$ by using: i) the current value of $\alpha(t)$, therefore to find a suitable method to estimate $\alpha(t)$ which in turn is linked to $D(t)$ is necessary; ii) the input operating conditions reflected in $p(\mathbf{x})$, where $p(\mathbf{x})$ could be controlled by the input $u = I(t)$ if the uncertain system (III.13)-(III.14) is controllable; and iii) the parameter m , which can be linked with the inner characteristics of the contact surfaces, e.g. the material of the surfaces.

From, Equations (III.21) and (III.37), we can write the dynamics \dot{D} with respect to $\dot{\alpha}$ and vice versa respectively³:

$$\dot{D} = -(1/m)\dot{\alpha} \quad (\text{III.38})$$

which according the Equation (III.37), can be rewritten as:

$$\dot{D} = \alpha p(\mathbf{x}) \quad (\text{III.39})$$

and:

$$\dot{\alpha} = -m\dot{D} = -m\alpha\Delta_v^2 \quad (\text{III.40})$$

Equation (III.40) can be rewritten taking into account the Equation (III.20):

$$\alpha = -m \int_{t_0}^t P_c dt + \alpha(0) \quad (\text{III.41})$$

Therefore:

$$\alpha = -mE_c + \alpha(0) \quad (\text{III.42})$$

Summarizing, assuming a monotonically increase of deterioration, the proposed model shows that the friction drive system reaches a maximum value of deterioration D_{max} at a failure time t_f , above which a failed transmission is considered, which depends on the initial value of the contact quality coefficient $\alpha(0)$ and the quality-deterioration ratio m , which represents the variation of $\alpha(0)$ with respect to deterioration D . Moreover, the normalized estimation of deterioration \hat{D} can be obtained from $\alpha(0)$ and its estimation $\hat{\alpha}$ assuming a constant m .

³ \dot{D} can be obtained deriving Equation (III.30) with respect to time.

III.3.2 State-space model for the friction drive system

The studied friction drive is an uncertain nonlinear system which depends on time-varying unknown-but-bounded uncertain parameters. Taking into account an augmented state vector \mathbf{x}_a as:

$$\mathbf{x}_a = \begin{pmatrix} \omega_1 \\ \omega_2 \\ D \end{pmatrix}, \quad (\text{III.43})$$

the input $u = T_m$ and the output \mathbf{y}_a , the representation of the augmented system can be expressed as:

$$\dot{\mathbf{x}}_a = f(\mathbf{x}_a) + \mathbf{B} u \quad (\text{III.44})$$

$$\mathbf{y}_a = \mathbf{C} \mathbf{x}_a \quad (\text{III.45})$$

where $f(\mathbf{x}_a)$ corresponds to:

$$f(\mathbf{x}_a) = \begin{pmatrix} -\frac{1}{J_1} (b_1 + \alpha r_1^2) \omega_1 + \frac{1}{J_1} \alpha r_1 r_2 \omega_2 \\ \frac{1}{J_2} \alpha r_2 r_1 \omega_1 - \frac{1}{J_2} (b_2 + \alpha r_2^2) \omega_2 \\ \alpha (r_1 \omega_1 - r_2 \omega_2)^2 \end{pmatrix} \quad (\text{III.46})$$

and \mathbf{B}_a , the input matrix, and \mathbf{C}_a the output matrix are respectively:

$$\mathbf{B}_a = \begin{bmatrix} \frac{1}{J_1} \\ 0 \\ 0 \end{bmatrix}; \quad \mathbf{C}_a = \begin{bmatrix} 1 & 0 & 0 \\ 0 & 1 & 0 \\ 0 & 0 & 1 \end{bmatrix} \quad (\text{III.47})$$

and where D is considered as a state that could be estimated, from following Remark III.3 and Equation III.33. Remark that in this case the non-linearity of the system is due to the introduction of the state D .

III.3.3 Estimating the dynamic efficiency of the friction drive

The dynamic efficiency of the friction drive is a measure of the current power provided by the motor (Power transferred to the load P_L), and the effective power recovered by the driven device (Power caused by contact observed by the driven device P_L^*) at the contact level.

From Equations (III.9) and (III.10), and the terms of power shown in Table III.2, we define the dynamic efficiency of the transmission $\eta_c(t)$ as:

$$\eta_c = \frac{P_L^*}{P_L} = \frac{P_L - P_c}{P_L} \quad (\text{III.48})$$

$$\eta_c = 1 - \frac{P_c}{P_L}$$

which is equivalent to:

$$\eta_c = \frac{F_c r_2 \omega_2}{F_c r_1 \omega_1} = \frac{r_2 \omega_2}{r_1 \omega_1} = \frac{v_2}{v_1} \quad (\text{III.49})$$

III.3.4 Introducing randomness in the model

Randomness in the model can be introduced in two complementary modes: a) *internal*, to model the uncertainty on the parameters m and $\alpha(0)$ (which are used to relate α with D) for a given system, and the system-to-system variability, and b) *external*, to model the variability of the input operating conditions and the usage system.

a) Uncertain/random parameters

In Equation (III.22) $\alpha(0) \geq 0$ and $m \geq 0$ are considered as unknown parameters, but belonging to a given interval with a given probability, taking into account real applications. For instance, a Normal distribution can be introduced to represent these uncertainties:

$$\alpha(0) \sim \mathcal{N}(\alpha(0)_m, \sigma_{\alpha(0)}^2), \quad \alpha(0)_m > 0 \quad (\text{III.50})$$

$$m \sim \mathcal{N}(m_m, \sigma_m^2), \quad m_m > 0 \quad (\text{III.51})$$

where m_m and σ_m are the mean value and the standard deviation of the slope m respectively, $\alpha(0)_m$ and $\sigma_{\alpha(0)}$ are the mean value and the standard deviation of $\alpha(0)$ respectively.

As depicted in the shaded area in Figure III.3 and according to Equations (III.22), (III.50) and (III.51), the behavior of α with respect to D constitutes a bi-dimensional space of variation with a probability linked to the uncertainty of $\alpha(0)$ and m . The solid line inside the shaded area is an example of a probable behavior of α with respect to D , with constant m .

b) Varying input operating conditions and usage

The developed model is single input $u(t)$. In this case, the variability of the *operating conditions* and *the usage system* can be represented, for instance, with a varying input u , following a known probability distribution. The input $u(t)$ could contain diverse sources of information about the operating conditions of the system, for instance: the shape in the time of the usage, the frequency, the amplitude, among others.

Consider an input u as a rectangular waveform. The times t_h in which u is in high, and t_l in which u is in low can vary randomly. Thus an exponential distribution, for instance, can be introduced to represent them, as follows:

$$t_l \sim \text{Exp}(1/\mu_{tl}), \quad 0 < \mu_{tl} \quad (\text{III.52})$$

$$t_h \sim \text{Exp}(1/\mu_{th}), \quad 0 < \mu_{tl} < \mu_{th} \quad (\text{III.53})$$

where μ_{tl} and μ_{th} are the mean values of t_l and t_h respectively.

The Section III.4 illustrates a first analysis on the system by means of a case study, showing both contexts: on the one hand, a deterministic operational mode, and on the other side, the stochastic operational modes: i.e. with the internal and external modes of randomness introduction.

III.4 Case study analysis

The friction drive analyzed is a roller-on-tire system, for which the driver device is a DC motor and the driven device a bicycle wheel. The used mechanical parameters for simulations in

Table III.3 – Used values for the mechanical parameters

Parameter	Value	Unit
b_1	6.36×10^{-3}	$[N \text{ m}/(\text{rad}/\text{s})]$
b_2	1.76×10^{-3}	$[N \text{ m}/(\text{rad}/\text{s})]$
J_1	3.47×10^{-4}	$[Kg \text{ m}^2]$
J_2	0.2	$[Kg \text{ m}^2]$
r_1	0.0315	m
r_2	0.35	m
K_m	0.0477465	$[V\text{s}/\text{rad}]$

order to validate the usefulness of the model are in Table III.3. ⁴ Since this case is about an electromechanical friction drive system, from Remark III.1, we consider that the input system can be represented as $u(t) = T_m(t) = K_m I(t)$ ⁵.

III.4.1 Deterministic operational mode

• Sharp stage of motion

A *sharp stage* of motion occurs when Δ_v is considerable and the system is not considered yet as a failed system (before the failure time t_f). These sharp stages could happen at the start of motion and in the stops. A sharp stage is simulated with the injection of an input step signal I with amplitude $I_A = 20A$. Thus, in this study case the unique sharp state occurs at the start (step input).

Figure III.4 shows the behavior of the power in the system. Here, P_L the transferred power to the load, and P_L^* , the power seen by the driven device have a high value only at the beginning, and such as it was assumed $P_L > P_L^*$. The difference between P_L and P_L^* reflects the loss in contact, primarily at the beginning of motion, i.e. a sharp stage.

Remark that P_L and P_L^* reach a peak in the sharp stage, and after they drop; while P_{motor} , the electrical power of the motor, and P_{b1} , the power that appears as a result of the viscous damping parameter b_1 , reach high and near values. P_L^* and P_{b2} are much lower than the other analyzed powers because they depend on ω_2 which is lower than ω_1 . In this numerical example, there is a considerable influence of the viscous damping parameter b_1 in the consumption of energy, i.e. the motor must provide a considerable power to drive its own viscous damping parameter b_1 .

Figure III.5 shows the behavior of the difference of power $P_L - P_L^*$ for given values of α with respect to time. Experimentally, a maximum peak of this difference was found, i.e. the minimum efficiency η_c when α is equal to 5.25. It means that the increasing of α tends to give lower losses but it do not necessarily produces the highest peak of losses. These dynamic changes reflect the importance to estimate and possibly to control the value of α .

⁴To build a more realistic scenario, the contributions of [Huang 2003] and [Rodriguez 2014] were analyzed. In the first article, workbench has a built-in bike wheel to model viscous and dry friction at the wheel bearing. The second contribution is a master-thesis developed in GIPSA-Lab (CNRS-France, Grenoble-INP, University Grenoble Alpes), which analyses the implementation of a real friction drive in an electrical bicycle.

⁵Where $I(t)$ is the electrical motor current and K_m the motor back-electromotive force constant.

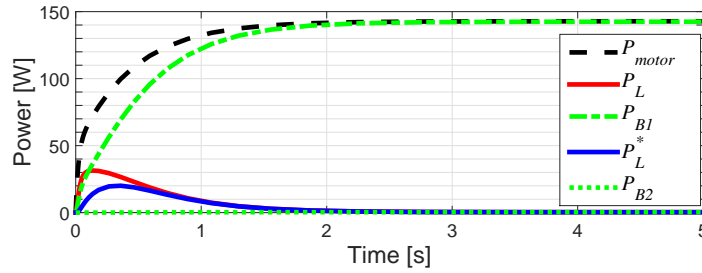

Figure III.4 – Behavior of power in roller-on-tire system

Figure III.5 – Loss between P_L and P_L^* for given values of α Figure III.6 – Deterioration for given values of α for the *sharp stage* of motion. The higher the Δ_v , the higher the D .

Figure III.6 shows the behavior of the instantaneous D for the same given values of α as in Figure III.5. It is evident that D is continuously increasing. The highest consumption of contact energy (which could be linked with the materials of contact according to the assumptions) happens in the first seconds for every value of α , i.e. the *sharp stage* of motion (when also Δ_v is higher). After the first seconds of the step, the value of D reaches a value that depends on the value of α : the lower the α , the higher the D .

• Smooth stage of motion

For the same scenario, with an input step signal I , the stage after the start (steady state) is considered here a *smooth stage* of motion, as Δ_v is lower. If the conditions of motion remains unvarying, the system deteriorates until getting \bar{D}_{max} (the total failure). Figure III.7 shows the behavior of states v_1 , v_2 (in this case we prefer to show the tangential speed instead of the angular speeds for convenience) and \bar{D} , with the input step signal I with amplitude $I_A = 20A$,

and used values $m=0.01$ and $\alpha(0)=10$.

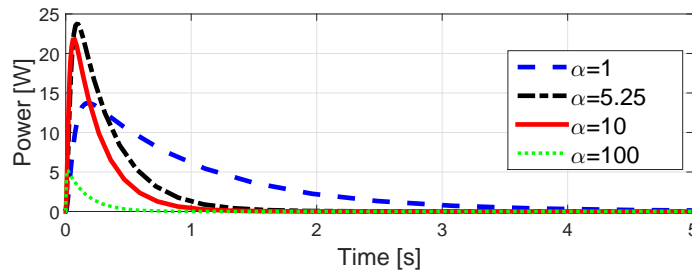
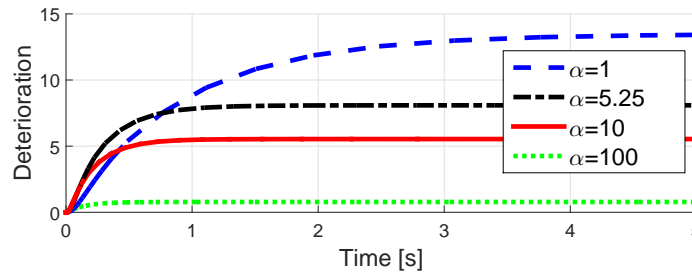
In this numerical example, the friction drive system reaches the D_{max} value at $t_f = 300 h$ (hours)⁶ of use for the given scenario.

Remark III.6

Assuming the knowledge of m (constant) and $\alpha(0)$, and that the operating input conditions do not change during the lifetime, at the current time t one can predict the failure time t_f carrying out the simulation of the system from t until the failure, with:

$$RUL = t_f - t \tag{III.54}$$

this is equivalent to predict the RUL at the time instant t in a deterministic way.

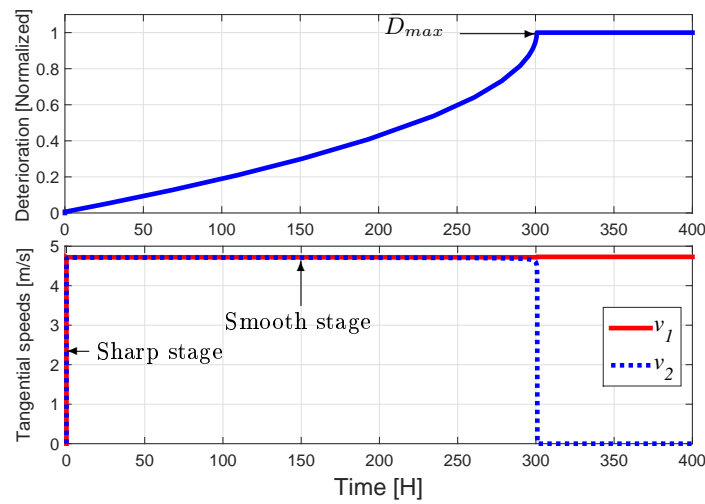

Figure III.7 – Step response of Deterioration D , tangential speed of motor v_1 and tangential speed of wheel v_2 . It shows the failure of system at $300h$.

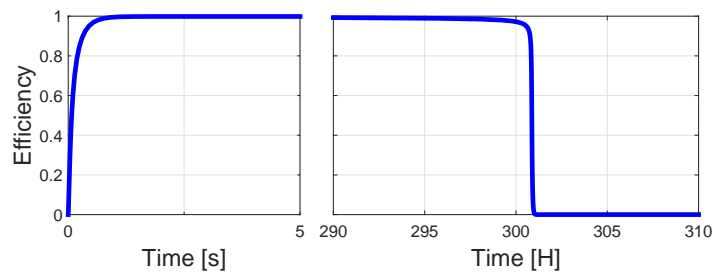

Figure III.8 – Efficiency η for sharp stage and failure stage. Step response.

⁶In this thesis, for practicality, in some cases time is expressed in “hours”

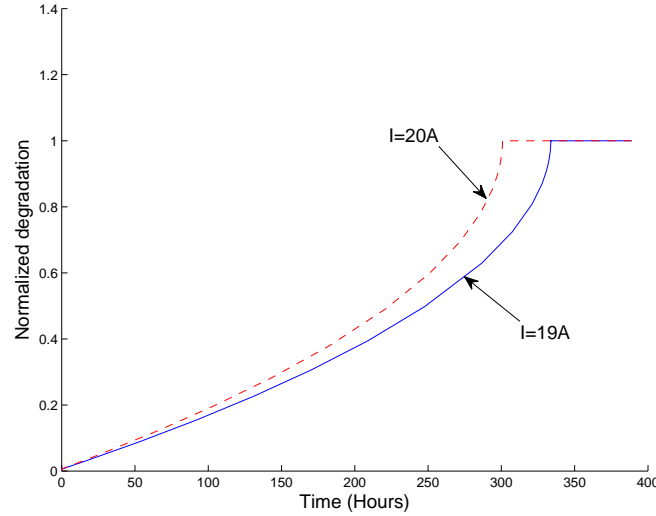

Figure III.9 – Normalized deterioration with respect to time, for two different constant electrical currents ($I_A = 19A$ and $I_A = 20A$), $\alpha(0) = 10$ and $m = 0.01$.

- On the efficiency of the friction drive system

Finally, the efficiency η_c of the mechanical power transmission is evaluated in the sharp stage and in the failure stage as depicted in Figure III.8. Notice that in the sharp stage the variation of η_c is sharp also. On the other hand, η_c begins to vary before the total failure and it has a slow variation compared to the start, but which remains abrupt with respect to the total lifetime.

From Equation (III.49), the instantaneous efficiency of the actuator, denoted $\eta_c(t)$, can be estimated at every time-instant by using the measured angular speeds $\omega_1(t)$ and $\omega_2(t)$ (or equivalently, v_1 and v_2) and it does not depend on the contact quality coefficient $\alpha(t)$.

Figure III.9 illustrates the behavior of $\bar{D}(t)$ with two different step input $u(t)$, with amplitude (electrical current in this case) equal to ($I_A = 19A$ and $I_A = 20A$). That means that in this scenario, there exist a unique start and the system is working until the failure.

Figure III.10 illustrates the obtained efficiency $\eta_c(t)$ during a total useful lifetime of the system with a step input $I_A = 20A$. For these scenarios, the efficiency $\eta_c(t)$ is admissible during all the lifetime, taking a value close to 1 after the start, and only decreases in the moment of the failure t_f (total deterioration), around $t = 300h$ for $I_A = 20A$, and around $t = 340h$ for $I_A = 19A$. This is consistent with [Imanian 2016]: Cumulative damage may not degrade performance; however, the item fails when the cumulative damage exceeds endurance limit of a unit.

For the same scenario, the obtained sliding $p(\mathbf{x})$ is illustrated in figure III.11. Notice that this function is almost constant during the total useful lifetime of the actuator, taking a value close to 0, and only increases at the begging of motion and the failure time t_f . The $p(\mathbf{x})$ does not depend on the contact quality coefficient α . Consequently, neither $p(\mathbf{x})$ nor $\eta_c(t)$ are proper indicators of the state of the deterioration of the actuator.

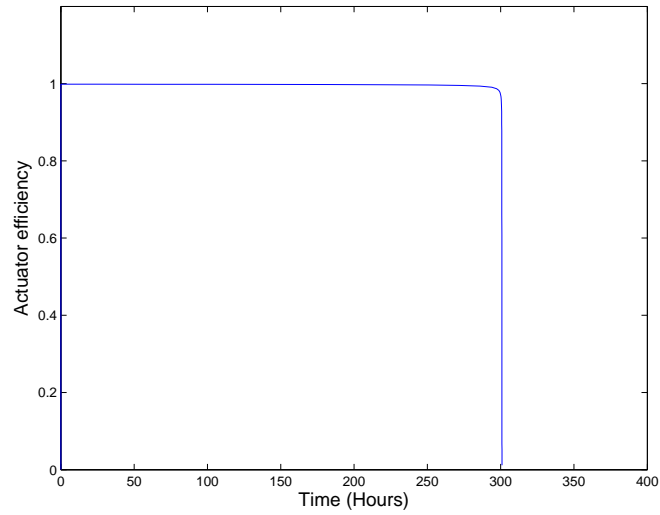

Figure III.10 – Efficiency of the actuator in the study case $\eta_c = (r_2\omega_2)/(r_1\omega_1)$ for constant input $I = 20A$.

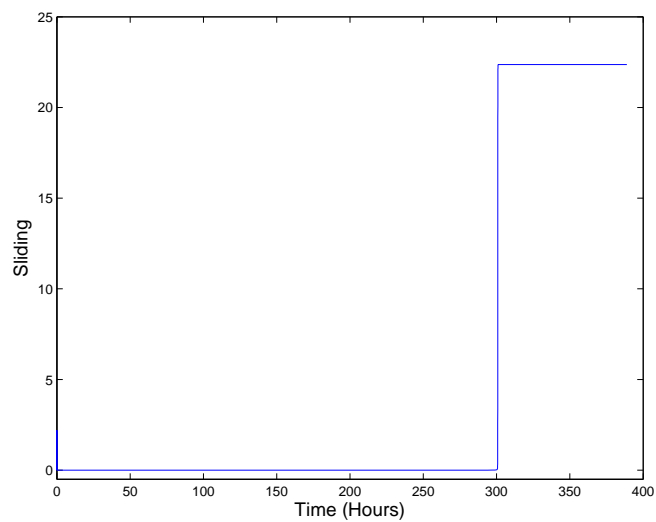

Figure III.11 – Sliding $p(\mathbf{x})$ with respect to time in hours (h).

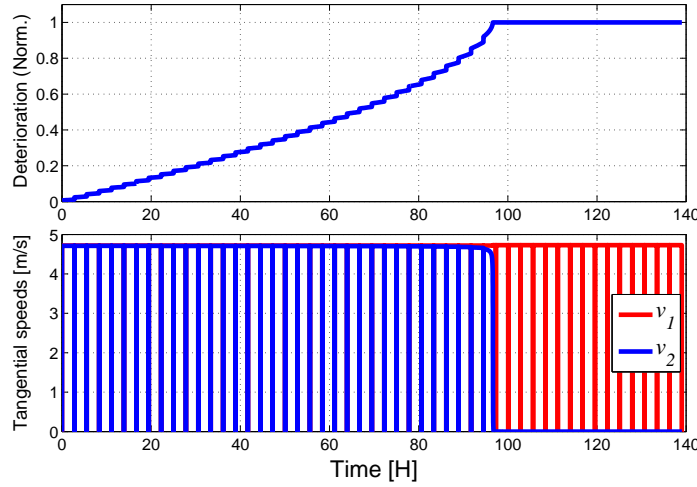

Figure III.12 – Normalized deterioration \bar{D} , tangential speed of motor v_1 and tangential speed of wheel v_2 for a rectangular waveform input with $t_h = 10000s$ and $t_l = 10s$. It shows the failure of system at $96.7h$.

Remark III.7

The calculation at a given time of the efficiency $\eta_c(t)$ and $p(\mathbf{x})$ are independent of the contact quality coefficient $\alpha(t)$, which depends on the input $u(t) = I$. This means that, at this given time, the calculation of the $\eta_c(t)$ could be indistinguishable for two input cases (for instance $I_A = 19A$ and $I_A = 20A$). For this reason, neither the efficiency $\eta_c(t)$ nor the sliding factor $p(\mathbf{x})$ of the actuator are suitable indicators of the state of the deterioration of the actuator, and in turn they do not allow to suitably predict the RUL.

• Varying behavior of input

A rectangular waveform signal is introduced to represent several cycles of use. In this case t_h and t_l are the times in which the signal is in high and low respectively.

Figure III.12 shows the states v_1 , v_2 and D with a fixed input of $t_h = 10000s$ and $t_l = 10s$ from the start until the failure. As a result, v_1 continues responding to the input signal, but not v_2 . As shown, the roller-on-tire system reaches the D_{max} near to $96.7h$. It means that with multiple cycles of activation, D_{max} is reached earlier (this is equivalent to multiple sharp stages).

Assuming here that one know the input operating conditions (the rectangular waveform signal), and that they remain the same during all the lifetime. Note that from Remark III.6, for a varying behavior it is also possible to predict the RUL at t_0 .

Figure III.13 shows the behavior of α for the same scenario. As expected, the value of α begins with $\alpha(0)$ and decreases monotonically until 0 (the failure time t_f).

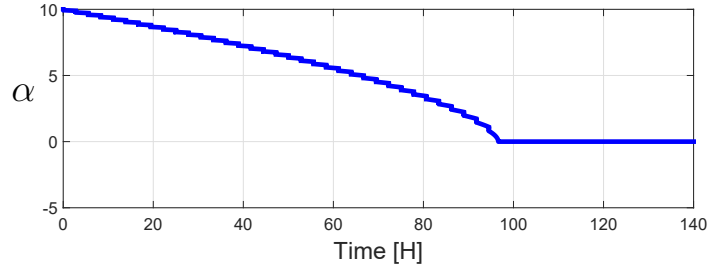

Figure III.13 – Contact-quality coefficient α for a rectangular waveform input with $t_h = 10000s$ and $t_l = 10s$.

III.4.2 Stochastic operational mode

• Internal mode of randomness

Now we can introduce randomness in the model, for instance, according the assumptions modeled by (III.50) and (III.51), i.e. assuming uncertain/random parameters following a given distribution.

Figure III.14 shows \bar{D} for 100 simulations. Here a rectangular waveform input u is introduced to the system, where t_h and t_l are constant and equal to $t_h = 10000s$ and $t_l = 10s$, and with amplitude $I_A = 20A$. The parameters m and $\alpha(0)$ are used randomly using the Normal distribution with mean values of $m_m = 0.01$ and $\alpha(0)_m = 10$ respectively, and with standard deviations of $\sigma_m = 0.001$ (i.e. the 10% of m_m) and $\sigma_{\alpha(0)} = 1$ (i.e. the 10% of $\alpha(0)_m$) respectively. The different behaviors are compared to a scenario with fixed values of $t_h = 10000s$ and $t_l = 10s$ and the fixed central values $m_m = 0.01$ and $\alpha(0)_m = 10$ (bold line).

Note that despite the randomness of m and $\alpha(0)$, the trajectories of \bar{D} follow a central tendency. In turn, the obtained failures times follow a central tendency around the failure time reached with the simulation with fixed values.

From Remark III.6, this simulation allows inferring that: *a*) if it is possible to know, the values of t_h and t_l , and m and $\alpha(0)$ with an uncertainty level from the start of motion, and *b*) assuming that conditions of the input remain the same during all the lifetime, then it could be possible to predict the failure time at the start of motion carrying out several simulations.

• External mode of randomness

Now let us also introduce external randomness in the model, for instance, according the assumptions modeled by (III.52) and (III.53) i.e. assuming varying operating conditions.

Figure III.15 shows \bar{D} for 100 simulations. Here t_h and t_l are chosen randomly using the exponential distribution with mean values of $\mu_{t_h} = 10000s$ and $\mu_{t_l} = 10s$ respectively and fixed parameters $\alpha(0) = 10$ and $m = 0.01$. The different behaviors are compared to a scenario with fixed values of $t_h = 10000s$ and $t_l = 10s$, and fixed parameters $\alpha(0) = 10$ and $m = 0.01$ (bold line). Note that this special external mode of randomness is similar to real operating conditions, for which the t_h and t_l are unknown⁷. Results show that despite the randomness

⁷In this kind of situations, it could be useful, for instance, to estimate the failure time with an acceptable level of uncertainty even if t_h and t_l are uncertain

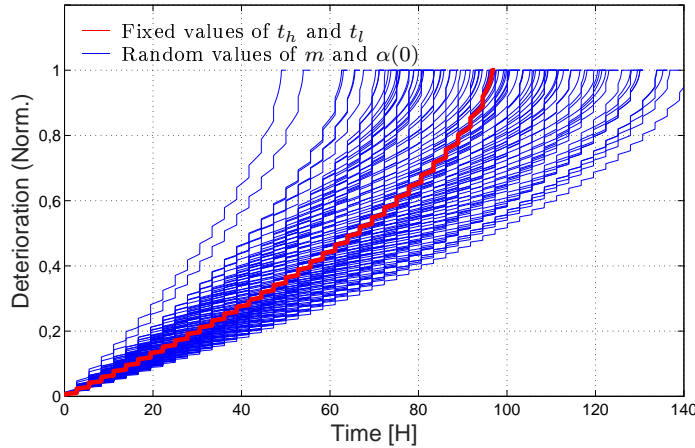

Figure III.14 – Internal mode of randomness. Deterioration D , for 100 random performances. m and $\alpha(0)$ are used randomly using a normal distribution. Bold line: simulation of performance for the fixed central values $m_m = 0.01$ and $\alpha(0)_m = 10$.

of t_h and t_l (here modeled with an exponential distribution), the obtained failure times (when $\bar{D} = 1$) follow what seems a normal distribution.

Again, from Remark III.6, and similarly to the internal mode of randomness, from this simulation one can infer that it could be possible to have a good prediction of the failure time t_f at the start of motion (i.e. equivalent to predict the RUL), assuming that the internal parameters m and $\alpha(0)$ remain the same during all the lifetime.

III.4.3 Invariant sets for detecting deterioration

In this Subsection, we analyze the use of robustly positive invariant (RPI) sets to characterize the nominal and the admissible degraded behavior of the system. These invariant sets can be computed using the approach proposed in [Martinez 2015].

Starting from the uncertain system (III.13), consider the discrete-time linear model of the actuator:

$$\mathbf{x}^+ = \mathbf{A}_d(\alpha)\mathbf{x} + \mathbf{B}_d u \quad (\text{III.55})$$

with $\mathbf{A}_d(\alpha) := (\mathbf{I}_{n \times n} + t_s \mathbf{A}(\alpha))$ and $\mathbf{B}_d = t_s \mathbf{B}$, where t_s stands by the sampling-time, $\mathbf{I}_{n \times n}$ an identity matrix of consistent dimensions, and $\mathbf{x}^+ \in \mathbb{R}^n$ is the successor state and $u \in \mathbb{R}^m$, the electrical current, is *a priori* considered as an unknown input (a bounded disturbance).

Because α affects the matrix $\mathbf{A}_d(\alpha)$ in an *affine* way, the model (III.55) can be rewritten in a polytopic form as follows:

$$\mathbf{x}^+ = [\lambda \mathbf{A}_d(\underline{\alpha}) + (1 - \lambda) \mathbf{A}_d(\bar{\alpha})] \mathbf{x} + \mathbf{B}_d u \quad (\text{III.56})$$

where $0 \leq \lambda \leq 1$. That is, the model (III.55) can be written as a convex combination of the extreme dynamics which are described by minimal and maximal possible values of α , denoted here as $\underline{\alpha}$ and $\bar{\alpha}$, respectively.

The problem now is to compute the *minimal robustly positive invariant-set (mRPI set)* for system (III.56), in order to characterize all possible trajectories of the angular speeds (the

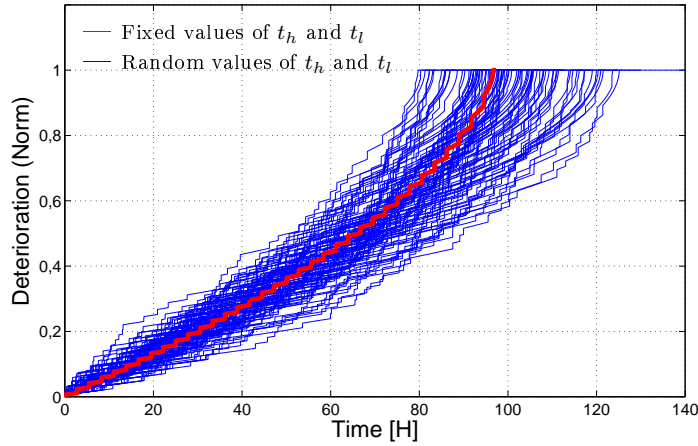

Figure III.15 – External mode of randomness. \bar{D} , for 100 random trials. t_h and t_l are chosen randomly using an exponential distribution with mean values of $\mu_{t_h} = 10000s$ and $\mu_{t_l} = 10s$ respectively. Bold line: simulation of performance for fixed values of $t_h = 10000s$ and $t_l = 10s$.

state \mathbf{x}), at any time and for any sequence of bounded electrical currents $I(t)$. Here we can use the method proposed in [Martinez 2015] for polytopic systems, which can be seen as a generic model to describe a certain class of LPV systems, uncertain systems, switched linear systems and any system that can be written as a convex combination of a finite number of subsystems. The subsystems, which describe the polytopic system, are assumed to be stable in presence of bounded disturbances and, in addition, to share a common Lyapunov function. Polyhedral RPI sets for linear systems (assuming constant α) could be also computed using methods such as those proposed in [Rakovic 2005], [Kofman 2007], [Seron 2008] and [Martínez 2009].

Figure III.16 depicts the obtained RPI sets for the maximal values of the contact quality coefficient α (i.e. $\bar{\alpha} = \alpha(0)$), the white set \mathcal{S}_0 . In addition, Figure III.16 illustrates the obtained RPI set for all “acceptable” values of α (i.e. $\underline{\alpha} \leq \alpha(t) \leq \bar{\alpha}$), the set \mathcal{S}_1 . As expected, the latter set \mathcal{S}_1 includes the set \mathcal{S}_0 . Those sets and the state trajectory, here the tangential speed $v(t) := [v_1(t) \ v_2(t)]^T$, can be used for robustly detecting a failure and/or an undesired deterioration of the contact quality.

Remark III.8

RPI sets can be used for starting on-line decision-making activities such as fault mitigation, mission re-planning, maintenance, etc. However, the RPI sets do not provide enough information for estimating the Remaining Useful Life (RUL) of the actuator.

III.5 Conclusions

In this chapter we have presented a novel dynamical model of deterioration for a friction drive system based on the dissipated energy at the contact level. Thus deterioration includes cumulated past information. A novel index of deterioration (called the contact quality coefficient) is presented and allows to model the mechanical actuator as a Linear Parameter Varying (LPV)

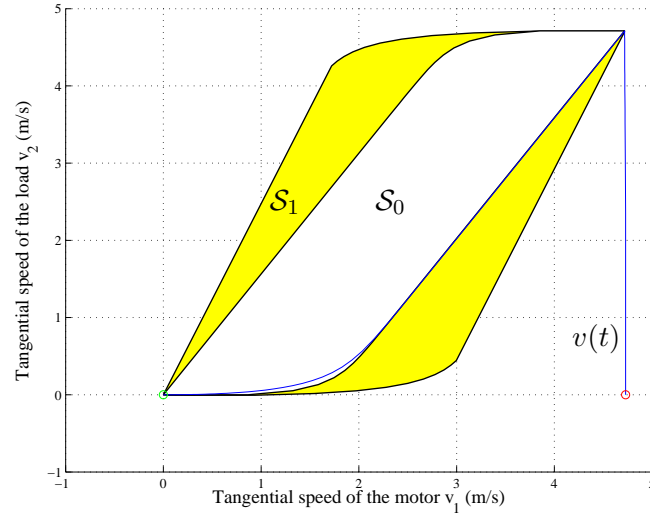

Figure III.16 – Robustly positive invariant sets for bounded electrical current ($0 \leq I(t) \leq 20A$) and admissible values of α such that ($\underline{\alpha} \leq \alpha(t) \leq \bar{\alpha}$). A tangential speed $v(t)$ out of these sets means that the actuator deterioration is not more admissible.

model where the contact-quality coefficient is used as a scheduling parameter. The model includes also a quality-deterioration ratio parameter, and a deterioration index linked to the difference of the tangential speeds measured in the friction drive. Thus, the more the difference, as happens in sharp motion stages, the more the deterioration. In smooth motion stages, as happens in steady state, the estimation of deterioration depends mainly on the initial estimations (or assumptions) of the contact-quality coefficient and the quality-deterioration ratio.

Simulations of a case study, show that the model represents properly and dynamically the deterioration depending on the inputs of the system. The proposed model allows also analytically to predict an interval of useful lifetime of the friction drive system before the total-failure-time of actuator, including stochastic internal and external perturbations. Simulations allow inferring that, characterization of the input operating conditions, the contact-quality coefficient and the quality-deterioration ratio with a given probabilistic model, makes possible to carry out suitable prediction of the failure time at the start of motion (i.e. equivalent to predict the RUL at this time). For this, prediction assumptions about the future operating conditions are needed. Despite the unknown (but bounded) input conditions and/or internal parameters, the deterioration behavior follows a central tendency with respect to the variation range of this input and/or internal parameters; the precision of the prediction of the failure time depends on the size of the input and the system parameters, and also on the level of the uncertainties. Additional conclusions can be found in the published article [Rodriguez Obando 2016a].

Here, it is shown that monitoring the efficiency is not a suitable (not enough) way for estimating the deterioration. In a complementary way, Robustly Positive Invariant sets can be used to characterize the nominal behavior of the actuator and the maximal admissible deterioration behavior. This aspect can be used for starting decision-making activities related with actuator maintenance and/or control reconfiguration/re-planning. However, these invariant

sets are not enough for predicting the remaining useful lifetime. Additional conclusions can be found in the published article [Rodriguez Obando 2016b].

In terms of application, contact-quality coefficient and quality-deterioration ratio parameters, could be linked with the inner characteristics of the contact surfaces, e.g. the material of the surfaces. That means that they could be used as indicator of possible abrupt and/or progressive faults in the material as studied in the published article [Rodriguez Obando 2017a].

This chapter can be seen as a first step towards the development of a comprehensive Reliability Adaptive System (RAS). The next chapters discuss how to use the information and the features of the model to estimate on-line the deterioration and the model parameters, and in turn, how to synthesize a control law for the RUL of the system.

Deterioration Estimation for RUL Prognosis

Contents

IV.1 Introduction	55
IV.2 On condition monitoring and prognosis for a friction drive	57
IV.3 Estimation of current condition of the friction drive	58
IV.3.1 Analysis of the observability of the system	58
IV.3.2 Synthesis of an Extended Kalman Filter	59
IV.3.3 Checking the consistence of the innovations	61
IV.3.4 Stochastic bounds for the state estimation	62
IV.4 Integration of the observer into the prognostic of Remaining Useful Lifetime	63
IV.4.1 Current condition D and prognostic of the RUL	63
IV.4.2 Tuning of the EKF observer	66
IV.4.3 Evaluation of the observer performance	67
IV.4.4 Prognostic of Remaining Useful Lifetime	71
IV.5 Numerical examples	72
IV.5.1 Case 1. RUL prognosis with endogenous changes of the system	73
IV.5.2 Case 2. RUL prognosis with exogenous changes of the system	73
IV.6 RUL prediction evaluation	74
IV.6.1 The RUL estimation problem	75
IV.6.2 Uncertain input case	75
IV.6.3 Uncertain parameter case	76
IV.7 Conclusions	76

IV.1 Introduction

This chapter focuses on the study of the deterioration of the contact of a friction drive composed by two rotational devices: a driver device which provides the power, and a driven device which acts as a load. For this, we start with the deterioration model presented in Chapter III which is based on the computation of an image of the dissipated energy at the contact level.

This deterioration model illustrated in Chapter III describes the time derivative of a deterioration index D depending on the current contact quality coefficient α , the input of the

system, and the current operating conditions obtained from sensors linked to the mechanics of the system. Thus, we assume reliable estimates of the states of the dynamical system based on the availability of a mathematical model and sufficiently accurate measurements.

In practice, the surfaces of the driver and the driven device are worn away with time, which in turn causes the deterioration of the contact quality. In this Chapter such a deterioration is again assumed as the loss in the quality of the contact at the joint level, for transferring the power from the driver device to the driven device. Here, the deterioration reaches eventually a threshold above which the system is considered a failed system. Thus, estimating with an enough degree of confidence the current condition of the contact (diagnosis) could be useful, which in turn enables also carrying out suitable predictions about its future condition (prognosis).

A logical assumption is that a proper knowledge of the current state of deterioration of a system can be used to prognosticate its future condition and in turn its RUL. Nevertheless, due to the stochastic nature of the deterioration phenomena, there exist several sources of uncertainty which influence the estimates, and therefore, it is rarely feasible to obtain a prediction of the RUL of the system with a suitable precision. In fact, it is not even meaningful to make such prediction without computing the uncertainty associated with RUL [Sankararaman 2013].

The objective of the condition monitoring is taking minimum necessary measurements from a machine to extract a diagnostic, so that a condition can be rapidly inferred, giving a clear indication of failure modes [Tavner 2008]. Thus, a general assumption for this Chapter is that control-oriented deterioration estimation on friction drive systems is feasible because in several friction-based motion applications, angular position, speed and/or acceleration measurements are often available, and in addition, because mechanical models of rotational devices can be considered as widely-known models with few parameters [Nandi 2005]. Existent data-based and data-driven approaches are not in the scope of this thesis, but the reader can infer some conclusions on those kind of approaches during the illustration of this model-based deterioration-estimation approach.

In this chapter, the relation between condition monitoring and the prognosis process is introduced in IV.2. An augmented non-linear model and a condition monitoring method based on an Extended Kalman Filter (EKF) are proposed in Section IV.3 for simultaneously: *i*) estimating the mechanical system states from a deterministic model based on mechanical motion equations; *ii*) estimating the current state of deterioration and/or the contact quality coefficient from a dynamical model of deterioration, and *iii*) estimating the quality-deterioration ratio, which in turn can be used for monitoring changes in the conditions of the surfaces. A complementary stage of the method to prognosticate the RUL from the deterioration estimation is also proposed in Section IV.4. Since the model uses a few number of unknown parameters describing the macroscopic deterioration phenomena, the state estimation process can be performed with low computational cost. In Section IV.5 simulated examples for RUL prognosis with respect to endogenous and exogenous changes are used to illustrate the potential use of the method. In Section IV.6 a preliminary work related to the use of *Probabilistic certification* approach, as proposed in [Alamir 2015], is explored and discussed. This chapter shows that it is possible to obtain an estimation of an interval of possible RUL, with a certain confidence percentage based on the presented deterioration model.

IV.2 On condition monitoring and prognosis for a friction drive

Consider the basic representation of the friction drive shown in Figure III.2 and the used modeling notation shown in Table V.1. This friction drive system consists of the *driver device* and the *driven device*. As depicted in Figure III.2, both devices are assumed to be affected by the contact force F_c that is produced by the driver device and causes a torque which drives the driven device. It is assumed also that this force depends on the tangential speeds of both devices, denoted as v_1 and v_2 , respectively. Therefore, the main assumption in the model is that $F_c(t)$ is proportional to the relative tangential speed at the contact level $v_1(t) - v_2(t)$, where $v_1(t) = r_1\omega_1(t)$ and $v_2(t) = r_2\omega_2(t)$.

For the case of an electro-mechanical friction drive, $T_m(t)$ can be produced for instance by a *dc* motor. In this Chapter, let us consider also, as illustrated in the case study in Section (III.4), that the driver device is a *dc* motor for which $T_m(t) = K_m I(t)$, where $I(t)$ is the electrical motor current and K_m the motor back-electromotive force constant.

In the previous Chapter III, this system is modeled as an Uncertain Linear System. Let us recall the friction drive dynamics state space representation (III.13)-(III.14). Let us recall also the calculation of the dissipated power at the contact level:

$$P_c(t) = \alpha (r_1\omega_1 - r_2\omega_2)^2 = \alpha p(\mathbf{x}) \quad (\text{IV.1})$$

where $p(\mathbf{x}) = (r_1\omega_1 - r_2\omega_2)^2$, called in this thesis the sliding factor, is a function that represents that, in this model, $P_c(t)$ depends on the mechanical states $x = [\omega_1(t), \omega_2(t)]$. Due to $\omega_1(t)$ and $\omega_2(t)$ are considered here as measured states, function $p(\mathbf{x})$ contains measured information about the input operating conditions.

Let us recall also Equation (III.39), the equation that shows the link between the rate of variation of D , the contact-quality coefficient α , and the sliding factor $p(\mathbf{x})$.

$$\dot{D} = \alpha p(\mathbf{x})$$

According to (III.36) (rewritten as (III.37)), the estimation of $\alpha(t)$ and the parameters $\alpha(0)$ and m , is unavoidable for estimation of the current condition of the deterioration index D of the friction drive, as well as for the prediction of the future D . On the one hand, the deterioration-based condition monitoring of the friction drive, could be done from the knowledge of $\alpha(t)$, $\alpha(0)$ and m . At the same time, an acceptable knowledge about the current condition of the friction drive is necessary to make prognostics about the future condition, for instance for the Remaining Useful Lifetime (RUL) prediction. The latter point requires also some knowledge about future operating conditions and eventual changes on m which could be modeled as uncertain conditions with some probabilistic assumptions.

In this thesis, we illustrate how the estimation of the varying parameters α and m are useful for RUL prediction from the estimation of the current condition of the deterioration D . A non-linear observer is presented for this goal in Section IV.3.

IV.3 Estimation of current condition of the friction drive

IV.3.1 Analysis of the observability of the system

Using Equations (III.13)-(III.14) and (III.36), and assuming no significant variations on m , consider the augmented system:

$$\dot{\mathbf{x}} = \mathbf{A}(\alpha) \mathbf{x} + \mathbf{B} u \quad (\text{IV.2})$$

$$\dot{\alpha} = -m p(\mathbf{x}) \alpha \quad (\text{IV.3})$$

$$\dot{m} = 0 \quad (\text{IV.4})$$

with the system output: $\mathbf{y} = [\omega_1(t) \ \omega_2(t)]^\top$.

Let us define now the state vector of the augmented system $\mathbf{x} := [\omega_1(t) \ \omega_2(t) \ \alpha(t) \ m]^\top$. A nonlinear state space representation of the model is:

$$\dot{\mathbf{x}} = f(\mathbf{x}) + \mathbf{B} u \quad (\text{IV.5})$$

$$\mathbf{y} = \mathbf{C}\mathbf{x} = [y_1(\mathbf{x}), y_2(\mathbf{x})]^\top \quad (\text{IV.6})$$

where $u = I(t)$ is the system input, and:

$$\mathbf{C} = \begin{bmatrix} 1 & 0 & 0 & 0 \\ 0 & 1 & 0 & 0 \end{bmatrix}, \quad \mathbf{B} = [(K_m/J_1) \ 0 \ 0 \ 0]^\top \quad (\text{IV.7})$$

For the particular case of the friction drive, the output equation \mathbf{y} means that $y_1(\mathbf{x}) = \omega_1(t)$ and $y_2(\mathbf{x}) = \omega_2(t)$ are assumed available from the sensors (in this case, angular speed sensors) at every time instant.

If the nonlinear system (IV.5)-(IV.6) is *observable*, then it is possible to design an observer, for instance an *Extended Kalman Filter (EKF)*, for estimating the states \mathbf{x} , by considering the knowledge of the input u and \mathbf{y} . The EKF is a standard technique used in a number of nonlinear estimation and machine learning applications; see for instance [Shi 2002, Bolognani 2003].

The *observability (locally weak observability)* property for the nonlinear system (IV.5)-(IV.6), can be checked if the *observability rank condition* is satisfied, i.e. if the dimension of the *observation space* of the system is equal to the dimension of \mathbf{x} ; see the mathematical theorem in [Hermann 1977] and its application in the framework of nonlinear observers in [Besançon 2007]. In that sense, following a similar procedure to [Torres 2011] and [Delgado-Aguinaga 2016] to analyze the observability of a nonlinear system, for this case the next steps are proposed:

1. Let us evaluate the case of operation with constant input $u(t) = u_0$, for which the state equation can be re-written as: $\dot{\mathbf{x}} = F_{u_0}(\mathbf{x})$.
2. Let us consider the vector $\Phi(\mathbf{x})$ as a vector that represents a finite linear combinations of linearly independent functions of \mathbf{y} , namely:

$$\Phi(\mathbf{x}) = [y_1(\mathbf{x}) \ L_{F_{u_0}} y_1(\mathbf{x}) \ L_{F_{u_0}}^2 y_1(\mathbf{x}) \ y_2(\mathbf{x})]^\top \quad (\text{IV.8})$$

where $L_{F_{u_0}} y(\mathbf{x})$ denotes the Lie derivatives of the function \mathbf{y} along F_{u_0} .

3. Let us find the *observation space* of the system (IV.5)-(IV.6), denoted as \mathbf{H}_x , in the sense of [Besançon 2007], which corresponds to the jacobian matrix of $\Phi(\mathbf{x})$.
4. Let us find the dimension of \mathbf{H}_x . In this case, this dimension is equal to $\mathbb{R}^{4 \times 1}$, which corresponds to the dimension of \mathbf{x} . Thus, the system (IV.5)-(IV.6) is *locally weakly observable*.
5. Let us find and analyze the determinant Δ_{H_x} of \mathbf{H}_x , which gives in this case:

$$\begin{aligned}\Delta_{H_x} &= -(\alpha (r_1^2 \omega_1 - r_1 r_2 \omega_2)^2 (r_1 \omega_1 - r_2 \omega_2)^2) / J_1^2 \\ \Delta_{H_x} &= -(\alpha (r_1^2 \omega_1 - r_1 r_2 \omega_2)^2 p(\mathbf{x})) / J_1^2\end{aligned}\tag{IV.9}$$

Unlike linear systems, the observability features of nonlinear systems are input-dependent, [Hermann 1977], [Besançon 2007], [Busawon 1998], it is necessary analyze how $u(t)$ affects Δ_{H_x} , and in turn the observability characteristics of the system (IV.5)-(IV.6). In that sense, notice that in (IV.9) Δ_{H_x} vanishes whenever the sliding factor $p(\mathbf{x})$ tends to 0, or in other words, when the tangential speeds between the devices, $r_1 \omega_1$ and $r_2 \omega_2$, tend to be close to each other. The latter condition corresponds for instance, to the response in steady state to a constant input u_0 .

If the system (IV.2)-(IV.4) has mostly a relative tangential speed that tends to 0 or if this is small enough to be confused with the measurement noise given by the sensors, then the system tends to be unobservable. Consequently, the estimation of \mathbf{x} requires an input $u = I(t)$ suitably time-varying to increase the variation of \mathbf{y} , and in turn for increasing the observability of \mathbf{x} (i.e. mainly α and m) of the nonlinear system (IV.2)-(IV.4). The latter follows the notion of *persistent input* in the sense of [Besançon 2007]. Consequently, in this case, it is necessary to increase the deterioration of the contact surfaces to better estimate the current D .

As an alternative way to analyze the observability of the system, considering the fact that parameter α affects the matrix $\mathbf{A}(\alpha)$ in an affine way in (IV.2), and the availability of measurements \mathbf{y} , the estimation of the state α is possible with an enough degree of variation of the input. In terms of the observability of m , notice that this parameter also appears into the dynamical equation characterizing the evolution of α in (IV.3). There, the variation of the parameter α depends on the parameter m in an affine way. Thus, m can be also estimated using previous estimations of α and its time-derivative. Therefore, the estimation of m requires persistence of the excitation on α in the sense of [Besançon 2007].

IV.3.2 Synthesis of an Extended Kalman Filter

From the system (IV.5)-(IV.6), consider the state transition equation and the system output equation in continuous time respectively:

$$\dot{\mathbf{x}} = f(\mathbf{x}) + \mathbf{B}u + \mathbf{w}\tag{IV.10}$$

$$\mathbf{y} = \mathbf{C}\mathbf{x} + \mathbf{v}\tag{IV.11}$$

where \mathbf{w} and \mathbf{v} are assumed to be a Gaussian process noise (affecting the model) and a measurement noise (affecting the measured external information) respectively, with zero mean and covariance matrices \mathbf{Q} and \mathbf{R} respectively.

In order to synthesize an Extended Kalman filter, the following covariance matrices are selected:

$$\mathbf{Q} = \text{diag}([0 \ 0 \ \sigma_\alpha^2 \ \sigma_m^2]); \quad \mathbf{R} = \text{diag}([\sigma_1^2 \ \sigma_2^2]) \quad (\text{IV.12})$$

where σ_m^2 stands for the disturbance variance affecting the behavior of the state m . The values σ_1^2 and σ_2^2 represent the sensor noise variances in the speed sensors measuring ω_1 and ω_2 , respectively.

The used matrix \mathbf{Q} takes into account the fact that in the model (IV.2)-(IV.4) the state m can be affected by neglected and/or unmodelled dynamics. This is, it is assumed that the model error is only associated to the misknowledge on the behavior of α and m . The used matrix \mathbf{R} represents the assumption that both speed sensors are affected by the same level of measurement noise, i.e. $\sigma_1 = \sigma_2$. It is assumed also that σ_1^2 and σ_2^2 are relatively smaller than possible state disturbances and/or model errors.

The estimation process is performed as follows:

Assuming the availability of discrete-time measurements at every time-instant, with a sample time t_s , the a priori prediction (represented with the suffix in the subindex “ $|k-1$ ”) of the state estimate in discrete time can be calculated by using the continuous-time state transition model (IV.10), as follows:

$$\hat{\mathbf{x}}_{k|k-1} = f(\hat{\mathbf{x}}_{k-1|k-1}) + \mathbf{B} u_{k-1} \quad (\text{IV.13})$$

and the estimated output:

$$\hat{\mathbf{y}}_{k|k-1} = \mathbf{C} \hat{\mathbf{x}}_{k|k-1} \quad (\text{IV.14})$$

The prediction of the a priori error covariance matrix $\mathbf{P} \in \mathbb{R}^4$ is calculated at every time instant as:

$$\mathbf{P}_{k|k-1} = \mathbf{F}_{k-1} \mathbf{P}_{k-1|k-1} \mathbf{F}_{k-1}^\top + \mathbf{Q} \quad (\text{IV.15})$$

where \mathbf{F}_{k-1} is the Jacobian of the function $f(\mathbf{x})$ in discrete time. That is,

$$\mathbf{F}_{k-1} = \exp(F t_s) \quad (\text{IV.16})$$

with

$$F = \left. \frac{\partial f(\mathbf{x})}{\partial \mathbf{x}} \right|_{\hat{\mathbf{x}}_{k|k-1}} \quad (\text{IV.17})$$

the Jacobian of the function $f(\mathbf{x})$ in continuous time, calculated as:

$$\frac{\partial f(\mathbf{x})}{\partial \mathbf{x}} = \begin{bmatrix} F_{11} & F_{12} & F_{13} & 0 \\ F_{21} & F_{22} & F_{23} & 0 \\ F_{31} & F_{32} & F_{33} & F_{34} \\ 0 & 0 & 0 & 0 \end{bmatrix} \quad (\text{IV.18})$$

where $F_{11} = -(\alpha r_1^2 + B_1)/J_1$, $F_{12} = (\alpha r_1 r_2)/J_1$, $F_{13} = (r_1 r_2 \omega_2 - r_1^2 \omega_1)/J_1$, $F_{21} = (\alpha r_1 r_2)/J_2$, $F_{22} = -(\alpha r_2^2 + B_2)/J_2$, $F_{23} = (r_1 r_2 \omega_1 - r_2^2 \omega_2)/J_2$, $F_{31} = -2\alpha m r_1 (r_1 \omega_1 - r_2 \omega_2)$, $F_{32} = 2\alpha m r_2 (r_1 \omega_1 - r_2 \omega_2)$, $F_{33} = -m (r_1 \omega_1 - r_2 \omega_2)^2$, and $F_{34} = -\alpha (r_1 \omega_1 - r_2 \omega_2)^2$.

The innovation covariance, denoted $\mathbf{S} \in \mathbb{R}^2$, is:

$$\mathbf{S}_k = \mathbf{C} \mathbf{P}_{k|k-1} \mathbf{C}^\top + \mathbf{R} \quad (\text{IV.19})$$

and the Kalman Gain:

$$\mathbf{K}_k = \mathbf{P}_{k|k-1} \mathbf{C}^\top \mathbf{S}_k^{-1} \quad (\text{IV.20})$$

Considering the prediction error:

$$\tilde{\mathbf{e}}_k = \mathbf{y}_k - \mathbf{C} \hat{\mathbf{x}}_{k|k-1} \quad (\text{IV.21})$$

the updating of the state estimate is calculated as:

$$\hat{\mathbf{x}}_{k|k} = \hat{\mathbf{x}}_{k|k-1} + \mathbf{K}_k \tilde{\mathbf{e}}_k \quad (\text{IV.22})$$

Finally, the a posteriori covariance matrix (represented with the suffix in the subindex “|k”) can be updated with:

$$\mathbf{P}_{k|k} = (\mathbf{I} - \mathbf{K}_k \mathbf{C}) \mathbf{P}_{k|k-1} \quad (\text{IV.23})$$

where \mathbf{I} is an identity matrix.

Then, the estimation process starts again, by considering all the updated and estimated state vectors and covariance matrices. The estimation process requires the initialization of the estimated state at instant $k = 0$, and an initial a priori covariance matrix $\mathbf{P}_{0|0}$.

IV.3.3 Checking the consistence of the innovations

In practice, one can not measure the performance of the observer with respect to the state error measures, since there is no knowledge of the true values of the states. Hence, one can check if the observer is performing correctly in terms of the innovation covariance \mathbf{S} . At the same time, this check is used for tuning the EKF, i.e. in this Chapter the usual trial-and-error method is replaced with a straightforward matrices choice, as suggested in similar approaches like [Bolognani 2003] and [Mohan M 2015].

It is known that if the observer is working correctly then $\tilde{\mathbf{e}}_k$ is zero mean and white noise with a covariance \mathbf{S}_k . Thus, one can verify that the observer is consistent by applying the following two tests: 1) check that the innovations are consistent with their covariance, and 2) check that the innovations are unbiased and white noise.

Test 1 can be performed by using the following bounds on the innovation signal:

$$\bar{\mathbf{e}}_k = \text{diag} \left(\mathbf{S}_{k|k}^{1/2} \right) \mathbf{c} \quad (\text{IV.24})$$

where $\mathbf{c} > 0$ can be chosen to guarantee that the innovations will be bounded by the above values with a given probability.

If Test 1 is not verified, then it is possible that there exist an under-estimate or an over-estimate of the variances of the disturbances. Thus, the chosen matrix \mathbf{Q} must be reformulated or adapted. Note that this adaptation process of \mathbf{Q} could be done by using approaches as the adaptive EKF as in [Jetto 1999, Han 2009, Gonzalez Silva 2018]. This focus is suggested in the perspectives of the thesis. Of course, if Test 2 is not verified, then it reflects that the model is not coherent, and it can be considered as un-suitable.

IV.3.4 Stochastic bounds for the state estimation

In this framework the estimates of the parameters α and m are intended to estimate the current state (for condition monitoring tasks) and the future states (for prognostic and RUL estimation) of D , thus it is necessary to evaluate the uncertainty of the parameter estimation. Here it is proposed doing this as follows:

Let us define the estimation error as $\tilde{\mathbf{x}}_{k|k} := \mathbf{x}_k - \hat{\mathbf{x}}_{k|k}$. Considering that the expected value of $\tilde{\mathbf{x}}_{k|k} \in R^n$ is equal to zero, its covariance equal to $\mathbf{P}_{k|k}$ and $\mathbf{c} > 0$ any real number, one can use the multidimensional *Chebyshev's inequality* as described in [Stellato 2017], as follows:

$$\Pr\left(\tilde{\mathbf{x}}_{k|k}^T \mathbf{P}_{k|k}^{-1} \tilde{\mathbf{x}}_{k|k} > \mathbf{c}^2\right) \leq \frac{n}{\mathbf{c}^2} \quad (\text{IV.25})$$

for computing a stochastic ellipsoidal set and then compute bounds of the state estimation error.

Inequality (IV.25) can be used when there is no knowledge of the probability distribution of the estimation error $\tilde{\mathbf{x}}_{k|k}$. Otherwise, it is possible to use a more accurate description, for instance in the case where the estimation error presents a normal distribution (that corresponds to the case studied in this Section), it is possible to bound the estimation error (with a given probability), as follows:

$$\Pr\left(\tilde{\mathbf{x}}_{k|k}^T \mathbf{P}_{k|k}^{-1} \tilde{\mathbf{x}}_{k|k} \leq \mathbf{c}^2\right) = \text{erf}\left(\frac{\mathbf{c}}{\sqrt{2}}\right) \quad (\text{IV.26})$$

where $\text{erf}(\cdot)$ corresponds to the Gauss error function.

Even if there is a probability that some trajectories of the estimation error $\tilde{\mathbf{x}}_{k|k}$ go out this set, one can use this set to establish an interval of possible values of the state \mathbf{x}_k with a given probability.

Using geometrical properties of the ellipsoids, bounds on the estimation error $\tilde{\mathbf{x}}_{k|k}$, denoted $\bar{\mathbf{x}}_k$, can be obtained as follows:

$$\bar{\mathbf{x}}_k = \text{diag}\left(\mathbf{P}_{k|k}^{1/2}\right) \mathbf{c} \quad (\text{IV.27})$$

These bounds along with the estimated value of the system state $\hat{\mathbf{x}}_{k|k}$ will be used as initial conditions for predicting the RUL. In particular, for the elements corresponding to the estimation of the parameters α and m it is obtained:

$$\hat{\mathbf{x}}_{k|k}(3) - \bar{\mathbf{x}}_k(3) \leq \alpha_k \leq \hat{\mathbf{x}}_{k|k}(3) + \bar{\mathbf{x}}_k(3) \quad (\text{IV.28})$$

$$\hat{\mathbf{x}}_{k|k}(4) - \bar{\mathbf{x}}_k(4) \leq m_k \leq \hat{\mathbf{x}}_{k|k}(4) + \bar{\mathbf{x}}_k(4) \quad (\text{IV.29})$$

with a probability greater than $1 - (n/\mathbf{c}^2)$, for an unknown probability distribution, or equal to $\text{erf}(\mathbf{c}/\sqrt{2})$ for normal probability distributions. Here $n = 4$ because $\mathbf{x} \in R^4$. That means that with $\mathbf{c} = 3$ one can expect that the real value is within the interval given by the estimates with a probability higher than 55.5% (for unknown distribution) or 99.7% (for normal distribution).

Remark IV.1

D can be included as state in the augmented system (IV.2)-(IV.4). In this case the new state vector state is $\mathbf{x}_D := [\omega_1(t) \ \omega_2(t) \ \alpha(t) \ m \ D]^T$. Inclusion of state D has as advantage the possibility of obtaining their uncertainty values directly from EKF, such as described in (IV.28) and (IV.29).

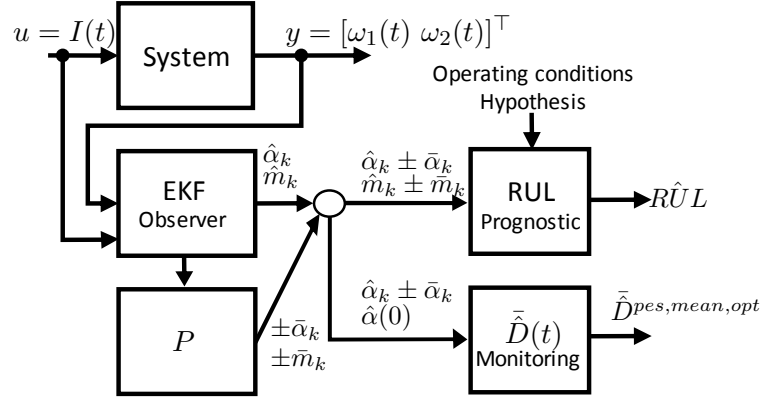

Figure IV.1 – Condition monitoring and RUL prognosis architecture.

The augmented system suggested in Remark (IV.1) is used in one scientific article that is in the process of writing by this time.

IV.4 Integration of the observer into the prognostic of Remaining Useful Lifetime

Let us call, the current time t_c and the failure time instant t_f . The proposed observer in Section IV.3 provides an estimate of the current state of α and m . Given those estimates, we can address two actions: (i) monitoring the current condition of the deterioration D , and (ii) prognosticate at t_c the RUL of the actuator, i.e. the time left from t_c until t_f .

Figure IV.1 depicts the proposed condition monitoring and the RUL prognosis architecture. Here two main informations are proposed to be obtained from the EKF estimator, namely: the estimates $\hat{\alpha}$ and \hat{m} , and their uncertainties $\bar{\alpha} := \bar{x}_k(3)$ and $\bar{m} := \bar{x}_k(4)$; these two latter given by (IV.28) and (IV.29) respectively. The architecture also shows that for the prognostic of the future condition of D for calculating the RUL, it is necessary to define hypothesis about the *operating conditions* and the assumptions about their future.

Definition IV.1

In this thesis the operating conditions are a set of characteristics that define the input $u(t)$ and the parameters α and m .

IV.4.1 Current condition D and prognostic of the RUL

In this Chapter the proposed algorithm for estimation of the current condition D and the algorithm for prognosticating the RUL are linked. Figure IV.2 outlines the operation of the used algorithm in the time domain for the RUL prognostic.

At a given time t_c (RUL estimation instant), an estimation of the normalized deterioration, denoted $\hat{D}(t)$, can be performed by using the dynamical model (IV.5)-(IV.6) and (III.31). The objective here is to simulate the system from t_o until the end of the useful lifetime or failure time denoted as t_f .

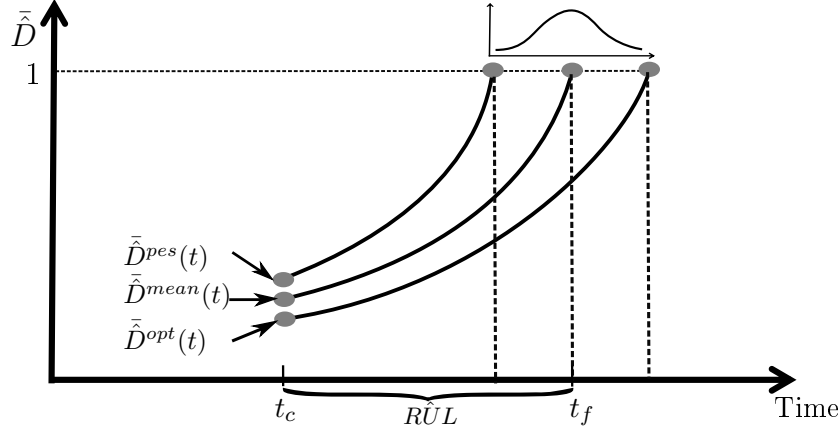

Figure IV.2 – Prognostic of the RUL at time t_c , by considering the current estimation uncertainties of $\hat{\alpha}$ and \hat{m} , which result in an uncertainty in the calculation of the initial condition for prognostic of \hat{D} . The resultant prognostic consist of three trajectories of deterioration: a mean trajectory and two bounds.

From t_c , the future D behavior is simulated by using the Equation (III.39): $\dot{D} = \alpha p(\mathbf{x})$.

The model is initialized with $\hat{\mathbf{x}}_{k|k}$ and with $\hat{D}_{k|k}$ at the time t_c . At this stage, we use the estimated values $\hat{\alpha}$ and \hat{m} with their available confidence intervals at the time t_c , the calculation results in an uncertainty in the estimation of $\hat{D}(t)$ which means that at a given time one can obtain three values $\hat{D}(t)$ from (III.33), namely:

$$\hat{D}^{opt}(t) = (\alpha(0) + (\hat{\alpha}(t) - \bar{\alpha})) / (\hat{m}(t) + \bar{m}) \quad (IV.30)$$

$$\hat{D}^{pes}(t) = (\alpha(0) - (\hat{\alpha}(t) + \bar{\alpha})) / (\hat{m}(t) - \bar{m}) \quad (IV.31)$$

$$\hat{D}^{mean}(t) = (\alpha(0) - \hat{\alpha}(t)) / \hat{m}(t) \quad (IV.32)$$

where \hat{D}^{opt} and \hat{D}^{pes} are the optimistic value and the pessimistic value of \hat{D} respectively. If $\bar{\alpha}$ and \bar{m} are not used as in (IV.32), \hat{D} results in an intermediate value \hat{D}^{mean} within the interval defined with \hat{D}^{opt} and \hat{D}^{pes} .

In a complementary way, one can obtain a priori the D_{max} value at t_c by using (III.28). Thus, one can obtain three critical values of D_{max} , namely: the mean, the optimistic and the pessimistic values, with respect to the initial conditions for prognostic. The latter are defined with $D_{max}^{mean} = \hat{\alpha} / \hat{m}$, $D_{max}^{opt} = (\hat{\alpha} + \bar{\alpha}) / (\hat{m} - \bar{m})$ and $D_{max}^{pes} = (\hat{\alpha} - \bar{\alpha}) / (\hat{m} + \bar{m})$ respectively. If $\mathbf{c} = 3$ is used in (IV.27), then it implies the following bounds: $\bar{\alpha} = 3 \cdot \sigma_{\alpha}$ and $\bar{m} = 3 \cdot \sigma_m$, where σ_{α}^2 and σ_m^2 correspond to the estimated variances of α and m respectively, obtained from the EKF.

From (III.29) we obtain the normalized values:

$$\bar{\hat{D}}^{opt}(t) = \hat{D}^{opt}(t) / D_{max}^{opt} \quad (IV.33)$$

$$\bar{\hat{D}}^{pes}(t) = \hat{D}^{pes}(t) / D_{max}^{pes} \quad (IV.34)$$

$$\bar{\hat{D}}^{mean}(t) = \hat{D}^{mean}(t) / D_{max}^{mean} \quad (IV.35)$$

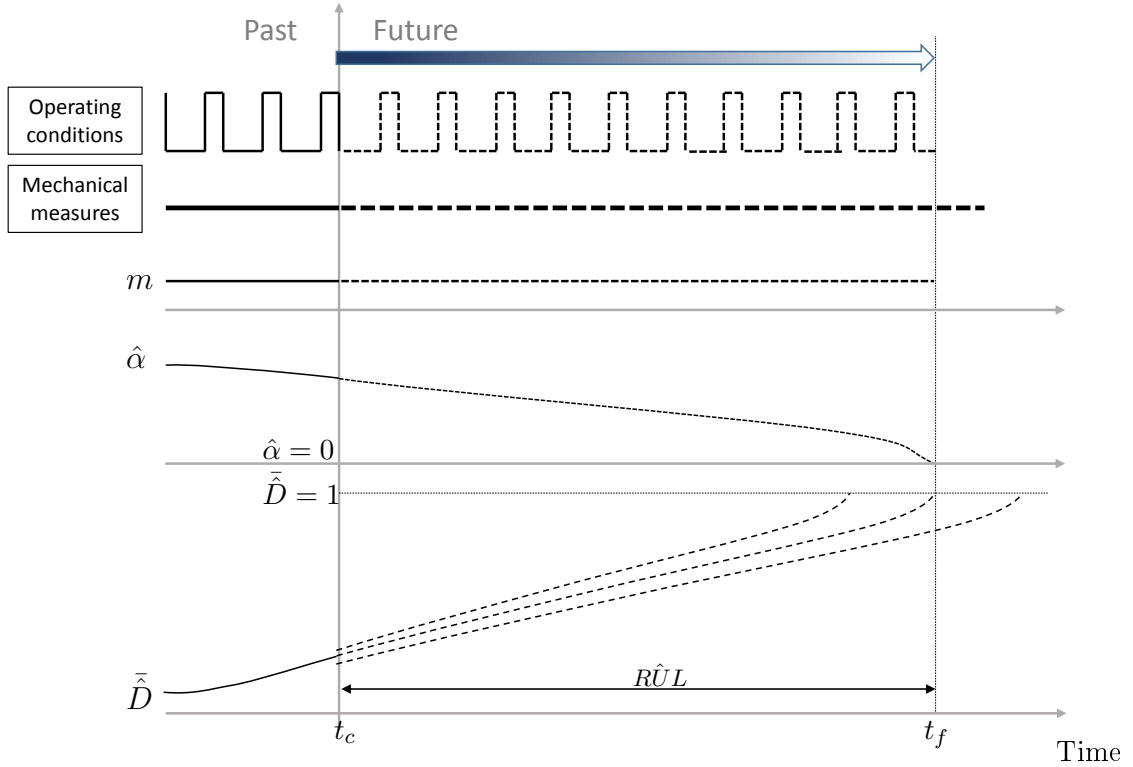

Figure IV.3 – Time diagram of a prognostic of the RUL at time t_c . At a given time t_c , a prognosis is performed, assuming future operation conditions. This prognostic can be updated as time goes on.

The simulated trial must be stopped once the normalized deterioration reaches the maximum value, i.e. when $\tilde{D}(t)=1$. Here we obtain the final time t_f at a threshold before the failure, taking the 99% of the respective \tilde{D} . The estimated \hat{RUL} is calculated as $\hat{RUL} = t_f - t_c$.

The uncertainties on the estimation of D_{max} defined by (IV.30)- (IV.32), produce two extreme values of \hat{RUL} , the pessimistic estimation \hat{RUL}^{pes} , the optimistic estimation \hat{RUL}^{opt} , and an intermediate value \hat{RUL}^{mean} within the interval defined by the extremes. That means that at t_c we can estimate the RUL with its corresponding uncertainty.

The simulation for the prognostic has to include additionally the assumptions about the future operating conditions on the current $u(t)$, from the estimation instant t_c until the failure time t_f . Figure IV.3 illustrates the time diagram for a prognostic in a given time t_c , for which the input operating conditions, the mechanical measures, and m are considered unvarying from t_c . In spite of they seem to be very strong conditions, this prognostic can be updated as the time goes on, when it is considered necessary.

If one consider that the time spent in the simulation is small enough, then it can be considered negligible in terms of prognostic. Hence, this prognostic can be “quickly” updated. Notice that for implementation issues, this simulation time plays an important roll for determining the minimum time to update the prognostic.

IV.4.2 Tuning of the EKF observer

The first step for analyzing the estimator performance is to tune the EKF estimator of the RUL. As a general design rule, if the quality of those estimations are technically defined as acceptable, then the estimation of the current condition of the contact is validated. This tuning must be consistent with the procedure presented in Section IV.3.

- **Setting of operating conditions**

In this case, the observer must be tested in simulated scenarios with known and predefined operating conditions (See Definition IV.1) from the activation of the actuator until the failure time t_f , to validate in simulation the quality of the obtained estimates $\hat{\alpha}$ and \hat{m} .

For the tuning process the used input $u(t)$ is a rectangular waveform with a predefined amplitude I , time-on t_h , and time-off t_l . Here we use $I = 20A$, $t_h = 0.42h$ (25min), and time-off $t_l = 60s$ ¹. The changes in $u(t)$ stand for *exogenous changes* affecting D and in turn RUL. The used mechanical parameters of the model (IV.2)-(IV.4) (shown in Table III.3) are considered constant, moreover $\alpha(0) = 10$ and $m = 0.01$ are used. The EKF is initialized in $\hat{\alpha}_{0|k-1} = 9.8$ and $\hat{m}_{0|k-1} = 0.011$. The used time step in this tuning process is $t_s = 60s$. (The suffix in the subindex “ $|k-1$ ” represents the *a priori* used value)

For tuning, we focus our interest on the parameter m , since if it changes, then it can also represent changes in the time-derivative of the quality of the contact α in (IV.3). These changes are not produced by the operating conditions, and in turn not modeled by the function $p(\mathbf{x})$. Hence, a logical assumption is that the system is highly sensitive to possible changes on m .

In the augmented system (IV.2)-(IV.4) the variations of the parameter m are assumed to be equal to 0. Nevertheless, from a more realistic point of view, there may be changes on the real value of m during work, here called *endogenous changes*.

Table IV.1 summarizes three different assumptions on the possible real dynamics of m in operation, namely: (i) the parameter m is always constant, (ii) the parameter m is piece-wise constant, and an abrupt change in the value of m can appear at the instant $k = t^*$ (a Dirac delta function models this aspect), and (iii) the parameter m can suffer a progressive change with a rate of change equal to ε (a possible random but *a priori* bounded parameter).

Table IV.1 – Possible model for the dynamics of m

Assumption	m	Meaning
<i>i</i>	$\dot{m} = 0$	No change, m is constant
<i>ii</i>	$\dot{m} = \delta(t^*)$	Abrupt change of m at $k = t^*$
<i>iii</i>	$\dot{m} = \varepsilon$	Incipient or progressive change

¹Note that time-on t_h , and time-off t_l can be set to carry out simulations such as accelerated deterioration process, which are common to test the quality of materials or systems

• **Setting of matrices \mathbf{Q} , \mathbf{R} and $\mathbf{P}_{0|0}$**

In terms of tuning of matrices \mathbf{Q} , \mathbf{R} and $\mathbf{P}_{0|0}$, we consider the worst case, as the one given by an abrupt change in the parameter m .

Assuming a known variance of the measurement noises \mathbf{v} , the matrix \mathbf{R} is selected as in (IV.12) with $\sigma_1^2 = 1 \times 10^{-8}$ and $\sigma_2^2 = 1 \times 10^{-10}$.

Concerning the matrix \mathbf{Q} in (IV.12), the chosen value for σ_m^2 is obtained by assuming possible abrupt variations on values of m . This variations can be modeled as impulse disturbances (a discrete-time Dirac delta, $\delta(t^*)$), which affects the dynamics of the state m , and that make that it takes values in the interval $(a, b) = (0.009, 0.011)$. If it is assumed, for instance, that these disturbances are random variables with a uniform probability distribution for all $k > 0$, i.e. $m \sim \mathcal{U}(a, b)$, then their variance can be calculated as:

$$\sigma_m^2 = \text{var}(\mathcal{U}(a, b)) = \frac{1}{12}(a - b)^2 \tag{IV.36}$$

which provides $\sigma_m^2 = 3.3333 \times 10^{-7}$. Here we use $\sigma_\alpha^2 = 1 \times 10^{-4}$ for giving to this tuning parameter a weight smaller in 3 orders of magnitude than the σ_m^2 value.

The used value to initialize the covariance matrix is $\mathbf{P}_{0|0} = \text{diag}([1 \ 1 \ \sigma_\alpha^2 \times 10^3 \ \sigma_m^2 \times 10^3])$. The third and fourth values of variance are the corresponding ones to α and m respectively. This kind of tuning is done taking into account [Mohan M 2015] to provide proper estimates and coherent uncertainties values. The first two values, which correspond to ω_1 and ω_2 respectively, are set arbitrarily at 1.

Additionally, in this numerical example, a moving average filter with window of 30 steps is used to obtain the final value of \hat{m} . That means that the final estimate of m at a given time t_k is the average of the 29 previous values and the current value of \hat{m} . This allows the reduction of the effect of noise during the estimation of this state.

IV.4.3 Evaluation of the observer performance

In this section, we focus on the evaluation of the observer also on the estimation of the parameter m for the assumptions *i*, *ii* and *iii* according to section IV.4.2.

• **Analysis of the variance of the innovations**

Figure IV.4 shows the prediction error $\tilde{\mathbf{e}}_k$, for both measured signals ω_1 and ω_2 . The dashed lines represent a confidence interval of $\pm 3\sigma_{\tilde{\mathbf{e}}}$ which is computed using (IV.24). As it is shown, the errors $\tilde{\mathbf{e}}_k$ are zero mean and most of the time they remain inside the confidence interval. Some values are observed just before the failure time t_f . Due to the assumption that the sensors are affected by Gaussian noise, we conclude that the estimation error belongs to the chosen confidence interval with a probability of 99%. Consequently, the test of consistence of the innovations described in IV.3.3 is verified.

Another interesting observation is that the variance of the prediction output error is increasing for ω_2 near to the end of the lifetime of the system, which seems logical for low values of contact quality coefficient α , for which the system should not work as well as new.

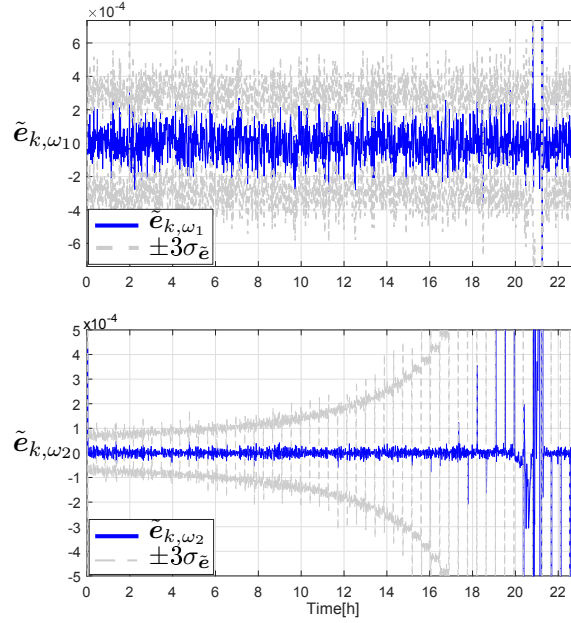

Figure IV.4 – Prediction output error \tilde{e}_k for ω_1 and ω_2 .

- **Analysis of the EKF estimates**

Figure IV.5.a shows the estimate $\hat{\alpha}$ (dashed line) compared to the real value α (continuous line). Figure IV.5.b shows the estimation error of $\hat{\alpha}$ with the value $\pm\bar{\alpha}$ with $\mathbf{c} = 3$ (dotted lines). This figure shows that: i) the error is zero-mean, ii) the uncertainty defined by $\pm\bar{\alpha}$ tends to decrease over time, and iii) the uncertainty bounds are in this case around the 0.3% of the maximum value of $\alpha(0) = 10$; thus, the estimation $\hat{\alpha}$ is considered highly accurate. Figure IV.5.c shows an enlargement of the first 10 steps of observation; there, the estimated value converge in the first 6 steps (i.e. $360s=6min$) from the initial value set in $\hat{\alpha}_{0|k-1} = 9.8$, showing a quick convergence time of the observer. For this scenario, the system fails at $t_f = 21h$.

Figure IV.6.a shows the estimate \hat{m} (dashed line) compared to the real value m (continuous line). Figure IV.6.a shows the estimation error of \hat{m} with the value $\pm\bar{m}$ with $\mathbf{c} = 3$ (gray dotted lines). This figure shows that: i) the error is zero-mean, ii) the uncertainty defined by $\pm\bar{m}$ tends to decrease over time, and iii) the uncertainty bounds are in this case around the 53% over the nominal value of $m = 0.01$, thus the estimation \hat{m} is considered appropriate but seems to be too conservative. The estimated value converge in the first 60 steps, showing a quick convergence time of the observer with respect the to the useful lifetime units, but slower than the convergence time of $\hat{\alpha}$. In this case, the estimation of m shows the need of a particular consideration for its use.

- **Why and how to use the EKF estimates?**

According the consideration for obtaining (IV.26) it is necessary to test the characteristics of the distribution of the EKF estimates. For nonlinear observers, there is no an a priori hypothesis of a normal distribution of the estimates (as for linear systems). For instance, for nonlinear systems, the a posteriori distribution is generally nonsymmetric and potentially

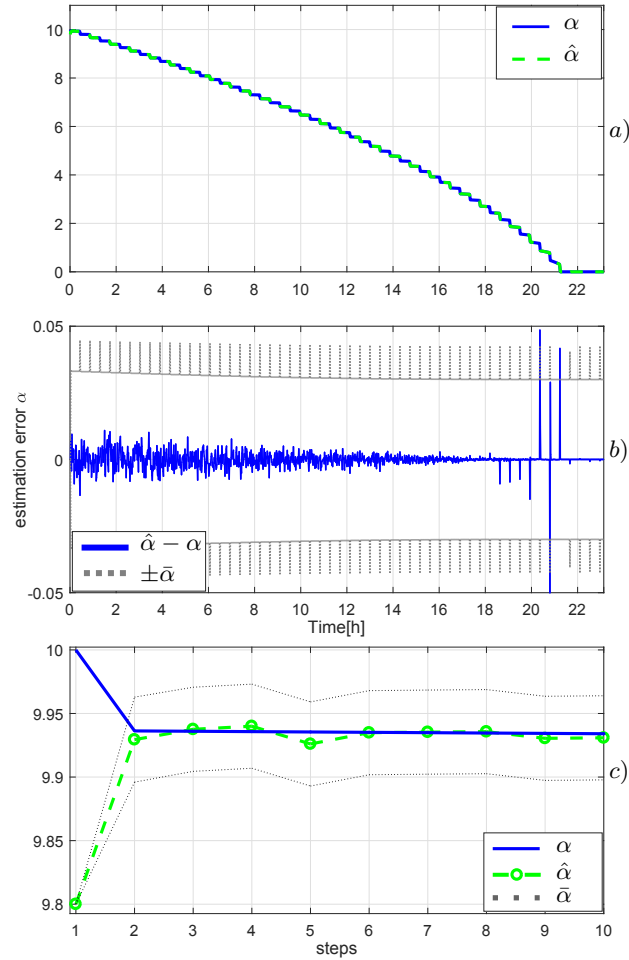

Figure IV.5 – Estimation of $\hat{\alpha}$. a) $\hat{\alpha}$ is a proper estimate of the real α during the lifetime. The failure time is around the 21h, b) the estimation error of α is zero-mean and Gaussian, c) enlargement of the 10 first steps of observation.

multimodal [Haseltine 2005].

Thus in this example, 300 Monte Carlo simulations were performed with the same tuning and initial conditions, in order to evaluate the distribution of the estimates for an arbitrary scenario. Measures $\hat{\mathbf{x}}_{k|k}$ are taken arbitrarily at $t_k = 1h$ ($t_k = 3600s$).

Figure IV.7 shows that the distribution of the obtained data for $\hat{\alpha}$ and \hat{m} at the $t_k = 1h$ fits correctly with a Normal distribution, which is confirmed with an obtained Kurtosis value of 3.00 [Bai 2005].

Table IV.2 shows a comparison between EKF estimates and the values obtained after the fitting of simulated data. It is shown that the standard deviation of the $\hat{\alpha}$ data, denoted $\sigma_{\hat{\alpha}}$, is always smaller with one order of magnitude (10^{-1}) than the standard deviation obtained from the matrix \mathbf{P} of the EKF, i.e. the obtained value $\bar{\mathbf{x}}_k(3)/\mathbf{c}$ with $\mathbf{c} = 1$, from (IV.27). In the case of \hat{m} , the standard deviation of the data, denoted $\sigma_{\hat{m}}$, is always smaller than the standard deviation given for the EKF, i.e $\bar{\mathbf{x}}_k(4)/\mathbf{c}$ with $\mathbf{c} = 1$, with almost two order of magnitude (10^{-2}) (for instance, in this case it was found that $\sigma_{m-EKF}/\sigma_{m-fit} = 87.2$). Note that the bigger

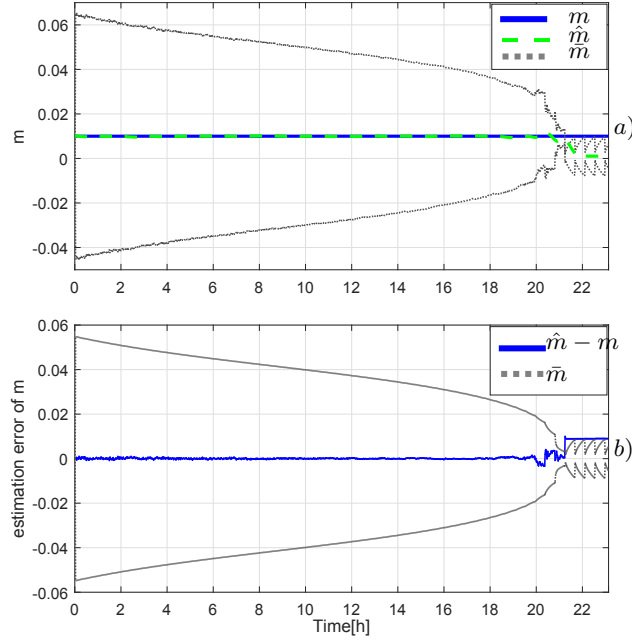

Figure IV.6 – Estimation of \hat{m} : a) \hat{m} is a proper estimate of the real m during the lifetime, and b) the estimation error of m is zero mean and Gaussian.

uncertainty of the EKF for m is due to the assumption on matrix \mathbf{Q} in (IV.12). This kind of direct tuning finally leads to some estimates, which usually may be close, and uncertainties which generally are away from the correct values [Mohan M 2015].

Results shows that the accuracy and the precision of the estimates are proper for this basic scenario of tuning. However, the evaluation of the algorithm in that sense, is linked to the inputs of the system. This evaluation is performed for one unit, for which the precision of the estimates is dependent on the variance of the input (due to the hypothesis of random Gaussian noise affecting them). However, the inclusion of new scenarios, for instance, multiple randomness introduction for a unit system and/or a fleet of systems, should be more deeply evaluated in terms of performance. See, for instance, [Saxena 2014, Rozas 2018].

Table IV.2 – Comparison between EKF estimates and fitting of simulated data

	With EKF at $t_k = 120s$	Value with fitting
$\hat{\alpha}$	9.763	9.763
$\sigma_{\hat{\alpha}}^2$	1.23×10^{-4}	9.55×10^{-7}
$\sigma_{\hat{\alpha}}$	1.11×10^{-2}	9.77×10^{-4}
\hat{m}	0.010	0.010
$\sigma_{\hat{m}}^2$	3.13×10^{-4}	4.12×10^{-8}
$\sigma_{\hat{m}}$	1.77×10^{-2}	2.03×10^{-4}

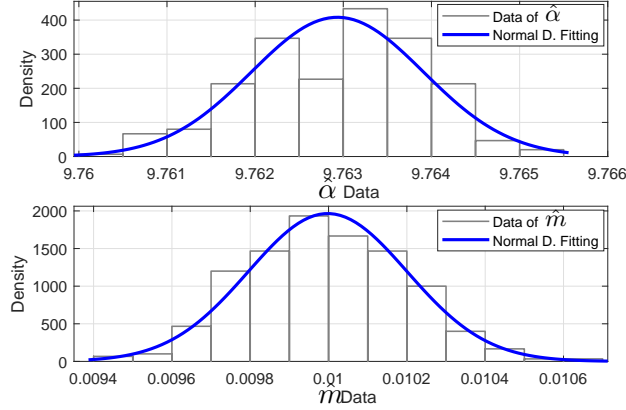
 Figure IV.7 – Distribution of $\hat{\alpha}$ and \hat{m} for 300 simulations of the EKF.

Consequently, for making the prognostics at $t_k = t_c$ one can trust in the values of the variances given by the matrix \mathbf{P} of the EKF at this time. In that sense, that allows us to use the condition (IV.26), and to take (IV.28) and (IV.29) to obtain the uncertainty level of the estimations from $\bar{\mathbf{x}}_k$, with the corresponding consideration on the values of the variances. For instance, in this case we take the final value $\bar{\alpha} = \bar{\alpha}_{EKF}$ (we prefer to be conservative with α) and $\bar{m} = \bar{m}_{EKF}/80$, as a correction factor with remains conservative but closer to the standard deviation found after the fitting.

IV.4.4 Prognostic of Remaining Useful Lifetime

At any time t_k , the pair $(\hat{\alpha}, \hat{m})$ can be used to calculate the corresponding $\tilde{D}|_{(\hat{\alpha}, \hat{m})}$ from that time, i.e. $t_c = t_k$, until t_f . In reality, all the state vector $\hat{\mathbf{x}}_{k|k}$ is needed, but $(\hat{\alpha}, \hat{m})$ are the states which define the maximum values $D_{max}^{mean}, D_{max}^{opt}, D_{max}^{pes}$ for calculating (IV.33)-(IV.35).

The assumed future operating conditions for the simulations are the same as for the tuning process, namely: a) the input signal $u(t)$ is a rectangular waveform with a predefined amplitude $I = 20A$, time-on $t_h = 0.42h$ (25min), and time-off $t_l = 60s$, b) a constant parameter m for all t_k such that $t_c < t_k < t_f$, and c) the used mechanical parameters of the model (IV.2)-(IV.4) (shown in Table III.3) are considered constant.

Let us take the values $\hat{\mathbf{x}}$ ($\hat{\omega}_1, \hat{\omega}_2, \hat{\alpha}, \hat{m}$) given by the EKF at $t_k = 1h$. Figure IV.8 shows the calculated trajectories of the deterioration \tilde{D} using (IV.33)-(IV.35). The bold line corresponds to the obtained trajectory \tilde{D}^{mean} and the dashed lines correspond to the trajectories of deterioration \tilde{D}^{pes} , and \tilde{D}^{opt} .

In addition, we use the estimated data $\hat{\mathbf{x}}$ of the 300 Monte Carlo simulations to initialize and calculate their corresponding \tilde{D} . Figure IV.8 also shows the 300 resultant trajectories of \tilde{D} (the gray lines). The 100% of these trajectories are within the bounds given a priori by the observer. This happens since we use the conservative $\bar{\alpha}$ and \bar{m} given by the matrix \mathbf{P} of the EKF for calculating the bounds optimistic and pessimistic.

Figure IV.9 shows that the obtained data of the estimated RUL with the 300 simulations, fitted with a normal distribution. It was found: a) a mean value $R\hat{U}L_{fit}^{mean} = 20.67h$ and a standard deviation $\sigma_{R\hat{U}L} = 0.42h$, b) the calculation $R\hat{U}L_{fit}^{mean} \approx R\hat{U}L^{mean}$, and c) all the

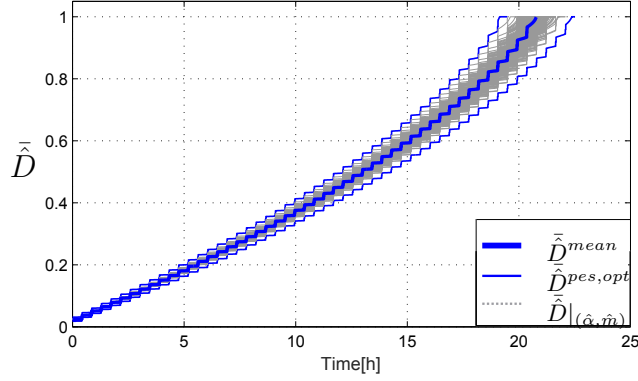

Figure IV.8 – Predicted deterioration \hat{D} for prognostic of RUL. The figure shows 300 possible trajectories of \hat{D} within the intervals given by the observer at the time t_c .

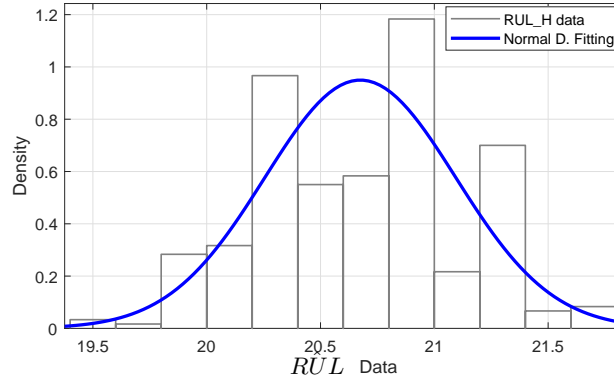

Figure IV.9 – Probability density function for a normal distribution fitting. $\hat{RUL} = 106.09h$ and a standard deviation of $\sigma_{\hat{RUL}} = 3.58h$.

$\hat{RUL} \in [\hat{RUL}^{pes}, \hat{RUL}^{opt}]$. That means we could know the uncertainty a priori of the RUL estimation linked with the precision of the EKF at any time instant at t_c making the prognostic and assuming that the operating conditions do not change.

Notice that, if the operating conditions change, for instance a change on m is detected between t_c and t_f , the prognostic can be quickly updated. For instance, in this experiment the calculation of these trajectory-bounds and the mean-trajectory only takes around 0.33s each one. Thus, the window time of estimation is around 1s, which is much smaller than the order of values of magnitude of the RUL, and therefore negligible.

IV.5 Numerical examples

In this section we exemplify the usefulness of the proposed architecture to prognostic the RUL. The objective is to evaluate the behavior of the deterioration trajectory and in turn, the prognostic of the RUL, with respect to the injection of a varying input $u(t)$ and two type of changes during the useful lifetime. In a general way we assume that the used mechanical parameters of the model (IV.2)-(IV.4) (shown in Table III.3) are considered constant.

IV.5.1 Case 1. RUL prognosis with endogenous changes of the system

Let us call *endogenous* the changes produced in the parameters that are not caused by the input of the system. In this case we focus the analysis on the changes on m .

Let us assume about $u(t)$: a) input signal is a rectangular waveform with a predefined amplitude $I = 20A$, time-on $t_h = 0.42h$ (25min), and time-off $t_l = 60s$, b) a constant parameter m for all t_k such that $t_c < t_k < t_f$.

Figure IV.10 shows the prognostic of \hat{D} with an endogenous change in the system. The solid line represents the real deterioration trajectory. At $t_c = 0.5h$ the first prognostic is performed taking the current values obtained from the EKF: $\hat{\alpha}$ and \hat{m} with their uncertainties $\bar{\alpha}$ and \bar{m} respectively. This prognostic is represented by the gray lines. In this example, the prognostic is performed assuming that the future operating conditions of $u(t)$ remain without changes for all t_k such that $t_c < t_k < t_f$.

At $t_k = 7h$ a change on m (augmentation of 10% on the nominal value) is introduced artificially. At this point, an updated prognostic is carried out, and from there the real trajectory changes. The bold-blue lines show the updated prognostic; the intermediate trajectory of this ends closer to the real failure than the previous prognostic.

Figure IV.10 shows also, that the uncertainty of the prognosticated $R\hat{U}L$ depends on the level of uncertainty of $\hat{\mathbf{x}}_{k|k}$, which in turn is linked to the precision of the EKF.

Moreover, the knowledge of the deterioration level at the updating time t_{ud} allows an estimation of the RUL with less uncertainty. The latter, due to the on-line knowledge of the new conditions, mainly the new estimated value $\hat{\alpha}$ and \hat{m} . In this numerical example (Case 1), this updating is inside the bounds calculated before the change, which means that this artificial change could be considered as "acceptable" in this case. Of course, if the new estimation goes out of given predefined constraints, it could be used for instance in fault detection applications.

Figure IV.10 shows an updated prognostic of the RUL every $0.5h$ until the failure time t_f . For simplicity, here we focus the simulation only on the analysis of the effect of the uncertainty of $\hat{\alpha}$ on the RUL estimation, assuming a perfect estimation \hat{m} . Figure IV.10 shows at every prognostic-time instant three main points: the two bounds of the prognosticated RUL ($R\hat{U}L^{pes}$, $R\hat{U}L^{opt}$), and the intermediate value of $R\hat{U}L^{mean}$ which corresponds to the mean value according to Sec. IV.4.4. The red line (bold line) represents the trajectory of RUL assuming only the second value of m during all the lifetime of the system. Of course, the latter assumption is only possible due to fact that in the framework of simulation there exist a full knowledge of the reality. As it can be seen, the prognostic $R\hat{U}L$ begin assuming the first value of m (before the change) and therefore the corresponding values of the $R\hat{U}L$ are not near to the red line. Once the change on m is detected the prognostics respond to the new condition, that means that from that time the new prognostics are closer to the red-line and they have lower uncertainties as the time passes until the failure time.

IV.5.2 Case 2. RUL prognosis with exogenous changes of the system

Let us call *exogenous* to the changes produced in the input u of the system. Now, let us assume that $u(t)$ is unknown, with rectangular waveform, for which its time-on t_h and time-off t_l follow

a Normal distribution, namely:

$$t_h \sim \mathcal{N}(t_{h\mu}, \sigma_{t_h}^2) \quad (\text{IV.37})$$

$$t_l \sim \mathcal{N}(t_{l\mu}, \sigma_{t_l}^2) \quad (\text{IV.38})$$

where $t_{h\mu}$ and $t_{l\mu}$ stand for the mean values of t_h and t_l respectively, and σ_{t_h} and σ_{t_l} stand for the standard deviations of the distributions of t_h and t_l respectively. Here $t_{h\mu} = 1500s$, $t_{l\mu} = 60s$, and $\sigma_{t_h} = \sigma_{t_l} = 10\%$ are used. An amplitude for the rectangular waveform $I = 20A$ is also used.

Figure IV.11 shows the prognostic of \bar{D} with an exogenous change in the system at $t_c = 7h$. At this time a change on the real input is introduced artificially, as a change in the probability law of the input with $\sigma_{t_h} = \sigma_{t_l} = 30\%$. The solid red line represents the real deterioration trajectory. It can be seen that from $t_c = 7h$ the real trajectory changes (more varying).

At $t_c = 0.5h$ a first prognostic is performed taking the current values obtained from the EKF: \hat{a} and \hat{m} with their uncertainties \bar{a} and \bar{m} respectively. This prognostic is represented by the gray lines. In this example, the prognostic is performed assuming that the operating conditions of $u(t)$ remain as described in (IV.37)-(IV.38) for all t_k such that $t_c < t_k < t_f$. For simplicity, and assuming the most probable values, we assume $\sigma_{t_h} = \sigma_{t_l} = 0\%$.

At $t_c = 7h$ (the current time of the change), an updated prognostic is carried out. The bold-blue lines shows the updated prognostic. In this scenario, the real trajectory of deterioration ends within the bounds given by the prognostic, nevertheless the real failure time is closer to the optimistic trajectory and not to the intermediate trajectory. That means that the prognostic at $t_c = 7h$ is not accurate enough due to the lack of knowledge of the current values of t_h and t_l at this time (the estimator does not have the information about σ_{t_h} nor σ_{t_l}), and moreover no assumption about the future σ_{t_h} nor σ_{t_l} was taken. Nevertheless, note that the following prognostics can be quickly performed as the time pass until the failure, as a result these new prognostics are more accurate as the time passes.

Figure IV.11 also shows an updated prognostic of the RUL every $0.5h$ until the failure. The Figure IV.11 shows at every prognostic-time instant the aforementioned three main points \hat{RUL}^{pes} , \hat{RUL}^{opt} , and \hat{RUL}^{mean} . In a similar analysis that for the scenario of the endogenous change, the red line represents the trajectory of \hat{RUL} assuming the true failure time. As it can be seen, the new prognostics are close to the red-line and they have lower uncertainties as the time passes until the failure time. In this case, there is not an evident change in the RUL trajectory around $t_c = 7h$; this is due to the lack of knowledge of the new σ_{t_h} and σ_{t_l} . This experiment shows that the prognostic of the RUL for a kind of variation of the input as described in (IV.37)-(IV.38) does not need an estimation of the σ_{t_h} nor σ_{t_l} to give acceptable estimations \hat{RUL} . Of course if there exist some hypothesis about the future values σ_{t_h} and/or σ_{t_l} , they can be included in the operating conditions for prognostic.

IV.6 RUL prediction evaluation

Given a family of constraints (deterioration produced by bounded inputs) scenario-based approach presented here, the *Probabilistic certification* approach, as proposed in [Alamir 2015], suggests to simulate N possible trajectories of the deterioration and compute the number of

times the constraints were violated. The obtained statistical probability is associated with a confidence parameter, since it is the probability that the success statement is wrong. As stated in [Alamo 2009], we have to compute a sufficiently large number of random trials to guarantee a certain confidence. This section is dedicated to analyze two cases of uncertainties (uncertain input and uncertain parameter cases). It is shown that it is possible to obtain an estimation of an interval of possible RUL, with a certain confidence percentage based on the presented deterioration model. The task associated to this prediction can be started by a condition based on the invariant sets characterizing the admissible deterioration.

In the sequel, we assume the availability of the estimations of α and m at every time instant. This means that, using Equation (III.29), the state of deterioration \bar{D} can be evaluated as well. However, it is not simple to evaluate or estimate online, in a reliable way, the Remaining Useful Life (RUL) of the actuator. Thus, the question is, given a deterioration at a particular time-instant, how to estimate the RUL, before reaching the total outage of the actuator? The latter question will be explored in section IV.6.1. There an approach that allows to numerically predict an interval of the RUL before reaching the total failure of the actuator is presented.

IV.6.1 The RUL estimation problem

The problem is, for a given predefined scenario and/or protocol (fixed duty cycles, minimal and maximal electrical motor current, etc.), at every time instant, estimate the RUL of the actuator with a certain precision. It is clear that the estimated RUL has to belong to an interval (a set) which consider the uncertainties of the model and the uncertainties on the realization of the motor current (the exogenous disturbances).

Due to the fact that mechanical equations of motions are widely known, the probabilistic certification approach, can be useful to estimate the interval values of the RUL under certain assumptions about the source of uncertainties.

There are two kind of uncertainties that have to be treated here. Uncertainties on the parameters of the model (for instance, the estimation error of the parameter m in (IV.2)) and uncertainties on the topology of the exogenous signals (for instance, the electrical current $I(t)$ which does not depend on the system state x in the described scenario).

IV.6.2 Uncertain input case

Figures IV.12 and IV.13 illustrate the behavior of the normalized deterioration $\bar{D}(t)$ for a constant electrical current $I(t) = I$. One case considers bounded possible electrical currents ($19A \leq I \leq 21A$), the continuous lines, and the second case considers random possible electrical currents, the dotted-lines. In Figure IV.12 an initial condition of the normalized deterioration $\bar{D} = 0$ is considered. The estimated RUL exactly belongs to the time interval $\{272.71, 333.88\}$ hours, for the bounded possible current case. However considering a more realistic scenario (a random possible current case), the number of *actuator population* which do not respect this interval is different to zero. In this example, there is a probability that 5% of the population will deteriorate faster than expected in the bounded current case (i.e. earlier than 272.71 Hours). This estimation was obtained by using $N = 233$ simulations, with *normally distributed pseudorandom values* of electrical currents $I(t)$, with mean $20A$ and a standard deviation of $0.5A$. As suggested in [Alamo 2009] and [Alamir 2015]), the number of simulations N has been

computed as follows

$$N \geq (1/\varepsilon) * (1 + \ln(1/\delta) + (2 \ln(1/\delta))^{1/2}) \quad (\text{IV.39})$$

which guarantee a *Confidence parameter* $\delta = 0.001$ (i.e. 99.9% of the reliability of the estimation procedure). Here, ε represents the percentage of actuator population which violate the condition (e.g. 5% of the population will deteriorate faster than expected).

For an initial condition of the normalized deterioration $\bar{D} = 0.4$ as depicted in figure IV.13, the estimated *RUL*, computed at the instant 200 hours, belongs to the time interval {297.03, 319.10} hours. In addition, we obtain the same probability of 5% of the population will deteriorate faster than expected in the bounded case, with the same confidence parameter $\delta = 0.001$.

It is clear that the precision of the estimation of the RUL basically depends on the precision of the estimated $\alpha(t)$ and the estimated m . Of course, the precision also depends on the quality of the proposed model structure and the assumptions relating the probability distribution of the electrical current $I(t)$.

Figure IV.14 illustrates the behavior of the deterioration \bar{D} for two different maximal amplitudes of the electrical current, but the same activation sequence, as depicted in figure IV.15. Activation sequence is equal to 1 when it is applied the maximal current, and equal to 0 when system is stopped. An interesting observation is that the prediction of the RUL is still quite simple and keeps a certain "invariance" property, providing an interval of possible values of RUL according to the interval of possible maximal electrical currents.

IV.6.3 Uncertain parameter case

Figure IV.16 illustrates the behavior of the deterioration \bar{D} for 233 random simulations of different values of the parameter m (the dashed lines). This parameter is assumed to be constant and verifies $0.0095 \leq m \leq 0.0105$. The current sequence is the same, depicted in figure IV.15. An interesting observation here, is that the behavior of the deterioration is harder to estimate. In particular, the extreme value of $m = 0.0105$, does not provides the faster deterioration index \bar{D} (the continuous line in Figure IV.16). This aspect clearly justify the use of probabilistic certification as a less conservative way to compute a reliable RUL.

IV.7 Conclusions

In this Chapter a non-linear state-observer is presented for estimation of the current state of deterioration in a friction drive system. A method for tuning the observer is proposed in the framework of RUL estimation. A properly tuned estimator allows us to know the current state of deterioration of the contact surfaces with high accuracy, and in turn gives useful information on the precision of the estimation at every time instant. The estimator was tested in simulation by taking into account known input operating conditions. It was found that the stochastic simulations allows to evaluate the precision of the estimates, and in turn, to take into account this performance for using the estimates in prognostic tasks.

The estimates of the contact quality coefficient and quality-deterioration ratio are highly dependent on the precision of the speed sensors and on the variation of the input operating conditions: the more variation of the input, the more ease to observe the parameters. The

estimation of the deterioration state enables making quick prognostics of the RUL with a confidence level linked to the precision of the estimations. Moreover the prognostic can be quickly updated after the detection of changes in the operating conditions. The results show the potential impact of the model and the approach in maintenance and condition monitoring tasks. A test rig is suitable to validate the model in a real application. A preliminary work using the Probabilistic certification approach has been presented and could be, combined with invariant sets, object of analysis in perspective.

Complementary conclusions can be found in the published article [Rodriguez Obando 2017b].

Next Chapter concerns the use of the proposed condition monitoring and the RUL estimation for designing a Reliability Adaptive System, i.e. a closed-loop controlled system.

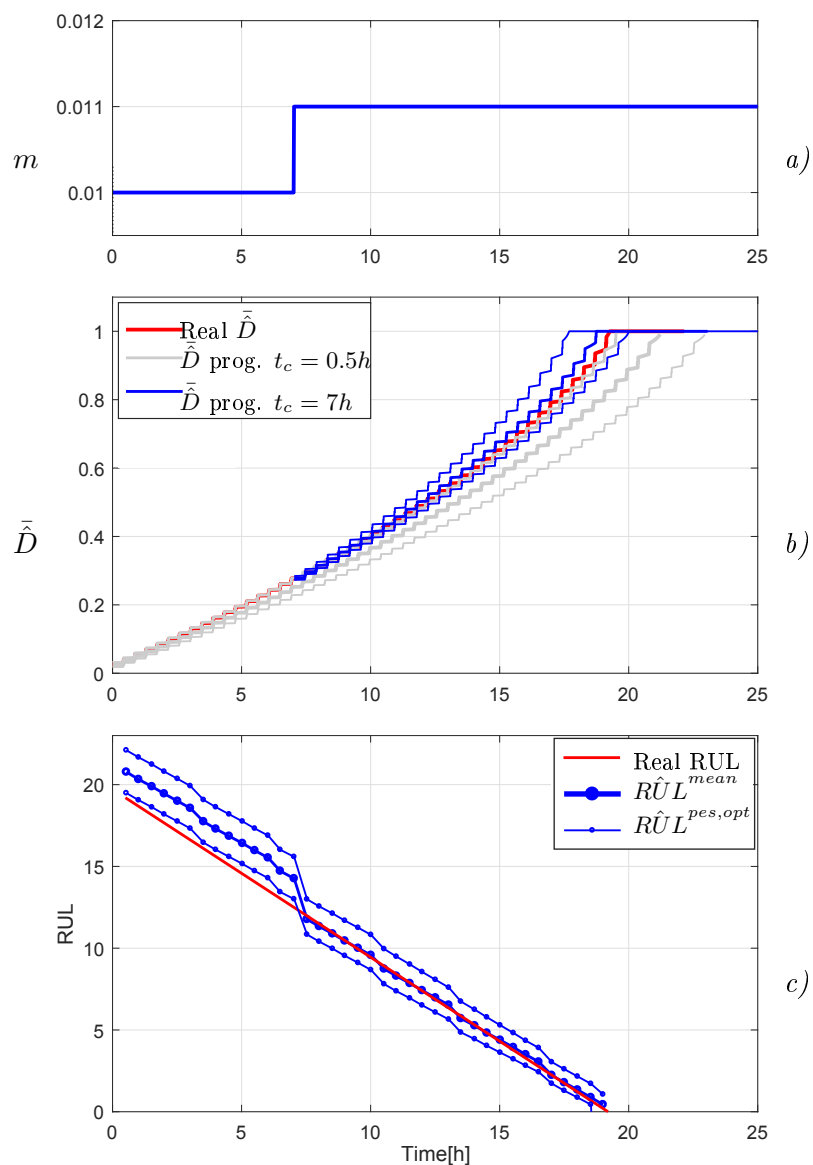

Figure IV.10 – Prognosis of RUL with an endogenous change in the system. a) A change on m (augmentation of 10% on the nominal m) at $t_c = 7h$. b) Real deterioration trajectory \tilde{D} , first prognostic at $t = 0.5h$ (shaded lines), and updated prognostic just after the change at $t = 7h$ (continuous lines); the updated prognostic is close to the real failure due to the on-line knowledge given by the EKF. c) Prognostic of \hat{RUL} per $0.5h$. Just after the change on m a change in the \hat{RUL} trajectory is observed.

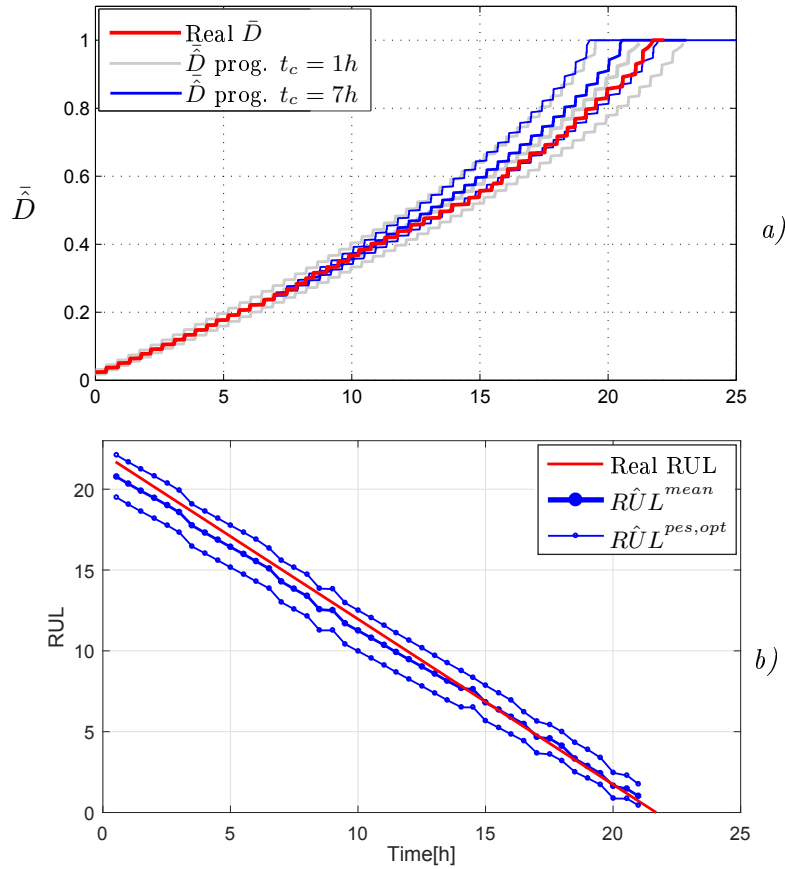

Figure IV.11 – Prognosis of RUL with an exogenous change in the system. *a)* Real deterioration trajectory \tilde{D} with change in input (an augmentation of 20% over the nominal σ_{th} and σ_{tl} from $t_c = 7h$), first prognostic at $t = 0.5h$ (shaded lines) and updated prognostic just after the change at $t_c = 7h$ (continuous lines); the updated prognostic is within the uncertainty interval. *b)* Prognostic of RUL per $0.5h$ with the exogenous change in the system.

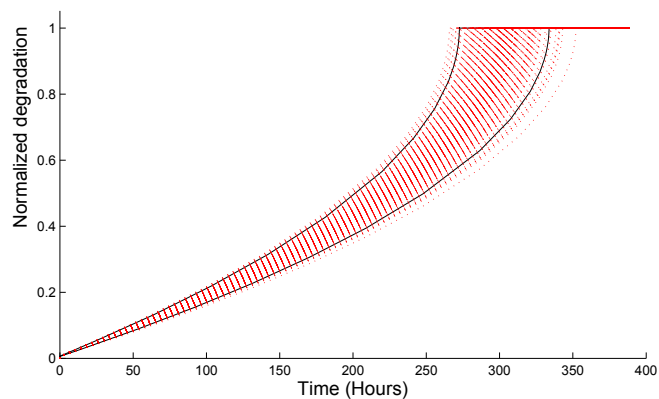

Figure IV.12 – Estimated deterioration for random input $I(t)$, with mean $20A$ and a standard deviation of $0.5A$. Here, 5% of the population age in more or less time than predicted (deterministic) bounded current case (i.e. $19A \leq I(t) \leq 21A$).

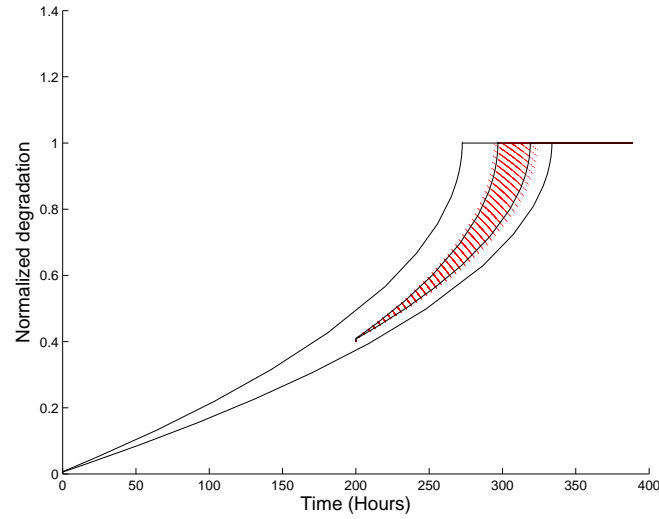

Figure IV.13 – Predicted deterioration trajectory at the very beginning and in future time (At $t = 200$ hours an initial condition $\bar{D} = 0.4$), for random inputs I , with mean $20A$ and a standard deviation of $0.5A$. Knowledge of the deterioration at this time allows a more accurate estimation of the remaining lifetime before outage of the actuator.

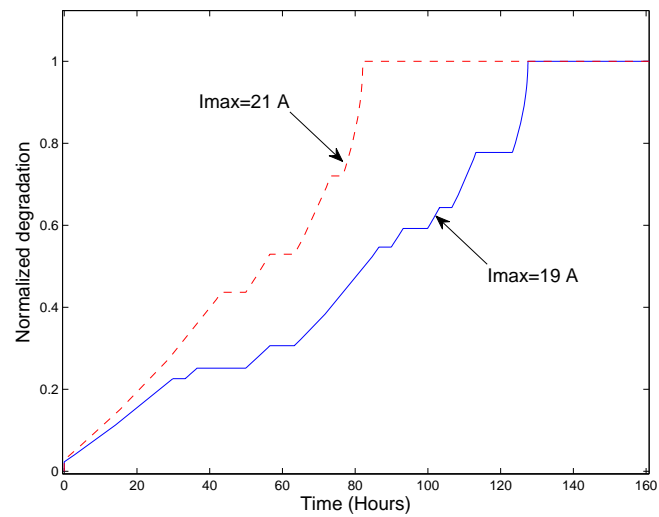

Figure IV.14 – Deterioration obtained with different maximal electrical currents for a predefined sequence of $u(t)$.

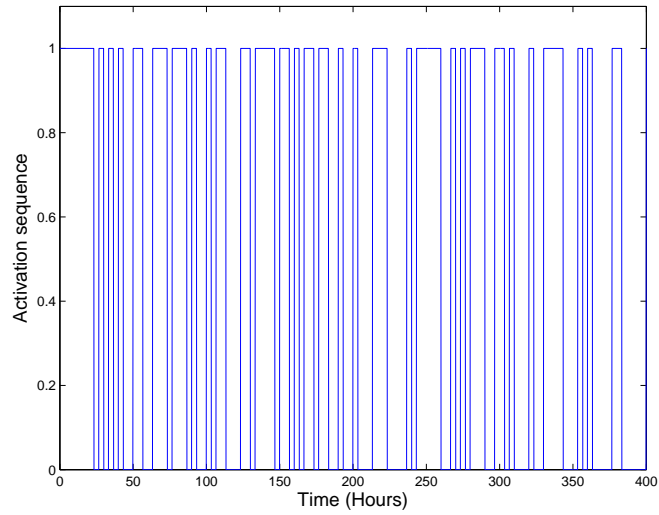

Figure IV.15 – Pseudo-random activation sequence of signal $u = I(t)$.

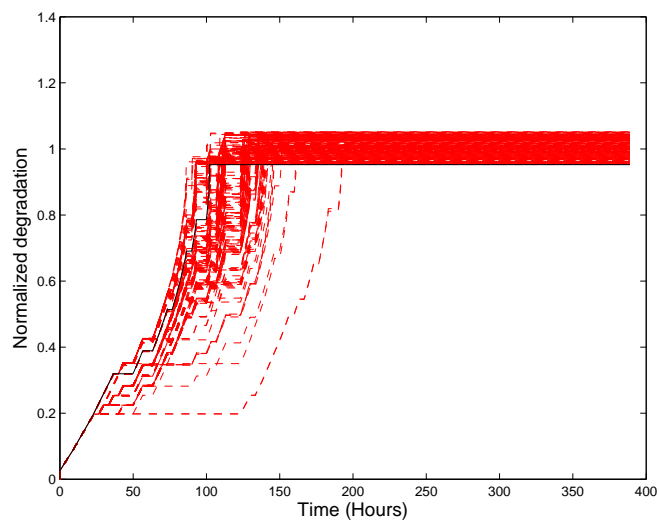

Figure IV.16 – Deterioration obtained with 233 random simulations for $0.0095 \leq m \leq 0.0105$. The (black line) concerns the curve with the maximal value of m .

Proposed Architecture for Controlling the RUL

Contents

V.1 Introduction	83
V.2 System description	84
V.3 Problem statement	85
V.4 Proposed RUL control architecture	87
V.4.1 The RUL actuating principle	87
V.4.2 The RUL predictor	88
V.4.3 The RUL controller	88
V.5 Numerical example	89
V.5.1 Chosen scenario	89
V.5.2 Chosen parametric varying filter	90
V.5.3 Used RUL predictor	91
V.5.4 Implemented RUL controller	92
V.6 Conclusions	93

V.1 Introduction

Several motion applications are based on friction. Friction rollers, railway wheels, and friction drive electrical bicycles are examples of this kind of actuators. The power delivered by the motor is transformed into mechanical power on the driven side through the contact forces. In practice, the contact surfaces of the motor device and the driven device deteriorate and their deterioration reaches eventually a threshold above which the system is considered as a failed system. The deterioration can be considered as a loss of the ability of the actuator to transfer power to the driven device.

The Remaining Useful Lifetime (RUL) is defined as the time left before a component or system no longer perform its intended function. This time mostly depends on the state of deterioration of the components and the operating conditions. As described in Chapter IV, accurately predicting the RUL is still an open problem [Si 2011]. This prediction is generally affected by exogenous and endogenous uncertainties. Even if a given mechanical system model is well-known, there are several sources of uncertainties that affect the precision of the RUL prediction. For instance, the initial condition of the deterioration and its dynamical behavior,

the future operating conditions, the measurement noise and process disturbances are generally considered into the literature.

The motion control actions are seen as a source of stress deteriorating the actuator, see for instance [Langeron 2017], [Rakowsky 2006] and [Meyer 2014]. In [Grosso 2012] and [Pereira 2010], the authors assume a deterministic relationship between the degradation and the motion control input. Therefore, controlling the RUL of a component could be achieved by modifying, in a suitable way, the motion control laws.

This chapter presents an approach to control the remaining useful lifetime (RUL) of a friction drive system. The control problem is defined in Section V.3. In Section V.4 the architecture is defined formally. The approach is based on the assumption that the system deterioration is a consequence of the motion control actions. These control actions have short-term objectives that have to be modified to be compatible with the required/desired RUL. Here, a RUL actuating principle is proposed in order to control the RUL. The proposed RUL actuating principle is based on a parametric varying filter which modifies the motion control realization based on the available information about the expected RUL. The total RUL control architecture also includes an operating condition estimator, a system state estimator, and a RUL predictor. The RUL controller determines the parameters of the actuating filter by solving an on-line optimization problem. The RUL controller has to solve the RUL control problem by considering a trade-off between desired motion control actions and desired RUL. In Section V.5 a numerical example is used to illustrate the use of the proposed global architecture.

V.2 System description

Consider the following dynamical friction drive system model, as presented in Chapter III:

$$J_1\dot{\omega}_1 = T_m - F_c r_1 - b_1\omega_1 \quad (\text{V.1})$$

$$J_2\dot{\omega}_2 = F_c r_2 - b_2\omega_2 - T_{load} \quad (\text{V.2})$$

$$F_c = \alpha(r_1\omega_1 - r_2\omega_2) \quad (\text{V.3})$$

where ω_1 and ω_2 are the angular speeds of the motor and driven device, respectively. T_m is the motor torque and T_{load} the driven load. The symbols J_1 , J_2 , r_1 , r_2 , b_1 and b_2 are known constant mechanical parameters of the system. F_c stands for the contact forces allowing the transmission of mechanical power from the motor to the driven device. That force is approximated by a linear function of the relative tangential speed ($r_1\omega_1 - r_2\omega_2$) and an uncertain parameter α , called here the contact quality coefficient.

As proposed in Chapter III, the deterioration rate of the contact quality coefficient can be modeled as a function of the dissipated energy at the contact surface level. This deterioration can be calculated from information of mechanical states and the knowledge of the contact-quality coefficient. This is summarized in Equation (III.39), which can be rewritten as:

$$\dot{D} = \alpha(r_1\omega_1 - r_2\omega_2)^2 \quad (\text{V.4})$$

where D represents a value of deterioration. This dissipated energy can be considered as an image of the heat and the material worn at the contact surface level during traction. In

addition, we assume, that the contact quality coefficient α changes according to the following dynamics:

$$\dot{\alpha} = -m\alpha(r_1\omega_1 - r_2\omega_2)^2 \quad (\text{V.5})$$

which means that, for $m > 0$, the deterioration D increases when α decreases. There is uncertainty on m , and this parameter can also vary with time. From (V.5), notice that the contact quality coefficient decreases if values of $(r_1\omega_1 - r_2\omega_2)^2$ increase. The rate of the decreasing of α also depends on the current state of α and the uncertain parameter m . Remark also that the trajectory of the states for system (V.1)-(V.3), i.e. ω_1 , ω_2 , D and/or α can be modified by using the input T_m .

V.3 Problem statement

In this chapter, it is assumed that a system state estimator (e.g. a state observer) is available, following the notions given in Chapter IV. See also for instance [Rodriguez Obando 2017b] where an Extended Kalman Filter has been proposed for simultaneously estimating the current values of α and m by assuming that ω_1 and ω_2 are measured.

In addition, it is assumed that the current operating conditions are known and assumed to remain unchanged on the predicting horizon to predict the RUL. The latter can be achieved by a RUL predictor, as it is also proposed in [Rodriguez Obando 2017b]. The following definitions are necessary for establishing the RUL control problem:

Definition V.1

At a given time t , the desired RUL, denoted RUL^{ref} , is the desired remaining period of time before the friction drive system can no longer perform its intended function (i.e. transmitting mechanical power from the motor to the driven device).

Definition V.2

At a given time t , the predicted RUL, denoted \hat{RUL} , is the predicted remaining period of time before the friction drive system can no longer perform its intended function. The predicted RUL is a random variable, which can be characterized by e.g. a probability distribution or a confidence metrics.

Now, the problem of controlling the RUL can be formulated as follows:

Problem V.1

Given a mechanical friction drive system (V.1)-(V.5), find, at every time-instant, the motor torque T_m (the only manipulable input of the system), which guarantees that the predicted RUL follows the desired one.

Due to the fact that the mechanical friction drive system has to follow possible short-time motion demands, the Problem 1 has to be reformulated in order to include these motion requirements. In the sequel we use the following additional definitions:

Definition V.3

The desired torque, denoted T^{ref} , is an exogenous motion demand which could be provided

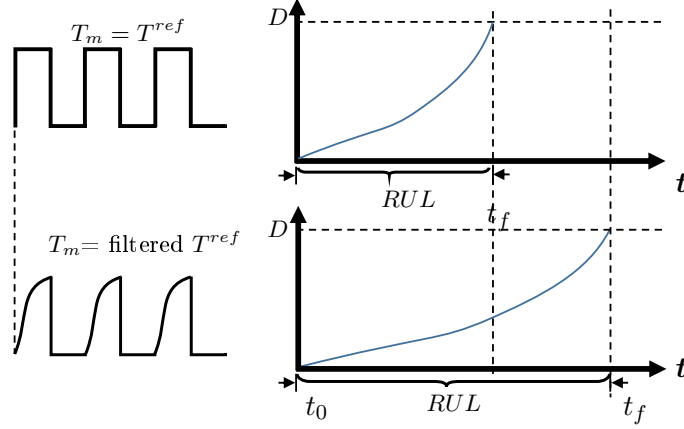

Figure V.1 – Illustration of the obtained RUL for two different sequences of the motor torque. The obtained RUL increases in cases where the motor torque is a filtered (or smoothed) signal of T^{ref} .

by a motion control system or a reference generator.

Definition V.4

The demanded motion satisfaction, denoted S^{ref} , is a value between 0 and 1 which quantifies the ability to deliver a motor torque T_m from a given reference torque T^{ref} . Thus, $S^{ref} = 1$ means that it is desired to obtain $T_m = T^{ref}$. A value of S^{ref} close to zero means that the applied torque T_m could be very different to T^{ref} .

Figure V.1 depicts two possible scenarios of deterioration. The first case concerns the case where $T_m = T^{ref}$ and the second case when T_m is a filtered signal of T^{ref} . This example clearly shows that filtering the input command to the motor (and removing the sharp edges in the command) decreases the deterioration rate, and increases the system lifetime. This phenomenon will be used to control the system RUL by modifying appropriately the motor command input.

Hence, by assuming the existence of a parameter varying filter, denoted $H(\theta)$, with θ a vector containing the filter parameters, which generates T_m from T^{ref} , the problem now becomes as follows:

Problem V.2

Given a friction drive system (V.1)-(V.5), find, at every time-instant, the parameters of the filter $H(\theta)$, such that the obtained motor torque T_m guarantees that the predicted RUL follows the desired one and respects as much as possible the demanded torque T^{ref} .

This problem can be solved as an on-line optimization problem that has to consider a trade-off between desired demanded motion satisfaction and desired RUL. The RUL control architecture will be presented in the next Section.

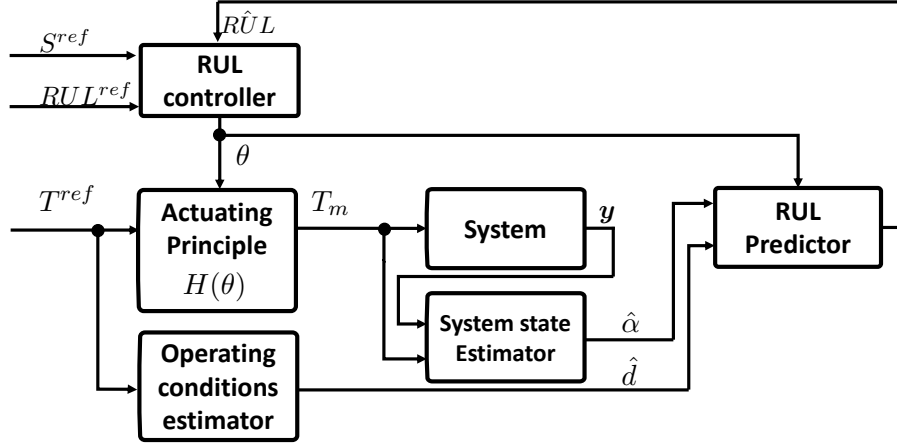

Figure V.2 – Architecture for an optimal control of the RUL.

V.4 Proposed RUL control architecture

The proposed RUL control architecture of a friction drive system, is depicted in Figure V.2. The main novelty of the proposed RUL control architecture concerns a parametric varying filter (called here the actuating principle). This parametric varying filter is intended to modify the motion control realization in order to actuate on the values of the predicted RUL. The RUL control architecture also includes an operating condition estimator, a system state estimator, and a RUL predictor. The RUL controller determines the scheduling parameters of the actuating filter by solving an on-line optimization problem. Every component of the control architecture is described in more details in the next subsections.

V.4.1 The RUL actuating principle

Considering the fact that the deterioration of the system is influenced by the shape of the signal T_m (the motor torque), the desired torque T^{ref} can be filtered by a filter $H(\theta)$ in order to modify, in real-time, the shape of the applied motor torque, i.e.

$$T_m = H(\theta) T^{ref} \quad (\text{V.6})$$

where θ represents a time-varying parameter vector generated by the RUL controller. Since the signal T^{ref} has to verify short-time motion requirements, the choice of the filter $H(\theta)$ allow us to constraint the original signal T^{ref} for generating a constrained signal T_m for satisfying long-term requirements. This solution is adopted here, since it can be seen as a particular realization of a Model Predictive Controller. The proposed architecture admits other versions of Model Predictive Controllers for constraining the motor torque and include other possible short-time state and/or control constraints. Here, two aspects are considered for constraining the signal T_m , the amplitude of the signal and its time-derivatives. Both these aspects are considered as sources of deterioration. High amplitudes and high time-derivatives of T_m produce more deterioration and then decrease the predicted RUL.

Figure V.3 sketches out possible applied motor torques with respect to the desired one $T^{ref}(t)$.

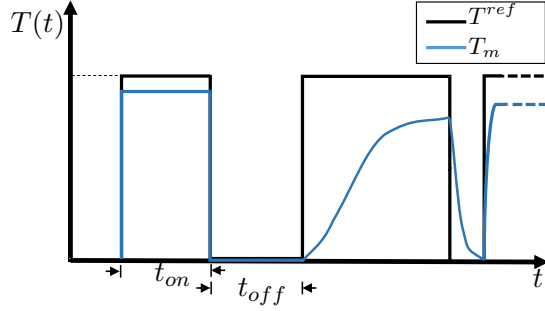

Figure V.3 – Examples of applied motor torque T_m compared to the desired one T^{ref} .

V.4.2 The RUL predictor

Figure V.2 shows the place of the RUL predictor into the control architecture. Here, it is supposed that the RUL predictor uses a dynamical model of the mechanical system together with a dynamical model of the deterioration (or an image of the deterioration). Since the quality of contact coefficient α is an image of the deterioration, its value and its associated uncertainty are estimated by a state estimator and used into the RUL predictor. In addition, the RUL predictor uses the information about the current operating conditions and performs the prediction based on the assumption that such operating conditions remain unchanged along the future time. In this chapter, it is assumed that the operating conditions are easily obtained from the desired torques T^{ref} , and therefore the value of the vector θ (the output of the RUL controller) will also be part of the necessary information for performing the prediction. Other solutions could just use the applied torque (the signal T_m) and any available image of the deterioration for performing the RUL prediction.

Figure V.2 illustrates the case where the signal θ , $\hat{\alpha}$ and \hat{d} are used. Here, \hat{d} corresponds to a metrics which characterizes the desired torques; \hat{d} could also include any other information about the past, current or future operating conditions. Hence, the RUL prediction will be a function of these inputs. That is, at every time instant, it follows that

$$R\hat{U}L := R\hat{U}L(\hat{\alpha}, \hat{d}, \theta) \quad (V.7)$$

Figure V.5 illustrates an example of the behavior of the predicted RUL for different values of $\hat{\alpha}$, \hat{d} and θ .

Remark V.1

The vector θ is the only tunable variable which allows the modification of the predicted RUL. This aspect is exploited by the RUL controller which decides, during operation, the values of the vector θ to assure the “tracking” of a desired RUL. This is explained in the following subsection.

V.4.3 The RUL controller

The RUL controller is intended to solve the control problem stated in Section V.3. This controller has to continuously decide the values of the vector θ (the parameters of the filter

$H(\theta)$ in (V.6)), as a function of the predicted RUL and minimizing a given cost function J , for instance:

$$J := J \left(RUL^{ref}, \hat{RUL}(\theta), S^{ref}, S(\theta) \right) \quad (V.8)$$

where RUL^{ref} represents the desired RUL and S^{ref} the demanded motion satisfaction. The symbols $\hat{RUL}(\theta)$ and $S(\theta)$ represent the predicted RUL as a function of θ and the obtained motion satisfaction, respectively. In this chapter, it is assumed that the cost function (V.8) includes also scalar values which allows considering a trade-off between the obtained predicted RUL and the obtained motion satisfaction $S(\theta)$.

Figure V.2 shows the place of the RUL controller into the proposed control architecture. The RUL controller can provide a decision variable θ by solving, at every time-instant, the following optimization problem:

$$\begin{aligned} & \underset{\theta}{\text{minimize}} && J \left(RUL^{ref}, \hat{RUL}(\theta), S^{ref}, S(\theta) \right) \\ & \text{subject to} && f_i(x, u) \leq 0, \quad i = 1, \dots, m. \end{aligned} \quad (V.9)$$

where the functions $f_i(x, u)$ allow the inclusion of other constraints on the system states x and/or on the system controls u . Notice that the optimization problem could be solved in real-time or by using an *a priori* calculated look-up table.

According to the PHM framework, Condition Monitoring (CM) scheme, can be carried out “continuously” (See. for instance [Bérengruer 2003]) or “discretely” (See. for instance [Huynh 2011]). By continuous CM, a machine is continuously monitored, and a warning alarm is triggered whenever something wrong is detected. Note that, such a continuous CM approach can be costly, and eventually cannot be implemented in practical engineering applications [Jardine 2006]. Thus, the policy for evaluating the cost function (V.8) can be decided to be done, for instance, event-based.

V.5 Numerical example

In this section the behavior of the proposed control architecture is illustrated by using the friction drive system (III.13)-(III.14) with the values presented in Table III.3.

V.5.1 Chosen scenario

For simplicity, the following scenario has been chosen:

- The desired torque T^{ref} is a rectangular waveform with duty-cycle equal to 50%.
- The signal T^{ref} is active during a period of time t_{on} , as it depicted in Figure V.3.
- The period of time t_{on} is assumed to be known but it can change along the time, modifying the predicted RUL.
- The operating conditions estimator provides the exact value of t_{on} in seconds. That is, $\hat{d} = t_{on}$. This values is assumed to be bounded as follows: $0 < t_{on} \leq 50$.

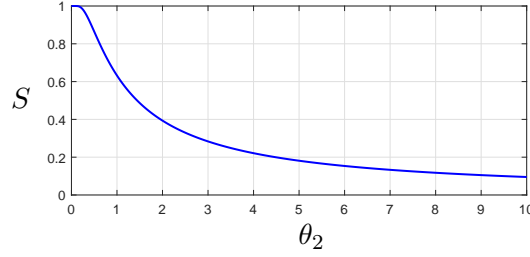

Figure V.4 – Obtained motion satisfaction S as a function of the parameter θ_2 .

- A state estimator provides the values of the estimated contact quality coefficient, i.e. $\hat{\alpha}$ by using available measurements and/or signals. Here, the state estimator uses the applied motor torque T_m and the measurements y (rotational speeds of the motor and driven device).

V.5.2 Chosen parametric varying filter

In this example it is used a first order filter:

$$H(\theta, s) = \frac{\theta_1}{1 + \theta_2 s} \quad (\text{V.10})$$

where s depicts the complex variable in Laplace representation, and θ is a parameter vector $\theta = [\theta_1 \ \theta_2]^T$. Notice that the parameter θ_1 modifies the gain of the transfer function (V.10), in the meantime θ_2 mostly modifies the time-response of the applied torque with respect to the desired one.

Taking (V.6) and (V.10) it can be obtained the following dynamical equation which describes the time-derivatives of the applied motor torque T_m :

$$\dot{T}_m(t) = -\frac{1}{\theta_2} T_m(t) + \frac{\theta_1}{\theta_2} T^{ref}(t) \quad (\text{V.11})$$

It is assumed that the amplitude of the signal $T_m(t)$ and its time-derivative with respect to time are bounded. In this example the RUL controller will modify the values of θ_2 and it will maintain $\theta_1 = 1$, for simplicity.

According to the definition V.4, the demanded motion satisfaction S^{ref} quantifies how much the form of the curve T_m is near to the demanded T^{ref} . In this example, it will be a value between 0 and 1. Here the obtained motion satisfaction will be quantified by using the following function:

$$S(\theta) = 1 - e^{-1/\theta_2} \quad (\text{V.12})$$

which decreases as long as the parameter θ_2 increases as illustrated in Figure V.4. On the other hand, Figure V.5 depicts the predicted RUL for different values of the parameter θ_2 , as a function of the current values of the estimated contact quality coefficient $\hat{\alpha}$ and the operating conditions \hat{d} . The used RUL predictor will be described in the next subsection.

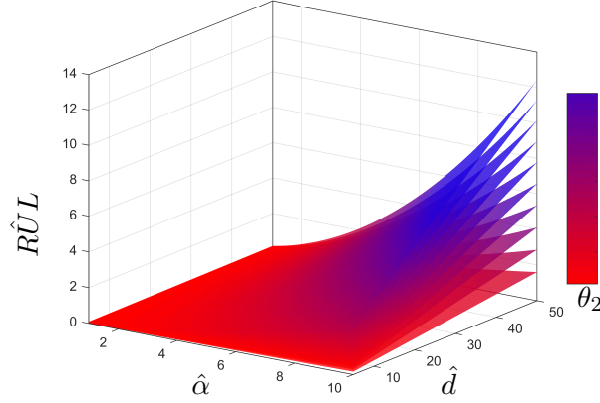

Figure V.5 – Predicted RUL as function of the parameter θ_2 , the estimated contact quality coefficient $\hat{\alpha}$, and the operating conditions \hat{d} .

Table V.1 – Nomenclature and used values

Symb.	Value	Units	Physical meaning
ω_1		$[rad/s]$	Angular speed of the motor
ω_2		$[rad/s]$	Angular speed of the driven device
r_1	0.0315	$[m]$	External radius of the motor
r_2	0.35	$[m]$	External radius of the driven device
b_1	6.36×10^{-3}	$[Kg\ m^2/s]$	Viscous friction coefficient
b_2	1.76×10^{-3}	$[Kg\ m^2/s]$	Viscous friction coefficient
J_1	3.47×10^{-4}	$[Kg\ m^2]$	Moment of inertia of the motor
J_2	0.2	$[Kg\ m^2]$	Moment of inertia of the driven device
$\alpha(0)$	10	$[N\ s/m]$	Contact quality coefficient
m	0.01	-	Parameter of the dynamics of α

V.5.3 Used RUL predictor

In this example, a model-based RUL predictor as proposed in [Rodriguez Obando 2017b] has been used. The friction drive system (1)-(5) together with the filter dynamics (V.11) can be rewritten in state space form as the following augmented dynamical system:

$$\dot{\mathbf{x}} = \mathbf{F}(\mathbf{x}) + \mathbf{B}\mathbf{w} \quad (\text{V.13})$$

with an augmented state defined as $\mathbf{x} := [\omega_1\ \omega_2\ \alpha\ T_m]^T$, the exogenous input $\mathbf{w} := T^{ref}$, and the matrix $\mathbf{B} := [0\ 0\ 0\ 1/\theta_2]^T$. The symbol $\mathbf{F}(\mathbf{x})$ represents the non-linear functions of the augmented state dynamics.

At every time-instant $t = t_0$, the RUL prediction can be performed by simulating the system (V.13) with initial conditions (i.e. at time equal to t_0) belonging to a set of values. Some of these values are measured (e.g. ω_1 , ω_2 , and T_m). However the state α , related to the deterioration, is estimated and the true value belongs to a given interval or set (i.e. it could be a stochastic set provided by the state estimator). Here, the confidence intervals provided by an Extended Kalman Filter, as proposed in [Rodriguez Obando 2017b], have been used.

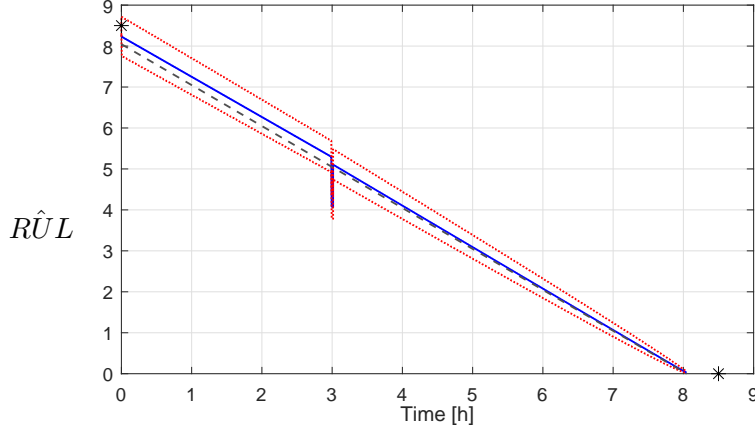

Figure V.6 – Predicted RUL along the useful lifetime: 1) by using the mean value of the estimated α (solid line), 2) by using extreme values of the estimated α (dotted line). Both compared to the obtained RUL (dashed line). The symbol * represents the desired RUL.

The prediction can be stopped once the maximal deterioration has been achieved, that is for $\alpha(t_f) = 0$ (equivalently $D(t_f) = \sup\{D\}$). Thus, the predicted RUL is computed as $R\hat{U}L = t_f - t_0$. Figure V.6 depicts the obtained $R\hat{U}L$ with respect to the time. This figure also illustrates the changes on the predicted RUL in cases where the operating conditions changes. Here a changes on the variable \hat{d} appears at $t = 3h$.

V.5.4 Implemented RUL controller

We propose to use an optimal controller to solve the Problem V.2, which minimizes a cost function including a double objective (i.e. satisfy a trade-off between a desired RUL and a desired torque). The problem can be reformulated as a single-objective optimization problem by using a suitable scalarization. That is,

Problem V.3

Given $\hat{\alpha}$ and \hat{d} at a time t_0 , find the value of θ_2 which minimizes the cost function:

$$J(\theta_2) = \left(\frac{RUL^{ref} - R\hat{U}L(\theta_2)}{RUL^{ref}} \right)^2 + \rho \left(S^{ref} - S(\theta_2) \right)^2 \quad (V.14)$$

subject to:

$$0 \leq \theta_2 \leq \bar{\theta}_2 \quad (V.15)$$

where $\rho > 0$ is a real value which allows considering a trade-off between satisfying desired RUL and/or satisfying the desired torque.

Here we assume also that the desired RUL^{ref} will be bigger than the estimated RUL to maintain the positivity of this cost function. In this case the cost function given in Equation

V.14 could be also treated as:

$$J(\theta_2) = \left(\frac{RUL^{ref} - R\hat{U}L(\theta_2)}{RUL^{ref}} \right) + \rho (S^{ref} - S(\theta_2)) \quad (V.16)$$

In this example it was chosen $\bar{\theta}_2 = 6$ and $\rho = 0.5$. The chosen weighting scalar ρ suggests that we put more focus on the respect of the desired RUL rather than on the respect of the desired torque.

Figure V.7 illustrates the behavior of the proposed controller. In this scenario we use $RUL^{ref} = 8.5h$, $S^{ref} = 1$ and introduce a change at $t = 3h$ on the operating conditions characterizing T^{ref} . Namely, T^{ref} is characterized by $d = 40s$, and after $t = 3h$ the operating conditions change by $d = 30s$. Notice that the RUL controller decides to modify the value of the filter parameter θ_2 . This value increases in order to reduce the rate of the deterioration due to the changes on the operating conditions \hat{d} .

The RUL predictor updates the value of the operating conditions and it gets closer to the true description of the RUL (dashed line in Figure V.7). Notice that at time $t = 3h$ there is a considerable transient. This is due to the fact that the RUL predictor uses the new value of the operating conditions \hat{d} but the RUL controller has not yet updated the new value of θ . This situation is depicted in the magnified view of the time scale in Figure V.8.

For comparison, Figure V.9 shows the obtained trajectories of $\hat{\alpha}$ for three cases:

Case 1, the *RUL* of the system is non-controlled (solid line), an important decrease of the contact quality coefficient α is observed (which implies a very fast deterioration), reaching the failure at $1.18h$.

Case 2, the RUL controller provides the optimal parameter θ_2 at the beginning of the lifetime and used it during the whole lifetime assuming no changes in the operating conditions \hat{d} . In this case the system reaches a failure time at $7.08h$ which is still far of the desired RUL.

Case 3, the RUL predictor uses the current value d and $\hat{\alpha}$ to update the RUL prediction and then the RUL controller finds a new optimal parameter θ_2 in order to adapt the behavior of the system. In this case the system reaches a failure time of $8.06h$ which is closer to the desired RUL which have been chosen as $RUL^{ref} = 8.5h$.

V.6 Conclusions

In this chapter, a novel Remaining Useful Lifetime (RUL) control architecture is presented. The control law is based on the on-line available prediction of the RUL (which includes a dynamical model of the mechanical system and its deterioration). The RUL controller can be implemented as an optimal controller which decides, in real-time, the parameters of a filter (called here the RUL actuating principle) in order to modify the predicted RUL. The parameter varying filter is intended for smoothing the desired torque (associated to a desired motion requirement) in order to increase or decrease the predicted RUL. An example of an optimal controller which deals with two opposite criteria, respect of the desired torque and respect of the desired RUL, has been presented. In this work we have illustrated the role and the importance of the RUL prediction for generating suitable control actions.

Some of the conclusions of this chapter for a particular scenario were published in the article [Rodriguez Obando 2018].

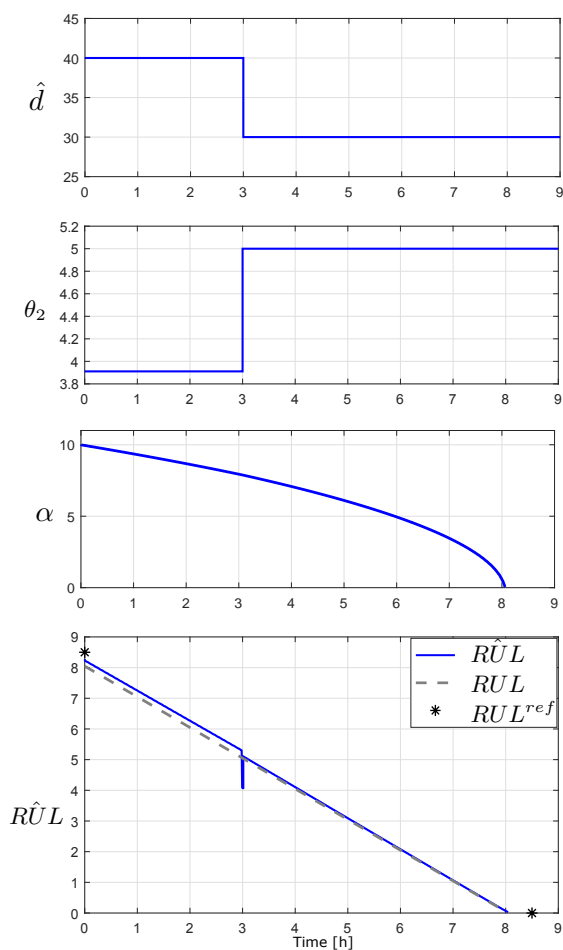

Figure V.7 – System behavior under the effect of the RUL controller.

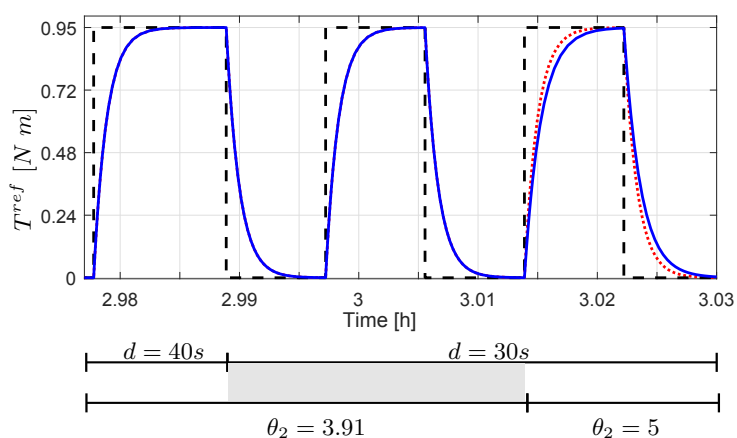

Figure V.8 – The desired torque T^{ref} (dashed line) and the applied motor torque T_m (solid line) - magnified view. For comparison, the dotted line corresponds to the applied torque without updating the value of the parameter θ_2 .

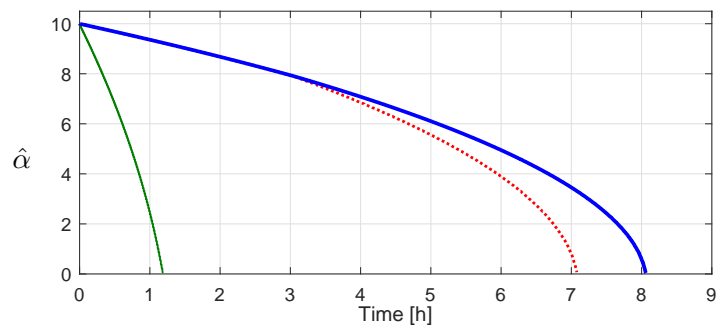

Figure V.9 – Estimated contact quality coefficient $\hat{\alpha}$ in presence of operating conditions changes and for three different cases: 1) without RUL control (thin line), 2) with a RUL control without updating the RUL prediction (dotted line), and 3) with a RUL control which adapts the control actions according to the current RUL prediction (bold line).

Conclusions and Perspectives

Contents

VI.1 General conclusions	97
VI.2 Perspectives	99
VI.2.1 On modeling	99
VI.2.2 On estimation	99
VI.2.3 On control of RUL	100

VI.1 General conclusions

This thesis deals with various issues from deterioration modeling to control of Remaining Useful Life (RUL). A comprehensive framework for post-prognosis decision-making applied to friction drive systems is proposed and illustrated. It is shown that, it is possible to control the RUL for a system taking into account a proper modeling, which includes systematically deterministic and stochastic assumptions on the inputs of the system and the current and future operating conditions. A global control architecture is proposed and illustrated. The architecture includes the systematic treatment of the uncertainties from modeling, estimation of current deterioration state, and prognosis of RUL. At the same time, the architecture describes how to use on line the prognosis information for closed-loop post-prognosis making-decision.

In Chapter II it is shown that the on-line management of the RUL can be stated as a control problem. The problem statement uses concepts of modeling, condition monitoring, diagnosis, prognosis and decision making. A state of the art on this issues is presented to provide context for the thesis. If the RUL is treated as any physical magnitude, for which a knowledge based on various types of uncertainty is assumed, and there is a systematic closed-loop oriented treatment of the prognosis information, then a control technique can be applied to convert a system under study into a Reliability Adaptive System (RAS), for which even the reliability of the control system can be included.

From Chapter III, after the analysis of the case study, it is concluded that the model of the system represents properly and dynamically the deterioration depending on the inputs of the system. The use of the model also allows to predict an interval of useful lifetime of the friction drive system before the total-failure-time, including stochastic internal and external perturbations.

This model includes a parameter linked with the deterioration (for instance the quality of a given fundamental mechanical property) and the ratio of the first with respect to the deterioration. This two parameters represent suitably the behavior of a system that deteriorates

monotonically. For the application case of the friction drive systems, it is needed for prediction: characterization of the input operating conditions, the contact quality coefficient and the quality-deterioration ratio, and assumptions about the future operating conditions, with models that include deterministic and probabilistic assumptions. The treatment of the involved information is feasible during work, which is interesting and useful for embedded systems.

In continuity with the preceding chapter, Chapter IV proposes an approach to estimate the current deterioration condition of the friction drive system. The approach is based on an Extended Kalman Filter (EKF) which uses an augmented model including the mechanical dynamical system and the deterioration dynamics. At every time instant, the EKF also provides intervals which includes the current deterioration value with a given probability. In this sense, the obtained values of the deterioration (and also the mechanical states and estimated varying parameters) include various sources of uncertainty, among others, parameter, structural, algorithmic and experimental sources. The estimation of the deterioration state enables making quick prognostics of the RUL with an uncertainty level, which is linked to the precision of the estimations. This quick action enables the using of the estimator during work for performing more “continuous” post-prognosis actions.

The EKF is a standard technique used in a number of nonlinear estimation and machine learning applications, see for instance [Shi 2002, Bolognani 2003] in the framework of condition monitoring. In this thesis, such an estimator is used as an interesting example for using the developed model of deterioration in the framework of the developed RAS. However, for years several improvements to EKF have been developed, which deals with theoretical and implementation issues [Wan 2000, Haseltine 2005, Zhao 2017]. For instance, for nonlinear systems, the a posteriori distribution is generally nonsymmetric and potentially multimodal. [Haseltine 2005]. The performance of the EKF can be tested on this issue and more analytical or experimental tests could be useful for making improvements of the developed estimation approach in this thesis. For instance, these tests could allow to characterize the probability distribution of the estimations. Of course, as shown in this thesis, such new methods should be developed taking into account the stages from the modeling to a final global architecture for controlling the RUL.

In Chapter V a Remaining Useful Lifetime (RUL) control architecture is presented. The control law is based on the on-line available prediction of the RUL, which includes a dynamical model of the mechanical system and its deterioration. The RUL controller can be implemented as an optimal controller which decides on-line, the parameters of a RUL actuating principle in order to modify the predicted RUL. The RUL actuating principle is intended for modifying the desired motion requirement in order to increase or decrease the predicted RUL. An example of an optimal controller is presented, which deals with two opposite criteria, namely the desired torque and the desired RUL, and showed a proper performance under the predefined scenario conditions.

As a result, a Reliability Adaptive System (RAS) is obtained and illustrated by means of a friction drive numerical example. For this system, behavior adaptation is achieved for managing the resource (in this case, the mating surfaces) for sustaining a predefined RUL. The RUL actuating principle allows the inclusion of a possible previous controller of short-term actions.

VI.2 Perspectives

From the results of the presented dissertation, the following mid- or long-term perspectives could be developed:

VI.2.1 On modeling

From Chapter III, one can consider that the deterioration model can be tested in multiple closed-loop scenarios, with the advantage of probing and simulating control techniques on reliability field for a basic mechanical system. These techniques could be particularly useful in research and development of RAS systems. Indeed, since such a model would link the control and the reliability of a system, it opens the door to develop control techniques which allows the device to autonomously adapt its behavior if user requirements or operating conditions change. This adaptation is commonly needed in embedded applications, thus, additional tests on related predefined scenarios are envisaged under this framework. These tests can be studied by using the deterministic and stochastic operational modes, as suggested for the analysis of the case study.

Concerning, RPI sets it is shown that, even though they are not enough for predicting the RUL in the scenario-based approach, they can be used to characterize the nominal behavior of the studied actuator and the maximal admissible deterioration behavior. This aspect can be used for starting decision-making activities related with actuator maintenance, for instance a fleet of this kind of actuators, and/or control reconfiguration/re-planing.

For a long-term perspective, adaptation of estimation to other systems, different from friction drive systems, is planned. The studied systems were analyzed under the assumption of monotonically decreasing state of health, nevertheless batteries or human body are systems that do not satisfy this requirement. In these cases the model of deterioration and the estimation methods could be adapted for controlling, for instance, the energy consumption during the useful life for the case of batteries.

For the case of the human body, in [Rosero 2018] discrete-time linear parameter-varying model for gas exchange dynamics during cycling is presented. This kind of modeling is useful for estimation of the state of fatigue during cycling. Under the assumption that state of fatigue is decreasing in a predefined horizon, the modeling presented in this thesis could be adapted for modeling such state of fatigue. Thus, the concept of final time (threshold) for develop an exercise within the given horizon could be studied as an analogous concept of RUL. This, in turn, could be useful for developing control techniques for the system human-machine in cycling.

VI.2.2 On estimation

From Chapter IV, the results showed the potential impact of the model and the estimation approach for studying theoretical approaches and real applications, for instance in maintenance and condition monitoring tasks.

Besides in perspective, different observers could be developed in order to improve the deterioration estimation. For instance [Jetto 1999, Han 2009, Gonzalez Silva 2018] where Adaptive

Extended Kalman Filter approach is systematically tuned to obtain more proper estimations and uncertainty intervals.

Machine learning is an opened door for developing identification and estimation problems. Actual machine learning tools can be analyzed in perspective, for instance, for using past information accompanied by the analytical model. This could be help to get RAS from actual advances in prognostic which have been already validated.

The proposed control architecture is envisaged to be studied into a stochastic context by considering more endogenous and exogenous sources of uncertainties into the RUL prediction and into the RUL control. For this, the stage of evaluation of performance of prognostic should be analyzed before and during the process of development of these future estimation scenarios and approaches based in this thesis. The actual PHM literature includes several works evaluation of performance of prognostic algorithms. In [Saxena 2014] it is presented a comprehensive view of various aspects that dictate what performance evaluation must be as far as prognostics is concerned. Also in [Rozas 2018], it is presented a comprehensive literature review of publications using datasets, moreover it provides guidelines and references for usage of these datasets in a manner that allows clear and consistent comparison between different approaches.

In this thesis the correctness as an attribute of prediction performance [Saxena 2014] is mentioned, in particular regarding to the precision and the accuracy of the estimations for a unit system, for the illustration scenarios. The evaluation of the developed algorithm in that sense, is linked basically to the perturbations in the inputs of the system. However, the inclusion of new scenarios, for instance, multiple randomness introduction for a unit system and/or a fleet of systems, should be more deeply evaluated in terms of performance.

VI.2.3 On control of RUL

Chapter V, illustrated the role and the importance of the RUL prediction for generating suitable control actions. As a future work, the proposed control architecture will be revisited in a stochastic context by considering more endogenous and exogenous sources of uncertainties in the RUL prediction and in the RUL control.

As for estimation, the performance of the whole strategy of control should be evaluated in terms of performance with a framework of suitable metrics. Additional work, not only scenario-dependent, could result useful for developing the RAS. Classical control evaluation of the performance, such a stability, time response, etc. are needed. Complementarily, as control in RAS involves prognosis stage, the methods cited in [Saxena 2014, Rozas 2018] could be used in terms of evaluation of the performance of the global strategy for RUL control. A further theoretical framework on this fields is suggested to be done for future work.

In this case randomized methods as proposed in [Alamo 2009, Alamo 2015] seem to have potential impact to improve the control strategies. In Chapter IV, for instance, a preliminary work using the Probabilistic Certification approach has been presented and could be, combined with invariant sets, the object of a future work. Since the studied system is subject to several sources of uncertainty sources, Probabilistic Certification Approach can be explored to evaluate different combination of “treatment” for the system taking into account predefined sets of uncertainties in a more structured way. For instance, in [Alamir 2015] Certification Approach

is used for combined therapy of cancer. The certification is viewed as the ability to guarantee with a predefined high probability the success of the therapy over a finite horizon, in spite of the unavoidable high uncertainties affecting a dynamic model; in this case, that is used to compute the optimal scheduling of drugs injection. Thus, recalling the analogy developed in Chapter II with the field of medicine, a friction drive system can be seen as a proper candidate to test Probabilistic Certification Approach to evaluate, for instance, the success of a defined control strategy.

From the theoretical point of view, Model Predictive Control (MPC) approaches can be included into the global architecture for controlling the RUL. This focus can be used to formalize an MPC general framework applied to RAS.

VI.2.3.1 Applications

In practice, the development of the deterioration model implies a *virtual sensor* of deterioration which could be validated. Thus, in Chapter IV one of the examples (endogenous changes) shows the potential use of the model for the detection of incipient or abrupt changes in the contact, which could be useful for fault detection and Fault Tolerant Control (FTC) applications.

Future work concern, among others, the application of the proposed condition monitoring and the RUL estimation for a real problem. Hence, a test rig could be useful for validating the model in such real applications. The development of the deterioration estimation is envisaged under the framework of the collaborative work described in the [Annexe](#). There, a platform for studying the wear of two-mating surfaces is described. Nowadays, this test rig is in the process of development. The inclusion of additional temperature and vibration sensors is envisaged in the framework of this test rig, for performing redundancy tests and a general validation of the model.

A.1 Test rig for studying surfaces wear

During the development of this thesis, there was an opportunity to establish an academic collaboration aimed at the development of one of the raised [perspectives](#). As a result of this academic link, the author of this thesis supervised the student Danilo Burbano for eight months, for the development of his final research work of the Electronic Engineering program (BACH + 5) of the *Universidad de Nariño*¹, Colombia.

Mr. Burbano worked mainly at the *Universidad de Nariño* had a short internship in the GIPSA-LAb (France), financed by the project “*Robótica UDENAR*” of the same institution.

A.1.1 Abstract

The phenomenon of electromechanical wear of components subject to friction is studied in the literature for its direct relationship with, among others, automation, tribology and material science. This type of wear contains a notorious stochastic nature and therefore its on-line estimation is not a simple task. A novel recently proposed theoretical approach for deterioration estimation seems an interesting way to tackle the problem. This model could be tested on a basic rolling-on-tire test rig, suitable for obtaining experimental data. This friction-drive system consists of an actuating device (motor) that drives a load device (wheel), which in turn contains angular speed sensors for each device and an electronic activation system. The research work is aimed at the development of such a test rig and for assessing the deterioration model, in the framework of educational purpose. The developed experimental set-up is composed of the electromechanical module, the power electronics, and the data acquisition system. The proposed methodology includes the development and experimentation stages to verify the wear behavior of the contact surfaces, particularly through data acquisition and identification of basic parameters. At the moment, the test platform is in the development process, particularly in the stage of tuning and data verification.

A.1.2 Summarized description of the test rig

It is intended to develop the test rig consisting of the modules:

- M1 *electromechanical assembly*, which includes the driver device (a motor-based roller), and the driven device (a wheel), and the mechanical structure.

¹ *Universidad de Nariño* is located in Pasto, Colombia. The Electronic Engineering program is part of its Faculty of Engineering.



(a) Modules

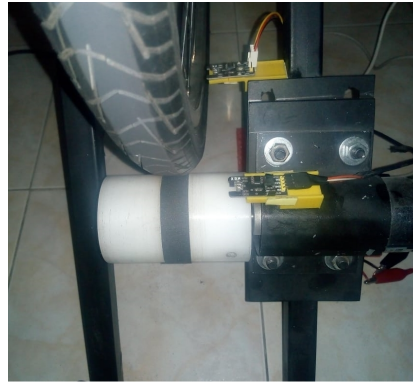

(b) Contact between motor roller and tire

Figure A.1 – Test Rig for Study of Surfaces Wear

M2 *the power electronics*, which contains the power supply and the drivers for the handling of the actuator and the sensors.

M3 *the data acquisition and control system*, which allows to obtain the data from the installed sensors and must guarantee a proper handling of the activation signals. The instrumentation work is intended to guarantee the identification of the basic mechanical and wear parameters of the test rig in order to obtain technical conclusions. Analysis on the feasibility of the system and the verification of the previously mentioned dynamic wear model are envisaged for short-term.

A.1.3 Advances

The following is a brief description of the progress made in the development of the test rig, which is close to be finalized:

- The work on electromechanical assembly, power electronics and the data acquisition and control system have been completed. Figure A.1(a) shows the current experimental set-up. Figure A.1(b) shows a more detailed view of the roller and the joint.
- A graphical interface was developed for the data acquisition and control system. The graphical interface is developed in Matlab and allows to see on-line the acquired data and to carry out a basic control of the actuator. The test rig is connected to a computer with operating system Windows 10, with processor Intel Core i7, RAM memory 16Gb. More technical details will be provided in the research report of Mr. Burbano.
- Speed sensors data have been collected for several use scenarios which could include, among others, soft use and accelerated process.
- The fine-tuning of the system is in the process of development.
- The analysis of the data for parameter identification is in the process of development.
- The final report of the research and its defense work is envisaged for December 2018.

Bibliography

- [Ahmad 2012] Rosmaini Ahmad et Shahrul Kamaruddin. *A review of condition-based maintenance decision-making*. European journal of industrial engineering, vol. 6, no. 5, pages 519–541, 2012. (cited on p. 3, 15, 16, 22 and 23.)
- [Ai 2005] Xiaolan Ai, Matthew Wilmer et David Lawrentz. *Development of friction drive transmission*. Journal of tribology, vol. 127, no. 4, pages 857–864, 2005. (cited on p. 21.)
- [Alamir 2015] Mazen Alamir. *On probabilistic certification of combined cancer therapies using strongly uncertain models*. Journal of theoretical biology, vol. 384, pages 59–69, 2015. (cited on p. 56, 74, 75 and 100.)
- [Alamo 2009] Teodoro Alamo, Roberto Tempo et Eduardo F Camacho. *Randomized strategies for probabilistic solutions of uncertain feasibility and optimization problems*. IEEE Transactions on Automatic Control, vol. 54, no. 11, pages 2545–2559, 2009. (cited on p. 75 and 100.)
- [Alamo 2015] Teodoro Alamo, Roberto Tempo, Amalia Luque et Daniel R Ramirez. *Randomized methods for design of uncertain systems: Sample complexity and sequential algorithms*. Automatica, vol. 52, pages 160–172, 2015. (cited on p. 100.)
- [Amari 2006] Suprasad V Amari, Leland McLaughlin et Hoang Pham. *Cost-effective condition-based maintenance using Markov decision processes*. In Reliability and Maintainability Symposium, 2006. RAMS'06. Annual, pages 464–469. IEEE, 2006. (cited on p. 22.)
- [Armstrong-Helouvry 1996] B. Armstrong-Helouvry et Carlos Canudas de Wit. The control handbook, chapitre Friction Modeling and Compensation, page 1369. CRS Press and IEEE Press, 1996. (cited on p. 33.)
- [Bai 2005] Jushan Bai et Serena Ng. *Tests for Skewness, Kurtosis, and Normality for Time Series Data*. Journal of Business & Economic Statistics, vol. 23, no. 1, pages 49–60, 2005. (cited on p. 69.)
- [Bastin 2013] Georges Bastin. On-line estimation and adaptive control of bioreactors, volume 1. Elsevier, 2013. (cited on p. 18.)
- [Bérengruer 2003] Christophe Bérengruer, Antoine Grall, Laurence Dieulle et Michel Roussignol. *Maintenance policy for a continuously monitored deteriorating system*. Probability in the Engineering and Informational Sciences, vol. 17, no. 2, pages 235–250, 2003. (cited on p. 89.)
- [Berenguer 2018] Christophe Berenguer. *Dynamic condition-based reliability evaluation for deteriorating systems: applications to deterioration management and joint maintenance/operation decision-making*. In Keynotes of: 10th IMA Int. Conf. on Modelling in Industrial Maintenance and Reliability. Manchester, 13-15 June, 2018, 2018. (cited on p. 17.)

- [Besançon 2007] Gildas Besançon. Nonlinear observers and applications, volume 363. Springer, 2007. (cited on p. 4, 16, 58 and 59.)
- [Bevan 2013] Adam Bevan, Paul Molyneux-Berry, Bridget Eickhoff et Mark Burstow. *Development and validation of a wheel wear and rolling contact fatigue damage model*. Wear, vol. 307, pages 100–111, 2013. (cited on p. 26 and 37.)
- [Bolognani 2003] Silverio Bolognani, Luca Tubiana et Mauro Zigliotto. *Extended Kalman filter tuning in sensorless PMSM drives*. IEEE Transactions on Industry Applications, vol. 39, no. 6, pages 1741–1747, 2003. (cited on p. 58, 61 and 98.)
- [Busawon 1998] K Busawon, M Farza et H Hammouri. *Observer design for a special class of nonlinear systems*. International Journal of Control, vol. 71, no. 3, pages 405–418, 1998. (cited on p. 59.)
- [Byington 2003] C Byington, Matthew Watson, Michael Roemer, Thomas Galie, Jack McGroarty et Christopher Savage. *Prognostic Enhancements to gas turbine diagnostic system*. In Proceedings of Aerospace Conference, IEEE, volume 7, pages 3247 – 3255, 2003. (cited on p. 3.)
- [Cambridge Dictionary 2018] Cambridge Dictionary. *Proactive*, 2018. Cambridge University Press. In <https://dictionary.cambridge.org/>. (cited on p. 14 and 16.)
- [Canudas-de Wit 2003] Carlos Canudas-de Wit, Panagiotis Tsiotras, Efstathios Velenis, Michel Basset et Gerard Gissinger. *Dynamic Friction Models for Road/Tire Longitudinal Interaction*. Vehicle System Dynamics, vol. 39, no. 3, pages 189–226, 2003. (cited on p. 33.)
- [Chen 2015] Fuyang Chen, Qingbo Wu, Bin Jiang et Gang Tao. *A reconfiguration scheme for quadrotor helicopter via simple adaptive control and quantum logic*. IEEE Transactions on Industrial Electronics, vol. 62, no. 7, pages 4328–4335, 2015. (cited on p. 18.)
- [Coble 2008] Jamie B Coble et J Wesley Hines. *Prognostic algorithm categorization with PHM challenge application*. In International Conference on Prognostics and Health Management, 2008. PHM 2008., pages 1–11. IEEE, 2008. (cited on p. 12 and 15.)
- [Cremona 2016] Marzia A. Cremona, Binbin Liu, Yang Hu, Stefano Bruni et Roger Lewis. *Predicting railway wheel wear under uncertainty of wear coefficient, using universal kriging*. Reliability Engineering & System Safety, vol. 154, pages 49–59, 2016. (cited on p. 13 and 37.)
- [Davis 1998] Wayne J Davis. On-line simulation: Need and evolving research requirements, pages 465–516. 1998. (cited on p. 18.)
- [Delgado-Aguinaga 2016] JA Delgado-Aguinaga, O Begovich et Gildas Besançon. *Exact-differentiation-based leak detection and isolation in a plastic pipeline under temperature variations*. Journal of Process Control, vol. 42, pages 114–124, 2016. (cited on p. 58.)

- [Exner 2017] Konrad Exner, Christian Schnürmacher, Sebastian Adolphy et Rainer Stark. *Proactive maintenance as success factor for use-oriented Product-Service Systems*. *Procedia CIRP*, vol. 64, pages 330–335, 2017. (cited on p. 3 and 16.)
- [Garcia 2006] Mari Cruz Garcia, Miguel A Sanz-Bobi et Javier del Pico. *SIMAP: Intelligent System for Predictive Maintenance: Application to the health condition monitoring of a windturbine gearbox*. *Computers in Industry*, vol. 57, no. 6, pages 552–568, 2006. (cited on p. 25.)
- [Gausemeier 2014] Jürgen Gausemeier, Franz Josef Rammig, Wilhelm Schäfer et Walter Sextro. *Dependability of self-optimizing mechatronic systems*. 2195-4356. Springer, 2014. (cited on p. 4, 18 and 25.)
- [Geffen 2009] V. Geffen. *A study of friction models and friction compensation*. Rapport technique, Technische Univ. Eindhoven, The Netherlands, 2009. (cited on p. 33.)
- [Geraci 1991] Anne Geraci, Freny Katki, Louise McMonegal, Bennett Meyer, John Lane, Paul Wilson, Jane Radatz, Mary Yee, Hugh Porteous et Fredrick Springsteel. *Ieee standard computer dictionary: Compilation of ieee standard computer glossaries*. IEEE Press, 1991. (cited on p. 21.)
- [Gits 1984] Christian Waltherus Gits. *On the maintenance concept for a technical system: a framework for design*. PhD thesis, Technische Hogeschool Eindhoven, 1984. (cited on p. 18.)
- [Gokdere 2005] LU Gokdere, Stephen L Chiu, Kirby J Keller et John Vian. *Lifetime control of electromechanical actuators*. In *Aerospace Conference, 2005 IEEE*, pages 3523–3531. IEEE, 2005. (cited on p. 25.)
- [Gonzalez Silva 2018] Jean Gonzalez Silva, Jose De Aquino et Eugenio Feitosa. *Adaptive Extended Kalman Filter using Exponential Moving Average*. In *Proceedings of: 9th IFAC Symposium on Robust Control Design and 2nd IFAC Workshop on Linear Parameter Varying Systems, Florianopolis, Brazil, September 3-5, 2018, 2018*. (cited on p. 61 and 99.)
- [Grall 2002] Antoine Grall, Laurence Dieulle, Christophe Bérenguer et Michel Roussinol. *Continuous-time predictive-maintenance scheduling for a deteriorating system*. *IEEE transactions on reliability*, vol. 51, no. 2, pages 141–150, 2002. (cited on p. 22.)
- [Grau 1910] O Peter Grau. *Friction drive mechanism.*, Mai 3 1910. US Patent 956,958. (cited on p. 21.)
- [Grosso 2012] Juan M Grosso, Carlos Ocampo-Martínez et Vicenç Puig. *A service reliability model predictive control with dynamic safety stocks and actuators health monitoring for drinking water networks*. In *Decision and Control (CDC), 2012 IEEE 51st Annual Conference on*, pages 4568–4573. IEEE, 2012. (cited on p. 4 and 84.)

- [Han 2009] Jaehyun Han, Dongchul Kim et Myoungcho Sunwoo. *State-of-charge estimation of lead-acid batteries using an adaptive extended Kalman filter*. Journal of Power Sources, vol. 188, no. 2, pages 606–612, 2009. (cited on p. 61 and 99.)
- [Haseltine 2005] Eric L Haseltine et James B Rawlings. *Critical evaluation of extended Kalman filtering and moving-horizon estimation*. Industrial & engineering chemistry research, vol. 44, no. 8, pages 2451–2460, 2005. (cited on p. 69 and 98.)
- [Hermann 1977] Robert Hermann et Arthur Krener. *Nonlinear controllability and observability*. IEEE Transactions on automatic control, vol. 22, no. 5, pages 728–740, 1977. (cited on p. 58 and 59.)
- [Hewko 1966] Lubomyr O Hewko. *Friction drive mechanism*, Novembre 8 1966. US Patent 3,283,614. (cited on p. 21.)
- [Hewko 1971] Lubomyr O Hewko. *Friction drive mechanism*, Octobre 5 1971. US Patent 3,610,060. (cited on p. 21.)
- [Huang 2003] Shuguang Huang et Mark Nagurka. *Friction Modeling of a Free-Spinning Bicycle Wheel*. In ASME, editeur, Proceedings of: STLE/ASME 2003 International Joint Tribology Conference, numéro 265 de 2003-TRIB-265, pages 53–57. American Society of Mechanical Engineers, 2003. (cited on p. 43.)
- [Huynh 2011] Khac Tuan Huynh, Anne Barros, Christophe Berenguer et Inmaculada Torres Castro. *A periodic inspection and replacement policy for systems subject to competing failure modes due to degradation and traumatic events*. Reliability Engineering & System Safety, vol. 96, no. 4, pages 497–508, 2011. (cited on p. 89.)
- [Huynh 2018] Khac Tuan Huynh, Antoine Grall et Christophe Bérenguer. *A Parametric Predictive Maintenance Decision-Making Framework Considering Improved System Health Prognosis Precision*. IEEE Transactions on Reliability, 2018. (cited on p. 17 and 23.)
- [Imanian 2016] Anahita Imanian et Mohammad Modarres. *Thermodynamics as a fundamental science of reliability*. Proceedings of the Institution of Mechanical Engineers, Part O: Journal of Risk and Reliability, vol. 230, no. 6, pages 598–608, 2016. (cited on p. 37 and 46.)
- [Jacques 1920] Murette Jacques. *Friction-drive mechanism*, Décembre 28 1920. US Patent 1,363,338. (cited on p. 21.)
- [Jardine 1999] AKS Jardine, T Joseph et D Banjevic. *Optimizing condition-based maintenance decisions for equipment subject to vibration monitoring*. Journal of Quality in Maintenance Engineering, vol. 5, no. 3, pages 192–202, 1999. (cited on p. 22.)
- [Jardine 2006] Andrew KS Jardine, Daming Lin et Dragan Banjevic. *A review on machinery diagnostics and prognostics implementing condition-based maintenance*. Mechanical systems and signal processing, vol. 20, no. 7, pages 1483–1510, 2006. (cited on p. 3, 13, 18, 19 and 89.)

- [Javed 2015] Kamran Javed, Rafael Gouriveau, Nouredine Zerhouni et Patrick Nectoux. *Enabling health monitoring approach based on vibration data for accurate prognostics*. IEEE Transactions on Industrial Electronics, vol. 62, no. 1, pages 647–656, 2015. (cited on p. 24.)
- [Javed 2017] Kamran Javed, Rafael Gouriveau et Nouredine Zerhouni. *State of the art and taxonomy of prognostics approaches, trends of prognostics applications and open issues towards maturity at different technology readiness levels*. Mechanical Systems and Signal Processing, vol. 94, pages 214–236, 2017. (cited on p. 12, 13, 17, 18 and 19.)
- [Jetto 1999] Leopoldo Jetto, Sauro Longhi et Giuseppe Venturini. *Development and experimental validation of an adaptive extended Kalman filter for the localization of mobile robots*. IEEE Transactions on Robotics and Automation, vol. 15, no. 2, pages 219–229, 1999. (cited on p. 61 and 99.)
- [Jørgensen 2008] Tine Herreborg Jørgensen. *Towards more sustainable management systems: through life cycle management and integration*. Journal of cleaner production, vol. 16, no. 10, pages 1071–1080, 2008. (cited on p. 18.)
- [Kaul 2017] Thorben Kaul, Tobias Meyer et Walter Sextro. *Formulation of reliability-related objective functions for design of intelligent mechatronic systems*. Proceedings of the Institution of Mechanical Engineers, Part O: Journal of Risk and Reliability, vol. 231, no. 4, pages 390–399, 2017. (cited on p. 25.)
- [Kofman 2007] E.J. Kofman, H. Haimovich et M.M. Seron. *A Systematic Method to Obtain Ultimate Bounds for Perturbed Systems*. International Journal of Control, vol. 80, no. 2, pages 167–178, February 2007. (cited on p. 51.)
- [Langeron 2015] Yves Langeron. *Modélisation stochastique pour la sûreté de fonctionnement des systèmes commandés*. PhD thesis, Univ. de Technologie de Troyes, 2015. (cited on p. 26.)
- [Langeron 2017] Yves Langeron, Antoine Grall et Anne Barros. *Joint maintenance and controller reconfiguration policy for a gradually deteriorating control system*. Proceedings of the Institution of Mechanical Engineers, Part O: Journal of Risk and Reliability, vol. 231, no. 4, pages 339–349, 2017. (cited on p. 4, 24 and 84.)
- [Lee 2014] Jay Lee, Fangji Wu, Wenyu Zhao, Masoud Ghaffari, Linxia Liao et David Siegel. *Prognostics and health management design for rotary machinery systems-Reviews, methodology and applications*. Mechanical systems and signal processing, vol. 42, no. 1-2, pages 314–334, 2014. (cited on p. 3, 13 and 15.)
- [Lu 2007] Susan Lu, Yu-Chen Tu et Huitian Lu. *Predictive condition-based maintenance for continuously deteriorating systems*. Quality and Reliability Engineering International, vol. 23, no. 1, pages 71–81, 2007. (cited on p. 22.)
- [Martinez 2004] J. Martinez, J. Avila et C. Canudas-de Wit. *A New Bicycle Vehicle Model with Dynamic Contact Friction*. In IFAC Advances in Automotive Control, pages 625–630, Salerno, Italy, 2004. Elsevier. (cited on p. 33.)

- [Martínez 2009] J.J. Martínez, M.M. Seron et J.A. De Doná. *Multi-sensor longitudinal control with fault tolerant guarantees*. In Proceedings of the European Control Conference, Budapest - Hungary., September 2009. (cited on p. 51.)
- [Martínez 2015] J.J. Martínez. *Minimal RPI sets computation for polytopic systems using the Bounded-real lemma and a new shrinking procedure*. In 1st IFAC Workshop on Linear Parameter Varying systems (IFAC LPVS), Oct 2015. (cited on p. 50 and 51.)
- [Mathur 2001] Amit Mathur, Kevin F Cavanaugh, Krishna R Pattipati, Peter K Willett et Thomas R Galie. *Reasoning and modeling systems in diagnosis and prognosis*. In Component and Systems Diagnostics, Prognosis, and Health Management, volume 4389, pages 194–204. International Society for Optics and Photonics, 2001. (cited on p. 12, 13 and 22.)
- [Meyer 2013] T Meyer, C Sondermann-Wölke, J Kimotho et W Sextro. *Controlling the remaining useful lifetime using self-optimization*. Chem. Eng. Trans, vol. 33, pages 625–630, 2013. (cited on p. 26.)
- [Meyer 2014] Tobias Meyer et Walter Sextro. *Closed-loop Control System for the Reliability of Intelligent Mechatronic Systems*. In European Conference of the Prognostics and Health Management Society - 2014 - Paderborn, Germany, pages 53–57, 2014. (cited on p. 4, 17, 25, 26, 37 and 84.)
- [Mohan M 2015] Shyam Mohan M, Naren Naik, R.M.O. Gemson et Mudambi Ananthasayanam. *Introduction to the Kalman filter and tuning its statistics for near optimal estimates and Cramer Rao bound*. Rapport technique, Department of electrical engineering Indian institute of technology Kanpur, 2015. (cited on p. 61, 67 and 70.)
- [Muller 2008] Alexandre Muller, Marie-Christine Suhner et Benoît Iung. *Formalisation of a new prognosis model for supporting proactive maintenance implementation on industrial system*. Reliability Engineering & System Safety, vol. 93, no. 2, pages 234–253, 2008. (cited on p. 3, 12 and 16.)
- [Nandi 2005] Subhasis Nandi, Hamid A Toliyat et Xiaodong Li. *Condition monitoring and fault diagnosis of electrical motors, A review*. IEEE transactions on energy conversion, vol. 20, no. 4, pages 719–729, 2005. (cited on p. 14 and 56.)
- [Nguyen 2014] Danh Nguyen, Laurence Dieulle et Antoine Grall. *Remaining useful life estimation of stochastically deteriorating feedback control systems with a random environment and impact of prognostic result on the maintenance process*. In Proceedings of the 2nd European Conference of the Prognostics and Health Management Society (PHME-14), pages 1–11. PHM Society, 2014. (cited on p. 4, 20 and 24.)
- [Oxford Living Dictionaries 2018] Oxford Living Dictionaries. *Proactive*, 2018. Oxford University Press. In <https://en.oxforddictionaries.com/definition/proactive>. (cited on p. 16.)
- [Pecht 2008] Michael G Pecht. Prognostics and health management of electronics. John Wiley & Sons, 2008. (cited on p. 12.)

- [Percy 1998] DF Percy, KAH Kobbacy et HE Ascher. *Using proportional-intensities models to schedule preventive-maintenance intervals*. IMA Journal of Management Mathematics, vol. 9, no. 3, pages 289–302, 1998. (cited on p. 22.)
- [Pereira 2010] Eduardo Bento Pereira, Roberto Kawakami Harrop Galvão et Takashi Yoneyama. *Model predictive control using prognosis and health monitoring of actuators*. In Industrial Electronics (ISIE), 2010 IEEE International Symposium on, pages 237–243. IEEE, 2010. (cited on p. 4 and 84.)
- [Popov 2010] V. Popov. Contact mechanics and friction: Physical principles and applications. Springer Science & Business Media, 2010. (cited on p. 31 and 33.)
- [Rakovic 2005] S.V. Rakovic, E.C. Kerrigan, K.I. Kouramas et D.Q. Mayne. *Invariant approximations of the minimal robust positively Invariant set*. IEEE Trans. on Automatic Control, vol. 50, no. 3, pages 406 – 410, march 2005. (cited on p. 51.)
- [Rakowsky 2006] Uwe K Rakowsky. *Modelling Reliability-Adaptive multi-system operation*. International Journal of Automation and Computing, vol. 3, no. 2, pages 192–198, 2006. (cited on p. 4, 17, 25 and 84.)
- [Rakowsky 2015] Uwe K Rakowsky et B Bertsche. In Luca Podofillini, Bruno Sudret, Bozidar Stojadinovic, Enrico Zio et Wolfgang Kröger, editeurs, Proc. of ESREL 2015 - Safety and Reliability of Complex Engineered Systems, pages 2451–2455. Taylor and Francis Group, 2015. (cited on p. 3, 4, 12 and 17.)
- [Ramasso 2014] Emmanuel Ramasso et Abhinav Saxena. *Review and analysis of algorithmic approaches developed for prognostics on CMAPSS dataset*. In Annual Conference of the Prognostics and Health Management Society 2014., 2014. (cited on p. 12.)
- [Rodriguez Obando 2016a] Diego Jair Rodriguez Obando, John Jairo Martinez Molina et Christophe Berenguer. *Deterioration modelling of contact surfaces for a friction drive system*. In Proc. of the 26th European Safety and Reliability Conference - ESREL 2016 - 26-29 Sep. 2016 - Glasgow, Scotland, pages 1961–1968, 2016. (cited on p. 52.)
- [Rodriguez Obando 2016b] Diego Jair Rodriguez Obando, John Jairo Martinez Molina et Christophe Berenguer. *Set-invariance analysis for deterioration prediction on a roller-on-tire actuator*. In Proc. 3rd Conference on Control and Fault-Tolerant Systems - SysTol2016 - 7-9 Sep. 2016 - Barcelona, Spain, pages 87–92, 2016. (cited on p. 53.)
- [Rodriguez Obando 2017a] Diego Jair Rodriguez Obando, John Jairo Martinez Molina et Christophe Berenguer. *Condition Monitoring of a Friction Drive System*. In Proc. 3rd IEEE Colombian Conference on Automatic Control, Oct. 2017. Cartagena, Colombia, pages 1–6, 2017. (cited on p. 53.)
- [Rodriguez Obando 2017b] Diego Jair Rodriguez Obando, John Jairo Martinez Molina et Christophe Berenguer. *Deterioration estimation for remaining useful lifetime prognosis in a friction drive system*. In Proc. 20th World Congress of the International Federation of Automatic Control - IFAC 2017, Jul. 2017. Toulouse, France, pages 13324–13329, 2017. (cited on p. 77, 85 and 91.)

- [Rodriguez Obando 2018] Diego Jair Rodriguez Obando, John Jairo Martinez Molina et Christophe Berenguer. *An architecture for controlling the remaining useful lifetime of a friction drive system*. In Proc. 10th IFAC Symposium on Fault Detection, Supervision and Safety for Technical Processes, SAFEPROCESS, Aug. 2018. Warsaw, Poland, pages 1–6, 2018. (cited on p. 93.)
- [Rodriguez 2014] Ricardo Rodriguez. Active force control for electric assist bicycles. Master’s thesis, Dep. of Physics and Electrical Engineering, Univ. Grenoble Alpes, 2014. (cited on p. 43.)
- [Rosero 2018] Nadia Rosero, John J. Martinez et Matteo Corno. *Modeling of gas exchange dynamics using cycle-ergometer tests*. In Proceedings of 9th Mathmod conference, volume 24, pages 1247–1256. Vienna, 2018. (cited on p. 99.)
- [Rozas 2018] Heraldito Rozas, Diego Muñoz-Carpintero, Aramis Perez, Kamal Medjaher et Marcos Orchard. *An Approach to Prognosis-Decision-Making for Route Calculation of an Electric Vehicle Considering Stochastic Traffic Information*. In PHM Society European Conference, volume 4, 2018. (cited on p. 23, 70 and 100.)
- [Salazar 2016] Jean C Salazar, Philippe Weber, Fatiha Nejjari, Didier Theilliol et Ramon Sarate. *MPC framework for system reliability optimization*. In Advanced and Intelligent Computations in Diagnosis and Control, pages 161–177. Springer, 2016. (cited on p. 26.)
- [Sankararaman 2013] Shankar Sankararaman et Kai Goebel. *Why is the remaining useful life prediction uncertain*. In Annual conference of the prognostics and health management society, volume 2013, 2013. (cited on p. 14, 19 and 56.)
- [Saxena 2014] Abhinav Saxena, Shankar Sankararaman et Kai Goebel. *Performance evaluation for fleet-based and unit-based prognostic methods*. In Second European conference of the Prognostics and Health Management society, pages 8–10, 2014. (cited on p. 70 and 100.)
- [Seron 2008] Maria M. Seron, Xiang W. Zhuo, Jose A. De Dona et John J. Martinez. *Multi-sensor switching control strategy with fault tolerance guarantees*. Automatica, vol. 44, no. 1, pages 88 – 97, 2008. (cited on p. 51.)
- [Shi 2002] KL Shi, TF Chan, YK Wong et SL Ho. *Speed estimation of an induction motor drive using an optimized extended Kalman filter*. IEEE Transactions on Industrial Electronics, vol. 49, no. 1, pages 124–133, 2002. (cited on p. 58 and 98.)
- [Si 2011] Xiao-Sheng Si, Wenbin Wang, Chang-Hua Hu et Dong-Hua Zhou. *Remaining useful life estimation—A review on the statistical data driven approaches*. European Journal of Operational Research, vol. 213, no. 1, pages 1–14, 2011. (cited on p. 2, 3, 13, 18, 19 and 83.)
- [Si 2014] Xiao-Sheng Si, Wenbin Wang, Chang-Hua Hu et Dong-Hua Zhou. *Estimating remaining useful life with three-source variability in degradation modeling*. IEEE Transactions on Reliability, vol. 63, no. 1, pages 167–190, 2014. (cited on p. 24.)

- [Skima 2014] Haithem Skima, Kamal Medjaher et Nouredine Zerhouni. *Accelerated life tests for prognostic and health management of MEMS devices*. In Second European Conference of the Prognostics and Health Management Society, PHM Society'2014., pages 1–7, 2014. (cited on p. 24.)
- [Stellato 2017] B. Stellato, B.P.G. Van Parys et P.J. Goulart. *Multivariate Chebyshev Inequality With Estimated Mean and Variance*. The American Statistician, vol. 71, no. 2, pages 123–127, 2017. (cited on p. 62.)
- [Swanson 2001] Laura Swanson. *Linking maintenance strategies to performance*. International journal of production economics, vol. 70, no. 3, pages 237–244, 2001. (cited on p. 16 and 23.)
- [Tang 2009] Liang Tang, Gregory J Kacprzynski, Kai Goebel et George Vachtsevanos. *Methodologies for uncertainty management in prognostics*. In Aerospace conference, 2009 IEEE, pages 1–12. IEEE, 2009. (cited on p. 2, 19 and 24.)
- [Tavner 2008] P J Tavner. *Review of condition monitoring of rotating electrical machines*. IET Electric Power Applications, vol. 2, no. 4, pages 215–247, 2008. (cited on p. 56.)
- [Torres 2011] Lizeth Torres, Gildas Besançon, Adrian Navarro, Ofelia Begovich, Didier Georges et al. *Examples of pipeline monitoring with nonlinear observers and real-data validation*. In 8th IEEE International Multi-Conf on Signals Systems and Devices, Sousse, Tunisia, 2011. (cited on p. 58.)
- [Tsang 1995] Albert HC Tsang. *Condition-based maintenance: tools and decision making*. Journal of Quality in Maintenance Engineering, vol. 1, no. 3, pages 3–17, 1995. (cited on p. 21.)
- [Vichare 2006] Nikhil M Vichare et Michael G Pecht. *Prognostics and health management of electronics*. IEEE transactions on components and packaging technologies, vol. 29, no. 1, pages 222–229, 2006. (cited on p. 3, 12, 14 and 15.)
- [Waeyenbergh 2002] Geert Waeyenbergh et Liliane Pintelon. *A framework for maintenance concept development*. International journal of production economics, vol. 77, no. 3, pages 299–313, 2002. (cited on p. 16.)
- [Wan 2000] Eric A Wan et Rudolph Van Der Merwe. *The unscented Kalman filter for nonlinear estimation*. In Adaptive Systems for Signal Processing, Communications, and Control Symposium 2000. AS-SPCC. The IEEE 2000, pages 153–158. Ieee, 2000. (cited on p. 98.)
- [Xie 2004] Jingsong Xie et Michael Pecht. *Application of in-situ health monitoring and prognostic sensors*. In 9th Pan Pacific Microelectronics Symposium Exhibits & Conference, Kahuku, Oahu, Hawaii, pages 10–12, 2004. (cited on p. 16.)
- [Zeng 2005] Sheng-kui Zeng, Michael G Pecht et Ji Wu. *Status and perspectives of prognostics and health management technologies*. Acta Aeronautica et Astronautica Sinica-Series A and B, vol. 26, no. 5, page 626, 2005. (cited on p. 12.)

- [Zhao 2017] JB Zhao, Marcos Netto et Lamine Mili. *A robust iterated extended Kalman filter for power system dynamic state estimation*. IEEE Trans. Power Syst, vol. 32, no. 4, pages 3205–3216, 2017. (cited on p. 98.)
- [Zio 2013] Enrico Zio. Prognostics and health management of industrial equipment, pages 333–356. IGI Global, 2013. (cited on p. 12 and 15.)

