



HAL
open science

Modeling and Control of Inhomogeneous Transport Phenomena

Emmanuel Witrant

► **To cite this version:**

Emmanuel Witrant. Modeling and Control of Inhomogeneous Transport Phenomena. Physics [physics]. Université Grenoble Alpes, 2015. <tel-02020735>

HAL Id: tel-02020735

<https://theses.hal.science/tel-02020735v1>

Submitted on 15 Feb 2019

HAL is a multi-disciplinary open access archive for the deposit and dissemination of scientific research documents, whether they are published or not. The documents may come from teaching and research institutions in France or abroad, or from public or private research centers.

L'archive ouverte pluridisciplinaire **HAL**, est destinée au dépôt et à la diffusion de documents scientifiques de niveau recherche, publiés ou non, émanant des établissements d'enseignement et de recherche français ou étrangers, des laboratoires publics ou privés.



HAL Authorization

SYNTHÈSE DES TRAVAUX DE RECHERCHE

Pour obtenir le grade de

HABILITATION À DIRIGER DES RECHERCHES DE L'UNIVERSITÉ DE GRENOBLE

Spécialité : **Physique**

Arrêté ministériel : 23 novembre 1988

Présentée par

Emmanuel Witrant

préparée au sein du

Laboratoire Grenoble Images Parole Signal Automatique

et de

L'École Doctorale de Physique

Modeling and Control of Inhomogeneous Transport Phenomena

Synthèse soutenue publiquement le **4 Mai 2015**,
devant le jury composé de :

Marco de Baar

Professeur d'Université, FOM-Institute for Plasma Physics Rijnhuizen, The Netherlands, Rapporteur

Eric Blayo

Professeur d'Université, LJK/UJF, Grenoble, Examineur

Miroslav Krstic

Professeur d'Université, Cymer Center for Control Systems and Dynamics, UCSD, USA, Rapporteur

Amelle Landais

Chargée de recherche CNRS, Chargée de conférences EPHE, LSCE, Gif-Sur-Yvette, Rapporteur

Lionel Rosier

Professeur d'Université, MINES ParisTech, Paris, Examineur



Contents

1	Introduction	5
2	Curriculum Vitae	8
2.1	Summary	8
2.2	Publications	10
2.2.1	International Journal Papers	10
2.2.2	Patents	12
2.2.3	Books	13
2.2.4	Coordinator of conference proceedings	13
2.2.5	Book Chapters	13
2.2.6	Papers in Proceedings of International Workshops or Conferences	14
2.3	Projects	14
2.4	Supervised students	16
2.5	Other international activities	18
2.6	Involvements in Academia and Teaching	19
3	Background on conservation laws	21
3.1	General form of a conservation law	21
3.2	Convection-diffusion form of a convection law	23
3.3	Inhomogeneous transport phenomena	24
3.4	Problems addressed	24
4	Inhomogeneous transport models	26
4.1	Diffusion in tokamak plasmas	26

4.2	Convection in inviscid Poiseuille flows	31
4.3	Diffusion-convection of trace gas in porous media	34
4.4	Specific difficulties	37
5	Estimation and control methods for inhomogeneous transport	39
5.1	Inverse strategies for advective-diffusive transport	40
5.1.1	Transport parameter estimate	40
5.1.2	Input estimate from sparse data	40
5.2	Identification of diffusive transport	41
5.3	Feedback control design	42
5.3.1	Distributed feedback control of diffusive transport	42
5.3.2	Boundary control of advection phenomena	46
6	Conclusions and perspectives	50
6.1	Linearities	50
6.2	Toward a unified estimation and control strategy?	52
6.3	Addressing new challenging physical problems	54
6.3.1	Environmental sciences	54
6.3.2	Controlled thermonuclear fusion.	55
6.3.3	Flow systems.	56

Chapter 1

Introduction

My objective is to propose new modeling, estimation and control methods for transport phenomena in inhomogeneous media with complex interconnections.

- Transport is considered as associated with a flow of particles [J-1]¹, energy [J-32] or information [J-5].
- Inhomogeneity is induced by structural modifications of the medium, for which classical models with constant transport coefficients (e.g. diffusivity or convection) cannot capture the effect of local variations (e.g. density, pressure, magnetic field, . . .) on the flow propagation [J-4, J-31, J-1].
- The complexity of the interconnections is first induced by local feedbacks, intrinsic when several variables interact between each other (e.g. coupling between density and temperature in gas transport [J-33]) or exogenous when the actuators for feedback regulation have a distributed effect (e.g. plasma controlled by wave-particles interactions using radio-frequency antennas in thermonuclear fusion [J-16]).
- This complexity also appears with boundary interconnections, when the system topology implies the interaction between several flows (e.g. mining ventilation [J-3] or the cooling of cryogenic power lines for the large hadrons collider at CERN [J-33]) or the use of sensors and actuators located at the boundaries of the flow (e.g. boundary control of a Poiseuille flow [J-12]).

Analyzing such phenomena implies to consider dynamic transport models described by partial differential equations (PDE) with transport coefficients that vary in space and time, and/or time-varying boundary conditions (inducing nonhomogeneous solutions of the PDEs). Such variations depend on feedback effects and imply a coupling with other systems, which can be described by ordinary differential equations, discrete equations (e.g. hybrid systems as in [Witrant et al., 2009a](#); [Di Benedetto et al., 2008](#); [Prieur et al., 2012](#)), functional differential equations (time-delay systems in [Witrant et al., 2006](#)), partial differential equations (PDEs) ([Castillo-Buenaventura et al., 2013b, 2012b](#)) or nonlinearities ([Georges et al., 2007](#)) that can be described as linear parameter-varying systems ([Rivas Caicedo et al., 2012a](#); [Bribiesca Argomedo et al., 2011](#)).

My research topic aims to adapt complex models inferred from physical laws (Maxwell equations for thermonuclear fusion, Euler and Navier-Stokes equations for ventilation systems and continuity for porous media and firm) to the analytical framework of automatic control. It requires an interdisciplinary approach combining:

¹see reference in the publication list, Section 2.2

- physics: modeling of transport phenomena with parameters capturing diffusion, convection, sink and source varying in time and space from fluid mechanics (J-12, [Witrant and Johansson, 2008](#); [Castillo-Buenaventura et al., 2013b](#)), thermodynamics (J-26, [Rahmani et al., 2012](#)) or electromagnetism (J-4, [Delebecque et al., 2008](#));
- applied mathematics: stability analysis and optimization of dynamical systems using analytical results on distributed systems (described by partial or functional differential equations, see [Witrant and Martinerie, 2010](#), and J-1), linear algebra, calculus of variations ([Santiago et al., 2011](#); [Witrant et al., 2006](#)) and solving inverse problems ([Witrant and Martinerie, 2013a](#), J-21, J-2, J-15);
- engineering: design of algorithms for real-time regulation or for modeling complex systems by associating the theoretical model to experiments using automatic control methods (synthesis of feedback control laws or identification strategies, see J-12, J-17, J-7, [Mechhoud et al., 2012, 2013b](#)), signal processing (to use distributed sensors, communication networks and data processing in the frequency domain as in [Witrant et al., 2004](#), J-29, BC-5) and numerical analysis (discretization methods and computational fluid dynamics, see J-4, J-1).

Combining these topics motivate new links between theories and application, in a problem-solving strategy that provide clear guidelines to develop new methods or to define suitable experimental campaigns. These problems are mostly still open, due to the lack of an explicit solution of transport PDEs with coefficients varying in space and time (typically several orders of magnitude, impairing the use of average solutions). The precision and real-time computing constraints on the models imply to integrate physical principles and system dynamics in the algorithm scheme (e.g. the structure is set according to the definition of the flux and conserved variables, to the localization of the eigenvalues spectrum despite the temporal variations, or to the use of artificial delays associated to nonlinear components to allow using implicit linear schemes).

Systems characterized by inhomogeneous transport, due to their peculiar structure, are generally only addressed with local models and regulation strategies. Each element is then optimized in a local framework, without specifically considering the distribution of inhomogeneities and the complex inter-connections. The aim of my work is to develop new approaches for modeling, analysis and control that allow for a global integration of the dynamics. These approaches are associated to the study of transport phenomena with a large societal impact (e.g. energy generation, global warming, pollutants emissions . . .).

The results presented in this manuscript are motivated by several physical processes for which inhomogeneous transport appears as a major challenge to model and control the input to output map. We consider mostly 1D transport in Cartesian or cylindrical coordinates, with space and/or time variations of the transport coefficients and express the dynamics of the process in terms of the convection-diffusion equation. Each physical system considered in my research was chosen to address a particular aspect of inhomogeneous transport, with different instrumentation capabilities and distinct objectives in terms of modeling and control. The specific results aim at providing adequate solutions to evaluate and answer the ever increasing need of humans for more energetic resources, with a humble attempt to do it with less environmental damage.

The manuscript is organized as follows. Chapter 2 is my curriculum vitae, providing an overview of the steps and numerous scientific interactions that led to the presented results. The general framework of inhomogeneous transport analysis is given in Chapter 3 as a background on conservation laws. Chapter 4 presents some specific processes involving inhomogeneous transport and the problems formulation from an estimation and control perspective. The methods developed to solve these problems are summarized in Chapter 5. Conclusions and perspectives are finally presented in Chapter 6. I selected specific processes and methods from my research to illustrate the different inhomogeneities and the different classes of problems.

The structure of the manuscript reflects an answer to the common friendly remark from my colleagues that a sentence mixing tokamaks, car engines, ice cores, mining ventilation and cryogenics while pretending they are all the same should be mine. I also attempted to address the discussions of the

manuscript to all the examination committee members, as key specialists in automatic control, glaciology, inverse problems, stability analysis and thermonuclear fusion. I am most grateful and honored by their interest in my research concerns.

As this work results from many strong collaborations with enthousiasming colleagues and students, I will use “we” to describe indistinctly the results of interconnections and more personal contributions. Indeed, my main reward from science comes from sharing stimulating intuitions and to watch them transforming into fruitful results when processes with other people, more than contributing as an isolated mind.

Chapter 2

Curriculum Vitae

2.1 Summary

Current position and Professional Experience _____

Since 2007

UJF / GIPSA-LAB, GRENOBLE, FRANCE. ASSOCIATE PROFESSOR IN THE PHYSICS DEPARTMENT.

Research activity on *Modeling and control of transport in inhomogeneous media*, Teaching at *UFR PhITEM* (Physique, Ingénierie, Terre, Environnement, Mécanique). PES/PEDR (national allowance for excellent research) since 2010
▷ *Theoretical research on* heterogeneous transport modeling and control: stabilization, identification and optimization for systems described by partial differential equations or time-delays.

▷ *Main collaborations (joint publications and/or projects):*

- Information transport and networked control systems: *KTH (Sweden), Un. of L'Aquila and Sienna (Italy)*.
- Energy transport and large-scale instruments: *CEA (IRFM-ITER)/Supélec/LISA/LJK (France), CERN/EPFL (Switzerland), KTH, JET (UK), IIT/UA (USA), IIT (India)*.
- Chemical transport in ice cores and environmental studies: *LGGE, IMAU (Netherlands), CIC (Denmark), INSTAAR/NOAA/UC (USA), UEA (UK), Univ. Bern (Switzerland)*.
- Industrial applications: mining/building ventilation, car engines: *ABB/Boliden (Sweden), Renault/PRISME (France)*.

▷ *Head of the international Master 2 in Systems, Control and Information Technologies.*

▷ *Head of the Automatic Control teachings and the PhyAuto lab at UFR PhITEM.*

▷ *Co-director and head of education for the Labex Persyval-lab.*

▷ *Research coordinator for the Fédération de Recherche sur la Fusion Contrôlée Magnétiquement.*

▷ *2013-2014: visiting professor in the Applied Mathematics and Optimization in Eng. Center (OPTEC) groups at Katholieke University Leuven and “collaborateur scientifique” in the Laboratoire de Glaciologie at Université Libre de Bruxelles (Belgium). Financed by CRCT from UJF and CNU, and by KUL.*

Since 2002

AUTOMATIC CONTROL AND INHOMOGENEOUS TRANSPORT.

- ▷ *Publications: 34 journal papers (including 2 in Nature and 1 in Nature Geoscience), 5 patents, 2 books, 3 coordinations of conf. proceedings, 8 book chapters, 51 papers in international conference proceedings.*
- ▷ *Projects: 14 international, 5 national, 6 industrial, 6 regional. Project coordinator for 11.*
- ▷ *Advised students: 8 Ph.D. (+5 external), 3 post-docs / ATER, 17 Master 2, 5 Master 1.*
- ▷ *Publication chair for the 2013 IFAC Joint Conference in Grenoble (SSSC, TdS, FDA).*
- ▷ *Invited sessions organizer for IEEE and AIAA.*
- ▷ *Reviewer for key journals / international conferences in Automatic Control, Thermonuclear Fusion and Atmospheric studies.*

1999-2003

UNITED TECHNOLOGIES (1 YEAR, ATLANTA, USA), CERN (2 MONTHS, GENEVA, SWITZERLAND) AND UNIV. OF TWENTE (3 MONTHS, ENSCHEDE, NETHERLANDS). SPONSORED INTERNSHIPS.

Post-docs

2006-2007

ROYAL INST. OF TECH. (KTH), STOCKHOLM, SWEDEN. POST-DOC IN CONTROL SYSTEMS (11 MONTHS).
Identification and control of networked embedded intelligent systems and distributed systems.

2006

CEA-CADARACHE, FRANCE. POST-DOC IN CONTROLLED THERMONUCLEAR FUSION (10 MONTHS).
Modeling, identification and control of the current profiles in Tokamak plasmas.

Education

2002- 09/2005

GRENOBLE UNIVERSITY, FRANCE. PHD IN CONTROL SYSTEMS.
Stabilization of Network Controlled Systems. INPG best Ph.D. thesis award.

2001-2002

INPG/LAG, GRENOBLE, FRANCE. MASTER OF SCIENCE IN CONTROL SYSTEMS.
Thesis on *Human Friendly Control: Application to the Drive-by-Wire System* (grad. with honors)

1999-2001

GEORGIA INSTITUTE OF TECHNOLOGY, ATLANTA, USA. BACHELOR OF SCIENCE IN AEROSPACE ENGINEERING.
Specialization in control theories; research projects with M.P. Kamat and P. Tsiotras. Dean's List.

1997-1999

EURO AMERICAN INSTITUTE OF TECHNOLOGY, SOPHIA-ANTIPOLIS, FRANCE. B. IN AEROSPACE ENGINEERING.
Freshman and sophomore years. Minors in Computer Sciences and Mathematics. Highest honors.

2.2 Publications

Preprints available at <http://www.gipsa-lab.grenoble-inp.fr/~e.witrant/>

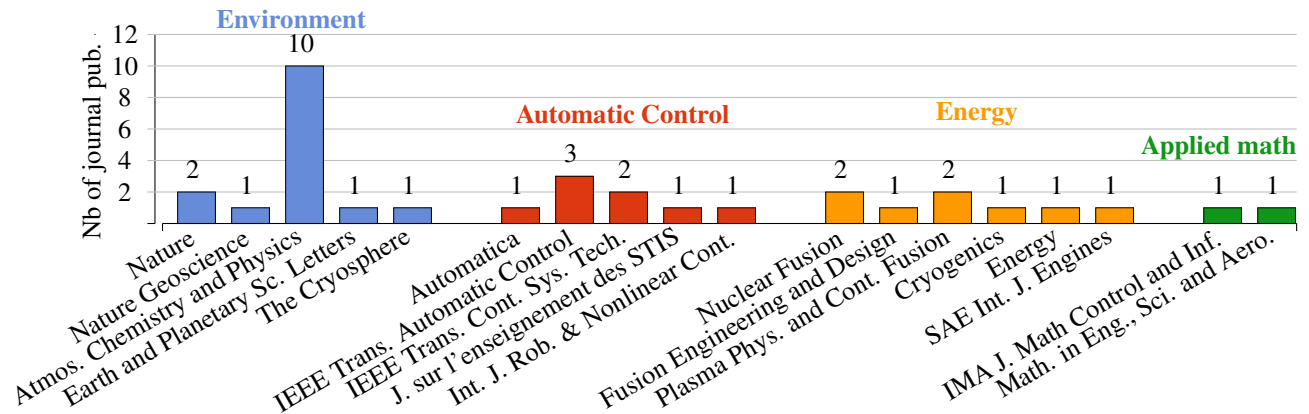

2.2.1 International Journal Papers

(<IF according to JCR 2011>, when available¹)

————— Top 5 —————

- J-1 E. Witrant, P. Martinerie, C. Hogan, J. C. Laube, K. Kawamura, E. Capron, S. A. Montzka, E. L. Dlugokencky, D. Etheridge, T. Blunier, and W. T. Sturges, **A new multi-gas constrained model of trace gas non-homogeneous transport in firn: evaluation and behavior at eleven polar sites**, *Atmos. Chem. Phys.*, 12, 11465-11483, 2012. < IF = 5.52 >
- J-2 C.J. Sapart, G. Monteil, M. Prokopiou, R.S.W. van de Wal, P. Sperlich, J.O. Kaplan, K.M. Krumhardt, C. van der Veen, S. Houweling, M.C. Krol, T. Blunier, T. Sowers, P. Martinerie, E. Witrant, D. Dahl-Jensen and T. Röckmann: **Natural and anthropogenic variations in methane sources over the last millennia**, *Nature*, 490, 85-88 (04 October), 2012. < IF = 36.3 >
- J-3 E. Witrant, A. D'Innocenzo, G. Sandou, F. Santucci, M. D. Di Benedetto, A. J. Isaksson, K. H. Johansson, S.-I. Niculescu, S. Olaru, E. Serra, S. Tennina and U. Tiberi, **Wireless Ventilation Control for Large-Scale Systems: the Mining Industrial Case**, *Int. J. Robust and Nonlinear Control*, vol. 20 (2), pp. 226 - 251, Jan. 2010. < IF = 1.55 >
- J-4 E. Witrant, E. Joffrin, S. Brémond, G. Giruzzi, D. Mazon, O. Barana et P. Moreau, **A control-oriented model of the current profile in Tokamak plasma**, *Plasma Physics and Controlled Fusion* 49 (2007) 1075-1105. < IF = 2.73 >
- J-5 E. Witrant, C. Canudas de Wit, D. Georges and M. Alamir, **Remote Stabilization via Communication Networks with a Distributed Control Law**, *IEEE Trans. on Automatic Control*, vol. 52, pp. 1480-1485, Aug. 2007. < IF = 2.11 >
- J-6 F. Castillo, E. Witrant, V. Talon and L. Dugard, **Air Fraction and EGR Proportion Control for Dual Loop EGR Diesel Engines**, *Revista Ingenieria y Universidad*, 19(1), 2015.
- J-7 S. Mechhoud, E. Witrant, L. Dugard and D. Moreau, **Estimation of Heat Source Term and Thermal Diffusion in Tokamak Plasmas Using a Kalman Filtering Method in the Early Lumping Approach**, *IEEE Transactions on Control Systems Technology*, 23(11), 449-463, 2015. < IF = 2.00 >

¹while the use of impact factors is clearly debatable, they are mentioned here due to the diversity of the research areas.

- J-8 F. Castillo, E. Witrant, C. Prieur, L. Dugard and T. Vincent, **Fresh Air Fraction Control in Engines Using Dynamic Boundary Stabilization of LPV Hyperbolic Systems**, *IEEE Transactions on Control Systems Technology*, to appear, 2015. < IF = 2.00 >
- J-9 Callens, D., Matsuoka, K., Steinhage, D., Smith, B., Witrant, E., and Pattyn, F., **Transition of flow regime along a marine-terminating outlet glacier in East Antarctica**, *The Cryosphere*, 8, 867-875, 2014. < IF = 3.77 >
- J-10 J. Laube, M. Newland, C. Hogan, C. Brenninkmeijer, P. Fraser, P. Martinerie, D. Oram, C. Reeves, T. Röckmann, J. Schwander, E. Witrant and W. Sturges, **Newly detected ozone depleting substances in the atmosphere**, *Nature Geoscience*, 1752-0908, 9 March, 2014. < IF = 12.37 (2012)>
- J-11 C. Prieur, A. Girard and E. Witrant, **Stability of switched linear hyperbolic systems by Lyapunov techniques**, *IEEE Trans. on Automatic Control*, 59(8), pp. 2196-2202, 2014. < IF = 2.11 >
- J-12 F. Castillo, E. Witrant, C. Prieur and L. Dugard, **Boundary Observers for Linear and Quasi-Linear Hyperbolic Systems with Application to Flow Control**, *Automatica*, 49(11), pp. 3180-3188, 2013. < IF = 2.83 >
- J-13 Helmig, D., Petrenko, V., Martinerie, P., Witrant, E., Röckmann, T., Zuiderweg, A., Holzinger, R., Hueber, J., Stephens, C., White, J., Sturges, W., Baker, A., Blunier, T., Etheridge, D., Rubino, M., and Tans, P., **Reconstruction of Northern Hemisphere 1950-2010 atmospheric non-methane hydrocarbons**, *Atmos. Chem. Phys.*, 14, 1463-1483, 2014.
- J-14 Alamir M., Witrant E., Della Valle G., Rouaud O., Josset C. and Boillereaux L., **Estimation of energy saving thanks to a reduced-model-based approach: Example of bread baking by jet impingement**, *Energy*, 53, 74-82, 2013. < IF = 3.49 >
- J-15 NEEM community members (126 co-authors in alphabetical order including E. Witrant), **Eemian interglacial reconstructed from a Greenland folded ice core**, *Nature*, 493, 489-494 (24 January), 2013. < IF = 36.3 >
- J-16 F. Bribiesca Argomedo, E. Witrant, C. Prieur, S. Brémond, R. Nouailletas and J.-F. Artaud, **Lyapunov-Based Distributed Control of the Safety Factor Profile in a Tokamak Plasma**, *Nuclear Fusion*, 53, 033005, 2013. < IF = 4.09 >
- J-17 F. Bribiesca Argomedo, C. Prieur, E. Witrant and S. Brémond, **A strict control Lyapunov function for a diffusion equation with time-varying distributed coefficients**, *IEEE Trans. on Auto. Control*, 58(2), 290-303, 2013. < IF = 2.11 >
- J-18 Petrenko, V. V., Martinerie, P., Novelli, P., Etheridge, D. M., Levin, I., Wang, Z., Blunier, T., Chappellaz, J., Kaiser, J., Lang, P., Steele, L. P., Hammer, S., Mak, J., Langenfelds, R. L., Schwander, J., Severinghaus, J. P., Witrant, E., Petron, G., Battle, M. O., Forster, G., Sturges, W. T., Lamarque, J.-F., Steffen, K., and White, J. W. C.: **A 60-yr record of atmospheric carbon monoxide reconstructed from Greenland firn air**, *Atmospheric Chemistry and Physics*, 13, 7567-7585, 2013. < IF = 5.52 >
- J-19 Zuiderweg, A., Holzinger, R., Martinerie, P., Schneider, R., Kaiser, J., Witrant, E., Etheridge, D., Rubino, M., Petrenko, V., Blunier, T., and Röckmann, T.: **Extreme 13C depletion of CCl₂F₂ in firn air samples from NEEM, Greenland**, *Atmos. Chem. Phys.*, 13, 599-609, 2013. < IF = 5.52 >
- J-20 J. Bock, P. Martinerie, E. Witrant and J. Chappellaz, **Atmospheric impacts and ice core imprints of a methane pulse from clathrates**, *Earth and Planetary Science Letters*, vol. 349-350, 98-108, 2012. < IF = 4.18 >
- J-21 Sapart, C. J., Martinerie, P., Witrant, E., Chappellaz, J., van de Wal, R. S. W., Sperlich, P., van der Veen, C., Bernard, S., Sturges, W. T., Blunier, T., Schwander, J., Etheridge, D., and Röckmann, T., **Can the carbon isotopic composition of methane be reconstructed from multi-site firn air measurements?**, *Atmos. Chem. Phys.*, 13, 6993-7005, 2013. < IF = 5.52 >
- J-22 J. C. Laube, C. Hogan, M. J. Newland, F. S. Mani, P. J. Fraser, C. A. M. Brenninkmeijer, P. Martinerie, D. E. Oram, T. Röckmann, J. Schwander, E. Witrant, G. P. Mills, C. E. Reeves, and W. T. Sturges, **Distributions, long term trends and emissions of four perfluorocarbons in remote parts of the atmosphere and firn air**, *Atmos. Chem. Phys.*, 12, 4081-4090, 2012. < IF = 5.52 >
- J-23 Sturges, W. T., Oram, D. E., Laube, J. C., Reeves, C. E., Newland, M. J., Hogan, C., Martinerie, P., Witrant, E., Brenninkmeijer, C. A. M., Schuck, T. J., and Fraser, P. J., **Emissions halted of the potent greenhouse gas SF₅CF₃**, *Atmos. Chem. Phys.*, 12, 3653-3658, 2012. < IF = 5.52 >

- J-24 Z. Wang, J. Chappellaz, P. Martinerie, K. Park, V. Petrenko, E. Witrant, L.K. Emmons, T. Blunier, C. A. M. Brenninkmeijer, and J. E. Mak, **The isotopic record of Northern Hemisphere atmospheric carbon monoxide since 1950, implications for the CO budget**, *Atmos. Chem. Phys.*, 12, Atmos. Chem. Phys., 12, 4365-4377, 2012. < IF = 5.52 >
- J-25 C. Buizert, P. Martinerie, V.V. Petrenko, J.P. Severinghaus, C.M. Trudinger, E. Witrant, J.L. Rosen, A.J. Orsi, M. Rubino, D.M. Etheridge, L. P. Steele, C. Hogan, J.C. Laube, W.T. Sturges, V.A. Levchenko, A.M. Smith, I. Levin, T.J. Conway, E.J. Dlugokencky, P.M. Lang, K. Kawamura, T.M. Jenk, J.W.C. White, T. Sowers, J. Schwander, and T. Blunier, **Gas transport in firn: multiple-tracer characterisation and model intercomparison for NEEM, Northern Greenland**, *Atmos. Chem. Phys.*, 12, 4259-4277, 2012. < IF = 5.52 >
- J-26 M. Rivas Caicedo, P. Higelin, C. Cailloil, O. Sename, E. Witrant, V. Talon **Validation and Application of a New 0D Flame/Wall Interaction Sub Model for SI Engines**, *SAE Int. J. Engines* 5(3):718-733, 2012.
- J-27 E. Witrant, J.-M. Thiriet and N. Retière, **Establishing a Systems & ICT Master program in the International Framework**, *Journal sur l'enseignement des sciences et technologies de l'information et des systèmes*, 2011.
- J-28 H. Ouarit, S. Brémond, R. Nouaillietas, E. Witrant and L. Autrique, **Validation of plasma current profile model predictive control in tokamaks via simulations**, *Fusion Engineering and Design*, Vol. 86, Issues 6-8, pp. 1018-1021, October 2011. < IF = 1.49 >
- J-29 E. Witrant, P. Di Marco, P. Park and C. Briat, **Limitations and performances of robust control over WSN: UFAD control in intelligent buildings**, *IMA J. of Mathematical Control and Information*, November 2010. < IF = 0.38 >
- J-30 J.C. Laube, P. Martinerie, E. Witrant, T. Blunier, J. Schwander, C.A.M. Brenninkmeijer, T.J. Schuck, M. Bolder, T. Röckmann, C. van der Veen, H. Bönisch, A. Engel, G.P. Mills, M.J. Newland, D.E. Oram, C.E. Reeves and W.T. Sturges, **Accelerating growth of HFC-227ea (1,1,1,2,3,3,3-heptafluoropropane) in the atmosphere**, *Atmospheric Chemistry and Physics*, 10, 5903-5910, 2010. < IF = 5.52 >
- J-31 E. Witrant and S.-I. Niculescu, **Modeling and control of large convective flows with time-delays**, *Mathematics in Engineering, Science and Aerospace*, Vol 1, No 2, 191-205, 2010.
- J-32 K.E.J. Olofsson, P.R. Brunzell, E. Witrant, J.R. Drake, **Synthesis and operation of an FFT-decoupled fixed-order RFP plasma control system based on identification data**, *Plasma Physics and Controlled Fusion*, 52(10), 104005 (19pp), 2010. < IF = 2.73 >
- J-33 B. Bradu, P. Gayet, S.-I. Niculescu and E. Witrant, **Modeling of the very low pressure helium ow in the LHC Cryogenic Distribution Line after a quench**, *Cryogenics*, vol. 50 (2), pp. 71-77, Feb. 2010. < IF = 0.67 >
- J-34 M. Chatelier on behalf of Equipe Tore Supra (including E. Witrant), **Integration of high power, long pulse operation in Tore Supra in preparation for ITER**, *Nuclear Fusion* 47 (2007) S579. < IF = 4.09 >

2.2.2 Patents

1. V. Talon, F. Castillo and E. Witrant, **Système et procédé d'estimation du rapport entre la pression en amont et la pression en aval de la turbine d'un moteur suralimenté d'un véhicule automobile**, WO2013120772 A1, 2013.
2. F. Castillo, V. Talon, E. Witrant and L. Dugard, **Système et procédé de détermination de la fraction massique de gaz frais dans le collecteur d'admission d'un moteur à combustion interne de véhicule automobile**, INPI No FR 1355045, 2013.
3. F. Castillo, E. Witrant, V. Talon and L. Dugard, **Procédé de Régulation d'un Turbocompresseur à Géométrie Variable**, INPI No FR 1260352, 2012.
4. F. Castillo, V. Talon and E. Witrant, **Estimation de la Pression Avant Turbine en Vue d'un Contrôle de la Suralimentation des Moteurs à Combustion Interne**, INPI No FR 1251468, 2011. **Price of the Renault Innovation Trophy**, Renault SAS.

5. F. Castillo, V. Talon and E. Witrant, **Procédé d'Acquisition de la Composition des Gaz d'Admission dans un Répartiteur d'Air d'un Moteur a Combustion Interne**, INPI No FR 2973441, 2011.

2.2.3 Books

- B-1 E. Witrant, E. Fridman, L. Dugard and O. Sename (Editors), **Recent results on time-delay systems: analysis and control**, series *Advances in Delays and Dynamics (ADD@S)*, Springer, 2014. To appear.
- B-2 F. Bribiesca Argomedo, E. Witrant and C. Prieur, **Safety Factor Profile Control in a Tokamak**, series *SpringerBriefs in Electrical and Computer Engineering*, subseries *Control, Automation and Robotics*, 94p., ISBN 978-3-319-01957-4, 2014.

2.2.4 Coordinator of conference proceedings

- B-1 E. Witrant, J.J. Martinez-Molina, M. Lovera, O. Sename and L. Dugard, (Eds.), **Proc. of the 5th Symposium on System Structure and Control**, *International Federation of Automatic Control*, ISBN: 978-3-902823-25-0, Feb. 6, 2013.
- B-2 E. Witrant, A. Seuret, E. Fridman, O. Sename and L. Dugard, (Eds.), **Proc. of the 11th Workshop on Time-Delay Systems**, *International Federation of Automatic Control*, ISBN: 978-3-902823-26-7, Feb. 6, 2013.
- B-3 E. Witrant, J. Sabatier, J. Tenreiro Machado, O. Sename and L. Dugard, (Eds.), **Proc. of the 6th Workshop on Fractional Differentiation and Its Applications**, *International Federation of Automatic Control*, ISBN: 978-3-902823-27-4, Feb. 6, 2013.

2.2.5 Book Chapters

- BC-1 D. F. Novella-Rodriguez, E. Witrant and O. Sename, **Control-Oriented Modeling of Fluid Networks: A Time-Delay Approach**, in I. Karafyllis, M. Malisoff, F. Mazenc and P. Pepe (Eds), *Recent Results on Nonlinear Time Delayed Systems*, series *Advances in Delays and Dynamics (ADD@S)*, Springer, 2015. To appear.
- BC-2 F. Castillo, E. Witrant, C. Prieur and L. Dugard, **Dynamic Boundary Stabilization of First Order Hyperbolic Systems**, in E. Witrant, E. Fridman, L. Dugard and O. Sename (Eds), *Recent results on time-delay systems: analysis and control*, series *Advances in Delays and Dynamics (ADD@S)*, Springer, 2015. To appear.
- BC-3 E. Witrant, **Control of Tokamak Plasmas**, in T. Samad and A.M. Annaswamy (eds.), *The Impact of Control Technology*, 2nd ed., IEEE Control Systems Society, 2014. To appear.
- BC-4 E. Witrant and E. Popescu, **A Problem-Based Learning Approach for Green Control & IT in a Master Program**, in Leung, H.; Popescu, E.; Cao, Y.; Lau, R.W.H.; Nejdil, W. (Eds.), *Advances in Web-based Learning - ICWL 2011, Lecture Notes in Control and Information Sciences (Artificial Intelligence)*, vol. 352, Springer, pp. 273-282, 2011.
- BC-5 E. Witrant, P. Park and M. Johansson, **Time-delay estimation and finite-spectrum assignment for control over multi-hop WSN**, in S.K. Mazumder (Ed), *Wireless Networking Based Control*, pp. 135-152, Springer, 2011.
- BC-6 E. Witrant and N. Marchand, **Modeling and Feedback Control for Air Flow Regulation in Deep Pits**, in S. Sivasundaram (Ed), *Mathematical Problems in Engineering, Aerospace and Sciences, Scientific Monographs and Text Books*, Cambridge Scientific Publishers, 2008.
- BC-7 E. Witrant, D. Georges, C. Canudas de Wit and O. Sename, **Stabilisation des systèmes commandés par réseau : une approche prédictive**, in J.-P. Richard & T. Divoux (Eds), *Systèmes commandés en réseau, vol. IC2 Hermès: systèmes automatisés*, Lavoisier, Feb. 2007.
- BC-8 E. Witrant, D. Georges, C. Canudas de Wit and M. Alamir, **On the use of State Predictors in Networked Control Systems**, in J. Chiasson & J.-J. Loiseau (Eds), *Applications of Time-Delay*

2.2.6 Papers in Proceedings of International Workshops or Conferences

International peer-reviewed papers. The typical format is 6 pages, double-column.

IEEE Conf. on Decision and Control / Control Applications / Automation Science and Engineering	8 / 2 / 4
IEEE International Conference on System Theory, Control and Computing	1 (best paper award)
IEEE Conférence Internationale Francophone d'Automatique	5
American / European Control Conference	4 / 5
IFAC World Congress / Conferences / Workshops	2 / 5 / 5
SAE World Congress	4
Other Control Conferences or Workshops	6

Thus a total of 51 contributions, including 15 as 1st author, 29 where the 1st author is one of my Ph.D. or Master students and 19 invited papers.

2.3 Projects

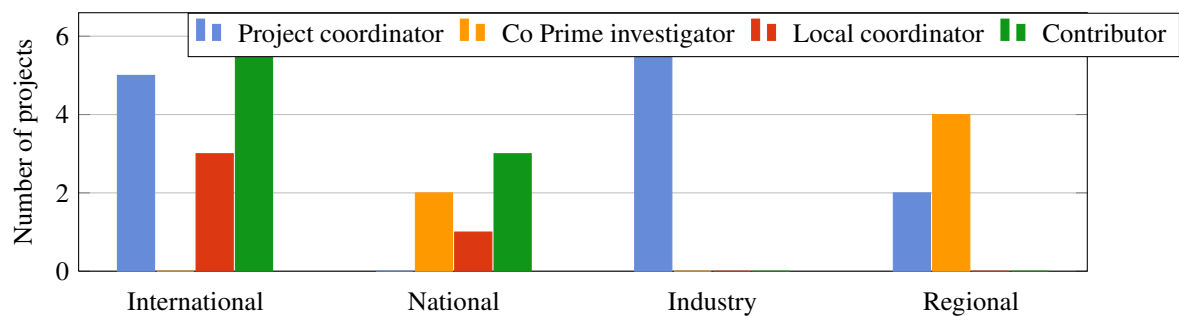

International Projects

- 2006-2007 **Contributor at KTH for 3 EU projects**: SOCRADES (FP6, “Service-Oriented Cross-layer infRAstructure for Distributed smart Embedded deviceS”), HYCON (Network of Excellence, “HYbrid CONTROL: taming heterogeneity and complexity of networked embedded systems”) and FeedNetBack (FP7, “Feedback Design for Wireless Network Systems”).
- 2008-2012 **DeSIRE2 (Atlantis EU/US)**: “Dependable Systems International Research and Educational Experience”. Collaboration with 3 US and 2 EU Universities. Leader of UFR PhITEM node.
- 2009-2011 **Brancusi (PHC)**: “Commande prédictive coopérative des systèmes complexes. Modélisation et gestion d’énergie pour le bâtiment intelligent”. Col. with Supélec (PI) and Univ. of Craiova. Leader of GIPSA-lab node.
- 2009-2012 **NEEM ice coring project**: “North Greenland Eemian Ice Drilling”. International project involving 14 nations. Contributor on firm modelling and analysis.

- 2010-2013 **Project coordinator for 4 yearly projects FR-FCM (EURATOM)** (Fédération de Recherche Fusion par Confinement Magnétique, financed by EURATOM and CNRS, in collaboration with CEA-IRFM) on “Optimal control of the safety factor profile in tokamaks” (2010), “Safety factor profile control and infra-red hot spots detection” (2011), “Plasma profiles identification and control: theoretical analysis (2012) and experimental application (2013)”.
- 2010-2014 **Network of Excellence HYCON2 (FP7-ICT)** : “Highly-Complex and Networked Control Systems”. Leader of GIPSA-lab node in WP1 - Analysis of complex systems and WP7 - Training.
- 2011-2013 **Project coordinator for a Chateaubriand fellowship**: 10 months of Ph.D. scholarship for A. Gahlawat, enrolled in joint supervision between Illinois Institute of Technology and Université de Grenoble (first joint Ph.D. degree with the USA of the EEATS doctoral school in Grenoble) on “Application of sum-of-squares polynomials and convex optimization for controller synthesis of infinite dimensional systems”.
- 2012-2013 **Tournesol (PHC)**: “Contrôle frontière de systèmes hyperboliques: application à la régulation d’un réseaux de canaux et de conduites”. Col. with Facultés Universitaires Notre-Dame de la Paix (FUNDP, Namur, Belgique). Contributor.
- 2012-present **GdRI DelSys**: “International Group of Research on Time Delays Systems”. Contributor.

National Projects

- 2008-2012 **ANR-ALIA BRAISE**: “Boulangerie RAISONnée et Efficacité énergétique” (GEPEA, LTN, LIMATB, INRA, EDF, INBP, BONGARD, GIPSA-lab). Contributor.
- 2010 **PEPS CNRS/INSIS MODELINEVE**: “Modélisation par identification pour le transport des gaz trace dans le névé” (LGGE, GIPSA-lab, L2S). Co prime investigator with P. Martinerie.
- 2012-2013 **Labex PERSYVAL-lab**: “Pervasive systems and algorithms at the convergence of the physical and digital worlds” (GIPSA-lab, G-SCOPE, INRIA, IF, LETI, LIG, LJK, TIMA, TIMC, Verimag). Co-directeur and head of education.
- 2012-2015 **ANR-BLANC TORID**: “Tokamak cOntrol of plasma Radial profiles in Infinite Dimensional setting” (CEA, GIPSA-lab, LISA). Leader of GIPSA-lab node.
- 2014-2018 **ANR-SEED CryoGreen**: “Innovative advanced control of large cryogenic systems to save energy and reduce carbon emission” (contrôle commande innovant de grands systèmes CRYO-Géniques pour l’optimisation ENergétique et la diminution de l’impact caRbone) (CEA, CERN, GIPSA-lab, 3A Alpes automatic). Contributor.
- 2015-2018 **LEFE NEVE-CLIMAT**: “Impact de la physique du névé sur les enregistrements climatiques de traces gazeuses dans les carottes de glace” (LGGE, LSCE, GIPSA-lab, SIMAP). Contributor.

Industrial contracts and regional projects

- 2009-2015 **Project coordinator of 6 industrial contracts with Renault**: 4 expertises (*contrôle EGR BP moteur essence* in 2009, *identification modèle 0D moteur diesel pour le contrôle Euro VI* in 2010, *Modèle thermique d’un Catalyseur* and *Algorithme d’optimisation multi-objectif pour le moteur* in 2014-2015) and 2 CIFRE (*Modélisation pour contrôle du moteur à allumage commandé pour Euro VI* and *Modélisation / Contrôle de la chaîne d’air des moteurs HCCI pour Euro VII*).
- 2010-2013 **Project coordinator for 2 regional projects**: BQR Grenoble-INP (Contrôle des profils et des barrières internes de transport en fusion thermonucléaire : application aux plasmas tokamak pour ITER) and UJF LAUTO (Expériences de TP d’Automatique pour la Licence).
- 2008-2014 **Co Principal Investigator on 4 regional projects**: BQR Grenoble-INP COGESI (Commande optimale de générateurs électrochimiques et de stockage ilôté), BQR GIPSA-lab (Hybrid Control for Intelligent Buildings), Carnot-LSI (Optimisation énergétique temps-réel de l’aérologie

des bâtiments intelligents), CIBLE Rhône-Alpes COHYBA (Contrôle Hybride pour les Bâtiments Verts).

2.4 Supervised students

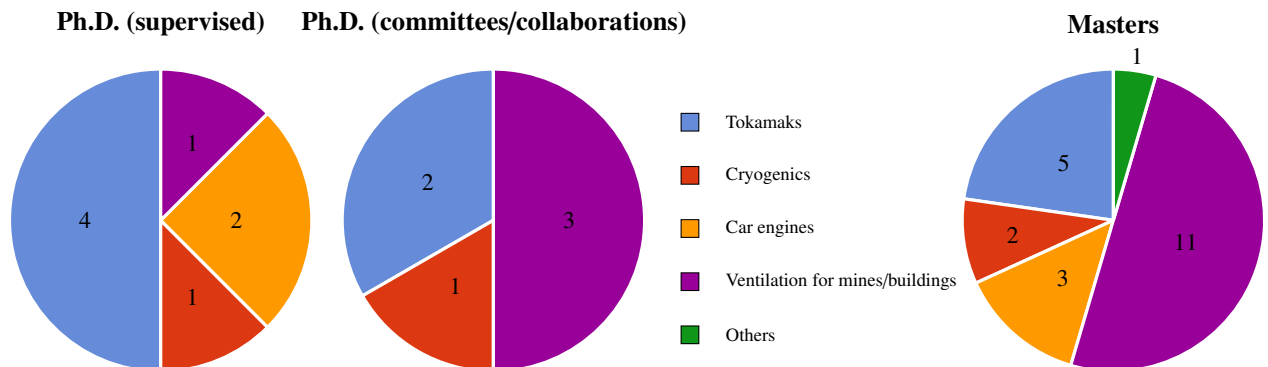

Ph.D. students (supervised)

- Federico BRIBIESCA ARGOMEDO, *Ph.D. Thesis*: Modeling and control of nonhomogeneous transport phenomena: application to tokamak plasmas, 2009-2012. Co-supervisor.
- Felipe CASTILLO BUENAVENTURA, *Ph.D. Thesis*: Air path modeling and control of HCCI engines for Euro 7, 2010-2013. Col. RENAULT. Co-supervisor.
- Aditya GAHLAWAT, *Ph.D. Thesis*: Application of sum-of-squares polynomials and convex optimization for controller synthesis of infinite dimensional systems, 2011-2014, Illinois Institute of Technology, USA. Co-supervisor.
- Bojan MAVKOV, *Ph.D. Thesis*: Modeling and control of coupled transport dynamics in thermonuclear fusion, 2013-2016. Co-supervisor.
- Sarah MECHHOUD, *Ph.D. Thesis*: Transport analysis and plasma control in thermonuclear fusion, 2010-2013. Col. CEA. Co-supervisor.
- Pierre-Jean MEYER, *Ph.D. Thesis*: Hybrid control for green buildings, 2012-2015. Col. LJK. Main supervisor.
- Alexandre MOREAU, *Ph.D. Thesis*: Investigation on dynamic performances and processes stability of the future cooling systems for the LHC trackers, 2009-2010. Col. CERN. Co-supervisor.
- Maria RIVAS, *Ph.D. Thesis*: Modeling and control for spark ignited Euro VI engines, 2009-2012. Col. RENAULT and Institut PRISME (Université d'Orléans). Co-supervisor.

Ph.D. students (scientific or defense committees, strong collaboration)

- Benjamin BRADU, *Ph.D. Thesis*: Modélisation Simulation et Contrôle des installations cryogéniques du CERN, 2007-2010, Université de Paris-Sud XI. Collaborator.
- Sumanth CHINTHALA, *Ph.D. Thesis*: Near Field Simulation of PM10 Dispersion in Open Pit Coal Mines, 2011-, Indian Institute of Technology, Dehli. Member of the scientific committee.
- Miguel-Angel HERNANDEZ-PEREZ, *Ph.D. Thesis*: LPV control of Poiseuille flows, 2012-2015. Col. Instituto Politécnico Nacional, Mexico. Collaborator.
- David F. NOVELLA RODRIGUEZ, *Ph.D. Thesis*: Time-delay compensation in flow networks, 2012-2015. Col. Instituto Politécnico Nacional, Mexico. Collaborator.

- Erik OLOFSSON, *Ph.D. Thesis*: Closed-loop control and identification of resistive shell magneto-hydrodynamics for the reversed-field pinch, 2007-2012, Alfvén lab, KTH, Stockholm. Member of the scientific committee.
- Menno LAURET, *Ph.D. Thesis*: Control of Mixing and Oscillations in Plasmas and Fluids, 2014, TU Eindhoven, Netherlands. Member of the Ph.D. defense committee.

Post-docs / ATER

- Xiao Dong LI, *Post-Doc*: Bread oven optimization and inverse modeling for firm air transport, 2012-2013.
- Fabrice BABET, *ATER*: design and operation of an experimental benchmark for intelligent building ventilation, 2009-2010.
- Basma TOUIL, *ATER*: Infrared hot spots detection in tokamaks, 2010-2011.

Masters 2:

- Corentin BRIAT, *Master 2 Thesis*: Synthesis of a control-dedicated network, 2005.
- Mateu CASTELLS, *Master 2 Thesis*: Design of linear quadratic regulators for bootstrap current maximization in tokamaks, 2015.
- Felipe CASTILLO BUENAVENTURA, *engineer internship* : Experiment design for advanced control methodologies in intelligent building ventilation, 2009. *Master 2 Thesis*: Air path modeling for an EGR Diesel Euro VI engine, 2010. Col. RENAULT.
- Ambre CORREARD, *Master 2 Thesis*: Embedded control and wireless networks design for intelligent buildings, 2013.
- Nicolas COUDURIER, *engineer internship* : UFAD pour bâtiments intelligents: analyse des outils de modélisation, 2010.
- Pierre MORTELMANS, *Master 2 Thesis*: Embedded control with wireless sensing capabilities for UFAD automation, 2010.
- Chakib MOUHOUBI, *Master 2 Thesis*: Design of human-machine interface and programmable logic controller for flow and vibration processes with adaptive methods, 2015.
- Hosein NAZARPOUR, *Master 2 Thesis*: Modeling, identification and control of an experimental benchmark for intelligent building ventilation, 2013. Col. LJK.
- Magdalena POLAC, *Master 2 Thesis*: Estimating the heat and density transport properties in a tokamak plasma, 2014. Col. KU Leuven.
- Mustapha Amine RAHMANI, *Master 2 Thesis*: Non-homogeneous transport in two-phase flows: improving dynamic performances of a CO₂ LHC-tracker cooling plant, 2011, Col. CERN.
- Maria RIVAS, *Master 2 Thesis*: F4RT EGR BP air path modeling, linearization and control, 2009. Col. RENAULT.
- Enrique SANTIAGO, *Master 2 Thesis*: Blind identification of the plasma edge electron density in Tore Supra, 2010. Col. CEA-Cadarache.
- Fateh TAIBI, *Master 2 Thesis*: Aerology optimization experiments for intelligent building ventilation, 2010.
- Amgad TAREK, *Master 2 Thesis*: Model predictive control strategies for bootstrap current maximization in tokamaks, 2015.
- Nhat-Quang TRAN, *Master 2 Thesis*: Identification tools for Diesel Euro VI engines, 2010. Col. RENAULT.
- Jacques WEYDERT, *Master 2 Thesis*: Source determination in non homogeneous dissipative media, 2009. Col. CEA-Cadarache.
- Fairouz ZOBIRI, *Master 2 Thesis*: Modeling and optimization of interconnected heat flows in thermal exchangers for cryogenics, 2015.

Masters 1:

- Jonathan CLAIRET, *Master 1 Thesis*: Air quality control in a convective flow benchmark, 2012.
- Ambre CORREARD, *Master 1 Thesis*: Distributed control over wireless networks for intelligent buildings ventilation, 2012.
- Mohamad EL-ACHKAR, *Master 1 Thesis*: Conception d'un micro-actionneur magnétique à grande échelle pour des expériences de commande, 2008.
- Farshid SARRAFIN-ARDEBILI, *Master 1 Thesis*: Air quality control in a convective flow, 2011.
- Laure TREMILLION, *Master 1 Thesis*: dsPIC programming and Scicos embedded control for green buildings, 2010.

2.5 Other international activities

Organization of invited sessions and contributions to international conferences

- **Organizer of the invited sessions** “Ventilation Control in Large-Scale Systems” for the IEEE Conference on Automation Science and Engineering and “Computational Methods for Nonlinear and Time-Delayed Systems with Applications” for the 7th International Conference on Mathematical Problems in Engineering, Aerospace and Sciences, 2008.
- **Head of the program committee** “Systèmes à dimension infinie & système à retards” for the IEEE Conférence Internationale Francophone d’Automatique (CIFA), Grenoble, 2012.
- **Publication chair** for the IFAC Joint conference: 5th Symposium on System Structure and Control, 11th Workshop on Time-Delay Systems, and 6th Workshop on Fractional Differentiation and Its Applications, Grenoble, 2013.
- **Member of the technical committees** IEEE CSS *Power Generation* and IFAC *Modeling & Control of Environmental Systems*.

Plenary talks and invitations

- Plenary/invited talks on
 - “Opportunities and challenges in distributed embedded control”, ARTEMIS Annual Conference, Berlin, Germany, 2007.
 - “Profiles Control and Stability in Thermonuclear Fusion: Some Issues for ITER”, Journées Nationales MACS, Angers (France), 2009.
 - “Control-oriented models and feedback control of the temperature and current profiles in Tokamak plasma” and “Stability analysis and model-based control in EXTRAP-T2R with time-delay compensation”, Workshop on Control for Nuclear Fusion, Eindhoven University of Technology, Netherlands, 2008.
- Invitations at:
 - **Royal Institute of Technology** (KTH, Stockholm, Sweden) for multiple stays ($\approx 2 \times 1$ or 2 weeks per year) between 2008 and 2012 to collaborate on networked controlled systems and controlled thermonuclear fusion.
 - **Illinois Institute of Technology** (Chicago, USA) for 1 month to collaborate on controlled thermonuclear fusion, 2010.
 - **Dalhousie University** (Halifax, Nova Scotia, Canada) for 1 week for a seminar on controlled thermonuclear fusion and to collaborate on passive control of transport phenomena, 2011.

- **Universidad Nacional Autonoma de Mexico** (Mexico city) for 2 weeks to collaborate on the stabilization of tidal effects on petroleum platforms, 2013.
- **Universidad Pedagogica y Tecnologica de Colombia** (Sogamoso, Colombia) for 2 weeks as an international representative for the 20th birthday of the university and to collaborate on mining ventilation control and on defining a new master program, 2013.
- **Katholieke University of Leuven** and **Université Libre de Bruxelles** (Belgium) as a visiting professor to collaborate on applied mathematics, control and numerical analysis for transport optimization (KUL) and inverse modeling of ice transport from radar measurements (ULB), 2013/2014.

Teaching in international schools for Ph.D. students and colleagues

- **An Introduction to System Identification** (15h), *Illinois Institute of Technology (Chicago, USA)*, May 2010.
- **Mining ventilation control** (15h), *Universidad Pedagogica y Tecnologica de Colombia (Sogamoso)*, April 2013.
- **Modeling and estimation for control** (21h), *HYCON2-EECI Graduate School on Control (L'Aquila, Italy, in May 2013 and Paris-Saclay, February 2015)*.
- **Control-oriented modeling of inhomogeneous transport** (2h) and **Time-delays in physics: from advection to time-delay systems** (3h), *33th and 34th International Summer School of Automatic Control (Grenoble)*, 2012/2013.
- **Inverse problems and environment: some new tools for atmospheric studies** (scientific coordinator and 5h30 of classes), *Ph.D. school Math and Complex*, University of Namur, Belgium, March 10-12, 2014.
- **Control-oriented modeling and system identification** (18h), *Graduate School in Systems, Optimization, Control and Networks*, KU Leuven, Belgium, April 22-25, 2014.

2.6 Involvements in Academia and Teaching



Figure 2.1: Pedagogical platform PhyAuto (from left to right): climate control over wireless networks in intelligent buildings, LEGO Mindstorm experiment (stabilizing an inverted half cube), quarter-scale vehicle for disturbance rejection with semi-active dampers, flow tube with heat and humidity regulation, magnetic suspension of a ball, and Programmable Logic Controllers for the quarter-scale vehicle and the flow tube.

New classes given at UJF (all these classes were new topics at UFR PhITEM and taught in English)

- **Feedback Control for SISO Systems: Design and Limitations** (Master 1, 2009-2013): 15h lectures, 9h ex., 12h labs

- Optimization and Optimal Control (Master 2, 2008-present): 21h lectures, 15h labs
- Multivariable Robust Control (Master 2, 2008-2011): 14h lectures, 16h labs
- Modeling and Estimation for Control (Master 2, 2008-present): 24h lectures, 27h labs
- Design projects on automation and systems (Master 2, 2008-present): 48h labs
- Linear systems: an geometric approach (Master 2, 2011-2012): 21h lectures

Curriculum design at UFR PhITEM

Since 2007 **Head of Automatic Control** at UFR PhITEM (program definition and internships for Bachelor and Master students).

Since 2008 **Definition and head of the international M2** in *Systems, Control and Information Technologies*² (MiSCIT), with a professional track *Industrial Processes Automation* (since 2008) and a research track *Systems & Control Theories* (since 2011).

Since 2008 Definition and set-up of the **new experimental platform PhyAuto**³ for learning and research. See pictures above.

Other management responsibilities

Since 2007 Leader or active contribution for **new programs in international student exchanges**:

- with the US through the international programs DeSIRE2 (Embry Riddle Aeronautical University, University of Arizona and University of Central Florida), 2008-2012.
- new ERASMUS agreements with Slovakia (Technical University of Kosice), Poland (AGH University of Science and Technology in Cracow and Silesian University of Technology), Belgium (Haute Ecole de la Province de Liège), Turkey (Bilkent University), Italy (University of L'Aquila) and Czech Republic (Brno University of Technology).
- new international exchange agreements with Colombia (UPTC), Mexico (Tech. Monterrey), India (LNMIIT, IIT Dehli), Indonesia (IT Sepuluh Nopember), Lebanon (Université Libanaise, definition of a double diploma).

Since 2011 Elected member of the lab council at GIPSA-lab.

Since 2012 **Co-director and head of education for the Labex Persyval-lab**⁴: to motivate interdisciplinary pedagogical actions on experimental platforms, attracting M2 student and innovating at the undergraduate level.

Since 2013 **Research coordinator for FR-FCM** (Fédération de Recherche sur la Fusion Contrôlée Magnétiquement): academic representative in a team (10 colleagues) and responsible for promoting the interactions with the automatic control and signal processing communities.

²http://physique-eea.ujf-grenoble.fr/intra/Formations/M2/EEATS/PSPI/home_obj.php

³http://physique-eea.ujf-grenoble.fr/intra/Formations/M2/EEATS/PSPI/projects_PhyAuto_over.php

⁴which involves 10 labs in Grenoble (GIPSA-lab, G-SCOPE, INRIA, IF, LETI, LIG, LJK, TIMA, TIMC, Verimag), <http://www.persyval-lab.org/education.html>

Chapter 3

Background on conservation laws

A physical system is modeled in relation with the scale of interest, e.g. events occurring at the subatomic, atomic or molecular, microscopic, macroscopic or astronomical scale. In fluid dynamics, the modeling objective is to study the interactive motion and behavior of a large number of elements, defined for a specific scale and possibly including simplified representations of the events occurring at the smaller or larger scales. The motion is then captured by a dynamical system of elements interacting as a spatially-distributed continuum in a given volume and media or environment. For example, consider an elementary volume containing a sufficiently large number of molecules with well defined mean velocity and mean kinetic energy. At each point in the volume we can define specific variables (e.g. velocity, temperature, pressure, entropy etc.) that determine the state and evolution of the physical system. This section presents a classical representation of the macroscopic behavior of fluid particles. The resulting mathematical formulation will provide the structure to classify inhomogeneous transport problems and their modeling and control methods presented in the next chapters.

3.1 General form of a conservation law

The *conservation* of a quantity can be generally defined as the variation of a conserved (intensive) flow quantity in a given volume resulting from internal sources and from the external action of a quantity, the *flux*, crossing the boundary. Fluxes and sources depend on space-time coordinates and are defined by the fluid motion. Not all the flow quantities obey conservation laws. For example, fluid flows are fully described by the conservation of mass, momentum (3-D vector) and energy, leading to five equations that fully define the behavior (state) of the flow. Other quantities (e.g. concentration, velocity, temperature, etc.) can be used but will not necessarily take the form of a conservation law.

Consider a scalar quantity per unit volume U enclosed in an arbitrary volume Ω fixed in space (the control volume) which is bounded by a closed surface S (control surface) crossed by the fluid flow \vec{F} , with surface sources \vec{Q}_S and volume sources Q_v , as depicted in Fig. 3.1. The main physical variables are summarized in Table 3.1. We can then define:

- the *total amount* of U inside Ω as $\int_{\Omega} U d\Omega$, its variation per unit time is $\frac{\partial}{\partial t} \int_{\Omega} U d\Omega$;
- the *flux* as the amount of U crossing S per unit time: $F_n dS = \vec{F} \cdot d\vec{S}$ with $d\vec{S}$ outward normal, and its net total contribution ($\vec{F} > 0$ when entering the domain) is $-\oint_S \vec{F} \cdot d\vec{S}$;
- the net total contribution of *volume and surface sources* as $\int_{\Omega} Q_v d\Omega + \oint_S \vec{Q}_S \cdot d\vec{S}$.

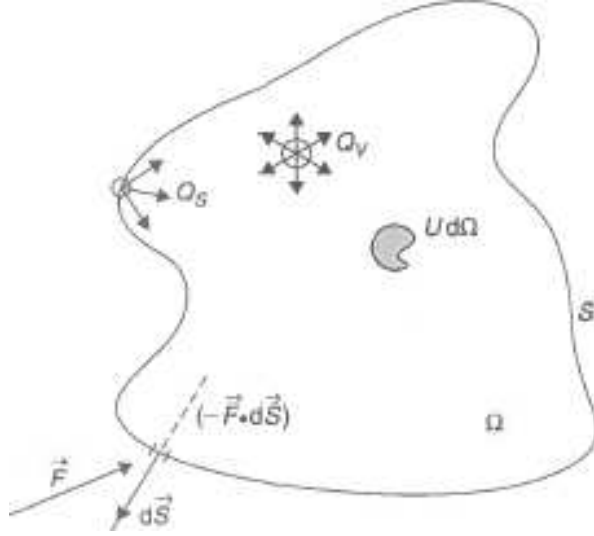

Figure 3.1: Conservation of a flow quantity affected by sources and a flux (exerpt from [Hirsch, 1989](#))

The variation of the total amount of U is fully determined by the net total contributions of the flux and sources, which provides the integral conservation form for the quantity U as:

$$\frac{\partial}{\partial t} \int_{\Omega} U d\Omega + \oint_S \vec{F} \cdot d\vec{S} = \int_{\Omega} Q_V d\Omega + \oint_S \vec{Q}_S \cdot d\vec{S} \quad (3.1)$$

Note that this conservation law is valid for all fixed surfaces and volumes, and at any point in the flow domain. The internal variation of U depends only on the fluxes through S , not on the fluxes that may appear inside the reference volume. As no derivative or gradient of F appear in (3.1), the flow may be discontinuous and admit shock waves. Finally, the conservative property of the dynamics is used to define conservative numerical scheme at the discrete level (i.e. to constrain a simulation algorithm).

The flow dynamics is more often described using the differential form of a conservation law, obtained using Gauss' theorem ($\oint_S \vec{F} \cdot d\vec{S} = \int_{\Omega} \vec{\nabla} \cdot \vec{F} d\Omega$) as:

$$\begin{aligned} \frac{\partial U}{\partial t} + \vec{\nabla} \cdot \vec{F} &= Q_V + \vec{\nabla} \cdot \vec{Q}_S \\ \Leftrightarrow \frac{\partial U}{\partial t} + \vec{\nabla} \cdot (\vec{F} - \vec{Q}_S) &= Q_V \end{aligned} \quad (3.2)$$

where $\vec{\nabla}$ is the divergence operator (e.g. in the 3D Euclidean space with basis $\{\vec{i}, \vec{j}, \vec{k}\}$ and $\vec{F} = F_x \vec{i} + F_y \vec{j} + F_z \vec{k}$, $\vec{\nabla} \cdot \vec{F} = \partial F_x / \partial x + \partial F_y / \partial y + \partial F_z / \partial z$, using the subscripts to denote each spacial component of the vector \vec{F}). Note that the effective flux ($\vec{F} - \vec{Q}_S$) appears exclusively in the divergence operator, which is a way to recognize conservation laws. The differential form is more restrictive than the integral form as the flux and surface sources have to be differentiable in (3.2) (which excludes shock waves). The precise definition of the flux and sources depend specifically on the quantity considered and are typically defined as functions of U and its gradient, as detailed in the next section. The previous descriptions (3.1)-(3.2) generally extend to systems of n_U scalar variables (e.g. $U \in \mathbb{R}^{n_U}$), possibly with internal couplings and nonlinearities (if \vec{F} , \vec{Q}_S and Q_V are nonlinear functions of U).

U	scalar quantity per unit volume
Ω	arbitrary volume fixed in space (control volume)
S	surface enclosing the volume of interest (control surface)
D	diffusivity (m^2/s)
x, y, z	coordinates in Euclidean space with basis $\{\vec{i}, \vec{j}, \vec{k}\}$ (m)
x_m	measurements location (m)
t	time (s or yr), possibly limited by initial and final values t_0 and t_f
r	radius in cylindrical coordinates (m)
\vec{F}_x	subscript x to denote a spacial component of the vector
\vec{F}	fluid flow vector
\vec{F}_C	convective flux
\vec{F}_D	diffusive flux
G	Green's function (impulse response)
\vec{Q}_S	surface sources
Q_v	volume sources
\vec{v}	velocity field
ρ	fluid density (kg/m^3 of void space)
$d\vec{m}$	local mass flow rate (kg/s)
q	quantity per unit mass
$\vec{\nabla} \cdot$	divergence operator
$\vec{\nabla}$	gradient operator
\cdot	dot (scalar) product

Table 3.1: Most relevant physical variables and units.

3.2 Convection-diffusion form of a convection law

While the specific definition of the flux term is problem dependent, there is a general interest to describe it in terms of a combination of convective and diffusive transports, which encompass the behavior of numerous processes and can be modeled using a limited number of well-established physical laws. The total flux is then the sum of a convective flux \vec{F}_C and a diffusive flux \vec{F}_D :

$$\vec{F} = \vec{F}_C + \vec{F}_D$$

Convection is defined by the amount of U carried away or transported by the flow. Denoting the flow velocity as \vec{v} , the convective flux is obtained as $\vec{F}_C = \vec{v}U$. For example, considering the fluid density $U = \rho$ (e.g. kg/m^3), the local flux through $d\vec{S}$ is the local mass flow rate $d\vec{m}$, calculated as $\vec{F}_C \cdot d\vec{S} = \rho\vec{v} \cdot d\vec{S} = d\vec{m}$ (e.g. kg/s). Another example is provided by the conservation of a concentration $U = \rho q$, where q is the quantity per unit mass: in this case $\vec{F}_C \cdot d\vec{S} = \rho q\vec{v} \cdot d\vec{S} = q d\vec{m}$. \vec{F}_C is also used to describe how the fluid motion is affected by exogenous (e.g. gravity) or endogenous (e.g. internal pressure) forces. While convection generally describes the movement of the fluid, the specific transport of particles due to the fluid's bulk motion is typically referred to as *advection*. If the flow carrying U is incompressible, then $\vec{\nabla} \cdot \vec{v} = 0$ (by continuity of the transporting fluid) and the equation of motion writes in the specific form (e.g. with $\vec{F}_D = 0$):

$$\frac{\partial U}{\partial t} + \vec{v} \cdot \vec{\nabla} U = 0 \quad (3.3)$$

where $\vec{\nabla}$ is the gradient operator (e.g. in the 3D Euclidean space with basis $\{\vec{i}, \vec{j}, \vec{k}\}$, then $\vec{\nabla} U = \partial U / \partial x \vec{i} + \partial U / \partial y \vec{j} + \partial U / \partial z \vec{k}$). The transport equation (3.3) describes the behavior of U along a streamline defined by the velocity field \vec{v} .

Diffusion represents the macroscopic effect of a gradient, for example on concentration or on heat. This transport goes from large to small values of U , in all directions, proportional to the quantity gradient (Fick's laws). The resulting flux writes with the general form $\vec{F}_D = -D \vec{\nabla} U$ where D is the diffusivity (e.g. m^2/s). Note that diffusivity can also be used to describe a mixing of U due to transport phenomena that counteract the effect of a sustained gradient, such as the averaged effect of turbulences on a flow modeled at a slower time-scale (turbulent mixing).

Combining both effects provides the convection-diffusion form of a transport equation as:

$$\frac{\partial U}{\partial t} = \vec{\nabla} \cdot (D \vec{\nabla} U - \vec{v} U + \vec{Q}_S) + Q_V \quad (3.4)$$

The terms \vec{Q}_S and Q_V act as sources or sinks depending on their signs (positive or negative quantities, respectively, U being positive by definition as a physical quantity). Sources may be controlled inputs, inputs from other conserved quantities or production by some internal reactions, while sinks may be associated to a distributed removal of U (e.g. trapping) or to a consumption by internal reactions (e.g. reaction-diffusion process when Q_V is expressed as a function of U). The transport equation (3.4) provides the backbone of mathematical modeling for fluid flow phenomena. It combines both parabolic and hyperbolic partial differential equations. Note that the D and \vec{v} may vary depending on space and time (i.e. in an inhomogeneous medium), and possibly on U (the transport is then nonlinear).

3.3 Inhomogeneous transport phenomena

The transport of a quantity is typically characterized as inhomogeneous when the diffusivity coefficient D in (3.4) varies in space (e.g. in the firm modeling problem). By extension, we can consider variations of D in time (e.g. in tokamak problems) and extend the inhomogeneity terminology to space and time variation of the convection coefficients \vec{v} . All these cases have in common the induced complexity of the flow mixing phenomena and the lack of a simple mathematical solution to the transport equation. Nevertheless, for transport equations that are linear in U , we can suppose that the existence and uniqueness of a solution to (3.4) can be proved if $D \geq 0$ and \vec{v} doesn't change sign (e.g. excluding the shock waves). This property (well-posedness in the sense of Hadamard, 1902) was established for most of the specific cases described in this manuscript.

3.4 Problems addressed

The estimation and control problems considered in this manuscript are classified depending on their dominant transport property: diffusive, convective or mixed. Considering a physical process involving inhomogeneous transport, the first challenge is to embed the complexity of the system in a structured model such as (3.4) (the complexity being expressed in the transport coefficients) to define the state-space model. This is addressed in Chapter 4, along with the problem formulation. The problems can be classified in two categories:

- *estimation*: given a partial knowledge and/or sparse measurements of the system, can we obtain a full knowledge of the dynamics? E.g. estimating D or \vec{v} from sparse measurements of U (inverse problem), or estimating the time-evolution of U over the whole space knowing D and \vec{v} and measurements of U at the boundary of the domain only (observer design);
- *control*: given a full knowledge of D and \vec{v} , can we use the surface and/or volumetric sources (\vec{Q}_S and Q_V) to have U reaching the desired value?

The specific methods that we designed to answer these questions, despite the difficulties related to space and/or time variations of the transport coefficients, are discussed in Chapter 5.

Chapter 4

Inhomogeneous transport models

Using the framework on conservation laws described in the previous chapter, the inhomogeneous transport property can be classified according to the major transport process, i.e. diffusion, convection or both. Models corresponding to these three cases are described in this chapter, along with their corresponding estimation and control problem.

4.1 Diffusion in tokamak plasmas

Controlled thermonuclear fusion has the potential to address the global need for sustainable energy. The energy generated by the fusion of deuterium and tritium (isotopes of hydrogen extracted from water and the earth's crust) can be done in a harmless way (no direct radioactive waste is generated and the radioactivity of the structure decays rapidly). Fusion devices using magnetic confinement of the plasma, such as tokamaks, can thus be envisaged as a major carbon-free energy resource for the future. But significant research challenges still need to be addressed before tokamaks can be reliably operated and commercially viable. The controls community will play a critical role in resolving these challenges.

Tokamaks use a magnetic field to confine plasma in the shape of a torus. The charged particles follow a helicoidal trajectory according to the field created by controlled magnets (see Fig. 4.1), which thus set the position and shape of the plasma. Radio-frequency antennas allow selective action on electrons or ions and modify internal plasma properties such as current and temperature. The plasma is fueled by pellets shot at high speed toward the plasma center and neutral particles are injected to increase the plasma momentum and energy. The ITER Tokamak, an international project involving seven members (the European Union, Russia, USA, Japan, China, Korea, and India), is planned to start its operation during the next decade. It is foreseen to produce 500 MW from 50 MW of input power.

Tokamak control is becoming more and more important for the success of magnetic fusion research and will be crucial for ITER. Feedback control of the main plasma macroscopic parameters, such as plasma position and shape, total current, and density, is now reasonably well mastered in the different worldwide tokamaks. But the control of internal plasma dynamics and radial profiles (1-D distributions) is still in its infancy. This control is likely to be crucial for robust stability and to maintain high-efficiency tokamak operation.

One of the major goals of thermonuclear fusion controlled by magnetic confinement (as achieved in tokamaks), is to guarantee the so-called *steady state operation* of the process, which relates to our ability to continue the Tokamak operation indefinitely, e.g. the pulse is terminated by the operator's choice and not

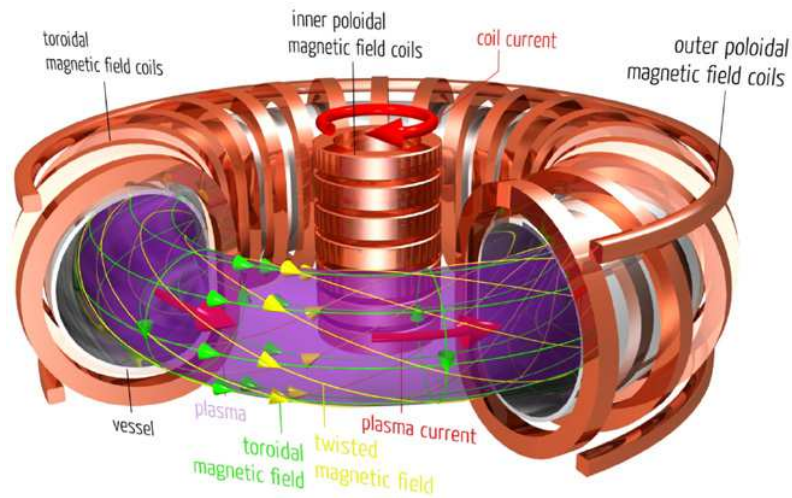

Figure 4.1: Tokamak confinement of a nuclear fusion plasma: the twisted magnetic field lines (green) required to confine the high temperature plasma (purple) are created by the currents in a set of planar coils (red) and a current flowing in the conductive plasma itself. “Tokamak (scheme)” by Abteilung Öffentlichkeitsarbeit - Max-Planck Institut für Plasmaphysik. Licensed under CC BY-SA 3.0 via Wikimedia Commons - <http://en.wikipedia.org/wiki/Tokamak>.

due to the plasma behavior. The “steady-state” terminology refers to the relatively slow dynamics of flow variables (such as magnetic flux, pressure, temperature, density, etc.) that are constant on isoflux surfaces during the stable operation of the plasma (depicted in Fig. 4.2). This terminology was adopted in comparison with the much faster time-scales involved in magneto hydro dynamics (MHD) instabilities. Averaged values such as the so-called “safety-factor” (dynamics evolving at the current density diffusion time $\approx 1-100$ s) and the pressure profiles provide an indicator on the potential avoidance of MHD instabilities (Troyn et al., 1984).

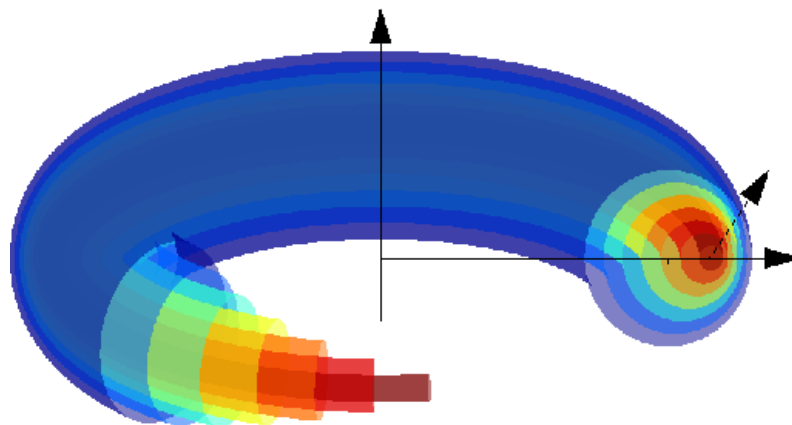

Figure 4.2: Ideal model of a tokamak plasma for profiles control, with structured isoflux surfaces and the radial direction (dashed arrow). The small dashed arrow denotes the direction of \vec{z}_r . Figure excerpt from [B-2].

The dynamics of the flow variables on the isoflux surfaces can be expressed in a 1D-coordinate framework by indexing the magnetic surfaces (Hinton and Hazeltine, 1976; Blum, 1989). With some simplifying hypotheses (Brégeon, 1998, J-4), the plasma can be considered as having a circular cross section (plasma lying on a toroidal limiter) and being a cylinder of infinite length (opening the torus and

extending its extremities)¹. We can then consider the divergence and the gradient operators only in the radial direction \vec{e}_r as (\vec{F} and U being constant along the cylindrical axis and the angular position):

$$\vec{\nabla} \cdot \vec{F} = \frac{1}{r} \frac{\partial}{\partial r}(rF_r) \quad \text{and} \quad \vec{\nabla} U = \frac{\partial U}{\partial r} \vec{e}_r$$

where $r \in [0, a]$ is radial position and a the small plasma radius.

For the quantities of interest (gradient of the poloidal magnetic flux - the total flux through a surface bounded by the toroidal ring - and energy of the electrons), we neglect the convective transport and do not have surface sources:

$$\vec{v} = \vec{Q}_s = 0$$

The volume sources Q_V are due to the use of radiofrequency antennas that generate a distributed profile (current or/and energy) inside the plasma through the coupling between the emitted waves and the particles, which is considered as instantaneous and depending only on the radial location. The convection-diffusion equation (3.4) then becomes:

$$\frac{\partial U}{\partial t} = \frac{1}{r} \frac{\partial}{\partial r} \left(rD \frac{\partial U}{\partial r} \right) + Q_V \quad (4.1)$$

The boundary condition at the plasma center $U(r = 0, t)$ is of the Neumann type due to the rotational symmetry and the one at the edge $U(r = a, t)$ depends on the problem considered.

Two different objectives can be considered to control or model the input-output map associated with the previous equation:

1. Having a well-defined physical model to describe the time and space evolution of the diffusivity D and of the impact of the controlled parameters on the source term Q_V , can we define Q_V such that U follows a desired trajectory?
2. Considering an highly uncertain physical model but imposing the diffusive structure on the dynamics, can we estimate the time and space evolution of D and Q_V in real time?

These two questions are illustrated, respectively, by the following two research problems in thermonuclear fusion.

Problem 4.1.1 (Question 1: Control of the safety factor profile through the magnetic flux)

An adequate control of the safety factor profile (q -profile, determined by the relationship between the toroidal and the poloidal components of the magnetic flux) is crucial to guarantee the plasma discharge stability and for an enhanced energy confinement (for a discussion on advanced tokamak scenarios, refer for instance to [Taylor, 1997](#); [Gomezano, 1999](#); [Wolf, 2003](#)).

While the toroidal component of the magnetic flux can be considered as constant in time, a PDE model is necessary to capture the dynamics of the poloidal component. A control-oriented model of the poloidal magnetic flux was thus derived in [J-4], capturing the complexity of the wave-to-particles coupling (use of radiofrequency antennas) as identified gaussian shapes and the quasi-steady-state variations of the temperature profiles using a neural-network approach constrained by energy conservation ([Witrant and](#)

¹Such hypotheses were motivated by the specific configuration of Tore Supra in Cadarache (southern France), which is now being upgraded to a more ITER-like configuration (WEST, for Tungsten (W) Environment in Steady-state Tokamak) with a more complicated shape due to the use of a divertor (extra magnetic control at the bottom of the plasma shell to obtain vertically-elongated plasmas). Nevertheless, the results obtained in cylindrical coordinates can easily be extended to more complex shapes by appropriate geometric transformations (e.g. including the Grad-Shafranov shift as in [J-4] or extending the control results to a variable-shape tokamak such as TCV in [B-2, Ch. 5]).

Brémond, 2011). With a specific care of the discretization issues in time and space, we could get an efficient model of the safety profile, including numerous physical principles and peripheral components. This control-oriented and simplified modeling of complex physics allowed for the first time to simulate the plasma behavior faster ($\times 20$) than real-time. This model provides the time-evolution of internal plasma variables for control while including enough physics to remain suitable for various operating conditions.

The magnetic flux (not a conservative quantity) is provided in a slightly modified version of (4.1) as (resistive diffusion equation):

$$\frac{\partial U}{\partial t} = D \left(\frac{1}{r} \frac{\partial}{\partial r} r \frac{\partial U}{\partial r} + Q_V \right) \quad (4.2)$$

where U is the poloidal magnetic flux, D is the ratio between the resistivity of the plasma and the permeability of free space and Q_V is the sum of (partially controlled) non-inductive current sources. The equivalency between the variables used in the transport equation and the physical variables is summarized in Table 4.1. The boundary condition at the edge includes the coupling with the poloidal coils and can be set on the space variation of the flux (Neumann condition) if the total plasma current is regulated or on the time-variation of the flux (Dirichlet condition) if the voltage of the coils is considered directly.

Our model can predict, for example, the plasma resistivity and its variations ahead of the time when the feedback control is calculated (this knowledge is crucial to render the feedback control robust to plasma fluctuations and modeling errors). The resistivity calculated with measured temperature profiles is depicted in Figs. 4.3(a)-4.3(b) for Tore Supra shot 35952. This plasma shot is characterized by power modulations of the lower hybrid (LH) and ion cyclotron radio heating (ICRH) antennas. Note the difference of three orders of magnitude in the diffusivity coefficient between the plasma center and its edge on Fig. 4.3(a), and the modulated and noisy time-evolution on Fig. 4.3(b). The crewels observed after 20 s result from LH modulations (step inputs, LH being one of the main controlled inputs for Tore Supra) at a relatively low power and illustrate a coupling effect between the input and the diffusivity (nonlinear behavior).

The control problem is to regulate $\partial U / \partial r$ such that it reaches a desired equilibrium by designing a feedback law for Q_V that accounts for the diffusivity variations. Q_V also has to satisfy specific shape constraints (e.g. gaussian-like distributions). $\diamond\diamond$

Problem 4.1.2 (Question 2: Estimation of the transport and source terms for the temperature profiles)

Understanding heat transport is one of the main challenges to develop future control strategies and operate a fusion reactor. Contrarily to the magnetic flux equation, this transport is much less well known and control strategies must rely on estimating the transport parameters. Research in this area includes computer simulations using theoretical knowledge of fluid dynamics, analysis of the steady-state using power balance equations and evaluation of transient behavior by means of perturbative transport experiments (*Ryter et al., 2010; Clémenton et al., 2004*).

The electron heat distribution can be studied by combining energy conservation and perturbative transport principles (*Hinton and Hazeltine, 1976*). The major problem in heat transport is the definition of reaction, diffusion and source components. Various empirical, theoretical, mixed, computational models exist in the literature, each one depending on the reactor itself, its operating mode, the discharge parameters, the temperature profiles, the shear effect, the safety factor and many other conditions (see *Taroni et al., 1994; Mikkelsen et al., 1997; Onjun et al., 2001; Moreau et al., 2008; Ryter et al., 2010; Witrant and Brémond, 2011*, and references therein). From a control perspective, we would like to know the transport parameters without having to rely on such dependencies, using only the measured temperature profiles (available at a high resolution for all tokamaks) and reconstructing the time and space variations of the parameters. The control and diagnostic objectives motivate us to estimate the transport parameters and

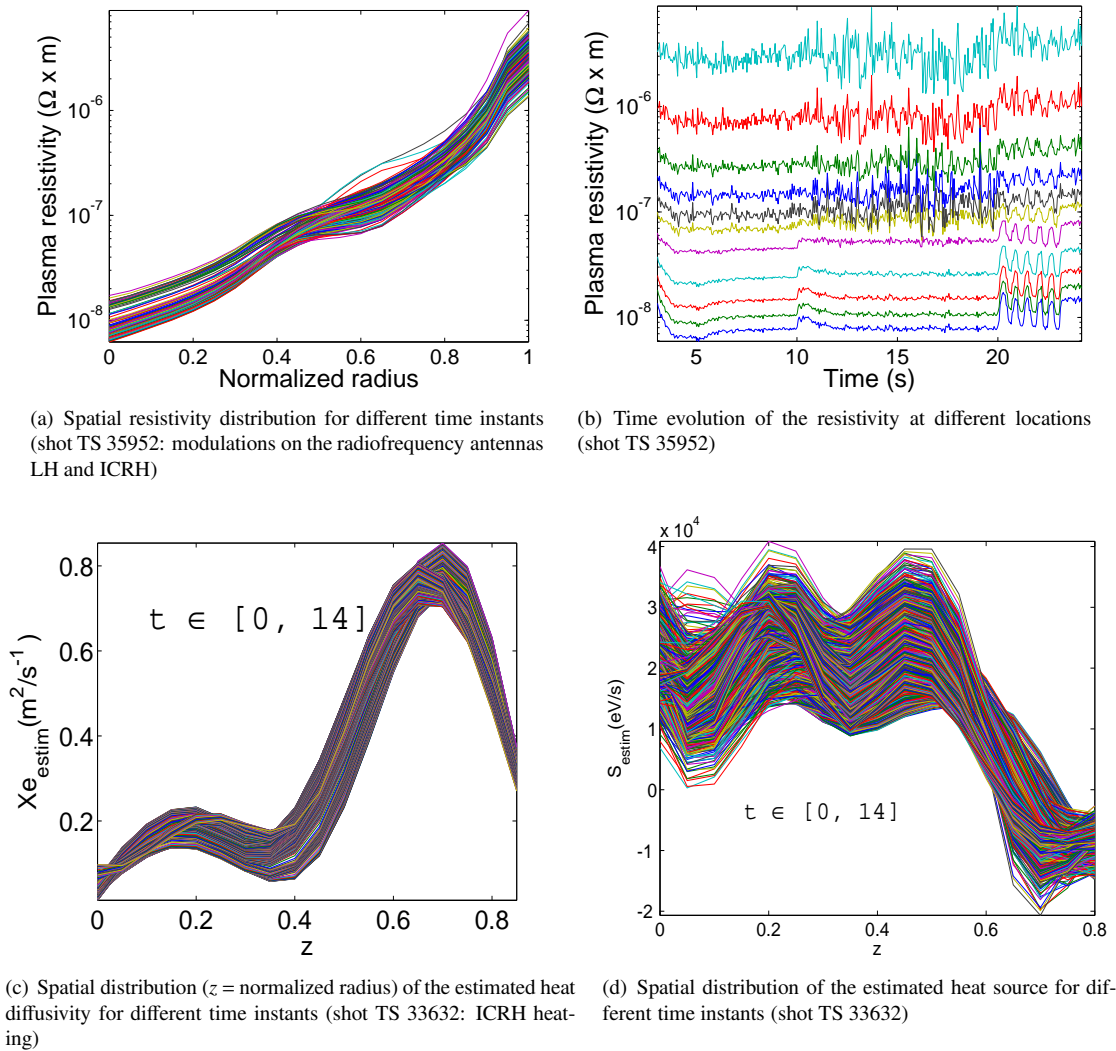

Figure 4.3: Inhomogeneity of diffusivity in tokamak plasmas. Figures excerpt from [B-2] (top) and [J-7] (bottom).

source term assuming no a priori knowledge of the plasma evolution except that the temperature is constrained by energy conservation (heat equation) and proposing to this end an on-line infinite dimensional estimator.

Assuming that the electron temperature is decoupled from the density evolution (linearization hypothesis), the temperature obeys the transport equation (4.1) with U being the averaged electrons temperature on an isoflux surface, D the thermal diffusion and Q_V the balance between the power input from the radiofrequency antennas and the dissipated energy (see for example Kroesen et al., 1990; Basiuk et al., 2003, for the diversity of the terms involved). The boundary condition at the plasma center is a Neumann one while it is of Dirichlet type at the edge (imposing a negligible temperature for the plasma-facing components).

The inhomogeneity of heat diffusivity and the variability of the source term resulting from our estimation algorithm are illustrated in Fig. 4.3(c)-4.3(d) for the Tore Supra shot 33632 (ICRH heating). The space variation of the profiles are estimated in this case using an extended Kalman filter with unknown

Normalized variable	Physical quantity	Classical notation
U D Q_v r	Problem 4.1.1 poloidal magnetic flux ratio between the plasma resistivity and the permeability of free space large plasma radius times the sum of the non-inductive current sources small plasma radius	ψ η_{\parallel}/μ_0 $R_0 j_{ni}$ $\rho = ax$
U D Q_v r	Problem 4.1.2 electrons temperature thermal diffusivity of the electrons ratio between the net input power and the density of electrons normalized small plasma radius	T_e χ_e P_e/n_e z
U Q_s Q_v U v	Problem 4.2.1 for the Euler equation mass density, momentum and total energy per unit volume pressure and rate of work on the fluid due to pressure rate of heat addition Problem 4.2.1 for the decoupled travelling waves Riemann coordinates characteristic velocities in terms of the particles velocity u and the speed of sound a	$\{\rho, \rho v, E\}$ $\{0, -p, -pv\}$ $\{0, 0, \rho \dot{q}\}$ $\{\zeta_1, \zeta_2, \zeta_3\}$ $\{u - a, u, u + a\}$
U D v $U(x_m, t_f)$ $G(x_m, t)$ $U(0, t)$	Problem 4.3.1 densities of: ice lattice (kg/m^3 of void space), trace gas α (mol/m^3 of void space) in open pores, α in closed pores, weighted by the total porosity ϵ and open porosity f (m^3/m^3) effective firm diffusivity per open porosity (m^2/year) advection with velocities (m/year) of firm sinking v and air w_{air} , and advection-driven diffusivity $v_{AD} = D_{\alpha}/f[M_{\alpha}g/RT + (\partial f/\partial z)/f]$ (molar mass M_{α} , gravitational acceleration g , ideal mass constant R , firm temperature T) Problem 4.3.2 modeled density profile at the collected samples depths x_m and date t_f discrete Green's function for the time vector $t \in [t_0, t_f]$ atmospheric density history	$\{\rho_{\text{ice}}(1 - \epsilon), \rho_{\alpha}^o f, \rho_{\alpha}^c(\epsilon - f)\}$ $\{0, D_{\alpha}/f, 0\}$ $\{v, v + w_{\text{air}} + v_{AD}, v\}$ Y \mathcal{G} \bar{U}
LPV	Abbreviations linear parameter-varying	

Table 4.1: Interpretation of the variables used in the conservation law in terms of the physical variables and link with the classical notations (used in the reference papers).

inputs without direct feed-through (EKF-UI-WDF) as proposed in [J-7]. Note the abrupt spatial changes in the diffusivity and the large variation of the source term.

The estimation objective is to track the time and space evolution of both diffusivity and source (and possibly a sink) in real-time for the design of adaptive control methods. Distributed measurements of the electrons temperature and density are available to design the estimator. $\diamond\diamond\diamond$

4.2 Convection in inviscid Poiseuille flows

Unlike diffusion, where the flow has a smooth transition between one boundary and another for a given constant input, convection can only be captured from boundary changes during the transient behavior of the flow (e.g. think about the transport of a step change in the boundary pressure of a tube: once the step has travelled through the tube, the profile is flat and equal to the boundary value). Specific care has to be

taken during numerical modeling to avoid any artificial diffusion and interesting results can be obtained by focusing on the traveling waves. We consider here the Poiseuille flow as a laminar flow between two plates or in a duct and neglect the viscosity effects. The interesting property of such a flow represented as a purely advective phenomenon is that the velocity field can be averaged over a cross-section to provide a 1D transport description (in the axial direction). “Mild” turbulences (e.g. excluding shocks) can also be considered in this framework as they tend to reduce the effect of the tube boundaries and induce a flatter velocity profile on the average (in the direction perpendicular to the main stream). This provides the simplest framework to analyze convection and corresponds to many industrial applications where a flow is transported in pipes or tubes.

Among the potential applications, hydraulic networks (Santos and Prieur, 2008), multiphase flow (Meglio et al., 2011), road traffic networks (Jacquet, 2006; Haut et al., 2009) or gas flow in pipelines (Bastin et al., 2008) are of significant importance. Controlling flow transport in ventilation systems or networks of pipes can also have an important impact on energy consumption or pollution. For example, the energy consumption for mining ventilation can account for more than 50% of the total mine consumption [J-3] (mining accounts for 5 to 8% of the total industrial energy consumption in mining countries). Combustion and recycling of exhaust gas in car engines is a crucial element to reduce cars’ pollution and match the future emission levels imposed by the European Commission (Castillo-Buenaventura, 2013; Castillo-Buenaventura et al., 2012a). The regulation of cryogenic lines for the Large Hadrons Collider (CERN, Geneva) is a key to achieve the objective of increasing the maximum power sustained by the experiment [J-33].

For mathematical modeling, the flow dynamics is provided by (3.4) in 1D space (denoted as x) with a velocity field $\vec{v} = v_x \vec{i}$, $D = 0$ and the divergence and gradient operators defined as:

$$\vec{\nabla} \cdot \vec{F} = \frac{\partial F_x}{\partial x} \quad \text{and} \quad \vec{\nabla} U = \frac{\partial U}{\partial x} \vec{i} \quad (4.3)$$

We then obtain the convective transport dynamics as:

$$\frac{\partial U}{\partial t} = \frac{\partial}{\partial x}(-v U + Q_S) + Q_V \quad (4.4)$$

A boundary condition is necessary for each component of U and is set on one end of the domain or the other depending on the transport direction of the specific quantity (sign of v).

The transport phenomenon is then captured by models where lossless signal propagation (e.g. no numerical diffusion) and ensuring stability necessitate a specific care (Witrant, 2005; Witrant and Johansson, 2008, J-33). Some system topologies can be simplified by decoupling the dynamics (using Riemann invariants, see J-12) or by modeling the transport as a functional differential equation with a delayed kernel [J-31]. The process automation is generally limited to sensing and actuating only the system boundaries (Castillo-Buenaventura et al., 2012a,b, 2013a,b), or to use communication networks involving time-varying delays and information loss (Witrant et al., 2007, BC-5). The automaton units available for such process (e.g. embedded control in mines, buildings and car engines) generally offer only limited computation capabilities and thus imply to design simple and robust control algorithms (e.g. reduced-order controllers as in J-29, BC-6 or strategies with linear parameter-varying algorithms, see Rivas Caicedo et al., 2012b,c). Slower dynamics (e.g. centralized control in mines, bread ovens) allow us to include nonlinearities and inhomogeneities in predictive control schemes (Sandou et al., 2008, 2010, J-14). When only limited actuation capabilities are available (e.g. ON/OFF only or a reduced number of operating levels), hybrid strategies provide solutions to guarantee safety and comfort (Di Benedetto et al., 2009, J-3), or to ensure controllability and robust invariance (Meyer et al., 2013a,b).

The following problem illustrates the general question: measuring U at one extremity of the domain and knowing all the transport coefficients (e.g. v and sources/sinks), can we design a feedback law for actuators located at the other extremity of the domain that ensures that the distribution of U along the whole domain remains stable and that the measurement reach the desired value (regulation objective)?

Problem 4.2.1 (Observation and control of the airflow in car engines)

The engine air-path has become crucial in the development of modern engines. The control of the air-path has a direct impact on the engine performance as well as on its pollutant emission level. Indeed, air system strategies allow us to control the species that are introduced in the cylinder, which is a cost-effective way to reduce pollutant emissions. As a consequence, automotive air systems have become increasingly complex in order to achieve pollutant reduction strategies and fuel consumption reductions. This is illustrated by the dual-loop exhaust gas recirculation (EGR) engine air-path presented in Fig. 4.4.

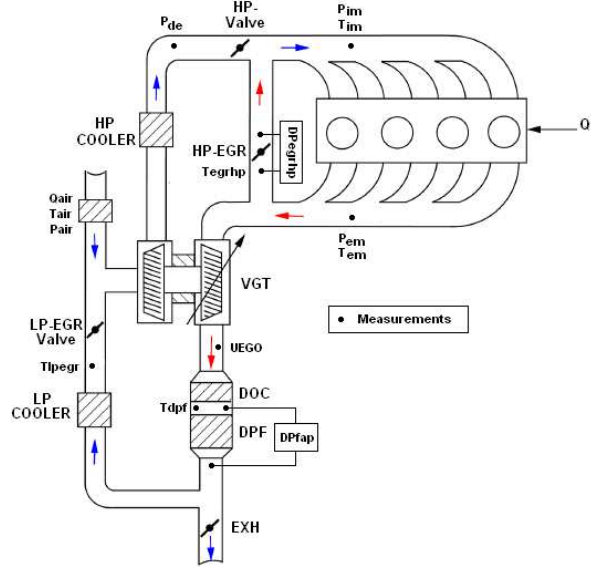

Figure 4.4: Dual-loop air-path for exhaust gas recirculation in Diesel engines (Castillo-Buenaventura, 2013).

Such flows are described by the Euler equation (an inviscid version of the Navier-Stokes equation) in a 1D space, which provides the conservation of the quantity U . U is then a vector containing the mass density, the momentum (a scalar in this case as the velocity field is considered unidirectional and uniform over the cross-section) and the energy of the flow. Note that a small amount of viscosity may be introduced in the model to stabilize the numerical behavior (e.g. see [Witrant and Johansson, 2008](#), for the addition of a resistive component to stabilize a simulator of large airflows and simplify the momentum equation). The pressure acts on the control surface and additional heat (volume) sources can possibly be considered in the energy equation. The 1D convective equation (4.4) can then be used to describe the flow, with the specific components mentioned in Table 4.1.

The Euler equation can also be written in a non-conservative form involving density, velocity and pressure as primitive variables (e.g. see [Winterbone and Pearson, 2000](#)). The dynamics of U (in 1D) is then expressed as a Jacobian matrix (nonlinear in U) which multiplies the gradient of U (thus closer to an advective form). We used this method, for example, to model the dynamics of the cryogenic distribution line of the LHC in [J-33]. Analyzing the flow close to an equilibrium (linearization of the dynamics), considering the isentropic case and using the Riemann invariants, we obtain a decoupled flow description in terms of Riemann coordinates (or characteristic variables) travelling at the velocity of the particles and at the velocity of the particles plus or minus the speed of sound (the characteristic velocities). The advective equation (3.3) can then be considered in the 1D form:

$$\frac{\partial U}{\partial t} + \text{diag}(v) \frac{\partial U}{\partial x} = 0 \quad (4.5)$$

where U is a vector containing the Riemann coordinates and v contains the characteristic velocities. The

different changes of variables are briefly described by [Castillo-Buenaventura et al. \(2012b\)](#). ◇◇◇

4.3 Diffusion-convection of trace gas in porous media

Unlike convection that can be analyzed in the framework of hyperbolic equations and diffusion that belongs to parabolic ones, a combination has to be considered in the diffusion-convection case. Both processes tend to compete against each other, as convection aims at transporting unchanged steep gradients of the boundary value through the medium while diffusion smoothes every large change between neighboring locations. The diffusion process prevents using the method of characteristics or Riemann coordinates (to reduce the PDE description to a set of ordinary differential equations) and implicit schemes should be preferred to preserve the stability, with fast computation objectives (e.g. as required for inversion or control purposes).

In porous media the control volume can be decomposed as a set of interconnected networks of the solid structure and transported fluids. The structure of the material (e.g. its tortuosity and permeability) affects the local path of the fluid particles and thus implies to consider a (possibly strong) inhomogeneity in the transport dynamics. The driving fluxes can be replaced by filtration vectors that include the impact of porosity (e.g. a measure of the space in the material that is filled by the fluid, expressed in terms of volumes ratio) and define the transport of conserved mass (e.g. see [Coussy, 2003](#), for a detailed description of poromechanics). The trace gas hypothesis implies that the gases are transported with the solid structure and with air but do not interact between each other in terms of volume occupancy. We also suppose no chemical interaction (between the gases, with air or with the solid structure). These last two hypotheses are made to preserve linearity with respect to the state, a property of prime interest for our methods.

Considering transport in a vertical column (the gravity effect is included) of unitary cross-section, the flow variables are averaged horizontally at a given depth and we can describe the convection-diffusion dynamics (3.4) with the divergence and gradient operators defined as in (4.3). Neglecting the impact of surface sources (no role in the continuity equation) but keeping the volume ones (exchange of mass between the networks), the transport dynamics writes as:

$$\frac{\partial U}{\partial t} = \frac{\partial}{\partial x} \left(D \frac{\partial U}{\partial x} - v U \right) + Q_v \quad (4.6)$$

where U is a stacked vector containing the quantities in each of the networks and D and v can be diagonal matrices to separate the transport properties of each network.

Two issues are considered in this framework:

1. given the time-evolution of the boundary condition $U(0, t)$ for $t \in [t_0, t_f]$ and the final distribution $U(x_m, t_f)$ (known only at the specific measurement locations x_m), how to estimate $D(x)$?
2. given $D(x)$, how to invert the measured profile $U(x_m, t_f)$ to obtain the boundary history $U(0, t)$?

The physical motivations and specific formulations are detailed in the next two problems.

Problem 4.3.1 (Question 1: diffusivity estimation in polar firns)

Polar ice cores provide a unique archive of atmospheric composition at time scales covering glacial-interglacial cycles (the last 800 000 years) to the rise of anthropogenic pollution (since about 1850 A.D.), as described in [IPCC \(2007\)](#); [WMO \(2007\)](#) and references therein. Insoluble trace gases are trapped in polar ice at the firn-ice transition, at approximately 50 to 100 m below the surface, depending primarily on the site temperature and snow accumulation. Models of trace gas transport in polar firn are used to relate firn air and ice core records of trace gases to their atmospheric history.

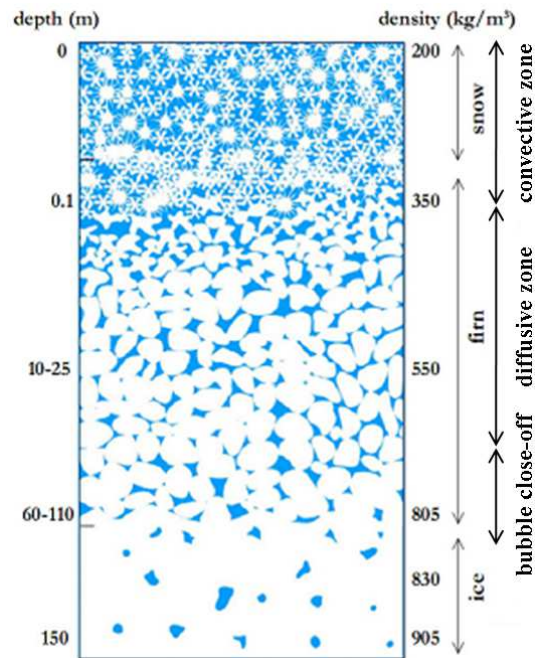

Figure 4.5: Polar firn structure as a function of depth and density (Witrant and Martinerie, 2010). Scheme adapted from Sowers et al. (1992); Lourantou (2008).

In polar regions where no melting occurs, snow transforms into ice through the effect of its own weight. The transition between an open-porosity material (snow/firn) into an airtight material (ice) then occurs in the bubbles close-off region, as depicted in Fig. 4.5. Within snow and firn (i.e. compacted snow), atmospheric trace gases are mostly transported by diffusion through air channels. Air trapping in bubbles also generates an advection flux which is most important at sites undergoing high snow accumulation rates. Finally gravitational fractionation occurs, transporting heavy molecules downward more efficiently. This slight fractionation needs to be taken into account at least for isotopic ratios, measured at the per-mil precision level. Such phenomena lead to the modeling of firns as inhomogeneous media where the trace gases move according to transport equations with space-dependent coefficients (e.g. Rommelaere et al., 1997; Trudinger et al., 1997, J-1).

Continuity in the firn can be modeled in the form of (4.6) by the densities in each network component scaled by their occupied space in a control volume. The vector U thus contains the (uncoupled) densities of the ice lattice, gases in open pores (connected to the surface through channels) and gases in closed pores (sinking bubbles), as described by [J-1]. Focusing on trace gases in open pores, D captures the relative diffusive motion of the gas in the air column (molecular diffusion from Fick's law combined with turbulence effects). The relative convective motion of the gas in the air column due to gravity is also parameterized in terms of D (advection-driven diffusivity from Darcy's law) to prevent the addition of an unknown parameter, the permeability, and nonlinearities in the state. This flux description was achieved in [J-1] by considering a small deviation in the velocity field from the quasi-steady state set by the hydrostatic equilibrium. This strategy is equivalent to distinguishing the fast (pressure and force-driven) effects from the slow (diffusion and convection) effects, expressing the momentum equation as an algebraic relationship. The remaining components of convection v are due to advection with the air flow and firn sinking. Q_V is a sink for the particles trapped in closed pores and possibly a radioactive decay. The boundary conditions are set by the atmospheric history on the surface (Dirichlet type) and as a no-flux condition (Robin type)

at the bottom of the firn. This physical description is summarized by the mathematical expression:

$$\frac{\partial}{\partial t} \underbrace{[\rho_{\alpha}^{\circ} f]}_1 + \frac{\partial}{\partial z} \underbrace{[\rho_{\alpha}^{\circ} f(v + w_{air})]}_2 + \underbrace{\rho_{\alpha}^{\circ}(\tau + \lambda)}_3 - \frac{\partial}{\partial z} \left[\underbrace{D_{\alpha} \rho_{air} \frac{\partial}{\partial z} \left(\frac{\rho_{\alpha}^{\circ}}{\rho_{air}} \right)}_4 + \underbrace{\mathcal{A}_{ss}}_5 \right] = 0$$

$$\rho_{\alpha}^{\circ}(0, t) = \underbrace{\rho_{\alpha}^{atm}(t)}_5, \quad \underbrace{\frac{RT}{M_f} \frac{\partial \rho_{\alpha}^{\circ}}{\partial z}(z_f, t) - \rho_{\alpha}^{\circ}(z_f, t)}_6 = 0,$$

with:

1. *Quantity of trace gas mass in the control volume* = trace gas density in open pores ρ_{α}° \times fraction of open pores volume in a unitary volume f ;
2. *Flux* driven by advection with air w_{air} and firn sinking v ;
3. *Sink* = particles trapped in bubbles at a rate τ and radioactive decay λ ;
4. *Flux* driven by molecular diffusion D_{α} due to concentration gradients (Fick's law) in the air column of density ρ_{air} ;
5. *Flux* driven by external forces: gravity included with Darcy-like flux ($\approx \partial[\rho_{\alpha,ss}^{\circ} f]/\partial t = 0$ at steady state);
6. *Boundary input*: surface concentration = atmosphere history;
7. No flux condition at the firn to ice transition, z_f being the depth of the last layer with open pores.

The relative importance of the fluxes at three polar sites is depicted in Figure 4.6. Note the variability in terms of the relative influence of the different fluxes depending on the polar site. The diffusivity estimation problem is to reconstruct the firn diffusivity profile (normalized to the CO_2 diffusivity) for each site from air-samples measurements of gases with known atmospheric history.

The modeling problems expressed above are then:

1. to identify *firn diffusivity* $\mathbf{D}_{\alpha}(z)$ from $\rho_{\alpha}^{atm}(t)$ and firn air measurement $\rho_{\alpha}^{\circ}(z_m, t_f)$, z_m being the measurements depths, using gases with known atmospheric history;
2. the reverse: to identify $\rho_{\alpha}^{atm}(t)$ from $\mathbf{D}_{\alpha}(z)$ and $\rho_{\alpha}^{\circ}(z_m, t_f)$ for gases with unknown atmospheric history (described in the next problem).

Note that solving the problem 1 implies bilinear tools (as the optimized coefficient $D_{\alpha}(z)$ multiplies the state ρ_{α}°) for single gas inversion and becomes more nonlinear for multi-gas inversion as diffusivity is then parameterized in a gas-dependent (molecular) component and a gas-independent one (turbulent effects).

◇◇◇

Problem 4.3.2 (Question 2: atmospheric history reconstruction from air samples measurements in ice cores)

Once the physical property (diffusivity profile) regulating gas transport in firn is identified by solving Problem 4.3.1, our aim is to reconstruct the atmospheric history of gases for which only measurements of firn air are available, possibly correlating the results obtained at different polar sites. Indeed, reconstructing the mixing ratio trends of trace gases prior to their atmospheric measurement period is a major motivation for firn air analysis (see e.g. Montzka et al., 2011, and references therein).

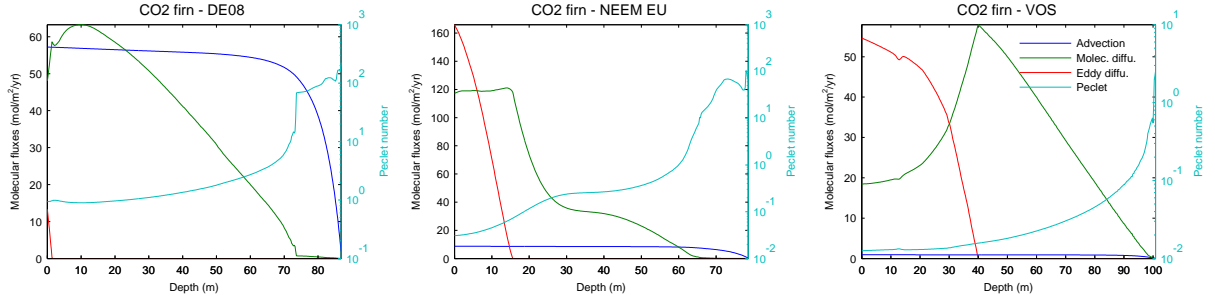

Figure 4.6: Relative importance of diffusion and advection for CO₂ transport in 1990 for three polar sites (NEEM in Greenland and DE08 and Vostok in Antarctic, sorted by decreasing snow accumulation rate): molar flux due to advection and firn sinking (blue), molar flux due to molecular diffusion (green), molar flux due to eddy diffusion (red) and Péclet number, the ratio between advective (particles transport with the bulk air motion) and diffusive (molecular diffusion counteracting the density gradient) fluxes (turquoise).

From (4.6) with known v and Q_v , the diffusivity fully determines the map between the upper (Dirichlet) boundary condition (atmospheric history) and the final density distribution (air samples measurements obtained during the ice coring campaign). Atmospheric history reconstruction necessitates to invert this map to estimate the surface boundary $U(0, t)$ from sparse measurements $U(x_m, t_f)$. The inversion does not induce specific technical difficulties as the model was constructed such that (4.6) is linear in the state (U containing the density distribution of the trace gas of interest) and D can be estimated with the desired accuracy (at least for ice core sites for which a sufficient number of chemical species have been measured). Nevertheless, only sparse measurements $U(x_m, t_f)$ are available. Thus, inferring $U(0, t)$ from $U(x_m, t_f)$ is an ill-posed problem due to the multiplicity of the solutions (their existence and stability being handled at the modeling and inverse-diffusivity stages, respectively). For example, all the data points can be fitted arbitrarily well using oscillating scenarios. The estimation challenge is thus to design an inversion method that is consistent with the information contained in data set taking into account uncertainties and sufficiently robust to handle multiple gases at multiple sites in an automatic way (e.g. without the hand tuning typically used in other models). ◇◇◇

4.4 Specific difficulties

Addressing the different problems characterized by inhomogeneous transport as described in this chapter involves overcoming several specific difficulties.

First, a broad knowledge of the different physical aspects and of fluid mechanics is necessary to identify the key components that need to be included in the model dynamics. These components can be separated as setting a transient or a steady-state behavior, depending on time-scale of interest, to write the simplest (in terms of dimension and linearity) parameterized model that can reproduce the measurements for various operating conditions. The inhomogeneous transport is then described with distributed (PDE) equations of parabolic, hyperbolic or mixed type. In comparison with the more classical approaches in automatic control or signal processing involving only black-box (non-physical) modeling strategies, the advantages of such physical modeling are typically our capability to interpret the results in physical terms, the extent of the results for similar transport processes, a wider range of operating conditions and our capability to substitute experimental capabilities by physical knowledge when only sparse measurements are available. The drawbacks are the difficulty (and time) to obtain a well-balanced model for a specific objective and the fact that few results exist to estimate or control the input-output map of inhomogeneous transport PDEs.

The second difficulty is related to the computational aspect, as lumped inhomogeneous transport PDEs may involve several orders of magnitude between the different representative time constants (directly inferred from the transport coefficients). This leads, most of the time, to robustness, stability and precision issues (e.g. avoiding positive eigenvalues and numerical diffusion) at the numerical implementation stage. While we consider only 1D problems, the resulting system of ordinary differential equations (ODE) is also sufficiently large (e.g. 400×9 ODE during a few hundred years for Problem 4.3.1 at the Greenland site NEEM) to motivate dedicated and efficient discretization strategies for real-time feedback implementation and nonlinear optimization objectives.

The last issue is related to the process instrumentation, both for sensing and actuation. The problem formulation strongly depends on whether the instrumentation is distributed (e.g. for the tokamak) or at the boundary (e.g. for the car engine), and if the information is available in real time or only at very few time instants (e.g. at a single date for the firm). Measurement of most distributed variables cannot be done directly but necessitates virtual sensors (e.g. plasma magnetic flux obtained from equilibrium reconstruction algorithms as proposed by [Blum et al., 2012](#)), complex manipulation of other variables (e.g. plasma electrons temperature variation inferred from electron cyclotron emission, see [Udintsev et al., 2006](#)) or proper inter-calibration strategies for data obtained at different laboratories (e.g. for the measurement of trace gases from firm air at different sites as discussed by J-1, J-21).

The efficiency of the estimation and control methods, such as those discussed in the next section, strongly depends on our capability to structure the model according to the method while overcoming the difficulties mentioned above. This leads to *control/estimation oriented* models that may significantly differ from classical physical models.

Chapter 5

Estimation and control methods for inhomogeneous transport

While the different problems described in the previous chapter are all related to the convective-diffusive transport described by PDEs such as (3.4), the design of efficient methods for estimating free parameters in a physical model (grey-box modeling or inverse problem) and for feedback control (referred to as *EC methods* below, for estimation and control) strongly depend on the problem formulation and available data. Two different approaches can be considered:

1. early-lumping: the space variation is discretized prior to the design of an EC strategy;
2. late-lumping: the design of methods is done on the distributed (PDE) dynamics and the estimator / feedback control law is discretized only a posteriori.

The early-lumping strategy has the major advantage to allow decoupling the problem formulation and forward model implementation from evaluating the EC methods efficiency. Indeed, inhomogeneities of the media change the transport coefficient by several orders of magnitude, which induces major numerical (mostly stiffness) issues. Furthermore, “real-life” problems such as those described in Chapter 4 necessitate a fair amount of physical descriptions and signal processing prior to obtaining a clear state-space formulation (more than 90 % of the complete algorithm). Obtaining a robust and efficient numerical model to capture the desired transport process is thus an important part of the EC method setup and the early lumping approach provides a wide range of tools to analyze the system properties. Once the discrete state-space description is obtained, well established EC methods are typically available to solve the problem or at least to refine the problem formulation according to the system characteristics.

On the other hand, late-lumping methods provide valuable insights on the interconnection between the process and the method. The dynamics being described in their “physical sense” by the PDEs (while discretization mostly provides a black-box model), the stability and convergence results obtained in terms of PDEs allow us to interpret the impact of the transport properties in a qualitative way. A drawback of late-lumping strategies is that contrarily to homogeneous transport, for which a reasonable literature of EC methods is available, handling the medium inhomogeneity necessitates new research and a tight interaction with applied mathematics.

From the pedagogical point of view, this two-stage approach for problem solving has the advantage to guide young researchers (such as the master and Ph.D. students who contributed to the work presented in this manuscript): first on understanding complex physical problems with known methods, and then on designing new methods that are tailored to the transport specificities.

This section provides an overview of several EC methods developed to solve the problems described in the previous section. Starting from inverse strategies, the impact of transport inhomogeneity is considered for parameter identification/estimation and finally for feedback control design.

5.1 Inverse strategies for advective-diffusive transport

5.1.1 Transport parameter estimate

As described in Problem 4.3.1 on firm diffusivity, a fundamental parameter characterizing inhomogeneous transport is the medium diffusivity, i.e. D in equation (4.6) knowing the boundary conditions. Using a simplified transport model (linear in diffusivity), we proposed a variational optimization strategy in the PDE framework in [Witrant and Martinerie \(2010\)](#), which generally applies to space-dependent transport coefficients. This method relies on linearizing the coupling between the state and the diffusivity, computing the adjoint (possibly extended to include inequality constraints) and setting a gradient-descent algorithm. The results of this strategy have shown that the initial physical model could not represent the subtleties of the data set (particularly challenging as some trace gas concentrations in air are measured in parts per billion), despite the proper convergence of the optimization method. This motivated a thorough revision of the physical processes inducing the medium heterogeneities and led to a new model that is no longer linear in terms of diffusivity [J-1]. A nonlinear optimization strategy was then used to solve the inverse diffusivity problem and a detailed sensitivity analysis was proposed, allowing us to handle the ill-posedness of the problem and to characterize numerous polar sites. This work (along with the results presented in the next section) sets the core of the LGGE-GIPSA model, which is now used to interpret the data from several labs in the world (UEA in England, IMAU in The Netherlands, Stony-Brook INSTAAR NOAA in the US, CIC in Denmark and CSIRO in Australia).

This methodology has been recently extended to 2D transport analysis of glaciers flow in [J-9] to invert ice flow velocities measured with a satellite and estimate the spatial distribution of basal friction. It is also used to reconstruct the spatial variations of the snow accumulation rate (parameterized with Legendre polynomials) from multiple radar measurements of ice isochrones in glaciers (work in progress with Denis Callens and Frank Pattyn at ULB in Belgium).

5.1.2 Input estimate from sparse data

Another inverse problem of major interest is the input estimate from sparse data, as described in Problem 4.3.2 ($D(x)$ is known in equation (4.6) and we estimate the time-varying boundary condition $U(0, t)$). Considering a lumped version of the transport PDE, this leads to finding the input history in a linear time invariant (LTI, for trace gas concentrations) or in a linear time-varying (LTV, appearing for isotopic ratios) model, from sparse measurements of the state at final time. The inverse solution is typically obtained with a Green function (impulse response map for LTI systems) to convolute/deconvolute the signals in the time domain. [Rommelaere et al. \(1997\)](#) developed this method for single site analysis of trace gases by considering the measurements as a convolution between the Green's function obtained from the impulse response of the numerical model and the atmospheric history. A more formal approach was proposed by [Witrant and Martinerie \(2013b\)](#), where we proposed an analytical expression to derive Green's function from the lumped state-space model that is suitable for multi-site analysis and for the inversion of isotopic ratios (implying a linear time-varying model). The estimation is then achieved by solving (analytically) a least-squares optimization problem parameterized in terms of the input rugosity (regularization term to cope with the under-constrained nature of the problem). The sparsity of the measurements (causing an ill-posed optimization problem) is handled with a stochastic analysis of the data. We could obtain an automatic tuning method which ensures that the amount of information extracted from the model is the same

as the one available in the dataset, while satisfying some robustness with respect to sparsity. The inclusion of positivity constraints in this framework also allowed us to precisely determine when the emission in the atmosphere of newly detected ozone-depleting substances started [J-NatLau13], see Fig. 5.1. This method is now extended to handle deep ice core measurements (which necessitate to consider specific numerical issues for the transition between the firm - mostly diffusive - media and the ice purely advective media).

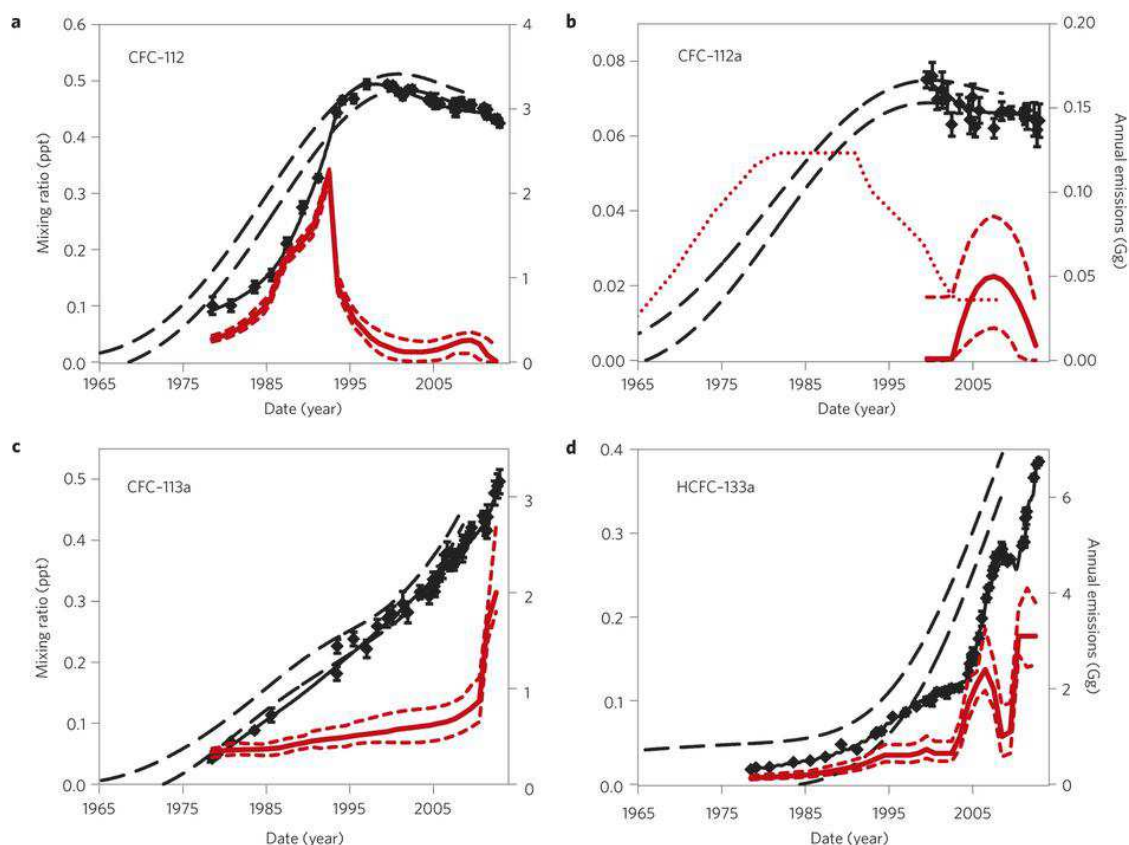

Figure 5.1: Atmospheric history and global emissions of CFC-112 (a), CFC-112a (b), CFC-113a (c), and HCFC-133a (d). ‘- -’ North hemisphere trend modeled from firn air, ‘◇’ Cape Grim measurements, ‘- -’: fit of South Hemisphere trends used to infer the emissions. [J-10]

The inverse diffusivity and inverse scenario methods for firn air modeling, developed in strong collaboration with P. Martinerie (LGGE), allowed us to propose a unique reconstruction tool for atmospheric histories that is used to interpret data from several laboratories in the world (UEA in England, IMAU in the Netherlands, Stony-Brook INSTAAR NOAA in the USA, CIC in Denmark, CSIRO in Australia). Its use and developments led to 14 journal papers including 2 *Nature* cited in the last GIEC report¹ and one *Nature Geoscience*, and 2 publications in international conference proceedings.

5.2 Identification of diffusive transport

We consider here Problem 4.1.2, which aims to estimate the diffusion coefficient $D(r, t)$ and the volumetric source $Q_V(r, t)$ in the transport equation (4.1), from distributed measurements of the state $U(r, t)$. A reaction term can also be included.

¹[http://www.climatechange2013.org/report/review-drafts/Ch.5\(5-23/24/42/43\)forJ-15andCh.6\(6-21\)forJ-2](http://www.climatechange2013.org/report/review-drafts/Ch.5(5-23/24/42/43)forJ-15andCh.6(6-21)forJ-2)

The first results are focused on a lumped approach to find the source term $Q_V(r, t)$ in the density distribution of tokamak plasmas (master theses of J. Weydert and E. Santiago, in collaboration with M. Goniche and F. Clairet at CEA IRFM). We formulated this problem as an optimal control problem by establishing that the optimal source (to minimize the least-squares error between the model output and the data) takes the form of a state feedback and can thus be obtained from a linear quadratic regulator with integral action (Weydert et al., 2009; Witrant et al., 2009b). A quasi steady-state approach is attempted in (Witrant and Goniche, 2009) but mostly concluded that the transients are essential for such an estimation. The importance of knowing the transport parameters and of the discretization method to obtain the final estimator is detailed in (Santiago et al., 2011).

The next step is to include the diffusion parameter $D(r, t)$ in the estimate, with a state feedback architecture (e.g. as opposed to the use of an inverse method based on an offline and partial knowledge of the state). This was the Ph.D. topic of S. Mechhoud on the heat equation in tokamak plasmas, carried in collaboration with L. Dugard (GIPSA-lab) and D. Moreau (CEA IRFM). Both "early" and "late" lumping approaches are considered in this thesis.

First, in [J-7] the Galerkin formulation (cubic b-splines finite element method) and the parameter projection method are combined to convert the PDE into a set of ODEs (early lumping definition). This leads to a finite dimensional linear time-varying state-space model with unknown parameters and inputs. The Extended Kalman Filter with Unknown Inputs Without Direct Feed-through is applied to estimate simultaneously the unknown parameters and inputs and an adaptive fading memory coefficient is introduced in the EKF-UI-WDF, to deal with time varying parameters. We could determine the conditions under which the direct problem is well posed and under which the reduced order model converges to the initial one (the number of unknowns used to estimate the discretized D and Q_V has to be less than the number of equations describing the measurements). The different steps of these results are presented by Mechhoud et al. (2012, 2013d,e).

We then developed a late-lumping method, where the adaptive estimation technique is chosen in order to reconstruct "freely" the unknown parameters without the constraints due to the model reduction / discretization. Once the parameters and input identifiability conditions are verified (assuming distributed sensing, only local linearly independent bases can be used to describe the source and diffusion) an adaptive estimator is derived in the infinite dimensional framework. It consists of a state observer and gradient-based parameters and input adaptation laws. The parameters convergence depends on the richness (in terms of frequency content) of the input signals (classical persistency of excitation condition), whereas the state convergence is established using a Lyapunov approach. As in adaptive control methods, the convergence of the proposed estimator is sensitive to the tuning gains selection, which is done on-line based on the minimization of the state estimation error. These results are presented by Mechhoud et al. (2013a,c, 2014). In a more recent work (master thesis of M. Polac), we could establish that the adaptive estimation method works particularly well for individual source or parameter estimation in comparison with the method proposed by Kolmanovsky et al. (2006) (use of source saturations to refine the parameter estimate online for ODEs) but that the combined estimate strongly depends on the choice of the discretization basis. This comparison is illustrated in Fig. 5.2.

5.3 Feedback control design

5.3.1 Distributed feedback control of diffusive transport

Considering Problem 4.1.1 and the diffusive transport equation (4.1), our aim is to control or ensure the convergence of the state $U(r, t)$ at a desired rate using the source $Q_V(r, t)$ while taking into account the known variations of $D(r, t)$. We considered this issue for the control of the safety factor in tokamaks based on linearized plasma dynamics in the Ph.D. thesis of F. Bribiesca-Argomedo, in collaboration with C. Prieur

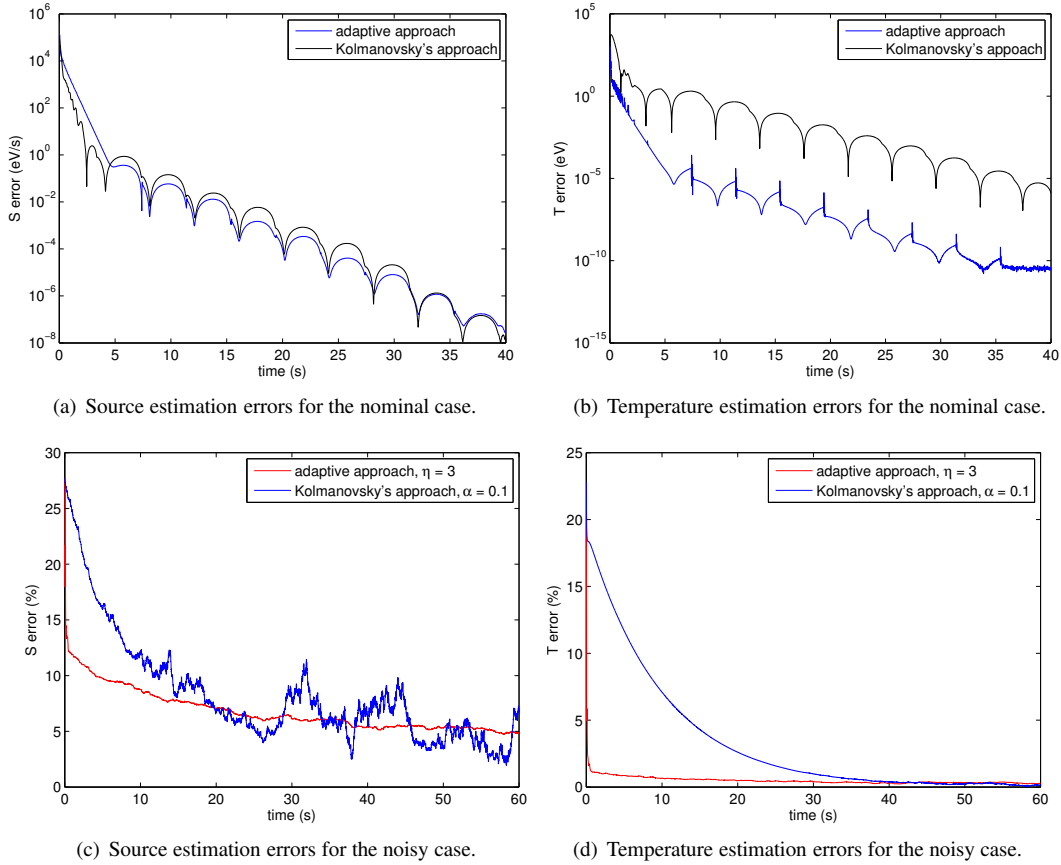

Figure 5.2: Comparison between the PDE-based adaptive method and the method of [Kolmanovsky et al. \(2006\)](#) for source estimation in a heat diffusion model. Both perfect (top) and noisy (bottom) measurements are considered. Excerpt from the Master thesis of M. Polac, 2014.

(GIPSA-lab) and S. Brémond (CEA-IRFM).

In the early lumping approach, the variations of D lead to an ODE description as a linear parameter-varying (LPV) system. As a feedback strategy we chose the design of linear quadratic regulators with integral action (e.g. see optimal control textbooks such as [Kirk, 1970](#)) and introduced a forgetting factor (a classical concept in recursive system identification) in the integrated error to cope with abrupt changes in the reference or the dynamics and to ensure that the extended state-space matrix is full rank. The reference design is based on solving an algebraic Riccati equation on-line ([Bribiesca Argomedo et al., 2010](#)), which is particularly demanding in terms of computation resources but this was the first result where both the time and space variations of the plasma resistivity were taken into account in a control perspective. A refined method is proposed by [Bribiesca Argomedo et al. \(2011\)](#) with a polytopic approach. In this case the variations of D are captured in a limited number of time-varying parameters of known extrema and the state convergence is ensured for all parameters between the extrema. The feedback law varies according to the varying parameters (adaptive control) but all the gains can be computed off-line, removing the computational burden from the control loop.

For the late lumping strategy, we first proved the uniqueness of a solution to the transport PDE and designed a Lyapunov function to analyze the stability property of the linearized gradient of the plasma magnetic flux with disturbed control action in ([Bribiesca Argomedo et al., 2012](#)). This Lyapunov function depends on a space-varying function, obtained by solving off-line an inequality constraint that involves the

extreme distributions of D (plasma resistivity). A proportional feedback law is then designed, using the resistivity as a time-varying gain, and is shown to ensure the desired convergence rate. Robustness with respect to modeling and input errors is also proved and quantified in [J-17]. The impact of the coupling with a dynamic boundary control (such as the total plasma current control using the poloidal coils) is investigated in [J-16], along with the sensitivity of the feedback to the operating point (thus investigating the limits of the linearity hypothesis). These results were summarized in a comparative perspective and tested on two reference plasma simulators (METIS and RAPTOR, more complex than the model used for feedback design) in [B-2]. The robustness of the feedback with respect to variations of the operating conditions (linear hypothesis) and external disturbances (error on the diffusion coefficient induced by ICRH antenna) is depicted on Fig. 5.3.

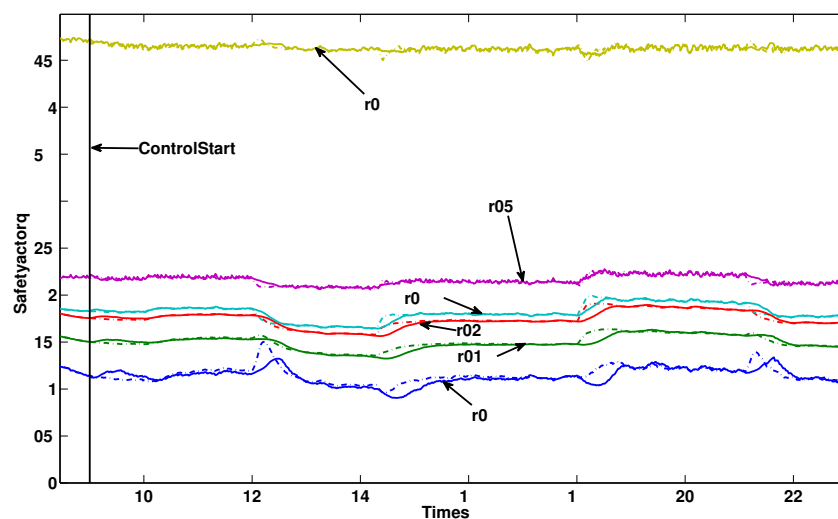

(a) Tracking of the safety factor profile. Dashed line: reference q value; full line: obtained q value.

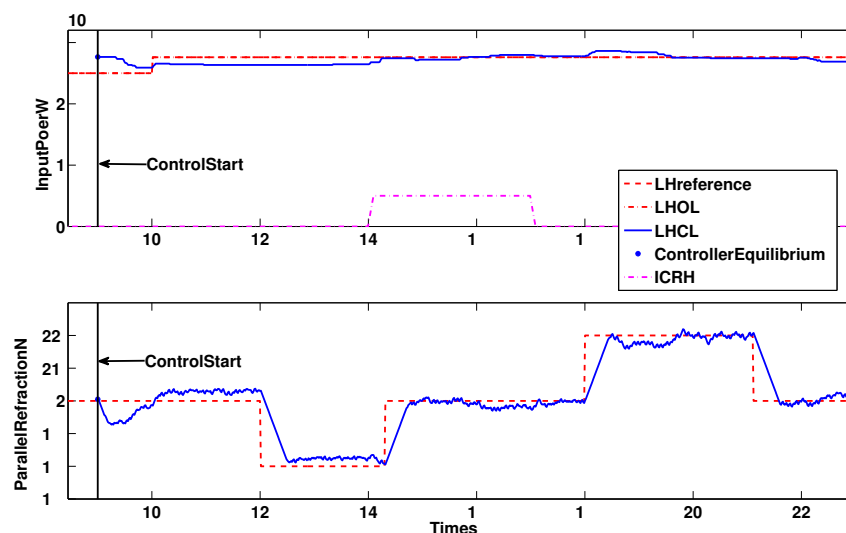

(b) Controller action and ICRH disturbance.

Figure 5.3: Safety factor profile tracking and radio-frequency antenna parameter evolution tested on METIS with independent I_p control, large variations of $N_{||}$ and ICRH heating disturbance. Excerpt from [B-2].

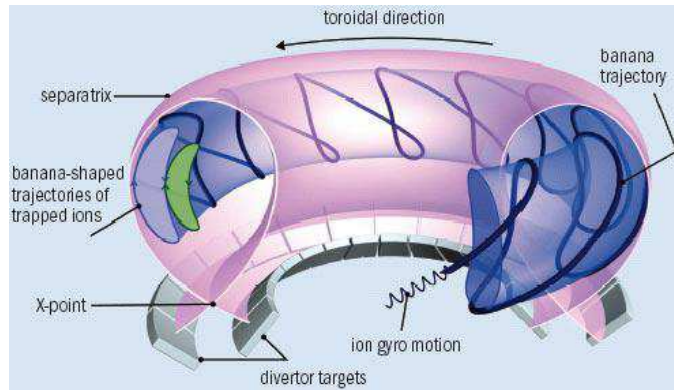

Figure 5.4: The banana-shaped cross-sections of particle orbits in the plasma lead to a bootstrap current in the presence of strong density or temperature gradients (from <http://physicsworld.com/cws/article/print/2006/mar/01/fusion-the-way-ahead>).

An alternative late lumping method is investigated in the Ph.D. thesis of A. Gahlawat, in collaboration with M. Peet (University of Arizona) and M. Alamir (GIPSA-lab). This work is based on the *sum-of-squares* polynomials, where the state is considered as squared polynomials in space and both input and diffusivity variations are supposed to be bounded by polynomials. The stability of the transport PDE is obtained in this framework by neglecting the time-variations of the diffusivity and a full-state feedback control is obtained by solving a dual version of the Lyapunov operator inequality (Gahlawat et al., 2011). The feedback gain is then obtained as a continuous function of space using numerical optimization. This method is also used in an optimization perspective, to investigate the possibility of maximizing the contribution of the bootstrap current (which acts as a nonlinearity in the transport dynamics) in the magnetic flux dynamics (Gahlawat et al., 2012). The bootstrap current is foreseen to play a major role in ITER and large tokamaks. This current is auto generated between the magnetic surfaces (thus acting as a local feedback, as illustrated in Fig. 5.4) and strongly depends on the plasma pressure distribution (fast time scale in comparison with the magnetic flux).

Results for diffusion in tokamak plasmas

Our dedicated identification and control methods were pioneering works for the automatic control of inhomogeneous (both time and space varying) diffusive phenomena as we could:

- regulate a distributed profile using constrained distributed inputs and an adaptive feedback gain;
- handle the nonlinear behavior in the transport PDE for optimization objectives;
- estimate the transport coefficients and source terms with filtering and adaptive methods.

In terms of tokamaks this allows, respectively, to:

- regulate the q -profile with robustness guarantees despite the fast variations of the local transport properties. The feedback structure parameterized in terms of the resistivity (which renders the controller adaptive) allows us to decrease the sensitivity to operating conditions and to decouple the magnetic flux control problem from the temperature control problem;
- set some first step on the design of controllers that optimize the bootstrap current and thus minimize the energy needed to operate a tokamak (this issue is further discussed in the perspectives);

- provide an online estimation of the coefficients, sources and sinks involved in the energy transport is of prime interest for diagnostic purposes (e.g. detecting transport anomalies that may trigger MHD instabilities) and feedback design (e.g. toward an integrated control of temperature and magnetic flux profiles).

These results were mostly derived with 5 Ph.D. theses (4 at GIPSA-lab and 1 at KTH) and supported by 4 European annual projects (EURATOM) and one national project (ANR TORID). This work allowed us to organize a national research group in the ANR and the model was used by other international teams (e.g. at EPFL for the development of RAPTOR by [Felici et al. \(2011\)](#), which may become a crucial interface for real-time control of tokamaks, and at TU Delft by [Djordjevic et al. \(2011\)](#)). The technical details of our contributions are described in 6 journal papers, 1 book, 1 book chapter and 17 papers in international conference proceedings.

5.3.2 Boundary control of advection phenomena

As described in Section 4.2, the bulk motion of particles with a fluid flow can be captured by an advection equation and written (e.g. using Riemann invariants) as a set of decoupled first-order hyperbolic equations such as (4.4). If there is no coupling between the state variables of interest and if distributed measurements are available, the (possibly time-varying) transport coefficients can be estimated and the control problem formulated as stabilizing a functional differential equation with a delayed kernel ([Witrant and Niculescu, 2010](#)). Alternatively, with distributed measurements one could use backstepping methods such as the one proposed by [Krstic and Smyshlyaev \(2008\)](#). With boundary measurements and supposing that the dynamics associated with the boundaries can be neglected, numerous Lyapunov-based methods are available (e.g. see [Prieur et al., 2005](#); [Bastin et al., 2009](#)).

Time-delay approach

Time-delay approaches provide efficient practical methods to address advective transport. It is practical, in the framework of this manuscript, as it implies that we approximate the transport phenomenon with an uncoupled advection equation. Nonlinearities can, in some specific cases (when we can find the appropriate set of Riemann invariants), be handled and lead to nonlinear functional differential equations [BC-1]. Considering limited sensing capabilities and the large degree of modeling uncertainties for processes involving fluids, a distributed approach based on time-delays can capture the main impact of the transport medium on the closed-loop systems and lead to an efficient regulation of the process [J-31]. Numerous feedback design approaches are then provided by the time-delay research community.

For example, an online estimator of time-varying transport coefficients can be used to estimate the corresponding time-varying delays and to set an adaptive control strategy [J-31] to reduce the mine energy consumption. Implementing such feedback on a reference simulator for a mining ventilation process (based on Euler equations), we could observe the exponential convergence of the tracking error despite the time-delay approximation when the process is operated smoothly (for hybrid operation, a Lyapunov-based method such as the one proposed in J-11 could be used). More advanced control methods, such as the predictive control scheme that specifically account for the time-variations of the delays proposed in [J-5] could remove the delay effect from the closed loop.

Another example is provided by the stabilization of a reversed field pinch device, EXTRAP-T2R, used for research in fusion plasma physics and general plasma dynamics. The plant exhibits, among other things, magneto hydrodynamic instabilities known as resistive-wall modes that grow at a time-scale set by a surrounding non-perfectly conducting shell. During the Ph.D. thesis of E. Olofsson (KTH, Sweden) and more specifically in ([Olofsson et al., 2008](#)), we proposed a new modeling approach that takes into

account experimental constraints, such as the actuators dynamics and control latencies leading to a multi-variable time-delay model of the system. We then designed an optimal PID controller (its structure being constrained by the intelligent-shell control architecture and the D action being tuned with a time-delay that approximates the derivative discretization) that achieves a direct eigenvalue optimization of the corresponding delay differential equation. Experimental results have shown a clear improvement on the closed loop efficiency in comparison with a more classical PID tuning approach (44% reduction of average field energy at the sensors during steady-state period at the expense of an input power increased by 28%). The optimal feedback gains and the resulting performance improvement are depicted on Fig. 5.5.

These two examples illustrate the effectiveness of time-delay approaches to handle advective transport (Euler equations or a full magneto-hydro-dynamics process) despite the raw approximations that need to be done from the fundamental physical equations, at least when neglecting the transients occurring at a faster time-scale is relevant.

Lyapunov-based PDE approach

The feedback design becomes more difficult for processes such as Problem 4.2.1 (EGR observation and control), where constraints on boundary measurements, dynamic boundary conditions and limited computational capabilities are combined. This issue is addressed in the Ph.D. thesis of F. Castillo, in collaboration with L. Dugard (GIPSA-lab), C. Prieur (GIPSA-lab) and V. Talon (Renault S.A.S.), along with 0D and 1D modeling of Diesel car engines. Advection is modeled as a set of n rightward first-order linear or a quasi-linear (depending on whether Euler equation is linearized or not) strict hyperbolic equations. The dynamic boundary stabilization of such systems is investigated by Castillo-Buenaventura et al. (2012b) [BC-2] based on a Lyapunov function that is composed by the distributed component and by the dynamic boundary. The quasi linear description is approximated as an LPV system (by representing the non-linear characteristic matrix in an uncertain linear form) and the dynamic boundary stabilization is obtained from polytopic arguments. The stability property is then verified by solving a set of linear matrix inequalities established for the extrema of the parameters. Sufficient conditions for observer design using only the information from the boundary control and the boundary conditions are thus obtained for both static and dynamic boundary controls. A robust boundary control strategy is proposed by Castillo-Buenaventura et al. (2013a) and we designed observers with dynamic boundary control in [J-12].

This method provides a new solution for air fraction control in a Diesel engine operated with low pressure exhaust gaz circulation. We modeled the air fraction transport using a cascade of first-order LPV hyperbolic systems with dynamics associated with the boundary conditions. By defining a minimal air fraction convergence time as the performance criterion, an air fraction regulation strategy was designed using the previous stability results. The conservatism of the boundary feedback control was significantly reduced by redefining the system varying parameters. The complexity of the obtained boundary control is very low, which made it suitable for real-time implementation. The effectiveness of the proposed boundary control was evaluated using a 1D simulation of the engine admission air-path.

Results

Taking into account convection as PDEs or time-delays allowed us to define new approaches in terms of:

- automation: the wireless control of mining ventilation proposed in 2008 is now proposed by several international companies and small and real scales prototypes are built at UPTC, Colombia;
- diagnostic for car engines: we increased (more than doubled) the net benefit made by Renault on each Diesel car sold, wrote several technical reports and 5 patents (4 accepted, 1 submitted) and got the Price of the Innovation Trophy in 2013;

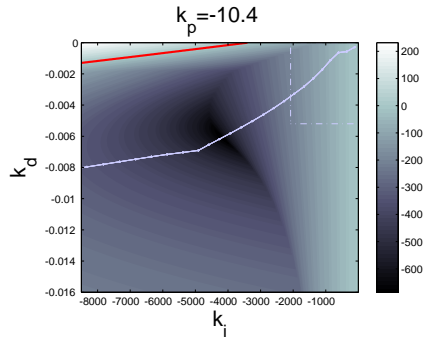

(a) Maximum value of the closed-loop spectrum for gain design in the (k_i, k_d) -space: stability limit (red) and optimal gains combination (white line).

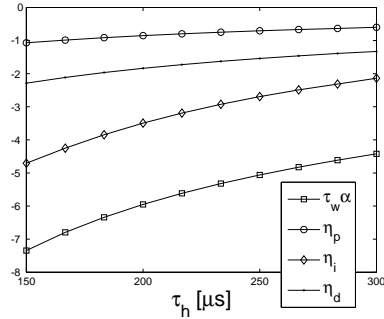

(b) Normalized PID optimization for gain design parameterized by the control latency.

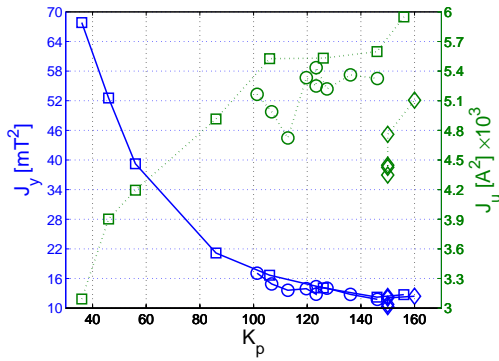

(c) Transient performance; 0 – 10ms. Experimental data.

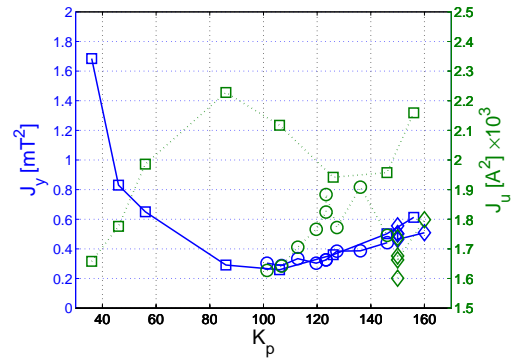

(d) Steady-state performance; 10 – 45ms. Experimental data.

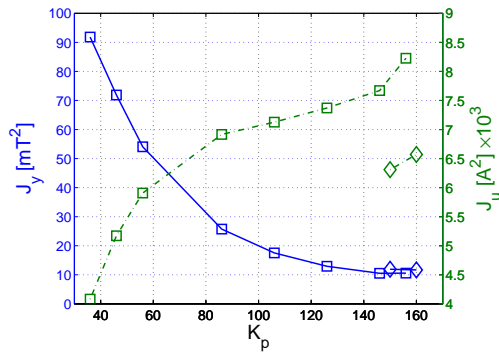

(e) Transient performance; 0 – 10ms. MIMO simulation.

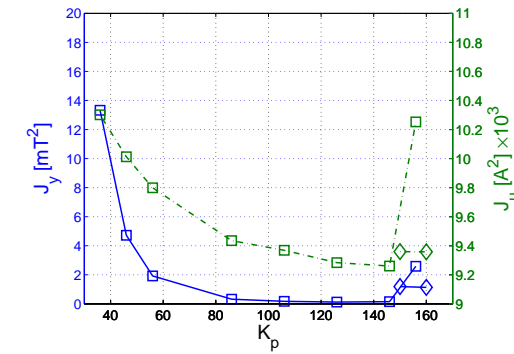

(f) Steady-state performance; 10–50ms. MIMO simulation.

Figure 5.5: Closed-loop spectrum optimization for EXTRAP-T2R. Optimal feedback gains design (a)-(b) and experimental performance measures (integrated quadratic costs of input u and output y) based on T2R datasets #20743 – #20755 and #20827 – #20838. Units for (blue) J_y : $(mT)^2$ and for (green dashed) J_u : $A^2 \times 10^3$, (c) to (f) (Olofsson et al., 2008).

- modeling: the simulator for cryogenic control at LHC/CERN is now extensively used to teach technical operators and to define operation and safety procedures;
- regulation: new strategies for exhaust gas recirculation (EGR) satisfying Euro 7 standards, 44% decrease of the average field energy (stability gain) verified experimentally on the *Reversed-Field Pinch EXTRAP-T2R* for thermonuclear fusion.

Our pragmatic approach to regulate the transport described by Euler and Navier-Stokes equations provided suitable solutions for optimization and control despite limited computing capabilities (patents, publications for SAE - society of automotive engineers -, EXTRAP-T2R results). Associating physics and automatic control motivated new collaborations with the research group of modeling and control of car engines at Renault (4 industrial contracts and 2 joint Ph.D. theses), a new experimental platform for mining ventilation control at UPTC and to educate more than 50 students (class projects and Master theses) on topics related to intelligent building ventilation (on an experimental platform built at l'UJF²). This work is published in 8 journal papers, 4 patents, 2 book chapters and 20 papers in international conference proceedings.

²http://physique-eea.ujf-grenoble.fr/intra/Formations/M2/EEATS/PSPI/projects_IB.php

Chapter 6

Conclusions and perspectives

The different methods that we obtained to estimate and control inhomogeneous transport (partly described in Chapter 5) are summarized in Table 6.1. This table illustrates the diversity of the methods considered (ranging from inverse problems to feedback control and system identification) and the nature of the transport considered. Most of these methods were applied on real data and experiments (or at least reference simulators), which allowed us to evaluate their robustness and performance (some of them had never before being implemented on real processes). The interdisciplinary characteristic of this research is reflected by the numerous national and international co-authors (more than 100) mentioned in the publications section. It is also highlighted by the numerous publications, in the key journals of different areas, successful patents, research projects and the motivated students who derived most of these results.

While some guidelines can now be drawn for modeling and control of inhomogeneous transport phenomena, many questions still remain open. This chapter aims at synthesizing some common solid ground for the methods as well as providing a glimpse on existing gaps, which would need to be addressed to tackle new challenging problems in physics.

6.1 Linearities

The common ground of the methods presented in Table 6.1, whether based on a lumped or a PDE description, is to provide results for distributed (mostly) linear systems. The linearity is with respect to the state and the transport coefficients can be time-varying or parameterized, implying a linear time-varying (LTV) or parameter-varying (LPV) system analysis. The distinction between LTV and LPV approaches depend on our capability to embed the parameter variations (e.g. the time and space variations of diffusivity or the internal couplings) into a limited number of parameters, which could be understood as a system reduction from the modeling point of view. Indeed, smoother transport parameters allow for coarser space discretization methods while large changes imply an important change of the corresponding time constant from one space location to the other. The linear framework guarantees the existence and uniqueness of a solution (a well known fact for lumped systems and we proved it for some PDEs with inhomogeneous transport) while such properties are only beginning to be addressed by researchers in applied mathematics for nonlinear systems. For “mild” nonlinearities verifying Lipschitz continuity, at least locally, the existence and uniqueness can also be proved locally and such problems can be addressed within the LTV/LPV framework.

Linearity can also be considered as a guideline to design control-oriented models (such as most of those presented in Chapter 4), acting as a tie point between physical models and EC methods. It has to be established at the stage of physical modeling along with the emphasis on the input-output dependencies, to

Table 6.1: Summary of the methods obtained for inhomogeneous transport

	Diffusion	Advection	Both
<i>Inversion for parameters varying in space or time</i>	lumped, PDE	none	lumped, PDE*
<i>Identification/online estimation</i>	lumped, PDE	time variations	none
<i>Feedback control</i>	lumped, PDE	lumped, time-delays, PDE	none
<i>Boundary control (observer design)</i>	none	lumped, time-delays, PDE	none
<i>Multivariable</i>	none	monodirectional	none
<i>2D inversion</i>	none	lumped*	none

*preliminary results

get a clear view on the physical hypotheses that are implied. Recursive methods can then be employed to set an adaptive scheme that adjusts the model behavior to the true observations. When a reference online model is used as a virtual sensor, which is often the case in distributed systems due to the lack of appropriate sensing capabilities (e.g. to obtain the magnetic flux distribution from equilibrium reconstruction in Problem 4.1.1), a large degree of confidence can be given to the adaptive design as a large part of the complexity has already been removed from the signals. Using direct measurements necessitates a specific care of processes acting at different time scales and possibly competing between each other, which may impair the identifiability of the system.

When “strong” nonlinearities cannot be avoided (e.g. when estimating diffusivity in polar firns with a very high precision, see Problem 4.3.1), specific care has to be given to the sensitivity analysis and the definition of constraints minimizing the influence of local equilibria. The design of EC methods is then particularly demanding in terms of computational resources (e.g. two weeks per polar site on a 12 cores CPU) and prevents advanced analysis that would imply multiple testing or imbricate optimization loops.

The perspectives along the linearity issue can be drawn in two directions. First, the competing dynamics are often due to local feedback processes occurring at a faster time-scale and could be addressed by designing distributed closed-loop identification methods. Identifying and quantifying feedback processes would be of major interest to gain a better understanding of complex physical models, such as those considered in climate science or tokamak plasmas. While separating the time scales is rather classical in physics, it still represents a difficulty in signal processing and identification in the PDE framework and deserves further interest. From a modeling and simulation perspective, this could also be related to multigrid methods, a very active field in applied mathematics. In that case the slow dynamics would be captured by the coarser grid while fast processes would be identified at a finer level.

Second, the nonlinearities could be addressed with hybrid LPV strategies, representing the discontinuities as switches from the reference case and assigning the switches to significantly different equilibria. Indeed, in the problems studied in this manuscript the nonlinearities are either related to different operating conditions (e.g. tokamak operation with high vs. low bootstrap current) or spatial variations of the transport process (e.g. turbulent diffusion in the upper part of the firn vs. molecular diffusion in the deeper firn). Our Lyapunov-based method [J-11] could be extended to parabolic and mixed systems to handle the control objective. The difficulty remains in the identification strategy, as the method has to be sensitive enough to capture the variations on several orders of magnitude but robust enough to remain stable despite the discontinuity.

Solving those issues would bring new solutions for the challenges described in Section 6.3.

6.2 Toward a unified estimation and control strategy?

The variety of the processes involving inhomogeneous transport phenomena and estimation and control problems considered in our research led us to use a wide spectrum of methods. Integrating the interdisciplinarity that is necessary to solve “real-life” complex problems implied problem-specific strategies, either combining existing methods or devising new ones. Nevertheless, some guidelines can be drawn on methods that typically work with a satisfying degree of robustness and performance. This section presents key issues that may define a dedicated strategy answering the specificity of inhomogeneous transport, keeping in mind that each method of the global strategy strongly affects the others. The synthetic view proposed in this section is that we need to combine methods to:

- formulate the problem in terms of mathematical expressions (are control, inverse problems, identification and observation so different?);
- choose between discretizing the medium or keeping a continuous description (in space);
- characterize the solution (sometimes an explicit expression may be found);
- adjust the solution to the real problem using free parameters;
- process the data to connect the reference model to experiments.

One may also wonder if diffusion and advection could be considered with a similar control approach.

Problem formulation. All our problems aim at decreasing the weighted \mathcal{L}_2 norm of quadratic functions involving the state and (possibly) the input:

- to stabilize the system (driving the state to zero) the minimized function is the Euclidean norm of the state (state feedback);
- to track a reference the minimized function depends on the error between the actual and the reference state (feedback tracking control);
- to estimate parameters or time-varying functions we minimize a norm of the error between the modeled and the measured state (inverse problems, estimation and observation)

Full information on the state can be available (state feedback, adaptive parameter estimation) or not (underconstrained inversion and observation). The quadratic functions are *cost functions* from an optimization perspective (the weights represent extra user-defined functions or the stochastic properties of the signal), integrated over time (inverse problems and off-line identification) or time-dependent (tracking, online estimation/recursive identification and observer design) and *Lyapunov functions* (time-dependent) when the problem is reduced to stabilization (in our problems, stability was ensured by finding a weight that guarantees the convergence of the Lyapunov function). The engineering objective is then to decrease the cost function at each iteration and the Lyapunov function over time.

Early versus late lumping. Lumped approaches allow using “on the shelf” well-established methods that provide: 1) a fast evaluation of the problem formulation and of the method implementation on (generally complex) simulation models, 2) testing different strategies and identifying the major difficulties to solve the classical performance versus robustness dilemma, 3) black-box solutions (in the sense that the physical parameters no longer appear after discretization). On the other hand, PDE approaches motivate new results for distributed methods and provide interesting insights on the role of transport parameters in the stability

or estimation results, with a high level of computation efficiency. Time-delays (for advective transport) can be considered as a link between PDEs and lumped approaches, in the sense that they are analytically directly related to PDEs (e.g. with the method of characteristics) but benefit more from lumped methods as most of them are now available for time-delay systems (the automatic control community on time-delay systems has been fairly large and active for more than two decades). Regardless of the lumping strategy, the medium inhomogeneity requires a specific care of the system sensitivity to changes in the parameters and/or inputs, of the system and cost function normalization, and of the validity domain of the method (in terms of frequencies).

Structure of the solution. When the dynamics is linear in the state and controlled input (e.g. feedback design or source estimation) and the cost function is quadratic, the solution of the optimization problem is to define the input as a proportional state feedback with a gain that satisfies constraints imposed by the weights. It is interesting to note that, despite the complexity induced by the PDE framework, our results on controller design led to a proportional state feedback controller for both parabolic (Problem 4.1.1) and hyperbolic systems (Problem 4.2.1), as described in [J-17] and [J-12], respectively. The medium inhomogeneity then implies to solve (offline) a time-independent optimization problem. Formulating the inverse atmospheric scenario reconstruction using Green's function (Problem 4.3.2) also implied a solution where the optimal scenario is proportional (through the generalized inverses, parameterized by the rugosity coefficient) to the firn air measurements.

Weighting and tuning parameters. From the methods, we can conclude that the medium inhomogeneity reflects on the definition of the weights, either to extract an information level from the model that is compatible with the content of data sets (estimation and identification objectives) or to guarantee the existence of the Lyapunov function (stabilization objective). The weights also include extra constraints on the system dynamics, such as dynamic boundary conditions or positivity. For example dynamic boundary conditions appear when controlling the total plasma current with the poloidal coils along with a distributed control (using radiofrequency antennas) of the safety profile [J-16]. Another example is provided by the detection of ozone-depleting substances in the atmosphere, where a positivity constraint is set on the reconstructed trends of chlorofluorocarbons and smoothly alleviated to detect the starting emission date as precisely as possible [J-10]. The weights are also essential to assess / ensure the robustness and performance properties of feedback controllers with respect to modeling or measurements errors [J-17].

Data processing issues. Filtering or smoothing methods used during the data processing stage are of foremost importance, especially if multiple data bases or multiple sensors are involved. Such processing necessarily involves extra dynamics (e.g. those of the filter) that may impair the estimation of time-varying transport coefficients. The design of identification methods for PDE systems using instrumental variables (the filtering stage is explicitly taken into account during the identification design) could be of prime interest. While we obtained convincing estimates of time-varying diffusivity coefficients or source term in diffusive systems, the identifiability property remains to be shown when both diffusion and convection are combined.

A unified approach for both advection and diffusion. A direct perspective from Table 6.1 is to extend the methods to the combined advection-diffusion framework. A main difficulty induced by the medium inhomogeneity is the abrupt change of the advection versus diffusion ratio, which leads to a hybrid hyperbolic-parabolic system of varying topology (e.g. the transition location may vary in time). The identifiability of both effects separately remains a difficult task (partially addressed in the Ph.D. of S. Mechhoud) and major discrepancies may appear when only partial measurements (e.g. only at the boundary or only the space distribution at final time) are available. For feedback control objectives, we can note the closeness of the Lyapunov function obtained for the inhomogeneous parabolic equations [J-17] (pure diffusion)

to the one obtained for inhomogeneous hyperbolic equations [J-12] (convection only). We can note also the closeness of the methods when including dynamic boundary conditions (the Lyapunov function is then extended to include the boundary states).

6.3 Addressing new challenging physical problems

6.3.1 Environmental sciences

Thermal diffusion in firn air transport models. Temperature variations effects in firn significantly impact the fractionation of the isotopes of inert gases, which can be used as temperature tracers in fast climate change conditions. An improvement of our firn air transport model will be to take into account this effect explicitly in the diffusive process. We plan to evaluate the resulting model on firn air measurements e.g. of $\delta^{15}\text{N}$ and $\delta^{40}\text{Ar}$ and possibly propose an inverse modeling strategy to calculate the thermal diffusion coefficients. These results will allow evaluating the equilibrium assumption made in a thermo-mechanical densification model developed at LGGE. This research is supported by the LEFE project NEVE-CLIMAT (2015-2018).

Using the firn model for paleoclimatic studies. While the actual firn air model necessitates measurements to characterize an ice core site, the transport model is linear in the trace gas density in open pores (the state) and the diffusivity do not vary in time, or at least slowly in comparison with the gas dynamics. This implies that the firn model acts as a linear filter between the atmospheric concentrations and the concentration at the first layer of ice (below the bubbles close-off depth). For example, with the lumped transport PDE the filter order would be equal to the number of discretization points. Expressing this idea in the time domain using Green's function (impulse response), we can embed the smoothing effect of the firn in the age distribution corresponding to the last firn depth. In a first instance, the precipitation rate defines the speed at which a firn layer crosses the bubble closure zone. It is thus the primary control on the Green's function width. Such simplification of the firn smoothing effect would allow us to include the firn effect in paleoclimatic models, which are used over on a time-scale that is much longer than our existing results on recent anthropogenic impact. Encouraging preliminary results were obtained by Patricia Martinerie (unpublished). Among the specific difficulties, uneven sampling of the measurements necessitates specific methods based on frequency analysis. The dependence of the solution on short signal sequences and data resolution also appear as crucial. A goal of this strategy is also to use the inverse results obtained on recent, high accumulation, sites (short period but with a better understanding) to infer our confidence on the results obtained for sites with less accumulation (smoother signals), which cover the longer time periods (currently up to 800 000 years).

Including surface pressure variations in the firn model. Modeling of trace gas transport can be also improved by separating more precisely the molecular diffusion effect from the impact of pressure variations. For example, surface pressure variations (seasonal effect) have been shown to induce pressure variations over the whole firn air column and impact the deep firn. Thermal effects could also be included as impacting the pressure distribution. In the actual model, we consider only gravity as an explicit exogenous force and pressure variations are taken into account as an advection-driven diffusivity term. This results in a fairly complex diffusivity profile (nonlinear and variations with several orders of magnitude), which is difficult to predict for different climatic conditions (e.g. to use the model for paleoclimate studies considering that the firn density and temperature distributions are provided by another model). The explicit consideration of external forces with Darcy's law may provide a diffusivity profile that can be parameterized more clearly in terms of density and temperature. First attempts to include Darcy's law (which renders the model nonlinear) gave us some interesting results but implied a permeability coefficient that is far (one or two

orders of magnitude) from the one obtained by experiments. This topic would necessitate new inversion methods to handle the nonlinearity.

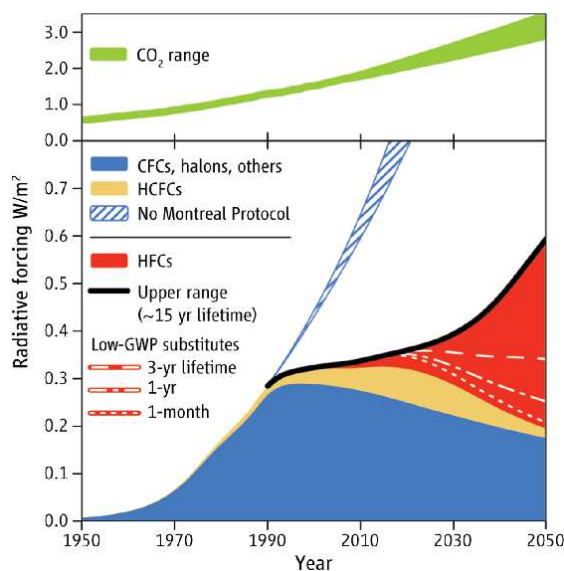

Figure 6.1: Projected radiative forcing by Ozone-Depleting Substances (ODSs), Hydrofluorocarbons, low global warming potential substitutes, and CO_2 . Also included (blue hatched) is the potential radiative forcing from ODSs which has been avoided due to the Montreal Protocol (from Velders et al. (2012)).

Understanding transport of greenhouse gases in the stratosphere. Estimation of gas transport in the stratosphere from chemical tracers has some interesting similarities with our approach to firm air modeling. For example, all the recent results are based on the analysis proposed by Hall and Plumb (1994), who use transport analysis to define a Green's function that is then used in an inverse perspective. This method relies on a flux definition that is stationary in time to derive an analytical Green's function. Improvements can clearly be obtained by introducing time-variations of the flux and a numerical Green's function while taking into account the data sparsity. This motivated our involvement (GIPSA-lab) as associate partner in EU projects submitted by Johannes Laube and William Sturges at UEA in England (ERC Starting grant of J. Laube EXC3ITE - EXploring Circulation and Chemistry Changes in the stratosphere Instrumentalising Tracer Ensembles - and European ITN - Innovative Training Network - "HALOA-ITN"). For example, the HALOA-ITN project aims at analyzing halogenated organic compounds emissions. Halogenated organic compounds have been produced for a variety of uses. Their release to the atmosphere, has led to the depletion of stratospheric ozone, which resulted in the regulation of many of these gases under the Montreal Protocol on Substances that Deplete the Ozone Layer. The submitted projects, if accepted, will lead to a better scientific understanding of the effect of these gases and also as a basis for political decisions regarding the long-term commitment of curbing climate change (e.g. see Fig. 6.1). We will use measurement and modeling of atmospheric halocarbons for deriving their European emissions, understanding their global atmospheric budgets and identifying new compounds with potential adverse environmental effects.

6.3.2 Controlled thermonuclear fusion.

Simultaneous control of the magnetic flux and temperature. Our results were focused on single-variable 1D descriptions on reduced scope models. Our objective is now to address the multi-variables and coupling issues associated with the transport phenomena. While the transport PDEs remain mostly diffusive, internal couplings appear in the diffusion coefficients for which physics models are either quite

reliable (e.g. dependence of the plasma resistivity on electronic temperature) or more uncertain (e.g. dependence of the thermal diffusivity on the safety factor profile). Furthermore, the source terms associated with non-inductive current drive systems introduce additional non linear couplings between the dynamics.

Novel dedicated modeling and control approaches thus need to be sought in order to address these issues. PDE parameters estimation techniques will be implemented in order to address the control design in the area where reliable physics model are not necessarily available. The control design will require analyzing the stability and control of nonlinear and non-affine coupled PDEs with strong actuation and robustness constraints. The advantage of such techniques on distributed parameters systems is that all the dynamics are taken into account when designing the controllers. All the techniques available in the literature consider either finite-dimensional nonlinear systems or linear PDE. One of the objectives of this Project is to consider the fully nonlinear PDE.

The aim of this study is to provide control methods for fusion burn control. The control objective can be either the maximization of fusion power or of the power amplification factor (defined as the ratio of fusion power to external injected power) and the considered actuators can be heating and fuelling systems. This perspective is partially founded by ANR TORID and the ongoing Ph.D. thesis of B. Mavkov.

Maximizing the bootstrap current. Our first results, based on the magnetic flux equation and including the pressure effects only implicitly, provided some interesting preliminary results on the use of the current generated by radio-frequency antennas to modify the bootstrap current. Nevertheless a method more focused on the pressure distribution would be more physical. It implies to consider the coupling between the magnetic flux and temperature and thus nonlinear analysis, for which model-predictive control methods may be a suitable solution. First results on model-predictive control of the q-profile are established at TU Eindhoven by [Maljaars et al. \(2015\)](#) and clearly deserve further interest. Two master students are currently working on this topic.

6.3.3 Flow systems.

Flow networks. An interesting perspective is to address the regulation of gases in flow networks using time-delays. Indeed, the computational constraints and handling the complexity of a large network topography limits the use of PDE approaches. We consider this problem with the Ph.D. theses of M.-A. Hernandez Perez (LPV control of Poiseuille flows) and D. Novella Rodriguez (Time-delay compensation in flow networks), in collaboration with B. del Muro Cuéllar (Instituto Politécnico Nacional, Mexico) and O. Sename (GIPSA-lab). Our first results (experimental) have shown that mist in a flow tube can be efficiently regulated by combining a time-delay identified model and robust LPV or internal model control strategies based on experimental results ([Hernandez Perez et al., 2014](#)). Another result is provided in [BC-1], where we established a (possibly nonlinear) description of an advective phenomenon with friction as a time-delay system and used bond graphs to define an automatic translation of the flow network into a state-space representation. While both results are preliminary, they set a strong basis for future research.

Using positivity and monotonicity for flow control in intelligent buildings. The design of energy management systems in intelligent buildings is one of the major goals to develop sustainable infrastructures in modern cities. Ventilation control for intelligent buildings is of foremost importance, both for energy savings and for the comfort of workers in open spaces or inhabitants. While only approximate models can be obtained for airflows in the building environment, hybrid models can be derived from thermodynamics [J-29] and we can rely on simple facts: the temperature (state of the system) is positive and injecting cold air in the rooms (e.g. for a cooling objective) will always decrease the temperature (monotonicity). We address this problem in the Ph.D. thesis of P.-J. Meyer (Hybrid control for green buildings) in collaboration with A. Girard (LJK, Grenoble). We could define robust controlled invariance, which describes the ability

to maintain, using suitable control actions, the state of a system in a set for any value of the disturbances. Thus we can guarantee, with specific conditions, the feasibility and feedback design to ensure that the room temperature remains between some desired bounds despite disturbances. Our future research will aim at designing symbolic controllers that rely on an abstraction for which the control design is simpler. If some behavioral relationship between the two models is satisfied, the original system can be controlled using a controller designed for the abstraction. This strategy will permit, for example, to ensure safety specifications while minimizing a cost function (such as the energy consumption) on a receding horizon.

Bibliography

- Basiuk, V., Artaud, J., Imbeaux, F., Litaudon, X., Bécoulet, A., Eriksson, L.-G., Hoang, G., Huysmans, G., Mazon, D., Moreau, D., and Peysson, Y.: Simulations of steady-state scenarios for Tore Supra using the CRONOS code, *Nuclear Fusion*, 43, 822, URL <http://stacks.iop.org/0029-5515/43/i=9/a=305>, 2003.
- Bastin, G., Coron, J.-M., and d'Andréa Novel, B.: Using Hyperbolic systems of Balance Laws for Modelling, Control and Stability Analysis of Physical Networks, Lecture notes for the Pre-Congress Workshop on Complex Embedded and Networked Control Systems, 17th IFAC World Congress, Seoul, Korea, 2008.
- Bastin, G., Coron, J.-M., and d'Andréa Novel, B.: On Lyapunov Stability of linearized Saint-Venant equations for a sloping channel, *Networks and Heterogeneous Media.*, 4(2), 177–187, 2009.
- Blum, J.: Numerical Simulation and Optimal Control in Plasma Physics, Wiley/Gauthier-Villars Series in Modern Applied Mathematics, Gauthier-Villars, John Wiley & Sons, 1989.
- Blum, J., Boulbe, C., and Faugeras, B.: Reconstruction of the equilibrium of the plasma in a Tokamak and identification of the current density profile in real time, *Journal of Computational Physics*, 231, 960 – 980, URL <http://www.sciencedirect.com/science/article/pii/S0021999111002294>, 2012.
- Brégeon, R.: Évolution résistive du profil de courant dans les tokamaks, application à l'optimisation des décharges de Tore Supra, Ph.D. thesis, Université de Provence (Aix-Marseille I), CEA - Cadarache, France, 1998.
- Bribiesca Argomedo, F., Witrant, E., Prieur, C., Georges, D., and Brémond, S.: Model-based Control of the Magnetic Flux Profile in a Tokamak Plasma, in: Proceedings of the 49th IEEE Conference on Decision and Control (CDC 2010), pp. 6926–6931, Atlanta, Georgie, États-Unis, doi:10.1109/CDC.2010.5717184, URL <http://hal.archives-ouvertes.fr/hal-00541884>, 2010.
- Bribiesca Argomedo, F., Prieur, C., Witrant, E., and Brémond, S.: Polytopic Control of the Magnetic Flux Profile in a Tokamak Plasma, in: Preprints of the 18th IFAC World Congress, vol. 18, pp. –, Milan, Italie, doi:10.3182/20110828-6-IT-1002.01067, URL <http://hal.archives-ouvertes.fr/hal-00573362>, 2011.
- Bribiesca Argomedo, F., Witrant, E., and Prieur, C.: D1-Input-to-State Stability of a Time-Varying Nonhomogeneous Diffusive Equation Subject to Boundary Disturbances, in: Proceedings of the 2012 American Control Conference, pp. –, Montréal, Canada, URL <http://hal.archives-ouvertes.fr/hal-00676534>, 2012.
- Castillo-Buenaventura, F.: Modeling and Control of the Air-Path of Diesel Engines for the EURO 7, Ph.D. thesis, Université de Grenoble, 2013.
- Castillo-Buenaventura, F., Witrant, E., Dugard, L., and Talon, V.: Restriction Model Independent Method for Non-Isentropic Outflow Valve Boundary Problem Resolution, in: Proceedings of the SAE World

- Congress 2012, pp. 2012–01–0676, Detroit, Michigan, États-Unis, doi:10.4271/2012-01-0676, URL <http://hal.archives-ouvertes.fr/hal-00681097>, 2012a.
- Castillo-Buenaventura, F., Witrant, E., Prieur, C., and Dugard, L.: Dynamic Boundary Stabilization of Hyperbolic Systems, in: Proceedings of CDC 2012, p. n/c, Maui, Hawaiï, États-Unis, URL <http://hal.archives-ouvertes.fr/hal-00718725>, 2012b.
- Castillo-Buenaventura, F., Witrant, E., and Dugard, L.: Dynamic Boundary Stabilization of Linear Parameter Varying Hyperbolic Systems: Application to a Poiseuille Flow, in: Proceedings 11th Workshop on Time-Delay Systems, Grenoble, France, URL <http://hal.archives-ouvertes.fr/hal-00752313>, 2013a.
- Castillo-Buenaventura, F., Witrant, E., Dugard, L., Talon, V., Chalet, D., and Chesse, P.: Intra-Pipe Restriction Non-Homentropic Boundary Resolution Method, in: SAE Technical Papers, pp. 2013–01–0582, Detroit, États-Unis, URL <http://hal.archives-ouvertes.fr/hal-00783134>, 2013b.
- Cléménçon, C., Guivarch, C., Eury, S. P., Zou, X. L., and Giruzzi, G.: Analytical solution of the diffusion equation in a cylindrical medium with step-like diffusivity, *Physics of Plasmas*, 11, 4998–5009, 2004.
- Coussy, O.: *Poromechanics*, John Wiley & Sons Ltd, 2nd edn., 2003.
- Delebecque, F., Quadrat, J.-P., Brémond, S., Witrant, E., and Artaud, J.-F.: Simple modelling and control of plasma current profile, in: Proceedings of the 8th Portuguese Conference on Automatic Control, p. CD, Portugal, URL <http://hal.archives-ouvertes.fr/hal-00329853>, 2008.
- Di Benedetto, M. D., D’Innocenzo, A., Serra, E., and Witrant, E.: Automatic verification of wireless control in a mining ventilation system, in: IEEE Conference on Automation Science and Engineering (CASE 2008), Washington DC, États-Unis, URL <http://hal.archives-ouvertes.fr/hal-00340446>, 2008.
- Di Benedetto, M. D., D’Innocenzo, A., Fischione, C., Isaksson, A. J., Johansson, K. H., Niculescu, S.-I., Oлару, S., Sandou, G., Santucci, F., Serra, E., Tennina, S., Tiberi, U., and Witrant, E.: Wireless Ventilation Control for Large-Scale Systems: the Mining Industrial Case, in: 6th IEEE SECON Conference, Rome, Italie, URL <http://hal-supelec.archives-ouvertes.fr/hal-00417237>, 2009.
- Djordjevic, S., Steinbuch, M., De Baar, M., Hogeweyj, D., and Citrin, J.: Control-oriented modeling of the Electron Cyclotron Current Drive actuated hybrid mode in ITER, in: Decision and Control and European Control Conference (CDC-ECC), 2011 50th IEEE Conference on, pp. 3652–3657, doi:10.1109/CDC.2011.6160653, URL http://ieeexplore.ieee.org/xpls/abs_all.jsp?arnumber=6160653, 2011.
- Felici, F., Sauter, O., Coda, S., Duval, B., Goodman, T., Moret, J.-M., Paley, J., and the TCV Team: Real-time physics-model-based simulation of the current density profile in tokamak plasmas, *Nuclear Fusion*, 51, 083 052, URL <http://stacks.iop.org/0029-5515/51/i=8/a=083052>, 2011.
- Gahlawat, A., Peet, M., and Witrant, E.: Control and verification of the safety-factor profile in tokamaks using Sum-of-Squares polynomials, in: Preprints of the 18th IFAC World Congress, Milan, Italie, URL <http://hal.archives-ouvertes.fr/hal-00667219>, 2011.
- Gahlawat, A., Witrant, E., Peet, M. M., and Alamir, M.: Bootstrap Current Optimization in Tokamaks Using Sum-of-Squares Polynomials, in: 51st IEEE Conference on Decision and Control, Maui, Hawaii, États-Unis, URL <http://hal.archives-ouvertes.fr/hal-01053418>, 2012.
- Georges, D., Besancon, G., Benayache, Z., and Witrant, E.: A Nonlinear State Feedback Design for Nonlinear Systems with Input Delay, in: Proceedings of the European Control Conference, ECC’07, 2-5 July 2007, Kos, Greece, pp. –, -, France, URL <http://hal.archives-ouvertes.fr/hal-00130121>, 2007.

- Gormezano, C.: High performance tokamak operation regimes, *Plasma Phys. Control. Fusion*, 41, B367–80, 1999.
- Hadamard, J.: Sur les problèmes aux Dérivées partielles et leur signification physique, *Princeton University Bulletin*, 13, 49–52, 1902.
- Hall, T. M. and Plumb, R. A.: Age as a diagnostic of stratospheric transport, *Journal of Geophysical Research: Atmospheres*, 99, 1059–1070, doi:10.1029/93JD03192, URL <http://dx.doi.org/10.1029/93JD03192>, 1994.
- Haut, F., Leugering, G., and Seidman, T.: Modeling and Analysis of Modal Switching in Networked Transport Systems, *Applied Mathematics and Optimization*, 59(2), 275–292, 2009.
- Hernandez Perez, M. A., Witrant, E., and Sename, O.: A time-delay approach for modeling and control of mist in a poiseuille flow, in: *Proc. of the European Control Conference (ECC)*, pp. 1115–1120, doi:10.1109/ECC.2014.6862318, 2014.
- Hinton, F. L. and Hazeltine, R. D.: Theory of Plasma transport in toroidal confinement systems, *Reviews of Modern Physics*, 48, 239–308, 1976.
- Hirsch, C.: Numerical Computation of Internal and External Flows, *Fundamentals of Numerical Discretization*, Numerical Methods in Engineering, Wiley, 1989.
- IPCC: The Physical Science Basis. Contribution of Working Group I to the Fourth Assessment Report of the Intergovernmental Panel on Climate Change, in: *Climate Change 2007*, edited by Solomon, S., Qin, D., Manning, M., Chen, Z., Marquis, M., Averyt, K., Tignor, M., and Miller, H., Cambridge University Press, United Kingdom and New York, NY, USA, URL <http://www.ipcc.ch/ipccreports/assessments-reports.htm>, 2007.
- Jacquet, D.: Macroscopic Freeway Modelling and Control, Ph.D. thesis, Institut National Polytechnique de Grenoble, 2006.
- Kirk, D. E.: OPTIMAL CONTROL THEORY, An Introduction, Dover Publications, Inc., 1970.
- Kolmanovskiy, I., Sivergina, I., and Sun, J.: Simultaneous input and parameter estimation with input observers and set-membership parameter bounding: theory and an automotive application, *International Journal of Adaptive Control and Signal Processing*, 20, 225 – 246, 2006.
- Kroesen, M. W. G., Schram, D. C., Timmermans, C. J., and Haas, J. C. M. D.: The energy balance of a plasma in partial local thermodynamic equilibrium, *IEEE Transactions on Plasma Science*, 18, 985–991, 1990.
- Krstic, M. and Smyshlyaev, A.: Backstepping boundary control for first-order hyperbolic PDEs and application to systems with actuator and sensor delays, *Systems and Control Letters*, 57(9), 750–758, 2008.
- Lourantou, A.: Contraindre l’augmentation en dioxyde de carbone (CO₂) lors des dglaciations bass sur son rapport isotopique stable du carbone ($\delta^{13}\text{CO}_2$), Ph.D. thesis, Universit Joseph Fourier, 2008.
- Maljaars, E., Felici, F., de Baar, M., van Dongen, J., Hogeweyj, G., Geelen, P., and Steinbuch, M.: Control of the tokamak safety factor profile with time-varying constraints using MPC, *Nuclear Fusion*, 55, 023001, URL <http://stacks.iop.org/0029-5515/55/i=2/a=023001>, 2015.
- Mechhoud, S., Witrant, E., Dugard, L., and Moreau, D.: Estimation de la diffusion thermique dans les plasmas de Tokamak, in: *Preprints CIFA 2012*, p. n/c, Grenoble, France, URL <http://hal.archives-ouvertes.fr/hal-00782885>, 2012.
- Mechhoud, S., Witrant, E., and Dugard, L.: Adaptive Space-Time Distributed Parameter and Input Estimation in Heat Transport with Unknown Bounds, in: *3d International Conference on Systems and Control (ICSC13, Alger, Algérie)*, URL <http://hal.archives-ouvertes.fr/hal-00931637>, 2013a.

- Mechhoud, S., Witrant, E., Dugard, L., and Moreau, D.: Adaptive Distributed Parameter and Input Estimation in Plasma Tokamak Heat Transport, in: Proc. of the 1st IFAC Workshop on Control of Partial Differential Equations (CPDE 2013), 2013b.
- Mechhoud, S., Witrant, E., Dugard, L., and Moreau, D.: Adaptive Distributed Parameter and Input Estimation in Plasma Tokamak Heat Transport, in: Proceedings of the 1st IFAC Workshop CPDE 2013, Paris, France, URL <http://hal.archives-ouvertes.fr/hal-00931642>, 2013c.
- Mechhoud, S., Witrant, E., Dugard, L., and Moreau, D.: Combined distributed parameters and source estimation in tokamak plasma heat transport, in: Proceedings of the ECC 2013, p. 0147, Zurich, Suisse, URL <http://hal.archives-ouvertes.fr/hal-00931650>, 2013d.
- Mechhoud, S., Witrant, E., Dugard, L., and Moreau, D.: Joint diffusivity and source estimation in tokamak plasma heat transport, in: Proceedings, p. 0335, Washington, DC, États-Unis, URL <http://hal.archives-ouvertes.fr/hal-00931657>, 2013e.
- Mechhoud, S., Witrant, E., Dugard, L., and Moreau, D.: Auto-tuning of Adaptive Distributed Parameter Estimation in linear parabolic PDEs and Heat Transport in Tokamak Plasma, submitted to Automatica, 2014.
- Meglio, F. D., Kaasa, G., Petit, N., and Alstad, V.: Slugging in multiphase flow as a mixed initial-boundary value problem for a quasilinear hyperbolic system, Proceedings of the American Control Conference, San Francisco, USA, pp. 3589–3596, 2011.
- Meyer, P.-J., Girard, A., and Witrant, E.: Controllability and invariance of monotone systems for robust ventilation automation in buildings, in: Proceedings of the 52nd IEEE Conference on Decision and Control, pp. 1289–1294, Florence, Italie, URL <http://hal.archives-ouvertes.fr/hal-00858715>, 2013a.
- Meyer, P.-J., Nazarpour, H., Girard, A., and Witrant, E.: Robust Controlled Invariance for UFAD Regulation, in: 5th ACM Workshop On Embedded Systems For Energy-Efficient Buildings (BuildSys), 2013b.
- Mikkelsen, D. R., Scott, S. D., and Dorland, W.: Testing the ρ_* scaling of thermal transport models: Predicted and measured temperatures in the tokamak fusion test reactor dimensionless scaling experiments, Physics of Plasmas, 4, 1362–1370, 1997.
- Montzka, S., Reimann S. (Coordinating Lead Authors), Engel, A., Krüger, K., O’Doherty, S., Sturges, W., Blake, D., Dorf, M., Fraser, P., Froidevaux, L., Jucks, K., Kreher, K., Kurylo, M., Mellouki, A., Miller, J., Nielsen, O., Orkin, V., Prinn, R., Rhew, R., Santee, M., Stohl, A., and Verdonik, D.: Scientific Assessment of Ozone Depletion: 2010, Global Ozone Research and Monitoring Project, Report No.52, 516 pp., chap. Ozone-Depleting Substances (ODSs) and Related Chemicals, Chapter 1, World Meteorological Organization, Geneva, Switzerland, 2011.
- Moreau, D., Mazon, D., Ariola, M., De Tommasi, G., Laborde, L., Piccolo, F., and *et al.*: A two-time-scale dynamic-model approach for magnetic and kinetic profile control in advanced tokamak scenarios on JET, Nuclear Fusion, 48, 1–38, 2008.
- Olofsson, E., Witrant, E., Briat, C., Niculescu, S.-I., and Brunsell, P.: Stability analysis and model-based control in EXTRAP-T2R with time-delay compensation, in: Proceedings of the 47th IEEE Conference on Decision and Control, CDC 2008, p. cd, Cancun, Mexique, URL <http://hal.archives-ouvertes.fr/hal-00329874>, 2008.
- Onjun, T., Bateman, G., Kritz, A., and Hannum, D.: Comparison of low confinement mode transport simulations using the mixed Bohm/gyro-Bohm and the Multi-Mode-95 transport model, Physics of Plasmas, 8, 975–985, 2001.

- Prieur, C., Winkin, J., and Bastin, G.: Boundary Control of Non-Homogeneous System of Two Conservation Laws, Proceedings of the 44th IEEE Conference on Decision and Control and the European Control Conference, 2005.
- Prieur, C., Girard, A., and Witrant, E.: Lyapunov functions for switched linear hyperbolic systems, in: Proceedings of the 4th IFAC conference series on Analysis and Design of Hybrid Systems (ADHS'2012), edited by Maurice Heemels, Bart De Schutter, M. L., pp. 382–387, IFAC, Eindhoven, Pays-Bas, doi:10.3182/20120606-3-NL-3011.00061, URL <http://hal.archives-ouvertes.fr/hal-00734469>, 2012.
- Rahmani, M., Witrant, E., and Petagna, P.: Modélisation d'un échangeur de chaleur pour les détecteurs du LHC, in: IEEE Conférence Internationale Francophone d'Automatique (CIFA), 2012.
- Rivas Caicedo, M. A., Senname, O., Witrant, E., Caillol, C., and Higelin, P.: A Parameter Varying Observer for the Enclosed Mass in a Spark Ignited Engine, in: Proceedings E-COSM 2012, p. Estimation / observers, Rueil-Malmaison, France, URL <http://hal.archives-ouvertes.fr/hal-00733262>, 2012a.
- Rivas Caicedo, M. A., Witrant, E., Senname, O., and Higelin, P.: A High Gain Observer for Enclosed Mass Estimation in a Spark Ignited Engine, in: Proceedings of the 2012 American Control Conference, p. ThA14.5, Montreal, Canada, URL <http://hal.archives-ouvertes.fr/hal-00680465>, 2012b.
- Rivas Caicedo, M. A., Witrant, E., Senname, O., Higelin, P., and Caillol, C.: Energy Wall Losses Estimation of a Gasoline Engine Using a Sliding Mode Observer, in: SAE Technical Paper, pp. 2012-01-0674, Detroit, États-Unis, doi:10.4271/2012-01-0674, URL <http://hal.archives-ouvertes.fr/hal-00765566>, 2012c.
- Rommelaere, V., Arnaud, L., and Barnola, J.: Reconstructing recent atmospheric trace gas concentrations from polar firn and bubbly ice data by inverse methods, *J. Geophys. Res.*, 102, 30 069–30 083, 1997.
- Ryter, F., Dux, R., Mantica, P., and Tala, T.: Perturbative studies of transport phenomena in fusion devices, *Plasma Physics and Controlled Fusion*, 52, 2010.
- Sandou, G., Olaru, S., Witrant, E., and Niculescu, S.: Receding horizon climate control in metal mine extraction rooms, in: Proceedings of the IEEE Conference on Automation Science and Engineering, p. CD ROM, Washington, États-Unis, URL <http://hal-supelec.archives-ouvertes.fr/hal-00339206>, 2008.
- Sandou, G., Olaru, S., Witrant, E., and Niculescu, S.: Receding Horizon Control: an Effective Methodology for Energy Management in Complex Systems, in: Proceedings of IFAC Conference on Control Methodologies and Technology for Energy Efficiency, pp. CD-Rom, Vilamoura, Portugal, URL <http://hal-supelec.archives-ouvertes.fr/hal-00452935>, 2010.
- Santiago, E., Witrant, E., Goniche, M., and Clairet, F.: An Optimal Feedback Approach to Particle Source Identification in Tokamaks, in: Proc. of the 15th IEEE International Conference on System Theory, Control and Computing, pp. 1–7, Roumanie, URL <http://hal.archives-ouvertes.fr/hal-00667236>, 2011.
- Santos, V. D. and Prieur, C.: Boundary Control of Open Channels with Numerical and Experimental Validations, *IEEE Transactions on Control Systems Technology*, 16(6), 1252–1264, 2008.
- Sowers, T., Bender, M., Raynaud, D., and Korotkevich, Y.: $\delta^{15}\text{N}$ of N_2 in air trapped in polar ice: a tracer of gas transport in the firn and a possible constraint on ice age-gas age differences, *J. Geophys. Res.*, 97, 15 683–15 697, 1992.
- Taroni, A., Erba, M., Springmann, E., and Tibone, F.: Global and local energy confinement properties of simple transport coefficients of the Bohm type, *Plasma physics and controlled fusion*, 36, 1629–1646, 1994.

- Taylor, T. S.: Physics of advanced tokamaks, *Plasma Phys. Control. Fusion*, 39, B47–73, 1997.
- Troyon, F., Gruber, R., Saurenmann, H., Semenzato, S., and Succi, S.: MHD-Limits to Plasma Confinement, *Plasma Physics and Controlled Fusion*, 26, 209, URL <http://stacks.iop.org/0741-3335/26/i=1A/a=319>, 1984.
- Trudinger, C., Enting, L., Etheridge, D., Francey, R., Levchenko, V., Steele, L., Raynaud, D., and Arnaud, L.: Modeling air movement and bubble trapping in firn, *J. Geophys. Res.*, 102, 6747–6763, 1997.
- Udintsev, V., Goniche, M., Ségui, J., Giruzzi, G., Molina, D., Turco, F., Huysmans, G., Maget, P., Krämer-Flecken, A., and Tore Supra Team: First Results of Correlation Electron Cyclotron Emission on Tore Supra, *Fusion Science and Technology*, 50, 508–520, 2006.
- Velders, G. J. M., Ravishankara, A. R., Miller, M. K., Molina, M. J., Alcamo, J., Daniel, J. S., Fahey, D. W., Montzka, S. A., and Reimann, S.: Preserving Montreal Protocol Climate Benefits by Limiting HFCs, *Science*, 335, 922–923, doi:10.1126/science.1216414, URL <http://www.sciencemag.org/content/335/6071/922.short>, 2012.
- Weydert, J., Witrant, E., and Goniche, M.: Optimal estimation of the particle sources in Tore Supra tokamak, in: 4th International Scientific Conference on Physics and Control, Italie, URL <http://hal.archives-ouvertes.fr/hal-00444545>, 2009.
- Winterbone, D. and Pearson, R.: *Theory of Engine Manifold Design: Wave Action Methods for IC Engines*, Society of Automotive Engineers. Inc, 2000.
- Witrant, E.: Stabilisation des systèmes commandés par réseaux., These, URL <http://tel.archives-ouvertes.fr/tel-00011606>, 2005.
- Witrant, E. and Brémond, S.: Shape Identification for Distributed Parameter Systems and Temperature Profiles in Tokamaks, in: Proceedings of the IEEE CDC-ECC 2011, Orlando, Floride, États-Unis, URL <http://hal.archives-ouvertes.fr/hal-00667227>, 2011.
- Witrant, E. and Goniche, M.: A QSS approach for particle source identification in Tore Supra tokamak, in: 48th IEEE Conference on Decision and Control (CDC'09), Shanghai, Chine, URL <http://hal.archives-ouvertes.fr/hal-00444549>, 2009.
- Witrant, E. and Johansson, K. H.: Air flow modelling in deep wells: application to mining ventilation, in: IEEE Conference on Automation Science and Engineering (CASE 2008), Washington DC, États-Unis, URL <http://hal.archives-ouvertes.fr/hal-00340619>, 2008.
- Witrant, E. and Martinerie, P.: A Variational Approach for Optimal Diffusivity Identification in Firms, in: Proceedings of the 18th Mediterranean Conference on Control & Automation (MED'10), Marrakech, Maroc, URL <http://hal.archives-ouvertes.fr/hal-00562220>, 2010.
- Witrant, E. and Martinerie, P.: Input Estimation from Sparse Measurements in LPV Systems and Isotopic Ratios in Polar Firms, in: Proc. of the 5th IFAC Symposium on System Structure and Control, 2013a.
- Witrant, E. and Martinerie, P.: Input Estimation from Sparse Measurements in LPV Systems and Isotopic Ratios in Polar Firms, in: Proceedings 5th IFAC Symposium on System Structure and Control, p. 150, Grenoble, France, URL <http://hal.archives-ouvertes.fr/hal-00931664>, 2013b.
- Witrant, E. and Niculescu, S.-I.: Modeling and control of large convective flows with time-delays, *Mathematics in Engineering, Science and Aerospace*, 1, 191–205, URL <http://hal.archives-ouvertes.fr/hal-00558009>, 2010.
- Witrant, E., Canudas De Wit, C., Georges, D., and Alamir, M.: Remote Stabilization via Time-Varying Communication Network Delays: Application to TCP networks, in: IEEE Conference on Control Applications, Taiwan, URL <http://hal.archives-ouvertes.fr/hal-00196872>, 2004.

- Witrant, E., Georges, D., and Canudas De Wit, C.: Optimal Control Design for the Stabilization of Network Controlled Systems, in: Proc. of IEEE American Control Conference, p. 6pp., États-Unis, URL <http://hal.archives-ouvertes.fr/hal-00196894>, 2006.
- Witrant, E., Gun Park, P., Johansson, M., Fischione, C., and Johansson, K. H.: Predictive control over wireless multi-hop networks, in: IEEE Conference on Control Applications, Singapour, URL <http://hal.archives-ouvertes.fr/hal-00196875>, 2007.
- Witrant, E., Mocanu, S., and Sename, O.: A Hybrid Model and MIMO Control for Intelligent Buildings Temperature Regulation over WSN, in: 8th IFAC Workshop on Time Delay Systems, Sinaia, Roumanie, URL <http://hal.archives-ouvertes.fr/hal-00444556>, 2009a.
- Witrant, E., Weydert, J., Goniche, M., and Clairet, F.: Toward particle source identification in Tore Supra tokamak, in: Proc. of IFAC Workshop on Control of Distributed Parameter Systems, p. 1, Toulouse, France, URL <http://hal.archives-ouvertes.fr/hal-00444543>, 2009b.
- WMO: Scientific Assessment of Ozone Depletion: 2006. Global Ozone Research and Monitoring Project - Report No.50, World Meteorological Organization, Geneva, URL <http://ozone.unep.org/Publications>, 2007.
- Wolf, R. C.: Internal transport barriers in tokamak plasmas, Plasma Phys. Control. Fusion, 45, R1–91, 2003.