



HAL
open science

All-Optical Multicast Routing under Optical Constraints

Dinh Danh Le

► **To cite this version:**

Dinh Danh Le. All-Optical Multicast Routing under Optical Constraints. Other [cs.OH]. Université Montpellier, 2015. English. NNT : 2015MONT214 . tel-02053171

HAL Id: tel-02053171

<https://theses.hal.science/tel-02053171v1>

Submitted on 1 Mar 2019

HAL is a multi-disciplinary open access archive for the deposit and dissemination of scientific research documents, whether they are published or not. The documents may come from teaching and research institutions in France or abroad, or from public or private research centers.

L'archive ouverte pluridisciplinaire **HAL**, est destinée au dépôt et à la diffusion de documents scientifiques de niveau recherche, publiés ou non, émanant des établissements d'enseignement et de recherche français ou étrangers, des laboratoires publics ou privés.

THÈSE

Pour obtenir le grade de
Docteur

Délivré par l'Université Montpellier

Préparée au sein de l'école doctorale **I2S***
Et de l'unité de recherche **LIRMM, UMR 5506**

Spécialité: **Informatique**

Présentée par **Dinh Danh Le**

All-Optical Multicast Routing under Optical Constraints

Soutenu le 27/03/2015 devant le jury composé de :

Bernard COUSIN	Prof.	IRISA, Université de Rennes 1	Rapporteur
Congduc PHAM	Prof.	LIUPPA, Université de Pau et des Pays de l'Adour	Rapporteur
Josep SOLÉ-PARETA	Prof.	Universitat Politècnica de Catalunya	Examineur
Christophe PAUL	DR CNRS	LIRMM, Université de Montpellier	Examineur
Miklós MOLNÁR	Prof.	LIRMM, Université de Montpellier	Directeur de thèse
Jérôme PALAYSI	MCF.	LIRMM, Université de Montpellier	Co-encadrant



Acknowledgments

This thesis could not be completed without the help of many people. I would like to take this opportunity to express my gratitude to the ones who motivated and helped me during the preparation and completion of the thesis.

First and foremost, I would like to express my greatest gratitude to Prof. **Miklós Molnár** who accepted to supervise me in spite of my poor background in optical networks at the first start. His knowledge, working spirit and boundless guidance have motivated me during my thesis. Also, his dedication and pursuit of perfection to high quality research work has encouraged me to be a better researcher and a better person every single day. Especially, I really appreciate his proposal of hierarchy structure which build up the cornerstone for my thesis. Besides, I always feel warm and close to his family for their enthusiasm and sharing in my daily life.

I would like to thank **Jérôme Palaysi** for his patient guidance and collaboration during the thesis. I really appreciate his strong background in graph theory and complexity which help make my dissertation precise in theoretical aspects. He also helped me on the correction of the French summary. Besides, I have never forgotten his kind help to set up my PhD life at the beginning days in Montpellier. I would also like to thank **Alexandre Pinlou** for his accompany with my thesis on the Committee de Suivi de These.

I am glad to thank two reviewers, Prof. **Bernard Cousin** and Prof. **Congduc Pham**, for their insightful and constructive comments. This manuscript is significantly improved respecting their feedbacks. I thank Prof. **Josep Solé-Pareta** and DR. **Christophe Paul** for their agreements to be members of the jury of my thesis.

I want to thank **Fen Zhou**, University of Avignon, for the fruitful collaboration with him on the multiple request multicast routing and wavelength assignment, which results in high-quality publications. To my colleagues at LIRMM, I would like to give a special thank to **Remi Watrigant** for his infinite helps and sharing during the time in Montpellier; **Masinissa Merabet** for his collaboration on the routing without splitters; **Richard Ewelle Ewelle** for sharing many interests in life. I would also like to thank all the col-

leagues at the MAORE team, the members of the PhD council for their kind helps and friendships at the LIRMM.

Many thanks to all the administration staffs of the LIRMM, especially **Nicolas Serurier** and **Laurie Lavernhe**, for their kind assistances and enthusiastic supports during the three years of my thesis. Many thanks to my colleagues at Hong Duc University, Vietnam for making all the arrangements such that I can focus entirely on my study abroad.

I am greatly indebted to my parents, my parents-in-law, my sister, my sister-in-law, and my brothers-in-law, for their loves and encouragements throughout my study. I would like to offer a special thank to my dearest wife, **Lan Anh** and my little son, **Tuan Khoi** for always being with me even from thousands miles apart. Their endless love and accompany have inspired me and made me stronger to overcome difficulties in research as well as in daily life.

Last but never least, I would like to express my big thank to all of Vietnamese friends in Montpellier for their helps, friendships and sharing in daily life. You guys helped me overcome the difficulties in the new environments during my PhD life.

This work would have been impossible without the support of Project 322, Ministry of Education and Training of Vietnam, and University of Montpellier.

Résumé

Au cours de la dernière décennie, le trafic dans les réseaux a connu une croissance explosive en double environ tous les trente trois mois. Les sources à l'origine de cette croissance proviennent de nombreuses applications à grande vitesse (par exemple, la vidéo à la demande ou la télévision haute définition) qui impliquent la transmission de données dans des groupes de multicast. Pour réaliser la multicast optique, les routeurs optiques peuvent avoir des répartiteurs de lumière spéciaux pour diviser des signaux lumineux et des convertisseurs de longueur d'onde pour modifier les longueurs d'onde où c'est nécessaire. Cependant, la division réduit l'énergie du signal qui nécessite alors une amplification ou une régénération qui nécessitent du matériel coûteux. Les convertisseurs de longueurs d'onde aussi ne sont pas suffisamment matures pour être largement déployés dans les technologies optiques actuelles. Par conséquent, dans les réseaux tout-optique, les unités de transformation des routeurs sont souvent hétérogènes et les algorithmes de routage doivent en tenir compte tout en parvenant à des solutions de compromis coût-performances qui satisfassent les exigences de bande passante et les contraintes optiques.

Dans cette thèse, nous étudions les problème de routage multicast tout-optique (AOMR) dans les réseaux tout-optique hétérogènes. L'hétérogénéité provient principalement de l'absence / présence de séparateurs de lumière et de convertisseurs de longueur d'onde et de la répartition inégale des longueurs d'onde dans les liens du réseau. En général, les problèmes de AOMR sont NP-difficiles. L'objectif de la thèse est d'analyser et de formuler les problèmes sous différentes contraintes optiques, pour rechercher des solutions optimales ou proposer des heuristiques efficaces. Les deux contextes possibles, la demande unique ou multiple de multicast, sont examinés. Toutes les propositions présentées dans la thèse sont validées par des simulations approfondies. Les principales contributions peuvent être résumées comme il suit.

1. Nous identifions les structures des routes optimales pour les problèmes de l'AOMR dans les réseaux WDM hétérogènes. Comme indiqué dans la thèse, les solutions optimales ne sont plus basées sur des arbres de lumière classiques, mais sur une structure arborescente plus générale appelée *hiérarchie*. Certaines formes de hiérarchie pour la

multicast WDM sont des parcours optiques, des hiérarchies optiques, des hiérarchies-araignée optiques ou encore des ensembles de ces routes optiques. Les algorithmes exacts et les heuristiques proposés dans la thèse sont principalement basés sur les hiérarchies.

2. Dans le cas du problème de multicast avec une seule demande dans des réseaux partiellement équipés de diviseurs de lumière, nous proposons une heuristique efficace dont les résultats font le compromis entre la consommation de longueur d'onde, le coût total, et le délai de bout-en-bout.
3. Dans le même cas mais dans des réseaux non équipés de diviseurs de lumière, nous prouvons la NP-difficulté, exprimons les problèmes au moyen d'un programme linéaire (ILP) pour trouver les solutions exactes et proposons plusieurs heuristiques pour calculer de bonnes solutions.
4. Pour le cas de multiples demandes, nous nous concentrons sur les modèles de trafic statiques dans des réseaux partiellement équipés de diviseurs mais sans convertisseurs de longueur d'onde. Tout d'abord nous proposons une formulation ILP sur la base de *hiérarchies optiques* afin de rechercher la solution optimale. Ensuite, utilisant un *modèle de graphe en couches*, nous développons plusieurs heuristiques adaptatives pour calculer des hiérarchies optiques de solutions approximatives. Ces algorithmes adaptatifs surpassent les techniques de routage existants pour minimiser la probabilité de blocage.

Dans l'ensemble, la thèse souligne que les solutions optimales pour les problèmes de l'AOMR considérés correspondent à des *hiérarchies*, que ce soit pour une seule demande ou des demandes multiples.

Mots-clés: réseaux WDM, routage multicast tout-optique (AOMR), routage multicast et affectation de longueurs d'onde (MCRWA), arbre optique, hiérarchies optiques.

Abstract

Over the past decade, network traffic levels experienced an explosive growth at about double amount in approximately every thirty months. The sources accounting for this growth come from numerous high-speed applications (e.g., video-on-demand, high-definition television) which involve the data transmission in multicast groups. To realize optical multicasting, optical routers should have light splitters to split light signals and wavelength converters to change the wavelengths wherever needed. However, the splitting reduces the energy of the output signal which in turn requires the costly power amplification or regeneration. Wavelength converters are also immature to be deployed widely in current optical technologies. Consequently, in all-optical networks, routers are often heterogeneous in their processing units, which challenges the routing. Therefore, it is crucial to design efficient multicast routing strategies at the backbone optical networks, in order to achieve cost-performance tradeoff solutions while satisfying the ever-increasing bandwidth demands and optical constraints.

In this thesis, we investigate the all-optical multicast routing (AOMR) problems in heterogeneous optical networks. The heterogeneity mainly comes from the absence/presence of light splitters and wavelength converters and the uneven distribution of wavelengths in the network links. In general, AOMR problems are often NP-hard. The objective of the thesis is to analyze and formulate the problems, to search for the optimal solutions, and to propose efficient heuristics to solve the problems under different optical constraints. Both possible contexts, namely single-request and multiple-requests, are examined. All the reported results in the thesis are supported by extensive and careful simulations. The major contributions can be summarized as follows.

1. We identify the optimal route structures for AOMR problems under heterogeneous mesh WDM networks. As shown in the thesis, the optimal solutions are no longer based on conventional light-trees, but a more general tree-like structure called *hierarchy*. Some forms of hierarchy realized for WDM multicasting are light-trails, light-hierarchies, light-spider-hierarchies and a set of these light-structures. The exact and heuristic algorithms proposed in the thesis are mainly based on hierarchy.

2. For single-request with sparse-splitting case, we propose an efficient heuristic algorithm to produce a good tradeoff solution among wavelength consumption, channel total cost and end-to-end delay.
3. For single-request with non-splitting case, we prove the NP-hardness, identify the optimal solution as a set of *light-spider-hierarchies*, formulate the problems by means of Integer Linear Program (ILP) formulations to find the exact solution, and propose several cost-effective heuristic algorithms to compute the approximate solutions.
4. For the case with multiple-requests, we focus on static traffic patterns under sparse-splitting without wavelength conversion. First, an ILP formulation based on *light-hierarchies* is proposed to search for the optimal solution. By applying the *layered graph model*, we then develop several adaptive heuristic algorithms to compute light-hierarchies for approximate solutions. These adaptive algorithms outperform the existing fixed routing ones in minimizing the blocking probability.

Overall, the thesis points out that the optimal solutions for heterogeneously constrained AOMR problems correspond to *hierarchies*, regardless of request multiplicity consideration.

Keywords: WDM networks, All-Optical Multicast Routing (AOMR), Multicast Routing and Wavelength Assignment (MCRWA), light-tree, light-hierarchy.

Contents

Acknowledgments	i
Résumé	iii
Abstract	v
Table of Contents	vii
List of Figures	xi
List of Tables	xiv
List of Acronyms	xv
I Preliminaries	1
1 Technical Background on WDM Networks	3
1.1 Introduction	3
1.2 WDM Networks	5
1.2.1 Optical Network Evolution	5
1.2.2 WDM Network Architecture	7
1.2.3 Optical Cross-Connect Devices	9
1.3 All-Optical Multicasting in WDM networks	16
1.4 Challenges of AOM	17
1.4.1 Challenges Due to Optical Hardware Impact	17
1.4.2 Challenges Due to Routing and Wavelength Assignment	20
1.5 AOM Classification	21
1.6 General Assumption and Problem Definition	22
1.6.1 General Assumption	23
1.6.2 Problem Definition	24
1.7 Research Contributions	25
1.8 Outline of the Dissertation	26

2	AOMR Modeling	29
2.1	Graph Models for WDM Networks	29
2.1.1	Physical Topology Models	29
2.1.2	Layered Graph Models	31
2.1.3	Other Graph Models	33
2.1.4	Two Routing Schemes Based on Layered Graphs	33
2.2	Hierarchy Model to Solve AOMR Problem	36
2.2.1	Hierarchy in Graphs	36
2.2.2	Optical Hierarchies to Solve Constrained AOM Problems	37
2.3	Conclusion	44
3	Literature Review and Propositions	47
3.1	Problem Classification and Solving Approaches	47
3.2	Single-Request AOMR	47
3.2.1	Full Splitting	49
3.2.2	Non Splitting	50
3.2.3	Sparse Splitting	53
3.3	Multiple-Request MCRWA Problems	61
3.3.1	Static MCRWA Problems versus Dynamic MCRWA Problems	61
3.3.2	ILP/MILP Solutions	62
3.3.3	Heuristic Algorithms	63
3.3.4	Typical Literature Works	66
3.4	Propositions on Exact Solutions for AOMR Problems	68
3.4.1	Full Splitting	69
3.4.2	Non Splitting	70
3.4.3	Spare Splitting	72
II	Single-Request AOMR	75
4	Heuristic Algorithm for Sparse Splitting	77
4.1	Introduction	77
4.2	Problem Formulation	79
4.3	Member-Splitter-First Algorithm	80
4.3.1	Member-First Algorithm	80
4.3.2	New Priority Model	81
4.3.3	Updating Bud-Links	83
4.3.4	Pruning Useless Branches	84
4.3.5	Member-Splitter-First Algorithm	86
4.3.6	The Correctness of MSF Algorithm	88

4.4	Simulation Results	89
4.4.1	Simulation Settings	89
4.4.2	Effect of Group Size	90
4.4.3	Effect of Splitting Capacity	91
4.5	Conclusion	95
5	AOMR without Splitters and Converters	97
5.1	Introduction	97
5.2	Problem Formulation	98
5.3	Exact Solutions	100
5.4	Problem Complexity	102
5.4.1	MNWF Problem	103
5.4.2	MTCF Problem	105
5.5	ILP Formulation Based on light-spider-hierarchies	106
5.5.1	Network Parameters and ILP Variables	106
5.5.2	ILP Formulation	107
5.5.3	Evaluation of Exact Solutions	110
5.6	Heuristic Algorithms for MNWF Problem	114
5.6.1	Useful Concepts	114
5.6.2	Algorithm Framework	117
5.6.3	Farthest First Algorithm	118
5.6.4	Performance Evaluation	122
5.7	Heuristic Algorithms for MTCF Problem	130
5.7.1	Notations	130
5.7.2	Nearest Destination First Algorithm	131
5.7.3	Critical Destination First Algorithm	133
5.7.4	Performance Evaluation	136
5.8	Conclusion	141
III	Multiple-Request AOM	143
6	Static MCRWA in Sparse Splitting	145
6.1	Introduction	145
6.2	MCRWA-SS Problem Definition	147
6.3	Light-Hierarchy Based ILP Formulations	148
6.3.1	ILP with Full Blocking Model (ILP-FB)	149
6.3.2	ILP with Partial Blocking Model (ILP-PB)	152
6.3.3	Comparison of the Two ILP Models	152
6.4	Heuristic Algorithms	153

6.4.1	Two Selected Fixed Routing Algorithms	153
6.4.2	Two Adaptive Routing Schemes Based on Layered Graphs	154
6.4.3	Nearest Destination Light-Hierarchy Algorithm	154
6.4.4	Adaptive Algorithms Based on NDH	156
6.4.5	Critical Destination Light-Hierarchy Algorithm	161
6.5	Performance Evaluation	164
6.5.1	Heuristics versus ILP Solutions	165
6.5.2	Comparison of Heuristic Algorithms	167
6.6	Conclusion	171
7	Conclusions and Perspectives	175
7.1	Conclusions	175
7.2	Perspectives	176
7.2.1	Traffic Grooming	176
7.2.2	Mixed-Line-Rates WDM networks	176
7.2.3	Flexible-Grid Elastic Optical Networking	177
7.2.4	Physical Layer Impairments-Aware Networking	177
7.2.5	Energy-Efficient Optical Networking	178
A	Résumé	179
A.1	Présentation	179
A.2	L'architecture de Réseau WDM	181
A.3	All-Optique Multicast (AOM) dans les Réseaux WDM	182
A.4	Défis du AOM	183
A.4.1	Impact des Séparateurs Optiques	183
A.4.2	Impact de la Conversion de Longueur d'Onde	184
A.4.3	Impact de la Perte de Puissance	184
A.4.4	Impact de la Disponibilité des Longueurs d'Onde	184
A.4.5	Challenges du Routage et de l'Association des Longueurs d'Onde	185
A.5	Portée de la Thèse	185
A.6	Plan et Résumé de la Thèse	186
A.7	Conclusions et Perspectives	190
A.7.1	Conclusions	190
A.7.2	Perspectives	191
	List of Publications	195
	Bibliography	197

List of Figures

1.1	Evolution of optical networks [1]	5
1.2	A typical WDM optical network architecture [2]	8
1.3	A general optical cross-connect architecture [2]	10
1.4	An $N \times N$ SaD-OXC architecture [3]	10
1.5	The sharing-concept design [4]	11
1.6	MOSaD-OXC architecture [5]	11
1.7	A TaC-OXC architecture [6]	12
1.8	The dedicated wavelength converter OXC architecture [7]	14
1.9	The share-per-node wavelength converter OXC architecture [7]	15
1.10	The share-per-link wavelength converter OXC architecture [7]	15
1.11	Three MC-OXC models in a WDM multicast network: (a) MSW. (b) MSDW. (c) MAW. [8]	16
1.12	Deployment of splitters and wavelength converters for MC-OXC models: (a) MSW. (b) MSDW. (c) MAW. [8]	16
1.13	AOM problem classification	23
2.1	A symmetric WDM network and its two physical topology models	30
2.2	Illustration of the ILG model: (a) a network topology, (b) an interconnected- layered-graph [9]	32
2.3	Illustration of the SILG model	33
2.4	A nonsymmetric WDM network (a) and the two variants with/without WC- OXCs of the layered graph models (b, c) [10]	34
2.5	A simple WDM network	35
2.6	Route computation by WG-routing scheme	35
2.7	Route computation by LG-routing scheme	36
2.8	Mapping of vertices for a hierarchy	37
2.9	Different optical hierarchies for constrained AOM problems	38
2.10	Illustration of several path-based hierarchies: (a) a light-path from A to B, a light-trail from C to E, and (b) multi λ -light-walk from A to D	40
2.11	Light-tree and light-forest for different WDM configurations	41
2.12	Mapping for the light-tree and light-forest mentioned in Fig. 2.11	41
2.13	Light-hierarchy solution versus light-tree solution	42

2.14	Illustration of multi λ -light-tree and multi λ -light-hierarchy	43
2.15	Mapping of vertices for a spider-based hierarchy	43
2.16	Illustration of light-spider and light-spider-hierarchy	44
3.1	AOM problem classification and solving approaches	48
3.2	Illustration of an MDT	52
3.3	Comparison of the solutions computed by MO and VS-1 in NSF network	57
3.4	Comparison of the solutions computed by MO and GRDP-LH in NSF network	58
3.5	Comparison between a solution based on a single light-trail with a solution based on a set of arc-disjoint light-trails	71
4.1	A network to consider	83
4.2	Effect of the improvements to the resultant light-forests	83
4.3	Demonstration of pruning useless branches	86
4.4	Illustration of MSF algorithm	88
4.5	Testbeds for simulations	89
4.6	Performances of algorithms versus Group Size in NSFNET and US Longhaul Network	92
4.7	Performances of algorithms versus Splitting Capacity in NSFNET and US Longhaul Network	93
4.8	Performances of algorithms in European COST-239 Network	94
5.1	An example WDM network	99
5.2	LSH based solution versus LS based solution for the same multicast request	101
5.3	Different LSH based solutions for the same multicast request	102
5.4	A network $G = (V, A)$, a source node s and a set $D = \{1, 2, 3, \dots, k-1, k\}$	102
5.5	Illustration of transformation from graph $H = (V_H, E_H)$ for graph $G = (V, A)$	104
5.6	Illustration of modeling MTCF problem using layered graph	105
5.7	Example to illustrate constraint 5.6	108
5.8	a) An example network topology. b) The failed result. c) The optimal solution.	109
5.9	Example of a DSPT and its conflict graph	116
5.11	A network to consider	118
5.12	Illustration of Farthest First heuristic	121
5.13	Performance of algorithms on 50-node undirected graphs	126
5.14	Performance of algorithms on 100-node undirected graphs	126
5.15	Performance of algorithms on 150-node undirected graphs	126
5.16	Performance of algorithms on 100-node directed graphs	127
5.17	Performance of algorithms on 100-node directed graphs	127
5.18	Performance of algorithms on 150-node directed graphs	127
5.19	Diameter versus Group Size on 50-node graphs	128

5.20	Diameter versus Group Size on 100-node graphs	128
5.21	Diameter versus Group Size on 150-node graphs	128
5.22	Illustration of the two heuristics	134
5.23	Performances of algorithms on 50-node random graphs with $W = 20$	139
5.24	Performances of algorithms on 100-node random graphs with $W = 20$	139
5.25	Performances of algorithms on 150-node random graphs with $W = 20$	139
5.26	Performances of algorithms on 50-node random graphs with $W = 10$	140
5.27	Performances of algorithms on 100-node random graphs with $W = 10$	140
5.28	Performances of algorithms on 150-node random graphs with $W = 10$	140
6.1	Diagram of all the proposed algorithms	165
6.2	Testbeds for simulations	168
6.3	DBP vs. Number of Requests	172
6.4	RBP vs. Number of Requests	172
6.5	DBP vs. Number of Wavelengths	172
6.6	RBP vs. Number of Wavelengths	173
6.7	DBP vs. Number of MC-OXCs	173
6.8	RBP vs. Number of MC-OXCs	173

List of Tables

1.1	Typical influential factors on AOM problems	21
3.1	Exact solutions for typical single-request AOMR problems	73
5.1	Network Parameters	106
5.2	ILP Variables	107
5.3	Performance comparison between LSH based solutions and LS based solutions for the two considered problems.	113
5.4	Comparison of heuristic solutions with exact solutions for MNWF problem .	123
5.5	Comparison of heuristic solutions with exact solutions for MTCF problem. .	137
6.1	Notations and Network Parameters	149
6.2	ILP Variables	149
6.3	Performance comparison of heuristics to ILP solutions.	166

List of Acronyms

AOMR	All-Optical Multicast Routing
AOM	All-Optical Multicasting
BER	Bit Error Rate
CAGR	Compound Annual Growth Rate
CAPEX	Capital Expense
CDF	Critical Destination First
CDLH	Critical Destination Light-Hierarchy
CDM	Code Division Multiplexing
DBP	Destination Blocking Probability
DCST	Delay Constrained Steiner Tree
DSPT	Directed Shortest Path Tree
E/O	Electrical/Optical
EON	Elastic Optical Networking
FB	Full destination Blocking probability
FDDI	Fiber Distributed Data Interface
FF	Farthest First
FG	Farthest-first Greedy
Gbps	Gigabits per second
HDTV	High-definition Television

ILG	Interconnected-Layered-Graph
ILP	Integer Linear Programming
IP	Internet Protocol
LRF	Largest Request First
LSH	Light-Spider-Hierarchy
LS	Light-Spider
MAW	Multicast with Any Wavelength
MC-OXC	Multicast Capable Optical Cross-Connect
MC-RSA	Multicast Routing and Spectrum Assignment
MCRWA-SS	MCRWA under Sparse Splitting capacity
MCRWA	Multicast Routing and Wavelength Assignment
MDMCT	Multiple-Destination Minimum Cost Trail
MDT	Multiple-Destination Trail
MFBH	Maximum Flow Based Heuristic
MF	Member-First
MI-OXC	Multicast Incapable Optical Cross-Connect
MILP	Mixed Integer Linear Programming
MLR	Mixed-Line-Rates
MNWF	Minimum Number of Wavelengths First
MOSaD-OXC	Multicast-Only Splitter-and-Delivery Cross-Connect
MOSaD	Multicast-Only Splitter-and-Delivery
MO	Member-Only
MPH	Minimum Path Heuristic
MSDW	Multicast with Same Destination Wavelength
MSF	Member-Splitter-First
MSW	Multicast with Same Wavelength

MTCF	Minimum Total Cost First
MWLG	Modified Wavelength-Layered Graph
NDF	Nearest Destination First
NDLH	Nearest Destination Light-Hierarchy
NF	Nearest First
NG	Nearest-first Greedy
NP-hard	Non-deterministic Polynomial-time hard
O/E	Optical/Electrical
OADM	Optical Add/Drop Multiplexer
OEO	Optical-Electronic-Optical
OLT	Optical Line Terminal
OPEX	Operation Expense
OSNR	Optical Signal to Noise Ratio
OSW	Optical Switch
OTDM	Optical Time Division Multiplexing
OXC	Optical Cross-Connect
PB	Partial destination Blocking probability
PLI	Physical Layer Impairments
QoS	Quality of Services
QoT	Quality of Transmission
R2A	Reroute-to-Any
R2S	Reroute-to-Source
RBP	Request Blocking Probability
ROADM	Reconfigurable Optical Add/Drop Multiplexer
RSA	Routing and Spectrum Assignment
RWA	Routing and Wavelength Assignment

SaD-OXC	Splitter-and-Delivery Cross-Connect
SaD	Splitter-and-Delivery
SDH	synchronous Digital Hierarchy
SDS	Space-Division Switch
SILG	Simplified Interconnected-Layered-Graph
SONET	Synchronous Optical Network
SPT	Shortest Path Tree
SRF	Smallest Request First
SSB	Split-Switch Bank
TaC-OXC	Tap-and-Continue Cross-Connect
TaC	Tap-and-Continue
Tbps	Terabits per second
TCM	Tap-and-Continue Module
VoD	Video-on-Demand
VoIP	Voice over Internet Protocol
WA	Wavelength Assignment
WC-OXC	Wavelength Converter Optical Cross-Connect
WCB	Wavelength Converter Bank
WC	Wavelength Converter
WDM	Wavelength Division Multiplexing

Part I

Preliminaries

Technical Background on WDM Networks

This chapter presents a brief introduction to the wavelength division multiplexing (WDM) networks, involving the infrastructure of the WDM core networks and the architecture of optical cross-connects (OXC)s. Then, the necessity and challenges of supporting all-optical multicasting (AOM) are presented. The AOM problems are then classified based on the typical factors and challenges. At the end of the chapter, the main contributions and the organization of the thesis are outlined.

1.1 Introduction

Over the past decade, network traffic levels experienced an explosive growth at about double amount in approximately every thirty months [11]. The latest Cisco's traffic forecast report also announces that the average global Internet traffic will increase threefold over the next five years, and IP traffic will grow at a compound annual growth rate (CAGR) of 21% from 2013 to 2018 [12]. The major sources accounting for this growth relate to video and voice traffic, which come from numerous high-speed Internet applications, including Video-on-Demand (VoD), High-definition Television (HDTV), Voice over Internet Protocol (VoIP), video conferencing, video sharing between data centers, etc.

To meet these arising demands, it is necessary to equip the core networks with an efficient transmission medium. This requirement gives rise to the evolution of huge-bandwidth optical fiber technology. The choice of fiber is due to its large bandwidth, low latency, transparency, reliability and scalability. Theoretically, a single-mode optical fiber has a potential bandwidth of 50 terabits per second (Tbps), while the electronic peak rate at about a few tens of gigabits per second (Gbps) [13].

In order to exploit the fiber's vast potential capability without experiencing electronics bottleneck, possible technologies can be realized by involving concurrent multiple user-data transmissions under different network architectures and protocols. In all-optical networks, concurrency can be deployed through either time slots (optical time division multiplexing-OTDM) [14], wave shape (code division multiplexing-CDM) [15] or wavelength (wavelength division multiplexing-WDM) [16]. Among them, as pointed later in this chapter, WDM is more attractive than OTDM and CDM.

In WDM technology, multiple channels (wavelengths) are multiplexed into a single optical fiber. For instance, at core backbone networks, the mature optical fiber is capable of carrying 80-160 wavelengths in parallel [11]. The commercially available wavelengths are operated at 10 Gbps, 40 Gbps and 100 Gbps [17]. The state-of-the-art technology can support super channels to operate at up to 500 Gbps [18] and the 1 Tbps-wavelengths are likely to be deployed in the 2015–2020 time frame [11].

On another aspect, the above-mentioned bandwidth-consuming applications mostly relate to the data transmission among multiple participants in multicast groups. Naturally, they are best supported with multicasting. Since communication from a source toward several destinations can use common links, multicasting is bandwidth-effective. Multicasting in all-optical domain, referred to as all-optical multicasting (AOM), is therefore indispensable.

However, unlike Internet Protocol (IP) multicasting in traditional electrical domain, AOM is subject to optical constraints. These constraints come from the availability of the network resources such as the number of wavelengths supported in a fiber, the supply of splitters, converters. Moreover, AOM schemes should adapt to multiple requests concurrently present in the networks. In the thesis we study both single-request and multiple-request AOM. While the single-request AOM just focuses on optimizing the route for one request, the multiple-request multicasting have to deal with multiple requests simultaneously. Despite their difference in nature, we show that single-request AOM routing schemes can be applied to multiple-request scenario in a suitable manner.

The rest of this chapter is organized as follows:

- An introduction to the WDM networks, including the architecture of WDM backbone networks, the optical devices deployed in WDM networks.
- The necessity and advantages of AOM.
- The challenges of AOM.
- The AOM classification.
- General assumption and problem definition.
- The main contributions of this thesis.
- The outline of the dissertation.

1.2 WDM Networks

1.2.1 Optical Network Evolution

The evolution of optical networks has undergone three evolution stages: opaque, translucent and transparent optical networks as shown in Fig. 1.1 [1]. In the first generation, so called opaque optical networks, although the data transmission is performed through optical fibers, the switches operate in electrical domain. The light signals passed by the switches are regenerated by optical-electronic-optical (OEO) conversions. Due to lots of OEO conversions needed, the opaque networks are costly and energy-consuming. Besides, the OEO conversions cause electro-optical bottlenecks that slowdown the line rate. Fiber distributed data interface (FDDI), synchronous optical networks (SONET) and synchronous digital hierarchy (SDH) networks are some examples of the first generation optical networks [19].

The second generation, namely translucent or optical-bypass networks, was then proposed as an intermediate architecture between opaque and all-optical networks. The principle of translucent networks is to place sparsely but strategically the electrical OEO switches combined with all-optical switches. The goal is to reduce the cost of required electrical processing and keep the light signal remain in the optical domain more in its paths.

In the third generation, both the transmission and the switching are performed in the optical domain with the help of reconfigurable optical add/drop multiplexers (ROADMs) and/or optical cross-connects (OXC), hence the name *all-optical networks*. This generation can be deployed through either optical time division multiplexing (OTDM) [14], wave shape code division multiplexing (CDM) [15] or wavelength division multiplexing (WDM) [16].

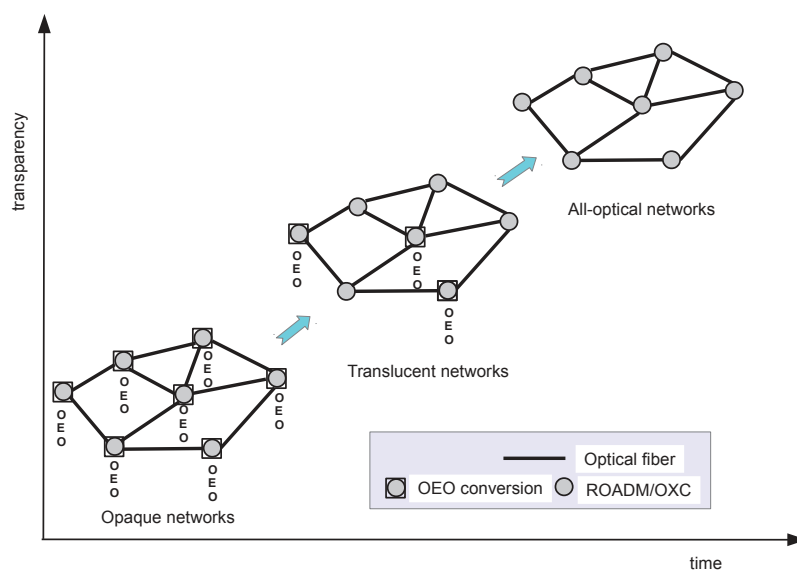

Figure 1.1 – Evolution of optical networks [1]

In OTDM [14], multiple low-speed channels are time interleaved to form a single high-speed channel. Each channel (reserved for one user) is transmitted in the form of ultra-short pulses and it should be synchronized within a time slot, and the OTDM bit rate is the aggregation over all OTDM channels in the system. In order to avoid interference between channels, transmitters should be capable of generating ultra-short pulses, which are perfectly synchronized to the desired channel (time slot), and receivers should have a perfect synchronization to desired channel (time slot).

In CDM [15], each channel is assigned a unique code sequence (very short pulse sequence), which is used to encode low-speed data. The channels are combined and transmitted in a single fiber without interfering with each other. To ensure this non-interference, the code sequence of each channel is chosen such that its cross-correlation between the other channels' code sequences is small, and the spectrum of the code sequence is much larger than the signal bandwidth. As a result, it is possible to have an aggregate network capacity beyond the speed limits of electronics. Like OTDM, CDM requires short pulse technology, and synchronization to one chip time for detection.

In contrast, in wavelength division multiplexing (WDM) technology [16], the fiber's spectrum is divided into multiple wavelength channels. Users can transmit and receive signal at peak electronic rates, and the different channels can be used simultaneously by many users. In this way, the aggregate network capacity can reach the number of channels multiplied by the rate of each channel. In order to develop an effective WDM network, each user may be able to transmit and receive from multiple channels. Therefore, the tunable transmitter (laser)/tunable receivers (filter) and/or multitude of fixed transmitters/receivers are employed at end-nodes.

WDM is the favourite choice over OTDM, and CDM for several reasons. The first reason is due to the complex hardware requirements, and synchronization requirements of OTDM and CDM (synchronization within one slot time and one chip time respectively). WDM does not have such requirements. Besides, OTDM bit rate or CDM chip rate may be much higher than the electronic processing speed. That means some parts of the networks operate at a speed higher than the electronic limit speed. In contrast, in WDM technology, all the user-equipments needs to operate at the bit rate of individual wavelength channel, each can be chosen arbitrarily, often under the peak rate of electronic processing speed.

Since the signal is always kept in the optical domain inside the core network until arriving at the access nodes (or edges nodes), WDM networks are referred to as transparent optical networks or all-optical WDM networks. The removal of costly electrical processing equipments along the route from the source to the destinations helps reduce power consumption, heat dissipation and site space requirements. In fact, the all-optical WDM networks are realized by using components that are already (or very nearly) available commercially. WDM network is still a promising candidate in the future core Internet. That is

why this thesis focuses on WDM networks, and reserves the other technologies for future studies.

Two commonly used architectural forms for WDM networks are broadcast-and-select WDM networks and wavelength-routed WDM networks. Broadcast-and-select WDM networks [20] are based on star, bus or ring topologies. In these networks, a sender simply broadcasts the light signal on different channels to a common shared medium, and the receivers tune to receive the right signal using an optical filter. The main disadvantages of these networks are power loss and lack of wavelength reuse. Therefore, broadcast-and-select networks are suitable for local area networks, though are not scalable to wide area networks. They are also applied in recent access networks, e.g., Passive Optical Networks (PONs) [21].

In contrast, the WDM technology can be built on the concept of wavelength routing, referring to as a wavelength-routed WDM network. In a wavelength-routed WDM network, the nodes are interconnected through a number of point-to-point WDM links in a mesh topology. Each node is equipped with a set of transmitters and receivers for transmitting or receiving light-signals, and optical cross-connects (OXC) to switch (route) the signals. As long as any two channels do not share the same fiber link anywhere on the network, they can use the same wavelength. This wavelength reuse feature results in a tremendous reduction in the number of wavelengths required for building wide area networks (WAN) optical networks. This kind of WDM network is more sophisticated than the broadcast-and-select WDM networks as more network functionalities are required: routing, wavelength assignment, multicasting, traffic grooming, etc. A brief introduction to the architecture of the wavelength-routed WDM networks is given in the next subsection. Since the thesis deals with wavelength-routed WDM networks, we use the term WDM networks to indicate wavelength-routed WDM networks in the rest of the thesis.

1.2.2 WDM Network Architecture

An example of a WDM network is shown in Fig. 1.2. In general, a typical WDM network is composed from three components: optical cross-connects, fiber links and access nodes (or edge nodes).

- Optical cross-connects (OXC) are in charge of the most important functionalities of the core networks, including: multiplexing, demultiplexing, routing, switching, converting wavelengths, etc. Through demultiplexing the incoming light signal, an OXC can switch each of the wavelengths at an input port to a particular output port, independent of the other wavelengths. Some particular OXC can also switch a wavelength to several output ports simultaneously by employing a light splitter to support multicast services.

- Optical fiber links carry the light-signals for end-to-end communications from senders to receivers, providing a high-speed transmission medium. Often, each link is bunched from multiple fibers such that they are able to offer a number of concurrent communications throughout the networks, as well as to strengthen the network survivability and reliability. Each fiber supports a number of optical channels or wavelengths.
- Access nodes (or edge nodes) play the roles as intermediate interfaces between the core WDM networks and the non-optical client networks (or edge networks such as IP/MPLS, SONET or ATM networks). An access node can be either a sender or a receiver in a certain communication. At the sender side, it aggregates the low speed traffics at input port and performs the electrical-optical (E/O) conversion. Meanwhile, at the receiver side, it performs the traffic disaggregation and optical-electrical (O/E) conversion.

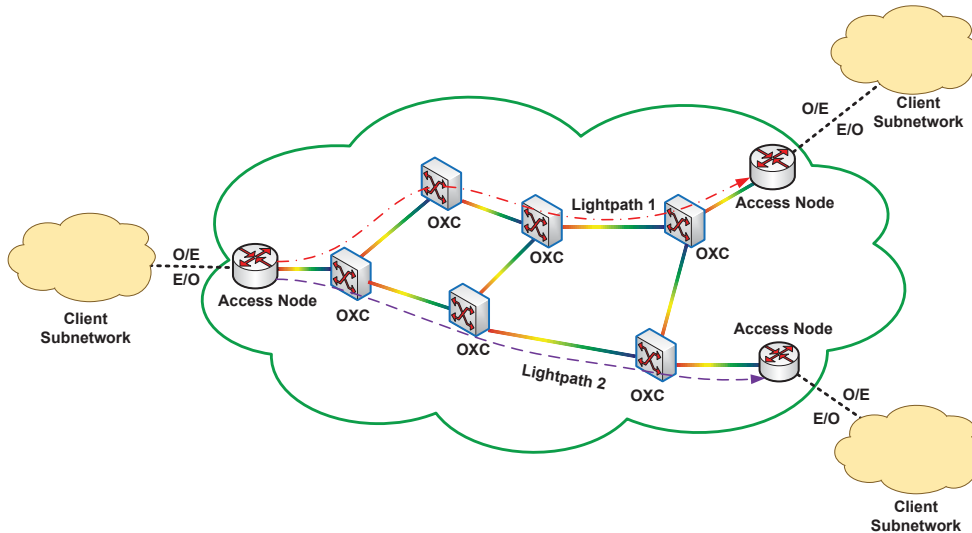

Figure 1.2 – A typical WDM optical network architecture [2]

To support point-to-point communication between any pair of nodes in WDM network, a logical all-optical connection between two access nodes called *light-path* is established. A light-path may pass multiple links using the same wavelength without undergoing any OEO conversion at any intermediate nodes [22]. Thus, a light-path is able to achieve as high as the capacity of a wavelength channel (e.g., on the order of hundreds Gbps) [18]. However, lightpaths must comply the following constraints [22]:

- *Distinct wavelength constraint*: Two light-paths cannot use the same wavelength in common links. This is also called *wavelength clash constraint* [23, 24].
- *Wavelength continuity constraint*: In the absence of any wavelength conversion, all the links on a light-path must use the same wavelength.

These constraints distinguish the WDM networks with traditional electrical networks. The properties of WDM networks and related issues are detailed in the next subsections.

1.2.3 Optical Cross-Connect Devices

In optical WDM networks, the switching devices are indispensable to exploit a great potential transmission medium of optical fibers. Together with the optical network evolution, one has been witnessed of a great development of diverse types of optical devices from optical line terminals (OLTs), optical add/drop multiplexers (OADMs), to optical cross-connects (OXC). The objective of the introduction of these devices aims at effectively utilizing the network resources as well as enhancing the network performance. This subsection describes several typical optical cross-connect architectures which serve as the basis for studying AOMR in the thesis.

General Cross-Connects Architecture

The OXCs provide the switching and routing functions that support communications between edge nodes. An $N \times N$ OXC supporting W wavelengths is implemented by N wavelength demultiplexers, W $N \times N$ optical switches (OSWs) and N wavelength multiplexers, as shown in Fig. 1.3 [2]. Each input port is followed by a wavelength demultiplexer and each output port is preceded by a wavelength demultiplexer. W OSWs are placed in the middle with each one responsible for a wavelength from λ_1 to λ_W . Since these OSWs are independent to each other, an OXC can cross-connect the same wavelengths from an input to any output, where the connection pattern of each wavelength is independent of the others. By appropriately configuring the OXCs along the physical path, logical connections (e.g., lightpaths) may be established between any pair of access nodes of the WDM network.

There are different technologies to implement OSWs, and thus, different types of OXCs exist. The simplest OXC architecture can be built by space-division switches (SDS) [25]. This OXC is suitable in supporting point-to-point communication. Some other OXCs are introduced in the following.

Splitter-and-Delivery Cross-Connects

In order to support point-to-multipoint communication (or multicast services), an optical device called light splitter should be integrated in an OXC. Thus, a splitter-and-delivery (SaD) switch was proposed in [3] for the OSWs in the OXC architecture. Fig. 1.4(a) shows an $N \times N$ SaD switch and one of OXC architecture based on SaD is shown in Fig. 1.4(b). An SaD switch consists of N power splitters, $N \times N$ optical gates (to reduce the excessive crosstalk), and $N \times N$ 2×1 photonic switches. An input lightbeam is initially

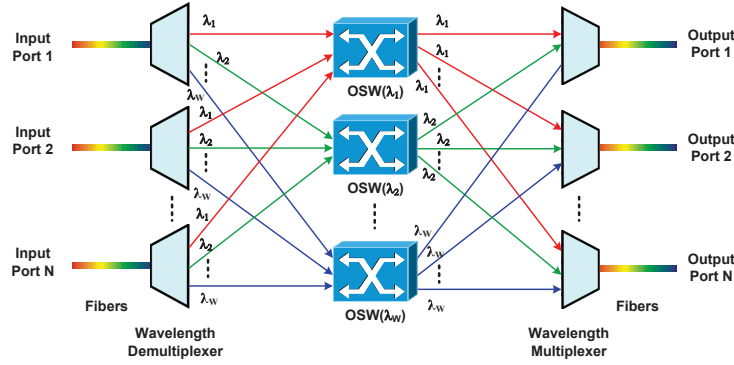
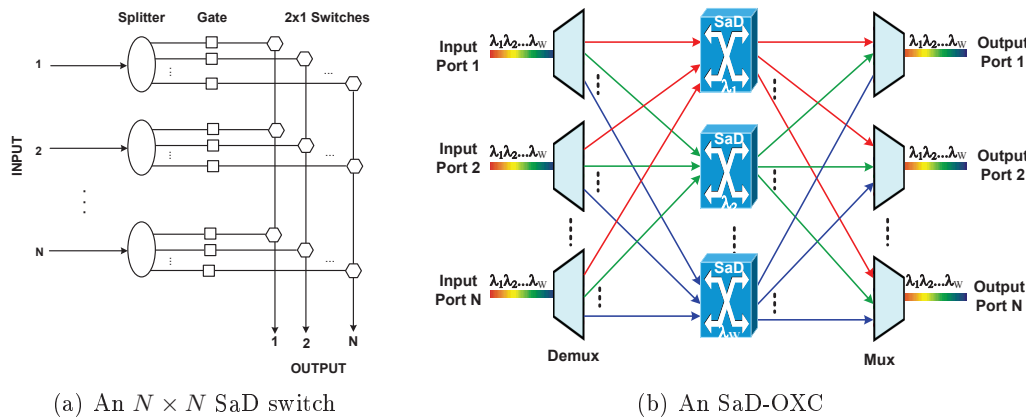

Figure 1.3 – A general optical cross-connect architecture [2]

split to N branches. Each branch is directed to an associated output port by a 2×1 optical switch. Therefore, any input can be connected to none, one, more or all the output ports. This features a strictly nonblocking property and multicasting capability. These components are well integrated on a silicon board using planar silica waveguide technology [26] so that a favorable crosstalk level less than -40dB could be achieved [3].

Figure 1.4 – An $N \times N$ SaD-OXC architecture [3]

However, these non-blocking SaD switches may be neither power-efficient nor cost-effective due to lots of splitters and amplifiers needed, which results in a significant power loss, even for unicast traffic. To overcome this drawback, another multicast capable OXC architecture was proposed in [5] in order to support both unicast and multicast traffics with less power losses compared with SaD-OXCs.

Multicast-Only Splitter-and-Delivery Cross-Connects

The multicast-only splitter-and-delivery (MOSaD) cross-connects are based on the *splitter-sharing design* concept [4]. As shown in Fig. 1.5, the unicast signal λ_a is sent directly to the multiplexer for a desired output port; while the multicast signal λ_b is sent

to the split-switch bank (SSB). In this architecture, the splitter in each SSB will be shared by different input wavelengths.

Fig. 1.6 shows how the proposed architecture for MOSaD cross-connects apply the sharing design concept. An $N \times N$ MOSaD cross-connect supporting W wavelengths consists of N demultiplexers to extract the input signal into individual channels, W space-division switches (SDSs) to perform the actual switching, and N multiplexers to aggregate individual channels on output fiber, W split-switch banks (SSB), $W \times N$ 2×1 lightwave switches [5].

The MOSaD architecture provides strictly nonblocking operation for unicast connections. However, it may cause high blocking for multicast connections when more than one multicast requests require an MOSaD switch at a common port on a same wavelength at a time [5]. Consequently, the MOSaD-OXC is suitable in the situation where multicast requests represent a relatively small fraction of the total requests in the network.

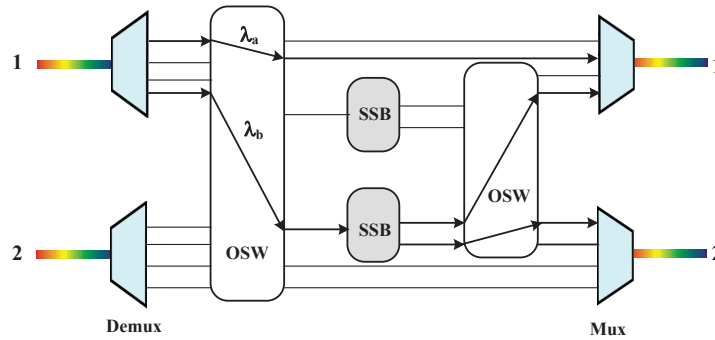

Figure 1.5 – The sharing-concept design [4]

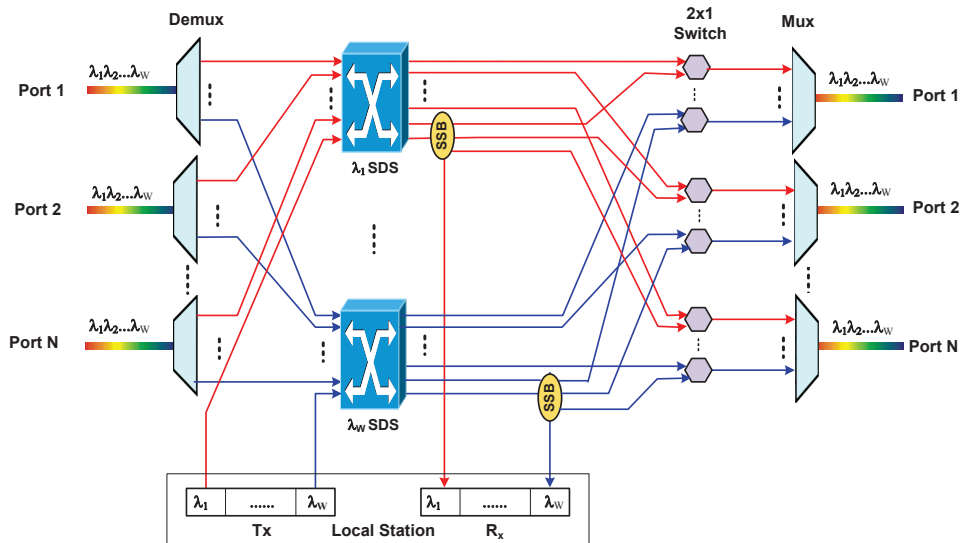

Figure 1.6 – MOSaD-OXC architecture [5]

The OXCs equipped with light splitters (like SaD-OXCs or MOSaD-OXCs) are called as a common name Multicast Capable OXCs (denoted as MC-OXCs, or MC nodes for short).

Tap-and-Continue Switch

In order to support multicasting avoiding high fabrication cost and power loss caused by splitters, Ali et al. [6] proposed an OXC architecture called Tap-and-Continue (TaC) OXC without employing any splitters. As shown in Fig. 1.7, the basic structure of this cross-connect is similar to the aforementioned MOSaD, except that a set of Tap-and-Continue Modules (TCMs) replace SSBs in TaC cross-connect. In a TCM, only a small fraction of the incoming light signal is tapped and forwarded to the local station. The remaining power of the order of 99.9% [6] is switched to the designated output port. In order to meet a certain optical signal to noise ratio (OSNR), the tapping device should be fully programmable to provide sufficient tapped signal power for the local station.

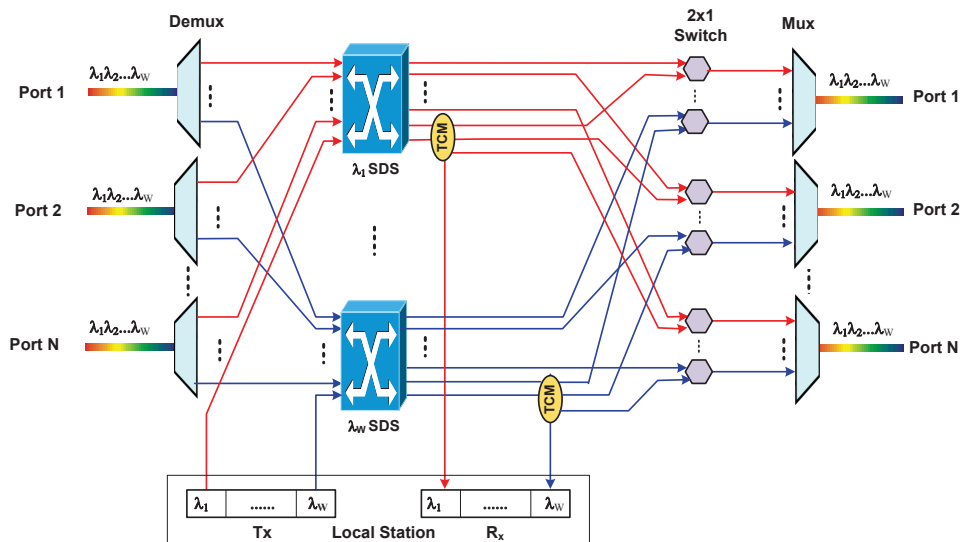

Figure 1.7 – A TaC-OXC architecture [6]

Functionally, a TaC-OXC can be able to:

- *drop only* the signal when the locally attached router is a destination and there is no need to forward it;
- *continue only* when the locally attached router is not a destination and there is a down-stream destination to forward the signal; and
- *drop/tap and continue* when the locally attached router is a destination and also there is a down-stream destination.

The authors in [6] also proved that TaC-OXC can feasibly realize multicasting with much cost-effective compared with SaD-OXC, but at the expense of high number of fiber links used. In addition, they showed in another work [27] that only about 50% of the OXC in a WDM network need actually to be SaD-OXC, while the remainder can just make use of the TaC devices. The OXC that are not equipped with light splitters (like TaC-OXC) are called as a common name Multicast Incapable OXC (denoted as MI-OXC, or MI nodes for short).

Wavelength Converter Cross-Connects

In WDM networks, the two aforementioned constraints (i.e., *wavelength continuity constraint* and *distinct wavelength constraint*) play a role of fundamental contributors for *blocking probability*. A connection request is said to be blocked if there are not sufficient wavelengths in all the links of its routes (e.g., light-paths). Therefore, a natural way to reduce blocking probability is to alleviate or to eliminate these constraints, especially the *wavelength continuity constraint*. It can be done by introducing a special device called wavelength converter (WC).

A WC can shift (convert) a wavelength arriving at an input port to another wavelength at an output port. It is useful when a signal is transmitted in a route that may not have the same wavelength on all the links. With the support of WC, different wavelengths may be used in a light-path, and so the *wavelength continuity constraint* is relaxed or eliminated.

WC can be deployed within an OXC resulting another OXC type as we call wavelength converter OXC (or WC-OXC). A WC-OXC can have *full* or *limited* range wavelength conversion capacity. A full WC-OXC can convert an input wavelength to any other output wavelength. Whereas, A limited WC-OXC can convert an input wavelength to set of wavelengths which does not cover all the wavelengths. Since full WC-OXC are costly in current technology [28], limited WC-OXC are preferred. To see how the WC-OXC can be realized, we briefly describe several typical WC-OXC architectures early proposed in [7].

Fig. 1.8 shows a *dedicated* WC-OXC architecture where a dedicated WC is used for each wavelength at every output port. For an $N \times N$ WC-OXC (with N fibers) supporting W wavelengths, a total of $N \times W$ wavelength converters are needed. The optical signals arriving at each input are first demultiplexed into the different wavelengths; then each wavelength is directed to its desired output port (one of W) by a nonblocking space photonic switch (OSW). A dedicated WC at each switch output then converts the signal, if needed, to the desired output wavelength; a multiplexer finally aggregates the W output wavelengths to the output optical fiber.

Obviously, this dedicated wavelength convertible switch can be used to realize the full wavelength conversion OXC. However, it is not cost efficient since some circuits may not always need wavelength conversions. An effective method is to share wavelength converters

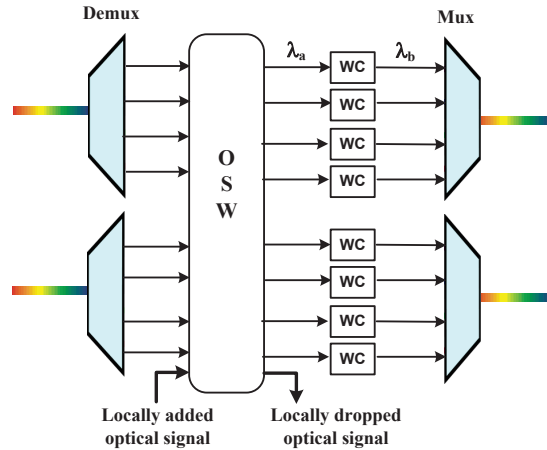

Figure 1.8 – The dedicated wavelength converter OXC architecture [7]

applying the aforementioned *sharing design discipline* (cf. Fig. 1.5). This results in two share-WC architectures: share-per-node (Fig. 1.9) and share-per-link (Fig. 1.10) depending on how the wavelength converters are shared.

In Fig. 1.9 the converters at the switching node are collected into a wavelength converter bank (WCB) (each of which is assumed to have identical feature and can convert an input wavelength to any of output wavelength). This bank can be accessed by any of the incoming wavelengths from any of the inputs by configuring the large optical switch (OSW). In this architecture, only the wavelengths needing conversion are routed to the converter bank, hence saving on the number of converters and conversion delay (since conversion to the same wavelength (e.g., λ_a) is not needed). The converted wavelengths are then switched to the appropriate output ports using the small optical switch. Despite introducing added costs of an additional small switch and more input ports to the multiplexers, the savings in the number of converters in the share-per-node architecture far outweighs those extra costs.

A variation is shown in Fig. 1.10 where the share-per-link approach dictates a dedicated converter bank which can be accessed only by those circuits going on that particular outbound link. Compared to the share-per-node architecture, this share-per-link approach needs more added cost but achieves better performance. It provides a good tradeoff between fabrication cost and performance obtained from the other two architectures.

We can see that the two share-WC architectures can be used to realize limited WC-OXCs, and they also can realize full WC-OXCs as well, provided that the number of converters is large enough to place in the WC banks.

Multicast-OXC Models

To support multicast connections, it is essential to equip the cross-connects with splitters which turns out to be MC-OXCs. To realize an MC-OXC, light splitters and wavelength

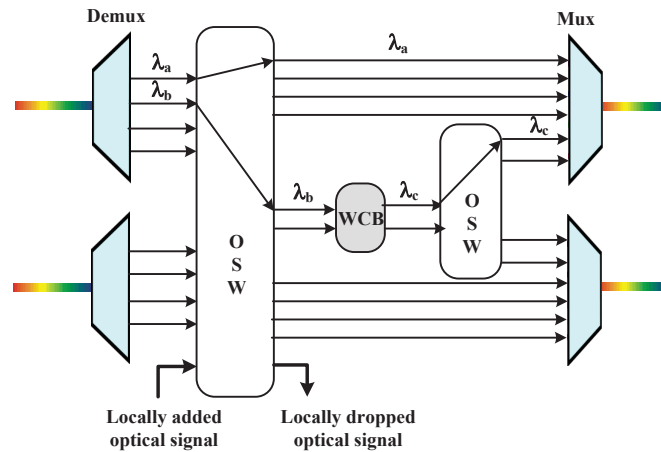

Figure 1.9 – The share-per-node wavelength converter OXC architecture [7]

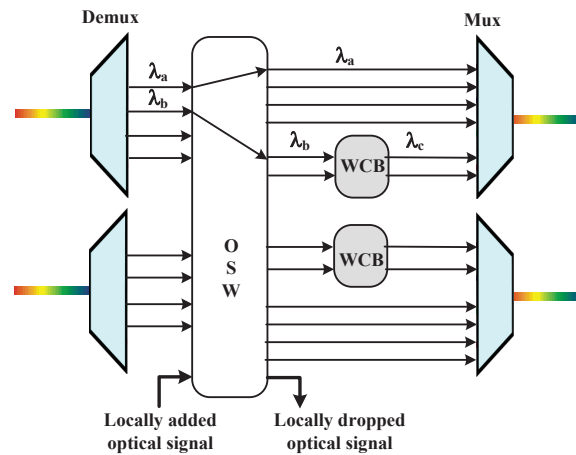

Figure 1.10 – The share-per-link wavelength converter OXC architecture [7]

converters can be integrated inside the OXC in some manners. Three possible models were proposed in [8], as shown in Fig. 1.11. The first model is to assign the same wavelength on all output links as well as the input link. This model is referred to as Multicast with Same Wavelength (MSW) model as shown in Fig. 1.11(a). The second model is to assign the same wavelength to all destination nodes of a multicast connection, but the source node may use a different wavelength and is referred to as the Multicast with Same Destination Wavelength (MSDW) model as shown in Fig. 1.11(b). The third model is that the source node and each of the destination nodes may use a different wavelength and is referred to as the Multicast with Any Wavelength (MAW) model as shown in Fig. 1.11(c). Obviously, MAW is a stronger model than MSDW, which in turn is stronger than MSW. Fig. 1.12 depicts the deployment of power splitters and wavelength converters for the corresponding MC-OXC models. It was revealed in [8] that there is a cost–performance trade-off between MSW and MAW models, while the MSDW model is not desirable since it has the same cost as MAW but its performance is inferior to that of MAW.

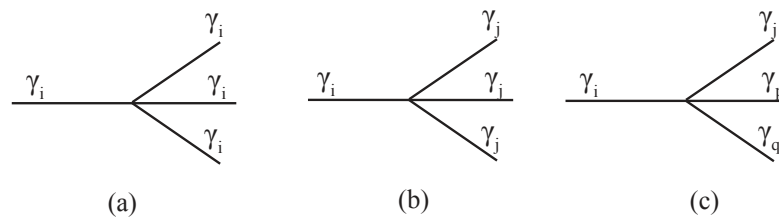

Figure 1.11 – Three MC-OXC models in a WDM multicast network: (a) MSW. (b) MSDW. (c) MAW. [8]

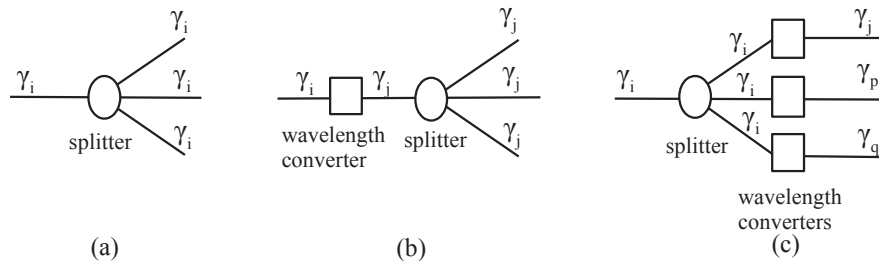

Figure 1.12 – Deployment of splitters and wavelength converters for MC-OXC models: (a) MSW. (b) MSDW. (c) MAW. [8]

1.3 All-Optical Multicasting in WDM networks

The purpose of multicasting is to provide efficient communication services for applications that necessitate the simultaneous transmission of information from one source to multiple destinations, i.e., point-to-multipoint communication. Multicasting is bandwidth-efficient compared with unicasting and broadcasting since it eliminates the necessity for a source to send an individual copy of the message to each destination, and avoids flooding the whole network by broadcasting [29].

Multicasting in WDM networks relates to transmitting signal from a single source to multiple destinations concurrently in all-optical domain, hence it is referred to as all-optical multicasting (AOM). AOM is getting more and more important in the backbone networks due to an increasing number of high performance applications involving group of destinations, including video conference, distance e-learning, HDTV, shared workspace, distributed interactive simulation and software upgrading, etc. AOM has many potential advantages [30]. Firstly, WDM multicasting is bandwidth-effective since the signal towards several destinations can use common links. Secondly, the replication of data in WDM networks is more power-efficient than that in IP networks. In WDM networks, an OXC duplicates the data by directly using light splitters, while the IP switches do it by copying the memory electronically in IP networks. The usage of light splitters also eliminates the need of buffering which is usually required for data duplication in the electronic domain. Since there is no OEO conversion needed, AOM has low latency. Finally, AOM provides a high data *transparency*. One does not need to care about either the bit rate or the

coding format of the data during a multicast communication in WDM networks. In fact, the original goal of the all-optical network was based on keeping the data signals entirely in the optical domain from source to destinations to eliminate the so-called electronic *bottleneck*, and to allow arbitrary signal formats, bit-rates, and protocols to be transported (which is referred to as *transparency*) [28]. However, these advantages always come together with their challenges as analyzed in the next section.

1.4 Challenges of AOM

Multicasting in IP networks is often realized by either using a shortest path tree (SPT) or approximated Steiner minimum tree (SMT) [31] depending on which objective either to minimize the delay or the cost of the multicast route. Although AOM is more beneficial, realizing multicasting in WDM layer may be more challenging. These challenges not only come from the multicast technique itself but also arise from the impact of optical hardware components in the WDM networks. The WDM multicast technique relates to co-operating the tight coupled tasks between routing (R) and wavelength assignment (WA) [22]. Whereas, the impact of optical hardware components including the heterogeneous deployment of them in the cross-connects, the asymmetric distribution of fibers in the links and the availability of wavelengths in the fibers. These distinctive features make WDM networks different from the conventional circuit-switched networks, which thus prevents us from transplanting the IP multicasting solutions directly to all-optical multicasting. In the following subsections, we will address several unique challengers in WDM networks and discuss about their impacts on AOM.

1.4.1 Challenges Due to Optical Hardware Impact

The optical hardware components mainly include splitters, wavelength converters, amplifiers and regenerators. The imperfection of them leads to the asymmetric deployment (non, sparse, full) in the networks. Besides, the hardware impact can be resulted from how many fibers bunched in each link (multifibers) and the availability of wavelengths in each fiber (wavelength availability).

1.4.1.1 Impact of Light Splitting

Without the need of optoelectronic conversion, power splitters are naturally the important components in supporting AOM. As mentioned in the subsection 1.2.3, splitters can be deployed in SaD-OXC [3] or MOSaD-OXC [5], resulting in Multicast Capable Cross-connects (MC-OXC). Accordingly, MC-OXC with nonblocking SaD-OXC have *complete* multicast capable since they can split a wavelength to as many as the number of outgoing ports. However, the benefit of splitting comes together with its power loss. In fact, an MC-

OXC with f output ports (fanouts) will divide the signal power equally to f outgoing ports (ignoring the extra loss inside the OXC), with each receiving at most $1/f$ of the original power [5]. Thus, in a large-scale WDM network equipped with complete MC-OXCs, the power received at receivers can be significantly degraded. In order to maintain the acceptable power level at the output port after splitting, a costly active amplification device is required to be installed in the splitter, which results in high total system cost. However, the amplification of the light signal also amplifies the noise. To obtain the expected signal level after splitting, an expensive regeneration may be needed, making the total system cost even higher.

As a result, the *limited* multicast capable MC-OXCs (supporting a limited number of fanouts) realized by a power-efficient MC architecture like MOSaD-OXCs is preferred. In another aspect, the power degradation can be further reduced when not all but a subset of the network nodes are multicast capable, referred to as *sparse splitting*. The WDM networks with sparse splitting capacity is referred to as sparse splitting WDM networks (while the one with all the MC-OXCs are known as *full splitting* WDM networks). As a matter of fact, only a half of nodes multicast capable can achieve a comparable performance of full splitting configurations [27]. Subsequently, extensive works have been done on the sparse splitting WDM networks with significant achievements. We also have several results on this configuration as presented in Chapter 4.

Regarding power-effective multicasting for WDM networks, a natural question: *is it possible to multicast without splitters ?* is also legitimate. It is an interesting topic since the expensive power splitting and amplification and/or regeneration are eliminated. Moreover, it is feasible since power-effective TaC-OXCs [6] can help to realize the multicasting with a simple version of the splitting capability. This configuration is known as *non splitting* capacity. We also have a contribution in this configuration as presented in Chapter 5.

1.4.1.2 Impact of Wavelength Conversion

With the support of wavelength converters, the *wavelength continuity constraint* (i.e., the same wavelength should be retained on all the links along the route [22]) is relaxed. Consequently, the wavelength converter can help to better utilize available wavelengths in the networks [13]. Like MC-OXCs, WC can be *complete* convertible (WC can convert optical signal from an incoming wavelength to any outgoing one) or *limited* convertible (WC can shift one signal from one wavelength to a limited range of wavelengths) depending on how converters are deployed in OXCs [7]. Also, similarly to splitting capability, the networks can be *non*, *sparse* or *full* wavelength conversion. However, compared with splitting support, all-optical wavelength converters are even far immature to be widely deployed on a large scale. It is mainly due to high fabrication cost and due to the limitation of the spectrally inefficient modulation formats [28]. Therefore, *non*, or *sparse* with *limited*

wavelength conversion are more commonly hypothesized. The former (multicasting without wavelength conversion) has been intensively studied in the literature. Accordingly, the aforementioned *wavelength continuity constraint* and *distinct wavelength constraint* should be respected both in depth (through lightpaths, e.g., from the source to each destination), and in breadth (due to light splitting at branching nodes in a lighttree). Whereas, the latter (i.e., limited and/or sparse conversion) requires some level of *wavelength continuity constraint*, which restricts the multicast route construction and challenges the AOM [32].

1.4.1.3 Impact of Power Loss

In AOM communication, three main power loss sources are splitting loss (mentioned above), fiber attenuation and power tapping [19]. The fiber attenuation occurs when the light is propagated in the fibers. Although the standard fiber attenuation factor equals 0.2 dB/km at low loss range near 1550 nm [13], the attenuation of light signal is not negligible in long distance optical fibers. Besides, when the light signal traverses a TaC-OXC attached with a destination, a portion of power is consumed for local usage and management in the network control plane. The tapping loss ratio is about 1 dB [33, 34].

To compensate the power loss, active optical amplification devices like erbium-doped fiber amplifier (EDFA) [35] are required, especially in longhaul distance networks. However, optical amplifiers are expensive to fabricate and introduce many problems which complicate network management such as *gain dispersion*, *gain saturation* and *noise* [36]. Therefore, a requirement of placing these amplifiers with minimal total number of amplifiers needed in the network (hence reducing its cost) arises. This problem is referred to as the optical amplifier placement (OAP) which has been intensively studied in the literature [32, 37].

1.4.1.4 Impact of Multiple Fibers

Another important aspect is the number of optical fibers in the network links. This leads to two kinds of networks: single-fiber (a single fiber pair between each pair of network nodes) and multiple-fiber or multi-fiber (multiple fiber pairs between each pair of network nodes) [22]. In fact, multi-fiber networks is more beneficial compared with single-fiber networks. First, the deployment of multiple fibers in one bundle can provide more (wavelength) channels in a link to use, which reserves more bandwidth for future demands and increases network survivability. Second, it can reduce the installation cost compared with those providing with the same bandwidth. Finally, the network with multiple fibers can have the same efficiency as a network with limited conversion capability [38]. The routing can be more complicated but interesting when there are k fibers coexisting in a link (known as the multifiber WDM routing problem). This network model can be found in several papers [39–43]. Current cabling technology permits bidirectional fibers available in marketplace [44], but they are not widely deployed in current optical networks [11]. In fact, most

previous works assumed to work with unidirectional fibers. Therefore, unidirectional fibers are also presumed in this thesis. Furthermore, we suppose to work with single-fiber WDM networks. To provide a full duplex communication in each link, two unidirectional fibers (with each for one direction) are needed [22].

1.4.1.5 Impact of Wavelength Availability

Last but not least, the availability of the wavelengths in the network links is a considerably influential factor. Most of the previous works suppose the *wavelength symmetric* case when the same set of wavelengths is available in all the links. This is, however, only valid for the first network stage (the design stage). It is not the case during the network operation stage [32]. When some demands hold some of the network resources, the availability of wavelengths can be different in the links, resulting in the *nonsymmetric* wavelength availability. Both cases are considered in this thesis for a deep investigation on AOM. The *wavelength nonsymmetric* case leads to a new challenge of having an appropriate model in order to reflect exactly the network state. Consequently, the traditional model based on physical topology is no longer suitable, therefore one should think about another model better. This challenge is elaborately discussed in Chapter 2.

1.4.2 Challenges Due to Routing and Wavelength Assignment

The routing and wavelength assignment (RWA) is the tight coupled fundamental problem in all-optical networks which consists in finding a route and assigning a wavelength for each connection request with respect to aforementioned *distinct wavelength constraint* and *wavelength continuity constraint* (if wavelength converters are not available). This problem was earlier posed just for unicast connections with the name RWA or Lightpath Establishment problem [45]. It was then extended to the case of multicast traffic for the names MCRWA [38] or MC-RWA [46].

The MCRWA problem is mainly concerned with establishing the multicast route in the network, and determining the appropriate wavelength to be assigned to the route, targeting a specific objective. The objective can be either minimizing the required resources (i.e., the number of wavelengths used, and/or the total channel cost) if wavelength availability is sufficient to route all the requests or maximizing the total number of requests provisioned, or equivalently, minimizing the blocking probability in the case of limited resources (wavelengths) [32, 47].

Solving the MCRWA problem can be done in joint (coupled) or separate (decoupled) manner. The joint MCRWA problem is NP-hard since it contains the NP-hard RWA problem [45] as a special case. So heuristics are often employed to solve the problem.

Although joint MCRWA approach results in the optimal solution, the two tasks are usually treated separately to alleviate the complexity of the joint MCRWA problem. The

separate MCRWA approach decouples the problem into two subproblems (namely *routing*, and *wavelength assignment*). However, the routing part still remains NP-hard since it involves the construction of the Steiner tree (for minimizing the total cost) and the wavelength assignment part is also NP-hard since it requires to find the chromatic number of the NP-complete graph-coloring problem [31].

Nevertheless, finding good heuristics in both (joint and separate) approaches is more challenging in the case with sparse splitting and/or sparse conversion. Several typical works will be reviewed in Chapter 3.

1.5 AOM Classification

Based on the optical issues and challenges for the AOM problems analyzed in Section 1.4 above, typical important factors that significantly influence on optical multicast routing can be summarized in the Table 1.1.

Table 1.1 – Typical influential factors on AOM problems

Multicast Capability	None	Sparse	Full
Wavelength Conversion	None	Sparse	Full
Fiber Multiplicity	Single-Fiber		Multiple-Fiber
Wavelength Availability	Symmetric		Nonsymmetric
Request Multiplicity	Single-Request		Multiple-Requests
Traffic Type	Static		Dynamic
Objective Function	Min- λ	Min-Cost	Min-Blocking

First, we consider the capacity of the optical cross-connects (OXCs), i.e., the multicast capable and the wavelength convertible availability of the MC-OXCs in the considered optical networks. When all the nodes are equipped with splitting capacity and wavelength conversion, the routing and wavelength assignment in optical WDM networks reduce to the circuit switching routing in electrical IP networks [32]. However, expensive fabrication cost of these devices prevents this ideal configuration from deploying in practical optical networks. Therefore, the heterogeneous optical network configuration has been intensively studied in the literature. This comes from the combination of *non*, *sparse* or *full* splitting with the corresponding *non*, *sparse* or *full* wavelength conversion (cf. Section 1.4, Chapter 1).

Second, regarding the availability of the wavelengths in the fibers, to reflect various network states, we consider both wavelength available cases: *symmetric* (the same set of wavelengths is supported in each fiber) and *nonsymmetric* (the set of available wavelengths is arbitrarily distributed in each fiber).

Third, regarding the request multiplicity, i.e., the number of requests present in the network, we divide the problems into two scenarios: *single-request* or *multiple-requests*. The single-request routing just concerns one request, while the multiple-request case takes into account multiple multicast requests concurrently present in the networks. For latter case, possibly considered traffic types can be: *static* (the information of requests are known in advance) or *dynamic* (the requests arrive and leave the networks in a stochastic manner).

Finally, the objective of the problem is an essential factor which decides what suitable routing approach should be applied. Generally, the objectives of the problems are firmly related to the number of requests considered. In the case of single-request, the objective concentrates on optimizing the network resources such as the *wavelength cost*, the *number of wavelengths* used, the *power consumption* or minimizing the *end-to-end delay*. Whereas, under multiple-request case, the objective focuses mainly on accommodating as many requests as possible in the acceptable time constraint, or minimizing the *blocking probability* for a limited number of available wavelengths.

Based on the aforementioned issues, AOM problems can be classified into many possible subproblems. As shown in Fig. 1.13, we first classify them into two broad classes with respect to the request multiplicity, resulting in *single-request* class and *multiple-request* class. For single-request case, the AOM mainly focuses on the routing, so we just study the All-Optical Multicast Routing (AOMR) problem. For multiple-request case, the wavelength assignment should be taken into account, so we investigate both routing and wavelength assignment, resulting in the combined MCRWA problem. In fact, the two classes are firmly relevant to each another. As will be shown in the thesis, a single-request routing algorithm is well suited to be applied in multiple-request case, provided that the network state should be kept up-to-date reflecting the current change of the network resources.

The single-request class can be further classified based on the three optical constraints: wavelength availability, splitting capability and wavelength conversion. Whereas the multiple-request class can be further divided as static and dynamic sub-classes depending on traffic types: static or dynamic. These two sub-classes can then be combined with the three heterogeneous constraints as mentioned for single-request case. However they are neglected in the figure to avoid the repetition.

1.6 General Assumption and Problem Definition

This section presents the general assumption of the network model which makes up a hypothesis for the whole thesis. Then we give the informal definition of the AOM problem afterwards.

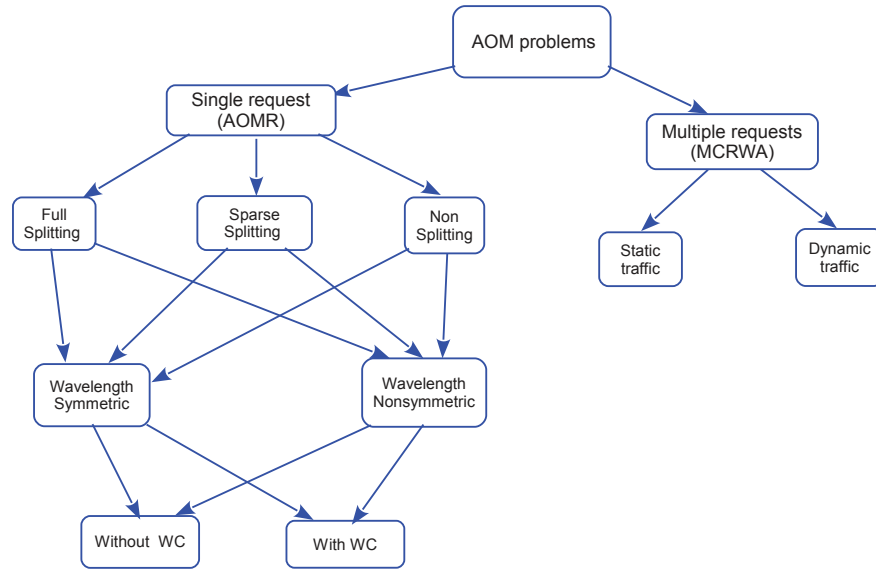

Figure 1.13 – AOM problem classification

1.6.1 General Assumption

First, the network heterogeneity is expressed by allowing the switches to be equipped with various functionalities: from *non* splitting/wavelength conversion to *sparse* splitting/wavelength conversion. The case of full splitting and/or full wavelength conversion is not considered due to its expensive fabrication and impracticality. For splitting level, since the WDM is usually operated in core optical networks, the nodes often have relatively low degree, so we assume that MC nodes (if any) are *complete* splitting capable as presumed in most of the previous studies. For wavelength conversion, we also assume they are *complete* wavelength convertible capable (if any) for the sake of simplicity. Moreover, in all the cases, we suppose that all nodes in a WDM network having tap-and-continue (TaC) function [6].

Besides, as mentioned earlier, this thesis works with single-fiber WDM networks, i.e., a pair of fibers per link to provide a full duplex communication in each link [22]. The multiple-fiber networks are reserved for future study. For the wavelength availability, we consider two cases: *wavelength symmetric* and *wavelength nonsymmetric*. The wavelength symmetric case represents the same set of wavelengths available in all the links; whereas, the wavelength nonsymmetric case corresponds to the arbitrary set of wavelengths in the links. Note that the wavelength nonsymmetric case is well-suited to be applied to the dynamic traffic where each request arrives to the network one-by-one under the recent network state.

In addition, although a multicast request triggers from an access (source) node to the other access (destination) nodes, and since we just consider the routing problem in core WDM networks, we do not explicitly consider these access nodes. Rather, we consider the cross-connect attached with a multicast source (e.g., a server) as the *source*. Similarly, a

destination is the cross-connect attached with (one or more) multicast destinations. By this assumption, the routing and wavelength assignment are performed totally in core WDM networks, regardless of the access nodes.

Furthermore, like the assumption made in many previous works (e.g., [48], [49]), we assume that the source of a multicast session is equipped with multiple transmitters, and hence it can inject a same wavelength to as many output ports as needed, i.e., it can have as many children as needed in a multicast tree rooted at itself even if the source is incapable of splitting. Similarly, a source can transmit to its children on different wavelengths (even if the source switch has no wavelength conversion). Accordingly, we will consider a source to be capable of both multicast (splitting) and "wavelength conversion", regardless of its actual capacity.

Finally, the huge bandwidth in a single wavelength can be better utilized using Traffic Grooming [11, 13, 50] (by multiplexing more low-bit-rate traffics onto a single high-capacity wavelength). Besides, Elastic Optical Networking (EON) have been received lots of attention in recent research in order to better utilize fiber's bandwidth [51–53]. However, considering rate control, traffic aggregation and elastic optical technology could overflow the main contents, this thesis focuses on pure WDM network with the assumption that the data transmission is operated on the whole wavelength channel capacity. We believe that the route structure and the routing approaches proposed in the thesis at wavelength level can be applied to those sophisticated technologies. This issue is discussed with more details in several perspectives in Chapter 7.

1.6.2 Problem Definition

The network topology is given by a directed graph $G = (V, A)$ in which V represents a set nodes, and A represents a set of unidirectional fibers. We denote $S \subset V$ a set of MC-OXCs, and $C \subset V$ a set of WC-OXCs. (In the case without the presences of splitters and converters, $S = C = \emptyset$.) Let W be the set of all the available wavelengths in the network. Since the number of wavelengths can be different in the links, we denote $w(e)$ the set of wavelengths available in the fiber $e \in A$. Also, each fiber $e \in A$ is associated with a positive number $c(e)$ representing the cost of using a wavelength in e . For single-request case, a request is denoted by a pair $r = (s, D)$, in which $s \in V$ is the source and $D \subset V$ is the set of destinations. For multiple-request case, a set of requests is given by $R = \{r_i, i = 1, 2, \dots\}$, in which $r_i = \{(s_i, D_i) : s_i \in V, D_i \subset V \setminus \{s_i\}\}$.

In general, the route computation is based on following metrics.

- *Number of wavelengths used*: the number of wavelengths required for a multicast session. It is calculated as the maximum number of wavelengths among those required in all the links. To shorten the term, we use *wavelength consumption* to indicate the number of wavelengths used.

- *Wavelength cost*: the cost of using a wavelength in a fiber. We also assume that in a fiber, the wavelength cost is the same for every wavelength.
- *Total cost*: the sum of the wavelength costs of all the links in the multicast route.
- *End-to-end delay*: the sum of the delay on the consecutive links from the source to the destination. It can be combined by switching, transmission and propagation components. In practice, the propagation delay is often proportional to the distance of the link. Sometimes we use the abbreviation *delay* for end-to-end delay.
- *Blocking probability*: the ratio between the number of requests (destinations) blocked and the total number of requests (destinations).

With all of the above notations, the all-optical multicast problem can be formally defined as follows.

Problem 1.1. General AOM Problem:

- **Instance:** A WDM network represented by a sextuple (G, S, C, W, c, w) ; a multicast request $r = (s, D)$ (for single-request case) or a set of multicast requests $R = \{r_i, i = 1, 2, \dots\}$ (for multiple-request case).
- **Solution:** A set of multicast routes originated from the source(s) covering all the destinations and satisfying the optical constraints.
- **Objective:** Various objectives can be: minimizing the number of wavelengths used, and/or minimizing the total cost, and/or minimizing the blocking probability, with/without considering delay bounds.

1.7 Research Contributions

The major contributions of this thesis work are summarized as follows.

1. We identify the optimal route structures for AOMR problems under heterogeneous mesh WDM networks. As shown in the thesis, the optimal solutions are no longer based on conventional light-trees, but a more general tree-like structure called *hierarchy*. Some of *optical hierarchy* forms realized for WDM multicasting are light-trails, light-hierarchies, light-spider hierarchies. The exact and heuristic algorithms proposed in the thesis are mainly based on hierarchy.
2. For single-request with sparse-splitting case, we propose an efficient heuristic algorithm to produce a good tradeoff solution among wavelength consumption, channel cost and end-to-end delay.

3. For single-request with non-splitting case, we prove the NP-hardness, identify the optimal solution, formulate the problem by means of Integer Linear Programming (ILP) formulations to find the exact solution, and propose several cost-effective heuristic algorithms to calculate the approximate solutions.
4. Especially, we also extend the single-request context to the multiple-request context, focusing on static traffic under sparse-splitting without wavelength conversion case. First, an ILP formulation is proposed to search for the optimal solution based on light-hierarchies. By applying the *layered graph model*, we then develop several efficient adaptive heuristic algorithms to compute the approximate solutions. These adaptive algorithms outperform the existing fixed routing ones in minimizing the blocking probability.

1.8 Outline of the Dissertation

Generally, the dissertation is divided into three parts. Part I (including the first three chapters 1, 2, 3) provides a comprehensive background in all the necessary preliminaries including WDM technological background, mathematical modeling, and literature review for the AOMR problems. Part II (including Chapter 4 and Chapter 5) presents the contributions on single-request context: Chapter 4 for sparse splitting capacity and Chapter 5 for non-splitting capacity. Part III (including Chapter 6) presents the contributions on multiple-request context. The details about them are organized as follows.

- Chapter 2 presents mathematical models for the AOMR problems. One model is for the network and the other is for route structure. For network modeling, graph models are discussed: physical-topology model and layered-graph model, in which one views the network at the fiber level while the other elaborates it at the wavelength level. Although physical-topology model can help facilitate the routing, layered-graph model reflects more exactly the network state. To identify the exact optical multicast routes, a tree-like structure called *hierarchy* is analyzed deeply. Hierarchy can model all the possible routes in all-optical multicast routing under different routing cases, including the existing light-structures like light-trees or light-forest as well as more general forms such as light-spiders, light-spider hierarchies, multi λ -light-trails.
- Chapter 3 provides a comprehensive literature review for both single-request AOMR and multiple-request routing and wavelength assignment (MCRWA). The state-of-the-art approaches and related works, including exact solutions and heuristic algorithms are reviewed in a top-down fashion respecting an appropriate classification. Especially, we propose several novel propositions for identifying exact solutions for AOMR problems under various optical constraints.

- Chapter 4 presents our first proposed heuristic algorithm for AOMR in sparse splitting case. The algorithm aims at finding a trade-off solution between *number of wavelengths used*, *total cost* and *maximum delay*. Our proposition makes several improvements on the Member-First algorithm, including the priority model of the links being added and the way of constructing the light-tree. Simulation results show that our proposed algorithm provides a better tradeoff solution in comparison with the well-known heuristic algorithms.
- Chapter 5 is dedicated for AOMR problems without splitters with arbitrarily available wavelengths in the links. First, the problems are formulated into two subproblems with respect to a combined objective function of the number of wavelengths used and the total cost. Then we show that the exact solutions for both subproblems correspond to a hierarchy based on spider called *spider-based hierarchy*. The two subproblems are then proved to be NP-hard. An ILP formulation to find the exact solution for each subproblem is therefore developed. Also, several efficient heuristic algorithms to compute the approximate solutions are proposed for each subproblem. Theoretical analysis and simulation results show that the optimal solution of the problems is a set of light-spider hierarchies. All the reported results are supported by extensive and careful simulations.
- Chapter 6 presents our contribution on AOM with multiple requests present together in the networks, known as MCRWA problems. Given a sparse splitting WDM network, and a set of available wavelengths, we investigate the problem of provisioning a set of multicast requests simultaneously which aims at minimizing the blocking probability. Two blocking models are taken into account: *full blocking probability* and *partial blocking probability*. As the problems are NP-hard, we propose to search for the optimal solutions by means of ILP formulation based on light-hierarchies. Especially, we propose several efficient *adaptive* heuristic algorithms to compute light-hierarchies based on layered graph model. Extensive simulations reveal that our adaptive algorithms are able to compute close-optimal solutions and they outperform *fixed* approaches. The results also show that it is more advantageous to provision multiple multicast communications with light-hierarchies, as they are able to accommodate more requests and destinations compared with the light-tree solutions.
- Chapter 7 concludes the thesis work and introduce several perspectives for the future study.

AOMR Modeling

Routing in networks consists in finding a route from sending nodes to receiving nodes in the physical network topology. As a result, the optimal route structure should be clearly identified. Even though lots of methods, approaches and algorithms have been proposed for multicasting in WDM networks, there are still lack of a deep study for optimal routes. The existing approaches based on light-paths, light-trees or light-forest models are insufficient to describe the optimal routes. The main objective of the this chapter is to develop the exact optical multicast routes based on the currently proposed model called *hierarchy*. Since hierarchy is defined in the close relationship with graphs, we first discuss some typical graph models for WDM networks. Based on the definition of hierarchy, various forms of it in optical domain (called *optical hierarchies*) are described. As will be shown in the chapter, all the existing structures belong to some types of the optical hierarchies.

2.1 Graph Models for WDM Networks

Recall that WDM networks consist of a set of nodes interconnected to each other by the optical fiber links, therefore they are well-suited to be modeled by means of graphs. In fact, several graph models have been proposed in the literature for the AOMR problems with different levels of details. Note that, however, no single model is suitable for all the network configurations. Deciding a suitable model for a specific AOMR problem and/or a certain WDM network is therefore essential.

2.1.1 Physical Topology Models

The very first attempt on the issue of AOMR modeling is mapping a WDM network to a graph based on the network *physical topology*. Accordingly, a WDM network is modeled by either an *undirected graph* or a *directed graph*. For the undirected graph model, each

vertex represents a network node, and each edge represents a network link between a pair of nodes. Whereas for the directed graph model, each link is mapped by two opposite arcs, and each arc represents a network *fiber*. Note that this approach needs a prerequisite that all the network links must contain the same set of wavelengths in both directions, which we called the *wavelength symmetric* case. Among the two models, undirected graphs can facilitate the route computation and can achieve solutions faster than the directed ones. For instance, computing the minimum cost Steiner tree [31] is easier in an undirected graph where this NP-hard problem can be approximated and several good heuristics exist and permit to compute guaranteed trees. Whereas the computation is more complicated and harder in a directed model. Nevertheless, by taking advantage of transmission in both directions (arcs) in each link, in some constrained routing cases, the directed model is more beneficial since it can help discover more solutions so that a better one can be chosen.

To illustrate the point, let us consider an example shown in Fig. 2.1. In Fig. 2.1a, a symmetric WDM network having the same set of three wavelengths ($\lambda_1, \lambda_2, \lambda_3$). Assume that the cost of the links (b, e) is equal to 1 (unit cost), all the other links have link costs of 2. The two physical topology models are shown in Fig. 2.1b (undirected graph), and Fig. 2.1c (directed graph). To illustrate how these models can help to solve a routing problem, let us consider a problem of finding a minimum cost route for a multicast demand $(a, \{d, e\})$ requested from the source a to the two destinations d, e . Without any constraints, the a minimum cost route corresponds to a Steiner tree which consists of the edges: $(a, b), (b, d), (b, e)$ (which is not shown in the figure). Trivially, this Steiner tree is easier computed in the undirected model than in the directed model.

Now let us impose a constraint by supposing that node b does not have spitting capacity (i.e., b is an MI-OXC). Of course, the above-mentioned optimal tree does not exist. As shown in Fig. 2.1b, the solution corresponding to an undirected Steiner tree with the total cost of 7, whereas a directed Steiner tree computed in the directed graph as shown in Fig. 2.1c has the total cost of 6. Obviously, the example shows that directed graphs are more beneficial than undirected ones under constrained routing cases.

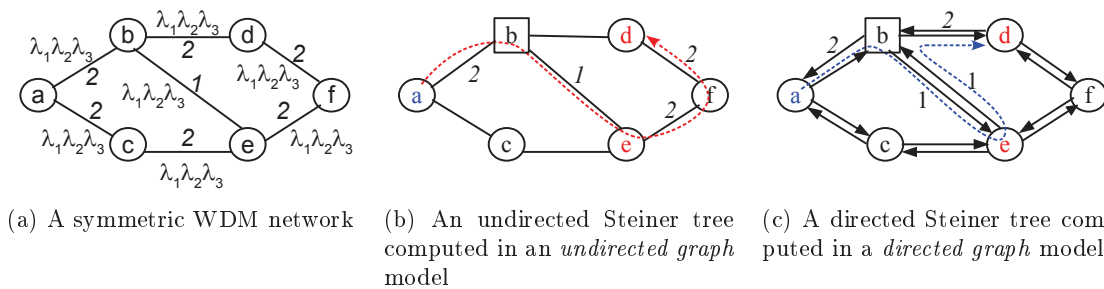

Figure 2.1 – A symmetric WDM network and its two physical topology models

However, routing based on physical topology is not always feasible since the wavelength assignment (WA) task may not find the available wavelengths required by the computed route. This is because the physical topology models do not reflect the availability of wavelengths in the links which is continuously changed during the RWA process. Specifically, when some wavelengths are occupied for some demands, the wavelength availability becomes uneven or *nonsymmetric*, hence making the physical topology models no longer valid. To overcome this limitation, another advanced approach has been proposed as discussed in the next subsection.

2.1.2 Layered Graph Models

At the wavelength level, a WDM network can be seen as the collection of layers, each represents the availability of a specific wavelength. This observation gives rise to the *layered graph model* with various variants for different levels of details. As one of the first endeavors on this model, an *interconnected-layered-graph* (ILG) model was proposed in [9] to solve the unicast RWA problems. This was the first complete model that can render closely the WDM networks regarding the presence of wavelength converters [7].

In this model, the optical network consists of core nodes (or router nodes) and access nodes. A unicast request starts from an access node and terminates at another access node. So an ILG is constructed relatively straightforward. First, duplicate the core network topology onto each wavelength (layer). The directed edges connecting the router nodes in each wavelength are called *wavelength edges*. Then, split access nodes into two parts: sources and destinations. Next, connect the two parts to the topology on each layer. Finally, connect the layers to each other through the *converter edges* representing the possible wavelength conversion at the core nodes. Fig. 2.2 illustrates the ILG model for a given WDM network whose physical topology is shown in Fig. 2.2a. It is assumed in this model that each network link has two (opposite) directed fibers, and each router has C wavelength converters inside in order to support up to $|C|$ wavelength conversions. The first two layers of the output ILG are shown in Fig. 2.2b. Note that the directed converter edges (c_i, c'_i) are shared among the router nodes r_i s at the layers.

However, this model is quite complex due to lots of nodes and arcs needed. In particular, the number of nodes in an ILG is $|R| \times |W| + 2|R| + 2|A|$ and the number of directed edges is $|E| = |L| \times |W| + 2|R| \times |W| + |R|$, in which: R is the set of core nodes, A is the set of access nodes, $|L|$ is the set of directed fibers in the network, and W is the set of supported wavelengths per link. This makes the route computation difficult. To alleviate the complexity, the *simplified interconnected-layered-graph* (SILG) model is then proposed (also in [9]) by eliminating the access node parts and replacing the directed converter edges by undirected inter-layer edges between the duplicates of core nodes.

To apply this SILG model, the routing algorithms have to take charge in two complementary missions. First, whenever a light-path request between an access node pair, e.g., (s, d) , arrives, add the extra arcs connecting these access nodes to their corresponding attached routers to the layered graph. Second, maintain a wavelength converter counter for each core node in order to keep track of the number of available wavelength converters of that node when routing. Fig. 2.3 illustrates the SILG model for the same network topology as Fig. 2.2a, with the presence of a request from access node A to C .

Regarding the weight assignment for the edges in the ILG/SILG models, the wavelength edges (or intra-layer edges) are assigned with a positive value representing the cost of using a wavelength in each link (wavelength cost). The converter edges (or inter-layer edges) can be assigned with a positive value to represent the conversion cost. Whenever occupied, they (wavelength edges or converter edges) should be assigned infinity to prevent them from reusing.

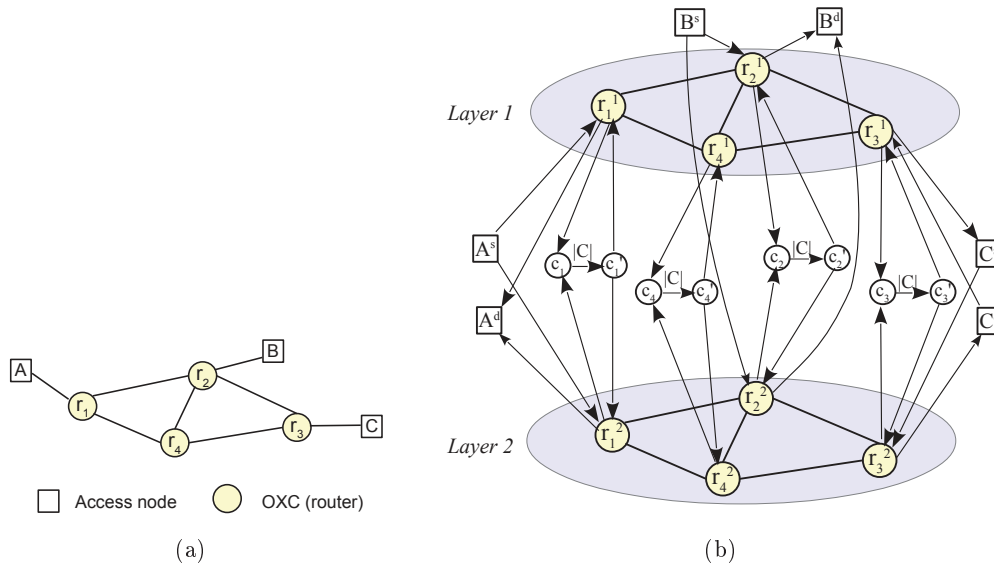

Figure 2.2 – Illustration of the ILG model: (a) a network topology, (b) an interconnected-layered-graph [9]

Originated from the idea of ILG model, several models have been developed for MCRWA problems. Among them are the *modified wavelength-layered graph (MWLG) model* [54], the *expanded graph model* [55] and the *layered-routing graph model* [10]. In fact, they can be seen as the aforementioned SILG model. In order to access all the wavelengths for routing, the wavelength set is accessed in some predetermined wavelength-search order or via the inter-layer edges representing the wavelength conversion at the WC-OXCs [10, 55]. Fig. 2.4 illustrates two possible layered graph models with respect to *non* and *sparse* wavelength conversion for a given nonsymmetric WDM network. Particularly, Fig. 2.4(b) shows a layered graph without WC-OXCs; whereas Fig. 2.4(c) presents another layered graph for which nodes 2 and 5 are supposed to have *complete* wavelength conversion.

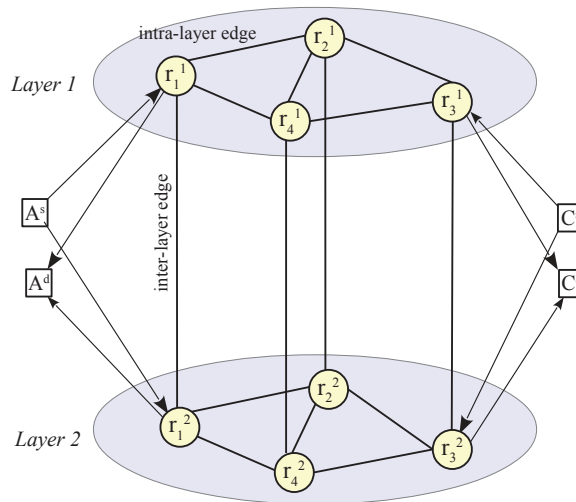

Figure 2.3 – Illustration of the SILG model

2.1.3 Other Graph Models

Apart from the above models, several more complicated ones have been proposed for different purposes. Among them, the *generic graph model* [56] proposed by Zhu *et al.* and the *wavelength graph (WG) model* proposed by Cinkler [57] are the most complete models that allow modeling different levels of the network heterogeneity (sparse-limited splitting and sparse-limited wavelength conversion). Particularly, the generic graph model can be seen as a layered graph model with higher degree of details, and it can render various nodal architectures (MAW, MSDW [8] as mentioned in Chapter 1). Whereas, the WG model can represent various types of nodes: OADMs, OXCs, with/without wavelength conversion. These models can help resolve many problems besides RWA, such as placement of wavelength converters and light splitters applying the generic graph model [58], or multicast routing protection, traffic grooming or physical impairment based routing applying the WG model [50]. Another model called *expanded graph* was proposed in [59] which allows to model various network configurations including sparse wavelength conversion, wavelength availability, and some related metrics. This was applied to solve the problem of minimizing the total cost with bounded delay. However, due to their high level of details, these models are quite complicated due to lots of vertices and arcs needed, which make the routing difficult. Since this thesis focuses on AOMR problem, for the purpose of facilitating the route computation, we do not suppose to investigate these models further. The reader is encouraged to refer to the aforementioned references for more details.

2.1.4 Two Routing Schemes Based on Layered Graphs

Two different routing schemes can be used to compute the routes and allocate wavelengths based on the layered graph model. In the first scheme, the routing can be done se-

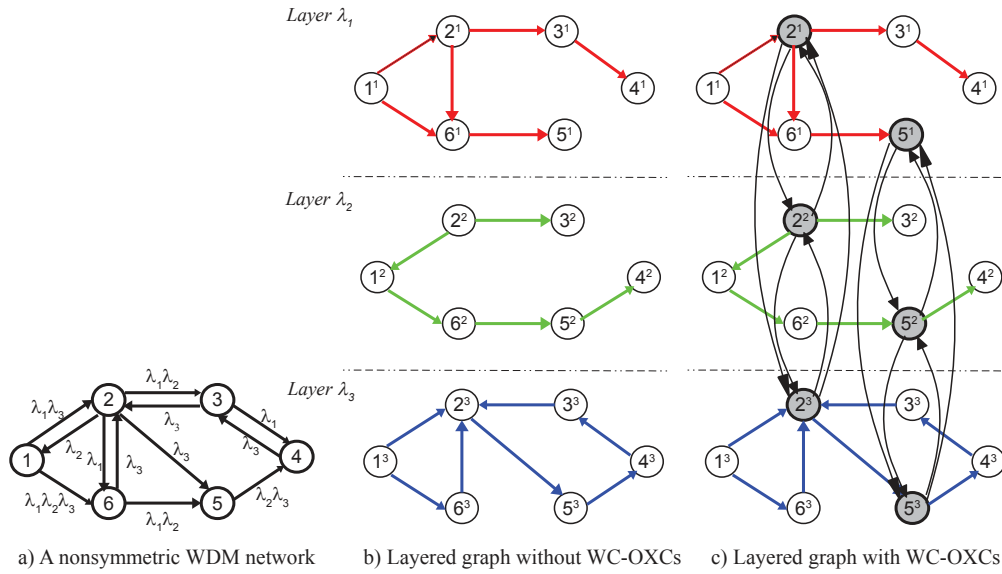

Figure 2.4 – A nonsymmetric WDM network (a) and the two variants with/without WC-OXCs of the layered graph models (b, c) [10]

quentially in a layer-to-layer order by using some predetermined *wavelength-search scheme*. Several wavelength-search schemes were proposed in [10,55], including *CONSERVATIVE*, *OPTIMISTIC*, *FIXED* and *RANDOM*. In fact, an algorithm running on each layer (or wavelength graph) takes almost the same (often less) computational time compared with running on physical topology graph. So this routing scheme is time-efficient. In the second scheme, the routing can be accomplished on a *full layered graph* (a layered graph attached with *pseudo vertices* and *pseudo arcs* which is presented shortly). In this scheme, every wavelength graph (layer) can be accessed and determined by the routing itself, without the need of any wavelength-search scheme. To distinguish the two schemes, we name the first scheme Wavelength Graph based routing (or WG-routing), and the second scheme Layer Graph based routing (or LG-routing). In the following, we demonstrate how the two routing schemes compute the multicast route for a given request.

Let us first examine the WG-routing scheme through an example. We consider a WDM network and a request $r = (1, \{3, 4, 5\})$ as shown in Fig. 2.5. For simplicity, we suppose that all the nodes are multicast capable (MC nodes), in which the two nodes 2 and 5 having wavelength conversion (MC-WC nodes). Also, all the wavelength edges are assigned a weight (wavelength cost) of 1, and all the converter edges are assigned a weight (wavelength conversion cost) of 2. We employ a *fixed* wavelength-search order in which the routing in the layer graph is first operated in the first layer, and then the second, and so on. Accordingly, the minimum cost route is composed of the two trees in bold arcs, and has the total cost of 7 as shown in Fig. 2.6.

For the LG-routing, to access all the wavelengths, a *full layered graph* which extends a layered graph by adding some supplementary *pseudo vertices* and *pseudo arcs* has to be constructed. First, we add a *pseudo source* s' and connect it to every duplicate of the source in all the layers by pseudo zero-cost arcs. Likewise, we add one *pseudo destination* d' for each destination d and connect the duplicates of d in all the layers to d' also by pseudo zero-cost arcs. The routing now can be done totally in the full layered graph, for the *pseudo multicast request* $r' = (s', D')$ rather than the original request $r = (s, D)$.

Back to the considering example, the optimal multicast tree computed in the full layered graph is the one shown in Fig. 2.7. The real multicast route is then obtained by pruning all the pseudo vertices and pseudo arcs. It is shown in Fig. 2.7(b) with the total cost of 5.

The LG-routing is applied in Chapter 5 to compute the cost-minimum route in the case of non splitting and arbitrary wavelength availability; and the two routing schemes are deeply evaluated in provisioning multiple requests that is presented in Chapter 6.

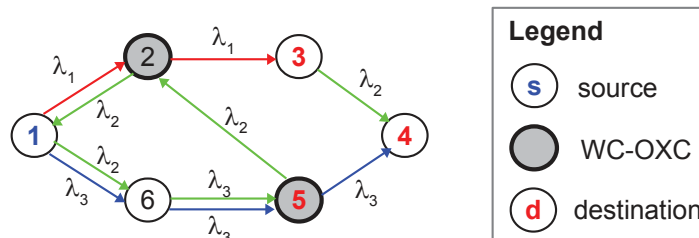

Figure 2.5 – A simple WDM network

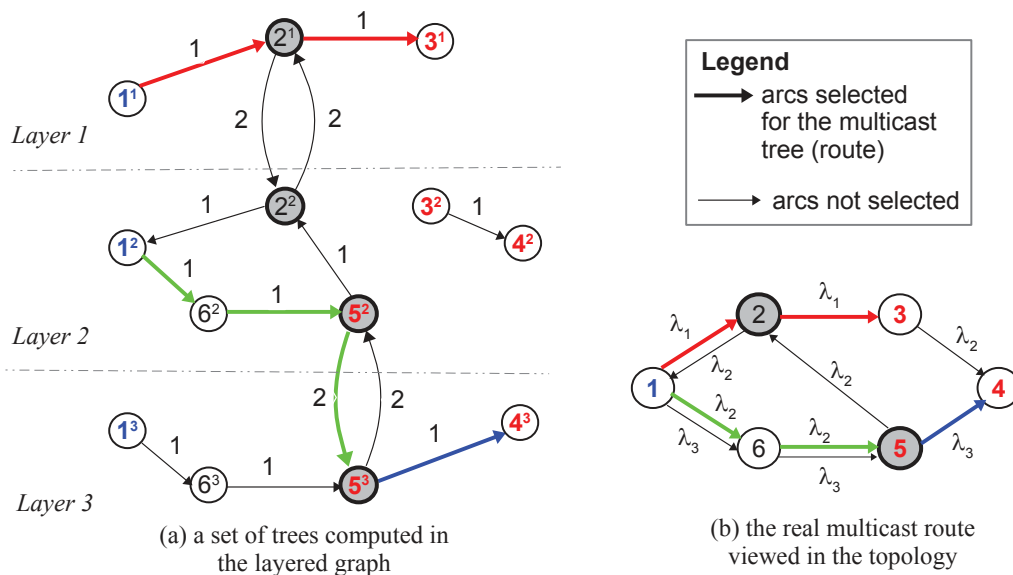

Figure 2.6 – Route computation by WG-routing scheme

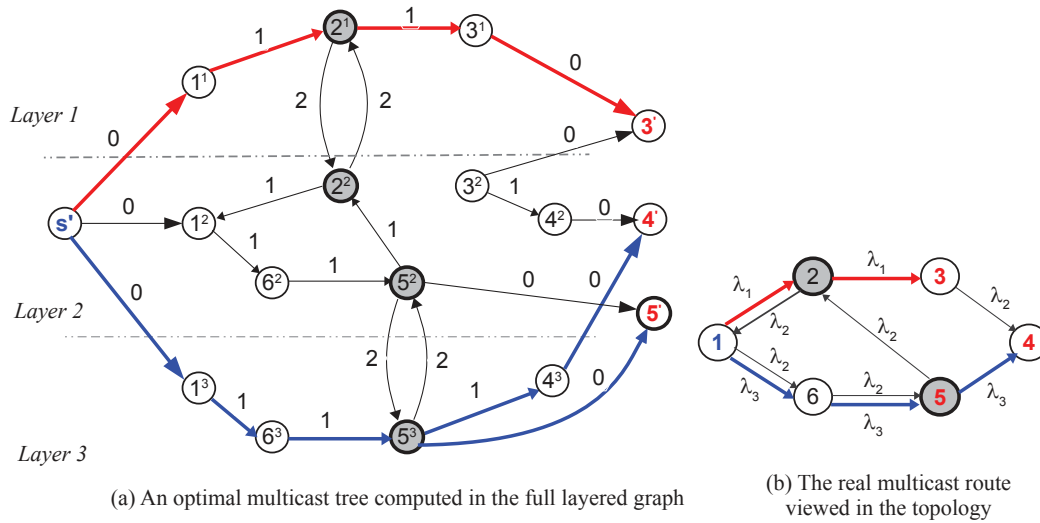

Figure 2.7 – Route computation by LG-routing scheme

2.2 Hierarchy Model to Solve AOMR Problem

The conventional route computation often bases on sub-graphs such as paths or trees thanks to their exclusion of redundant edges (arcs). In all-optical networks, they are realized as light-paths [22] (for unicast communication) and light-trees [4] (for multicast communication). Light-path is a point-to-point communication between a pair of nodes in which light signal propagates all-optically without suffering from any optoelectronic conversion. Light-tree is a point-to-multipoint extension of light-path to support multicast communication, in which the transmission from a source to multiple destinations can share common links. Previous research has pointed out that light-tree is the optimal solution in supporting all-optical multicasting [4, 13, 48]. However, this may not be always correct in constrained routing case. Specifically, this thesis will show that a more general tree-like structure called *hierarchy* is the optimal solution for AOMR problems. In this section, first we briefly describe and analyse the advantages of hierarchy, then introduce several special forms of hierarchies to solve AOMR problems.

2.2.1 Hierarchy in Graphs

In constrained routing case, the solution does not necessarily base on sub-graphs (e.g., paths, trees) but on any types of structures that retain the connectivity and spanning properties. Based on this observation, the concept *hierarchy* was proposed by Molnar in [60] to replace the traditional solutions. It is a graph-related structure obtained by a homomorphism of a tree in a graph. A hierarchy in graphs was defined as follows [60].

Definition 2.1. Let $T = (W, F)$ and $G = (V, E)$ be two graphs, in which T is a tree called the base graph, and G is the target graph. A homomorphism $h : W \rightarrow V$ maps

each vertex in W to a vertex in V such that the mapping preserves the adjacency, i.e., $(u, v) \in F \Rightarrow (h(u), h(v)) \in E$. The triplet (T, h, G) defines a hierarchy H in G .

Fig. 2.8 gives an example of a mapping h from a tree T to a target graph G for a hierarchy H . Each vertex of tree T is associated with a unique vertex of G . In the reverse direction, some vertices of G are mapped from several vertices in T (e.g., vertex e). As we can see, the hierarchy H is not a subgraph of G but remains the connectivity and can be used as a spanning structure for (multicast) routing. Especially, when the mapping h is injective, the hierarchy corresponds to a tree. Thus, tree is a special case of hierarchy.

To distinguish the occurrences in hierarchy H associated with the same vertex v in G , we label them as v^1, v^2, \dots, v^k in T and also in H . The degree of a vertex occurrence v^i in the hierarchy H is defined as the degree of the corresponding vertex occurrence v^i in the base graph T . In particular, let v^i be a vertex in T associated with $v \in V$, the degree of the vertex occurrence v^i in H ($d_H(v^i)$) is equal to the degree of v^i in T ($d_T(v^i)$): $d_H(v^i) = d_T(v^i)$.

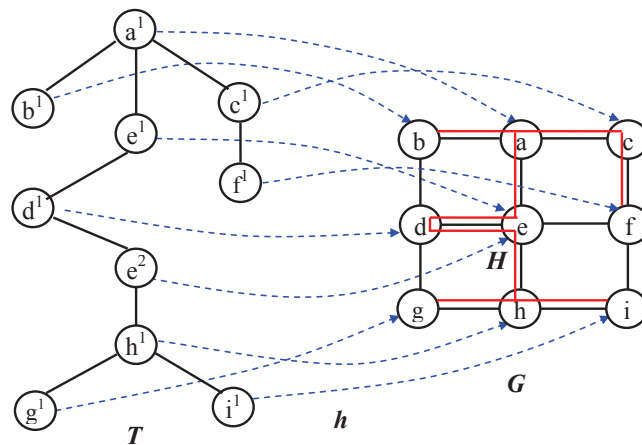

Figure 2.8 – Mapping of vertices for a hierarchy

By relaxing from tree structure restriction, spanning hierarchies provides more solutions in comparison with spanning trees, thereby resulting in more flexible solutions for the routing. As pointed out in [60] (pp. 19-20), in some constrained routing problems, a spanning hierarchy satisfying the constraints may exist even if spanning trees do not; or when spanning trees exist, the optimal spanning tree solution may be more expensive than the optimal spanning hierarchy one (cf. Fig. 2.13 for an example). In the next subsection, we analyse this evaluation deeply by introducing various types of spanning hierarchies for AOMR problems under optical constraints.

2.2.2 Optical Hierarchies to Solve Constrained AOM Problems

In WDM multicast routing, the optimal route depends on the optical constraints. For example, the degree-constrained routing problem arises when splitters are not available

in the network. The optimal tree-based solution may not satisfy the constraints. Fortunately, the aforementioned general tree-like hierarchy, which preserves the connectivity and spanning properties, can be used to solve routing problem. Moreover, since hierarchy is a general case of tree, every tree solution is maintained for hierarchy. Besides, hierarchy is more flexible than tree for allowing repetition of vertices and probably edges. As a result, hierarchy is better than tree in generic routing cases, especially in the constrained routing case. In the following, we introduce different hierarchies with respect to various optical constraints and their implementation for multicasting in WDM networks. We will show that all the traditional structures (e.g., light-path, light-tree, light-forest) can also be expressed by means of hierarchy.

According to the definition of hierarchy mentioned above, an output hierarchy is decided by the two input factors: the base graph (tree) T and the homomorphism h . Regarding the first factor, we divide T into three types: a path, a general tree, or a spider (a special tree having at most one branch vertex [61]). Whereas, for the second factor, homomorphism h can be *injective* or *non-injective*. Accordingly, the different types of optical hierarchies can be classified as depicted in Fig. 2.9.

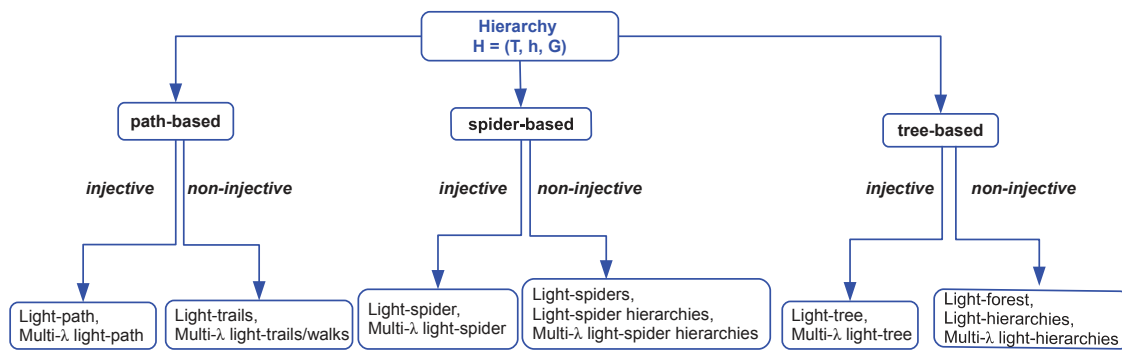

Figure 2.9 – Different optical hierarchies for constrained AOM problems

In general, the injective homomorphism results in a sub-graph of the target graph, which corresponds to an *elementary* route like *path* or *tree* as the output hierarchy; whereas non-injective homomorphism permits to create *non-elementary* structures like *trail* or *walk*. One more remark in the Fig. 2.9 is the appearance of the term so called *multi-λ* routes. These structures occur when the routes need to use more than one wavelength (with the help of wavelength converters) to perform the all-optical transmission. We name the optical routes based on hierarchy as *optical hierarchies*. All of the optical hierarchies are elaborated in the following.

2.2.2.1 Path-Based Hierarchies

In some constrained wavelength routing cases, the constraint is imposed on the absence of any splitters in the optical switches. This constraint precludes branching nodes (i.e.,

nodes having degree more than two) in the multicast routes. If it is the case, a path based solution is one of the possible choices. Traditionally, the path based solution appears as the aforementioned *light-path* structure. However, with the flexibility of hierarchy, several extensions of light-path are now possible.

Let us back to the definition of hierarchy, when the tree T reduces to a path, the homomorphism h defines a special hierarchy as we name *path-based hierarchy*. If h is injective, i.e., each vertex of the target graph G is associated (if any) with only vertex of the tree T , the output hierarchy retains the path structure, appearing as *light-path* or *semi-light-path* in the viewpoint of technical implementation in WDM networks. Specifically, a *light-path* or a *wavelength-continuous channel* is the all-optical transmission path between two end nodes realized by only one wavelength without suffering any optical wavelength conversion as well as OEO conversion [22]. A *semi-lightpath* or a *wavelength-converted channel* is the light-path using several wavelengths with allowing possible wavelength changes in the path at some intermediate wavelength convertible nodes [62]. In this thesis, we name the *semi-lightpath* as *multi λ -light-path*.

In contrast, if homomorphism h is non-injective, i.e., each vertex of the target graph G can be associated with several vertices of the path T , the output hierarchies present two possible *non-elementary* route structures: trail and walk. Recall that, in terms of graph theory, a trail is a general case of a path with allowing repetition of vertices but not edges; and a walk is a general case of a trail with allowing possible repetition of edges [63] (p. 6). It is easy to see that all of them can be modeled by a *path-based hierarchy*. In terms of WDM networks, these structures are realized as *light-trail* (the all-optical trail between two end nodes realized by only one wavelength), or *multi λ -light-trail* (the trail using several wavelengths). Especially, a multi λ -light-walk is a general case of multi λ -light-trail when it traverses a same link several times (using several wavelengths). Note that, however, this thesis suppose to work in single-fiber networks, i.e., there is at most one unidirectional fiber in each direction of a link, so a link is traversed at most twice in both directions with the same wavelength. Subsequently, the link can be traversed more than once in the same direction *iff* different wavelengths are used (with possible wavelength conversion).

Let us consider a WDM network consisting of access nodes (A, B, C, D, E) and core routers as shown in Fig. 2.10. Three examples of path-based hierarchy include: a light-path connecting node A to node B on wavelength λ_1 , a light-trail from C to E on wavelength λ_2 , and multi λ -light-walk from A to D on wavelengths λ_3 and λ_1 .

2.2.2.2 Tree-Based Hierarchies

Light-Tree, Light-Forest and Light-Hierarchy

The original objective of proposing the concept of hierarchy is to solve constrained multicast routing which relates to the transmission from a source to multiple destina-

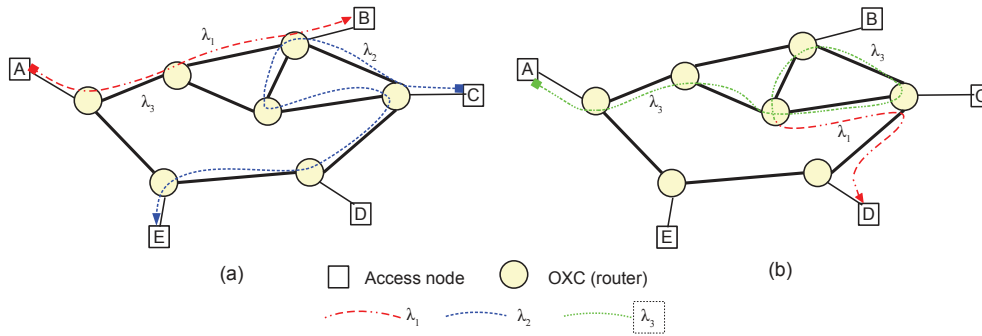

Figure 2.10 – Illustration of several path-based hierarchies: (a) a light-path from A to B, a light-trail from C to E, and (b) multi λ -light-walk from A to D

tions concurrently. Therefore, the base graph T is assumed to be a tree as indicated in the hierarchy’s definition. Similar to the analysis for path-based hierarchy, different types of tree-based hierarchies can be modeled depending on whether the homomorphism h is injective or non-injective.

With injective homomorphism h , the output hierarchy retains a tree. In technical WDM network point of view, it is realized as a *light-tree* [4]. A light-tree is a general extension of a light-path which allows branching at some intermediate nodes. These branching nodes must be equipped with light-splitters earlier mentioned in Chapter 1. Since common links from the sender to receivers can be shared in a light-tree, it has been considered as optical solution for multicasting in WDM networks [4, 13, 48]. However, as analyzed in Chapter 1, sparse splitting is more common in current WDM technology, meaning that only a subset of nodes having light-splitters. Consequently, a single light-tree may not suffice to cover all the destinations in a multicast request, hence a concept *light-forest* was proposed [48] to route the request. Accordingly, a light-forest is a set of light-trees rooted at the multicast source sharing some common links, hence each light-tree using a distinct wavelength to respect the *distinct wavelength constraint*.

Fig. 2.11 demonstrates a concept of light-tree and light-forest for two different configurations. In the example, a multicast request consists of a source s trying to reach four destinations (d_1, d_2, d_3, d_4) in a simple WDM topology. In Fig. 2.11(a), all the middle nodes are multicast capable (MC-OXCs), a light-tree is enough to carry signal from the source to the destinations, using one wavelength. In contrast, in Fig. 2.11(b), two middle nodes are multicast incapable (MI-OXCs), two light-trees composing a light-forest are required, using two wavelengths.

In fact, light-tree and light-forest can all be defined by a hierarchy mapping a tree to a topology graph. Fig. 2.12 illustrates such a mapping from different base trees for the mentioned light-tree and light-forest. Subsequently, under hierarchy point of view, these two structures are some kinds of a hierarchy.

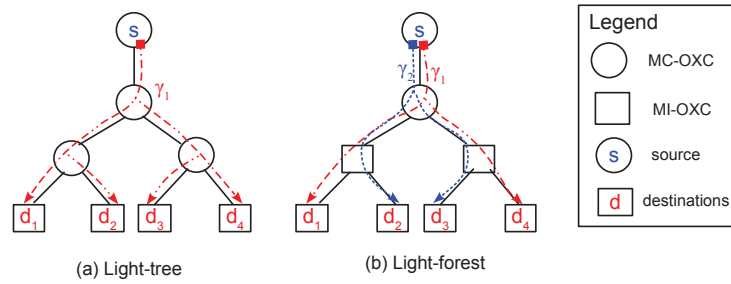

Figure 2.11 – Light-tree and light-forest for different WDM configurations

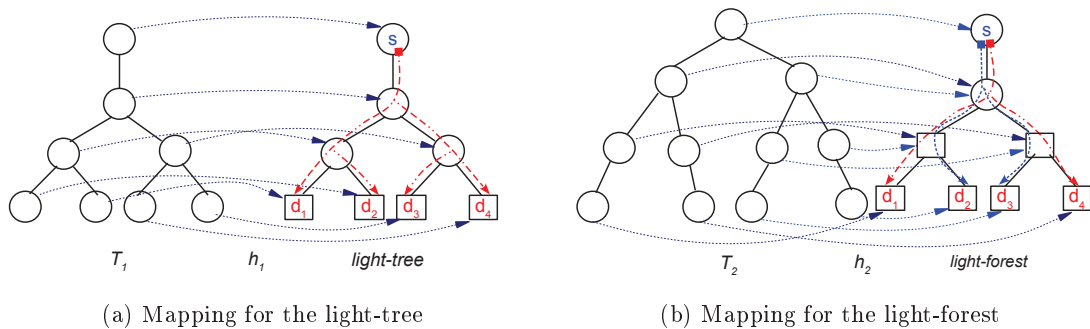

Figure 2.12 – Mapping for the light-tree and light-forest mentioned in Fig. 2.11

However, light-tree and light-forest are based on light-tree which prevents nodes from being visited more than once if using one wavelength. In fact, an optical cross connect (OXC) in WDM networks consists of multiple input ports as well as output ports, which allows light signal on a wavelength to traverse the OXC through any input port to any output port provided no conflict occurs. This means that an OXC can be traversed more than once with using only one wavelength whenever needed. As a result, tree structure is not general enough to represent the structure of the possible physical route for multicasting. A general hierarchy overcomes this limitation. It is obtained by a *non-injective* homomorphism from a tree to a graph representing a WDM physical network topology. In supporting AOM, a hierarchy realized by a single wavelength is called *light-hierarchy* [64]. Two different views can be for understanding a light-hierarchy. On one hand, a light-hierarchy can be considered as a light-tree folded inside the topology graph. On the other hand, it can also be seen as an extension of a light-trail with allowing branching at some intermediate vertices.

Consider the network topology in Fig. 2.13 in which all the nodes are MI-OXCs except node 1, an arrival multicast request $(s, \{d_1, d_2\})$. The optimal light-tree solution is shown in the dash-dotted line in Fig. 2.13(a) with the total cost of 7 (supposed that all links have an identical cost). However, a light-hierarchy can be found by using different ingress-egress fibers crossing node 3 as shown in Fig. 2.13(b) with the total cost of 6. The solution

can still be improved by another light-hierarchy that utilizes the links in both directions as shown in Fig. 2.13(c) with the total cost of 5 (we supposed two fibers in every link). Obviously, the light-hierarchy solution outperforms the light-tree solution.

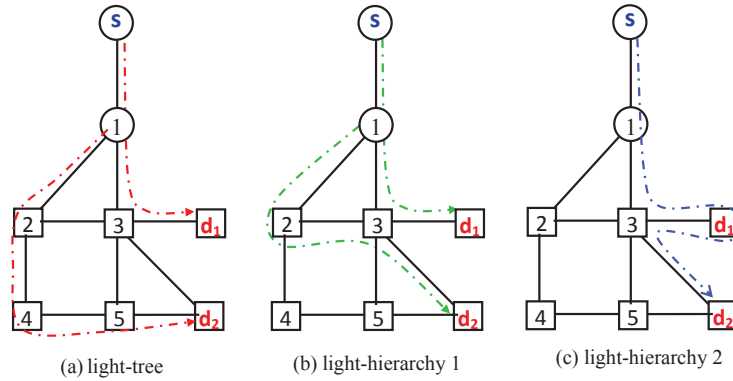

Figure 2.13 – Light-hierarchy solution versus light-tree solution

Multi λ -Light-Tree and Multi λ -Light-Hierarchy

In some cases, the solution is not a light-tree nor a light-hierarchy, but a *multi λ -light-tree* or a *multi λ -light-hierarchy*. A *multi λ -light-tree* (*light-hierarchy*) is a light-tree (light-hierarchy) using several wavelengths, with the help of wavelength converters at the wavelength changes. These multi λ -light-structures are useful when available wavelengths are not the same in the network links (i.e., the wavelength nonsymmetric case). Trivially, a multi λ -light-tree is a special case of a multi λ -light-hierarchy. A light-forest can also be considered as a multi λ -light-hierarchy.

Fig. 2.14(a) illustrates a multi λ -light-tree with the support of the cross-connect (node 2) having both splitting and wavelength conversion capability (MC-WC or virtual source [65]); and Fig. 2.14(b) presents a multi λ -light-hierarchy with the support of MC-WC at node 1.

2.2.2.3 Spider-Based Hierarchies

When the base graph T is a tree with at most one branching vertex, i.e., T is a *spider* [61, 66], rooted at the branching vertex (corresponding to the multicast source), the triple (T, h, G) defines a special hierarchy. We call it *spider-based hierarchy*. Figure 2.15 shows an example of a spider-based hierarchy from a spider T .

The spider-based hierarchy is applied in multicast routing without splitters. Unlike the path-based hierarchy which imposes the constraint that all the vertices should have degree not exceed two, the spider-based hierarchy allows only the root of base graph (corresponding to the multicast source) to have degree greater than two. In terms of technical WDM networking, this is feasible under the condition that the source uses multiple transmitters

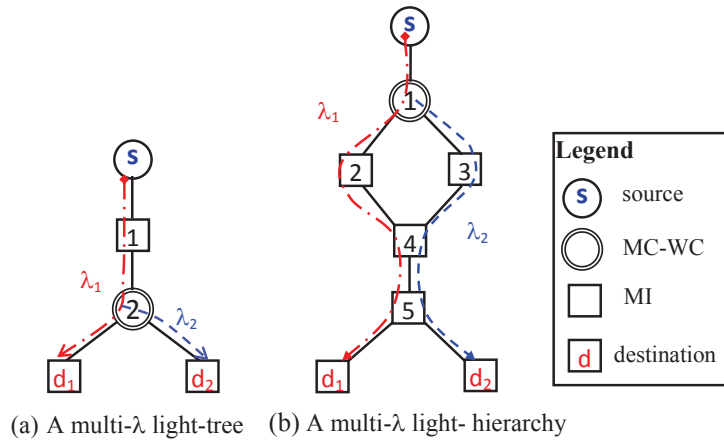

Figure 2.14 – Illustration of multi-λ-light-tree and multi-λ-light-hierarchy

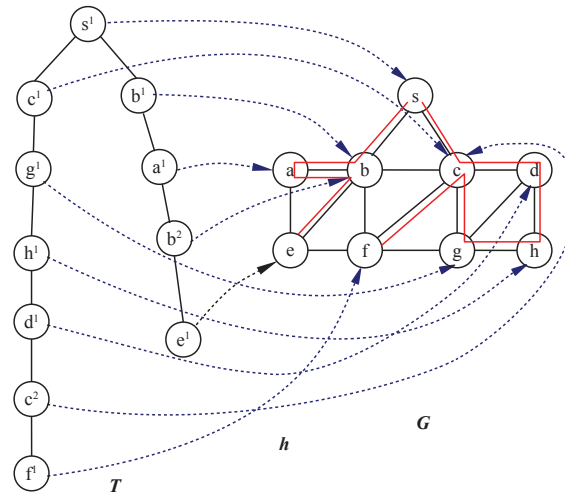

Figure 2.15 – Mapping of vertices for a spider-based hierarchy

to inject wavelengths into the network. The multicast route, therefore, can be based on a spider, which is realized by a spider-based hierarchy. Note that a path is a special case of a spider (i.e., a spider with only one leg), so every path-based hierarchy can be expressed by a spider-based hierarchy. In other words, spider-based hierarchy can be used to solve multicasting in WDM networks without light splitters.

Similar to the analysis above, we consider two types of spider-based hierarchies. The first type corresponds to the injective homomorphism which results in *light-spider (LS)*, and the second one corresponds to the non-injective homomorphism h which results in *light-spider-hierarchy (LSH)*. Accordingly, an LS is a spider realized by using a single wavelength. Likewise, an LSH is a spider-based hierarchy implemented by one wavelength. Intuitively, an LSH corresponds to a set of rooted arc-disjoint paths (trails) in the target graph G , so only one wavelength is needed to spread the light signal. In fact, an LS or an

LSH may not suffice to cover all the destinations in a multicast request, a set of LSs or a set of LSHs may be needed.

To illustrate, let us consider an example in Fig. 2.16. The topology graph is depicted in solid line. The request is given by the source node is s and the set of destinations $D = \{d, e, g, h\}$. As shown in Fig. 2.16a), only one LSH is sufficient to span all the destinations. Meanwhile, as shown in Fig. 2.16b), two LSs (with each using a distinct wavelength) are required, i.e., two different wavelengths needed to span all the destinations.

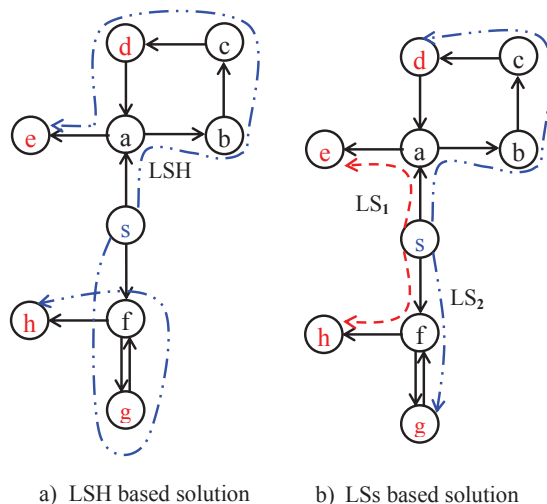

Figure 2.16 – Illustration of light-spider and light-spider-hierarchy

2.3 Conclusion

This chapter discusses on mathematical modeling for the AOMR problems: the graph models for the WDM networks and the route models for the solutions.

Regarding network modeling, two graph models are examined: *physical topology model* and *layered graph based model*. No single model is well suited to all the network configurations (contexts), rather, each context is suitably modeled by an appropriate model. This chapter (also the whole thesis) considers various network contexts, from symmetric to nonsymmetric wavelength distribution, from non-splitting and non-wavelength conversion to sparse splitting and sparse wavelength conversion. It turns out that single-request wavelength-symmetric WDM networks are better modeled by directed topology graphs. Meanwhile, the cases of multiple requests and/or wavelength nonsymmetric are more beneficially modeled by layered graphs.

Regarding route modeling, a flexible structure called hierarchy is analysed, and several novel hierarchy-based forms are introduced for the first time for different AOMR problems. We show that all kinds of route structures can be modelled by hierarchies. We specify them

under different optical constraints. Without wavelength converters, they can be a set of light-trails, a set of light-trees, a set of light-hierarchies, a set of light-spiders, a set of light-spider-hierarchies, etc. In contrast, with the presence of wavelength converters, the solution can be the corresponding extended routes using multiple wavelengths, including a set of multi λ -light-trees, multi λ -light-hierarchies, etc. Under heterogeneous WDM networks, the solutions can be the combination of these various structures.

■ Key points of Chapter 2 ■
<ul style="list-style-type: none">• Two graph models for WDM networks are analysed: topology graph model and layered graph model, in which layered graph model plays an important role in route computation.• A tree-like structure called <i>hierarchy</i> is analyzed and various forms of optical-hierarchies are introduced to solve constrained AOMR problems. The flexibility of hierarchy permits to identify exact solutions for different AOMR problems under different optical constraints.

Literature Review and Propositions

Many possible AOM problems can be defined under different optical constraints. In fact, a lot of network models and solving approaches have been proposed in the literature. A single thesis cannot cover all of the problems with all the possible scenarios. Therefore, we focus the thesis on some typical network configurations.

We review the literature works in a top-down fashion. To this end, the problems are first classified into groups based on the most important constraints. The typical existing works are then divided with respect to the solving approaches. Especially, the chapter concludes by identifying the exact solutions for several single-request AOMR problems under typical heterogeneous configurations based on the optical hierarchies mentioned in Chapter 2.

3.1 Problem Classification and Solving Approaches

One possible classification of AOM problems and existing solving approaches are shown in Fig. 3.1. For the sake of simplicity, the concerns regarding wavelength conversion and wavelength availability are excluded from the figure. Also, the objectives of the problems (which will be described in the Section 3.2 below) are not specified in the figure, but they are taken into account when we investigate each problem.

3.2 Single-Request AOMR

A lot of works in the literature considered the single-request AOMR class [6, 27, 48, 59, 64, 67–71]. Although routing a single multicast request does not reflect the realistic scenarios, it can be served as a fundamental brick for a later building (i.e., for the case with multiple requests present together). Also, since the wavelength assignment is often

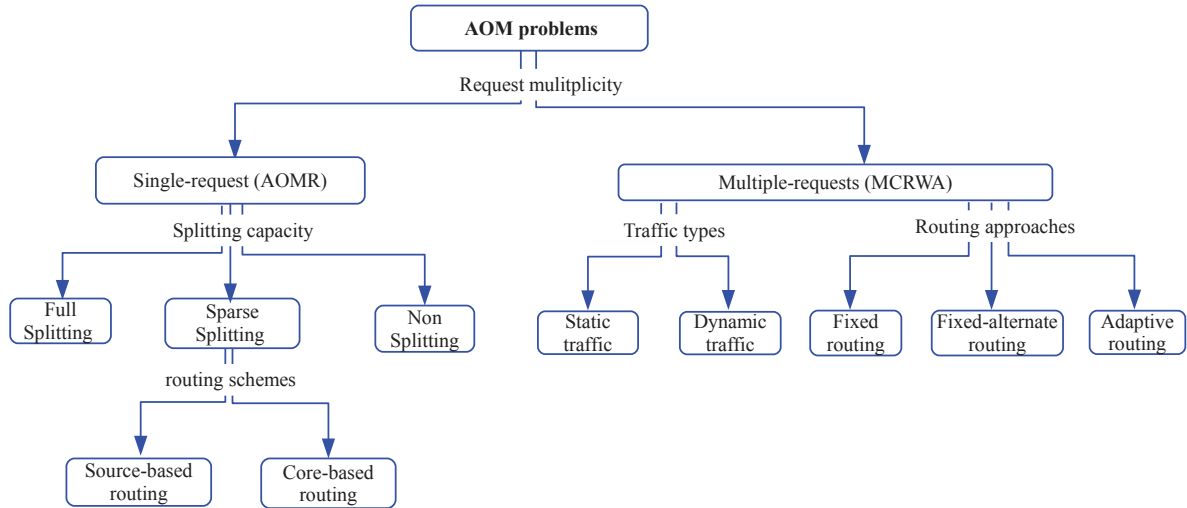

Figure 3.1 – AOM problem classification and solving approaches

not taken into account for single multicast, the focus is mainly on the routing part under the name AOMR.

In the single multicast case, the problem consists in finding the routes from the source to the set of destinations satisfying optical constraints and targeting a specific objective. The route structures and the method to compute them depends strongly on the capacity of the network nodes. For the full-splitting configuration when all the nodes have full splitting capacity, the route computation reduces to traditional routing without constraints. Accordingly, a minimum cost light-tree (usually an approximated Steiner tree) computed in the topology graph is often preferable. However, this configuration is so expensive that none of practical networks is affordable. Another extreme is the non-splitting case arising when none of the nodes is equipped with light-splitters. The route is no long based on trees, but on a paths with the help of TaC-OXCs. The two mentioned configurations have their own pros and cons, regarding the capital expenditures (CAPEX) and the operation expenditures (OPEX) [1]. Therefore, the more realistic configuration, i.e., sparse splitting, can achieve a better trade-off between the two expenses. Under sparse splitting, the route can take advantage of possible light-splitters supported in some nodes, while avoid unnecessarily excessive overheads. The multicast route for sparse splitting case is often a tree-based structure known as light-tree or light-forest.

In the following, the single-request AOMR problems are deeply investigated in accordance with respect to the three different splitting capabilities and the possible wavelength conversion support. For each specific problem, the typical state-of-the-art exact algorithms and approximation heuristics are selected to give a concrete but comprehensive review.

3.2.1 Full Splitting

3.2.1.1 Wavelength Symmetric Case

Recall that the *wavelength symmetric case* is defined as the networks equipped with two opposite fibers in each link and with the same wavelength availability in every fiber. Thanks to the full splitting capacity, a *single light-tree* realized by any wavelength is sufficient to accommodate a request regardless of availability of wavelength converters.

To compute the minimum cost light-tree for a given multicast request, the traditional multicast routing algorithms can be applied on the physical topology. In particular, it corresponds to the Steiner tree computation problem without constraints (which is NP-hard [31]). Since the Steiner tree problem has been intensively studied in the literature, we do not go to it any further. A number of exact algorithms and heuristics can be found in [72], or the reader can refer to [73–76] for some typical approximated Steiner tree heuristics.

For the problem of minimizing the end-to-end delay, to ensure the optimal end-to-end delay for all the destinations, a shortest path tree (SPT) composed from multiple shortest paths (in terms of a specific delay metrics) from the source to each of destinations is desirable. Unlike a Steiner tree, the SPT can be obtained (e.g., by Dijkstra’s algorithm) in polynomial time.

However, the minimization of the cost and the minimization of the delay often conflicts one another. In particular, an approximated Steiner tree has a low cost at a high delay, and the SPT is often not cost optimal. In real-time applications, the requirement is that the delay from the source to each destination should not exceed the pre-specified bound. Thus, the problem of minimizing the total cost under delay bound is preferable. It is known as the Delay Constrained Steiner Tree problem (DCST) which is NP-hard [77] and has been intensively studied in the literature [77–83]. A comprehensive review for the DCST problem can be found in [84].

Regarding delay bounded multicasting in full splitting WDM networks, the authors in [68] proposed two integrated algorithms that combine both routing and wavelength assignment tasks. First, the algorithms generate a light-tree with low cost by applying a minimum spanning tree based heuristic proposed in [74]. Then modify this tree by checking the delay requirement at each destination one at a time. If the delay at a destination exceeds the delay bound, the existing path is replaced by the shortest path, and the algorithm then removes the redundant path to remain the tree structure. According to the authors, the proposed algorithm have three gains: the number of wavelengths is small, the tree cost is low, and the delay from the source to any destination is bounded.

3.2.1.2 Wavelength Nonsymmetric Case

We now investigate the AOMR problem under *nonsymmetric wavelength* distribution, i.e., different wavelength availability in the links.

The problem of finding a multicast tree with minimal the number of wavelengths when the wavelengths distribute unevenly is mentioned in [67]. The authors prove that this problem is NP-hard by reduced from the set cover problem [31] and then propose an approximation algorithm. The basic idea of the algorithm consists of two steps. The first step is to find a minimal set of wavelengths that can cover all the destination nodes. In the second step, a minimum cost spanning tree is computed in the topology with the chosen wavelength set. According to [67], this method achieves two goals simultaneously: a minimal set of wavelengths that can cover the source and all the destinations and a routing tree that implicates a minimal number of wavelength conversions is created.

However, in the case that the tree is known beforehand, to find the minimum set of wavelengths to assign to the tree is proved to be not NP-hard [85]. An optimal wavelength assignment was proposed. Given a multicast tree and available wavelengths on each link, the algorithm employs a two-phase process to find the optimal solution. First, it computes the wavelength conversion cost for each subtree rooted at each internal node in a bottom-up order, and then based on the computation result, in a top-down order, one available wavelength on the incoming link for each node will be chosen if such wavelength leads to a least number of wavelength conversions at the subtree rooted at the node.

The delay bounded minimum cost multicast routing in this type of WDM networks has been studied in [59] and three heuristics are proposed. Similar to the work [68] mentioned in Subsubsection 3.2.1.1, the idea of these heuristics is to compute a minimum cost tree and to handle any delay violation that may occur in the tree. The solution is a tree composed from *semi-lightpaths* (or a multi λ -light-tree mentioned in Chapter 2) between the source and the destinations. Compared with the work [68], this work reflects a more realistic network configuration since it is done in uneven (nonsymmetric) wavelength distribution with sparse wavelength conversion.

3.2.2 Non Splitting

This subsection investigates the AOMR problem under an opposite configuration to the previous mentioned one, i.e., none of the nodes is splitting capable. To ensure the feasibility of multicast without light-splitters, as presumed, all the nodes should have Tap-and-Continue function.

Typical works on multicasting in non-splitting WDM networks can be found in [6, 49, 86, 87]. These works try to accommodate a single multicast request with a combinatorial optimization objective of: first, minimizing the number of wavelengths, and then minimize

the wavelength total cost. In practice, the objective can be formulated by a single combinatorial cost function combining two components. For the sake of simplicity, we mention *cost* hereafter for this combinatorial cost. In addition, the previous works just investigated the symmetric wavelength distribution, without consideration of wavelength converters. In this context, the previous works were based on three models: trail, spider and multi-drop path.

3.2.2.1 Trail-Based Model [6]

In [6], the authors studied the problem of finding a route that accommodates a multicast request just using a single wavelength and by using only the proposed TaC-cross-connects. This problem consists in finding a trail started from the source and spanning all the destinations with minimizing the number of directed edges traversed. Hence it is called Multiple-Destination Minimum Cost Trail (MDMCT) problem. The MDMCT problem was proved to be NP-hard by reducing to the NP-complete directed Hamiltonian path problem. Hence a 4-approximation algorithm called Multiple-Destination Trail (MDT) heuristic was developed to find a feasible trail for a given multicast request. Initially, an approximated Steiner tree is computed using the Minimum Path Heuristic (MPH) (also called Shortest Path Heuristic) proposed in [73]. A trail is then computed based on the *backtracking* method which allows a bidirectional link to be traversed twice in both directions. Accordingly, the trail starts from the root of the computed tree, i.e., the multicast source. When the signal reaches to a TaC-OXC having multiple downstream links, only one of them is forwarded. When the forwarded signal reaches to the leaf-node of the tree, it can be forwarded back to the previous link in the opposite direction. By that way, the signal can reach all the remaining destinations.

Fig. 3.2 demonstrates a multiple-destination trail computed by the MDT algorithm in a WDM network whose topology is shown in Fig. 3.2a. Suppose that all the links are bidirectional, the request $r = (s, D)$, in which $D = \{2, 5, 6, \dots, 12, 13\}$, the MDT is given in Fig. 3.2b.

Although having the benefit of using only one wavelength and one transmitter, this algorithm is not cost-effective. Due to multitude of round-trip traversing, a large number of fibers is traversed in both directions, hence the total cost and the diameter (the delay) can be very high. To improve the total cost, it is necessary to reduce the round-trip traversing. Moreover, it is worth noting that, the source can inject the light signal by multiple transmitters independently. By taking this feature into account, one can considerably reduce the reversal arcs (needed to backtrack to the source), then the total cost and the diameter can also be reduced. This is the idea to make a modified version of MDT algorithm, called MMDT that will be discussed later in Subsection 3.4.2 in this chapter.

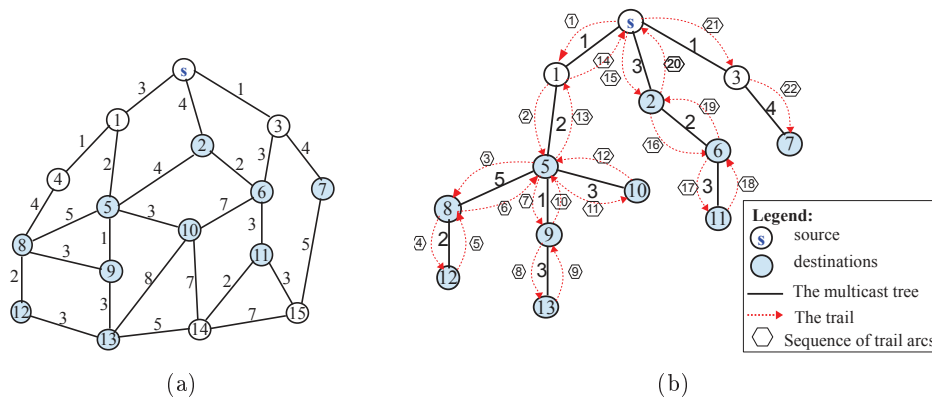

Figure 3.2 – Illustration of an MDT

3.2.2.2 Spider-Based Model [49]

The multicasting under WDM networks with only TaC cross-connects without wavelength conversion was also investigated in [49]. Unlike the approach of [6] that based on light-trail, the author based the multicast route on *light-forest*. By taking advantage of multiple transmitters at the source, each light-tree in the light-forest is exactly a *light-spider* rooted at the source using a single wavelength (cf. Chapter 2). So the solution for the problem is indeed a *set of light-spiders*. The author tried to compute a light-forest which uses a minimal number of wavelengths and has a low total cost. The objective was formulated as a combined cost function taking two component metrics: the number of wavelengths used and the total cost, in which the number of wavelengths is assigned with a higher weight.

The author proposed two heuristic algorithms, namely Farthest-first Greedy (FG) and Nearest-first Greedy (NG), based on the shortest path tree (SPT). The two algorithms separate the original graph into W wavelength graphs $G_i, i = 1, 2, \dots, W$ (the same set of wavelengths W is assumed to be available in every network link). This graph separation is similar to the construction of the layered graph model mentioned in Chapter 2. The algorithms work as follows: compute a SPT from the source to the destinations, keep some paths in the tree and reroute the destinations that interfere the splitting constraint. For each rerouting, a pair of destination nodes is selected: one to be the *connecting* node and the other to be the *connected* node. This is the point leading to the two proposed heuristics. FG selects the *connecting* node as the farthest destination resided in a subtree of the SPT, and the *connected* node as the farthest *unreached* destination. Whereas, NG selects the *connecting* node as the nearest destination resided in a subtree of the SPT, and the *connected* node as the nearest *unreached* destination. Then the rerouting is either done in the current wavelength graph (G_i) or the other wavelength graphs $G_i, i = 1, 2, \dots, i + 1$ depending on which can provide a better cost respecting the combined cost function. Details about them can be found in the given reference. Simulation results showed that FG is better than NG and the above-mentioned MDT heuristic.

3.2.2.3 Multi-Drop Path Model [86, 87]

The previously mentioned light-trail or light-forest model does not take into account the power loss along the route from the source to the destinations. In fact, as mentioned in the Chapter 1, when the light is transmitted in a long route, it is subject to the propagation loss. This phenomenon prevents the multicast route from delivering arbitrary number of destinations. Rather, it is practical to allow a specific number of destinations served in a multicast route. This fact gives rise to the multi-drop path model for multicasting which uses multiple paths to establish the multicast session and each can drop signals at most k -destinations. This model was proposed first in [86] and then developed in [87]. In [86], the MCRWA problem in the multi-drop path model for minimizing the number of wavelengths was proven to be NP-complete. In addition, the lower bound of the minimal number of wavelengths required to complete the multicast request was derived based on several specified topologies, such as rings, tori and hypercubes.

Aiming at the objective of minimizing the number of wavelengths and the number of fibers used (total cost), the authors in [87] formulated the problem by a mixed integer linear programming (MILP) program based on multi-commodity flow model, and also derived a tighter lower bound on the number of wavelengths needed. Especially, they proposed a heuristic namely Maximum Flow Based Heuristic (MFBH) to compute the edge-disjoint paths to accommodate the multicast request. At each step, the MFBH tries to reach as many destinations using edge-disjoint paths as possible provided that no path can drop signals at more than k destinations. When these paths cannot be extended, it results in a set of edge-disjoint paths that can be grouped into a *light-spider-hierarchy* using one wavelength. Due to the limitation of number of destinations reached, one light-spider-hierarchy may not cover all the destinations, several light-spider-hierarchies may be needed to reach all the destinations. Thus, the solution for the multi-drop path model proposed in [86, 87] is indeed a *set of light-spider-hierarchies* that was mentioned in Chapter 2. The simulation results showed that MFBH can achieve the lower bound on the number of wavelengths in most of simulation cases.

3.2.3 Sparse Splitting

The two aforementioned network configurations have their own pros and cons. On one hand, the case without splitters has benefit of low capital expense (CAPEX) but with high operation expense (OPEX). On the other hand, the full splitting case helps ease the route computation at high equipment cost. Subsequently, the sparse splitting configuration arises to satisfy the need for a cost-performance trade-off. As the matter of fact, this configuration has been received an excessive attention from the optical research community, mainly with wavelength symmetric case [48, 64, 65, 69–71, 88–92], but no study has done for the case with wavelength nonsymmetric.

Like the investigation done above with non-splitting configuration, we consider *cost* metric hereafter as the combinatorial cost of: first, minimizing the number of wavelengths, and then minimize the wavelength total cost. The other possible concerns regarding QoS, or power-aware routing is not discussed in this thesis. Obviously, the minimum cost AOMR problem under sparse splitting is NP-hard since it contains the NP-hard Steiner tree as a special case when all the nodes are multicast capable.

Most of the previous studies based on light-tree concept to construct solutions for AOMR problems. Under sparse splitting, a single light-tree may not be sufficient to cover all the destinations for a given multicast request. Hence, a set of light-trees rooted at the same source (a light-forest) is considered as the solution. In fact, many studies attempted to construct light-trees or light-forest for AOMR problems [48, 65, 69–71, 90].

In the following, the comprehensive overview for AOMR problems including state-of-the-art exact solutions by means of ILP formulations and existing heuristic approaches is presented.

3.2.3.1 ILP Formulations

Light-Tree Based ILP Formulations

In order to search for cost-optimal light-trees, many ILP solutions are proposed. In [93], given a multicast communication, the ILP solution is developed for searching the *loss-balanced* light-forest with minimum cost. Three criteria are regarded as the feature of a loss-balanced light-forest. First, the number of destinations included in a light-tree is restricted by the optical power budget, which is also referred to as limited drop-off. Second, the difference of tree drop-offs between any two trees is restricted by a given number. Third, the distance from each destination to the source is bounded. The ILP formulation in this paper is comprehensive which can model heterogeneous networks with sparse splitting and sparse wavelength conversion. The main ILP variable is defined as whether a fiber link on a wavelength is used in the light-forest. In order to guarantee the resultant light-forest is loop-free and connected, a commodity flow constraint is developed to restrict the main ILP variables. In the following chapters, we apply this technique for our proposed ILP formulations.

In [94], AOMR with delay constraints is investigated in WDM networks with heterogeneous splitting capabilities without converters. By setting the objective function as minimizing the weighted combination of the cost and the number of wavelengths used, an ILP formulation is proposed to find a light-forest for a single multicast session. In the formulation, whether a link is used by the lightpath from the source to a destination is regarded as variables, and it is proved that the required light-forest is the combination of all the lightpaths from the source to each destination. A significant advantage of this

method is that it is easy to determine the delay from the source to each destination by linear equations, and thus the delay constraint is very easy to impose.

Light-Hierarchy Based ILP Formulations

The concept light-hierarchy proposed in [91] is the first *optical hierarchy* implementation in all-optical domain to accommodate a multicast request. It was then proved to be the optimal solution for AOMR in sparse splitting WDM networks in [64]. By applying technique in [93] mentioned above, plus constraints for light-hierarchies, the authors proposed an ILP formulation based on light-hierarchies for a single multicast request. Simulations showed that the light-hierarchy based ILP solution outperforms the light-tree based ILP counterpart.

3.2.3.2 Heuristic Algorithms

From a point of view of methodology, the route construction can be divided into two approaches: *Source-based routing* and *Core-based routing*. Source-based routing schemes construct a multicast route (here light-forest) from the source, based on the Shortest Path Tree (SPT) or Steiner tree computation with some modifications to satisfy the sparse splitting constraints. Meanwhile, core-based routing schemes first build a core tree around the powerful nodes, then connect the destinations to the core with respect to the sparse splitting constraint.

Source-Based Routing Algorithms

We discuss the most cited source-based routing schemes belonging to this class: Reroute-to-source, Reroute-to-any, Member-First, Member-Only [48], Virtual Source Based Heuristic [65], and Graph Renewal & Distance Priority Light-hierarchy algorithm (GRDP-LH) [91].

Reroute-to-Source (R2S) and Reroute-to-Any (R2A) [48]

The first two algorithms (R2S and R2A) are based on SPT. First, a spanning tree is created from a source to all destinations by employing a shortest path algorithm (e.g., Dijkstra's algorithm). Then, the algorithm checks the light splitting capability of each branching node in the SPT. If the number of its children is greater than its splitting capacity, only some children are kept, and the other must be re-routed. For example, if the branching node occurs at an MI-OXC, then only one child can be kept, and all the other children (and sub-trees rooted at the MI node) must be re-routed either at an MC node along the shortest paths to the source (R2S), or to any other node on the tree (which can be an MC node or a leaf MI node) if possible (R2A). Obviously, the end-to-end delay of

R2S is minimized. However, the number of wavelengths used on a link can be very high, because downstream branches of an MI node have to connect to the source on different wavelengths. This also results in high wavelength cost. In contrast, R2A consumes fewer wavelengths and lower wavelength cost, but produces higher diameter (and hence, the end-to-end delay) compared with R2S.

Member-First (MF) and Member-Only (MO) [48]

Member-First algorithm is also based on SPT while taking membership information into consideration. The algorithm constructs the spanning tree link by link by Dijkstra's algorithm. The candidate links (called *fringe links*) are managed in a priority queue and iteratively added to the tree in such a way that the link leading to a member has a higher priority. Whenever a link is added, the tree is adjusted in order to ensure the tree extended from an MC node or a leaf node. If this is violated, the affected nodes and links must be detached from the tree, and wait for the future expansion. When all the destinations are included, a supplementary step is needed to prune all the links that does not lead to any member. As concluded in [48], MF achieves a better wavelength consumption and cost in comparison to R2A, and produces a good trade-off among performance metrics (i.e., wavelength consumption, total cost, maximum delay, and delay) compared with the other algorithms.

On the other approach, Member-Only is a typical heuristic to minimize the total cost which is based on the Minimum Path Heuristic (MPH) proposed in [73] considering the splitting constraint. MO begins to build a multicast light-tree (initialized by the source) by adding the destinations to the tree one by one just with the shortest paths (the closest, the first). To meet the sparse splitting constraint, the expansion of the multicast tree is just possible from the source, the MC nodes or the leaf nodes. Since only one member is added one at a time, the pruning step is not necessary. When a current tree cannot be grown any more, it is terminated and a new light-tree on another wavelength is started until all the destinations have been covered. According to [48], the light-forest computed by *MO* has a low wavelength usage and total cost.

Virtual Source Based Heuristic (VS-1) [65]

In this scheme, the virtual sources (VS) are defined as the nodes possessing both light splitting and wavelength conversion capabilities. So, four types of nodes that were taken into consideration in [65] (sorted descending depending on their capability): nodes with both capabilities (VS nodes), nodes with only splitting capability (MC nodes), nodes with only wavelength conversion capability (WC nodes) and nodes without splitting and wavelength conversion capabilities (MI nodes). Note that every node has TaC capacity.

Basically, the Virtual Source Based Heuristic (denoted as *VS-1*) is similar to *Member-Only* algorithm with two improvements. First, when a destination can be reached from more than one *expandable node* (including MC nodes or MI leaf nodes) with the same distance, the expandable node with highest priority will be selected. Second, when the shortest path from a being-added destination to the nearest expandable node traverses any non-leaf MI node, the VS nodes are considered if it can reduce the cost and/or the number of wavelengths used. The reader is encouraged to refer to [65] for more details.

Let us consider the solutions obtained by *MO* and *VS-1* on the NSF network topology in Fig. 3.4 in which 5 is the only VS node. The multicast request $r=(4, \{6, 7, 11, 13\})$, all the links have the same cost (unity cost). The solutions obtained by *MO* and *VS-1* are plotted in Figs. 3.4a and 3.4b, respectively. As it is shown, by making use of the VS node 5, *VS-1* heuristic can save one wavelength channel compared with *MO*.

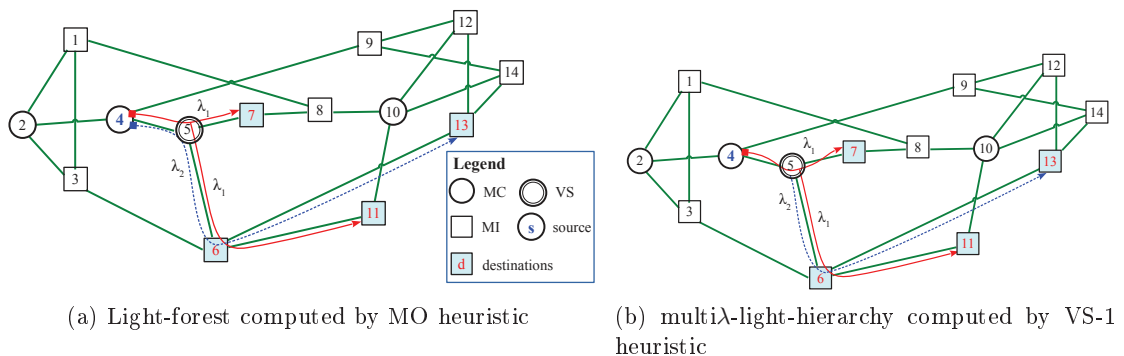

Figure 3.3 – Comparison of the solutions computed by MO and VS-1 in NSF network

Graph Renewal & Distance Priority Light-hierarchy algorithm (GRDP-LH) [91]

In [91], the authors also proposed a heuristic called Graph Renewal & Distance Priority Light-hierarchy algorithm (*GRDP-LH*) to compute the light-hierarchy for sparse splitting WDM networks. In fact, *GRDP-LH* is an improvement based on Member-Only heuristic [48] to compute the light-hierarchies for a given multicast request. The algorithm computes light-hierarchies by iteratively adding destinations through the shortest paths from the current light-hierarchy *LH*. However, unlike *MO* that computes the shortest path in the original graph, *GRDP-LH* computes it in the renewal graph G_i (G_0 is the original graph). *GRDP-LH* generates G_{i+1} by excluding the edges incident to any non-leaf MI-nodes in the path in order to make full use of high degree MI-OXC's to compute light-hierarchies. The simulations results showed that *GRDP-LH* outperforms *MO* in terms of the number of wavelength used.

Let us consider the solutions obtained by *MO* and *GRDP-LH* on the NSF network topology in Fig. 3.4. The multicast request $r=(4, \{6, 7, 11, 13\})$, all the links have the

same cost (unity cost). The solutions obtained by *MO* and *GRDP-LH* are plotted in Figs. 3.4a and 3.4b, respectively. As it is shown, by making use of the 4-degree MI node 6, *GRDP-LH* consumes just a single wavelength while *MO* needs two wavelengths to cover the destinations.

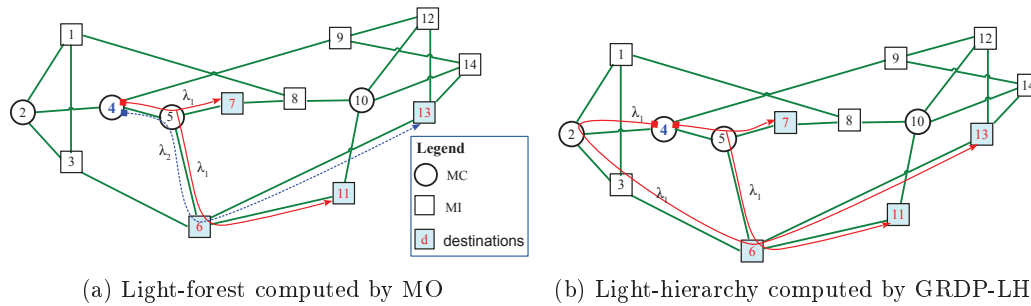

Figure 3.4 – Comparison of the solutions computed by MO and GRDP-LH in NSF network

Core-Based Routing

Another effective approach for multicast routing, namely *core-based routing*, is to build a core tree surrounded by the powerful nodes (having MC and/or WC) in the networks, and then connect each of the remaining destination nodes to the tree separately. Various algorithms have been proposed which are different from each other in the core tree construction as well as strategies for the other nodes to join in the core. We review hereafter typical algorithms: All-Optical Multicast Heuristic (AOMH) [54], On-Tree MC node First (OTMCF), Nearest MC node First (NMCFF) [69], Cost-Effective Multicasting Using Splitters (MUS) [70], Sparse Splitting Multicast Routing Heuristic (SSMRH) [95], Multicast Capable Node First Heuristic (MCNFH) [71], and Virtual source based routing (VS-2) [96]. In these algorithms, MC-OXCs are supposed to be equipped with full wavelength conversion, hence the powerful nodes simply refer to these MC-OXCs in the network, and the core tree is referred to MC-tree.

All-Optical Multicast Heuristic (AOMH) [54]

AOMH first divides the multicast members into two groups: MC group (contains only MC nodes attached with destination nodes, or MC *member* nodes) and MI group (contains only MIs attached with destination nodes, or MI *member* nodes). An MC tree (core tree) is constructed around the MC group. Then a whole multicast light-forest is completed by connecting each destination node in the MI group into the nearest MC node on the MC tree. The total cost of a multicast route (light-forest) is the sum of the cost of the MC tree and the cost of the paths connecting the remaining destinations. However, AOMH just

tries to minimize the MC tree cost, while does not take the location of the *non-member* MC nodes into account. As a result, the total cost may not be minimized. To overcome the limitation, two heuristics were proposed in [69].

On-Tree MC node First (OTMCF) and Nearest MC node First (NMCF) [69]

Like AOMH, the two algorithms first construct an MC tree, and then connect the destinations to the MC tree. The two algorithms (OTMCF, NMCF) differ from AOMH in the way of building the MC tree. While AMOH employs an approximated Steiner tree algorithm combining with possible rerouting to satisfy sparse splitting constraint, the other two are based on the "Auxiliary Network Transformation (ANT)" technique which is similar to the KMB algorithm [74]. This difference helps the two algorithms benefit from a lower MC tree cost. In addition, AOMH connects the remaining destinations at MC *member* nodes on MC tree, while OTMCF/NMCF connects them at the *nearest* MC nodes on the MC tree, so the cost connecting the MI members is also lower than AMOH.

Among the two algorithms, On-Tree MC node First (OTMCF) scheme attempts to minimize the cost of an MC tree by just constructing it around the MC member nodes. Whereas, Nearest MC node First (NMCF) approach is designed to minimize the cost of MI member nodes joining the MC tree. The set of MC nodes used to construct the MC tree includes all the member MC-OXCs and the MC-OXCs nearest to member MI nodes. NMCF expands on-tree MC-OXCs in such a way that each MC node nearest to each MI node in the group should also be on-tree. The simulations in [69] pointed out that NMCF is better than OTMCF, and the two algorithms outperforms AOMH and MO in terms of cost as well as the number of wavelengths needed.

Cost-Effective Multicasting Using Splitters (MUS) [70]

In [70], the authors proposed an algorithm (MUS) that can reduce the total cost of the MC tree as well as the cost of light-paths connecting the remaining destinations. MUS is similar to OTMCF in which it constructs an MC tree with only member MC-OXCs. Besides, MUS has two basic improvements that make it more efficient. First, in MUS, the MI destinations are connected in increasing order according to the cost of the shortest path between them and the MC tree, while in OTMCF this is not taken into account. Second, after adding a path that connects an MI destination to the tree, the unconnected MI destinations are checked whether they can be connected efficiently (i.e., with low cost) through any MC-OXCs belonging to this path (whereas OTMCF ignores these nodes). The simulations presented in [70] showed that MUS outperforms both OTMCF and NMCF in terms of the cost.

Sparse Splitting Multicast Routing Heuristic (SSMRH) [95]

In [95], SSMRH algorithm was proposed based on MUS algorithm. The SSMRH algorithm works as follows. First, a tree is computed using MUS. Then, each one of the MC nodes that are not part of the tree, is added temporarily in the destination set D , the new tree is calculated and the MC node is removed from D . The MC node that, if added in D , gives the tree with the least cost, is added permanently into D . The procedure is repeated until no further cost reduction can be obtained. Simulation showed that SSMRH outperforms MUS and OTMCF and NMCF. However, SSMRH suffers from high time complexity, e.g., S times higher than MUS, with S the number of MC nodes.

Multicast Capable Node First Heuristic (MCNFH) [71]

Based on the above-mentioned MC node first scheme, the authors in [71] proposed an algorithm called Multicast Capable Node First Heuristic (MCNFH) under sparse splitting with full wavelength conversion. They also use the auxiliary graph to implement the chosen MC node first scheme.

The algorithm consists of two steps. The first step constructs an auxiliary graph whose vertex set includes MC-OXCs, the source and the destinations and edge set corresponds to shortest paths connecting the nodes. Then the auxiliary spanning tree satisfying sparse splitting constraint is computed in the auxiliary graph in such a way that paths consisting more MC-OXCs are given higher priority. The routing tree is computed by replacing the edges in the auxiliary graph by the paths in the original graph.

The simulation in [71] showed that the MCNFH outperforms Member-Only [48] and NMCF [69] in terms of total cost and the number of wavelengths used, especially with the small percentage of VS nodes and/or a large percentage of destinations.

Virtual source based routing (VS-2) [96]

Another virtual source based routing (denoted as VS-2) was proposed in [96], however it belongs to core-based routing scheme. The basic idea of it indeed the same as the *core-based tree* routing architecture proposed for IP multicast switching [97]. It consists of two phases as follows. In the network partition phase, every node in the network needs to find a shortest path to the nearest VS and establish a connection to it. In this way, the network is partitioned into regions, each including a tree rooted at a VS. The VSs are interconnected to each other by a pre-established connection. In the tree generation phase, when a request arrives, the source first establishes a connection to a VS called Primary VS (PVS). This PVS connects to the other VSs, then these VSs establish connection to their own regions. In this way, the multicast tree is built faster since this phase makes use

of the connectivity provided in the previous phase. This scheme differs from the other in that, the multicast tree is VS-based rather than source-based. Among the main advantages of VS-based routing are the less set-up time for a multicast tree and simpler procedure for dynamic addition or deletion of multicast group. While the disadvantage is due to the overhead resource reservation for establishment of the VSs.

3.3 Multiple-Request MCRWA Problems

We switch our focus on a more realistic scenarios when multiple requests together present in the networks. Unlike the single-request routing problem which tries to optimize the request itself, multiple-request case attempts to achieve the optimality as a whole, giving rise to a combined optimization problem. Since it relates to both routing and wavelength assignment, we investigate the two tasks: routing (R) and wavelength assignment (WA). For the consistency, we use the acronym MCRWA for multiple-request routing and wavelength assignment.

According to traffic types, MCRWA problems can be roughly divided into two categories: *static MCRWA problems* and *dynamic MCRWA problems* depending on static traffic or dynamic traffic, respectively. Based on routing approaches, three approaches are proposed: *fixed routing*, *fixed-alternate routing* or *adaptive routing*. For wavelength assignment, there also exist several approaches that will be detailed in the next subsections.

3.3.1 Static MCRWA Problems versus Dynamic MCRWA Problems

For the static MCRWA problems, a set of requests is known beforehand and they remain in the network in a relatively long-term period. Therefore the route computation can be done off-line. In this scenario, the objective is mainly to minimize the network resources consumption (i.e., the number of wavelengths used, and/or the total cost of all the links used) with the assumption that wavelength availability is sufficient to route all the requests. However, practical limitations on the fiber technology and optical devices restrict the maximum number of wavelengths supported in a fiber. For instance, in core optical networks, a fiber can be multiplexed on the order of 80-100 wavelengths [11]. In this case, due to lack of wavelengths, not all the requests routed. The requests not routed are called *blocked*. The objective of static MCRWA problems in this case is to maximize the total number of requests provisioned, or equivalently, to minimize the number of requests blocked (i.e., to minimize the *blocking probability*). In fact, minimizing resources implies more spare resources for the other requests, therefore reducing the blocking probability.

For the dynamic MCRWA problems, requests arrive at random times and have random holding times. Therefore, each request is set up and torn down individually while the other requests are present in the network. Usually, the limited network resource is as-

sumed for this case. Therefore, the optimization objective is often to minimize the blocking probability.

Regarding blocking probability, two blocking probability models were proposed: *full destination blocking probability (FB)* and *partial destination blocking probability (PB)* [38, 46]. Accordingly, under FB model, a multicast request is accepted if and only if all the destinations of the request can be reached, i.e., if one arbitrary destination fails to be reached, the whole request will be blocked. The appropriate metric to evaluate the solutions is request (session) blocking probability, defined as the probability that an arriving multicast request is blocked. It is suitable for the applications that require all the multicast members receiving the data to take place, e.g., video-conferencing, distributed databases and distributed computing. On the other hand, in other applications such as video-on-demand, it may not be obligatory to reach all destinations at the same time. Rather, if some of the destinations are not reachable through the selected route, the connection is set-up between the source and the reachable destinations. This is the case where PB model is supposed to use. The performance metric is the so-called destination (user) blocking probability, which is defined as the probability that a destination in the group is blocked.

Since RWA problem for multiple unicast requests was proved to be NP-hard [45], MCRWA problem is NP-hard since it contains the RWA problem as a special case [27]. For NP-hard problems, Integer Linear Programming (ILP) is often used to search for exact solution, and heuristic algorithms are preferable for large-scale instances. In the following subsections, typical ILP formulations and heuristic approaches for MCRWA problems are reviewed.

3.3.2 ILP/MILP Solutions

Several ILP/MILP formulations were proposed to solve static MCRWA problems. Aimed at minimizing the network resource consumption, various light-tree based MILP formulations for different network systems with all the nodes being multicast capable with/without wavelength conversion, and with sparse-limited splitting were formulated in [13].

In [98], two optimization problems are treated. The objective of the first one is to find the optimal routing and wavelength assignment strategy for multicast communications with the end-to-end delay constraint. Meanwhile the optimal placement of light splitters and wavelength converters can also be determined. In the latter one, the virtual topology design problem is formulated to minimize the congestion or the average packet hop distance. The novelty of the proposed MILP is that it uses the relationship between the delays from each spanned node to the source to avoid loops in resultant light-trees.

On the assumption that all nodes are MC without wavelength conversion, an ILP formulation was proposed in [46] to minimize the destination blocking probability by allowing partial multicast trees to be accommodated (i.e., under PB model).

For dynamic MCRWA, the dynamic multicast session provisioning in WDM optical networks with sparse splitting capability was studied in [99]. The objectives are to minimize the network resources in terms of wavelength-links used by each session and to reduce the multicast session blocking probability. Since the requests are not known until they arrive, no exact solution can be computed. Therefore, the authors proposed a quasi-exact solution by means of ILP formulation. Accordingly, an ILP optimization tool on "a per multicast session basis" is designed to compute the optimal for one request under the current network topology and its residual network resource information. With this ILP formulation, the multicast session blocking probability can then be estimated based on solving a series of ILPs offline.

3.3.3 Heuristic Algorithms

Solving MCRWA problems can be done either by integrating the routing (R) and wavelength assignment (WA) in one step (*coupled* approach), or by separating them into two separated steps (*decoupled* approach). According to most of existing works, coupled MCRWA is more complicated, hence it is usually decomposed into two subproblems. In this subsection, we present heuristic approaches for routing first, followed by wavelength assignment approaches.

3.3.3.1 Routing Approaches

Several routing approaches for MCRWA problems were suggested in [38]. In the first approach, a pre-determined set of routes (e.g., trees, hierarchies) are considered as a possible route *pool* to establish the request connections. Then network resources are checked to see if they can accommodate these routes or not. Belonging to this approach are *fixed routing* and *fixed-alternate routing*. The opposite approach is known as *adaptive routing*. The routes are determined based on the availability of the network resources. By taking the network state into account, adaptive routing can achieve better solutions than the other two. Next, these routing schemes are presented in detail. Note that they can be applied for both static and dynamic MCRWA problems.

Fixed Routing

In *fixed routing*, a route is pre-determined for each request using a routing algorithm (e.g., shortest path or Steiner tree heuristics). When a multicast request arrives, a wavelength set is searched in some order (several wavelength-search schemes are presented in Subsubsection 3.3.3.2), to find a set of available wavelengths, each for a link of the route.

If it is found, the wavelengths are assigned to the route. The request is blocked if all the wavelengths are exhausted without success.

Fixed-Alternate Routing

In *fixed-alternate routing*, a set of routes are pre-computed for each request. When a multicast request arrives, the routes are examined sequentially using the same wavelength search as mentioned in the fixed routing. If any route in the set is supported by a set of wavelengths, the found wavelengths are assigned to it. The request is blocked if none of the routes is supported by available wavelengths.

Adaptive Routing

In *adaptive routing*, for each request, the routes from the source to the destinations are computed dynamically, depending on the network state. The network state is determined by the availability of wavelengths in the network. The wavelengths are then searched and assigned to the computed route right away. Then the network state is updated in such a way that the wavelengths used for the computed route should be removed. Hence, the request is blocked only if there is no available route to carry it.

Among the three schemes, adaptive routing performs the best, while fixed routing performs the worst. The reason is as follows. The two fixed approaches decompose the MCRWA problem into two subproblems, namely, the multicast routing problem and the wavelength assignment problem, and solve them sequentially. Although in each step an optimal solution may be found, the overall result may not be optimal. Adaptive routing solves the two subproblems in a coupled manner. It can always make the best use of the available wavelengths by adaptively building multicast routes according to the current wavelength usage on the links, therefore achieving the best performance among the three. Fixed-alternate routing outperforms fixed routing because it provides more choices in choosing the multicast route and hence leads to a better usage of the wavelengths. On the other hand, adaptive routing has the highest computational complexity, while fixed routing is the simplest [29].

3.3.3.2 Wavelength Assignment for Static MCRWA Problems

When the number of wavelengths is sufficient enough, the wavelength assignment aims at minimizing the number of wavelengths used to accommodate all the arrival requests. WA schemes in all-optical networks comply two constraints: *wavelength continuity constraint* and *distinct wavelength constraint*. The two constraints are mentioned in Chapter 1 for the case of unicast with light-paths. They can be stated for the case of multicast as follows [100]. To simplify, the presentation is based on light-trees. However, it is also valid for light-hierarchies or light-spider-hierarchies.

- **Wavelength continuity constraint:** In the absence of wavelength converters, the same wavelength must be used on all the links along a light-tree from the source to the destinations.
- **Distinct wavelength constraint:** Different light-trees sharing the common link must be allocated distinct wavelengths.

The wavelength assignment for static MCRWA problems is stated as follows. Given a set of light-trees, assign to each light-tree a wavelength in such a way that two light-trees which shares a common link must be assigned with two different wavelengths. One approach to solve this problem is to transform it to the *vertex-coloring problem* [101] in graph theory as follows. Each light-tree is represented by a vertex in an auxiliary graph (G_a), and there is an undirected edge between two vertices in G_a if and only if two trees share a common link in the topology graph. Assigning wavelengths to the trees is reduced to assign a color to each vertex in G_a such that no two adjacent vertices receive the same color. Finding the minimum number of colors in this coloring problem is NP-hard [31]. Fortunately, a number of heuristics are available to compute the approximation number of colors needed, including Largest-Degree-First [102] or Smallest-Degree-Last [103].

3.3.3.3 Wavelength Assignment Schemes for Dynamic MCRWA Problems

In dynamic traffic case (i.e., requests arrive one at a time), heuristic schemes must be used to assign wavelengths to light-trees. For the dynamic problem, instead of attempting to minimize the number of wavelengths as in the static case, we assume that the number of wavelengths is fixed (this is the practical situation), and we attempt to minimize the connection blocking.

Given a multicast route for a request, WA is to search for a set of wavelengths¹ from the set of available wavelengths (called wavelength pool) to assign to the route in order to minimize the blocking probability. The searching can be in some order. Typical WA schemes for single-fiber WDM networks are suggested in [47], including: *Random*, *First-Fit*, *Least-Used*, *Most-Used*. Although these algorithms were proposed for the unicast case, the same principles can be used for the multicast case. Also, these schemes may be applied for static MCRWA problems, by ordering the light-trees and then assigning wavelengths to them sequentially.

Random

This scheme first searches the wavelength pool to determine the set of all wavelengths that can be assigned to the links in the multicast route. Among the available wavelengths for each link, one is chosen randomly.

¹In general case, a route can be assigned several wavelengths.

First-Fit

Initially, all wavelengths are indexed. When searching for available wavelengths, a lower-index wavelength is attempted sooner than a higher-index wavelength. The first available wavelength is then selected. Compared with Random wavelength assignment, the computation cost of this scheme is lower because there is no need to search the entire wavelength pool for each route. The idea behind this scheme is to pack all of the in-use wavelengths toward the first end of the wavelength pool so that reserves spare higher-index wavelengths for future usage. This scheme performs well in terms of blocking probability and fairness, and is preferred in practice because of its low computational overhead and low complexity.

Least-Used/SPREAD

Least-Used selects the wavelength that is the least-used in the network, thereby trying to balance the using of all the wavelengths. The performance of Least-Used is worse than Random, while also introducing additional communication overhead (e.g., global information is required to compute the least-used wavelength) [47]. The scheme also requires additional storage and computation cost, thus, Least-Used is not preferred in practice.

Most-Used/PACK

Most-Used is the opposite of Least-Used in that it attempts to select the most-used wavelength in the network. Although the communication overhead, storage, and computation cost are all similar to those in Least-Used, it outperforms Least-Used significantly. Most-Used is also slightly better than First-Fit, since it works better in packing connections into fewer wavelengths, and hence maintaining free space of less-used wavelengths.

3.3.4 Typical Literature Works

3.3.4.1 Minimizing the Network Resources

Targeting the objective of minimizing the total number of wavelengths needed to establish all the requests, the multi-drop path model was proposed in [104]. In fact, this problem was extended for the multi-drop path model for a single-request as discussed in Section 3.2. Accordingly, given a set of multicast requests, the problem tries to route all the requests using multi-drop paths such that each path allows signal to be dropped at no more than k destinations. To this end, the authors proposed two heuristic algorithms. The first heuristic is based on the MFBH algorithm mentioned in [87]. It tries to compute a set of edge-disjoint paths for each request, then applies the vertex-coloring algorithm Smallest-Degree-Last [103] to assign wavelengths for all the light-paths. The second heuristic is based on the first one combined with a Tabu search method. First, set a sequential number to each of the requests and apply the first heuristic to each request; then randomly change the sequential number and apply the first heuristic again. After ten iterations, if the number of

wavelengths used does not decrease, the search stops and the least number of wavelengths recorded is considered as the final solution.

Assuming the networks equipped with full splitting capability and wavelength converters, the work [105] focuses on minimizing the number of wavelength converters required to support all the static multicast requests with a given number of wavelengths. To achieve the objective, the RWA approach consists of two sequential steps: routing first, followed by wavelength assignment. The routing is accomplished by employing Alternate Multicast Tree Algorithm [106]. For each request, a number of candidate multicast trees are computed, the one chosen having the minimum conflicts with the trees already computed. The wavelength assignment comprises two sub-steps. In the first step, it tries to assign a wavelength to as many trees as possible, employing a vertex-coloring algorithm on a conflict graph. The second step is done by applying the two-phase process wavelength assignment [85] to assign wavelengths to the remaining trees.

3.3.4.2 Minimizing the Blocking Probability

On the assumption that all nodes are multicast capable without wavelength conversion, an ILP formulation was proposed in [46] to minimize the destination blocking probability under PB model. Two algorithms were proposed. The first algorithm is based on the ILP formulation. The idea is to accommodate only complete multicast groups first, and then try to serve as many users as possible by allowing partial accommodation. The greedy heuristic (namely Max-First) was relatively straightforward. It tries to accommodate the group having the largest number of users that can be served using a certain wavelength at each of the iterations.

In [10,55], the authors investigated the dynamic MCRWA problem under sparse splitting and sparse wavelength conversion networks. Several heuristic algorithms based on approximated Steiner tree heuristics, namely Minimum Path Heuristic [73] and Average Distance Heuristic (ADH) [75] were proposed. Simulations showed that MPH based heuristics outperforms the others. Although the two works were based on layered graph model, the routing approaches are different. In [55], the routes are computed in the whole layered graph, while in [10], the layered routing approach was proposed to compute in a layer-to-layer order, which moves from one to the other layer through wavelength converter nodes. Obviously, the time complexity of the latter approach is lower than the former, however, no evaluation on performance of the two approaches is revealed.

To decide which layer to move to, several wavelength-search schemes were also proposed. They are CONSERVATIVE, OPTIMISTIC, FIXED and RANDOM which are equivalent

to Most-Used, Least-Used, Fixed and Random wavelength schemes mentioned in Subsubsection 3.3.3.3.

The work concluded that CONSERVATIVE scheme is slightly better than the others, and the wavelength search scheme is not an important factor. Lastly, although the *multiλ-light-trees* were used instead of light-trees, they do not make full use of possible arcs as the light-hierarchies do.

In [99], an online algorithm was proposed for dynamic MCRWA problems in sparse splitting configurations. For each arriving request, the algorithm computes all the shortest paths from the source to the destinations. These paths are then sorted in ascending order of the number of MC nodes in them. Then the algorithm tries to merge these paths to form a light-tree or a set of light-trees (a light-forest) that span to reach all the destination nodes. First, an initial path with highest number of MC nodes is selected, then the unchecked destinations are checked to see if they can be reached from MC nodes or the destination nodes in the initial path. If the path is found, then assign the first free wavelengths to the links used. If no such path found, or the path found conflicts with available wavelengths, the request is rejected. The routing algorithm belongs to fixed routing approach (since the initial shortest paths are computed in the physical topology), the WA employs First-Fit scheme, and the blocking probability is calculated under FB model.

3.4 Propositions on Exact Solutions for Single-Request AOMR Problems

This section is dedicated for identifying the exact solutions for the single-request AOMR problems with respect to the classification as shown in Fig. 1.13 (Chapter 1). Accordingly, the three different splitting capabilities, the wavelength conversion support at the nodes and the wavelength availability are taken into account. This section is not about the state-of-the-art works but our analysis for the optimal routes for the constrained AOMR problems.

To focus the reader's mind, we narrow the problem's scope by just considering the combined optimization objective of: first, minimizing the number of wavelengths used, and then minimizing the total cost. We refer to this combined cost as *cost* for short. For the other objective functions, e.g., minimizing the total cost first, the propositions can be proposed in a similar reasoning. Moreover, in all the cases, we assume that the solution exists, i.e., there is at least a directed path from the source to each of destinations (using one or more than one wavelength). Note that although only single-request case is considered, the propositions are still valid for the case of multiple-requests.

3.4.1 Full Splitting

In the full splitting WDM networks, all the nodes are able to split the light signal. At a glance, the solutions for the AOMR problems correspond to a tree. However, they can be different structures depending on the availability of wavelengths in the links and the presence of wavelength converters as shown below. For the consistency, we come up with the following trivial proposition.

3.4.1.1 Wavelength Symmetric Case

Proposition 3.1. *The cost optimal solutions for wavelength symmetric AOMR problems under full splitting is a light-tree regardless of possible wavelength conversion support.*

Indeed, the *wavelength symmetric* case is suitably modeled by an undirected topology graph. Thanks to the full splitting, the cost optimal solution is a Steiner tree computed in the undirected graph. A single *light-tree* realized by any available wavelength is thereby sufficient to accommodate a request regardless of availability of wavelength converters.

3.4.1.2 Wavelength Nonsymmetric Case

We now investigate the *nonsymmetric wavelength* case, i.e., different wavelength availability in the links. To compute the cost optimal tree, we may try to compute a Steiner tree in the physical topology. However, it is likely that the computed tree may not be routed because of nonsymmetric wavelength distribution and/or unavailable wavelength converters. Fortunately, layered graphs (cf. Section 2.1) which can model the availability of all the wavelengths and wavelength conversion in the networks, can help to search for the exact solutions.

Full Splitting with Full Wavelength Conversion

Proposition 3.2. *The cost optimal solutions for wavelength nonsymmetric AOMR problems under full splitting with full wavelength conversion is a multi λ -light-tree.*

With full wavelength conversion, the *wavelength continuity constraint* is free and the optimal solution is always a single tree. This tree may use one wavelength (if one wavelength is available in all links of the tree) or more than one wavelength (otherwise) with the support of wavelength converters. Since light-tree is a special case of multi λ -light-tree, the optimal solution is a *multi λ -light-tree*.

Full Splitting without Wavelength Conversion

Proposition 3.3. *The cost optimal solutions for wavelength nonsymmetric AOMR problems under full splitting without wavelength conversion is a light-forest.*

Without wavelength conversion, the wavelength continuity constraint must be respected. Refer to the layered graph, there is no connection between the layers, except at the pseudo source and the pseudo destinations. Therefore, a wavelength should be retained along all the links of the multicast route on each layer. Minimizing the number of wavelengths used is equivalent to finding a route which traverses the fewest layers. Whereas, minimizing the total cost is reduced to searching for the least total-cost route. Obviously, the least total-cost route is a *directed Steiner tree* computed in the layered graph. In any cases, the optimal solution is a tree rooted at the pseudo source that covers all the pseudo destinations. The tree consists of a set of subtrees with each rooted at a duplicate of the actual source in a distinct layer. Hence, the final solution is a *light-forest* obtained after pruning the pseudo arcs.

Full Splitting with Sparse Wavelength Conversion

Proposition 3.4. *The cost optimal solutions for wavelength nonsymmetric AOMR problems under full splitting with sparse wavelength conversion is a set of multi λ -light-hierarchies.*

To minimize the number of wavelengths used, the route should make full use of each layer it passed. Because of nonsymmetric availability of wavelengths, the route may have to return to a node or traverse a link twice in a layer (provided the same wavelength is available in both directions). Besides, for the sparse wavelength conversion, there are connections between the layers at some WC nodes. Therefore, the route can cross several layers through the available WC nodes for a better cost solution. After pruning pseudo vertices and arcs, the optimal solution is a *set of multi λ -light-hierarchies*. The figures 2.6 and 2.7 at the end of Subsection 2.1.4 (Chapter 2) exemplify this proposition.

3.4.2 Non Splitting

This subsection investigates the AOMR problem under non splitting capability. Like the above discussion, we give propositions respecting both configurations with symmetric and nonsymmetric wavelength distribution.

3.4.2.1 Wavelength Symmetric Case

Proposition 3.5. *The cost optimal solutions for wavelength symmetric AOMR problems under non-splitting is a light-spider-hierarchy regardless of possible wavelength conversion support.*

For wavelength symmetric case, the same set of wavelengths is available in all the links (in both directions). Thus, the first objective, i.e., minimizing the number of wavelengths required is solved with only one wavelength regardless of wavelength conversion. The problem of minimizing number of wavelengths and then finding a low cost is now reduced to minimizing the total cost using a single wavelength.

As mentioned in Subsection 3.2.2 above, three possible solutions for multicasting without splitting capacity were proposed. They can be either a minimum cost multiple destination trail (MCMDT) [6], a light-forest (composed from a set of light-spiders) [49] or a set of edge-disjoint paths [86,87]. However, only the first solution is feasible with using just one wavelength, while the other two may use multiple wavelengths. Nevertheless, the MCMDT is not cost-effective since it consumes a lot of arcs.

Another possible solution (which has not been mentioned in the literature) can be a set of arc-disjoint trails. This solution should be more cost-effective than an MCMDT, since it takes advantage of multiple transmitters equipping the source (as presumed), thereby reducing significantly multiple backward arcs required by the backtracking in MCMDT computation. Fig. 3.5 illustrates a comparison between the two solutions for the same input (network and multicast request) as shown in Fig. 3.2a (Subsection 3.4.2). While a single light-trail (Fig. 3.5a) consumes 24 arcs with a total cost of 55, a set of arc-disjoint light-trails (Fig. 3.5b) traverses 15 arcs with a total cost of 36.

Even if a single light-trail can form the optimal solution, this optimal solution is also considered belonging to a set of arc-disjoint trails. In other words, the optimal solution is a set of arc-disjoint trails. Since a set of arc-disjoint trails can be model by a hierarchy based on a spider, it corresponds to a light-spider-hierarchy. So the proposition follows.

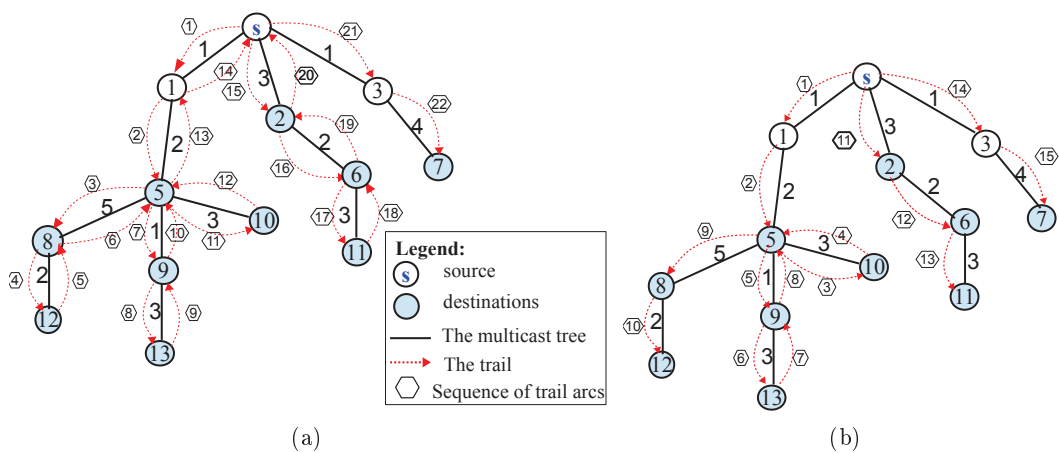

Figure 3.5 – Comparison between a solution based on a single light-trail with a solution based on a set of arc-disjoint light-trails

3.4.2.2 Wavelength Nonsymmetric Case

This subsection briefly presents a proposition regarding the cost optimal solutions for the combination of non splitting with/without wavelength conversion. Detailed proofs are reserved in Chapter 5.

Proposition 3.6. *The cost optimal solutions for wavelength nonsymmetric AOMR problems under non splitting without wavelength conversion is a set of light-spider-hierarchies;*

and they are a set of multi λ -light-spider-hierarchies with the support of wavelength conversion.

For the wavelength nonsymmetric case, this proposition can be straightforward followed from Proposition 3.5. However, a light-spider-hierarchy may not sufficient to cover all the destinations. Thus, in this case, a set of light-spider-hierarchies forms the optimal solutions. In the case with wavelength conversion, the route can make use of possible wavelength conversion to benefit from lower cost. This leads to the optimal solutions as a set of multi λ -light-spider-hierarchies.

3.4.3 Spare Splitting

3.4.3.1 Wavelength Symmetric Case

Proposition 3.7. *The cost optimal solutions for wavelength symmetric AOMR problems under sparse splitting is a light-hierarchy regardless of possible wavelength conversion support.*

Thanks to the same set of wavelengths available in all the links (in both directions), only one wavelength can be used to cover all the destinations, regardless of wavelength conversion. To satisfy a multicast request using only one wavelength, a light-hierarchy which allows backtracking at some nodes is always feasible, while a single light-tree may not. In the case that both solutions are feasible, a light-hierarchy can provide a lower cost than a light-tree as exemplified in Fig. 2.13 (Chapter 2).

3.4.3.2 Wavelength Nonsymmetric Case

Proposition 3.8. *The cost optimal solutions for wavelength nonsymmetric AOMR problems under sparse splitting without wavelength conversion is a set of light-hierarchies; and they are a set of multi λ -light-hierarchies with the support of wavelength conversion.*

Without wavelength converters, the multicast route cannot propagate the light crossing the layers. To cover all the destinations or to have a lower cost under the condition of limited wavelengths and lack of split nodes, the repetition of nodes are likely to be occurred. If it is the case, a light-hierarchy will be produced in some layer. Otherwise, the result should be a light-tree which is indeed a special light-hierarchy. Therefore, the cost optimal solutions is a set of light-hierarchies.

With sparse or full wavelength conversion, there are connections between the layers at WC-OXCs. Therefore, the optimal route can use several wavelengths by crossing the layers. Since a node may be visited more than once, and the wavelengths can be changed, the solution a set of multi λ -light-hierarchies.

In this section, we have pointed out that the structures of optimal solutions for single-request AOMR problems are hierarchies, and specified them under specific constraints. The results are summarized in Table 3.1.

Table 3.1 – Exact solutions for typical single-request AOMR problems

Wavelength Availability	Wavelength Conversion	Full Splitting	Sparse Splitting	No Splitting
<i>Symmetric</i>	<i>Full WC</i>	a light-tree	a light-hierarchy	a light-spider-hierarchy
	<i>Sparse WC</i>			
	<i>No WC</i>			
<i>Nonsymmetric</i>	<i>Full WC</i>	a multi λ -light-tree	a set of multi λ -light-hierarchies	a set of multi λ -light-spider-hierarchies
	<i>Sparse WC</i>	a set of multi λ -light-hierarchies		
	<i>No WC</i>	a light-forest	a set of light-hierarchies	a set of light-spider-hierarchies

■ **Key points of Chapter 3** ■

- A comprehensive literature review on AOM problems are presented with respect to an appropriate classification.
- Exact solutions for typical single-request AOMR problems are identified with the help of hierarchies.

Part II

Single-Request AOMR

An Improved Heuristic Algorithm for Sparse Splitting

Multicasting with sparse splitting WDM networks has received a special attention from the literature because of its interests and challenges. Among others, the cost-efficient and delay sensitive routes are often desirable. This chapter is aligned in the efforts of improving the existing works for better solutions. Particularly, we make several improvements on a well-known heuristic for a better trade-off solution between resource consumption and the end-to-end delay.

4.1 Introduction

Numerous high-speed multimedia applications (such as VoD, HDTV, VoIP, Video Conferencing) involve multicast transmission from one sender to many receivers. These real-time applications often consume a large amount of bandwidth while requiring some level of Quality of Service (QoS) (e.g., delay, power should be bounded by a specific value).

As indicated in Subsection 3.2.3 (Chapter 3), the cost-optimal AOMR problems are NP-hard regardless of delay consideration. Although ILP formulations can help to find the cost optimal route, they are not scalable and just able to work in small networks. Therefore, searching for efficient heuristics for larger network configurations is preferable.

Most of the existing works focus on minimizing the resource consumption, i.e., the number of wavelengths used (or the wavelength consumption) and the wavelength channel cost, but ignoring the delay [48,64,65,69–71,88,89,91]. Although optical fibers can support a very high speed in optical networks, there is a propagation delay on each link. Since WDM backbone networks span worldwide, the distances from senders to receivers can be on the order of thousands kilometers. When passing multiple hops, the additive end-to-end

delay becomes significant that is not negligible. As a result, the delay should be taken into account when designing a cost-effective routes. The typical works taking the delay into account include: [90,92,94].

The fact is that minimizing the wavelength consumption often conflicts with the end-to-end delay minimization. Good evidences can be seen from several algorithms introduced in [48]. Reroute-to-Source (Re2S) algorithm which is based on the shortest path tree (SPT) although achieves the optimal delay, the wavelength consumption is very high. In contrast, Member-Only (MO) algorithm which is based on an approximated Steiner tree achieves low wavelength consumption and low total cost, but the end-to-end delay is quite high. Thus a tradeoff solution is desired.

In [90], the authors proposed an algorithm called Avoidance of Multicast Incapable Branching (MIB) Nodes for Multicast Routing aimed at finding a such a tradeoff solution. The algorithm is based on Reroute-to-Any (Re2A) algorithm [48] with some improvements. First, a modified Dijkstra algorithm was developed taking some priorities of candidate nodes into account to construct an SPT rooted at the source. Then MIB nodes (if any) of the SPT are processed by some techniques to resolve the splitting conflicts. Finally, it uses a distance based post-treatment to create the final light-forest. According to [90], the algorithm is better than Re2A and provides a good trade-off between wavelength consumption and end-to-end delay in the network with sparse splitting capability. In another work [92], a distance priority heuristic was proposed to post-process the light-trees computed by MO algorithm. By choosing a better candidate connectors and candidate destinations, the tree diameter can be greatly reduced while keeping the wavelength consumption and the total cost as low as the original MO light-forest.

Inspired by the above, we propose in this chapter a new algorithm targeting a trade-off solution among wavelength consumption, maximum delay and total cost. Unlike the works presented above, our proposition is based on the framework of Member-First (MF) algorithm, also proposed in [48]. Since MF outperforms Re2A, we believe that our algorithm provide a better solution.

Our proposition makes three important improvements on Member-First: the priority model of the links being added and the way of constructing the light-tree. For the priority model, not only membership but also the MC nodes and the degree of the nodes in the network are taken into account, thereby increasing the quality of the resulting light-forest. Second, a priority queue is managed more efficiently that permits only one best candidate link from MI nodes, which facilitates the process of the tree repair. Finally, an efficient technique is developed to process useless links when computing the light-tree.

One thing to notice here is that, the optimal route for sparse splitting case corresponds to a set of light-hierarchies instead of light-trees (cf. Section 3.4, Chapter 3). However, since the purpose of our proposal is to improve the existing works, so we propose to compute light-trees for ease of comparison with the counterpart.

Simulation results and comparison point out that our proposition provides the lowest wavelength consumption, a low maximum delay and low total cost among the considered algorithms. Especially, our algorithm works better with very sparse splitting, and/or with a large multicast group size in comparison to the classical algorithms, and in highly connected networks.

4.2 Problem Formulation

A WDM network with sparse splitting capacity without wavelength conversion and wavelength symmetric is supposed in this chapter. The network topology is modeled by an undirected graph $G = (V, E)$. Any link $e \in E$ is associated with two positive values $c(e)$ and $d(e)$. $c(e)$ represents the wavelength channel cost (or cost, for short) and $d(e)$ denotes the propagation delay (or delay, for short) in each link. Both of them are additive along a light-path $LP_{u,v}$. We consider the multicast request $r = (s, D)$ from the source node s to the set of destinations $D = \{d_1, d_2, \dots, d_n\} \subset V$, $s \notin D$. To express sparse splitting capacity, let $S \subset V$ be the set of MC nodes in the network, only the nodes in S can branch. We call it the *sparse splitting constraint*. Due to sparse splitting constraint, it is likely that a single light-tree may not be sufficient to span all the destinations. Therefore, a light-forest $F = \{LT_i, i = 1, \dots, k\}$ composed from k (not edge-disjoint) light-trees will be built. Due to the *distinct wavelength constraint*, the light-trees must be assigned with different wavelengths. Thus, the number of wavelengths required for the multicast request r is equal to the number of light-trees in F :

$$num_wave(F) = k \quad (4.1)$$

The *total cost* of the forest F is the sum of the cost of all the links in the light-forest:

$$total_cost(F) = \sum_{i \in [1, k]} \sum_{e \in LT_i} c(e) \quad (4.2)$$

Let LP_{s, d_i} be the light-path from the source s to destination d_i . The *maximum delay* is calculated by:

$$max_delay(F) = \max_{d_i \in D} \sum_{e \in LP_{s, d_i}} d(e) \quad (4.3)$$

With all the notations mentioned above, the concerned AOMR problem can be stated as follows.

- **Instance:** A WDM network (G, S) : $G = (V, E)$ representing network topology and $S \subset V$ is a set of MC nodes; a multicast request $r = (s, D)$

- **Solution:** A light-forest F satisfying the three constraints: *wavelength continuity constraint*, *distinct wavelength constraint* and *sparse splitting constraint*.
- **Objective:** A trade-off solution among *number of wavelengths used*, *total cost*, and *maximum delay*

To simplify, as in [48,90], in this study, we assume that all the wavelengths in a link has the same cost, and the cost using a wavelength on different links is the same as well. In addition, the propagation delay is also the same on each link. With this assumption, for every link e , $c(e) = 1$ *unit cost* and $d(e) = 1$ *unit delay*. The *total cost* is now reduced to the total number of branches (links) of the forest, and the *maximum delay* is the diameter of the light-forest (i.e., maximum number of hops from the source to the destinations).

4.3 Member-Splitter-First Algorithm

Since Member-First algorithm [48] plays a role as a framework for our proposed proposition, we first describe it in more details, then analyse it for possible improvements. The proposed algorithm is followed as the combination of all the improvements at the end of this section.

4.3.1 Member-First Algorithm

This heuristic incrementally selects the candidate links called *fringe links* from the topology graph to constructs light-trees. A *fringe link* is defined as a link adjacent to a node in the current tree without forming a cycle with edges of the tree or the existing fringe links. These fringe links are managed by a priority queue, in which each fringe link is associated with a priority. The tree construction begins at the source and can be briefly described as follows.

- 1: Initialize the fringe link set L to be the adjacent links from the source
- 2: Select the fringe link with the highest priority from L
- 3: Add the selected fringe link with its end-node, say u to the tree and remove it from L
- 4: When reaching a destination (i.e., u is a member), cut any branches grown from any MI nodes in the reverse path from u back to the source, and remove any fringe links affected by the cutting from L (in order to avoid multiple branches from MI nodes in the final tree)
- 5: Update L with the adjacent links from u
- 6: If there are fringe links in L , go to Step 2
- 7: Prune branches that do not lead to any destinations
- 8: If there are destinations not yet covered, then go to Step 1 to construct another tree

Keeping the basic sequence of Member-First as a framework, the algorithm can be improved to construct more favourable light-trees by changing the priority of fringe links and the way to update them (cf. Fig. 4.2).

4.3.2 New Priority Model

One of the primary factor that affects a lot on algorithm's performance is the priority of links in the fringe link set. In Member-First, the priority of a fringe link (v, u) can be briefly presented as the order of $\langle h, member \rangle^1$, in which h is the number of hops (or length) from the source to u , and $member$ stands for the multicast membership of u . Accordingly, the link (v_i, u_i) have higher priority than (v_j, u_j) if $h(u_i) < h(u_j)$, or when $h(u_i) = h(u_j)$, u_i is a member, but u_j is not [48].

The fact that more than two factors mentioned above can affect the performance of the algorithm as analysed in following sections. Moreover, Member-First provides a good framework for easily alternating the possible combinations of these factors. In this section, we analyse possible alternatives and their effect on the algorithm's performance.

Apart from the two aforementioned factors $\langle h, member \rangle$ taken by Member-First, the other ones that can affect the algorithm performance are the multicast capable node (*MC*) and the degree of a node (*degree*). Thus, there are totally four factors should be taken into account: $\langle h, member, MC, degree \rangle$. Different combinations of these factors can lead to different results, and to choose the best combination needs careful analysis and realistic verification as well. Naturally, a good combination should correspond to the order of the importance of each factor. Let us analyze each of these factors in detail.

For the first factor, the number of hops h (or the length) from a node to the source directly impacts the end-to-end delay. In fact, Reroute-to-Source (mentioned in Section 4.1) takes only this metric into account, hence resulting in the optimal delay but with high total cost. The second factor (*member*) can affect the total cost and the wavelength consumption of the light-forest as the case of Member-Only (cf. Section 4.1). Recall that Member-Only connects the destinations to the current tree one by one, just considering the membership information, so the cost is close to optimal but the delay is too high.

Member-First takes into account both factors (with the sequence of $\langle h, member \rangle$) in order to give a good trade-off between the end-to-end delay and the total cost. However, it does not regard to the available MC nodes in the network. Thus, it leaves a question that when all the previous factors $\langle h, member \rangle$ are the same for two fringe links, which link should be given higher priority. Obviously, in such a case, the link leading to an *MC* node should be the first choice because MC nodes can connect to many of its children (probably including destinations) with only a single wavelength. From the set of being-connected

¹We use notation $\langle x_1, x_2, \dots, x_n \rangle$ to indicate an ordered list of the elements x_1, \dots, x_n . If the elements are vertices, $\langle x_1, x_2, \dots, x_n \rangle$ indicates a path from x_1 to x_n .

children, the connection to other destinations seems to be more likely. Thus, we propose to give higher priority to links leading to MC nodes.

Finally, the *degree* of the nodes also has a significant effect on the quality of the multicast tree. Indeed, the probability that a high-degree node can lead to other destinations not yet spanned is higher. However, high-degree MI nodes are likely to produce more MIB nodes in the resultant light-tree, resulting in more wavelengths needed to cover all the destinations. That means the wavelength consumption can be high. Thus, giving higher priority to the higher-degree nodes can lead to lower end-to-end delay. In contrast, using frequently MI nodes with smaller degree probably implies higher delay but lower wavelength consumption.

From this fact, we give higher priority to links leading to the MC nodes with higher degree, and then MI nodes with smaller degree (when they have the same h and *member*). By this way, the end-to-end delay and the wavelength consumption can be balanced.

Combination of these aforementioned elements, the new priority of fringe links can be defined in the order of: $\langle h, \textit{member}, \textit{MC}, \textit{degree} \rangle$. In particular, a link (v_i, u_i) have higher priority than (v_j, u_j) if:

- $h(u_i) < h(u_j)$;
- or when $h(u_i) = h(u_j)$, u_i is a *member*, but u_j is not;
- or when $h(u_i) = h(u_j)$ and if their memberships are the same, u_i is MC and u_j is MI;
- or when all the above criteria are the same, if both are MC nodes, then u_i has higher degree; otherwise, if both are MI nodes, then u_i has smaller degree.

To verify the analysis and the new priority model above, we carried out series of simulations in which the order of the mentioned factors were permuted, then the quality of each outcome corresponding to each permutation was evaluated and compared together. The simulation results revealed that the order $\langle h, \textit{member}, \textit{MC}, \textit{degree} \rangle$ works best among the alternatives. Details of the simulations can be found in our technical report [107].

To better visualize the effect of the new priority model, let us consider the network in Fig. 4.1 where the MC nodes (4, 6, 9) are drawn in circles, and the other MI nodes in squares². Suppose that the multicast request $r = (6, \{1, 2, 3, 5, 7, 8, 10, 11\})$, the destinations are shaded in grey.

The light-forest created by the original Member-First is shown in Fig. 4.2a. It consists of 2 light-trees, (i.e., the number of wavelengths used is 2, or $\textit{num_wave} = 2$), with the total number of branches is 10 (i.e., $\textit{total_cost} = 10$), and the maximum number of hops from the source to destinations is 3 (i.e., $\textit{max_delay} = 3$). In Fig. 4.2b, the light-forest created

²In graphs representing WDM networks, MC nodes are drawn in circles, and MI nodes are drawn in squares. This is applied to the whole thesis.

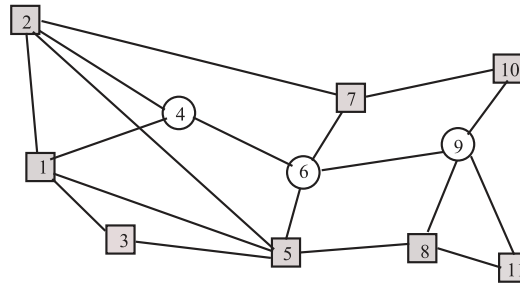

Figure 4.1 – A network to consider

by Member-First with the new priority model contains one light-tree having $num_wave = 1$, $total_cost = 9$, and $max_delay = 4$. So, even though the wavelength consumption and total cost are better with the new priority model, the delay is higher. To further improve the solution, we come up with the second improvement as described in the next subsection.

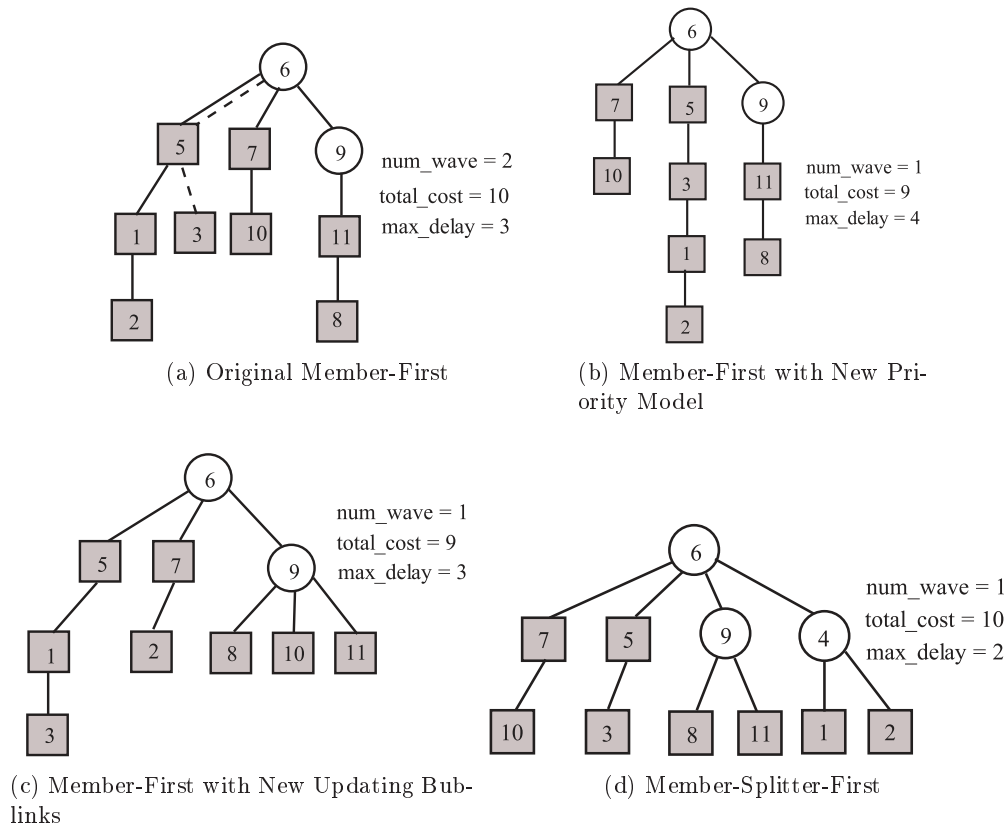

Figure 4.2 – Effect of the improvements to the resultant light-forests

4.3.3 Updating Bud-Links

When updating fringe links (step 5) from a node, say, node v , Member-First algorithm adds all the possible adjacent links of v to the fringe link set L regardless to its splitting capacity. It is worth noting that, if v is an MC node, there is no problem. However, if it is

an MI node, it can support only one child, if all the possible adjacent links are added, it is likely that less chance for other (better) links to be added to L . Let us explain this point in detail by considering the topology in Fig. 4.1 and employing Member-First. Suppose that at first Member-First select link (6,5) from the source, there are four possible adjacent fringe links from node 5: (5,1), (5,2), (5,3) and (5,8). If all of these links are added to fringe link set L , then when updating L from node 4, there is no chance for the (better) links (4,1) and (4,2) to be added to L because they have the same priority to (5,1) and (5,2). This is one of the key reasons making Member-First inefficient.

Consequently, it is more reasonable to add only one link from an MI node provided that the selected link must have the highest priority. By this way, when selecting the highest priority link from L in order to add to the multicast tree, we just go straight-forward without any branch-cutting or link-removing (cf. step 4 of MF algorithm in Subsection 4.3.1). Moreover, there are chances for other adjacent nodes of v to be end-nodes of other fringe links.

To this end, we define a new concept called *bud-link* that is quasi-equivalent to fringe link. A bud-link (BL) is similar to a fringe link except that from an MI node there is only one possible bud-link (whereas there may be more than one fringe link). Formally, given a network (G, S) , a request multicast $r = (s, D)$ and an under-construction tree T , a *bud-link* is an directed edge (x, y) such that $x \in V(T)$ and $y \notin V(T)$ and if $x \notin S$ (i.e., x is an MI node) then the degree of x in T is 1. The bud-link set is updated in such a way that:

1. From any MI node in T , the only selected bud-link is the link with highest priority among possible links adjacent to it.
2. At any time, a bud-link (x, y) is the link that has the highest priority among those possible links leading to node y . Thus, when updating a bud-link (x, y) , if there are links (x', y) already in the bud-link set, the selected link is the one that has highest priority, and the other must be removed from the set.

Using the new concept of bud-links and applying the way they are updated as mentioned above to the network in Fig. 4.1, the resultant light-forest including a single light-tree is created with the total cost of 9, and the maximum delay of 3 as shown in Fig. 4.2c. This is the best tradeoff solution among the others.

However, there are cases where the heuristic can lead to useless branches in the computed light-tree from MI nodes. These unnecessary branches need to be resolved by a special mechanism that is detailed in the next subsection.

4.3.4 Pruning Useless Branches

As mentioned above, with the defined priority of the bud-links, in some cases our heuristic could direct the tree following the same route for different iterations in con-

structuring light-tree. If nothing should be done, this would make the algorithm suffer from infinite loops without termination. To make it clear, let us consider the example in the topology in Fig. 4.3. For the topology shown in Fig. 4.3(a), according to the new priority model described in Section 4.3.2, the algorithm selects bud-links in the order of $\langle (0, 1), (0, 2), (1, 4), (2, 5), (4, 8), (4, 9) \rangle$ to compute the first tree as shown in Fig. 4.3(b) (note that the source is always considered as an MC node as presumed). After pruning useless branches, the first tree includes the path $\langle 0, 1, 4, 8 \rangle$. If nothing is done, the algorithm will stop and it is the only tree could be computed although there are two more destinations yet to be spanned. This is because, the stricter rule for updating bud-links prevents the heuristic from adding other bud-links from MI nodes (1 and 2 as in the example). As a result, it gives no chance for other destinations (nodes 7 and 10 in the example) to be visited.

Realizing the situation, we equip the heuristic with an efficient technique to re-direct the tree in such cases: when the tree cannot grow more, all the useless branches (branches that do not lead to any member) in the current tree as well as in the graph must be pruned. The pruning is operated in a bottom-up manner from the non-member leaves up to the root of the current tree. It will be stopped when reaching a destination, or a MC branching node in the current tree, or an MI node that can lead to other nodes in the graph. Then the BL set is re-updated from MI nodes (if any) at which the pruning stops. By this way, the above-mentioned situation will be avoided. This pruning process is implemented in the algorithm as described in Algorithm 4.1, lines 13–20.

Back to the above example, suppose that the algorithm chooses bud-link (1,4) before (2,5). After the algorithm selects bud-link (1,4), from node 4, links (4,8) and (4,9) can be added to the BLs, whereas from node 5, there is no more bud-link can be updated (the link (5,9) cannot be updated because its priority is not higher than bud-link (4,9) that is already in BLs). Besides, node 5 is not a destination, so node 5 and its adjacent links must be pruned from the tree as well as from the graph. After pruning node 5, node 2 is taken into consideration. Since there is an other possible bud-link (2,6) from node 2, it should not be pruned. Besides, because node 2 is MI, the algorithm re-updates the BLs from it and hence bud-link (2,6) is added. The algorithm then adds bud-links (2,6), and (6,10) to the tree. It then chooses bud-links (4,8) and then (4,9) to add to the tree. Similarly, node 9 and its adjacent links are pruned from the tree and the graph. Finally, the algorithm stops with the first tree as shown in Fig. 4.3(c).

In order to compute the next tree, after completely constructing a tree, the algorithm must prune useless parts of the graph that cannot grow any tree. For example, the sub-graph corresponding to the first tree in Fig. 4.3(c) must be pruned from the graph. This pruning is also performed in a bottom-up manner as described above. First, remove from the graph the nodes that are leaves in the current tree. Then, while there exists a leaf in the current tree, and it is also a leaf node of the graph, then remove it from the graph

and the tree as well. Applying this to the example, nodes 8, 10, 4, 6, 2 (and their adjacent links) are in turn removed from the graph. The remaining part of the graph is shown in Fig. 4.3(d). Thus, the second tree is then created as shown in Fig. 4.3(e). This pruning process is shown in the description of the algorithm in the next section (cf. Algorithm 4.1, lines 22–25).

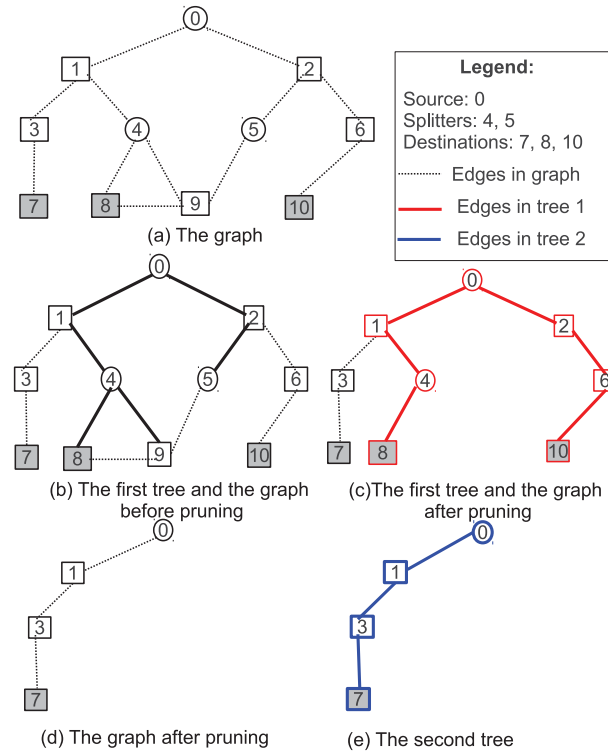

Figure 4.3 – Demonstration of pruning useless branches

4.3.5 Member-Splitter-First Algorithm

Combination of the above improvements results in the new algorithm, and we call it Member-Splitter-First, or MSF in short. The resultant forest obtained when applying MSF to the network in Fig. 4.1 is shown in Fig. 4.2d. As it is shown, this light-forest includes a single light-tree with the total cost of 10, and the maximum delay of 2. It is the best trade-off solution in comparison to the previous light-forests.

The description of Member-Splitter-First Algorithm is given in Algorithm 4.1. The procedure *UpdateBL* for updating bud-links is followed right after.

In the **while** loop in lines 8–19, the tree T grows as much as possible based on the graph G' by choosing a highest priority link among all possible bud-links. During this time, the **for** loop in lines 12–16 prunes vertices and related branches from the tree and from the graph that cannot grow more. After pruning branches, there is an important step to re-update the bud-link set from an MI node (line 17) in order to re-direct the light-tree to

Algorithm 4.1 Member-Splitter-First Algorithm

Input: A network (G, S) and a multicast session (s, D) **Output:** A light forest F satisfying (s, D)

```

1:  $G' \leftarrow G$ ; {Make  $G'$  a copy of  $G$ }
2:  $BL \leftarrow \emptyset$ ; { $BL$  is the fringe link set}
3:  $D' \leftarrow D$ ; { $D'$  is set of destinations yet to be included}
4:  $F \leftarrow \emptyset$ ;  $T \leftarrow \emptyset$ ;
5: while  $D' \neq \emptyset$  do
6:    $V(T) \leftarrow \{s\}$ ;  $E(T) \leftarrow \emptyset$ ;
7:   UpdateBL( $s, BL$ ){Initialize fringe link set  $BL$  from  $s$ }
8:   while  $L \neq \emptyset$  do
9:     Choose a fringe link  $e = \{v, u\}$  with highest priority
10:     $V(T) \leftarrow V(T) \cup \{u\}$ ;  $E(T) \leftarrow E(T) \cup \{e\}$ ;
11:    UpdateBL( $u, BL$ );{Update fringe link set  $BL$  from  $u$ }
12:    for every node  $x$  along the path  $P_{u,s}$  from  $u$  to  $s$  do
13:      if  $x \notin D'$  and  $x$  is a leaf of  $T$  that do not lead to any fringe links then
14:        delete  $x$  and its adjacent edges from  $T$  and  $G'$ 
15:      end if
16:    end for
17:    if  $x$  is an MI node, then UpdateBL( $x, BL$ ); {Re-update  $BL$  from MI node  $x$ }
18:    if  $u \in D'$  then  $D' \leftarrow D' \setminus \{u\}$ ;
19:  end while
20:   $T' \leftarrow T$  {Make  $T'$  a copy of  $T$ };
21:   $F \leftarrow F \cup T$ ;
22:  Delete from  $T'$  and  $G'$  the leaves of  $T'$  and their adjacent edges
23:  while there exists a leaf  $l \in T'$  and  $l$  is also a leaf node of  $G'$  do
24:    delete  $l$  and its adjacent edges from  $T'$  and  $G'$ 
25:  end while
26: end while

```

Procedure UpdateBL(v, BL){update bud-link set BL from v }

```

for every adjacent link  $e = (v, u)$  do
  if  $\exists u \notin T$  and  $\nexists e' = (v', u) \in BL$ 
  or  $\exists e' \in BL$  has lower priority then
    if  $v$  is an MC node then
       $BL \leftarrow BL \cup \{e\}$ ;
      if  $\exists e' \in BL$  has lower priority then  $BL \leftarrow BL \setminus \{e'\}$ ;
    else
      find  $e^*$  with highest priority among  $e$ ;
    end if
  end if
end for
if  $v$  is an MI node then
   $BL \leftarrow BL \cup \{e^*\}$ ;
  if  $\exists e' \in BL$  has lower priority then  $BL \leftarrow BL \setminus \{e'\}$ ;
end if

```

grow from another bud-link. Finally, when the tree is constructed and added to the forest, instructions in lines 22–25 prune vertices and related edges from T and G' that are no longer necessary to continue the forest computation.

An example to illustrate the tree computation of MSF algorithm is shown in Fig. 4.4. Fig. 4.4(a) represents a network and a multicast request. Fig. 4.4(b) shows the first tree in which vertices 3, 1, 4 and 5 are not destinations. These vertices have been removed by the loop of line 8. Then the procedure *UpdateBL* is invoked to re-update the bud-link from MI node 2. The light-tree continue to cover 8, 9, 10 and 11 as shown in Fig. 4.4(c). It is the actual first light-tree. After that, vertices 9, 11 and then 10 are deleted. Finally, a second tree corresponding to the path $\langle 0, 2, 6, 7, 8 \rangle$ is created as shown in Fig. 4.4(d).

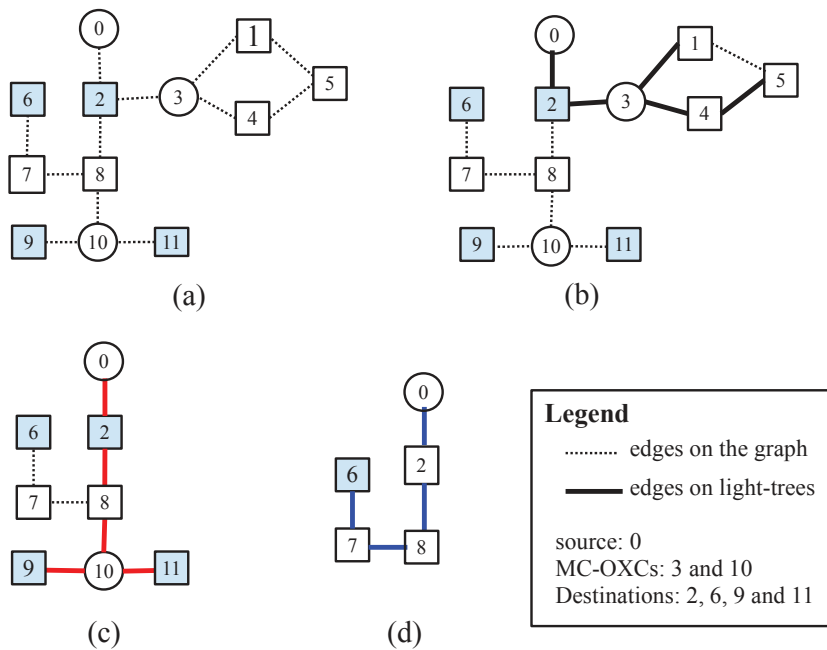

Figure 4.4 – Illustration of MSF algorithm

4.3.6 The Correctness of MSF Algorithm

The algorithm is correct and deterministic. Indeed, during the execution of the algorithm, the graph G' remains connected. This is because the pruning process making on leaves of T' or leaf vertices of G' does not affect the connectedness of the graph G' . Moreover, every tree built has at least two vertices (s and a destination). Thus, at least one node of G' is deleted by instructions in lines 22–25. Since $D' \subset V(G')$ and that $|V(G')|$ strictly decrease, it is eventually empty and the algorithm stops.

4.4 Simulation Results

To evaluate the proposed algorithm in comparison to the other classical ones, we carry out series of simulations with well-known networks: NSF network (NSFNET) (Fig. 4.5a), European COST-239 network (Fig. 4.5b) and US Longhaul network (Fig. 4.5c). These networks are testbeds of many studies [56, 58, 70, 71, 90, 91], that is the reason for our selection. These topologies also are used very often in the following chapters.

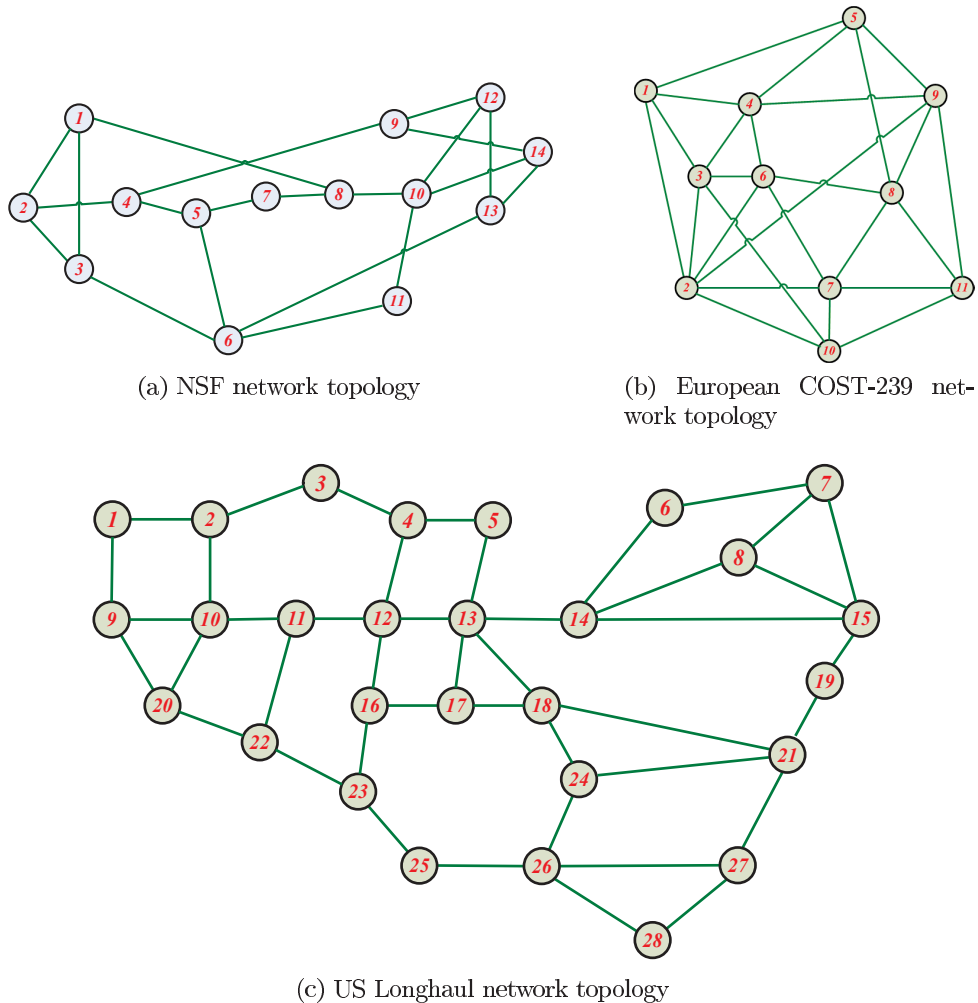

Figure 4.5 – Testbeds for simulations

4.4.1 Simulation Settings

In our simulation, each node of the network is in turn selected as the source for a multicast session. As presumed, the source is equipped with multiple transmitters, so it is considered to be capable of both splitting and "wavelength conversion" regardless of its actual capacity. Besides, the source is not be counted in the group size nor in the number of MC nodes. Therefore, given an N -node network, after selecting the source, the group size

and MC nodes are selected from $N-1$ remaining nodes. The destinations and MC nodes are distributed uniformly throughout the network. For a given source, a given multicast group size, and a given number of MC nodes, 100 random multicast sessions are generated. Hence, the average result is calculated on $100 \times |V|$ values for the three metrics: *wavelength consumption*, *total cost*, and *maximum delay*. We compute the 95% confidence intervals for all the results as shown in the figures.

To evaluate the performance of the proposed algorithm in comparison with the others, the simulations are divided into two scenarios: effect of Group Size (i.e., the number of destinations) and effect of Splitting Capacity (i.e., the number of MC nodes). Details of these settings are described in the next two subsections.

4.4.2 Effect of Group Size

Firstly, we study the performance of the proposed algorithm versus multicast group size, i.e., the number of MC nodes is set fixed while the group size varies. For the sparse splitting capacity of network, a few MC nodes is set. In particular:

- For 14-node NSFNET (Fig. 4.5a), the number of MC nodes is set at 3 nodes (23%) and the group size is varied from the list (1, 2, 3, ..., 13).
- For 28-node US Longhaul network (Fig. 4.5c), the number of MC nodes is set as 9 nodes (33%) and the group size is varied from the list (3, 6, 9, ..., 27).
- For 11-node European COST-239 network (Fig. 4.5b), the number of MC nodes is set at 2 nodes (20%) and the group size is varied from the list (1, 2, 3, ..., 10).

Fig. 4.6 shows the performances of all the algorithms operated in NSFNET and Longhaul network on the three metrics. First, performances on the number of wavelengths used are shown in Fig. 4.6a and Fig. 4.6b. When the group size increases, MSF keeps the lowest wavelength consumption constant around the optimal value (1). It outperforms MF, especially when the group size becomes large. As shown in Fig. 4.6a, when the group size is 13 (100%), the difference between the two peaks at 32.5%. The average improvement obtained for all the group sizes is 12.4%. Similar results can be seen in Fig. 4.6b with Longhaul network, the corresponding improvement values are: 29.2% and 15.3%. For the total cost, as shown in Fig. 4.6c and Fig. 4.6d, all the algorithms experience increasing cost when the group size increases. Also, MSF provides a better total cost than MF (with the maximum gain of 8% in NSFNET and 7% in Longhaul network). When group size becomes larger, MSF is close to the best reference cost resulted from MO. For the delay (Fig. 4.6e and Fig. 4.6f), MSF provides a better delay than MF (with the average gain of 3.5% in NSFNET and 6.6% in Longhaul network). Especially, it performs better than Re2A and MO in NSFNET.

For the denser COST-239 network, the results are shown in Figs. 4.8a,4.8c and 4.8e. As presented, MSF (together with MO and Re2A) results in the minimal wavelength consumption, which better than MF; the maximum delay is close to the optimal delay of Re2S and much better than MF; while the total cost is the same as MF.

In short, with the sparse splitting capacity, MSF algorithm outperforms MF counterpart. Among all the algorithms, it produces the lowest wavelength consumption, a low total cost and a low end-to-end delay. Especially, its performance is better when the group size is large and is more advantageous the denser connectivity network.

4.4.3 Effect of Splitting Capacity

This subsection presents the performances of the all the algorithms versus splitting capacity (or the number of MC nodes), thereby evaluating the proposed heuristic in comparison to the others. The settings for each topology is given as follows.

- For NSFNET, the group size is set at 10 nodes (77%) while the number of MC nodes varies from the list (1, 2, 3, ..., 13).
- For US Longhaul network, the group size is set at 24 nodes (89%) while number of MC nodes varies from the list (3, 6, 9, ..., 27).
- For European COST-239 network, the group size is set at 8 nodes (80%) while the number of MC nodes varies from the list (1, 2, 3, ..., 10).

The simulation results conducted in NSFNET and Longhaul network are shown in Fig. 4.7. According to Fig. 4.7a and 4.7b, MSF retains the best wavelength consumption constant around the optimal value (1). It even performs better than MO at very sparse splitting. For the total cost (cf. Fig. 4.7c and 4.7d) and the end-to-end delay (cf. Fig. 4.7e and 4.7f) while MO achieves the lowest total cost but the highest delay and Re2S, in contrast, produces the lowest delay but the highest total cost, MSF provides a good trade-off between the two metrics when always ranking second in those metrics. Again, it always outperforms MF. In particular, on average, MSF achieves 12% (in NSFNET) and 16% (in Longhaul network) on wavelength consumption compared with MF. The difference between the two is clearer when the number of MC nodes is small (sparse splitting).

For the COST-239 network, the better performance can be seen for MSF as shown in Fig. 4.8b,4.8d and 4.8f. With the large group size (80%), MSF appears the best one when achieving the minimal wavelength consumption (together with MO and Re2A), nearly the optimal end-to-end delay as Re2S (Fig. 4.8f), while keeping slightly better total cost compared with MF (Fig. 4.8d).

In short, when the group size is set fixed at high percentage, MSF achieves the best wavelength consumption, a good total cost and low end-to-end delay. MSF also works better in dense networks.

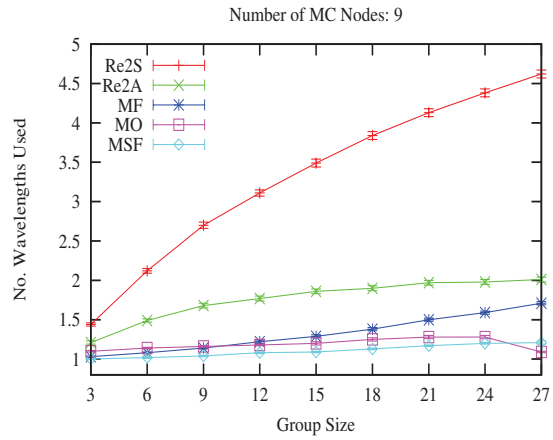
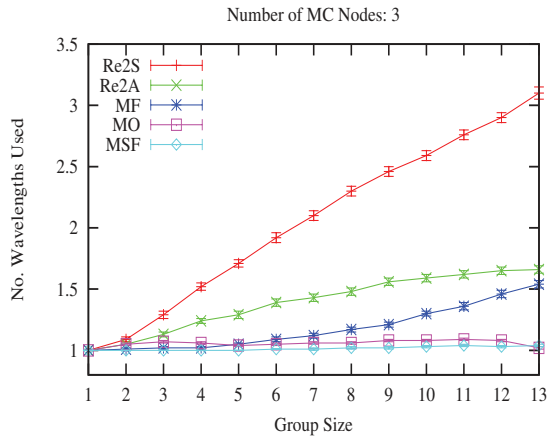

(a) No. Wavelengths Used vs. Group Size in NSFNET (b) No. Wavelengths Used vs. Group Size in US Longhaul Network

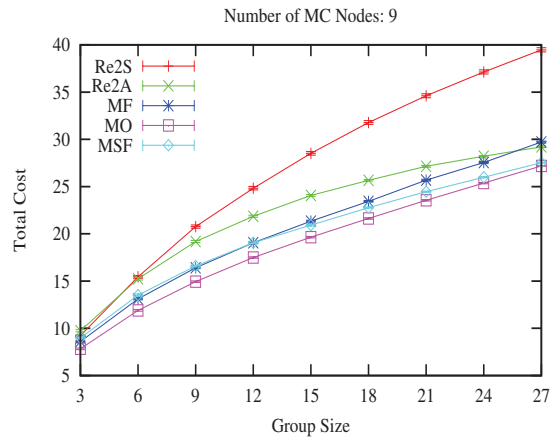
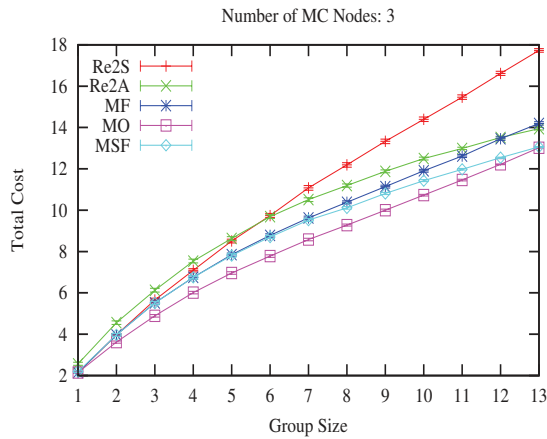

(c) Total Cost vs. Group Size in NSFNET (d) Total Cost vs. Group Size in US Longhaul Network

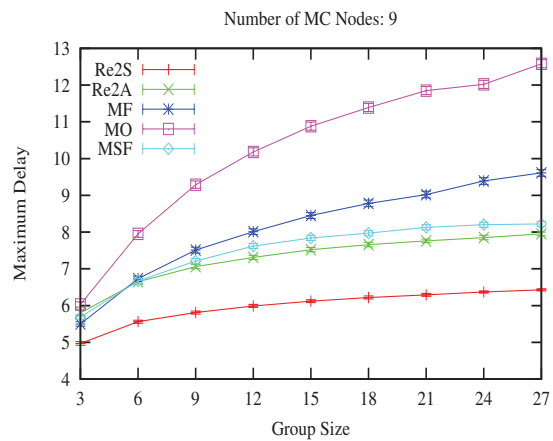
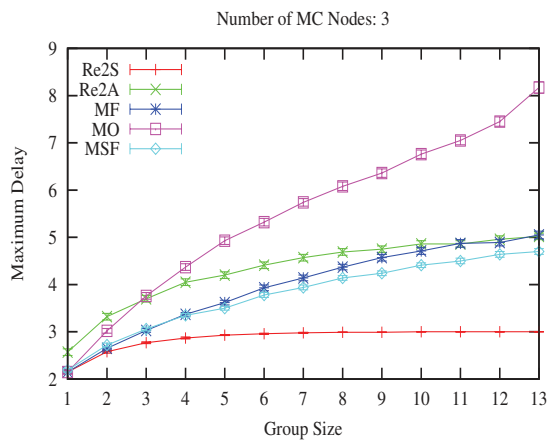

(e) Maximum Delay vs. Group Size in NSFNET (f) Maximum Delay vs. Group Size in US Longhaul Network

Figure 4.6 – Performances of algorithms versus Group Size in NSFNET and US Longhaul Network

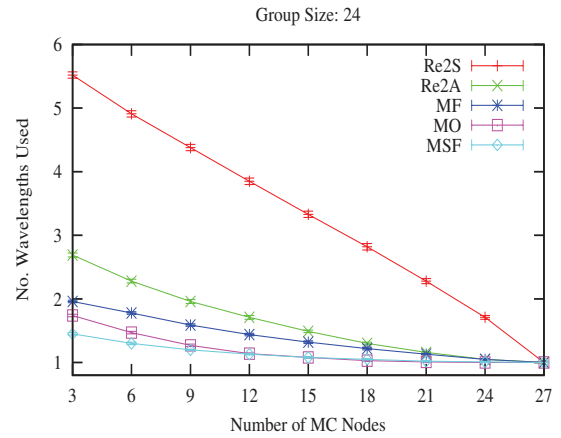
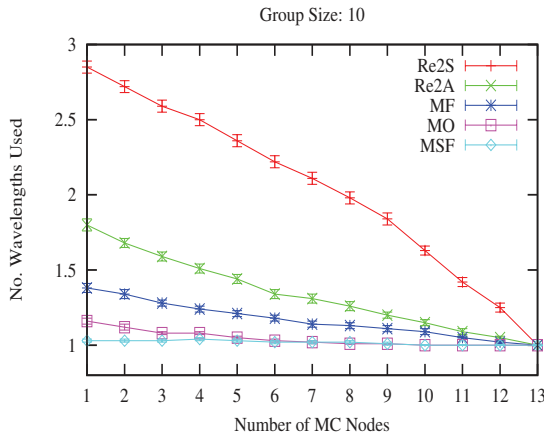

(a) No. Wavelengths Used vs. Splitting Capacity in NSFNET

(b) No. Wavelengths Used vs. Splitting Capacity in US Longhaul Network

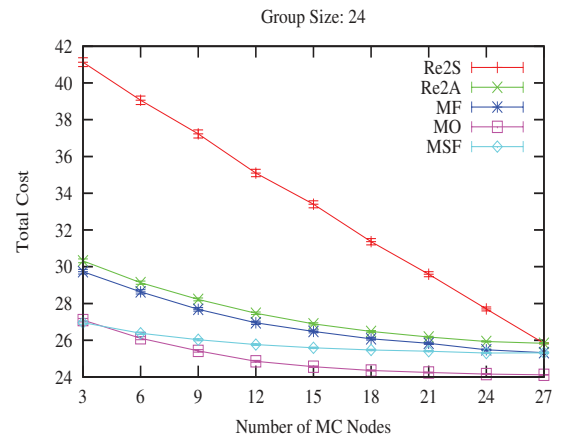
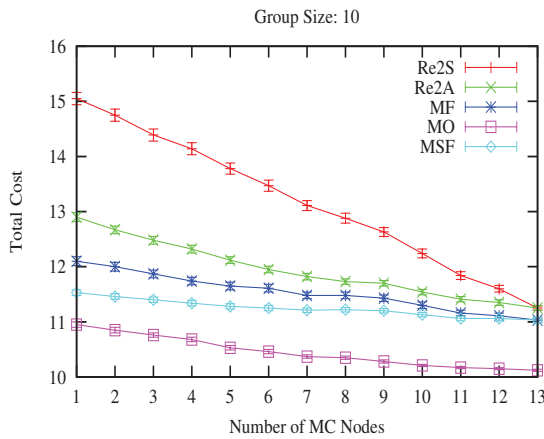

(c) Total Cost vs. Splitting Capacity in NSFNET

(d) Total Cost vs. Splitting Capacity in US Longhaul Network

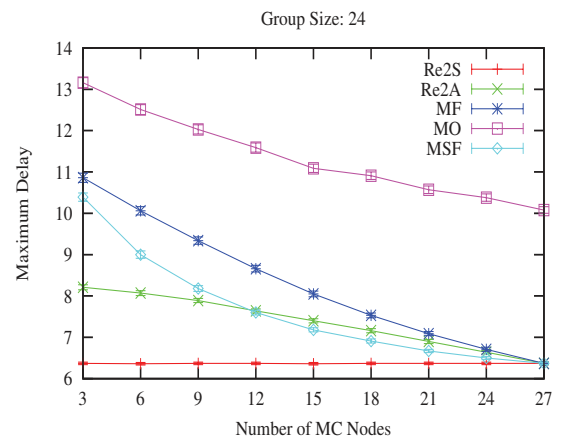
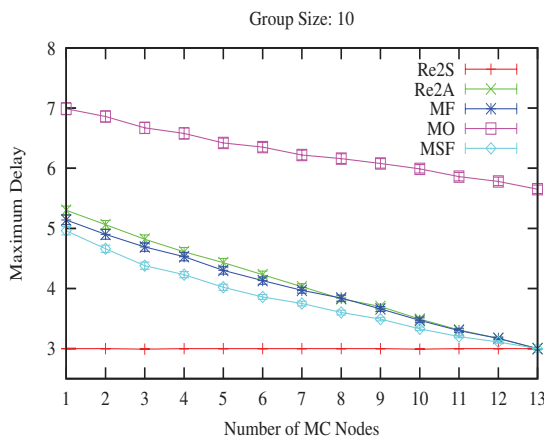

(e) Maximum delay vs. Splitting Capacity in NSFNET

(f) Maximum delay vs. Splitting Capacity in US Longhaul Network

Figure 4.7 – Performances of algorithms versus Splitting Capacity in NSFNET and US Longhaul Network

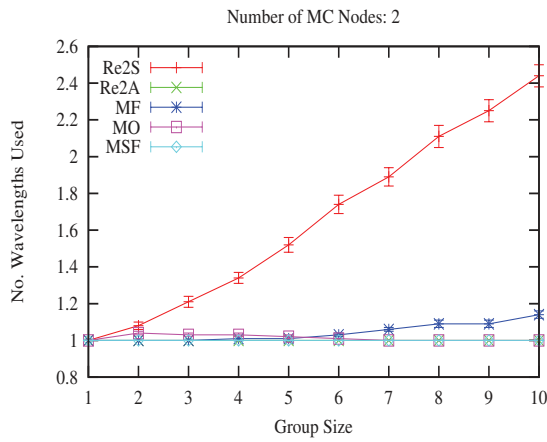

(a) No. Wavelengths Used vs. Group Size

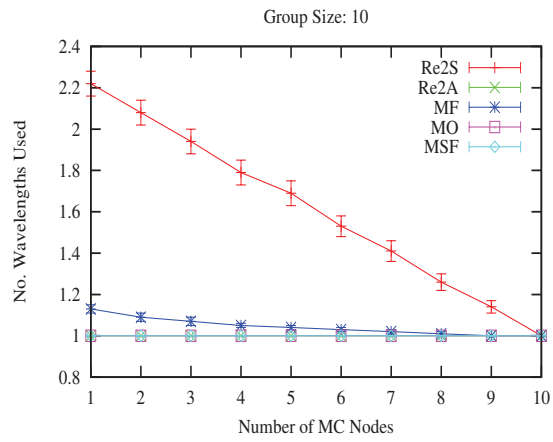

(b) No. Wavelengths Used vs. Splitting Capacity

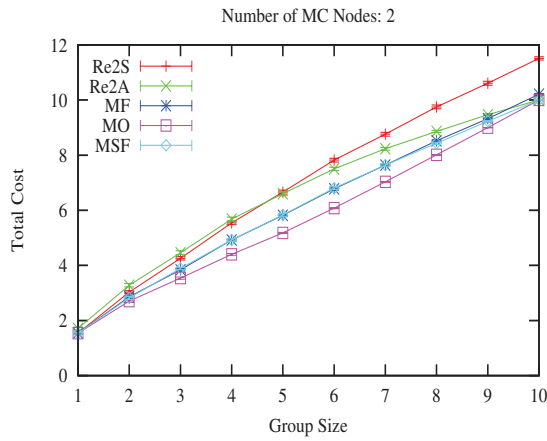

(c) Total Cost vs. Group Size

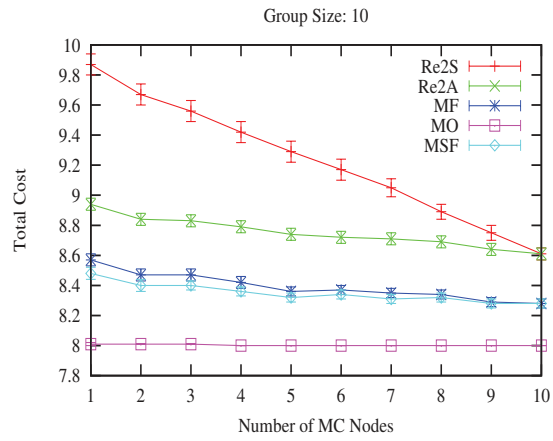

(d) Total Cost vs. Splitting Capacity

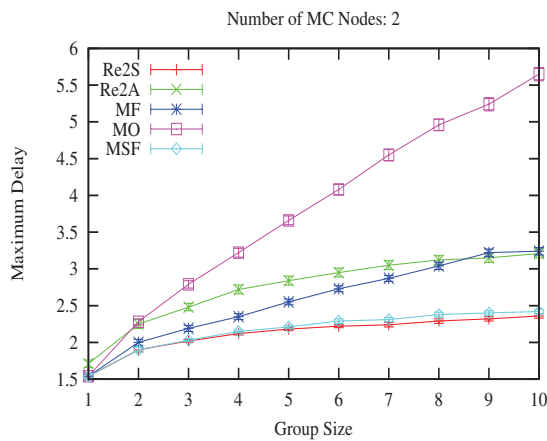

(e) Maximum delay vs. Group Size

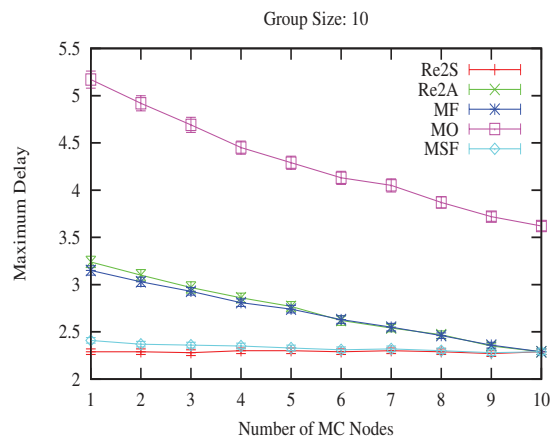

(f) Maximum delay vs. Splitting Capacity

Figure 4.8 – Performances of algorithms in European COST-239 Network

4.5 Conclusion

In this chapter, the AOMR problems in sparse splitting WDM networks without wavelength conversion were investigated and the known algorithms for light-forest construction were also evaluated. Since no algorithm can achieve a good tradeoff among cost, delay and wavelength consumption, we proposed a new algorithm called Member-Splitter-First (MSF). MSF is based on the framework of Member-First algorithm, making several improvements on the priority model and the way of constructing light-trees. MSF not only consider the membership but also take into account the available MC nodes and degree of the nodes.

Various simulations have been carried out to evaluate the performance of our proposed algorithm and to compare with the other algorithms. Simulation results show that MSF outperforms Member-First in all the performance metrics. Among the others, MSF achieves the lowest wavelength consumption, a low total cost (ranks second, behind Member-Only) and a low end-to-end delay (also ranks second, just behind Reroute-to-Source). In general, MSF provides a good trade-off among performance metrics in sparse splitting capacity and with the large number of destinations. Especially, MSF works better in highly connected networks (e.g., European COST-239 network).

■ Key points of Chapter 4 ■

- A new algorithm called Member-Splitter-First to construct a light-forest in sparse splitting WDM networks without wavelength conversion is proposed, taking the wavelength consumption, cost and delay into account.
- Member-Splitter-First algorithm based on three improvements on Member-First algorithm. First, a new priority model which helps to better explore the possible MC nodes, therefore reducing the cost and the delay. Second, a priority queue is managed more efficiently that permits only one best candidate link from MI nodes, which facilitates the process of the tree repair. Finally, a special heuristic is proposed to prune the useless branches, which helps the tree computation to quickly obtain the feasible solution.

AOMR without Splitters and Converters

This chapter devotes to investigate the AOMR problems without splitters and converters with arbitrarily available wavelengths in the links. We aim at minimizing the network resources which are characterized by two metrics: the number of wavelengths used and the total cost. The *light-spider-hierarchy* mentioned in Chapter 2 is discussed in detail for the exact solutions of the problems. An ILP formulation based on light-spider-hierarchy is developed to find the exact solution, and several efficient heuristic algorithms are also proposed to compute the approximate solutions. Theoretical analysis and simulation results show that the optimal solution of the problem is a set of light-spider-hierarchies independent to the focus either on the number of wavelengths used or the total cost.

5.1 Introduction

Among the optical constraints, the availability of light splitters in the switches is often the most difficult one due to many reasons. First, splitters are expensive and complicated in fabrication. Besides, splitting causes significant power loss¹. Also, wavelength converters are still immature. Therefore, we assume neither splitters nor wavelength converters present in this study. Fortunately, multicasting in WDM networks without splitters and wavelength converters is still feasible with the help of TaC cross-connects proposed in [6].

In fact, multicasting in non-splitting WDM networks without wavelength converters have been studied in several works [6, 49, 86, 87] as mentioned earlier in Subsection 3.2.2 (Chapter 3). These works were based on either light-paths [86, 87], light-trails [6], or light-

¹In the ideal case, the power loss is inversely proportional to the number of split signals at the outgoing ports [5]

spiders [49]. However, there is lack of a deep investigation on the best light-structures for the problem as well as efficient algorithms to find the exact solutions.

In addition, all of the above previous works assume the same set of wavelengths available in all the network links (i.e., *symmetric wavelength distribution*). Regarding the optimization objective, these works aimed at minimizing the network resources taking both the number of wavelengths and the wavelength total cost into account, in which the number of wavelengths is assigned with a focus weight. However, in some practical AOMR cases, the optical networks are given with arbitrary wavelengths available in each link. In such cases, minimizing the total number of links is more important than the number of wavelengths.

This chapter aims at filling the holes in literature works for routing in non-splitting WDM networks. Specifically, first, we consider a general case with arbitrary wavelength distribution. Second, we consider the combined objective function either focused on wavelength consumption or on total cost. Moreover, we identify the exact solution for the problem and compute it based on an appropriate ILP formulation. Finally, several heuristic algorithms are proposed to approximately compute the routes. Various simulations are conducted to support any announced outcome.

The rest of this chapter is organized as follows. In Section 5.2, two variants of the concerned problem are formulated: Minimum Number of Wavelengths First (MNWF) and Minimum Total Cost First (MTCF). Section 5.3 identifies the exact solutions for the two problems. Section 5.4 discusses their hardness with regard to the defined solutions. Section 5.5 develops an ILP formulation based on light-spider-hierarchies to compute exact solutions. Section 5.6 introduces an algorithm to solve MNWF problem and Section 5.7 presents two other heuristics to solve MTCF problem. Section 5.8 summaries the important contributions presented in this chapter.

5.2 Problem Formulation

A WDM network topology is given by a directed graph $G = (V, A)$, in which V represents a set of nodes and A represents a set of directed fibers. We assume that there are at most two fibers between every node pair, and each fiber has arbitrarily available wavelengths. Let W be the set of all the possible wavelengths in the network (and for the sake of presentation, we also use W for the number of the wavelengths $|W|$ as well). Since the number of wavelengths can be different in the fibers, we denote $w(a)$ the set of available wavelengths in fiber $a \in A$: $w(a) \subseteq W$, $\forall a \in A$. Also, we assume that each fiber a is associated with a positive number $c(a)$ representing the cost of using a wavelength (e.g., wavelength cost) on that fiber. Fig. 5.1 illustrates an example of a network with different distribution of wavelengths in the fibers.

Given a multicast request denoted by $r = (s, D)$, the problem consists in finding a multicast route F starting at the source s that spans the destinations D and targeting

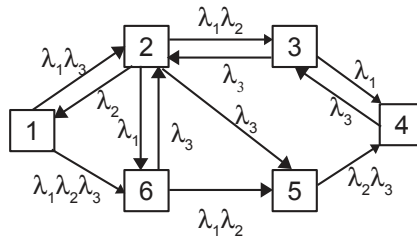

Figure 5.1 – An example WDM network

a given objective. Each link used in F is assigned a wavelength such that it satisfies the aforementioned constraints. Without loss of generality, suppose that F consists of several light-structures, with each using a distinct wavelength. Since there is no wavelength converter, a wavelength should be retained on all the links along a light-structure (*wavelength continuity constraint*), and the light-structures sharing a common link must use different wavelengths (*distinct wavelength constraint*) (cf. Subsection 3.3.1).

Besides, F must comply a supplementary constraint called *degree constraint*: every node *except the source* used in any light-structure should have a degree bounded by two, or equivalently, there is no branching vertices (except at the source) in all the light-structures. As analysed in Subsection 2.2.2 (Chapter 2), such a multicast route F corresponds to a *spider-based hierarchy*, and each light-structure can be either a light-spider or a light-spider-hierarchy.

This chapter considers the problem of minimizing the network resources which are characterized by the number of wavelengths used and the total cost. Assume that F consists of K light-structures T_i , $i = 1, \dots, K$, the number of wavelengths needed to perform the multicast request r is equal to K :

$$\text{num_wave}(F) = K$$

The total cost is the cost of F , calculated by the summation of the costs of all the light-structures T_i :

$$\text{total_cost}(F) = \sum_{i=1}^K \text{cost}(T_i) = \sum_{i=1}^K \sum_{a \in T_i} c(a)$$

The combined objective function can be expressed as:

$$\alpha \cdot \text{num_wave}(F) + \beta \cdot \text{total_cost}(F) \quad (5.1)$$

in which the coefficients (α, β) represent the importance of the number of wavelengths used and the wavelength total cost, respectively.

From the combined objective function 5.1, two extremity subproblems can be derived depending on the focus either on one or the other component: 1) *Minimum Number of Wavelengths First (MNWF)*: finding minimum number of wavelengths used first, then searching for the multicast route having the least total cost; and 2) *Minimum Total Cost First (MTCF)*: finding the least cost multicast route using as few number of wavelengths as possible. By setting appropriate values to the coefficients, the two problems can be stated formally as follows.

Problem 5.1. Non-splitting AOMR problems:

- **Instance:** a directed graph $G = (V, A)$, a request (s, D) , a set of wavelengths W , a mapping w , and a cost function c
- **Solution:** a set of light-structures $\{T_i, i = 1, \dots, K\}$ satisfying the three constraints: wavelength continuity constraint, distinct wavelength constraint and degree constraint.
- **Objective:** minimize the objective function 5.1 with:
 1. $\alpha = 1 + W \times \sum_{a \in A} c(a)$ and $\beta = 1$ (for MNWF) or
 2. $\alpha = 1$ and $\beta = 1 + W$ (for MTCF).

In the next two sections, the exact light-structure mentioned in the *Solution* is identified (Section 5.3), and the hardness of the two problems with respect to the defined structure is discussed (Section 5.4).

5.3 Exact Solutions

First, we consider the Minimum Number of Wavelengths First (MNWF) problem.

Theorem 5.1. *The optimal solutions for the problem of minimizing the number of wavelengths in non-splitting WDM networks is a set of light-spider-hierarchies.*

Proof. As mentioned in Subsection 2.2.2 (Chapter 2), we have concluded that all possible solutions for the non-splitting AOMR problems can be modeled by a spider-based hierarchy. In WDM multicasting, it can be realized as either a set of *light-spiders* or a set of *light-spider-hierarchies*. Since light-spider-hierarchy is a general case of light-spider, every solution based on light-spider can be considered belonging to light-spider-hierarchy. So to prove Theorem 5.1, it is sufficient to point out that the light-spider solution does not guarantee the optimal solution. To this end, let us consider an example in Fig. 5.2.

The network topology given in Fig. 5.2a where there are two wavelengths available in all the links. The wavelength cost on every arc is assumed to be unity (1). The multicast request include the source s and the set of destinations $D = \{a, d, e, f\}$. Two solutions based on light-spider (LS) and based on light-spider-hierarchy (LSH) are shown in Fig. 5.2b and

Fig. 5.2c, respectively. As shown in Fig. 5.2b, two LSs (with each using one wavelength) are required, so two different wavelengths are needed to span all the destinations. Whereas only one LSH (hence one wavelength) is sufficient to span all the destinations satisfying the aforementioned *degree constraint* as shown in Fig. 5.2c. Besides, two solutions have the same total cost of 10. Hence, in this case, the light-spider solution is not optimal. So Theorem 5.1 follows.

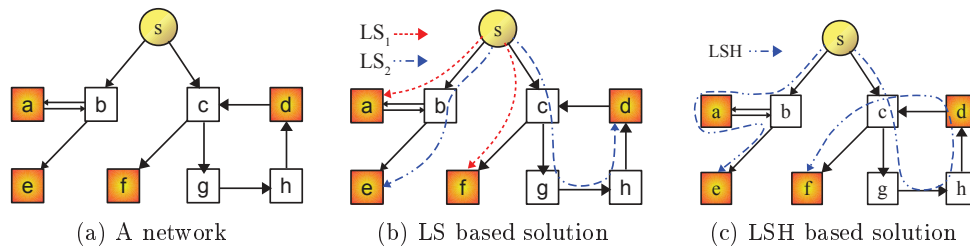

Figure 5.2 – LSH based solution versus LS based solution for the same multicast request

□

Now we consider the Minimum Total Cost First (MTCF) problem.

Theorem 5.2. *The optimal solutions for the problem of minimizing the total wavelength cost in non-splitting WDM networks is a set of light-spider-hierarchies.*

Proof. It is known that the minimum cost multicast route corresponds to tree structure, since there is no redundant edge (arc) created. However, without splitters, the nodes (except the source) cannot have degree greater than two. To guarantee this degree constraint, the solution is a spider-based hierarchy. Taking into account the unicity of wavelengths, the solution can be of three types: a set of light-spiders, a set of edge-disjoint paths or a set of arc-disjoint trails rooted at the source. In fact, all of them are different forms of light-spider-hierarchies. The first one (a spider) corresponds to injective mapping h , and the two latter ones correspond to non-injective mapping h . To prove Theorem 5.2, it is sufficient to point out that light-spiders does not guarantee the optimal solution. This is shown in the example below.

Fig. 5.3 illustrates three possible solutions for the request $(s, \{d_1, d_2\})$ on the same network. Assume that every link is undirected and has unity cost. Among them, Fig. 5.3c shows the cost optimal solution that the light-spider based solution never find.

So the optimal solution always a set of light-spider-hierarchies. □

However, the two aforementioned problems (MNWF and MTCF) may not be optimized at the same time. This is stated by the following lemma.

Lemma 5.1. *In non-splitting WDM networks, the optimal solution for the problem of minimizing the number of wavelengths does not necessarily minimize the total cost, and vice versa.*

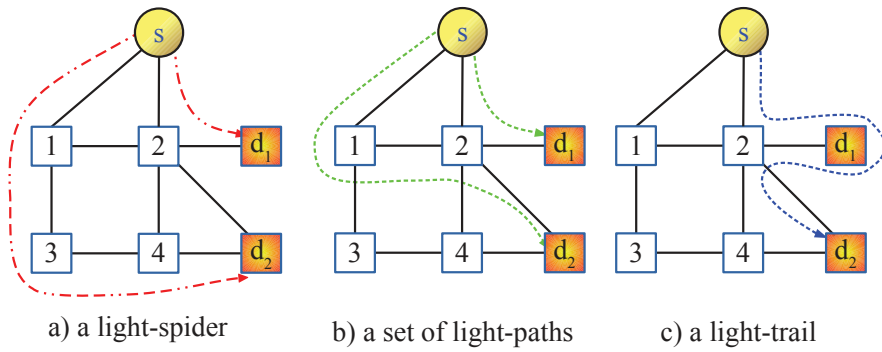

Figure 5.3 – Different LSH based solutions for the same multicast request

Proof. Consider an example in Fig. 5.4. The light-spider-hierarchy based solution consists of a light-trail that spans all destinations nodes in the order $\langle s, 0, 1, 0, 2, 0, 3, 0, \dots, k-2, 0, k-1, 0, k \rangle$. So just only one wavelength is sufficient for this trail. In other words, this light-spider-hierarchy is optimal in terms of number of wavelengths. In contrast, the light-spider based solution corresponds to the set of light-paths $\{ \langle s, 0, 1 \rangle, \langle s, 0, 2 \rangle, \langle s, 0, 3 \rangle, \dots, \langle s, 0, k-1 \rangle, \langle s, 0, k \rangle \}$. All these light-paths share link $(s, 0)$. So the number of wavelengths needed to perform multicast is equal to k .

Suppose that the cost of arc $(s, 0)$ is equal to 1, all the others have costs of 10. Accordingly, the light-spider-hierarchy consumes $cost(LSH) = 1 + 2 \times (k - 1) \times 10 + 10 = 20 \times (k - 1) + 11$. Whereas, the light-spider based solution consumes $cost(LS) = k \times 1 + k \times 10 = 11 \times k$. Obviously, $cost(LSH) > cost(LS), \forall k > 1$. Furthermore, when $k > 1, cost(LS)$ is the optimal cost. Hence, the lemma follows.

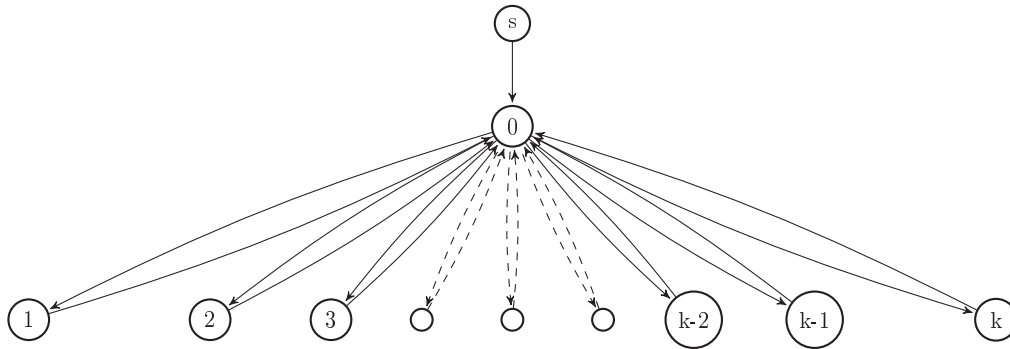

Figure 5.4 – A network $G = (V, A)$, a source node s and a set $D = \{1, 2, 3, \dots, k-1, k\}$.

□

5.4 Problem Complexity

Regarding the exact solutions based on light-spider-hierarchy, this section discusses the complexity of the two mentioned problems.

5.4.1 MNWF Problem

First, we discuss the complexity of MNWF problem. A decision version of the MNWF problem using graph model can be expressed as follows.

Definition 5.1. *Minimum Number of Wavelengths First (MNWF) Problem:*

- *INSTANCE:* A directed graph $G = (V, A)$ representing a network topology, a source $s \in V$, a set of destinations D , $k \in \mathbb{N}$, and a bound $B \in \mathbb{N}$.
- *QUESTION:* Does there exist a set of k trails starting from s that contains at most B arcs and covers all destinations in D ?

We will prove the MNWF problem to be NP-complete by reducing the Multiple-Destination Minimum-Cost Trail (MDMCT) problem [6] to it.

Definition 5.2. *Multiple-Destination Minimum-Cost Trail (MDMCT) Problem:*

- *INSTANCE:* A directed graph $H = (V_H, E_H)$ representing a network topology, a source $x \in V_H$, a set of Destination $U \subseteq V_H \setminus \{x\}$ and a bound $C \in \mathbb{N}$.
- *QUESTION:* Does there exist a trail starting from node x that contains at most C arcs and traverses all destinations in U at least once?

The following theorem provides an insight into the complexity of the MNWF problem.

Theorem 5.3. *Minimum Number of Wavelengths First problem is NP-complete.*

Proof. Clearly, MNWF \in NP since a solution for it can be verified in polynomial time. We will transfer the MDMCT problem to MNWF problem in the following.

Given an instance of MDMCT problem, namely, a directed graph $H = (V_H, E_H)$, a vertex $x \in H$ a set of vertices $U \subseteq V_H \setminus \{x\}$ and $C \in \mathbb{N}$, we create an instance of MNWF problem as follows. First, we duplicate the graph H into k copies, namely $H_1 = (V_1, E_1)$, $H_2 = (V_2, E_2)$, ..., $H_k = (V_k, E_k)$. Accordingly, x is duplicated into vertices x_1, x_2, \dots, x_k , and the set of vertices U is duplicated into k sets U_1, U_2, \dots, U_k . Then, we add two new vertices s, z and connect them by the arc (s, z) . Then we connect z to all the vertices $x_i, i = 1, 2, \dots, k$ of each copy of H_i (cf. Fig. 5.5). In short, we have an instance of MNWF problem, namely: $G = (V, A)$, in which $V = V_1 \cup V_2 \dots \cup V_k \cup \{s\} \cup \{z\}$ and $E = E_1 \cup E_2 \dots \cup E_k \cup (s, z) \cup (z, x_1) \cup (z, x_2) \cup \dots \cup (z, x_k)$. We consider s as a source, and define $D = U_1 \cup U_2 \cup \dots \cup U_k$ as a set of destinations, and bound $B = k \times (C + 2)$. Clearly, this is a polynomial-time reduction.

We now prove that there exists a solution for the instance of MNWF problem if and only if there exists a solution for the instance of MDMCT problem.

1. Suppose that there is a trail T started from x , that contains at most C arcs and traverses all vertices in U at least once. It implies that each component H_i has a trail T_i started from x_i , that contains at most C arcs and traverses all vertices in U_i at least once. Each trail T_i concatenated with a path in the form $\langle s, z, x_i \rangle$ at vertex x_i results in a new trail T'_i started from s , which contains at most $C + 2$ arcs and traverses all vertices in U_i at least once. Thus, a set of k trails $T'_i, i = 1, 2, \dots, k$ defines a solution for MNWF problem.

2. Conversely, suppose there exists k trails starting at s that covers all vertices in D in G , contains at most B arcs and covers all destinations in D . Since the components $H_i, i = 1, 2, \dots, k$ can only be reached from s by a path in the form $\langle s, z, x_i \rangle$, to cover all the destinations in D , k different trails are needed. Each of these trails implies that there must be a trail started from x_i , that contains at most C_i arcs and traverses all vertices in U_i at least once. It is only the case if there exists a solution of MCMDT problem, namely a trail from x that contains at most C arcs and traverses all vertices in U at least once.

Since MCMDT problem is NP-complete, MNWF problem is NP-complete. □

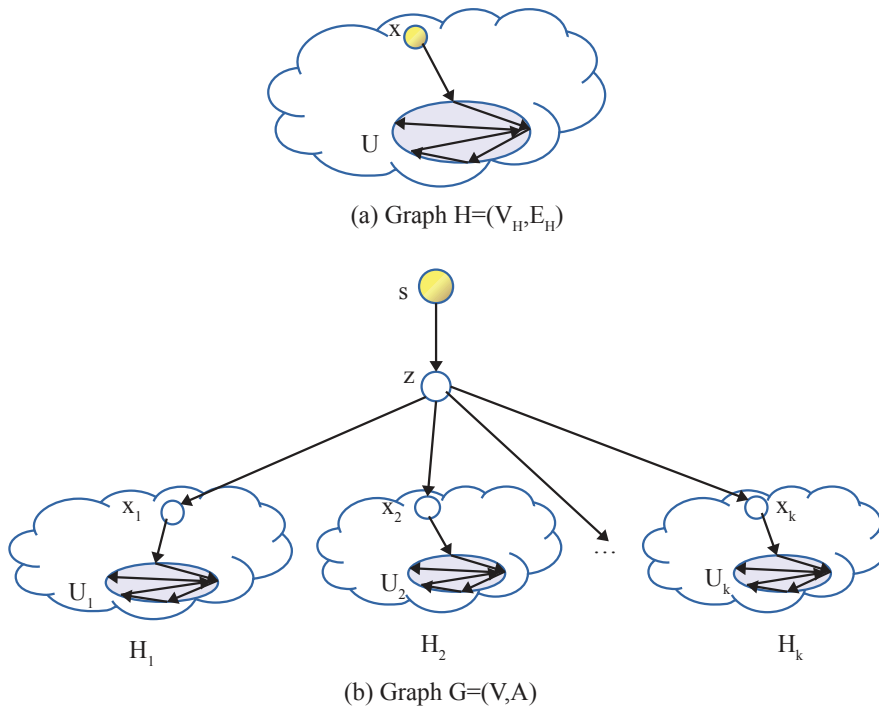

Figure 5.5 – Illustration of transformation from graph $H = (V_H, E_H)$ for graph $G = (V, A)$

5.4.2 MTCF Problem

Now we discuss the complexity of the second problem: Minimum Total Cost First (MTCF).

Theorem 5.4. *The Minimum Total Cost First problem is NP-hard.*

Proof. To prove the NP-hardness of MTCF problem, it is sufficient to prove the problem of minimizing total cost using W wavelengths is NP-hard. To this end, we first model the problem using the layered graph model, then the NP-hard proof is followed.

Given a directed graph $G = (V, A)$ representing the physical topology, a set W representing all possible wavelengths distributed arbitrarily in the network links, and a multicast request $r = (s, D)$, we construct a full layered graph $G' = (V', A')$ including pseudo source s' and the set D' of the pseudo destinations (cf. Chapter 2). To avoid confusion, the terms "node" and "link" are used for the physical topology G , whereas the terms "vertex" and "arc" are used for the layered graph G' . G' consists of W layers. On each layer i , each node $v \in V$ is mapped to a vertex v^i , and each link $(u, v) \in A$ is mapped to an arc $(u^i, v^i) \in A'$ if the wavelength λ_i is available on link (u, v) . We add a pseudo source s' and connect it to every duplicate s^i of the source in all the layers by zero-cost pseudo arcs (s', s^i) . Likewise, for each destination d , we add one pseudo destination d' and connect the duplicates d^i of d to d' also by zero-cost pseudo arcs (d^i, d') . We define $D' = \{d'_1, d'_2, \dots, d'_{|D|}\}$ the set of the pseudo destinations. As a result, the layered graph $G' = (V', A')$ includes a vertex set V' of size $|V'| = |V| \times W + 1 + |D|$ and an arc set A' of size $|A'| = |A| \times W + W + W \times |D|$. Fig. 5.6b gives an example of a layered graph constructed from a given network with the multicast request $r = (1, \{3, 4, 5\})$ shown in Fig. 5.6a.

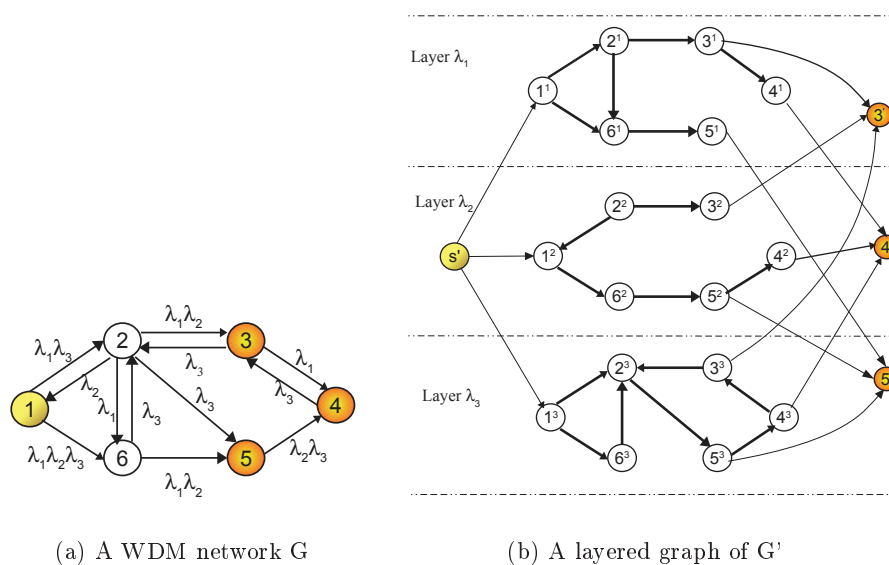

Figure 5.6 – Illustration of modeling MTCF problem using layered graph

Table 5.1 – Network Parameters

$G = (V, A)$	A directed graph representing the network topology
W	The set of available wavelengths (also denote for $ W $)
λ	A wavelength $\lambda \in W$
$wa_{m,n}^\lambda$	$wa_{m,n}^\lambda = 1$ if there is wavelength λ available in link $(m, n) \in A$; $wa_{m,n}^\lambda = 0$, otherwise.
$c_{m,n}$	The wavelength cost of link (m, n)
α	An integer, $\alpha \in \{1, 1 + W \times \sum_{(m,n) \in A} c_{m,n}\}$
β	An integer, $\beta \in \{1, 1 + W\}$
$In(m)$	The set of nodes which have incoming links to node m in G
$Out(m)$	The set of nodes which have outgoing links from node $m \in V$
(s, D)	A multicast request
$Indeg(m)$	The in degree of node m
$Outdeg(m)$	The out degree of node m

The MTCF problem now is transformed to finding a minimum cost multicast tree for the request $r' = (s', D')$ in the layered graph G' , such that:

- the source s' and the vertices s^i can branch without bounded degree, the vertices d^i can have at most two successors in which one successor is d' , $\forall i = 1, 2, \dots, W$,
- and the other vertices cannot branch.

In other words, the MTCF problem becomes the Degree Bounded Directed Steiner tree problem which is NP-hard [72]. So the theorem follows. \square

5.5 ILP Formulation Based on light-spider-hierarchies

In this section, we formulate the considering problem with the solution corresponding to a set of *light-spider-hierarchies*. Let us recall that each LSH can be composed by a set of rooted arc-disjoint trails (and thus, each requiring a distinct wavelength). Since one wavelength can may not sufficient to cover all the destinations, several LSHs (i.e., several wavelengths) may be needed.

5.5.1 Network Parameters and ILP Variables

All the network parameters are presented in Table 6.1 and the ILP variables are shown in Table 6.2 just below. Just a notice for variables $wa_{m,n}^\lambda$, we use them to represent the availability of wavelength λ on the link (m, n) , i.e., $wa_{m,n}^\lambda = 1$ if wavelength λ is available in link $(m, n) \in A$; $wa_{m,n}^\lambda = 0$, otherwise.

Table 5.2 – ILP Variables

$L_{m,n}^\lambda$	Binary variable: $L_{m,n}^\lambda = 1$ if wavelength λ is used on link (m, n) on wavelength λ ; $L_{m,n}^\lambda = 0$, otherwise.
$F_{m,n}^\lambda$	Commodity flow, integer variable: denotes the number of destinations served by link (m, n) on wavelength λ .
$w(\lambda)$	Binary variable: $w(\lambda) = 1$ if wavelength λ is used by the light-trails; $w(\lambda) = 0$, otherwise.

5.5.2 ILP Formulation

The combined objective comprises two components: the number of wavelengths required and the total cost. The (α, β) -notation of the objective (see also the objective function 5.1) can be expressed as follows.

$$\text{Minimize : } \alpha \cdot \sum_{\lambda \in W} w(\lambda) + \beta \cdot \sum_{\lambda \in W} \sum_{n \in V} \sum_{m \in \text{Out}(n)} c_{m,n} \cdot L_{m,n}^\lambda \quad (5.2)$$

We focus on one or the other component by setting the couple (α, β) . Specifically, to minimize the wavelengths first, set: $(\alpha = 1 + W \cdot \sum_{(m,n) \in A} c_{m,n}, \beta = 1)$; to minimize the total cost first, set: $(\alpha = 1, \beta = 1 + W)$.

This objective function is subject to a set of constraints which are listed below.

LSH Structure Constraints

Distinct wavelength constraint:

$$L_{m,n}^\lambda \leq w a_{m,n}^\lambda, \forall (m, n) \in A, \forall \lambda \in W \quad (5.3)$$

Source constraint:

$$\sum_{\lambda \in W} \sum_{m \in \text{In}(s)} L_{m,s}^\lambda = 0 \quad (5.4)$$

$$1 \leq \sum_{\lambda \in W} \sum_{n \in \text{Out}(s)} L_{s,n}^\lambda \leq |D| \quad (5.5)$$

Destination constraint:

$$1 \leq \sum_{\lambda \in W} \sum_{m \in \text{In}(d)} L_{m,d}^\lambda \leq |D| - 1, \forall d \in D \quad (5.6)$$

Degree constraint:

$$\sum_{n \in \text{Out}(m)} L_{m,n}^\lambda \leq \sum_{n \in \text{In}(m)} L_{n,m}^\lambda, \forall \lambda \in W, \forall m \in V \setminus \{s\} \quad (5.7)$$

Non-member nodes constraint:

$$\sum_{n \in \text{Out}(m)} L_{m,n}^\lambda = \sum_{n \in \text{In}(m)} L_{n,m}^\lambda, \forall \lambda \in W, \forall m \in V \setminus (s \cup D) \quad (5.8)$$

Relationship between $L_{m,n}^\lambda$ and $w(\lambda)$:

$$w(\lambda) \geq L_{m,n}^\lambda, \forall m, n \in V, \forall \lambda \in W \quad (5.9)$$

$$w(\lambda) \leq \sum_{m \in V} \sum_{n \in V} L_{m,n}^\lambda, \forall \lambda \in W \quad (5.10)$$

Constraint 5.3 serves two purposes: 1/ to guarantee that a wavelength on a link may be used provided that it is available; 2/ to prevent two LSHs from using a common wavelength on a link, thereby guaranteeing the distinct wavelength constraint. Constraints 5.4 and 5.5 ensure that the source s must not have any incoming links in an LSH, but must have at least one outgoing link on some wavelength and the total number of outgoing links from s should not exceed the number of destinations, i.e., $|D|$.

Constraint 5.6 guarantees that each destination should be spanned in at least one LSH but at most $|D| - 1$ LSHs. For instance, let us see an example as shown in Fig. 5.7 where destination d_1 is spanned by $|D| - 1$ LSHs.

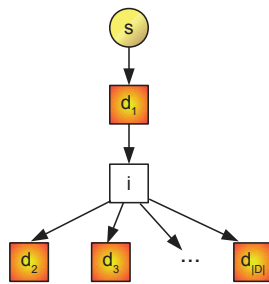

Figure 5.7 – Example to illustrate constraint 5.6

Since all the nodes are MI nodes having TaC option, they can be transited several times provided that the signals are passed on different port pairs. Thus, constraint 5.7 is necessary to ensure that the number of outgoing links should not exceed the number of incoming ones for every LSH. In other words, every node in an LSH should have degree not exceeded 2. Constraint 5.8 makes sure that non-member nodes can be either not used or served only as intermediate nodes. In this case, the number of outgoing links is equal to

the number of incoming ones in every LSH. Constraints 5.7 and 5.8 also imply that only destinations can be leaf nodes. Constraints 5.9 and 5.10 indicate that wavelength λ is used in an LSH if and only if at least one link uses it.

However, the above set of constraints is not enough to guarantee the connectivity of the LSHs as shown in the following. Let us see Fig. 5.8. In Fig. 5.8a, an example network topology is given with the multicast request $r = (s, \{d_1, d_2, d_3\})$. The result when applying the above constraints is shown in Fig. 5.8b in which $L_{s,d_1}^{\lambda_1} = L_{d_2,d_3}^{\lambda_1} = L_{d_3,d_2}^{\lambda_1} = 1$, and all the other variables $L_{m,n}^{\lambda} = 0$. It is easy to verify that these values are satisfied all the above LSH constraints. Unfortunately, the result is not correct, because the resultant structure is not connected (d_2, d_3 are not reachable from the source s). To solve this problem, we use the community method that is proposed in [93]. We introduce an other variable, commodity flow $F_{m,n}^{\lambda}$, as the support of the variable $L_{m,n}^{\lambda}$ in order to make sure the continuity and connectivity of the resultant LSHs.

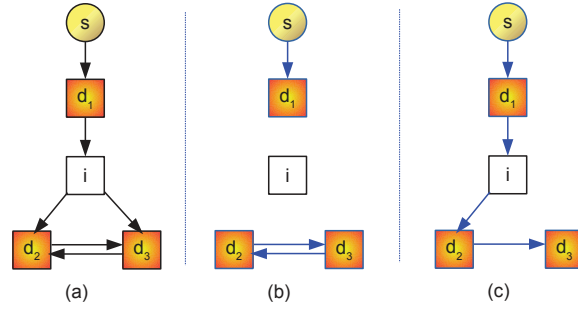

Figure 5.8 – a) An example network topology. b) The failed result. c) The optimal solution.

Connectivity Constraints

$$\sum_{\lambda \in W} \sum_{n \in \text{Out}(s)} F_{s,n}^{\lambda} = |D| \quad (5.11)$$

$$\sum_{\lambda \in W} \sum_{n \in \text{In}(d)} F_{n,d}^{\lambda} = \sum_{\lambda \in W} \sum_{n \in \text{Out}(d)} F_{d,n}^{\lambda} + 1, \forall d \in D \quad (5.12)$$

$$\sum_{n \in \text{In}(d)} F_{n,d}^{\lambda} - 1 \leq \sum_{n \in \text{Out}(d)} F_{d,n}^{\lambda} \leq \sum_{n \in \text{In}(d)} F_{n,d}^{\lambda}, \forall \lambda \in W, \forall d \in D \quad (5.13)$$

$$\sum_{n \in \text{In}(m)} F_{n,m}^{\lambda} = \sum_{n \in \text{Out}(m)} F_{m,n}^{\lambda}, \forall \lambda \in W, \forall m \in V \setminus (s \cup D) \quad (5.14)$$

$$F_{m,n}^{\lambda} \geq L_{m,n}^{\lambda}, \forall m, n \in V, \forall \lambda \in W \quad (5.15)$$

$$F_{m,n}^{\lambda} \leq |D| \cdot L_{m,n}^{\lambda}, \forall m, n \in V, \forall \lambda \in W \quad (5.16)$$

Constraint 5.11 indicates that the sum of flows emitted by the source is equal to the number of destinations in the given multicast session. Constraints 5.12 and 5.13 ensure that each destination must be consumed totally one and only one flow in all the LSHs. These constraints also guarantee that each destination is reachable from the source. Equation 5.14 ensures that non-member nodes are only served as intermediate nodes without consuming any flows. Equations 5.15 and 5.16 indicate that a link should carry a positive number of flows if it is used in an LSH, and this number should not exceed the total flows emitted by the source.

It is worth noting that with the supplementary connectivity constraints, the constraints 5.5 and 5.6 are now relaxed.

Light-Spider Structure Constraint

Note that the above ILP formulation can be used to compute the LS solution, provided that the following constraint for LS should be satisfied. For LS structures, there is at most one incoming arc to every node (except the source) for every given wavelength. Thus, to adjust ILP formulation for LS solution, we just add one more constraint as follows:

$$\sum_{n \in In(m)} L_{n,m}^{\lambda} \leq 1, \forall \lambda \in W, \forall m \in V \setminus \{s\} \quad (5.17)$$

5.5.3 Evaluation of Exact Solutions

This section evaluates the light-spider-hierarchy (LSH) solution in comparison with the light-spider (LS) counterpart for the concerned problems by simulations.

5.5.3.1 Simulation Settings

We carry out a series of simulations with random graphs generated by using LEDA library [108]. In fact, all the random graphs generated in the thesis are simple (i.e., containing no loops or multiple edges/arcs). LEDA generates random graphs based on $G(n, m)$ -model. A graph in this model consists of n nodes and m random edges/arcs. A random edge is generated by selecting a random element from a candidate set C defined as follows:

- C is initialized to the set of all $n(n - 1)$ pairs of distinct nodes (to guarantee no loops).
- Upon selection of a pair (u, w) from C the pair (u, w) is removed from C (to guarantee no multiple edges/arcs).

Since ILP programs do not scale well, we test with relatively small graphs in which the number of nodes $|V| \in \{20, 30, 40, 50\}$. To guarantee relatively low average nodal degree

of realistic backbone networks², the graphs are generated as follows. First, we generate random undirected simple graphs such that the number of edges is equal to two times the number of nodes. Then we consider each edge as two reversely-directed arcs. So each generated random graph is considered having an average degree of 4. The availability of wavelengths on each arc is then controlled by the binary variables $wa_{m,n}^\lambda$ whose values are randomly assigned in $\{0,1\}$. The costs of arcs are randomly selected in the set of integer $\{1, 2, \dots, 20\}$ (note that two reverse arcs between a same node pair do not necessary have the same cost). The set of destinations D are also randomly chosen with different size $|D| \in \{10\%, 20\%, \dots, 50\%\}$ (of $|V|$). Moreover, for each group size $|D|$, we conduct various simulations and select 100 successful instances, each on a different random graph, different source and destination set. We calculate the 95% confidence intervals (CIs) for all the results. Since the CIs are relatively narrow, they are negligible, we just show the means (average values calculated from 100 results) in the resulting table.

The ILP programs are solved with CPLEX and run on a machine with Intel Core i3, 2.20GHz processor and 4GB of RAM. ILPs are run for maximum of one-hour each run. If the solver cannot find the optimal solution within one hour, the quasi-optimal solution is accepted with the gap of 1% to the optimal. Otherwise, the instance is considered failed and our program directs the ILPs to run on another instance.

Note that, for the consistency, the method of conducting simulations with ILPs mentioned above (generating random graphs, calculating CIs but just showing the means, and operating simulations with CPLEX) is applied in the same manner in the following sections.

For each simulation instance, we compute two exact solutions for the two corresponding problems (MNWF and MTCF). Besides, since we consider the arbitrary distribution of wavelengths (wavelength nonsymmetric case), it is interesting to compute the *absolutely* optimal solutions computed in the corresponding *fully symmetric* networks (i.e., the wavelength symmetric case). These absolutely optimal solutions can be served as the references for the solutions in the wavelength nonsymmetric cases. It can be done by simply setting all the variables $wa_{m,n}^\lambda = 1, \forall \lambda \in W, \forall (m, n) \in A$.

5.5.3.2 Simulation Results

The overall simulation results are presented in Table 5.3. The table is divided into two halves. The left-half of the table shows the results on the MNWF problem, and the right-half shows the results on the MTCF problem. For each problem, two performance metrics (number of wavelengths used, and total cost) are shown. Regarding the notations for the columns: *LS* is for light-spider solutions, *LSH* is for light-spider-hierarchy solutions, *wave* \searrow is for the percentage decrease of LSH solutions to LSH solutions on the number of wavelengths used, and *cost* \searrow is for the percentage decrease of LSH solutions to LSH

²The average nodal degree is commonly from 2.5 to 3 in most US backbone networks, and it is 3.5 in European networks [11].

solutions on total cost. In the table, also in the following tables of this chapter, $wave \searrow$ and $cost \searrow$ are calculated by subtracting (the values of) LSH solutions from LS solutions and then dividing by LS solutions. This means, if $wave \searrow$ or $cost \searrow$ are positive, LSH solutions are better (lower values) than LS solutions, and vice versa. Besides, for each series of graphs with same size ($|V|$), we calculate the average values for each metric with different group sizes, denoted by avg . We also calculate the overall average in the last two rows, denoted by $avg(avg)$.

Note that values in bold with a star correspond to the *absolute* average optimal solutions for symmetric networks, and values in bold without star correspond to average optimal solutions for nonsymmetric networks. For the first remark, for any instance, the optimal number of wavelength used is always resulted from MNWF side, while the optimal cost solution always come from the MTCF side. So the overall results are credible. Furthermore, the optimal values always occur in LSH columns (column 3 for MNWF problem and column 12 for MTCF problem). This reveals that LSH based solutions are optimal for the two problems.

Let us focus on the left-half. As it is expected, the light-spider-hierarchy is always better than light-spider in terms of the number of wavelengths used, especially in wavelength nonsymmetric cases. In particular, the average saving percentage on the number of wavelengths used of LSH solution to that of LS solution is 14.5% (at $|V| = 20$), 15.7% (at $|V| = 30$), 17.6% (at $|V| = 40$) and 16.6% (at $|V| = 50$). The overall average on this saving percentage is 16.1%. This is because in general, by allowing the repetition of nodes, more destinations can be covered by an LSH than by an LS. Therefore, in terms of the number of wavelengths used, LSH solution requires fewer or at most equal to the number of wavelengths needed by LS solution. This is compatible with Theorem 5.1. In contrast, the improvement on total cost is not stable, i.e., it is worse in the cases with small graphs but better the cases with larger graphs. The reason is that for larger graphs, there are more possible routes under LSH structures, and the better cost ones can be achieved. The average total cost is the same for the two solutions. This is compatible with Lemma 5.1.

In the fully wavelength symmetric cases, however, the results appear to be relatively inverse. The overall average saving percentage on the number of wavelengths is just 2.1%, while on the total cost it is significantly at 6.8%. In fact, it is not surprise. On one hand, more available wavelengths entails a fewer LSs (hence fewer number of wavelengths) needed to reach all the destinations. The number of wavelengths needed is close to 1, and it is always equal to 1 when LSH is used. On the other hand, LSH provides more choices, it can help to select better cost solutions, so the total cost can be significantly decreased.

Now let us switch to the right-half where the results for MTCF problem are presented. Interestingly, the LSH always outperforms LS significantly in both performance metrics. In particular, the profit on wavelengths used from LSHs in the range of 5.3% (at $|V| = 20$), 9.4% (at $|V| = 30$), 9.5% (at $|V| = 40$) and 6.3% (at $|V| = 50$), and the overall

Table 5.3 – Performance comparison between LSH based solutions and LS based solutions for the two considered problems.

Size	MINIMUM NUMBER OF WAVELENGTHS FIRST						MINIMUM TOTAL COST FIRST					
	No. Wavelengths Used			Total Cost			No. Wavelengths Used			Total Cost		
$ D $	LS	LSH	wave \searrow	LS	LSH	cost \searrow	LS	LSH	wave \searrow	LS	LSH	cost \searrow
$ V =20$. Nonsymmetric cases												
2	1.02	1.00	2.0%	42.8	45.5	-6.3%	1.30	1.26	3.1%	38.1	37.7	1.0%
4	1.23	1.06	13.8%	79.1	79.7	-0.8%	1.73	1.61	6.9%	69.0	66.9	3.0%
6	1.39	1.15	17.3%	103.1	104.1	-0.9%	2.12	1.95	8.0%	89.8	86.4	3.8%
8	1.66	1.29	22.3%	127.3	130.5	-2.5%	2.27	2.15	5.3%	115.0	109.7	4.6%
10	1.79	1.48	17.3%	141.9	149.9	-5.6%	2.67	2.59	3.0%	127.9	122.6	4.1%
avg	1.42	1.20	14.5%	98.9	101.9	-3.2%	2.02	1.91	5.3%	88.0	84.7	3.3%
$ V =20$. Symmetric cases												
2	1.00	1.00	0.0%	33.9	34.9	-3.0%	1.11	1.05	5.4%	30.1	29.9	0.7%
4	1.00	1.00	0.0%	51.8	50.3	2.8%	1.30	1.07	17.7%	49.2	48.1	2.3%
6	1.02	1.00	2.0%	67.2	63.4	5.6%	1.38	1.13	18.1%	63.9	62.1	2.9%
8	1.02	1.00	2.0%	83.9	79.0	5.8%	1.65	1.20	27.3%	79.3	76.8	3.1%
10	1.00	1.00	0.0%	99.4	92.7	6.7%	1.90	1.25	34.2%	93.1	89.4	4.0%
avg	1.01	1.00*	0.8%	67.2	64.1	3.6%	1.47	1.14	20.5%	63.1	61.2*	2.6%
$ V =30$. Nonsymmetric cases												
3	1.07	1.00	6.5%	81.5	76.9	5.7%	1.71	1.54	9.9%	67.7	64.8	4.3%
6	1.50	1.31	12.7%	132.5	134.4	-1.4%	2.51	2.22	11.6%	111.3	107.7	3.2%
9	1.76	1.44	18.2%	165.5	165.1	0.2%	2.79	2.60	6.8%	139.4	132.4	5.1%
12	2.05	1.67	18.5%	209.5	213.3	-1.8%	3.12	2.86	8.3%	184.1	177.7	3.5%
15	2.36	1.83	22.5%	235.6	246.1	-4.4%	3.435	3.01	10.1%	209.1	198.9	4.9%
avg	1.75	1.45	15.7%	164.9	167.2	-0.4%	2.70	2.45	9.4%	142.3	136.3	4.2%
$ V =30$. Symmetric cases												
3	1.00	1.00	0.0%	49.6	46.7	5.9%	1.23	1.06	13.8%	46.2	45.0	2.5%
6	1.00	1.00	0.0%	82.1	77.0	6.3%	1.62	1.24	23.5%	75.3	73.8	2.0%
9	1.00	1.00	0.0%	105.1	98.7	6.1%	1.75	1.22	30.3%	97.0	94.1	3.0%
12	1.00	1.00	0.0%	138.4	129.9	6.2%	2.12	1.34	36.8%	125.6	122.0	2.9%
15	1.04	1.00	3.8%	155.7	140.3	9.9%	2.15	1.31	39.1%	141.4	135.6	4.1%
avg	1.01	1.00*	0.8%	106.2	98.5	6.9%	1.77	1.23	28.7%	97.1	94.1*	2.9%
$ V =40$. Nonsymmetric cases												
4	1.22	1.08	11.5%	114.6	112.3	2.0%	1.95	1.75	10.3%	96.9	93.1	3.9%
8	1.77	1.46	17.5%	184.1	185.9	-1.0%	2.70	2.53	6.3%	153.5	146.2	4.8%
12	2.12	1.67	21.2%	250.0	248.9	0.5%	3.26	2.98	8.6%	210.3	199.4	5.1%
16	2.38	1.92	19.3%	322.7	309.1	4.2%	3.66	3.25	11.2%	267.8	250.4	6.5%
20	2.57	2.09	18.7%	361.6	341.3	5.6%	3.92	3.48	11.2%	303.8	283.4	6.7%
avg	2.01	1.64	17.6%	246.6	239.5	2.3%	3.10	2.80	9.5%	206.4	194.5	5.4%
$ V =40$. Symmetric cases												
4	1.00	1.00	0.0%	71.1	66.7	6.2%	1.39	1.12	19.4%	64.6	62.4	3.5%
8	1.02	1.00	2.0%	114.6	105.6	7.9%	1.76	1.23	30.1%	103.8	99.8	3.8%
12	1.02	1.00	2.0%	157.8	141.1	10.6%	2.24	1.35	39.7%	137.8	132.9	3.6%
16	1.07	1.00	6.5%	198.8	180.7	9.1%	2.46	1.50	39.0%	177.4	170.2	4.0%
20	1.06	1.00	5.7%	231.5	212.2	8.4%	2.81	1.64	41.6%	201.1	194.0	3.5%
avg	1.03	1.00*	3.2%	154.8	141.2	8.4%	2.13	1.37	34.0%	136.9	131.9*	3.7%
$ V =50$. Nonsymmetric cases												
5	1.38	1.23	10.9%	151.1	151.9	-0.6%	2.44	2.33	4.5%	122.1	118.9	2.6%
10	1.89	1.63	13.8%	259.9	253.2	2.6%	3.106	2.86	6.5%	213.4	202.0	5.3%
15	2.30	1.90	17.4%	356.0	332.3	6.7%	3.52	3.27	7.1%	288.8	271.3	6.1%
20	2.48	1.96	21.0%	414.8	390.4	5.9%	3.73	3.44	7.8%	341.0	316.8	7.1%
25	2.76	2.21	19.9%	473.0	438.8	7.2%	3.85	3.64	5.5%	399.4	366.5	8.3%
avg	2.16	1.79	16.6%	330.9	313.3	4.4%	3.32	3.11	6.3%	272.9	255.1	5.9%
$ V =50$. Symmetric cases												
5	1.00	1.00	0.0%	90.8	85.0	6.5%	1.51	1.19	21.2%	81.3	79.2	2.5%
10	1.01	1.00	1.0%	156.2	143.8	7.9%	1.96	1.33	32.1%	137.2	132.5	3.4%
15	1.03	1.00	2.9%	211.8	197.2	6.9%	2.59	1.58	39.0%	182.6	175.8	3.7%
20	1.03	1.00	2.9%	255.6	233.6	8.6%	2.88	1.68	41.7%	219.5	211.4	3.7%
25	1.12	1.00	10.7%	292.4	260.4	10.9%	3.05	1.79	41.3%	253.9	243.2	4.2%
avg	1.04	1.00*	3.5%	201.4	184.0	8.2%	2.40	1.51	35.1%	174.9	168.4*	3.5%
avg(avg)	Network types		wave \searrow	cost \searrow			wave \searrow			cost \searrow		
	Nonsymmetric		16.1%	0.8%			7.6%			4.7%		
Symmetric		2.1%	6.8%			29.6%			3.2%			

average saving is 7.6% for the nonsymmetric cases. For the symmetric cases, that benefit on wavelengths used is even considerably higher: 20.5% (at $|V| = 20$), 28.7% (at $|V| = 30$), 34.0% (at $|V| = 40$) and 35.1% (at $|V| = 50$), and for the overall average of 29.6%. For the total cost, in both scenarios, the LSH solutions outperform LS counterparts with the overall average gains of 4.7% (nonsymmetric cases) and 3.2% (symmetric cases).

From all the results shown above, we can conclude that LSH is the optimal solution for routing problem without splitters and converters, whatever the objective focus on minimizing the wavelengths used or the total cost.

In the next two sections, we present several efficient heuristic algorithms to compute the approximate solutions for the two aforementioned problems.

5.6 Heuristic Algorithms for MNWF Problem

As proved in Section 5.4, the MNWF problem is NP-complete. Although the above ILP formulation can find the optimal solution, the exponential-time consumption prevents it from employing in realistic networks. Therefore, we propose an efficient heuristic algorithm to compute approximate solutions for it. The basic idea of the algorithm is to diminish the conflicts between the overlapped trails in the links, and hence reducing the number of wavelengths required. The final solution consists of a set of light-trails, which indeed corresponds to a set of light-spider-hierarchies (LSHs). We compute the ratio of our solution to the optimal solution obtained by the ILP formulation for MNWF problem mentioned in Section 5.5. We also evaluate the performance of our proposed algorithm in comparison with the existing approaches proposed in [49] based on light-spiders. Note that, for the MNWF problem, we assume that the networks consists of directed fibers (but not obligatory *bidirected*) between each pair of nodes, and each fiber has the same set of wavelengths. We call this configuration *semi-symmetric* to distinguish with the two other aforementioned configurations: *symmetric* and *non-symmetric* in terms of wavelength distribution.

5.6.1 Useful Concepts

This subsection presents some concepts used in our algorithm.

Definition 5.3. *Directed Shortest Path Tree (DSPT):* A directed tree rooted at the multicast source consisting of the shortest paths from the source to each of destinations.

A DSPT can be computed by employing any shortest path algorithms, e.g., Dijkstra's algorithm.

To represent the conflicts among the trails computed in a graph, we use the concept of *conflict graph* as follows.

Definition 5.4. *Conflict graph:* A conflict graph between trails is given by $G_C = (T, E)$, in which T is a set of nodes corresponding to the trails and E is a set of edges such that

$e = \{t, p\} \in E$ if and only if there is a conflict between trail t and trail p , i.e., the two trails share a common arc.

At first, the trails are directed paths extracted from the DSPT, so the conflicts between the trails (if any) just occur from the prefixes of the trails. Because of this property, each of connected components in the conflict graph corresponds to a subtree of the DSPT (Fig. 5.9).

Several properties regarding the conflict graph are discussed in the following.

Property 5.1. *Each connected component in a conflict graph G_C is a clique³ of G_C . We call it the conflict clique.*

Proof. Trivially, if the shared arcs of conflicting trails are the prefixes of the trails, then conflicts are transitive (if there is a conflict between T_1 and T_2 and between T_2 and T_3 , then there is a conflict between T_1 and T_3). Indeed, all the trails in the same connected component share the first arc from the source. So Property 5.1 follows. \square

We call the number of nodes in each clique as the cardinality of that clique.

Property 5.2. *The number of wavelengths needed to assign to all the trails respecting the distinct wavelength constraint is equal to the number of colors needed to color all the nodes in the conflict graph; and it is equal to the cardinality of the maximal clique in the conflict graph.*

Proof. We can apply the approach proposed in [101] for assigning wavelengths to the trails in this problem as earlier mentioned in Subsection 3.3.1 (Chapter 3). Accordingly, the number of wavelengths needed to assign to all the trails is equal to the number of colors needed to color all the vertices in the conflict graph such that no two adjacent vertices receives the same color.

Besides, according to Property 5.1, all the vertices in the conflict graph are self-organized into separate cliques. So the colors can be reused among the cliques. Since each clique is a complete graph, the number of colors needed to color all the vertices in a clique is equal to the cardinality of that clique. Thus to assign to color all the nodes, the number of colors (or the number of wavelengths) needed is equal to the cardinality of the maximal clique of the conflict graph. So Property 5.2 holds. \square

As a sequence of Property 5.2, the problem of minimizing the number of used wavelengths for MNWF problem is reduced to the problem of minimizing the cardinality of the maximal clique in the conflict graph.

Fig. 5.9 illustrates a set of trails composing a DSPT for the multicast request $r = (s, \{d_1, d_2, d_3, d_4\})$ and the resulting conflict graph. Initially, the trails appear as paths as

³A clique of a graph G is a complete subgraph of G [63]

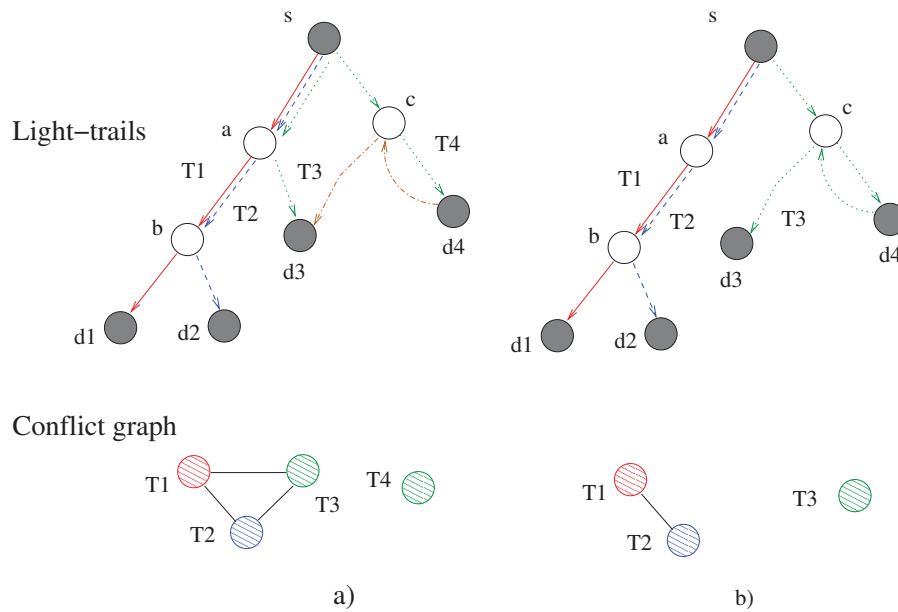

Figure 5.9 – Example of a DSPT and its conflict graph

shown in Fig. 5.9a, there are two cliques corresponding to two subtrees (rooted at a and c). (Note that arcs (d_4, c) and (c, d_3) are not in the DSPT, they are in the original graph that can be used to reroute the trails.) The maximal clique is composed from paths T_1, T_2, T_3 which start from the source and terminate at the destinations d_1, d_2, d_3 , respectively. Three wavelengths (marked as red, green and blue) are needed to assign to the three trails. The second clique (composed from only path T_4) can re-use one wavelength that were assigned to the maximal clique. In Fig. 5.9b, path T_3 is replaced by the concatenation of path T_4 and the extended path $\langle d_4, c, d_3 \rangle$. The new conflict graph is shown just below. The number of wavelengths needed to assign to all the trails is now reduced to two. By taking advantage of the extended path $\langle d_4, c, d_3 \rangle$, we can diminish the cardinality of the maximal conflict, and hence diminish the number of wavelengths required.

Apart from the above concepts, some more notations are used in the algorithm description including:

- *terminal* of a trail is the leaf-node of it.
- *first destination* of a trail T is the first destination on the subpath from the nearest branching node in the DSPT to the terminal of T .
- $P(u, v)$: the directed path from node u to node v .
- *arc-disjoint path*: the path does not share arcs with any existing trails.
- *extended path*: the path can be used to extend a trail.

To illustrate the above notations, let us consider an example shown in Fig. 5.10. The DSPT is composed from three trails: $T_1 = \langle s, 1, 4, 6 \rangle$, $T_2 = \langle s, 1, 3, 5, 7 \rangle$, and $T_3 =$

$\langle s, 2 \rangle$. The *first destination* of trail T_1 is node 4, since it is the first destination counted from the nearest branching node (node 1) to its *terminal* (node 6). Similarly, the first destinations of trails T_2, T_3 are their terminals: node 7 and node 2, respectively, since there is no other destinations between them and the nearest branching nodes.

Among two *extended paths* orienting to destination 4, path $\langle 2, 3, 4 \rangle$ is an *arc-disjoint path* with all the existing trails, while path $\langle 2, 3, 5, 4 \rangle$ is an arc-shared path since it shares the arc $(3, 5)$ with the existing trail T_2 . Only arc-disjoint paths are useful in rerouting the trails in our algorithm. This is because if the arc-shared paths are used, the conflict still remains. For instance, if we use path $\langle 2, 3, 5, 4 \rangle$, although the trail $\langle s, 1, 4, 6 \rangle$ is removed, a new conflict is created at the shared arc $(3, 5)$ between the new trail $\langle s, 2, 3, 5, 4, 6 \rangle$ and the existing trail T_2 .

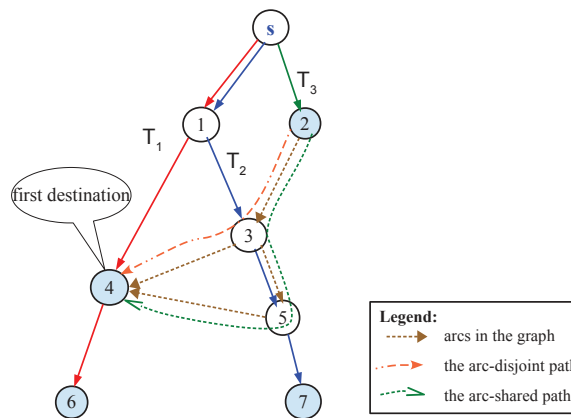

Figure 5.10 – The DSPT and two extended paths

5.6.2 Algorithm Framework

Informally, the general idea of the algorithm is to diminish the cardinality of the maximal clique of the conflict graph until it cannot be reduced.

The algorithm starts from a set of directed trails (at first, paths in the DSPT). The cliques are then calculated and organized in a priority queue. At each iteration, the maximal clique is identified and one trail is selected to reroute.

We call the selected trail *rerouted trail*. Several mechanisms can be employed to select this trail. After that, the algorithm looks for all the existing trails and find one such that there exists an *extended path* from the terminal of it to the *first destination* of the rerouted trail. The trail found at this step is called the *rerouting trail*. The extended path should be the shortest path among the others and arc-disjoint with all the existing trails. Then replace the rerouted trail by the new trail which is the concatenation of the rerouting trail, the extended path and the subpath from the first destination to the terminal of the rerouted trail. The cardinality of the maximal clique is reduced by one. The algorithm

iterates until the maximal clique cannot be reduced. Finally, the set of the final trails are used to construct a set of light-spider-hierarchies.

5.6.3 Farthest First Algorithm

To determine the rerouted trail in the maximal conflict clique, say C_{max} , two heuristics are proposed here, namely: Farthest First (FF) and Nearest First (NF). Specifically, Farthest First selects the longest trail (in terms of cost) among all the other trails in C_{max} ; or equivalently, FF selects the *farthest* terminal among the terminals of the other trails. Whereas, Nearest First selects the shortest trail, or equivalently, the *nearest* terminal, in C_{max} . Since the two variants are similar, we just describe Farthest First heuristic as shown in Algorithm 5.1. After having the set of the final trails, a set H of LSHs is constructed and assigned wavelengths by Algorithm 5.2. For NF heuristic, the difference occurs at line 7 where the trails in clique C_i are organized in a queue according to the *ascending order* of their lengths, in order to choose the shortest trail first.

In order to demonstrate the algorithm, we use a network in Fig. 5.11 as an example. Again, since FF and NF have the same principle, we just illustrate the heuristic FF in Fig. 5.12 below.

Initially, the DSPT and the initial conflict graph are shown in Fig. 5.12a. The maximal clique comprises three paths T_{10}, T_{12}, T_{13} , in which T_{12} is the longest one, so it is selected first. The first destination of T_{12} is node 8, the shortest arc-disjoint path found is $P(10, 8) = \langle 10, 5, 8 \rangle$. Thus T_{12} is replaced by the new trail is $T'_{12} = T_{10} \cup P(10, 8) \cup P(8, 12)$ (Fig. 5.12b). In a same way, T'_{12} is then replaced by T''_{12} in the next run (Fig. 5.12c). For the next iteration, the new maximal clique consists of two paths T_7, T_{11} , and T_{11} is replaced by T'_{11} . The algorithm terminates and returns the final set of trails shown in Fig. 5.12d.

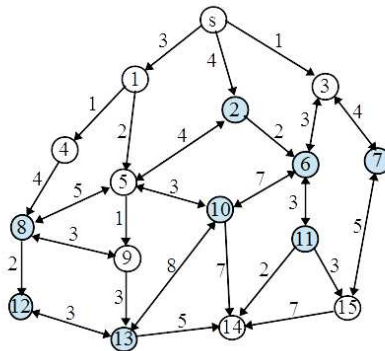

Figure 5.11 – A network to consider

The following theorem gives the computational complexity of FF heuristic. It is also the complexity of NF heuristic.

Algorithm 5.1 Farthest First

Input: A directed connected graph G , number of available wavelengths W , a multicast request $r = (s, D)$.

Output: A set of light-spider-hierarchies H , and number of wavelengths used

- 1: construct the DSPT from s covering all destinations in D .
- 2: initialize T by a set of paths from s to the leaves of the DSPT.
- 3: **if** there is no branching node in the DSPT **then**
- 4: **return** $\langle T, 1 \rangle$ {return T as the DSPT using one wavelength}
- 5: **end if**
- 6: calculate cliques $C_i, i = 1, 2, \dots, n_c$: n_c is the number of sub-trees rooted at the successors of s in the DSPT.
- 7: organize trails in each clique C_i by a priority queue according to the *descending order* of lengths
- 8: organize cliques by a priority queue PQ by their cardinalities
- 9: $G' \leftarrow G \setminus T$ { G' is created by removing from G arcs used by trails in T }
- 10: **while** $PQ \neq \emptyset$ **do**
- 11: find the maximal clique C_{max} from PQ
- 12: **for** $i \leftarrow 1$ to $|C_{max}|$ **do**
- 13: identify the terminal l_i and the first destination f_i of T_i
- 14: find the connector c among s and all the terminals l_k of all the existing trails by the arc-disjoint shortest paths in the form $P(c, f_i)$ in G'
- 15: **if** c is found **then break**
- 16: **end for**
- 17: **if** c is not found **then break**
- 18: **if** $c = s$ **then**
- 19: $T_j \leftarrow P(s, f_i) \cup P(f_i, l_i)$ {create a new trail T_j }
- 20: $T \leftarrow T \cup \{T_j\}$ {and add it to the set T }
- 21: **else**
- 22: {if a terminal l_k is selected, let T_k be the corresponding *routing trail*}
- 23: $T'_k \leftarrow T_k \cup P(l_k, f_i) \cup P(f_i, l_i)$; $T \leftarrow T \cup \{T'_k\}$
- 24: $T \leftarrow T \setminus \{T_i\}$; $C_{max} \leftarrow C_{max} \setminus \{T_i\}$ {remove the trail T_i from T and C_{max} }
- 25: $|C_{max}| = |C_{max}| - 1$ {decrease the cardinality of clique C_{max} by 1}
- 26: **if** $|C_{max}| = 1$ **then** remove C_{max} from PQ
- 27: **else** update the new cardinality $|C_{max}|$ for the C_{max} in PQ
- 28: **end if**
- 29: **end while**
- 30: **if** $|C_{max}| > W$ **then**
- 31: **return** FALSE
- 32: **end if**
- 33: $H = \text{ConstructLSH}(T, |C_{max}|)$ {construct a set of LSHs H from the final trails and assign wavelengths to them using Algorithm 5.2}
- 34: **return** $\langle H, |C_{max}| \rangle$

Algorithm 5.2 ConstructLSH(T, n)

Input: A set of final trails T , number of wavelengths n **Output:** A set of light-spider-hierarchies H $H \leftarrow \emptyset$ **for** $i \leftarrow 1$ **to** n **do** $L_i \leftarrow \emptyset$ {initialize a light-spider-hierarchy L_i }move one trail (select arbitrarily) from every *not-empty* clique to L_i $H \leftarrow H \cup L_i$ assign wavelength λ_i to all the trails in L_i **end for****return** H

Theorem 5.5. *FF algorithm takes $O(D \times (\log D)^2 \times (V \log V + A))$ time⁴ to compute the trails for MNWF problem.*

Proof. Suppose that the priority queue PQ of cliques and the priority queues of trails in each clique C_i are implemented by binary heaps [109]. For the binary heap of size n , it takes time $O(\log n)$ to adjust the heap (e.g., "insert", "delete", "change priority") after extracting the minimum-priority element.

To find the clique C_{max} takes time $O(\log n_c)$, with n_c the total number of cliques. Since only cliques with cardinality greater than one should be put into PQ , n_c is bounded by $|D|/2$. Hence, in the worst case, it take time $O(\log(D/2))$ to find the clique C_{max} . Similarly, to find trail T_i to process in clique C_{max} takes time $O(\log C_{max})$ with $|C_{max}|$ bounded by the total number of destinations $|D|$. So in the worst case, it take time $O(\log D)$ to find T_i in clique C_{max} . As a result, it takes time $O(\log(D/2) \times \log D) = O((\log D)^2)$ to find T_i . Note that, however, the two upper bounds for PQ and C_{max} does not come at the same time. In fact, they are quasi-reversely proportional. Besides, the two queues get smaller after a trail is replaced. Thus, from the implementation's point of view, it takes less time than that in the worst case.

For each selected trail T_i , to identify the candidate connector c among the source s and the terminals of T_k s which can connect to the first destination f_i of T_i by arc-disjoint shortest paths, the Dijkstra's algorithm should be used once. This is because, s or the terminals could be virtually gathered and viewed together as a virtual source (e.g., by connecting the source to them by zero-cost arcs), and it is sufficient to find the connector c by constructing a shortest path from the virtual source to f_i in G' . The time complexity of Dijkstra's algorithm to compute a shortest path between two vertices (c, l_i) in the graph $G' = (V', A')$ (implemented by a Fibonacci heap) is $O(V' \log V' + A')$ [110] in the worst case. However, the computation of a shortest path between two vertices is often better than for the single-source shortest path problem [108]. Since there are $|D|$ destinations,

⁴To make the O notations more readable, we do not show the set cardinality notation to represent the number of elements in the set, i.e., we will use V instead of $|V|$.

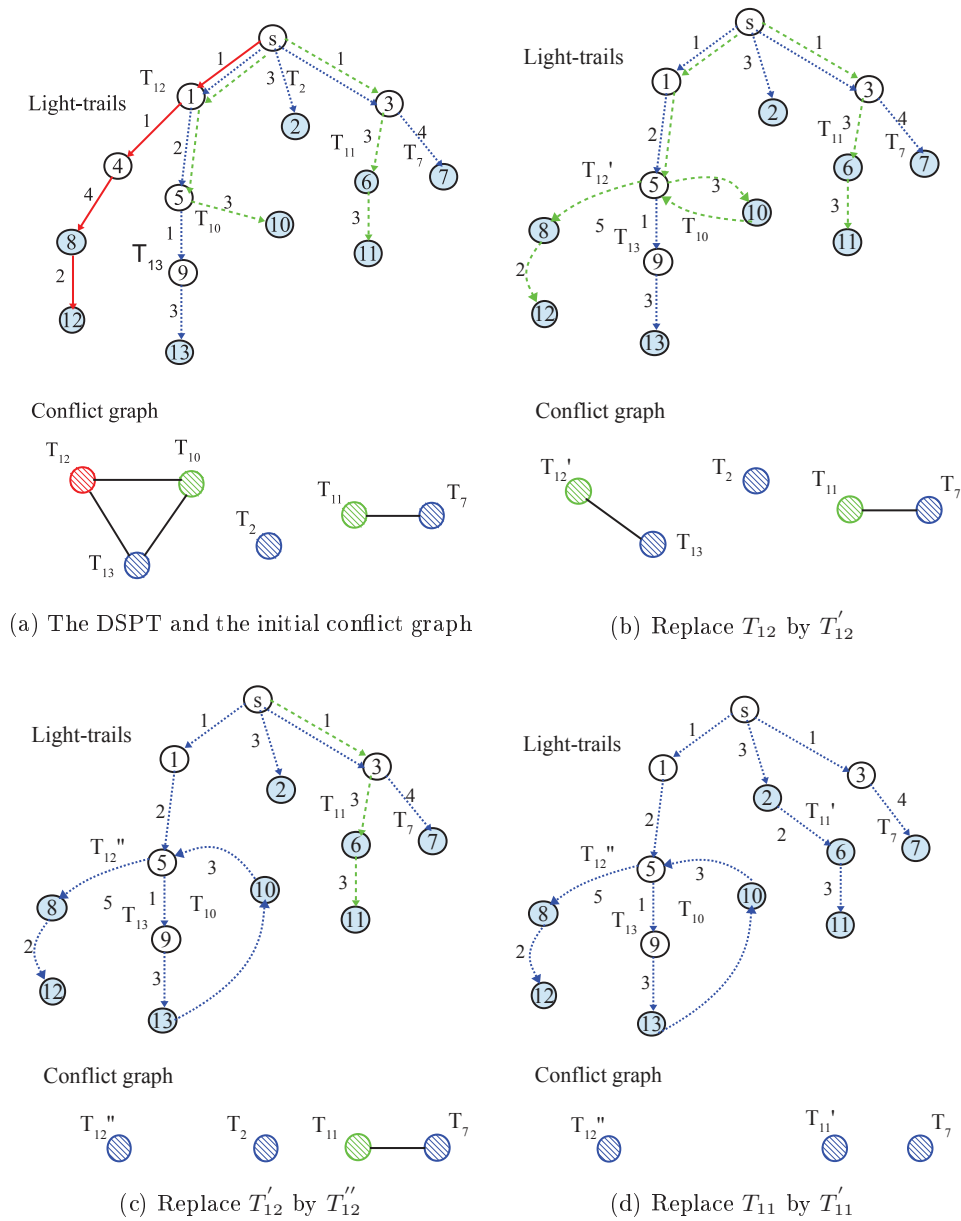

Figure 5.12 – Illustration of Farthest First heuristic

meaning that at most $|D|$ trails can be processed. In other words, it takes at most $|D|$ time to process all the trails. Hence the Dijkstra's algorithm needs to run at most $|D|$ times.

Overall, FF algorithm takes at most $O(D \times (\log D)^2 \times (V' \log V' + A'))$ time. Since G' has quasi-same size to G , the time complexity is $O(D \times (\log D)^2 \times (V \log V + A))$. The actual computation time is, however, often better for the aforementioned reasons. \square

5.6.4 Performance Evaluation

In this subsection we evaluate our heuristics in comparison with the exact solutions computed from ILP formulations. We also compare our algorithms with the two existing heuristics proposed for the same problem. They are Farthest-first Greedy (FG) and Nearest-first Greedy (NG) proposed in [49] based on light-spiders as earlier mentioned in Subsection 3.2.2 (Chapter 3). Note that the objective was formulated as a combined cost function taking two component metrics into account: $total_cost(F) + \alpha' * num_wave(F)$, in which F is the light-forest under construction, and $num_wave(F)$ is the number of wavelengths that has been used so far. According to [49], the coefficient α' is added to the cost of new light-tree every time a new wavelength has to be introduced. Thus, to let the heuristics to focus on wavelength consumption first then the total cost of light-trees, it is sufficient to set: $\alpha' = \sum_{(m,n) \in A} c_{m,n}$ (the summation of cost of all the arcs). This setting is equivalent to the setting: $\alpha = 1 + W \cdot \sum_{(m,n) \in A} c_{m,n}$ for the objective function 5.1 presented in Section 5.2. By such settings, all the algorithms (ILPs and heuristics) tend to explore all the available links in the already or currently used wavelength graphs before using a new one, hence targeting the considering objective.

5.6.4.1 Heuristic Solutions versus Exact Solutions

We evaluate the two proposed heuristics (FF and NF) and the two counterparts (FG and NG) versus the exact solutions computed by the ILP formulations for MNWF problem mentioned in Section 5.5. Like in Subsection 5.5.3, for ILP programs we just test with relatively small graphs in which the number of nodes $|V| = \{20, 30, 40, 50\}$. In order to simulate the realistic backbone networks with low average nodal degree, first we generate random *oriented simple* graphs (which has neither self-loops nor 2-cycles) such that $|A| = 2 \times |V|$. Then, to create general directed graphs, we randomly add $m \in \{0, 1, 2, \dots, |A|\}$ reverse arcs of the existing arcs to the graphs. The costs of arcs are randomly selected from the set of integer $\{1, 2, \dots, 20\}$, and the set of destinations D are also randomly selected with different size $|D| = \{10\%, 20\%, \dots, 50\%\}$ of the number of nodes. The number of wavelengths W is fixed to 10. Recall that (as mentioned at the beginning of Section 5.6), the networks are supposed to be neither *symmetric* nor *arbitrarily nonsymmetric* but *semi-symmetric*. That is, all the graphs are generated directed (but not obligatorily bidirected), and all the fibers have the same set of wavelengths. For each group size $|D|$, we conduct redundant simulations and stop when reaching 100 *successful* simulations; each simulation is run on a different random graph, different source and destination set. Two metrics are taken into account are the number of wavelengths used and the total cost.

We calculate the 95% confidence intervals (CIs) for all the results. Since CIs are relatively narrow, and to make the comparison easier, we just show the average values calculated on 100 instances instead of showing CIs. All the results are presented in Table 5.4

in which the optimal values are marked in bold and with stars, the lowest values but not optimal are in bold. This is because for MNWF problem, if the optimal values could be obtained, it is just the case for the number of wavelengths used, not the case for total cost. For each series of graphs with same size ($|V|$), we calculate the average ratio of each heuristic solution to the optimal solution, and show in *ratio* rows in the table. These ratios are finally averaged for the results shown in the last row.

According to the simulation results, on average, ILP-LSH results in the optimal number of wavelengths used and lowest total cost as well. Especially for the wavelength consumption, its optimal solution is by far better than that obtained by its counterpart (ILP-LS). On average, ILP-LSH achieves 17.8% lower than ILP-LS. For total cost, ILP-LS also outperforms ILP-LSH, with the average decrease of 4.9%.

Comparing between heuristics, FF and NF outperform FG and NG in terms of wavelength consumption (with an average of 40.9% lower). Especially, our algorithms even achieve lower number of wavelengths used than those obtained by the optimal light-spiders based solutions (ILP-LS). In particular, the average ratio of FF is 1.08, NF's is 1.11, while the optimal solution obtained by ILP-LS is 1.24. Thus, FF achieves 14.8% lower and NF achieves 11.7% lower on the number of wavelengths compared with ILP-LS. For the total cost, the four algorithms appear the same for total cost, in which FF works best since it achieves the smallest ratio of 1.16 to the lowest cost solution (obtained by ILP-LSH).

Table 5.4 – Comparison of heuristic solutions with exact solutions for MNWF problem

		Number of Wavelengths Used							Total Cost						
$ V $	$ D $	FG	NG	FF	NF	ILP-LS	ILP-LSH	wave ↘	FG	NG	FF	NF	ILP-LS	ILP-LSH	cost ↘
20	2	1.07	1.08	1.00	1.00	1.01	1.00*	1.0 %	46.6	44.2	43.5	44.9	42.3	42.5	-0.5%
	4	1.43	1.38	1.02	1.01	1.10	1.01*	8.2 %	84.7	82.9	80.6	82.0	77.5	74.4	4.1%
	6	1.65	1.67	1.06	1.06	1.26	1.05*	16.7%	118.8	115.7	116.9	117.6	106.1	100.9	4.9%
	8	1.91	1.98	1.18	1.15	1.37	1.10*	19.7%	136.2	131.1	129.9	135.3	119.2	116.7	2.1%
	10	2.13	2.05	1.16	1.22	1.46	1.12*	23.3%	161.1	147.1	151.2	157.1	136.6	133.0	2.7%
	<i>ratio</i>	1.55	1.55	1.03	1.03	1.17	1.00*	13.8%	1.17	1.11	1.12	1.15	1.03	1.00	2.7%
30	3	1.15	1.14	1.01	1.01	1.02	1.01*	1.0 %	83.0	77.4	78.0	82.0	76.1	75.2	1.2%
	6	1.81	1.78	1.08	1.10	1.25	1.05*	16.0%	143.5	135.5	129.6	139.1	121.7	120.8	0.7%
	9	2.21	2.17	1.25	1.27	1.42	1.17*	17.6%	185.0	177.2	180.1	187.0	161.0	153.2	4.8%
	12	2.42	2.46	1.33	1.40	1.58	1.25*	20.9%	228.9	228.1	225.8	232.1	203.9	194.4	4.7%
	15	2.83	2.90	1.51	1.58	1.86	1.31*	29.6%	265.1	263.0	263.3	274.1	231.8	217.5	6.1%
	<i>ratio</i>	1.80	1.80	1.07	1.10	1.23	1.00*	17.0%	1.19	1.16	1.15	1.20	1.04	1.00	3.5%
40	4	1.37	1.34	1.11	1.10	1.13	1.08*	4.4 %	119.3	113.4	112.6	115.5	110.7	108.2	2.3%
	8	2.00	1.96	1.16	1.19	1.28	1.10*	14.1%	201.3	197.6	184.7	197.4	172.5	167.1	3.1%
	12	2.49	2.42	1.20	1.26	1.47	1.12*	23.8%	268.3	277.2	264.0	269.6	235.2	218.9	6.9%
	16	2.86	2.81	1.35	1.49	1.74	1.22*	29.9%	319.6	318.6	306.3	321.9	270.4	253.5	6.3%
	20	3.19	3.18	1.86	1.92	2.07	1.48*	28.5%	371.5	363.2	376.5	374.2	327.2	301.3	7.9%
	<i>ratio</i>	1.99	1.95	1.11	1.16	1.28	1.00*	20.1%	1.22	1.21	1.19	1.22	1.06	1.00	5.3%
50	5	1.62	1.51	1.05	1.05	1.12	1.05*	6.3 %	160.4	156.1	150.7	152.2	144.8	141.9	2.0%
	10	2.33	2.24	1.29	1.35	1.43	1.22*	14.7%	268.0	257.9	243.9	260.9	236.3	223.3	5.5%
	15	2.77	2.83	1.39	1.43	1.63	1.28*	21.5%	346.7	344.9	326.2	339.8	302.1	272.6	9.8%
	20	3.06	3.16	1.58	1.61	1.85	1.31*	29.2%	410.8	403.6	392.1	410.6	361.9	316.3	12.6%
	25	3.86	3.95	1.97	2.09	2.29	1.62*	29.3%	490.7	485.1	468.6	503.8	420.0	377.3	10.2%
	<i>ratio</i>	2.10	2.11	1.12	1.16	1.28	1.00*	20.2%	1.26	1.24	1.19	1.25	1.10	1.00	8.0%
<i>avg(ratio)</i>		1.86	1.85	1.08	1.11	1.24	1.00*	17.8%	1.21	1.18	1.16	1.21	1.06	1.00	4.9%

5.6.4.2 Comparison among Heuristic Solutions

Two Simulation Settings

We compare the four aforementioned algorithms (FG, NG, FF and NF) in larger realistic networks. Since the algorithms FG and NG are supposed to work with undirected graphs, in which the links are all bidirectional, to be fair, we divided the simulations into two settings. In the first setting, all the algorithms are run on undirected graphs. In the second setting, they are run on arbitrary directed graphs. The latter represents better real arbitrary network states. Besides two performance metrics: the number of wavelengths required and the total cost, the diameter of the resultant routes (light-trails or light-forests) is also taken into account. The diameter is defined as the number of maximal hop counts from the source to all the destinations. The reason for evaluation of diameter is that it can be represented for the end-to-end maximal delay.

Simulation Results with Undirected Graphs

In this setting, all the heuristic algorithms are run on randomly undirected simple graphs with different number of nodes $|V| \in \{50, 100, 150\}$, and the number of edges is equal to two times the number of nodes. The costs of edges are randomly selected from the set of integer $\{1, 2, \dots, 20\}$, and the set of destinations D are also randomly selected with different size $|D| = \{10\%, 20\%, \dots, 90\%\}$ (of $|V|$). The number of available wavelengths $W = 10$ and we observe that it is sufficient for each generated multicast request.

For a given group size $|D|$, we conduct 1000 simulations with different source and destination set, and calculate the 95% confidence intervals for all the results. The results are shown in Figs. 5.13, 5.14 and 5.15.

The performances of the algorithms in terms of wavelength consumption are shown in Figs. 5.13a, 5.14a and 5.15a. In all the cases, FG and NG result in large number of wavelengths, while FF and NF keep it constant at the optimal (1) wavelength. On average, the improvements on wavelength consumption obtained by LSH-based algorithms (FF and NF) to LS-based counterparts (FG and NG) are 48.7% at $|V| = 50$, 63.4% at $|V| = 100$, 71% at $|V| = 150$, and the overall gain is 61%. For the total cost, as shown in Figs. 5.13b, 5.14b and 5.15b, FF and NF always achieve less cost than the two counterparts. On average, the improvements on total cost obtained by LSH-based algorithms to LS-based counterparts are 8.3% at $|V| = 50$, 13.2% at $|V| = 100$, 16% at $|V| = 150$, and the overall gain is 12.5%.

In contrast, Figs. 5.19a, 5.20a and 5.21a show better performances on diameter for LS-based algorithms. Accordingly, FG and NG achieve significantly lower diameter compared with the other two.

In short, with undirected graphs, FF and NF produce better solutions for the number of wavelengths used, and also lower total cost but with higher diameter compared with FG and NG.

Simulation Results with Directed Graphs

The network parameters of this setting are similar to the ones set for the first setting, except two points: 1) $W = 20$ (to augment the feasibility of finding solutions for the randomly generated instances), and 2) the graphs are arbitrarily directed graphs (using the same method for generating the directed graphs mentioned in Subsection 5.6.4.1). All the results (with 95% confidence intervals) on resource consumption of the considered algorithms are shown in Figs. 5.16, 5.17 and 5.18.

As shown in Figs. 5.16a, 5.17a and 5.18a, all the algorithms need larger number of wavelengths when the group size increases. Again, the two algorithms based on LSHs (i.e., FF and NF) result in smaller number of wavelengths compared with the ones based on LSs (i.e., FG and NG). On average, the number of wavelengths used by LSH-based algorithms (FF and NF) are less than 43.3% at $|V| = 50$, 45.5% at $|V| = 100$, and 48% at $|V| = 150$ compared with those consumed by LS-based algorithms (FG and NG). For the total cost (shown in Figs. 5.16b, 5.17b and 5.18b), the first group results in slightly lower (about 5%) than the second, in which FF works better than the others.

Regarding the diameter, once again, as shown in Figs. 5.19b, 5.20b and 5.21b, the LS-based algorithms outperform the LSH-based algorithms. Accordingly, FG and NG achieve significantly lower diameter compared with the other two.

In short, with directed graphs, LSH-based algorithms achieve lower number of wavelengths, slightly lower cost but higher diameter in comparison with the LS-based algorithms.

Result Analysis

LSH-based algorithms versus LS-based algorithms

As seen in the simulation results above, LSH-based algorithms (FF and NF) outperform LS-based algorithms (FG and NG) in terms of the number of wavelengths and also the total cost, especially in bidirectional networks, but with the expense of the diameter. This can be explained as follows.

The two approaches start with the same DSPT tree. In the rerouting phase, FG and NG try to extend the tree but always keep the tree structure which does not allow multiple visits at nodes. Moreover, the nodes used for the tree extension are always restricted by the source or the leaves which are either the farthest (FG) or nearest (NG) destinations in each subtree of the computed trees. These two properties limit the number of destinations

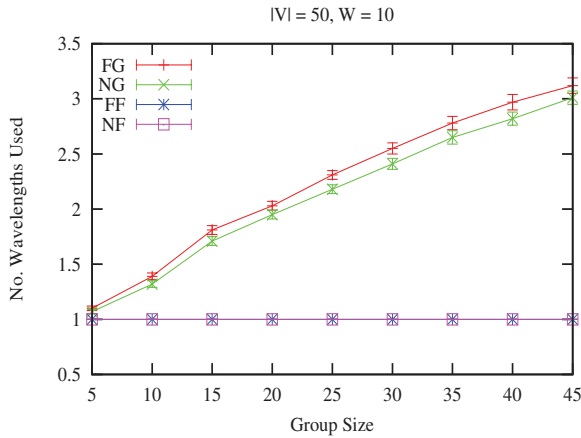

(a) No. Wavelengths Used vs. Group Size

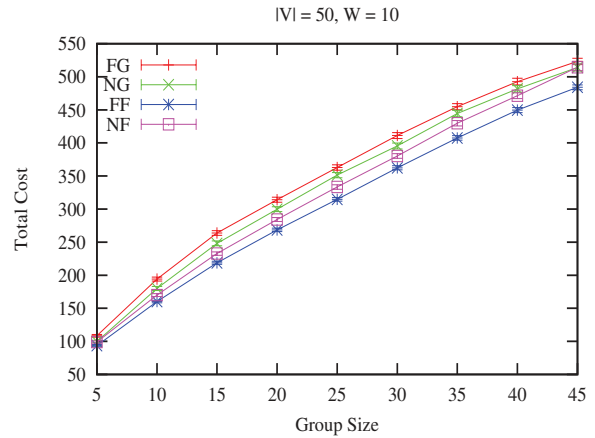

(b) Total Cost vs. Group Size

Figure 5.13 – Performance of algorithms on 50-node undirected graphs

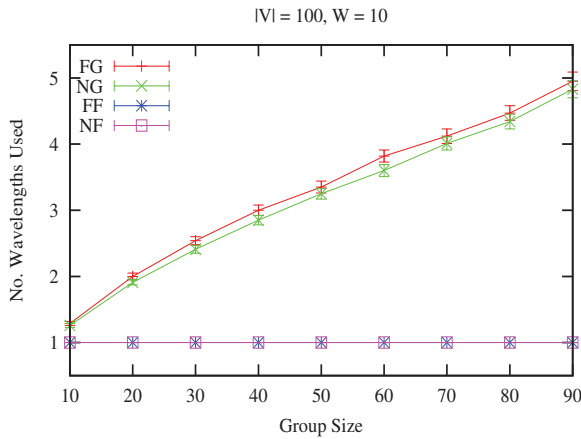

(a) No. Wavelengths Used vs. Group Size

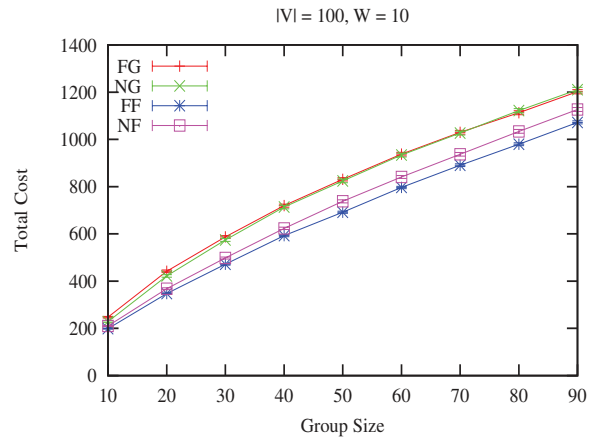

(b) Total Cost vs. Group Size

Figure 5.14 – Performance of algorithms on 100-node undirected graphs

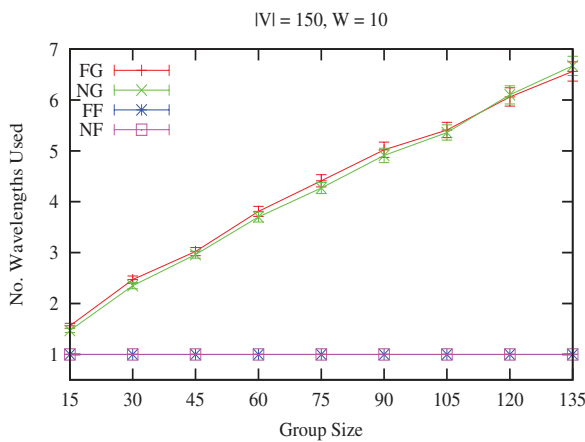

(a) No. Wavelengths Used vs. Group Size

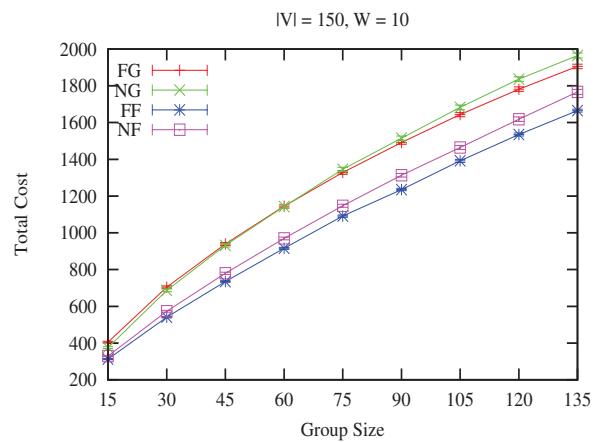

(b) Total Cost vs. Group Size

Figure 5.15 – Performance of algorithms on 150-node undirected graphs

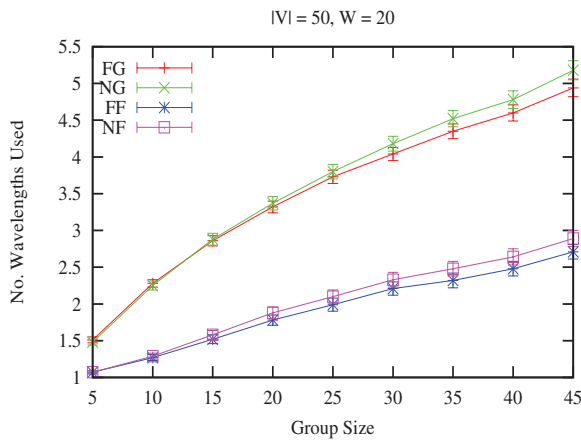

(a) No. Wavelengths Used vs. Group Size

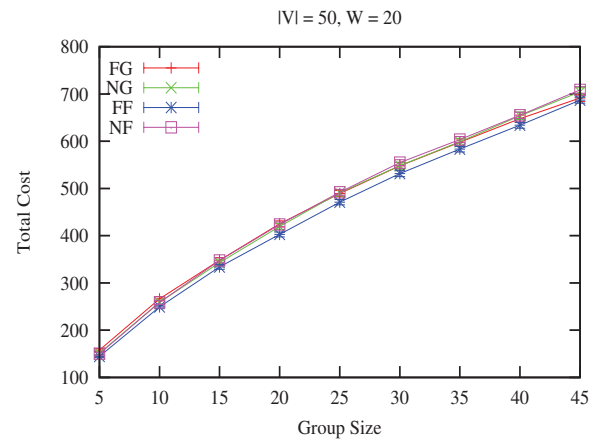

(b) Total Cost vs. Group Size

Figure 5.16 – Performance of algorithms on 100-node directed graphs

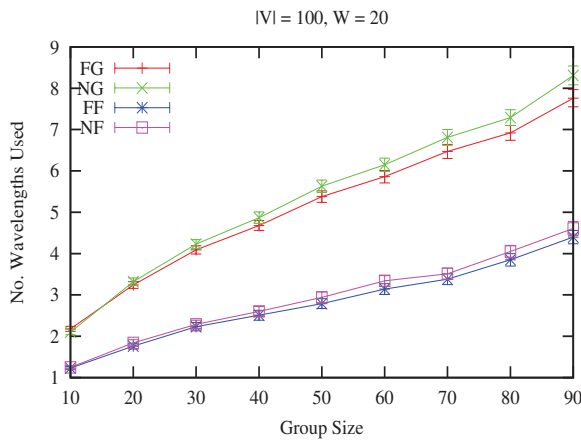

(a) No. Wavelengths Used vs. Group Size

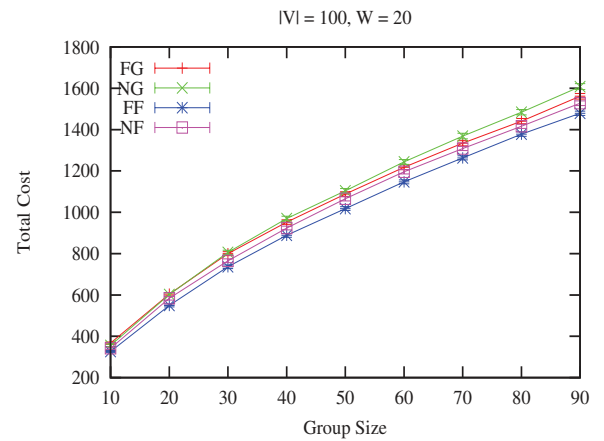

(b) Total Cost vs. Group Size

Figure 5.17 – Performance of algorithms on 100-node directed graphs

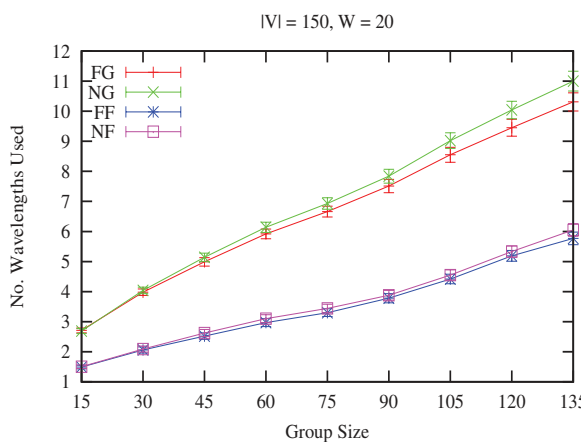

(a) No. Wavelengths Used vs. Group Size

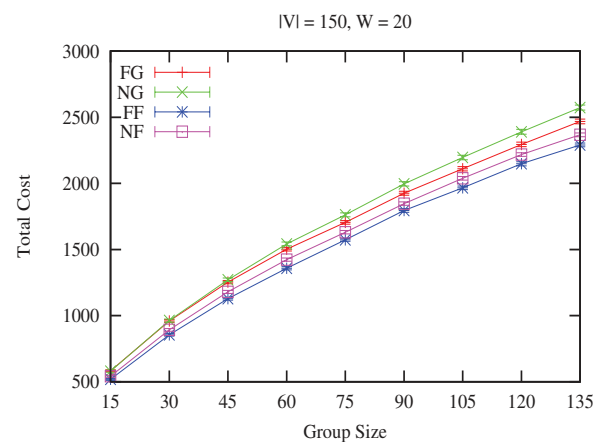

(b) Total Cost vs. Group Size

Figure 5.18 – Performance of algorithms on 150-node directed graphs

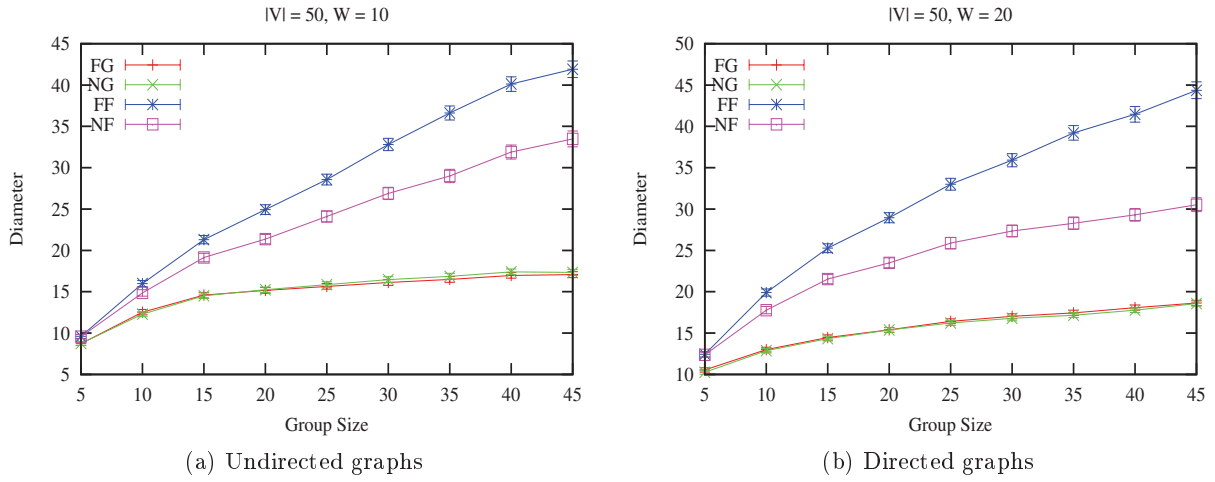

Figure 5.19 – Diameter versus Group Size on 50-node graphs

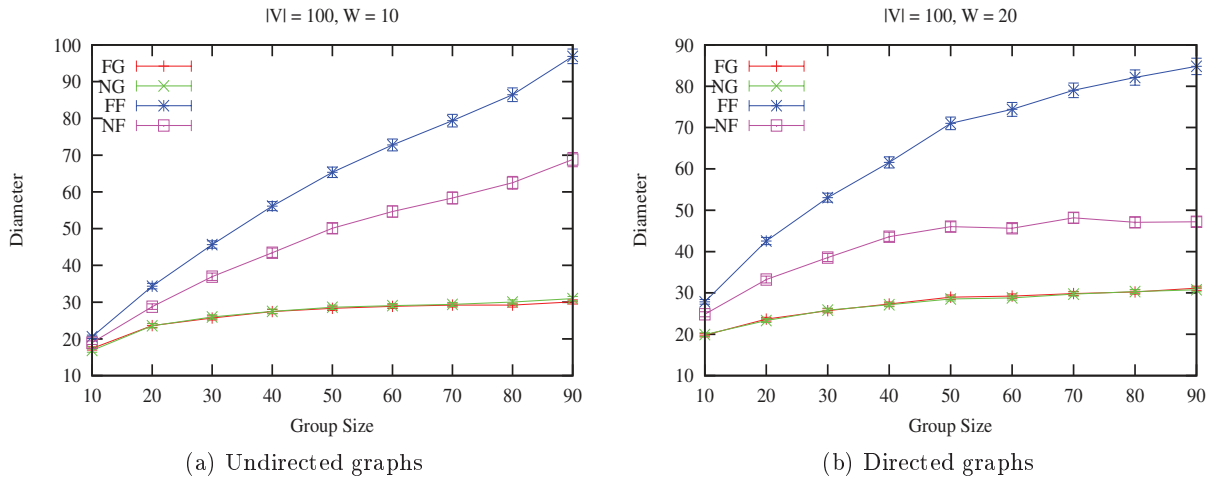

Figure 5.20 – Diameter versus Group Size on 100-node graphs

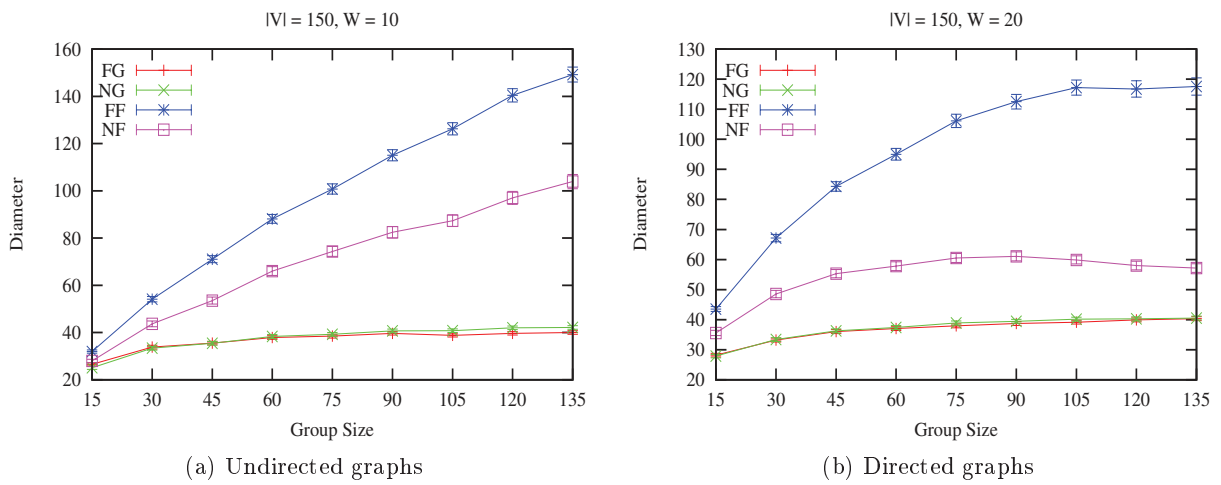

Figure 5.21 – Diameter versus Group Size on 150-node graphs

to be covered in one tree, causing larger number of wavelengths needed and higher cost. Besides, when the destinations cannot be routed in the current tree, they are routed in a new tree by the shortest paths from the source, so the diameter is short.

In contrast, our LSH-based algorithms are more flexible. After the first step, the route structure is no longer a tree, but a set of trails which allows to return some vertices more than once without conflicts. Hence, more arcs can be used for the trail extension. In addition, since all the terminals of the existing trails (and the source) can be considered, more nodes can be used for the trail extension. In short, more nodes and arcs can be used for the trail extension. This property helps increase the number of destinations which can be covered in one trail, resulting in a fewer number of wavelengths required, but, of course, with a longer diameter. Besides, because more nodes are considered for choosing lowest-cost path, a lower total cost of the final trails can be achieved.

Farthest First versus Nearest First

As shown in the simulation results, FF results in slightly fewer wavelengths and total cost compared with NF; and FF always results in a longer diameter. This can be explained as follows.

First, when the rerouted trail (say, T_i) (cf. Algorithm 5.1), is rerouted by a routing trail (say, T_k), the new-created trail must be longer (in terms of cost) than the rerouted trail. Thus, the longer the rerouted trail is, the longer the new-created trail can be. FF chooses the longest trail in the maximal clique, hence it makes the new trail longer than NF does. Furthermore, because the new trail is usually longer than rerouted trail in the old maximal clique, and it will probably become the farthest one in the new maximal clique (if it is the case) and will be first considered next time. Hence it gets longer and longer until the cardinality of the contained clique cannot be reduced. That is the reason why FF causes a longer diameter than NF.

Second, when a rerouted trail T_i is rerouted by the rerouting trail T_k , the difference between total cost before and after rerouting is calculated by: $diff(cost) = cost(P(l_k, f_i)) - cost(P(s, f_i))$, in which l_i, l_k are the terminals of T_i, T_k , respectively. ($cost(P(u, v))$ is the cost of the directed path from u to v .) It is likely that the longer the trail T_i is, the less $diff(cost)$ can be obtained. Since FF chooses the longest trail and NF chooses the shortest one in the maximal clique to reroute first, FF can reduce more cost than NF. Besides, FF tends to include more destinations in a long trail, thus probably that fewer number of wavelengths used can be obtained than NF does.

5.7 Heuristic Algorithms for MTCF Problem

Since MTCF problem of minimizing the total cost is NP-hard, and ILP program is not able to compute the optimal solution in a time-efficient manner, heuristics are required. In this section, we propose two efficient heuristic algorithms to solve MTCF problem. The first heuristic is based on the idea of the Minimum Path Heuristic (MPH) [73] for computing an approximate Steiner tree. It is called Nearest Destination First (NDF) algorithm. In the second heuristic, the idea is to route the most critical destination first, hence the name Critical Destination First (CDF). The primary purpose of the two heuristics is to compute the light-spider-hierarchies (LSHs), however they can also be used to compute light-spiders (LSs) with a minor modification. In the simulation subsection, the performances of the two heuristics are compared with the exact ILP solutions as well as compared with each other. We also make a comparison between LSH based solutions versus LS based solutions using the same algorithm to verify the goodness of LSHs over LSs structure.

5.7.1 Notations

The two heuristic algorithms work on layered graph model instead of topology graph. To support the description of the two heuristic algorithms, we define some used notations as follows.

- $G' = (V', A')$: the layered graph constructed from the topology graph $G = (V, A)$.
- $r' = (s', D')$: the corresponding request of the original request $r = (s, D)$ created in the layered graph. We call the pseudo source s' the *source*, and each pseudo destination $d' \in D'$ *sink* for short.
- MC_SET : the set of copies of the original source s in all the layers.
- $CONN_SET$: the set of connectors, which can be used to grow the current hierarchy H . For the aforementioned *degree constraint* imposed on the vertices of G' (cf. Subsection 5.4.2), not all the vertices in H , but a subset of them, can be used to grow the hierarchy. They include the pseudo source s' , copies of the original source s (MC_SET) and leaf-nodes in H .
- $SPT(c, D')$: the shortest path tree from source c to set D'
- $P(u, v)$: the shortest path from u to v .
- $pred(d')$: the predecessor of sink $d' \in D'$ in the shortest path from s' to a sink d' .
- $post(v)$: the successor of vertex $v \in V'$. It is used to check whether a vertex attached with a sink. In particular, $post(v) \neq nil \iff v$ is attached with a sink by a pseudo arc, otherwise $post(v) = nil$. It is used in CDF algorithm.

5.7.2 Nearest Destination First Algorithm

Nearest Destination First (NDF) algorithm employs the basic idea of the Minimum Path Heuristic [73], which constructs an approximate Steiner tree from an initial vertex by iteratively adding a destination together with the shortest path (one at a time) until all the destinations reached. However, to satisfy the aforementioned *degree constraint* imposed on the vertices of G' (cf. Subsection 5.4.2), MPH is modified in our NDF heuristic to compute a valid route.

Given a WDM network modeled by a topology graph $G = (V, A)$, and a multicast request $r = (s, D)$, NDF is designed to compute a minimum cost route for a corresponding request $r' = (s', D')$ on layered graph $G' = (V', A')$. The algorithm returns a *directed hierarchy* H rooted at the source s' and covers all the *sinks* $D' = d'_1, d'_2, \dots, d'_{|D'|}$ (provided that the solution is feasible). After pruning pseudo vertices and arcs from H , the resultant hierarchy H consists of a set of light-spider-hierarchies (LSHs). Each of these LSHs is located in a different layer, using a distinct wavelength. The description of NDF is given in the Algorithm 5.3.

Initially, H consists of only the source s' . At each iteration, the algorithm searches for the nearest sink d' (line 11) from $CONN_SET$ in the current hierarchy H to all the *unreached* sinks $d' \in D'$. This is done by gathering set $CONN_SET$ as a virtual source c , and then creating a shortest path tree from c to the sinks in D' (line 7). Then the algorithm adds all vertices and arcs in the path $P(c, pred(d'))$ to H , then remove the arcs in the path $P(c, d')$ from the layered graph G' , and update $CONN_SET$. The update of $CONN_SET$ (shown in line 15) is done by adding the predecessor of d' , i.e., $pred(d')$, and removing the connector c if it is a destination duplicate in $CONN_SET$ (lines 16–18) since it cannot support any other successors. Note that d' is a pseudo destination which is not useful to add to H and to extend H . That is why $P(c, pred(d'))$ (but not $P(c, d')$) is added to H and $pred(d')$ (but not d') is considered as a leaf-node of H in the algorithm.

The algorithm terminates when there is no reachable destination remaining, or equivalently, H cannot be extended. To obtain the final multicast route, the supplementary step is needed to prune all the pseudo vertices (source and sinks) and the relevant pseudo arcs. The result is a set of LSHs routed at the source duplicates. Obviously, the resultant hierarchy remains the properties of hierarchy while respecting the degree constraint. One example to illustrate the algorithm is shown in Fig. 5.22.

Theorem 5.6. *NDF algorithm can compute the hierarchy H for a multicast request $r = (s, D)$ in the time of $O(D \times W \times (V \log(WV) + A))$.*

Proof. To find the nearest sink d' from set $CONN_SET$ of the connectors to set D' of the sinks in layered graph G' (line 11), Dijkstra's algorithm should be used once. This is because, after gathering the connectors in $CONN_SET$ as a virtual source c (e.g., by connecting the pseudo source to each of them by zero-cost arcs), it is sufficient to find

Algorithm 5.3 Nearest Destination First Algorithm

Input: A topology graph $G = (V, A)$, a set of wavelengths W , a multicast request $r = (s, D)$

Output: A minimum cost hierarchy H

- 1: Construct the layered graph $G' = (V', A')$ from G , and the multicast request $r' = (s', D')$ from r
- 2: $MC_SET \leftarrow \{s^1\} \cup \{s^2\} \cup \dots \cup \{s^{|W|}\}$
- 3: $CONN_SET \leftarrow \{s'\} \cup MC_SET$
- 4: $H \leftarrow \{s'\}$
- 5: **while** ($D' \neq \emptyset$) **do**
- 6: Gather set $CONN_SET$ as a virtual source c
- 7: Compute in G' the shortest path tree $SPT(c, D')$
- 8: **if** ($SPT(c, D') = \emptyset$) **then**
- 9: **break**
- 10: **end if**
- 11: Find the nearest sink d' from c
- 12: $H \leftarrow H \cup P(c, pred(d'))$
- 13: $D' \leftarrow D' \setminus \{d'\}$
- 14: $A' \leftarrow A' \setminus \{\text{arcs in } P(c, d')\}$
- 15: $CONN_SET \leftarrow CONN_SET \cup \{pred(d')\}$
- 16: **if** ($c \notin MC_SET$) **then**
- 17: $CONN_SET \leftarrow CONN_SET \setminus \{c\}$
- 18: **end if**
- 19: **end while**
- 20: Prune all the pseudo vertices and relevant pseudo arcs from H
- 21: **return** H

the nearest destination d' by constructing a single shortest path tree from the pseudo source to all the sinks in G' (line 7). The **while** loop (line 5) takes at most $|D'| = |D|$ times to cover all the sinks in D' . Hence the Dijkstra's algorithm needs to run at most $|D|$ times. The time complexity of Dijkstra's algorithm running on a graph $G' = (V', A')$ (implemented by a Fibonacci heap) is $O(V' \log V' + A')$ [110], in which V' is a vertex set of the size $|V'| = |V| \times W + 1 + |D| \leq |V| \times W + |V|$; and A' is an arc set of the size $|A'| = |A| \times W + W + W \times |D| = (|A| + 1 + |D|) \times W \leq (|A| + |V|) \times W$. Thus, $O(V' \log V' + A') = O(W \times (V \log(W \times V) + A + V)) = O(W \times (V \log(WV) + A))$. Thus, to implement a multicast session $r = (s, D)$, the NDF algorithm takes time $O(D \times W \times (V \log(WV) + A))$. \square

However, the actual time computation can be less since not all the vertices and arcs in G' are involved in the computation of the shortest paths. First, the vertices and arcs that cannot be reached from the source should be eliminated when constructing the G' before running the algorithm. Second, as each iteration, several arcs are removed from A' , hence reducing $|A'|$.

5.7.3 Critical Destination First Algorithm

NDF heuristic always chooses the nearest pseudo destination (sink) to extend the current hierarchy. However there are cases in which this policy is not effective. Let us see Fig. 5.22 for an example. The network is shown in Fig. 5.22a, with the multicast request $r = (s, \{d_1, d_2, d_3\})$. The corresponding layered graph with attached link costs are shown in Fig. 5.22b. According to NDF, the first sink should be d'_3 with the shortest path computed in layer 1: $\langle s', s^1, 2^1, 4^1, 5^1, d_3^1, d'_3 \rangle$ with length (cost) of 4. For the next iteration, only d'_1 can be reached (through layer 2) with the corresponding shortest path $\langle s', s^2, 1^2, 4^2, 6^2, d_1^2, d'_1 \rangle$ with length of 8. The algorithm terminates and d'_2 is never routed (cf. Fig. 5.22c)!

Now let us take a closer look at all the sinks, we see that d'_2 has a least number of incoming arcs (1 in this case). Naturally, it should be chosen first since it has the least probability to be routed. Suppose that we choose d'_2 first, the corresponding shortest path is $\langle s', s^1, 2^1, 4^1, 5^1, d_2^1, d'_2 \rangle$ with the length of 5 is added to the hierarchy. To choose the next sink between d'_1 and d'_3 , since they have the same number of incoming links, the nearest one from the current hierarchy should be chosen. So the next sink should be d'_3 , and the corresponding shortest path $\langle d_2^1, 5^1, d_3^1, d'_3 \rangle$ with the length of 3. Finally, the last sink d'_1 and the shortest path $\langle s', s^2, 1^2, 4^2, 6^2, d_1^2, d'_1 \rangle$ with the length of 8 is added to the hierarchy, resulting in the solution that reaches all the sinks with total cost of 16 as shown in Fig. 5.22d.

From the above observation, it is more beneficial to give higher priority to the sinks with lower incoming degree when extending the current hierarchy. We call these sinks *critical destinations*, and the incoming degree *critical degree*, since the incoming degree of a sink indicates the reachability of it from the source s' (cf. Fig. 5.22b). The least critical degree sink is thus the most critical destination. This gives rise to the new policy, i.e., choosing the most critical destination first, and hence the name: Critical Destination First (CDF) heuristic. When there are multiple sinks having the same critical degree, the nearest one from the current hierarchy will be chosen first as in NDF.

With the notations introduced in Subsection 5.7.1, the pseudo code of CDF heuristic is shown in Algorithm 5.4.

Basically, CDF heuristic is the same NDF heuristic, except that instead of finding a nearest sink of D' , CDF finds the most critical sink from D' . This difference leads to two other different points in the description of CDF algorithm. The first point is the **for** loop in lines 14–18. This comes from the possibility that the shortest path $P(c, pred(d'))$ may contain destination duplicates which are associated with some sinks. If so, the corresponding sinks must be removed from D' . To this end, we use $post(v)$ (line 15) to store the *associated vertices* for each vertex $v \in V'$, such that $post(v) = d' \in D'$ if v is associated with a sink d' , and $post(v) = nil$, otherwise. For example, back to the example shown in

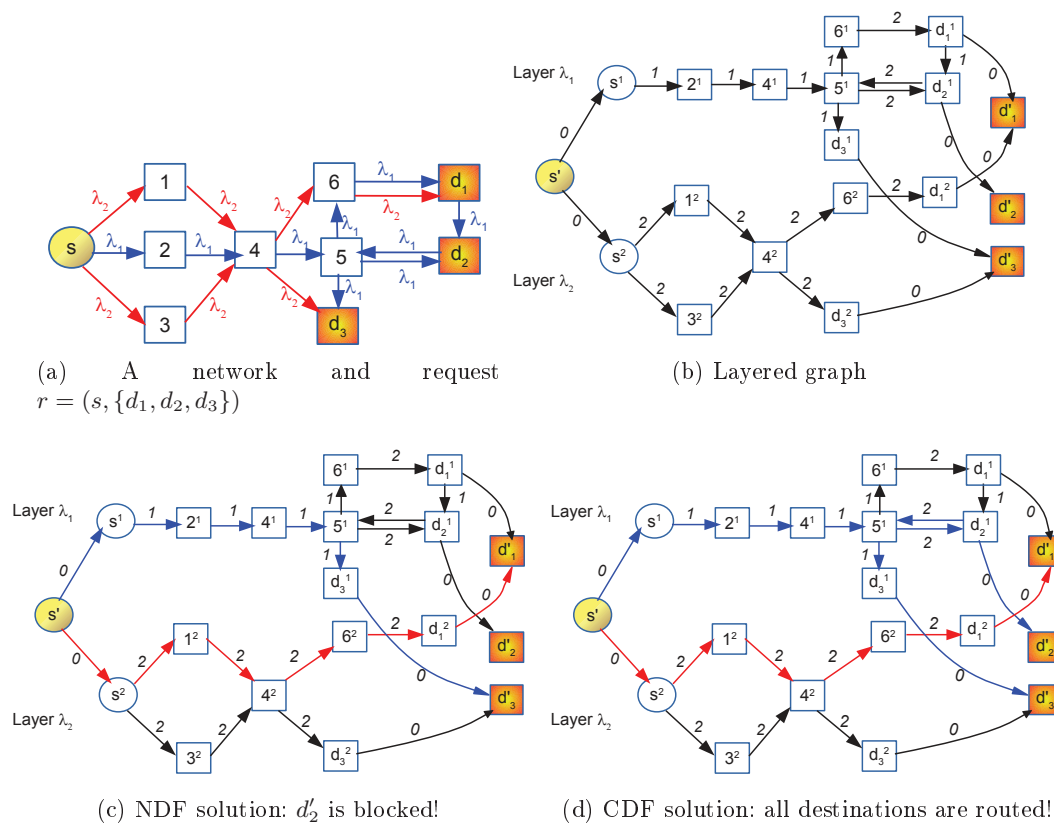

Figure 5.22 – Illustration of the two heuristics

Fig. 5.22b, we have $post(d_1^1) = post(d_2^1) = d_1'$, $post(d_2^2) = d_2'$, $post(d_3^1) = post(d_3^2) = d_3'$; for the other vertices v , $post(v) = nil$.

The second different point is that the algorithm should update the reachability of all the *affected* sinks whenever $P(c, pred(d'))$ has been added (line 25). Note that not all the remaining sinks but just some of them may be affected by this addition. In the following, we present techniques to detect the affected sinks and update their incoming degrees.

The straightforward technique is using a breath first search (BFS) from s' to visit the vertices in V' . Calculate a set of vertices U that is not reachable from s' . Then scan through all the vertices $u \in U$, check to see if $post(u) \neq nil$. If it is the case, then $post(u) = u'$ is the sink that is not reachable. Remove arc (u, u') from G' , it also reduces one incoming degree to u' . However, since this method works on the whole layered graph G' , the BFS takes time $O(V' + A')$ which is time-consuming. Thus, we propose another technique that can reduce the time computation.

Given a critical destination d' , we observe that the path $P(c, d')$ locates totally in one layer (since there is no link between layers except the source and sinks). So the affected sinks (if any) must be affected only by that layer. Moreover, when constructing the layered graph, we add all the copies of nodes in the topology graph to a layer, one layer at a time, so the indices of vertices in the layered graph G' can be divided into groups of size $|V|$.

Algorithm 5.4 Critical Destination First Algorithm

Input: A topology graph $G = (V, A)$, a set of wavelengths W , a multicast request $r = (s, D)$

Output: A minimum cost hierarchy H

- 1: Construct the layered graph $G' = (V', A')$ from G , and the multicast request $r' = (s', D')$ from r
- 2: calculate the reachability (incoming degree) of all sinks in D'
- 3: $MC_SET \leftarrow \{s^1\} \cup \{s^2\} \cup \dots \cup \{s^{|W|}\}$
- 4: $CONN_SET \leftarrow \{s'\} \cup MC_SET$
- 5: $H \leftarrow \{s'\}$
- 6: **while** ($D' \neq \emptyset$) **do**
- 7: Gather set $CONN_SET$ as a virtual source c
- 8: Compute in G' the shortest path tree $SPT(c, D')$
- 9: **if** ($SPT(c, D') = \emptyset$) **then**
- 10: **break**
- 11: **end if**
- 12: Find the most critical sink $d' \in D'$
- 13: $H \leftarrow H \cup P(c, pred(d'))$
- 14: **for all** $v \in P(c, pred(d'))$ **do**
- 15: **if** $post(v) \in D'$ **then**
- 16: $D' \leftarrow D' \setminus \{post(v)\}$ {remove $post(v)$ from D' }
- 17: **end if**
- 18: **end for**
- 19: $D' \leftarrow D' \setminus \{d'\}$
- 20: $A' \leftarrow A' \setminus \{\text{arcs in } P(c, d')\}$
- 21: $CONN_SET \leftarrow CONN_SET \cup \{pred(d')\}$
- 22: **if** ($c \notin MC_SET$) **then**
- 23: $CONN_SET \leftarrow CONN_SET \setminus \{c\}$
- 24: **end if**
- 25: Update the incoming degree of affected sinks in D'
- 26: **end while**
- 27: Prune the pseudo source s' and the relevant pseudo arcs from H
- 28: **return** H

Each group is associated with a layer index ranging from 0 to $W - 1$. As a result, given an index of a vertex $v \in SP(c, pred(d'))$, we can specify the index of the containing layer by $\lambda = index(v) \div |V|$.

After having determined λ , the affected sinks can be detected by using a BFS as mentioned in the above technique. However, instead of using a BFS from the source s' , the new BFS starts from the copy of the source s^λ (in order to scan just through the vertices in layer λ), and the unreachable set U is also computed from the vertices of layer λ . The time computation is reduced to $O(V + A)$.

Theorem 5.7. *The complexity of CDF algorithm is $O(D \times W \times (V \log(W \times V) + A))$.*

Proof. To determine the most critical destination (sink) d' , it takes time $O(\log D') = O(\log D)$ (with the help of binary heap). To find the shortest path $P(c, d')$ in layered graph

G' , Dijkstra's algorithm should be used once in $O(V' \log V' + A')$ times. Note that in terms of implementation, the actual time computation is much better than the worst case [108]. To determine affected sinks and update their critical degrees, a BFS is used once in a layer, and it takes time $O(V+A)$. Thus, for each sink d' , CDF takes time $O(V' \log V' + A' + \log D + V + A)$. According to Theorem 5.6, $O(V' \log V' + A') = O(W \times (V \log(WV) + A))$, and it is much bigger than $O(\log D + V + A)$. Thus, $O(V' \log V' + A' + \log D + V + A) = O(V' \log V' + A')$. Since there are $|D'| = |D|$ sinks, the time complexity of CDF is: $O(D \times (V' \log V' + A')) = O(D \times W \times (V \log(WV) + A))$. In other words, the time complexity of CDF algorithm is the same as that of NDF algorithm. \square

5.7.4 Performance Evaluation

We divide the simulations into two parts. The first part is to evaluate the proposed heuristics with the optimal solutions obtained from the corresponding ILP formulations with relatively small instances. The second part presents the comparison among heuristics with larger scale realistic configurations. Note that each algorithm (NDF, CDF and ILP) has two variants: one computes the light-spider-hierarchies which we name NDF-LSH, CDF-LSH and ILP-LSH; and the other computes the light-spiders, which are called NDF-LS, CDF-LS and ILP-LS, respectively.

5.7.4.1 Heuristic Solutions versus Exact Solutions

We evaluate the two proposed heuristics versus the exact solutions computed by the ILP formulations mentioned in Section 5.5. The random graphs and related parameters are set in the same method for *wavelength nonsymmetric* case as mentioned in Subsection 5.5.3.

The results of all the heuristic variants and ILPs are presented in Table 5.5. ILP-LSH results in the cost optimal solutions (so we mark them in bold and with stars in the left-half of the table). Compared with ILP-LS, ILP-LSH achieves the average gain of 3.9% on total cost. Moreover, although the wavelength consumption is the second concern, ILP-LSH also achieves the lowest wavelength consumption in all the cases (though they are not considered as the optimal ones). On average, ILP-LSH profits 7.2% on wavelength consumption compared with ILP-LS. These results are compatible with those obtained from Table 5.3.

For each heuristic algorithm, the LSH based solutions always outperform the LS counterparts as expected. Besides, CDF based heuristics always outperform NDF based rivals in both performance metrics. Among the heuristics, CDF-LSH is closest to the cost optimal solution with average ratio of 1.16, and also achieves the smallest average ratio of 1.24 to the lowest wavelength consumption solution (obtained by ILP-LSH).

Table 5.5 – Comparison of heuristic solutions with exact solutions for MTCF problem.

V	D	TOTAL COST							NUMBER OF WAVELENGTHS USED						
		NDF-LS	CDF-LS	NDF-LSH	CDF-LSH	ILP-LS	ILP-LSH	cost \searrow	NDF-LS	CDF-LS	NDF-LSH	CDF-LSH	ILP-LS	ILP-LSH	wave \searrow
20	2	42.5	41.9	41.4	41.1	39.9	39.2*	1.8%	1.6	1.5	1.5	1.4	1.3	1.2	7.7%
	4	75.5	72.3	70.7	69.6	64.1	62.0*	3.3%	2.7	2.5	2.4	2.3	1.8	1.7	5.6%
	6	101.0	96.6	97.1	94.9	85.3	83.4*	2.2%	3.0	2.9	2.8	2.8	2.2	2.0	9.1%
	8	122.3	114.3	120.9	110.7	100.1	96.8*	3.3%	3.4	3.3	3.3	3.0	2.6	2.4	7.7%
	10	143.2	136.8	140.3	133.5	118.0	113.3*	4.0%	3.6	3.4	3.5	3.2	2.7	2.5	7.4%
	<i>ratio</i>	1.21	1.16	1.17	1.13	1.03	1.00*	2.9%	1.46	1.38	1.37	1.29	1.08	1.00	7.5%
30	3	66.4	66.9	64.8	65.0	61.9	60.0*	3.1%	2.0	2.1	2.0	2.0	1.7	1.6	5.9%
	6	127.0	121.7	122.6	117.9	109.0	105.4*	3.3%	3.1	3.1	3.0	2.8	2.5	2.3	8.0%
	9	170.2	164.8	163.5	158.7	141.1	136.0*	3.6%	3.6	3.5	3.4	3.4	2.8	2.6	7.1%
	12	210.2	201.3	200.7	191.0	169.2	162.0*	4.3%	4.0	3.8	3.8	3.5	3.2	2.9	9.4%
	15	260.7	246.2	247.7	235.6	203.8	195.6*	4.0%	4.2	4.1	4.0	3.9	3.6	3.3	8.3%
	<i>ratio</i>	1.24	1.20	1.19	1.15	1.04	1.00*	3.7%	1.33	1.31	1.28	1.23	1.08	1.00	7.7%
40	4	96.6	94.0	93.4	91.8	86.8	83.7*	3.6%	2.5	2.5	2.4	2.4	2.0	1.9	5.0%
	8	177.1	177.0	169.5	166.3	147.9	142.8*	3.4%	3.4	3.5	3.2	3.2	2.7	2.5	7.4%
	12	252.6	245.8	247.9	233.0	203.5	194.7*	4.3%	4.0	3.9	3.7	3.6	3.1	2.9	6.5%
	16	306.3	295.8	293.3	280.0	239.8	228.4*	4.8%	4.3	4.1	4.1	3.9	3.4	3.2	5.9%
	20	357.6	343.2	345.9	325.1	277.2	265.2*	4.3%	4.5	4.5	4.4	4.2	3.8	3.6	5.3%
	<i>ratio</i>	1.28	1.24	1.23	1.18	1.04	1.00*	4.1%	1.33	1.32	1.26	1.23	1.06	1.00	6.0%
50	5	136.9	135.6	129.8	129.4	120.2	115.4*	4.0%	2.8	2.9	2.7	2.7	2.4	2.2	8.3%
	10	251.2	234.1	233.7	222.4	202.1	192.5*	4.8%	3.9	3.8	3.7	3.5	3.1	2.9	6.5%
	15	318.3	300.5	294.1	284.6	248.8	236.6*	4.9%	4.3	4.2	4.1	4.0	3.5	3.2	8.6%
	20	395.6	376.9	379.7	356.7	303.8	287.7*	5.3%	4.5	4.5	4.4	4.3	3.9	3.6	7.7%
	25	454.4	436.2	431.5	412.9	345.3	327.9*	5.0%	4.7	4.6	4.4	4.4	4.0	3.7	7.5%
	<i>ratio</i>	1.32	1.26	1.24	1.20	1.05	1.00*	4.8%	1.30	1.29	1.24	1.21	1.08	1.00	7.7%
<i>avg(ratio)</i>		1.26	1.21	1.21	1.16	1.04	1.00*	3.9%	1.35	1.32	1.29	1.24	1.08	1.00	7.2%

5.7.4.2 Comparison among Heuristic Solutions

This work considers the case with arbitrary distribution of the wavelengths in the links, i.e., wavelength nonsymmetric case. Hence, in the cases with limited available wavelengths, it is possible that not all the destinations routed for a given multicast request. If it is the case, we assume that the connection is set-up between the source and the reachable destinations. This is the idea of the *partial destination blocking* model [46] mentioned in Subsection 3.3.4.2 (Chapter 3).

In this section, two scenarios: *full destinations routed* and *partial destinations routed* are taken into account. In the first scenario, we make sure that all the destinations are reached, and the solutions are evaluated based on two metrics: total cost and number of wavelengths used. In the second scenario, not all the destinations are reached. In this case, the partial destination blocking (PB) model is supposed, and the solutions are evaluated based on the other metric called *destination blocking probability* (DBP), i.e., the ratio between the destinations blocked and the total number of destinations of the request. Besides, in order to give comprehensive evaluation of the all algorithms, we also calculate the ratio between the number of requests blocked and the total number of requests examined. Note that a request is considered blocked if there exists one destination of it blocked. We call this metric the *request blocking probability* (RBP).

Simulation Settings

Two simulation scenarios are set up as follows.

- *Full destinations routed*: For this case, provided that all the destinations are reached for all the algorithms for each given instance, we investigate the performances of the algorithms based on two metrics: total cost and number of wavelengths used. To make sure all the destinations reached, we run a redundant number of simulations with different instances, and record the successful ones wherein all the destinations routed for all the algorithms. The simulations are run on random network topologies $G = (V, A)$, with random distribution of wavelengths in each arc. We choose $|V| \in (50, 100, 150)$, $W = 20$, and $|D|$ varies in (10%, 20%, ..., 90%) of $|V|$. For each $|D|$, we run redundant number of simulations and select 1000 successful instances. Then we calculate the 95% confident intervals for all the mean values for the total cost and the number of wavelengths used by each algorithm. The results are shown in Figs. 5.23, 5.24 and 5.25.
- *Partial destinations routed*: For this case, it is supposed the connection is established even if not all the destinations are reached, i.e., the Partial blocking probability model is used. To evaluate solutions, we calculate the two above-defined blocking probability metrics (DBP and RBP) as performance metrics. To generate partial destinations routed, we set the number of wavelengths $W = 10$. All the other parameter settings are the same as the above scenario. The 95% confident intervals for all the results are shown in Figs. 5.26, 5.27 and 5.28.

Performances Comparison on Resource Efficiency

For the first scenario (full destinations routed), the performances of all the algorithms on the basis of resource efficiency (i.e., total cost and wavelength consumption) are shown in Figs. 5.23, 5.24 and 5.25. On the whole, LSH solutions always outperform LS counterparts in both metrics and independent to heuristics employed.

In particular, with NDF heuristic, NDF-LSH achieves 4% gain in total cost, and 6% improvement in wavelength consumption compared with NDF-LS. The same comparative values (4.5% and 7.5%, respectively) are recorded when comparing CDF-LSH with CDF-LS. This once again verifies the conclusion resulted from the previous sections.

Comparing the two heuristics, CDF works better (about 6%) than NDF in total cost but they consume the quasi-same number of wavelengths whatever LS or LSH is used.

Performances Comparison on Blocking Probability

For the second scenario (partial destinations routed), the performance of all the algorithms in terms of blocking probability are shown in Figs. 5.26, 5.27 and 5.28. Generally, given a fixed number of available wavelengths ($W = 10$), two blocking probability metrics (DBP and RBP) computed from all the algorithms get increased when group size increases.

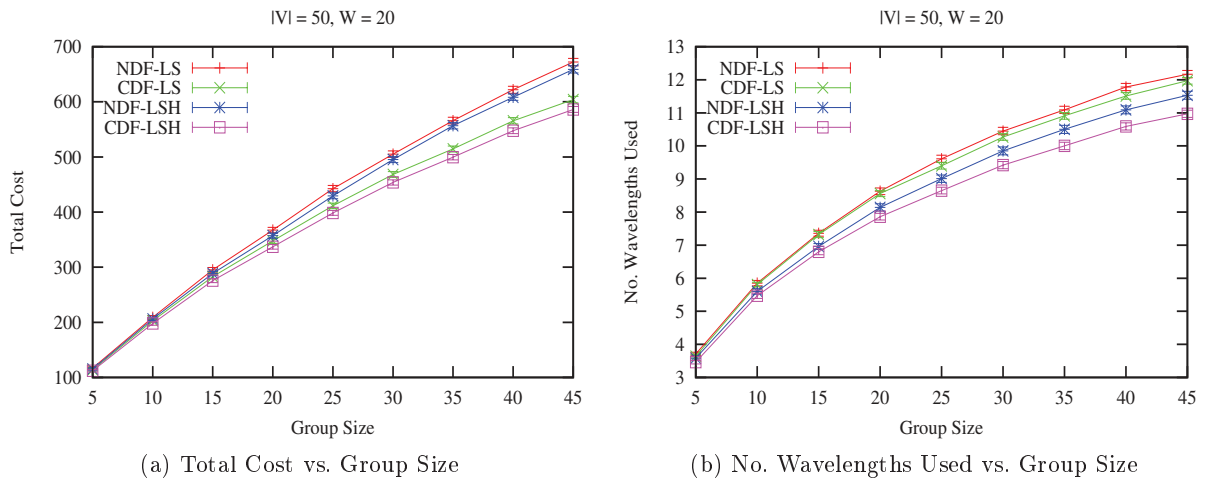

Figure 5.23 – Performances of algorithms on 50-node random graphs with $W = 20$

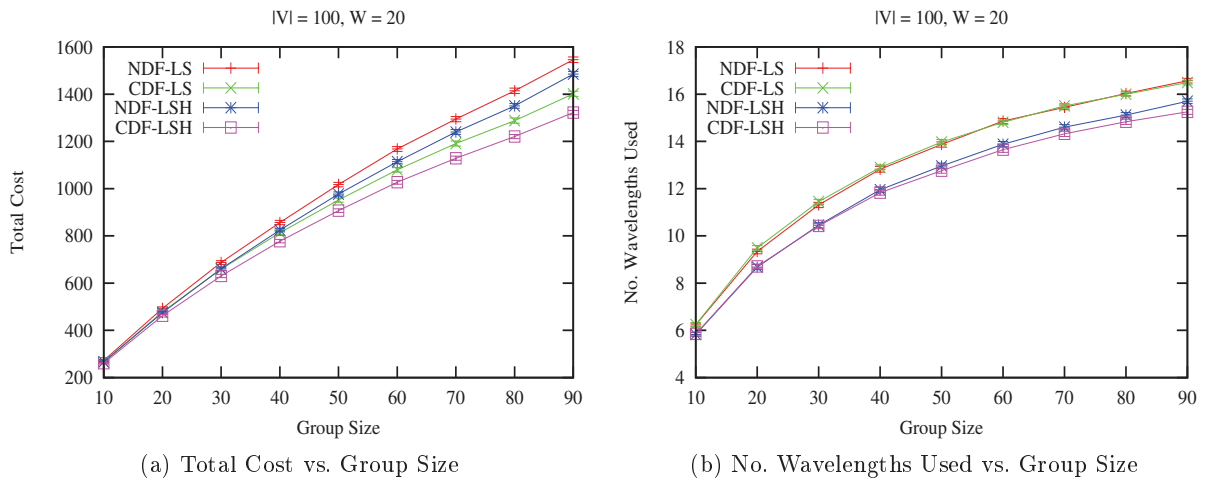

Figure 5.24 – Performances of algorithms on 100-node random graphs with $W = 20$

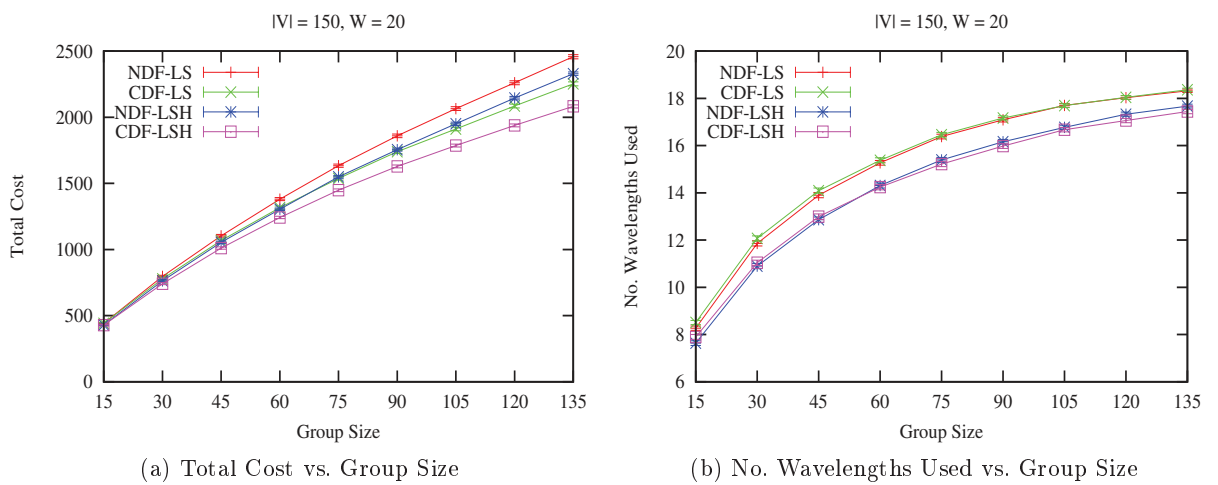
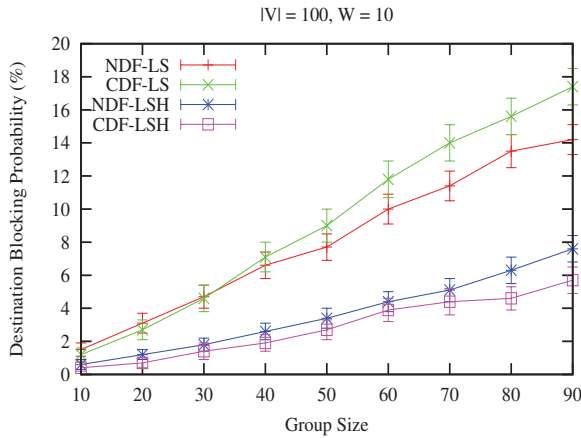
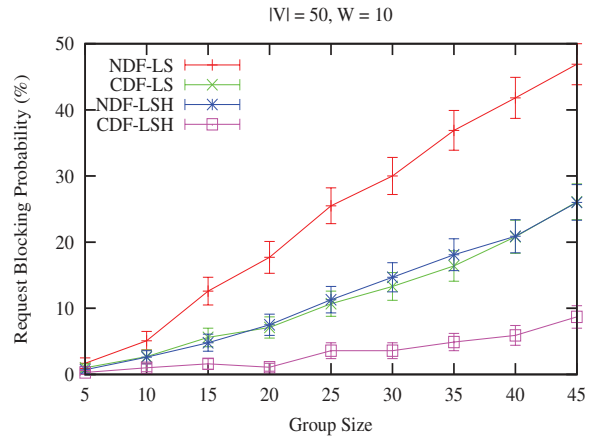

Figure 5.25 – Performances of algorithms on 150-node random graphs with $W = 20$



(a) DBP vs. Group Size



(b) RBP vs. Group Size

Figure 5.26 – Performances of algorithms on 50-node random graphs with $W = 10$

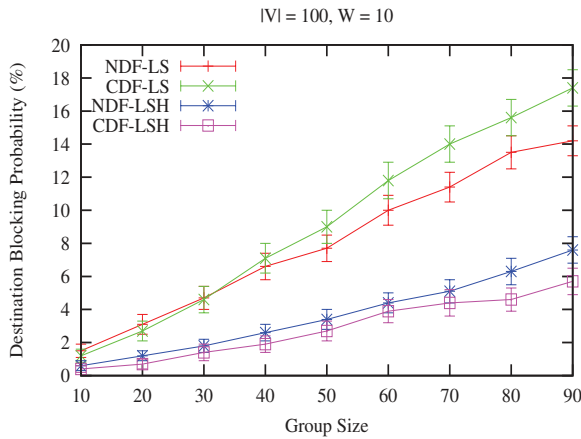

(a) DBP vs. Group Size

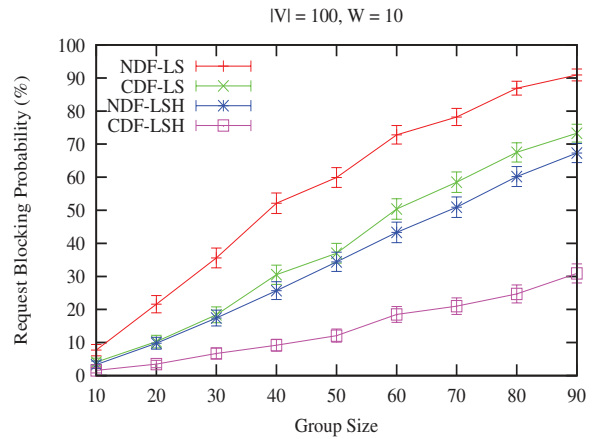

(b) RBP vs. Group Size

Figure 5.27 – Performances of algorithms on 100-node random graphs with $W = 10$

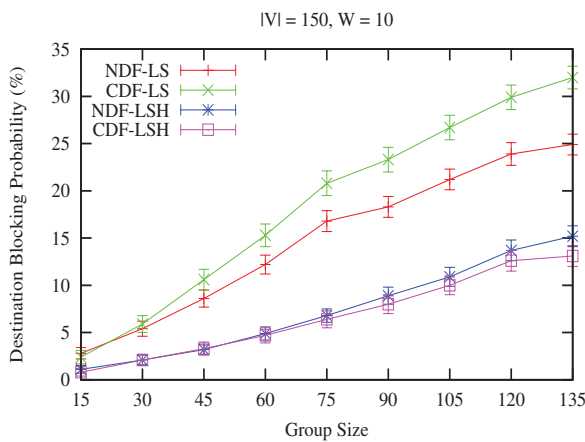

(a) DBP vs. Group Size

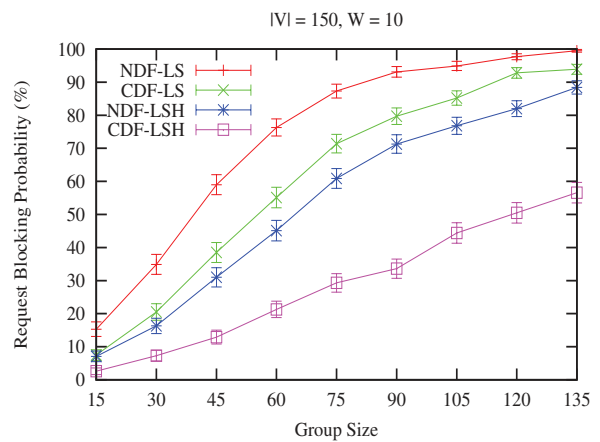

(b) RBP vs. Group Size

Figure 5.28 – Performances of algorithms on 150-node random graphs with $W = 10$

Among them, CDF-LSH outperforms the others when always achieving lowest DBP as well as RBP. NDF-LSH appears close to CDF-LSH on DBP but it is by far higher on RBP.

Comparing LSH with LS solutions over all the conducted simulations, LSHs are always better than LSs whatever heuristics are employed. In particular, with NDF algorithm, NDF-LSH profits 4.5% (on average) lower on DBP, and 18% on RBP compared with NDF-LS. Similarly, the corresponding gains of 6.5% and 21.5% obtained when comparing CDF-LSH with CDF-LS. Especially, based on the same LSH solutions, CDF-LSH works better than NDF-LSH when achieving 18% lower RBP, 1% lower DBP.

In short, the LSH solutions are always better than LS counterparts; and the CDF algorithm outperforms NDF, too. The results are expected and explainable. On one hand, by permitting vertices to be visited more than once, LSH allows to make full use of all the available wavelengths in the links while respecting the three aforementioned constraints. Consequently, more destinations can be reached with a limited available links and wavelengths, it in turn results in better blocking probability. On the other hand, CDF gives high priority to the most critical destinations to extend the hierarchy. Naturally, the most critical destinations will not be abandoned whenever there is a chance. Meanwhile NDF always chooses the nearest one, which may leave some destinations unreached even if there are many other choices.

5.8 Conclusion

A thorough investigation on the AOMR problems without splitters and converters are discussed in this chapter. First, two variant problems of minimizing the network resources are formulated, namely: 1) *Minimum Number of Wavelengths First* and 2) *Minimum Total Cost First*. Then we proved that the problems are NP-hard, and identified the optimal solution for both problems as *a set of light-spider-hierarchies*. An ILP formulation based on *light-spider-hierarchies* was developed, and the simulation results verified the correctness of the statement. The simulations also showed that, in general, the minimum wavelength consumption solution using light-spider-hierarchies also consumes a lower total cost; and the minimum total cost solution with light-spider-hierarchies also consumes fewer wavelengths compared with the light-spiders counterpart. We also proposed several efficient heuristic algorithms for each problem to compute the routes in large-scale networks with different scenarios.

For MNWF problem, we proposed a heuristic algorithm with two variants based on light-spider-hierarchies: Farthest First and Nearest First. The idea of the algorithm is to diminish the conflicts between the light-trails until it cannot be reduced. Especially, unlike the common approaches which assume to work on *symmetric* networks with bidirectional links, our algorithm can work well in arbitrarily *semi-symmetric* networks in which links are not necessarily bidirectional. The two heuristics are compared with the exact ILP so-

lutions and the other algorithms based on light-spiders proposed in the literature. Our algorithm achieves lower number of wavelengths used, lower cost but quite high diameter compared with light-spider based algorithms. Between the two variants, although Farthest First can result in slightly smaller number of wavelengths and lower cost, Nearest First provides better diameter, hence it produces a trade-off solution among the three performance metrics.

For MTCF problem, we proposed two cost-effective heuristics for the MTCF problem: Nearest Destination First and Critical Destination First. These algorithms aim at minimizing the total cost for a given multicast request under the arbitrary availability of wavelengths in non-splitting networks. The two algorithms are designed to compute low-cost hierarchies based on the auxiliary layered graph model, then the final solution (which is a set of light-spider-hierarchies) is obtained by pruning the pseudo vertices and arcs. They are different in the way of choosing the candidate destinations. NDF always chooses the nearest destinations one at a time, CDF selects the critical destinations first. The performances of the two heuristics are compared with the exact ILP solutions as well as compared with each other. Simulation results reveal that the proposed algorithms produce close-to-the-optimal solutions. They also show that, taking the critical degree of the destinations into account, particularly choosing the most critical destination first, results in a better solution under arbitrary wavelength configuration. Once again, the simulation results confirm that light-spider-hierarchies outperform light-spiders counterpart in supporting multicast in non-splitting capacity.

■ Key points of Chapter 5 ■
<ul style="list-style-type: none">• Two problems, namely MNWF and MTCF, for minimizing the network resources in WDM networks without splitters and converters are formulated and both are proved to be NP-hard.• An ILP formulation based on <i>light-spider-hierarchies</i> is developed to solve exactly the problems.• An efficient heuristic algorithm with two variants are proposed for MNWF problem.• Two cost-effective heuristic algorithms are also proposed for MTCF problem under arbitrary availability of wavelengths.

Part III

Multiple-Request AOM

Provisioning Multiple Static Requests in Sparse Splitting

This chapter investigates the multicast routing and wavelength assignment (MCRWA) problem in terms of multiple requests present together in the networks. Specifically, given a sparse splitting WDM network, and a set of available wavelengths, we investigate the problem of provisioning a set of multicast requests simultaneously aiming at minimizing the blocking probability. Two blocking models are taken into account: *full blocking probability* and *partial blocking probability*. As the problems are NP-hard, we propose an ILP formulation with two variants (each for a blocking model) to search for the optimal solution and several efficient adaptive algorithms to compute approximated solutions. Extensive simulations reveal that our *adaptive* algorithms are able to compute near-optimal solution and they outperform those based on *fixed approaches* under both blocking probability models. The results also show that light-hierarchies are able to accommodate more requests and destinations compared with light-trees.

6.1 Introduction

As discussed in Chapter 3, lots of works solve multicast routing problems under sparse splitting configuration, however, most of them deal with single multicast request context [27, 48, 64, 65, 69, 71, 99]. Due to the explosive nature of traffic loads, requests are generated everywhere and at any time, so it is more practical to consider a set of requests present together in the networks. Nevertheless, the studies on multiple multicast requests usually assumed to work with full splitting configuration [38, 46, 105]. Several ILP/MILP formulations were proposed to search for the exact solutions based on light-trees [13, 46, 111]; however, no ILP based on light-hierarchies is proposed in the literature.

This chapter addresses the multicast routing and wavelength assignment problem in the case of multiple requests (MCRWA) under sparse splitting context. For the sparse splitting networks, besides the two aforementioned constraints: *wavelength continuity constraint* and *distinct wavelength constraint*, the MCRWA problem is subject to an additional constraint, namely *sparse splitting constraint*, i.e., only MC-OXC's can be branching nodes in the computed routes (e.g., light-trees) while MI-OXC's cannot.

The objective of an MCRWA problem is often to minimize the network resource consumption (i.e., the number of wavelengths used and/or the total cost) with the assumption that wavelength availability is sufficient to route all the requests. In response, we investigated the MCRWA problem to minimize network resource consumption in [112]. However, practical limitations on the fiber technology and optical devices restrict the maximum number of wavelengths supported in a fiber. For instance, in core optical networks, a fiber can be multiplexed on the order of 80-100 wavelengths [11]. In the case with limited wavelengths, probably not all the requests are routed. The requests not routed are called *blocked*. The objective of MCRWA in this case is to maximize the total number of requests accepted, or equivalently, to minimize the number of requests blocked (i.e., to minimize the *blocking probability*). In fact, minimizing resources reserves more spare space for the other requests, therefore reducing the blocking probability. Regarding the blocking probability, two blocking probability models were proposed: *full destination blocking probability (FB)* and *partial destination blocking probability (PB)* [38, 46]. The reader is encouraged to refer to Section 3.3 (Chapter 3) for more details about these two models.

Solving an MCRWA problem can be done either by integrating routing (R) and wavelength assignment (WA) in one step (*coupled MCRWA*), or by separating them into two separated steps (*decoupled MCRWA*) [29, 46]. In decoupled MCRWA, a predetermined set of routes (e.g., light-trees) is computed in the physical topology as possible candidate routes for each connection request. The predetermined route set contains either a single route (in *fixed routing*) or multiple ones (in *fixed-alternate routing*) [29, 38, 47]. When a request is examined, these fixed routes are tried one by one until one is accepted. The request is blocked if all the routes are attempted without success. Although decoupled MCRWA approach is simple, they may get penalty for not taking the network state into account.

In contrast, coupled MCRWA computes and then assigns wavelengths to the routes depending on the network state. Since the routes are computed dynamically depending on the network state, the routing belongs to adaptive routing approach. The request is blocked only if there is no available route to carry it. Hence, the adaptive routing approach performs better than the above-mentioned fixed approaches [29, 38].

A few literature works tackled static MCRWA for multiple multicast requests [10, 38, 46, 105]. The static MCRWA problem was first studied in [38] and [46] targeting the objective of minimizing the blocking probability. The work [105] focused on minimizing the number of wavelength converters (WCs) that are required to support the entire group of static

multicast requests. However, these studies assumed to work on the networks wherein nodes are equipped with full splitting capability and/or wavelength converters, which is not practical in the current network configurations. In [10], the authors studied the MCRWA problem under sparse splitting and sparse wavelength conversion networks. They proposed several heuristic algorithms applying the wavelength graph based routing scheme. Although *multiλ-light-trees* (trees using several wavelengths) were used instead of simple light-trees, they do not make full use of possible arcs as light-hierarchies do.

In this chapter, the static MCRWA problem is investigated in sparse splitting WDM networks (abbreviated as *MCRWA-SS*) where wavelength conversion is not available. We aim at minimizing the blocking probability of multicast demands for a given number of wavelengths. Two blocking models (FB and PB) with the corresponding metrics (RBP and DBP) are taken into account. To this end, we propose an ILP formulation with two variants (each for a blocking model) to search for the optimal solution. Since the ILPs are not able to run with large instances, we propose several scalable adaptive MCRWA strategies that integrate the routing and wavelength assignment tasks in one step. Especially, both exact solutions and heuristics make full use of light-hierarchies instead of light-trees. The rest of the chapter is organized as follows. The definition of MCRWA-SS problem is given in Section 6.2. The ILP formulations for computing light-hierarchies are presented in Section 6.3. In Section 6.4, after briefly introducing two routing schemes based on layered graph model, we present several adaptive heuristic algorithms, followed by the simulation results shown in Section 6.5. The chapter is concluded in Section 6.6.

6.2 MCRWA-SS Problem Definition

A WDM network topology is represented by a directed graph $G = (V, A)$ where V is a set of OXCs. Under sparse splitting, $V = MC \cup MI$, in which MC is the set of MC-OXCs, MI is the set of MI-OXCs. A link between two adjacent OXCs u and v consists of two optical directed fibers (u, v) and (v, u) in charge of the communications in two opposite directions. All the optical fibers constitute the arc set A , in which each arc $(u, v) \in A$ is associated with a cost c_{uv} . Let $W = \{\lambda_1, \lambda_2, \dots, \lambda_{|W|}\}$ be the set of wavelengths which are supported in all the fibers.

A set R of multicast requests are known beforehand, $R = \{r_i, i = 1, 2, \dots, |R|\}$, in which $r_i = (s_i, D_i) : s_i \in V, D_i \subseteq V \setminus \{s_i\}, i = 1, 2, \dots, |R|$. For each request, a set of light-hierarchies LHs are computed to deliver the multicast message from the source s_i to the set of destinations D_i while satisfying all the three constraints: *wavelength continuity constraint*, *distinct wavelength constraint* and *sparse splitting constraint* which were mentioned in Section 6.1.

We denote $LH^i = \{LH_1^i, LH_2^i, \dots, LH_{k_i}^i\}$ the set of light-hierarchies required for routing a multicast request $r_i = (s_i, D_i)$, and $k_i = |LH^i|$. The total cost for provisioning all

multicast requests of R can be expressed as the sum of costs of all links used in the resultant light-hierarchies:

$$total_cost = \sum_{i=1}^{|R|} \sum_{k=1}^{k_i} c(LH_k^i) = \sum_{i=1}^{|R|} \sum_{k=1}^{k_i} \sum_{(u,v) \in LH_k^i} c_{uv} \quad (6.1)$$

Let B_i, B_i^d be two sets of binary variables such that: $B_i = 1$ if request r_i is accepted, 0 otherwise; and $B_i^d = 1$ if destination d of request r_i is accepted, 0 otherwise. Two metrics, request blocking probability (RBP) and destination blocking probability (DBP), are defined as follows:

$$RBP = 1 - \frac{\sum_{i \in \mathcal{I}} B_i}{|R|} \quad (6.2)$$

$$DBP = 1 - \frac{\sum_{i \in \mathcal{I}} \sum_{d \in D_i} B_i^d}{\sum_{i \in \mathcal{I}} |D_i|} \quad (6.3)$$

Both RBP and DBP can be calculated in each blocking model. As indicated in Section 6.1, however, RBP is more suitable to be evaluated under the FB model, while DBP is more appropriate to be evaluated under the PB model.

Formally, the considered problems can be defined in general form as follows.

- **Problem: MCRWA-SS**
- **Instance:** A directed graph $G = (V, A)$, a set W of wavelengths in each arc, a set MC of MC-OXCs, and a set of multicast requests $R = \{r_i, i = 1, 2, \dots, |R|\}$
- **Solution:** A set of light-hierarchies satisfying the three constraints: *wavelength continuity constraint*, *distinct wavelength constraint* and *sparse splitting constraint*
- **Objective:** Minimize RBP (under FB model) or minimize DBP (under PB model)

6.3 Light-Hierarchy Based ILP Formulations

Due to its flexibility, a light-hierarchy can cover more destinations compared with a light-tree. Therefore, the light-hierarchy structure can help provide better solutions in terms of resource consumption as well as blocking probability. In this section, two integer linear programming (ILP) formulations are proposed to search for the optimal light-hierarchy solutions for the MCRWA-SS problem, each for a blocking probability (FB or PB) model. The two ILP formulations differ from one another in the objective function and some related constraints.

To formulate, several notations and network parameters are predefined in Table 6.1; and four ILP variable vectors $L_{uv}^{i\lambda} \in \{0, 1\}^{|R| \times |W| \times |A|}$, $F_{uv}^{i\lambda} \in \mathbb{N}^{|R| \times |W| \times |A|}$, $B_i \in \{0, 1\}^{|R|}$, and $B_i^d \in \{0, 1\}^{|R| \times |D_i|}$ are described in Table 6.2.

Table 6.1 – Notations and Network Parameters

$G = (V, A)$	A directed graph representing the network topology
R	A set of multicast requests.
W	A set of wavelengths supported per fiber.
λ	A wavelength, $\lambda \in W$.
$N^+(v)$	Extremities of the outgoing arcs from node v .
$N^-(v)$	Extremities of the incoming arcs to node v .
Deg	The maximum degree of vertices in G .
(u, v)	The arc from node u to node v .
c_{uv}	The cost of the arc (u, v) .
Δ	An integer big enough such that $\Delta > W \times \sum_{(u,v) \in A} c_{uv}$.
MC	The set of MC-OXCs in G .
MI	The set of MI-OXCs in G .
\mathcal{I}	The index set of R : $\mathcal{I} = \{1, 2, \dots, R \}$
$i \in \mathcal{I}$	The index of request r_i
s_i	The source node of the multicast request r_i .
D_i	The destination nodes involved in the multicast request r_i .
$[0, D_i]$	The closed integer interval between 0 and $ D_i $, i.e., $\{0, 1, \dots, D_i \}$

Table 6.2 – ILP Variables

$L_{uv}^{i\lambda} \in \{0, 1\}$	Equals to 1 if multicast request r_i uses wavelength λ on link (u, v) , 0 otherwise.
$F_{uv}^{i\lambda} \in [0, D_i]$	Commodity flow. Denotes the number of destinations in request r_i receiving a flow from s_i via arc (u, v) on λ .
$B_i \in \{0, 1\}$	Equals to 1 if request r_i is accepted, 0 otherwise. Used in ILP-FB.
$B_i^d \in \{0, 1\}$	Equals to 1 if destination d of request r_i is accepted, 0 otherwise. Used in ILP-PB.

6.3.1 ILP with Full Blocking Model (ILP-FB)

For the sake of presentation, let $LH^{i\lambda}$ be a light-hierarchy on wavelength λ , which is used for the request r_i . The binary variable $L_{uv}^{i\lambda}$ denotes whether the arc (u, v) is used by $LH^{i\lambda}$, integer variable $F_{uv}^{i\lambda}$ represents the number of destination nodes in the request r_i receiving a flow from s_i via arc (u, v) on λ , and binary variable B_i decides whether the request r_i is accepted. As we suppose that the wavelength availability is limited, the primary objective of our problem is to minimize the RBP, or equivalently to maximize the number of accepted requests, i.e., $\sum_{i \in \mathcal{I}} B_i$. Secondly, we also try to minimize wavelength

channel cost. To this end, a big enough integer Δ should be introduced, such that the contribution of $\Delta \times \sum_{i \in \mathcal{I}} B_i$ in the overall objective function should be much bigger than the total wavelength channel cost in the case that all the wavelengths in all the fibers were used, i.e., $\Delta > |W| \times \sum_{(u,v) \in A} c_{uv}$.

Hence the objective function can be expressed as follows:

$$\text{Maximize} : \Delta \cdot \sum_{i \in \mathcal{I}} B_i - \sum_{i \in \mathcal{I}} \sum_{\lambda \in W} \sum_{(u,v) \in A} c_{uv} \cdot L_{uv}^{i\lambda} \quad (6.4)$$

This objective function is subject to the light-hierarchy constraints 6.5–6.11 and the connectivity constraints 6.12–6.18. In the following, we use $\forall i$, $\forall d$, $\forall \lambda$, and $\forall (u, v)$ to imply $\forall i \in \mathcal{I}$, $\forall d \in D_i$, $\forall \lambda \in W$, and $\forall (u, v) \in A$ respectively.

6.3.1.1 Light-Hierarchy Constraints

$$\sum_{v \in N^-(s_i)} L_{vs_i}^{i\lambda} = 0, \quad \forall i, \forall \lambda \quad (6.5)$$

$$\sum_{u \in N^-(v)} L_{uv}^{i\lambda} \leq B_i, \quad \forall i, \forall \lambda, \forall v \in MC \setminus \{s_i\} \quad (6.6)$$

$$\sum_{u \in N^+(v)} L_{vu}^{i\lambda} \leq \sum_{u \in N^-(v)} L_{uv}^{i\lambda} \cdot Deg, \quad \forall i, \forall \lambda, \forall v \in MC \setminus \{s_i\} \quad (6.7)$$

$$\sum_{u \in N^+(v)} L_{vu}^{i\lambda} \leq \sum_{u \in N^-(v)} L_{uv}^{i\lambda}, \quad \forall i, \forall \lambda, \forall v \in MI \setminus \{s_i\} \quad (6.8)$$

$$\sum_{u \in N^+(v)} L_{vu}^{i\lambda} \geq \sum_{u \in N^-(v)} L_{uv}^{i\lambda}, \quad \forall i, \forall \lambda, \forall v \notin D_i \quad (6.9)$$

$$\sum_{i \in \mathcal{I}} L_{vu}^{i\lambda} \leq 1, \quad \forall \lambda, \forall (v, u) \quad (6.10)$$

$$L_{vu}^{i\lambda} \leq B_i, \quad \forall i, \forall \lambda, \forall (v, u) \quad (6.11)$$

For any $i \in \mathcal{I}$ and $\lambda \in W$, constraint 6.5 ensures that the light-hierarchies for a multicast request r_i are rooted at the source node s_i . Constraint 6.6 guarantees that each MC-OXC has at most one input arc in each light-hierarchy $LH^{i\lambda}$, while constraint 6.7 indicates that each MC-OXC is able to split the light signal. Constraints 6.7 and 6.8 make sure that no node in V can be the root of $LH^{i\lambda}$ except the source node s_i . Constraint 6.8 together with constraint 6.9 indicate that an intermediate MI-OXC may have multiple input links and multiple output links with the help of cross pair switching, but the number of input links must be equal to the number of output links. Constraint 6.9 determines that only the destinations in D_i can be leaf nodes of a light-hierarchy $LH^{i\lambda}$. For all $i \in \mathcal{I}$, constraint 6.10 corresponds to the distinct wavelength constraint, which forbids two light-hierarchies to

share a link using the same wavelength. Constraint 6.11 indicates that there is no link used for the blocked request.

With the above light-hierarchy structure constraints, however, we can not guarantee the connectivity of the light-hierarchy (cf. Section 5.5, Chapter 5). Thus, we employ a commodity flow method [111] to impose supplementary constraints on variables $L_{uv}^{i\lambda}$ so that the connectivity of the resultant light-hierarchy could be guaranteed.

6.3.1.2 Connectivity Constraints

To establish a multicast request, several light-hierarchies may be required, and the same destination may be spanned by several light-hierarchies. However, a destination can only be served in one light-hierarchy to consume the light signal (i.e., receive the multicast messages), while it is spanned in the other light-hierarchies just to forward the light signal to the successor node.

$$\sum_{\lambda \in W} \sum_{v \in N^+(s_i)} F_{s_i v}^{i\lambda} = |D_i| \cdot B_i, \quad \forall i \quad (6.12)$$

$$\sum_{\lambda \in W} \sum_{v \in N^-(d)} F_{vd}^{i\lambda} = \sum_{\lambda \in W} \sum_{v \in N^+(d)} F_{dv}^{i\lambda} + B_i, \quad \forall i, \forall d \quad (6.13)$$

$$\sum_{v \in N^-(d)} F_{vd}^{i\lambda} - B_i \leq \sum_{v \in N^+(d)} F_{dv}^{i\lambda}, \quad \forall i, \forall d, \forall \lambda \quad (6.14)$$

$$\sum_{v \in N^-(d)} F_{vd}^{i\lambda} \geq \sum_{v \in N^+(d)} F_{dv}^{i\lambda}, \quad \forall i, \forall d, \forall \lambda \quad (6.15)$$

$$\sum_{u \in N^-(v)} F_{uv}^{i\lambda} = \sum_{u' \in N^+(v)} F_{vu'}^{i\lambda}, \quad \forall i, \forall \lambda, \forall v \notin D_i \quad (6.16)$$

$$F_{uv}^{i\lambda} \geq L_{uv}^{i\lambda}, \quad \forall i, \forall (u, v), \forall \lambda \quad (6.17)$$

$$F_{uv}^{i\lambda} \leq |D_i| \times L_{uv}^{i\lambda}, \quad \forall i, \forall (u, v), \forall \lambda \quad (6.18)$$

If multicast request r_i is accepted, i.e., $B_i = 1$, constraint 6.12 indicates that s_i should generate $|D_i|$ commodity flow so that each destination of this multicast request can be served once. Constraints 6.13 and 6.14 ensure that each destination of request r_i must consume one and only one commodity flow generated by s_i in all the light-hierarchies built for this request. In other words, they guarantee that each destination is reachable from the source s_i in all light-hierarchies. Constraint 6.16 guarantees that the flow does not drop after passing a non-member node. Relationship between $L_{uv}^{i\lambda}$ and $F_{uv}^{i\lambda}$ is expressed by constraints 6.17 and 6.18. They assure that a link should carry non-zero flow if it is used in a light-hierarchy, and the value of this flow should not beyond the total flow emitted by the source node.

6.3.2 ILP with Partial Blocking Model (ILP-PB)

The ILP-PB is formulated based on the previous ILP-FB with some changes. As earlier analysed in Section 6.1, with the partial blocking model (PB), some destinations in a request may be rejected while the other destinations in the same request are served. The objective is to maximize the number of destinations served for all multicast requests (equivalently, to minimize the *DBP*). Thus, we use the ILP variable B_i^d instead of B_i , and several constraints should be changed accordingly. The resource (total cost) should be also minimized. Accordingly, the new objective function can be expressed as:

$$\text{Maximize} : \Delta \cdot \sum_{i \in \mathcal{I}} \sum_{d \in D_i} B_i^d - \sum_{i \in \mathcal{I}} \sum_{\lambda \in W} \sum_{(u,v) \in A} c_{uv} \cdot L_{uv}^{i\lambda} \quad (6.19)$$

To adjust the previous ILP-FB model for the partial blocking model, we replace constraints 6.12–6.14 by constraints 6.22–6.24.

Besides, constraints 6.6 and 6.11 are changed as follows.

$$\sum_{u \in N^-(v)} L_{uv}^{i\lambda} \leq 1, \quad \forall i, \forall \lambda, \forall v \in MC \setminus \{s_i\} \quad (6.20)$$

$$L_{vu}^{i\lambda} \leq \sum_{d \in D_i} B_i^d, \quad \forall i, \forall \lambda, \forall (v, u) \quad (6.21)$$

Constraint 6.20 makes sure the unique input link coming to any MC-OXCs. Constraint 6.21 guarantees that there is no link used for a request if all of its destinations are blocked. Constraint 6.25 ensures that if destination d of request i is rejected, then d will not have any input link reserved for request i on any wavelength.

$$\sum_{\lambda \in W} \sum_{v \in N^+(s_i)} F_{s_iv}^{i\lambda} = \sum_{d \in D_i} B_i^d, \quad \forall i \quad (6.22)$$

$$\sum_{\lambda \in W} \sum_{v \in N^-(d)} F_{vd}^{i\lambda} = \sum_{\lambda \in W} \sum_{v \in N^+(d)} F_{dv}^{i\lambda} + B_i^d, \quad \forall i, \forall d \quad (6.23)$$

$$\sum_{v \in N^-(d)} F_{vd}^{i\lambda} - B_i^d \leq \sum_{v \in N^+(d)} F_{dv}^{i\lambda}, \quad \forall i, \forall d, \forall \lambda \quad (6.24)$$

$$L_{ud}^{i\lambda} \leq B_i^d, \quad \forall i, \forall d, \forall u \in N^-(d), \forall \lambda \quad (6.25)$$

In short, ILP-PB is subject to light-hierarchy constraints: 6.5, 6.7–6.10 and 6.20–6.21, and connectivity constraints: 6.15–6.18, and 6.22–6.25.

6.3.3 Comparison of the Two ILP Models

In the proposed ILP-FB model, there are $|R| \times (2|W| \times |A| + 1)$ variables and $|R| \times |W| \times (3|V| + 3|A| + |MC| + 1) + R + W \times A + \sum_{i \in \mathcal{I}} |D_i|$ constraints. Regarding the

ILP-PB model, there are $\sum_{i \in \mathcal{I}} |D_i| - |R|$ more variables and $|W| \times \sum_{i \in \mathcal{I}} \sum_{d \in D_i} |N^-(d)|$ more constraints compared with ILP-FB.

The two ILP formulations above are run to search the exact solutions for the two problems corresponding to the two blocking models. The results are used as the references to evaluate the proposed heuristics presented in the next sections.

6.4 Heuristic Algorithms

In this section, we propose several algorithms for MCRWA-SS problem that integrate routing and wavelength assignment in one step. Also, the route computation is operated respecting the current state of the network, so they belong to *coupled* and *adaptive* approaches.

Furthermore, two routing schemes to design the algorithms are used: Wavelength Graph based routing which performs routing in each wavelength graph one by one, and Layer Graph based routing which performs routing in the whole layered graph. The two schemes have their own pros and cons in terms of performance and time complexity.

Besides, to evaluate our proposed adaptive strategies with the fixed-routing ones, we implement two fixed strategies: *fixed* and *fixed-alternate* based on the well-known Member-Only (MO) heuristic [48].

6.4.1 Two Selected Fixed Routing Algorithms

We implement two fixed-routing strategies by employing MO algorithm [48] to compute the light-trees (for routing part) and First-Fit scheme [47] to assign wavelengths to the computed light-trees (for wavelength assignment part). The rationale of choosing these candidates is that MO is a cost-effective heuristic for routing under sparse splitting, meanwhile First-Fit is an efficient heuristic for wavelength assignment. To distinguish the two resulting algorithms, we name MO with fixed routing *MO-FIX* and MO with fixed-alternate routing *MO-ALT*. Note that due to the sparse splitting constraint, a single light-tree may not be sufficient to accommodate a request. So a set of light-trees (i.e., a light-forest) may need to be computed.

In *MO-FIX* algorithm, the light-trees are computed one-by-one for each request on the physical topology. Each light-tree is tried to assign an available wavelength (employing First-Fit scheme) complying the distinct wavelength constraint until the wavelength pool is exhausted. Under FB model, the requests having at least one unreachable destination are blocked. Thus, whenever a light-tree (say, for request r) is not accepted, the algorithm blocks r by excluding it from the request set, freeing the wavelengths that have been assigned for the previous light-trees for r , and continuing with the next request. On the

other hand, if partial blocking (PB) model is used, all the light-trees for r are retained even though some destinations may be rejected.

In MO-ALT algorithm, given a request, we computed two arc-disjoint trees for each light-tree in the light-forest. The first tree is computed by executing MO in the topology graph. To compute the second tree, the algorithm removes all the arcs used for the first tree, then execute MO in the remaining topology graph. If the first light-tree is not accepted, the alternate tree is tried. The request is blocked if none of the two light-trees is accepted. The two blocking models are also applied in the same manner as mentioned with fixed routing approach above.

6.4.2 Two Adaptive Routing Schemes Based on Layered Graphs

In both *fixed* routing approaches, the routing is done in the physical topology without information of currently available wavelengths in the links. The wavelength assignment is needed afterwards to allocate appropriate wavelengths to the routes. So they belong to *decoupled* routing approaches. In contrast, layered graphs reflect the network at the wavelength level, they can be used to design *coupled* routing strategies that integrates wavelength assignment in the routing. Since the route is decided depending on network state, these routing strategies belong to *adaptive* routing approach.

As earlier analysed in Subsection 2.1.4 (Chapter 2), two different schemes can be used to compute the routes and allocate wavelengths based on the layered graph model, namely Wavelength Graph based routing (WG-routing), and Layer Graph based routing (LG-routing). In the WG-routing scheme, the routing can be done sequentially in a layer-to-layer order by using some predetermined *wavelength-search scheme*. This routing scheme is time-efficient, because an algorithm running on each layer (or wavelength graph) takes almost the same (often less) computational time compared with running on physical topology graph. In the LG-routing scheme, the routing can be accomplished by using the *full layered graph* containing pseudo vertices and arcs as mentioned in Section 5.7 (Chapter 5). This scheme can access every wavelength graph (layer) by the routing itself, without the need of a wavelength-search scheme. Each scheme has its own pros and cons in terms of time complexity and performance. This is analyzed and evaluated further in the next subsections.

6.4.3 Nearest Destination Light-Hierarchy Algorithm

This subsection presents the framework of Nearest Destination Light-Hierarchy (NDLH) algorithm. Then we will describe two routing schemes employing NDLH in the following subsection.

First, we define some notations used in the NDLH algorithm as follows.

- H : the hierarchy to be computed.

- $CONN_SET$: set of connectors in current hierarchy H , including MC vertices and MI leaf vertices in H .
- $SP(u, v)$: the shortest path from u to v .

NDLH is based on the basic idea of Minimum Path Heuristic [73] with modification to satisfy the sparse splitting constraint. It takes the input as an arbitrary directed graph $G = (V, A)$, a set MC of MC vertices and a multicast request $r = (s, D)$. NDLH computes a hierarchy H in G rooted at s that spans destinations in D . Note that, NDLH may produce no hierarchy due to the sparse splitting constraint and/or lack of arcs in the graph. Also, the computed H may or may not cover all the destinations of the request.

Initially, H consists only the source s . NDLH then extends H by iteratively adding destinations one at a time by the shortest paths, with respect to the sparse splitting constraint. To this end, at each iteration, the algorithm tries to find the shortest path $SP(c, d)$ from $c \in CONN_SET$ to the nearest destination $d \in D$. If it is found, add all the vertices and arcs of $SP(c, d)$ to H . Then remove the arcs in the shortest path $SP(c, d)$ from graph G and update $CONN_SET$. The algorithm terminates when there is no destination remaining, or when H cannot be extended. The description of NDLH algorithm is given in Algorithm 6.1. Since H is only grown from MC vertices and leaf MI vertices (the set $CONN_SET$) of the current light-hierarchy, the resulting light-hierarchy respects the sparse splitting constraint.

Algorithm 6.1 Nearest Destination Light-Hierarchy Algorithm

Input: A digraph $G = (V, A)$, a set MC of MC vertices, a multicast request $r = (s, D)$.

Output: A hierarchy H in G for r .

```

1:  $CONN\_SET \leftarrow \{s\}$ 
2:  $H \leftarrow \{s\}$ 
3: while (there exists a directed path from  $c \in CONN\_SET$  to  $d \in D$ ) do
4:   Compute the shortest path  $SP(c, d)$ 
5:    $H \leftarrow H \cup SP(c, d)$ 
6:    $CONN\_SET \leftarrow CONN\_SET \cup \{\text{MC vertices in } SP(c, d)\} \cup \{d\}$ 
7:   if  $c \notin MC$  then
8:      $CONN\_SET \leftarrow CONN\_SET \setminus \{c\}$ 
9:   end if
10:   $D \leftarrow D \setminus \{d\}$ 
11:   $A \leftarrow A \setminus \{\text{arcs in } SP(c, d)\}$ 
12: end while
13: return  $H$ 

```

Theorem 6.1. *The time complexity of NDLH algorithm is $O(D \times (V \log V + A))$ ¹.*

Proof. Let us see Algorithm 6.1. The most expensive operation is in line 4 to compute the shortest path $SP(c, d)$, or to find the nearest destination in D from set $CONN_SET$. Let

¹As indicated in Theorem 5.5 (Chapter 5), we do not show the set cardinality notation to represent the number of elements in the set in O notations, i.e., we use V instead of $|V|$.

us describe a technique for this step. The connector nodes in $CONN_SET$ can be virtually gathered and viewed together as a virtual source. It is done by temporarily creating a new vertex, called virtual source (say v_s), and then adding an zero-cost arc from v_s to every connector in $CONN_SET$. Obviously, it is sufficient to find the nearest destination by constructing a single shortest path tree in G_s from v_s to all the destinations. Thus, for this step, Dijkstra's algorithm should be used once.

Since there are $|D|$ destinations, the Dijkstra's algorithm should be used at most $|D|$ times during the construction of hierarchy H for request r . The time complexity of Dijkstra's algorithm implemented by a Fibonacci heap is $O(V \log V + A)$ [110]. So, the time complexity of the proposed NDLH algorithm is $D \times O(Dijkstra) = O(D \times (V \log V + A))$. \square

Next, we present two possible ways of applying NDLH to design adaptive strategies mentioned above.

6.4.4 Adaptive Algorithms Based on NDLH

To provision multiple requests using NDLH, one can apply either Wavelength Graph (WG) routing or Layered Graph (LG) routing schemes mentioned above.

6.4.4.1 Wavelength Graph Routing Algorithm Based on NDLH (NDLH-WG)

In this algorithm, the requests are examined one by one. For each request, it computes a set of light-hierarchies in layers, one light-hierarchy for each layer using NDLH algorithm, then assign the corresponding wavelength to the computed light-hierarchy.

To move from one layer to the other, we employ the *FIXED* wavelength-search scheme [10], i.e., the next layer is chosen in a fixed order. Since we assume that all the links have the same set of wavelengths at the first time, meaning that all the wavelength graphs are identical at the beginning. So, following the same order of wavelength graphs implies that the most-utilized wavelength will be tried first. Accordingly, the *FIXED* order acts like the *CONSERVATIVE* wavelength-search scheme also proposed in [10] which is better than other schemes.

To describe NDLH-WG algorithm, some used notations are defined as follows.

- G^λ : the wavelength graph corresponding to wavelength $\lambda \in W$.
- LG : the layered graph composed from a set of wavelength graphs G^λ , i.e., $LG = \{G^\lambda, \lambda \in W\}$.
- LH_i^λ : the light-hierarchy computed for request $r_i \in R$ in wavelength graph G^λ .
- LH_i : the set of light-hierarchies computed for request r_i , i.e., $LH_i = \{LH_i^\lambda, \lambda \in W\}$.
- MC^λ : the set of MC vertices in wavelength graph G^λ . It is the set of copies of MC nodes from the physical topology graph to layer λ .

- *numBlockReqst*: the number of blocked requests.
- *numBlockDest*: the number of blocked destinations.
- *numDest_i*: the original number of destinations of request r_i , i.e., $numDest_i = |D_i|$ at the beginning.

The NDLH-WG algorithm works as follows. At first, the wavelength graphs and the requests are indexed as $\lambda_1, \lambda_2, \dots, \lambda_{|W|}$, and $r_1, r_2, \dots, r_{|R|}$. For each request $r_i = (s_i, D_i)$, we execute NDLH algorithm on each of the layers one by one following the indexed order. For each layer λ , a light-hierarchy LH_i^λ is computed and the destinations covered are removed from D_i (cf. Algorithm 6.1). The computation terminates when all the destinations are covered (if all destinations are routed) or when all the layers are attempted (if partial destinations are routed). The outcome for request r_i is a set LH_i of light-hierarchies LH_i^λ .

Whenever a light-hierarchy is computed in certain layer, it is directly assigned with the corresponding wavelength (e.g., LH_i^λ is assigned with wavelength λ). Then the affected layer is updated in such a way that the used arcs are removed from the corresponding wavelength graph. This is to ensure that each fiber is not used twice with the same wavelength. Repeat the operations until all the requests are attempted. The pseudo code of NDLH-WG algorithm is shown in Algorithm 6.2.

To compute the blocking probability (RBP and DBP), we use both aforementioned blocking models and apply them for all the proposed algorithms described in the next subsections. Under FB model, a request is considered to be accepted if all of its destinations are accepted. Otherwise, the algorithm blocks the request, and restores the status of the layers which are affected by the route computation for it. This is done by freeing the wavelengths that have been assigned to the light-hierarchies computed for the blocked request. In contrast, when PB model is used, if the request is not totally accepted, the adopted destinations are still served. Thus, the algorithm does not have to restore the status of the affected layers.

The NDLH-WG strategy is natural and relatively straightforward. The requests are examined one by one without a special order. It does not need the global information of all the requests. Thus it can be applied to design online algorithms for the dynamic traffic case.

6.4.4.2 Two Variants for NDLH-WG

NDLH-WG algorithm examines each request at a time without a special order. However, since all the requests are known in advance, one can select them in a specific order following by a *request selection policy*. One possible policy is to choose the requests with a smallest number of destinations (group size) first, namely Smallest Request First (SRF). The other possible policy is to select the larger requests first (LRF).

Algorithm 6.2 NDLH-WG Algorithm**Input:** A layered graph $LG = \{G^\lambda, \lambda \in W\}$, a set of multicast requests R .**Output:** A set H of light-hierarchies, RBP, DBP

```

1:  $H \leftarrow \emptyset$ 
2:  $numBlockReqst \leftarrow 0$ 
3:  $numBlockDest \leftarrow 0$ 
4: for all  $r_i = (s_i, D_i), i = 1, 2, \dots, |R|$  do
5:    $LH_i \leftarrow \emptyset$ 
6:    $numDest_i \leftarrow |D_i|$ 
7:   for all  $\lambda \in W$  do
8:      $LH_i^\lambda = \text{NDLH}(G^\lambda, MC^\lambda, r_i)$  {call NDLH to compute light-hierarchy  $LH_i^\lambda$ 
      on  $G^\lambda$  with the set of MC vertices  $MC^\lambda$ }
9:     assign  $\lambda$  to  $LH_i^\lambda$ 
10:     $LH_i \leftarrow LH_i \cup LH_i^\lambda$ 
11:    if  $D_i = \emptyset$  then break
12:  end for
13:  if  $D_i \neq \emptyset$  then
14:     $numBlockReqst ++$ 
15:    if FB model is used then
16:       $numBlockDest \leftarrow numDest_i$  {original number of destinations of  $r_i$ }
17:      restore all the arcs removed by  $LH_i^\lambda, \forall \lambda \in W$ 
18:    else
19:       $numBlockDest \leftarrow |D_i|$  {current number of destinations of  $r_i$ }
20:    end if
21:  end if
22:   $H \leftarrow H \cup LH_i$ 
23: end for
24:  $RBP \leftarrow numBlockReqst / |R|$ 
25:  $DBP \leftarrow numBlockDest / \sum_{i \in \mathcal{I}} numDest_i$ 
26: return  $\langle H, RBP, DBP \rangle$ 

```

Smallest Request First Based on NDLH-WG (NDLH-WG-SRF)

It is similar to NDLH-WG except that, for each iteration, it selects the smallest request (in terms of group size) to consider first. To this end, the requests are sorted beforehand according to the *non-descending* order of group size. After that it follows the same operations as NDLH-WG for all the requests considered. The idea of this strategy (choosing the smallest request first) is based on the observation that a larger number of small items can be put into a bin with limited capacity than if we put larger ones in first. NDLH-WG-SRF can help to increase the total number of requests accepted, and hence can achieve a lower RBP.

Largest Request First Based on NDLH-WG (NDLH-WG-LRF)

It is somewhat contrary to NDLH-WG-SRF, instead of provisioning the smallest request, it chooses the largest one first. By choosing the largest request sooner, more destinations might be adopted, hence NDLH-WG-LRF can increase the total number of des-

tinations served or decrease the DBP. However, it can also increase the probability that small requests will be blocked, leading high RBP compared with NDLH-WG-SRF. This is elaborated in Section 6.5.

6.4.4.3 Computational Complexity of NDLH-WG Based Algorithms

Theorem 6.2. *To provision all the requests $R = \{(s_i, D_i), i \in \mathcal{I}\}$, NDLH-WG algorithm takes time $O(\sum_{i \in \mathcal{I}} D_i \times (V \log V + A))$.*

Proof. Algorithm 6.2 employs NDLH algorithm (line 8) to compute light-hierarchies for each of the requests in one layer at a time. Since each wavelength graph has a quasi-same size as the topology graph, according to Theorem 6.1, it takes time $O(D_i \times (V \log V + A))$ to serve request $r_i = (s_i, D_i)$. So, to provision all the all the requests in R , the time complexity of NDLH-WG algorithm is $O(\sum_{i \in \mathcal{I}} D_i \times (V \log V + A))$. \square

NDLH-WG-SRF (or NDLH-WG-LRF) has one supplementary step of sorting the requests before calling NDLH-WG. The average time complexity recorded for sorting a set of N elements is $O(N \log N)$. Consequently, the complexity of NDLH-WG-SRF (and NDLH-WG-LRF) is: $O(R \log R + \sum_{i \in \mathcal{I}} D_i \times (V \log V + A))$.

6.4.4.4 Layered Graph Routing Scheme Based on NDLH (NDLH-LG)

Unlike the Wavelength Graph (WG)-routing schemes that compute the routes in a layer-to-layer fashion, the Layered Graph (LG)-routing schemes do it in the whole layered graph. To this end, at first a *full* layered graph G' is constructed by adding pseudo vertices and pseudo arcs. Then a routing algorithm is run on G' . In the following, we present the application of LG-routing scheme based on NDLH, namely NDLH-LG, in detail.

Besides the notations given in Subsubsection 6.4.4.1, some more notations used in the NDLH-LG algorithm are given as follows.

- $G' = (V', A')$: the *frame* layered graph constructed from the physical topology $G = (V, A)$ (regardless of requests). Note that the frame layered graph is not fixed, because whenever an arc is used for the routing, it is removed from A' .
- $G'_i = (V'_i, A'_i)$: the *full* layered graph constructed from the frame layered graph $G' = (V', A')$ and the request $r_i = (s_i, D_i)$, by adding pseudo vertices and zero-cost arcs to G' .
- s_i^λ : a copy of the source s_i in layer λ .
- MC^λ : a copy of the set MC of MC nodes in layer λ .

- MC_SET : consists of the copies of the source s_i and the copies of all the MC nodes in all the layers, i.e., $MC_SET \leftarrow \bigcup_{\lambda=1}^{|W|} s_i^\lambda \cup \bigcup_{\lambda=1}^{|W|} MC^\lambda$. We also call them *MC vertices* in the layered graph G' .
- $r'_i = (s'_i, D'_i)$: the *pseudo request* created from the original request $r_i = (s_i, D_i)$ in the layered graph G'_i . To simplify, we call pseudo destinations $d' \in D'_i$ the *sinks*.
- H_i : the hierarchy computed for request r_i . After pruning the pseudo vertices and pseudo arcs, it becomes a set of light-hierarchies.
- H : the set of light-hierarchies computed for all the requests, i.e., $H = \bigcup_{i=1}^{|R|} H_i$.

With all the above notations, the NDLH-LG algorithm is described in Algorithm 6.3. The blocking probability (RBP and DBP) are computed (cf. line 11) following the same manner as mentioned in Algorithm 6.2, so we do not detail it in the algorithm.

Since the description is self-explained, we just notice one remark in applying NDLH algorithm in line 7. The NDLH algorithm is called to compute hierarchy H_i in G'_i for the pseudo request $r'_i = (s'_i, D'_i)$. In NDLH algorithm, whenever a destination is found, it is also added to the set $CONN_SET$ of connectors because it can grow the hierarchy using TaC function. However, in the pseudo request, sinks (pseudo destinations) cannot grow the hierarchy, but only the predecessors of them can. Thus, whenever a sink is found, the predecessor of it is added to $CONN_SET$.

Algorithm 6.3 NDLH-LG Algorithm

Input: A topology graph $G = (V, A)$, a set W of wavelengths in each arc, a set MC of MC nodes, a set of multicast requests $R = \{(s_i, D_i)\}$.

Output: A set H of light-hierarchies, RBP, DBP .

- 1: $H \leftarrow \emptyset$
 - 2: Construct the layered graph frame $G' = (V', A')$ from G
 - 3: **for all** $r_i = (s_i, D_i), i = 1, 2, \dots, |R|$ **do**
 - 4: Construct the full layered graph $G'_i = (V'_i, A'_i)$ by adding pseudo vertices in $\{s'_i\} \cup D'_i$ to V' and relevant pseudo arcs to A'
 - 5: Construct the pseudo multicast request $r'_i = (s'_i, D'_i)$
 - 6: $MC_SET \leftarrow \bigcup_{\lambda=1}^{|W|} s_i^\lambda \cup \bigcup_{\lambda=1}^{|W|} MC^\lambda$
 - 7: $H_i \leftarrow \mathbf{NDLH}(G'_i, MC_SET, r'_i)$ {call *NDLH* to compute hierarchy H_i in G'_i for r'_i with MC_SET the set of MC vertices}
 - 8: Prune all the pseudo vertices and the pseudo arcs from H_i
 - 9: $H \leftarrow H \cup H_i$
 - 10: **end for**
 - 11: Compute blocking probability metrics RBP and DBP
 - 12: **return** $\langle H, RBP, DBP \rangle$
-

6.4.4.5 Two Variants of NDH-LG

Like the proposed variants of NDH-WG mentioned above, we propose two variants of NDH-LG which are different in the order of requests to be considered. They are: Smallest Request First based on NDH-LG for the name NDH-LG-SRF and Largest Request First based on NDH-LG for the name NDH-LG-LRF. NDH-LG-SRF selects the smaller requests first and NDH-LG-LRF chooses the larger requests first in terms of group size. Since they are simple and similar to those mentioned for the original NDH-LG, we do not go further in them. The performances of these variants are evaluated in Section 6.5.

6.4.4.6 Computational Complexity of NDH-LG Based Algorithms

Theorem 6.3. *To provision all the requests $R = \{(s_i, D_i), i \in \mathcal{I}\}$, the NDH-LG algorithm takes time $O(\sum_{i \in \mathcal{I}} D_i \times W \times (V \log(WV) + A))$.*

Proof. The most expensive operation in Algorithm 6.3 is to compute light-hierarchies for request r_i employing NDH algorithm (line 7) in layered graph $G'_i = (V'_i, A'_i)$, with $|V'_i| = |V| \times |W| + 1 + |D_i| \leq |V| \times |W| + |V|$ and $|A'_i| = (1 + |A| + |D_i|) \times |W| \leq (|A| + |V|) \times |W|$. According to Theorem 6.1, to serve request $r_i = (s_i, D_i)$, it takes time $O(D_i \times (V' \log V' + A')) = O(D_i \times (V \times W + V) \times \log(V \times W + V) + (A + V) \times W) = O(D_i \times W \times (V \log(WV) + A))$. Thus, to provision all the requests in R , NDH-LG algorithm takes time $O(\sum_{i \in \mathcal{I}} D_i \times W \times (V \log(WV) + A))$. \square

Following the same analysis mentioned in Subsubsection 6.4.4.3, the complexity of each variant of NDH-LG, namely NDH-LG-SRF and NDH-LG-LRF, is: $O(R \log R + \sum_{i \in \mathcal{I}} D_i \times W \times (V \log(WV) + A))$.

Comparing the two routing schemes based on NDH algorithm, Theorem 6.2 and 6.3 show that the complexity of Layered Graph routing scheme is roughly $|W|$ times higher than that of Wavelength Graph routing scheme. This is because LG-routing works in the *full layered graph*, while WG-routing runs on each layer at a time. The performances of them on the basis of the blocking probability are evaluated in Section 6.5.

6.4.5 Critical Destination Light-Hierarchy Algorithm

Inspired from the fact that routing critical destinations sooner can significantly reduce the blocking probability as shown in Critical Destination First heuristic proposed for single request under non-splitting WDM networks (cf. Section 5.7, Chapter 5), we develop an extension of it for multiple requests under sparse splitting context, called Critical Destination Light-Hierarchy (CDLH) heuristic. Compared with CDF, CDLH is able to work in the networks with the sparse availability of MC nodes (as NDH). The critical degree of

a destination (precisely, pseudo destination or *sink*) is calculated as the number of wavelengths (or layers) can reach to that destination. It is equal to the incoming degree of a destination computed in G' . As a result, CDLH is just suitable for running in the whole layered graph G' , like NDLH-LG. Thus, we design the CDLH for LG-routing approach only, hence the name CDLH-LG.

For the CDLH-LG description, some notations used in NDLH-LG description above are reused, including $r'_i = (s'_i, D'_i)$, $SP(u, v)$, s_i^λ , MC^λ , MC_SET , $CONN_SET$. Besides, we define other notations as follows.

- $pred(d')$: the predecessor of sink d' (in the shortest path from s' to d'). It is $pred(d')$ but not d' that should be added to the current light-hierarchy and can be used to grow it.
- $post(v)$: the successor of v . It is used to check whether a vertex attached with a sink, in order to remove possible sinks which may be involved in the added path. In particular, $post(v) \neq nil \iff v$ is attached with a sink, otherwise $post(v) = nil$.

The description of CDLH-LG algorithm is given in Algorithm 6.4. Note that CDLH-LG algorithm is similar to NDLH-LG algorithm. However, instead of computing the shortest path $SP(c, d')$ from $c \in CONN_SET$ to $d' \in D'_i$ (in CDLH-LG algorithm), CDLH-LG computes the most critical destination (line 10), then updates the critical degrees of the affected sinks (line 27). The techniques to compute critical sinks and to update their critical degrees have been described in detail in Subsection 5.7.3 (Chapter 5) for CDF algorithm (for single request under non-splitting capacity). They can be directly applied in CDLH-LG algorithm, so we do not detail them here for CDLH-LG algorithm.

6.4.5.1 Two Variants of CDLH-LG

Like above mentioned NDLH-based adaptive strategies, we develop two variants for provisioning multiple requests based on CDLH algorithm. They are: Smallest Request First based on CDLH-LG for the name CDLH-LG-SRF and Largest Request First based on CDLH-LG for the name CDLH-LG-LRF. They are different to each other in the request selection policy. CDLH-LG-SRF always selects the smallest requests first in terms of group size; whereas CDLH-LG-LRF chooses the larger requests sooner. Since they are similar to the origin CDLH-LG, no further presentation is needed. The performances of these variants are evaluated in Section 6.5.

6.4.5.2 Computational Complexity of CDLH-LG Based Algorithms

Theorem 6.4. *To provision all the requests $R = \{(s_i, D_i), i \in \mathcal{I}\}$, CDLH-LG algorithm takes time $O(\sum_{i \in \mathcal{I}} D_i \times W \times (V \log(WV) + A))$.*

Algorithm 6.4 CDLH-LG Algorithm

Input: A topology graph $G = (V, A)$, a set W of wavelengths in each arc, a set of MC nodes, a set of multicast requests $R = \{(s_i, D_i)\}$.

Output: A set H of light-hierarchies, RBP, DBP .

```

1: Construct the frame layered graph  $G' = (V', A')$  from  $G$  (regardless of requests)
2:  $H \leftarrow \emptyset$ 
3: for all  $r_i = (s_i, D_i) \in R, i \in \mathcal{I}$  do
4:   Construct full layered graph  $G'_i = (V', A')$  by adding pseudo vertices in  $\{s'_i\} \cup D'_i$ 
   to  $V'$  and relevant pseudo arcs to  $A'$ 
5:   Construct the pseudo multicast request  $r'_i = (s'_i, D'_i)$ 
6:    $MC\_SET \leftarrow \bigcup_{\lambda=1}^{|W|} s_i^\lambda \cup \bigcup_{\lambda=1}^{|W|} MC^\lambda$ 
7:    $CONN\_SET \leftarrow \{s'_i\} \cup \bigcup_{\lambda=1}^{|W|} s_i^\lambda$ 
8:    $H_i \leftarrow \{s'_i\}$ 
9:   while  $(D'_i \neq \emptyset)$  do
10:    Find the most critical sink  $d' \in D'_i$ 
11:    Compute in  $G'_i$  the shortest path  $SP(c, d')$  from  $\forall c \in CONN\_SET$  to  $d'$ 
12:     $H_i \leftarrow H_i \cup SP(c, pred(d'))$   $\{d'$  and arc  $(pred(d'), d')$  should not be added $\}$ 
13:    for all  $v \in SP(c, pred(d'))$  do
14:      if  $post(v) \in D'_i$  then
15:         $D'_i \leftarrow D'_i \setminus \{post(v)\}$   $\{\text{remove } post(v) \text{ from } D'_i\}$ 
16:      end if
17:      if  $v \in MC\_SET$  then
18:         $CONN\_SET \leftarrow CONN\_SET \cup \{v\}$ 
19:      end if
20:    end for
21:     $CONN\_SET \leftarrow CONN\_SET \cup \{pred(d')\}$   $\{\text{NOTE: } pred(d') \text{ (but not } d') \text{ should be added}\}$ 
22:    if  $(c \notin MC\_SET)$  then
23:       $CONN\_SET \leftarrow CONN\_SET \setminus \{c\}$ 
24:    end if
25:     $D'_i \leftarrow D'_i \setminus \{d'\}$ 
26:     $A' \leftarrow A' \setminus \{\text{arcs in } SP(c, d')\}$ 
27:    Update the incoming degree of remaining sinks  $d' \in D'_i$ 
28:  end while
29:  Prune the pseudo source  $s'_i$  and the relevant pseudo arcs from  $H_i$ 
30:   $H \leftarrow H \cup H_i$ 
31: end for
32: Compute blocking probability metrics RBP and DBP
33: return  $\langle H, RBP, DBP \rangle$ 

```

Proof. As proved in Theorem 5.7 (Chapter 5), to compute light-hierarchies for a given request $r_i = (s_i, D_i)$, CDF algorithm takes time $O(D_i \times W \times (V \log(WV) + A))$. Thus, to compute light-hierarchies for all the requests in R , CDLH-LG algorithm takes time $O(\sum_{i \in \mathcal{I}} D_i \times W \times (V \log(WV) + A))$. \square

Following the same analysis mentioned in Subsubsection 6.4.4.3, the complexity of each variant of CDLH-LG, namely CDLH-LG-SRF and CDLH-LG-LRF, is: $O(R \log R + \sum_{i \in \mathcal{I}} D_i \times W \times (V \log(WV) + A))$.

Comparing the two adaptive routing strategies based on Layered Graph, as shown in Theorem 6.3 and 6.4, NDLH-LG and CDLH-LG algorithms have the same time complexity. In the next section, the performances of all the above-mentioned algorithms are evaluated on the basis of blocking probability.

6.5 Performance Evaluation

Since the two selected fixed algorithms (MO-FIX and MO-ALT) compute light-trees, whereas all the adaptive algorithms compute light-hierarchies, we develop a light-tree version of NDLH-WG algorithm called NDLT-WG. NDLT-WG serves two purposes: 1/ to compare fixed algorithms with adaptive algorithms, and 2/ to compare the two light-structures under a same adaptive algorithm.

The light-tree version NDLT-WG is basically similar to NDLH-WG, except that whenever a destination is added, all the intermediate MI nodes and their adjacent arcs are removed from the layered graph (to obtain trees).

In fact, we have evaluated light-spider versions for Nearest Destination First and Critical Destination First algorithms in the case of single request without splitters as mentioned in Section 5.7 (Chapter 5). Naturally, the light-tree versions for NDLH-LG or CDLH-LG algorithms will perform similarly in comparison with NDLH-LG or CDLH-LG algorithms. Besides, taking into account all of them would overwhelm the content of this chapter. That is why we do not consider light-tree versions for NDLH-LG or CDLH-LG algorithms here.

In total, we have proposed twelve algorithms altogether and two ILP formulations. All of them are shown in Fig. 6.1. Among twelve algorithms, two are based on fixed routing approaches: MO-FIX and MO-ALT; the others are based on adaptive routing approaches. Among adaptive strategies, four algorithms are based on WG-routing scheme: NDLT-WG, NDLH-WG, NDLH-WG-SRF, and NDLH-WG-LRF. The six remaining algorithms are based on LG-routing scheme and they are divided in two groups: NDLH core-based and CDLH core-based, with each having three variants for different request selection policies. For each algorithm, two blocking probability models are taken into account.

In the following, we divide the simulations into two parts. In the first part, all the proposed heuristics are run together with the exact ILP solutions for small instances. The second part presents the comparison among heuristics with larger realistic configurations.

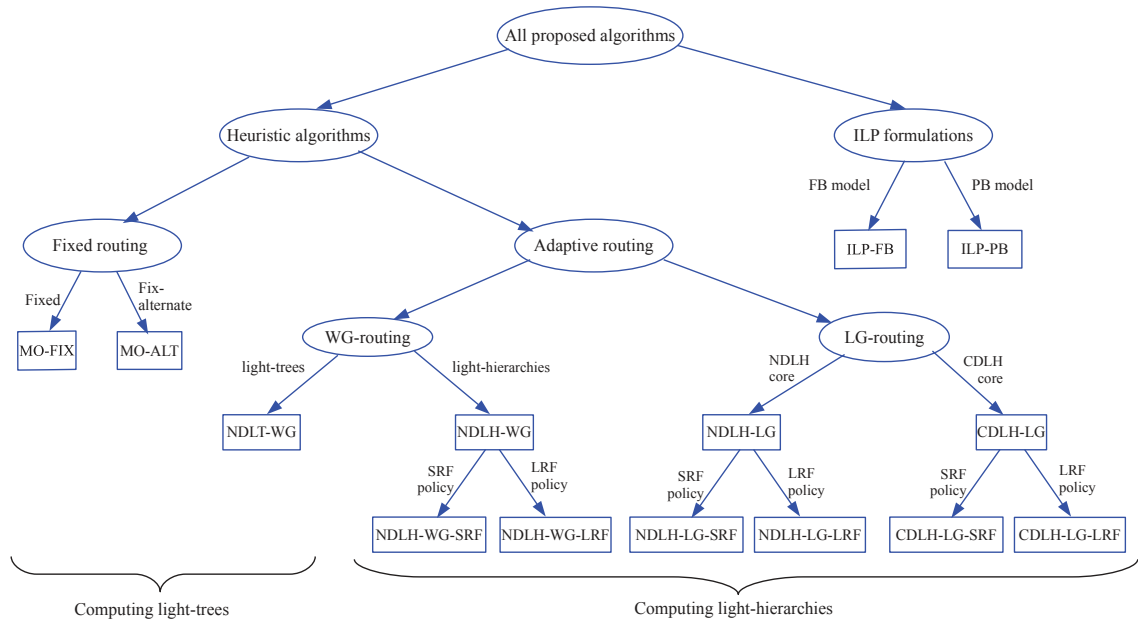

Figure 6.1 – Diagram of all the proposed algorithms

6.5.1 Heuristics versus ILP Solutions

Due to the exponential complexity of ILP formulations, simulations should be conducted with small instances. We use the 14-node NSF network (cf. Fig. 6.2a). To simulate with sparse splitting capacity, the number of MC-OXCs is set at 0 (no MC-OXC) and 3 MC-OXCs. Given $|MC|$ MC-OXCs (in the table we denote S instead of $|MC|$ just for saving the spaces), 10 multicast requests are randomly generated in such a way that the source and destinations are distributed uniformly in the networks. The number of wavelengths ($|W|$) varies from 1 to 3. The ILPs were solved with CPLEX 12.5. ILPs and heuristic algorithms were run on a machine with Intel Core i3, 2.20GHz processor and 4GB of RAM. We run ILPs for maximum of one-hour each instance. If the solver cannot find the optimal solution within one hour, the quasi-optimal solution with the gap of 1% to the optimal is adopted. Otherwise, the instance is considered failed and our program directs the ILP to run on another instance. Moreover, for each pair ($|W|, |MC|$), we conduct 30 simulations and calculate the 95% confidence interval (CI). For the ease of comparison, we just show the mean values in the Table 6.3.

The table presents the request blocking probability (RBP) under full blocking (FB) model and the destination blocking probability (DBP) under partial blocking (PB) model². There are two notations for two last columns of the table: *Avg.BP* and *Avg.Gap*. *Avg.BP* stands for the average blocking probability, calculated by averaging all the values for each algorithm. *Avg.Gap* stands for the average gap to the optimal average blocking probability

²To simplify, in the rest of the chapter, whenever RBP appears, it means the RBP calculated under the FB model; similarly, whenever DBP appears, it means the DBP calculated under the PB model.

Table 6.3 – Performance comparison of heuristics to ILP solutions.

<i>Algorithms</i>	$ W =1$		$ W =2$		$ W =3$		Avg.BP	Avg.Gap
	<i>S=0</i>	<i>S=3</i>	<i>S=0</i>	<i>S=3</i>	<i>S=0</i>	<i>S=3</i>		
RBP(%) under FB model								
MO-FIX	76.7	79.7	60.7	60.7	47.3	48.7	<i>62.3</i>	35.6
MO-ALT	74.7	76.0	56.0	56.0	42.7	40.0	<i>57.6</i>	30.9
NDLT-WG	67.3	67.0	43.3	44.0	20.7	19.7	<i>43.7</i>	17.0
NDLH-WG	67.7	67.3	39.3	43.0	16.3	15.7	<i>41.6</i>	14.9
NDLH-LG	69.0	69.0	39.3	42.3	18.3	19.3	<i>42.9</i>	16.2
CDLH-LG	68.7	68.3	40.3	41.3	19.3	17.3	<i>42.6</i>	15.9
NDLH-WG-SRF	63.3	60.7	34.7	36.3	14.7	13.0	<i>37.1</i>	10.4
NDLH-LG-SRF	61.3	59.7	35.0	36.7	16.0	15.0	<i>37.3</i>	10.6
CDLH-LG-SRF	61.3	59.7	33.3	35.3	15.3	14.0	<i>36.5</i>	9.8
NDLH-WG-LRF	75.7	75.0	52.0	52.0	21.3	20.7	<i>49.4</i>	22.7
NDLH-LG-LRF	73.7	75.7	49.7	49.0	21.3	20.7	<i>48.3</i>	21.6
CDLH-LG-LRF	74.3	75.0	50.7	49.0	21.0	20.7	<i>48.4</i>	21.7
ILP-FB	54.3	53.0	22.0	23.7	3.7	3.7	<i>26.7</i>	0.0*
DBP(%) under PB model								
MO-FIX	82.5	84.2	68.2	68.4	49.9	52.8	<i>67.7</i>	43.2
MO-ALT	78.7	81.1	59.8	61.2	43.8	44.1	<i>61.4</i>	36.9
NDLT-WG	63.3	63.1	35.7	34.7	11.2	10.9	<i>36.5</i>	12.0
NDLH-WG	62.9	60.7	33.2	34.3	8.9	8.7	<i>34.8</i>	10.3
NDLH-LG	61.5	59.6	29.3	31.5	8.2	11.1	<i>33.6</i>	9.1
CDLH-LG	60.4	59.9	29.4	31.3	8.8	10.2	<i>33.3</i>	8.8
NDLH-WG-SRF	68.5	68.1	37.6	39.1	11.4	8.9	<i>38.9</i>	14.4
NDLH-LG-SRF	67.3	66.9	36.5	35.7	10.7	8.8	<i>37.6</i>	13.1
CDLH-LG-SRF	67.2	66.8	34.9	35.5	9.8	7.7	<i>37.0</i>	12.5
NDLH-WG-LRF	58.0	54.5	27.2	27.4	6.8	7.1	<i>30.2</i>	5.7
NDLH-LG-LRF	56.9	53.1	25.3	24.8	7.7	6.7	<i>29.1</i>	4.6
CDLH-LG-LRF	56.9	53.6	25.5	24.5	7.4	6.3	<i>29.0</i>	4.5
ILP-PB	53.3	51.3	18.2	18.6	2.7	2.6	<i>24.5</i>	0.0*

(obtained from ILP-FB or ILP-PB), calculated by subtracting the optimal average blocking probability from the average blocking probability of each algorithm.

As it is shown, the two fixed strategies (MO-FIX and MO-ALT) suffer from the highest RBP (35.6%, 30.9% higher than the optimal RBP obtained by ILP-FB) as well as highest DBP (43.2%, 36.9% higher than the optimal DBP obtained by ILP-PB).

Among the adaptive heuristic algorithms, the request selection policy has a significant influence on performances of the algorithms. Choosing smallest requests first can result in low RBP, but high DBP; whereas, choosing largest requests first can reduce DBP, but increase RBP. In particular, the three algorithms choosing smallest requests first (NDLH-WG-SRF, NDLH-LG-SRF and CDLH-LG-SRF) achieve lowest RBP (9.8–10.6% higher RBP on average compared with the optimal RBP). However, these algorithms is subject to high DBP (12.5%–14.4% higher than the optimal DBP). Meanwhile, the three algorithms choosing largest requests first (NDLH-WG-LRF, NDLH-LG-LRF and CDLH-LG-LRF)

obtain lowest DBP (4.5%–5.7% higher DBP on average compared with the optimal DBP). However, they suffer from high RBP (21.6%–22.7% higher than the optimal RBP).

Moreover, light-hierarchy based solutions are better than light-tree based ones: NDLH-WG reduces about 2% on both metrics compared with NDLT-WG. The differences between performances of LG-routing versus WG-routing schemes, as well as between NDLH core versus CDLH core, are not obvious. The reason is likely due to the fact that simulations are conducted with small instances. In the next, all of these comparisons are investigated in depth with larger realistic instances.

6.5.2 Comparison of Heuristic Algorithms

6.5.2.1 Simulation Settings

In this part, we use the US Longhaul network (28 nodes, 45 bidirectional links) (cf. Fig. 6.2b) as the platform for our simulations. We conduct the simulations by setting up three scenarios:

1. Performances versus traffic load: given $|MC|$ MC-OXCs, $|W|$ wavelengths, evaluate the solutions versus $|R|$. In particular, $|MC| = 6$, $|W| = 30$, $|R|$ varies in the list (100,110,120,...,200) (cf. Figs. 6.3a, 6.3b, 6.4a, 6.4b).
2. Performances versus resource supply: given $|MC|$ MC-OXCs, $|R|$ requests, evaluate the solutions versus the number of wavelengths $|W|$. In particular, $|MC| = 6$, $|R| = 150$, $|W|$ varies in the list (10,15,20,...,50) (cf. Figs. 6.5a, 6.5b, 6.6a, 6.6b).
3. Performances versus sparse splitting level: given $|W|$ wavelengths, $|R|$ requests, evaluate the solutions versus $|MC|$. In particular, $|W| = 30$, $|R| = 150$, $|MC|$ varies in the list (0,3,6,...,21) (cf. Figs. 6.7a, 6.7b, 6.8a, 6.8b).

In the simulations: MC-OXCs are randomly selected throughout the network such that only nodes with degree larger than two are possibly selected for MC-OXCs³; multicast requests are randomly generated such that their group sizes are randomly selected in the interval of $[1, |V| - 1]$. For a given triplet ($|W|, |MC|, |R|$), we run 1000 simulations and calculate 95% confidence interval for both RBP and DBP. Since RBP is suitable for FB model and DBP is suitable for PB model, we just show the RBP under FB model and the DBP under PB model.

6.5.2.2 Performance Evaluation

All the twelve algorithms are run together for each instance for the comparison. However, showing all of the results in one graph makes it difficult to see. So, for each scenario

³In 28 node-Longhaul topology, there are 7 nodes with degree of 2, that is why we set up to 21 nodes to be MC-OXCs.

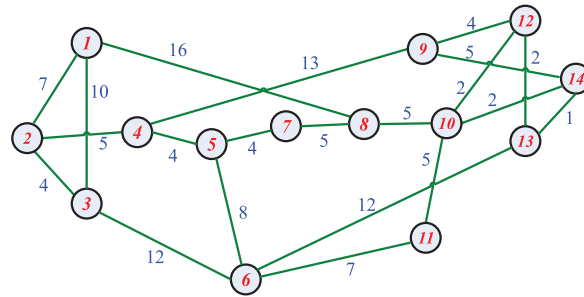

(a) NSF weighted network topology

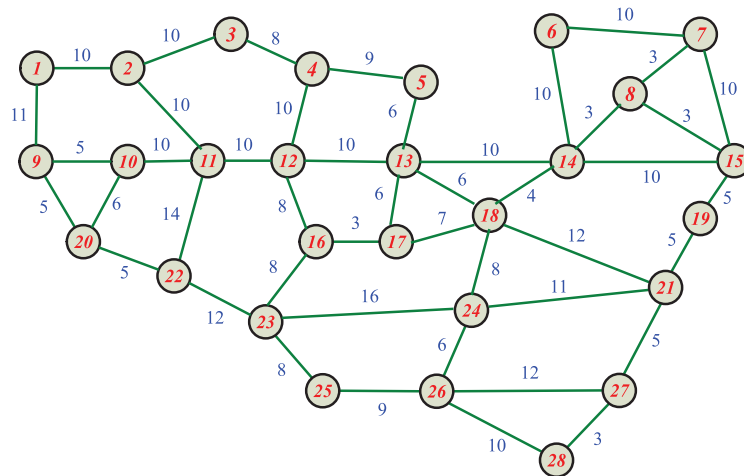

(b) US Longhaul weighted network topology

Figure 6.2 – Testbeds for simulations

and for each blocking metric, we divide the results into two groups and show in two charts. The first group includes six basic algorithms without a special request selection policy, including: MO-FIX, MO-ALT, NDLT-WG, NDLH-WG, NDLH-LG and CDLH-LG (shown in *a*-figures). The second group consists of six remaining algorithms with a specific request selection policy (shown in *b*-figures).

Many comparative aspects can be found in the first group. We can compare fixed strategies (MO-FIX, MO-ALT) with adaptive strategies; Wavelength Graph routing scheme (NDLT-WG, NDLH-WG) with Layered Graph routing scheme (NDLH-LG, CDLH-LG); and NDLH core based algorithms with CDLH core based algorithms. For the second group, we will see how the request selection policy affects on the performance of algorithms.

Let us begin with the first group. As shown in *a*-figures (6.3a, 6.4a, 6.5a, 6.6a, 6.7a and 6.8a), the performances of the algorithms follow the descending order of: MO-FIX, MO-ALT, NDLT-WG, NDLH-WG, NDLH-LG and CDLH-LG. The two fixed strategies suffer from highest blocking probability in both metrics (DBP and RBP), with MO-ALT better than MO-FIX. The two adaptive algorithms based on WG-routing scheme (NDLT-WG, NDLH-WG) rank at the middle, in which NDLH-WG is better. The two adaptive

algorithms based on LG-routing scheme (NDLH-LG, CDLH-LG) perform best, in which CDLH-LG is better. In the following, we compare them in pairs in detail.

Routing Approaches: Adaptive Routing versus Fixed Routing

For this comparison, we choose NDLT-WG as the representative for adaptive algorithms, since it computes light-trees and is based on Minimum Path Heuristic [73], like MO. It is easy to realize the dominance of NDLT-WG over MO-ALT and MO-FIX in all the simulation contexts. In particular, on average, the blocking probability reduction obtained from NDLT-WG over MO-ALT are: 22% on DBP and 13% on RBP for the first simulation scenario; 21% on DBP and 12.5% on RBP for the second simulation scenario; and 24% on DBP and 13% on RBP for the third simulation scenario. The difference is even higher when comparing NDLT-WG with MO-FIX. On average, NDLT-WG achieves 22.5% lower on DBP and 13% lower on RBP compared with MO-ALT, and 30.5% lower on DBP and 17% lower on RBP compared with MO-FIX.

The results are reasonable, because adaptive strategies try to route as many requests as possible by making use of the available wavelengths on each wavelength graph, leading to lower blocking probability. Meanwhile, fixed strategies compute light-trees in the physical topology neglecting the current state of network, causing high blocking probability. Although fixed-alternate strategy has more choices compared with fixed strategy, it still suffers from high blocking probability due to the inherent shortcoming of fixed routing approaches.

Light-Structures: Light-Hierarchies versus Light-Trees

We compare the two representatives: NDLT-WG and NDLH-WG based on the same (WG-routing) scheme. As shown from the figures, NDLH-WG performs better than NDLT-WG in both blocking metrics in all the studied contexts. On average, NDLH-WG achieves about 2.5% on DBP and 3% on RBP better than its counterpart NDLT-WG. The advantage of NDLH-WG over NDLT-WG is more significant at very sparse splitting level (small number of MC-OCXs), with low traffic load (small number of requests), or with high resource supply (large number of wavelengths).

In short, the light-hierarchy based solutions are better than the light-tree counterparts in both blocking metrics, especially at very sparse splitting level. This is because light-hierarchies allow to exploit all the available wavelengths in current network state by taking advantage of all possible directions (arcs) on every link and cross pairing ports in MI-OXC. Since there are more choices to route the requests, light-hierarchies allow to better reduce blocking probability than light-trees.

Routing Schemes: LG-Routing versus WG-Routing

We compare two representatives of the two routing schemes: NDLH-LG (based on

LG-routing scheme) and NDLH-WG (based on WG-routing scheme). A significant gap between the two schemes can be observed from the simulation results in which NDLH-LG outperforms NDLH-WG. Especially, NDLH-LG works better on DBP when achieving 5% improvement on average over NDLH-WG, while the gain on RBP is about 1.5%. Also, NDLH-LG works better at very sparse splitting level.

The above results show that routing in the whole layered graph leads to better performance compared with routing in the layer-to-layer fashion. However, as shown in Subsection 6.4.4.6, LG-routing scheme takes roughly $|W|$ times higher than WG-routing scheme. Thus, the tradeoff between time performance and time computation should be considered.

Core Algorithms: NDLH versus CDLH

Since CDLH is just suitable in LG-routing scheme, we compare the two representatives based on LG-routing scheme: NDLH-LG and CDLH-LG. The performance of CDLH-LG is slightly better than NDLH-LG in both metrics: about 1.5% on DBP and 1% on RBP. With the same time complexity, the improvement of CDLH-LG over NDLH-LG (even with a little amount) should be interesting in large-scale network configurations.

Request Selection Policies: SRF versus LRF

Now let us focus on the b -figures (Figs. 6.3b, 6.4b, 6.5b, 6.6b, 6.7b and 6.8b) where the performances of the six remaining algorithms are shown. The overall results show that, among two proposed request-selection policies, Largest Requests First works best on DBP but worst on RBP. In contrast, Smallest Requests First works best on RBP but worst on DBP. This is true for whatever core algorithm (NDLH or CDLH) is employed and whatever routing scheme (WG-routing or LG-routing) is applied.

The results are predictable. It is because, given a same number of destinations, the destinations in a large request would be relatively closer to each other than those from smaller requests. Provisioning larger requests first therefore would consume less resource than provisioning smaller requests sooner, consequently, allows more destinations to be served, resulting in lower DBP. However, when the availability of wavelengths becomes exhausted, many other requests (including many small requests) will be blocked, causing high RBP. In contrast, since it is easier for small requests to be totally accepted, provisioning smaller requests sooner results in lower RBP. However, when most of the requests has been adopted, the network resource becomes exhausted and block the other (larger) requests, causing high DBP.

The lowest blocking probability (DBP or RBP) is always desirable when designing routing algorithms. But when routing in large scale networks, one should consider to balance performance and time computation. From the simulation results, under PB model, CDLH-LG-LRF which integrates CDLH-LG with LRF policy produces lowest DBP. However, the high time complexity of LG-routing scheme may prevent such algorithms from deploy-

ing in large-scale network configurations. Fortunately, a time-efficient WG-routing scheme combining with LRF policy (i.e., NDLH-WG-LRF) provides a relatively low DBP. Particularly, as shown in the *a*-figures, the DBP obtained by NDLH-WG-LRF is the same those obtained from NDLH-LG and CDLH-LG which is 6.5% lower than NDLH-WG, although it is 6% higher than the lowest DBP obtained by CDLH-LG-LRF. Thus, to minimize DBP, NDLH-WG-LRF should be considered as a tradeoff candidate between performance and time computation.

Especially, if the objective is to minimize RBP under FB model, NDLH-WG-SRF is the best choice, since it produces lowest RBP, equal to that obtained by the LG-routing based algorithms. The gain obtained by NDLH-WG-SRF is about 8% over NDLH-WG that selects the requests arbitrarily, with a quasi-same low time complexity.

6.6 Conclusion

A lot of aspects on provisioning multiple static multicast requests in sparse splitting WDM networks (MCRWA-SS) are discussed in this chapter. We developed two ILP formulation variants using light-hierarchies to find the exact solutions for these NP-hard problems under two blocking probability models: full blocking probability and partial blocking probability. To compute light-hierarchies for realistic large-scale networks, we propose several adaptive algorithms based on two routing schemes: WG-routing and LG-routing. Besides, since all the requests are known in advance, several request selection policies are proposed, including: indexed order (requests are taken in an arbitrary order), ascending order of group size or Smallest Request First (SRF), and descending order of group size or Largest Request First (LRF). In addition, two heuristic algorithms, namely Nearest Destination Light-Hierarchy and Critical Destination Light-Hierarchy, are proposed and deployed in the core parts of these algorithms. Several comparative results obtained from the simulations are summarized as follows.

- On routing approaches: adaptive routing outperforms fixed routing, with the improvement of 22.5% on DBP and 13% on RBP compared with fixed-alternate routing, and 30.5% on DBP and 17% on RBP.
- On routing schemes: LG-routing outperforms WG-routing, with the improvement of 5% on DBP and 1.5% on RBP (with $|W|$ times higher on computational complexity).
- On light-structures: light-hierarchies are better than light-trees, with the gain of 2.5% on DBP and 3% on RBP.
- On core algorithms: CDLH is better than NDLH, with the gain of 1.5% on DBP and 1% on RBP.

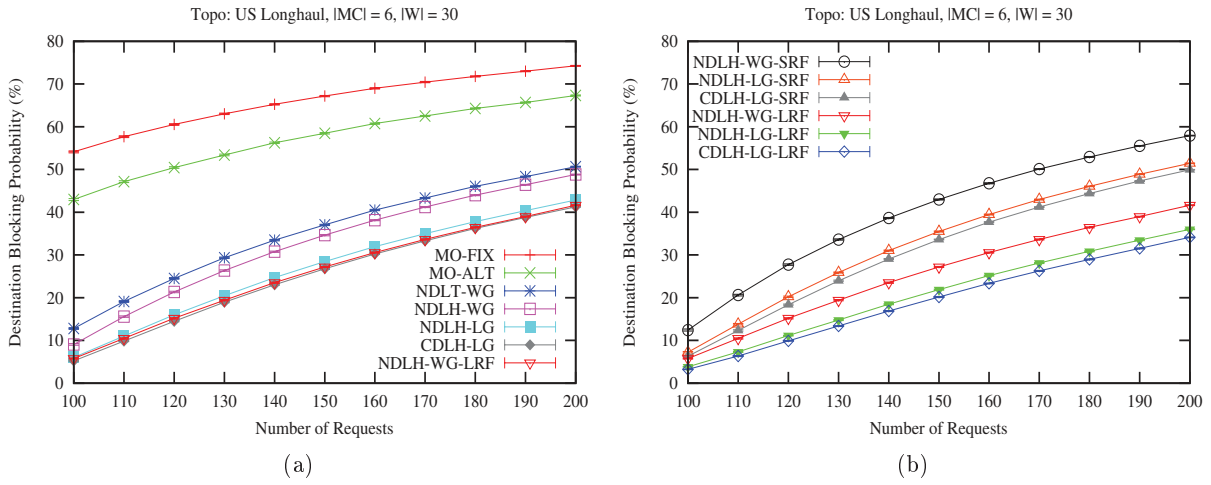

Figure 6.3 – DBP vs. Number of Requests

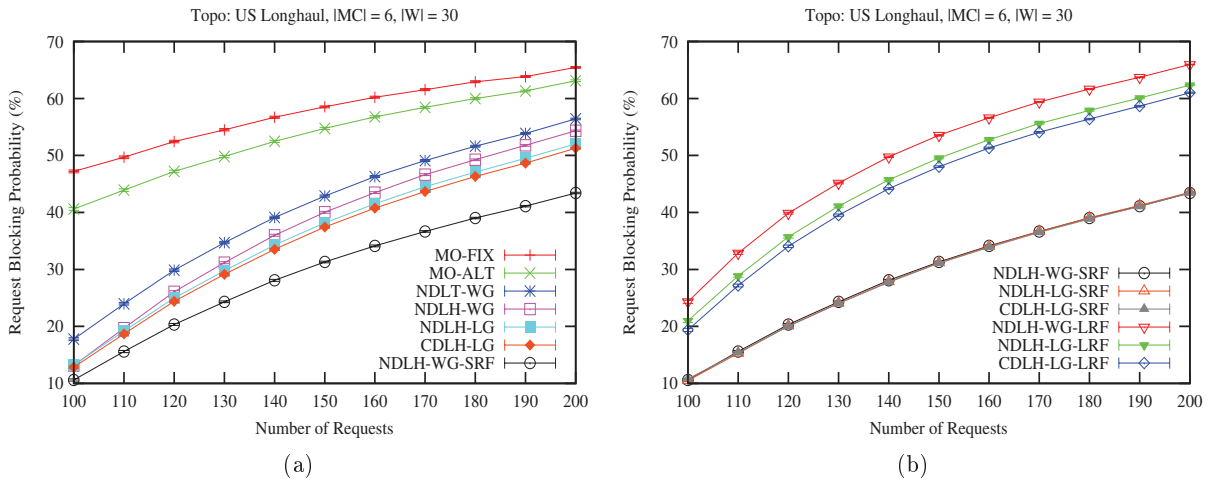

Figure 6.4 – RBP vs. Number of Requests

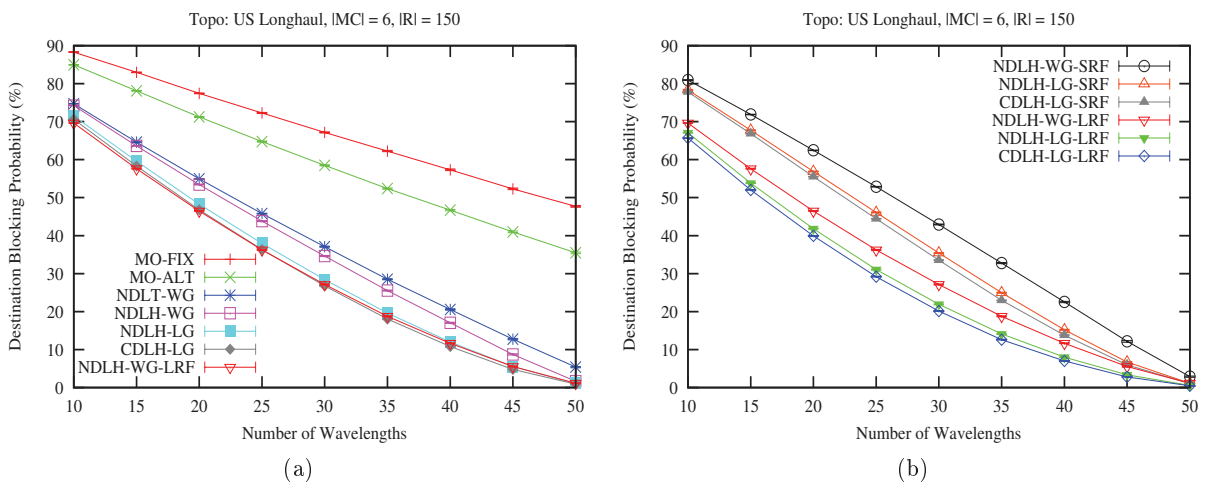

Figure 6.5 – DBP vs. Number of Wavelengths

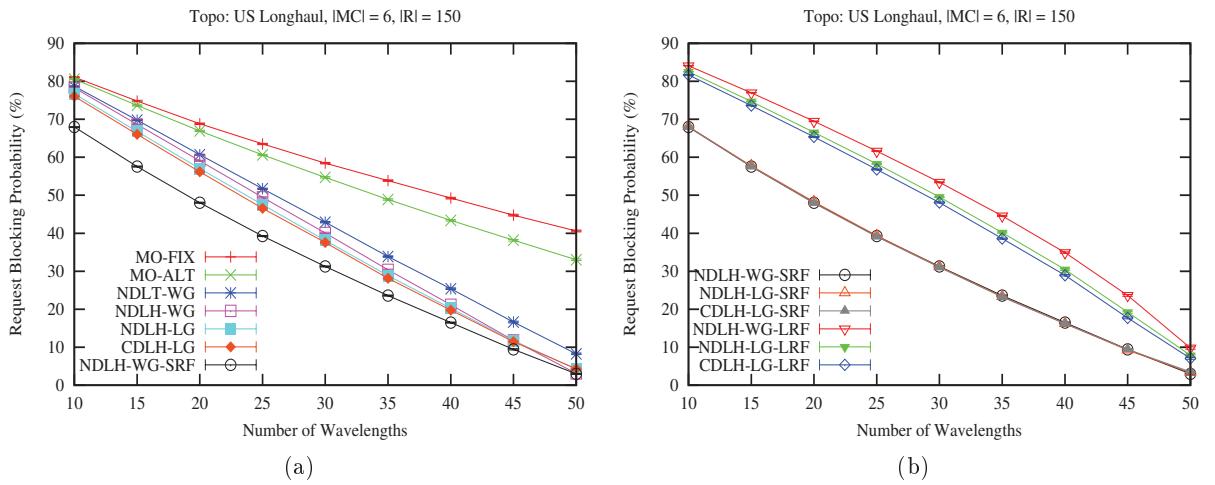

Figure 6.6 – RBP vs. Number of Wavelengths

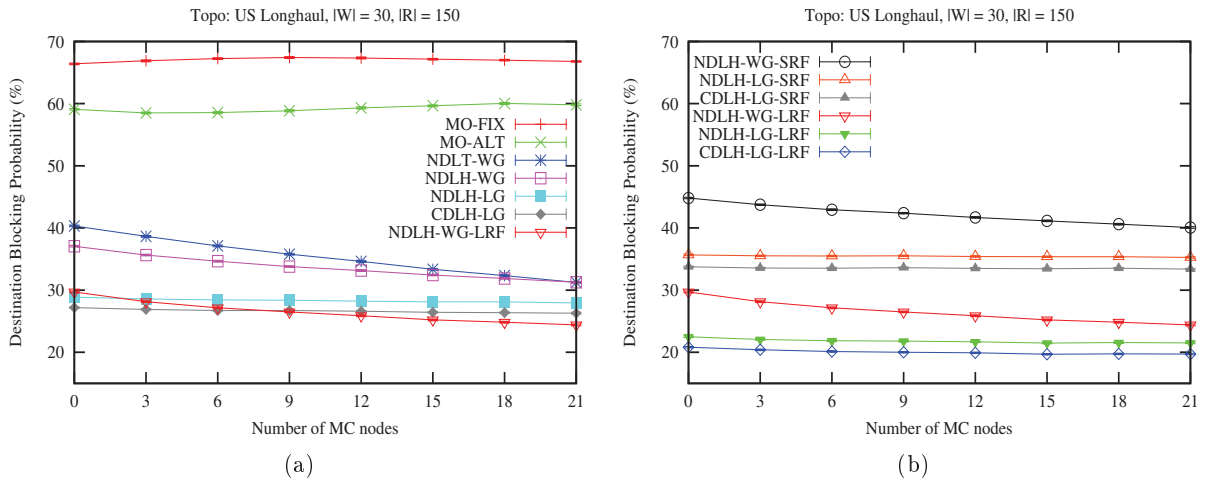

Figure 6.7 – DBP vs. Number of MC-OXC's

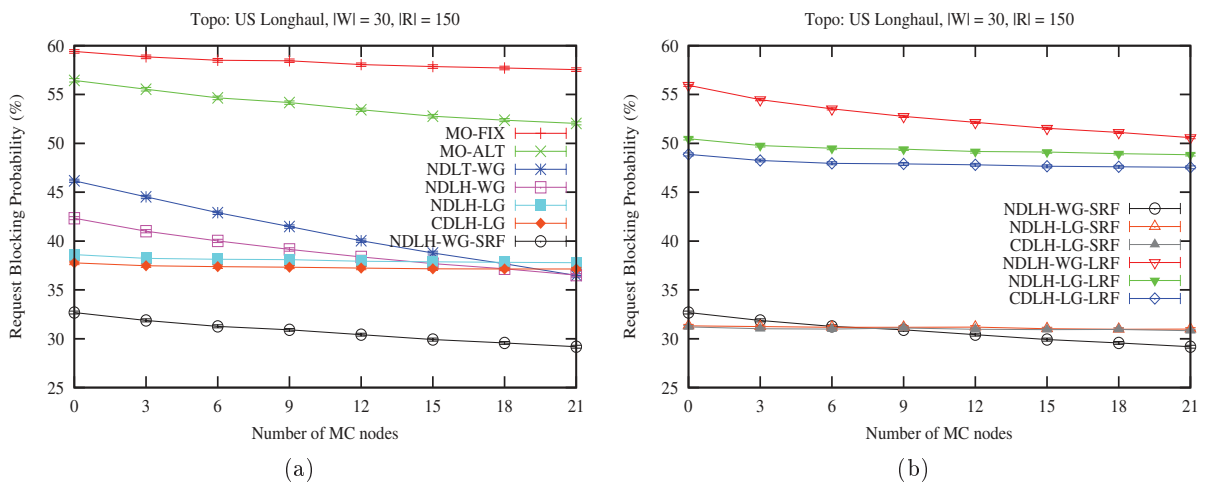

Figure 6.8 – RBP vs. Number of MC-OXC's

- On request selection policies: LRF produces lowest DBP but high RBP, while SRF results in lowest RBP but high DBP. The indexed order policy ranks at the middle between the other two, with the gain of lower time complexity. Besides, for its natural property, the indexed order policy can be used to design online algorithms for the dynamic traffic case.
- Recommendation: NDLH-WG-LRF is best suited for minimizing DBP without considering RBP; NDLH-WG-SRF is a good candidate for a performance-time tradeoff on minimizing RBP without considering DBP.

■ **Key points of Chapter 6** ■

- Two variants of a light-hierarchy based ILP formulation respecting FB model and PB model are developed to find the exact solutions for MCRWA-SS problems.
- Two routing schemes, namely layered graph-routing and wavelength graph-routing, are introduced to design adaptive algorithms using light-hierarchies, in which LG-routing scheme achieves lower blocking probability at higher time computation.
- Three policies of selecting requests for the routing are proposed, in which Smallest Request First works best under FB model, and Largest Request First achieves close-optimal solution under PB model. Besides, selecting requests randomly has benefits of lower complexity, and especially, can be used to design online algorithms for the dynamic traffic case.
- Simulation results showed that adaptive routing strategies are by far better than fixed routing ones, and that light-hierarchies are better than light-trees for the MCRWA-SS problem in terms of blocking probability.

Conclusions and Perspectives

In this chapter, we conclude the thesis and draw some perspectives for the future research.

7.1 Conclusions

This dissertation investigates the all-optical multicasting (AOM) in heterogeneous optical networks. The heterogeneity comes from the absence/presence of light splitters and wavelength converters and the uneven availability of wavelengths in the network links. The thesis deals with the routing problems (AOMR), which determines the routes from the source(s) to the destinations. Especially, in the case of multiple-requests, the AOMR problems are studied in the combination with wavelength assignment (WA), known as the multicast routing and wavelength assignment (MCRWA). The examined optimization objective is to minimize the network resources, e.g., number of wavelengths and/or total cost, and/or to minimize the blocking probability. Since AOM problems are mainly NP-hard, we developed several ILP formulations to search for exact solutions, and proposed heuristic algorithms to compute the routes in large-scale network configurations.

The most important and original results of the thesis are to demonstrate that the optimal solutions of different AOMR problems can be described by the graph-related *hierarchy* structure. Several forms of *optical hierarchies* in supporting AOM are identified for certain routing cases. Accordingly, hierarchy can model all the existing solutions (e.g., light-paths, light-trees, light-forest) as well as the novel light-structures (e.g., light-hierarchies, light-spider-hierarchies, multi λ -light-hierarchies). Another important contribution is to show that layered graphs reflect the WDM networks more exactly compared with topology graphs. In constrained routing cases (e.g., AOMR in heterogeneous WDM networks, and/or with multiple requests), the application of layered graph model is indispensable. Besides, taking advantage of available MC-OXCs (which are often rare) in the networks leads to the

cost-effective solutions. Meanwhile, routing the critical destinations first results in lower blocking probability.

7.2 Perspectives

Many challenging issues on all-optical networking are not covered in the thesis. Several potential perspectives are suggested below for the future research.

7.2.1 Traffic Grooming

For the current steady rate of traffic growth, the capacity limit of conventional fiber will be reached by around the year 2025 [11]. In response, there is a need to efficiently utilize the capacity in a fiber. Besides, the clients of optical networks often generate traffic that has a lower rate than the wavelength capacity. The wavelength capacity may be 40, 100 Gbps or even more, whereas more than 90% of client demands require rates of 10 Gbps or below, with almost half of them requiring rates of 2.5 Gbps or below [113]. This mismatch gives rise to the need to *multiplex* or *groom* the multiple low-rate traffics on a wavelength in order to improve the bandwidth allocation efficiency. The technique to groom low-rate traffics are known as Traffic Grooming, which is discussed in [11, 13, 114]. However, most of previous works on traffic grooming deal with unicast traffics. Few studies investigate multicast traffic grooming but they are just based on light-trees [114]. Since more candidate routes can be produced with the help of flexible light-hierarchies, multicast traffic grooming using light-hierarchies may achieve better solutions than light-trees.

7.2.2 Mixed-Line-Rates WDM networks

To satisfy the heterogeneous traffic demands with cost-efficiency, the Mixed-Line-Rates (MLR) networking paradigm is introduced [115–118]. In MLR networks, different wavelengths in the links are modulated in different line-rates (e.g., 10/40/100 Gbps). This approach can be cost effective because low-bit-rate traffics will need less grooming, while high-bit-rate traffics can be accommodated directly on a wavelength itself. Besides, the line-rates are subject to different bandwidth-cost efficiency and different maximum transmission reaches. Given a set of requests with different traffic demands, we not only solve the MCRWA problems but also need to deal with the line-rate selection. The MCRWA problem with MLR was studied in [115, 116]. However, all the nodes are assumed to have full splitting capacity and/or wavelength converters, and based on light-trees. For stricter constraints imposed on the network elements (e.g., sparse splitting and/or heterogeneous wavelength availability), it should be better employing light-hierarchies in such problems.

7.2.3 Flexible-Grid Elastic Optical Networking

Another networking paradigm to deal with increase traffic demands is Elastic Optical Networking (EON). For many years, networks have been based on the International Telecommunication Union (ITU) fixed-grid model: wavelengths are typically spaced 50 GHz apart in backbone WDM networks. The recently proposed flexible-grid EON paradigm has been considered as a potential replacement of the conventional fixed-grid WDM networks [51]. For example, Spectrum-Sliced EONs (SLICE), based on a grid of 12.5 GHz, can satisfy more flexible rate requirements. Under EONs, the optical channels are no longer based on wavelengths but based on spectrum (composed from a set of contiguous frequency slots).

Multicast routing and spectrum allocation (MC-RSA) is important to achieve high spectrum utilization in elastic optical networks, but it is more challenging than MCRWA in the legacy WDM networks. However, routing on wavelength level and routing on spectrum basis have a close relationship with one another. The spectrum are subject to spectrum splitting and spectrum conversion mechanism, and also spectrum continuity and spectrum distinct constraints [53], just like in pure WDM technologies. As a result, the concepts of light-trees, light-hierarchies proposed for WDM can be used for this sophisticated technology. The MC-RSA problem based on light-trees has been studied in [52, 53, 119]. However, it should be beneficial taking advantage of light-hierarchies in EONs.

7.2.4 Physical Layer Impairments-Aware Networking

The thesis assumes to work in transparent all-optical networks, so the AOM is just subject to available resources and optical-layer constraints itself. In fact, noise and signal distortions incurred due to non-ideal transmission devices degrade the quality of transmission (QoT) [1, 120–122], which can be measured by the bit error rate (BER). Noise accumulation actually decreases the optical signal to noise ratio (OSNR) increasing the corresponding bit error rate (BER). Distortions due to fiber propagation modify the shape of the received pulse inducing a reduction of the OSNR [120].

The routing may be infeasible since the route computed may fail to satisfy the quality requirements due to these impairments. The AOM considering physical layer impairments (PLI) are known as physical layer impairment-aware routing and wavelength assignment (PLI-RWA) problems. However, the consideration of PLI induces a number of linear and non-linear relations and thus dramatically increases the complexity of the PLI-RWA optimization. Also, the combination of multicast and PLI-RWA, makes the PLI-MCRWA optimization even more complicated and hard to solve.

PLI-MCRWA problems can be considered as multi-constrained multicast routing problems [50, 123, 124] in which the constraints are imposed by physical impairments. Fortunately, the flexibility of hierarchies can help to facilitate the problem. In fact, to satisfy

some required level of quality of services (QoS) under optical physical layer impairments, the flexible hierarchies are better candidates than trees in a manner that they permit to explore more possible solutions, thereby increasing the possibility of success in routing.

7.2.5 Energy-Efficient Optical Networking

With the ever-increasing demands for bandwidth and the evolution of new networking paradigms like MLRs or EONs, computer networks are requiring more and more sophisticated and power-hungry devices, such as reconfigurable optical add/drop multiplexers (ROADMs), optical cross-connects (OXC), signal regenerators, optical amplifiers, and very fast processing units. The energy consumption is becoming a significant factor hindering the overall scalability of next-generation telecommunication networks [125]. Besides, mainly due to fabrication cost, signal regeneration, wavelength conversion and traffic grooming are currently accomplished by OEO transponders which involves electronic processing, hence consumes large power [28]. To reduce the power consumption, technology based on all-optical processing (e.g., all-optical wavelength converters, all-optical grooming devices) is desired. In the meantime, there should be something done to have instant solutions in current optical technologies to deal with the increasing power-consumption problem. Several solutions have been proposed for this problem [34, 126–129]. Furthermore, the aforementioned physical impairments can greatly impact on the power level received at receiver's sides. Hence, the incorporation of the physical impairments with the energy-efficient networking problem in transparent optical networks is more realistic but more challenging.

Résumé

A.1 Présentation

Au cours de la dernière décennie, le trafic dans les réseaux a connu une croissance explosive en doublant les communications environ tous les trente mois [11]. Le dernier rapport prévisionnel de Cisco sur le trafic annonce aussi que le trafic d'Internet sera multiplié par trois au cours des cinq prochaines années, et le trafic IP augmentera avec un taux de croissance annuel composé (CAGR) de 21% de 2013 à 2018 [12]. Les principales sources responsables de cette croissance correspondent au trafic voix et vidéo, provenant de nombreuses applications Internet y compris la vidéo à la demande (VoD), la télévision haute définition (HDTV), la voix sur protocole Internet (VoIP), le partage vidéo entre les centres de données, la vidéoconférence, etc. Pour répondre à ces demandes en forte augmentation, il est nécessaire d'équiper les réseaux de base avec un médium de transmission efficace. Cette condition donne lieu à l'évolution de la technologie basée sur l'énorme bande passante de la fibre optique. La fibre optique a été choisie en raison de critères comme sa large bande passante, sa faible latence, sa fiabilité, son évolutivité et sa maintenabilité. Théoriquement, une fibre optique monomode a une bande passante potentielle de 50 téraoctets par seconde (Tbps) tandis que le taux de pointe électronique a environ quelques dizaines de gigaoctets par seconde (Gbps) [13].

Afin d'exploiter la grande capacité potentielle de la fibre, différentes technologies peuvent être envisagées pour transmettre un grand nombre de flux de données simultanément. Dans les réseaux tout optique, la concurrence peut être mise en oeuvre par un multiplexage temporel [14] (OTDM: Optical Time Domain Multiplexing), en code [15] (CDM: Code Division Multiplexing) ou en longueur d'onde [16] (WDM: Wavelength Division Multiplexing). La technologie WDM s'avère être la plus attractive.

Dans la technologie WDM, plusieurs canaux (longueurs d'ondes) sont multiplexés dans une seule fibre optique. Actuellement la technologie permet de transporter 80 à 160 longueurs d'onde dans une fibre optique [11] et le matériel dans le commerce per-

met d'exploiter chaque longueur d'onde à 10 Gbps, 40 Gbps ou 100 Gbps [17]. L'état de l'art mentionne des super canaux fonctionnant jusqu'à 500 Gbps [18] et un Tbps par longueur d'onde est susceptible d'être atteint entre 2015 et 2020 [11].

Les demandes de bande passante mentionnées plus haut impliquent la transmission de données entre plusieurs participants (des groupes de multicast). Naturellement, ils sont mieux pris en charge avec le multicast. La communication depuis une source vers plusieurs destinations peut utiliser des liens communs, la multicast est l'utilisation efficace de la bande passante. Le multicast dans le domaine tout-optique, appelé multicast tout-optique (AOM), est indispensable pour organiser la communication dans les groupes. Notre thèse s'articule autour du routage AOM.

Par rapport au multicast IP dans le domaine électronique traditionnelle, AOM est soumis à plusieurs contraintes spécifiques. Ces contraintes proviennent de la disponibilité des ressources du réseau tels que le nombre de longueurs d'onde pris en charge dans une fibre, la disponibilité des services des répartiteurs, des convertisseurs, etc. En outre, AOM doit pouvoir s'adapter à plusieurs requêtes simultanées dans le réseau. Dans cette thèse, nous étudions à la fois la demande unique de multicast et les demandes multiples. Alors que l'AOM unique se concentre seulement sur l'optimisation de la route optique pour une demande, le cas des multiples requêtes multicast doit prendre en compte la présence de plusieurs demandes simultanément. En dépit de leur différence de nature, nous montrons que les solutions de routage de multicast unique peuvent être appliquées à plusieurs scénarii de multicast d'une manière appropriée.

Le résultat majeur de cette thèse est l'illustration du fait que la route optimale et les routes approchées sous différentes contraintes optiques dans les réseaux optiques peut toujours être modélisée par une hiérarchie, concept expliqué dans la thèse. Cette hiérarchie peut être implémentée sous différentes formes, avec des routes optiques différentes dans les différents cas de figures.

Le reste de ce résumé suit l'organisation globale de la thèse:

- Une introduction à l'architecture des réseaux WDM
- La nécessité et le défis de l'AOM
- Portée de la thèse
- Plan et résumé de la thèse
- Conclusion et perspectives.

A.2 L'architecture de Réseau WDM

En général, un réseau WDM typique est composé de trois éléments: des brasseurs optiques (OXC: Optique cross-connect), des liens (composés de fibres) et des noeuds d'accès (ou noeuds de pointe).

- Les OXCs sont en charge des fonctionnalités les plus importantes des réseaux de base, y compris le multiplexage, le démultiplexage, le routage, la commutation, la conversion des longueurs d'onde, etc. Grâce aux démultiplexeurs, le signal de la lumière entrante est éclaté en longueurs d'onde et un OXC peut commuter chacune des longueurs d'onde d'un port d'entrée vers un port de sortie particulier, indépendamment des autres longueurs d'onde. Certains OXCs particuliers peuvent également passer une longueur d'onde à plusieurs ports de sortie simultanément en utilisant un "séparateur" de lumière pour soutenir les services de multicast.
- Les liens (les fibres optiques) portent le signal lumineux pour les communications de bout en bout de l'expéditeur au destinataire, en fournissant un support de transmission à haute vitesse. Souvent, chaque lien est constitué de plusieurs fibres optiques qui tout en augmentant le nombre possible de communications simultanées permettent de renforcer la capacité de survie du réseau et sa fiabilité. Chaque fibre peut porter un certain nombre de canaux optiques (ou longueurs d'onde).
- Les noeuds point d'accès (ou noeuds de bord) jouent les rôles d'interfaces intermédiaires entre le réseau WDM de base et les réseaux de clients optiques / non-optiques (ou réseaux de pointe telles que l'IP/MPLS, SONET ou les réseaux ATM). Dans notre cas, un noeud d'accès peut être soit un expéditeur soit un récepteur dans une certaine communication. Du côté de l'émetteur, il peut regrouper des trafics à faible vitesse. Dans l'autre sens, il peut effectuer la désagrégation du trafic et les conversions O/E (Opto-Électroniques).

Pour soutenir le multicast dans les réseaux WDM, les OXCs doivent être équipés de diviseurs (duplicateurs, ou encore splitters) de lumière. Deux architectures soutiennent les manipulations qui sont les commutateurs non-bloquants: Splitter-and-Delivery (SaD) [3] et Member-Only Splitter-and-Delivery (MoSaD) [5]. Ce dernier est basé sur la *conception de séparateur partagé*, notion introduit par [4]. Il est plus économe en énergie et plus rentable que le premier. Les OXCs équipés de séparateurs de lumière sont appelés OXCs multicast (abbrégé par MC-OXCs ou noeuds MC).

Toutefois, les MC-OXCs sont toujours coûteux en fabrication et en la consommation d'énergie. Par conséquent, une autre architecture de commutation a été proposé dans [6] qui est basée sur les dispositifs Tap-and-Continue (TaC). Le TaC-OXCs ne peut pas diviser le signal lumineux mais peut délivrer une petite partie de sa puissance à la station locale

(s'il s'agit d'une destination) et envoyer le reste à l'un des ports de sortie, afin qu'il puisse continuer sa route. Les OXCs qui ne sont pas équipés de séparateurs de lumière (dont les TaC OXCs) sont appelés des Multicast Incapable OXCs (MI-OXCs ou nœuds MI).

Dans les réseaux WDM, les deux contraintes mentionnées ci-dessous s'imposent aux algorithmes de calcul de routes dont un critère de performance est donc *la probabilité de blocage*:

- *la contrainte de continuité de longueur d'onde sur la route et*
- *la contrainte des longueurs d'onde distinctes dans les fibres* [22]

Une façon naturelle de réduire la probabilité de blocage (le fait que l'algorithme de routage ne trouve pas de solution à une requête) est d'atténuer ou d'éliminer ces contraintes, en particulier *la contrainte de continuité de longueur d'onde*. Ce peut être fait par l'introduction d'un dispositif spécial appelé convertisseur de longueur d'onde (WC). Un WC peut changer (convertir) une longueur d'onde qui arrive par un port d'entrée en une autre longueur d'onde sur un port de sortie. Il est utile quand un signal est transmis sur une route qui ne peut pas avoir la même longueur d'onde sur tous ses liens. Avec le soutien de WCs, différentes longueurs d'onde peuvent être utilisés dans un parcours de lumière, et donc *la contrainte de continuité de longueur d'onde* est relâchée ou éliminée si tous les nœuds sont capables de faire n'importe quelle conversion. Un WC peut être intégré dans un OXC et il en résulte un autre type d'OXC capable de convertir des longueurs d'onde (WC-OXCs).

A.3 All-Optique Multicast (AOM) dans les Réseaux WDM

Le but du multicast est de fournir des services de communication efficaces pour les applications qui nécessitent la transmission simultanée de l'information d'une source vers plusieurs destinations, i.e., la communication point-à-multipoint. Le multicast est économe en bande passante par rapport à l'unicast, car il élimine la nécessité pour une source d'envoyer une copie individuelle du message à chaque destination : il évite donc d'inonder l'ensemble du réseau [29].

Le multicast dans les réseaux WDM concerne la transmission simultanée et tout-optique d'un signal provenant d'une source unique vers plusieurs destinations (AOM). AOM est de plus en plus important dans les réseaux dorsaux en raison d'un nombre croissant d'applications de haute performance impliquant plusieurs destinations telles que la conférence vidéo, le e-learning, la HDTV, les espaces de travail partagés, les logiciels de simulation interactifs et distribués ou encore la mise à niveau de programmes, etc. AOM présente de nombreux avantages potentiels [30]. Tout d'abord, WDM multicast utilise la bande passante efficacement puisque le signal vers plusieurs destinations peut utiliser des

liens communs. En second lieu, la réplication de données dans les réseaux WDM est plus économe en énergie que celle dans les réseaux IP. En outre, puisqu'il n'y a pas de conversion O/E/O nécessaire, AOM a une faible latence. Enfin, AOM fournit une haute *transparence* des données. On n'a pas besoin de se soucier de la vitesse ou du format de codage des données lors d'une communication multicast dans les réseaux WDM. En fait, l'objectif initial du réseau tout optique était basé sur le maintien des signaux de données dans le domaine optique de la source jusqu'à la destination pour éliminer les goulots électroniques, et pour permettre n'importe quel débit, format de signaux ou protocole (propriété connue sous le nom de *transparence*) [28]. Toutefois, ces avantages sont accompagnés de problèmes que nous analysons dans la section suivante.

A.4 Défis du AOM

Le multicast dans les réseaux IP est souvent réalisé en utilisant soit un arbre de plus court chemin (SPT) ou un arbre, généralement approché, de Steiner (MST pour Minimum Steiner Tree) [31] en fonction de l'objectif qui est à minimiser: le délai ou le coût de la route multicast. Bien que l'AOM soit plus bénéfique, réaliser le multicast dans la couche WDM peut être plus difficile. Ces défis ne viennent pas seulement de la technique de multicast en soi, mais proviennent également de l'impact des composants matériels optiques dans les réseaux WDM. Les techniques de multicast WDM doivent faire coopérer des tâches comme le routage (R) et l'attribution de longueur d'onde (WA) [22]. Les composants matériels optiques (le déploiement hétérogène des composants dans les brasseurs, la répartition asymétrique des fibres dans les liens et la disponibilité des longueurs d'onde dans les fibres) impactent la recherche de solutions. Ces particularités font que les réseaux WDM sont différents des réseaux à commutation de circuits classiques, ce qui nous empêche d'implémenter directement des solutions de multicast IP pour le multicast tout-optique. Dans les paragraphes suivants, nous allons aborder plusieurs challenges propres aux réseaux WDM et discuter de leurs impacts sur le AOMR.

A.4.1 Impact des Séparateurs Optiques

Les séparateurs optiques sont très avantageux pour le multicast tout-optique, cependant la perte de puissance lors des divisions pose des problèmes. Lorsqu'un signal de puissance p est divisé en k signaux, la puissance de chacun de ces k signaux est au plus égale à $\frac{p}{k}$ [5]. Un dispositif d'amplification dans les MC-OXC est donc nécessaire tout en entraînant un coût supplémentaire et une amplification du bruit. Des MC-OXC (appelés MOSaD-OXC) aux capacités de séparation *limitées* mais limitant la perte d'énergie sont donc préférés.

Pour pallier la dégradation de puissance on peut décider d'équiper de séparateurs optiques seulement un sous ensemble des nœuds du réseau. Un réseau dont seule la moitié

des nœuds serait équipée de séparateurs peut atteindre des performances comparables à un réseau qui en serait entièrement équipé [27]. De nombreux travaux dont nous parlons dans le chapitre 3 se sont intéressés aux réseaux partiellement équipés de séparateurs. En outre, le multicast sans séparateur est également possible, à condition que tous les nœuds soient équipés de la fonction TaC.

A.4.2 Impact de la Conversion de Longueur d'Onde

Les convertisseurs de longueur d'onde permettent de relâcher la *contrainte de la continuité de longueur d'onde* et aident à mieux utiliser cette ressource [13]. Cependant, les convertisseurs optiques actuels n'ont pas atteint une maturité suffisante pour être déployés à grande échelle, principalement à cause de leur coût et de difficultés techniques [28]. Par conséquent, *l'absence ou la présence partielle* avec conversion *limitée* des longueurs d'onde sont les hypothèses les plus communément admises. Le premier cas (multicast sans conversion de longueur d'onde), a été étudié de manière intensive dans la littérature. Dans ces conditions, les contraintes *de continuité de longueur d'onde* et *de longueurs d'onde distinctes* doivent être complètement respectées. La présence de quelques convertisseurs avec des capacités de conversion limitées ne relâche qu'en partie ces contraintes [32].

A.4.3 Impact de la Perte de Puissance

Dans la communication AOM, les trois principales causes de perte de puissance sont: les divisions, l'atténuation le long de la fibre et la délivrance du signal à une destination [19]. En effet l'atténuation du signal lumineux n'est pas négligeable dans les fibres optiques longue distance (il est égal à 0,2 dB/km vers 1550 nm [13]) et lorsque le signal lumineux traverse un TaC-OXC attaché à une destination, une partie de l'énergie est consommée pour l'utilisation locale (le ratio de pertes est d'environ 1 dB [33,34]).

Pour compenser la perte de puissance, des dispositifs d'amplification optiques actifs comme l'amplificateur à fibre dopée à l'erbium (EDFA) [35] sont nécessaires. Cependant, les amplificateurs optiques sont coûteux à fabriquer et introduisent de plusieurs problèmes tels que la *dispersion de gain*, la *saturation de gain* et le *bruit* [36]. Par conséquent il est important de minimiser leur nombre dans le réseau. Le placement des amplificateurs optiques (OAP) est un problème qui a été intensément étudié [32,37].

A.4.4 Impact de la Disponibilité des Longueurs d'Onde

La plupart des travaux précédents supposent que la disponibilité des longueur d'onde est la même partout et en particulier dans les deux sens de communication d'un même lien (*longueurs d'onde symétrique*). Cependant cette hypothèse n'est valable qu'au départ et au fur et à mesure la disponibilité des longueur d'onde n'est plus la même partout et n'est plus forcément symétrique. Les deux cas sont considérés dans cette thèse pour une

enquête approfondie sur l'AOM. Le cas des *longueurs d'onde non symétrique* conduit au besoin d'avoir un modèle approprié afin de représenter au mieux l'état des ressources du réseau.

A.4.5 Challenges du Routage et de l'Association des Longueurs d'Onde

Le routage et l'affectation des longueurs d'onde sont des problèmes couplés dans les réseaux tout optique. Dans un premier temps, ce problème a été posé pour les connexions unicast avec sous le nom RWA ou Lightpath Établissement [45]. Il a ensuite été étendu au cas du trafic multicast sous les noms MCRWA [38] ou MC-RWA [46].

Le problème MCRWA vise donc à établir les routes multicasts dans le réseau et leurs longueurs d'onde. L'objectif peut être soit la minimisation du nombre de longueurs d'onde utilisées et/ou des canaux si leur est suffisante pour acheminer toutes les demandes, soit la maximisation du nombre total de demandes satisfaites (ou de manière équivalente, la minimisation de la probabilité de blocage) dans le cas de ressources insuffisantes [32, 47].

Résoudre le problème MCRWA peut être fait en utilisant des méthodes découplées ou conjointes. Puisque le problème RWA est NP-difficile [45], le problème MCRWA est lui aussi NP-difficile. Des heuristiques sont donc souvent employées pour résoudre le problème. Bien que l'approche MCRWA conjointe donne de bons résultats pour le calcul de solutions optimales, les deux tâches sont habituellement traitées séparément pour des raisons de commodité. Il s'agit alors de calculer un *routage* et ensuite *d'attribuer des longueurs d'onde*. Si le critère d'optimisation le plus important est le poids alors la partie routage est NP-difficile car elle implique la construction d'arbres de Steiner. Dans un second temps, selon l'algorithme choisi à la première étape, l'attribution des longueurs d'onde peut également s'avérer NP-difficile.

A.5 Portée de la Thèse

La thèse porte sur les problèmes de routage multicast AOM tout-optique sous contraintes optiques hétérogènes. L'hétérogénéité est considérée comme provenant de l'absence / présence de séparateurs de lumière ou de convertisseurs de longueur d'onde dans les OXCs et de la répartition *inégaie* des longueurs d'onde dans les liens du réseau. Pour le niveau de présence de séparateurs, tous les cas sont considérés. En outre, dans les réseaux WDM, les nœuds ont souvent des degrés relativement faibles, donc nous supposons que les nœuds MC (le cas échéant) ont une *pleine* capacité de division de la lumière, comme dans la plupart des études antérieures. Pour la conversion des longueurs d'onde, nous supposons également que les convertisseurs ont une capacité de conversion *complète*. Enfin, dans tous les cas, nous supposons que tous les nœuds dans un réseau WDM possèdent la fonction tap-and-continue (TaC) [6].

Dans cette thèse, on suppose les réseaux WDM avec une paire de fibres par lien de sorte que chaque lien est capable de fournir une communication en duplex intégral [22]. Les réseaux à fibres multiples sont réservés pour des études futures. Pour connaître la disponibilité en longueurs d'onde, nous considérons deux cas: *longueurs d'onde symétriques* et *longueurs d'onde non symétrique*. Le cas symétrique représente le même ensemble de longueurs d'onde disponibles dans tous les liens alors que l'autre cas correspond à un ensemble arbitraire de longueurs d'onde dans les liens. Notez que le cas non symétrique de longueurs d'onde est bien adapté pour refléter la nature des états du réseau qui sont constamment modifiés pour servir des demandes aléatoires.

En ce qui concerne l'objectif d'optimisation, on souhaite minimiser l'utilisation des ressources du réseau et la probabilité de blocage. Les ressources du réseau sont le nombre de longueurs d'onde utilisées et le coût total des itinéraires de multidiffusion. La probabilité de blocage, elle, est définie comme le rapport entre le nombre de demandes (destinations) bloquées et le nombre total de demandes (destinations).

Dans cette thèse, nous divisons le problème AOM en deux grandes catégories par rapport à la multiplicité des demandes: le *multicast unique* et les *multicasts multiples*. Pour le cas unique de multicast, l'AOM se concentre principalement sur le routage, nous étudions seulement le problème de l'AOMR. Pour le cas des multicasts multiples, l'affectation de longueurs d'onde doit être pris en compte, alors nous étudions à la fois le routage et l'affectation de longueurs d'onde, ce qui entraîne le problème combiné MCRWA.

A.6 Plan et Résumé de la Thèse

Le mémoire est divisé en trois parties. La partie I (comprenant les trois premiers chapitres 1, 2, 3) fournit les préliminaires nécessaires, y compris la présentation technologique, la modélisation mathématique et l'état de l'art pour les problèmes de AOMR. La partie II (comprenant les chapitres 4 et 5) présente les contributions dans le contexte de demande unique de multicast: le chapitre 4 dans le cas d'une présence clairsemée de séparateurs optiques et le chapitre 5 dans le cas d'une absence totale de séparateurs optiques. La partie III (le chapitre 6) présente les contributions dans le cas de multiples demandes. Les résultats obtenus sont détaillés comme suit.

- Le chapitre 1 présente une brève introduction au multiplexage par répartition en longueur d'onde (WDM), incluant l'infrastructure de base des réseaux WDM et l'architecture des switches optiques (OXCs). Ensuite, la nécessité et les défis associés au multicast dans le domaine tout optique (AOM) sont présentés en profondeur. Les problèmes d'AOM sont ensuite classés en fonction des facteurs et des défis typiques.
- Dans le chapitre 2, deux modèles mathématiques importants pour résoudre les problèmes d'AOM sont discutés. Pour le modèle de réseau, deux façons de voir un réseau

WDM sont discutés: on considère le réseau au niveau des fibres tandis qu'une vue plus élaborée donne des informations au niveau des longueurs d'onde. En conséquence, deux modèles de graphes correspondants sont appliqués: un modèle physique et un modèle topologique-couches-graphe. Nous montrons que, bien que le modèle basé sur la topologie puisse faciliter le routage, le modèle en couches fournit un outil plus précis pour l'optimisation de l'itinéraire. Pour le modèle de la route optique, une structure en forme d'arbre appelé *hiérarchie* qui a été proposé pour les routes multicast optique est analysée en profondeur. Nous rappelons que, la hiérarchie peut modéliser toutes les routes possibles utiles dans le routage multicast tout optique, y compris les structures existantes comme les arbres optiques ou les forêts optiques. Nous introduisons aussi pour la première fois, de nombreuses formes de *hiérarchies optiques* réalisées pour AOMR, comme les araignées optiques, les hiérarchies-araignées optiques, les multi- λ structures optiques, etc. pour différents cas de routage.

- Le chapitre 3 fournit un parcours profond de la littérature de l'AOMR à la fois pour le multicast unique et pour le routage (et l'affectation des longueurs d'onde) multiple-multicast (MCRWA). Les approches et les travaux connexes, y compris les solutions exactes (formulations ILP) et heuristiques de l'état de l'art sont examinées par rapport à une classification appropriée. Surtout, outre l'examen des ouvrages existants, nous faisons de nouvelles propositions pour identifier des solutions exactes pour les problèmes de AOMR basés sur la hiérarchie sous diverses contraintes optiques. Elles sont résumées dans le tableau 3.1.
- Le chapitre 4 présente notre première heuristique proposée pour AOMR dans le cas de séparateurs optiques clairsemés, à savoir Members-Splitter-First (MSF). L'algorithme vise à trouver un compromis entre le *stress des liens*, le *coût total* et le *délaï maximum*. Notre proposition fait trois améliorations importantes sur l'algorithme bien connu Member First concernant le modèle de priorité des liens ajoutés et le mode de construction de l'arbre optique. Pour le modèle de priorité, non seulement les membres mais aussi les nœuds MC et le degré des nœuds sont pris en compte, augmentant ainsi la qualité de la forêt résultante. Deuxièmement, une file de priorité des liens sortant des sommets MI est gérée qui ne permet qu'un seul candidat successeurs de nœuds MI, ce qui facilite le processus de la réparation de l'arbre. Enfin, une technique efficace est développée pour traiter des liens inutiles lors du calcul de l'arbre optique. Les résultats de simulation montrent que MSF est meilleur que Member First pour tous les indicateurs de performance. Parmi les autres, MSF réalise le stress de lien le plus faible, un faible coût total et un faible délai de bout en bout. En général, notre proposition offre un bon compromis entre les mesures de performance dans le cas de séparateurs optiques clairsemée et quand le nombre de destinations est important.

- Le chapitre 5 présente une analyse approfondie sur le problème du multicast tout optique sans diviseurs ni convertisseurs. Tout d'abord, deux problèmes (deux variantes) sur la minimisation des ressources du réseau sont formulées, à savoir: 1) *Trouver le nombre minimum de longueurs d'onde d'abord (MNWF)* et 2) *Minimiser le coût total en premier (MTCF)*. Nous avons prouvé que les problèmes sont NP-difficiles, et nous avons identifié que la solution optimale pour les deux problèmes est *un ensemble de hiérarchies-araignées optiques*. Une formulation ILP sur la base de *hiérarchies-araignées optiques* a été développée (les résultats de simulation vérifient l'exactitude de la déclaration).

Les simulations ont également montré que, en général, la solution qui minimise le nombre de longueurs d'onde à l'aide des hiérarchies araignées réduit également le coût total; et la solution avec le coût total minimum (basée sur les hiérarchies-araignées optiques) consomme également moins de longueurs d'onde par rapport à de simples araignées optiques. Nous avons également proposé plusieurs heuristiques efficaces pour chaque problème pour calculer les routes dans les réseaux à grande échelle avec différents scénarios.

Pour le problème MNWF, nous proposons un algorithme heuristique avec deux variantes basées sur les hiérarchies-araignées optiques: le plus loin d'abord et le plus proche d'abord. L'idée de l'algorithme est de diminuer les conflits entre les parcours optiques jusqu'à ce qu'il ne puisse plus être réduit. Surtout, à la différence des approches communes qui supposent de travailler sur les *réseaux symétriques* avec des liens bidirectionnels, notre algorithme peut bien fonctionner dans les *réseaux semi-symétriques* dans lequel les liens ne sont pas nécessairement bidirectionnels. Les deux heuristiques sont comparées avec les solutions exactes ILP et les autres algorithmes basés sur les araignées optiques dans la littérature. Notre algorithme permet la diminution du nombre de longueurs d'onde utilisées, un moindre coût mais un diamètre assez grand par rapport à des algorithmes basés sur des araignées optiques.

Pour le problème MTCF, nous proposons deux heuristiques: Destinations proches d'abord (NDF) et Destinations critiques d'abord (CDF). Ces algorithmes visent à minimiser le coût total pour une demande de multicast donnée en vertu de la disponibilité arbitraire de longueurs d'onde dans les réseaux sans splitters. Deux algorithmes sont conçus pour calculer des hiérarchies à faible coût basés sur le modèle de graphe en couches auxiliaire, puis la solution finale (qui est un ensemble de hiérarchies-araignées optiques) est obtenue après la suppression des pseudo-éléments. Ils diffèrent dans la manière de choisir les destinations candidates. NDF choisit toujours à chaque fois la destination la plus proche, CDF sélectionne les destinations critiques en premier. Les performances des deux heuristiques sont comparées aux solutions exactes (ILP) ainsi qu'entre elles. Les résultats des simulations révèlent que les algorithmes proposés pro-

duisent des solutions proches de l'optimum. Ils montrent également que, en prenant le degré critique des destinations en compte, notamment le choix de la destination la plus critique en premier lieu, les résultats sont meilleurs dans des configurations différentes de longueurs d'onde. Une fois de plus, les résultats des simulations confirment que les hiérarchies-araignées optiques sont plus performantes que les araignées optiques.

- Chapitre 6 présente notre contribution dans le cas de multicast avec plusieurs demandes. En partant d'un réseau WDM avec fractionnement clairsemé, et un ensemble de longueurs d'onde disponibles, nous étudions le problème de l'approvisionnement d'un ensemble de requêtes multicast simultanément dans le réseau. Notre investissement vise à réduire au minimum la probabilité de blocage. Deux modèles de blocage sont pris en compte: *probabilité de blocage de groupes* et *probabilité de blocage partielle*. Comme les problèmes sont NP-difficiles, nous proposons de rechercher les solutions optimales au moyen de la programmation linéaire en nombres entiers (ILP) à base des hiérarchies optiques. Nous proposons plusieurs heuristiques *adaptive* efficaces pour construire des hiérarchies optiques. Ces algorithmes sont basés sur deux algorithmes de base, à savoir la plus proche destination light-hiérarchie (NDLH) et la plus critiques destination light-hiérarchie (CDLH), qui peuvent être considérés comme les extensions des algorithmes NDF et CDF proposées au Chapitre 5. Deux schémas de routage, basé sur le graphe en couches (LG) et et un autre basé sur le graphe de longueurs d'onde (WG) sont introduits pour concevoir des algorithmes adaptatifs couplés en utilisant les hiérarchies optiques. Le régime LG-routage qui calcule l'itinéraire dans l'ensemble des couches peut obtenir de bonnes performances avec un temps de calcul raisonnable. En revanche, le schéma WG-routage permet le calcul des itinéraires à effectuer d'une manière couche à couche, réduisant ainsi la complexité de temps tout en obtenant de très bonnes performances. Des simulations approfondies ont montré que nos algorithmes proposés sont capables de calculer des solutions quasi-optimales avec une performance meilleure que les algorithmes basés sur des approches *fixes*. Les résultats montrent également qu'il est plus avantageux de concevoir de multiples communications multicast avec les hiérarchies optiques, car elles permettent d'accueillir plus de demandes et plus de destinations par rapport aux solutions basées sur les arbres optiques. Finalement, pour déterminer l'ordre des demandes, trois politiques de sélection sont également proposées: la plus petite demande d'abord fonctionne mieux dans les problèmes visant la minimisation de blocage des groupes, et la plus grande demande d'abord atteint des solutions quasi-optimales au niveau du blocage partiel. En outre, la sélection des demandes au hasard (ou à la suite de l'ordre indexé) à des avantages d'une plus faible complexité, et surtout,

elle peut être utilisée pour concevoir des algorithmes en ligne pour le cas du routage dynamique.

- Le chapitre 7 conclut le travail de thèse et introduit plusieurs perspectives.

A.7 Conclusions et Perspectives

A.7.1 Conclusions

Cette thèse étudie le multicast tout-optique (AOM) dans les réseaux optiques hétérogènes. L'hétérogénéité provient de l'absence / présence de séparateurs optiques, de convertisseurs de longueur d'onde et de la disponibilité inhomogène des longueurs d'onde dans les liens du réseau. La thèse porte sur les problèmes de routage (AOMR), qui détermine les routes de la source (s) vers les destinations d'une demande multicast. Dans le cas de demandes multiples, les problèmes AOMR sont étudiés en combinaison avec l'attribution de longueurs d'onde (WA), connu sous le nom de routage et assignation de longueurs d'onde pour des sessions multicast (MCRWA). Nous visons à minimiser les ressources du réseau, par ex., le nombre de longueurs d'onde et/ou le coût total, ou encore la probabilité de blocage. Comme les problèmes d'AOM sont principalement NP-difficiles, des formulations ILP sont développés pour rechercher des solutions exactes, et des algorithmes heuristiques sont proposées pour calculer les routes. Les résultats les plus importants et originaux de la thèse sont liés aux démonstrations que les solutions optimales de différents problèmes de AOMR peuvent être décrits par la structure hiérarchie. Plusieurs formes spécifiques des hiérarchies sont identifiées pour réaliser le routage optique sous différentes contraintes. En conséquence, la hiérarchie peut modéliser toutes les solutions existantes dans la littérature (par ex., chemins optiques, parcours optiques, arbres et forêts optiques) ainsi que les nouvelles structures (hiérarchies optiques, hiérarchies-araignées optiques, multi λ -hiérarchies optiques). Les messages les plus importants de la thèse se résument comme suit.

1. Les solutions optimales ne sont pas basées uniquement sur les arbres, mais sur les *hiérarchies*. Certaines *hiérarchies optiques* WDM pour le multicast sont réalisées à l'aide des parcours optiques, hiérarchies optiques, hiérarchies-araignées optiques.
2. Profiter des MC-OXC disponibles (qui sont souvent rares) dans les réseaux conduit à des solutions moins chères.
3. Les graphes en couches reflètent l'état des réseaux WDM plus précisément que le simple graphe de topologie. Pour résoudre les problèmes (par ex., AOMR avec la disponibilité arbitraire de longueurs d'onde dans les liens, ou MCRWA ayant plusieurs demandes), l'application de ce modèle est indispensable.

A.7.2 Perspectives

De nombreuses questions difficiles sur la mise en réseau tout-optique ne sont pas couverts dans la thèse. Plusieurs perspectives potentielles sont suggérées ci-dessous pour des recherches futures.

A.7.2.1 Traffic Grooming

Avec le taux actuel de croissance du trafic, la limite des capacités de la fibre conventionnelle sera atteint vers l'an 2025 [11]. Il est donc nécessaire d'utiliser efficacement la capacité de ces fibres. Les clients génèrent souvent un trafic qui a un débit inférieur à la capacité d'une longueur d'onde. La capacité de la longueur d'onde peut être de 40, 100 Gbps ou même plus, alors que plus de 90 % des demandes des clients exigent un débit de 10 Gbps ou moins, avec près de la moitié d'entre elles nécessitant un débit de 2,5 Gbps ou moins [113]. Ce décalage donne lieu à la nécessité de l'*agrégation* des multiples trafics à faible débit sur une longueur d'onde afin d'améliorer l'efficacité de l'allocation de la bande passante. La technique pour l'agrégation de trafics à faible débit est connue sous le nom de Traffic Grooming, qui est discuté par exemple dans [11, 13, 114]. Cependant, la plupart des travaux antérieurs sur le Traffic Grooming sont formulés pour des trafics unicast. Peu d'études examinent le Traffic Grooming pour le multicast et ils sont juste basés sur les arbres optiques [114]. Dans ce cas aussi les hiérarchies optiques devraient donner de meilleures solution en général.

Pour mieux satisfaire des demandes hétérogènes avec plus de rentabilité, les réseaux optiques Mixed-Line-Rates (MLR) ont été introduits [115–118]. Dans les réseaux MLR, les différentes longueurs d'onde dans les liens sont modulés en proposant des débits différents (par ex., 10/40/100 Gbps). Cette approche peut être efficace parce que les trafics à faible débit auront besoin de moins d'agrégation, tandis que les trafics avec un débit élevé peuvent utiliser une longueur d'onde entièrement. Dans ces systèmes, étant donné un ensemble de requêtes avec des exigences différentes, non seulement les problèmes MCRWA doivent être résolus mais aussi il faut faire face à la sélection de la fréquence de la ligne. Le problème MCRWA dans les réseaux MLR a été étudiée dans [115, 116]. Cependant, les conditions sont peu réalistes: tous les nœuds sont supposés avoir des séparateurs optiques complets et/ou des convertisseurs de longueur d'onde. Par conséquent, les solutions sont basées sur des arbres optiques, mais avec des contraintes plus réalistes sur les équipements des OXCs, les hiérarchies devraient être mieux placées pour résoudre ces problèmes.

A.7.2.2 Réseaux Optiques Élastiques avec une Grille Flexible

Un autre paradigme de réseau pour répondre aux demandes d'augmentation de trafic est le modèle des réseaux optiques élastiques (EON). Pendant de nombreuses années, les réseaux ont été fondés sur le fait que les longueurs d'onde sont généralement espacés de

50 GHz à part dans les réseaux backbone WDM. Le paradigme EON avec une grille flexible, récemment proposé, peut être considéré comme un remplaçant potentiel des réseaux WDM conventionnels avec une grille fixe [51]. Sous EON, des canaux optiques ne sont plus basés sur des longueurs d'onde longues mais sur des spectres (composées d'un ensemble d'intervalles de fréquences contiguës).

Cependant, l'architecture EON apporte de nombreux défis opérationnels. Le problème de routage et l'affectation des spectres (RSA) dans EON est plus difficile que l'opération RWA dans les réseaux WDM. L'utilisation des spectres dans les réseaux optiques élastiques est délicat mais on peut supposer que le routage WDM et le routage EON ont une relation étroite entre eux. À noter que les spectres sont soumis aux fractionnements du spectre et qu'il y a des mécanismes de conversion de spectre, ainsi que des contraintes similaires: continuité du spectre et spectres distincts dans les fibres existent [53], tout comme dans les technologies WDM. En conséquence, les concepts de l'arbre optique ou de la hiérarchie optique proposés pour WDM peuvent être utilisés pour ces technologies plus sophistiquées. Le problème MC-RSA basé sur les arbres optiques a été étudié dans [52,53,119]. Cependant, il devrait être bénéfique de profiter de la hiérarchie optique dans EON.

A.7.2.3 Réseaux Prenant en Compte des Imperfections Physiques

La thèse suppose de travailler d'une manière transparente dans les réseaux tout-optique, de sorte que le routage est juste sous réserve des ressources disponibles et des contraintes optiques. En fait, le bruit et les distorsions des signaux encourus en raison des dispositifs de transmission non idéals dégradent la qualité de transmission (QoT) [1,120–122], qui peut être mesurée par le taux d'erreur binaire (BER). L'accumulation de bruit diminue réellement le rapport signal optique sur bruit (OSNR) et augmente le taux d'erreur (BER). Les distorsions dues à la propagation dans la fibre modifient la forme de l'impulsion induisant une réduction de l'OSNR [120].

La transmission de données peut être infaisable en utilisant une route calculée qui ne peut pas satisfaire les exigences de qualité en raison de ces déficiences. Par conséquent, l'AOM devrait coopérer avec des modèles prenant en compte les contraintes de la couche physique (PLI) de sorte que le routage et l'affectation de longueurs d'onde puissent tenir compte des imperfectionnements physiques (PLI-RWA). Cependant, l'examen de PLI induit un certain nombre de relations linéaires et non linéaires, et donc augmente considérablement la complexité de l'optimisation PLI-RWA. En outre, la combinaison de multicast et PLI-RWA (PLI-MCRWA) est difficile à résoudre.

Le PLI-MCRWA peut être considéré comme le problème de routage multicast multi-contraintes [50,123,124] dans lequel les contraintes sont dues aux déficiences physiques. Heureusement, la flexibilité des hiérarchies peut aider à résoudre le problème. En fait, pour satisfaire un certain niveau de qualité de services (QoS) sous contraintes de la couche

physique optique, les hiérarchies flexibles sont de meilleurs candidats que les arbres. Elle permettent d'explorer plus des solutions possibles, augmentant ainsi les chances de succès dans le routage.

A.7.2.4 Econergétiques Réseaux Optiques

Du fait de l'évolution de nouveaux paradigmes dans les réseaux comme MLR ou EON, les réseaux informatiques appliquent de plus en plus de dispositifs sophistiqués tels que les multiplexeurs et des brasseurs reconfigurables, des régénérateurs de signaux, des amplificateurs optiques, et des unités de traitement très rapides. La consommation d'énergie devient un facteur important, entravant l'évolutivité globale des réseaux de télécommunications de nouvelle génération [125]. Par ailleurs, principalement en raison des coûts de fabrication, la régénération du signal, la conversion de longueur d'onde et l'agrégation du trafic sont actuellement accomplis par transpondeurs O/E/O qui impliquent le traitement électronique, et qui consomment donc beaucoup d'énergie [28]. Pour réduire la consommation d'énergie, des technologies basées sur les traitements tout-optique (par ex., des convertisseurs de longueur d'onde tout optique, trafic grooming dans le domaine optique) sont souhaitables. En attendant, la recherche doit se focaliser sur les technologies optiques actuelles pour faire face à l'aggravation du problème de consommation d'énergie. Plusieurs solutions ont été proposées pour ce problème [34, 126–129]. En outre, les déficiences physiques mentionnées plus haut peuvent influencer grandement sur le niveau de puissance par les récepteurs. Par conséquent, l'incorporation des contraintes dues aux imperfections physiques et prendre en compte le rendement énergétique dans le problème de routage dans les réseaux optiques transparents est plus réaliste, mais aussi plus difficile.

List of Publications

International Journal Papers

- **Dinh Danh Le**, Fen Zhou, and Miklos Molnar, "Minimizing Blocking Probability for MCRWA problem in WDM Networks: Exact Solutions and Heuristic Algorithms," *Journal of Optical Communications and Networking (JOCN)*, Vol. 7, Iss. 1, pp. 36–48 (2015), doi: 10.1364/JOCN.7.000036, Impact Factor (2013): 1.547.
- **Dinh Danh Le**, Miklos Molnar, and Jerome Palaysi, "Multicast Routing in WDM Networks without Splitters," *IEEE Communications Magazine*, Vol. 52, no. 7, pp.158–167, July 2014, ISSN: 0163-6804, doi: 10.1109/MCOM.2014.6852098, Impact Factor (2013/2014): 4.46.

International Conference Papers

- **Dinh Danh Le**, Fen Zhou, and Miklos Molnar, "Light-Hierarchy for Provisioning Multiple Multicast Requests in Sparse Splitting WDM Networks," *The IEEE International Conference on Computing, Networking and Communications (ICNC 2015)*, USA, pp. 847–852, February, 2015.
- **Dinh Danh Le**, Fen Zhou, and Miklos Molnar, "Adaptive MCRWA Strategies to Reduce Blocking Probability in Sparse Splitting WDM Networks," *The International Conference on Advanced Technologies for Communications (ATC'14)*, pp. 153–159, October, 2014, doi: 10.1109/ATC.2014.7043375.

- **Dinh Danh Le** and Massinissa Merabet, "Light-trail based hierarchy: the optimal multicast route in WDM networks without splitters and converters," *The International Conference on Photonics, Optics and Laser Technology, Portugal* (Photoptics'2014), pp.66–73, Jan, 2014, doi: 10.5220/0004705300660073.
- **Dinh Danh Le**, Miklos Molnar and Jerome Palaysi, "An Improved Multicast Routing Algorithm in Sparse Splitting WDM Networks," *The International Conference on Computing, Management and Telecommunications* (ComManTel), pp.99–104, Jan, 2013, doi: 10.1109/ComManTel.2013.6482373.

Technical Reports

- **Dinh Danh Le**, Miklos Molnar, and Jerome Palaysi, "All-Optical Multicast Routing in WDM Networks without Splitters," LIRMM, University of Montpellier, France, June 2013, url: <http://hal-lirmm.ccsd.cnrs.fr/lirmm-00834276>.
- **Dinh Danh Le**, Miklos Molnar, and Jerome Palaysi, "Performance Analysis of All-Optical Multicast Routing Algorithms with Sparse Splitting," LIRMM, University of Montpellier, France, October 2012, url: <http://hal-lirmm.ccsd.cnrs.fr/lirmm-00737121>.

Bibliography

- [1] S. Azodolmolky, M. Klinkowski, E. Marin, D. Careglio, J. S. Pareta, and I. Tomkos, "A survey on physical layer impairments aware routing and wavelength assignment algorithms in optical networks," *Computer Networks*, vol. 53, no. 7, pp. 926 – 944, 2009.
- [2] G. N. Rouskas, "Routing and wavelength assignment in optical wdm networks," *Encyclopedia of Telecommunications*, 2003.
- [3] W. Hu and Q. Zeng, "Multicast optical cross connects employing splitter-and-delivery switch," *IEEE Photon. Technol. Lett.*, vol. 10, pp. 970–972, 1998.
- [4] L. Sahasrabudde and B. Mukherjee, "Light trees: optical multicasting for improved performance in wavelength routed networks," *Communications Magazine, IEEE*, vol. 37, pp. 67–73, Feb 1999.
- [5] M. Ali and J. S. Deogun, "Power-efficient design of multicast wavelength-routed networks," *Selected Areas in Communications, IEEE Journal on*, vol. 18, no. 10, pp. 1852–1862, 2000.
- [6] M. Ali and J. S. Deogun, "Cost-effective implementation of multicasting in wavelength-routed networks," *EEE/OSA Journal of Lightwave Technology*, vol. 18, pp. 1628–1638, 2000.
- [7] K.-C. Lee and V. Li, "A wavelength-convertible optical network," *Lightwave Technology, Journal of*, vol. 11, pp. 962–970, May 1993.
- [8] Y. Yang, J. Wang, and C. Qiao, "Nonblocking WDM Multicast Switching Networks," *IEEE Transactions on parallel and distributed systems*, vol. 11, pp. 1274–1287, Dec 2000.
- [9] C. Chen and S. Banerjee, "A new model for optimal routing and wavelength assignment in wavelength division multiplexed optical networks," in *INFOCOM '96. Fifteenth Annual Joint Conference of the IEEE Computer Societies. Networking the Next Generation. Proceedings IEEE*, vol. 1, pp. 164–171, March 1996.

- [10] G.-S. Poo and A. Ding, "Layered-routing approach for solving multicast routing and wavelength assignment problem," *Photonic Network Communications*, vol. 13, no. 2, pp. 123–137, 2007.
- [11] J. M. Simmons, *Optical Network Design and Planning*. Springer, Second Edition ed., 2014.
- [12] Cisco, "Cisco Visual Networking Index: Forecast and Methodology, 2013-2018," in *White Paper, Cisco, Tech. Rep.*, June 2014.
- [13] B. Mukherjee, *Optical WDM Networks*. Springer, 2006.
- [14] D. Cotter, J. Lucek, and D. Marcenac, "Ultra-high-bit-rate networking: from the transcontinental backbone to the desktop," *Communications Magazine, IEEE*, vol. 35, pp. 90–95, Apr 1997.
- [15] M. Marhic, "Coherent optical CDMA networks," *Lightwave Technology, Journal of*, vol. 11, pp. 854–864, May 1993.
- [16] C. Brackett, A. Acampora, J. Sweitzer, G. Tangonan, M. Smith, W. Lennon, K.-C. Wang, and R. Hobbs, "A scalable multiwavelength multihop optical network: a proposal for research on all-optical networks," *Lightwave Technology, Journal of*, vol. 11, pp. 736–753, May 1993.
- [17] Infinera, "Infinera Introduces New Line System, Sets New Standard for Capacity," Sep 2008.
- [18] Infinera, "White paper: A Comprehensive Approach to Multi-layer Transport Network Automation," Mar 2014.
- [19] F. Zhou, *All-optical multicast routing in wavelength-routed WDM networks*. PhD thesis, INSA Rennes, 2010.
- [20] R. Ramaswami, "Multiwavelength lightwave networks for computer communication," *IEEE Communications Magazine*, vol. 31, 1993.
- [21] F. Abtahi, *Optimal Design of Cost-and Energy-Efficient Scalable Passive Optical Backbone Networks*. PhD thesis, KTH Royal Institute of Technology, 2013.
- [22] J. Zheng and H. T. M, *Optical WDM Networks: concepts and design principles*. Wiley-IEEE Press, 2004.
- [23] N. Skorin-Kapov, "Routing and wavelength assignment in optical networks using bin packing based algorithms," *European Journal of Operational Research*, vol. 177, no. 2, pp. 1167–1179, 2007.
- [24] N. Charbonneau and V. Vokkarane, "Static Routing and Wavelength Assignment for Multicast Advance Reservation in All-Optical Wavelength-Routed WDM Networks," *Networking, IEEE/ACM Transactions on*, vol. 20, pp. 1–14, Feb 2012.

- [25] Y. Jin and M. Kavehrad, "Optical cross connect based on WDM and space-division multiplexing," *IEEE Photon. Technol. Lett.*, vol. 7, pp. 1300–1303, 1995.
- [26] A. Watanabe, S. Okamoto, M. Koga, K. Sato, and M. Okuno, " 8×16 delivery and coupling switch board for 320 gbit/s throughput optical path cross-connect system," *Electronics Letters*, vol. 33, pp. 67–68, Jan 1997.
- [27] M. Ali and J. S. Deogun, "Allocation of splitting nodes in all-optical wavelength-routed networks," *Photonic Network Communications*, vol. 2, pp. 247–265, 2000.
- [28] A. A. M. Saleh and J. M. Simmons, "All-Optical Networking - Evolution, Benefits, Challenges, and Future Vision," *Proceedings of the IEEE*, vol. 100, pp. 1105–1117, May 2012.
- [29] J. He, S.-H. Gary Chan, and D. H. K. Tsang, "Multicasting in WDM networks," *IEEE Communications Surveys & Tutorials*, vol. 4, 2002.
- [30] C. Qiao, M. Jeong, A. Guha, X. Zhang, and J. Wei, "WDM multicasting in IP over WDM networks," in *Network Protocols, 1999. (ICNP '99) Proceedings. Seventh International Conference on*, pp. 89–96, Oct 1999.
- [31] M. R. Garey and D. S. Johnson, *Computers and Intractability: A Guide to the Theory of NP-Completeness*. New York, NY, USA: W. H. Freeman & Co, 1979.
- [32] A. Hamad, T. Wu, A. E. Kamal, and A. K. Somani, "On multicasting in wavelength-routing mesh networks," *Computer Networks*, vol. 50, no. 16, pp. 3105–3164, 2006.
- [33] A. Hamad and A. Kamal, "Power-Aware Connection Provisioning for All-Optical Multicast Traffic in WDM Networks," *Optical Communications and Networking, IEEE/OSA Journal of*, vol. 2, pp. 481–495, July 2010.
- [34] F. Zhou, M. Molnar, B. Cousin, and G. Simon, "Power Optimal Design of Multicast Light-Trees in WDM Networks," *Communications Letters, IEEE*, vol. 15, pp. 1240–1242, November 2011.
- [35] P. Becker, J.R.Simpson, and N. Olsson, *Erbium-Doped Fiber Amplifiers: Fundamental and Technology*. San Diego: Academic Press, 1999.
- [36] S. Yan, J. S. Deogun, and M. Ali, "Routing in sparse splitting optical networks with multicast traffic," *Computer Networks*, vol. 41, no. 1, pp. 89 – 113, 2003.
- [37] A. Hamad and A. Kamal, "Optical Amplifiers Placement in WDM Mesh Networks for Optical Multicasting Service Support," *Optical Communications and Networking, IEEE/OSA Journal of*, vol. 1, pp. 85–102, June 2009.
- [38] G. Sahin and M. Azizoglu, "Routing and wavelength assignment in all-optical networks with multicast traffic," *European Transactions on Telecommunications*, vol. 11, pp. 55–62, 2000.

- [39] A. Ferreira, S. Perennes, A. Richa, H. Rivano, and N. Stier, "Models, complexity, and algorithms for the design of multifiber WDM networks," in *Proceedings of the IEEE International Conference on Telecommunications (ICT)*, pp. 12–18, 2003.
- [40] L. Margara and J. Simon, "Wavelength assignment problem on all-optical networks with k fibres per links," *ICALP'00*, pp. 768–779, 2000.
- [41] M. Daad and Z.-Q. Luo, "On the Routing and Wavelength Assignment in Multifiber WDM Networks," *IEEE Journal on Selected Areas in Communications*, vol. 22, pp. 1708–1717, Nov. 2004.
- [42] Wali and Z.M., "Static RWA in All-Optical Network under Multifiber, Multiple requests assumptions," *Computer Engineering and Systems*, pp. 172–177, Nov. 2006.
- [43] F. Köksal and C. Ersoy, "Multicasting for All-Optical Multifiber Networks," *Journal of Optical Networking*, vol. 6, 2007.
- [44] Cisco, "Fiber-Optic Cabling Connectivity Guide for 40-Gbps Bidirectional and Parallel Optical Transceivers," in *White Paper, Cisco, Tech. Rep.*, 2013.
- [45] I. Chlamtac, A. Ganz, and G. Karmi, "Lightpath communications: An approach to high bandwidth optical WAN's," *Communications, IEEE Transactions on*, vol. 40, no. 7, pp. 1171–1182, 1992.
- [46] J. He, S.-H. Chan, and D. Tsang, "Routing and Wavelength Assignment for WDM Multicast Networks," *IEEE GLOBECOM'01*, vol. 3, pp. 1536–1540, 2001.
- [47] H. Zang, J. P. Jue, and B. Mukherjee, "A review of routing and wavelength assignment approaches for wavelength-routed optical WDM networks," *Optical Networks Magazine*, vol. 1, pp. 47–60, 2000.
- [48] X. Zhang, J. Wei, and C. Qiao, "Constrained multicast routing in WDM networks with sparse light splitting," *IEEE/OSA Journal of Lightwave Technology*, vol. 18, pp. 1917–1927, 2000.
- [49] D.-R. Din, "Heuristic Algorithms for Finding Light-Forest of Multicast Routing on WDM Network," *Information Science and Engineering*, vol. 25, pp. 83–103, 2009.
- [50] P. Soproni, *Efficient Algorithms for Multi-Layer Unicast and Multicast Routing in Optical Networks*. PhD thesis, Budapest University of Technology and Economics, 2012.
- [51] O. Gerstel, M. Jinno, A. Lord, and S. Yoo, "Elastic Optical Networking: A New Dawn for the Optical layer?," *Communications Magazine, IEEE*, vol. 50, pp. s12–s20, February 2012.

- [52] Q. Wang and L. K. Chen, "Performance analysis of multicast traffic over spectrum elastic optical networks," in *Optical Fiber Communication Conference*, p. OTh3B.7, Optical Society of America, 2012.
- [53] L. Gong, X. Zhou, X. Liu, W. Zhao, W. Lu, and Z. Zhu, "Efficient resource allocation for all-optical multicasting over spectrum-sliced elastic optical networks," *Optical Communications and Networking, IEEE/OSA Journal of*, vol. 5, pp. 836–847, Aug 2013.
- [54] W.-Y. Tseng and S.-Y. Kuo, "All-optical multicasting on wavelength-routed WDM networks with partial replication," in *Information Networking, 2001. Proceedings. 15th International Conference on*, pp. 813–818, 2001.
- [55] A. Ding, G.-S. Poo, and S.-T. Tan, "An expanded graph model for MCRWA problem in WDM networks," in *Local Computer Networks, 2002. Proceedings. LCN 2002. 27th Annual IEEE Conference on*, pp. 557–564, Nov 2002.
- [56] Y. Zhou, G.-S. Poo, S. Chen, P. Shum, and L. Zhang, "Dynamic multicast routing and wavelength assignment using generic graph model for wavelength-division-multiplexing networks," *Communications, IET*, vol. 2, pp. 951–959, August 2008.
- [57] T. Cinkler, "ILP Formulation of Grooming over Wavelength-Routing with Protection," in *Proceedings of the IFIP TC6 Fifth Working Conference on Optical Network Design and Modeling: Towards an Optical Internet: New Visions in Optical Network Design and Modelling*, ONDM '01, (Deventer, The Netherlands, The Netherlands), pp. 25–48, Kluwer, B.V., 2001.
- [58] S. Chen, T. H. Cheng, and G.-S. Poo, "Placement of wavelength converters and light splitters in a WDM network using the generic graph model," *Computer Communications*, vol. 33, no. 7, pp. 868 – 883, 2010.
- [59] T. F. Znatiya, T. Alrabiaha, and R. Melhema, "Low-cost, delay-bounded point-to-multipoint communication to support multicasting over WDM networks," *Computer Networks*, vol. 38, pp. 423–445, 2002.
- [60] M. Molnar, "Hierarchies to Solve Constrained Connected Spanning Problems," tech. rep., LIRMM, University Montpellier 2, France, <http://hal-lirmm.ccsd.cnrs.fr/lirmm-00619806>, Sept. 2011.
- [61] L. Gargano, P. Hell, L. Stacho, and U. Vaccaro, "Spanning trees with bounded number of branch vertices," in *Automata, Languages and Programming*, pp. 355–365, Springer, 2002.
- [62] I. Chlamtac, A. Farago, and T. Zhang, "Lightpath (wavelength) routing in large WDM networks," *Selected Areas in Communications, IEEE Journal on*, vol. 14, pp. 909–913, Jun 1996.

- [63] K. Ruohonen, *Graph Theory*. Tampere University of Technology, 2008.
- [64] F. Zhou, M. Molnár, and B. Cousin, "Light-Hierarchy: The Optimal Structure for Multicast Routing in WDM Mesh Networks," *IEEE Symposium on Computers and Communications (ISCC'10)*, vol. 15, pp. 1–6, 2010.
- [65] N. Sreenath, G. Mohan, and C. Murthy, "Virtual source based multicast routing in WDM optical networks," *Photon. Netw.*, vol. 3, pp. 213–226, 2001.
- [66] L. Gargano, M. Hammar, P. Hell, L. Stacho, and U. Vaccaro, "Spanning spiders and light-splitting switches," *Discrete mathematics*, vol. 285, no. 1, pp. 83–95, 2004.
- [67] D. Li, X. Du, X. Hu, L. Ruan, and X. Jia, "Minimizing number of wavelengths in multicast routing trees in WDM networks," *Networks*, vol. 35, pp. 260–265, 2000.
- [68] X.-H. Jia, D.-Z. Du, and X.-D. Hu, "Integrated algorithms for delay bounded multicast routing and wavelength assignment in all optical networks," *Computer Communications*, vol. 24, pp. 1390–1399, 2001.
- [69] C.-Y. Hsieh and W. Liao, "All optical multicast routing in sparse splitting optical networks," *IEEE International Conference on Local Computer Networks*, pp. 162–167, 2003.
- [70] S.-H. Cho, T.-J. Lee, M. Y. Chung, and H. Choo, "Minimum Cost Multicast Routing Based on High Utilization MC Nodes Suited to Sparse-Splitting Optical Networks," *ICCSA*, vol. 2, pp. 288–297, 2006.
- [71] X. Wang, S. Wang, and L. Li, "A novel efficient multicast routing algorithm in sparse splitting optical networks," *Photon Netw Commun*, vol. 14, pp. 287–295, July 2007.
- [72] F. K. Hwang, D. S. Richards, and P. Winter, *The Steiner tree problem*. Elsevier, 1992.
- [73] H. Takahashi and A. Matsuyama, "An approximate solution for the Steiner problem in graphs," *Mathematica Japonica*, vol. 24, pp. 573–577, 1980.
- [74] L. Kou, G. Markowsky, and L. Berman, "A fast algorithm for Steiner trees," *Acta informatica*, vol. 15, no. 2, pp. 141–145, 1981.
- [75] V. Rayward-Smith, "The computation of nearly minimal Steiner trees in graphs," *International Journal of Mathematical Education in Science and Technology*, vol. 14, no. 1, pp. 15–23, 1983.
- [76] A. Shaikh and K. Shin, "Destination-driven routing for low-cost multicast," *Selected Areas in Communications, IEEE Journal on*, vol. 15, no. 3, pp. 373–381, 1997.
- [77] V. P. Kompella, J. C. Pasquale, and G. C. Polyzos, "Multicast routing for multimedia communication," *IEEE/ACM Transactions on Networking*, vol. 1, pp. 286–292, 1993.

- [78] R. Widyono, "The design and evaluation of routing algorithms for real-time channels," *International Computer Science Institute, Technical Report TR-94-024*, 1994.
- [79] Q. Zhu, M. Parsa, and J. J. Garcia-Luna-Aceves, "A source-based algorithm for delay-constrained minimum-cost multicasting," in *Proceedings of the Fourteenth Annual Joint Conference of the IEEE Computer and Communication Societies (Vol. 1)-Volume - Volume 1*, INFOCOM '95, pp. 377–385, IEEE Computer Society, 1995.
- [80] Q. Sun and H. Langendörfer, "Efficient Multicast Routing for Delay-Sensitive Applications," in *in Proc. Second Workshop on Protocols for Multimedia Systems (PROMS)*, pp. 452–458, 1995.
- [81] Q. Sun and H. Langendörfer, "An efficient delay-constrained multicast routing algorithm," *J. High Speed Netw.*, vol. 7, pp. 43–55, Jan. 1998.
- [82] L. Guo and I. Matta, "QDMR: An Efficient QoS Dependent Multicast Routing Algorithm," in *Proceeding of 5th IEEE realtime technology and application symposium (RTAS) '99*, pp. 213–222, 1998.
- [83] L. Zhou, W. xiong Ding, and Y. xi Zhu, "Delay-Constrained Multicast Routing Algorithm Based on Average Distance Heuristic," *Computer networks and Communications*, vol. 2, pp. 155–162, 2010.
- [84] H. F. Salama, D. S. Reeves, and Y. Viniotis, "Evaluation of multicast routing algorithms for real-time communication on high-speed networks," *Selected Areas in Communications, IEEE Journal on*, vol. 15, no. 3, pp. 332–345, 1997.
- [85] B. C. J. Wang, "Efficient routing and wavelength assignment for multicast in WDM networks," *IEEE Journal on Selected Areas in Communications*, vol. 20, 2002.
- [86] R. Libeskind-Hadas, "Efficient collective communication in WDM networks with a power budget," in *Computer Communications and Networks, 2000. Proceedings. Ninth International Conference on*, pp. 612–616, 2000.
- [87] S. Yan and J. Deogun, "Multi-drop path model for multicast routing and wavelength assignment," *Information Sciences*, vol. 149, no. 1, pp. 113–134, 2003.
- [88] S. Yan, M. Ali, and J. Deogun, "Route optimization of multicast session in sparse light-splitting optical networks," *IEEE GLOBECOM*, vol. 4, pp. 2134–2138, 2001.
- [89] A. Zsigri, A. Guitton, and M. Molnar, "Construction of light-trees for WDM multicasting under splitting capability constraints," in *Telecommunications, 2003. ICT 2003. 10th International Conference on*, vol. 1, pp. 171–175, IEEE, 2003.
- [90] F. Zhou, M. Molnár, and B. Cousin, "Avoidance of multicast incapable branching nodes for multicast routing in WDM networks," *Photonic Network Communications*, vol. 18, pp. 709–714, 2008.

- [91] F. Zhou, M. Molnár, and B. Cousin, "Is light-tree structure optimal for multicast routing in sparse light splitting WDM networks?," *IEEE International Conference on Computer Communications and Networks (ICCCN'09)*, vol. 18, pp. 1–7, Aug 2009.
- [92] F. Zhou, M. Molnár, and B. Cousin, "Distance priority based multicast routing in WDM networks considering sparse light splitting," *IEEE Singapore International Conference on Communication Systems*, vol. 18, pp. 378–392, 2009.
- [93] O. Yu and Y. Cao, "Mathematical formulation of optical multicast with loss-balanced light-forest," in *Global Telecommunications Conference, 2005. GLOBECOM '05. IEEE*, vol. 4, pp. 1968–1972, Dec 2005.
- [94] M.-T. Chen, B. M. Lin, and S.-S. Tseng, "Multicast routing and wavelength assignment with delay constraints in WDM networks with heterogeneous capabilities," *Journal of Network and Computer Applications*, vol. 31, no. 1, pp. 47–65, 2008.
- [95] C. Constantinou and G. Ellinas, "A heuristic algorithm for multicast routing in sparse-splitting optical WDM networks," in *Optical Network Design and Modeling (ONDM), 2013 17th International Conference on*, pp. 65–69, April 2013.
- [96] N. Sreenath, N. Krishna Mohan Reddy, G. Mohan, and C. Murthy, "Virtual source based multicast routing in WDM networks with sparse light splitting," in *High Performance Switching and Routing, 2001 IEEE Workshop on*, pp. 141–145, 2001.
- [97] A. Ballardie, "Core Based Trees (CBT) Multicast Routing Architecture," RFC 2201, Internet Engineering Task Force, Sept. 1997.
- [98] D.-N. Yang and W. Liao, "Design of light-tree based logical topologies for multicast streams in wavelength routed optical networks," in *INFOCOM 2003. Twenty-Second Annual Joint Conference of the IEEE Computer and Communications. IEEE Societies*, vol. 1, pp. 32–41, March 2003.
- [99] T. Mannan and B. Wang, "Dynamic Multicast Session Provisioning in WDM Optical Networks with Sparse Splitting Capability," *Photonic Network Communications*, vol. 12, no. 1, pp. 5–13, 2006.
- [100] Y. Zhou and G.-S. Poo, "Optical multicast over wavelength-routed WDM networks: A survey," *Optical Switching and Networking*, vol. 2, pp. 176–197, 2005.
- [101] X.-H. Jia, D.-Z. Du, X.-D. Hu, M.-K. Lee, and J. Gu, "Optimization of wavelength assignment for QoS multicast in WDM networks," *Communications, IEEE Transactions on*, vol. 49, no. 2, pp. 341–350, 2001.
- [102] D. W. Matula, G. Marble, and J. D. Isaacson, "Graph Coloring Algorithms," *Graph Theory and Computing*, pp. 109–122, 1972.

- [103] D. W. Matula and L. L. Beck, "Smallest-last Ordering and Clustering and Graph Coloring Algorithms," *ACM*, vol. 30, pp. 417–427, July 1983.
- [104] S. Yan and J. Deogun, "Multicast wavelength routing and assignment under multi-drop path model," in *Communications, 2003. ICC '03. IEEE International Conference on*, vol. 2, pp. 1453–1457, May 2003.
- [105] W. Huang, L. Tang, M. Razo, A. Sivasankaran, M. Tacca, and A. Fumagalli, "Routing and wavelength assignment computed jointly for a given set of multicast trees reduces the total wavelength conversion," in *Transparent Optical Networks (ICTON), 2010 12th International Conference on*, pp. 1–5, June 2010.
- [106] L. Tang, W. Huang, M. Razo, A. Sivasankaran, P. Monti, M. Tacca, and A. Fumagalli, "Computing alternate multicast trees with maximum latency guarantee," in *High Performance Switching and Routing (HPSR), 2010 International Conference on*, pp. 82–87, June 2010.
- [107] D. D. Le, M. Molnár, and J. Palaysi, "Performance Analysis of All-Optical Multicast Routing Algorithms with Sparse Splitting," tech. rep., LIRMM, University Montpellier 2, France, <http://hal-lirmm.crsd.cnrs.fr/lirmm-00737121>, Oct. 2012.
- [108] K. Mehlhorn and S. Naeher, "LEDA- A Library of Efficient Data Types and Algorithms," Nov. 2010.
- [109] J. W. J. Williams, "Algorithm 232: Heapsort," *Communications of the ACM*, vol. 7, no. 6, p. 347–348, 1964.
- [110] M. L. Fredman and R. Tarjan, "Fibonacci Heaps And Their Uses In Improved Network Optimization Algorithms," in *Foundations of Computer Science, 1984. 25th Annual Symposium on*, pp. 338–346, Oct 1984.
- [111] D.-N. Yang and W. Liao, "Design of light-tree based logical topologies for multicast streams in wavelength routed optical networks," in *INFOCOM 2003. Twenty-Second Annual Joint Conference of the IEEE Computer and Communications. IEEE Societies*, vol. 1, pp. 32–41 vol.1, March 2003.
- [112] D. D. Le, F. Zhou, and M. Molnar, "Light-hierarchy for Provisioning Multiple Multicast Requests in Sparse Splitting WDM Networks," in *2015 International Conference on Computing, Networking and Communications, Optical and Grid Networking Symposium (ICNC'15 OGN)*, (Anaheim, USA), pp. 847–852, Feb. 2015.
- [113] Infinera, "Lowering Network TCO through Integrated Digital Switching and WDM transport, White Paper, WP-EQ-09-2012," Jun 2012.
- [114] A. K. Pradhan and T. De, "Multicast Traffic Grooming based Light-tree in WDM Mesh Networks," *Procedia Technology*, vol. 10, no. 0, pp. 900 – 909, 2013. First

- International Conference on Computational Intelligence: Modeling Techniques and Applications (CIMTA) 2013.
- [115] F. Zhou, "Multicast provision in transparent optical networks with Mixed Line Rates," in *Optical Network Design and Modeling (ONDM), 2013 17th International Conference on*, pp. 125–130, April 2013.
- [116] S. Harve, M. Batayneh, and B. Mukherjee, "Optimal multicasting in a Multi-Line-Rate Ethernet-over-WDM network," in *Communications and Photonics Conference and Exhibition (ACP), 2009 Asia*, vol. 2009-Supplement, pp. 1–4, Nov 2009.
- [117] A. Nag, M. Tornatore, and B. Mukherjee, "Optical Network Design With Mixed Line Rates and Multiple Modulation Formats," *Lightwave Technology, Journal of*, vol. 28, pp. 466–475, Feb 2010.
- [118] S. Ferdousi, A. Nag, A. S. Reaz, M. Tornatore, and B. Mukherjee, "Mixed-line-rate optical network design with wavebanding," *Optical Switching and Networking*, vol. 9, no. 4, pp. 286–296, 2012.
- [119] X. Liu, L. Gong, and Z. Zhu, "On the Spectrum-Efficient Overlay Multicast in Elastic Optical Networks Built with Multicast-Incapable Switches," *Communications Letters, IEEE*, vol. 17, pp. 1860–1863, September 2013.
- [120] R. Cardillo, V. Curri, and M. Mellia, "Considering transmission impairments in wavelength routed networks," in *Optical Network Design and Modeling, 2005. Conference on*, pp. 421–429, Feb 2005.
- [121] J. He, M. Brandt-Pearce, Y. Pointurier, and S. Subramaniam, "QoT-Aware Routing in Impairment-Constrained Optical Networks," in *Global Telecommunications Conference*, pp. 2269–2274, IEEE, 2007.
- [122] J. Zhao, W. Li, X. Liu, W. Zhao, and M. Maier, "Physical Layer Impairment (PLI)-Aware RWA Algorithm Based on a Bidimensional QoS Framework," *Communications Letters, IEEE*, vol. 17, pp. 1280–1283, June 2013.
- [123] M. Molnár, A. Bellabas, and S. Lahoud, "The cost optimal solution of the multi-constrained multicast routing problem," *Computer Networks*, vol. 56, no. 13, pp. 3136 – 3149, 2012. Challenges in High-Performance Switching and Routing in the Future Internet.
- [124] J.-W. Park and J. Kim, "QoS-driven multicast routing in sparse-splitting optical networks," *Photonic Network Communications*, vol. 25, no. 3, pp. 178–188, 2013.
- [125] S. Ricciardi, F. Palmieri, U. Fiore, D. Careglio, G. Santos-Boada, and J. Solé-Pareta, "An energy-aware dynamic rwa framework for next-generation wavelength-routed networks," *Computer Networks*, vol. 56, no. 10, pp. 2420–2442, 2012.

- [126] X.-D. Hu, T.-P. Shuai, X. Jia, and M.-Z. Zhang, "Multicast routing and wavelength assignment in WDM networks with limited drop-offs," in *INFOCOM 2004. Twenty-third Annual Joint Conference of the IEEE Computer and Communications Societies*, vol. 1, pp. 487–494, March 2004.
- [127] F. Idzikowski, E. Bonetto, L. Chiaraviglio, A. Cianfrani, A. Coiro, R. Duque, F. Jiménez, E. Le Rouzic, F. Musumeci, W. Van Heddeghem, J. López Vizcaíno, and Y. Ye, "TREND in energy-aware adaptive routing solutions," *Communications Magazine, IEEE*, vol. 51, pp. 94–104, November 2013.
- [128] S. Du, S. Zhang, Y. Peng, and K. Long, "Power-efficient RWA in dynamic WDM optical networks considering different connection holding times," *Science China Information Sciences*, vol. 56, no. 4, pp. 1–9, 2013.
- [129] K. Manousakis, A. Angeletou, and E. Varvarigos, "Energy efficient RWA strategies for WDM optical networks," *Optical Communications and Networking, IEEE/OSA Journal of*, vol. 5, pp. 338–348, April 2013.