



HAL
open science

Scheduling policies considering both production duration and energy consumption criteria for environmental management

Firas Abdulmajeed Al-Qaseer

► **To cite this version:**

Firas Abdulmajeed Al-Qaseer. Scheduling policies considering both production duration and energy consumption criteria for environmental management. Environmental Engineering. Université Clermont Auvergne [2017-2020], 2018. English. NNT: 2018CLFAC028 . tel-02058816

HAL Id: tel-02058816

<https://theses.hal.science/tel-02058816>

Submitted on 6 Mar 2019

HAL is a multi-disciplinary open access archive for the deposit and dissemination of scientific research documents, whether they are published or not. The documents may come from teaching and research institutions in France or abroad, or from public or private research centers.

L'archive ouverte pluridisciplinaire **HAL**, est destinée au dépôt et à la diffusion de documents scientifiques de niveau recherche, publiés ou non, émanant des établissements d'enseignement et de recherche français ou étrangers, des laboratoires publics ou privés.

UNIVERSITE CLERMONT AUVERGNE

ECOLE DOCTORALE SCIENCES POUR L'INGENIEUR

**Scheduling Policies Considering both Production
Duration and Energy Consumption Criteria for
Environmental Management**

By

AL-QASEER FIRAS ABDULMAJEED

Supervised by

Professor GIEN DENIS

**Pour Obtenir le Grade de
DOCTEUR D'UNIVERSITE CLERMONT AUVERGNE
SPECIALITE : INFORMATIQUE
(Génie Industriel et Environnement Management)**

Soutenue publiquement le 15 novembre 2018

JURY

Nikolay TCHERNEV	(PU Université Clermont Auvergne)	Président
Alice YALAOUI	(MdC HdR UTT)	Rapporteur
Aline CAUVIN	(MdC HdR Polytech Marseille)	Rapporteur
Denis GIEN	(PU Sigma Clermont)	Directeur de thèse
Henri PIERREVAL	(PU Sigma Clermont)	Invité

Acknowledgements

I would like to thank my Supervisor

Professor

GIEN DENIS

for having accepted me, and for his follow-up, his orientations and his precious advices, and who knew how to make me profit from his great experience

I would like to thank The Ministry of Higher Education and Scientific Research of Iraq and the University of Technology (Baghdad)

Dedication

To my mother who sacrificed herself to give us a better life.

To my father who has always supported me.

To my wife for her patience

To my children

To my brothers and sisters,

To all my family

To all my friends

I dedicate this work

Table of Contents

Number	Name	Page
Abstract		7
Résumé		10
Published papers in international journal and conferences		14
1.	Environment Management and industry	15
	1.1 Introduction	16
	1.2 ISO 14000	17
	1.3 Cleaner production	20
	1.4 Green Manufacturing	22
	1.5 Life cycle assessment	23
	1.6 Sustainable Manufacturing	26
	1.7 Structure of thesis	28
2	Energy consumption in manufacturing systems	29
	2.1 Introduction	30
	2.2 Energy and Climate Change	32
	2.2.1 Energy sector and CO2 emissions	32
	2.3 Energy in manufacturing systems	36
	2.4 Electrical Energy Demand of Machine Tools	38
	2.5 Energy Efficiency	41
	2.5.1 Energy Efficiency process planning	43
	2.5.2 Energy Efficiency production scheduling	43
3	A Genetic Algorithm Energy Optimization	45
	3.1 Introduction	46
	3.2 Background and motivation	47
	3.3 Job Shop scheduling	51
	3.4 Energy consumption model	55
	3.5 Single population multi objectives Genetic algorithm energy job shop scheduling	59
	3.6 Multi population multi objectives Genetic algorithm energy job shop scheduling MPGE1	59
	3.6.1 MPGE1	60
	3.6.2 Initial Population	61
	3.6.3 Chromosomes Crossover	65
	3.6.4 Mutation operator	65
	3.6.5 Fitness function	66
	3.7 Multi population multi objectives Genetic algorithm energy job shop scheduling MPGE2	69
	3.7.1 Initial Population	70
	3.7.2 Crossover Strategy	71
	3.7.3 Mutation operator	72
	3.7.4 Threshold operation	72
	3.7.5 Elite strategy	74
3.8 Case study and concoction	76	

Number	Name	Page
4	Mixed Integer and Linear constraint programming Job Shop Energy Optimization MILCE	83
4.1	Introduction	84
4.2	Development environment	84
4.2.1	Constraint Programming	84
4.2.2	Linear Programming	84
4.2.3	Mixed Integer Programming MIP	86
4.2.4	Mixed Integer and Constraint Programming	86
4.2.4.1	Branch and Bound	86
4.2.4.2	Branch and cut	87
4.2.4.3	Strong Branching	88
4.2.5	ILOG CPLEX	88
4.3	Mathematical model, constraints and objectives	89
4.3.1	Job shop	89
4.3.2	Energy consumption	91
4.4	Minimize Energy Constrain Programming ECP	93
4.5	A Mixed Integer Linear Programming Minimized Energy MILPE	96
4.5.1	Classification trees	97
4.5.1.1	Jobs-Operations-Machines trees (J-O-M)	98
4.5.1.2	Machines-Operations-Jobs trees (M-O-J)	107
4.5.2	Lower and Upper bound limits	117
4.5.3	Local Lower and Upper bound limits	118
4.5.4	Branching	120
4.5.5	Left shift	122
4.5.6	Turn on/off or standby to reduce total energy	123
4.6	Case study and Conclusions	126
5	Case study, conclusion and future work	128
5.1	Summary of the research	129
5.1.1	Work Environment Development	129
5.1.2	Job shop problems types	132
5.2	Results and Conclusion	132
5.3	Future works	136
	References	138

List of Figures

Number	Name	Page
1-1	Model and relationship ISO System	18
1-2	Framework of Clean Production	21
1-3	History of Green Manufacturing	22
1-4	Green Manufacturing Activities	23
1-5	Product life cycle	24
1-6	Sustainable Manufacturing	26
1-7	Sustainable system	27
1-8	Theses constriction	28
2-1	Growing gap between energy supply and demand	30
2-2	Energy environment impacts	30
2-3	Total energy production	31
2-4	Total energy development	31
2-5	Greenhouse gas emissions	33
2-6	GHG emissions per unit of electricity generated from the different full life cycle electricity generation	34
2-7	Energy consumption at different in enterprise levels	36
2-8	Consuming energy at different machine parts	38
2-9	Classification of energy types in machine tools	39
2-10	Energy consumption models during operation (zooming in of an operation at a machine)	40
2-11	Energy consumption during operation states	40
2-12	Energy Efficiency levels in industrial plants	42
2-13	An example of process planning systems	43
3-1	Illustration of computation of C_m and W_t	53
3-2	Example of constraints between two jobs	54
3-3	Energy model of job shop	55
3-4	Idle time during machine operation	57
3-5	Sampled energy consumption model	57
3-6	Initial population of the chromosomes	61
3-7	First generation parents	64
3-8	Crossover Processing	65
3-9	Mutation Processing	65
3-10	MPGE1 Genetic algorithm energy job shop	67
3-11	Total work load reduction (job shop problem 4×4)	68
3-12	Total energy reduction (job shop problem 4×4)	68
3-13	Makspan reduction (job shop problem 4 × 4)	68
3-14	AvR_1 reduction (job shop problem 4×4)	68
3-15	MPGA2 flow chart	70
3-16	First initial chromosomes	71
3-17	Crossover operation	72
3-18	Mutation operation	72
3-19	Threshold operation	73
3-20	Adaptation of a solution by using Threshold operation	74
3-21	Elitism strategy	74

Number	Name	Page
3-22	Effect of Threshold operation and Elite strategy for MPGA2	75
3-23	Makespan % reduction	80
3-24	Total energy % reduction	81
3-25	Total energy and makespan of Job shop problem 6×6 n=4	81
4-1	Linear programming	85
4-2	Branch-bound method	87
4-3	Total possible solution	89
4-4	Time and energy objectives and constraint (objectives and constraint's map)	95
4-5	Rout solution	96
4-6	MILP and CP flow chart	97
4-7	Jobs-operations-machines relationship (roots-levels-nods)	98
4-8	Explain the machine subset	99
4-9	Processing energy jobs-operations-machines tree (E-J-O-M)	106
4-10	Processing time jobs-operations-machines tree(T-J-O-M)	107
4-11	Machines-Operations-Jobs relationship (roots-levels-nods)	107
4-12	Explain the jobs subset	108
4-13	Processing energy machines-operations-jobs tree(E-M-O-J)	115
4-14	Processing time machines-operations-jobs tree(T-M-O-J)	115
4-15	An example of different trees methods	116
4-16	Local boundary limits	120
4-17	Branching method of a machine	120
4-18	MILP and CP concerned with B&B machine operation energy	121
4-19	Solving scheduling problem by MILEP	121
4-20	Job shop scheduling S before left shit of operation	122
4-21	job shop scheduling after left shit of operation	122
4-22	Turn on – off or standby operation	123
4-23	Power consumed relationship during machine operation cycle	124
4-24	scheduling problems 12x12 (number of operations n=6)	127
5-1	development steps	129
5-2	MPGA1 general structure	130
5-3	MPGA1 general structure	131
5-4	MILP general structure	131
5-5	job shop problem 6x6 instance 6 operations	133
5-6	job shop problem 6x6 instance 12 operations	133
5-7	Total work load and total energy (12x12x12 job shop problem)	134
5-8	Cmax and total energy (12x12x12 job shop problem)	134
5-9	Total idle time and total idle energy (12x12x12 job shop problem)	134
5-10	Multi populations related with one job operation	137

List of Tables

Number	Name	Page
1-1	ISO system types and objectives	18
2-1	Greenhouse gas emissions	33
2-2	Greenhouse gas emissions of energy sectors M ton	34
2-3	Global environmental impact of energy	35
3-1	Global minimum time assignment selection	61
3-2	Processing time (operations set)	63
3-3	Processing energy (operation set)	63
3-4	Global processing time assignment	64
3-5	Global processing energy assignment	64
3-6	Results of the examination the <i>MGEJI</i> of several problems of scheduling problems	69
3-7	Global minimum time assignment selection	71
3-8	Result of <i>MPGA2</i>	76
3-9	Operation time $T_{p\ m,j,n}$ to $O_{m,j,n}$ (number of operations of jobs =5)	77
3-10	Machine electricity characteristics	78
3-11	Operation power $p_{p\ m,j,n}$ to $O_{m,j,n}$ (number of operations of jobs =5)	78
3-12	Summaries of all genetic algorithms	82
4-1	Processing energy of problem (3*3)	100
4-2	Processing time of problem (3*3)	100
4-3	Sorting the machine according processing energy	101
4-4	Assigning the operation according to m machine, j job, and n operation	102
4-5	Determine the decision factor $h1_{E_{m,j,n}}$ to the operation of jobs	103
4-6	Sorting machines according processing time	104
4-7	Assigning the operation according to m machine, j job, and n operation, and determine decision factor $h1_{t_{m,j,n}}$ to the operation $O_{j,n}$ of jobs J_j	105
4-8	Sorting the job in subset according to processing energy	110
4-9	Assigning the operation according to m machine, j job, and n operation	111
4-10	Determine $h2_{E_{j,j}}$ of each operation	112
4-11	Sorting the job according to their processing time	113
4-12	Assigning the operation according to m machine, j job, and n operation, and processing time decision factor $h2_{t_{m,j,n}}$ to each operation	114
4-13	Values of $h1_{E_{m,j,n}}$, $h1_{t_{m,j,n}}$, $h2_{E_{m,j,n}}$, $h2_{t_{m,j,n}}$, $D1_{m,j,n}$, $D2_{m,j,n}$ and $Dr_{m,j,n}$ $\alpha = 0.5$, $\varphi = 0.5$	117
5-1	Comparing between all optimization methods	135

Abstract:

Since the Industrial Revolution until 1960s, economists were looking of the environment as an inexhaustible source of raw materials and energy sources, and were considering that industry had no negative impact on the environment. However, it was accompanied by strong needs in energy and materials and has led to high waste and high emissions from production activities and energy plants. The rate of greenhouse gases emission has increased by 70% (between 1970 and 2004), which has caused climate change.

After many years, Stockholm Conference, held in 1972 under the auspices of the United Nations, was the most important international meeting to discuss the environmental risks posed by the industry and the impact of industry on the environment. The states have expressed strong concerns over the urgency of closing the significant gap between the global effects of the parties' mitigation commitments in terms of annual global greenhouse gas emissions up to 2020. The evolution of global emissions was aimed compatible with the prospect of containing the increase in the average temperature of the planet significantly below 2° c compared to pre-industrial levels and to continue the action taken to limit the rise in temperatures at 1.5° c.

The motivations of companies to place the environment in their policies can be of several types:

- compliance with regulations,
- saving money by reducing the consumption of energy and resources, and reducing environmental taxes imposed on companies,
- improving relations with local people (for polluting companies and emission of CO₂),
- enhancing corporate image for the companies' clients supported by environmental standards or ecolabel marks.

Over the past 50 years, energy consumption by the industrial sector has more than doubled and the industry currently consumes about half of the energy in the world. The energy consumption is a very important cost component for manufacturing companies. At the same time, costs for energy have increased by almost 70% since the late 1990s. Today manufacturing companies and enterprise face the challenge of raising energy environmentally impacts and their CO₂ gaze emissions and economic energy prices.

Most of the work on reducing manufacturing energy consumption today focuses on the need to improve the efficiency of resources. Companies largely ignore the possibility of system-wide power reduction where the operational method can be used as an energy-saving approach. Indeed corporate responsibility for this problem could be involved to improve the solutions to this major problem.

In industrial sector, four methods are used to reduce energy. The first consists in designing more efficient machines that consume less energy. The second is eco-design to modify the product and its life cycle in order to reduce the whole impact. The third is eco-manufacturing to modify manufacturing processes. Finally, the production lines may be adjusted to get better efficiency in job shop scheduling problem. The first three methods seem to be strategically interesting, but they revealed too expensive, and the impact of such a decision is minimal, especially for small and medium-sized industries that can have a limited budget. Finally, it is on the last point that many improvements can be done in order to obtain relevant results, responding to the industrial expectations.

Generally, industrial job shop problems minimize criteria such as the makespan, the cost, and other objective and satisfying various scheduling constraints. Up to now, a few researchers studied the

energy consumption as an important objective functions in job shop scheduling, but they remain to reduce energy only by reducing total work time load and reducing idle time.

From previous research and studies, energy reduction was done indirectly by reducing the time required to accomplish the work and the waiting time (idle time). In this thesis, we consider to minimize energy directly through reducing operation (processing) and setup energy. Since all previous research and studies have taken into account the time effect on energy reducing, assuming that operation power is constant at machine when operating the different jobs. Therefore they have considered that only the processing time, with additionally the idle time between operations, impacts the needed energy. We agree with them about the great impact of processing and idle time on energy, but we also take into account the direct impact of specific process energy itself. Actually, the process power to operate the jobs is not static but dynamically depends on the process and the machine operating the job. However, in our optimisation methods, we have multi populations, that represent processing energy, processing time, setup energy, and setup time, where each operator has different energy value, and different setup energy.

We optimize total energy consumption for optimum job shop scheduling minimizing the following criteria:

- a) processing energy and processing time,
- b) setup energy and setup time,
- c) maximum makespan and total non-processing time (idle time).

Mathematical models are proposed for multi-objective genetic algorithms to solve job shop scheduling optimisation problems. For a bi-objective problem, we generate two populations, one to minimise the total energy consumption and the other to minimise the total workload time. For a tri-objective problem, we generate three populations to minimise respectively total electricity consumption, total non-processing time (idle time), and total setup time.

This thesis consists in five chapters as following:-

1. Chapter one presents a general introduction to environmental management systems, and their concepts tools, such as concept of ISO 14000 standard, cleaner production, green manufacturing, Life Cycle Assessment, and Sustainable Manufacturing.
2. Chapter two addresses energy problem in manufacturing system, energy efficiency principles and methods are discussed. Effect of energy and climate change, energy consumed in various enterprise sectors, and energy efficiency techniques are described.
3. In chapter three, we propose a multi objectives genetic algorithm with bi-populations to reduce total processing energy consumption with minimized makespan and idle time. To solve multi objectives-multi populations we use two types of genetic algorithms: traditional with two chromosomes each chromosome representing a population and parallel genetic algorithms with two sub-genetic algorithms, each of them representing a population. These genetic algorithms could solve small and medium job shop problems with only the effects of processing energy and processing time, because we assumed that setup time and energy as parts of processing energy and time to simplify the solution. The genetic algorithms are developed using MATLAB GA tools.

4. In chapter four; we propose constraint programming and mixed Integer linear programming to improve energy job shop scheduling. By way of mixed integer linear programming, we can solve larger problems. The problem in chapter three is extended by energy reducing with setup time effects and by modifying the traditional job shop constraints with two new constraints: left shift and turn off/standby unused machines. For this problem, we propose a nonlinear program, its linearization and we illustrate its resolution according to the different parameters with the CPLEX solver.

5. Chapter five; is a case study, where all optimizations methods are tested with different scheduling problems (3×3) up to (12×12) problems also at different jobs size (number of operations of job). The result of all optimization methods are compared and discussed, to evaluate these methods and to test their capability and efficiency to solve different job shop scheduling problems. So we determine which method is more appropriated according to problem sizes or job sizes and we can conclude and foresee future work.

Résumé:

Depuis la révolution industrielle jusqu'aux années 1960, les économistes considéraient l'environnement comme une source inépuisable de matières premières et d'énergie. Par conséquent, cette période a été marquée par un accroissement des besoins en énergie et en matériaux et a conduit à une augmentation des déchets et des émissions provenant des activités de production et des centrales énergétiques. Le taux d'émission de gaz à effet de serre a augmenté de 70% (entre 1970 et 2004), ce qui a provoqué des changements climatiques.

Après plusieurs années, la Conférence de Stockholm, tenue en 1972 sous les auspices des Nations Unies, a été la réunion internationale la plus importante pour discuter des risques environnementaux posés par l'industrie et de l'impact des activités humaines sur l'environnement. Les États ont exprimé de vives inquiétudes quant à l'urgence de combler l'écart important entre les engagements d'atténuation des parties en termes d'émissions annuelles mondiales de gaz à effet de serre jusqu'en 2020 et les effets attendus sur le changement climatique. L'évolution des émissions globales était compatible avec la perspective de contenir l'augmentation de la température moyenne de la planète significativement inférieure à 2 ° C par rapport aux niveaux préindustriels et de poursuivre les actions menées pour limiter la hausse des températures à 1,5 °C.

Les motivations des entreprises à placer l'environnement dans leurs politiques peuvent être de plusieurs types:

- conformité à la réglementation.
- économiser de l'argent en réduisant la consommation d'énergie et de ressources et en réduisant les taxes environnementales imposées aux entreprises.
- améliorer les relations avec les populations locales (pour les entreprises polluantes et les émissions de CO₂).
- améliorer l'image de l'entreprise pour les clients des entreprises, soutenue par des normes environnementales ou des marques d'écolabel.

Au cours des 50 dernières années, la consommation d'énergie du secteur industriel a plus que doublé et l'industrie consomme actuellement environ la moitié de l'énergie dans le monde. La consommation d'énergie est un élément de coût très important pour les entreprises manufacturières. Dans le même temps, les coûts de l'énergie ont augmenté de près de 70% depuis la fin des années 1990. Aujourd'hui, les entreprises manufacturières et les industries sont confrontées au défi d'augmenter les impacts environnementaux énergétiques et leurs émissions de CO₂ et les coûts de l'énergie économique.

De nombreux travaux sur la réduction de la consommation d'énergie dans le secteur manufacturier se concentrent aujourd'hui sur la nécessité d'améliorer l'efficacité des ressources. Les entreprises ignorent en grande partie la possibilité d'une réduction de la puissance à l'échelle du système en optimisant l'ordonnancement instituant ainsi une approche d'économie d'énergie. La responsabilité des entreprises sur ce problème pourrait être encouragée pour améliorer leur impact énergétique.

Dans le secteur industriel, quatre méthodes sont utilisées pour réduire la consommation d'énergie :

- La première consiste à concevoir des machines plus efficaces et moins gourmandes en énergie.
- La seconde est l'introduction de l'écoconception en modifiant le produit et son cycle de vie afin de réduire l'impact global.
- La troisième est l'éco-fabrication pour modifier les processus de fabrication.
- Enfin, les lignes de production peuvent être ajustées pour obtenir une meilleure efficacité énergétique en agissant sur l'ordonnancement des ateliers.

Les trois premières méthodes semblent être stratégiquement intéressantes, mais elles se révèlent trop coûteuses, et l'impact d'une telle décision est minime, en particulier pour les petites et moyennes industries qui peuvent avoir un budget limité. Finalement, c'est sur le dernier point que de nombreuses améliorations peuvent être apportées afin d'obtenir des résultats pertinents, répondant aux attentes de l'industrie.

Généralement, les problèmes de job shop minimisent des critères tels que la durée totale de fabrication, le coût et d'autres performances objectives. Jusqu'à maintenant, quelques chercheurs ont étudié la consommation d'énergie en tant qu'objectif important dans la planification des ateliers, mais ils se contentent de réduire l'énergie en agissant uniquement sur la charge de travail totale et en réduisant le temps d'inactivité.

D'après des recherches et des études antérieures, la réduction de la consommation d'énergie a été réalisée indirectement en réduisant le temps requis pour accomplir le travail et le temps d'attente (temps d'inactivité). Dans cette thèse, nous proposons de minimiser l'énergie en agissant directement sur l'énergie nécessaire à la fabrication et l'énergie requise pour le réglage.

Toutes les recherches et études antérieures ont pris en compte l'effet du temps sur la réduction d'énergie, en supposant que la puissance de fonctionnement de la machine était constante lors de l'exécution des différents travaux. Par conséquent, ils ont considéré que seul le temps de fonctionnement, et le temps d'inactivité entre les opérations, avaient un impact sur l'énergie nécessaire.

Nous sommes d'accord avec eux sur l'impact considérable de la fabrication et des temps morts sur l'énergie, mais nous prenons également en compte l'impact direct de l'énergie spécifique au processus sélectionné. En réalité, la puissance du processus pour faire fonctionner les tâches n'est pas statique mais dépend dynamiquement du processus et de la machine qui exécute le travail. Par conséquent, dans nos méthodes d'optimisation, nous avons plusieurs populations, qui représentent l'énergie et le temps de traitement ainsi que l'énergie et la durée de préparation, chaque opération ayant des valeurs différentes pour ces quatre paramètres.

Dans cette thèse, nous développons des méthodes d'optimisation multicritère, en utilisant un algorithme génétique multi-population ou la programmation linéaire mixte. Nous évoquerons enfin l'introduction de la logique floue pour traiter l'imprécision de l'information sans développer ce point.

Nous optimisons la consommation d'énergie totale pour une planification optimale des ateliers en minimisant les critères suivants:

- a) Energie consommée et durée de fabrication,
- b) énergie consommée et durée de préparation,
- c) durée de fabrication maximale et temps durée totale des opérations non productives

Des modèles mathématiques d'optimisation multicritère de l'ordonnancement des ateliers sont proposés pour modéliser les durées de fabrication et les consommations d'énergie en vue de la résolution par des algorithmes génétiques.

Pour un problème bi-objectif, nous générons deux populations, l'une pour minimiser la consommation d'énergie totale et l'autre pour minimiser le poids total.

Pour un problème tri-objectif, nous générons trois populations afin de minimiser respectivement la consommation totale d'électricité, le temps d'inactivité total et le temps de préparation total.

Les modèles mathématiques sur ensuite sensiblement modifiés en vue de la résolution par des algorithmes de programmation linéaire mixte.

Cette thèse se compose de cinq chapitres comme suit (comme le montre la figure ci-dessous): -

1. Le chapitre un présente une introduction générale aux systèmes de gestion environnementale et à leurs outils conceptuels, tels que le concept de la norme ISO 14000, la production propre, la fabrication écologique, l'analyse du cycle de vie et la fabrication durable.
2. Le chapitre deux aborde le problème de l'énergie dans les systèmes de production, les principes et les méthodes d'efficacité énergétique sont discutés. Les effets de l'énergie et du changement climatique, l'énergie consommée dans divers secteurs d'entreprises et les techniques d'efficacité énergétique sont décrits.
3. Dans le troisième chapitre, nous proposons un algorithme génétique multicritère avec deux populations pour réduire la consommation totale d'énergie de fabrication et la durée totale de production. Pour résoudre ce problème nous utilisons deux types d'algorithmes génétiques, d'une part un algorithme traditionnel avec deux chromosomes chaque chromosome représentant une population, d'autre part des algorithmes génétiques parallèles avec deux algorithmes sous-génétiques, chacun d'eux représentant une population. Ces algorithmes génétiques pourraient résoudre les problèmes de petites et moyennes tailles avec les effets seuls critères d'énergie et de temps de production, car nous y avons intégré le temps et l'énergie de préparation. Les algorithmes génétiques sont développés à l'aide des outils MATLAB GA.
4. Au chapitre quatre; Nous proposons le recours à un algorithme de programmation linéaire par contraintes mixte pour améliorer l'ordonnancement multicritère des ateliers. Grâce à la programmation linéaire mixte, nous pouvons résoudre des problèmes plus importants. Le modèle du chapitre trois est complété avec réduction de l'énergie et de la durée de préparation. Nous pouvons modifier le problème traditionnel d'ordonnancement d'atelier avec deux nouvelles possibilité : le décalage à gauche et l'arrêt des machines inactives. Pour ce problème, nous proposons un programme non linéaire, sa linéarisation et nous illustrons sa résolution en fonction des différents paramètres avec le solveur CPLEX.
5. Le chapitre cinq; est une étude de cas, où toutes les méthodes d'optimisation sont testées avec différents problèmes d'ordonnancement de (3×3) jusqu'à (12×12) et aussi à différentes tailles de travaux (nombre d'opérations par travail). Le résultat de toutes les méthodes d'optimisation est comparé et discuté, pour évaluer ces méthodes et pour tester leur capacité et leur efficacité à résoudre différents problèmes de planification d'atelier. Nous déterminons donc quelle méthode est la plus appropriée en fonction de la taille des problèmes ou de la taille des travaux et nous pouvons conclure et proposer des pistes pour poursuivre nos travaux.

This thesis took place in the Laboratory of Computer Science, Modelling and Optimization of Systems (LIMOS Laboratoire d'Informatique de Modélisation et d'Optimisation des Systèmes) University of Clermont Auvergne, France.

The work was performed at Sigma Clermont (a Unique Alliance between Advance Mechanics and Chemistry), Great School of Engineering.

By

AL-QASEER FIRAS ABDULMAJEED

Supervised by

Professor GIEN DENIS

Published papers in international journals and conferences:-

1. AL-QASEER F., GIEN D. (2015). *A multi-objective genetic method minimizing tardiness and energy consumption during idle times*, 15th IFAC Symposium on Information Control Problems in Manufacturing, INCOM'15; IFAC-PapersOnLine, Volume 48, Issue 3, 2015, pp. 1216-1223.
2. AL-QASEER F., LOUATI A., GIEN D., ELKOSANTINI, S. (2016). *Nonlinear Programming CPLEX/ILOG Optimization Job shop Energy Consumption*, 4th International Conference on Innovation & Engineering Management (IEM 2016), 20-21 march 2016, 6 p., Hammamet, Tunisie.
3. AL-QASEER F. GIEN D. (2016). *A Fuzzy GA Energy Optimization for Flexible Job Shop Scheduling*, 4th International Conference on Innovation & Engineering Management (IEM 2016), 20-21 march 2016, 9 p., Hammamet, Tunisie.
4. AL-QASEER F. GIEN D. (2016). *A Machines Location and Job shop Scheduling Multi Objectives Energy GA Optimization*, 6th International Conference on Sustainable Energy Information Technology (SEIT 2016), 23-26 May 2016, 5p., Madrid, Spain.
5. AL-QASEER F., GIEN D. (2017). *Allocation of Machines and Job shop Scheduling Energy GA Optimization*, 12th International Conference on Industrial Engineering (CIGI 2017), 3-5 May 2017, 6 p., Compiègne, France
6. Mukattash A., Dahmani N., AL-QASEER F., GIEN D. 2018. *Design of cellular manufacturing systems with the presence of processing time*, 2018 Third International Conference on Electrical and Biomedical Engineering, Clean Energy and Green Computing (EBECEGC) IEEE

Chapter One

Environment Management and industry

Number	Name	Page
1.	Environment Management and industry	15
1.1	Introduction	16
1.2	ISO 14000	17
1.3	Cleaner production	20
1.4	Green Manufacturing	22
1.5	Life cycle assessment	22
1.6	Sustainable Manufacturing	28

1. Environment Management and industry

1.1 Introduction

Economic development is fundamental to the functioning of our society as a driving force for developments. Since the Industrial Revolution until 1960s (Kniivilä M. 2007) Economists were looking to the environment as an inexhaustible source of raw materials and energy sources, and were considering that industry had no negative impact of to the environment However, it was accompanied by strong needs in energy and materials and leads to a high waste production and high emissions from production activities and energy plants. After many years Stockholm Conference, held in 1972 under the auspices of the United Nations, was the most important international meeting to discuss the environmental risks posed by the industry and the impact of industry on the environment.

After the report of Portland in 1987, under the name of “Our Common Future“, which was aimed at the rational uses of resources, the United Nations Conference on Environment and Development (UNCED), at Rio de Janeiro (Brazil) in 1992, has sought to put in place elements of response in a program of large-scale national and global actions based on a socio-economic approach. In this conference the concept of "Sustainable Development" was expressed. Then, 10 years after the first Earth Summit in Rio de Janeiro, followed the World Summit on Sustainable Development, held in Johannesburg in 2002. It was convened to discuss sustainable development by the United Nations to focus the world's attention and direct action toward meeting difficult challenges, including improving people's lives and conserving our natural resources in a world.

- Following these orientations, many aspects have evolved in society, in particular the demand of markets and consumers. Today, a wider range of products can meet technical and environmental requirements, with the emergence of eco-labels as a means of certification. These developments have led companies to develop their points of view and adopt eco-strategies to address different issues:
- Green manufacturing
- Management of energy consumption / energy efficiency
- Use of renewable energies,
- More appropriate end-of-life scenarios, less impacting
- Sustainable development,
- Services durable goods market
- Clean production techniques

Consideration of the environment in everyday life is established as a fact but everyone takes a different view on the preservation of the environment (Brundtland G.H. 1989) according to his training, his mission or his profession (Friend G. 2009).

Because of damage caused by industrial activities, governments and organizations, committed to environmental issues, introduce measures in various forms: Constraints, Standards, Limits, Legislation, Recommendations and Rules. Those measures are aimed at controlling the negative effects of industries, in particular at manufacturing and production levels (Mathieux, F. 2008).

Thus, companies adopt different objectives and strategies according to the priorities of the management or the organization (Janin M., 2000). The areas related to standards vary between “management, quality, product, system, process, measurement, or testing standards”. Many approaches now allow socio-economic actors to face the environmental reality without, however, endangering their economic potential. At the same time, research centres propose technical means and solutions to improve environmental integration in industrial and commercial activities (Haoues N., 2006). They are beginning to develop methods and tools capable of adapting environmental standards and constraints in the product development process via the Eco-Design, (Alhomsy H., 2009)

1.2 ISO 14000

ISO 14000 is an internationally recognized standard that sets the requirements for an environmental management system (ISO 2015). It helps organizations improve their environmental performance through more efficient use of resources and waste reduction. Governments and organizations committed to environmental issues introduce measures in various forms: Constraints, Standards, Limits, Legislation, Recommendations, Rules, etc. (Nishitani K., 2009). ISO 14000 represent a consensus on good practice and state of the art (Finkbeiner M., 2013). Several Standards are proposed to integrate environmental requirements into industrial activities. An environmental management system (EMS) (Kollman K., 2002) is explained in figure 1-1. It is a systematic approach to managing the environmental aspects of an organization. The EMS is a “*tool*” that allows any type of organization, whatever its size (Souza Campos L. M., 2012), to control the impact of its activities, products or services on the environment. EMS helps to situate company operational aspects that have a significant impact on the environment. Set targets of objectives and the goals to mitigate this impact, and develop programs to achieve targets and implement effective, other operational control measures to ensure the implementation of the established environmental policy. The activities of ISO system can be summarized in table 1-1

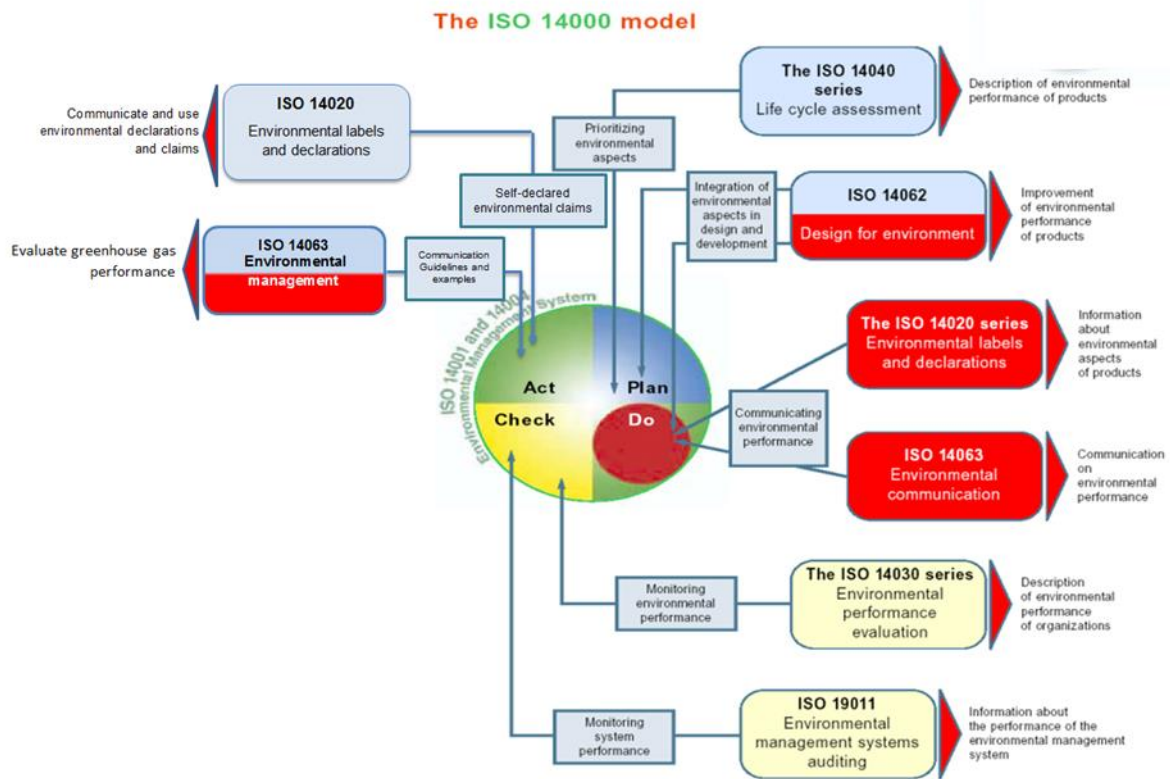

Figure 1-1 Model and relationship of ISO System (ISO, 2002).

Table 1-1 ISO system types and objectives (ISO, 2002-2010).

Plan	Do	Check	Act
Environmental management system implementation	Conduct life cycle assessment and manage environmental aspects	Conduct audits and evaluate environmental performance	Communicate and use environmental declarations and claims
ISO 14050:2009	Vocabulary ISO 14040:2006	ISO 14015:2001	ISO 14020:2000
Environmental management	Environmental management Life cycle assessment Principles and framework	Environmental management Environmental assessment of sites and organizations (EASO)	Environmental labels and declarations General principles
ISO 14001:2004	ISO 14044:2006	ISO 14031:1999	ISO 14021:1999
Environmental management systems Requirements with guidance for use	Environmental management Life cycle assessment Requirements and guidelines	Environmental management Environmental performance evaluation Guidelines	Environmental labels and declarations Self-declared environmental claims (Type II environmental labelling)

plan	Do	Check	Act
ISO 14004:2004 Environmental management systems General guidelines on principles, systems and support techniques	ISO/TR 14047:2003 Environmental management Life cycle impact assessment Examples of application of ISO	14042 ISO 19011:2002 Guidelines for quality and/or environmental management systems auditing ISO	14024:1999 Environmental labels and declarations Type I environmental labelling Principles and procedures
ISO/DIS 14005 Environmental management systems Guidelines for the phased implementation of an environmental management system, including the use of environmental performance evaluation	ISO/TS 14048:2002 Environmental management Life cycle assessment Data documentation format		ISO 14025:2006 Environmental labels and declarations Type III environmental declarations Principles and procedures
			ISO/AWI 14033 Environmental management Quantitative environmental information Guidelines and examples
Address environmental aspects in products and product standards		Evaluate greenhouse gas performance	
plan	Do	Check	Act
ISO Guide 64:2008 Guide for addressing environmental issues in product standards	ISO/TR 14049:2000 Environmental management Life cycle assessment Examples of application of ISO 14041 to goal and scope definition and inventory analysis	ISO 14064-3:2006 Greenhouse gases Part 3 : Specification with guidance for the validation and verification of greenhouse gas assertions	ISO 14063:2006 Environmental management Environmental communication Guidelines and examples
ISO/CD 14006 Environmental management systems Guidelines on eco-design	ISO/CD 14051 Environmental management Material flow cost accounting General principles and framework	ISO 14065:2007 Greenhouse gases Requirements for greenhouse gas validation and verification bodies for use in accreditation or other forms of recognition	
	ISO/WD 14045 Eco-efficiency assessment Principles and requirements		

Manage greenhouse gases			
plan	Do	Check	Act
ISO/TR 14062:2002 Environmental management Integrating environmental aspects into product design and development	ISO 14064-1:2006 Greenhouse gases Part 1: Specification with guidance at the organization level for quantification and reporting of greenhouse gas emissions	ISO/CD 14066 Greenhouse gases Competency requirements for greenhouse gas validators and verifiers document	
	ISO 14064-2:2006 Greenhouse gases Part 2 : Specification with guidance at the project level for quantification, monitoring and reporting of greenhouse gas emission reductions or removal enhancements		
	ISO/WD 14067-1 Carbon footprint of products Part 1: Quantification ISO/WD 14067-2 Carbon footprint of products Part 2: Communication		
	ISO/AWI 14069 GHG Quantification and reporting of GHG emissions for organizations (Carbon footprint of organization) Guidance for the application of ISO 14064- 1		

1.3 Cleaner production

Cleaner production is a preventive and specific initiative to protect the environment (ASIE/2006/122-578, 2008). It aims to minimize waste and emissions and to maximize production. The manufacturing process is designed to minimize the impact on the environment, reducing energy and raw materials consumption as well as waste and polluting emissions (Saez-Martínez F. J., 2016). By analysing the flow of materials and energy within a company, options are identified for minimizing waste and

polluting emissions from the industrial process. Since source reduction strategies are more effective than pollution prevention, cleaner production focuses on environmental management by reducing sources rather than pollution control methods (Gavrilescu M., 2004) as in figure 1-2.

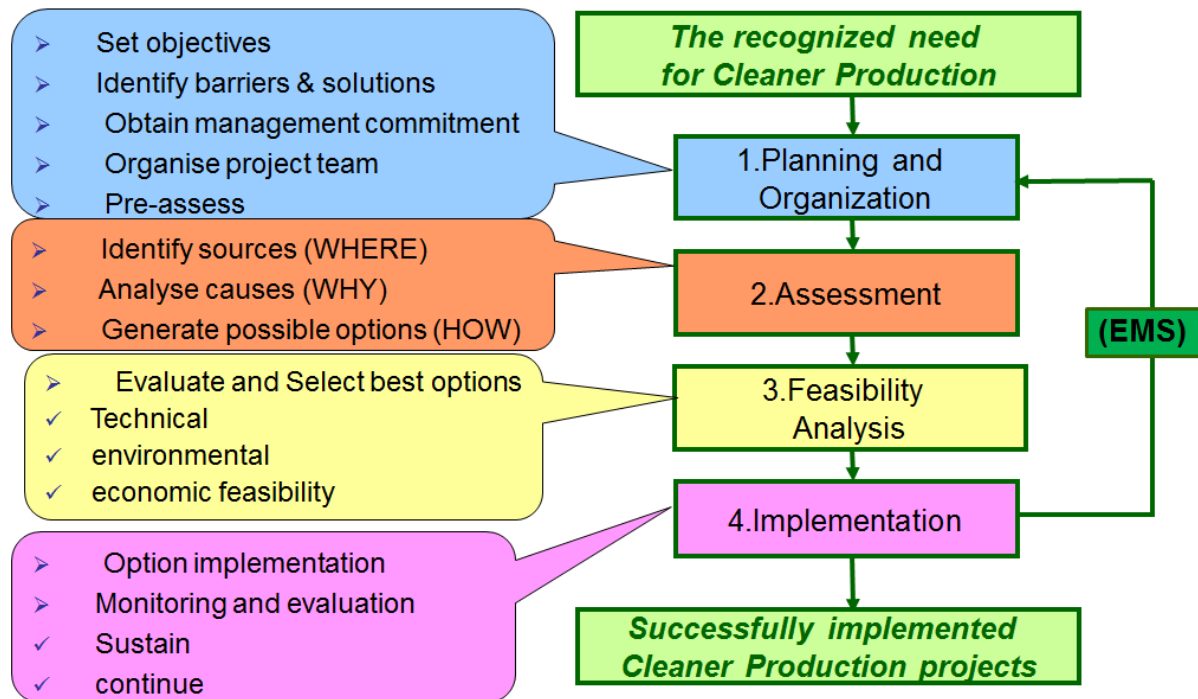

Figure1-2 Framework of Clean Production

Cleaner production is the continuous application of an integrated preventive environmental strategy applied to processes, products, and services to increase eco-efficiency and reduce risks for humans and the environment. It applies to:

- Production process: raw material and energy, eliminating toxic raw material (Mikulcic H., 2016) and reduction of all emission waste (Maiti S., 2018).
- Products: reduction of negative impacts during products life cycle (Abel E., 2005) from firstly raw material to final product and recycling to raw material.
- Services: incorporating environmental concerns into designing and delivering services. Making organisational improvements. Improving environmental performance by the implementation of no-cost and low-cost measures.

In short, clean production is the correct use of industrial processes, raw materials and products to prevent air, water and soil pollution, to reduce waste, to avoid environmental and human health hazards as well as making efficient use of raw materials, water and energy.

1.4 Green Manufacturing

Now the focus is on green manufacturing (Sarkis J., 2011). A diminished source of energy and raw materials and recent volatility in the price of fossil fuels and global awareness about limited resources creates a need for a more sustainable way of how to produce and use (Diabata A., 2011). Green industry is not new as in figure 1-3



Figure 1-3 History of Green Manufacturing (Sarkis J., 2011)

The concept around for a couple of decades, but has not received much attention from manufacturers with the exception of participating in seminars and scored well in opinion polls, surveys and studies. But recent trends show that with the increased focus on climate change a transformation of mind-set is happening and so positive action is now finally imminent. There are many interpretations of green manufacturing and all convey similar meaning. The centre for Green Manufacturing University of Alabama defines the goal of green manufacturing as *“To prevent pollution and save energy through the discovery and development of new know edge that reduces and/or eliminates the use or generation of hazardous substances in the design, manufacture, and application of chemical products or processes.”* (Lele S., 2009) (Figure 1-4). According to (Melnyk S.A., 1996), it is a system that integrates product and process design with issues of manufacturing, planning and control in such a manner as to identify, quantify, assess, and manage the flow of environmental waste with the goal of reducing and ultimately minimizing environmental impact while also trying to maximize resource efficiency (Seow Y., 2016).

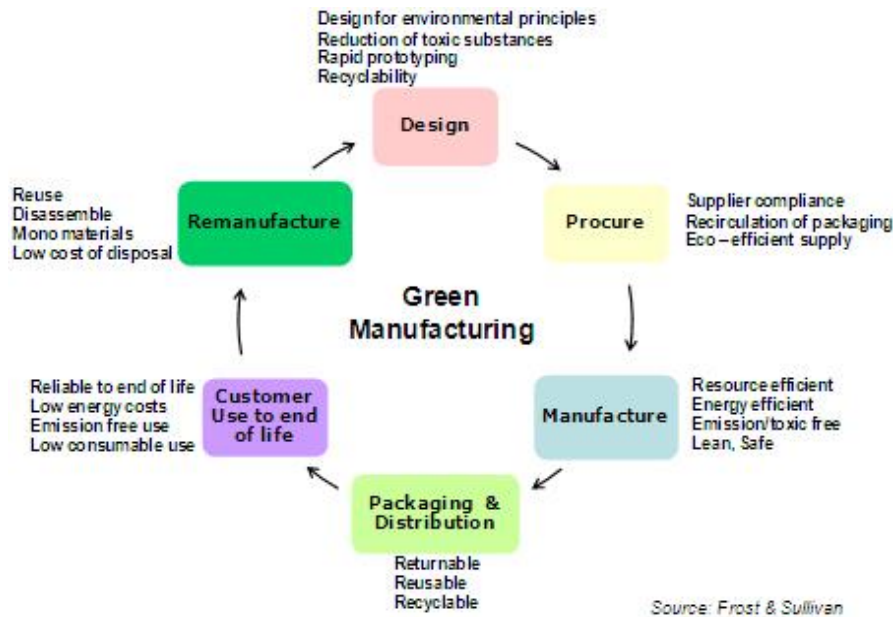

Figure 1-4 Green Manufacturing Activities (Seow Y., 2016)

The scope of green operations (GO) spans from product development to management of the entire product life cycle involving such environmental practices as eco-design, clean production, recycling, and reuse with a focus on minimizing the expenses associated with manufacturing, distribution, use, and disposal of products (Lai K., 2012) Green manufacturing is an important part of business.

1.5 Life cycle assessment

The life cycle assessment (LCA) analyses the effects of a product on the environment during its entire existence, from production to its period of use and its end-of-life recycling (figure 1-5). It is a quantitative evaluation of ecological aspects such as the emission of greenhouse gases (including carbon dioxide CO₂), energy consumption, acidification or summer smog. According to ISO 14040 standards, LCA is a technique to assess the environmental aspects and potential impacts associated with a product, process, or service, by:

- Compiling an inventory of relevant energy and material inputs and environmental releases;
- Evaluating the potential environmental impacts associated with identified inputs and releases;
- Interpreting the results to help make a more informed decision about the human health and environmental impacts of products, processes, and activities.

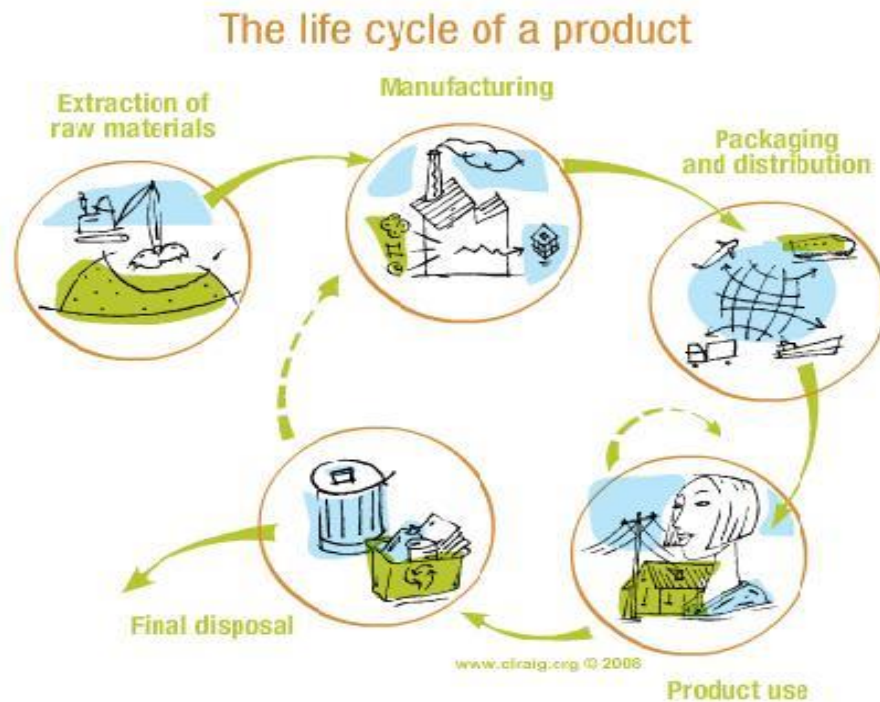

Figure 1-5 Product life cycle

There are four main phases of the LCA process:

1. **Goals and Scoping:** The scoping step determines which processes will be included, which environmental concerns will be included, what economic or social good is provided by the goods or services in question, resolves any technical issues and defines the audience for the LCA.

2. **Life Cycle Inventory (LCI):** The inventory provides information about all environmental inputs and outputs from all parts of the product system involved in the life cycle assessment.

3. **Life Cycle Impact Assessment:** The assessment takes inventory data and converts it to indicators for each impact category. A typical list of impact indicators includes:

- Global Climate Change.
- Stratospheric Ozone Depletion.
- Acidification.
- Eutrophication.
- Decrease in Natural Resources (habitat, water, fossil fuels, minerals, biological resources).
- Human Toxicity.
- Eco toxicity

4. **Interpretation** The last step is an analysis of the impact data, which leads to the conclusion whether the ambitions from the goal and scope can be met.

The life cycle of a product consists of:

- Raw material: This phase includes the extraction of materials and their rifling and processes manufacturing to the semi-finished product (such as steel plates) or final products.
- Production: to produce a product, it needs raw material resources and energy, as well as the manufacturing and assembly; both at suppliers and in production.
- Transport (Distribution): This phase covers the whole supply chain, suppliers to end-users and takes into account the means of transport (ships, trains, planes, trucks, vans, cars, etc.). The transport includes all activities of transports of raw marital, parts, semi products and final product; where at this a phase generally includes packaging activities.
- Use: This phase takes into account all the elements related to the use of the product in order to ensure its function for example car need diesel and battery as energy water and oil to work properly. The phase of use also includes installation and maintenance activities to repair and replace parts.

The main interest is on the CO₂ emissions that are strongly related with the energy consumed during the production of the part. The most cost-effective way to reduce CO₂ emissions is to reduce the energy use. The recent developments in manufacturing production technologies has however gone in the opposite direction with higher performance and higher energy using machines and processes, in order to increase productivity and reliability of the process. At present, LCA is by far the most common method for evaluating environmental footprint and has been found to be useful in assessing the environmental performance of machine tools. It is also not tied to production perspectives and does not measure economic value. However, there are inherent problems associated with LCA, which reduce its preciseness and limit its value for companies. The problem regarding LCA is that it provides static assessment results under the specific application assumptions (use of lumped parameters and site-independent models) and cannot show the dynamic association (the models used are static) between environmental impact and operation conditions of machine tools and the whole production line. Additionally, the focus is mainly on environmental considerations, not economic or social aspects disregarding in this way two out of the three main pillars of sustainable manufacturing. Consequently, the decision makers may make an unreliable decision for eco-design of machine tools and low carbon manufacturing based on the results. However, it is a very helpful tool that if used correctly can severely enhance the decision making towards a more sustainable management.

1.6 Sustainable Manufacturing

The concept of sustainability emerged from a series of meetings and reports in the 1970s and 1980s, and was largely motivated by environmental incidents and disasters as well as fears about chemical contamination and resource depletion. As pointed out in the 1987 Brundtland Report, the phrase

sustainable manufacturing is sometimes used to describe the actions related to characterizing and reducing the environmental impacts of manufacturing.

Sustainable manufacturing is frequently defined, according to US department of commerce (Moldavska A.2017), as *“The creation of manufactured products that use processes that minimize negative environmental impacts, conserve energy and natural resources, are safe for employees, communities, and consumers and are economically sound”* (see figure 1-6).

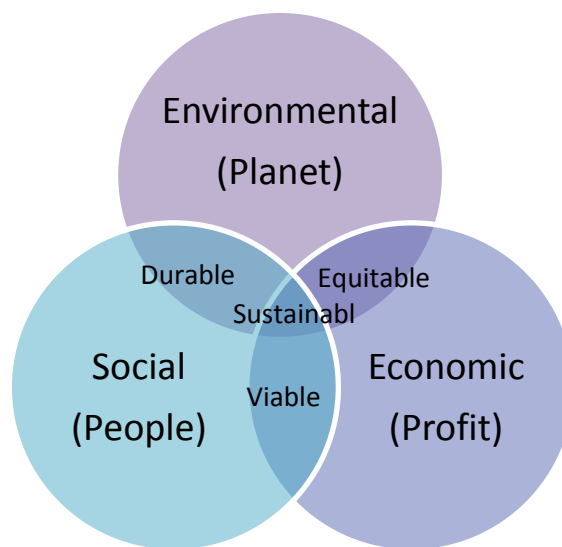

Figure 1-6 Sustainable Manufacturing

System might be thought of as unsustainable when society consumes resources and produces wastes at a rate that exceeds nature’s ability to transform industry and society wastes into environmental nutrients and resources. *“Sustainability, however, implies a great deal more than the simple act of analysing and modifying the environmental performance of manufacturing processes and system”* (Paul I., 2014). Sustainable manufacturing is a philosophy that cannot be considered independent of broader environmental and socioeconomic systems (Dornfeld D., 2013). Sustainable Manufacturing Fundamentals Manufacturing is a business function, and, as such, engineers are well-versed in establishing the economic value of engineering solutions for manufacturing. Measuring environmental and social performance presents a more challenging engineering and business task. Sustainability-related impacts result from operations and activities that manufacturing processes and systems employ to convert input materials and energy into marketable products. Material and energy are necessary inputs of manufacturing processes and systems; wastes and emissions, which are generally classified as outputs, are, in turn, inputs to other industrial and natural systems, where their impact is felt socially, environmentally, and economically (Dornfeld D. A., 2013) figure 1-7.

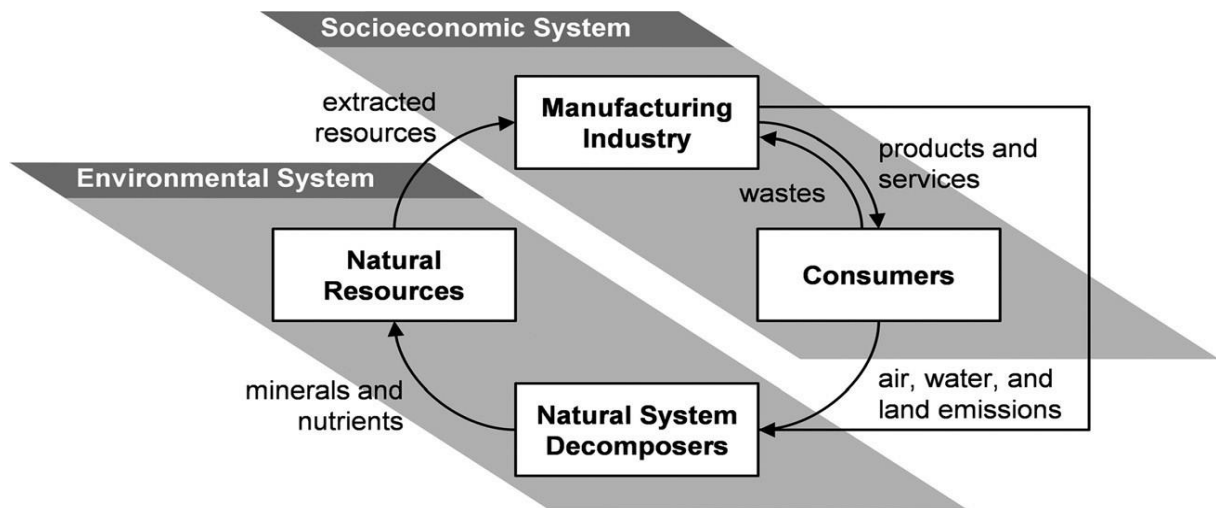

Figure 1-7 Sustainable system (Dornfeld D. A., 2013).

Sustainable Green operations Sustainable green operations as an innovative environmental management approach, GO serves to ensure the quality and environmental compliance of electronics manufacturers' inputs (electronics components and metals) and outputs

1.7 Structure of thesis

This thesis consists of five chapters as shown in figure (1-8) as shown:

Structure of thesis

1. Chapter One represent general introduction to management environment system, and their concepts tools.
2. Chapter Two problem energy and manufacturing system principles and energy efficiency methods are discussed
3. Chapters Three and Four Energy Efficiency production scheduling
 - Firstly a multi objectives genetic algorithm (chapter three) with multi populations to reduce total energy consumption with minimized makespan and idle time by reduce processing energy and time. To solve multi objectives-multi populations we use two types of genetic algorithms traditional and parallel genetic algorithms
 - In chapter four two mixed Integer linear programming are used to improve energy job shop scheduling, grace of mixed Integer linear programming we can solve problem larger to the problem in chapter three, and energy reducing with setup time effects.
4. Chapter five a case study and general discussing to all optimization method with conclusion and future work.

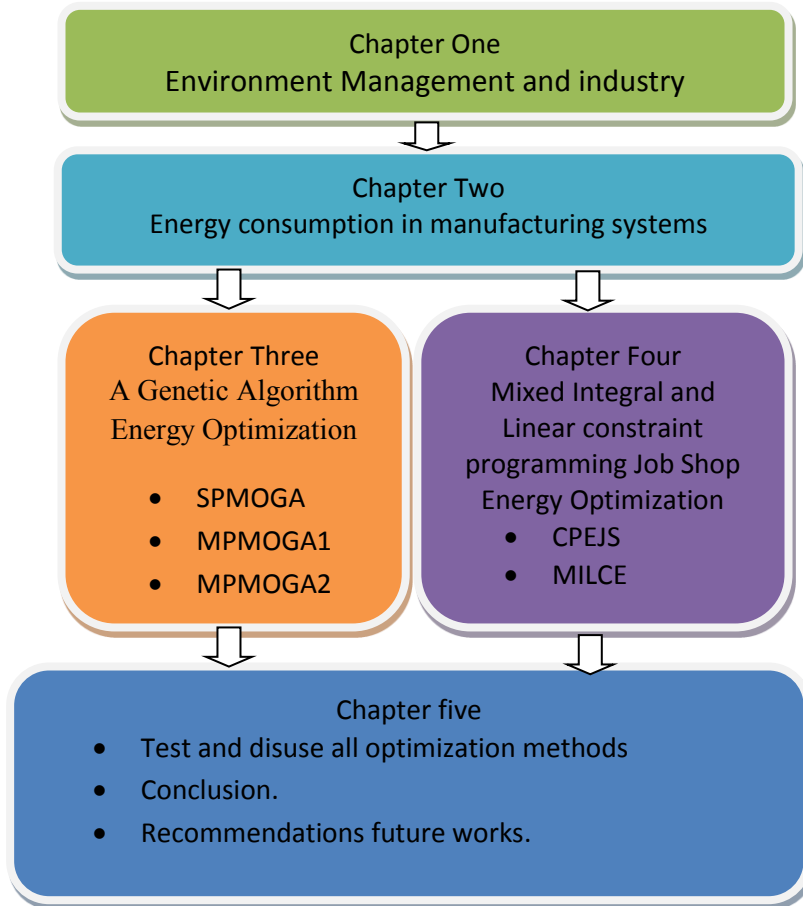

Figure 1-8 Theses construction

Chapter Two

Energy consumption in manufacturing systems

Number	Name	Page
2	Energy consumption in manufacturing systems	29
2.1	Introduction	30
2.2	Energy and Climate Change	32
	2.2.1 Energy sector and CO2 emissions	32
2.3	Energy in manufacturing systems	36
2.4	Electrical Energy Demand of Machine Tools	38
2.5	Energy Efficiency	41
	2.5.1 Energy Efficiency process planning	43
	2.5.2 Energy Efficiency production scheduling	43

2 Energy consumption in manufacturing systems

2.1. Introduction

Energy is very important part of life in the 21st Century. Its utilisation, demand and availability will become increasingly important as global climate (DOE/EIA 2009) change and the world population rise. In 2030, energy demand is expected to continue to increase over the coming decades, with demand estimated at more than 55% when compared to today's levels (IEA, 2017a) figure 2-1.

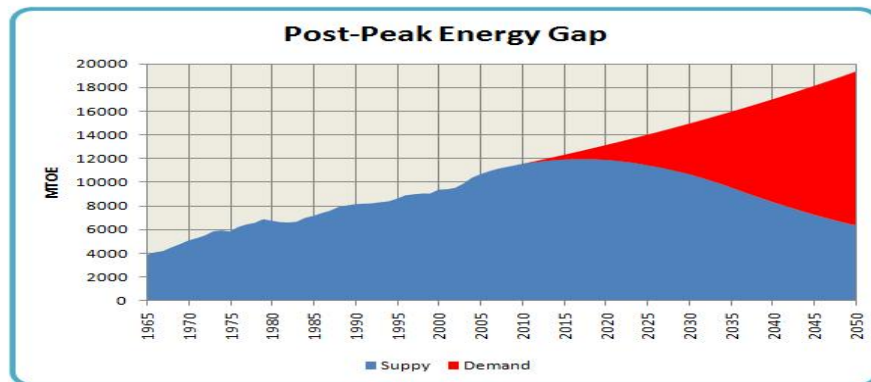

Figure 2-1 Growing gap between energy supply and demand. (IEA, 2017a)

The consumption of energy is one of the main contributors to greenhouse gas emission in the climate (figure 2-2). The term “low-carbon manufacturing” (Seow Y., 2011) has been invented to reflect an overall effort to reduce CO₂ emissions from energy consumed directly by manufacturing activities (e.g. specific process energy consumed per kilo of material processed, or per product manufactured), and the CO₂ produced through indirect energy consumption (e.g. general facility energy overheads such as heating and lighting).

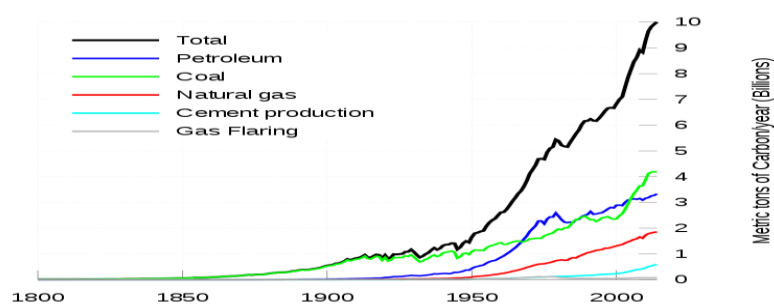

Figure 2-2 Energy environment impacts. (IEA, 2017b)

Future manufacturing enterprises will have to adapt energy concept based on the most efficient processes in their production facilities. It is said that, despite the expected growth in renewable energy technologies, short and medium term of manufacturing activities will continue to rely heavily on fossil fuel-generated electricity (figure 2-3).

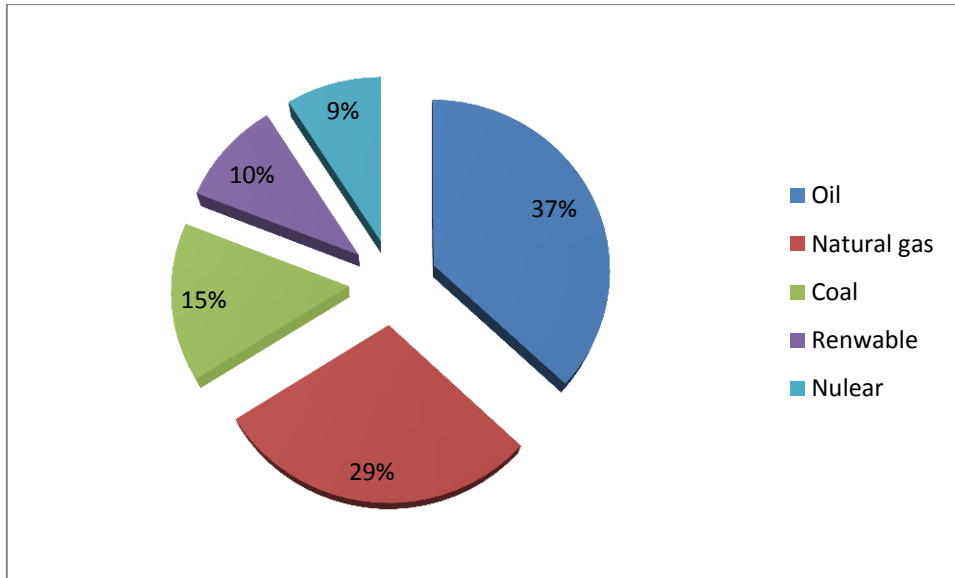

Figure 2-3 Total energy production (sources EC/PBL 2017)

For example, the introduction of renewable energy in Europe in 2016, require European electricity suppliers to source 20% of their capacity from renewable technologies by 2020 (EEA, 2016) (figure 2-4). For instance, French renewable energy production up over 23% in 2015 (MTES 2017).

Lower capital costs and the availability of tax credits boost near-term wind additions and sustain solar additions; whereas coal-fired unit retirements in the Reference case are driven by low natural gas prices and the Clean Power Plan

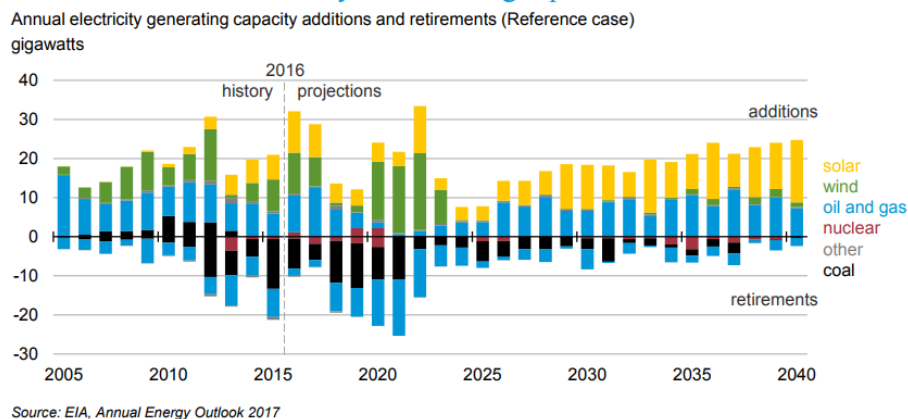

Figure 2-4 Total energy development (sources EIA 2017)

The remaining energy will clearly have to be produced through nuclear and fossil fuel power. The achievement of increasing energy efficiency has become vital in light of rising energy demand, coupled with deficit expectations. Using energy more efficiently is often a cost effective way of cutting carbon dioxide emissions which also improves productivity and contributes to the security of our future energy supply.

2.2. Energy and Climate Change

The climate change has been of interest within both the scientific community and public. The average global air and Ocean temperatures have risen increasingly among politicians over the last 100 years, and the last decade has been the warmest since records began 0.7°C higher since 1990 (IPCC, 2014). There is empirical evidence of increases in air and ocean temperatures, widespread melting of snow and ice and rising sea levels

2.2.1 Energy sector and CO₂ emissions

Many governments around the world have agreed on the need to take action to significantly reduce greenhouse gas (GHG) emissions over the coming decades in order to adapt to the effects of climate change. Energy represents about two-thirds of total Greenhouse-gas emissions and CO₂ emissions (Ritchie, H., 2018, United States Environmental Protection Agency USEPA 2017) from the sector have risen over the past century to ever higher levels. Effective action in the energy sector is therefore necessary to address the problem of climate change. An important change in the energy sector from 2014 to 2015 has been the rapid drop in world oil prices and, to a lesser extent, natural gas and coal prices. After a prolonged period of high and relatively stable prices, oil dropped from over \$100 per barrel in mid-2014 to below \$50 in early 2015 (Husain A. M., 2015). Natural gas prices also declined, but the pace and extent depended on prevailing gas pricing mechanisms and other regional factors (Dudley B., 2017).

Fossil fuels continue to meet more than 80% of total primary energy demand and over 90% of energy-related emissions (International energy and climate change, 2015) are CO₂ from fossil-fuel combustion as shown in table 2-1 and Figure 2-5. Since 2000, the share of coal has increased from 38% to 44% of energy-related CO₂ (DOE//EIA 2016) emissions, the share of natural gas stayed flat at 20% and that of oil declined from 42% to 35% in 2014. While the second “*and less long-lasting in the atmosphere, though with higher global warming potential*”, methane (CH₄) and nitrous oxide (N₂O), which are other powerful greenhouse gases emitted by the energy sector. Methane accounts for around 10% of energy sector emissions and originates mainly from oil and gas extraction, transformation and distribution.

Table 2-1 Greenhouse gas emissions (sources World Energy Outlook OECD/IEA, 2015)

	2015	2020	2025	2030
Energy related				
Carbon dioxide(CO ₂)	32.3	33.9	34.3	34.8
Methane (CH ₄)	3.0	3.1	3.1	3.1
Nitrous oxide (N ₂ O)	0.3	0.3	0.4	0.4
Process related				
Carbon dioxide(CO ₂)	2.0	2.2	2.2	2.3
Total	37.6	39.5	40.0	40.6

In the INDC Scenario, annual global energy- and process-related GHG emissions grow from 37.5 Gt CO₂-eq¹ in 2013 to 40.6 Gt CO₂-eq by 2030. If stronger action were not forthcoming after 2030, the emissions path in the INDC Scenario would be:

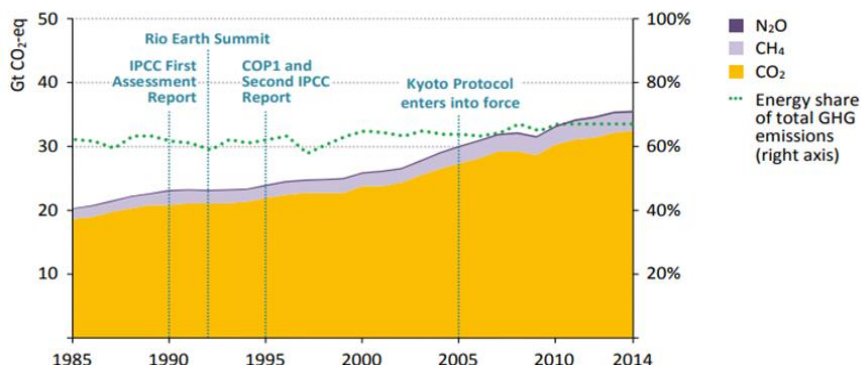
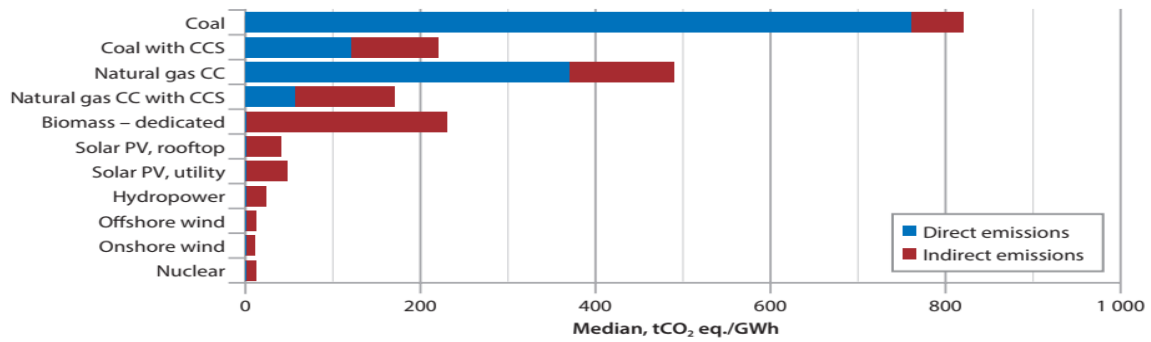

Figure 2-5 Greenhouse gas emissions (sources IEA and EC/PBL 2014)

Nuclear power is the second largest source of low-carbon electricity generation in the world after hydroelectricity, where government owned entities build, own and operate the plants. The process of nuclear fission does not produce any CO₂ or other GHGs, and thus nuclear power plants do not emit any GHGs directly during operation. However, some indirect emissions can be attributed to nuclear energy, mainly because of the use of fossil energy sources in the various stages of the nuclear fuel cycle. (For example, during uranium mining). Figure 2-6 compares the GHG emissions per unit of electricity generated from the different full life cycle electricity generation chains averaged across several European countries. It shows that lignite and coal have the highest GHG emissions, with natural gas having the lowest emissions among fossil systems.

¹ Gigatonnes of carbon-dioxide equivalent



Note: Lifecycle emissions from dedicated energy crops are relatively high due to the N₂O emissions from agricultural soils. N₂O has a global warming factor that is 298 times that of CO₂ (IPCC [2014], Chapter 11, p. 880).

CC = combined cycle; CCS = carbon capture and storage; GWh = Gigawatt-hour.

Source: Data from IPCC (2014).

Figure 2-6 GHG emissions per unit of electricity generated from the different full life cycle electricity generation (IPCC, 2014)

For the nuclear fuel cycle, most GHG emissions of air pollutants increased upstream of the production table 2-2. Most of these upstream emissions are from non-nuclear power plants needed to power centrifuge technology for uranium enrichment, including particulate matter, SO₂, N₂O and volatile organic compounds. (Nuclear Energy agency, 2015). However, these emissions are attributable to the structure of the electricity system and will decrease with the lower use of fossil fuels. Table 2-3 shows the total energy impact on the environment.

Table 2-2 Greenhouse gas emissions of energy sectors M ton (Nuclear Energy agency, 2015)

	Coal		Natural Gas		Bioenergy	Nuclear
	Hard coal	Lignite	Combined cycle	Steam turbine		
SO₂	530-7680	425-27250	1-324	0-5830	40-490	11-157
N₂O	540-4230	790-2130	100-1400	340-1020	290-820	9-240
PM	17-9780	113-947	18-133	-	29-79	0-7

Table 2-3 Global environmental impact of energy (IEA 2015)

Energy Source	Force of Origin	Energy production	Usage	Environmental Impact
Oil, Petroleum	Electromagnetic forces in atomic bonds	Non renewable	38% of world's consumption in 2000. Easily transported. Large portion in transportation industry	Refining and consuming produce air, water, and solid waste pollutants
Natural Gas	Electromagnetic forces in atomic bonds	Non renewable	20% of world's consumption in 2000. Flexible for use in industries, transportation, power generation	Produces fewer pollutants than oil and coal, and less CO ₂
Coal	Electromagnetic forces in atomic bonds	Non renewable	Primary resource for electricity	Produces CO ₂ and other air, water and solid waste pollutants
Biomass: Wood and organic waste including societal waste	Electromagnetic forces in atomic bonds	Renewable. In terms of timber, it is easily harvested and abundant in certain areas; but it takes a long time to grow a tree.	Low energy potential relative to other resources	Burning emits CO ₂ and other pollutants. Possible toxic by-products from societal waste. Loss of habitat when trees harvested, unless sustainable tree farms
Hydro electric	Gravitational force of water	Renewable. Clean resource with high efficiency. Influenced by climate and geography	Low economic cost, though high start-up costs	Destruction of farmlands, dislocation of people, loss of habitat, alteration of stream flows
Solar Power (photo voltaic)	Electromagnetic energy from the sun	Renewable. High economic cost particularly in terms of start-up. Dependent on climate and geographical location. Need a storage system for the energy to ensure reliability. Not advanced enough for global use	Technology is already in use for remote applications and non-centralized uses where it is economically competitive with alternatives. Unlimited resource that is clean, efficient, safe, and renewable	Large land use
Solar Power (solar thermal)	Electromagnetic energy from the sun	Renewable. Central thermal systems to convert solar energy directly to heat. More competitive economically than photovoltaics Dependent on climate and geographical location	Solar energy technology not advanced enough for global use. Many industrial plants use solar	
Geo-thermal	Gravitational pressure and nuclear reactions in the Earth's core	Extracts heat from underground masses of hot rock. Technology is still undeveloped. Can be geographically dependent	Consumption is localized efficient	Disrupts natural geyser activity
Wind Power	Gravitational & electromagnetic energy from the sun	Renewable unlimited resource that is a very clean process, no pollutants	Economic cost comparable to current technologies system must be designed to operate reliably at variable rotor speeds. Technology not advanced enough for global societal us	Aesthetic issues. Needs lots of land. Possible impacts on birds and their migration patterns. Some noise pollution
Nuclear Fission	Strong nuclear forces in nuclear bonds	Non-renewable resource U-235 (uranium). Highly technological infrastructure necessary for safe operation. Production of nuclear energy has a high cost due in part to regulations High water usage for cooling	Currently accounts for 10-12% of the world's electricity	By-product is highly radioactive and highly toxic. Produces radioactive wastes that have a long lifetime. Disposal solution complex technically and politically. Safety issues in terms of operating a facility with the potential to release radiation to the atmosphere. Public perception problem in terms of radiation, etc.
Nuclear Fusion	Weak nuclear force	Technology is not yet viable and requires research investment. Technology still not developed enough to make this a viable source		Possibility high for water pollution because of radioactive tritium

2.3 Energy in manufacturing systems

Electricity consumption (energy) has increased in modern manufacturing. (Seow Y., 2011) it's a need for analysing the machining system and energy flow which is presented before in a three-level structure, enterprise level, shop floor level and process level (figure 2-7).

Enterprise level receives the total energy input and distributes among different departments, design, production, services and management department. Energy here used in the lighting, heating, ventilation, air conditioning and other services. The energy consumed in the sector sometimes represents a remarkable percentage, 40-60% of total energy consumption in industrial enterprises (Thiede S., 2011).

Shop floor level, energy consumption can be analysed in the production departments. The mostly methods to reduce energy in shop floor level are production planning and process scheduling, which were developed by (Mouzon G., 2007), and line balancing in the production line in order to save more energy is another approach recommended.

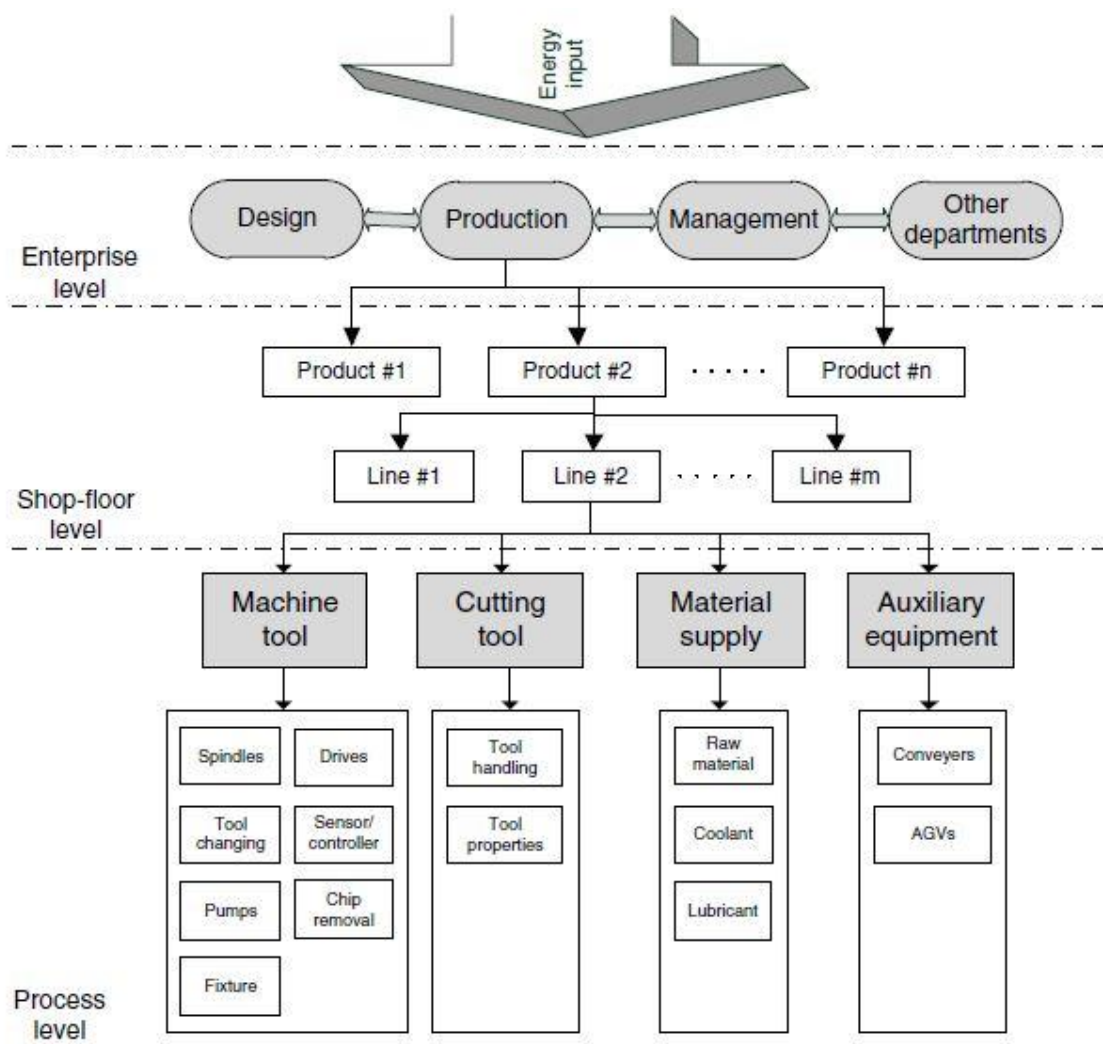

Figure 2-7 Energy consumption at different enterprise levels (Peng T., 2014)

Suppose that a workshop needs to produce several products that must be manufactured by a few production lines. In each line, the different types of machine tools cooperate with each other, as well as with supporting devices. Energy consumption in the infrastructures, the challenges lie in optimal process scheduling between multiple products and multiple production lines, dynamically scheduled operational states, (e.g. idle, work, and stop), could minimize the non-productive time.

The bottom level is a process level in which it is shown that energy is distributed among four parts: (a) machine tools, (b) auxiliary equipment, (c) tools and (d) material supply. Further detailed analysis may be needed due to diverse capabilities of machine tools, functionalities of auxiliary equipment, tools and variety of materials. They all have different effect on the energy consumption at this level (Peng T., 2014). More specific analysis is involved because different capability of machine tools, functionality of auxiliary equipment, various tools, and materials all have an impact on the energy consumption at this level. Research has been intensively conducted on the key part machine tools. Meanwhile, attention is being placed on the whole energy consumption at this level, due to the fast emerging digital factories. The ways to achieve energy savings at this level include, but not limited to, online parameter optimization, energy-efficient component employment, and real-time condition monitoring.

At each of these levels there are a number of specific improvements or enhancements to be considered. For example, at the machine construction level, engineer requests minimum energy, materials, and resources per unit of performance (positioning accuracy, speed, thermal stability, etc. in machine tool frame and components). At the machine operating level, manager requests minimum energy (hydraulics, spindles, tables/axes, idle, energy recovery), and alternate energy sources for operation (fuel cell, solar, etc.) and energy storage/recovery capability. In addition, the working envelope can be optimized with minimized environmental requirements and footprint. One can also consider design for re-use/remanufacturing component upgrade.

In machining systems, shop floor and process level are discussed more frequently. Research carried out previously place an emphasis on typical energy consuming components, spindles, motors, or cutting mechanism. Saidu R. (2010) presented a review of energy consumption of machine tool motors. Abele E. (2011) chose machine tool spindle as the representative unit to identify the potential improvement of energy efficiency. However, indicated that limited understanding of energy consumption focused on process level will be a problem. The researchers point out not only the material removal process itself, but also associated processes that should be considered in parallel to provide a complete collection of energy usage. (Dahmus J., 2004; Gutowski G., 2006) presented a systematic environmental analysis of machining process.

2.4 Electrical Energy Demand of Machine Tools

Each product generated undergoes different phases of life. The basic approach considers that three of them count for production (design and manufacture of the product), Operation and recycling or end of life.

During manufacturing processes, reducing of energy, is the most important objectives of environment management system MES. Raw materials are transformed into final product through a sequence of technological processes, in production systems. These processes are carried out by machines tools, which represent a distinct class of metalworking machinery. They can define as stationary operating assembled systems, fitted with a drive system other than directly applied human effort (Schischke K., 2011). Machine tools are the most important elements to consume energy during the manufacturing process. Machine tool passes through different states to get an operational readiness, the energy consumed by the whole machine tool (e.g. control systems, cooling and lubrications units, drive systems, spindle motor, manufacturing process, etc.) (Figure 2-8).

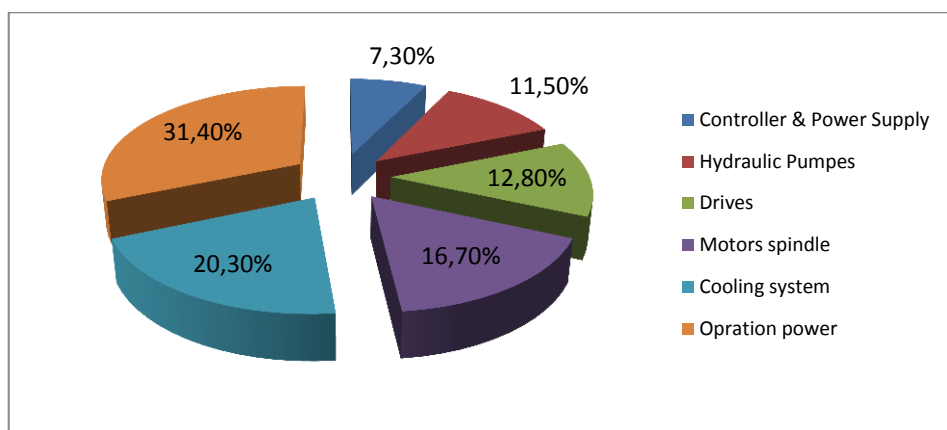

Figure 2-8 Consuming energy at different machine parts

Machine tools play a major role in manufacturing. The European Commission has cited machine tool as being in a top three priority for inclusion into the product categories regulated through the eco-design directive. Energy consumption model is based on existing research work on environmental analysis of machining. The Cooperative Effort in Process Emission proposed a UN fiend taxonomy and methodology, so that in manufacturing, energy data collection can be standardized and presented in a globally compatible approach. Machine tool states are classified into two categories: “Basic state” and “Cutting State”. The states are based on operational characteristics of the processes. In the “Basic state”, electrical energy is needed to activate required machine components. In the ‘Cutting State’ the energy is demanded at the tool tip to remove work piece material as well as for modes of energy loss e.g. through machine noise or friction.

While sets the framework, it does not clarify the existence of a transitional state between the Start-up’ and ‘Cutting State.’ We define a third and fourth and intermediate state called the ‘Start up’ and run

time. These additional states are required to clarify the process that takes place after the machine is started. these stages of the process requires more energy for the drives and spindle movement to bring the tool and work piece to the correct, about to cut position and to run time the necessary cutting velocity (figure 2-9).

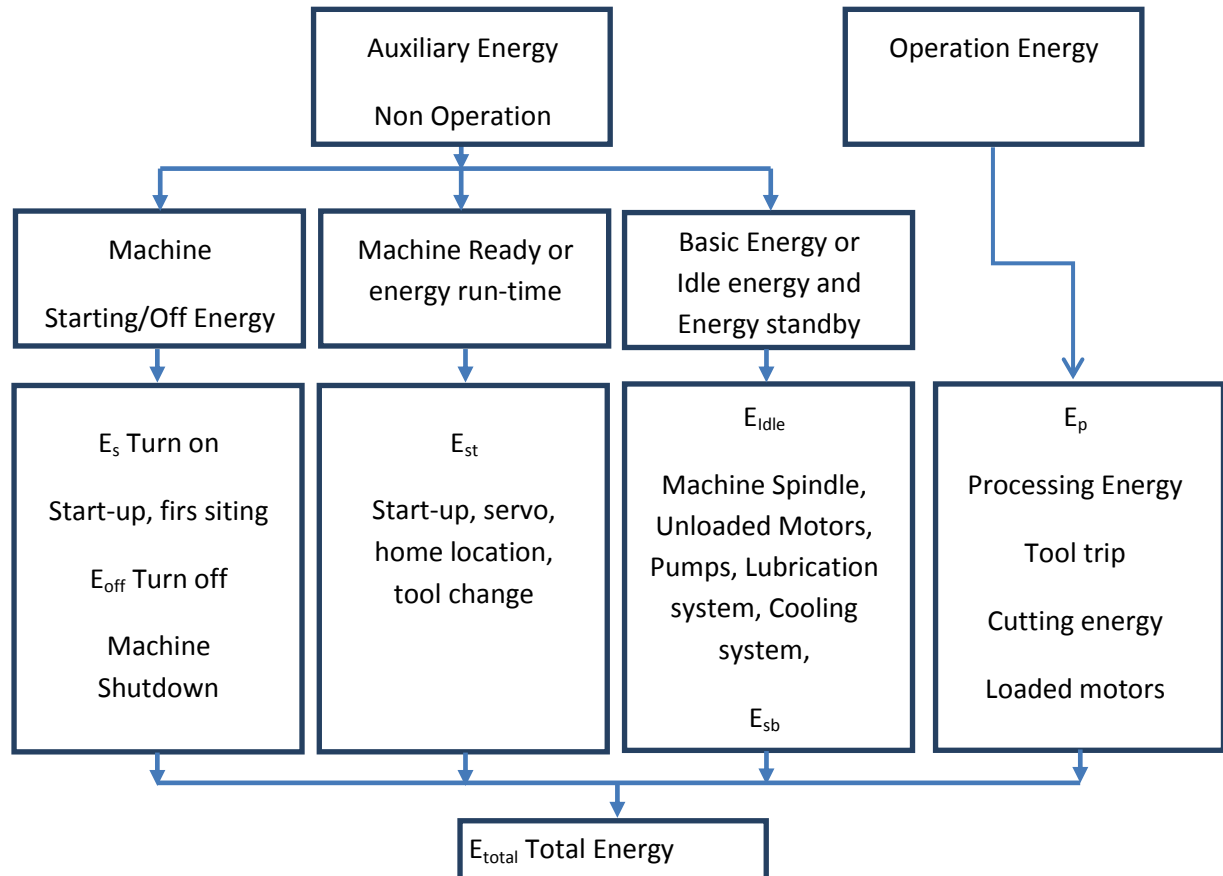

Figure 2-9 Classification energy types in machine tools

Energy consumption model is based on existing research work on environmental analysis of machining. A simplified power input model for each operation (Weinert N., 2011; Luo, H., 2013) at machine when it is working on operation has been developed as shown in (Fig.2-10).

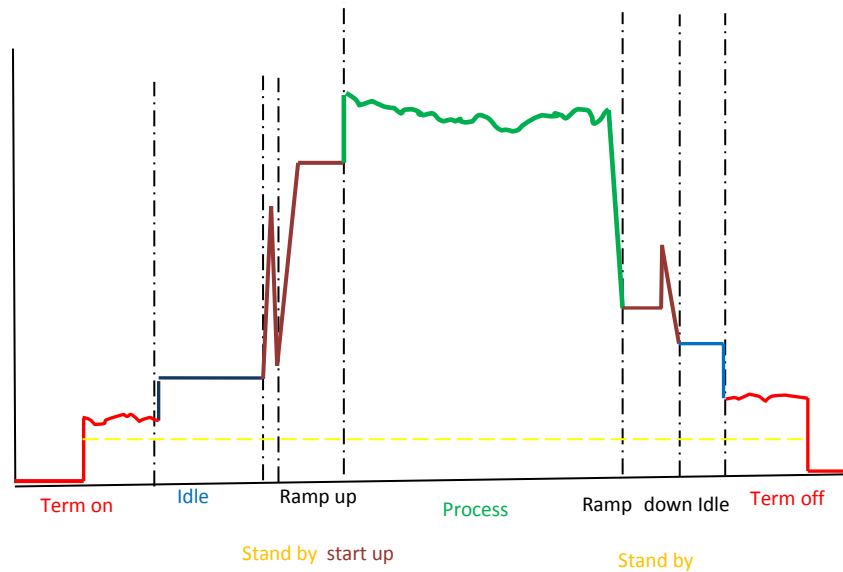

Figure 2-10 Energy consumption models during operation (zooming in of an operation at a machine)

That model assumes that each machine M_m has six levels of power consumption: during standby, during idle time, when switched into set-up mode, to carrying out the actual operation; operations as cutting operation and at machine starting and shut down. Figure 2-11 represents the relationship among cretin energy.

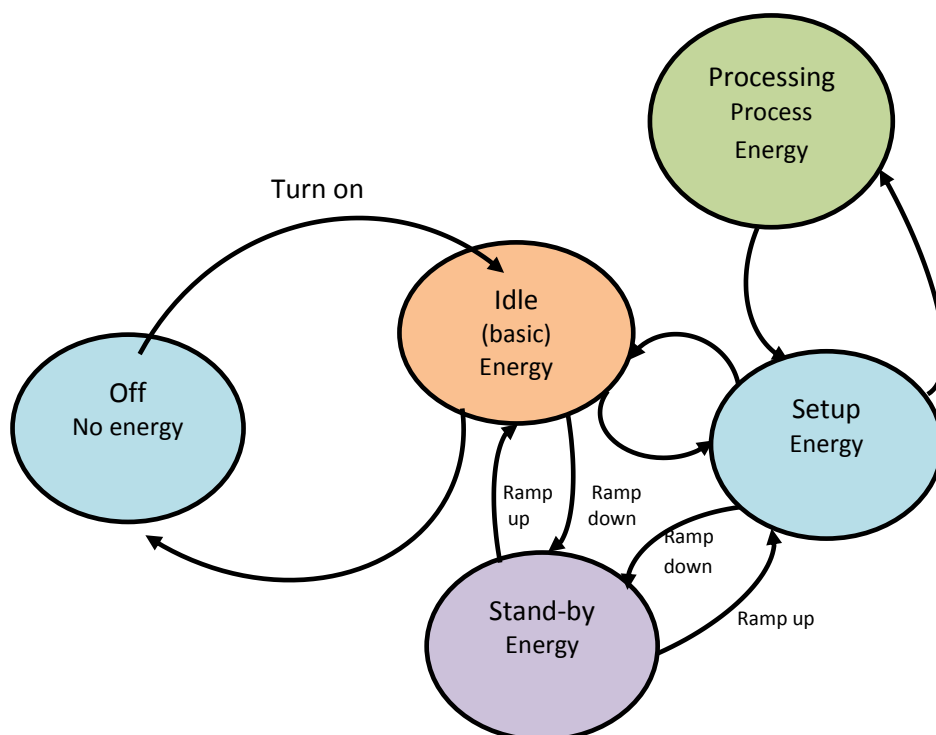

Figure 2-11 Energy consumption during operation states

- Turn on Energy consumption for start-up: the total energy consumption during the start-up period.

- Ramp up power: maximum instantaneous power requirement during change machine states idle and standby states to setup or from standby state to basic state, which is relevant to the additional energy cost due to power peaks.
- Ramp down-power: maximum instantaneous power requirement during change machine state, from setup state to basic or standby states idle state to standby.
- Setup power : power needed to change tools or machine to be ready to process the operations
- Operation power : power demand to distinctively operate components
- Constant power: as defined before, it can be used to estimate energy consumption of remaining machine availability during idle state.
- Turn off power:
 - Time for machine power-off: duration from machine switch-off until every component is inactivated.
 - Energy consumption for power-off: the total energy to shut down the machine or the total energy consumption during the power-off period.

2.5 Energy Efficiency

Energy efficiency is defined as the ratio of “useful” outputs to energy consumed by a system (Herring H, 2009). It can be measured by different ratios of physical or thermal indicators (tonne of steel per kWh (kilowatt hour) spent or the tonne of steel per tonne of coal consumed). The relevant data should be carefully chosen to measure, on a common scale, the energy equivalent on the one hand the useful outputs, on the other hand the elements consumed. At company level (paragraph 2-3), energy efficiency can also be defined as the production compared to the energy use at the firm level for that production (thermal capacity of a cooling system, in BTU/h (British Thermal Unit per hour = 0,293W), per watt absorbed; output product amount per kWh spent).

For conventional processes (Neugebauer, R., 2012) such as forming or material or removal processes, energy efficiency is measured as the volume of material removed per kWh consumed in the machine by the displacement of the axes and the losses in the machine structure and actuators (Grigor'eva S., 2014). For unconventional processes such as laser machining (Kellens K., 2014), it is necessary to add the energy consumed by the tool, such as the laser beam.

For this reason, the raw energy efficiency is not appropriate for the comparison of two production lines, since the energy is proportional to the size of the product, the number of parts in the product and the types of processes used for the production. A fortiori, the raw energy efficiency cannot be considered appropriate for the comparison of two factory configurations. Energy efficiency remains an important objective for industrial companies for ecological, political and economic reasons. The control of energy efficiency is essential for the implementation of energy efficient production strategies and therefore globally more efficient plants. Many studies aimed to optimize the energy

efficiency of conventional manufacturing processes and, to a lesser extent, of unconventional processes such as laser machining (Fysikopoulos A., 2014).

The main consideration of this approach is the division of energy efficiency analysis into four levels (figure 2-12):

- Factory level: at this level different production lines and production methods that may interact and include devices, required the mean objective at this level is line balance to reduce total energy in enterprise (Krones M., 2014; Peng T., 2014).
- Production line level: at this different machines and any other equipment devices that may be required for manufacturing the products at production line. It is a fact that a very significant amount of energy is spent on the idle consumption of machines. The production schedule, which determines the idle times, one of the most objective of energy efficiency to reduce idle time between operations(Behrendt T., 2012; Peng T., 2011)
- Machine level: This includes machine that ensure proper machining conditions.(Neugebauer, R., 2011). In some cases, the machine level can be identical with a machine tool; however, special care has to be taken when some peripheral devices are shared among different machines. At the machine level, any energy losses due to machine peripherals or machine inefficiencies have to be taken into account. for example the processes are under study, are removing processes. The possible differences between the process-level “result” and the machine-level “result” have to be taken into account, at the same time.
- Process level: that related to physical mechanisms of the process itself, select process type, processes parameters (feed rate cutting speed etc.) and technology. For example in milling the energy in process level is the energy required to remove material, but in laser machining, it is the energy of laser beam (electricity currant). (Fysikopoulos A., 2013; Gutowski G., 2010; Weinert N., 2011).

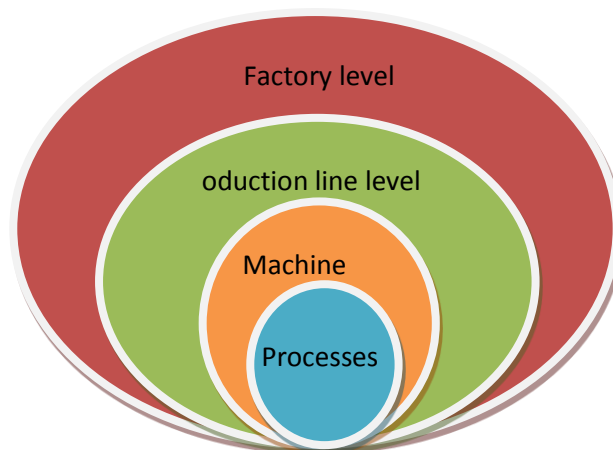

Figure 2-12 Energy efficiency levels in industrial plants (Fysikopoulos A., 2013)

2.5.1 Energy Efficiency process planning

Process planning is defined as the link between design processes and manufacturing processes to determine operations sequence that needed to produce a designed part. Process planning translates part and assembly design to physical products. Process planning is performed before actual manufacturing take place (Givehchi, M. 2017; Thao-Le V., 2017). Usually it takes a significant amount of time and requires sufficient information to make the decision (figure 2-13). In energy-efficient process planning, energy consumption is taken into consider, where it adds a newer dimension to traditional processes planning problem. (Trstenjak M., 2017; Abele E et al 2017)

- The first studies were deal with energy consumption, production rate, mass flow of waste streams and quality parameters need to be analysed at the planning state (Newman,S., 2012; Dufloy J. R., 2012).
- The second studies used to obtain process energy, machining time, mass of waste streams and quality parameters by using feature based two-phase planning scheme (Behrendt T.,2012, Mori M., 2011)

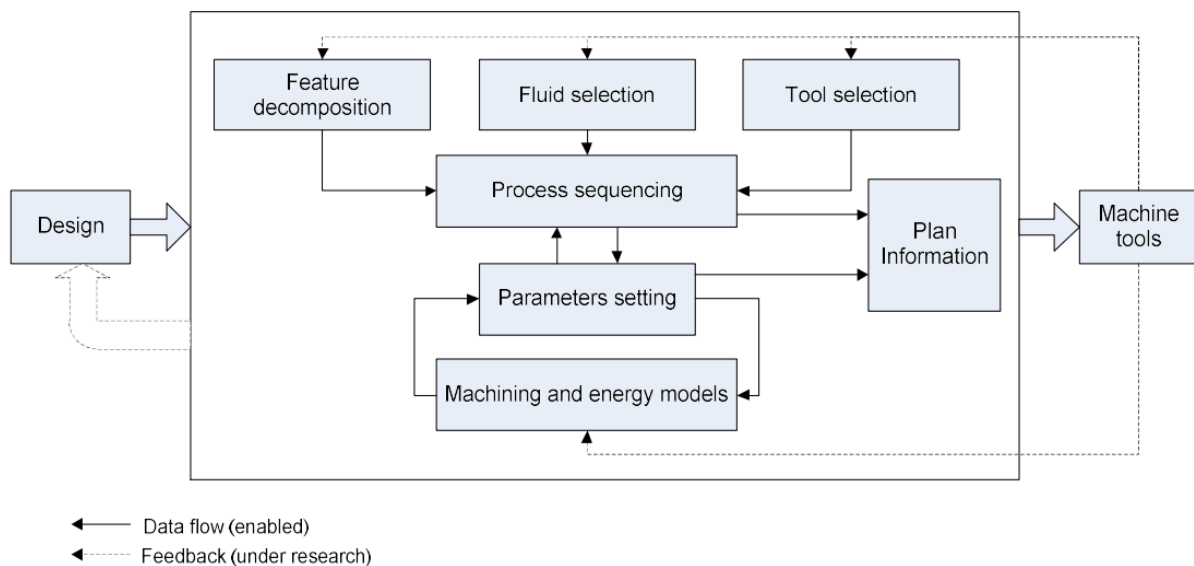

Figure 2-13 An example of process planning systems (Peng T., 2014)

2.5.2 Energy Efficiency production scheduling

Energy consuming during processing of jobs represented a small amount of total energy that consumed in production lines. In another field, Yin J. (2017) considers that rather than 40% of the total energy is consumed in system idle and losses. This dissertation is aimed to study an optimum energy consuming in job shop problem. We use:

- Firstly a multi objectives genetic algorithm (chapter three) with multi populations to reduce total energy consumption with minimized makespan and idle time by reduce processing energy and time. To solve multi objectives-multi populations we use two types of genetic algorithms traditional and parallel genetic algorithms

- In chapter four two mixed Integer linear programming are used to improve energy job shop scheduling, grace of mixed Integer linear programming we can solve problem larger to the problem in chapter three, and energy reducing with setup time effects.

Chapter Three

A Genetic Algorithm Energy Optimization

Number	Name	Page
3	A Genetic Algorithm Energy Optimization	45
3.1	Introduction	46
3.2	Background and motivation	47
3.3	Job Shop scheduling	51
3.4	Energy consumption model	55
3.5	Single population multi objectives Genetic algorithm energy job shop scheduling	59
3.6	Multi population multi objectives Genetic algorithm energy job shop scheduling MPGE1	59
	3.6.1 MPGE1	60
	3.6.2 Initial Population	61
	3.6.3 Chromosomes Crossover	65
	3.6.4 Mutation operator	65
	3.6.5 Fitness function	65
3.7	Multi population multi objectives Genetic algorithm energy job shop scheduling MPGE2	69
	3.7.1 Initial Population	70
	3.7.2 Crossover Strategy	71
	3.7.3 Mutation operator	72
	3.7.4 Threshold operation	72
	3.7.5 Elite strategy	74
3.8	Case study and concoction	76

3. A Genetic Algorithm Energy Optimization

3.1 Introduction

Nowadays, besides facing complex and diverse economic trends of shorter product life cycles, rapidly changing science and technology, increased diversity in customer demand, and the globalization of production activities, manufacturing enterprises also face enormous environmental challenges (Mouzon G., 2008a). These include global climate change (e.g. greenhouse effect, rapid exhaustion of various non-renewable resources (e.g. gas, oil, coal), and decreasing biodiversity. In Germany, statistical data shows that industrial sector is responsible for approximately 47% of total national electricity consumption. The corresponding amount of CO₂ emissions generated by this electricity was 18–20% (EIA, 2017. Annual Energy Review 2011, DOE/EIA-0384, 2017). Over the past 50 years, energy consumption by the industrial sector has more than doubled and the industry currently consumes about half of the energy in the world (Mouzon G., 2008b). The energy consumption is a very important cost component for manufacturing companies, at the same time; costs for energy have increased by almost 70% since the late 1990s as in (EIA, 2012. Annual Energy Review, 2011, DOE/EIA-0384, 2011). Manufacturing companies today face the challenge of raising energy prices and the requirements to reduce their emissions. Most of the work on reducing manufacturing energy consumption today focuses on the need to improve the efficiency of resources (machines). Largely ignores the possibility of system-wide power reduction where the operational method can be used as an energy-saving approach (Al-Qaseer F.2015). Corporate responsibility for this problem could be limited. Indeed, to improve the solutions to this major problem.

Four methods could be taken and are presented. The first is development of more efficient machines that consume less energy. The second is eco-design by modifying the product to reduce energy spending along its life cycle. Third is eco-manufacturing to modify manufacturing processes using less energy wasting techniques. Finally, the production lines must be adjusted to get better efficiency. The first three methods seem to be strategically interesting but too expensive, and sustained that the impact of such a decision is minimal especially for a small and medium-sized industry that can have a limited budget. Finally, it is on the last point that many improvements can be done without cost in order to obtain relevant results, responding to the industrial expectations. Generally, industrial job shop problems minimize such as the makespan or the cost but other objective and constraint can be addressed. Up to now, a few researchers studied the energy consumption as an important objective functions in scheduling.

3.2 Background and motivation

A considerable of the researches has been conducted in the area of sustainable machining. (Duflou N., 2012; Fysikopoulos A., 2013) provided the state-of-the-art reviews in energy and resource efficiency increasing methods and techniques in the area of discrete part manufacturing. A detailed process model that can be used to determine the environmental impacts resulting from the machining of a particular part have been presented by (Munoz A., 1995) based on experiments on an automated milling machine.

In the literature, industrial problems such as minimizing the total treatment time (makespan), the cost, and other objective functions have been widely studied. Until recently, only a few works addressed the energy consumption as an important constraint in scheduling. However, several papers have spread on this subject concerning the “Green and Sustainable Manufacturing” this past years and a non-exhaustive review is proposed in this section.

Gutowski T., (2005) conducted a study on almost fifty interlocutors, such as enterprises or laboratory in Japan, Europe and USA. They noticed that enterprises are well implicated in their environmental impact, partly linked with government’s tax system.

Mouzon G., (2007) proposed a turn-on/turn-off scheduling framework. This strategy is based on the finding who observe that non-bottleneck machines consume a considerable amount of energy when left idle; consequently, scheduling methods are conducted to determine when non-bottleneck underutilized machines must be turned off when they remain idle for a certain amount of time.

Mouzon G. (2007) proposed a Greedy Randomized Adaptive Search Procedure (GRASP) which objective is to find a solution minimizing both the total energy used and the total tardiness

Mouzon G.,(2008a) used turn off/on and Process Route Selection (PRS) to reduce both total Processing Energy (PE) and total Non-Processing Energy (NPE) for parallel machine environment. The limitation is that the PRS is only effective in the systems which have alternative routes with different energy characteristics for the same job. PRS not apply to the workshops without alternative routes, or having the same alternative routes for jobs, for instance, job shop environment.

Mouzon G., Yildirim M., (2008b) proposed a framework to solve a multi objective optimization problem that minimizes total energy consumption and total tardiness. Since total tardiness problem with release dates is NP-hard, they developed a new greedy randomized multi-objective adaptive search metaheuristic to obtain an approximate set of non-dominated solutions.

Diaz N., (2009) concluded that high-speed cutting would reduce the energy consumption per volume of material processed for machine tool switch demands high constant power.

Fang, K., (2011) approach advantage was the possibility to link the Energy Aware Scheduling (EAS) with an existing Advanced Planning and Scheduling (APS) without requiring a solution doing both at the same time.

Haït A., (2011) proposed a hybrid heuristic based on a two- step constraint /mathematical programming approach that improves significantly the computation time, compared to the full MILP model

He Y., (2012a) used event graph methodology based on the task-oriented energy consumption characteristics to model the energy consumption caused by the tasks in the production processes of the machining manufacturing system. This method is solved in the Simulink simulation environment, and applied to select flexible task processes to optimize power consumption.

He Y., (2012b) proposed a method that gives a quick way to assess the potential energy consumption of machining processes. They used a process route selection (PRS) method to decrease both total (PE) and total (NPE) for a flexible job shop environment. The typical Electricity Saving Method (ESMs) on the system level include: Sequencing, Turn Off/Turn On and Process Route Selection (PRS). As previously indicated, the limitation for PRS is that it is only effective in systems which have alternative routes with different energy characteristics for the same job. PRS is not applicable to workshops without alternative routes, or having identical alternative routes for jobs, for instance, the job shop.

Duflou J. R., (2012) proposed a state of the art of good practices concerning the production systems with energetic constraints. They underlined the difficulty to get data concerning energy consumption. They also plot the fact it is difficult to optimize recently built manufactures because they are energetically well designed; however, even a smooth optimization in old manufactures could lead to a strong amelioration.

Bruzzone A.G., (2012) used a time-indexed formulation for optimizing the timing of a schedule produced by an Advanced Planning and Scheduling (APS) system in order to minimize the peak consumption, while accepting the trade-off of a possible increase in the total tardiness in a flow shop system. They proposed a solution that consists in avoiding consumption peaks on a production system, modelled as a Flexible Flow Shop. They use an Energy Aware Scheduling (EAS) on the existing schedule obtained with an APS (Advanced Planning and Scheduling).

Fang, K., (2013) proposed a mathematical model for minimizing the carbon footprint, the makespan and the consumption peaks in a Flow-shop. The market tool they used did not permit to find convenient results in a calculation day. According to them, it is better in an industry context to first find a solution respecting one constraint and then modify the solution in order to take into account the others. They also noted the lack of models implying flexible machines.

Dai M., (2013) proposed a Genetic Algorithm associated to a Simulated Annealing. They took into consideration the power used by the machines in function of the state on it. They propose to turn on/off the machines according to the need of the production system and respecting given conditions. Thus, a machine would not be turned off if the next operation to be scheduled starts earlier than the duration of the turn off/on process. Their results are given in a Pareto graphic. However, they note that their model does not handle the possible breakdown and their data are not from industry.

Taking into account this last point, Fang, K., (2013) considered a flow shop scheduling problem with a restriction on peak power consumption, in addition to the traditional time based objectives. They investigate both mathematical programming and combinatorial approaches includes flexible systems that contain several machines and resources which are able to process the available jobs by consuming different levels of energy and time.

Luo H., (2013) take into account the variable prices of electricity during a day, including Time-Of-Use (TOU) rates in a Flexible Flow-shop. They noticed that it is current to find old and recent machines at the same production stage of a production system, and observed that it is better to have in parallel a fast and energy expensive machine with a low and economic one rather than two medium machines. They addressed hybrid flow shop scheduling problem with the consideration of energy consumption point of view; they propose a new ant colony optimization meta-heuristic considering not only production efficiency but also electric power cost with the presence of time-of-use electricity prices.

Salido M. A., (2013) showed that a more energy efficient system is more robust and thus less sensitive to breakdowns. They worked on the correlation between makespan, energy and robustness. By inclusion of variable speeds in the operation processes, a machine which is processing a task quickly will consume more energy but the treatment time will be reduced. Thus if a breakdown occur, the lost time could be caught up by increasing processing speed. Their work is one of the first including robustness in the optimization of production systems under energy constraints.

Moon J., (2013) dealt with the production and energy efficiency of the unrelated parallel machine scheduling problem. They presented a mixed-integer linear programming formulation for the problem to minimize the weighted sum of two criteria: makespan and the time-dependent electricity costs. Since the problem is NP-hard, they suggest a hybrid genetic algorithm to solve it.

Liu Y., (2014) observed that a few work have been done concerning the Job-shop with energy constraints and thus they proposed a Job-shop where both the total energy consumption and the total tardiness are minimized. Their review show that most of the studies are input-oriented and quite recent, and they point out the relative absence of output-oriented or mixed methods. The literature shows a lack of study concerning the Job-shop problem under energy constraints.

Zhang H., (2014) proposed a time indexed linear program which objective is to minimize the energy spending and the carbon footprint under a TOU pricing in a height level Flow-Shop. The energy expenses can be lowered by moving operations from on-peak hours to mid- or off-peak hours. However, they noticed that this kind of improvements could have a bad impact on carbon footprint in regions where gas combustion is used during on-peak hours whereas coal combustion is used during mid- and off-peak hours.

O'Rielly K., (2014) showed that a lot of improvements in energy efficiency could be made in Canada enterprises but they pointed out industrial mind-set for whom energy optimization is considered time-consuming and too expensive is still a major barrier.

Furthermore the recent state of the art proposed by (Trentesaux D., Prabhu V., 2016) stresses the lack of decision tools relative to energy efficiency of production systems.

Shrouf F., (2014) used a similar approach by taking into account TOU and the transitions between machine states in a single machine process. They point out that the genetic algorithm they implemented could be used in extension of an MRPII (Manufacturing Resource Planning). However their models do not modify the sequence given in input in order to find a better makespan.

Artigues C.,(2015) addresses a scheduling problem with continuous resources and energy constraints, they referred to as the Energy-Constrained Scheduling Problem with Continuous Resources.

Shrouf F., (2015) proposed a mathematical model to minimize energy consumption costs for single machine production scheduling during production processes. To obtain near optimal solutions, they utilize a genetic algorithm approach.

Further researchers study the case of manufacturing systems in which the turn-on/turn-off strategy is not applicable since it may cause the consumption of a considerable amount of additional energy or damage the machines. The alternative framework proposed for this kind of systems is based on the machine speed scaling control (controllable processing times). Machines are allowed to work at different speed levels when processing different jobs; if a machine works at a higher speed, the processing time is shortened but the consumption of energy increases. The problem is to determine the speed of the machines and the sequence of jobs on them so that the cost function, which includes the total energy cost, is minimized.

Masmoudi O., (2015) presented a capacitated lot-sizing problem in flow-shop system with energy consideration. A mixed integer linear programming is formulated; each period is characterized by demand, duration, electricity cost and maximum peak power. (Masmoudi O., 2016) used both non-linear and linear mixed integer programming. Masmoudi O., (2017) used fix-and-relax and genetic algorithms, which are presented for solving a capacitated flow-shop problem with minimizing total energy costs.

Zhang R., (2016) addressed the job shop scheduling problem with the objective of minimizing energy consumption based on a machine speed scaling framework. To solve this kind of optimization problem, they propose a multi-objective genetic algorithm.

Nattaf M.,(2016) addressed a scheduling problem with a continuously divisible, cumulative and renewable resource with limited capacity, by presenting two new mixed-integer linear programs *MILP*.

The last research stream includes flexible systems that contain several machines and resources that are able to process the available jobs by consuming different levels of energy and time.

Jian-Ya D., (2016) considered a permutation flow shop (PFS) scheduling problem with the objectives of minimizing the total carbon emissions and the makespan .To solve this multi- objective optimization problem, they first investigate the structural properties of non-dominated solution.

Chao L., (2017) studied formulates a mathematical model with the objectives of minimizing both the makespan and the total additional resource consumption. They propose a new Multi-Objective Discrete Virus Optimization Algorithm (MODVOA) with a three-part representation, by including NSGA-II and SPEA2.

Mokhtari H. and Hasani A (2017) designed an energy-efficient scheduling in a shop floor industrial environment, i.e., Flexible Job-shop Scheduling Problem (FJSP). To this end, a multi-objective optimization model is developed with three objective functions: minimizing total completion time, maximizing the total availability of the system, and minimizing total energy cost of both production and maintenance operations in the FJSP.

Lvjian Y., (2017) proposed a new low-carbon mathematical scheduling model, where were proposed for the flexible job-shop environment that optimizes productivity, energy efficiency and noise reduction. In their model, the machining spindle speed which affects production time, power and noise is flexible and is treated as an independent decision-making variable.

Yuxin Z., (2017) proposed a dynamic scheduling approach to minimize the electricity cost of a flow shop with a grid-integrated wind turbine. Time series models are used to provide updated wind speed and electricity prices as actual data becomes available. The production schedule and energy supply decisions are adjusted based on the new formation.

Zhang L., (2017) has obtained the lower bound of energy-efficient flexible job shops with machine selection, job sequencing, and machine on-off decision making. He used a new mathematical model to find more energy-efficient rules with easy implementation in real practice via an efficient Gene Expression Programming (eGEP) algorithm.

3.3 Job Shop scheduling

The Job-shop Scheduling Problem (JSP) is concerned with allocating limited resources to operations over time (Pezzella F., 2008) satisfying precedence constraints between the operations for a job. Scheduling, as decision-making process plays an important role in most manufacturing and production systems as well as in most information processing environments (O’Rielly K., 2014). The Flexible Job-shop Scheduling Problem (FJSP) is expanded from the traditional Job-shop Scheduling Problem, by a wider availability of machines for all the operations. The FJSP is as follows: j jobs are to be scheduled on m machines. Each job j contains l ordered n operations (Yuan, Y., 2013a, Yuan, Y., 2013b , Al-Qaseer F., 2015).

The execution of each operation requires one machine, and will occupy that machine until the operation is completed. The FJSP problem aims to assign operations on machines and to schedule operations assigned on each machine, subject to the specifications (Salido M. 2014):

1. The operation sequence for each job is prescribed.
2. Each machine can process only one operation at a time.

Firstly, we consider minimizing the following three objectives:

1. (C_{max}) , the makespan, i.e. the completion time on all machines in job shop scheduling.
2. (TWT) , the total working time over all machines.
3. (TT_{id}) , the total non-productive time for the job shop scheduling.

Notations:

\mathcal{M} : a finite set of M machines ; $\mathcal{M} = \{M_m\}_{m=1}^M$

\mathcal{J} : a finite set of job J jobs, $\mathcal{J} = \{J_j\}_{j=1}^J$

\mathcal{O}_j : a finite set of N_j ordered operation of J_j , $\mathcal{O}_j = \{O_{j,n}\}_{n=1}^{N_j}$;

$O_{m,j,n}$: n^{th} operation of job J_j on machine M_m

\mathcal{S} : a finite set of all feasible scheduling plans; $\mathcal{S} = \{s\}$

t_{s_m} : start up time of machine M_m .

$t_{off\ m}$: turn off time of machine M_m .

$t_{p_{m,j,n}}$: processing time of operation $O_{m,j,n}$ on machine M_m

$t_{id\ m,j,n}$: idle time between $O_{m,j',n'}$ and $O_{m,j,n}$ on machine M_m .

$t_{sp_{m,j',j,n'n}}$: setup time of $O_{m,j,n}$ on M_m depends on machine and precedes job

$S_{m,j,n}$: starting time of $O_{m,j,n}$ on M_m

$Ct_{m,j,n}$: completion time of $O_{m,j,n}$ on machine M_m

- Decision variables

$$x_{m,j,n} = \begin{cases} 1 & \text{if the } n - \text{th operation of } J_j \text{ is performed on } M_m \\ 0 & \text{otherwise} \end{cases}$$

$$\beta_{m,j',j,n'n} = \begin{cases} 1 & \text{if } O_{m,j',n'} \text{ precedes } O_{m,j,n} \text{ on } M_m \\ 0 & \text{otherwise} \end{cases}$$

Job shop objective function computation

$$Ct_{m,j,n} = S_{m,j,n} + t_{o_{m,j,n}} \quad (3-1)$$

(C_m) , the completion time on the machine M_m

$$C_m = \max_{j,n} \{Ct_{m,j,n}\} \quad (3-2)$$

$$C_{max} = \max_{m,j,n} \{Ct_{m,j,n}\} \quad (3-3)$$

$$t_{o_{m,j,n}} = t_{p_{m,j,n}} x_{m,j,n} + t_{sp_{m,j',j,n'n}} \beta_{m,j',j,n'n} \quad n > 1 \quad (3-4)$$

(Wt_m), the total working time spent at machines M_m .

$$Wt_m = \sum_{j=1}^J \sum_{n=1}^{N_j} t_{o_{m,j,n}} x_{m,j,n} \quad (3-5)$$

$$TW_t = \sum_{m=1}^M Wt_m \quad (3-6)$$

(Tt_{id_m}), the non-productive time, i.e idle time, for machine M_m

$$Tt_{id_m} = C_m - Wt_m \quad (3-7)$$

$$TTt_{id_t} = \sum_{m=1}^M Tt_{id_m} \quad (3-8)$$

The method to calculate C_m , TW_t and Tt_{id_m} as explain in figure 3-1

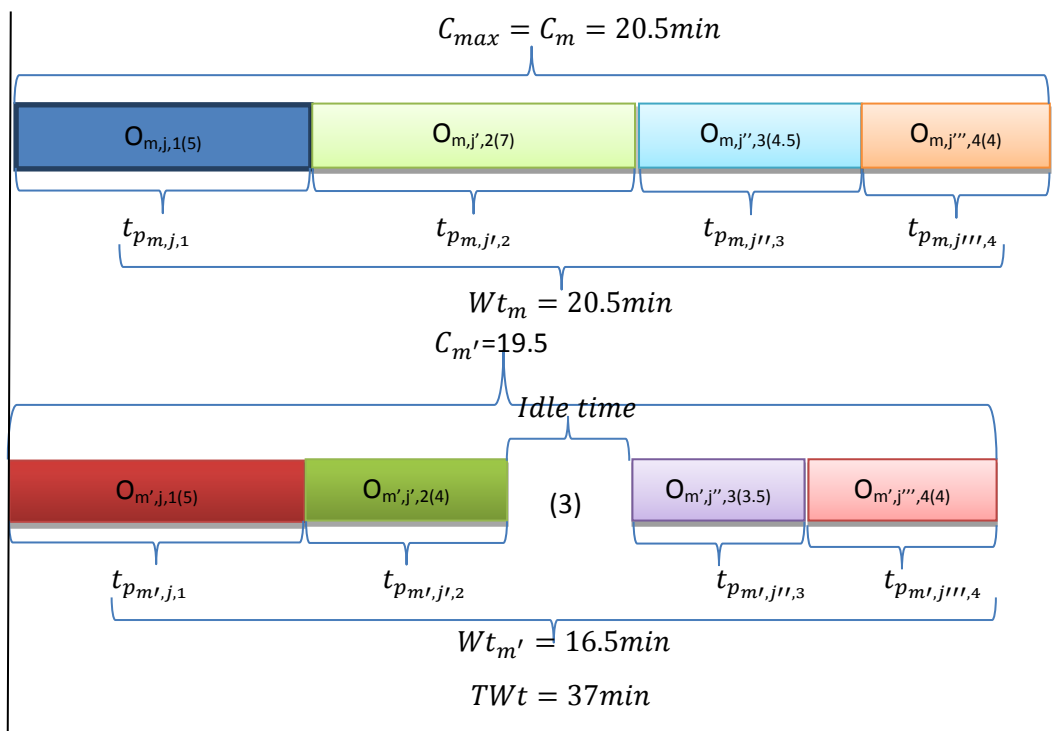

Figure 3-1 Illustration of computation of C_m and Wt

Job shop Constraints

- A machine cannot process more than one operation at a time:

$$\sum_{j=1}^J x_{m,j,n} \in \{0,1\} \forall m, n \quad (3-9)$$

- A job can process more than on one machine at the same time.

$$\sum_{m=1}^M x_{m,j,n} \in \{0,1\} \forall j, n \quad (3-10)$$

- An operation $O_{m,j,n}$ is immediately started in machine M_m when the previous operation of the job $O_{m',j,n-1}$ has been completed and that the previous operation on the machine $O_{m,j',n'}$ has been completed (figure 3-2):

$$S_{m,j,n} = \begin{cases} \max_{m',j',n'} \{ Ct_{m,j',n'} \cdot \beta_{m,j',n'} \cdot Ct_{m',j,n-1} \cdot x_{m',j,n-1} \} & \text{if } n > 1 \\ \max_{m',j',n'} \{ Ct_{m,j',n'} \cdot \beta_{m,j',n'} \} & \text{if } n = 1 \end{cases} \quad \text{if } x_{m,j,n} = 1 \quad (3-11)$$

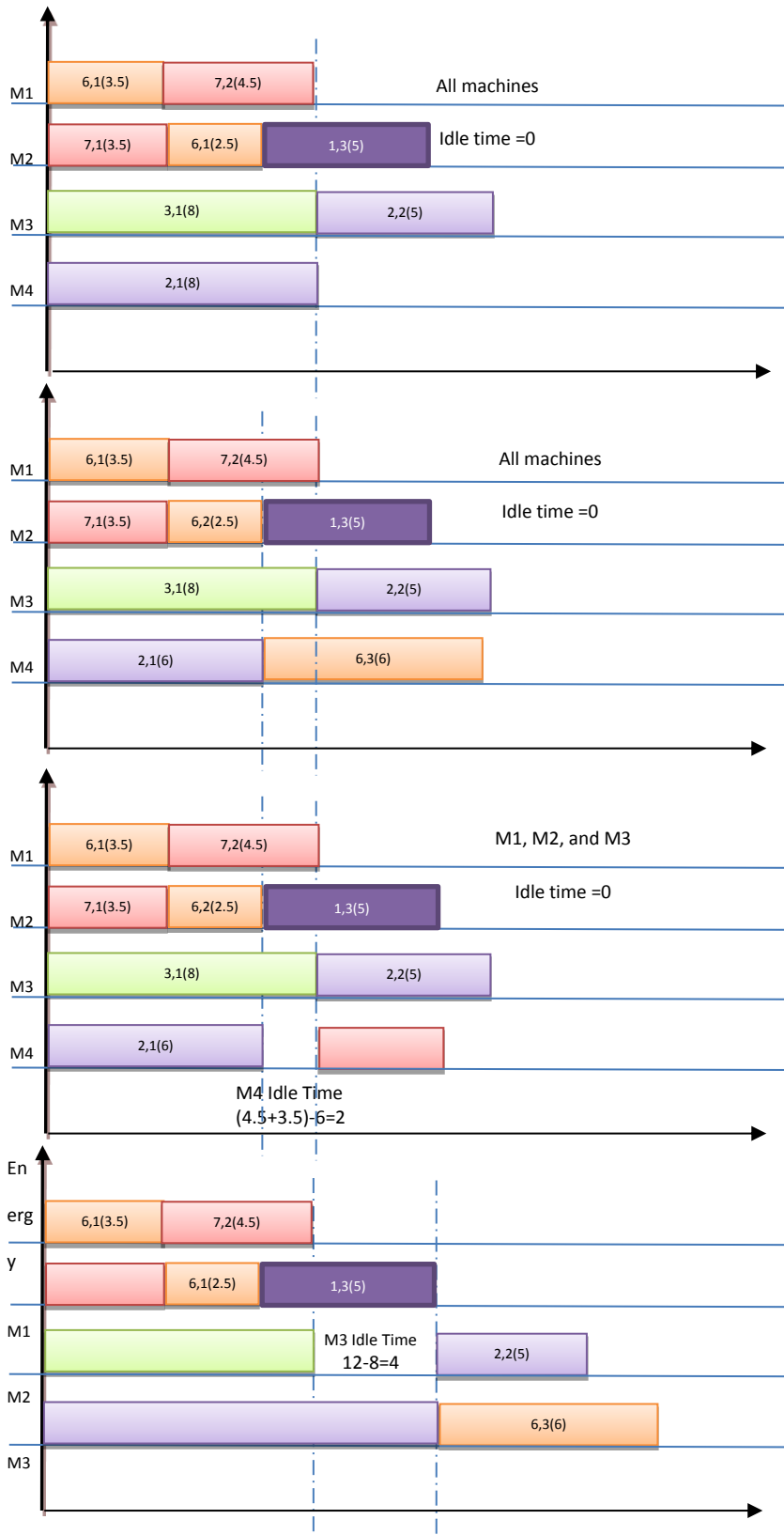

Figure 3-2 Example of constraints between two jobs

3.4 Energy consumption model

Energy consumption model is based on existing research work on environmental analysis of machining. Machine energy model is simplified as flowing (Weinert N., 2011 and Luo H., 2013) firstly machine M_m is starting, operation, and turning off after finished all operations as shown in (Fig.3-3).

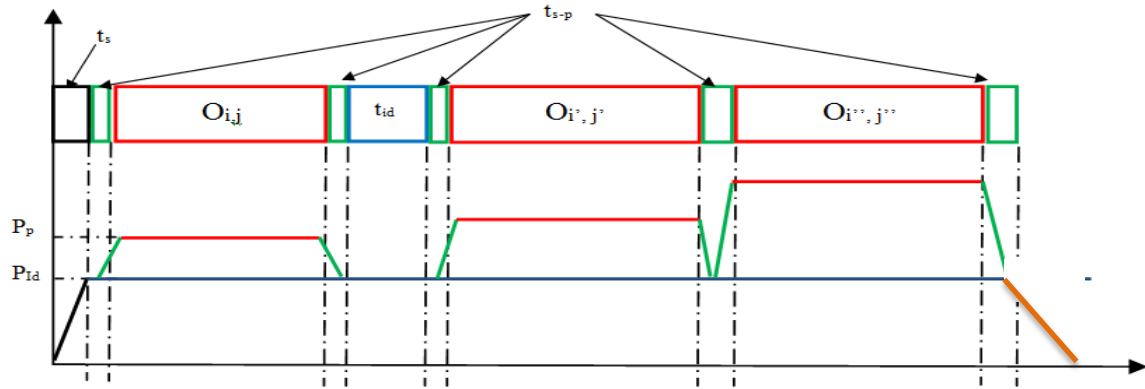

Figure 3-3 Energy model of job shop

This model assumes that machine M_m has five levels of power consumption: (a) during starting time (black line) to switch on the machine, and become capable to processes the jobs, (b) basic mode (idle time) (blue lines), (c) setup time (green lines) to prepare the machine (tools change, change machine programming etc.) to processes the jobs. (d) Operations time (red lines) as cutting operation, this time is actual processing time to process operation $O_{m,j,n}$ in machine M_m . (e) After, machine finished all operations of jobs to turn off the machine, it also consume energy during this process, and this process called turn off mod (orange line).

Energy parameters

Ps_m : starting power in machine M_m

$Pp_{m,j,n}$: processing power of operation $O_{m,j,n}$ of j^{th} job in m^{th} machine.

Pb_m : power Basic of machine M_m .

$Psp_{m,j',j,n',n}$: setup power of operation $O_{m,j,n}$ of job j in machine M_m (change machine setting from $O_{m,j',n'}$ to $O_{m,j,n}$).

$Poff_m$: power off to shutdown of machine M_m .

Energy objectives

Minimizing total energy consumption in all machines and non-operation energy at idle time .

$$\text{Min Total energy consumption } TTE = \sum_{m=1}^M E_m \quad (3-12)$$

$$\text{Min Total non-operative energy } TTE_{id} = \sum_{m=1}^M TE_{id_m} \quad (3-13)$$

Total energy consumed during production schedule, TTE, consists of flowing energy according our energy model for each machine.

- Es_m : starting energy of machine M_m .
- $Eoff_m$: turn off energy of machine M_m .
- Esb_m : standby energy of machine M_m .
- $Ep_{m,j,n}$: processing energy of operation $O_{m,j,n}$ of J_j in machine M_m .
- $Eo_{m,j,n}$: energy consumed during operation $O_{m,j,n}$ of J_j in machine M_m .
- $Eid_{m,j,n}$: idle time Energy between two jobs $J_{j'}$ and J_j in machine M_m .
- $Esp_{m,j',j,n}$: setup Energy of $O_{m,j,n}$ in machine M_m .
(machine setting change from $O_{m,j',n'}$ to $O_{m,j,n}$).
- $Eb_{m,j,n}$: basic non-productive energy of machine M_m during operation $O_{m,j,n}$.
- TE_{id_m} : total idle-time energy consumed machine M_m .
- TTE_{id} : total Idle-time energy consumed by all machine M_M in job shop problem.
- TE_{sp_m} : total set-up energy consumed by machine M_m .
- TTE_{sp} : total set-up energy consumed by all machine M_m .
- TE_{p_m} : total process energy consumed by machine M_m .
- TE_{o_m} : total processing energy consumed by machine M_m .
- TTE_p : total processing energy consumed by all machine M_m .
- TE_m : total energy consumed by machine M_m .
- TTE : total energy consumed by the workshop

Mathematical models

Energy consumption models consider three dynamic energy, setup energy, processes energy and idle energy (non-productive energy), and two static energy, turn on energy and turn off energy.

In classical energy models, processing power on a machine, Pp_m , is fixed independently of operation, and setup energy is constant.

$$E_m = Es_m + TE_{id_m} + TE_{p_m} + Ep_{sp} + Eoff_m \quad (3-14)$$

$$Es_m = P_s m t_{s m} \quad (3-15)$$

$$TE_{p_m} = \sum_{j=1}^J \sum_{n=1}^{N_j} Ep_{m,j,n} x_{m,j,n} \quad Ep_{m,j,n} = Pp_m t_{p_{m,j,n}} \quad (3-16)$$

Idle energy is calculated as the product of basic power and idle time (Equ. 3-7) for the machine (figure 3-4):

$$TE_{id\ m} = P_{b\ m} T t_{id\ m} \quad (3-17)$$

$$TE_{id\ m} = P_{b\ m} (C_m - W t_m) \quad (3-18)$$

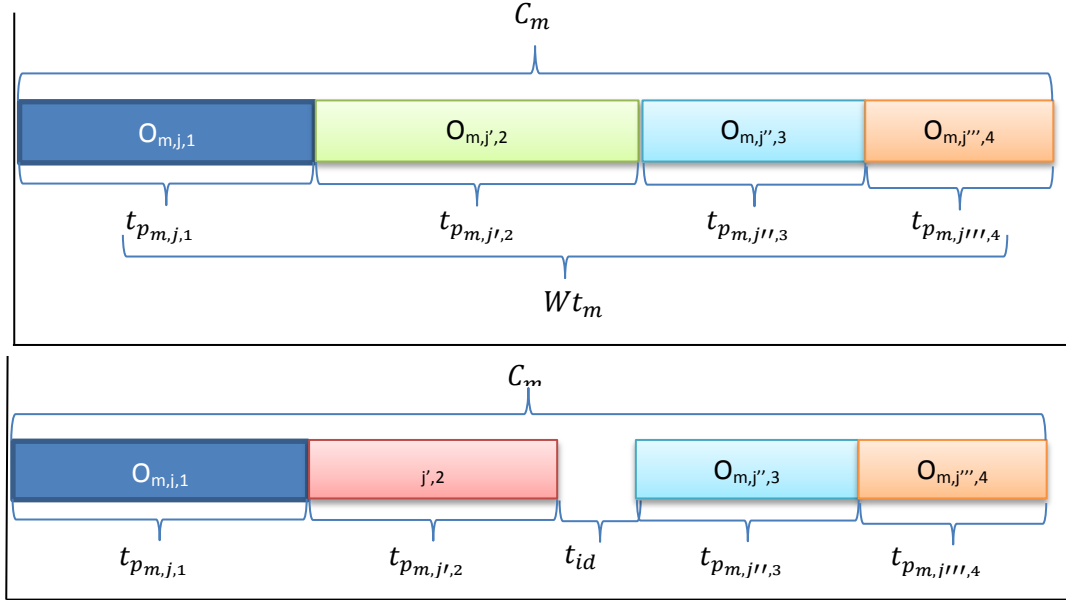

Figure 3-4 Idle time during machine operation

$E_{O_{m,j,n}}$, the energy consumed during the operation $O_{m,j,n}$, consists of processing energy $E_{p_{m,j,n}}$, and basic machine energy $E_{b_{m,j,n}}$, consumed during operation, as shown in (figure 3-5) :

$$E_{O_{m,j,n}} = (P_{p_{m,j,n}} + P_{b_m}) t_{p_{m,j,n}} \quad (3-19)$$

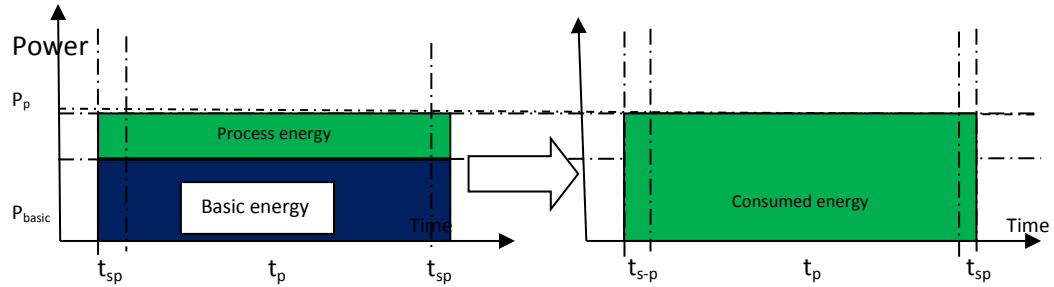

Figure 3-5 Sampled energy consumption models

In our model, processing energy depends on processing time and processing power, which varies with job operations $O_{j,n}$ and selected machine M_m . Setup energy depends on operations sequence.

$$TE_{sp\ m} = \sum_{j'=1}^J \sum_{j=1}^J \sum_{n'=1}^{N_{j'}} \sum_{n=1}^{N_j} (P_{sp_{m,j'j,n'n}} + P_{b_m}) t_{sp_{m,j'j,n'n}} \beta_{m,j'j,n'n} \quad (3-20)$$

$$TE_{O\ m} = \sum_{j=1}^J \sum_{n=1}^{N_j} E_{O_{m,j,n}} x_{m,j,n} = \sum_{j=1}^J \sum_{n=1}^{N_j} (P_{p_{m,j,n}} + P_{b_m}) t_{p_{m,j,n}} x_{m,j,n} \quad (3-21)$$

$$E_{off\ m} = P_{off\ m} t_{off\ m} \quad (3-22)$$

Our first objective consists in minimizing total energy consumption, the sum of energy consumed on each machine:

$$TTE = \sum_{m=1}^M TE_m \quad (3-12)$$

For each machine, the total sums start-up energy, total setup energy, total operating energy, total idle energy and shutdown energy:

$$TE_m = P_s t_{s m} + TEs p_m + TEo_m + TEid_m + P_{off m} t_{off m} \quad (3-23)$$

Finally the objective function is:

$$TTE = \sum_{m=1}^M P_s t_{s m} + \sum_{m=1}^M \sum_{j'=1}^J \sum_{j=1}^J \sum_{n'=1}^{N_{j'}} \sum_{n=1}^{N_j} (P_{sp_{m,j',j,n'}} + P_{bm}) t_{sp_{m,j',j,n'}} \beta_{m,j',j,n'} + \sum_{m=1}^M \sum_{j=1}^J \sum_{n=1}^{N_j} (P_{p_{m,j,n}} + P_{bm}) t_{p_{m,j,n}} x_{m,j,n} + \sum_{m=1}^M P_{bm} (C_m - W t_m) + \sum_{m=1}^M P_{off m} t_{off m} \quad (3-24)$$

According to the above definitions, the energy can be classified in following categories:

- Turn on Energy consumption for starting: the total energy consumption during the starting of machine.
- Setup power for preparing machine form one operation to another one including ramp down, tool changing, machine adjusting, ramp up, summarized by $P_{sp_{m,j',j,n'}}$.
- Operation power : power demand to distinctively operate components
- Constant power: energy consumption of remaining machine availability during idle state.
- Turn off power: Time for machine power-off: duration from machine switch-off until every component is inactivated. Energy consumption for power-off: the total energy to shut down the machine or the total energy consumption during the power-off period.

Therefore, from that we conclude the processing energy consumption, TE_m , required for all operations processed on a machine M_m is not constant which will be affected by different scheduling plans.

From lean manufacturing angle, the objective consists in reducing the non-productive energy consumption, i.e. the total idle time energy TTE_{id} and total setup energy TTE_{sp} . To achieve that aim, the objective function can also be set as the sum of all the non-productive energy consumed (only during idle-time in our model) by all the machines in a job shop to carry out a given job schedule.

3.5 Single population multi objective Genetic algorithm energy job shop scheduling

Genetic algorithms represent traditional methods, used in previous research and studies, to minimize energy in job shop scheduling problems. The objective of this GA. It reduces energy by minimising total work load and so total non-productive electricity consumption. In those genetic algorithms, chromosomes are selected according to processing time only. Operation energy has not effect to select the chromosome, so energy is indirectly reduced by minimizing workloads and idle time.

3.6 Multi population multi objective Genetic algorithm energy job shop scheduling MPGE1

This work (Al-Qaseer F., 2015) considers minimizing energy directly throw reducing operation energy. We agree with previous research and studies, taking into account the effect of time to reduce energy and about the great impact of non-productive time (idle) and its impact on energy. But we also take into account the direct impact of processes energy itself, because the power is not static but dynamically depends on the job operation $O_{j,n}$ and the machine M_m to operate the job J_j . Therefore we have a new population representation including operations (processing) energy, where each job operation $O_{j,n}$ has different energy values according to selected machine M_m .

In this genetic algorithm, we have two chromosomes, the first chromosome is represent energy is drown from energy population. This chromosome represents energy effect to the job shop scheduling. The second chromosome is drown from time population where it also carries the indirectly effect of energy in job shop scheduling. Our objectives are

Energy objectives;

1. Min Total energy consumption TTE
2. Min Total non-productive energy consumption TTE_{id}

Job shop objectives;

1. (C_{max}) , the makespan, i.e. the completion time on all machines in job shop scheduling
2. (TWt) , the total working time over all machines.
3. (TT_{id}) , the total non-productive time for the job shop scheduling

These objectives depend on following main variables:

1. Processing time $t_{p_{m,j,n}}$.
2. Processing power $P_{p_{m,j,n}}$
3. Setup time $t_{sp_{m,j',n'n}}$
4. Setup power $P_{sp_{m,j',n'n}}$
5. Idle times between the operations

The relationships between these objectives are very complex. As in most multi-objective optimization problems, energy objectives are compatible with the job shop objectives. Energy objectives depend on

all criteria, and job shop objectives are only depend on processing time $t_{p_{m,j,n}}$, setup time $t_{sp_{m,j',j,n}}$, and idle time between the operations.

This means that if the genetic algorithm works to reduce total energy without considering the directly energy effects (time population only), it may satisfy the job shop objectives without energy objectives. For example an operation of job $O_{j,n}$ can be processed with two machines $M_m, M_{m'}$ the first machine M_m has processing time $t_{p_{m,j,n}} = 5 \text{ min}$ and processing power $P_{p_{m,j,n}} = 20 \text{ kw}$, the second machine $M_{m'}$ has processing time $t_{p_{m',j,n}} = 5 \text{ min}$ and processing power $P_{p_{m',j,n}} = 15 \text{ kw}$. In this problem, optimization of energy objectives depends on chance, or needs large number of iterations.

3.6.1 MPGE1

The general frame of *MPGE1* is as follow:

Each chromosome represents a solution for the problem.

1. Initial population: The initial chromosomes are obtained by a mix of two assignment procedures (global minimum energy and global minimum time), here each chromosome represents the two populations. The chromosome that represents the energy population is selected by use global minimum energy and the other chromosome which presents the time population is selected by use global minimum time. This population (initial population, or new generations after crossover and mutation) must be evaluated to satisfy job shop scheduling constraints.
2. Fitness evaluation: The makespan and total energy consumption are computed for each chromosome in the current generation.
3. Selection: At iteration, the best chromosomes are chosen for reproduction by one among three different methods, i.e., binary tournament, n-size tournament and linear ranking.
4. Offspring generation: The new generation is obtained by changing the assignment of the operations to the machines (assignment crossover, assignment mutation, intelligent mutation) and by changing the sequencing of operations (crossover and mutation). These rules preserve feasibility of new individual's chromosomes. New individuals are generated until a fixed maximum number of individuals are reached. In our approach, only the new individuals form the mating pool for the next generation, at each algorithm step.
5. Stop criterion: Fixed number of generations is reached. If the stop criterion is satisfied, the algorithm ends and the best chromosome, together with the corresponding schedule, is given as output. Otherwise, the algorithm iterates again steps 3–5.

3.6.2 Initial Population

In order to deal with both time and energy optimization we select two initial population for time and energy. We use two ways to select initial population

- Assignment 1: search for the global minimum in the processing time.
- Assignment 2: search for the global minimum in the processing energy;

That mean the chromosomes are selected in two populations, where one chromosome is selected by searching the global minimum time, this chromosome represents time population, another one is selected by searching the global minimum processing energy as in the table 3-1, this chromosome represents energy population (figure 3-6).

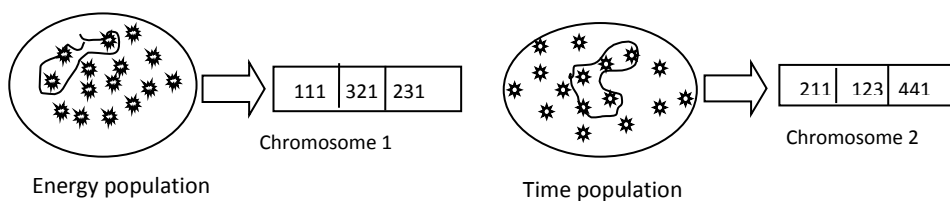

Figure 3-6 Initial population of the chromosomes

Table 3-1: Global minimum time assignment selection

Time		M1	M2	M3	Assig1	M1	M2	M3
$t_{p_{m,j,n}}$								
J1	O11	8	11	12	J1	O11	1	0
	O12	11	16	10		O12	0	0
	O13	11	13	12		O13	0	0
J2	O21	12	8	8	J2	O21	0	0
	O22	9	11	17		O22	1	0
	O23	17	8	10		O23	0	1
J3	O31	16	11	11	J3	O31	0	1
	O32	12	12	16		O32	0	1
	O33	9	12	14		O33	1	0
Energy		M1	M2	M3	Assig2	M1	M2	M3
$Eo_{m,j,n}$								
J1	O11	33	40	36	J1	O11	1	0
	O12	40	60	55		O12	1	0
	O13	55	35	40		O13	0	1
J2	O21	60	55	40	J2	O21	0	0
	O22	45	40	50		O22	0	1
	O23	36	30	40		O23	0	1
J3	O31	55	40	30	J3	O31	0	1
	O32	55	30	55		O32	0	0
	O33	40	30	55		O33	1	0

Chromosome assignments are applied with

1. Vertically research, machines search to the operations with minimum processing time and minimum processing energy.
2. And then, horizontally research; operations search the machines with minimum processing time and minimum processing energy

From global minimum operation time, we compare processing time to the first operations of all jobs, then the second operations of all jobs, until reaching to final operations of the jobs.

In our example of problem 3×3 , each job consisted of three operations ($O_{1,1}, O_{2,1}, O_{3,1}; O_{1,2}, O_{2,2}, O_{3,2}; O_{1,3}, O_{2,3}, O_{3,3}$), these operations can be process in the set machine $\{M_1, M_2, M_3\}$.

Processing time and processing energy of the first operation $O_{j,1}$ of the job J_j in machine $M_{m \rightarrow M}$ can be denoted by the set processing time and processing energy $t_{p_{m,j,1}}, E_{p_{m,j,1}}$ of operation $O_{m,j,1}$ as shown below:

The first $O_{j,1}$ of the job J_j in machine $M_{m \rightarrow M}$

$$\{t_{p_{1,1,1}}, t_{p_{2,1,1}}, t_{p_{3,1,1}}; t_{p_{1,2,1}}, t_{p_{2,2,1}}, t_{p_{3,2,1}}; t_{p_{1,3,1}}, t_{p_{2,3,1}}, t_{p_{3,3,1}}\},$$

$$\{E_{p_{1,1,1}}, E_{p_{2,1,1}}, E_{p_{3,1,1}}; E_{p_{1,2,1}}, E_{p_{2,2,1}}, E_{p_{3,2,1}}; E_{p_{1,3,1}}, E_{p_{2,3,1}}, E_{p_{3,3,1}}\}$$

The second $O_{j,2}$ of the job J_j in machine $M_{m \rightarrow M}$

$$\{t_{p_{1,1,2}}, t_{p_{2,1,2}}, t_{p_{3,1,2}}; t_{p_{1,2,2}}, t_{p_{2,2,2}}, t_{p_{3,2,2}}; t_{p_{1,3,2}}, t_{p_{2,3,2}}, t_{p_{3,3,2}}\},$$

$$\{E_{p_{1,1,2}}, E_{p_{2,1,2}}, E_{p_{3,1,2}}; E_{p_{1,2,2}}, E_{p_{2,2,2}}, E_{p_{3,2,2}}; E_{p_{1,3,2}}, E_{p_{2,3,2}}, E_{p_{3,3,2}}\},$$

The third $O_{j,2}$ of the job J_j in machine $M_{m \rightarrow M}$

$$\{t_{p_{1,1,3}}, t_{p_{2,1,3}}, t_{p_{3,1,3}}; t_{p_{1,2,3}}, t_{p_{2,2,3}}, t_{p_{3,2,3}}; t_{p_{1,3,3}}, t_{p_{2,3,3}}, t_{p_{3,3,3}}\}$$

$$\{E_{p_{1,1,3}}, E_{p_{2,1,3}}, E_{p_{3,1,3}}; E_{p_{1,2,3}}, E_{p_{2,2,3}}, E_{p_{3,2,3}}; E_{p_{1,3,3}}, E_{p_{2,3,3}}, E_{p_{3,3,3}}\}$$

Until reaching to final operations O_{j,N_j} of the jobs in machine $M_{m \rightarrow M}$

$$\{t_{p_{1,1,N_1}}, t_{p_{2,1,N_1}}, \dots, t_{p_{3,1,N_1}}; t_{p_{1,2,N_2}}, t_{p_{2,2,N_2}}, \dots, t_{p_{M,2,N_2}}; t_{p_{1,3,N_3}}, t_{p_{2,3,N_3}}, \dots, t_{p_{M,3,N_3}}\}$$

$$\{E_{p_{1,1,N_1}}, E_{p_{2,1,N_1}}, \dots, E_{p_{M,1,N_1}}; E_{p_{1,2,N_2}}, E_{p_{2,2,N_2}}, \dots, E_{p_{M,2,N_2}}; E_{p_{1,3,N_3}}, E_{p_{2,3,N_3}}, \dots, E_{p_{M,3,N_3}}\}$$

Or generally from the first jobs operations

$$\{t_{p_{1,1,1}}, t_{p_{2,1,1}}, \dots, t_{p_{M,1,1}}; t_{p_{1,2,1}}, t_{p_{2,2,1}}, \dots, t_{p_{M,2,1}}; \dots; t_{p_{1,J,1}}, t_{p_{2,J,1}}, \dots, t_{p_{M,J,1}}\},$$

$$\{E_{p_{1,1,1}}, E_{p_{2,1,1}}, \dots, E_{p_{M,1,1}}; E_{p_{1,2,1}}, E_{p_{2,2,1}}, \dots, E_{p_{M,2,1}}; \dots; E_{p_{1,J,1}}, E_{p_{2,J,1}}, \dots, E_{p_{M,J,1}}\}$$

Up to final operations of the jobs.

$$\{t_{p_{1,1,N_1}}, t_{p_{2,1,N_1}}, \dots, t_{p_{3,1,N_1}}; t_{p_{1,2,N_2}}, t_{p_{2,2,N_2}}, \dots, t_{p_{M,2,N_2}}; \dots; t_{p_{1,J,N_J}}, t_{p_{2,J,N_J}}, \dots, t_{p_{M,J,N_J}}\}$$

$$\{E_{p_{1,1,N_1}}, E_{p_{2,1,N_1}}, \dots, E_{p_{M,1,N_1}}; E_{p_{1,2,N_2}}, E_{p_{2,2,N_2}}, \dots, E_{p_{M,2,N_2}}; \dots; E_{p_{1,J,N_J}}, E_{p_{2,J,N_J}}, \dots, E_{p_{M,J,N_J}}\}$$

The processing time according operations set of all jobs explain in table 3-2, and the processing energy according operations set of all jobs explain in table 3-3

Table 3-2 Processing time (operations set)

First operations of all jobs	M1	M2	M3
O11	8	11	12
O21	12	8	8
O31	16	11	11
Second operations			
O12	11	16	10
O22	9	11	17
O32	12	12	16
Third operations			
O13	11	13	12
O23	17	8	10
O33	9	12	14

According to global minimum processing time of the example above, we cannot select machine M_1 to process operation $O_{1,3}$ because the $O_{3,3}$ has the smaller processing time if it process in M_1 comparing with the processing time of the operation $O_{1,3}$ if it process in machine M_1 .

Table 3-3 Processing energy (operation set)

First operations of all jobs	M1	M2	M3
O11	33	40	36
O21	60	55	40
O31	55	40	30
Second operations			
O12	40	60	55
O22	45	40	50
O32	55	30	55
Third operations			
O13	55	35	40
O23	36	30	40
O33	40	30	55

According to minimum processing energy, machine M_2 firstly select to process the operation $O_{3,1}$ but machine M_3 has the smaller processing energy if the operation $O_{3,1}$ is processed in this machine M_3 , from that M_3 is selected to process the operation $O_{3,1}$ to accord the constraint (one machine selected to process only one operation at the same time), and to accord the constraint (one operation process in

only one machine at the same time) machine M_2 is selected to process $O_{2,1}$, and M_2 cannot selected to process the operation $O_{3,3}$ because it is processed in machine M_2 with smallest processing energy comparing with the other machines(as explain in tables 3-4, 3-5).

Table 3-4 Global processing time assignment

First operations of all jobs	M1	M2	M3
O11	1	0	0
O21	0	1	0
O31	0	0	1
Second operations			
O12	0	0	1
O22	1	0	0
O32	0	1	0
Third operations			
O13	0	0	1
O23	0	1	0
O33	1	0	0

Table 3-5 Global processing energy assignment

First operations of all jobs	M1	M2	M3
O11	1	0	0
O21	0	1	0
O31	0	0	1
Second operations			
O12	1	0	0
O22	0	0	1
O32	0	1	0
Third operations			
O13	0	0	1
O23	1	0	0
O33	0	1	0

The first initial population represents the global minimum energy and time for the jobs, the parents chromosomes coded as shown in (Figure 3-7), according the assignments in table 3-4 and 3-5.

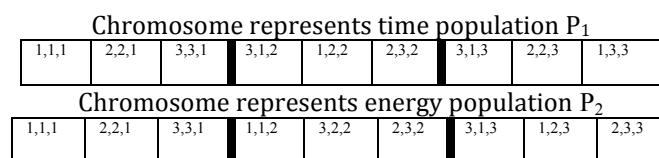

Fig. 3-7 First generation parents.

The chromosomes are divided into segments (as shown in figure 3-7), each segment represents the operations of jobs, number of elements in segment depends on number of machines and number of segments depends on number of operations in each jobs

These chromosomes are selected in the first generation from initial population are not the final or optimum solution, because they modify after each generation in the next iteration, by selection another values with new global minimum processing time and processing energy , by thesis method we can modify the genes of chromosome, and to ensure to test all better probability to find the best solution, selection of the initial population correctly which helps to ensure the best solution is correct with a few of iterations.

3.6.3 Chromosomes Crossover

The operation-based order crossover (OOX). The advantage of OOX is that it can avoid producing illegal chromosome in offspring. Given parent 1-P1 and parent 2-P2, OOX generates child 1-C1 and child 2-C2 by the following procedure (Fig. 3-8):

1. Randomly, choose the same operations from both of the parents P1 and P2. The local of the selected operations are preserved.
2. Copy the operations chosen at step 1 from P1 to C1, P2 to C2, the position of them are preserved in the offspring C1 and C2.
3. Copy the operations, which are not copied at step 2 , from P2 to C1, P1 to C2 , the order of them are preserved in the offspring. For example, in a 3×3 job shop.

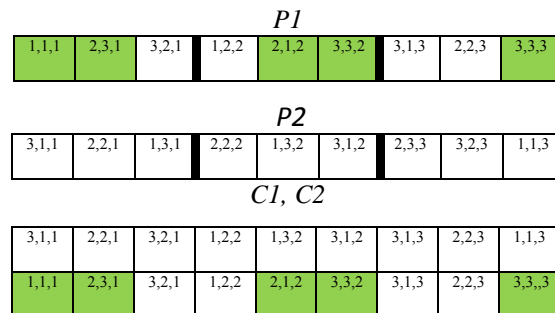

Fig.3-8 Crossover Processing

3.6.4 Mutation operator

The swap mutation operator is employed in this research which means two difference arbitrary genes of the parent chromosome are chosen and swap the values following

The above example, C'1 is the final child chromosome of P1 after applying mutation on C1 (Fig.3-9).

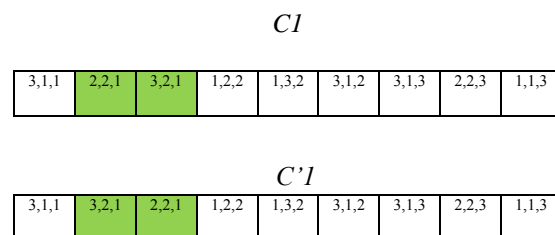

Fig.3-9 Mutation Processing

3.6.5 Fitness Function

In this genetic we have two decision make factions, minimum energy and minimum time, therefore we fine a relationship between energy and time, as following (Fig.3-10).

Assuming that the two parents are selected by the global minimum energy and time for the jobs, Total workload (WT) of P_i represent WT_0 and WT_l represent the total workload of each feasible child chromosomes in l generation; rt_l Reduction of total workload in iteration l .

Then for each l generation or iteration (crossover and mutation, etc.) we recalculate TW_{t_l} , C_{max_l} , TTE_l and TE_{id_l}

rTW_{t_l} : Reduction percentage of total workload in l iteration.

$$rTW_{t_l} = \frac{TW_{t_l}}{TW_{t_0}} \times \% \quad (3-25)$$

$rTTE_l$: Reduction percentage of total energy in l iteration

$$rTTE_l = \frac{TTE_l}{TTE_0} \times \% \quad (3-26)$$

$$rC_{max_l} = \frac{C_{max_l}}{C_{max_0}} \times \% \quad (3-27)$$

rC_{max_l} : Reduction percentage of makespan in l iteration

$$rTE_{id_l} = \frac{TE_{id_l}}{TE_{id_0}} \times \% \quad (3-28)$$

rTE_{id_l} : Reduction percentage of non-productive energy in l iteration

The average reduction AvR_l

$$AvR_l = \frac{rTW_{t_l} + rTTE_l + rC_{max_l} + rTE_{id_l}}{4} \quad (3-29)$$

AvR_l : Average of total reduction

AvR_l Represent the fitness faction to select the best sequence S with minimum energy and time.

Where l : iteration number $l = 1 \dots L$; L is total number of iteration

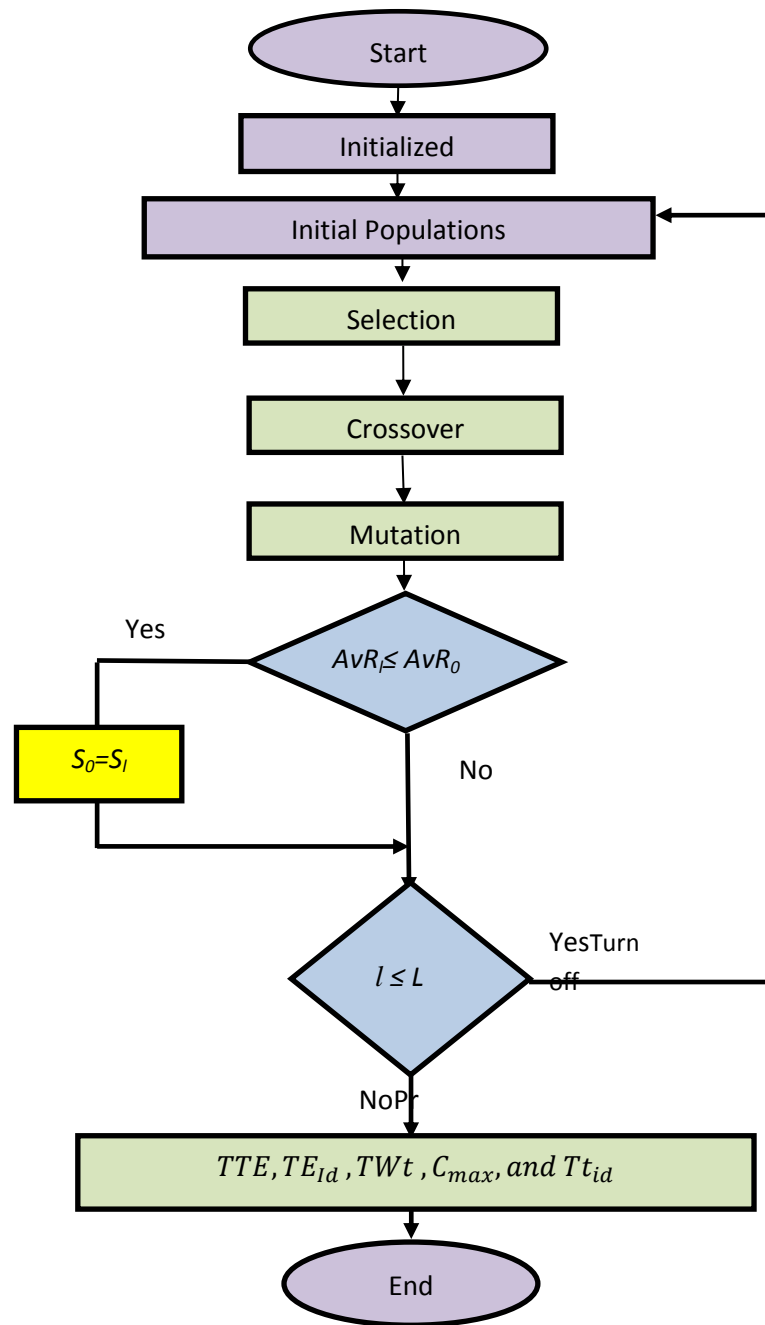

Fig.3-10 *MPGEI* Genetic algorithm energy job shop

The general objective of job shop scheduling is to find the optimum time for the workshop. In this paper we aim to optimize both energy and time. *MPGAI* tested with problems $(2 \times 2 \rightarrow 10 \times 10)$ with operations $(2 \rightarrow 16)$ the figures (3-11, 3-12, 3-13 and 3-14) shown the values rt_1, rE_1 and AvR_1 respectively. And table 3-6 shows the results of the examination the GEJ of several problems of scheduling problems where the results are compare with single GA.

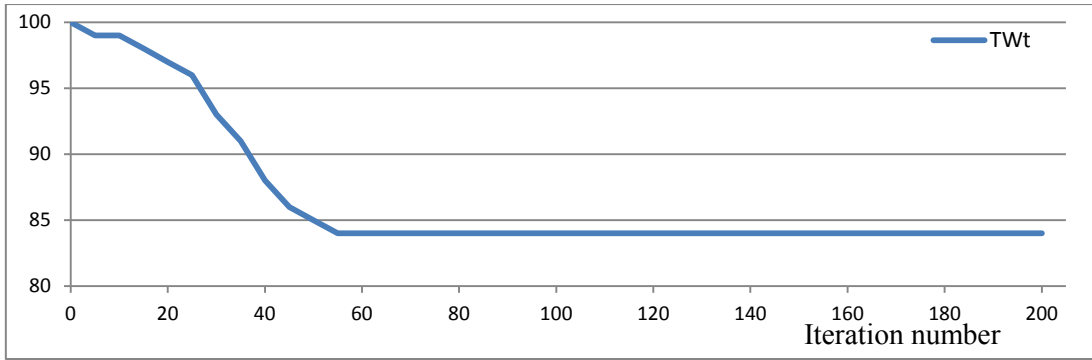

Fig. 3-11 Work load Reduction (job shop problem 4×4)

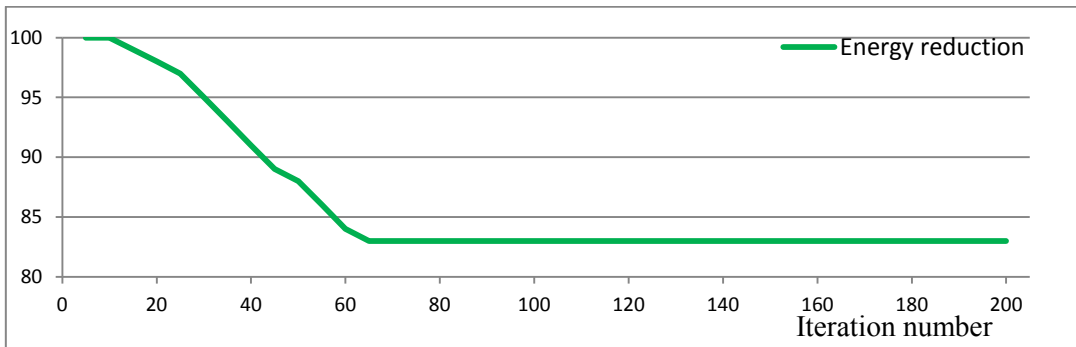

Fig. 3-12 Total Energy reduction (job shop problem 4×4)

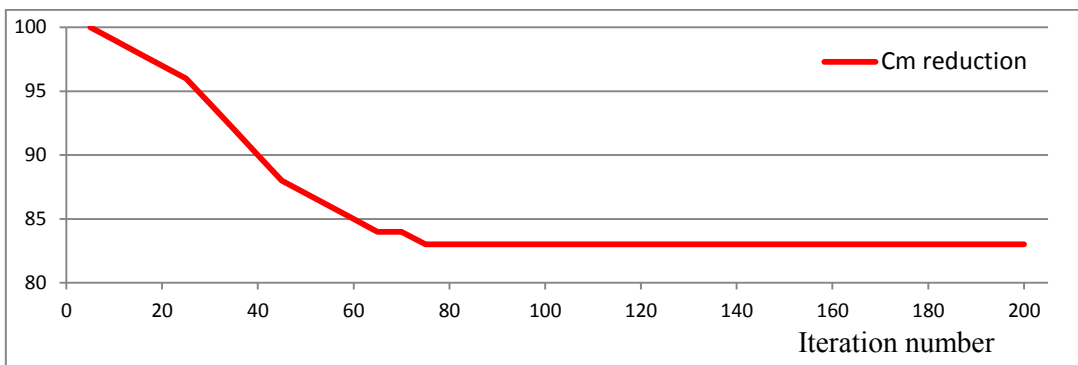

Fig. 3-13 Makespan reduction (job shop problem 4×4)

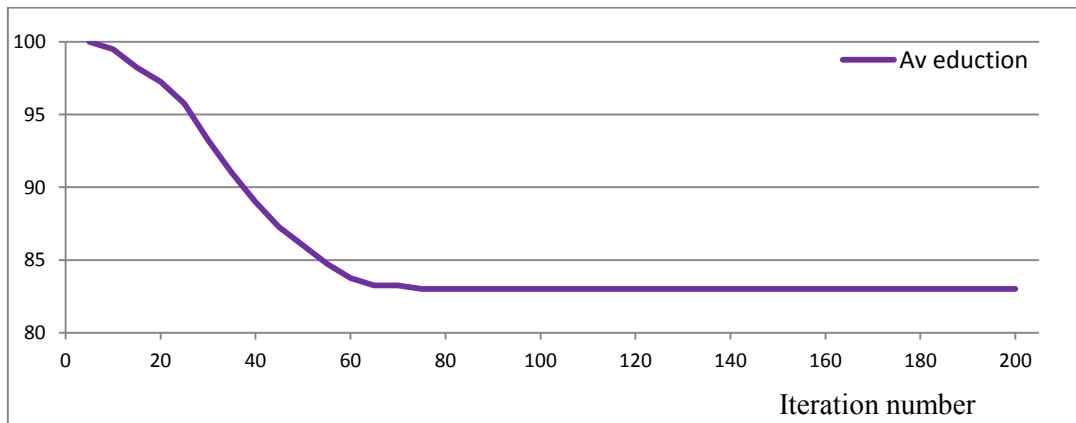

Fig. 3-14 AvR_1 Reduction (job shop problem 4×4)

Table 3-6 Results of the examination the MGEJ1 of several problems of scheduling problems

		6×6 -6	6×6-12	10×10-6	10×10-12	12×12-6	12×12-12
SPGA	C _{max} (min)	128	266	129	268	129	268
	TWt (min)	798	1744	1346	2910	1696	3374
	Tl _{dt} (min)	8	35	11	46	14	56
	T _{sp} (min)	124	340	210	457	262	542
	TE (KWh)	2618.42	5342.28	4292.45	8684.6	5051.22	10233
	CPU (min)	22.12	31.45	22.35	32.18	22.55	32.18
MPGA1	C _{max} (min)	124	266	128	268	132	270
	TWt (min)	788	1640	1248	2812	1498	3280
	Tl _{dt} (min)	6	22	8	51	14	58
	T _{sp} (min)	118	335	206	448	255	530
	TE (KWh)	2288.54	4832.2	3664.21	7960.17	4426.29	9596
	Er%	12.6%	9.5%	13.9%	8.3%	12%	6.2%
	CPU (min)	22.18	24.18	22.18	24.18	24.55	30.18

3.7 Multi population multi objective Genetic algorithm energy job shop scheduling *MPGE2*

Genetic algorithm generally consists of one single population; *MPGE1* used two chromosomes to represents two population but with complex populations that have diverges between their parameters or that have large population size this type of genetic is still work with limitations because of one chromosome is not enough to clearly represents these types of populations. However, better results can be achieved by introducing multiple populations in parallel. We use a genetic algorithm consist to two parallel subs genetic for each population, where each sub genetic population has individual route (selection, crossover, and mutation) but we added two operations after mutation operation, which are threshold operation and elite strategy as illustrate in figure (3-15).

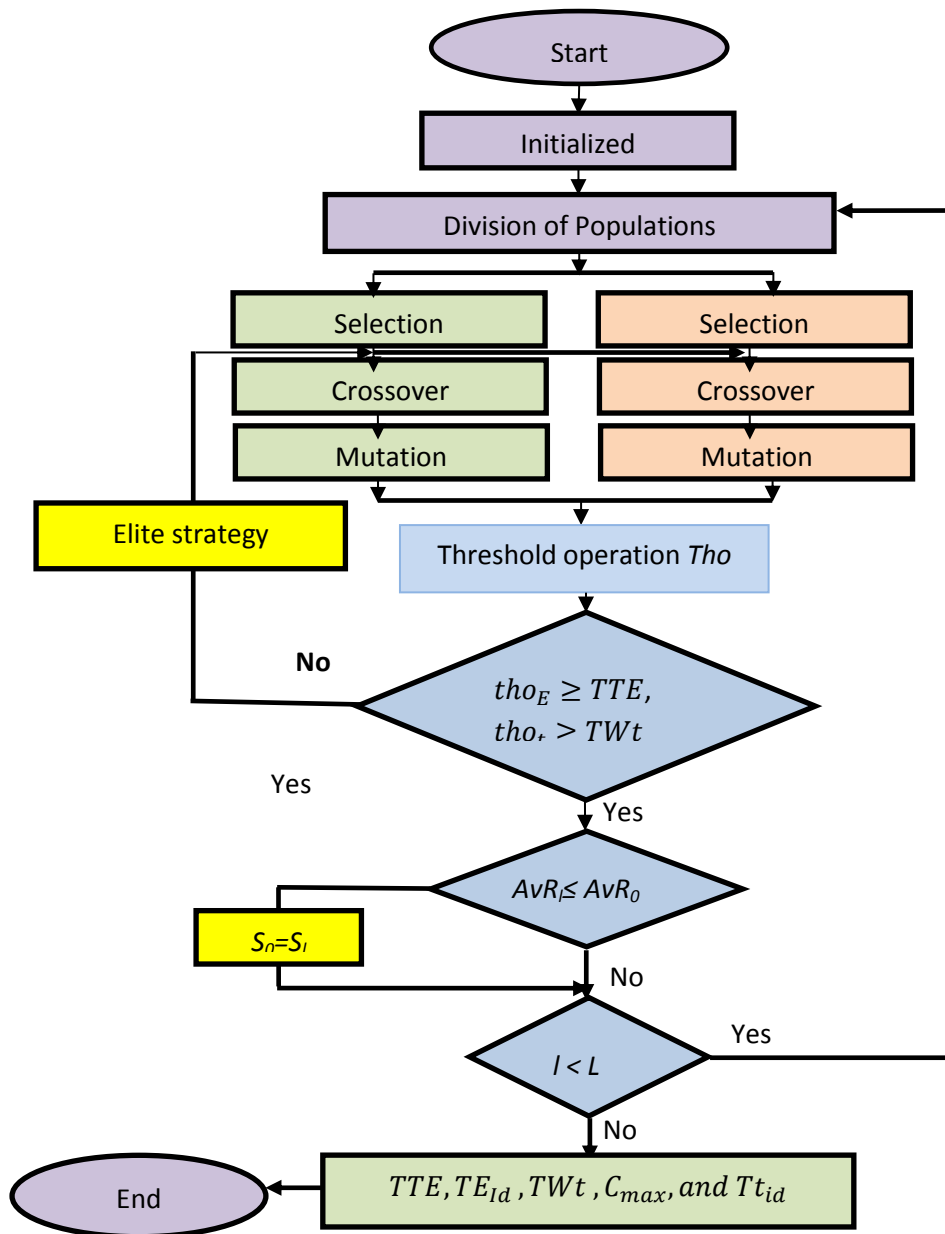

Figure 3-15 MPGA2 flow charts

3.7.1 Initial Population

The chromosomes are selected in two populations, where two chromosomes are selected by search the global minimum time these select to time sub genetic(as explain in table 3-7), this chromosome represent time population, another is selected. chromosome selection process consists in selecting two chromosomes which are selected by search the global minimum time for sub genetic1 or sub genetic of time, hover these chromosome represent time population, another are selected by search the global minimum processing energy, which represent energy population for sub GA2 or GA energy.

Table3-7: Global minimum time and energy assignments selection

Time		M1	M2	M3	Assig1		M1	M2	M3
J1	O11	8	11	12	J1	O11	1	2	0
	O12	11	16	10		O12	0	1	2
	O13	11	13	12		O13	1	0	2
J2	O21	12	8	8	J2	O21	0	1	2
	O22	9	11	17		O22	1	2	0
	O23	17	8	10		O23	0	1	2
J3	O31	16	14	11	J3	O31	0	0	1
	O32	12	13	16		O32	0	2	0
	O33	9	12	14		O33	1	2	0
Energy		M1	M2	M3	Assig2		M1	M2	M3
J1	O11	33	40	36	J1	O11	2	0	0
	O12	40	60	55		O12	1	0	0
	O13	55	35	40		O13	0	2	0
J2	O21	60	55	40	J2	O21	0	0	1
	O22	45	40	50		O22	2	1	0
	O23	36	30	40		O23	2	1	0
J3	O31	55	40	30	J3	O31	0	2	1
	O32	55	30	55		O32	0	1; 2	0
	O33	40	30	55		O33	2	1	0

Where the shaded numbers with green colour in the table 3-7 represent the two first chromosomes for each genetic, and the shaded number with yellow colore represent the two second chromosomes for each genetic, and figure 3-16 illustrate the first initial chromosomes for the two genetic algorithms.

1,3,1	2,1,1	3,3,1	2,2,2	1,2,2	1,3,2	2,3,2	3,2,2	3,3,2
3,3,1	2,2,1	1,1,1	2,2,2	1,2,4	3,2,3	2,3,3	1,3,2	3,3,1

Chromosome represents energy population P₁

1,1,1	2,1,3	3,1,3	2,2,1	1,2,4	3,2,4	2,3,2	1,3,1	3,3,1
1,1,2	2,1,2	3,1,4	2,2,2	1,2,3	3,2,2	2,3,3	1,3,3	3,3,2

Chromosome represents time population P₂

Figure 3-16 First initial chromosomes

3.7.2 Crossover Strategy

The crossover strategy is the same to that used in the *MPGE1*, also used operation-based order crossover (*OOX*).but here we have four chromosomes that mean we have two separated crossover for each genetic algorithms as in figure 3-17.

P ₁ GA1								
3,1,3	2,1,1	1,1,4	2,2,2	1,2,1	1,3,4	2,3,2	3,2,2	3,3,2
P ₂ GA1								
3,1,2	2,1,3	1,1,1	2,2,1	1,2,4	3,2,3	2,3,3	1,3,2	3,3,1
C ₁ GA1								
3,1,3	2,1,1	1,1,4	2,2,1	1,2,4	3,2,3	2,3,2	3,2,2	3,3,1
C ₂ GA1								
3,1,3	2,1,1	1,1,1	2,2,1	1,2,4	3,2,3	2,3,3	3,2,2	3,3,2
P ₁ GA2								
1,1,1	2,1,3	3,1,3	2,2,1	1,2,4	3,2,4	2,3,2	1,3,1	3,3,1
P ₁ GA2								
1,1,2	2,1,2	3,1,4	2,2,2	1,2,3	3,2,2	2,3,3	1,3,3	3,3,2
C ₁ GA2								
1,1,1	2,1,3	3,1,4	2,2,2	1,2,3	3,2,2	2,3,2	1,3,1	3,3,1
C ₁ GA2								
1,1,1	2,1,2	3,1,4	2,2,2	1,2,3	3,2,4	2,3,2	1,3,1	3,3,2

Figure 3-17 Crossover operation

3.7.3 Mutation operator

The swap mutation operator is employed in this research which means two difference arbitrary genes of the parent chromosome are chosen and swap the values. Following The above example, *C'1* is the final child chromosome of *P1* after applying mutation on *C1* (Fig.3-18).

C ₁ GA1								
3,1,3	2,1,1	1,1,4	2,2,1	1,2,4	3,2,3	2,3,2	3,2,2	3,3,1
C' ₁ GA1								
3,1,3	2,1,1	1,1,4	2,2,1	1,2,4	3,2,3	2,2,2	3,3,2	3,3,1
C ₂ GA1								
3,1,3	2,1,1	1,1,1	2,2,1	1,2,4	3,2,3	2,3,3	3,2,2	3,3,2
C' ₂ GA1								
3,1,3	2,1,1	1,1,1	2,2,1	1,2,4	3,2,3	2,3,3	3,3,2	3,2,2
C ₁ GA2								
1,1,1	2,1,3	3,1,4	2,2,2	1,2,3	3,2,2	2,3,2	1,3,1	3,3,1
C' ₁ GA2								
1,1,2	2,1,2	3,1,4	3,2,2	1,2,3	2,2,2	2,3,3	1,3,3	3,3,2
C ₂ GA2								
1,1,1	2,1,2	3,1,4	2,2,2	1,2,3	3,2,4	2,3,2	1,3,1	3,3,2
C' ₂ GA2								
1,1,1	2,1,2	3,1,4	2,2,2	1,2,3	3,2,4	3,3,2	1,3,1	2,3,2

Figure 3-18 Mutation operation

3.7.4 Threshold operation

It is also known that each sub GA has a specific objective, the first to reduce the energy required to schedule the jobs, while the second is in a traditional GA and their objective is to reduce the time required for job scheduling. Taking into consideration of the two GA structure and objective. Kemmoé S., (2015) proposed energy consumption threshold must not be exceeded to get optimum scheduling. In the MPEGGA2, first s-GA, which relied on the selection of chromosomes on the basis of minimum operating energy? Consequently, the energy is more accurate and high quality result, through it, this algorithm works as energy threshold thoE for the second algorithm. To improve energy objective in second GA, assume that

$$tho_{E_l} = \max\{TTE_{l_{C1G1}}, TTE_{l_{C2G1}}\} \quad (3-30)$$

tho_{E_l} : Energy threshold value in l iteration

$TTE_{l_{C1G1}}$: Total energy in machine according the feasible scheduling plans s of the first child in first sub-GA1 in l iteration

$TTE_{l_{C2G1}}$: Total energy in machine according the feasible scheduling plans s of the second child in first sub-GA1 in l iteration

Otherwise for the second s-GA2 because it select by select global minimum operation time, therefore it has high job time scheduling quality result. This algorithm works as time threshold tho_t the first sub-GA1 algorithm. To improve scheduling time objective in the first sub-GA1, assume that

$$tho_{t_l} = \max\{TWt_{l_{C1G2}}, TWt_{l_{C2G2}}\} \quad (3-31)$$

tho_{t_l} : Time threshold value in l iteration.

$TWt_{l_{C1G2}}$: Total work load in machine according the feasible scheduling plans s of the first child in second sub-GA2 in l iteration

$TWt_{l_{C2G2}}$: Total work load in machine according the feasible scheduling plans s of the second child in second sub-GA2 in l iteration

This method improves both GA objectives, to achieve the objective (reduction total energy, non-productive energy, and total work time load, and makespan, total idle time). In this method all chromosomes are evaluated and modified the up normal gene has maximum operation time or it may be has maximum operation energy and adapting these genes, (as see in figure 3-19 and 3-20) by local crossovers-mutation between them to modify their values of these gens (processing time and processing energy), this modification must be take into account and ensure the job shop constraints.

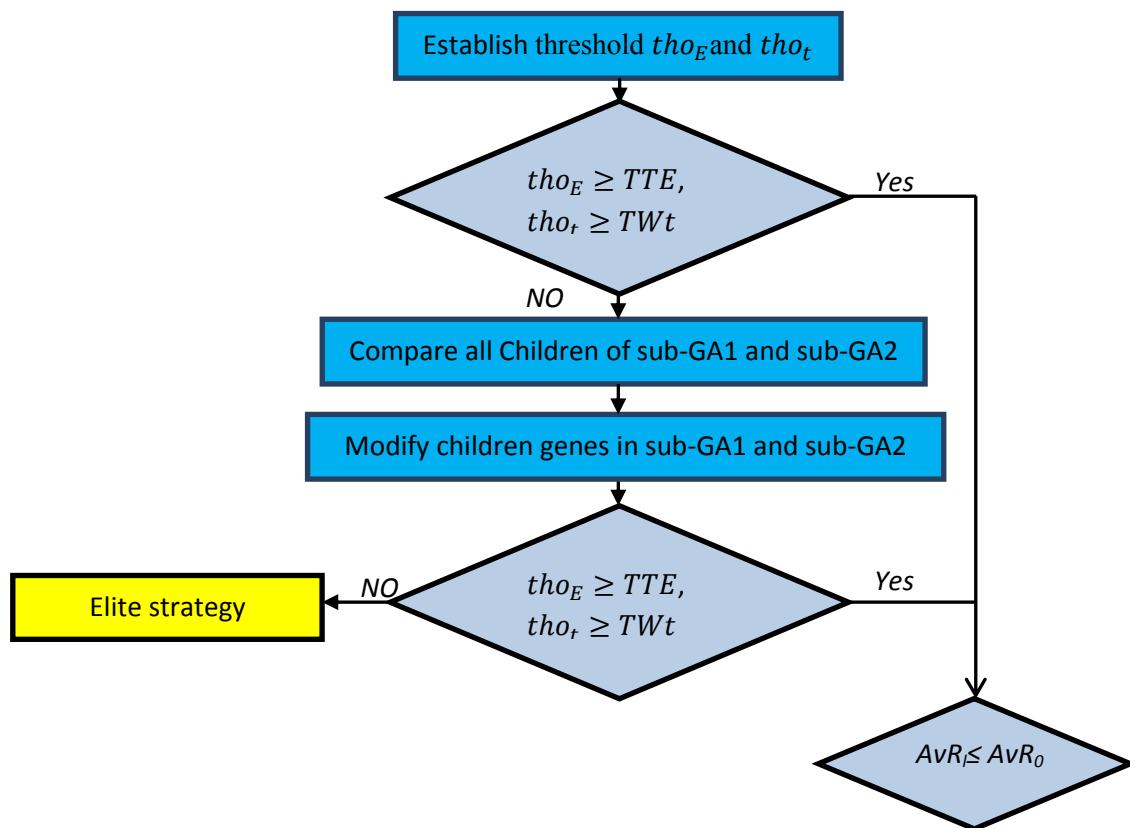

Figure 3-19 Threshold operation

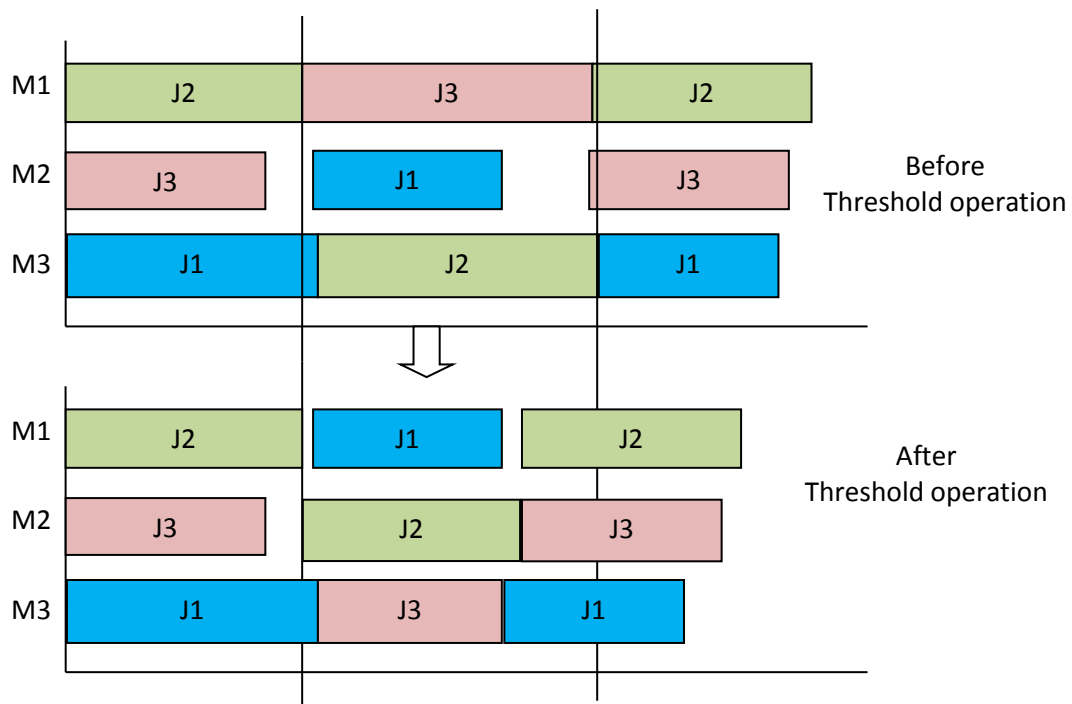

Figure 3-20 Adaptation of a solution by using Threshold operation

3.7.5 Elitism strategy

Operators such as selection, crossover and mutation are applied to generate the individuals of the next generation. Elitism involves copying a small proportion of the fittest candidates, (Shengxiang Y., 2008) unchanged, into the next generation (Shengxiang Y., 2007). This can sometimes have a dramatic impact on performance by ensuring that the EA does not waste time re-discovering previously discarded partial solutions (Renato T., 2007.) Reduces the diversity of the population. Candidate solutions that are preserved unchanged through elitism remain eligible for selection as parents when breeding the remainder of the next generation. If the chromosomes children not succeed in the threshold operations, we have four chromosomes children must be elite (figure 3-21) to select two new chromosomes that represent the parents for the next generation.

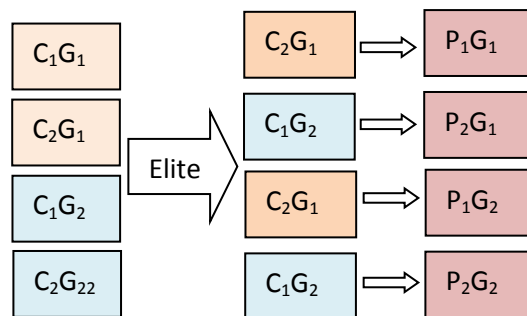

Figure 3-21 Elitism strategy

The first stricture of the MPGA not consisted to Threshold operation and elitism strategy figure 3-22 explains the effect of the Threshold operation and elitism strategy in problem job shop 10× 10.

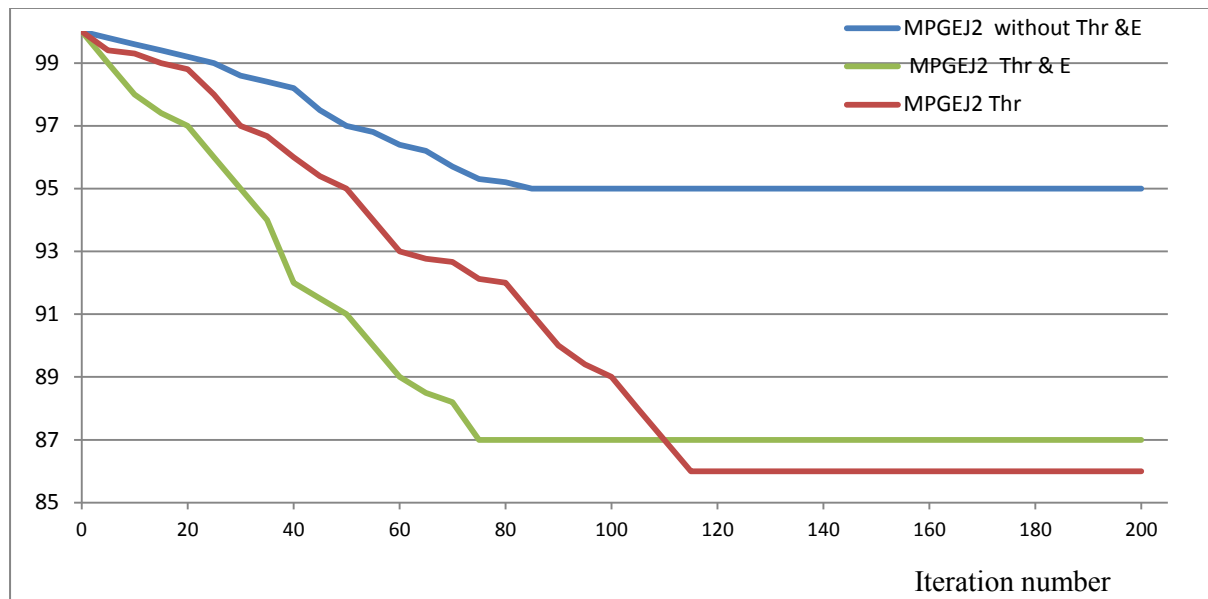

Figure 3-22 Threshold operation and elitism strategy effect to reduce total energy in *MPGE2*

Threshold operation reduces the error of solution, where the threshold reduces the deviation from the target objectives of the genetic algorithm, generally each sub GA has different objectives, and the threshold works to have been converge these objectives. But it increases the time required for each iteration loop because it acts as an internal cycle within the iteration loop. The elitism strategy reduces the time of iteration to get the solution and reach to objectives with little number of internal threshold cycles. Because it reduces the number of population probability at in for example in our MPG2 we have firstly four chromosomes two for each sub genetic but elitism strategy elected the best two from four copy insert them in the two sub genetics in the next internal threshold cycle. However, reducing population probability also reduces solution quality, and this is one of disadvantage of the elitism strategy. The MPGA2 result is explained in table 3-8.

Table 3-8 Result of *MPGE2*

		6×6 -6	6×6-12	10×10-6	10×10-12	12×12-6	12×12-12
SPGA	C _{max} (min)	128	266	129	268	129	268
	TWt (min)	798	1744	1346	2910	1696	3374
	TIdt (min)	8	35	11	46	14	56
	T _{sp} (min)	124	340	210	457	262	542
	TE (KWh)	2618.42	5342.28	4292.45	8684.6	5051.22	10233
	CPU (min)	22.12	31.45	22.35	32.18	22.55	32.18
MPGA1	C _{max} (min)	124	266	128	268	132	270
	TWt (min)	788	1640	1248	2812	1498	3280
	TIdt (min)	6	22	8	51	14	58
	T _{sp} (min)	118	335	206	448	255	530
	TE (KWh)	2288.54	4832.2	3664.21	7960.17	4426.29	9596
	Er%	12.6%	9.5%	13.9%	8.3%	12%	6.2%
	CPU (min)	22.18	24.18	22.18	24.18	24.55	30.18
MPGA2	C _{max} (min)	122	262	126	264	129	268
	TWt (min)	776	1560	1246	2684	1494	3172
	TIdt (min)	6	18	6	40	12	46
	T _{sp} (min)	114	332	206	438	242	524
	TE (KWh)	2198.85	4726.28	3632.85	7888	4319.34	9328.2
	Er%	16%	11.5%	14.5%	11.4%	14.4%	8%
	CPU (min)	24.25	30.25	24.25	32.55	25.58	35.45

3.8 Case study and conclusion

In this chapter, we used three type genetic algorithms:

1. Classical genetic algorithm with single population (SGA).
2. Classical with parent select from two different populations one with operation energy criterion and the other with operation time criterion (*MPGE1*.)
3. Parallel genetic algorithm *MPGE2* with two population, with three strategies: classical parallel, parallel with threshold operation, and parallel with threshold operation and elitism strategy, as discussed above (3.5.4 and 3,5.5),

However after exclusion classical SGA we have two GA. all these genetics are multi objective GA, hover the different between these GA the first GA reduce total energy by reducing total work load and idle time only, these GA were tested with different fixable job shop scheduling problem to test their performance their ability to find solution. The database is developed 10×10 with 5 operations in each job. This database is based on the Fisher and Thompson instance (F&T). To satisfy the requirements

of this research. The job shop problem given in table 3-9, where the numbers are the operation time for each operation of each job.

Table 3-9 Processing time $t_{p_{m,j,n}}$ of $O_{m,j,n}$ (number of operations of jobs =5)

$t_{p_{m,j,n}}$ min	M1	M2	M3	M4	M5
J1	(29) (36) (29) (28) (39)	(23) (20) (25) (21) (29)	(21) (25) (39) (24) (20)	(21) (25) (21) (29) (19)	(14) (26) (22) (21) (26)
J2	(25) (24) (28) (18) (52)	(26) (37) (61) (13) (32)	(31) (26) (26) (14) (22)	(26) (29) (26) (14) (25)	(25) (13) (21) (17) (24)
J3	(22) (28) (19) (26) (19)	(23) (29) (20) (25) (15)	(21) (25) (39) (17) (30)	(21) (25) (31) (19) (19)	(14) (16) (22) (21) (26)
J4	(19) (18) (14) (22) (22)	(13) (32) (16) (17) (21)	(31) (26) (26) (24) (22)	(26) (29) (26) (21) (25)	(25) (13) (21) (17) (24)
J5	(29) (28) (19) (26) (29)	(23) (30) (21) (19) (25)	(21) (15) (19) (24) (19)	(21) (25) (21) (29) (19)	(14) (26) (22) (22) (26)
J6	(24) (22) (22) (25) (28)	(26) (27) (21) (23) (22)	(31) (26) (26) (24) (32)	(26) (29) (26) (21) (25)	(25) (23) (26) (17) (24)
J7	(29) (28) (19) (26) (19)	(43) (20) (25) (21) (29)	(21) (25) (29) (24) (20)	(21) (25) (19) (19) (19)	(24) (16) (22) (21) (26)
J8	(19) (18) (14) (22) (22)	(13) (32) (16) (17) (21)	(19) (28) (24) (22) (22)	(13) (32) (16) (17) (21)	(31) (26) (26) (24) (22)
J9	(29) (28) (21) (36) (29)	(23) (20) (275) (21) (29)	(22) (85) (39) (24) (20)	(21) (95) (71) (29) (9)	(14) (26) (22) (21) (26)
J10	(19) (18) (14) (22) (22)	(13) (32) (16) (17) (21)	(13) (32) (16) (17) (21)	(19) (28) (24) (22) (22)	(23) (32) (16) (17) (21)
J11	(21) (15) (19) (24) (19)	(21) (25) (21) (29) (19)	(14) (26) (22) (22) (26)	(26) (27) (21) (23) (22)	(24) (26) (22) (21) (26)
$t_{p_{m,j,n}}$ min	M6	M7	M8	M9	M10
J1	(21) (22) (26) (24) (21)	(28) (36) (26) (22) (30)	(10) (12) (29) (25) (23)	(22) (25) (18) (22) (33)	(19) (21) (19) (22) (23)
J2	(22) (27) (25) (26) (25)	(21) (32) (19) (30) (25)	(18) (19) (18) (26) (19)	(11) (26) (18) (22) (24)	(26) (27) (22) (20) (25)
J3	(14) (20) (26) (24) (21)	(29) (18) (21) (26) (19)	(23) (30) (25) (31) (19)	(22) (25) (18) (22) (23)	(19) (21) (19) (22) (23)
J4	(22) (27) (25) (26) (25)	(21) (32) (19) (30) (25)	(18) (19) (18) (36) (19)	(17) (20) (26) (26) (34)	(26) (17) (22) (20) (25)
J5	(15) (22) (26) (24) (21)	(26) (26) (28) (22) (30)	(29) (18) (24) (26) (29)	(22) (20) (19) (25) (23)	(29) (21) (29) (32) (23)
J6	(22) (37) (25) (26) (25)	(21) (32) (19) (30) (55)	(18) (19) (28) (36) (19)	(16) (45) (25) (26) (24)	(26) (27) (22) (20) (25)
J7	(21) (22) (26) (24) (21)	(19) (28) (21) (36) (19)	(23) (30) (25) (31) (19)	(22) (15) (18) (22) (23)	(29) (21) (29) (22) (23)
J8	(22) (27) (25) (26) (25)	(21) (32) (29) (30) (55)	(28) (19) (28) (36) (29)	(18) (30) (29) (26) (24)	(26) (27) (22) (20) (25)
J9	(29) (28) (21) (36) (29)	(23) (20) (25) (21) (29)	(20) (17) (29) (25) (33)	(22) (25) (28) (22) (23)	(29) (21) (29) (22) (23)
J10	(22) (37) (25) (26) (25)	(24) (36) (29) (35) (23)	(28) (19) (28) (36) (29)	(15) (24) (19) (36) (30)	(36) (27) (32) (20) (35)
J11	(15) (32) (26) (24) (24)	(20) (26) (26) (22) (30)	(20) (22) (19) (25) (33)	(22) (25) (28) (22) (23)	(19) (31) (29) (22) (33)

And energy parameters given in table 3-10, 3-11-A and 3-11-B.

Table 3-10 Machine electricity characteristics

	P _{basic} W	Starting (Term on)			Shutdown(Term off)		
		P _s W	t _s min	E _s ws	P _{off}	t _{off} min	E _{off} ws
M1	2400	1700	4.3	438600	1300	1.2	93600
M2	3360	1800	5.7	615600	1600	1.6	153600
M3	2000	1400	4.0	336000	1200	0.8	57600
M4	2300	1200	5.8	417600	1000	1.2	72000
M5	3600	1500	4.6	414000	1100	1.5	99000
M6	6300	2300	3.5	483000	1700	1.8	183600
M7	4700	1700	2.2	224400	1100	1.3	85800
M8	6200	2100	4.6	579600	1500	1.2	108000
M9	5700	1600	5.3	508800	1300	1.7	132600
M10	3800	2000	2.8	336000	1200	1.3	93600

Table (3-11-A) Operation power $p_{p_{m,j,n}}$ of $O_{m,j,n}$ (number of operations of jobs =5)

$P_{p_{m,j,n}}$ W	M1		M2		M3		M4		M5	
J1	(2450)	(5730)	(3900)	(3300)	(5700)	(2550)	(4350)	(4760)	(4620)	(3520)
	(3000)	(2700)	(3550)	(6080)	(3600)	(4900)	(3970)	(3170)	(5600)	(7800)
	(4300)		(3250)		(5700)		(3780)		(2980)	
J2	(5050)	(4750)	(6000)	(2800)	(4670)	(3600)	(3870)	(5500)	(5100)	(2980)
	(9700)	(3050)	(3540)	(5100)	(4200)	(6500)	(2560)	(6500)	(3500)	(4890)
	(4300)		(3970)		(4760)		(3250)		(3970)	
J3	2450	(5730)	(3900)	(3300)	(5700)	(2550)	(4350)	(4760)	(4620)	(3520)
	(5000)	(2700)	(5550)	(3080)	(3600)	(4900)	(3970)	(3170)	(5600)	(2800)
	(4300)		(3250)		(5700)		(3780)		(2980)	
J4	(5050)	(4750)	(6000)	(2800)	(4670)	(3600)	(3870)	(5500)	(5100)	(2980)
	(7700)	(3050)	(3540)	(5100)	(4200)	(3000)	(2560)	(5500)	(3500)	(4890)
	(4300)		(3970)		(4760)		(3250)		(3970)	
J5	(2450)	(5000)	(3900)	(3300)	(5700)	(2550)	(4350)	(4760)	(4620)	(3520)
	(2700)	(5730)	(5550)	(9080)	(3600)	(4900)	(3970)	(3170)	(5600)	(4800)
	(4300)		(3250)		(5700)		(3780)		(2980)	
J6	(5700)	(5050)	(6000)	(2800)	(4670)	(3600)	(3870)	(5500)	(5100)	(2980)
	(4750)	(3050)	(3540)	(5100)	(4200)	(3000)	(2560)	(3500)	(3500)	(4890)
	(4300)		(3970)		(4760)		(3250)		(3970)	
J7	2450	(5730)	(3900)	(3300)	(5700)	(2550)	(4350)	(4760)	(4620)	(3520)
	(4000)	(2700)	(6550)	(4080)	(3600)	(4900)	(3970)	(3170)	(5600)	(2800)
	(4300)		(3250)		(5700)		(3780)		(2980)	
J8	(5050)	(4750)	(6000)	(2800)	(4670)	(3600)	(3870)	(5500)	(5100)	(2980)
	(4700)	(3050)	(3540)	(5100)	(4200)	(3000)	(2560)	(3500)	(3600)	(4890)
	(4300)		(3970)		(4760)		(3250)		(3970)	
J9	2450	(5730)	(3900)	(3300)	(5700)	(2550)	(4350)	(4760)	(4620)	(3520)
	(5600)	(2700)	(4550)	(7080)	(3600)	(4900)	(3970)	(3170)	(5600)	(2900)
	(4300)		(3250)		(5700)		(3780)		(2980)	
J10	(5050)	(4750)	(6000)	(2800)	(4670)	(3600)	(3870)	(5500)	(5100)	(2980)
	(7000)	(3050)	(3540)	(5100)	(4200)	(3000)	(2560)	(5400)	(3500)	(4890)
	(4300)		(3970)		(4760)		(3250)		(3970)	
J11	2450	(5730)	(3900)	(3300)	(5700)	(2550)	(4350)	(4760)	(4620)	(3520)
	(5000)	(2700)	(8550)	(3080)	(3600)	(4900)	(3970)	(3170)	(5600)	(8050)
	(4300)		(2560)		(5700)		(3780)		(2980)	

Table (3-11-B) Operation power $p_{p_{m,j,n}}$ of $O_{m,j,n}$ (number of operations of jobs =5)

$P_{p_{m,j,n}} W$	M6		M7		M8		M9		M10	
J1	(6200) (2670) (10000)	(4900) (5130)	(5800) (8100) (5000)	(4900) (3600)	(4800) (4280) (3370)	(3300) (4700)	(5290) (2750) (4500)	(3960) (4000)	(5210) (3250) (5000)	(4780) (3800)
J2	(7080) (4480) (2720)	(2420) (3520)	(9000) (3390) (5500)	(8030) (3500)	(5100) (4000) (3520)	(5690) (2900)	(5060) (2520) (4260)	(3450) (4200)	(3700) (3400) (3500)	(5000) (5210)
J3	(9200) (2670) (5000)	(4900) (5130)	(8100) (5000) (4900)	(3600) (5800)	(7900) (4280) (3370)	(2300) (2700)	(5290) (2750) (3500)	(2960) (3000)	(5210) (3250) (5000)	(4780) (4800)
J4	(9080) (4480) (7720)	7420 (3520)	(9000) (3390) (5500)	(6030) (3500)	(8000) (3520) (5690)	(2900) (5100)	(4360) (2520) (4260)	(3450) (4300)	(2700) (3400) (3500)	(5000) (5210)
J5	(9200) (5130) (5000)	(2670) (4900)	(5800) (7100) (5000)	(4900) (3600)	(7100) (4280) (3370)	(2300) (2700)	(5290) (2750) (8500)	(2960) (4000)	(5210) (3250) (5000)	(4780) (3800)
J6	(8080) (4480) (2720)	(2420) (3520)	(8000) (3390) (5500)	(9030) (3500)	(5100) (5700) (3520)	(5690) (2900)	(4760) (2520) (4260)	(3450) (4500)	(3700) (3400) (3500)	(3000) (5210)
J7	(5200) (2670) (6000)	(4900) (5130)	(5800) (3100) (5000)	(4900) (3600)	(3900) (4280) (3370)	(2300) (2700)	(5290) (2750) (4500)	(2960) (3000)	(5210) (3250) (5000)	(4780) (6800)
J8	(4080) (4480) (2720)	(2420) (3520)	(3000) (3390) (5500)	(2030) (3500)	(5100) (5000) (3520)	(5690) (2900)	(10060) (2520) (4260)	(3450) (4000)	(3700) (3400) (3500)	(4000) (5210)
J9	(11200) (2670) (3000)	(4900) (5130)	(5800) (5100) (5000)	(4900) (3600)	(4900) (4280) (3370)	(2300) (2700)	(5290) (2750) (2500)	(2960) (3000)	(5210) (3250) (5000)	(4780) (5800)
J10	(2080) (4480) (2720)	(2420) (3520)	(3000) (3390) (5500)	(2030) (3500)	(5100) (4000) (3520)	(5690) (2900)	(2060) (2520) (4260)	(3450) (4000)	(2700) (3400) (3500)	(3000) (5210)
J11	(3200) (2670) (3000)	(4900) (5130)	(5800) (2100) (5000)	(4900) (3600)	(2900) (4280) (3370)	(2300) (2700)	(5290) (2750) (2500)	(2960) (3000)	(5210) (3250) (5000)	(4780) (3800)

Performance measurement is done by measuring the percentage of total energy reduction and the makespan reduction of each algorithm.

We use the same fitness function as following:

$rTWt_l$: Reduction percentage of total workload in l iteration.

$$rTWt_l = \frac{TWt_l}{TWt_0} \times \% \quad (3-25)$$

$rTTE_l$: Reduction percentage of total energy in l iteration

$$rTTE_l = \frac{TTE_l}{TTE_0} \times \% \quad (3-26)$$

$$rC_{max_l} = \frac{C_{max_l}}{C_{max_0}} \times \% \quad (3-27)$$

rC_{max_l} : Reduction percentage of makespan in l iteration

$$rTE_{id\ l} = \frac{TE_{id\ l}}{TE_{id\ 0}} \times \% \quad (3-28)$$

$rTE_{id\ l}$: Reduction percentage of non-productive energy in l iteration

The average reduction AvR_l

$$AvR_l = \frac{rTWt_l + rTTE_l + rC_{max\ l} + rTE_{id\ l}}{4} \quad (3-29)$$

Where l : iteration number $l = 1 \dots L$ total number of iteration

TE_0 is the average of total energy at first five iterations and TE_l is the total energy of l iteration, as the same method was applied to test makespan reduction; here C_0 is the average of makespan at the first five iterations and C_l where l is number of iteration $l = 1, \dots, L$, L is total number of iteration.

The four algorithms were checked for the same job shop problem (3×3) up to (12×12). Figure 3-23 illustrate the makespan reduction and figure 3-24 the total energy reduction. From the figure 3-23 single population SPGA is faster to reduce total work load and makespan by comparing it with multi populations GA. SPGA design to reduce total energy by reduction makespan and total idle time to reduce non-productive energy that mean the reduction of energy is secondary objective, but MPGA have the best results for energy reduction. But when it work with multi objective the other genetic best reduce both energy and total work load

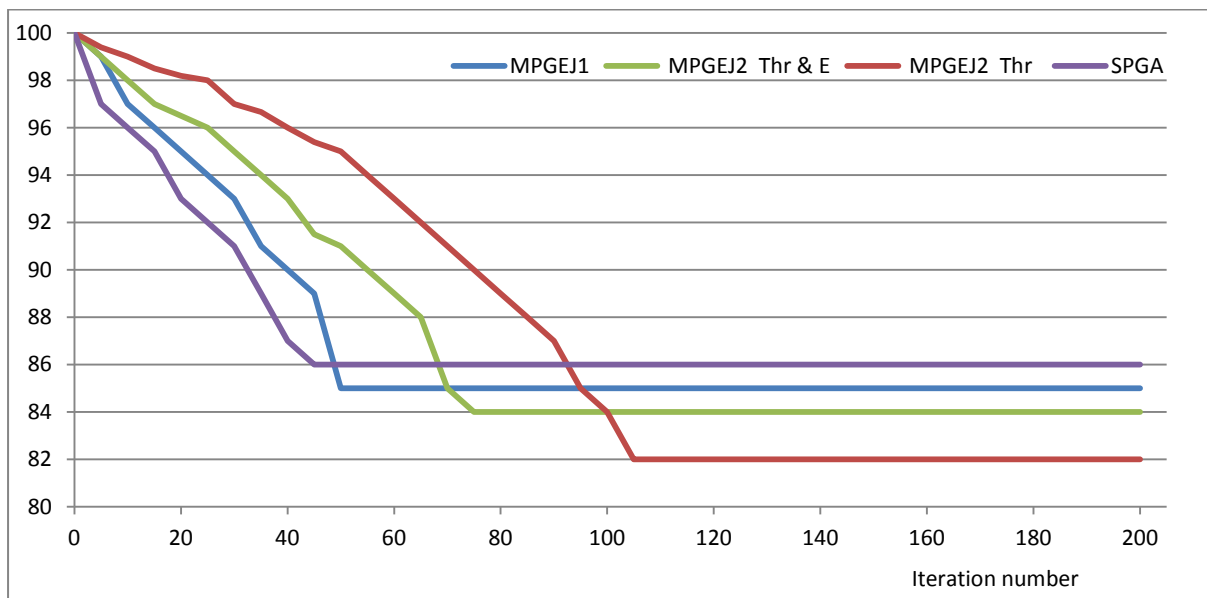

Figure 3-23 Total work load % reduction

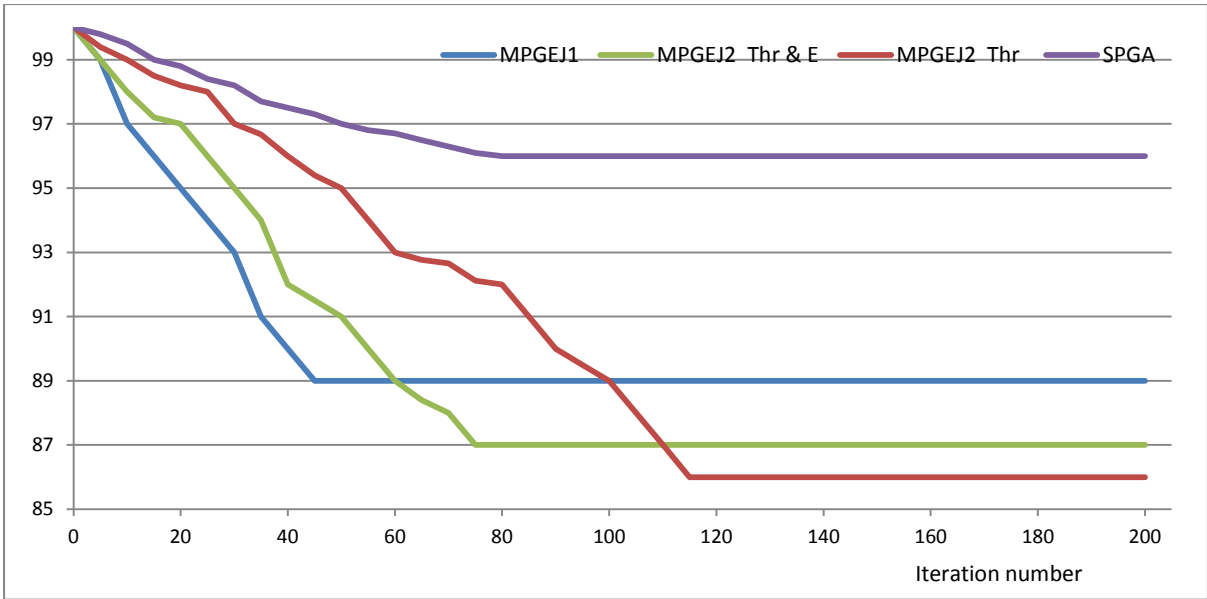

Figure 3-24 Total energy % reduction

As shown in the figure 3-24 the maximum energy reduction in MPGA2 only with threshold operation but this genetic algorithm needs a long time to finish here iteration because of the internal threshold cycle, we can reduce this time by using an elitism strategy but this strategy also reduces energy and makespan reduction.

Comparison of the four algorithms is illustrated by the figure 3-25. Table 3-12 explains the general results of these genetic algorithms.

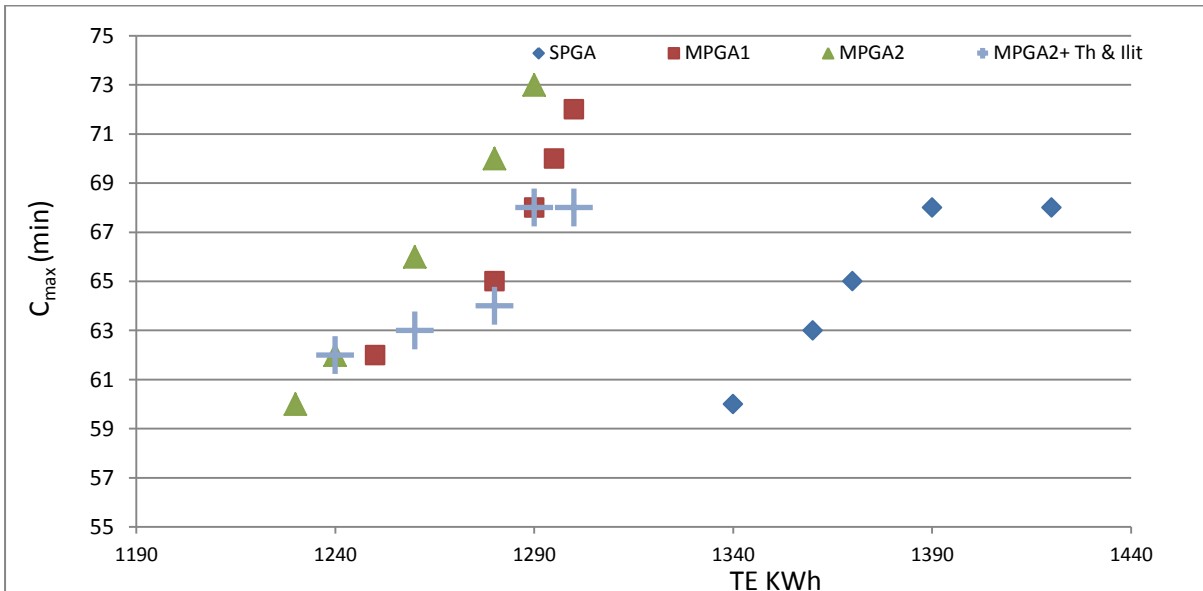

Figure 3-25 Total energy and makespan of Job shop problem 6x6 n=6

Table 3-12 Summaries of all genetic algorithms

Method	Objectives	Indicators	Number of populations	Limitation
1 SPGA	Total energy Makespan	Reduction of total energy by reduction total machine work load and idle time.	Only time population	Operation energy not effect
MPGA1	Total energy Makespan	Directly reduction operation energy reduction indirectly by reduction total machine work load and idle time.	Processing energy and processing time	Small and medium JS up to 6×6
MPGA2 tho	Total energy Makespan	Directly reduction operation energy reduction indirectly by reduction total machine work load and idle time.	Processing energy and processing time	Genetic processing time CPU very long
MPGA2 tho &E	Total energy Makespan	Directly reduction operation energy reduction indirectly by reduction total machine work load and idle time.	Processing energy and processing time	Results have less accurate and processing time than CPU of MPGA2 tho

Chapter Four

Mixed Integer and Linear constraint programming Job Shop Energy Optimization MILCE

Number	Name	Page
4	Mixed Integer and Linear constraint programming Job Shop Energy Optimization MILCE	83
4.1	Introduction	84
4.2	Development environment	84
	4.2.1 Constraint Programming	84
	4.2.2 Linear Programming	84
	4.2.3 Mixed Integer Programming MIP	86
	4.2.4 Mixed Integer and Constraint Programming	86
	4.2.4.1 Branch and Bound	86
	4.2.4.2 Branch and cut	87
	4.2.4.3 Strong Branching	88
	4.2.5 ILOG CPLEX	88
4.3	Mathematical model, constraints and objectives	89
	4.3.1 Job shop	89
	4.3.2 Energy consumption	91
4.4	Minimize Energy Constrain Programming ECP	93
4.5	A Mixed Integer Linear Programming Minimized Energy MILPE	96
	4.5.1 Classification trees	97
	4.5.1.1 Jobs-Operations-Machines trees (J-O-M)	98
	4.5.1.2 Machines-Operations-Jobs trees (M-O-J)	107
	4.5.2 Lower and Upper bound limits	117
	4.5.3 Local Lower and Upper bound limits	118
	4.5.4 Branching	120
	4.5.5 Left shift	121
	4.5.6 Turn on/off or standby to reduce total energy	123
4.6	Case study and Conclusions	126

4 Mixed Integer and Linear constraint programming Job Shop Energy Optimization MILCE

4.1 Introduction

Mixed Integer Programming (MIP) is often the default approach for solving scheduling problems. Mixed Integer Programming (MIP) has been widely applied to scheduling problems and it is often the initial approach to attack a new scheduling problem. For example, of the 60 research papers published in the 18 Journal, use MIP, more than any other technology. Given this popularity, together with the improvements in commercial MIP technology (Hojae L., 2017, Kooli A., 2014; Wang T., 2015, Karimi S., 2017), it is valuable to understand how various MIP model can be used for scheduling optimization. In this chapter we developed, a mixed integer linear programming (MILP) and constraint programming (CP) job shop scheduling, to minimize total energy consumption, as well as total weighted tardiness and idle times of the machines. A case study based on a modified 12×12 job shop is presented to show the effectiveness and to prove the feasibility of the model.

In the implementation phase, we will present the development environment, the software used, and then we present our implementation approach.

4.2 Development environment

4.2.1 Constraint Programming

Constraint programming (CP) is a programming paradigm in computing (Altinakar S.,2016,Hinder O., 2017, Rossi R., 2015), where relationships between variables are expressed in terms of constraints (equations) (Olarte C., 2015). In computer science, constraint programming is a programming model where relationships between variables are mentioned in the form of constitutions (Goel V., 2015). Constraint programming methods are different from usual programming languages in that they do not specify a step or series of steps to implement them, but the properties of the looked-for solution. It is currently used as a software technology for the description and resolution of particularly difficult combinatorial problems, especially in the areas of planning and scheduling tasks (Shen L., 2018).

4.2.2 Linear Programming

Linear programming (LP) is a basic and important method that helps decision-makers to make correct decisions in a scientific way (Kemmoé S., 2015). Linear programming is part of mathematical programming (Yamanaka N., 2014), including linear and nonlinear programming; mathematical programming is in turn part of a more comprehensive subject, called operations research (Tanaka S.,2012), all of which concern management, transportation, agriculture, industry. Here, we seek to minimize linear multi-objective function placed into linear mathematical constraints as well. Our linear optimization problem requires minimizing a linear function on a convex polyhedron. The

function that is minimized as well as the constraints are described by linear expressions, hence the name given to these problems. Linear Optimization (LO) is the discipline that studies these problems. It is also called linear programming, a term introduced by George Dantzig around 1947(George B.D.1978), but this name tends to be abandoned because of possible confusion with the notion of computer programming. As shown in figure 4-1 it must have the following basics:

1. The existence of an objective or goal to be reached such as achieving greater profit or achieving a minimal cost or economy in time or effort and more. This is expressed as a linear mathematical dimension that we call the goal or profit continuum in the case of maximization, or the consequent loss in case of minimization.
2. The presence of a large number of variables or unknowns that must determine their values to reach the following end required, and these are called variables decision.
3. There are linear correlations between these variables and these relationships are called constraints.

The general formal of LP \min or $\max z = c_1x_1 + c_2x_2 + c_3x_3 + \dots c_nx_n$

Subject to $a_{11}x_1 + a_{12}x_2 + a_{13}x_3 + \dots + a_{1n}x_n (\leq, =, \geq) b_1$

$a_{21}x_1 + a_{22}x_2 + a_{23}x_3 + \dots + a_{2n}x_n (\leq, =, \geq) b_2$

$a_{m1}x_1 + a_{m2}x_2 + a_{m3}x_3 + \dots + a_{mn}x_n (\leq, =, \geq) b_m$

- Z is the objective function.
- x_1, x_2, \dots, x_n are the decision variables.
- The expression ($\leq, =, \geq$) means that each constraint may take any one of the three signs.
- c_j ($j = 1, \dots, n$) represents the per unit cost or profit to the j^{th} variable.
- b_i ($i = 1, \dots, m$) is the requirement or availability of the i^{th} constraint.
- $x_1, x_2, \dots, x_n \geq 0$ is the subset of non-negative restriction on the LP.

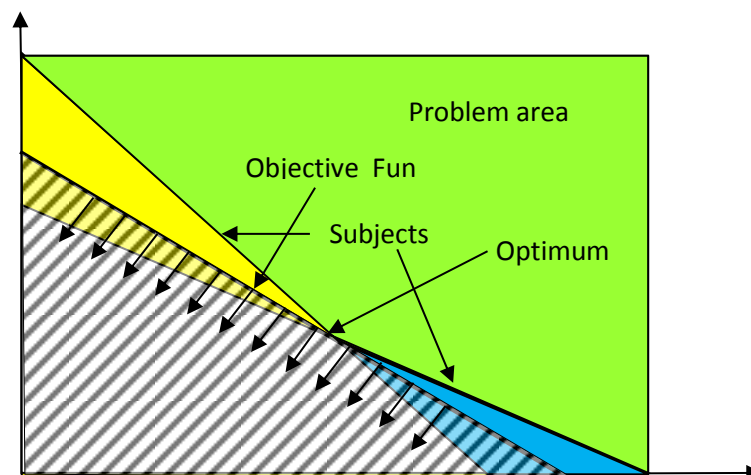

Figure 4-1 Linear programming

In real life problems, negative decision variables have no valid meaning. In this module we shall only discuss cases in which the constraints are strictly inequalities (either have a \leq or \geq).

4.2.3 Mixed Integer Programming (MIP)

A mixed integer programming (MIP) issue is one where a portion of the choice factors are compelled to be whole number esteems (Pochet Y., Laurence A. W., 2006) “*entire numbers, for example, -1, 0,1,2, and so forth at the ideal arrangement*”. The utilization of whole number factors extraordinarily extends the extent of valuable streamlining issues that can characterize and comprehend (Schultz R., 2003). An extraordinary case is a choice variable X_1 that must be either 0 or 1 at the arrangement. Such factors are called 0-1 or paired whole number factors and can be utilized to display yes/no choices, for example, selecting or not machine m to carry operation n of job j . Indeed, even with exceedingly complex calculations and present day supercomputers, there are models with only a couple of hundred number factors that have never been understood to optimality. This is on the grounds that numerous mixes of particular whole number esteems for the factors must be tried, and every blend requires the arrangement of a “*typical*” straight or nonlinear improvement issue. The quantity of blends can rise exponentially with the extent of the issue.

4.2.4 Mixed Integer and Constraint Programming

Since MIP and CP issues are non-raised, they should be understood by some sort of deliberate and conceivably comprehensive hunt. The “*work of art*” (Schultz R., 2003) technique for tackling these issues is called Branch and Bound. This strategy starts by finding the ideal answer for the “*unwinding*” of the issue without the whole number limitations “*through standard straight or nonlinear enhancement techniques*” (Ghimire D., Lee J ,2011). On the off chance that in this arrangement, the choice factors with number imperatives have whole number esteems, at that point no further work is required (James C., 2018).

Forefront Systems streamlining agents understand blended whole number and limitation programming issues utilizing these strategies:

- Branch and Bound
- Branch and cut
- Strong Branching

For a clarification of these sorts of issues, please observe Mixed-Integer and Constraint Programming.

4.2.4.1 Branch and Bound

Branch and Bound technique to tackle MIP issues. Its speed constraints make it appropriate just for issues with a modest number (maybe 50 to 100) (Pochet Y., Laurence A. W., 2006) whole number

factors. The Branch and Bound method tries to explore intelligently all admissible solutions by eliminating the search space subsets of solutions that cannot provide an optimal solution. Stidsen T., (2014) developed branch and bound method for solving a subclass of bi-objective mixed integer programming problems to find the full subset of non-dominated points, lower bounds correspond to solutions of a single-objective scalarized version of the original bi-objective problem.. The Premium Solver and Premium Solver Platform utilize an expanded branch and bound technique that backings the all different imperative as a local sort, and in addition diminished cost settling for whole number factors. Introduced a general-purpose branch-and-bound algorithm for bi-objective mixed integer linear programming, and the continuous variables may appear in both objective functions. Research can be represented by the decomposition of a set of solutions (figure 4-2). It is this representation that comes with the name "tree search method".

- Each sub-problem created during exploration symbolizes a node from a tree. The root node represents the initial problem.
- The branches of the tree symbolize the separation process. They represent the relationship between nodes.
- When separated, the "Father" node creates a set of "child" nodes, this method represents sub solution rout or solution level.
- The nodes refer to solution method, where it branching between the upper and lower bounds

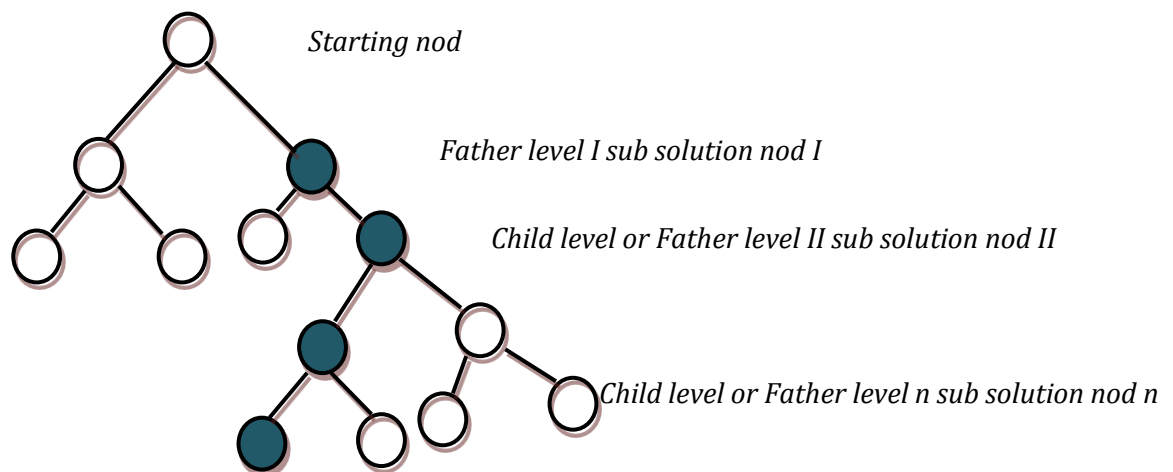

Figure 4-2 Branch-bound method

The shaded node represents the optimum possible solution with different solution levels until Reach the goal.

4.2.4.2 Branch and cutting

The branch and cutting is a way to improve the synthesis of linear programming to solve the right problems. Lower bound can be defined as a polynomially solvable multi-objective problem

(Jozefowicz N., 2012), they developed the lower and upper bounds by defining the lower and upper bounds as sets of points in the objective spaces as opposed to single values. Effectively calculate the lower limit, can be express it as the solution of a pseudo-polynomially solvable multi-objective problem. "Cuts," is a method to reduce the span of the attainable locale for the advancement sub problems that must be illuminated, without killing any potential number arrangements (Letchford A., Lodi A., 2003). The branch-and-cut procedure manages a search tree consisting of nodes (Toussaint H., (2013) the branch and cut is a branch and bound with dynamic generation of constraints.

4.2.4.3 Strong Branching

Strong Branching is a technique used to assess the effect of stretching on every number variable on the goal work "its pseudo cost", (Jozefowicz N., 2012). by playing out a couple of emphases of the Dual Simplex strategy.(Danna E., 2007) Such pseudo costs are utilized to manage the decision of the following sub problem to investigate, and the following number variable to branch upon, all through the Branch and Bound process.

4.2.5 ILOG CPLEX

ILOG CPLEX (more commonly known as "CPLEX") is an IT optimization tool. Its name refers to the C language and the simplex algorithm. It consists of an executable called "*interactive CPLEX*" and a function library that can interface with different programming languages C, C ++, C # and Java. ILOG is a French company; publisher of management software, this computer company bought in 1997 the activity of CPLEX optimization. Our construction processes are:

- Pre-processing; first to read a text file that represents the instance to solve, this file represent the parameters and variables of power and time. In the coding phase we used C ++. This software started in 1983; it was an improvement of the C language. C ++ is a programming language that allows programming under multiple paradigms, procedural programming, object-oriented programming and generic programming, it is widely used. Nobody has the C⁺⁺ language, it is free. Programming in C⁺⁺ has the phases:
- Edit the program with a text editor.
- Compile the program with (g⁺⁺).The main advantages of C⁺⁺ are: large number of features, performances of C, ease of use of object languages, portability of the source files, ease of conversion of C programs into C⁺⁺, and, in particular, ability to use all the features of C language, and increased error control. The characteristics of C⁺⁺ make it an ideal language for certain types of projects. It is essential in the realization of major programs. The current compiler optimizations also make it a favourite's language for those looking for performance. Finally, this language is, with the C, ideal for those who must ensure the portability of their programs at the source files (not executables).

- Node and variable selection: And then create by C programming a new text file containing the same data of first instance with the addition of new data such as, number of machines, number of jobs, and number of operations to each job, the energy matrixes (operation energy, Start up Time of each machine, deduced from each job, the operation time matrix and the sting time matrix. At the first part (C program) we create total possible rote to solve scheduling problem with different probability solutions for each job and machine, where the nodes represent machines and arrows possibility to operate the job in the machines figure 4-3

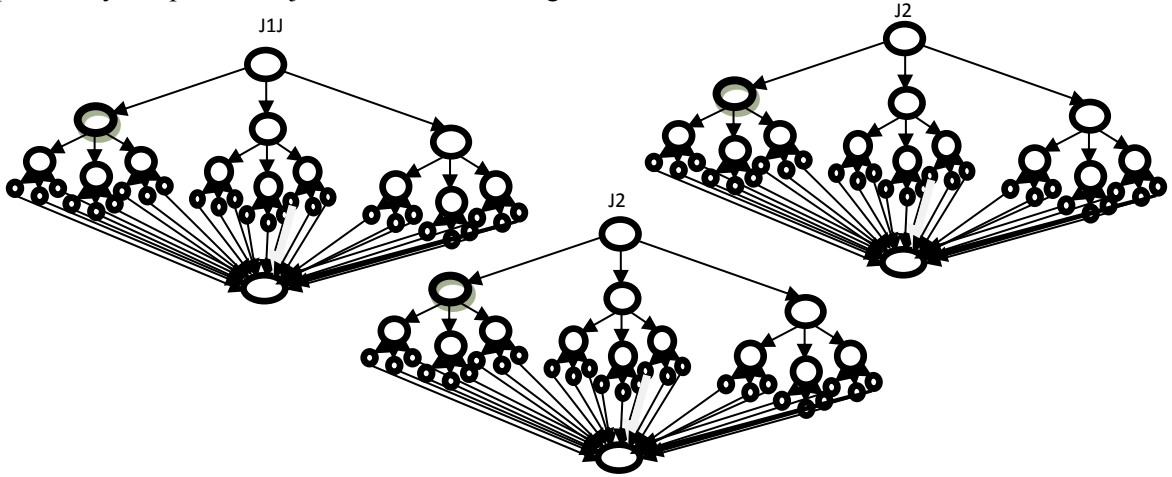

Figure 4-3 Total possible solution

Once the instance is ready, a second file will be created containing the complete model to solve by CPLEX, where searches step by step the optimum sequences of each job with minimum intersection with other jobs to ensure the reduction idle time. This method similar to travelling in the roads, but we have two differences objectives there are total energy and total workload time with minimized makespan of total machines.

4.3 Mathematical model, constraints and objectives

4.3.1 Job shop

Firstly, we consider minimizing the following six objectives:

1. (C_{max}), the makespan, i.e. the completion time on all machines in job shop scheduling
2. (TWt), the total working time over all machines.
3. (TT_{id}), the total non-productive time for the job shop scheduling

- **Notations:**

\mathcal{M} : a finite set of M machines ; $\mathcal{M} = \{M_m\}_{m=1}^M$

\mathcal{J} : a finite set of job J jobs, $\mathcal{J} = \{J_j\}_{j=1}^J$

\mathcal{O}_j : a finite set of N_j ordered operation of J_j , $\mathcal{O}_j = \{O_{j,n}\}_{n=1}^{N_j}$;

$O_{m,j,n}$: n -th operation of job J_j on machine M_m

\mathcal{S} : a finite set of all feasible scheduling plans; $\mathcal{S} = \{s\}$

t_{s_m} : start up time of machine M_m .

$t_{off\ m}$: turn off time of machine M_m .

$t_{p_{m,j,n}}$: processing time of operation $O_{m,j,n}$ on machine M_m

$t_{id\ m,j,n}$: idle time between $O_{m,j',n'}$ and $O_{m,j,n}$ on machine M_m .

$t_{sp_{m,j',j,n'n}}$: setup time of $O_{m,j,n}$ on M_m depends on machine and precedes job

$S_{m,j,n}$: starting time of $O_{m,j,n}$ on M_m

$Ct_{m,j,n}$: completion time of $O_{m,j,n}$ on machine M_m

- Decision variables

$$x_{m,j,n} = \begin{cases} 1 & \text{if the } n\text{-th operation of } J_j \text{ is performed on } M_m \\ 0 & \text{otherwise} \end{cases}$$

$$\beta_{m,j',j,n'n} = \begin{cases} 1 & \text{if } O_{m,j',n'} \text{ precedes } O_{m,j,n} \text{ on } M_m \\ 0 & \text{otherwise} \end{cases}$$

• Job shop objective function computation

$$Ct_{m,j,n} = S_{m,j,n} + t_{o_{m,j,n}} \quad (3-1)$$

(C_m) , the completion time on the machine M_m

$$C_m = \max_{j,n} \{Ct_{m,j,n}\} \quad (3-2)$$

$$C_{max} = \max_{m,j,n} \{Ct_{m,j,n}\} \quad (3-3)$$

$$t_{o_{m,j,n}} = t_{p_{m,j,n}} x_{m,j,n} + t_{sp_{m,j',j,n'n}} \beta_{m,j',j,n'n} \quad n > 1 \quad (3-4)$$

(Wt_m) , the total working time spent at machines M_m .

$$Wt_m = \sum_{j=1}^J \sum_{n=1}^{N_j} t_{o_{m,j,n}} x_{m,j,n} \quad (3-5)$$

$$TW_t = \sum_{m=1}^M Wt_m \quad (3-6)$$

(T_{id_m}) , the non-productive time, i.e. idle time, for machine M_m

$$Tt_{id\ m} = C_m - Wt_m \quad (3-7)$$

$$TTt_{id\ t} = \sum_{m=1}^M Tt_{id\ m} \quad (3-8)$$

- **Job shop Constraints**

- A machine cannot process more than one operation at a time:

$$\sum_{j=1}^J x_{m,j,n} \in \{0,1\} \forall m, n \quad (3-9)$$

- A job can process more than on one machine at the same time.

$$\sum_{m=1}^M x_{m,j,n} \in \{0,1\} \forall j, n \quad (3-10)$$

- An operation $O_{m,j,n}$ is immediately started in machine M_m when the previous operation of the job $O_{m',j,n-1}$ has been completed and that the previous operation on the machine $O_{m,j',n'}$ has been completed:

$$S_{m,j,n} = \begin{cases} \max_{m',j',n'} \{ Ct_{m,j',n'} \cdot \beta_{m,j',n'} \cdot Ct_{m',j,n-1} \cdot x_{m',j,n-1} \} & \text{if } n > 1 \\ \max_{m',j',n'} \{ Ct_{m,j',n'} \cdot \beta_{m,j',n'} \} & \text{if } n = 1 \end{cases} \quad \text{if } x_{m,j,n} = 1 \quad (3-11)$$

4.3.2 Energy Consumption

- **Energy parameters**

Ps_m : starting power in machine M_m

$Pp_{m,j,n}$: processing power of operation $O_{m,j,n}$ of job j in machine m .

Pb_m : power Basic of machine M_m .

$Psp_{m,j',j,n'}$: setup power of operation $O_{m,j,n}$ of job j in machine M_m (change machine setting from $O_{m,j',n'}$ to $O_{m,j,n}$).

$Poff_m$: power off to shutdown of machine M_m .

- **Energy objectives**

Minimizing total energy consumption in all machines and non-operation energy at idle time.

$$\text{Min Total energy consumption } TTE = \sum_{m=1}^M E_m \quad (3-12)$$

$$\text{Min Total non-operative energy } TTE_{id} = \sum_{m=1}^M TE_{id_m} \quad (3-13)$$

Total energy consumed during production schedule, TTE, consists of flowing energy according our energy model for each machine.

- Es_m : starting energy of machine M_m .
- Eof_m : turn off energy of machine M_m .
- Esb_m : standby energy of machine M_m .
- $Ep_{m,j,n}$: processing energy of operation $O_{m,j,n}$ of J_j in machine M_m .

- $E_{O_{m,j,n}}$: energy consumed during operation $O_{m,j,n}$ of J_j in machine M_m .
- $E_{id_{m,j,n}}$: idle time Energy between two jobs $J_{j'}$ and J_j in machine M_m .
- $E_{sp_{m,j',j,n}}$: setup Energy of $O_{m,j,n}$ in machine M_m .
(machine setting change from $O_{m,j',n'}$ to $O_{m,j,n}$).
- $E_{b_{m,j,n}}$: basic non-productive energy of machine M_m during operation $O_{m,j,n}$.
- $TE_{id m}$: total idle-time energy consumed machine M_m .
- TTE_{id} : total Idle-time energy consumed by all machine M_M .in job shop problem.
- $TE_{sp m}$: total set-up energy consumed by machine M_m .
- TTE_{sp} : total set-up energy consumed by all machine M_m .
- $TE_{p m}$: total process energy consumed by machine M_m .
- $TE_{O m}$: total processing energy consumed by machine M_m .
- TTE_p : total processing energy consumed by all machine M_m .
- TE_m : total energy consumed by machine M_m .
- TTE : total energy consumed by the workshop

• Mathematical models

Energy consumption models consider three dynamic energy, setup energy, processes energy and idle energy (non-productive energy), and two static energy, turn on energy and turn off energy.

In classical energy models, processing power on a machine, Pp_m , is fixed independently of operation, and setup energy is constant.

$$E_m = E_{S_m} + TE_{id m} + TE_{p m} + E_{p_{sp}} + E_{off m} . \quad (3-14)$$

$$E_{S_m} = P_s m t_s m . \quad (3-15)$$

$$TE_{p m} = \sum_{j=1}^J \sum_{n=1}^{N_j} E_{p_{m,j,n}} x_{m,j,n} . \quad E_{p_{m,j,n}} = Pp_m t_{p_{m,j,n}} . \quad (3-16)$$

Idle energy is calculated as the product of basic power and idle time (Equ. 3-7) for the machine:

$$TE_{id m} = P_b m T t_{id m} \quad (3-17)$$

$$TE_{id m} = P_b m (C_m - W t_m) \quad (3-18)$$

$$E_{O_{m,j,n}} = (P_{p_{m,j,n}} + P_{b_m}) t_{p_{m,j,n}} \quad (3-19)$$

$$TE_{sp m} = \sum_{j'=1}^J \sum_{j=1}^J \sum_{n'=1}^{N_{j'}} \sum_{n=1}^{N_j} (P_{sp_{m,j',j,n'}} + P_{b_m}) t_{sp_{m,j',j,n'}} \beta_{m,j',j,n'} \quad (3-20)$$

$$TE_{O m} = \sum_{j=1}^J \sum_{n=1}^{N_j} E_{O_{m,j,n}} x_{m,j,n} = \sum_{j=1}^J \sum_{n=1}^{N_j} (P_{p_{m,j,n}} + P_{b_m}) t_{p_{m,j,n}} x_{m,j,n} \quad (3-21)$$

$$E_{off m} = P_{off m} t_{off m} \quad (3-22)$$

$$TTE = \sum_{m=1}^M TE_m \quad (3-12)$$

$$TE_m = P_s t_{s m} + TE_{sp m} + TE_{o m} + TE_{id m} + P_{off m} t_{off m} \quad (3-23)$$

$$TE = \sum_{m=1}^M P_s t_{s m} + \sum_{m=1}^M \sum_{j'=1}^J \sum_{j=1}^J \sum_{n'=1}^{N_{j'}} \sum_{n=1}^{N_j} (P_{sp_{m,j',j,n'}} + P_{bm}) t_{sp_{m,j',j,n'}} \beta_{m,j',j,n',n} + \sum_{m=1}^M \sum_{j=1}^J \sum_{n=1}^{N_j} (P_{p_{m,j,n}} + P_{b m}) t_{p_{m,j,n}} x_{m,j,n} + \sum_{m=1}^M P_{b m} (C_m - W t_m) + \sum_{m=1}^M P_{off m} t_{off m} \quad (3-24)$$

4.4 Minimize Energy Constrain Programming ECP

The problem can be formulated entirely using constraint programming (CP). However, these models are difficult to resolve. (Al-Qaseer F. 2016). We firstly consider to the objectives of the problem (eq. 3-12) or final formula (eq3-24) refers to minimizing total energy consumption all machine, which is depended on dynamic and static energy consumed in each machine. Assuming that, statics energie are $E_{s m}$, and $E_{off m}$, which are constant in each machine, the dynamic energies are the consumed energy to be minimized.

Dynamic energy is the sum of processing energy $E_{p_{m,j,n}}$, setup energy $E_{sp_{m,j',j,n'}}$, and non-productive energy during idle time $TE_{id m}$.

1. Processing energy $E_{p_{m,j,n}}$ is the energy consumed during processing the operation $O_{m,j,n}$ of job J_j in machine M_m , processing energy constraint with min processing power $P_{p_{m,j,n}}$ and min processing time $t_{p_{m,j,n}}$.
2. Setup energy $E_{sp_{m,j',j,n'}}$ is the energy consumed to prepare the operation $O_{m,j,n}$ of job J_j in machine M_m dependent on setup power $P_{sp_{m,j',j,n'}}$ and setup time $t_{sp_{m,j',j,n'}}$, that are constrained by the sequence of jobs in machine ($O_{m,j',n'}$ precedes $O_{m,j,n}$ on M_m).
3. Non-productive energy is the energy consumed during idle time $TE_{id m}$. The summation of energy during idle time represents the second energy objective (eq. 3-13) that depends on basic machine power $P_{b m}$, which is constant for each machine and total idle time of machine $Tt_{id m}$, (eq 3-7).
4. Total idle time of machine and total workload in machine $W t_m$ (eq 3-5) constrain the completion time on the machine M_m (C_m) (eq 3-2).
5. Completion time C_m , on the machine M_m , is constrained by choosing minimum operating time $t_{o_{m,j,n}}$, sum of processing time $t_{p_{m,j,n}}$ and setup time $t_{sp_{m,j',j,n'}}$. Setup time and $S_{m,j,n}$ depends on the selection of sequence of jobs in machine ($O_{m,j',n'} < O_{m,j,n}$ on M_m).

On the other hand job shop objectives are C_{max} , TWt , and TTt_{id} (eq 3-3,3-6 and 3-8). C_{max} relies on C_m , TWt relies on Wt_m and TTt_{id} relies on Tt_{id_m} .

By these constraints (with accord to general job shop constraints (3-9,3-10,and 3-11) job search to machine with minimum processing energy and time as see in figure (4-4), with route solution figure (4-5).

Energy Objectives & Constraints

Energy Objectives & mathematical models

Constraints

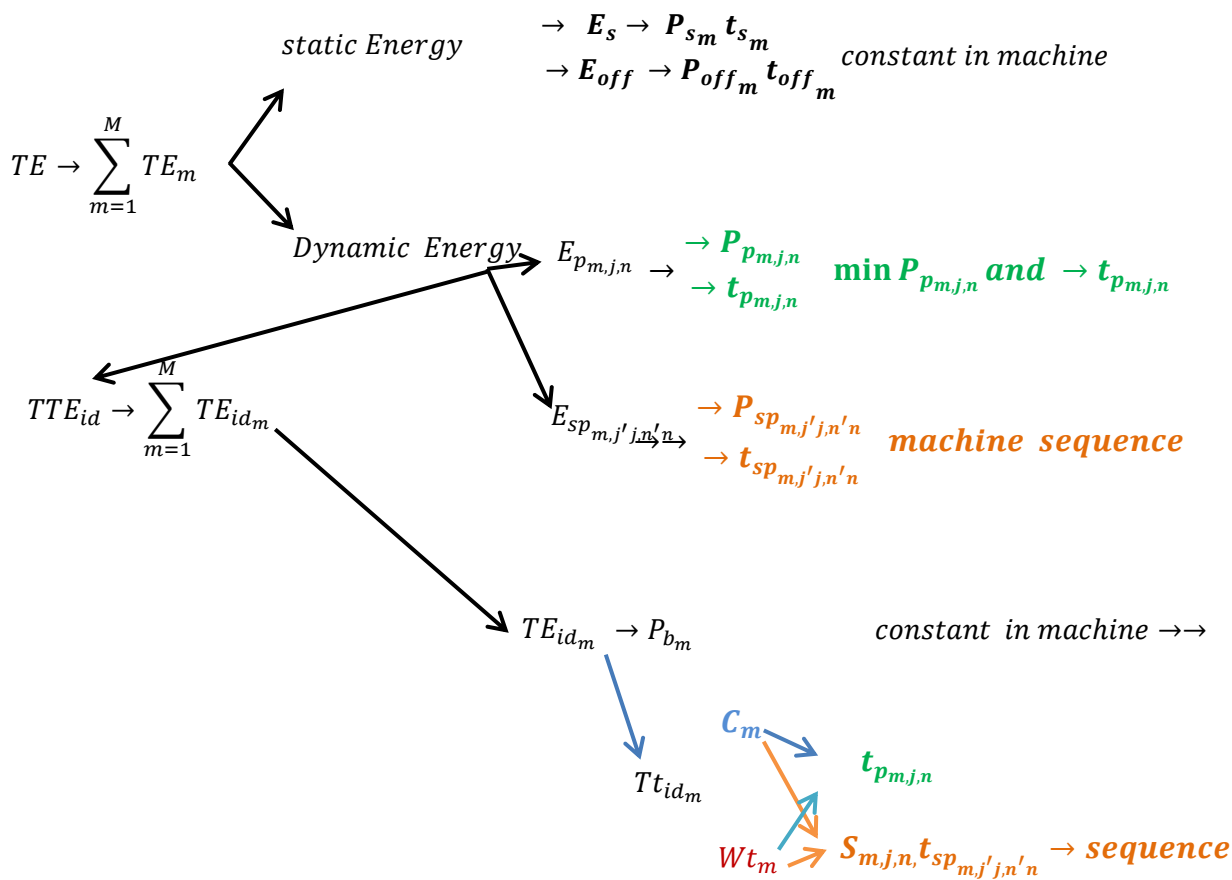

Job Shop Objectives & mathematical models

Constraints

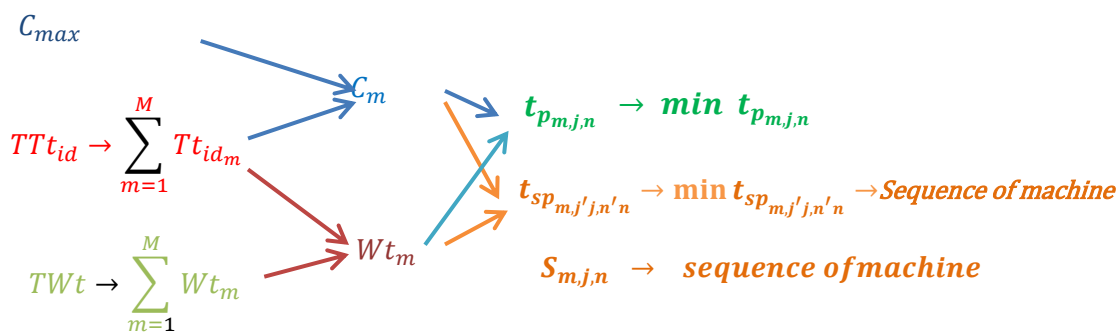

Figure 4-4 Time and energy objectives and constraint (objectives and constraint's map)

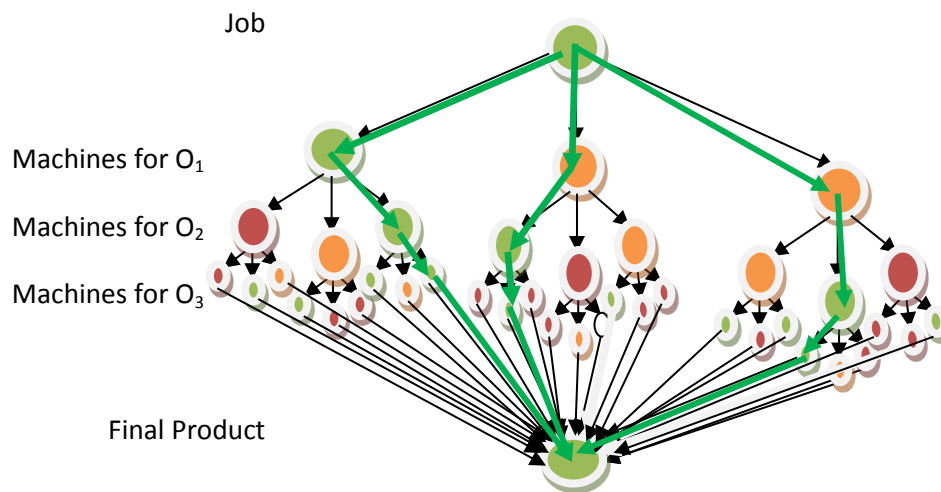

Figure 4-5 Route solutions

The first level node refers to job and the second level refers to the machines operating the first operation and so on for third and fourth levels and final product in last level

4.5 A Mixed Integer Linear Programming Minimized Energy MILPE

MILPE methods use constraint programming and linear programming. In this method, in order to understand the relationship between the jobs and machine, we use two branch and bound levels as see in (fig 4-6).

At the first branching operation of job searches to machine with minimum processing energy and processing time.

In the second branching machine searches to job, which can be process with minimum processing energy and minimum processing time.

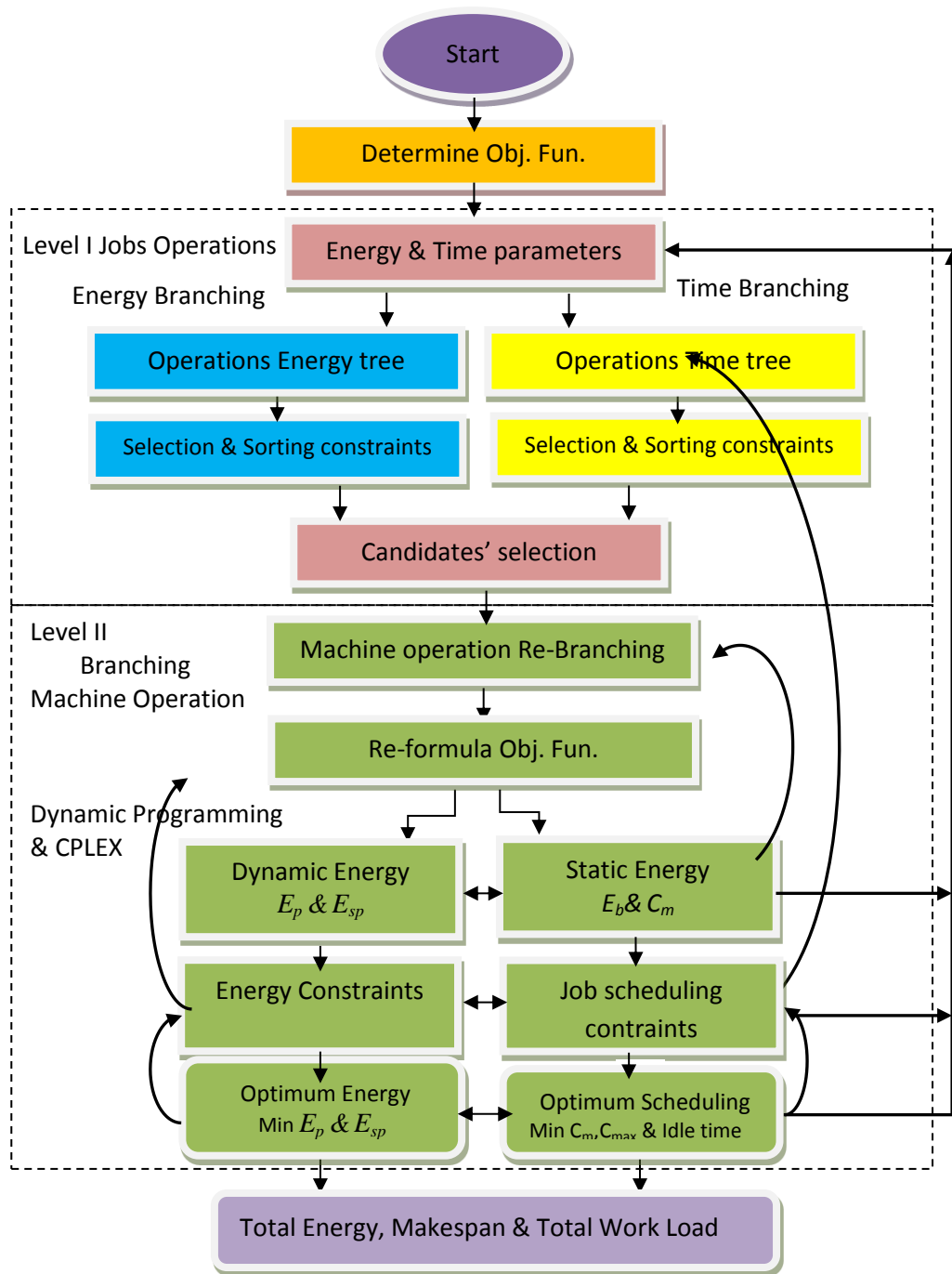

Figure 4-6 MILP and CP flow chart

4.5.1 Classification trees

In genetic algorithm, we start the optimization process choosing candidate solutions, but in constraint programming (CP) and mixed Integer linear programming (MILP), we first design a classification tree to understand the relationship between the machines and the jobs. Two types of trees are using; Jobs-Operations-Machines (J-O-M), and Machines-Operations-Job (M-O-J).

4.5.1.1 Jobs-Operations-Machines trees (J-O-M)

In this method, the Jobs search for machines from minimum to maximum processing time and processing energy. It is similar to horizontal research in genetic algorithm. It is called job-operation-machine (J-O-M). Here the jobs represent the routes, the operations represent the levels and machines represent the nodes as shown in figure 4-7. This method gives us a clear vision to understand the effect of machines to process an operation of job and the relationship between these machines to process an operation of job.

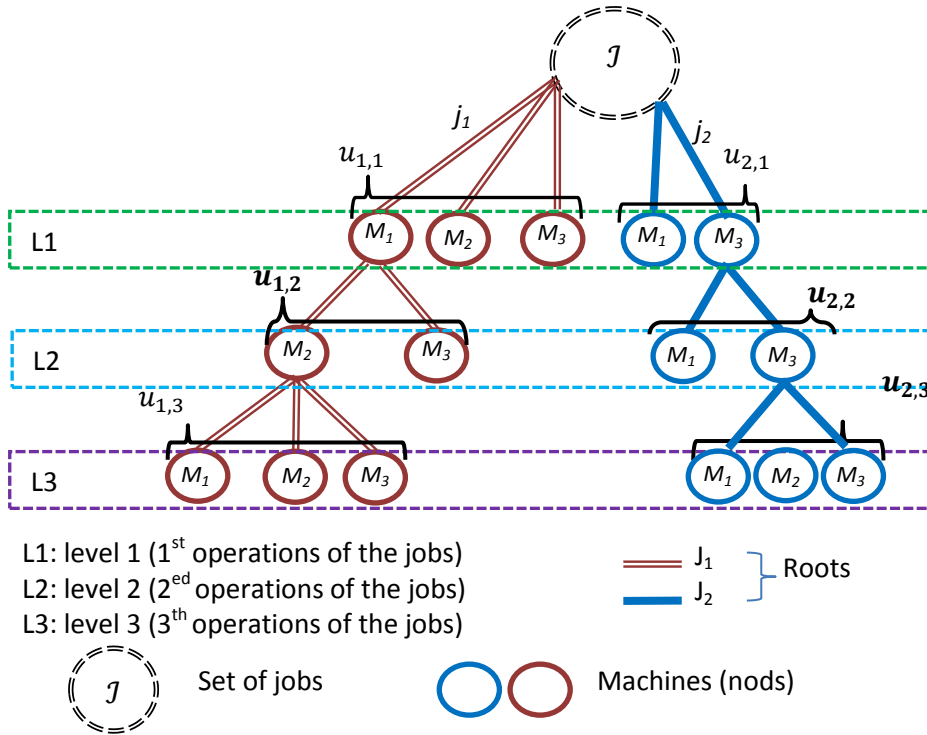

Figure 4-7 Jobs-operations-Machines relationship (roots-levels-nods)

- Notation

$u_{j,n}$: subset of machine M_m to process the operation $O_{j,n}$ of the job J_j , $u_{j,n} \subseteq \mathcal{M}$. (as see in figure 4-7)

M' : Total number of machines in subset $u_{j,n}$

$h1_{E_{m,j,n}}$: classification factor of machine M_m according to processing energy to process $O_{j,n}$;

$h1_{t_{m,j,n}}$: classification factor of machine M_m according to processing time to process $O_{j,n}$

$D1_{mj,n}$: The mean of classification factors of machine M_m according to processing energy and processing time to process $O_{j,n}$ of job J_j in machine M_m , ($O_{m,j,n}$).

α : Energy weight

$$\alpha = \begin{cases} 0.5 < \alpha \leq 0.6 & \text{strongly accord with energy objectives} \\ 0.4 \leq \alpha \leq 0.5 & \text{strongly accord with time objectives} \end{cases} \quad (4-1)$$

To work closely with the energy objectives, energy weight α is greater than 0.5, and to work closely with the job shop objectives energy weight α must be less than 0.5.

In this method, there are two sub trees.

- a) Processing Energy-Jobs-Operations-Machines (E-J-O-M) tree: in this method jobs and operations search to machine with minimum processing energy, the machines, in subset of machines $u_{j,n}$, which process job operations are sorted from the minimum to the maximum according to their processing energy. This method is done for each job, operation by operation, until to final operation N_j of job. For example $O_{j,n}$ operation of job J_j search to machine M_m to process this operation with minimum processing energy, and machines in the subset $u_{j,n}$ that are capable to process this operation are sorted from minimum to maximum according their processing energy.
- b) Processing Time-Jobs-Operations-Machines (T-J-O-M) tree: in this method jobs operations search machine with minimum processing time, the subset of machines $u_{j,n}$ that process job operations are sorted from the minimum to the maximum according to their processing time. This method is done with the job, operation by operation, until it reaches final operation N_j of job.

$$\text{sort} \{u_{j,n} \rightarrow E_{p_{m \rightarrow M,j,n}}\} \quad (4-2)$$

$$\forall n \in N_j; \forall j \in J; M_m, M_{m'} \in u_{j,n}; u_{j,n} \subseteq \mathcal{M}$$

$$\text{sort} \{u_{j,n} \rightarrow t_{p_{m,j,n}}\} \quad (4-3)$$

$$\forall n \in N_j; \forall j \in J; M_m, M_{m'} \in u_{j,n}; u_{j,n} \subseteq \mathcal{M}$$

Number of machines in subset $u_{j,n}$ is sometime equal to the total number of machines in the scheduling problem. However, if a machine does not process an operation $O_{j,n}$ of a job, the subset of available machines that process the n^{th} operation does not contain this machine. In our example (figure 4-8), machine M_1 does not process the second operation of job J_1 , then the subset of machine is $u_{1,2} = \{M_3, M_2\}$ does not contain this machine.

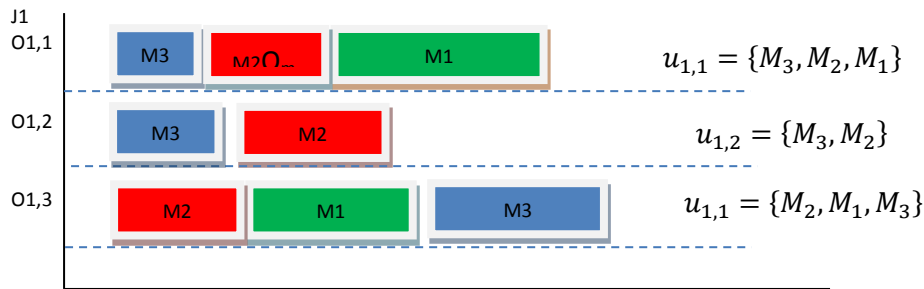

Figure 4-8 Explain the machine subset $u_{j,n}$

To explain this method we use the same example, which is used in chapter three (initial population) as shown table 4-1 and 4-2

Table 4-1 Processing energy of problem (3*3)

$E_{p_{m,j,n}}$		M_1	M_2	M_3
J_1	$O_{1,1}$	33	40	36
	$O_{1,2}$	40	60	55
	$O_{1,3}$	55	35	40
J_2	$O_{2,1}$	60	55	40
	$O_{2,2}$	45	40	50
	$O_{2,3}$	36	30	40
J_3	$O_{3,1}$	55	40	30
	$O_{3,2}$	55	30	55
	$O_{3,3}$	40	30	55

Table 4-2 Processing time of problem (3*3)

$t_{p_{m,j,n}}$		M_1	M_2	M_3
J_1	$O_{1,1}$	8	11	12
	$O_{1,2}$	11	16	10
	$O_{1,3}$	11	13	12
J_2	$O_{2,1}$	12	8	8
	$O_{2,2}$	9	11	17
	$O_{2,3}$	17	8	10
J_3	$O_{3,1}$	16	11	11
	$O_{3,2}$	12	12	16
	$O_{3,3}$	9	12	14

a) Processing energy jobs-operations–machines (E-J-O-M) tree

- Applying the equation (4-2) the machines are sorted according to their processing energy as explain in table 4-3

Table 4-3 Sorting the machine according processing energy

$E_{p_{m,j,n}}$					
J_1	$O_{1,1}$	Machine Sorting	M1	M3	M2
		$E_{p_{m,1,1}}$	33	36	40
	$O_{1,2}$	Machine Sorting	M1	M3	M2
		$E_{p_{m,1,2}}$	40	55	60
	$O_{1,3}$	Machine Sorting	M2	M3	M1
		$E_{p_{m,1,3}}$	35	40	55
J_2	$O_{2,1}$	Machine Sorting	M3	M2	M1
		$E_{p_{m,2,1}}$	40	55	60
	$O_{2,2}$	Machine Sorting	M2	M1	M3
		$E_{p_{m,2,2}}$	40	45	50
	$O_{2,3}$	Machine Sorting	M2	M1	M3
		$E_{p_{m,2,3}}$	30	34	40
J_3	$O_{3,1}$	Machine Sorting	M3	M2	M1
		$E_{p_{m,3,1}}$	30	40	55
	$O_{3,2}$	Machine Sorting	M2	M1	M3
		$E_{p_{m,3,2}}$	30	55	55
	$O_{3,3}$	Machine Sorting	M2	M1	M3
		$E_{p_{m,3,3}}$	30	40	55

- After sorting the machine in subset $u_{j,n}$ of machines according to processing energy $E_{p_{m,j,n}}$, ($u_{j,n} \rightarrow E_{p_{m \rightarrow M,j,n}}$), we can assign the operation with m^{th} machine j^{th} job n^{th} operation as explain in table 4-4

Table 4-4 Assigning the operation according to m machine, j job, and n operation

$E_{p_{m,j,n}}$					
J_1	$O_{1,1}$	Machine Sorting	M1	M3	M2
		$E_{p_{m,1,1}}$	33	36	40
		$O_{m,1,1}$	$O_{1,1,1}$	$O_{3,1,1}$	$O_{2,1,1}$
	$O_{1,2}$	Machine Sorting	M1	M3	M2
		$E_{p_{m,1,2}}$	40	55	60
		$O_{m,1,2}$	$O_{1,1,2}$	$O_{3,1,2}$	$O_{2,1,2}$
	$O_{1,3}$	Machine Sorting	M2	M3	M1
		$E_{p_{m,1,3}}$	35	40	55
		$O_{m,1,3}$	$O_{2,1,3}$	$O_{3,1,3}$	$O_{1,1,3}$
J_2	$O_{2,1}$	Machine Sorting	M3	M2	M1
		$E_{p_{m,2,1}}$	40	55	60
		$O_{m,2,1}$	$O_{3,2,1}$	$O_{2,2,1}$	$O_{1,2,1}$
	$O_{2,2}$	Machine Sorting	M2	M1	M3
		$E_{p_{m,2,2}}$	40	45	50
		$O_{m,2,2}$	$O_{2,2,2}$	$O_{1,2,2}$	$O_{3,2,2}$
	$O_{2,3}$	Machine Sorting	M2	M1	M3
		$E_{p_{m,2,3}}$	30	34	40
		$O_{m,2,3}$	$O_{2,2,3}$	$O_{1,2,3}$	$O_{3,2,3}$
J_3	$O_{3,1}$	Machine Sorting	M3	M2	M1
		$E_{p_{m,3,1}}$	30	40	55
		$O_{m,3,1}$	$O_{3,3,1}$	$O_{2,3,1}$	$O_{1,3,1}$
	$O_{3,2}$	Machine Sorting	M2	M1	M3
		$E_{p_{m,3,2}}$	30	55	55
		$O_{m,3,2}$	$O_{2,3,2}$	$O_{1,3,2}$	$O_{3,3,2}$
		$h1_{E_{m,3,2}}$	1	2	2
	$O_{3,3}$	Machine Sorting	M2	M1	M3
		$E_{p_{m,3,3}}$	30	40	55
$O_{m,3,3}$		$O_{2,3,3}$	$O_{1,3,3}$	$O_{m3,3,3}$	

- We can determine the decision factor $h1_{E_{m,j,n}}$ to $O_{j,n}$ of J_j in machine M_m as in table 4-5, the first has $h1_{E_{m,j,n}} = 1$, and the last has maximum number, if two or more machines have the same processing energy, they have the same decision factors.

Table 4-5 Determine the decision factor $h1_{E_{m,j,n}}$ to the operation of jobs

jobs					
J_1	$O_{1,1}$	Machine Sorting	M1	M3	M 2
		$E_{p_{m,1,1}}$	33	36	40
		$O_{m,1,1}$	$O_{1,1,1}$	$O_{3,1,1}$	$O_{2,1,1}$
		$h1_{t_{m,1,1}}$	1	2	3
	$O_{1,2}$	Machine Sorting	M1	M3	M2
		$E_{p_{m,1,2}}$	40	55	60
		$O_{m,1,2}$	$O_{1,1,2}$	$O_{3,1,2}$	$O_{2,1,2}$
		$h1_{E_{m,1,2}}$	1	2	3
	$O_{1,3}$	Machine Sorting	M2	M3	M1
		$E_{p_{m,1,3}}$	35	40	55
		$O_{m,1,3}$	$O_{2,1,3}$	$O_{3,1,3}$	$O_{1,1,3}$
		$h1_{E_{m,1,3}}$	1	2	3
J_2	$O_{2,1}$	Machine Sorting	M3	M2	M1
		$E_{p_{m,2,1}}$	40	55	60
		$O_{m,2,1}$	$O_{3,2,1}$	$O_{2,2,1}$	$O_{1,2,1}$
		$h1_{E_{m,2,1}}$	1	2	3
	$O_{2,2}$	Machine Sorting	M2	M1	M3
		$E_{p_{m,2,2}}$	40	45	50
		$O_{m,2,2}$	$O_{2,2,2}$	$O_{1,2,2}$	$O_{3,2,2}$
		$h1_{E_{m,2,2}}$	1	2	3
	$O_{2,3}$	Machine Sorting	M2	M1	M3
		$E_{p_{m,2,3}}$	30	34	40
		$O_{m,2,3}$	$O_{2,2,3}$	$O_{1,2,3}$	$O_{3,2,3}$
		$h1_{E_{m,2,3}}$	1	2	3
J_3	$O_{3,1}$	Machine Sorting	M3	M2	M1
		$E_{p_{m,3,1}}$	30	40	55
		$O_{m,3,1}$	$O_{3,3,1}$	$O_{2,3,1}$	$O_{1,3,1}$
		$h1_{t_{m,3,1}}$	1	2	3
	$O_{3,2}$	Machine Sorting	M2	M1	M3
		$E_{p_{m,3,2}}$	30	55	55
		$O_{m,3,2}$	$O_{2,3,2}$	$O_{1,3,2}$	$O_{3,3,2}$
		$h1_{E_{m,3,2}}$	1	2	2
	$O_{3,3}$	Machine Sorting	M2	M1	M3
		$E_{p_{m,3,3}}$	30	40	55
		$O_{m,3,3}$	$O_{2,3,3}$	$O_{1,3,3}$	$O_{m3,3,3}$
		$h1_{E_{m,3,3}}$	1	2	3

b) Processing time jobs-operations–machines (T-J-O-M) tree

- With same method, but by applying equation 4-3, the machines in subset $u_{j,n}$ of machines are sorting according to processing time, as explain in table 4-6

Table 4-6 Sorting machines according processing time

jobs					
J_1	$O_{1,1}$	Machine Sorting	M1	M2	M3
		$t_{p_{m,1,1}}$	8	11	12
	$O_{1,2}$	Machine Sorting	M3	M1	M2
		$t_{p_{m,1,2}}$	10	11	16
	$O_{1,3}$	Machine Sorting	M1	M3	M2
		$t_{p_{m,1,3}}$	11	12	13
J_2	$O_{2,1}$	Machine Sorting	M2	M3	M1
		$t_{p_{m,2,1}}$	8	8	12
	$O_{2,2}$	Machine Sorting	M1	M2	M3
		$t_{p_{m,2,2}}$	9	11	17
	$O_{2,3}$	Machine Sorting	M2	M3	M1
		$t_{p_{m,2,3}}$	8	10	17
J_3	$O_{3,1}$	Machine Sorting	M2	M3	M1
		$t_{p_{m,3,1}}$	11	11	16
	$O_{3,2}$	Machine Sorting	M1	M2	M3
		$t_{p_{m,3,2}}$	12	12	16
	$O_{3,3}$	Sorting machine	M1	M2	M3
		$t_{p_{m,3,3}}$	9	12	14

After sorting the machine in subset $u_{j,n}$ of machines according to processing energy $E_{p_{m,j,n}}$, ($u_{j,n} \rightarrow E_{p_{m \rightarrow M,j,n}}$), we can assign the operation with m^{th} machine j^{th} job n^{th} operation

- After sorting the machine in subset $u_{j,n}$ of machines according to processing time $t_{p_{m,j,n}}$, ($u_{j,n} \rightarrow t_{p_{m \rightarrow M,j,n}}$), we can assign the operation with m^{th} machine j^{th} job n^{th} operation and determine the decision factor $h1_{t_{m,j,n}}$ to $O_{j,n}$ of J_j in machine M_m as in table 4-7.

Table 4-7 Assigning the operation according to m machine, j job, and n operation, and determine decision factor $h1_{t_{m,j,n}}$ to the operation $O_{j,n}$ of jobs J_j

jobs					
J_1	$O_{1,1}$	Machine Sorting	M1	M2	M3
		$t_{p_{m,1,1}}$	8	11	12
		$O_{m,1,1}$	$O_{1,1,1}$	$O_{2,1,1}$	$O_{3,1,1}$
		$h1_{t_{m,1,1}}$	1	2	3
	$O_{1,2}$	Machine Sorting	M3	M1	M2
		$t_{p_{m,1,2}}$	10	11	16
		$O_{m,1,2}$	$O_{3,1,2}$	$O_{1,1,2}$	$O_{2,1,2}$
		$h1_{t_{m,1,2}}$	1	2	3
	$O_{1,3}$	Machine Sorting	M1	M3	M2
		$t_{p_{m,1,3}}$	11	12	13
		$O_{m,1,3}$	$O_{1,1,3}$	$O_{3,1,3}$	$O_{2,1,3}$
		$h1_{t_{m,1,3}}$	1	2	3
J_2	$O_{2,1}$	Machine Sorting	M2	M3	M1
		$t_{p_{m,2,1}}$	8	8	12
		$O_{m,2,1}$	$O_{2,2,1}$	$O_{3,2,1}$	$O_{1,2,1}$
		$h1_{t_{m,2,1}}$	1	1	2
	$O_{2,2}$	Machine Sorting	M1	M2	M3
		$t_{p_{m,2,2}}$	9	11	17
		$O_{m,2,2}$	$O_{1,2,2}$	$O_{2,2,2}$	$O_{3,2,2}$
		$h1_{t_{m,2,2}}$	1	2	3
	$O_{2,3}$	Machine Sorting	M2	M3	M1
		$t_{p_{m,2,3}}$	8	10	17
		$O_{m,2,3}$	$O_{2,2,3}$	$O_{3,2,3}$	$O_{1,2,3}$
		$h1_{t_{m,2,3}}$	1	2	3
J_3	$O_{3,1}$	Machine Sorting	M2	M3	M1
		$t_{p_{m,3,1}}$	11	11	16
		$O_{m,3,1}$	$O_{2,3,1}$	$O_{3,3,1}$	$O_{1,3,1}$
		$h1_{t_{m,3,1}}$	1	1	2
	$O_{3,2}$	Machine Sorting	M1	M2	M3
		$t_{p_{m,3,2}}$	12	12	16
		$O_{m,3,2}$	$O_{1,3,2}$	$O_{2,3,2}$	$O_{3,3,2}$
		$h1_{t_{m,3,2}}$	1	2	3
	$O_{3,3}$	Machine Sorting	M1	M2	M3
		$t_{p_{m,3,3}}$	9	12	14
		$O_{m,3,3}$	$O_{1,3,3}$	$O_{2,3,3}$	$O_{3,3,3}$
		$h1_{t_{m,3,3}}$	1	2	3

In some cases, if two or more machines have the same processing energy or processing time to operate an operation, these machines take the same decision factor, (in our example, $h1_{E_{1,3,2}} = h1_{E_{3,3,2}}$ because $E_{p_{1,3,2}} = E_{p_{3,3,2}}$, and $h1_{t_{2,2,1}} = h1_{t_{3,2,1}}$ because $t_{p_{2,2,1}} = t_{p_{3,2,1}}$)

After completion of the sorting process, each operation has two decision factors for processing energy $h1_{E_{m,j,n}}$ and for processing time $h1_{t_{m,j,n}}$.

$D1_{m,j,n}$: The mean of classification factor $(h1_{E_{m,j,n}}, h1_{t_{m,j,n}})$ of j^{th} job at n^{th} operation in m^{th} machine according to processing energy and processing time to process $O_{j,n}$ of job J_j in machine M_m , ($O_{m,j,n}$) in J-O-M trees.

$$D1_{m,j,n} = \alpha h1_{E_{m,j,n}} + (1 - \alpha) h1_{t_{m,j,n}} \quad (4-4)$$

The better machine has the smaller decision factor, When we have to work closely with the energy objectives, energy weight α must be greater than 0.5, and we have to work closely with the job shop objectives, energy weight α must be less than 0.5. Figure 4-9 and 4-10 shows the final sorting results

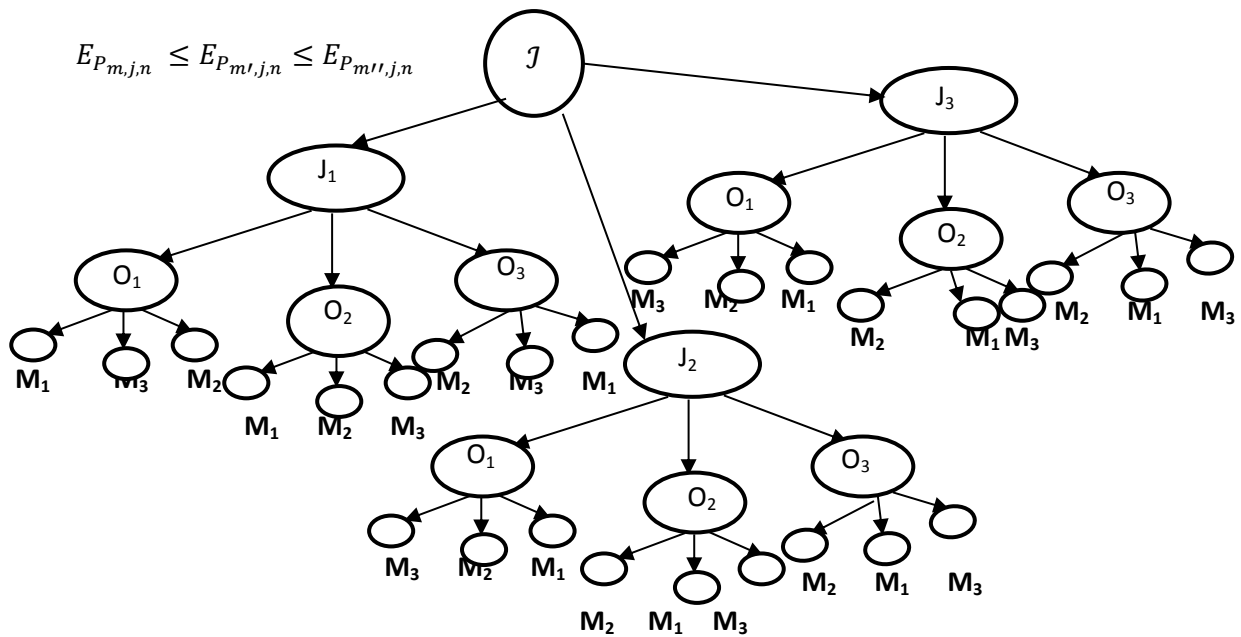

Figure 4-9 Processing energy jobs-operations-machines classification tree (E-J-O-M)

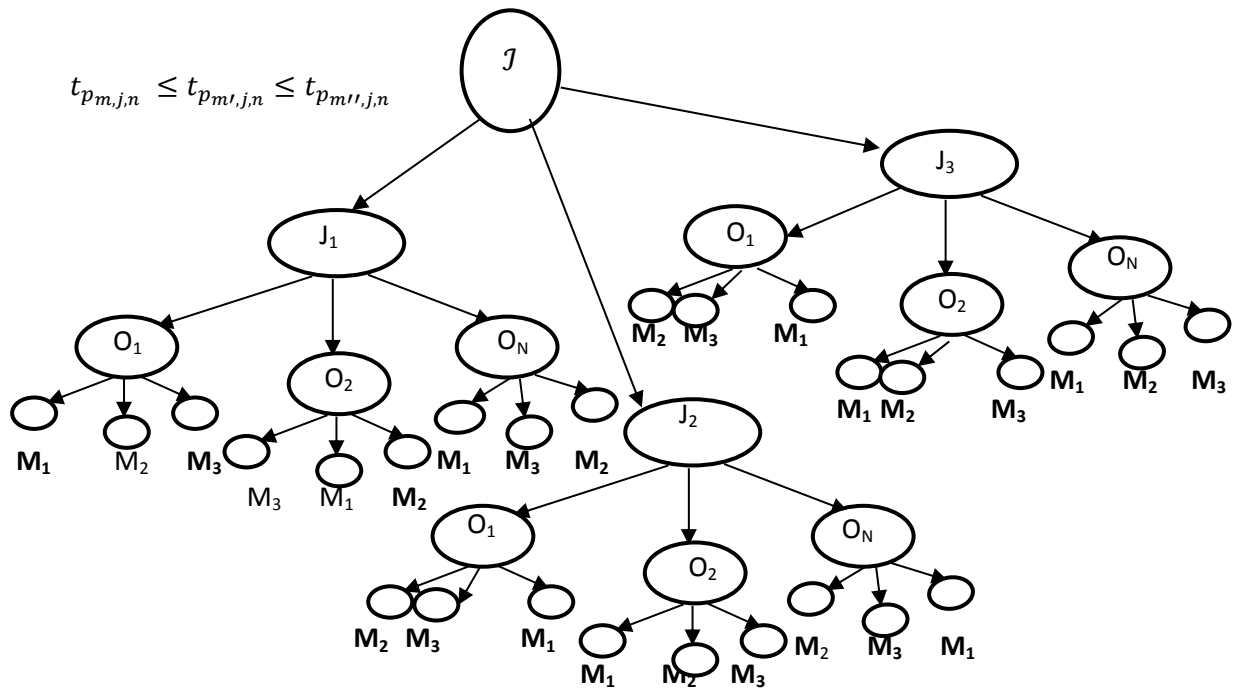

Figure 4-10 Processing time jobs-operations-machines classification tree (T-J-O-M)

4.5.1.2 Machines-Operations -Jobs trees (M-O-J)

In this method, machine search for job operation from minimum to maximum processing energy and processing time. It's called machines-operations-jobs. Machines represent the roots, operations represent the levels and jobs represent the nodes (as shown in figure 4-11).

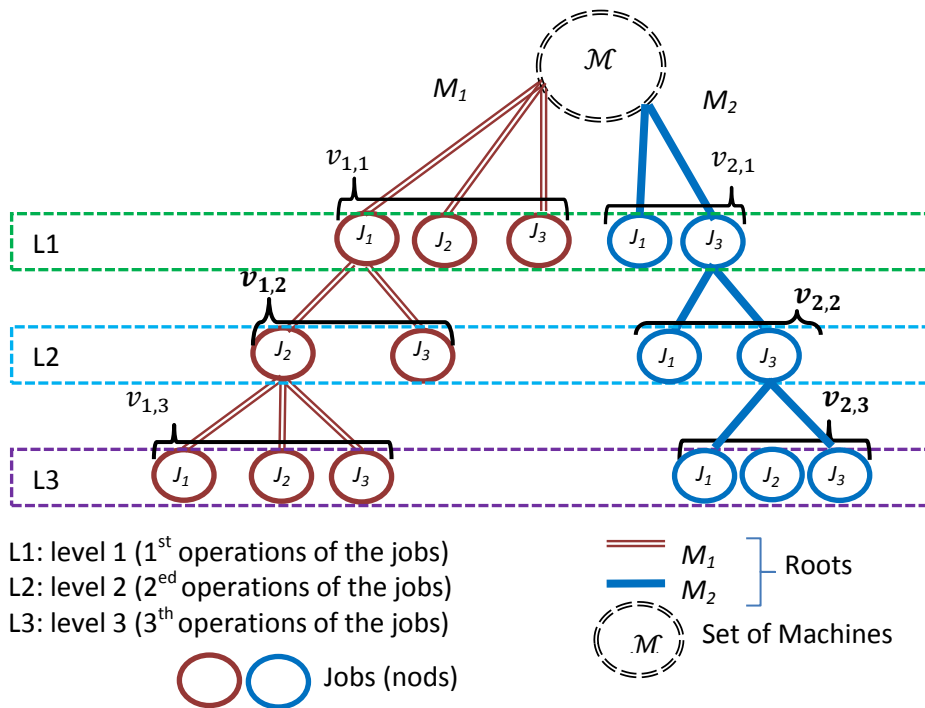

Figure 4-11 Machines-operations-jobs relationship (roots-levels-nods)

- Notation

$v_{m,n}$: Subset of jobs at n^{th} operation process in m^{th} machine(M_m); $v_{m,n} \subseteq J$ (as explained figure 4-12)

J' : Total number of jobs in subset $v_{m,n}$

$h2_{E_{m,j,n}}$: classification energy factor of j^{th} job at n^{th} operation in m^{th} machine according to processing energy.

$h2_{t_{m,j,n}}$: classification energy factor of j^{th} job at n^{th} operation in m^{th} machine according to processing time.

$D2_{m,j,n}$: The mean of classifications factors ($h2_{E_{m,j,n}}, h2_{t_{m,j,n}}$) for j^{th} job at n^{th} operation in m^{th} machine according to processing energy and processing time to process $O_{j,n}$ of job J_j in machine $M_m, (O_{m,j,n})$.

$Dr_{m,j,n}$: Classification factor for j^{th} job at n^{th} operation in m^{th} machine according to $D1_{m,j,n}$ and $D2_{m,j,n}$

ϕ : decision weight, $\phi = \{0.4 - 0.6\}$

$$\phi = \begin{cases} 0.5 < \phi \leq 0.6 & \text{the slution strongly accord to J - O - M trees} \\ 0.4 \leq \phi \leq 0.5 & \text{the slution strongly accord to M - O - J trees} \end{cases} \quad (4-5)$$

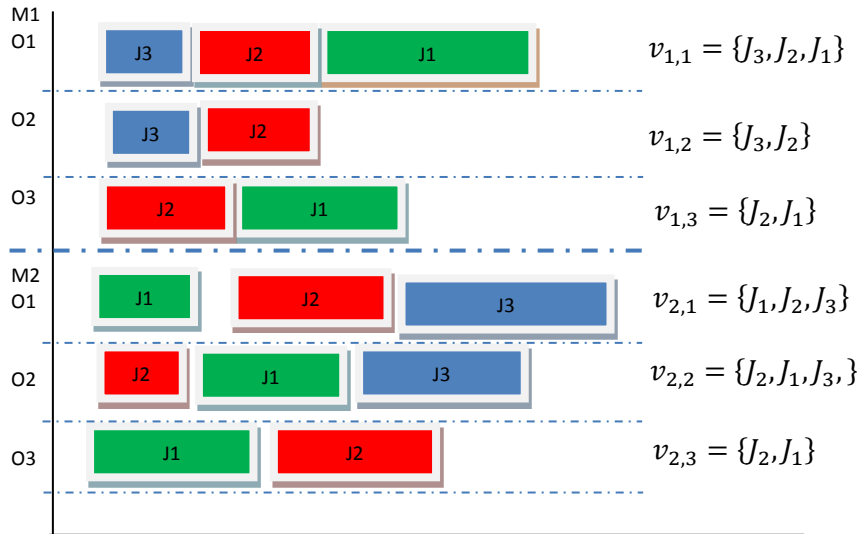

Figure 4-12 Explain of subset of jobs $v_{m,n}$

Number of jobs in each job subset $v_{m,n}$ is sometime equal to the total number of jobs in the scheduling problem, but as explain in the example above (figure 4-12).

- If the a machine does not process n^{th} operation of j^{th} job, the job subset $v_{m,n}$ does not contain this job (for example in figure 4-12, the subset of jobs of machine $M_1, v_{1,2}$ does not contain job j_1 ; $v_{1,2} = \{J_3, J_2\}$).

- On other hand if the jobs have not the same number of operation, the smaller j^{th} job is not consisted in the latest job subset that operate in the machines (example the job j_3 , has only two operations, but other jobs (j_1 and j_2) have three operations),

Let $J_{j''}, J_{j'}, J_j$ are three jobs

$$N_{j''} < N_{j'} = N_j$$

The subsets jobs $v_{m,N_{j'}}$ or v_{m,N_j} for any machine does not contain the job $J_{j''}$, in our example job J_3 has only two operations, but the jobs J_1 and J_2 have three operations, these job subsets at third level does not contain job J_3 , they contains only J_1 and J_2 ; $v_{1,3} = \{J_2, J_1\}$ or $v_{2,3} = \{J_1, J_2\}$

This method has two sub trees.

- Processing energy machine-operations-jobs (E-M-O-J) tree searches for operations jobs with minimum processing energy. This method processes the jobs, operation after operation. The operations are grouped by operation according to operation index n^{th} (from the group of the first operations $n=1$ of each job, until to the group of the final operations $n = N_j$ of each job). Subset of jobs $v_{m,n}$ are sorted from the minimum to the maximum according to their processing energy. This method is done to each machine operation after operation (level by level). For example m^{th} machine search to $O_{j,n}$ operation of j^{th} job, and it process this operation with minimum processing energy, jobs subset being sorted from minimum to maximum according their processing energy.
- Processing time machine-operations-jobs (T-M-O-J) tree searches to operations jobs with minimum processing time. This method processes the jobs, operation after operation. The operations are grouped by operation according to operation index n^{th} (from the group the first operations $n=1$ of subset job $v_{m,n}$, until the group of the final operations $n = N_j$ of each jobs). The jobs in the same operations group are sorted from the minimum to the maximum according to their processing time

From that, the $O_{j,n}$ of j^{th} job has the smallest processing energy $E_{p_{m,j,n}}$ (minimum processing energy) in machine M_m , it has $h2_{E_{m,j,n}} = 1$, and the $O_{j',n}$ of job $J_{j'}$ has highest processing energy $E_{p_{m,j',n}}$ (maximum processing energy) in machine M_m , it has $h2_{E_{m,j',n}} = \text{maximum value}$

$$\text{sort} \{v_{m,n} \rightarrow E_{p_{m,j,n}}\} \quad (4-6)$$

$$\forall n \in N_j; \forall m \in M; j, j' \leq J; J_j, J_{j'} \in v_{m,n}; v_{m,n} \subseteq J$$

$$\text{sort} \{v_{m,n} \rightarrow t_{p_{m,j,n}}\} \quad (4-7)$$

$$\forall n \in N_j; \forall m \in M; j, j' \leq J; J_j, J_{j'} \in v_{m,n}; v_{m,n} \subseteq J$$

$$D2_{m,j,n} = \alpha h2_{E_{m,j,n}} + (1 - \alpha) h2_{t_{m,j,n}} \quad (4-8)$$

$$Dr_{m,j,n} = \varphi D2_{m,j,n} + (1 - \varphi) D1_{m,j,n} \quad (4-9)$$

If two or more jobs have the same processing energy and or processing time at the n^{th} operation in m^{th} machine, they have the same classification factors.

If we work closely with the energy objectives, the energy weight α must be great than 0.5, and if we work closely with the job shop objectives energy weight α must be less than 0.5

a) Processing energy machine-operations-jobs (E-M-O-J) tree.

- Sorting the jobs in subset $v_{m,n}$ according to processing energy by using equation (4-6) as explain in table 4-8

Table 4-8 Sorting the job in subset according to processing energy

$E_{p_{m,j,n}}$					
M ₁	$O_{1,j,1}$	$E_{p_{1,j,1}}$	33	55	60
		J_j	J_1	J_3	J_2
	$O_{1,j,2}$	$E_{p_{1,j,2}}$	40	55	55
		J_j	J_1	J_2	J_3
	$O_{1,j,3}$	$E_{p_{1,j,3}}$	36	40	55
		J_j	J_2	J_3	J_1
M ₂	$O_{2,j,1}$	$E_{p_{2,j,1}}$	40	40	55
		J_j	J_1	J_3	J_2
	$O_{2,j,2}$	$E_{p_{2,j,2}}$	30	40	60
			J_3	J_2	J_1
	$O_{2,j,3}$	$E_{p_{2,j,3}}$	30	30	35
		J_j	J_3	J_2	J_1
M ₃	$O_{3,j,1}$	$E_{p_{3,j,1}}$	30	36	40
			J_3	J_1	J_2
	$O_{3,j,2}$	$E_{p_{3,j,2}}$	50	55	55
		J_j	J_2	J_1	J_3
	$O_{3,j,3}$	$E_{p_{3,j,3}}$	40	40	55
		J_j	J_1	J_2	J_3

- After sort the jobs in subset $v_{m,n}$ we can assign the operation with m^{th} machine j^{th} job n^{th} operation as explain in table 4-9

Table 4-9 assigning the operation according to m machine, j job, and n operation

$E_{p_{m,j,n}}$					
M1	$O_{1,j,1}$	$E_{p_{1,j,1}}$	33	55	60
		J_j	J_1	J_3	J_2
			$O_{1,1,1}$	$O_{1,3,1}$	$O_{1,2,1}$
	$O_{1,j,2}$	$E_{p_{1,j,2}}$	40	55	55
		J_j	J_1	J_2	J_3
			$O_{1,1,2}$	$O_{1,2,2}$	$O_{1,3,2}$
	$O_{1,j,3}$	$E_{p_{1,j,3}}$	36	40	55
		J_j	J_2	J_3	J_1
			$O_{1,2,3}$	$O_{1,3,3}$	$O_{1,1,3}$
M2	$O_{2,j,1}$	$E_{p_{2,j,1}}$	40	40	55
		J_j	J_1	J_3	J_2
			$O_{2,1,1}$	$O_{2,3,1}$	$O_{2,2,1}$
	$O_{2,j,2}$	$E_{p_{2,j,2}}$	30	40	60
		J_j	J_3	J_2	J_1
			$O_{2,3,2}$	$O_{2,2,2}$	$O_{2,1,2}$
	$O_{2,j,3}$	$E_{p_{2,j,3}}$	30	30	35
		J_j	J_3	J_2	J_1
			$O_{2,3,3}$	$O_{2,2,3}$	$O_{2,1,3}$
M3	$O_{3,j,1}$	$E_{p_{3,j,1}}$	30	36	40
		J_j	J_3	J_1	J_2
			$O_{3,3,1}$	$O_{3,1,1}$	$O_{3,2,1}$
	$O_{3,j,2}$	$E_{p_{3,j,2}}$	50	55	55
		J_j	J_2	J_1	J_3
			$H2E_{3,j,2}$	$O_{3,2,2}$	$O_{3,1,2}$
	$O_{3,j,3}$	$E_{p_{3,j,3}}$	40	40	55
		J_j	J_1	J_2	J_3
			$O_{3,1,3}$	$O_{3,2,3}$	$O_{3,3,3}$

- In this step we determine the values of energy classification factor $h2_{E_{m,j,n}}$ to each operation as in table 4-10.

Table 4-10 Determine $h2_{E_{1,j,1}}$ of each operation

$E_{p_{m,j,n}}$					
M1	$O_{1,j,1}$	$E_{p_{1,j,1}}$	33	55	60
		J_j	J_1	J_3	J_2
			$O_{1,1,1}$	$O_{1,3,1}$	$O_{1,2,1}$
			$h2_{E_{1,j,1}}$	1	2
	$O_{1,j,2}$	$E_{p_{1,j,2}}$	40	55	55
		J_j	J_1	J_2	J_3
			$O_{1,1,2}$	$O_{1,2,2}$	$O_{1,3,2}$
			$h2_{E_{1,j,2}}$	1	2
	$O_{1,j,3}$	$E_{p_{1,j,3}}$	36	40	55
		J_j	J_2	J_3	J_1
			$O_{1,2,3}$	$O_{1,3,3}$	$O_{1,1,3}$
			$h2_{E_{1,j,3}}$	1	2
M2	$O_{2,j,1}$	$E_{p_{2,j,1}}$	40	40	55
		J_j	J_1	J_3	J_2
			$O_{2,1,1}$	$O_{2,3,1}$	$O_{2,2,1}$
			$h2_{E_{2,j,1}}$	1	1
	$O_{2,j,2}$	$E_{p_{2,j,2}}$	30	40	60
		J_j	J_3	J_2	J_1
			$O_{2,3,2}$	$O_{2,2,2}$	$O_{2,1,2}$
			$h2_{E_{2,j,2}}$	1	2
	$O_{2,j,3}$	$E_{p_{2,j,3}}$	30	30	35
		J_j	J_3	J_2	J_1
			$O_{2,3,3}$	$O_{2,2,3}$	$O_{2,1,3}$
			$h2_{E_{2,j,3}}$	1	1
M3	$O_{3,j,1}$	$E_{p_{3,j,1}}$	30	36	40
		J_j	J_3	J_1	J_2
			$O_{3,3,1}$	$O_{3,1,1}$	$O_{3,2,1}$
			$h2_{E_{p_{3,j,1}}}$	1	2
	$O_{3,j,2}$	$E_{p_{3,j,2}}$	50	55	55
		J_j	J_2	J_1	J_3
			$O_{3,2,2}$	$O_{3,1,2}$	$O_{3,3,2}$
			$h2_{E_{3,j,2}}$	1	2
	$O_{3,j,3}$	$E_{p_{3,j,3}}$	40	40	55
		J_j	J_1	J_2	J_3
			$O_{3,1,3}$	$O_{3,2,3}$	$O_{3,3,3}$
			$h2_{E_{3,j,3}}$	1	1

b) Processing time machine-operations-jobs (T-M-O-J) tree.

- We apply the same steps that are used in (E-M-O-J) tree, but here we use equation 4-7 to sort the jobs according to processing time as explain in table 4-11

Table 4-11 Sorting the job according to their processing time

$t_{p_{m,j,n}}$					
M1	$O_{1,j,1}$	$t_{p_{1,j,1}}$	8	12	16
		J_j	J_1	J_2	J_3
	$O_{1,j,2}$	$t_{p_{1,j,2}}$	9	11	12
		J_j	J_2	J_1	J_3
	$O_{1,j,3}$	$t_{p_{1,j,3}}$	9	11	17
		J_j	J_3	J_1	J_2
M2	$O_{2,j,1}$	$t_{p_{2,j,1}}$	8	11	11
		J_j	J_2	J_1	J_3
	$O_{2,j,2}$	$t_{p_{2,j,2}}$	11	12	16
			J_2	J_3	J_1
	$O_{2,j,3}$	$t_{p_{2,j,3}}$	8	12	13
		J_j	J_2	J_3	J_1
M3	$O_{3,i,1}$	$t_{p_{3,j,1}}$	8	11	12
			J_2	J_3	J_1
	$O_{3,j,2}$	$t_{p_{3,j,2}}$	10	16	17
		J_j	J_1	J_3	J_2
	$O_{3,j,3}$	$t_{p_{3,j,3}}$	10	12	14
		J_j	J_2	J_1	J_3

- After sorting the jobs in subset $v_{m,n}$ we can assign the operation with m^{th} machine j^{th} job n^{th} operation, and determine the values of processing time classification factor $h_{2t_{m,j,n}}$ to each operation. as explain in table 4-12.

Table 4-12 Assigning the operation according to m^{th} machine, j^{th} job, and n^{th} operation, and processing time decision factor $h2_{t_{m,j,n}}$ to each operation

		$t_{p_{m,j,n}}$			
M1	$O_{1,j,1}$	$t_{p_{1,j,1}}$	8	12	16
		J_j	J_1	J_2	J_3
			$O_{1,1,1}$	$O_{1,2,1}$	$O_{1,3,1}$
		$h2_{t_{1,j,1}}$	1	2	3
	$O_{1,j,2}$	$t_{p_{1,j,2}}$	9	11	12
		J_j	J_2	J_1	J_3
			$O_{1,2,2}$	$O_{1,1,2}$	$O_{1,3,2}$
		$h2_{pE_{1,j,2}}$	1	2	3
	$O_{1,j,3}$	$t_{p_{1,j,3}}$	9	11	17
		J_j	J_3	J_1	J_2
			$O_{1,3,3}$	$O_{1,1,3}$	$O_{1,2,3}$
		$h2_{t_{1,j,3}}$	1	2	3
M2	$O_{2,i,1}$	$t_{p_{2,j,1}}$	8	11	11
		J_j	J_2	J_1	J_3
			$O_{2,2,1}$	$O_{2,1,1}$	$O_{2,3,1}$
		$h2_{tp_{2,j,1}}$	1	2	2
	$O_{2,j,2}$	$t_{p_{2,j,2}}$	11	12	16
			J_2	J_3	J_1
			$O_{2,2,2}$	$O_{2,3,2}$	$O_{2,1,2}$
		$h2_{t_{2,j,2}}$	1	2	3
	$O_{2,j,3}$	$t_{p_{2,j,3}}$	8	12	13
		J_j	J_2	J_3	J_1
			$O_{2,2,3}$	$O_{2,3,3}$	$O_{2,1,3}$
		$h2_{t_{2,j,3}}$	1	2	3
M3	$O_{3,j,1}$	$t_{p_{3,j,1}}$	8	11	12
			J_2	J_3	J_1
			$O_{3,2,1}$	$O_{3,3,1}$	$O_{3,1,1}$
		$h2_{t_{3,j,1}}$	1	2	3
	$O_{3,j,2}$	$t_{p_{3,j,2}}$	10	16	17
		J_j	J_1	J_3	J_2
			$O_{3,1,2}$	$O_{3,3,2}$	$O_{3,2,2}$
		$h2_{t_{3,j,2}}$	1	2	3
	$O_{3,j,3}$	$t_{p_{3,j,3}}$	10	12	14
		J_j	J_2	J_1	J_3
			$O_{3,2,3}$	$O_{3,1,3}$	$O_{3,3,3}$
		$h2_{t_{3,j,3}}$	1	2	3

The figure 4-13 and 4-14 explain the final result of classification trees

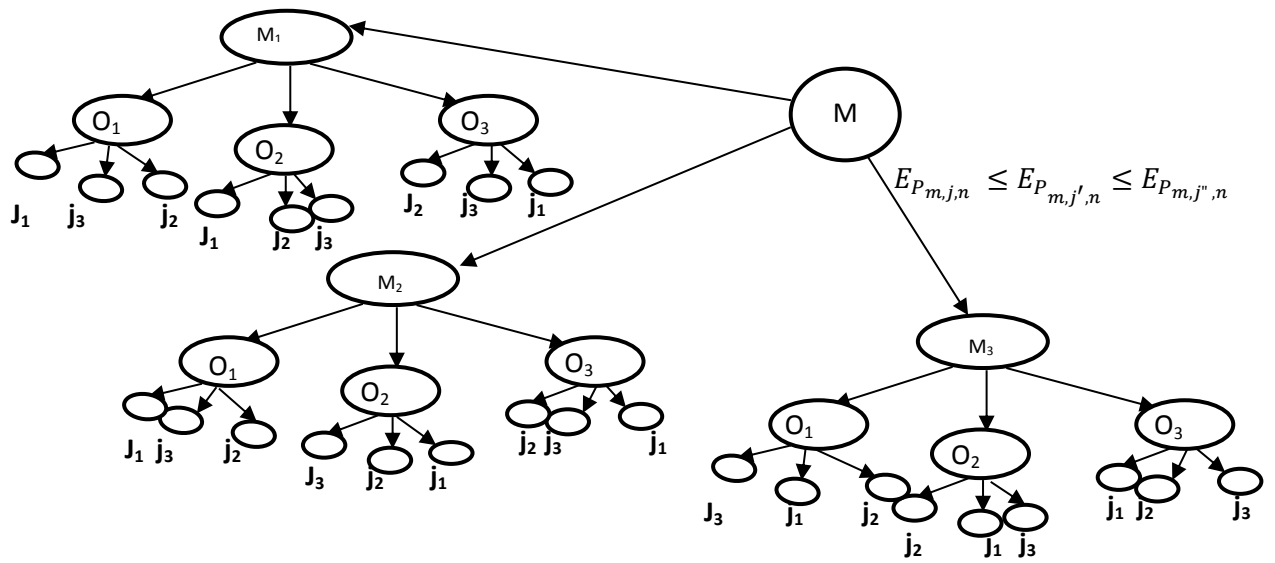

Figure 4-13 Processing energy machines-operations-jobs tree (E-M-O-J)

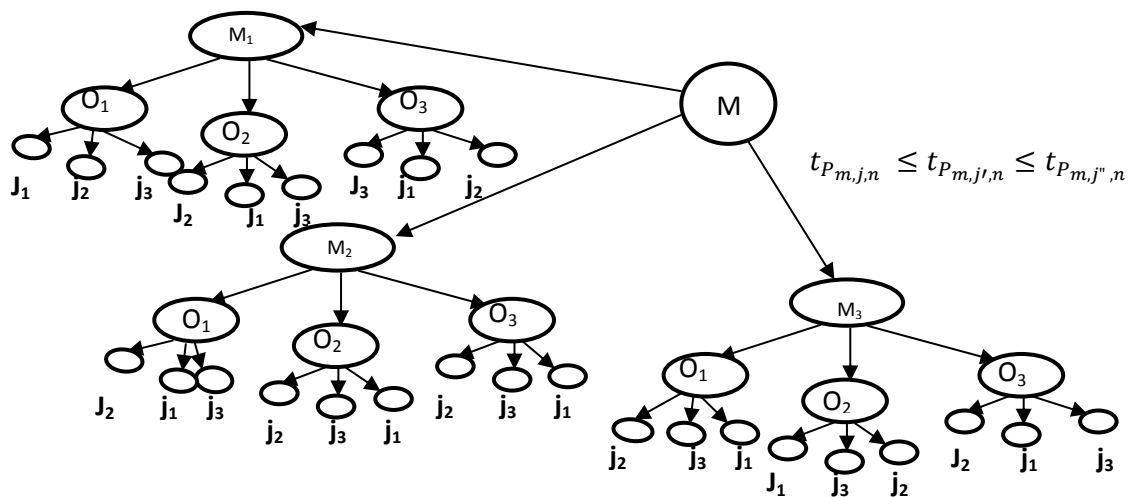

Figure 4-14 Processing time machines-operations-jobs tree (T-M-O-J)

With two tree methods, the solution is more correct, because it is built according to the relationship with all possibility between jobs and machines as shown in figure 4-15 and table 4-13

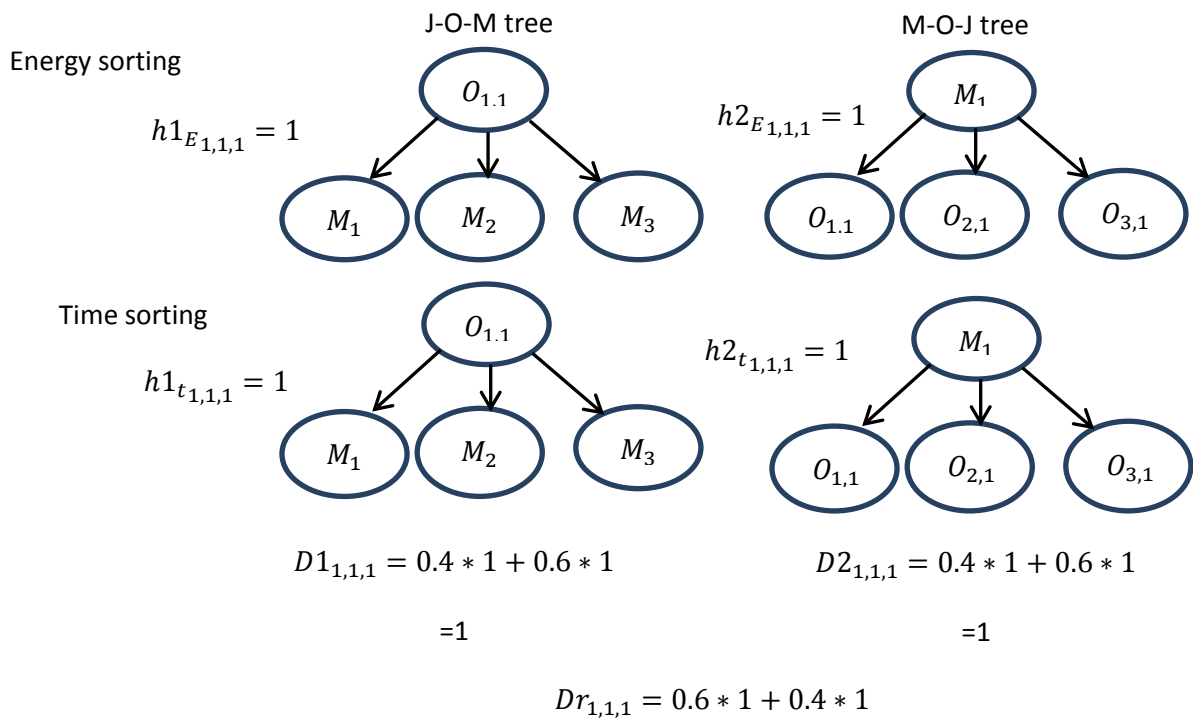

Figure 4-15 An example of different trees methods

Table 4-13 Values of $h1_{E_{m,j,n}}$, $h1_{t_{m,j,n}}$, $h2_{E_{m,j,n}}$, $h2_{t_{m,j,n}}$, $D1_{m,j,n}$, $D2_{m,j,n}$ and $Dr_{m,j,n}$ $\alpha = 0.5$, $\varphi = 0.5$

		$h1_{E_{m,j,n}}$	$h1_{t_{m,j,n}}$	$D1_{m,j,n}$	$h2_{E_{m,j,n}}$	$h2_{t_{m,j,n}}$	$D2_{m,j,n}$	$Dr_{m,j,n}$
J_1	$O_{1,1,1}$	1	1	1	1	1	1	1
	$O_{2,1,1}$	3	2	2,5	1	2	1,5	2
	$O_{3,1,1}$	2	3	2,5	2	3	2,5	2,5
	$O_{1,1,2}$	1	2	1,5	1	2	1,5	1,5
	$O_{2,1,2}$	3	3	3	3	3	3	3
	$O_{3,1,2}$	2	1	1,5	2	1	1,5	1,5
	$O_{1,1,3}$	3	1	2	3	2	2,5	2,25
	$O_{2,1,3}$	1	3	2	2	3	2,5	2,25
	$O_{3,1,3}$	2	2	2	1	2	1,5	1,75
J_2	$O_{1,2,1}$	3	2	2,5	3	2	2,5	2,5
	$O_{2,2,1}$	2	1	1,5	2	1	1,5	1,5
	$O_{3,2,1}$	1	1	1	3	1	2	1,5
	$O_{1,2,2}$	2	1	1,5	2	1	1,5	1,5
	$O_{2,2,2}$	1	2	1,5	2	1	1,5	1,5
	$O_{3,2,2}$	3	3	3	1	3	2	2,5
	$O_{1,2,3}$	2	3	2,5	1	3	2	2,25
	$O_{2,2,3}$	1	1	1	1	1	1	1
	$O_{3,2,3}$	3	2	2,5	1	1	1	1,75
J_3	$O_{1,3,1}$	3	2	2,5	2	3	2,5	2,5
	$O_{2,3,1}$	2	1	1,5	1	2	1,5	1,5
	$O_{3,3,1}$	1	1	1	1	2	1,5	1,25
	$O_{1,3,2}$	2	1	1,5	2	3	2,5	2
	$O_{2,3,2}$	1	2	1,5	1	2	1,5	1,5
	$O_{3,3,2}$	2	3	2,5	3	2	2,5	2,5
	$O_{1,3,3}$	2	1	1,5	2	1	1,5	1,5
	$O_{2,3,3}$	1	2	1,5	1	2	1,5	1,5
	$O_{3,3,3}$	3	3	3	2	3	2,5	2,75

4.5.2 Lower and Upper bound limits

To determine the lower and upper bounds.

We calculate two lower bounds one for time objective and other for energy objective. These bounds are (Wt_m) , total working time spent at machines M_m and (TE_m) , total energy consumed in machine M_m .

We calculate three upper bounds, (Wt_m) , the total working time spent at machines M_m and (TE_m) total energy consumed in machine M_m and makespan C_{max} .

Notation:

Lb_E : lower bound energy objectives

Lb_t : lower bound job shop objectives

Ub_E : upper bound energy objectives

$Ub1_t$: first upper bound job shop objectives

$Ub2_t$: second upper bound job shop objectives

$$Lb_E = \min\{TE_m\} \quad (4-10)$$

$$Lb_t = \min\{Wt_m\} \quad (4-11)$$

In lower bound operations are assigned according to minimum values of average classification decision index $Dr_{m,j,n}$

$$Ub_E = \max\{TE_m\} \quad (4-12)$$

$$Ub1_t = \max\{Wt_m\} \quad (4-13)$$

$$Ub2_t = C_{max} \quad (4-14)$$

In upper bound operations are assigned according to maximum values of average classification decision index $Dr_{m,j,n}$

4.5.3 Local lower and Upper bound limits

Each job has local lower and upper bound according to classification factors $h1_{E_{m,j,n}}$ and $h1_{t_{m,j,n}}$ values. If the operations of jobs are selected according to minimum decisions factors, then the solution represents the local lower bound, and if the operations of jobs are selected with maximum classification factors, then the solution represents the local upper bound,

Local lower bounds; two local lower bound

LLb_{E_j} : Local lower bound processing energy, LLb_{E_j} is minimum total energy consumed to process all operations of j^{th} job, these operations are selected according to their classification energy factor $h1_{E_{m,j,n}}=1$.

For example (in table 4-13) the operations $\{O_{1,1,1}, O_{1,1,2}, O_{2,1,3}\}$ of job J_1 have $h1_{E_{m,j,n}}=1$, that means if this job process this machine sequence $\{M_1 \rightarrow M_1 \rightarrow M_2\}$, that job at this sequence consume minimum energy.

$$LLb_{E_j} = \sum_{m=1}^M \sum_{n=1}^{N_j} E_{p_{m,j,n}} x_{m,j,n} = 1 \text{ if } h1_{E_{m,j,n}} = 1 \quad (4-15)$$

LLb_{t_j} : local lower bound processing time, LLb_{t_j} is the minimum total processing time to process all operations of j^{th} job, if these operations are selected according to their classification time factor $h1_{t_{m,j,n}}=1$, that job at this sequence has smallest total processing time.

For example, the operations $\{O_{1,1,1}, O_{3,1,2}, O_{1,1,3}\}$ of job J_1 have $h1_{t_{m,j,n}} = 1$, that means if this job processed in machines sequence $\{M_1 \rightarrow M_3 \rightarrow M_1\}$, at this sequence, the job (J_1) has minimum processing time .

$$LLb_{t_j} = \sum_{m=1}^M \sum_{n=1}^{N_j} t_{p_{m,j,n}} \quad x_{m,j,n} = 1 \text{ if } h1_{t_{m,j,n}} = 1 \quad (4-16)$$

Local upper bounds; two local upper bound

LUb_{E_j} : Local upper bound processing energy LUb_{E_j} is maximum total energy consumed to process all operations of j^{th} job, if these operations are selected according to their maximum energy classification factor $h1_{E_{m,j,n}}$.

$$LUb_{E_j} = \sum_{m=1}^M \sum_{n=1}^{N_j} E_{p_{m,j,n}} \quad x_{m,j,n} = 1 \text{ if } h1_{E_{m,j,n}} = \max \text{ value} \quad (4-17)$$

For example (in table 4-13) the operations $\{O_{2,1,1}, O_{2,1,2}, O_{1,1,3}\}$ of job J_1 have $h1_{E_{m,j,n}} =$ maximum values (in our example $h1_{E_{2,1,1}} = 3, h1_{E_{2,1,2}} = 3, \text{ and } h1_{E_{1,1,3}} = 3$), that means if this job processes in machines sequence $\{M_2 \rightarrow M_2 \rightarrow M_1\}$, this job at this sequence consume maximum processing energy.

LUb_{t_j} : local upper bound processing time, LUb_{t_j} is minimum total processing time to process all operations of j^{th} job, if these operations are selected according to their maximum classification time factor $h1_{t_{m,j,n}} =$ maximum value, the result is local upper bound .

$$LUb_{t_j} = \sum_{m=1}^M \sum_{n=1}^{N_j} t_{p_{m,j,n}} \quad x_{m,j,n} = 1 \text{ if } h1_{t_{m,j,n}} = \max \text{ value} \quad (4-18)$$

For example, the operations $\{O_{3,1,1}, O_{2,1,2}, O_{2,1,3}\}$ of job J_1 have $h1_{t_{m,j,n}} =$ maximum value (in our example $h1_{t_{3,1,1}} = 3, h1_{t_{2,1,2}} = 3, \text{ and } h1_{t_{2,1,3}} = 3$), that means if this job processes in this machines sequence $\{M_3 \rightarrow M_2 \rightarrow M_2\}$, the job (J_1) has maximum processing time .

To determine these local bound, the lower bounds establish how we can improve an objective. For example, if the solution is below LLb_{E_j} , the energy objectives are improved. As same, if it is below LLb_{t_j} the time objective is improved (Figure 4-16).

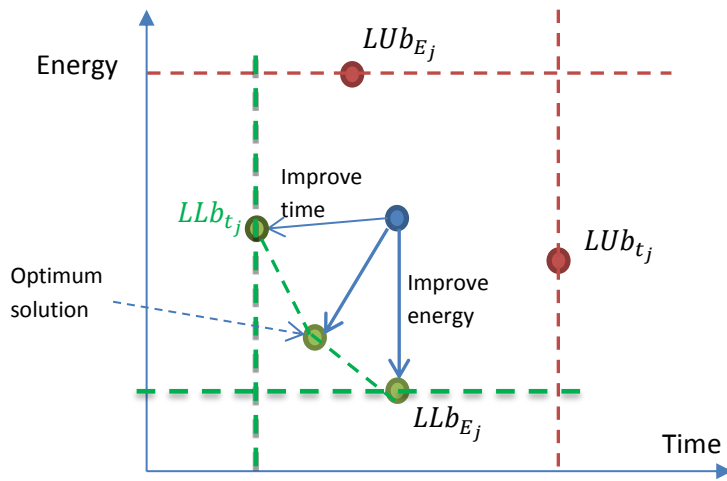

Figure 4-16 Local boundary limits

4.5.4 Branching

According to classification decision $Dr_{m,j,n}$ (as explain in table 4-13) operation assignment in the machines are shown in figure 4-17. Any machine works as local constraint to other machines to attain minimum total workload time and min total energy as showed in figure 4-18.

Machine selects the operations with minimum decision $Dr_{m,j,n}$. We consider the job shop constraints and the same constraints that are used in (Minimize Energy Constrain Programming ECP), with modification of solution with lower bound and local lower bound, and stay away from upper bound and local upper bounds.

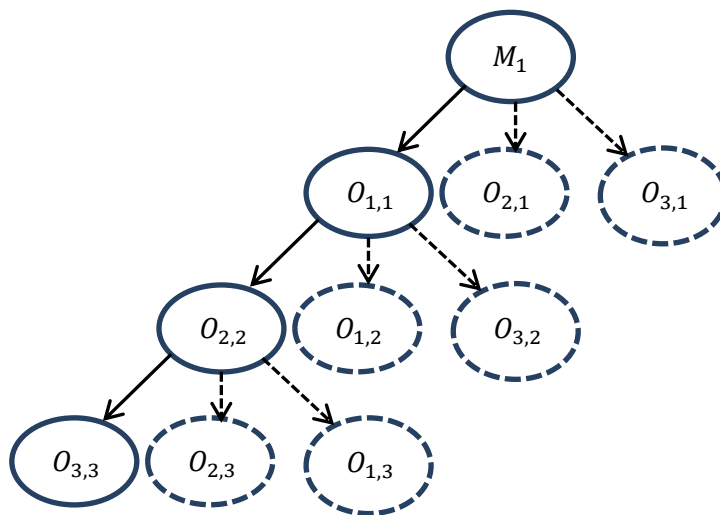

Figure 4-17 Branching method of a machine

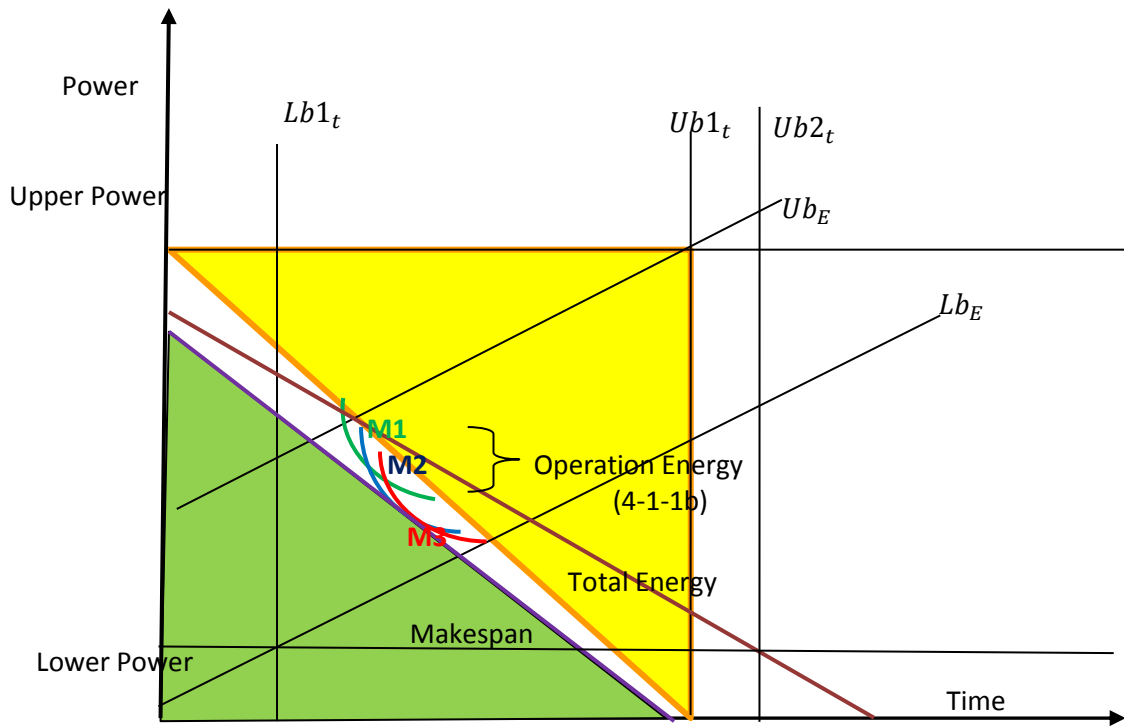

Figure 4-18 MILP and CP concerned with B&B machine operation energy

The jobs are scheduled in the machines process after process. All machines load the jobs process by process until finish all jobs operations as see in figure 4-19.

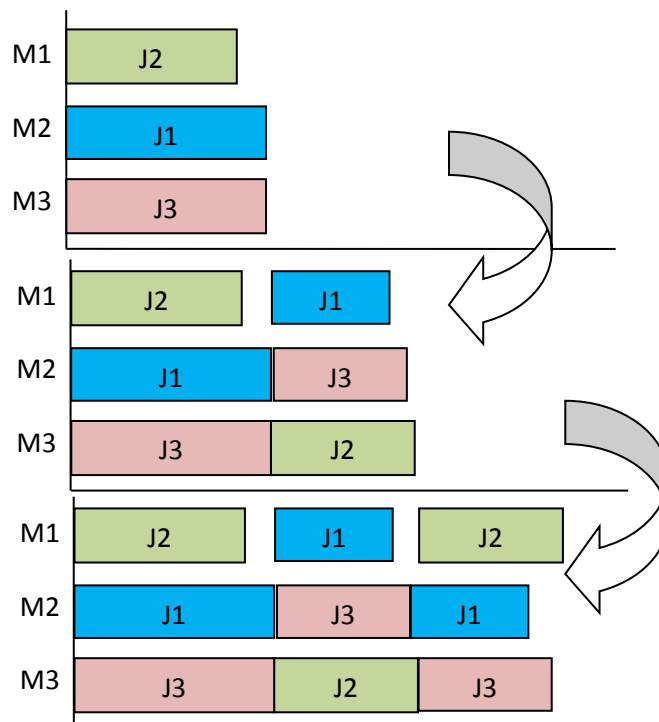

Figure 4-19 Solving scheduling problem by MILEP

With this method, jobs are scheduled clearly and accurately. Also processes are selected clearly with small setup time, because setup time depends on the previous operation on machine and the machine

itself. Since the previous process is known, the next process can be select with a small setup and processing time.

4.5.5 Left shift

Consider in schedule \mathcal{S} , in machine scheduling s_m of m^{th} machine, two operations $O_{m,j',n'} < O_{m,j,n}$ process in m^{th} machine figure 4-20. If the two operation are independent, and $O_{m,j',n'}$ is processed to $O_{m,j,n}$ ($O_{m,j',n'} < O_{m,j,n}$) and m^{th} machine has an idle period longer than processing time of $O_{m,j,n}$ then the operation $O_{m,j,n}$ is reassigned to be processed before processing $O_{m,j',n'}$ (figure 4-21). Such reassignment is called (Yamada T., 2003) “a permissible left shift and a schedule with no more permissible left shifts are called an active schedule”.

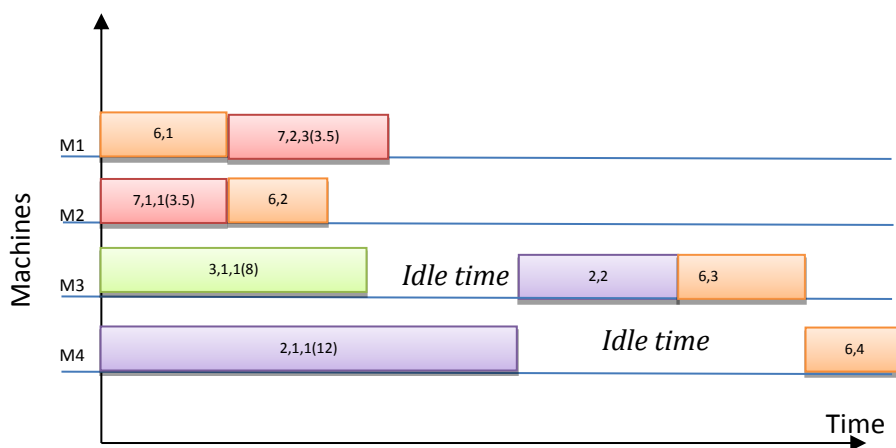

Figure 4-20 Job shop scheduling S before left shit of operation

Let the two operations $O_{3,2,2}$ and $O_{3,6,3}$ process in machine 3 , and $O_{3,2,2}$ process before $O_{3,6,3}$ according to left shift possibility machine M_3 reassignment, where the $O_{3,6,3}$ processing before $O_{3,2,2}$ and also $O_{3,6,4}$ left moving to improve machine 4 scheduling s_4 (figure 4-21):

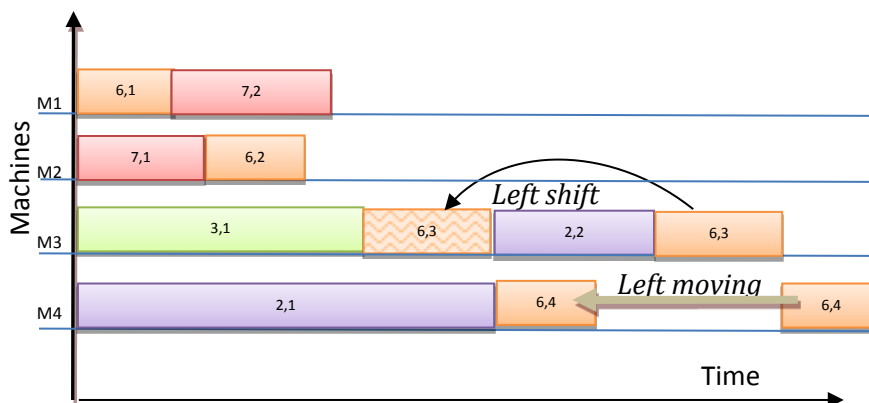

Figure 4-21 Job shop scheduling after left shit of operation

if $O_{m,j',n'} < O_{m,j,n}$ on M_m and $O_{m,j'',n''} < O_{m,j',n'}$ on M_m

s_m scheduling of m^{th} machine , $s_m \in \mathcal{S}$

$$s_m = \{O_{m,j'',n''} < O_{m,j',n'} < O_{m,j,n}\} \quad (4.19)$$

$$j \neq j' \neq j'' \quad j, j', j'' \leq J$$

$$S_{m,j',n'} > Ct_{m,j'',n''} \quad (4.20)$$

$$t_{id_{j'',n''}'} = S_{m,j',n'} - Ct_{m,j'',n''} \quad (4.21)$$

$$t_{id_{j'',n''}'} \geq t_{p_{m,j,n}} \quad (4.22)$$

Modify $s_m \rightarrow s'_m$

$$s'_m = \{\dots O_{m,j'',n''} < O_{m,j,n} < O_{m,j',n'}, \dots\} \quad (4.23)$$

4 5.6. Turn on/off or standby to reduce total energy

In several cases optimum scheduling plant has an idle time, (idle energy). Left shift is used to reduce idle time problem. But, this method isn't applicable in many cases; for example, inoperability to move an operation and change scheduling job sequence.

Turn off/on (turn off entirely the machine tool) was used by (Mouzon, et al. 2007,) as shown in figure (4-22), but, they not proposed machine state such as standby state (energy saving mode) to reduce total energy during idle time.

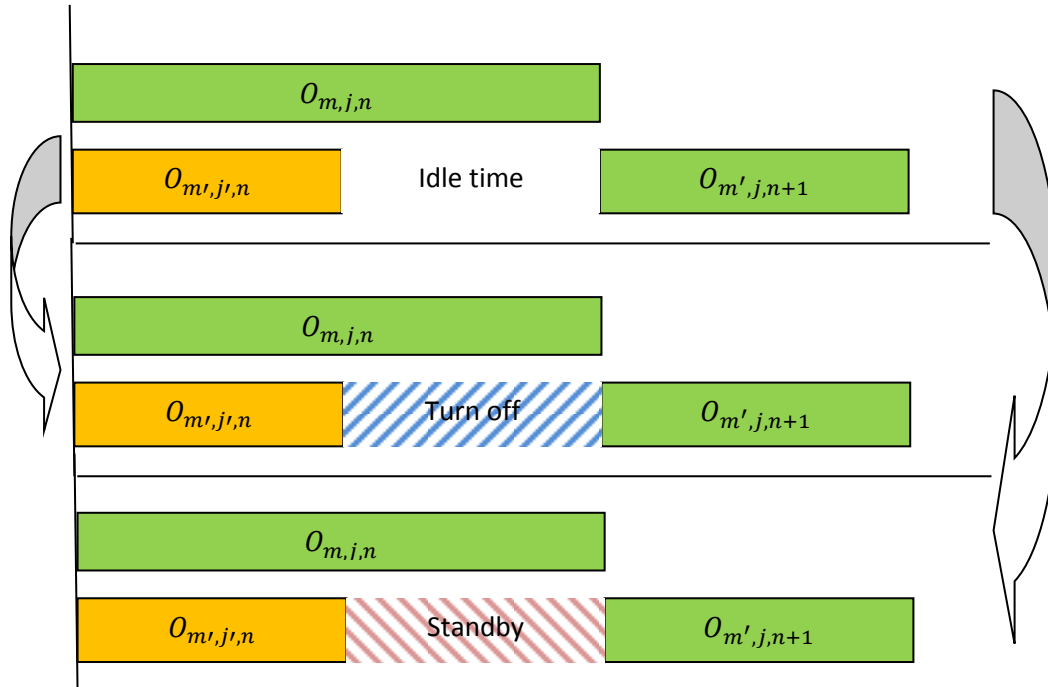

Figure 4-22 Turn on – off or standby operation

Standby power is less than basic power, it also called semi-active state, in this state the general machines and equipment's devices are turn off, and during standby state, machine consume 20-40 % of basic power as illustrate as see in figure 4-23.

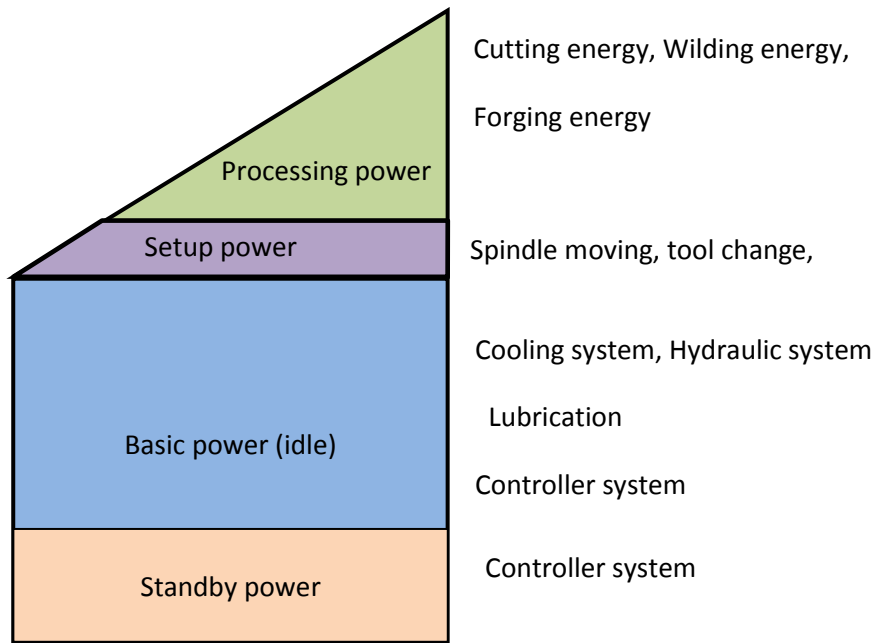

Figure 4-23 Power consumed relationship during machine operation cycle

To make the decision to turn the machine into standby or shutdown depends on a lot of parameters such as time saving, energy consumption during idle

- Notation

t_{sleep_m} : sleep time in machine M_m . Time needed to change machine state from basic state to standby state

t_{wake_m} : wake-up time in machine M_m . Time needed to change machine state from standby state to basic state

P_{std_m} : standby power in machine M_m .

$$P_{std_m} = (0.4) P_{b_m} \quad (4-34)$$

P_{sleep_m} : sleep power in machine M_m . To change machine state from basic state to standby state

P_{wake_m} : wake-up power in machine M_m . To change machine state from standby state to basic state

E_{std_m} : standby energy in machine M_m .

E_{sleep_m} : sleep energy in machine M_m . Energy consumed to change machine state from basic state to standby state

E_{wake_m} : wake-up energy in machine M_m . Energy consumed to change machine state from standby state to basic state

1. Turn on energy: energy needed to starting or restarting machine and be going to basic state this process need period t_{s_m} .

$$E_{s_m} = P_{s_m} t_{s_m}. \quad (3-15)$$

2. Idle time energy

$$TE_{id\ m} = P_{b\ m} T t_{id\ m} \quad (3-17)$$

3. Standby energy $E_{std\ m}$ during idle time $t_{id\ m}$

$$P_{std\ m} = 0.4 P_{b\ m} \quad (4-35)$$

$$E_{std\ m} = P_{std\ m} t_{id\ m} \quad (4-36)$$

4. Turn off energy: energy consumed by machine to safety shutdown with period $t_{off\ m}$

$$E_{off\ m} = P_{off\ m} t_{off\ m} \quad (3-22)$$

5. sleep energy $E_{sleep\ m}$: To change the device to standby, it takes the time $t_{sleep\ m}$ and need to power $P_{sleep\ m}$

$$E_{sleep\ m} = P_{sleep\ m} t_{sleep\ m} \quad (4-37)$$

6. wake-up energy $E_{wake\ m}$: energy consume to reactive of the machine, which takes the time $t_{wake\ m}$ and power $P_{wake\ m}$

$$E_{wake\ m} = P_{wake\ m} t_{wake\ m} \quad (4-38)$$

7. power saving constraints

$$P_{sleep\ m} < P_{off\ m}$$

$$P_{wake\ m} < P_{on\ m}$$

$$p_{id\ m} > p_{off\ m} + p_{on\ m}$$

8. time constraints

$$t_{sleep\ m} < t_{off\ m}$$

$$t_{wake\ m} < t_{on\ m}$$

$$t_{id\ m} > t_{off\ m} + t_{on\ m}$$

z_m : Integer decision variable $z_m \in \{1,2,3\}$

$$z_m = \left\{ \begin{array}{l} 1 \quad \text{if } E_{id\ m} > E_{off\ m} + E_{on\ m} \text{ else} \\ 2 \quad \text{if } E_{id\ m} > E_{wake\ m} + E_{sleep\ m} + E_{std} \text{ else} \\ 3 \quad \text{otherwise} \end{array} \right\}$$

❖ Machine be turn off if

$$E_{id\ m} > E_{off\ m} + E_{on\ m} \quad (4-39)$$

$$z_m = 1$$

❖ Machine change to standby state (*Std*) if

$$E_{off\ m} + E_{on\ m} \geq E_{id\ m} > E_{wake\ m} + E_{sleep\ m} + E_{std} \quad (4-40)$$

$$z_m = 2$$

❖ Machine remain in idle state (idle) if

$$E_{wake\ m} + E_{sleep\ m} + E_{std} \geq E_{id\ m} \quad (4-41)$$

$$z_m = 3$$

4.6 Case study and Conclusions

In this chapter, we used two types of solutions

(i.) Minimize Energy Constrain Programming *ECP*, and (ii.) A Mixed Integer Linear Programming Minimized Energy *MILPE*. The database size is 10×10 with 12 operations in each job, to satisfy the requirements of this research.

Performance measurement is done by measuring the percentage of total energy reduction and the makespan reduction of each algorithm. Where it is done through following:

$rTWt_l$: Reduction percentage of total workload in l iteration.

$$rTWt_l = \frac{TWt_l}{TWt_0} \times \% \quad (3.25)$$

$rTTE_l$: Reduction percentage of total energy in l iteration

$$rTTE_l = \frac{TTE_l}{TTE_0} \times \% \quad (3.26)$$

$$rC_{max_l} = \frac{C_{max_l}}{C_{max_0}} \times \% \quad (3.27)$$

rC_{max_l} : Reduction percentage of makespan in l iteration

$$rTE_{id_l} = \frac{TE_{id_l}}{TE_{id_0}} \times \% \quad (3.28)$$

rTE_{id_l} : Reduction percentage of non-productive energy in l iteration

The average reduction AvR_l

$$AvR_l = \frac{rTWt_l + rTTE_l + rC_{max_l} + rTE_{id_l}}{4} \quad (3.29)$$

Where l : iteration number $l = 1 \dots L$;

L : total number of iteration, $L = n!$.

$TWt_0, TTE_0, C_{max_0},$ and TE_{id_0} are the average of their values in the first five iterations and $TWt_l, TTE_l, C_{max_l},$ and TE_{id_l} are output at l iteration, as the same method was applied to test makespan reduction; here C_0 is the average of makespan at the first five iterations and C_l

General objective of job shop scheduling is to find the optimum time for the workshop. We aim to optimize both energy and time. These methods are tested with problems ($2 \times 2 \rightarrow 12 \times 12$) with operations ($2 \rightarrow 10$) the. Reducing electricity consumption as well as maintaining good time performances in the objectives of FJSP is a difficult problem that can take a long time to solve optimally. The model is formulated entirely of constraint programming (*ECP*) or mixed integer/linear

programming problem (*MILPE*) problem. Figure 4-24 shows the comparing between using *ECP* and *MILPE* results. Here we find that *MILPE* gives the best solution compare with the result of *ECP*. Figure 4-24 shows the result of problem 6x6 with six operations of each job that means this problem is more complex that the problems used to test genetic algorithms (chapter three). In chapter six, we will be discuses with detail explanation the advantages and disadvantage of all optimization methods.

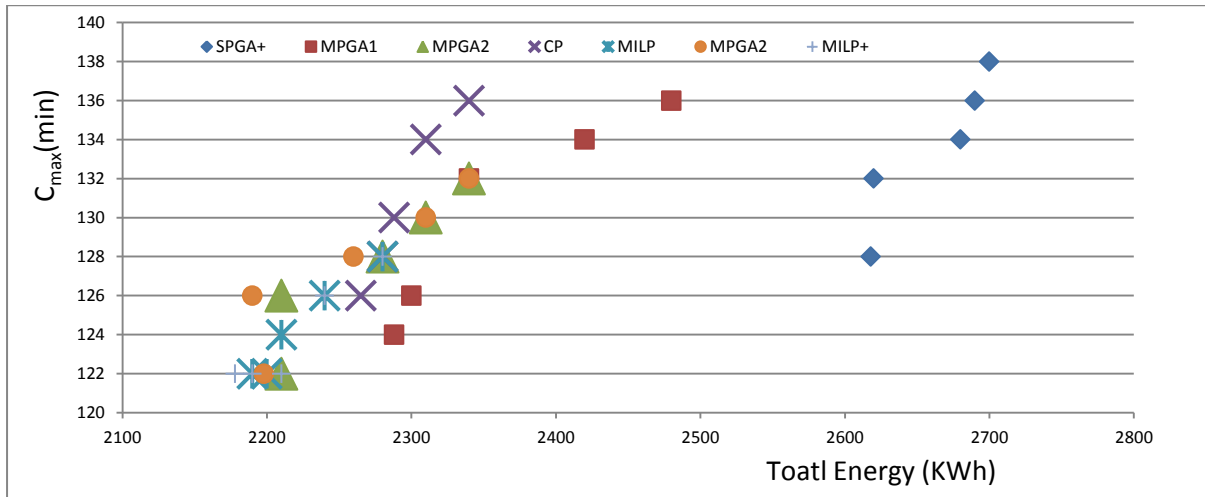

Figure 4-24 Scheduling problems 6x6 (number of operations n=6)

Chapter Five

Case study, conclusion and future work

Number	Name	Page	
5	Case study, conclusion and future work	128	
	5.1	Summary of the research	129
	5.1.1	Work Environment Development	129
		5.1.2	Job shop problems types
	5.2	Results and Conclusion	132
	5.3	Future works	136

5 Case study, conclusion and future work

5.1 Summary of the research

In this thesis two types of optimization methods are used, which are genetic algorithms and linear programming. In genetic algorithm, two types of genetic algorithms are used classical and parallel, as explained in chapter three. In constraint programming, mixed integer programming and linear programming are used, as explained in chapter four.

In this thesis we developed traditional job shop scheduling method to reduce and optimise energy consumed by machines in workstation, by:

1. Mathematical model for the energy consumption for machine tools and workstation has been formalized, this model combines energy objectives and job shop objectives
2. New multi-population multi-objective optimization models considering reducing electricity consumption and its related
3. Initial populations for multi-population genetics algorithms are selected by global minimum processing energy and processing time
4. To reduce the divergence between the objectives of the two sub-genetics in multi populations genetic algorithm MPMOGA2, threshold operation and elite works are used
5. New constraint programming method to reduce total energy, and then a Mixed Integer Linear Programming Minimized Energy MILPE algorithm to reduce both energy and time objectives
6. In Mixed Integer Linear Programming Minimized Energy MILPE, we developed a method (Classification Trees). This method is a good way to minimize energy and time objectives
7. And we developed a new lower and upper bonds limits for each job, these called local lower and upper limits

5.1.1. Works Environment Development

The work in this thesis passes in three development steps figure (5-1).

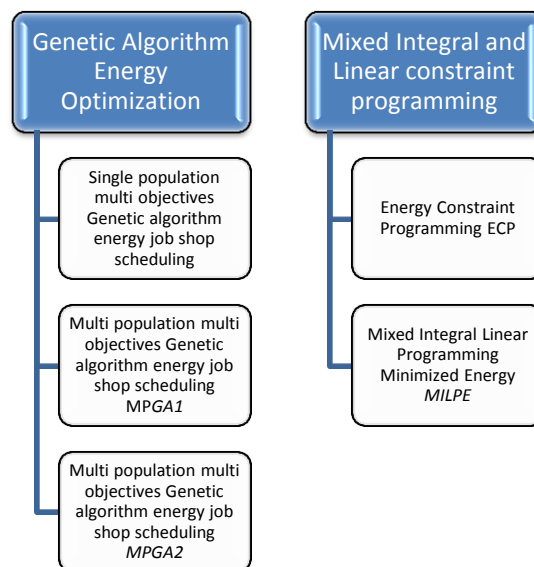

Figure 5-1 Development steps

- **Genetic algorithms**

As presented in chapter three the genetic algorithms were used with initial population selected using global minimum processing energy and global minimum processing time criteria.

We used two types of genetic algorithm,

- In the first genetic algorithm MPGA1 (figure 5-2) , this genetic is classical genetic algorithm, with two populations, one chromosome, selected from energy (processing energy) population, represents the energy population, and another chromosome, selected from time (processing time), represents the time population. From that each population is represented by only one chromosome. This genetic is still limited to solve large scheduling problems, because representing a population with one chromosome is not enough to give clear solution with complex and large job shop scheduling problems populations

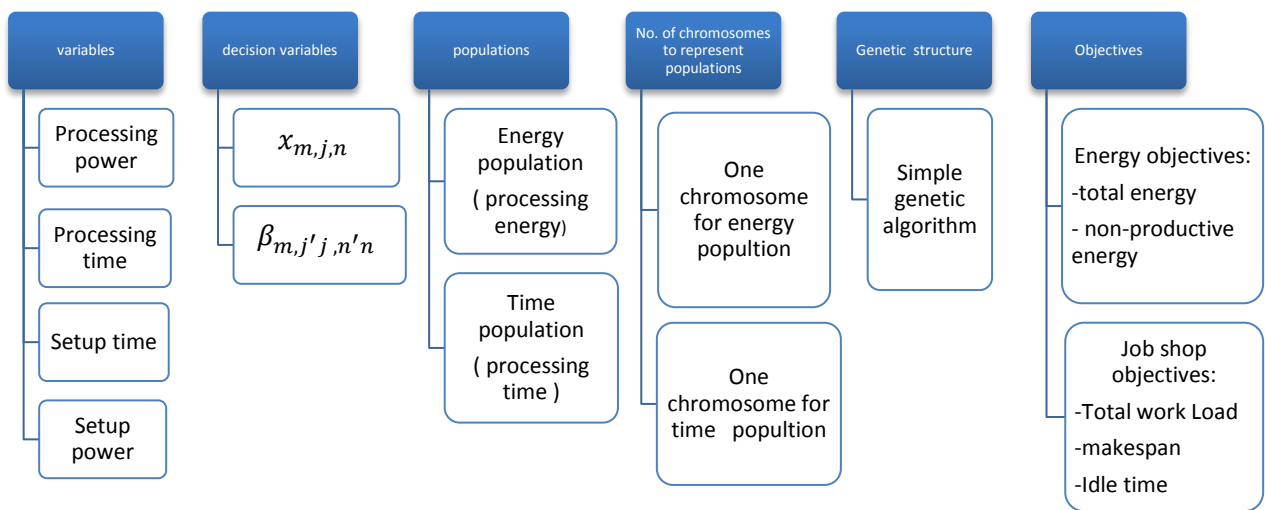

Figure 5-2 MPGA1 general structure

- The second genetic algorithms MPGA2 (figure 5-3), this genetic has the same initial population selection method, but it consists of two parallel sub-genetic. However, in each sub-genetic two chromosome are selected to represent energy initial population selected according to global minimum processing energy for energy sub-genetic, other two chromosomes are selected to represent time initial population selected according to global minimum processing time for time sub-genetic. From that in this genetic algorithm MPGA2, each population represented by two chromosomes, that gives a greater ability to solve more complex and large job shop scheduling problems scheduling problems comparing with the first genetic algorithm MPGA1

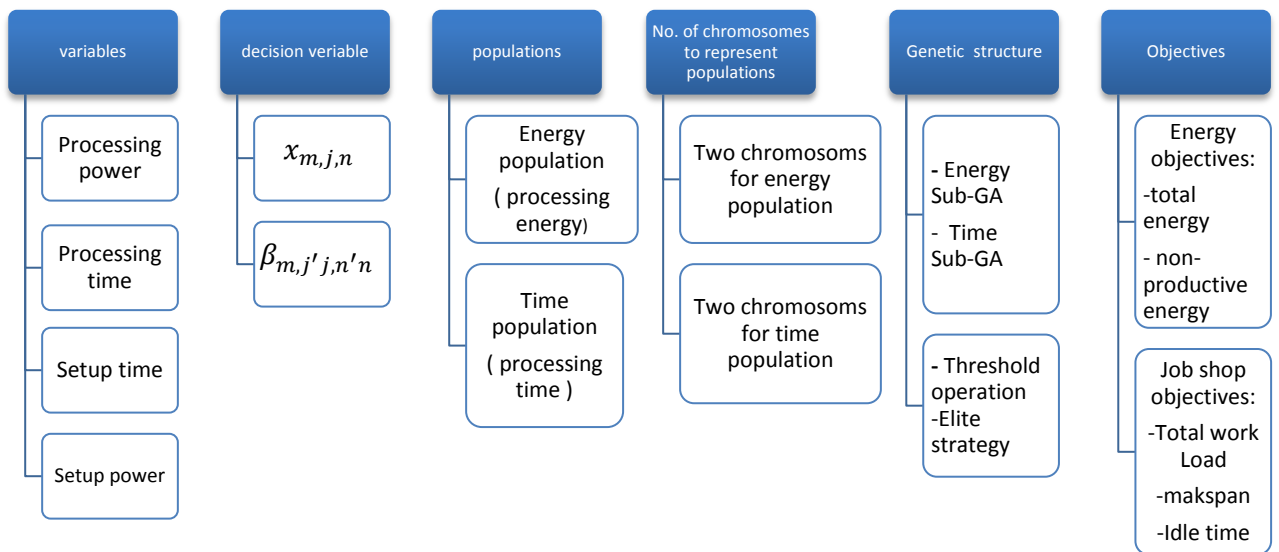

Figure 5-3 MPGGA2 general structure

- **Constraint Programming ECP and Mixed Integer Linear Programming MILPE**

In mixed integer programming (figure 5-4) method classifications trees are developed to determine the candidate solutions and understand the relationship between the jobs and machines.

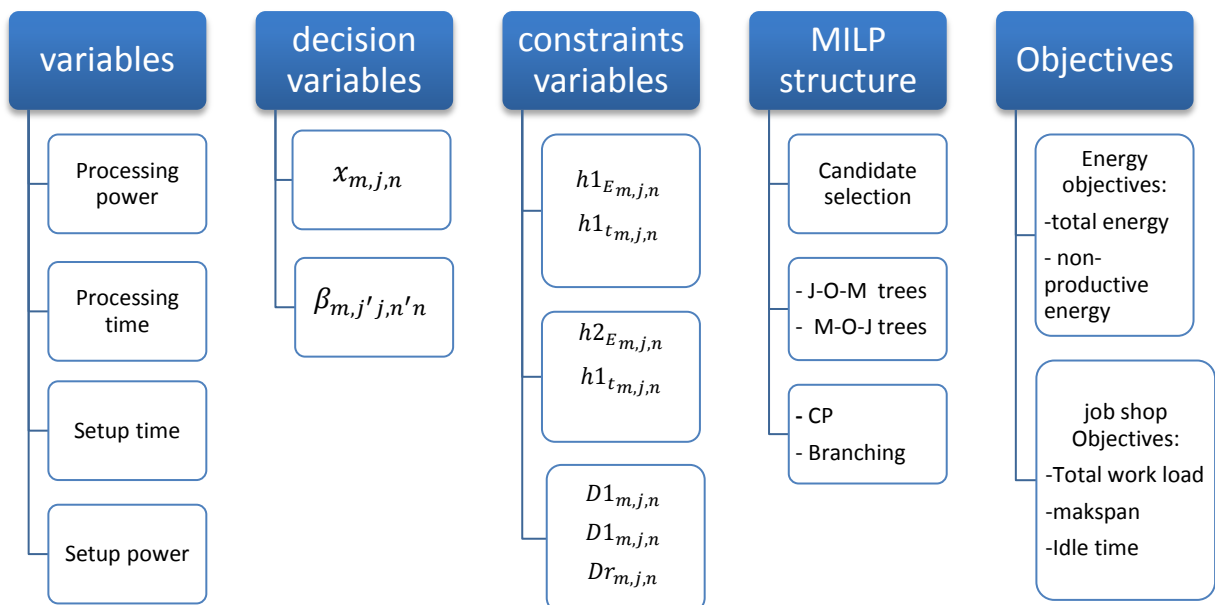

Figure 5-4 MILP general structure

In mixed Integer programming optimization method, the first candidate solution represents the suggesting solution in first step, and then candidates are selected according to constraint variables

(classification factors). These classification factors works to constrain the machines in machine subset $u_{j,n}$ or to constrain the jobs in jobs subset $v_{m,n}$, and also works as decision variables, to determine local lower and upper limits, for example;

$$LLb_{E_j} = \sum_{m=1}^M \sum_{n=1}^{N_j} E_{p_{m,j,n}} \quad x_{m,j,n} = 1 \text{ if } h1_{E_{m,j,n}} = 1 \quad (4-15)$$

5.1.2. Job shop problem type

Generally, in this thesis all optimizations methods are tested with job shop problems that have number of machine equal to number of jobs. However, these methods are also capable to solve problem that have number of machines not equal to number of jobs. These cases are divided into:

- **Number of machines less than number of jobs**

In these cases, jobs have small flexibility to search to machine, and that reduces the chances of selecting a machine, because of the lower probability of solution with smaller number of machines.

In these cases machines may process two or more operations with same operation index at the same time for example machine M_3 process $O_{2,1}$ and $O_{4,1}$ and the constraint $\sum_{j=1}^J x_{m,j,n} \in \{0,1\} \forall m,n$ is disabled. In these cases machines process one operation of first job and the other operation of second job stays waiting until the operation of the first job finish. To select which be the first and which be second operation we adapt the job shop constraints with queuing theory as flow:

1. First come first served: in this case the job that arrives first is processed first in machine.
2. Shortest processing time: if two jobs wait for a machine, that machine process firstly the job that has the shortest processing time.

By queuing theory constraint, we can solve scheduling problem with genetic algorithm GA and mixed Integer programming.

- **Number of machines greater than number of jobs**

In these cases, jobs have larger flexibility to select the machine, because of largest machine availability. But not all machine charge, this leads to the possibility of an idle time, because a machine M_m not process an operation $O_{j,n}$. These cases can be improved by;

1. Left shifting and left moving as explained in chapter four (4.5.4 Left shifting) to improve job scheduling sequences and reduce idle time between the operations.
2. If the left shifting cannot apply or does not give good result, idle time energy can be reduced by applying turn on/off or standby strategy to reduce total energy, as explained in chapter four (Turn on/off or standby to reduce total energy).

5.2 Results and Conclusion

Job shop scheduling problem size refers to number of machines; number of jobs and jobs size (number of operations in job). All optimisations methods (except single population genetic algorithm) have well and near results with small medium job shop problem, as shown in figure 5-5 (6 job x 6 machine problem with 6 operations per job).

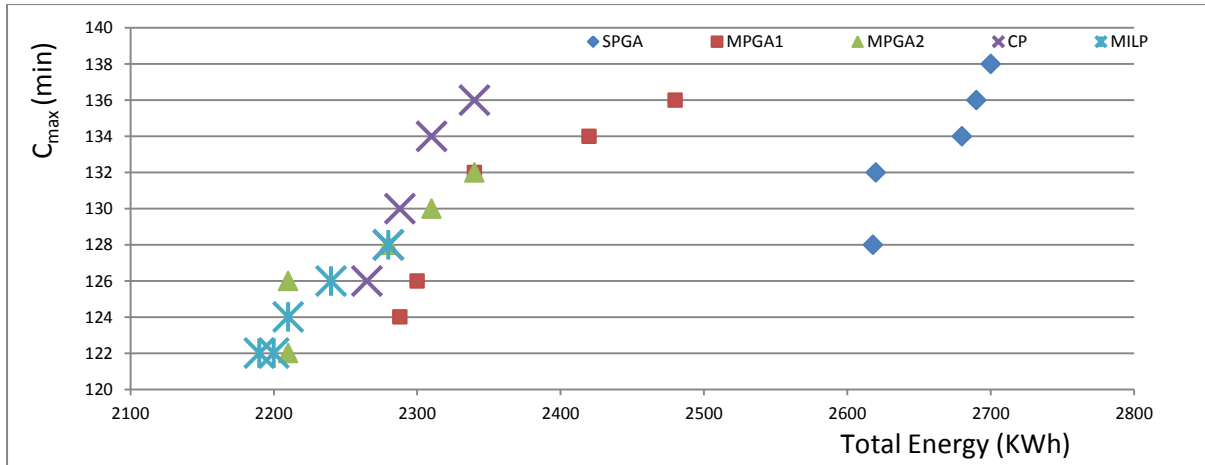

Figure 5-5 Comparison of algorithm results for 6x6x6 job shop problem

As shown in figure (5-5) constraint programming (CP) works well to reduce energy, but does not give a good result for job scheduling objectives, because it is designed to strongly reduce energy. However, with mixed integer linear programming (MILP) by developing classification trees and branching methods, we can obtain the best results. Multi populations genetic MPGA2 (parallel genetics) and MPGA1 (classical genetics), gives quite good results.

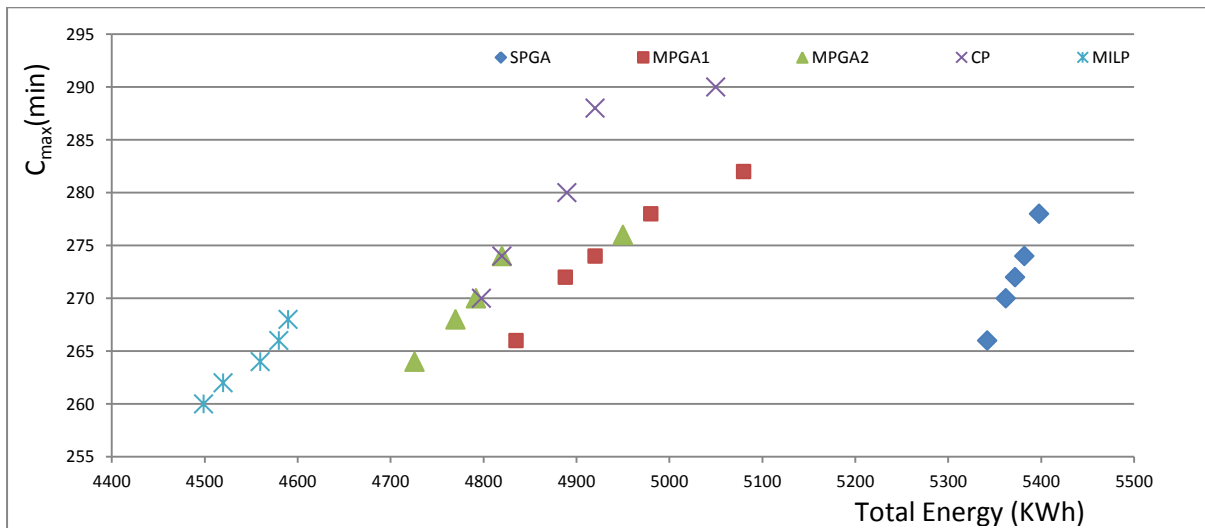

Figure 5-6 Comparison of algorithm results for 6x6x12 job shop problem

MPGE2 is more capable to solve bigger problems for example increasing the number of operations from 6 to 12 operations as shown in figure 5-6. For this reason, MILP and MPGA2 are developed by adding left shift and turn off-on/ standby constraints to improve their results.

When increasing the number of operations that mean increasing number of segments in the chromosomes. One chromosome is not sufficient to represent well complex variables, from that we found the result of MPGE1 less correct comparing with MILP or MPGE2.

When increasing number of machines and number of jobs to 12 machines and 12 jobs, we found that MILP is more efficient to reduce all objectives (ENERGY and JOB shop objectives) as shown in figures (5-7,5-8 and 5-9), because increasing number of machines and jobs increases population's size. However, increasing the number of machines also increases the CPU processing time to find best solution in MILP method, because any machine works as a branching tree. Increasing the number of

machines increases number of branching trees of machines, and number of operations increases number of levels and branching length, but not reduce the accuracy of result because in MILP, machines are scheduling step by step operation after operation until finish last operation in scheduling problem.

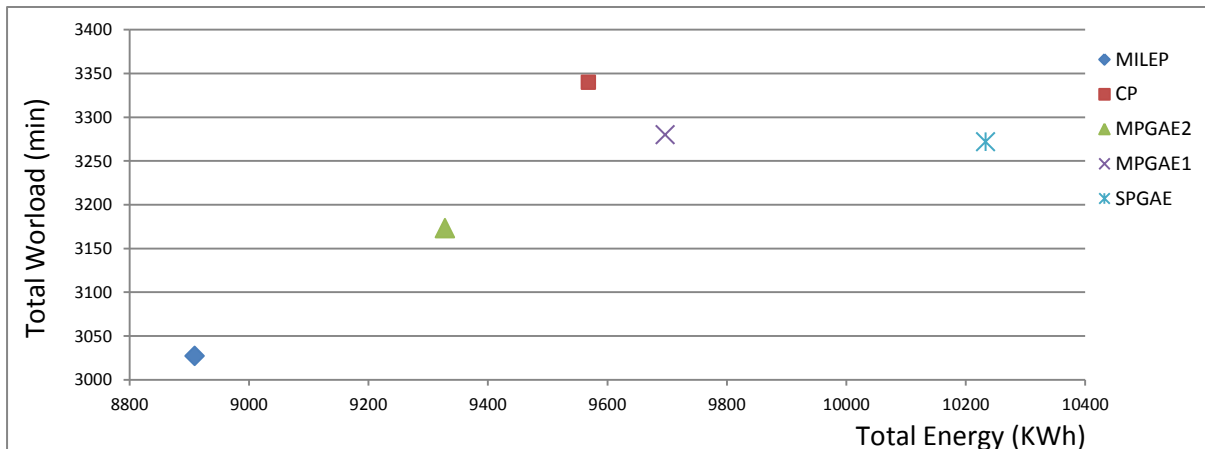

Figure 5-7 Total work load and total energy (12x12x12 job shop problem)

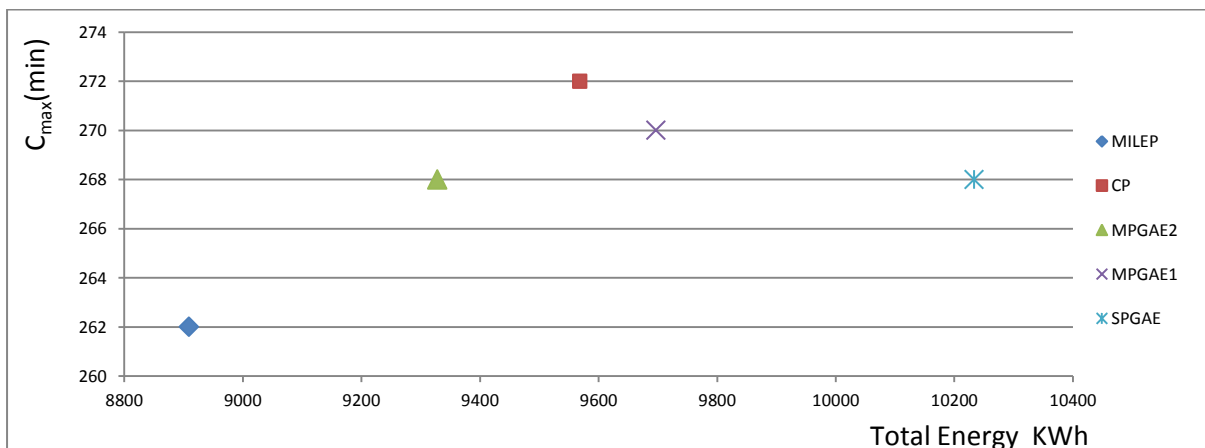

Figure 5-8 C_max and total energy (12x12x12 job shop problem)

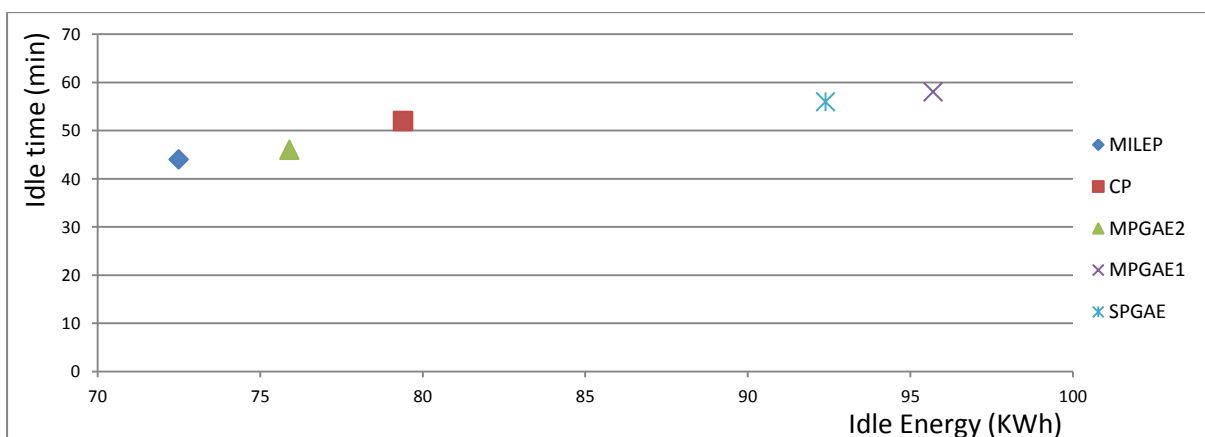

Figure 5-9 Total idle time and total idle energy (12x12x12 job shop problem)

These optimization methods are tested with different problems size up problem 12x12 with 12 operations. The table 5-1 shows the best results all optimization methods.

Table 5-1 Comparing between all optimization methods

		6×6 -6	6×6 -12	10×10 -6	10×10- 12	12×12 -6	12×12 -12
SPGA	C _{max} (min)	128	266	129	268	129	268
	TWt (min)	798	1744	1346	2910	1696	3374
	TlDt (min)	8	35	11	46	14	56
	T _{sp} (min)	124	340	210	457	262	542
	TE (KWh)	2618.42	5342.28	4292.45	8684.6	5051.22	10233
	CPU (min)	22.12	31.45	22.35	32.18	22.55	32.18
MPGA1	C _{max} (min)	124	266	128	268	132	270
	TWt (min)	788	1640	1248	2812	1498	3280
	TlDt (min)	6	22	8	51	14	58
	T _{sp} (min)	118	335	206	448	255	530
	TE (KWh)	2288.54	4832.2	3664.21	7960.17	4426.29	9596
	Er%	12.6%	9.5%	13.9%	8.3%	12%	6.2%
MPGA2 +	C _{max} (min)	122	262	126	264	129	268
	TWt (min)	776	1560	1246	2684	1494	3172
	TlDt (min)	6	18	6	40	12	46
	T _{sp} (min)	114	332	206	438	242	524
	TE (KWh)	2198.85	4726.28	3632.85	7888	4319.34	9328.2
	Er%	16%	11.5%	14.5%	11.4%	14.4%	8%
	CPU (min)	24.25	30.25	24.25	32.55	25.58	35.45
CP	C _{max} (min)	126	264	128	270	131	274
	TWt (min)	794	1630	1290	2768	1498	3380
	TlDt (min)	8	28	12	42	16	48
	T _{sp} (min)	112	328	200	410	242	518
	TE (KWh)	2265.42	4798.43	3735.25	8036	4399.78	9568
	Er%	13.4%	10%	13%	7.4%	12.8%	6.4%
	CPU (min)	25.28	35.52	28.20	38.24	30.45	40.55
MILP+	C _{max} (min)	122	258	124	260	129	262
	TWt (min)	752	1526	1252	2520	1494	3027
	TlDt (min)	6	22	8	38	10	44
	T _{sp} (min)	112	326	200	408	220	504
	TE (KWh)	2178.85	4499.45	3588.25	7471	4280	8909
	Er%	16.7%	15.7%	16.3%	13.9%	14.6%	12%
	CPU (min)	22.18	22.18	38.48	62.42	40.18	65.20

From the figures and table above all method reduce total energy and non-productive energy. We can conclude that:

1. All methods are capable to solve different job shop scheduling problems.
2. Selecting an initial population minimising both processing energy and time is a good method to ensure reducing both energy and time objectives.
3. Developing parallel genetic algorithm by adding threshold operation and elite strategy increases their efficiency to optimize energy and time.
4. Classification trees works to constrain both energy and time variable. Constraint variables are working to restrain the machine to operate the intended job operations, and works as decision variable to calculate lower and upper limits.
5. Local lower and upper limits are used to improve the results, where lower limits represent the goals to improve the solution, and upper limits are point of avoidance to ensure the correction of solutions.
6. By left shifting the scheduling is more feasible to improve and reduce total energy and makespan.
7. Also turn off is a good method to reduce non-productive energy without changing scheduling planning. Change to standby state is also very effective to maintain machine reliability and rise their life cycle.

But there are several limits for any optimisation method, we can note:

1. Classical genetic algorithm MPGA1 can be used with small and medium scheduling problems, because one chromosome is not enough to represent large population clearly. We solve this problem by using parallel genetic MPGA2 with two sub-genetics.
2. The two genetics MPGA1 and MPGA2 are very limited with problems that have a large operation number because the chromosome is divided into segments for each job. With large number of job operations, these segments will be very large and it will be difficult to select the initial population.
3. The number of machines impacts mixed Integer MILP because MILP works to branch each machine as a solution tree, operation by operation, handling all machines at the same time. That increases the number of branching tree that needs large processing CPU time. Nevertheless the results are remaining the best comparing with other methods.

5.3 Future Works

For future works, we suggest to deal with those flawing points:

For multi-objectives energy job shop scheduling (MOEJSS) problems it is quite necessary to consider the trade-off between all conflictive objectives (for example energy and C_{max}). Consequently it leads to difficulties for solving, because any objective is depending on special population. Then, initial population selection is very important in genetic algorithm as well as selecting solution candidates in mixed Integer programming. If population is not chosen clearly and intelligently, it becomes very difficult to find the correct solution to solve the problem.

When developing initial population for genetic algorithm or initial candidates for MILPE, we propose to use fuzzy multi-criterion to generate an equivalent fuzzy set to represent processing energy, processing time, setup time and setup energy. This population is more appropriate to select

chromosomes. In multi objective (time, energy) job shop problems, these objectives generally depend on processing energy, processing time, setup energy, and setup time. Assuming that setup time contains setup time and transportation time between two machines and, assuming that transport capacity is fixed, each parameter takes its values from specific population. Generally we have two type of populations (energy and time), and each type of population consist of two sub-populations for processing and setup (considering that setup contains actual setup and transportation). Finally in this problem (OPEJSS) we have four populations, all job operation have four parameters related to four populations (see in figure 5-10). The problem is how to select a machine to process a job operation with minimum of these parameters from their populations?

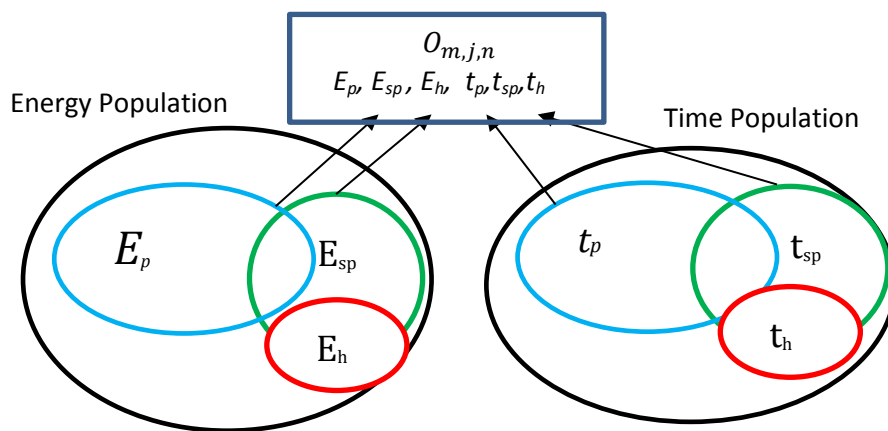

Figure 5-10 Multi populations related with one job operation

By using fuzzy logic we can also solve the problem of uncertainty with operations that have fluctuating processing time or power levels (for instance tool wear over time).

Of course job shop is very important class of system in manufacturing environments, but there are other structure types such as cellular manufacturing or open shop. From that, we suggest to apply these optimization methods to another manufacturing organisation, to reduce total energy during manufacturing processes.

Generally reducing energy leads to reduce energy cost. But energy cost system is very complex. For example, electricity tariff depends on period (time of use) and number of KWh units consumed during this period. Developing these methods, leads to optimize energy cost according to job periods and how many KWh are consumed during these periods.

Changing to standby is a good method to ensure machine reliability, but no research deals with the impact of number of cycle turn on/off to reduce total machine reliability, and their effect on machine life cycle. For future works the cycle of turn on/off must be studied regarding failure or wear caused by this cycle.

Developing optimization methods to reduce energy consumption in a dynamic job shop should be studied in the future for improving the productivity for job shops. In addition, it would be relevant to consider methods to reduce energy consumption in other plant design such as cellular manufacturing systems.

References

Chapter one

- Kniivilä M., 2007. *Industrial development and economic growth: Implications for poverty reduction and income inequality*, <https://books.google.fr/books?isbn=9211045649> United Nations. Department of Economic and Social Affairs
- Brundtland, H., 1987. *Report: Our Common Future*, "Closing Ceremony of the Eighth and Final Meeting of the World Commission on Environment and Development", World Commission on Environment and Development: Tokyo, Japan
- Brundtland, G.H., 1989. *Rapport Brundtland : Notre Avenir à Tous*, in Report of the World Commission on Environment and Development: Our Common Future, UN Documents: Montréal
- Friend G, 2009. *The truth about green business*. <https://books.google.fr/books?isbn=0768694205>
- Mathieux, F., Froelich D., and Moszkowicz P., 2008. *ReSICLED, 2008. a new recovery-conscious design method for complex products based on a multicriteria assessment of the recoverability*, Journal of Cleaner Production, 16(3): p. 277- 298.
- Janin, M., 2000. *Démarche d'éco-conception en entreprise. Un enjeu : construire la cohérence entre outils et processus*, in (ENSAM. Ecole nationale supérieure d'arts et métiers. France), Arts et Métiers ParisTech: Paris
- Haoues, N., 2006. *Contribution à l'intégration des contraintes de désassemblage et de recyclage dès les premières phases de conception des produits*, in *Sciences de l'économie, de la gestion et de la société*, 2006, Arts et Métiers ParisTech.
- Alhomsy, H. and Zwolinski P., 2009. *Utilisation de règles DFE en conception préliminaire*, in *11ème Colloque National AIP PRIMECA*, La Plagne-France.
- Nishitani, K., 2009, *An empirical study of the initial adoption of ISO 14001 in Japanese manufacturing firms*, Ecological Economics 68 pp. 669-679
- ISO 2015. *Une introduction à la norme ISO 14001*, Organisation internationale de normalisation Secrétariat central de l'ISO, 8 Chemin de Blandonnet, Case Postale 401 CH – 1214 Vernier, Genève, Suisse. https://www.iso.org/iso/fr/introduction_to_iso_14001_fr_ld.pdf
- Finkbeiner M., 2013. *From the 40s to the 70s—the future of LCA in the ISO 14000 family*, Int J Life Cycle Assess 18:1–4 DOI 10.1007/s11367-012-0492-
- Kollman K. And Aseem Prakash A., 2002. *EMS-based Environmental Regimes as Club Goods: Examining Variations in Firm-level Adoption of ISO 14001 and EMAS in U.K., U.S. and Germany*, Policy Sciences 35: pp.43-67, Kluwer Academic Publishers, Netherlands.
- Souza Campos L. M., 2012. *Environmental management systems (EMS) for small companies: a study in Southern Brazil*, Journal of Cleaner Production 32 pp. 141-148.
- ASIE/2006/122-578, 2008. *Improving the living and working conditions of people in and around industrial clusters and zones*, Cleaner Production Manual pp 9-12

- Saez-Martínez F. J., Lefebvre G., Hernandez J. J. and Clark J. H., 2016. *Drivers of sustainable cleaner production and sustainable energy options*, Journal of Cleaner Production 138, pp.1-7.
- Gavrilescu M., 2004. *Cleaner production as a tool for sustainable development*, Environmental Engineering and Management Journal, March 2004, Vol.3, No.1, pp. 45-70.
- Mikulcic H., Jaromir J., Kleme J. J., Vujanovic M., Urbaniec K., 2016. *Reducing greenhouse gasses emissions by fostering the deployment of alternative raw materials and energy sources in the cleaner cement manufacturing process*, Journal of Cleaner Production 136 pp. 119-132.
- Maiti S., Gallastegui G., Suresh G., Sarma S. J., Brara S. K., Drogui P., LeBihan Y., Buelna G., Verma M., Carlos Ricardo Soccol C. R., 2018. *Hydrolytic pre-treatment methods for enhanced biobutanol production from agro-industrial wastes*, Bioresource Technology 249, pp. 673-683.
- Eberhard Abele E., Reiner Anderl R., Herbert Birkhofer H., 2005. *Environmentally-Friendly Product Development: Methods and Tools*, Springer-Verlag, London.
- Sarkis J., Zhu Q., Lai K.-H., 2011. *An organizational theoretic review of green supply chain management literature*, Int. J. Production Economics 130, pp. 1-15.
- Diabata A., Govindan K., *An analysis of the drivers affecting the implementation of green supply chain management*, Resources, Conservation and Recycling 55 (2011) pp.659-667.
- Lele S., 2009. *Getting serious about green manufacturing*, Frost & Sullivan, Singapore.
www.frost.com/prod/servlet/cio/168777968
- Melnyk S. A., Smith R. T., 1996. *Green manufacturing*, Dearborn, Michigan USA : Computer Automated Systems of the Society of Manufacturing Engineers.
- Seow Y., Goffin N., Rahimifard S., Elliot Woolley E., 2016. *A “Design for Energy Minimization” approach to reduce energy consumption during the manufacturing phase*, Energy 109, pp. 894-905
- Lai K., Wong C. W. Y., 2012. *Green logistics management and performance: Some empirical evidence from Chinese manufacturing exporters*, Omega 40, pp. 267-282.
- GAO 2001. *Federal Enterprise Architecture*, United States Government Accountability Office
- Moldavska A., Welo T., 2017. *The concept of sustainable manufacturing and its definitions: A content-analysis based literature review*, Journal of Cleaner Production, Volume 166, pp. 744-755.
- Paul I.D., Bholeb G.P., Chaudharin J.R., 2014. *A review on Green Manufacturing: It's important, Methodology and its Application*, 3rd International Conference on Materials Processing and Characterisation (ICMPC 2014) Procedia Materials Science 6, pp. 1644-1649
- Dornfeld D. A., Yuan C., Diaz N., Zhang T., Vijayaraghavan A., 2013. *Introduction to Green Manufacturing*, Green Manufacturing, Fundamentals and Applications, Editor David A. Dornfeld, Laboratory for Manufacturing and Sustainability (LMAS) University of California, Berkeley Berkeley, California, USA, Springer Science+Business Media New York, pp 1-24.

Chapter 2

DOE/EIA, 2017, *International Energy Outlook 2017*, U.S. Energy Information Administration, [https://www.eia.gov/outlooks/ieo/pdf/0484\(2017\).pdf](https://www.eia.gov/outlooks/ieo/pdf/0484(2017).pdf)

International Energy Agency (IEA), 2017a, *World Energy Outlook 2017*, http://www.iea.org/media/weowebiste/2017/Chap1_WEO2017.pdf

International Energy Agency (IEA), 2017b, *CO2 Emissions from Fuel Combustion (OECD countries)*, Preliminary edition, OECD/IEA, Paris. <https://www.iea.org/statistics/relateddatabases/co2emissionsfromfuelcombustion>

European Environment Agency (EEA), 2016, *Renewable energy in Europe 2016 - Recent growth and knock-on effects*, Publications Office of the European Union, Luxembourg 2016.

Ministère de La Transition Écologique et Solidaire (MTES) 2017. *Les énergies renouvelables en France en 2016 - Suivi de la directive 2009/28/CE relative à la promotion de l'utilisation des énergies renouvelables*, http://www.statistiques.developpement-durable.gouv.fr/fileadmin/documents/Produits_editoriaux/Publications/Datalab_essentiel/2017/datalabessentiel-118-energies-renouvelables-septembre2017-b.pdf

Intergovernmental Panel on Climate Change (IPCC) 2014
<http://www.ipcc.ch/ipccreports/tar/wg1/index.php?idp>

Ritchie H., Roser M., 2018. *CO2 and other Greenhouse Gas Emissions*, <https://ourworldindata.org/co2-and-other-greenhouse-gas-emissions>

Husain A. M., Arezki R., Breuer P., Haksar V., Helbling T., Medas P., Sommer M., (2015). *Global Implications of Lower Oil Prices*, International Monetary Fund, <https://www.imf.org/external/pubs/ft/sdn/2015/sdn1515.pdf>

Dudley B., 2017. *BP Statistical Review of World Energy*, <https://www.bp.com/content/dam/bp/en/corporate/pdf/energy-economics/statistical-review-2017/bp-statistical-review-of-world-energy-2017-full-report.pdf>

DOE/EIA, 2016, *International Energy Outlook 2016*, U.S. Energy Information Administration, [https://www.eia.gov/outlooks/ieo/pdf/0484\(2016\).pdf](https://www.eia.gov/outlooks/ieo/pdf/0484(2016).pdf)

International Energy Agency (IEA) 2015. *Energy Climate and Change World Energy Outlook*, <https://www.iea.org/publications/freepublications/publication/WEO2015SpecialReportonEnergyandClimateChange.pdf>

Seow Y., 2011. *A Framework for Modelling Embodied Product Energy to Support Energy Efficient Manufacturing*, Doctoral Thesis PhD, Loughborough University.

Thiede S., 2011. *Energy Efficiency in Manufacturing Systems*, chapter two, Theoretical Background, Energy Consumption in Manufacturing, pp. 16-21.

Mouzon, G., Yildirim, M.B., Twomey, J., 2007, *Operational methods for minimization of energy consumption of manufacturing equipment*, International Journal of Production Research, 45(18-19), pp. 4247-4271.

- Peng T., Xun X., 2014. *Energy-efficient machining systems: a critical review* Int. J. Adv. Manuf. Technol., 72, pp. 1389-1406.
- Saidu R., 2010. *A review on electrical motors energy use and energy savings*, Renewable and Sustainable Energy Reviews pp. 877-898.
- Abele E., Sielaff T., Schiffler A., Rothenbücher S., (2011). *Analysing energy consumption of machine tool spindle units and identification of potential for improvements of efficiency*, Proceedings of the 18th CIRP international conference on life cycle engineering globalized solutions for sustainability in manufacturing. Springer, Berlin, pp. 280-285.
- Dahmus J., Gutowski G., 2004. *An Environmental Analysis of Machining ASME 2004 International Mechanical Engineering Congress and Exposition Manufacturing Engineering and Materials Handling Engineering Anaheim, California, USA, November 13-19.*
- Gutowski G., Dahmus J., Thiriez A., 2006, *Electrical Energy Requirements for Manufacturing Processes Electrical Energy Requirements for Manufacturing Processes*, 13th CIRP International Conference of Life Cycle Engineering, Lueven, May 31 -2 June
- Weinert, N., Chiotellis S., Seliger G., 2011, *Methodology for planning and operating energy efficient production systems* CIRP Annals - Manufacturing Technology 60 (2011) pp. 41-44.
- Luo H., Du B., Huang G.Q., Chen H., Li X., 2013. *Hybrid flow shop scheduling considering machine electricity consumption cost*, International Journal of Production Economics, 146, pp. 423-439.
- Herring, H., 2009. *Energy efficiency and sustainable consumption*, Springer, pp. 1-19
- Neugebauer R., Drossel W., Wertheim R., Hochmuth C., Dix M., 2012. *Resource and Energy Efficiency in Machining Using High Performance and Hybrid Processes*, Procedia CIRP 1;pp 3–16
- Grigor'eva S., Kuznetsova A., Volosovaa M., Koriathb H., 2014. *Classification of Metal Cutting Machines by Energy Efficiency*, Russian Engineering Research, 2014, 34, (3), pp. 136-141.
- Schischke K, Hohwieler E, Feitscher R, König J, Kreuschner S, Nissen NF, Wilpert P, 2011, *Energy using product group analysis. Lot 5: Machine tools and related machinery. Executive Summary Version2.*
http://www.ecomachinetools.eu/typo/reports.html?file=tl_files/pdf/EuP_LOT5_ExecutiveSummary_v05_280211.pdf.
- Kellens K.,Rodrigues G., Dewulf W., Duflou J., 2014. *Energy and Resource Efficiency of Laser Cutting Processes*, Physics Procedia 56, pp. 854-864.
- Fysikopoulos A. Pastras G. Alexopoulos T Chryssolouris G. 2014. *On a generalized approach to manufacturing energy efficiency*, Int. J. Adv. Manuf. Technol. 73, pp. 1437-1452
- Fysikopoulos A., Anagnostakis D., Salonitis K., Chryssolouris G., 2012. *An Empirical Study of the Energy Consumption in Automotive Assembly*, 45th CIRP Conference on Manufacturing Systems.
- Krones M., Müller E., 2014. *An Approach for Reducing Energy Consumption in Factories by Providing Suitable Energy Efficiency Measures*, Procedia CIRP 17, pp. 505-510.

- Behrendt T, Zein A, Min S., 2012. *Development of an energy consumption monitoring procedure for machine tool*, CIRP Annals Manufacturing Technology 61, pp. 43-46.
- Peng T., Xun X., 2011. *A framework of an energy-informed machining system*, Proceedings of the 7th International Conference on Digital Enterprise Technology, Athens, Greece, pp. 160-169.
- Neugebauer, R., Wabner M., Rentzsch H., Ihlenfeld S., 2011. *Structure principles of energy efficient machine tools*, CIRP Journal of Manufacturing Science and Technology, 4, pp.136-147.
- Fysikopoulos A., Alexios P., Georgios P. Panagiotis S., George C., 2013. *Energy Efficiency of Manufacturing Processes: A Critical Review*, Procedia CIRP 7, pp. 628-633.
- Gutowski G., 2010. *The Efficiency and Eco-efficiency of Manufacturing*, International Journal of Nanomanufacturing, 6(1-4), pp. 38-45.
- Givehchi M., Aghighi A., Wang L., 2017, *Cloud-DPP for distributed process planning of mill-turn machining operations*, Robotics and Computer-Integrated Manufacturing, 47, pp. 76-84.
- Thao-Le V., Paris H., Mandil G., 2017. *Process planning for combined additive and subtractive manufacturing technologies in a remanufacturing context*, Journal of Manufacturing Systems, 44, pp.243-254.
- Trstenjak M., Cosic P., 2017. *Process planning in Industry 4.0 environment*, Procedia Manufacturing, 11, pp. 1744-1750.
- Abele E., Flum D., Strobel N., 2017. *A systematic approach for designing learning environments for energy efficiency in industrial production*, Procedia Manufacturing, 9, pp. 9-16
- Newman S., Nassehi A, Imani-Asrai R., Dhokia V.,2012. *Energy efficient process planning for CNC machining*, CIRP Journal of Manufacturing Science and Technology, 5, pp. 127-136.
- Duflou J.R., Sutherland J.W, Dornfeld D, Herrmann C., Jeswiet J.,Kara S., Hauschild M., Kellens K., 2012. *Towards energy and resource efficient manufacturing: A processes and systems approach*, CIRP Annals-Manufacturing Technology, 61, pp. 587-609.
- Mori M., Fujishima M., Inamasu Y., Oda Y., 2011. *A study on energy efficiency improvement for machine tools*, CIRP Annals Manufacturing Technology, 60 (1), pp. 145-148.
- Yin J., Yang Y., Tang Y., Gao Z., Ran B. 2017. *Dynamic passenger demand oriented metro train scheduling with energy-efficiency and waiting time minimization: Mixed-integer linear programming approaches*, Transportation Research, Part B, 97, pp. 182-213.

Chapter 3

Mouzon G., 2008a, *Operational methods and models for minimization of energy consumption in a manufacturing environment*, Wichita State University. No. p 157

International Energy Agency, 2017, *World Energy Outlook 2017*, available at: <http://www.worldenergyoutlook.org>

Mouzon G. Yildirim M.B., 2008b, *A framework to minimize total energy consumption and total tardiness on a single machine*, In Proceedings of 4th Annual GRASP Symposium. Wichita State University, pp. 105-116.

U.S. International Energy Agency September(IEA) 27, 2012, *AnnualEnergyReview2011*, <https://www.eia.gov/totalenergy/data/annual/pdf/aer.pdf>

Duflou J.R., Sutherland J.W., Dornfeld D., Herrmann C., Jeswiet J., Kara S., Hauschild M., Kellens K., 2012, *Towards energy and resource efficient manufacturing: a processes and systems approach*, CIRP Annals-Manufacturing Technology 61,pp. 587-609.

Fysikopoulos A., Alexios P., Georgios P., Panagiotis S., George C., 2013, *Energy Efficiency of Manufacturing Processes: A Critical Review*, Procedia CIRP 7,pp. 628-633

Munoz A., Sheng P., 1995, *An analytical approach for determining the environmental impact of machining processes*. Journal of Materials Processing Technology 53,pp.736-758.

Gutowski T., Murphy C., Allen D., Bauer D., Bras B., Piwonka T., Sheng P., Thurston D., Wolff E., 2005, *Environmentally benign manufacturing: Observations from Japan, Europe and the United States*, Journal of Cleaner Production, 13, pp.1-17.

Diaz N., Helu M., Jarvis A., Tönissen S., Dornfeld D., Schlosser R., 2009. *Strategies for Minimum Energy Operation for Precision Machining*, *Proceedings of MTTRF annual meeting*. No. p 6.

Fang K., Uhan N., Zhao F., Sutherland. J.W., 2011, *A New Shop Scheduling Approach in Support of Sustainable Manufacturing*, In J. Hesselbach & C. Herrmann, eds. *Glocalized Solutions for Sustainability in Manufacturing*. Berlin, Heidelberg: Springer Berlin Heidelberg, pp 305-310.

Haït A., Artigues C., 2011, *An hybrid CP/MILP method for scheduling with energy costs*. European Journal of Industrial Engineering, 5 (4), pp.471-489

He Y., Liu F., Wu T., Zhong F.P., Peng B., 2012a, *Analysis and estimation of energy consumption for numerical control machining*, Journal of Engineering Manufacture, 226(2), pp255-266

He, Y, Liu, B., Zhang, X., Gao, H., Liu X., 2012b. *A modelling method of task oriented energy consumption for machining manufacturing system*, Journal of Cleaner Production, 23(1), pp167-174

Fang K., Uhan N.A, Zhao F., Sutherl J.W. 2013. *Flow shop scheduling with peak power consumption constraints*, Annals of Operations Research, 206(1):pp.115-145,

- Bruzzone A.G., Anghinolfi D., Paolucci M., Tonelli F., 2012. *Energy-aware scheduling for improving manufacturing process sustainability: A mathematical model for flexible flow shops*, CIRP Annals – Manufacturing Technology, 61,pp. 459-462.
- Dai M., Tang D., Giret A., Salido M.A., Li W.D. 2011, *Energy-efficient scheduling for a flexible flow shop using an improved genetic-simulated annealing algorithm*, Robotics and Computer-Integrated Manufacturing, 29,pp. 418-429.
- Luo H., Du B., Huang G.Q., Chen H., Li X., 2013, *Hybrid flow shop scheduling considering machine electricity consumption cost*. International Journal of Production Economics, 146,pp. 423-439.
- Salido M.A., Escamilla J., Barber F., Giret A., Tang D., Dai M., 2013, *Energy-aware Parameters in Job-Shop Scheduling Problems*, GREEN-COPLAS 2013; IJCAI 2013 Workshop on Constraint Reasoning, Planning and Scheduling Problems for a Sustainable Future, Beijing, China, pp.. 44-53
- Moon J., Park J., 2013, *Smart production scheduling with time-dependent and machine-dependent electricity cost by considering distributed energy resources and energy storage*, International Journal of Production Research, vol. 52, no. 13, pp.3922-3939.
- Liu Y., Dong H., Lohse N., Petrovic S., Gind, N. 2014, *An investigation into minimising total energy consumption and total weighted tardiness in job shops*, Journal of Cleaner Production, 65,pp. 87-96.
- Zhang H., Zhao, F., Fang K., Sutherland J.W. 2014, *Energy-conscious flow shop scheduling under time of use electricity tariffs*, CIRP Annals – Manufacturing Technology. 63 pp. 37-40
- O’Rielly K., Jeswiet J. 2014, *Strategies to improve industrial energy efficiency*, 21st CIRP Conference on Life Cycle Engineering, Procedia CIRP, 15,pp. 325-330.
- AL-QASEER F., A GIEN D., 2015, *Multi-objective genetic method minimizing tardiness and energy consumption during idle times*, IFAC-PapersOnLine 48-3, pp. 1216-1223
- Trentesaux D., Prabhu V., 2016, *Sustainability in Manufacturing Operations Scheduling: Stakes, Approaches and Trends* HAL Id: hal-01387853 <https://hal.inria.fr/hal-01387853> Submitted on 26 Oct 2016 No. p 9
- Shrouf F., Ordieres-Meré J., García-Sánchez A., OrtegaMier M., 2014, *Optimizing the production scheduling of a single machine to minimize total energy consumption costs*, Journal of Cleaner Production, 67, pp.197-207.
- Artigues C., Lopez P., 2015, *Energetic reasoning for energy-constrained scheduling with a continuous resource*. J Sched (2015) 18:pp 225-241
- Shrouf F., Miragliotta G., 2015, *Energy management based on Internet of Things: practices and framework for adoption in production management*, Journal of Cleaner Production 100 pp.235-246.

- Masmoudi O., Yalaoui A., Ouazene Y., Chehade H., 2015, *Lot-sizing in flow-shop with energy consideration for sustainable manufacturing systems* IFAC-PapersOnLine 48-3 pp 727-732
- Masmoudi O., Yalaoui A., Ouazene Y., Chehade H., 2016, *Lot-sizing in a multi-stage flow line production system with energy consideration*, International Journal of Production Research, No. ps 25
- Masmoudi O., Yalaoui A., Ouazene Y., Chehade H., 2017, *Solving a capacitated flow-shop problem with minimizing total energy costs*, Int J Adv Manuf Technol 90: pp2655-2667
- Zhang R., Chiong R., 2016, *Solving the energy-efficient job shop scheduling problem: a multi objective genetic algorithm with enhanced local search for minimizing the total weighted tardiness and total energy consumption*, Journal of Cleaner Production 112 pp. 3361-3375.
- Nattaf M., Artigues C., Lopez P., Rivreau D., 2016 *Energetic reasoning and mixed-integer linear programming for scheduling with a continuous resource and linear efficiency functions* OR Spectrum 38: pp 459-492
- Jian-Ya D., Shiji S., Cheng W., 2016, *Carbon-efficient scheduling of flow shops by multi-objective optimization*. European Journal of Operational Research 248 pp. 758-771.
- Chao L., Liang G., Xinyu L., Quanke P., Wang Q., 2017, *Energy-efficient permutation flow shop scheduling problem using a hybrid multi-objective backtracking search algorithm*, Journal of Cleaner Production 144 pp. 228-238.
- Mokhtari H., Hasani A., 2017, *An energy-efficient multi-objective optimization for flexible job-shop scheduling problem*, Computers and Chemical Engineering 104 pp. 339-352.
- Lvjian Y., Liang G., Xinyu L., Hao X. 2017, *An Improved Genetic Algorithm with Rolling Window Technology for Dynamic Integrated Process Planning and Scheduling Problem*, Proceedings of the 2017 IEEE 21st International Conference on Computer Supported Cooperative Work in Design.
- Yuxin Z., Konstantin B., Fu Zhao., John W., 2017, *Dynamic scheduling of a flow shop with on-site wind generation for energy cost reduction under real time electricity pricing*, CIRP Annals - Manufacturing Technology 66 pp.41-44.
- Zhang L., Tang Q., Wu Z., Wang F., 2017, *Mathematical modelling and evolutionary generation of rule sets for energy-efficient flexible job shops*, J Energy 138 pp. 210-227.
- Pezzella F., Morganti G., Ciaschetti G. 2008, *A genetic algorithm for the Flexible Job-shop Scheduling Problem*, Computers & Operations Research 35 pp. 3202-3212
- Yuan Y., Hua X., Yang J., 2013a, *A hybrid harmony search algorithm for the flexible job shop scheduling problem*, Applied Soft Computing 13 pp. 3259-3272.
- Yuan Y., Hua X., 2013b, *Flexible job shop scheduling using hybrid differential evolution algorithms*, Computers & Industrial Engineering 65 pp. 246-260

Kemmoé S., Lamy D., Tchernev N., 2015, *A Job-shop with an Energy Threshold Issue Considering Operations with Consumption Peaks*. IFAC-PapersOnLine 48-3 pp. 788-793

Shengxiang Y., Xin Y., 2008, *Genetic Algorithms with Memory- and Elitism Based Immigrants in Dynamic Environments Massachusetts*, Institute of Technology Evolutionary Computation 16(3) pp.385-41.

Shengxiang Y., 2008, *Genetic Algorithms with Elitism-Based Immigrants for Changing Optimization Problems*, Department of Computer Science, University of Leicester University Road, Leicester LE1 7RH, United Kingdom No.p 10.

Renato T., Shengxiang Y., 2007, *A Self-Organizing Random Immigrants Genetic Algorithm for Dynamic Optimization Problems*, Genetic Programming and Evolvable Machines, 8(3) pp. 255-286.

Chapter 4

- Hojae L., Christos T. M., 2017, *Discrete-time mixed-integer programming models for short-term scheduling in multipurpose environments*, Computers and Chemical Engineering 107 p 171-183
- Kooli A., Serairi M., 2014, *A mixed integer programming approach for the single machine problem with unequal release dates*, Computers & Operations Research 51 p 323–330
- Wang T., Meskens N., Duvivier D., 2015, *Scheduling operating theatres: Mixed integer programming vs. constraint programming*, European Journal of Operational Research 247 p 401-413
- Karimi S, Zaniar A, B. Naderi B, Mohammadi M., 2017, *Scheduling flexible job-shops with transportation times: Mathematical models and a hybrid imperialist competitive algorithm*, Applied Mathematical Modelling 41 p 667-682
- Altinakar S., Caporossi G., Hertz A., 2016, *A comparison of integer and constraint programming models for the deficiency problem*, Computers & Operations Research Volume 68, April, p 89-96.
- Hinder O., Mason A. J., 2017, *A novel integer programming formulation for scheduling with family setup times on a single machine to minimize maximum lateness*, European Journal of Operational Research 262 p 411-42
- Rossi R., Kilic O., Armagan S., 2015, *Piecewise linear approximations for the static–dynamic uncertainty strategy in stochastic lot-sizing*, Omega 50 p 126-140
- Olarte C., Pimentel E. 2015, *Proving Concurrent Constraint Programming Correct*, Revisited. Electronic Notes in Theoretical Computer Science 312 p 179-195
- Goel V., Slusky M., Furmand K., Shao Y., 2015, *Constraint programming for LNG ship scheduling and inventory management*, European Journal of Operational Research 241 p662-673
- Shen L., Dauzère-Pérès S., Neufeld J. S., 2018, *Solving the flexible job shop scheduling problem with sequence-dependent setup times*, European Journal of Operational Research 265 p 503-516
- Kemmoé S., Lamy D., Tchernev N., 2015, *A Job-shop with an Energy Threshold Issue Considering Operations with Consumption Peaks*, IFAC-PapersOnLine 48-3 p 788-793
- Yamanaka N., Satob T., Kubot T., 2014, *Linear programming analysis of the R-parity violation within EDM-constraints*, Journal of High Energy Physics ISSN, p 1029-8479.
- Tanaka S., Fujikuma S., 2012. *A dynamic-programming-based exact algorithm for a machine idle time*. Journal of Scheduling 15(3) p347-361.
- George B. D. May 1987, *Origins of the simplex method* Repot sol 87-5 Systems Optimization Laboratory Department of Operation Research Stanford University Stanford California 94305-4022 No. p 17.

- Pochet Y., Laurence A. W., 2006, *Production Planning by Mixed Integer Programming With 77 Illustrations*, Springer Science Business Media, Inc
- Schultz R., 2003, *Mixed-Integer Value Functions in Stochastic Programming*, Combinatorial Optimization (Edmonds Festschrift), LNCS 2570, pp. 171-184.
- Ghimire D., Lee J ,2011, *Nonlinear Transfer Function-Based Image Detail Preserving Dynamic Range Compression for Color Image Enhancement*, PSIVT 2011, Part I, LNCS 7087, Springer-Verlag Berlin Heidelberg p 1-12.
- James C., 2018, *Mixed-integer programming model and branch-and-price-and-cut algorithm for urban bus network design and timetabling*. Transportation Research Part B 108 p 188-216
- Stidsen T., Andersen K. A., Dammann. B., 2014, *A branch and bound algorithm for a class of biobjective mixed integer programs*, MANAGEMENT SCIENCE 60(4) p.1009-1032.
- Jozefowicz N., Laporte G., Semet F., 2012 *A Generic Branch-and-Cut Algorithm for Multi objective Optimization Problems: Application to the Multilabel Traveling Salesman Problem* NFORMS Journal on Computing4,p554-564.
- Letchford A., Lodi A.,2003 *An Augment-and-Branch-and-Cut Framework for Mixed 0-1 Programming*, Combinatorial Optimization (Edmonds Festschrift), LNCS 2570, p 119-133
- Toussaint H ,2013 *Introduction au Branch Cut and Price et au solveur SCIP (Solving Constraint Integer Programs)*, Rapport de recherche LIMOS/RR-13-07. 2013.
- Danna E., Fenelon M., G., Wunderling R., 2007, *Generating Multiple Solutions for Mixed Integer Programming Problems* Integer Programming and Combinatorial Optimization p 280-294
- Yamada, T., 2003, *Studies on metaheuristics for job shop and flow shop scheduling problems*. Kyoto University thesis of doctor of informatics No.ps 133.

Abstract:

We present the challenges of environmental management and underline the importance of an energy saving policy for companies. We propose a model to determine the energy balance of manufacturing by integrating the different productive and non-productive phases. We define two purposes for minimizing production time and energy consumption. We apply this model to the scheduling of flexible job-shop workshops. To determine the optimal solution we use two types of methods:

- The first is genetic algorithms. We propose different types of algorithms to solve this multi-criteria problem. For example, we propose to develop two populations to minimize the energy consumed and the production time, and to cross them to achieve the overall objective.
- The second is constraint programming. We propose to find the optimal solution by developing a double tree to evaluate the energy consumed and the production time. We build our algorithm starting from the tasks to be performed on the machines or from the machines that will perform the tasks. We discuss the construction of the Pareto front to get the best solution.

We finish by comparing the different approaches and discussing their relevance to deal with problems of different sizes. We also offer several improvements and some leads for future research.

Keywords: Environment Management, Sustainable manufacturing, Job shop scheduling, Energy efficient, Multi-objective optimization, Genetic Algorithms, Mixed Integer Linear Programing

Résumé:

Nous présentons les enjeux du management environnemental et soulignons l'importance d'une politique d'économie d'énergie pour les entreprises. Nous proposons un modèle pour déterminer le bilan énergétique de la fabrication en intégrant les différentes phases productives et non-productives. Nous définissons un double objectif pour la minimisation de la durée de production et de la consommation d'énergie. Nous appliquons ce modèle à l'ordonnancement d'ateliers job-shop flexibles. Pour déterminer la solution optimale nous utilisons deux classes de méthodes :

- La première relève des algorithmes génétiques. Nous proposons différents types d'algorithmes pour résoudre ce problème multicritère. Nous proposons par exemple de faire évoluer deux populations pour minimiser respectivement l'énergie consommée et la durée de production et de les croiser pour atteindre l'objectif global.
- La seconde relève de la programmation sous contrainte. Nous proposons de rechercher la solution optimale en développant une double arborescence pour évaluer l'énergie consommée et la durée de production. Nous construisons notre algorithme en partant des tâches à réaliser sur les machines ou en partant des machines qui réaliseront les tâches. Nous discutons de la construction du front de Pareto pour l'obtention de la meilleure solution.

Nous terminons en comparant les différentes approches et en discutant leur pertinence pour traiter des problèmes de différentes tailles. Nous proposons également plusieurs améliorations et quelques pistes pour de futures recherches.

Mots-Clés : Environnement Management, Production durable, Job Shop Planification, efficacité énergétique, Optimisation multi-objectifs, Algorithmes génétiques, Programmation Mixte Linéaire Intègre.