



HAL
open science

Percolation in the plane: dynamics, random tilings and nodal lines

Hugo Vanneuville

► **To cite this version:**

Hugo Vanneuville. Percolation in the plane: dynamics, random tilings and nodal lines. General Mathematics [math.GM]. Université de Lyon, 2018. English. NNT : 2018LYSE1262 . tel-02067958

HAL Id: tel-02067958

<https://theses.hal.science/tel-02067958>

Submitted on 14 Mar 2019

HAL is a multi-disciplinary open access archive for the deposit and dissemination of scientific research documents, whether they are published or not. The documents may come from teaching and research institutions in France or abroad, or from public or private research centers.

L'archive ouverte pluridisciplinaire **HAL**, est destinée au dépôt et à la diffusion de documents scientifiques de niveau recherche, publiés ou non, émanant des établissements d'enseignement et de recherche français ou étrangers, des laboratoires publics ou privés.

Université Claude Bernard Lyon 1
École doctorale InfoMaths (ED 512)
Spécialité : Mathématiques
n°. d'ordre : 2018LYSE1262

Percolation dans le plan : dynamiques, pavages aléatoires et lignes nodales

Thèse présentée en vue d'obtenir le diplôme de
Doctorat de l'Université de Lyon

soutenue publiquement le 28 novembre 2018 par
Hugo Vanneuville

devant le jury composé de :

Vincent Beffara	(Université Grenoble Alpes)	Rapporteur
Oriane Blondel	(Université Lyon 1)	Examinatrice
Hugo Duminil-Copin	(Institut des Hautes Études Scientifiques)	Rapporteur
Christophe Garban	(Université Lyon 1)	Directeur de thèse
Christophe Sabot	(Université Lyon 1)	Examineur
Vincent Tassion	(École polytechnique de Zürich)	Examineur
Marie Théret	(Université Paris Nanterre)	Examinatrice
Béatrice de Tilière	(Université Paris Est Créteil)	Présidente du jury

Percolation dans le plan : dynamiques, pavages aléatoires et lignes nodales

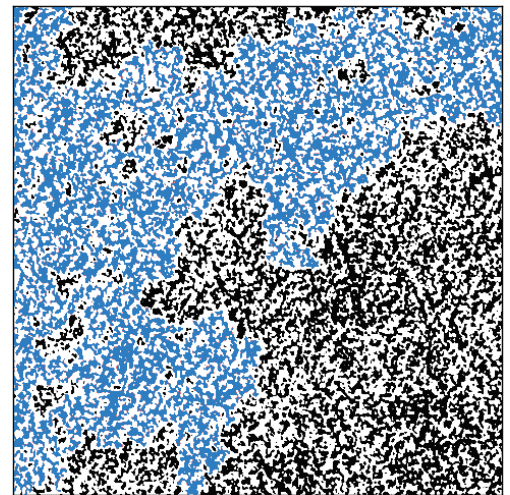
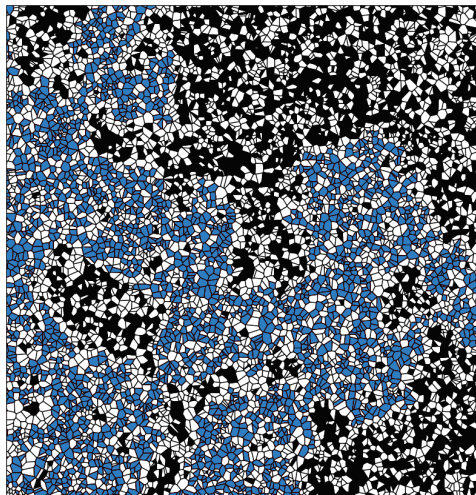
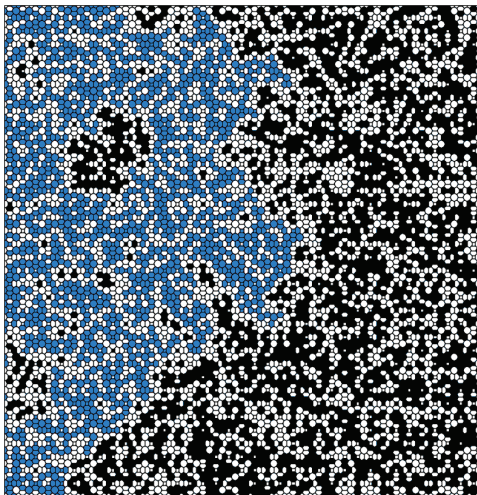

Hugo VANNEUVILLE

Thèse de doctorat

Remerciements

Je souhaiterais tout d’abord remercier mon directeur de thèse Christophe Garban. Cher Christophe, lorsque je t’ai rencontré j’ai tout de suite été frappé par ton enthousiasme extrêmement communicatif ! Je mesure maintenant la chance que j’ai eue lorsque tu as accepté d’encadrer mon mémoire de master puis ma thèse. Tu as su partager à la fois cet enthousiasme et tes belles intuitions, tu t’es montré disponible tout en veillant à ce que je forge mon indépendance, et sans tes encouragements j’aurais eu un mal fou à prendre confiance en moi. Pour cela et toutes les mathématiques que tu m’as apprises, un grand merci !

J’ai été très heureux lorsque Vincent Beffara et Hugo Duminil-Copin ont accepté de rapporter ma thèse. Vincent et Hugo, vos travaux ont constitué une source d’inspiration cruciale pour ma thèse. J’ai par ailleurs beaucoup appris lors des discussions que j’ai eues avec Vincent à Grenoble et avec Hugo à l’IHES et Genève. Je vous remercie chaleureusement pour votre accueil en ces lieux et pour votre relecture attentive du manuscrit. L’intérêt que vous avez ainsi porté à ma recherche m’a beaucoup touché.

J’aimerais remercier Oriane Blondel, Christophe Sabot, Vincent Tassion, Marie Théret et Béatrice de Tilière d’avoir accepté de participer à mon jury de thèse. Je suis honoré par leur présence. Vincent, merci de m’avoir accueilli plusieurs fois à Zürich, c’était toujours extrêmement enrichissant. J’espère avoir de nouveau l’occasion de travailler avec toi, et je me demande à quoi ma thèse ressemblerait sans tes “arguments de type RSW” !

Cette thèse doit beaucoup à mes co-auteurs : Christophe Garban, Stephen Muirhead et Alejandro Rivera. J’ai beaucoup appris en travaillant avec Stephen et j’espère renouveler cette expérience. Alejandro, tu tiens une place à part dans cette thèse. Ce fut une chance immense d’avoir en toi à la fois un frère de thèse, un co-auteur et un ami. J’espère pendant longtemps encore parcourir les lignes de niveaux de paysages aléatoires avec toi et passer ces longues soirées à discuter de percolation, politique, champs gaussiens, musique, vie personnelle, puis de nouveau percolation... ! Merci aussi pour ta disponibilité, notamment en cette période de fin de thèse : les échanges quasi-quotidiens alors que nous préparons tous les deux notre soutenance (en vérité pour toi c’est déjà fait à l’heure à laquelle je termine ces remerciements!!) m’ont énormément aidé.

Je souhaiterais remercier toutes les personnes avec qui j’ai eu des discussions mathématiques pendant cette thèse, particulièrement (au risque d’oublier des gens !) Damien Gayet, Gábor Pete, Xiaolin Zeng, Daniel Ahlberg, Rangel Baldasso, Loïc Richier, Avelio Sepúlveda, Thomas Letendre, Sébastien Ott, Thomas Budzinski, Ivan Gentil, Romain Durand, Nina Holden, Xin Sun, Aran Raoufi... Merci aussi à mon grand frère de thèse Juhan Aru, que je croise toujours avec grand plaisir.

Je remercie les personnes avec qui j’ai parlé d’enseignement et/ou partagé des enseignements, en particulier Jean-Michel Génévaux, Nabil Kazi-Tani, Thomas Gérard, Vincent Le-

rouvillois, Coline Wiatrowski, Mélanie Theillière et Gwladys Fernandes. Je pense par ailleurs aux professeur.e.s sans qui je n'aurais pas choisi cette voie, que ce soient mes professeur.e.s de collège/lycée/prépa (un merci tout particulier à Josiane Mai, Serge Dupont et Alain Pommellet pour leurs cours limpides) ou d'après (je pense particulièrement à Raphaël Cerf et Wendelin Werner sans qui je ne me serais probablement pas orienté vers ce sujet de thèse et à Thomas Duquesne qui m'a conseillé d'aller voir Christophe). Merci aussi, Wendelin, pour ton accueil à chaque fois que je suis venu à Zürich.

C'est avec joie que je remercie mes co-bureaux et ex co-bureaux. Merci à Avelio (il faut vraiment qu'on trouve du temps pour travailler ensemble!), Andrea, Thomas G (merci pour les blagues et les conseils musicaux!), Yannick (notre militant infatigable), Alexandre, Clemens, Maxime H, Simon C, Corentin et Mathias (qui ont tous les deux accueilli chaleureusement et avec simplicité le petit stagiaire dans le groupe des vieux.illes). D'ailleurs merci à tou.te.s les autres vieux.illes : Agathe, Benoît, Blanche (grâce à qui j'ai appris que j'aimais beaucoup randonner!), Cécile-mamy et Thomas-papy (avec qui les séances d'escalade et les pizzas commencent à sérieusement me manquer), Adriane et François IM, Cécile F, François mini, François V (mon modèle de grimpeur)...

Un merci chaleureux à mes collègues doctorant.e.s et ex-doctorant.e.s (désolé aux personnes que j'oublie!) : Marion (merci - entre autres! - d'être si attentive à nous tout.e.s), Gwladys (dont la manie de mettre beaucoup trop de points d'exclamation m'a contaminé comme on peut le voir dans ces remerciements!!!), Théo, Vincent L (merci notamment pour ton aide indispensable pour les simulations de cette soutenance!), Benjamin C, Ariane, Simon A, Zug (merci de partager sans compter ton enthousiasme!), Simon B, Caterina, Daniel, Michele, Jean-Cyril, Maxime P, Xiaolin, Mélanie, Rémy (Poudrevigne), Lola (avec qui j'ai la chance de co-représenter les doctorant.e.s à l'école doctorale), Jiao, Olga, Tingxiang, Kévin, Antoine, Benjamin D, Mickaël, Coline, Godfred, Christian, Octave, Martin, Samuel... Merci aussi aux doctorant.e.s, ex doctorant.e.s et AGPR de l'UMPA : Valentine (dont je ne squatte plus assez le bureau cette année!), Loïc R, Benoît, Jonathan, Léo, Arthur, Mickaël, Loïc dR, Alexandre...

La vie au laboratoire aurait été bien plus compliquée et moins agréable sans les personnes qui veillent (ou ont veillé) à son bon fonctionnement : merci en particulier aux personnes avec qui j'ai souvent interagi : Aurélie (avec qui j'aimais beaucoup couper les brioches!), Naïma, Vincent F, Céline, Maria, Betty, Jean-Louis (avec qui il était très agréable de discuter quand il passait dans le bureau)... Je remercie par ailleurs Vincent Beffara et Simon Masnou d'avoir participé à mon "suivi de thèse". Merci aussi à tout.e.s les chercheur.ses et enseignant.e.s de l'ICJ avec qui j'ai eu l'occasion de parler de mathématiques, de politique de la fac, d'enseignement ou d'autre chose. Au risque d'oublier de nombreuses personnes importantes merci à Morgane, Thibault, Thomas B, Anne, Philippe, Frédéric... Merci à tous les membres de l'équipe de probabilité : Oriane, Charles-Édouard, Jean-Marie, les Christophes, Nadine, Fabio, Guillaume, Xinxin... j'aurais avec plaisir travaillé de nombreuses autres années parmi vous. J'aimerais aussi remercier Claire grâce à qui il est toujours très agréable de descendre à la bibliothèque!

Un grand merci à mes ami.e.s lyonnais.es et villeurbannais.es. Je pense en premier lieu à tou.te.s les personnes avec qui j'ai habité : merci à Sammy avec qui j'ai fait mes premiers pas à Lyon, à Balthazar, Lucas et Victor que j'ai rejoints pendant un très court mais très plaisant moment, et merci beaucoup à Gabrielle et Simon A pour cette année passée ensemble (et pour me faire sentir si simplement que je suis encore membre de la coloc!!). Merci aussi, Ariane, pour tout ce que tu m'as apporté. Merci à tous les membres de la BDR (étendue) avec qui j'ai passé des moments très forts et très agréables à la fois : Jean, Roseline, Patrick, Peggy, Sidoni, Franck... Merci aussi à Joëlle (dont la générosité m'épate!) et un grand merci à Julie et Simon B (dont je ne profite pas assez des pâtamitiés!!).

Je pense maintenant à mes ami.e.s parisien.ne.s. Merci à Anne, Benjamin, Charles et Jean de m'avoir accueilli si souvent à la tour Tokyo! Votre amitié m'est plus que précieuse. J'ai hâte de venir de nouveau à la tour et boire de l'eau chaude en votre compagnie! J'ai eu de la

chance de faire de belles rencontres lors de mes cinq années d'étude à Paris et je remercie très chaleureusement Antonin, Colette et Ben (qui m'ont supporté tout un week-end dix jours avant la soutenance!), Delphine, Luc G, Paul D, Quentin, Salim, les B4ain.e.s...

Après Villeurbanne/Lyon et Paris, un petit passage dans le sud de la France! Je pense aux Guérins et à Caroline et Luc. C'est à chaque fois un très grand plaisir de vous revoir. Un merci tout particulier à Paul : je lève un verre de jus multivitaminé à notre longue amitié qui n'est pas prête de s'arrêter! Faisons maintenant un petit tour par le nord de la France. Cela m'a fait un grand bien d'y passer peu avant ma soutenance; merci à mamie, les cousin-cousines, Thierry, Catherine...

Je voudrais finir ces remerciements en pensant à mes parents et mon frère. Merci à Théo (avec qui les duos de musique me manquent!) et à mes parents : tout aurait été tellement plus compliqué si vous n'aviez pas été toujours là pour me soutenir, m'écouter, m'encourager...!!

Introduction	1
1 Trois modèles de percolation planaire	1
1.1 La percolation de Bernoulli	1
1.2 La percolation de lignes nodales	4
1.3 Dynamiques et percolation de Voronoi	6
2 Percolation de Bernoulli planaire et influences	9
2.1 Probabilités de croisement	9
2.2 Influences	12
3 La percolation de lignes nodales	18
3.1 La quasi-indépendance	22
3.2 Le calcul du niveau critique	29
4 Une courte parenthèse : le raisonnement par analogie	32
5 Les relations d'échelle	34
5.1 L'inégalité de BK-Reimer	35
5.2 La longueur de corrélation et les relations d'échelle	36
6 La percolation de Voronoi	37
6.1 Relations d'échelle annealed pour la percolation de Voronoi	39
6.2 Estimations quenched quantitatives	42
7 Des modèles de percolation dynamique	45
7.1 La sensibilité au bruit	45
7.2 La décomposition de Fourier des fonctions Booléennes	47
7.3 La percolation dynamique conservative	51
7.4 Dynamiques en percolation de Voronoi	53
8 Miscellaneous sur les limites d'échelles	58
I Percolation de lignes nodales	61
1 Quasi-indépendance pour les lignes nodales	63
1 Introduction	64
2 Quasi-independence for Gaussian vectors	71
3 Quasi-independence for planar Gaussian fields: the proof of Theorem 1.12	73
3.1 The proof of Theorem 1.12 in the case of crossing and circuit events	74
3.2 Pivotal sites imply exceptional geometric events	76
3.3 End of the proof of Proposition 3.4 via Kac-Rice estimates	79
3.4 Completing the proof of Theorem 1.12	81
4 Tassion's RSW theory: the proof of Theorem 1.1	84

5	Concentration from below of the number of nodal lines: the proof of Theorem 1.4	88
A	Classical tools	90
	A.1 Classical results for Gaussian vectors and fields	90
	A.2 Transversality of the level set and a non-quantitative discretization lemma	92
B	A uniform discrete RSW estimate	94
2	Le niveau critique pour la percolation de Bargmann-Fock	99
1	Main results	100
2	Proof strategy and intermediate results	105
	2.1 Some ingredients for the proof of Kesten’s theorem	106
	2.2 Conditions on the Gaussian fields	107
	2.3 A box-crossing criterion	108
	2.4 A discretization procedure and a discrete phase transition theorem for more general fields	108
	2.5 Sharp threshold at the discrete level	112
	2.6 From discrete to continuous	117
3	Proofs of the phase transition theorems and of the exponential decay	118
	3.1 Proof of the phase transition theorems	118
	3.2 Proof of the exponential decay	123
4	Percolation arguments	125
	4.1 Proof of Lemma 2.9	125
	4.2 Proof of Proposition 2.20	126
5	A KKL theorem for biased Gaussian vectors: the proof of Theorem 2.19	128
	5.1 Sub-linearity of influences implies Theorem 2.19	128
	5.2 Sub-linearity of influences for monotonic events	130
6	An estimate on the infinite operator norm of square root of infinite matrices: the proof of Proposition 2.21	132
7	Sprinkling discretization scheme	136
A	An additional sub-linearity result for influences	138
3	Transition de phase pour la percolation de lignes de niveau de champs gaussiens planaires lisses	143
1	Introduction	144
	1.1 Gaussian fields and percolation	145
	1.2 Statement of the main results	146
	1.3 A family of examples	151
	1.4 The percolation universality class	152
	1.5 Overview of rest of the chapter	152
	1.6 Acknowledgments	152
2	Overview of our methods and outline of the proof	153
	2.1 Truncation and discretisation	153
	2.2 The OSSS inequality	155
	2.3 Outline of the proof	157
3	Gaussian techniques	158
	3.1 Notation for sub- σ -algebras	158
	3.2 Consequences of the assumptions	158
	3.3 Varying the level via the Cameron–Martin theorem	161
	3.4 Comparison to truncated and discretised versions of the field	165
4	Quasi-independence and RSW estimates	167
5	A first description of the phase transition	171
	5.1 Sprinkling	171
	5.2 Connecting Russo’s formula to the OSSS influences	172

5.3	Applying the OSSS inequality	174
6	Proof of the main results	177
II Dynamiques et percolation de Voronoi		183
4	Temps exceptionnels pour la percolation sous une dynamique d'exclusion	185
1	Introduction	186
1.1	Dynamical percolation	186
1.2	Percolation under exclusion dynamics	187
1.3	Main results	189
2	Background and outline of proof	191
2.1	Arm events and some other notations	191
2.2	Second moment method and exclusion sensitivity	192
2.3	The spectral sample in the i.i.d. setting	194
2.4	Spectral representation of correlations in the conservative case	196
2.5	Outline of proof and new spectral estimates	196
3	Warm-up without spectral analysis: proofs of Propositions 1.3 and 1.4	201
4	Exceptional times at criticality: proofs of Theorem 1.5 and Proposition 1.6	204
5	Clustering effect for the spectral sample	212
5.1	The proof of Proposition 2.10	212
5.2	Small residual spectral mass away from the origin	212
6	Open questions	228
A	Graphical construction (à la Harris) of exclusion dynamics	229
B	The proof of Lemma 5.7	230
C	The 4-arm event conditioned on the configuration in a half-plane	231
5	Relations d'échelle annealed pour la percolation de Voronoi	235
1	The model and the main result	237
1.1	Percolation on planar lattices	237
1.2	Planar Voronoi percolation	237
1.3	The main result: annealed scaling relations for Voronoi percolation	240
1.4	Estimates on the 4-arm events, $\theta^{an}(p)$, and $L^{an}(p)$	242
1.5	Quenched or annealed results?	242
2	Strategy and organization of the chapter	243
2.1	Some notations	243
2.2	Correlation inequalities for Voronoi percolation	243
2.3	Consequences of the annealed quasi-multiplicativity property	244
2.4	Some important events: the pivotal events and the “good” events	246
2.5	Organization of the chapter and interdependence of the sections	248
2.6	Some ideas of proof	248
3	Preliminary results	250
3.1	Warm-up: proof of (1.1) and of the quasi-multiplicativity property for $j = 1$	250
3.2	A generalization of Theorem 1.4 to a family of quads	253
3.3	“Strong” well-separateness of interfaces	254
4	Pivotal events and some estimates on arm events	256
4.1	The case of the bulk	256
4.2	An estimate on the 4-arm event	262
4.3	Pivotal events for crossing events and arm events	264
5	Extension of the results to the near-critical phase	270
5.1	Extension of the annealed and quenched box-crossing properties	270
5.2	Extension of the results of Sections 3, 4 and 7	272

6	Proof of the annealed scaling relations	273
7	The quasi-multiplicativity property	276
7.1	The case j even	276
7.2	A consequence of the quasi-multiplicativity property	287
7.3	Arm events in the half-plane	287
7.4	The case j odd	288
A	An extension of Schramm and Steif’s algorithm theorem	289
B	The proof of the quenched box-crossing property in [AGMT16]	291
C	Pivotal events for $\mathbf{A}_j(1, R)$ when j is odd	293
D	The quantities $\mathbb{E} \left[\mathbf{P}^\eta [\mathbf{A}_j(r, R)]^2 \right]$	294
D.1	The quasi-multiplicativity property	294
D.2	Pivotal events	298
6	Estimations quenched quantitatives pour la percolation de Voronoi	303
1	Introduction	304
1.1	Main results	304
1.2	An application: Reimer’s inequality and the annealed percolation function	306
1.3	Ideas of proof	307
2	The martingale method	309
3	First estimates on arm and pivotal events	311
3.1	Arm-events and pivotal events	311
3.2	The “good” events	313
3.3	A quenched quasi-multiplicativity property	314
4	Proof that $\alpha_j^{an}(r, R) \asymp \tilde{\alpha}_j(r, R)$	316
5	Strict inequality for the exponent of the annealed percolation function	318
6	Other estimates on arm events	319
7	Quantitative quenched estimates	322
7	L’échantillon spectral annealed de la percolation de Voronoi	325
1	Introduction	326
1.1	Models and main results	326
1.2	Noise sensitivity for Voronoi percolation	328
1.3	Estimates on arm events	330
2	The annealed spectral sample of Voronoi percolation	332
2.1	Definition of the annealed spectral sample and links to the dynamics	332
2.2	Why don’t we study a quenched spectral sample?	335
2.3	Main results on the annealed spectral sample	336
2.4	Proofs of existence of exceptional times	338
3	Proofs of the spectral estimates	340
3.1	Preliminary results and pivotal sets	340
3.2	Proof of the main estimates on the annealed spectral sample	342
3.3	Quasi-multiplicativity properties for the annealed spectral sample	350
A	Simple properties of the μ -dynamical processes	358
B	The 2^{nd} moment method	360
C	Absence of noise sensitivity for t_n sufficiently small	361
D	The probability of a 4-arm event conditioned on the configuration in a half-plane	362
	Bibliographie	371

1 Trois modèles de percolation planaire

Dans cette thèse, nous étudions trois modèles de percolation dans la plan : la **percolation de Bernoulli**, la **percolation de Voronoi** et la **percolation de lignes nodales**. Deux fils conducteurs principaux ont dirigé nos travaux. Le premier est la recherche de **similarités entre ces modèles**, en ayant à l’esprit que l’on s’attend à ce qu’ils admettent une même limite d’échelle. Le deuxième est l’étude de **dynamiques** sur ces modèles. Commençons par les définir.

1.1 La percolation de Bernoulli

La percolation de Bernoulli a été introduite par Broadbent et Hammersley [BH57] dans le but de modéliser l’écoulement d’un fluide dans un matériau poreux. Ce modèle est souvent considéré comme le modèle le plus simple à définir admettant une **transition de phase**. De plus, il illustre (du moins si l’on croit aux conjectures!) la **théorie d’universalité** en physique statistique. La percolation a aussi des liens étroits avec d’autres domaines des mathématiques et des domaines de l’informatique théorique tels que l’analyse complexe ou la théorie des fonctions booléennes.

Dans cette thèse, nous nous intéressons à des modèles de percolation **dans le plan**. Définissons plus spécifiquement la percolation **par arêtes sur le réseau carré \mathbb{Z}^2** et la percolation **par sites sur le réseau triangulaire régulier \mathcal{T}** . Pour cela, considérons un de ces deux réseaux (voir la Figure 1.1), un paramètre $p \in [0, 1]$, et déclarons chaque arête de \mathbb{Z}^2 ou chaque site de \mathcal{T} **ouvert** avec probabilité p et **fermé** avec probabilité $1 - p$, indépendamment des autres arêtes ou sites (voir la Figure 1.2). En choisissant que 1 signifie “ouvert” et -1 signifie “fermé”, ceci définit une variable aléatoire ω à valeurs dans l’espace produit $\{-1, 1\}^{\mathcal{I}}$, où \mathcal{I} est l’ensemble des arêtes de \mathbb{Z}^2 ou des sites de \mathcal{T} . Dans toute cette introduction, nous noterons \mathbb{P}_p la mesure de probabilité de percolation de paramètre p i.e. $\mathbb{P}_p = (p\delta_1 + (1 - p)\delta_{-1})^{\otimes \mathcal{I}}$. Un élément de $\{-1, 1\}^{\mathcal{I}}$ est appelé “configuration de percolation”.

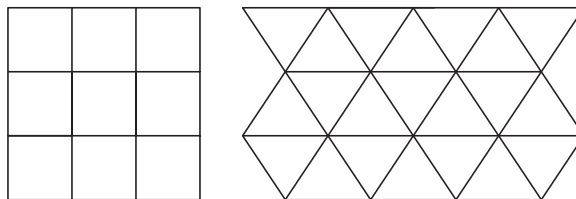

FIGURE 1.1 – Une portion des réseaux carré et triangulaire.

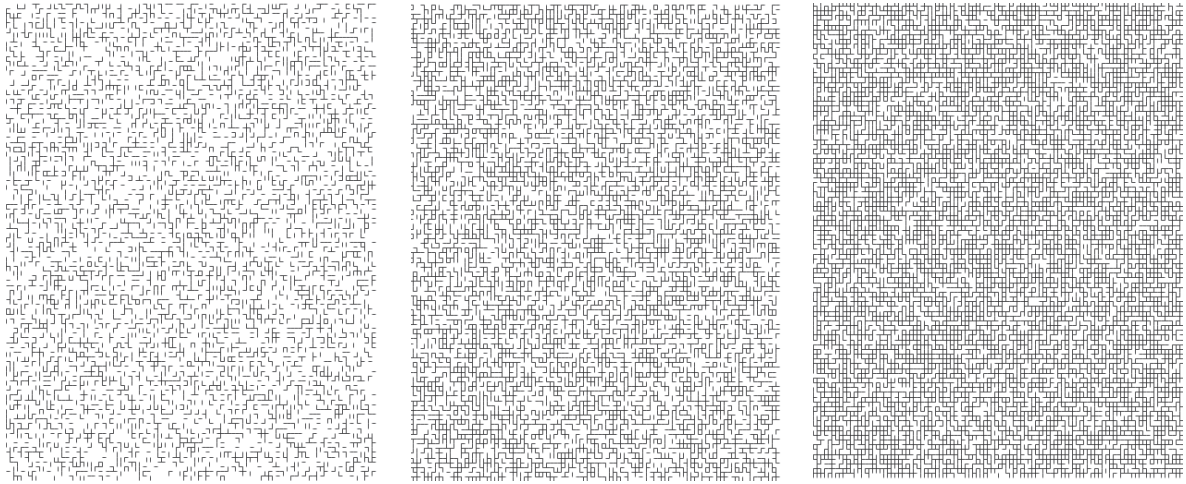

FIGURE 1.2 – Percolation par arêtes sur \mathbb{Z}^2 aux paramètres $p = 0.3$, $p = 0.5$ et $p = 0.7$. Les arêtes fermées ont été effacées.

En théorie de la percolation, on s’intéresse aux propriétés de connexion dans le sous-graphe obtenu en effaçant les arêtes fermées (ou les sites fermés). On appelle “cluster” une composante connexe de ce sous-graphe. On se demande ainsi s’il existe de grands clusters, et en premier lieu s’il existe des **clusters infinis**. La première réponse que l’on peut donner (voir par exemple [Gri99] ou [BR06b]) est qu’il existe un **paramètre critique** $p_c \in]0, 1[$ tel que :

- Pour tout $p \in [0, p_c[$, presque sûrement tous les clusters sont finis.
- Pour tout $p \in]p_c, 1]$, presque sûrement il existe au moins un cluster infini.

Un tel phénomène est appelé **transition de phase**. La phase $p \in [0, p_c[$ est appelée “phase sous-critique” et la phase $p \in]p_c, 1]$ est appelée “phase sur-critique”. On peut à ce stade se poser par exemple les questions suivantes : Quelle est la valeur de p_c ? Comment caractériser la transition de phase ? Que se passe-t-il au paramètre critique ? Et en particulier : y a-t-il un cluster infini au paramètre critique ? La première question (i.e. que vaut p_c) ne semble pas être la question la plus importante en général car la valeur de p_c dépend du réseau et que l’on considère souvent que les quantités les plus intéressantes à étudier sont les quantités “universelles”. Cependant, lorsque le modèle a des propriétés d’auto-dualité - ce qui est le cas des deux modèles que nous avons introduit - cette question est particulièrement intéressante et Kesten a prouvé le résultat suivant :

Théorème 1.1 ([Kes80]). *Le paramètre critique est égal à $1/2$.*

En Section 2.2, nous présentons plusieurs preuves de ce résultat. Vingt ans auparavant, Harris [Har60] avait prouvé que, si $p = 1/2$, alors presque sûrement il n’y avait pas de cluster infini, ce qui impliquait en particulier que $p_c \geq 1/2$. Les travaux d’Harris et Kesten impliquent un résultat important qui est connu pour les modèles de percolation par arêtes et par sites sur une très grande classe de réseaux planaires (voir [Kes82]) : **au paramètre critique, il n’y a presque sûrement aucun cluster infini**. Notons que ce résultat n’est pas connu en dimension 3, et le fait qu’il soit vrai en cette dimension est peut-être la conjecture la plus importante de la théorie de la percolation.

L’auto-dualité. La propriété d’auto-dualité des deux modèles peut par exemple s’énoncer en leur associant un coloriage du plan (en noir et blanc) dans lequel chaque cluster correspond naturellement à une composante noire (voir la Figure 1.3) :

- Le réseau hexagonal régulier est le réseau dual de \mathcal{T} . Étant donné une configuration de percolation par sites sur \mathcal{T} , on peut donc colorier chaque face du réseau hexagonal en noir si le site associé est ouvert et en blanc s’il est fermé.
- Concernant le modèle de percolation par arêtes sur \mathbb{Z}^2 , on peut tout d’abord remarquer que $(\mathbb{Z}^2)^*$, le réseau dual de \mathbb{Z}^2 , est isomorphe à \mathbb{Z}^2 . Plus précisément, $(\mathbb{Z}^2)^* = \mathbb{Z}^2 + (1/2, 1/2)$. Étant donné une configuration de percolation sur \mathbb{Z}^2 , on peut définir une configuration de percolation sur $(\mathbb{Z}^2)^*$ de la façon suivante : une arête duale est ouverte si et seulement si elle n’intersecte pas d’arête primale ouverte. On peut alors colorier le plan en noir et blanc comme sur la Figure 1.3.

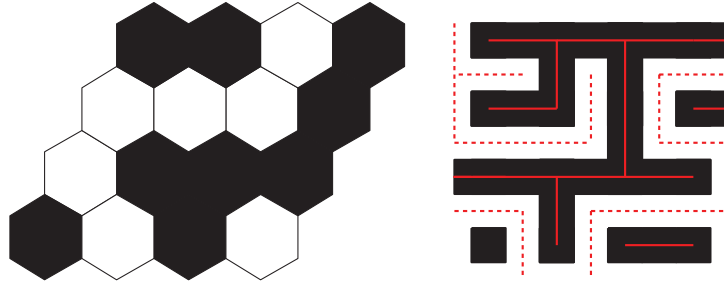

FIGURE 1.3 – (a) Le coloriage du plan issu d’une configuration de percolation sur \mathcal{T} . (b) Celui issu d’une configuration de percolation sur \mathbb{Z}^2 : les voisinages de rayon $1/4$ (pour la norme infinie) des clusters primaux et duaux sont coloriés respectivement en noir et en blanc.

Donnons-nous un rectangle dessiné dans le plan et remarquons qu’il existe un chemin noir de son côté gauche à son côté droit si et seulement s’il n’existe pas de chemin blanc de bas en haut. Il y a ainsi un phénomène de “compétition” entre les deux couleurs. Notons par ailleurs que le paramètre $1/2$ est particulier : si $p = 1/2$, les ensembles noir et blanc ont la même loi (à une translation de $(1/2, 1/2)$ près pour le modèle sur \mathbb{Z}^2). Ces observations permettent de calculer facilement la probabilité d’événements de percolation dans un carré ou un losange : Plaçons-nous au paramètre $1/2$ et considérons un carré (dans le cas du modèle sur \mathbb{Z}^2) ou un losange (dans le cas du modèle sur \mathcal{T}) tracé dans le plan.¹ Dans les deux cas, l’auto-dualité et les symétries du modèle impliquent que la probabilité qu’il y ait un chemin noir de gauche à droite est $1/2$.

En raison de ces propriétés, le paramètre $p = 1/2$ est qualifié d’**auto-dual**. Le Théorème 1.1 peut ainsi se traduire de la façon suivante : **le paramètre critique est égal au paramètre auto-dual** auquel il y a un “équilibre” entre les connexions noires et blanches.

La fonction de percolation. Une fois le paramètre critique calculé, comment décrire la transition de phase ? On peut par exemple étudier la **fonction de percolation** définie par :

$$\theta(p) = \mathbb{P}_p [0 \leftrightarrow \infty] ,$$

où $\{0 \leftrightarrow \infty\}$ est l’événement qu’il existe un cluster infini contenant 0. Notons que, par la loi du 0-1 de Kolmogorov, pour tout p , soit $\theta(p) = 0$ et presque sûrement il n’existe aucun cluster infini, soit $\theta(p) > 0$ et presque sûrement il existe au moins un cluster infini. On sait que cette fonction est continue et infiniment dérivable en dehors de $p = 1/2$ (voir la Section 8.7 de [Gr99] et les références citées dans ce livre). Concernant la “forme” de cette fonction au point critique, on peut citer le résultat suivant de Kesten et Zhang :

¹Le carré et le losange doivent en fait être choisis convenablement pour pouvoir utiliser les symétries du modèle, mais cela n’a pas grande importance ici.

Théorème 1.2 ([KZ87]). *Il existe $\varepsilon > 0$ tel que, pour tout $p \geq 1/2$:*

$$\theta(p) \geq \varepsilon(p - 1/2)^{1-\varepsilon}.$$

On s'attend ainsi à ce que θ ressemble à la fonction dessinée sur la Figure 1.4. Notons que cette inégalité est particulièrement intéressante car on sait qu'en grandes dimensions $\theta(p)$ est de l'ordre de $p - p_c$ dans la phase sur-critique, voir [HS94, FvdH15].

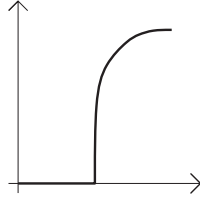

FIGURE 1.4 – L'allure de la fonction de percolation.

Avant d'étudier plus en détail la percolation de Bernoulli, définissons les autres modèles de percolation planaire auxquels nous nous sommes intéressés dans cette thèse.

1.2 La percolation de lignes nodales

Dans des travaux en commun avec avec Stephen Muirhead et Alejandro Rivera, nous avons étudié un modèle de percolation continue construit à l'aide de champs gaussiens planaires : la **percolation de lignes nodales**. Nous nous y sommes intéressés notamment dans le cas particulier où le champ gaussien est le **champ de Bargmann-Fock**, qui apparaît comme limite locale d'un modèle de polynômes homogènes aléatoires naturels sur la sphère : les **polynômes de Kostlan** (voir la Figure 1.5 et, pour des détails, l'introduction de [BG16]). Commençons par définir le champ de Bargmann-Fock.

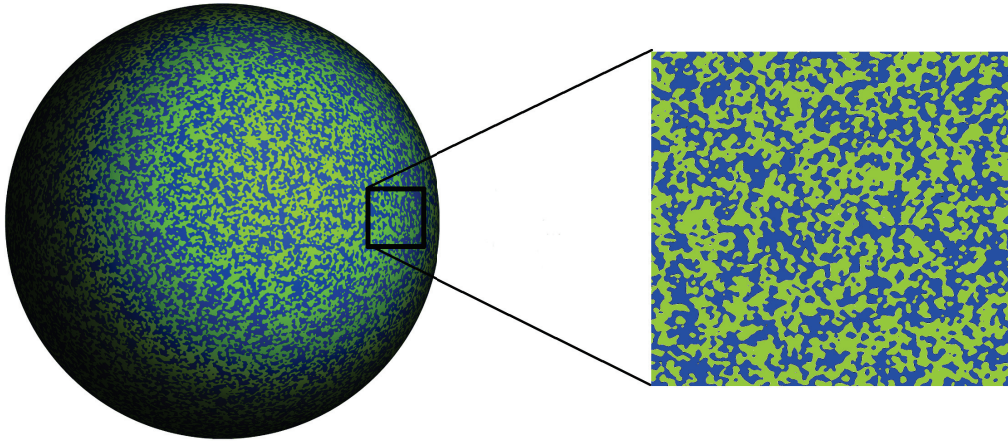

FIGURE 1.5 – Le champ de Bargmann-Fock est la limite locale des polynômes de Kostlan, simulations par Vincent Beffara et Alejandro Rivera. L'ensemble des points où les champs sont positifs est colorié en bleu ; l'ensemble où ils sont négatifs est colorié en vert.

Définition 1.3. Le champ de Bargmann-Fock, que nous noterons Υ dans cette introduction, est un champ gaussien planaire centré dont la fonction de covariance est la fonction gaussienne i.e. :

$$\forall x, y \in \mathbb{R}^2, \mathbb{E}[\Upsilon(x)\Upsilon(y)] = \exp\left(-\frac{|x - y|^2}{2}\right),$$

où $|\cdot|$ est la norme euclidienne sur \mathbb{R}^2 .

On peut montrer qu'il existe une famille de variables gaussiennes centrées indépendantes $(a_{i,j})_{i,j \in \mathbb{N}}$ telles que la variance de $a_{i,j}$ est $1/(i!j!)$ et, pour tout $x \in \mathbb{R}^2$:

$$\Upsilon(x) = \Upsilon(x_1, x_2) = \sum_{i,j \in \mathbb{N}} a_{i,j} x_1^i x_2^j,$$

la somme ci-dessous convergeant presque sûrement uniformément sur tout compact. En particulier, la fonction $x \mapsto \Upsilon(x)$ est presque sûrement analytique.

De nombreux travaux ont pour sujet le lieu des zéros des polynômes de Kostlan ou du champ de Bargmann-Fock, avec comme buts principaux l'estimation de quantités telles que le volume ou le nombre de composantes connexes de ce lieu des zéros (voir par exemple les notes de lecture [Ana15] - décrivant des travaux de Gayet et Welschinger et ceux de Nazarov et Sodin - et les références qui s'y trouvent). Les composantes connexes du lieu des zéros sont appelées **lignes nodales**. Dans cette thèse, nous nous intéressons au lien entre ces modèles et la percolation. Afin d'expliquer ce lien, donnons-nous un niveau $\ell \in \mathbb{R}$ et colorions en bleu les points du plan où le champ de Bargmann-Fock Υ est plus grand que $-\ell$ et en vert les points où il est plus petit que $-\ell$ (le choix de $-\ell$ plutôt que ℓ vient uniquement du fait qu'ainsi les ensembles bleus sont croissants à la fois rapport à ℓ et à Υ). On peut étudier les propriétés de connexion par des chemins monochromatiques, ce qui constitue l'analogie des propriétés auxquelles on s'intéresse en percolation de Bernoulli.

Notons que le niveau $\ell = 0$ est auto-dual dans le sens que i) les coloriages bleus et verts ont la même loi à ce paramètre et ii) pour tout rectangle, il y a un chemin bleu de gauche à droite si et seulement s'il n'y a pas de chemin vert de bas en haut. Dans [Ale96a], Alexander a montré que, si $\ell \leq 0$, il n'y avait presque sûrement pas de composante connexe non bornée bleue.² Dans [V2], nous avons montré avec Alejandro Rivera le résultat suivant qui fait échos au résultat démontré par Kesten (Théorème 1.1).

Théorème 1.4 (Théorème 1.3 du Chapitre 2, en commun avec Alejandro Rivera). *Si $\ell > 0$, il y a presque sûrement une composante connexe bleue non bornée. Le niveau critique du modèle de percolation de Bargmann-Fock est donc égal à 0 (voir la Figure 1.6.)*

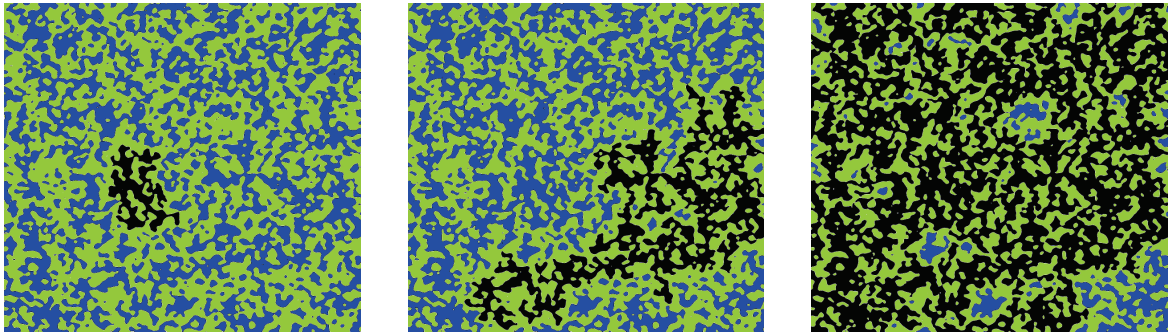

FIGURE 1.6 – Le modèle de percolation de Bargmann-Fock aux niveaux $\ell = -0.1$, $\ell = 0$ et $\ell = 0.1$ dans une grande fenêtre, simulation d'Alejandro Rivera. La plus grande composante bleue incluse dans la fenêtre est coloriée en noir.

Notre preuve repose sur un résultat de Beffara et Gayet [BG16] sur les probabilités de connexion dans des rectangles. Par ailleurs, l'idée de lier les modèles de lignes nodales à la percolation de Bernoulli est issue des travaux de Bogomolny et Schmit [BS02]. Notons de plus que nous avons généralisé ce théorème à une grande classe de champs gaussiens ; nous renvoyons à la Section 3 pour ce résultat qui est issu d'un travail en commun avec Stephen Muirhead. Les travaux de cette thèse sur la percolation de lignes nodales en constituent la Partie I.

²Alexander n'a pas démontré ce résultat que pour le champ de Bargmann-Fock, mais pour une très grande classe de champs planaires (non nécessairement gaussiens).

1.3 Dynamiques et percolation de Voronoi

Dans la Partie II de cette thèse, nous nous intéressons à des modèles de **percolation dynamique** et au modèle de **percolation de Voronoi**, notre but principal étant d'étudier des modèles de percolation de Voronoi dynamique. Commençons par définir le modèle de percolation dynamique, qui a été introduit indépendamment par Benjamini et par Häggström, Peres et Steif [HPS97].

1.3.1 La percolation dynamique

Donnons-nous un paramètre $p \in [0, 1]$, considérons une configuration de percolation (par arêtes sur \mathbb{Z}^2 ou par sites sur \mathcal{T}) $\omega(0)$ de loi \mathbb{P}_p , et définissons un processus dynamique $(\omega(t))_{t \in \mathbb{R}_+}$ en rééchantillonnant l'état de chaque arête ou site à taux 1. On obtient ainsi un processus de Markov à valeurs dans $\{-1, 1\}^{\mathcal{I}}$ (rappelons que \mathcal{I} est l'ensemble des arêtes de \mathbb{Z}^2 ou des sites de \mathcal{T}). Une propriété cruciale est que \mathbb{P}_p est une mesure invariante pour ce processus (en fait l'unique mesure de probabilité invariante). Ceci implique que, si $p \leq 1/2$, pour tout temps $t \in \mathbb{R}_+$ fixé il n'existe presque sûrement aucun cluster infini dans $\omega(t)$. De même, si $p > 1/2$, pour tout t fixé il existe presque sûrement un cluster infini dans $\omega(t)$. L'ensemble \mathbb{R}_+ n'étant pas dénombrable, on peut se demander s'il existe toutefois des temps t "atypiques" auxquels $\omega(t)$ a un cluster infini (si $p \leq 1/2$) ou n'en a pas (si $p > 1/2$). De tels temps sont appelés **temps exceptionnels**.

Les auteurs de [HPS97] ont montré que, si $p \neq p_c$, presque sûrement il n'existait pas de temps exceptionnels (cette propriété est vraie pour les modèles de percolation sur n'importe quel graphe dénombrable). L'étude du modèle au point critique s'avère bien plus difficile, et il a tout d'abord été prouvé par Schramm et Steif dans [SS10] que, pour la percolation par sites critique sur \mathcal{T} , **il y avait presque sûrement des temps exceptionnels**. Le théorème analogue dans le cas du réseau carré a été obtenu par Garban, Pete et Schramm dans [GPS10]. Les techniques de [GPS10] ont par ailleurs permis de calculer la dimension de Hausdorff des temps exceptionnels dans le cas de la percolation par sites sur \mathcal{T} . L'énoncé suivant réunit les deux résultats.

Théorème 1.5 ([SS10, GPS10]). *Considérons la percolation dynamique par arêtes sur \mathbb{Z}^2 ou par sites sur \mathcal{T} . Si on se place au point critique, il existe presque sûrement des temps exceptionnels. Par ailleurs, dans le cas du modèle sur \mathcal{T} , la dimension de Hausdorff des temps exceptionnels est presque sûrement égale à $31/36$.*

Nous renvoyons à la Section 2.1 pour la raison pour laquelle l'étude de la percolation sur \mathcal{T} est plus aisée que celle sur le réseau \mathbb{Z}^2 . La preuve du Théorème 1.5 est inspirée de la notion de **sensibilité au bruit** introduite par Benjamini, Kalai et Schramm [BKS99], voir la Section 7.1.

Avec Christophe Garban, nous avons étudié un modèle de percolation dynamique **conservative** dans lequel, à chaque fois qu'un élément ouvert $i \in \mathcal{I}$ devient fermé, un élément fermé devient ouvert. Définissons ce modèle, qui a été introduit par Broman, Garban et Steif [BGS13]. Pour cela, donnons-nous un paramètre $p \in [0, 1]$, une configuration de percolation $\omega(0)$ de loi \mathbb{P}_p , et un noyau de Markov symétrique K sur \mathcal{I} . Associons par ailleurs une horloge exponentielle à chaque élément $i \in \mathcal{I}$ (indépendante des autres horloges). Lorsque l'horloge de i sonne, choisissons un autre élément $j \in \mathcal{I}$ avec probabilité $K(i, j)$, et échangeons l'état de i et j . Le processus ainsi obtenu - que nous notons $(\omega_K(t))_{t \in \mathbb{R}_+}$ - est appelé **processus d'exclusion** (voir par exemple [Lig05]). Comme dans le cas de la dynamique indépendante définie ci-dessus, \mathbb{P}_p est une mesure invariante, de sorte que l'on peut encore se demander s'il existe des temps exceptionnels. Nous avons montré qu'il n'y en avait presque sûrement pas en dehors du point critique, et ce quel que soit le noyau K . Dans l'étude du modèle au point critique, nous nous

sommes intéressés aux noyaux K^α (où $\alpha > 0$) définis de la façon suivante :³

$$\forall i, j \in \mathcal{I}, \begin{cases} K^\alpha(i, i) & := 0 \\ K^\alpha(i, j) & := c_\alpha |i - j|^{-(2+\alpha)} \text{ si } i \neq j, \end{cases}$$

où c_α est une constante de renormalisation telle que K^α est un noyau de Markov. Dans [V4], nous avons obtenu le résultat suivant (voir aussi la Figure 1.7) :

Théorème 1.6 (Théorème 1.5 du Chapitre 4, en commun avec Christophe Garban). *Considérons la percolation critique par arêtes sur \mathbb{Z}^2 ou par sites sur \mathcal{T} . Il existe $\alpha_0 \in]0, +\infty[$ tel que, si $\alpha \in]0, \alpha_0[$, alors il y a presque sûrement des temps exceptionnels dans le processus $(\omega_{K^\alpha}(t))_{t \in \mathbb{R}_+}$. De plus, dans le cas de la percolation par sites sur \mathcal{T} , la mesure de Hausdorff de l'ensemble des temps exceptionnels est une constante presque sûre qui appartient à l'intervalle $[d(\alpha), 31/36]$ où*

$$d(\alpha) := 1 - \frac{5}{36} \left(1 - \frac{68}{21}\alpha\right)^{-1}.$$

En particulier, on peut choisir $\alpha_0 = 217/816$.

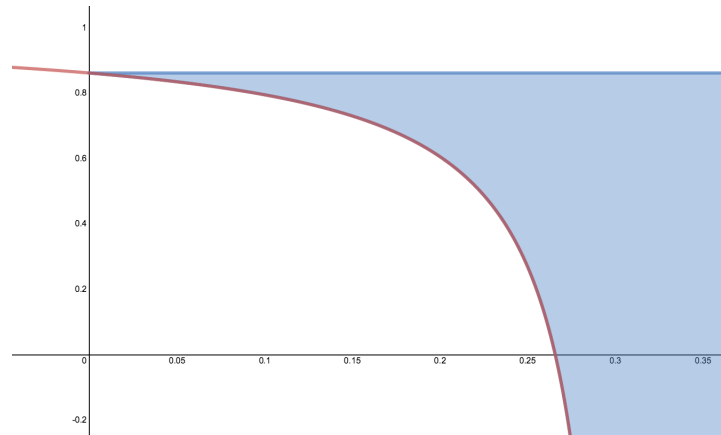

FIGURE 1.7 – La courbe rouge représente la borne inférieure $\alpha \mapsto d(\alpha)$ sur la dimension de Hausdorff de l'ensemble des temps exceptionnels du Théorème 1.6. La courbe bleue représente la borne supérieure égale à $31/36$. Notons que ces deux bornes coïncident à la limite $\alpha \searrow 0$.

Nous n'avons pas réussi à résoudre cette question dans le cas des dynamiques à moins grande portée, i.e. le cas α grand et en particulier le cas limite $\alpha = +\infty$ correspondant à une dynamique "à plus proches voisins". En effet, l'étude spectrale correspondante devient de plus en plus hors de portée de nos techniques, voir la Section 7.3. Nous nous attendons cependant à ce qu'il existe aussi des temps exceptionnels dans ces cas.

1.3.2 La percolation de Voronoi

Définissons maintenant le modèle de percolation de Voronoi, qui est un modèle de percolation sur un **pavage aléatoire du plan**. Pour cela, donnons-nous en premier lieu un processus de Poisson dans le plan d'intensité 1, que nous notons η . La cellule de Voronoi d'un point $x \in \eta$ est l'ensemble des points $u \in \mathbb{R}^2$ tels que, pour tout $y \in \eta$, $|x - u| \leq |y - u|$, où $|\cdot|$ est toujours la norme euclidienne. Il n'est pas difficile de montrer que presque sûrement toutes les cellules sont des polygones convexes bornés. Donnons-nous maintenant un paramètre $p \in [0, 1]$ et, conditionnellement à η , colorions chaque cellule en noir avec probabilité p et en blanc avec

³Dans le cas de la percolation par arêtes sur \mathbb{Z}^2 , on définit par exemple $|i - j|$ comme la distance entre les milieux des arêtes.

probabilité $1 - p$, (conditionnellement) indépendamment des autres cellules, voir la Figure 1.8. Nous notons $\omega \in \{-1, 1\}^\eta$ la configuration obtenue (où 1 signifie noir et -1 signifie blanc). Par ailleurs, nous notons \mathbb{P}_p^{an} la loi de ω et \mathbf{P}_p^η la loi de ω sachant η , i.e. $\mathbf{P}_p^\eta = (p\delta_1 + (1-p)\delta_{-1})^{\otimes \eta}$.

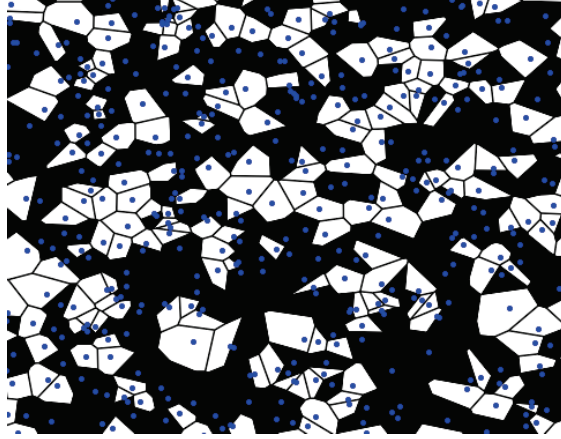

FIGURE 1.8 – Percolation de Voronoi de paramètre 1/2.

Lorsque l'on travaille en environnement aléatoire, on utilise souvent la terminologie suivante : quand on conditionne par rapport à l'environnement (qui ici est η), les probabilités calculées sont dites **gelées** ou **quenched**, alors qu'elles sont dites **moyennées** ou **annealed** quand on intègre aussi sur l'environnement. Notons $\{0 \leftrightarrow \infty\}$ l'événement qu'il existe un chemin noir non borné issu de 0. La fonction de percolation quenched est ainsi la fonction $p \mapsto \mathbf{P}_p^\eta [0 \leftrightarrow \infty]$ et la fonction de percolation annealed est $\theta^{an} : p \mapsto \mathbb{P}_p^{an} [0 \leftrightarrow \infty]$. Le point critique du modèle est défini par :

$$p_c = \inf\{p \in [0, 1] : \theta^{an}(p) > 0\}.$$

Nous aurions bien sûr aussi pu définir un point critique quenched mais il est en fait facile de montrer que celui est presque sûrement égal à p_c . Bollobás et Riordan ont prouvé l'analogie du théorème démontré par Kesten i.e. :

Théorème 1.7 ([BR06a]). *Le point critique est égal à 1/2.*

Tout comme pour les modèles de percolation de Bernoulli définis dans la Section 1.1 et le modèle de percolation de lignes nodales défini dans la Section 1.2, les propriétés d'auto-dualité du modèle de Voronoi permettent de montrer que, si $p = 1/2$, la probabilité annealed qu'il y a un chemin noir de gauche à droite dans un carré est égale à 1/2. Mais qu'en est-il de la probabilité quenched ? Il a été conjecturé par Benjamini, Kalai et Schramm [BKS99] que, asymptotiquement presque sûrement, celle-ci **ne dépendait pas de l'environnement** η est valait donc 1/2. Ce résultat a été prouvé par Ahlberg, Griffiths, Morris et Tassion (en utilisant notamment un résultat sur les propriétés de croisement de rectangles annealed dues à Tassion [Tas16], voir la Section 6) :

Théorème 1.8 ([AGMT16]). *Notons $\text{Cross}(R, R)$ l'événement qu'il y a un chemin de noir de gauche à droite dans le carré $[0, R]^2$. Il existe $\varepsilon > 0$ tel que, pour tout $R \in]0, +\infty[$:*

$$\mathbb{E} \left[\left(\mathbf{P}_{1/2}^\eta [\text{Cross}(R, R)] - \frac{1}{2} \right)^2 \right] = \text{Var} \left(\mathbf{P}_{1/2}^\eta [\text{Cross}(R, R)] \right) \leq \frac{1}{\varepsilon} R^{-\varepsilon}.$$

Nous avons pour notre part prouvé une version plus quantitative de ce résultat et en avons démontré un analogue pour des événements dégénérés et non monotones : les "événements à j bras". Nous renvoyons à la Section 6.2 pour ces résultats, qui nous ont notamment permis de montrer dans [V6] l'analogie suivant du Théorème 1.2.

Théorème 1.9 (Théorème 1.8 du Chapitre 6). *Il existe $\varepsilon > 0$ tel que, pour tout $p \geq 1/2$:*

$$\theta^{an}(p) \geq (p - 1/2)^{1-\varepsilon}.$$

Définissons maintenant les deux modèles de percolation de Voronoi dynamique auxquels nous sommes intéressés. L'un est inspiré par la dynamique indépendante introduite dans [HPS97] et l'autre par la dynamique conservative introduite dans [BGS13]. Considérons une configuration initiale de loi \mathbb{P}_p^{an} . Dans le premier modèle, les cellules de Voronoi n'évoluent pas au cours du temps mais leur couleur est rééchantillonnée à taux 1. Appelons ce modèle **percolation dynamique de Voronoi gelée**. Dans le deuxième modèle, la couleur des cellules n'évolue pas au cours du temps, mais chacun des points du processus η se déplace selon un processus de Lévy planaire (conditionnellement indépendant des autres processus de Lévy) dont la loi a été choisie au préalable, ce qui entraîne un changement de la géométrie des cellules. Appelons ce modèle **percolation de Voronoi mouvante**. La mesure \mathbb{P}_p^{an} étant invariante pour ces deux modèles, on peut définir la notion de temps exceptionnel comme plus haut. Nous avons démontré le résultat suivant :

Théorème 1.10 (Théorèmes 1.1 et 1.2 du Chapitre 7). *Plaçons-nous au point critique $p = 1/2$ et considérons la percolation dynamique de Voronoi gelée ou la percolation de Voronoi mouvante dans le cas d'un processus de Lévy α -stable avec α suffisamment petit. Dans les deux cas, il existe des temps exceptionnels avec une composante connexe noire non bornée.*

Tout comme pour le Théorème 1.6, nous laissons en question ouverte le cas des dynamiques à plus courte portée, notamment le cas $\alpha = 2$ correspondant au mouvement brownien.

Avant d'expliquer certaines idées derrière les différents résultats de cette thèse, retournons à l'étude de la percolation de Bernoulli et faisons notamment un détour par la notion d'**influence** qui est cruciale pour tous les chapitres de cette thèse.

2 Percolation de Bernoulli planaire et influences

2.1 Probabilités de croisement

Considérons les modèles de percolation par arêtes sur \mathbb{Z}^2 et de percolation par sites sur \mathcal{T} . Dans cette section, nous étudions les **probabilités de croisement** pour ces modèles, ce qui nous permettra d'énoncer une version de la conjecture d'universalité de la percolation planaire ainsi que des résultats clefs de la preuve que p_c vaut $1/2$. Nous avons déjà vu que, si $p = 1/2$, les probabilités de croisement de carrés (ou de losanges) valaient $1/2$, et ce à toutes les échelles. Mais que peut-on dire de la probabilité de croisement d'un rectangle topologique plus général, i.e. d'un quad ?

Définition 2.1. Un **quad** Q est un sous-ensemble du plan difféomorphe à un disque, avec la donnée de deux segments fermés S_1 et S_2 tracés sur sa frontière, disjoints, et de longueur non nulle. On appelle **croisement** de Q un chemin inclus dans Q reliant les deux segments distingués. Notons $\text{Cross}(Q)$ et $\text{Cross}^*(Q)$ les événements qu'il existe un croisement de Q par un chemin noir et par un chemin blanc respectivement.

Comme mentionné au début de cette introduction, on s'attend à ce que les modèles définis jusqu'à présent admettent une même limite d'échelle. Cependant, l'existence d'une telle limite n'est connue que pour la percolation par sites sur \mathcal{T} . Ici, nous entendons par existence de limite d'échelle l'existence d'une limite d'échelle des probabilités de croisement de tout quad. Le fait que la percolation par sites sur \mathcal{T} admette une limite d'échelle a été démontré par Smirnov (voir aussi la Section 8 où nous mentionnons des résultats de limite d'échelle plus forts mais reposant tous sur le théorème de Smirnov) :

Théorème 2.2 ([Smi01]). *Considérons le modèle de percolation par sites sur \mathcal{T} et un quad Q . La quantité $\mathbb{P}_{1/2}[\text{Cross}(RQ)]$ converge quand R tend vers $+\infty$. De plus, la limite est **invariante conforme** dans le sens que, si Q' est un quad obtenu en appliquant une transformation conforme à Q , la limite de $\mathbb{P}_{1/2}[\text{Cross}(RQ')]$ est égale à celle de $\mathbb{P}_{1/2}[\text{Cross}(RQ)]$. D'après le théorème de Riemann, il suffit ainsi, pour connaître les limites, de les calculer dans le cas où Q est un triangle équilatéral (appelons a, b, c ses sommets) dont les segments distingués sont $[a, b]$ et $[c, d]$ où $d \in]a, c[$. Dans ce cas, la limite est égale à $|c - d|/|a - b|$.*

Lorsque Q est un rectangle, on connaît une formule explicite de la limite de $\mathbb{P}_{1/2}[\text{Cross}(RQ)]$, qui avait été conjecturée par Cardy [Car92] en utilisant des outils de la théorie conforme des champs. Carleson en a déduit la formule dans le cas d'un triangle équilatéral. On appelle **propriété d'universalité** la conjecture qui affirme que le Théorème 2.2 est vrai pour une grande classe de réseaux au point critique (essentiellement pour tous les réseaux transitifs planaires plongés "convenablement" dans le plan). De nombreuses simulations numériques (voir par exemple [LPPSA92, LPSA94]) confortent cette conjecture. Voir [Bef08] pour des pistes dans le but d'adapter la preuve de Smirnov à d'autres modèles de percolation (et notamment dans le but de comprendre ce que plonger "convenablement" signifie pour la percolation). Comme autre résultat allant dans le sens de la propriété d'universalité, on peut citer le théorème d'Ahlberg, Griffiths, Morris et Tassion qui permet de comparer des modèles de percolation sur différents pavages du plan (voir le Théorème 6.2). Si on adopte le point de vue de la Section 8, la sensibilité au bruit de la percolation planaire (voir la Section 7.1) est aussi un signe en faveur de l'universalité. Terminons ce paragraphe ici au risque de ne pas citer d'autres travaux importants liés à l'universalité de la percolation planaire.

Dans le cas de la percolation par arêtes sur \mathbb{Z}^2 , si l'on ne sait pas que les probabilités de croisement convergent, le théorème suivant, démontré indépendamment par Russo et par Seymour et Welsh, implique toutefois que ces probabilités ne sont pas dégénérées.

Théorème 2.3 ([Rus78, SW78]). *Considérons la percolation par arêtes sur \mathbb{Z}^2 ou la percolation par sites sur \mathcal{T} . Pour tout quad Q , il existe une constante $c = c(Q) \in]0, 1[$ telle que, pour tout R assez grand :*

$$c \leq \mathbb{P}_{1/2}[\text{Cross}(RQ)] \leq 1 - c.$$

Par auto-dualité, le même résultat est vrai pour les événements $\text{Cross}^(RQ)$.*

Nous renvoyons par exemple à [Gri99] et [BR06b] pour des preuves de ce résultat. Dans cette thèse, nous étudierons une preuve de ce théorème due à Tassion qui permet de le généraliser à une grande famille de modèles. Le Théorème 2.3 (souvent appelé théorème de RSW) permet de démontrer le résultat dû à Harris i.e. $\theta(1/2) = 0$.

Une preuve que $\theta(1/2) = 0$. Pour expliquer comment montrer ce résultat à partir du théorème de RSW, introduisons quelques notations :

- Pour tout $R \in]0, +\infty[$, notons $\{0 \leftrightarrow R\}$ l'événement qu'il existe un chemin ouvert reliant 0 à $\partial[-R, R]^2$. Notons aussi $\theta_R(p) = \mathbb{P}_p[0 \leftrightarrow R]$.
- Si $\rho_1, \rho_2 \in]0, +\infty[$, notons $\text{Cross}(\rho_1, \rho_2) = \text{Cross}(Q)$ et $\text{Cross}^*(\rho_1, \rho_2) = \text{Cross}^*(Q)$ où $Q = [0, \rho_1] \times [0, \rho_2]$ (avec les côtés gauche et droit comme segments distingués).

L'égalité $\theta(1/2) = 0$ est une conséquence du Théorème 2.3 et d'une inégalité de corrélation : l'**inégalité de Fortuin-Kasteleyn-Ginibre (FKG)**. Celle-ci s'énonce de la façon suivante (nous renvoyons par exemple à [Gri99] pour une preuve). Considérons deux événements A et B de la tribu produit sur $\{-1, 1\}^{\mathcal{I}}$ qui sont tous deux croissants ou tous deux décroissants pour l'ordre donné par $\omega \leq \omega'$ si $\omega_i \leq \omega'_i$ pour tout $i \in \mathcal{I}$. Alors, pour tout $p \in [0, 1]$ on a :

$$\mathbb{P}_p[A \cap B] \geq \mathbb{P}_p[A] \mathbb{P}_p[B]. \quad (2.1)$$

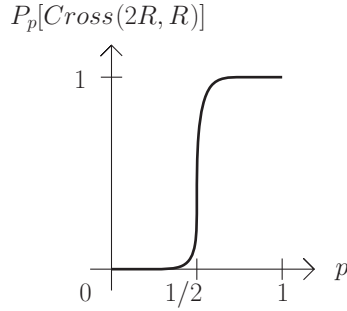

FIGURE 2.3 – Transition de phase pour la probabilité de croisement.

2.2 Influences

2.2.1 Les influences et l'inégalité $p_c \leq 1/2$

La notion d'influence est centrale dans cette thèse. Une des raisons est qu'elle apparaît de façon naturelle dans l'étude des transitions de phase, mais nous verrons aussi cette notion apparaître pour d'autres raisons. Selon le contexte, nous utiliserons différentes définitions d'influences ; un des points communs entre toutes celles-ci est que la notion de points pivots y est intimement liée.

Définition 2.5. Soit $n \in \mathbb{N}^*$ et soit Ω_n l'hypercube de dimension n i.e. $\Omega_n = \{-1, 1\}^n$. Étant donné $A \subseteq \Omega_n$, $i \in \{1, \dots, n\}$ et $\omega \in \Omega_n$, nous notons $\omega^i \in \{-1, 1\}^n$ la configuration obtenue à partir de ω en changeant la valeur de la coordonnée i . Le point i est dit **pivot** pour A et ω si $\mathbb{1}_A(\omega^i) \neq \mathbb{1}_A(\omega)$. Nous notons $\mathbf{Piv}_i(A) \subseteq \Omega_n$ l'événement “ i est pivot pour A ”. Par ailleurs, étant donné un paramètre $p \in [0, 1]$, nous notons $\mathbb{P}_p^n = (p\delta_1 + (1-p)\delta_{-1})^{\otimes n}$. L'**influence** de i sur A au paramètre p est la quantité $I_i^p(A) := \mathbb{P}_p^n[\mathbf{Piv}_i(A)]$. Cette terminologie est issue des travaux de Ben-Or et Linial [BOL89].

Une preuve que $p_c \leq 1/2$. Utilisons la notion d'influence pour montrer que $p_c \leq 1/2$. Rappelons que nous voulons montrer que la fonction $p \mapsto \mathbb{P}_p[\text{Cross}(2R, R)]$ ressemble à celle dessinée sur la Figure 2.3. Autrement dit, notre but est de montrer que cette fonction ressemble à une fonction de Heaviside. Nous allons donner une première preuve de ce résultat en nous reposant sur un résultat dû à Russo (qui est postérieur au résultat de Kesten, ce dernier a utilisé des méthodes plus géométriques - voir aussi dans [Tas14] une preuve géométrique due à Beffara et Tassion). Ce résultat de Russo repose sur une analogie avec la loi du 0-1 de Kolmogorov. Considérons l'espace produit $\{-1, 1\}^{\mathbb{I}}$ et utilisons les mêmes notations que dans la Définition 2.5 (il n'était pas utile dans cette définition que l'espace produit soit de dimension finie). La loi du 0-1 de Kolmogorov implique que, si A est un ensemble croissant de la tribu produit et si $\mathbf{Piv}_i(A) = \emptyset$ pour tout i , alors $p \mapsto \mathbb{P}_p[A]$ est une fonction de Heaviside, i.e. cette fonction vaut 0 sur un intervalle $[0, p_c[$ et 1 sur un intervalle $]p_c, 1]$ pour un certain $p_c \in [0, 1]$. Russo a démontré une **loi du 0-1 “approximative”** :

Théorème 2.6 ([Rus82]). *Soit $\varepsilon > 0$. Il existe $\delta = \delta(\varepsilon) > 0$ tel que, pour tout $n \in \mathbb{N}$ et tout ensemble croissant $A \subseteq \Omega_n$ tels que $\max_{i \in \{1, \dots, n\}, p \in [0, 1]} I_i^p(A) \leq \delta$, la fonction $p \mapsto \mathbb{P}_p^n[A]$ est à distance ε (pour la norme infinie, disons) d'une fonction de Heaviside.*

L'idée générale de la preuve de ce résultat est la suivante : Supposons qu'il existe un paramètre $p_c \in]0, 1[$ tel $\mathbb{P}_{p_c}^n[A]$ n'est ni très proche de 0 ni très proche de 1 et considérons la mesure de probabilité $\mathbb{P}_{p_c}^n[\cdot | A]$. Si l'influence de chacun des points $i \in \{1, \dots, n\}$ est suffisamment petite, on peut s'attendre à ce que le conditionnement par A ne modifie pas beaucoup la mesure de probabilité, dans le sens qu'il existe un couplage (ω_1, ω_2) des mesures de probabilité $\mathbb{P}_{p_c}^n[\cdot | A]$ et $\mathbb{P}_{p_c+\varepsilon}^n$ tel que $\mathbb{P}[\omega_2 \geq \omega_1] \geq 1 - \varepsilon$, ce qui permet de conclure que $\mathbb{P}_{p_c+\varepsilon}^n[A] \geq \mathbb{P}_{p_c}^n[A | A] - \varepsilon = 1 - \varepsilon$.

Comme expliqué dans [Rus82], cette intuition est correcte et donne une preuve rapide lorsque la probabilité qu'aucun point soit pivot est proche de 1, mais la preuve demande plus de travail dans le cas général.

Appliquons le Théorème 2.6 au modèle de percolation : Grâce au Théorème 2.3, nous savons que $\mathbb{P}_{1/2}[\text{Cross}(2R, R)]$ est uniformément éloigné de 0 et 1. Par conséquent, si nous montrons que $\max_{i,p} I_i^p(\text{Cross}(2R, R))$ converge vers 0 quand R tend vers $+\infty$, nous obtiendrons que $p \mapsto \mathbb{P}_p[\text{Cross}(2R, R)]$ est asymptotiquement proche d'une fonction Heaviside centrée en $1/2$. Cela impliquera alors que $p_c \leq 1/2$ - et donc terminera la preuve du Théorème 1.1 - grâce au résultat suivant (dont on pourra par exemple consulter la preuve dans [BR06b]) :

Lemme 2.7 (Critère de taille finie). *Il existe $c > 0$ et $\varepsilon_0 > 0$ tels que, pour tout $r_0 \in [1, +\infty[$ et tout $p \in [0, 1]$, si $\mathbb{P}_p[\text{Cross}(2r_0, r_0)] \geq 1 - \varepsilon_0$ alors :*

$$\forall R \in [r_0, +\infty[, \mathbb{P}_p[\text{Cross}(2R, R)] \geq 1 - \frac{1}{c} \exp(-cR).$$

En particulier, les hypothèses du Lemme 2.4 sont satisfaites et $\theta(p) > 0$.

Preuve du Théorème 1.1. Comme expliqué ci-dessus, il ne nous reste plus qu'à montrer que $\max_{i,p} I_i^p(\text{Cross}(2R, R)) \xrightarrow{R \rightarrow +\infty} 0$. Remarquons tout d'abord que, pour tout $i \in \mathcal{I}$, $\mathbf{Piv}_i(\text{Cross}(2R, R))$

est l'événement qu'il existe quatre chemins monochromatiques alternant entre le noir et blanc comme sur la Figure 2.4). En particulier, quelle que soit la position de i , il existe un chemin noir et un chemin blanc de i jusqu'au bord de la boîte $i + [-R/2, R/2]^2$. Comme nous l'avons observé à la fin de la Section 2.1, la probabilité qu'un tel chemin noir ou blanc existe est polynomialement petite si $p = 1/2$. Or, si $p < 1/2$, la probabilité qu'il existe un tel chemin noir est plus petite qu'au paramètre $1/2$, et si $p > 1/2$ c'est le cas de la probabilité de l'existence d'un tel chemin blanc. Par conséquent, il existe $c > 0$ tel que, pour tout $i \in \mathcal{I}$ et tout $p \in [0, 1]$:

$$I_i^p(\text{Cross}(2R, R)) \leq \frac{1}{c} R^{-c},$$

ce qui implique en particulier que $\max_{i,p} I_i^p(\text{Cross}(2R, R)) \xrightarrow{R \rightarrow +\infty} 0$. □

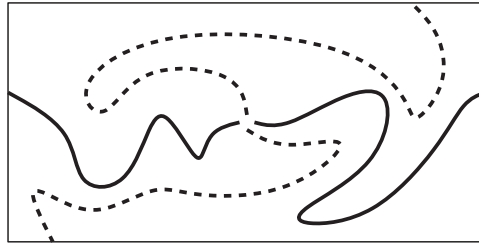

FIGURE 2.4 – Un événement pivot pour $\text{Cross}(2R, R)$.

Notons que (par auto-dualité) il n'est pas difficile de déduire de la propriété de décroissance exponentielle du Lemme 2.7 que, dans la phase sous-critique, la probabilité de $\{0 \leftrightarrow R\}$ tend exponentiellement vite vers 0. Associé aux résultats de la fin de la Section 2.1, ceci implique la description quantitative de la transition de phase suivante (voir la Figure 2.5 pour une illustration de ce théorème) :

Théorème 2.8 ([Kes80]). *On a la description suivante de la transition de phase :*

- Si $p < 1/2$, il existe $c = c(p) \in]0, +\infty[$ telle que $\theta_R(p) \leq \frac{1}{c} \exp(-cR)$.
- Si $p = 1/2$, il existe $c' \in]0, +\infty[$ telle que $\theta_R(p) \leq \frac{1}{c'} R^{-c'}$.

- Si $p > 1/2$, alors $\theta(p) > 0$.

Remarque 2.9. Il n'est pas difficile de montrer que $\theta_R(p)$ admet aussi des bornes inférieures exponentielle et polynomiale dans la phase sous-critique et critique respectivement.

La propriété de décroissance exponentielle de θ_R dans la phase sous-critique est connue en toute dimension $d \geq 2$ (mais avec des preuves très différentes de celle expliquée ci-dessus dans le cas planaire). La preuve du résultat en toute dimension remonte aux travaux d'Aizenman et Barsky [AB87]. On pourra aussi consulter [Men86] et la courte preuve de Duminil-Copin et Tassion [DCT15].



FIGURE 2.5 – Les plus grands clusters dans une fenêtre de grande taille R dans les phases sous-critique, critique et sur-critique. Dans la phase sous-critique, le plus grand cluster est de taille $\log(R)$ alors que dans la phase sur-critique, un unique cluster envahit tout l'espace. Au paramètre critique, il n'y a pas de cluster infini ; toutefois, il y existe typiquement des clusters dont la taille est de l'ordre de R et on peut montrer (en étudiant par exemple les “événements à 4 bras” définis en Section 5 et leur lien avec les points pivots) que les clusters ont une apparence fractale et ont tendance à se toucher en de très nombreux points.

2.2.2 Quantification de la transition de phase

Poursuivons l'étude des influences en présentant des méthodes permettant de prouver des estimations quantitatives sur les transitions de phase. Nous verrons par exemple que **la taille de la “fenêtre presque critique” de la percolation de Bernoulli est polynomiale**. Plus précisément :

Proposition 2.10. *Il existe $c \in]0, +\infty[$ tel que :*

$$\mathbb{P}_{1/2+R^{-c}} [\text{Cross}(2R, R)] \xrightarrow{R \rightarrow +\infty} 1.$$

Cependant, pour tout $C > 1$:

$$\mathbb{P}_{1/2+R^{-C}} [\text{Cross}(2R, R)] - \mathbb{P}_{1/2} [\text{Cross}(2R, R)] \xrightarrow{R \rightarrow +\infty} 0.$$

La formule de Russo, que nous énonçons maintenant, est un résultat clef dans l'étude des transitions de phase (cette formule différentielle était déjà au cœur de la preuve du Théorème 2.6).

Lemme 2.11 ([Rus81]). *Soit $n \in \mathbb{N}^*$ et soit $A \subseteq \Omega_n$ un ensemble croissant. On a :*

$$\frac{d}{dp} \mathbb{P}_p^n [A] = \sum_{i=1}^n I_i^p(A) = \mathbb{E}_p^n [\text{nombre de points pivots pour } A].$$

Démonstration. Pour les détails de la preuve, nous renvoyons par exemple à [Gri99], [BR06b] ou [GS14]. L'idée est de considérer la fonction $(p_1, \dots, p_n) \mapsto \mathbb{P}_{(p_1, \dots, p_n)}^n [A]$ au point $(p_1, \dots, p_n) = (p, \dots, p)$ et de remarquer que la dérivée partielle dans la $i^{\text{ème}}$ direction est $I_i(A)$, ce qui est assez naturel car la $i^{\text{ème}}$ dérivée partielle donne une mesure de l'importance de la coordonnée i sur la cette fonction. On peut alors conclure en appliquant la règle de la chaîne. \square

Considérons la quantité :

$$\frac{\sum_{i=1}^n I_i^p(A)}{\mathbb{P}_p^n [A] (1 - \mathbb{P}_p^n [A])}. \quad (2.3)$$

Nous allons essayer de montrer que, pour les événements qui nous intéressent, cette quantité est grande en tout paramètre p . Nous obtiendrons ainsi que, en tout paramètre p , soit $\frac{d}{dp} \mathbb{P}_p^n [A] = \sum_{i=1}^n I_i^p(A)$ est grande, soit $\mathbb{P}_p^n [A]$ est proche de 0, soit $\mathbb{P}_p^n [A]$ est proche de 1, ce qui est bien le type de résultat que nous voulons montrer.

Une première idée dans la recherche d'une borne inférieure pour (2.3) est d'utiliser l'**inégalité de Poincaré discrète** (qui est l'analogue de l'inégalité de Poincaré continue si l'on voit les influences comme des gradients et si l'on remarque que $\text{Var}_p^n(\mathbf{1}_A) = \mathbb{P}_p^n [A] (1 - \mathbb{P}_p^n [A])$). Il est facile de démontrer cette inégalité en révélant une par une les coordonnées ω_i , ce qui fera intervenir la somme des influences, voir par exemple le Chapitre 1 de [GS14].

Proposition 2.12 (Inégalité de Poincaré discrète). *Soient $n \in \mathbb{N}^*$ et $A \subseteq \Omega_n$. Pour tout $p \in [0, 1]$, on a :*

$$\sum_{i=1}^n I_i^p(A) \geq \frac{1}{p(1-p)} \mathbb{P}_p^n [A] (1 - \mathbb{P}_p^n [A]).$$

L'inégalité de Poincaré donne donc une borne inférieure uniforme à la quantité (2.3). Cependant, cela ne nous suffit pas car notre but est de montrer que cette quantité est très grande. Nous présentons ci-dessous quelques améliorations de l'inégalité de Poincaré. La première est le **théorème de Kahn-Kalai-Linial (KKL)** qui réconcilie l'idée derrière le Théorème 2.6 (i.e. l'idée qu'on a une transition de phase si toutes les influences sont petites) et l'idée derrière la formule de Russo (i.e. l'idée que si le nombre de pivots est grand en espérance, alors on a une transition de phase) :

Théorème 2.13 ([KKL88] pour $p = 1/2$, [BKK⁺92] pour tout p). *Il existe une constante $c > 0$ telle que, pour tous $n \in \mathbb{N}^*$, $A \subseteq \Omega_n$ et $p \in [0, 1]$:*

$$\sum_{i=1}^n I_i^p(A) \geq c \mathbb{P}_p [A] (1 - \mathbb{P}_p [A]) \log \left(\frac{1}{\max_{i=1}^n I_i^p(A)} \right).$$

La preuve du théorème de KKL repose sur des estimations d'hypercontractivité et la décomposition de Fourier des fonctions booléennes (voir la Section 7.2 pour la définition de cette décomposition). Nous renvoyons par exemple à [GS14] pour une preuve de ce résultat. Remarquons par ailleurs que le Théorème 2.13 et la formule de Russo impliquent le Théorème 2.6. On consultera [Tal94] pour une généralisation des Théorèmes 2.13 et 2.6.

Appliquons maintenant⁴ le Théorème 2.13 et la formule de Russo à l'événement $\text{Cross}(2R, R)$. Si on se souvient que le maximum des influences décroît polynomialement vite (voir la preuve des Théorèmes 1.1 et 2.8), on obtient facilement que :

$$\frac{\frac{d\mathbb{P}_p[\text{Cross}(2R, R)]}{dp}}{\mathbb{P}_p[\text{Cross}(2R, R)] (1 - \mathbb{P}_p[\text{Cross}(2R, R)])} \geq c' \log(R),$$

⁴L'idée d'utiliser une inégalité de KKL pour calculer un point critique vient des travaux de Bollobás et Riordan, voir par exemple [BR06a, BR06d]. Pour d'autres relations entre le théorème KKL et les transitions de phase, on peut citer [FK96]; dans le cas particulier de la percolation on peut aussi citer [GG06, GG11, BDC12, DCRT16, Rod15].

pour une certaine constante $c' > 0$. Il n'est pas difficile d'en déduire qu'il existe $c'' > 0$ telle que, pour tout $p > 1/2$:

$$\mathbb{P}_p [\text{Cross}(2R, R)] \geq 1 - \frac{1}{c''} R^{-c''(p-1/2)}. \quad (2.4)$$

Notons que cela implique que les hypothèses du Lemme 2.4 sont satisfaites, donc permet d'obtenir que $p_c \leq 1/2$ sans utiliser le Lemme 2.7.

Présentons maintenant une autre inégalité améliorant l'inégalité de Poincaré : l'**inégalité de O'Donnell-Saks-Schramm-Servedio (OSSS)**. Dans le cas de la percolation planaire, elle améliore aussi les estimations données par le théorème KKL et implique que la fenêtre presque critique est de taille polynomiale (alors que l'approche ci-dessus ne donne qu'une borne logarithmique). Cependant, elle n'implique pas le Théorème 2.6 en général. L'idée de la preuve est de révéler les coordonnées ω_i une par une, mais - contrairement à la preuve qui donnerait l'inégalité de Poincaré - de **les révéler dans un ordre aléatoire** bien choisi. Nous énonçons cette inégalité dans un cadre plus général car nous en aurons besoin dans la Section 3.2. Donnons-nous un espace de probabilité (E, \mathcal{E}, μ) , un entier $n \in \mathbb{N}^*$, et définissons l'**influence avec retraitage** d'une coordonnée $i \in \{1, \dots, n\}$ sur un événement $A \in \mathcal{E}^{\otimes n}$ comme suit :

$$I_i^{\mu, ret}(A) = \mathbb{P} \left[\mathbf{1}_A(\omega^{(i)}) \neq \mathbf{1}_A(\omega) \right], \quad (2.5)$$

où $\omega \sim \mu^{\otimes n}$ et $\omega^{(i)}$ est obtenu à partir de ω en rééchantillonnant la coordonnée i (toujours selon la loi μ). Notons que si $E = \{-1, 1\}$ et $\mu = \mu_p = p\delta_1 + (1-p)\delta_{-1}$, on a :

$$I_i^{\mu_p, ret}(A) = 2p(1-p)I_i^p(A).$$

Nous avons aussi besoin de la notion d'algorithme \mathcal{A} déterminant un événement $A \in \mathcal{E}^{\otimes n}$. C'est une procédure qui révèle étape par étape les coordonnées d'une configuration $\omega \in E^n$ de telle façon que : i) la première coordonnée est choisie aléatoirement et indépendamment du reste de la procédure et de ω , ii) le choix d'une coordonnée à révéler ne se fait qu'en fonction des coordonnées déjà révélées et de la valeur de ω en ces coordonnées, iii) la procédure s'arrête lorsque l'on connaît $\mathbf{1}_A(\omega)$. On appelle "revealment" de i pour \mathcal{A} , noté $\delta_i^\mu(\mathcal{A})$, la probabilité sous $\mu^{\otimes n}$ que la $i^{\text{ème}}$ coordonnée soit révélée par \mathcal{A} . L'inégalité d'OSSS est le résultat suivant :

Théorème 2.14 ([OSSS05]). *Pour tout $n \in \mathbb{N}^*$, tout $A \in \mathcal{E}^{\otimes n}$, et pour tout algorithme \mathcal{A} qui détermine A :*

$$\sum_{i=1}^n \delta_i^\mu(\mathcal{A}) I_i^{\mu, ret}(A) \geq \mu(A)(1 - \mu(A)).$$

L'idée d'appliquer l'inégalité OSSS à des modèles de percolation vient des travaux de Duminil-Copin, Raoufi et Tassion [DCRT17b, DCRT17a, DCRT18]. Appliquons cette inégalité à l'événement $\text{Cross}(2R, R)$. L'idée générale dans le choix d'un algorithme est de découvrir progressivement des composantes noires ou blanches⁵ de telle façon que la probabilité qu'un élément $i \in \mathcal{I}$ soit révélé soit de l'ordre de la probabilité qu'il y a un chemin noir (si $p \leq 1/2$) ou blanc (si $p \geq 1/2$) de i jusqu'à $i + \partial[-R, R]^2$. Comme cette probabilité décroît polynomialement vite (et ce uniformément en p), l'inégalité d'OSSS implique alors que :

$$\sum_i I_i^{\mu_p, ret}(\text{Cross}(2R, R)) \geq cR^c \mathbb{P}_p [\text{Cross}(2R, R)] (1 - \mathbb{P}_p [\text{Cross}(2R, R)]),$$

⁵Plus précisément, on pourra par exemple dans le cas $p \geq 1/2$ choisir uniformément un segment horizontal croisant le rectangle et découvrir les composantes blanches intersectant ce segment. Dans le cas $p \leq 1/2$, on pourra choisir uniformément un segment vertical croisant le rectangle et découvrir les composantes noires l'intersectant.

pour une certaine constante $c > 0$. Il n'est pas difficile, en associant cette inégalité à la formule de Russo, de montrer qu'il existe une constante $c' > 0$ telle que, pour tout $p > 1/2$:

$$\mathbb{P}_p [\text{Cross}(2R, R)] \geq 1 - \frac{1}{c'} \exp(-c'(p - 1/2)R^{c'}). \quad (2.6)$$

De même qu'avec l'inégalité KKL, cela implique que les hypothèses du Lemme 2.4 sont vraies sans utiliser le Lemme 2.7. On peut par ailleurs déduire de (2.6) que la fenêtre presque critique est de taille au plus polynomiale, qui est la première partie de la Proposition 2.10.

2.2.3 Miscellaneous

Nous terminons la Section 2.2 avec la preuve de la deuxième partie de la Proposition 2.10 et une généralisation de l'inégalité de Poincaré.

Démonstration de la deuxième partie de la Proposition 2.10. L'idée est de montrer que, pour tout $\varepsilon > 0$, il existe une constante $C' = C'(\varepsilon) < +\infty$ telle que, pour tout $n \in \mathbb{N}^*$ et tout ensemble croissant $A \subseteq \Omega_n = \{-1, 1\}^n$, on a :

$$\forall p \in [\varepsilon, 1 - \varepsilon], \sum_{i=1}^n I_i^p(A) \leq C' \sqrt{n}. \quad (2.7)$$

Si on associe cette inégalité à la formule de Russo on obtient que (si $\delta > 0$ et $p \in [\varepsilon + \delta, 1 - (\varepsilon + \delta)]$) :

$$\mathbb{P}_{p+\delta}[A] - \mathbb{P}_p[A] \leq C' \delta \sqrt{n}, \quad (2.8)$$

ce qui implique le résultat voulu. Afin de montrer (2.7), définissons les fonctions :

$$\chi_i^p : \omega \mapsto \sqrt{\frac{1-p}{p}} \mathbb{1}_{\omega_i=1} - \sqrt{\frac{p}{1-p}} \mathbb{1}_{\omega_i=-1}.$$

Ces fonctions forment une famille orthonormée pour le produit scalaire L^2 . Par ailleurs, A étant croissant, on peut facilement montrer que :

$$\mathbb{E}_p^n [\chi_i^p(\omega) \mathbb{1}_A(\omega)] = \sqrt{p(1-p)} I_i^p(A).$$

Associée à l'inégalité de Cauchy-Schwarz, cette identité implique que :

$$\sum_{i=1}^n I_i^p(A) \leq \sqrt{n} \sqrt{\sum_{i=1}^n \frac{\mathbb{E}_p^n [\chi_i^p(\omega) \mathbb{1}_A(\omega)]^2}{p(1-p)}} \leq \sqrt{n} \sqrt{\frac{\mathbb{E}_p^n [\mathbb{1}_A^2]}{p(1-p)}} \leq \sqrt{\frac{n}{p(1-p)}}.$$

□

La preuve de (2.7) donne un autre point de vue sur les influences : connaître les influences, c'est connaître la projection de $\mathbb{1}_A$ sur l'espace engendré par les fonctions χ_i^p . Or cet espace est de dimension n alors que l'espace $L^2(\Omega_n, \mathbb{P}_p^n)$ est de dimension 2^n ! Afin d'obtenir plus d'informations, nous étudierons la décomposition de A sur une base de fonctions orthonormales contenant les fonctions χ_i^p : la base de Fourier (voir la Section 7.2).

Énonçons maintenant l'inégalité d'Efron-Stein, qui est une généralisation de l'inégalité de Poincaré (et dont la preuve en est très proche, voir par exemple [BLM13]). Nous verrons que cette proposition est utile pour avoir une intuition derrière des résultats de percolation en milieu aléatoire.

Proposition 2.15. *Soient (E, \mathcal{E}, μ) un espace de probabilité et $n \in \mathbb{N}^*$. Soient de plus ω une variable aléatoire de loi $\mu^{\otimes n}$. Pour tout $i \in \{1, \dots, n\}$, notons $\omega^{(i)}$ la configuration obtenue à partir de ω en rééchantillonnant la coordonnée i . Pour toute fonction mesurable $f : (E^n, \mathcal{E}^{\otimes n}) \rightarrow \mathbb{R}$, on a :*

$$\sum_{i=1}^n \mathbb{E} \left[\left(f(\omega) - f(\omega^{(i)}) \right)^2 \right] \geq 2 \text{Var}(f(\omega)).$$

2.2.4 Des notations

À partir de maintenant, nous utilisons les notations suivantes : (a) $O(1)$ est une fonction bornée à valeurs strictement positive, (b) $\Omega(1)$ est une fonction positive telle que $\inf \Omega(1) > 0$, (c) si f et g sont deux fonctions à valeurs positives, $f \asymp g$ signifie $\Omega(1)f \leq g \leq O(1)f$.

3 La percolation de lignes nodales

Dans la Section 1.2, nous avons défini le modèle de percolation de Bargmann-Fock et avons énoncé un analogue du théorème de Kesten (voir le Théorème 1.4) ; rappelons que nous notons Υ le champ de Bargmann-Fock. Avant d’expliquer des idées derrière ce théorème - et afin d’avoir un modèle auquel comparer le champ de Bargmann-Fock - définissons un autre champ gaussien planaire : l’**onde planaire aléatoire** (voir la Figure 3.1).

Définition 3.1. Le modèle d’**onde planaire aléatoire**, que nous noterons Φ dans cette introduction, est un champ gaussien planaire centré dont la covariance est donnée par :

$$\mathbb{E}[\Phi(x)\Phi(y)] = J_0(|x - y|),$$

où J_0 est la fonction de Bessel⁶ d’ordre 0.

On peut montrer que presque sûrement la fonction $x \mapsto \Phi(x)$ est lisse et vérifie $\Delta\Phi = \Phi$.

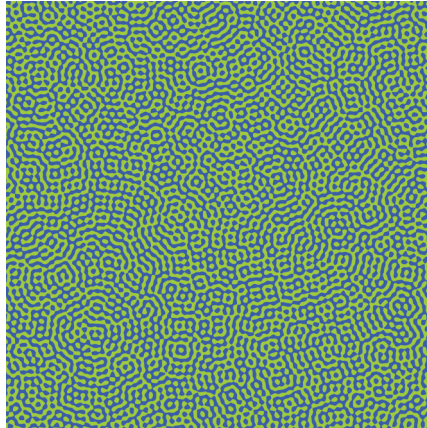

FIGURE 3.1 – Une onde planaire aléatoire, simulation par Vincent Beffara. L’ensemble bleu est l’ensemble où le champ est positif ; l’ensemble vert est celui où il est négatif.

Tout comme dans la Section 1.2, nous renvoyons aux notes de lecture [Ana15] (et aux références que l’on peut y trouver) pour des résultats sur des quantités telles que le volume du lieu des zéros ou le nombre de lignes nodales de modèles associés aux ondes planaires aléatoires. Énonçons tout de même un résultat dû à Nazarov et Sodin, qui est un théorème limite sur le nombre de lignes nodales (et est vrai pour une grande classe de champs gaussiens et en dimension quelconque) :

Théorème 3.2 ([NS16]). *Notons f_n le champs Υ ou Φ restreint à $[-n, n]^2$. Il existe une constante $c \in]0, +\infty[$ (dépendant du modèle) telle que, presque sûrement et en norme L^1 , le nombre de lignes nodales de f_n divisé par n^2 converge vers c .*

⁶La fonction de Bessel d’ordre zéro $J_0 : x \in \mathbb{R}_+ \mapsto \mathbb{R}$ vaut 1 en 0, oscille “de façon sinusoïdale” autour de zéro, et décroît vers 0 en $+\infty$ à vitesse racine de x .

Dans cette thèse, nous nous intéressons au lien entre ces modèles et la percolation. Les résultats que nous avons obtenus dans ce contexte en constituent la Partie I. Étant donné un champ gaussien (qui est pour le moment le champ de Bargmann-Fock Υ ou l'onde plane aléatoire Φ) et un niveau $\ell \in \mathbb{R}$, colorions en bleu les points où le champ est plus grand que $-\ell$ et en vert les points où il est plus petit que $-\ell$. Si Q est un quad, notons $\text{Cross}_\ell(Q)$ l'événement de croisement de Q par un chemin bleu. Si Q est le rectangle $[0, \rho_1] \times [0, \rho_2]$ dont les segments distingués sont les côtés gauche et droit, notons $\text{Cross}_\ell(\rho_1, \rho_2) = \text{Cross}_\ell(Q)$. Commençons par les observations suivantes :

- Comme remarqué en Section 1.2, le modèle de percolation de lignes nodales possède des propriétés d'auto-dualité au niveau $\ell = 0$.
- La fonction de covariance de Υ est positive, ce qui implique une inégalité de type FKG, mais ce n'est pas le cas de Φ . Plus précisément, on a le résultat suivant dû à Pitt (qui s'applique aussi aux événements de croisement par discrétisation) :

Théorème 3.3 ([Pit82]). *Soit $(X_k)_{1 \leq k \leq n}$ un vecteur gaussien de dimension n . Les deux propriétés suivantes sont équivalentes :*

- Pour tous $i, j \in \{1, \dots, n\}$, $\mathbb{E}[X_i X_j] \geq 0$.
- Pour tous ensembles boréliens croissants $A, B \subseteq \mathbb{R}^n$, on a :

$$\mathbb{P}[X \in A \cap B] \geq \mathbb{P}[X \in A] \mathbb{P}[X \in B].$$

- La fonction de corrélation de Υ décroît très vite (plus qu'exponentiellement vite). Ceci suggère que ce modèle possède des propriétés de "quasi-indépendance" le rapprochant d'un coloriage du plan "vraiment indépendant" comme celui de la percolation de Bernoulli. Cependant, cette propriété n'est pas aussi claire qu'à première vue. En effet, le champ étant analytique, Υ est mesurable par rapport à $\Upsilon|_D$ pour tout ouvert $D \subseteq \mathbb{R}^2$. Même si l'on ne s'intéresse qu'aux lignes nodales le modèle est **très rigide** : chaque ligne nodale est fonction de n'importe quel segment inclus dans celle-ci. La fonction de corrélation de Φ , quant à elle, décroît beaucoup moins vite vers 0 (à vitesse racine carrée). Nous renvoyons à la Section 3.1 pour des résultats de quasi-indépendance.

Ces trois observations peuvent suggérer que (si on oublie pour le moment la rigidité analytique !) le modèle de coloriage aléatoire défini à partir de Υ est très proche de la percolation de Bernoulli. A priori, on s'attendrait à ce stade que ce ne soit pas le cas du modèle défini à partir de Φ . En fait - pour des raisons que nous essaierons d'expliquer plus bas - on peut s'attendre à ce que ces modèles soient tous deux "dans la même classe d'universalité" que la percolation de Bernoulli, par exemple dans le sens suivant :

Conjecture 3.4. *Le théorème d'invariance conforme - i.e. le Théorème 2.2 - est vrai pour ces deux modèles de coloriage aléatoire au niveau $\ell = 0$.*

Cette conjecture a en fait en premier lieu été énoncée pour les ondes planaires aléatoires. L'heuristique, par Bogomolny et Schmit [BS02], repose sur le fait que le coloriage aléatoire issu de ce modèle a une "structure de réseau" (comme peut le suggérer la Figure 3.1). On pourra aussi consulter [BDS07].

Pour mieux comprendre les idées derrière cette conjecture, élargissons notre point de vue et considérons une classe de champs gaussiens planaires dont on s'attend que certains appartiennent à la classe d'universalité de la percolation et d'autres non. Pour cela, donnons-nous un paramètre $\alpha \in]0, +\infty[$ et considérons un champ gaussien planaire centré Ψ^α tel que :

- Ce champ est invariant par n'importe quelles translations, rotations et par symétries.

- La fonction $x \mapsto \Psi^\alpha(x)$ est presque sûrement lisse.
- La fonction de covariance de Ψ^α est à valeurs positives.
- La fonction de covariance de Ψ^α décroît polynomialement vite vers 0 avec exposant $\alpha \in]0, +\infty[$, i.e. il existe $c \in]0, 1]$ telle que, pour tous $x, y \in \mathbb{R}^2$ vérifiant $|x - y| \geq 1$:

$$c|x - y|^{-\alpha} \leq \mathbb{E}[\Psi^\alpha(x)\Psi^\alpha(y)] \leq \frac{1}{c}|x - y|^{-\alpha}.$$

Nous formulons la conjecture suivante (voir aussi [Wei84] pour une conjecture similaire). Nous expliquerons dans la Section 3.1 pourquoi on peut s'attendre à ce qu'elle soit vraie (particulièrement dans le cas $\alpha < 3/2$).

Conjecture 3.5. *Le modèle de coloriage aléatoire en bleu et vert au niveau $\ell = 0$ défini à partir du champ Ψ^α est dans la même classe d'universalité que la percolation si $\alpha > 3/2$, mais ce n'est pas le cas si $\alpha < 3/2$.*

Il peut sembler étrange que, d'après la Conjecture 3.5, des champs **positivement corrélés** dont la covariance décroît à vitesse $|x - y|^{-1/2}$ (et plus généralement à vitesse $|x - y|^{-\alpha}$ pour un certain $\alpha \in [1/2, 3/2[$) n'appartiennent pas à la classe d'universalité de la percolation de Bernoulli, alors que le modèle d'ondes aléatoires, dont la covariance n'est pas toujours positive et décroît à vitesse $|x - y|^{-1/2}$, est dans cette classe d'après la Conjecture 3.4. Nous verrons que l'on peut en fait s'attendre à ce que la fluctuation autour de 0 de la covariance des ondes aléatoires soit à l'origine d'un **mélange spatial** de l'information qui diminue les dépendances.

Énonçons maintenant des résultats de **transition de phase**. Si f est un des champs définis ci-dessus (i.e. le champ de Bargmann-Fock, les ondes planaires aléatoires, ou un champ Ψ^α), notons $\mathcal{E}_\ell = f^{-1}([-\ell, +\infty[)$. Les ensembles \mathcal{E}_ℓ sont appelés **ensembles d'excursion**.

Avertissement 3.6. Dans toute la Section 3, nous omettons dans les énoncés des théorèmes certaines hypothèses techniques de lissité ou de non dégénérescence des champs gaussiens considérés et renvoyons aux chapitres correspondants pour des énoncés plus précis. Nous n'omettons bien entendu aucune hypothèse qui semble avoir un sens plus profond.

Comme mentionné dans la Section 1.2, Alexander a démontré l'analogie du théorème d'Harris :

Théorème 3.7 ([Ale96a]). *Considérons le champ de Bargmann-Fock ou un des champs Ψ^α pour n'importe quel $\alpha \in]0, +\infty[$. Alors, toutes les composantes connexes de \mathcal{E}_0 sont bornées.*

Une version plus quantitative a été obtenue par Beffara et Gayet dans le cas où la covariance décroît suffisamment vite. Nous utilisons la définition suivante : $\theta_R^{nod}(\ell)$ est la probabilité qu'il y ait un chemin inclus dans \mathcal{E}_ℓ reliant 0 au bord de $[-R, R]^2$.

Théorème 3.8 ([BG16]). *Considérons le champ de Bargmann-Fock ou un des champs Ψ^α pour un paramètre $\alpha > 3/2$. Alors, $\theta_R^{nod}(0)$ décroît polynomialement vite vers 0 quand R tend vers $+\infty$.*

Tout comme le résultat analogue en percolation de Bernoulli, la preuve de ce théorème se repose sur un théorème de RSW, qui est le résultat principal de [BG16] :

Théorème 3.9 ([BG16]). *Considérons le champ de Bargmann-Fock ou un des champs Ψ^α pour un paramètre $\alpha > 3/2$. Alors, pour tout quad Q , il existe $c = c(Q) \in]0, 1[$ telle que, pour tout $R \in]0, +\infty[$:*

$$c \leq \mathbb{P}[\text{Cross}_0(RQ)] \leq 1 - c.$$

Comme nous l'avons déjà vu dans le Théorème 1.4, nous avons avec Alejandro Rivera démontré dans [V2] l'analogie du théorème de Kesten dans le cas du champ de Bargmann-Fock. Notre preuve implique aussi la décroissance exponentielle des probabilités de connexion dans la phase sous-critique :

Théorème 3.10 (Théorèmes 1.3 et 1.8 du Chapitre 2, en commun avec Alejandro Rivera). *Considérons le champ de Bargmann-Fock. Si $\ell > 0$, l'ensemble \mathcal{E}_ℓ possède une (unique) composante connexe non bornée. De plus, si $\ell < 0$, la fonction $\theta_R^{\text{nod}}(\ell)$ décroît exponentiellement vite vers 0.*

Si les résultats ci-dessus sont des signes de similarités entre les modèles de ligne nodale aléatoire et la percolation de Bernoulli, on ne peut pas dire qu'ils suggèrent fortement que ces modèles sont dans la même classe d'universalité. En effet, ils sont aussi vrais pour des modèles appartenant à d'autres classes d'universalité (voir par exemple [BDC12] dans le cas de la percolation FK).

Le Théorème 3.9 (en fait, une version discrète de ce théorème) est un point clef de la preuve du Théorème 3.10. La preuve par Beffara et Gayet du Théorème 3.9 repose sur un résultat de quasi-indépendance et sur une méthode générale due à Tassion [Tas16]. Dans cette thèse, nous avons aussi étudié les propriétés de quasi-indépendance des champs gaussiens (voir la Section 3.1). Ceci nous a permis de généraliser les Théorèmes 3.8 et 3.9 dans l'article [V1] :

Théorème 3.11 (Théorème 1.1 et Proposition 4.5 du Chapitre 1, en commun avec Alejandro Rivera). *Les Théorèmes 3.8 et 3.9 sont vrais pour les champs Ψ^α dès que $\alpha > 4$.*

Notons que Beliaev et Muirhead [BM18] avaient quant à eux démontré ce résultat dans le cas $\alpha > 16$. Citons aussi [BMW17] où les auteurs prouvent un résultat de RSW pour des champs sur la sphère.

Énonçons maintenant une généralisation du Théorème 3.10 que nous avons obtenue avec Stephen Muirhead. Pour cela, adoptons un autre point de vue sur les champs gaussiens planaires et définissons-les en utilisant un **bruit blanc planaire**.

Définition 3.12. Un bruit blanc planaire W est un champ gaussien centré indexé par les fonctions $u \in L^2(\mathbb{R}^2)$ tel que :

$$\mathbb{E}[W_u W_v] = \int_{\mathbb{R}^2} uv.$$

Nous utiliserons la notation $\int_{\mathbb{R}^2} udW = W_u$.

Soit f un champ gaussien planaire transitif. Sa fonction de corrélation peut s'écrire sous la forme

$$\mathbb{E}[f(x)f(y)] = \kappa(x - y)$$

pour un certain $\kappa : \mathbb{R}^2 \rightarrow \mathbb{R}$. Supposons pour simplifier les expressions que $\kappa(-x) = \kappa(x)$ pour tout $x \in \mathbb{R}^2$. Si $\kappa = q \star q$ pour une certaine fonction $q \in L^2(\mathbb{R}^n)$ vérifiant aussi $q(-x) = q(x)$, alors f peut s'écrire

$$f = q \star W : x \mapsto \int_{\mathbb{R}^2} q(x - y)W(dy),$$

pour un certain bruit blanc W . Dans le cas du champ de Bargmann-Fock, on peut choisir $q(x) = \exp(-\frac{1}{2}|x|^2)$ car la fonction gaussienne est sa propre racine carrée convolutive. Le bruit blanc ayant une **structure produit** (on peut écrire formellement $\mathbb{E}[W(dx)W(dy)] = \delta_x(y)$ où δ_x est la fonction de Dirac centrée en x), l'écriture $f = q \star W$ est particulièrement utile pour appliquer des techniques issues de la théorie des influences, comme nous le verrons plus bas.

Afin de comparer les différents résultats énoncés dans cette section, notons que si q est intégrable **et positive**, elle décroît à la même vitesse que la fonction de covariance $\kappa = q \star q$. Avec Stephen Muirhead, nous avons prouvé dans [V3] un résultat de quasi-indépendance (voir le Théorème 3.18) qui implique le résultat de RSW suivant :

Théorème 3.13 (Théorème 1.11 du Chapitre 3, en commun avec Stephen Muirhead). *Les Théorèmes 3.8 et 3.9 sont vrais pour le champ $q \star W$ si q est suffisamment lisse, suffisamment symétrique, si $\kappa = q \star q$ est à valeurs positives, et si q décroît vers 0 au moins polynomialement vite avec un exposant $\alpha > 2$. Notons que si q est à valeurs positives cette dernière propriété est équivalente à $\kappa(x) \leq O(1)|x|^{-\alpha}$ pour un certain $\alpha > 2$.*

Nous avons par ailleurs généralisé le calcul du niveau critique (voir le Théorème 3.10) dans le cas où le champ est “fortement” positivement corrélé i.e. dans le cas où $q \geq 0$. Cependant, nous n’avons pas réussi à démontrer la décroissance exponentielle des probabilités de connexion dans la phase sous-critique mais avons tout de même prouvé qu’il y avait décroissance super-polynomiale.

Théorème 3.14 (Théorèmes 1.6 et 1.11 du Chapitre 3, en commun avec Stephen Muirhead). *Le niveau critique du modèle de percolation construit à partir du champ $q \star W$ est égal à 0 dès que la fonction q est suffisamment lisse, suffisamment symétrique, positive, et décroît au moins polynomialement vite avec exposant $\alpha > 2$. Notons que cette dernière propriété est équivalente à $\kappa(x) \leq O(1)|x|^{-\alpha}$ pour un certain $\alpha > 2$. Par ailleurs :*

$$\forall \ell < 0, \exists c = c(\ell) > 0, \forall R \in]0, +\infty[, \theta_R^{nod}(\ell) \leq \frac{1}{c} \exp(-c \log^2(R)) .$$

Avant d’expliquer les idées principales derrière les théorèmes de transition de phase, focalisons-nous sur la première étape des preuves : la propriété de quasi-indépendance. Ceci nous permettra aussi de comprendre un petit peu mieux les conjectures énoncées dans cette section.

3.1 La quasi-indépendance

Dans cette section, nous nous plaçons essentiellement au niveau $\ell = 0$ même si la plupart des résultats s’étendent aux autres niveaux. Soit f un des champs gaussiens planaires (invariants par translation) définis plus haut et soit $\kappa : \mathbb{R}^2 \rightarrow \mathbb{R}$ sa fonction de covariance :

$$\mathbb{E}[f(x)f(y)] = \kappa(x - y) .$$

Pour qu’un modèle de percolation soit dans la même classe d’universalité que la percolation de Bernoulli, il semble nécessaire que les événements de croisement de deux boîtes à distance strictement positive soient indépendants à la limite d’échelle. Ainsi, pour que le coloriage induit par f au niveau 0 soit dans cette classe d’universalité, il semble par exemple nécessaire que, si Q_R et Q'_R sont deux carrés de côté R à distance R l’un de l’autre (voir la Figure 3.2), alors :

$$\left| \mathbb{P} \left[\text{Cross}_0(Q_R) \mid \text{Cross}_0(Q'_R) \right] - \mathbb{P}[\text{Cross}_0(Q_R)] \right| \xrightarrow{R \rightarrow +\infty} 0 . \quad (3.1)$$

(Rappelons que $\text{Cross}_\ell(Q)$ est l’événement de croisement de Q par un chemin inclus dans \mathcal{E}_ℓ .) Ci-dessous, nous proposons une heuristique pour estimer le membre de gauche de la quantité de (3.1). À la fin de l’heuristique, nous verrons le rôle joué par les exposants $\alpha = 3/2$, $\alpha = 2$ et $\alpha = 4$ qui sont apparus plus haut.

Considérons en premier lieu une version discrète du modèle. Pour cela, donnons-nous un réseau triangulaire⁷ \mathcal{G} avec suffisamment de symétries - comme par exemple le réseau défini en Figure 3.3 - et définissons un modèle de percolation par sites de la façon suivante : Chaque site v de \mathcal{G} est colorié en bleu si $f(v) \geq 0$ et en vert sinon. Notons $\text{Cross}_0^{dis}(Q_R)$ et $\text{Cross}_0^{dis}(Q'_R)$ les événements de croisement (par un chemin bleu, disons) pour ce modèle discret et essayons d’estimer la quantité :

$$\mathbb{P} \left[\text{Cross}_0^{dis}(Q_R) \mid \text{Cross}_0^{dis}(Q'_R) \right] - \mathbb{P} \left[\text{Cross}_0^{dis}(Q_R) \right] . \quad (3.2)$$

⁷Le fait que le réseau soit triangulaire est utile pour avoir des propriétés d’auto-dualité.

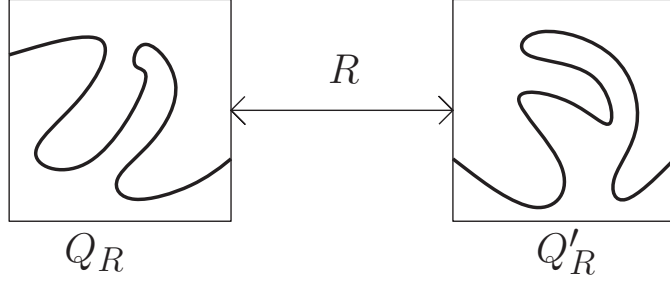

FIGURE 3.2 – Ces deux événements sont-ils presque indépendants lorsque R est grand ?

Pour cela, utilisons les notations suivantes analogues à celles de la Section 2.2, où v est un site de \mathcal{G} et A est un événement mesurable par rapport au coloriage de \mathcal{G} :

$$\begin{aligned} \mathbf{Piv}_v^{dis}(A) &= \{\text{Changer la couleur de } v \text{ modifie la valeur de } \mathbb{1}_A\}; \\ I_v^{dis}(A) &= \mathbb{P} \left[\mathbf{Piv}_v^{dis}(A) \mid f(v) = 0 \right]. \end{aligned}$$

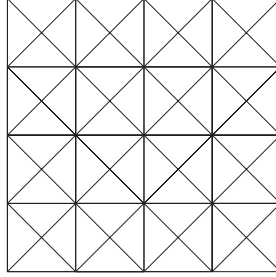

FIGURE 3.3 – Le réseau carré auquel on a ajouté un sommet par face est une triangulation transitive invariante par rotation d'angle $\pi/2$.

Essayons maintenant de trouver une formule pour la quantité (3.2) i.e. essayons de quantifier l'effet du conditionnement par $\text{Cross}_0^{dis}(Q'_R)$. Pour cela, donnons-nous un site $v \in \mathcal{G} \cap Q_R$ et un site $v' \in \mathcal{G} \cap Q'_R$. L'idée générale (pour laquelle il peut être bien d'avoir à l'esprit la formule de Russo i.e. le Lemme 2.11) est la suivante (on pourra dans cette heuristique oublier le conditionnement par $\{f(v) = 0\}$ dans la définition de $I_v^{dis}(A)$) :

- Le conditionnement par $\text{Cross}_0^{dis}(Q'_R)$ augmente la moyenne de $f(v')$ d'une quantité de l'ordre de $I_{v'}^{dis}(\text{Cross}_0^{dis}(Q'_R))$. (Ici, nous avons négligé de façon abusive les interactions entre les sites de Q'_R .)
- Ceci implique une augmentation de l'ordre de $\kappa(v - v') I_{v'}^{dis}(\text{Cross}_0^{dis}(Q'_R))$ de la moyenne de $f(v)$.
- Cette augmentation de la moyenne de $f(v)$ entraîne une augmentation de la probabilité de $\text{Cross}_0^{dis}(Q_R)$ d'une quantité de l'ordre de

$$I_v^{dis}(\text{Cross}_0^{dis}(Q_R)) \kappa(v - v') I_{v'}^{dis}(\text{Cross}_0^{dis}(Q'_R)).$$

Finalement, on peut s'attendre à une formule du type :

$$\begin{aligned} &\mathbb{P} \left[\text{Cross}_0^{dis}(Q_R) \mid \text{Cross}_0^{dis}(Q'_R) \right] - \mathbb{P} \left[\text{Cross}_0^{dis}(Q_R) \right] \\ &= \sum_{\substack{v \in \mathcal{G} \cap Q_R \\ v' \in \mathcal{G} \cap Q'_R}} I_v^{dis}(\text{Cross}_0^{dis}(Q_R)) \kappa(v - v') I_{v'}^{dis}(\text{Cross}_0^{dis}(Q'_R)). \end{aligned} \quad (3.3)$$

Il s'avère que cette formule n'est pas vraie (même à une constante près) mais donne une bonne idée de la vraie formule que l'on peut obtenir. Plus précisément, dans le Chapitre 1, nous avons effectué une interpolation entre le champ f et un champ qui restreint à chacune des boîtes a la même loi que f mais dont la restriction à Q_R est indépendante de la restriction à Q'_R . En utilisant des formules différentielles propres aux vecteurs gaussiens (qui sont par exemples centrales dans [Sle62]), nous avons obtenu la formule suivante analogue à (3.3). Cette formule est une réinterprétation d'une formule due à Piterbarg [Pit96].

Theorem 3.15 (Théorème 1.1 de [Pit96]; Proposition 2.4 du Chapitre 1, en commun avec Alejandro Rivera). ⁸ Soient A un événement croissant mesurable par rapport aux couleurs des sites de $\mathcal{G} \cap Q_R$ et B un événement croissant mesurable par rapport aux couleurs des sites de $\mathcal{G} \cap Q'_R$. Soit de plus g un champ défini sur $Q_R \cup Q'_R$, indépendant de f , tel que $g|_{Q_R}$ a la même loi que $f|_{Q_R}$, $g|_{Q'_R}$ a la même loi que $f|_{Q'_R}$, et $g|_{Q_R}$ est indépendant de $g|_{Q'_R}$. Notons $f_t = tg + \sqrt{1-t^2}f$ (défini sur $Q_R \cup Q'_R$). Alors :

$$\begin{aligned} & \mathbb{P}[A \cap B] - \mathbb{P}[A] \mathbb{P}[B] \\ &= \sum_{\substack{v \in \mathcal{G} \cap Q_R \\ v' \in \mathcal{G} \cap Q'_R}} \int_0^1 \frac{\kappa(v-v')}{2\pi \sqrt{\kappa(0)^2 - (t\kappa(v-v'))^2}} \mathbb{P} \left[f_t \in \text{Piv}_v^{dis}(A) \cap \text{Piv}_{v'}^{dis}(B) \mid f_t(v) = f_t(v') = 0 \right] dt. \end{aligned}$$

On peut remarquer que ce résultat implique une inégalité de type FKG lorsque κ est à valeurs positives. La principale différence avec (3.3) est que les événements pivots ne sont a priori pas découplés lorsque t n'est pas proche de 1.

Quelques conséquences de la formule de quasi-indépendance discrète. Pour le reste de cette section, gardons à l'esprit la formule (approximative mais suffisante pour les heuristiques) (3.3) et appliquons-la aux champs Ψ^α pour lesquels κ est positive et décroît polynomialement vite avec un exposant α . Si on majore les influences par 1 on obtient que :

$$0 \leq \mathbb{P} \left[\text{Cross}_0^{dis}(Q_R) \mid \text{Cross}_0^{dis}(Q'_R) \right] - \mathbb{P} \left[\text{Cross}_0^{dis}(Q_R) \right] \leq O(1) R^{-\alpha} R^4.$$

On voit ainsi apparaître l'exposant 4 (qui est le même exposant que dans le Théorème 3.11) : si $\alpha > 4$, les événements de croisement (discrets) sont quasi-indépendants.

Souvenons-nous maintenant de l'inégalité (2.7), à savoir le fait que l'espérance du nombre de pivots pour un événement croissant $A \subseteq \Omega_n = \{-1, 1\}^n$ est d'ordre plus petit que \sqrt{n} (où Ω_n était muni d'une mesure produit pour un certain paramètre $p \in [0, 1]$). Par analogie, on peut s'attendre à ce que :

$$\begin{aligned} & \sum_{\substack{v \in \mathcal{G} \cap Q_R \\ v' \in \mathcal{G} \cap Q'_R}} I_v^{dis}(\text{Cross}_0^{dis}(Q_R)) I_{v'}^{dis}(\text{Cross}_0^{dis}(Q'_R)) \\ &= \left(\sum_{v \in \mathcal{G} \cap Q_R} I_v^{dis}(\text{Cross}_0^{dis}(Q_R)) \right) \left(\sum_{v' \in \mathcal{G} \cap Q'_R} I_{v'}^{dis}(\text{Cross}_0^{dis}(Q'_R)) \right) \\ &\leq O(1) \sqrt{R^2} \sqrt{R^2} = O(1) R^2. \quad (3.4) \end{aligned}$$

⁸Dans le Chapitre 1, nous n'avons en fait montré qu'une borne supérieure pour $|\mathbb{P}[A \cap B] - \mathbb{P}[A] \mathbb{P}[B]|$, mais sans hypothèse de monotonie sur A et B . Avec la même preuve, on peut obtenir l'égalité énoncée ici dans le cas où les événements sont croissants.

Notons par ailleurs que le théorème donne une formule pour $\mathbb{P}[A \cap B] - \mathbb{P}[A] \mathbb{P}[B]$ alors que (3.3) donne une formule pour $\mathbb{P}[A | B] - \mathbb{P}[A]$, et ce dans le cas où A et B sont les événements de croisement de Q_R et Q'_R au niveau 0. Mais comme la probabilité de croisement d'un carré au niveau 0 est égale à 1/2, on a $\mathbb{P}[A | B] - \mathbb{P}[A] = 2(\mathbb{P}[A \cap B] - \mathbb{P}[A] \mathbb{P}[B])$ dans le cas de ces événements.

Ce qui impliquerait que, si $f = \Psi^\alpha$:

$$0 \leq \mathbb{P} \left[\text{Cross}_0^{\text{dis}}(Q_R) \mid \text{Cross}_0^{\text{dis}}(Q'_R) \right] - \mathbb{P} \left[\text{Cross}_0^{\text{dis}}(Q_R) \right] \leq O(1) R^{-\alpha} R^2.$$

C'est de cette observation que vient l'intuition derrière l'exposant $\alpha = 2$ qui apparaît dans les Théorèmes 3.13 et 3.14. Cependant, la preuve de ces résultats repose non pas sur une formule du type de (3.3) mais plutôt sur la représentation de f à l'aide d'un bruit blanc, comme nous l'expliquons plus bas. Avant cela, rappelons un résultat fondamental de la percolation planaire (prouvé dans le cas du réseau triangulaire régulier par Smirnov et Werner [SW01], voir la Section 5 pour des discussions en lien avec ce résultat) : Pour la percolation de Bernoulli critique, la probabilité qu'un point⁹ soit pivot pour le croisement d'une boîte de taille R est égale à $R^{-5/4+o(1)}$. Ainsi, si l'on suppose que la limite d'échelle du modèle de percolation de lignes nodales étudié est bien la percolation de Bernoulli, on peut s'attendre à ce que :

$$\begin{aligned} \mathbb{P} \left[\text{Cross}_0^{\text{dis}}(Q_R) \mid \text{Cross}_0^{\text{dis}}(Q'_R) \right] - \mathbb{P} \left[\text{Cross}_0^{\text{dis}}(Q_R) \right] \\ \simeq (R^{-5/4})^2 \int_{Q_R \times Q'_R} \kappa(x-y) dx dy = R^{-5/2} \int_{Q_R \times Q'_R} \kappa(x-y) dx dy. \end{aligned} \quad (3.5)$$

Dans le cas où $f = \Psi^\alpha$, cela implique que :

$$\mathbb{P} \left[\text{Cross}_0^{\text{dis}}(Q_R) \mid \text{Cross}_0^{\text{dis}}(Q'_R) \right] - \mathbb{P} \left[\text{Cross}_0^{\text{dis}}(Q_R) \right] \simeq \left(R^2 R^{-5/4} \right)^2 R^{-\alpha} \simeq R^{3/2-\alpha}.$$

En particulier, si $\alpha < 3/2$, on obtient une contradiction, ce qui est derrière l'idée de la Conjecture 3.5. La partie " $\alpha > 3/2$ " est bien moins claire ; toutefois, certains arguments venant de physique théorique tels que le **critère de Harris** suggèrent que la covariance décroît suffisamment vite pour que le modèle appartienne à la même classe d'universalité que la percolation de Bernoulli. Nous renvoyons par exemple à [Wei84] ; on pourra aussi consulter l'article [BS07] dans lequel les auteurs appliquent des arguments similaires au modèle d'ondes planaires aléatoires.

La formule (3.5) permet par ailleurs de comprendre pourquoi le fait que le signe de κ fluctue peut parfois être une propriété clef sans laquelle le modèle ne serait pas dans la même classe d'universalité que la percolation. Concernant par exemple le modèle des ondes planaires aléatoires, même si $|\kappa(x)|$ décroît vers 0 à vitesse $\sqrt{|x|}$, on peut montrer (voir [BDS07] pour des calculs et arguments similaires) que $R^{-5/2} \int_{Q_R \times Q'_R} \kappa(x-y) dx dy$ converge vers 0 quand R tend vers $+\infty$. Il n'y a donc pas de contradiction avec la Conjecture 3.4.

Le cas des croisements continus. Essayons maintenant de comprendre comment prouver des formules similaires pour les événements de croisement **continus**. L'idée est de considérer le champ f restreint au réseau $\varepsilon\mathcal{G}$, d'appliquer (3.3) à ce modèle, et de faire tendre ε vers 0. Notons $\text{Cross}_0^\varepsilon(Q_R)$ l'événement de croisement de Q_R pour ce modèle et $\text{Piv}_v^\varepsilon(\text{Cross}_0^\varepsilon(Q_R))$ l'événement pivot correspondant, où $v \in (\varepsilon\mathcal{G}) \cap Q_R$. Notons aussi :

$$I_v^\varepsilon(\text{Cross}_0^\varepsilon(Q_R)) = \mathbb{P} \left[\text{Piv}_v^\varepsilon(\text{Cross}_0^\varepsilon(Q_R)) \mid f(v) = 0 \right].$$

De même qu'en Section 2.2, les événements pivots sont des événements d'existence de "4 bras" tels que sur la Figure 2.4. Cela se traduit localement par l'existence d'un "point-selle discret". Dans le Chapitre 1, nous avons prouvé que :

$$I_v^\varepsilon(\text{Cross}_0^\varepsilon(Q_R)) \leq \mathbb{P} \left[\text{point-selle discret en } v \mid f(v) = 0 \right] \leq O(1) \varepsilon^2. \quad (3.6)$$

⁹Pour que ce résultat soit vrai, il faut que le point soit assez éloigné des côtés de la boîte afin que l'on puisse décrire l'événement pivot à l'aide d'un événement "à 4 bras", voir la Figure 2.4. Nous négligeons ici ce point technique.

La preuve consiste à : i) montrer que l'existence d'un point-selle discret implique que les dérivées partielles du champ selon deux directions non colinéaires s'annulent en des points proches de v puis ii) appliquer une formule de Kac-Rice pour contrôler la probabilité que ces dérivées s'annulent. Les formules de Kac-Rice permettent de calculer l'espérance du nombre de points d'annulation d'un champ. Nous renvoyons au Chapitre 1 (plus particulièrement à la Section 3 et l'appendice de ce chapitre) pour un énoncé de formules de Kac-Rice et la preuve de (3.6). Utilisons maintenant la formule (3.3) (ou plutôt la formule analogue pour le réseau $\varepsilon\mathcal{G}$). Comme dans cette formule on somme sur $(R/\varepsilon)^4$ points, (3.6) implique que :

$$\begin{aligned} & \left| \mathbb{P} \left[\text{Cross}_0^\varepsilon(Q_R) \mid \text{Cross}_0^\varepsilon(Q'_R) \right] - \mathbb{P}[\text{Cross}_0^\varepsilon(Q_R)] \right| \\ & \leq O(1) \sup_{\substack{x \in Q_R \\ y \in Q'_R}} |\kappa(x-y)|(R/\varepsilon)^4 \varepsilon^2 \varepsilon^2 = O(1) R^4 \sup_{\substack{x \in Q_R \\ y \in Q'_R}} |\kappa(x-y)|. \end{aligned} \quad (3.7)$$

Finalement, comme le membre de droite est indépendant de ε , la même formule est vraie pour les événements de croisement continus et on obtient le résultat suivant :

Théorème 3.16 (Théorème 1.12 du Chapitre 1, en commun avec Alejandro Rivera). *Plaçons-nous dans le cas du champ de Bargmann-Fock ou d'un champ Ψ^α pour un certain $\alpha > 4$. Alors, la convergence (3.1) est vraie.*

En particulier, la rigidité analytique du modèle de Bargmann-Fock n'est pas assez importante pour empêcher une quasi-indépendance spatiale des événements de percolation. Étudions maintenant deux conséquences du Théorème 3.16.

3.1.1 La méthode de RSW par Tassion

La première conséquence est un résultat de type RSW. La preuve originelle du théorème de RSW (Théorème 2.3) utilise de façon cruciale l'indépendance des couleurs de chaque arête/site lorsque les auteurs **conditionnent sur des interfaces** entre noir et blanc. Une telle preuve ne s'adaptant pas dans le contexte des lignes nodales (on peut par exemple se rappeler de l'analyticité du champ de Bargmann-Fock). Ce type de difficultés se retrouve dans d'autres modèles de percolation continue, telles que la percolation de Voronoi. Pour ce modèle, Tassion [Tas16] a développé de nouvelles techniques qui permettent de démontrer un résultat de croisement de boîte à condition que : i) le modèle ait assez de symétries, ii) le modèle possède une propriété de FKG et iii) le modèle possède une propriété de quasi-indépendance du type de (3.1). Le Théorème 3.16 et la méthode de Tassion permettent ainsi d'obtenir le Théorème 3.11.

La méthode de Tassion repose de façon crucial sur la propriété de FKG. Nous renvoyons à [BG17] pour des résultats de RSW (par perturbation) pour des modèles qui ne satisfont pas FKG. Pour d'autres théorèmes de RSW sur des modèles avec dépendance, on pourra consulter [DCHN11, ATT16, BS17, NTW17].

3.1.2 Une autre application : la concentration par le haut du nombre de lignes nodales

Le Théorème 3.16 est aussi vrai pour d'autres événements que les événements de croisement. Nous l'avons en particulier aussi obtenu pour des événements mesurables par rapport au nombre de lignes nodales dans les boîtes Q_R et Q'_R , ce qui nous a permis d'obtenir un résultat de **concentration par le haut** pour le nombre de lignes nodales :¹⁰

Théorème 3.17 (Théorème 1.4 du Chapitre 1, en commun avec Alejandro Rivera). *Étant donné un champs gaussien planaire f , notons $N_n(f)$ le nombre de lignes nodales de f contenues*

¹⁰Nous énonçons le résultat dans le cas du champ de Bargmann-Fock et des champs Ψ^α . Toutefois, nous n'avons pas besoin ici de supposer que la covariance est à valeurs positives.

dans $[-n, n]^2$. Soit $\alpha \in]0, +\infty[$. Notons par ailleurs c_{BF} la constante du Théorème 3.2 dans le cas du champ de Bargmann-Fock Υ et notons-là c_α dans le cas du champ Ψ_α .¹¹ Pour tout $\varepsilon > 0$ et tout $h > 0$, il existe $\delta_1 = \delta_1(\varepsilon) > 0$ et $\delta_2 = \delta_2(\varepsilon, h) > 0$ tels que :

$$\mathbb{P} \left[\frac{N_n(\Upsilon)}{n^2} - c_{BF} \leq -\varepsilon \right] \leq \frac{1}{\delta_1} \exp(-\delta_1 n)$$

et :

$$\mathbb{P} \left[\frac{N_n(\Psi_\alpha)}{n^2} - c_\alpha \leq -\varepsilon \right] \leq \frac{1}{\delta_2} n^{4+h-\alpha}.$$

Un résultat de concentration exponentielle par le haut **et par le bas** a été obtenu par Nazarov et Sodin [NS09] dans le cas du modèle des harmoniques sphériques aléatoires. Pour d'autres résultats de concentration pour les lignes nodales, on pourra consulter [GW11] et [Let18].

3.1.3 Quasi-indépendance et bruit-blanc

Avec Stephen Muirhead, nous avons suivi une autre méthode de preuve de propriétés de quasi-indépendance, dans le but de montrer le Théorème 3.13. Rappelons que celui-ci est un résultat de RSW pour des champs dont la décroissance décroît polynomialement avec un exposant $\alpha > 2$. Rappelons aussi que i) une façon de définir des champs gaussiens planaires transitifs est d'écrire $f = q \star W$, où W est un bruit blanc spatial et ii) pour simplifier les notations, nous supposons que $q(-x) = q(x)$ pour tout $x \in \mathbb{R}^2$, cela impliquant en particulier que la covariance de f est $\kappa = q \star q$. On a :

Théorème 3.18 (Théorème 4.2 du Chapitre 3, en commun avec Stephen Muirhead). *Soit $R \in]0, +\infty[$ et soient Q_R et Q'_R deux boîtes de côté R à distance R l'une de l'autre. Soient de plus A_R et B_R des événements croissants mesurables par rapport au champ restreint à Q_R et à Q'_R respectivement. Si q est suffisamment lisse et s'il existe $\alpha > 2$ tel que $|q(x)| \leq O(1)|x|^{-\alpha}$, alors .¹²*

$$|\mathbb{P}[f \in A_R \cap B_R] - \mathbb{P}[f \in A_R]\mathbb{P}[f \in B_R]| \leq O(1)R^{2-\alpha} \log(R).$$

Le Théorème 3.13 est maintenant une conséquence du Théorème 3.18 et de la méthode de RSW due à Tassion.

Terminons cette section sur la quasi-indépendance par quelques idées derrière la preuve du Théorème 3.18. L'idée principale est de considérer une famille de champs $(f_R)_{R \in [1, +\infty[}$ définie par :

$$f_R = q_R \star W,$$

où $q_R(x) = q(x)\mathbb{1}_{|x| \geq R}$ (il faut ici plutôt considérer une approximation lisse de $\mathbb{1}_{|x| \geq R}$). Notons que le champ f_R est R -dépendant. Ainsi, $(f_R)_{|Q_R}$ est indépendant de $(f_R)_{|Q'_R}$. Afin de prouver le Théorème 3.18, il suffit donc de montrer que, si q et A_R sont comme dans l'énoncé de ce théorème alors :

$$|\mathbb{P}[f_R \in A_R] - \mathbb{P}[f \in A_R]| \leq O(1)R^{2-\alpha} \tag{3.8}$$

(nous omettons ici et ci-dessous les termes logarithmiques en R). Afin de montrer un tel résultat, nous avons suivi une méthode en deux étapes :

¹¹Le Théorème 3.2 s'applique aussi aux champs Ψ_α , voir [NS09].

¹²On a ici aussi besoin d'une hypothèse sur la transformée de Fourier de q , voir le Chapitre 3. Cependant, elle n'est pas utile dans le cas où $\kappa = q \star q$ est à valeurs positives.

Étape A : La première étape consiste à estimer le maximum de $|f_R - f|$ sur la boîte Q_R . Pour cela, on utilise l'inégalité de Borell-Tsirelson-Ibragimov-Sudakov (BTIS, voir par exemple [AW09] ou [AT07]). Celle-ci implique que, si g est un champ gaussien transitive et D un ensemble borélien borné du plan, alors la variable aléatoire $|\max_D g - \mathbb{E}[\max_D g]|$ a une queue gaussienne. Si on pave Q_R par des carrés de côté 1 et que l'on applique l'inégalité de BTIS à chaque carré, on obtient que la valeur typique de $\max_{Q_R} |f_R - f|$ est :¹³

$$\sqrt{\int_{|x| \geq R} q^2(x) dx},$$

la quantité $\int_{|x| \geq R} q^2(x) dx$ étant la variance de $f_R - f$, qui est au plus de l'ordre de $R^{2(1-\alpha)}$ si $|q(x)| \leq O(1)|x|^{-\alpha}$.

Étape B : La deuxième étape consiste à étudier l'effet d'une perturbation du champ f sur la quantité $\mathbb{P}[f \in A_R]$. Plus précisément, nous avons prouvé une estimation de la quantité suivante (en ayant à l'esprit que nous choisirons $\varepsilon = \sqrt{\int_{|x| \geq R} q^2(x) dx}$) :

$$\mathbb{P}[f + \varepsilon \in A_R] - \mathbb{P}[f \in A_R].$$

Si on se souvient de l'inégalité (2.8) (issuée d'une inégalité sur les influences), on peut s'attendre au résultat suivant :

Lemme 3.19 (Proposition 3.6 du Chapitre 3, en commun avec Stephen Muirhead). *Si q satisfait les hypothèses du Théorème 3.18 alors, pour tout $\varepsilon > 0$ on a :*

$$\mathbb{P}[f + \varepsilon \in A_R] - \mathbb{P}[f \in A_R] \leq O(1) \sqrt{R^2} \varepsilon = O(1) R \varepsilon.$$

L'inégalité (3.8) (et donc le Théorème 3.18) est bien une conséquence de ce lemme et de l'étape A. Pour démontrer le Lemme 3.19, nous avons utilisé un théorème de Cameron-Martin en dimension infinie (voir [Jan97]). Ce théorème permet de comparer la loi de f et celle de $f + \eta$ pour une fonction η choisie de telle façon que **ces deux lois soient continues l'une par rapport à l'autre**. L'idée pour trouver une telle fonction η est que le bruit blanc est un objet suffisamment peu rigide pour que la loi de $W + \bar{\eta}$ soit continue par rapport à la loi de W pour n'importe quel $\bar{\eta} \in L^2(\mathbb{R}^2)$. Un bon choix pour η est donc une fonction du type $q \star \bar{\eta}$ pour un certain $\bar{\eta} \in L^2(\mathbb{R}^2)$. Nous avons par ailleurs choisi une telle fonction η qui majore ε de telle façon que :

$$\mathbb{P}[f + \varepsilon \in A_R] - \mathbb{P}[f \in A_R] \leq \mathbb{P}[f + \eta \in A] - \mathbb{P}[f \in A_R].$$

La formule de Cameron-Martin de dimension infinie nous donne alors le résultat voulu quitte à appliquer l'inégalité de Cauchy-Schwarz de façon analogue à la preuve de (2.7) ; nous renvoyons à la Section 3.3 du Chapitre 3 pour les détails.

Pour des références concernant d'autres résultats de quasi-indépendance (tels que ceux de Nazarov, Sodin et Volberg), nous renvoyons à la Remarque 4.4 du Chapitre 3. Notons par ailleurs que les méthodes développées dans [BG16] sont différentes que celles proposées dans cette thèse : Beffara et Gayet y prouvent un résultat de quasi-indépendance pour le modèle discrétisé avec dépendance en la maille ε et un résultat d'approximation quantitatif, ce qui permet d'obtenir un résultat de quasi-indépendance dans le continu.

¹³Rappelons que l'on omet les termes logarithmiques.

3.2 Le calcul du niveau critique

Dans cette section, nous expliquons les idées générales des preuves des Théorèmes 3.10 et 3.14 dans lesquels nous montrons que le niveau critique pour des modèles de percolation de lignes nodales est 0. Rappelons que le Théorème 3.7 implique que le niveau critique est plus grand que 0. Notre but est donc de prouver qu'il existe presque sûrement une composante connexe infinie dans $\mathcal{E}_\ell = f^{-1}([-\ell, +\infty[)$ dès que $\ell > 0$. Comme dans la Section 2, nous allons pour cela montrer que la quantité $\mathbb{P}[\text{Cross}_\ell(2R, R)]$ converge vers 1 (suffisamment vite pour avoir une estimation du type de celle du Lemme 2.4).

3.2.1 Une preuve à la KKL

L'élément central de la preuve du Théorème 3.10 est un théorème de type KKL pour des vecteurs gaussiens corrélés (voir la Section 2.2.2 pour un énoncé du théorème de KKL dans le contexte des mesures produit sur l'hypercube et une application à la percolation de Bernoulli). Ce résultat concernant des champs de dimension finie, nous l'appliquerons à une version discrétisée du modèle de percolation de lignes nodales. Afin d'énoncer nos résultats, nous avons tout d'abord besoin d'une nouvelle notion d'influence :

Définition 3.20. Soient μ une mesure finie sur \mathbb{R}^n , $i \in \{1, \dots, n\}$ et $A \subseteq \mathbb{R}^n$ un ensemble borélien. L'**influence géométrique** de i sur A sous μ est définie par :

$$I_{i,\mu}^{\mathcal{G}}(A) = \liminf_{r \downarrow 0} \frac{\mu(A + [-r, r]e_i) - \mu(A)}{r} \in [0, +\infty],$$

où e_i est le $i^{\text{ème}}$ vecteur de la base canonique.

Cette notion est inspirée de la notion d'influence géométrique définie dans le cas de mesures produit par Keller, Mossel et Sen (voir [KMS12]).¹⁴ Nous nous intéressons à ces influences dans le cas où A est un "événement seuil" d'un vecteur gaussien.

Définition 3.21. Étant donné un niveau $\ell \in \mathbb{R}$ et un vecteur gaussien centré X à valeurs dans \mathbb{R}^n de covariance Σ , nous notons $\omega^\ell \in \Omega_n = \{-1, 1\}^n$ le vecteur défini par :

$$\omega_i^\ell = \text{sgn}(X_i + \ell).$$

Un événement du type $\{\omega^\ell \in B\}$ pour un certain $B \subseteq \Omega_n$ est appelé **événement seuil**. Nous notons $\mathbf{Piv}_i^\ell(B)$ l'événement que i est pivot pour B et ω^ℓ i.e. $\mathbf{Piv}_i^\ell(B) = \{\mathbb{1}_B(\omega^{i,\ell}) \neq \mathbb{1}_B(\omega^\ell)\}$ où $\omega^{i,\ell}$ est obtenu à partir de ω^ℓ en changeant la $i^{\text{ème}}$ coordonnée.

Dans cette section, nous notons μ_X la loi d'une variable aléatoire X . On a la formule différentielle suivante.

Lemme 3.22 (Proposition 2.17 du Chapitre 2, en commun avec Alejandro Rivera). *Utilisons les mêmes notations que dans la Définition 3.21. En particulier, $B \subseteq \Omega_n$ et X est un vecteur gaussien centré à valeurs dans \mathbb{R}^n de covariance Σ . Si B est croissant, alors :*¹⁵

$$\frac{d}{d\ell} \mathbb{P}[\omega^\ell \in B] = \sum_{i=1}^n I_{i,\mu_X}^{\mathcal{G}}(\omega^\ell \in B).$$

Par ailleurs, pour tout $i \in \{1, \dots, n\}$:

$$I_{i,\mu_X}^{\mathcal{G}}(\omega^\ell \in B) = \mathbb{P}[\mathbf{Piv}_i^\ell(B) \mid X_i = -\ell] \frac{1}{\sqrt{2\pi\Sigma_{i,i}}} \exp\left(-\frac{1}{2\Sigma_{i,i}}\ell^2\right).$$

¹⁴Dans le cas produit, la définition ci-dessus et celle de [KMS12] coïncident même pour une grande classe d'événements, voir la Section 5 du Chapitre 2.

¹⁵Nous utilisons l'abus de notation consistant à utiliser aussi (dans $I_{i,\mu_X}^{\mathcal{G}}(\omega^\ell \in B)$) la notation " $\omega^\ell \in B$ " pour désigner l'ensemble borélien $C \subseteq \mathbb{R}^n$ tel que $\{\omega^\ell \in B\} = \{X \in C\}$.

Keller, Mossel et Sen ont démontré un théorème de type KKL pour les influences géométriques dans le cas d'un vecteur gaussien standard. Considérons un vecteur gaussien centré X à valeurs dans \mathbb{R}^n de covariance Σ . En nous souvenant que la loi de X est la mesure image de la loi gaussienne standard par Σ et en montrant des inégalités de sous-additivité pour les influences, nous avons obtenu le résultat suivant :

Théorème 3.23 ([KMS12] pour le cas produit. Pour le cas général, voir le Théorème 2.19 du Chapitre 2, en commun avec Alejandro Rivera). *Soit X un vecteur gaussien centré à valeurs dans \mathbb{R}^n de covariance Σ . Il existe une constante absolue $c > 0$ telle que, pour tout ensemble borélien monotone $A \subseteq \mathbb{R}^n$, on a :*

$$\sum_{i=1}^n I_{i,\mu_X}^{\mathcal{G}}(A) \geq c \|\sqrt{\Sigma}\|_{\infty,op}^{-1} \mu_X(A) (1 - \mu_X(A)) \sqrt{\log_+ \left(\frac{1}{\|\sqrt{\Sigma}\|_{\infty,op} \cdot \max_{i=1}^n I_{i,\mu_X}^{\mathcal{G}}(A)} \right)}.$$

où $\|\sqrt{\Sigma}\|_{\infty,op}$ est la norme d'opérateur de $\sqrt{\Sigma}$ pour la norme infinie i.e. :

$$\|\sqrt{\Sigma}\|_{\infty,op} = \max_{i=1}^n \sum_{j=1}^n |(\sqrt{\Sigma})_{i,j}|.$$

Nous renvoyons au travail de Cordero-Erausquin et Ledoux [CEL12] pour une preuve alternative dans le cas produit reposant sur des inégalités d'hypercontractivité.

La différence principale entre le Théorème 3.23 et le théorème de KKL (i.e. le Théorème 2.13) est - outre la racine carrée qui ne change pas l'esprit de l'inégalité - la présence du terme $\|\sqrt{\Sigma}\|_{\infty,op}$ qui est en général difficile à estimer.

Afin d'appliquer ces résultats au modèle de percolation de lignes nodales, considérons le modèle de percolation discrète que nous avons déjà rencontré dans la Section 3.1 i.e. considérons le réseau triangulaire $\varepsilon\mathcal{G}$ où \mathcal{G} est le réseau de la Figure 3.3 et, étant donné un niveau $\ell \in \mathbb{R}$ et un champ gaussien planaire f , colorions en bleu chaque site v tel que $f(v) \geq -\ell$ et en vert les autres sites. Notons par ailleurs $\text{Cross}_{\ell}^{\varepsilon}(2R, R)$ l'événement de croisement de gauche à droite du rectangle $[0, 2R] \times [0, R]$ par un chemin bleu pour ce modèle de percolation par sites.

Il s'agit maintenant d'appliquer le Lemme 3.22 et le Théorème 3.23 à cet événement. Pour cela, il faut estimer la quantité $\|\sqrt{\Sigma}\|_{\infty,op}$ du Théorème 3.23 où $\Sigma = \Sigma^{\varepsilon}$ est la matrice de covariance du champ restreint à¹⁶ $\varepsilon\mathcal{G}$. Ce calcul s'est avéré difficile en règle générale, et nous n'avons trouvé une estimation satisfaisante que dans le cas du champ de Bargmann-Fock. Plus précisément, le fait que la covariance de ce champ soit la fonction gaussienne nous a permis d'utiliser des techniques de décomposition de Fourier et nous avons obtenu l'inégalité suivante :

$$\|\sqrt{\Sigma^{\varepsilon}}\|_{\infty,op} \leq O(1) \frac{1}{\varepsilon} \log \left(\frac{1}{\varepsilon} \right). \quad (3.9)$$

Une fois ce calcul effectué, la preuve est très proche de la preuve analogue dans le cas de la percolation de Bernoulli. L'idée générale est que, grâce aux estimations de quasi-indépendance **uniformes en ε** telles que (3.7), on peut obtenir des théorèmes de RSW avec des constantes elles aussi uniformes en ε . Finalement, si on suit les calculs effectués en Section 2.2 et que l'on utilise (3.9), on obtient l'analogue suivant¹⁷ de (2.4) :

$$\exists c' > 0, \forall \ell > 0, \mathbb{P}[\text{Cross}_{\ell}^{\varepsilon}(2R, R)] \geq 1 - \exp \left(-c' \ell \varepsilon \sqrt{\log \left(O(1) \frac{R^{-c'}}{\varepsilon} \right)} \right).$$

¹⁶Il faudrait plutôt considérer le champ restreint à $(\varepsilon\mathcal{G}) \cap [0, 2R] \times [0, R]$ mais cela n'a pas grande importance comme expliqué dans la Section 3.1 du Chapitre 2.

¹⁷On néglige ici les termes logarithmiques en ε .

En particulier, $\mathbb{P}[\text{Cross}_\ell^\varepsilon(2R, R)]$ est très proche de 1 si $\varepsilon \gg \log^{-1/2}(R)$. L'idée est donc que, si l'événement $\text{Cross}_\ell^\varepsilon(2R, R)$ approxime bien l'événement continu pour un bon choix de $\varepsilon = \varepsilon(R) \gg \log^{-1/2}(R)$, on peut conclure que la probabilité de croisement continu est très proche de 1, qui est le résultat que l'on cherche à prouver. Cependant, les résultats d'approximation connus (voir par exemple [BG16, BM18]) impliquent que cet événement discret approxime bien l'événement continu pour un bon choix de $\varepsilon = \varepsilon(R)$ qui tend vers 0 **au moins polynomialement vite** en R . Ceci n'étant pas applicable dans notre cas, nous avons plutôt utilisé une méthode de **saupoudrage** ("sprinkling").

Rappelons que $\text{Cross}_\ell(2R, R)$ est l'événement de croisement continu. L'idée est qu'il nous suffit de montrer que l'événement de croisement discret au niveau $\ell/2$ implique avec grande probabilité l'événement de croisement continu au niveau ℓ pour un bon choix de $\varepsilon \gg \log^{-1/2}(R)$. On a l'estimation suivante :

Lemme 3.24 (Proposition 2.22 du Chapitre 2, en commun avec Alejandro Rivera). *Soit $\ell > 0$. Si $\varepsilon = \varepsilon(R) \ll \log^{-1/4}(R)$ alors :*

$$\mathbb{P}[\text{Cross}_\ell^\varepsilon(2R, R) \setminus \text{Cross}_{\ell/2}(2R, R)] \xrightarrow{R \rightarrow +\infty} 0.$$

En choisissant n'importe quelle suite $\varepsilon = \varepsilon(R)$ vérifiant $\log^{-1/2}(R) \ll \varepsilon \ll \log^{-1/4}(R)$, on obtient bien que la probabilité de l'événement de croisement continu est très proche de 1, qui est le résultat central de la preuve du Théorème 3.10. Nous renvoyons au Chapitre 2 pour les détails et pour la preuve de la décroissance exponentielle des probabilités de connexion dans la phase sous-critique.

3.2.2 Une preuve utilisant l'inégalité d'OSSS

Nous expliquons maintenant les idées principales derrière la preuve du Théorème 3.14 qui généralise le Théorème 3.10. Plus précisément, nous expliquons comment utiliser l'inégalité d'OSSS (voir le Théorème 2.14) pour montrer que, pour tout $\ell > 0$, $\mathbb{P}[\text{Cross}_\ell(2R, R)]$ converge vers 1 quand R tend vers $+\infty$. Concernant les résultats de décroissance des probabilités de connexion dans la phase sous-critique du Théorème 3.14, nous renvoyons à la Section 6 du Chapitre 3. Rappelons que dans le Théorème 3.14 nous considérons un champ

$$f = q \star W,$$

où W est un bruit blanc spatial et $q : \mathbb{R}^2 \rightarrow \mathbb{R}$ est suffisamment lisse, suffisamment symétrique et décroît vers 0 polynomialement vite avec un exposant $\alpha > 2$. Par ailleurs, dans ce théorème **q (et pas seulement la covariance $\kappa = q \star q$) est supposée à valeurs positives**. Tout comme dans la preuve à la KKL ci-dessus, la première étape consiste à discrétiser le modèle. Ici, c'est le bruit blanc que nous discrétisons.

Définition 3.25. Pour tout $\varepsilon \in]0, +\infty[$, définissons le bruit blanc discret W^ε par :

$$W^\varepsilon(x) = \frac{1}{\varepsilon} \sum_{v \in \varepsilon\mathbb{Z}^2} \eta_v \mathbf{1}_{x \in v + [-\varepsilon/2, \varepsilon/2]^2},$$

où $(\eta_v)_{v \in \varepsilon\mathbb{Z}^2}$ est la famille de variables gaussiennes centrées réduites indépendantes définie par :

$$\eta_v = \frac{1}{\varepsilon} \int_{v + [-\varepsilon/2, \varepsilon/2]^2} dW.$$

Il est alors naturel de définir le champ suivant dont on s'attend à ce qu'il approxime bien f :

$$f^\varepsilon = q \star W^\varepsilon.$$

Remarque 3.26. Dans le Chapitre 3, nous considérons en fait le champ $f_R^\varepsilon = q_R \star W^\varepsilon$ où q_R est la fonction q tronquée définie dans la Section 3.1.3. Ceci permet de travailler avec des champs à portée finie, ce qui est très important dans plusieurs arguments expliqués ci-dessous. Pour simplifier les notations, nous énonçons toutefois les résultats avec le champ f^ε .

Notons que, contrairement aux discrétisations effectuées en Section 3.1 et 3.2.1, le champ considéré après discrétisation **reste un champ continu** (i.e. indexé par le plan et non par un réseau).

L'idée générale de la preuve est que la famille $(\eta_v)_{v \in \varepsilon\mathbb{Z}^2}$ nous donne une structure produit appropriée à l'application d'une méthode à la OSSS. Soit $\text{Cross}_\ell^\varepsilon(2R, R)$ l'événement de croisement de $[0, 2R] \times [0, R]$ par $f^\varepsilon([-l, +\infty[)$ (notons qu'il y a ici un petit conflit de notations avec la Section 3.2.1). Énonçons en premier lieu la formule différentielle (classique) suivante :

Lemme 3.27. *Soit X un vecteur gaussien standard de dimension n et soit $A \subseteq \mathbb{R}^n$ un ensemble borélien. Notons $\vec{\ell} = (\ell, \dots, \ell) \in \mathbb{R}^n$. On a :*

$$\frac{d}{d\ell} \mathbb{P} [X + \vec{\ell} \in A] = \sum_{i=1}^n \mathbb{E} [X_i \mathbf{1}_{X + \vec{\ell} \in A}].$$

Si on applique cette égalité à la famille $(\eta_v)_{v \in \varepsilon\mathbb{Z}^2}$, on obtient l'inégalité suivante :

$$\frac{d}{d\ell} \mathbb{P} [\text{Cross}_\ell^\varepsilon(2R, R)] \geq \frac{\varepsilon}{\int_{\mathbb{R}^2} q} \sum_{v \in \varepsilon\mathbb{Z}^2} \mathbb{E} [\eta_v \mathbf{1}_{\text{Cross}_\ell^\varepsilon(2R, R)}].$$

Cependant, si l'on veut appliquer l'inégalité d'OSSS, nous avons besoin d'exprimer la dérivée ci-dessus en fonction des "influences avec retraitage" définies en (2.5). Or, il n'est pas difficile de montrer qu'il existe une constante $c > 0$ telle que, pour tout ensemble borélien $A \subseteq \mathbb{R}^n$ croissant et tout $i \in \{1, \dots, n\}$, on a :

$$\mathbb{E} [X_i \mathbf{1}_{X \in A}] \geq c I_i^{\gamma_n, \text{ret}}(A), \quad (3.10)$$

où γ_n est la mesure gaussienne standard. Afin d'appliquer cette inégalité à la famille $(\eta_v)_{v \in \varepsilon\mathbb{Z}^2}$ et à un événement de croisement (pour le champ f^ε), il faut que l'événement de croisement soit **croissant par rapport aux variables η_v** , ce qui est le cas car nous avons fait l'hypothèse (forte!) $q \geq 0$. On peut maintenant appliquer l'inégalité d'OSSS (i.e. le Théorème 2.14) de la même façon qu'en Section 2.2, ce qui permet d'obtenir l'inégalité suivante (qui est l'analogie de (2.6)) :

$$\exists c' > 0, \forall \ell > 0, \mathbb{P} [\text{Cross}_\ell^\varepsilon(2R, R)] \geq 1 - \frac{1}{c'} \exp(-c' \ell \varepsilon R^{c'}).$$

Notons la présence, de même que dans la Section 3.2.1, d'une constante $\varepsilon > 0$ dans l'inégalité, ce qui la rend inutile lorsque ε est trop petit. De même que dans la Section 3.2.1, on peut, à l'aide d'arguments de sprinkling, déduire de cette inégalité que les probabilités de croisement pour le champ f convergent vers 1. Par ailleurs, comme dans le cas de la percolation de Bernoulli (voir la Section 2.2), on peut en déduire que la taille de la fenêtre presque critique est d'ordre polynomiale :

Proposition 3.28 (Théorème 1.15 du Chapitre 3, en commun avec Stephen Muirhead). *L'analogie de la Proposition 2.10 est vraie sous les hypothèses du Théorème 3.18.*

4 Une courte parenthèse : le raisonnement par analogie

¹⁸Cette section constitue une parenthèse écrite dans le but de prendre un petit peu de recul sur les méthodes utilisées. Comme mentionné au début de cette introduction (et comme nous

¹⁸Je remercie Damien Gayet et Alejandro Rivera d'avoir pris le temps de discuter de ce sujet. Que le caractère éventuellement naïf de cette petite section ne leur soit cependant pas attribué! Merci aussi à Emmanuelle Danblon pour les premières pistes de réflexion.

avons commencé à le voir dans les premières sections) un des buts de cette thèse est de montrer des similarités entre des modèles dont on s’attend à ce qu’ils aient une même limite d’échelle. Autrement dit, et en utilisant une expression due à Poincaré, on veut montrer une “parenté profonde mais cachée” entre différents modèles de percolation planaire.

“Maintenant, qu’est-ce que la science ? [...] c’est avant tout une classification, une façon de rapprocher des faits que les apparences séparaient, bien qu’ils fussent liés par quelque parenté naturelle et cachée.” (pp 265-266 de [Poi05])

Il semble que, pour essayer de montrer une telle parenté, la méthode de raisonnement la plus naturelle soit une méthode par analogie. Mais qu’est-ce que cela signifie ici ? Il me semble qu’une telle méthode de raisonnement se traduit souvent par les étapes suivantes :

- (1) On observe deux modèles A et B (dont souvent un plus simple que l’autre, disons le A), avec la sensation qu’ils “se ressemblent”.
- (2) On essaye de répondre à des questions sur le modèle A .
- (3) On “tord” le modèle B pour le faire entrer dans le formalisme du modèle A . Autrement dit, on change notre point de vue sur le modèle B pour adopter une vision moins intrinsèque mais inspirée du modèle A .
- (4) On essaye d’en déduire des résultats sur le modèle B .
- (5) On se rend compte a posteriori qu’il n’y avait pas besoin de “tordre” le modèle B pour le faire entrer dans le cadre du modèle A . Plus précisément, soit i) on trouve dans le modèle B un analogue convaincant et intrinsèque du formalisme du modèle A soit ii) on trouve une méthode plus générale s’appliquant aux deux modèles.
- (6) On répète les points (1) à (5) ci-dessus afin de résoudre d’autres questions sur les modèles.

Bien entendu, on peut aussi suivre les étapes ci-dessus en omettant l’étape (5). Il me semble que c’est cependant souvent plus dans l’étape (5) que peut nous apparaître la “parenté profonde” entre les différents modèles. Pour tenter de clarifier cette feuille de route, donnons quelques exemples venant de modèles étudiés dans cette thèse. Focalisons-nous particulièrement sur le théorème de RSW. Celui-ci a été démontré pour la percolation de Bernoulli indépendamment par Russo [Rus78] et Seymour et Welsh [SW78]. Une des propriétés clefs utilisées par ces auteurs est que, lorsque l’on conditionne (par exemple) par rapport au croisement le plus bas dans un rectangle, la configuration au-dessus de ce croisement reste non biaisée. Cette propriété n’est plus vraie dans les modèles de percolation continue tels que le modèle booléen [MR96], la percolation de Voronoi (défini en Section 1.3.2) ou le modèle de percolation de lignes nodales (voir la Section 3). L’analogie avec la percolation de Bernoulli a toutefois permis à Alexander [Ale96b] de montrer un théorème de RSW pour le modèle booléen (avec rayons déterministes). Pour cela, il a suivi les méthodes de preuves originelles en cherchant l’analogie de la “région sous le chemin le plus bas”, analogue probablement moins naturel qu’en percolation de Bernoulli mais dont l’étude minutieuse a permis à Alexander d’arriver à ses fins. Cette preuve me semble suivre les étapes (1) à (4) ci-dessus. Tassion [Tas16] a quant à lui développé une méthode plus générale (voir aussi [ATT16] pour la percolation booléenne) qui correspond probablement plus à l’étape (5) ci-dessus. Celle-ci suggère une parenté entre de nombreux modèles, plus précisément entre tous les modèles de percolation planaire suffisamment symétriques, positivement corrélés, et avec une “propriété de quasi-indépendance”, voir la Section 3.1.1.

Comme nous l’avons vu en Section 3, Beffara et Gayet ont démontré un théorème de RSW pour les lignes nodales en suivant les méthodes de Tassion. La partie la plus délicate a été de montrer que le modèle avait une propriété de quasi-indépendance (l’idée était plus précisément de montrer que le modèle était assez proche d’un modèle avec des propriétés de quasi-indépendance,

mais cela revient finalement au même). Leur méthode a consisté à discrétiser le modèle, démontrer des propriétés de quasi-indépendance sur des modèles discrets, puis conclure en montrant que les modèles discrets approximaient bien le modèle continu. Il me semble que cela constitue un retour aux étapes (1) à (4) ci-dessus, la discrétisation étant une manière de faire entrer le modèle de percolation de lignes nodales dans le formalisme de modèles discrets. De même, dans nos preuves que le niveau critique de la percolation de lignes nodales est le niveau 0, nous avons à chaque fois discrétisé le modèle afin de pouvoir importer des techniques telles que les inégalités KKL ou OSSS. Peut-on démontrer de telles inégalités de façon plus intrinsèque ? Est-il possible de montrer une inégalité de KKL directement dans le continu ? (Concernant la quasi-indépendance, peut-être que notre preuve utilisant la décomposition avec un bruit blanc constitue un premier pas vers l'étape (5) ci-dessus, tous les objets considérés étant continus, et le théorème de Cameron-Martin de dimension infinie pouvant être considéré comme l'analogie naturel d'outils issus de théories discrètes.)

Finalement, il semble que l'on peut observer un va-et-vient entre des étapes dans lesquelles l'analogie est essentiellement un outil efficace de travail (les étapes (1) à (4) ci-dessus) et une étape où elle prend peut-être un sens plus profond qui me semblerait intéressant d'étudier (notamment en lien avec la théorie d'universalité en physique statistique planaire dans laquelle l'analogie a une place centrale).

5 Les relations d'échelle

Dans cette section, nous nous focalisons de nouveau sur le modèle de percolation de Bernoulli sur \mathbb{Z}^2 ou \mathcal{T} étudié dans la Section 2. Commençons par énoncer une conséquence du théorème d'invariance conforme (Théorème 2.2) : le calcul d'**exposants critiques**. Comme nous le mentionnons dans la Section 8, le théorème d'invariance conforme permet de prouver des résultats forts d'existence de limite d'échelle. En particulier (voir [Smi01, CN07, Wer07]), il a permis de montrer que, au point critique, les **interfaces** (i.e. la frontière entre l'ensemble noir et l'ensemble blanc) convergeaient vers un **processus SLE** de paramètre 6 (Schramm-Loewner Evolution, voir [Sch00] où Schramm a introduit ces processus). Grâce à l'étude de ce processus, on peut décrire de façon plus quantitative le modèle de percolation planaire. Il a par exemple été prouvé par Lawler-Schramm-Werner et Smirnov-Werner [LSW02, SW01] que, dans le cas de la percolation par sites sur \mathcal{T} :

$$\theta(p) = \mathbf{1}_{p \geq 1/2} (p - 1/2)^{5/36 + o(1)}, \quad (5.1)$$

où $o(1)$ converge vers 0 en $p = 1/2$.

L'existence et la valeur de cet exposant (et des autres exposants que nous rencontrerons dans cette section) avaient été auparavant prédites en utilisant des méthodes venant de la physique théorique ("scaling", renormalisation, théorie conforme des champs, gaz de Coulomb, gravité quantique..., nous renvoyons à [Kes87, SW01] pour des références).

Résumée en une phrase, la preuve de (5.1) consiste à calculer les **exposants critiques des événements à j bras** (voir leur définition ci-dessous) en utilisant les processus SLE puis à utiliser les **relations d'échelles** entre exposants critiques. Ces relations, prouvées par Kesten dans [Kes87], ont été prédites en utilisant des techniques de "scaling" (voir par exemple les références de [Kes87] et le Chapitre 9 de [Gri99]). Dans cette section, nous expliquons ce que sont les relations d'échelles. Pour cela, nous devons tout d'abord définir les quantités que ces relations décrivent. Tout comme pour la fonction de percolation θ , on s'attend à ce que celles-ci soient décrites par des exposants critiques ; l'exposant de θ est lui souvent noté β (ainsi, on sait que $\beta = 5/36$ pour la percolation par sites sur \mathcal{T}).

Définition 5.1. Si $1 \leq r \leq R < +\infty$ et $j \in \mathbb{N}^*$, l'événement à j bras est l'événement qu'il existe j chemins monochromatiques reliant $\partial[-r, r]^2$ à $\partial[-R, R]^2$ dont les couleurs alternent, voir la Figure 5.1. Notons cet événement $\mathbf{A}_j(r, R)$ et notons $\alpha_{j,p}(r, R) = \mathbb{P}_p[\mathbf{A}_j(r, R)]$ (en particulier, $\alpha_{1,p}(1, R) = \theta_R(p)$).

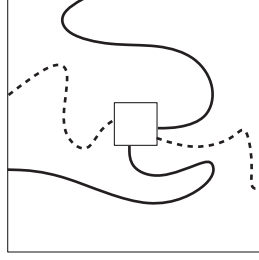

FIGURE 5.1 – L'événement à 4 bras

Il est conjecturé qu'il existe des exposants ζ_j tels que $\alpha_{j,1/2}(r, R) = (r/R)^{\zeta_j + o(1)}$, où $o(1)$ converge vers 0 quand r/R tend vers 0. Il est connu (voir [LSW02, SW01]) que ces exposants existent pour la percolation par sites sur \mathcal{T} , que $\zeta_1 = 5/48$, et que $\zeta_j = (j^2 - 1)/12$ dès que $j \geq 2$. Dans le cas de la percolation par arêtes sur \mathbb{Z}^2 , il n'est pas difficile - en utilisant le théorème de RSW - de montrer que les probabilités d'événements à j bras décroissent polynomialement vite : Pour tout $j \in \mathbb{N}^*$, il existe une constante $C = C(j) \in [1, +\infty[$ telle que (si $R \geq r$ est que r est assez grand) :

$$\frac{1}{C}(r/R)^C \leq \alpha_{j,1/2}(r, R) \leq C(r/R)^{1/C}.$$

Énonçons une autre propriété très importante des quantités $\alpha_{j,1/2}(\cdot, \cdot)$: la propriété de **quasi-multiplicativité** (qui est naturelle si on a à l'esprit l'existence des exposants ζ_j) :

Proposition 5.2 ([Kes87], voir aussi [Wer07, Nol08, SS10]). *Considérons la percolation par arêtes sur \mathbb{Z}^2 ou la percolation par sites sur \mathcal{T} . Pour tout $j \in \mathbb{N}^*$, il existe $C = C(j) \in [1, +\infty[$ telle que, pour tous $r_1 \leq r_2 \leq r_3$ assez grands :*

$$\alpha_{j,1/2}(r_1, r_3) \leq \alpha_{j,1/2}(r_1, r_2)\alpha_{j,1/2}(r_2, r_3) \leq C\alpha_{j,1/2}(r_1, r_3).$$

(Notons que l'inégalité de gauche est une conséquence directe de l'indépendance spatiale du modèle.)

Pour la percolation par arêtes sur \mathbb{Z}^2 , même si l'existence des exposants ζ_j n'est pas prouvée, certaines inégalités sont connues. Par exemple, il existe $\varepsilon > 0$ tel que, pour tous $1 \leq r \leq R$:

$$\alpha_{4,1/2}(r, R) \leq \frac{1}{\varepsilon}(r/R)^{1+\varepsilon}, \quad (5.2)$$

$$\alpha_{4,1/2}(r, R) \geq \varepsilon(r/R)^{2-\varepsilon}. \quad (5.3)$$

L'inégalité (5.2) est prouvée dans l'appendice B de [SS11] à l'aide de techniques d'algorithmes aléatoires. L'inégalité (5.3) est quant à elle l'occasion d'ouvrir une parenthèse sur une inégalité de corrélation que nous n'avons pas encore rencontrée dans cette introduction.

5.1 L'inégalité de BK-Reimer

Une façon de démontrer (5.3) est d'utiliser l'inégalité de BK-Reimer, que l'on peut énoncer de la façon suivante : Donnons-nous deux ensembles $A, B \subseteq \Omega_n = \{-1, 1\}^n$ et définissons l'**occurrence disjointe** de A and B par :

$$A \square B = \{\omega \in \Omega_n : \exists I \subseteq \{1, \dots, n\}, \omega^I \subseteq A \text{ and } \omega^{I^c} \subseteq B\},$$

où ω^I est l'ensemble des configurations $\omega' \in \Omega_n$ telles que $\omega'_I = \omega|_I$. L'**inégalité de van den Berg et Kesten (BK)** nous dit que, si A et B sont croissants, alors :

$$\forall p \in [0, 1], \mathbb{P}_p^n [A \square B] \leq \mathbb{P}_p^n [A] \mathbb{P}_p^n [B]. \quad (5.4)$$

On pourra consulter [Gri99] pour une preuve de cette inégalité.

L'**inégalité de Reimer**, [Rei00] (ou inégalité de BK-Reimer) permet quant à elle de généraliser à la fois l'inégalité de FKG et l'inégalité de BK : elle affirme que (5.4) est vraie même si l'on ne suppose plus que A et B sont croissants. Cette inégalité permet par exemple d'obtenir que :

$$\alpha_{2j+1,p}(r, R) = \mathbb{P}_p [\mathbf{A}_{2j}(r, R) \square \mathbf{A}_1(r, R)] \leq \alpha_{1,p}(r, R) \alpha_{2j,p}(r, R). \quad (5.5)$$

Comme on sait que, les quantités $\alpha_{j,1/2}(r, R)$ décroissent polynomialement vite vers 0, on obtient qu'il existe $\varepsilon > 0$ tel que :

$$\alpha_{2j+1,1/2}(r, R) \leq (r/R)^\varepsilon \alpha_{2j,1/2}(r, R).$$

Cette inégalité permet de démontrer (5.3). En effet, il a été remarqué par Aizenman (voir par exemple la première feuille d'exercices de [Wer07]) que le théorème de RSW permet de calculer trois exposants bien particuliers : les exposants des événements à 2 et 3 bras dans le demi-plan et l'exposant à 5 bras dans tout le plan (i.e. ζ_5). Il est ainsi connu que, même pour le réseau \mathbb{Z}^2 , ζ_5 existe et est égal à 2. De tels exposants sont appelés universels car ils sont les mêmes pour des modèles appartenant à différentes classes d'universalité.

En fait, on peut même montrer l'inégalité suivante qui améliore (5.3) (et dont nous verrons l'importance plus bas) :

$$\exists \varepsilon > 0, \forall 1 \leq r \leq R, \alpha_{4,1/2}(r, R) \alpha_{1,1/2}(r, R) (r/R)^\varepsilon \geq \varepsilon (r/R)^2. \quad (5.6)$$

Pour la preuve de cette inégalité, nous renvoyons à l'appendice (par Beffara) de [GPS10].

5.2 La longueur de corrélation et les relations d'échelle

Afin d'énoncer les deux relations d'échelle auxquelles nous nous sommes intéressés dans cette thèse, nous devons maintenant définir la **longueur de corrélation**. Plaçons-nous à un paramètre $p = 1/2 + \varepsilon$ pour un certain $\varepsilon > 0$ très petit et observons le modèle de percolation dans une fenêtre de taille R . Si R est suffisamment grand, alors on peut se rendre facilement compte que le modèle est sur-critique (voir la Figure 2.5). Au contraire, si R n'est pas très grand, on ne peut pas faire la différence entre ce modèle et un modèle critique. La longueur de corrélation $L(p)$ est la plus petite des longueurs auxquelles la sur-criticalité du modèle est claire. On peut par exemple la définir de la façon suivante, où $\varepsilon_0 > 0$ est un paramètre suffisamment petit.

$$\forall p \in]1/2, 1], L(p) = L^{\varepsilon_0}(p) = \inf \{ R \geq 1 : \mathbb{P}_p [\text{Cross}(RQ)] \geq 1 - \varepsilon_0 \},$$

pour un quad Q bien choisi (par exemple, $Q = [0, 2] \times [0, 1]$). Le théorème de RSW implique que (si ε_0 est assez petit) $L(p)$ tend vers $+\infty$ quand p tend vers $1/2$.

Il est conjecturé qu'il existe un exposant ν tel que $L(p) = |p - 1/2|^{-\nu+o(1)}$. Dans le cas du réseau triangulaire, il a été prouvé (voir [SW01]) que ν existe et vaut $4/3$. Comme mentionné plus haut, les auteurs de [LSW02, SW01] ont calculé les exposants ζ_j . Par ailleurs, Smirnov et Werner en ont déduit la valeur des autres exposants en utilisant des relations d'échelles dans [SW01]. Énonçons les deux relations d'échelle liant η et ν aux exposants ζ_j .

Théorème 5.3 ([Kes87]). *Si les exposants ζ_1 et ζ_4 existent, alors les exposants β et ν existent aussi et vérifient :*

$$\nu = 1/(2 - \zeta_4); \quad \zeta_1 \nu = \beta.$$

De plus, même si l'on ne sait pas que les exposants ζ_1 et ζ_4 existent, les relations correspondantes pour la fonction de percolation, la longueur de corrélation et les probabilités d'événements à 1 et 4 bras sont vraies, i.e. (pour tout $p \in]1/2, 1]$) :

$$\begin{aligned}\alpha_{4,1/2}(1, L(p)) L(p)^2 &\asymp (p - p_c)^{-1} \\ \alpha_{1,1/2}(1, L(p)) &\asymp \theta(p),\end{aligned}$$

où les constantes dans \asymp ne dépendent que du choix de ϵ_0 dans la définition de $L(p)$.

Ainsi, l'étude du modèle au point critique donne beaucoup d'informations sur le comportement de celui-ci dans la "phase presque critique". Notons par ailleurs que, si on combine ces relations avec l'inégalité (5.6), on obtient le Théorème 1.2 qui en termes d'exposants nous dit que si β existe alors il est strictement plus petit que 1. De la même façon, si on combine la première relation d'échelle avec l'inégalité (5.2), on obtient que si ν existe alors il est strictement plus grand que 1.

Terminons cette section en expliquant brièvement les idées principales derrière le Théorème 5.3. En ayant à l'esprit la formule de Russo (Lemme 2.11) et le fait que les événements de pivots sont intimement liés aux événements à 4 bras (voir la Figure 2.4), on peut s'attendre à ce que :

$$\frac{d}{dp} \mathbb{P}_p [\text{Cross}(2R, R)] \asymp R^2 \alpha_{4,p}(1, R). \quad (5.7)$$

Fixons un certain $p \in]1/2, 1]$ et supposons que R est plus petit que $L(p)$. Alors, le modèle à échelle R étant censé être "proche du modèle critique" pour tout paramètre $u \in]1/2, p]$, on peut s'attendre à ce que $\alpha_{4,u}(1, R)$ soit de l'ordre de $\alpha_{4,1/2}(1, R)$ pour de tels paramètres u . En particulier, (5.7) implique que :

$$\mathbb{P}_p [\text{Cross}(2R, R)] \simeq \mathbb{P}_{1/2} [\text{Cross}(2R, R)] + (p - 1/2) R^2 \alpha_{4,1/2}(1, R).$$

Le modèle n'est donc plus "presque critique" dès que $R^2 \alpha_{4,1/2}(1, R) \gg (p - 1/2)^{-1}$ (rappelons ici que (5.3) implique que $R^2 \alpha_{4,1/2}(1, R)$ tend vers $+\infty$ lorsque R tend vers $+\infty$). On voit ainsi apparaître la première relation d'échelle.

Concernant la seconde relation d'échelle, l'idée est que, si $p > 1/2$, la probabilité qu'il y ait un chemin infini noir issu de 0 est de l'ordre de la probabilité qu'il y ait un chemin de 0 jusqu'à distance $L(p)$. En effet, aux échelles supérieures plus grandes que $L(p)$, le modèle est suffisamment sur-critique pour qu'il y ait des connexions noires infinies avec grande probabilité. Par ailleurs, comme nous l'avons déjà vu dans le cas de l'événement à 4 bras, on peut s'attendre à ce que, aux échelles inférieures à $L(p)$, $\alpha_{j,p}(\cdot, \cdot)$ soit du même ordre de grandeur que $\alpha_{j,1/2}(\cdot, \cdot)$, ce qui donne finalement la deuxième relation d'échelle.

6 La percolation de Voronoi

Dans la Section 1.3.2, nous avons défini le modèle de percolation de Voronoi dans le plan. Rappelons que, d'après un résultat de Bollobás et Riordan, le point critique de ce modèle est égal à $1/2$. Pour une preuve alternative, nous renvoyons à [DCRT17a] où Duminil-Copin, Raoufi et Tassion démontrent la propriété de décroissance exponentielle des probabilités de connexions dans la phase sous-critique pour ce modèle en toute dimension (cette propriété a été démontrée en dimension 2 dans [BR06a]). Duminil-Copin, Raoufi et Tassion ont par ailleurs montré que la fonction de percolation vérifiait $\theta^{an}(p) \geq \varepsilon(p - 1/2)$ (toujours en toute dimension). Comme mentionné dans la Section 1.3.2 nous avons prouvé qu'en dimension 2 on a l'inégalité stricte suivante (voir le Théorème 1.9) :

$$\theta^{an}(p) \geq \varepsilon(p - 1/2)^{1-\varepsilon}. \quad (6.1)$$

Comme expliqué dans la Section 5, cette inégalité est dans le cas de la percolation de Bernoulli une conséquence de : i) deux relations d'échelles et ii) une inégalité sur les probabilités d'événements à j bras (l'inégalité (5.6)). Dans le Chapitre 5 de cette thèse, nous prouvons des relations d'échelle annealed pour la percolation de Voronoi, voir la Section 6.1 ci-dessous. Dans le Chapitre 6, nous démontrons l'analogie de (5.6) et en déduisons (6.1), voir la Section 6.2 ci-dessous. Notons cependant que notre principale motivation dans les Chapitres 5 et 6 était de développer des outils destinés à l'étude des modèles de percolation de Voronoi dynamiques. Les deux outils principaux sont une **propriété de quasi-multiplicativité annealed** - qui s'avère être l'étape principale dans la preuve de relations d'échelles annealed - et des **estimations quenched sur les probabilités d'événements à j bras** - celles-ci sont au centre de la preuve de l'analogie de (5.6). Énonçons tout d'abord quelques résultats fondamentaux sur la percolation de Voronoi et discutons de l'intérêt de ce modèle. Rappelons que nous notons η le processus de points non colorés, $\omega \in \{-1, 1\}^\eta$ le processus de points colorés, \mathbb{P}_p^{an} la loi annealed de paramètre p , et enfin \mathbf{P}_p^η la loi quenched.

Pourquoi étudier le modèle de percolation de Voronoi ? Comme c'est un modèle en environnement aléatoire, l'étude de celui-ci permet de comparer naturellement des modèles de percolation sur différents pavages (voir par exemple le Théorèmes 6.2). Par ailleurs, ce modèle semble être très approprié à l'étude de limites d'échelles. En effet, si l'on veut passer d'une échelle à l'autre, il suffit d'ajouter des points dans η (i.e. d'augmenter son intensité). Au contraire, dans les modèles sur réseau fixé, il faut modifier radicalement le réseau pour passer d'une échelle à l'autre. Comme expliqué par Benjamini et Schramm dans [BS98], ce modèle possède une autre propriété très utile : le **découplage entre la métrique et la mesure**. Expliquons brièvement cette propriété, qui est liée à la conjecture d'invariance conforme du modèle (i.e. la conjecture selon laquelle le Théorème 2.2 est vrai pour la percolation de Voronoi ; nous renvoyons à [BS98] pour des liens précis entre cette conjecture et les résultats que nous énonçons maintenant). Pour cela, changeons la définition du modèle : donnons-nous un entier n , un domaine de Jordan lisse $D \subseteq \mathbb{R}^2$, une mesure μ sur D équivalente à la mesure de Lebesgue, une métrique riemannienne d sur D , et un automorphisme conforme φ de D . Donnons-nous aussi S_1 et S_2 deux segments disjoints non vides sur ∂D et notons Q le quad associé. Par ailleurs, considérons un processus de Poisson η d'intensité $n\mu$, construisons son diagramme de Voronoi dans D à l'aide de la distance d plutôt qu'à l'aide de la distance euclidienne, et appliquons φ à ce diagramme. Cette opération a deux effets sur la loi du diagramme : elle modifie **à la fois la mesure et la métrique**. Les auteurs de [BS98] ont montré qu'une telle modification de la métrique n'a asymptotiquement (i.e. quand n tend vers $+\infty$) pas d'effet sur l'événement de croisement de Q . Le cas de la mesure est quant à lui toujours ouvert. Terminons ce paragraphe en notant qu'une inégalité que nous avons déjà rencontrée, à savoir le fait que la somme des influences est plus petite que la racine du nombre de points (voir (2.7)), est au cœur des preuves de [BS98]. On appelle "défaut" le fait que deux cellules soient voisines avant application de φ au diagramme mais ne le soient plus après (ou vice versa). Benjamini et Schramm ont en premier lieu démontré que, avec grande probabilité, l'application de φ au diagramme de Voronoi crée bien moins que \sqrt{n} défauts. L'inégalité (2.7) suggère que cette perturbation n'a asymptotiquement pas d'effet sur les probabilités de croisement. Ainsi, de même que dans la Section 3.1.3, l'inégalité (2.7) est au centre du contrôle d'une perturbation sur un modèle de percolation.

Théorèmes de RSW annealed et quenched. Retournons à l'étude du modèle dans le cas $\mu = \text{Leb}_{\mathbb{R}^2}$ et $d = |\cdot|$ et étudions les événements de croisement. Comme pour les autres modèles étudiés dans cette introduction, nous notons $\text{Cross}(Q)$ l'événement de croisement d'un quad Q et $\text{Cross}(\rho_1, \rho_2) = \text{Cross}(Q)$ si Q est le rectangle $[0, \rho_1] \times [0, \rho_2]$ dont les segments distingués sont les côtés gauche et droit. Tassion [Tas16] a montré que le théorème de RSW était vrai pour la percolation de Voronoi :

Théorème 6.1 ([Tas16]). *Pour tout quad Q , il existe $c = c(Q) > 0$ telle que, pour tout $R \in]0, +\infty[$:*

$$c \leq \mathbb{P}_{1/2}^{an} [\text{Cross}(RQ)] \leq 1 - c.$$

Comme expliqué dans la Section 3.1.1, la preuve de Tassion utilise les propriétés de quasi-indépendance du modèle (qui dans le cas de la percolation de Voronoi ne posent pas de difficulté), les symétries de celui-ci, ainsi que des inégalités de type FKG. Comme les mesures quenched sont des mesures produit, nous avons une inégalité de FKG au niveau quenched. Il s'avère qu'une telle inégalité est aussi vraie au niveau annealed, si on considère qu'un événement A est croissant s'il est stable par ajout de points noirs et retrait de points blancs. (Voir par exemple le Lemme 14 du Chapitre 8 de [BR06b] ; c'est cette inégalité annealed qui est importante pour la preuve du Théorème 6.1.)

Comme mentionné dans la Section 1.3.2, dans le cas où Q est un carré, il a été prouvé par Ahlberg, Griffiths, Morris et Tassion que les probabilités de croisement quenched ne dépendaient asymptotiquement presque sûrement pas de l'environnement η . Le résultat est vrai pour les événements de croisement de tout rectangle :

Théorème 6.2 ([AGMT16]). *Soit $\rho \in]0, +\infty[$. Il existe une constante absolue $\varepsilon > 0$ et une constante $C = C(\rho) < +\infty$ telles que, pour tout $R \in]0, +\infty[$:*

$$\text{Var} \left(\mathbf{P}_{1/2}^\eta [\text{Cross}(\rho R, R)] \right) \leq CR^{-\varepsilon}.$$

Notons que ce résultat - ou au moins le fait que la variance tende vers 0 - est intuitif si on a à l'esprit la conjecture d'universalité de la percolation (et si l'on considère qu'il y a assez de propriétés de "mélange spatial" dans le processus η pour que le pavage de Voronoi se comporte avec grande probabilité comme un pavage possédant de nombreuses symétries). Notons par ailleurs que, si ce résultat est un indice fort de l'universalité de la percolation, il ne permet cependant pas de comparer le modèle à deux échelles différentes. Dans cette thèse, nous démontrons une version plus quantitative du Théorème 6.2 (voir la Section 6.2).

6.1 Relations d'échelle annealed pour la percolation de Voronoi

Tout comme dans la Section 5, nous étudions ci-dessous les relations d'échelle entre la fonction de percolation, la longueur de corrélation et les événements à j bras. La définition des événements à j bras est la même que dans le cas de la percolation de Bernoulli (voir la Définition 5.1). Nous les notons toujours $\mathbf{A}_j(r, R)$ et nous notons par ailleurs $\alpha_{j,p}^{an}(r, R) = \mathbb{P}_p^{an} [\mathbf{A}_j(r, R)]$ leur probabilité annealed. On peut montrer, comme corollaire du théorème de RSW annealed, que ces quantités décroissent vers 0 à vitesse polynomiale si $p = 1/2$. La partie la plus technique de notre étude de la percolation de Voronoi est probablement la preuve du résultat suivant :

Proposition 6.3 (Proposition 1.6 du Chapitre 5). *La propriété de quasi-multiplicativité est vraie pour les quantités $\alpha_{j,1/2}^{an}(r, R)$. Ainsi, pour tout $j \in \mathbb{N}^*$, il existe une constante $C = C(j) \in [1, +\infty[$ telle que :*

$$\frac{1}{C} \alpha_{j,1/2}^{an}(r_1, r_3) \leq \alpha_{j,1/2}^{an}(r_1, r_2) \alpha_{j,1/2}^{an}(r_2, r_3) \leq C \alpha_{j,1/2}^{an}(r_1, r_3).$$

Définissons maintenant la **longueur de corrélation annealed**. Étant donné un réel $\varepsilon_0 > 0$ suffisamment petit et un paramètre $p \in]1/2, 1]$, la longueur de corrélation annealed est :

$$L^{an}(p) = \inf \{ R \geq 1 : \mathbb{P}_p^{an} [\text{Cross}(2R, R)] \geq 1 - \varepsilon_0 \}.$$

Dans le Chapitre 5, nous avons étendu les théorèmes de RSW annealed et quenched (i.e. les Théorèmes 6.1 et 6.2) à la phase presque critique, c'est-à-dire pour tout p et à toute échelle plus

petite que $L(p)$. Grâce à ces résultats, à la propriété de quasi-multiplicativité, et à l'étude de notions quenched et annealed d'ensembles pivot (voir plus bas), nous avons prouvé dans [V5] des relations d'échelles annealed pour la percolation de Voronoi :

Théorème 6.4 (Théorème 1.11 du Chapitre 5). *Les relations d'échelles du Théorème 5.3 sont vraies pour la percolation de Voronoi dans le sens que (si $p \geq 1/2$) :*

$$\alpha_{4,1/2}^{an}(1, L^{an}(p)) L^{an}(p)^2 \asymp (p - 1/2)^{-1}$$

et :

$$\alpha_{1,1/2}^{an}(1, L^{an}(p)) \asymp \theta^{an}(p),$$

les constantes dans \asymp ne dépendant que du paramètre ε_0 de la définition de $L(p)$.

Donnons maintenant quelques idées derrière les preuves de ces différents résultats. Commençons par une observation générale sur les difficultés rencontrées : Comme nous étudions des événements dégénérés (les événements à j bras) il n'est pas du tout clair a priori que, lorsque l'on conditionne par rapport à un de ces événements, l'environnement η ne devient pas lui-même dégénéré, voir la Figure 6.1. Intéressons-nous tout d'abord à la preuve de la propriété de quasi-multiplicativité.

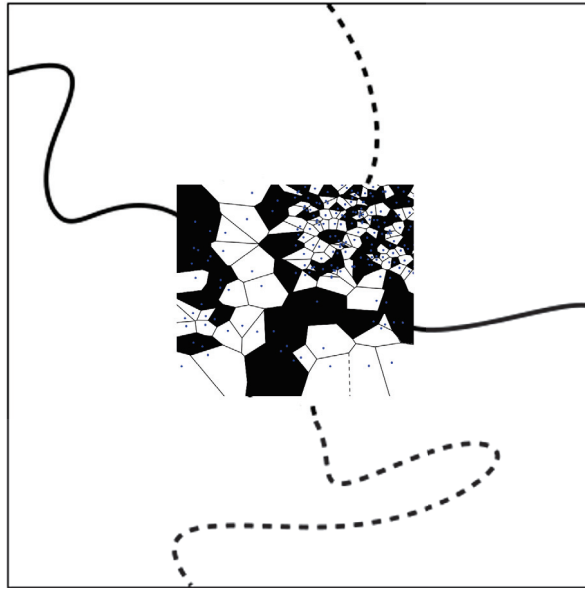

FIGURE 6.1 – Ce que l'on espère ne pas rencontrer : une configuration dégénérée après conditionnement par un événement à 4 bras. La dégénérescence peut être caractérisée par exemple par une très grande densité de points en certains endroits, ici en haut à droite (ce qui rend très coûteux l'existence de longues connexions), et une très faible densité de points en d'autres endroits, ici en bas à gauche (ce qui implique des propriétés de dépendance spatiale fortes et est probablement le pire cas de figure).

A. Idées générales de la preuve de la propriété de quasi-multiplicativité. La principale difficulté (si on compare la percolation de Voronoi à la percolation de Bernoulli sur \mathbb{Z}^2 ou \mathcal{T}) provient des dépendances entre échelles. Par exemple (si $r_1 \leq r_2 \leq r_3$), les événements $\mathbf{A}_j(r_1, r_2)$ et $\mathbf{A}_j(r_2, r_3)$ ne sont pas indépendants. En particulier, contrairement à la percolation de Bernoulli, l'inégalité de gauche dans la Proposition 6.3 n'est pas évidente. Pour palier ces difficultés, nous avons considéré les événements et quantités suivantes :

Définition 6.5 (Définition 2.3 du Chapitre 5). Soient $r \in]0, +\infty[$ et $R \in [r, +\infty[$. Notons $A(r, R)$ l'anneau $[-R, R]^2 \setminus]-r, r[^2$ et :

$$\begin{aligned}\widehat{\mathbf{A}}_j(r, R) &= \left\{ \mathbb{P}_{1/2}^{an} \left[\mathbf{A}_j(r, R) \mid \omega \cap A(r, R) \right] > 0 \right\} ; \\ f_j(r, R) &= \mathbb{P}_{1/2}^{an} \left[\widehat{\mathbf{A}}_j(r, R) \right] .\end{aligned}$$

Ainsi, $\widehat{\mathbf{A}}_j(r, R)$ est l'événement que, sachant la position et la couleur des points de η dans $A(r, R)$, il est possible que l'événement à j bras soit réalisé. Le résultat suivant est le résultat intermédiaire le plus important du Chapitre 5.

Proposition 6.6 (Proposition 2.4 du Chapitre 5). *Pour tout $j \in \mathbb{N}^*$, il existe une constante $C = C(j) \in [1, +\infty[$ telle que :*

$$\alpha_{j,1/2}^{an}(r, R) \leq f_j(r, R) \leq C \alpha_{j,1/2}^{an}(r, R) .$$

Notons que - par indépendance spatiale des processus de Poisson - l'inégalité de gauche de la Proposition 6.3 est maintenant une conséquence directe de la Proposition 6.6.

Rappelons brièvement l'idée générale des preuves de (l'inégalité de droite de) la propriété de quasi-multiplicativité pour la percolation de Bernoulli. On peut découper celles-ci en deux étapes. i) La première étape consiste à trouver une notion de "bonne configuration" qui est telle que, si la configuration de percolation est bonne aux échelles $r_2/2$ et $2r_2$ et si $\mathbf{A}_j(r_1, r_2/2)$ et $\mathbf{A}_j(2r_2, r_3)$ sont réalisés, alors il n'est pas difficile de connecter les bras qui traversent l'anneau $[-r_2/2, r_2/2]^2 \setminus]-r_1, r_1[^2$ à ceux qui traversent $[-r_3, r_3]^2 \setminus]-2r_2, 2r_2[^2$. Dans le cas de la percolation de Bernoulli, la configuration est bonne si les interfaces entre noir et blanc sont suffisamment séparées, ce qui permet d'utiliser des théorèmes de RSW pour connecter les bras (voir la Figure 6.2). ii) La deuxième étape consiste à utiliser la première étape et les propriétés d'indépendance spatiale du modèle pour montrer que, conditionnellement à l'événement dégénéré $\mathbf{A}_j(r, R)$, la configuration est bonne aux échelles r et R avec probabilité non négligeable.

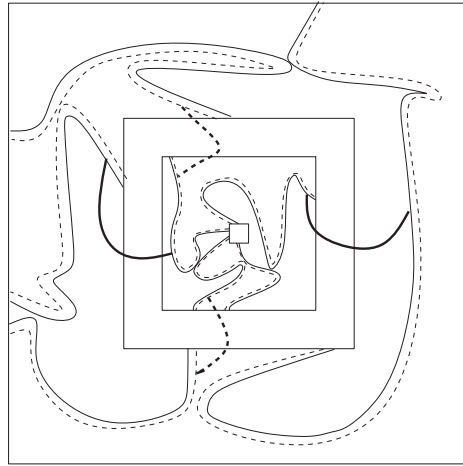

FIGURE 6.2 – L'extension des bras à une échelle supérieure si les interfaces sont suffisamment séparées.

Dans le cas de la percolation de Voronoi, l'idée est qu'une configuration est bonne à échelle R non seulement si les interfaces sont suffisamment séparées à cette échelle, mais aussi si la configuration de points non coloriés η n'est pas trop dégénérée. Par exemple, nous demanderons que η soit suffisamment dense (pour que l'on ait assez de propriétés d'indépendance spatiale) et que, pour une grande famille de quads, les probabilités quenched de croisement

soient non-dégénérées. Le fait que l'on puisse demander que cette deuxième propriété soit vraie sans que cela soit trop coûteux provient du Théorème 6.2. Dans l'étape ii) de la preuve de quasi-multiplicativité, nous utiliserons de façon centrale les événements $\hat{\mathbf{A}}_j(r, R)$.

B. Ensembles pivots et preuve des relations d'échelle annealed. Concentrons-nous maintenant sur la notion de pivots qui, comme on l'a vu dans la Section 5, est centrale dans la preuve des relations d'échelle. Nous avons utilisé les définitions suivantes :

Définition 6.7 (Section 2.4.1 du Chapitre 5). Soit $D \subset \mathbb{R}^2$ un ensemble borélien borné. Nous disons que D est **pivot-quenched** pour un événement A si l'on peut modifier $\mathbb{1}_A(\omega)$ en changeant les couleurs des points dans D mais sans changer le processus sous-jacent η . Nous disons par ailleurs D **pivot-annealed** si on peut changer $\mathbb{1}_A(\omega)$ en ajoutant et/ou en enlevant des points (noirs ou blancs) dans D . Notons $\mathbf{Piv}_D^{quen}(A)$ et $\mathbf{Piv}_D^{an}(A)$ ces deux événements. On peut remarquer que $\mathbf{Piv}_D^{quen}(A) \subseteq \mathbf{Piv}_D^{an}(A)$.

La notion d'ensembles pivots annealed est plus facile à manipuler ($\mathbf{Piv}_D^{an}(A)$ est indépendant de $\eta \cap D$). La notion quenched apparaît quant à elle naturellement dans des formules différentielles de Russo.

Si on applique une formule de Russo **quenched** et qu'on lie suffisamment les différents événements pivots aux événements à 4 bras au niveau **annealed**, on peut suivre la preuve des relations d'échelle dans le cas de la percolation de Bernoulli (i.e. telle que résumée dans la Section 5) et obtenir le Théorème 6.4 i.e. les relations d'échelles annealed pour la percolation de Voronoi (nous renvoyons au Chapitre 5 pour les détails). Terminons donc cette section avec le résultat suivant, qui est un exemple de lien entre les événements pivots et les événements à 4 bras (et dont la preuve repose sur la propriété de quasi-multiplicativité et l'étude des événements $\hat{\mathbf{A}}_j(r, R)$) :

Proposition 6.8 (Proposition 4.1 du Chapitre 5). *Pour tous $1 \leq r \leq R$:*

$$\sum_{S \text{ carré de la grille } r\mathbb{Z}^2} \mathbb{P}_{1/2}^{an} [\mathbf{Piv}_S^{an}(\text{Cross}(2R, R))] \asymp R^2 \alpha_{4,1/2}^{an}(r, R).$$

Notons que, contrairement au cas de la percolation de Bernoulli, toutes les boîtes peuvent influencer sur les événements de croisement, de sorte que, même si S n'intersecte pas $[0, 2R] \times [0, R]$ la quantité $\mathbb{P}_{1/2}^{an} [\mathbf{Piv}_S^{an}(\text{Cross}(2R, R))]$ est non nulle. Cependant, ce sont les boîtes à l'intérieur du rectangle qui contribuent le plus à cette somme.

6.2 Estimations quenched quantitatives

Dans [V6], nous avons démontré une version quantitative du Théorème 6.2 :

Théorème 6.9 (Théorème 1.6 du Chapitre 6). *Soit $\rho \in]0, +\infty[$. Il existe une constante $C = C(\rho) < +\infty$ telle que, pour tout $R \in]0, +\infty[$:*

$$\text{Var} \left(\mathbf{P}_{1/2}^\eta [\text{Cross}(\rho R, R)] \right) \leq C R^2 \alpha_{4,1/2}^{an}(1, R)^2.$$

Le théorème ci-dessus n'est utile que si l'on sait que $R \alpha_{4,1/2}^{an}(1, R)$ converge vers 0 quand R tend vers $+\infty$, ce qui est donné par le lemme suivant :

Lemme 6.10 (Proposition 6.2 du Chapitre 6). *L'analogue de (5.2) est vrai pour $\alpha_{4,1/2}^{an}(r, R)$ i.e. : Il existe $\varepsilon > 0$ tel que, pour tous $1 \leq r \leq R$:*

$$\alpha_{4,1/2}^{an}(r, R) \leq \frac{1}{\varepsilon} (r/R)^{-(1+\varepsilon)}.$$

Nous avons par ailleurs obtenu un analogue du Théorème 6.9 dans le cas des événements à j bras. Pour énoncer ce résultat, nous avons besoin de la notation suivante :

$$\tilde{\alpha}_{j,p}(r, R) = \sqrt{\mathbb{E} \left[\mathbf{P}_p^\eta [\mathbf{A}_j(r, R)]^2 \right]}.$$

Théorème 6.11 (Théorème 1.4 du Chapitre 6). *Soit $j \in \mathbb{N}^*$. Il existe une constante $C = C(j) < +\infty$ telle que, pour tous $1 \leq r \leq R < +\infty$:*

$$\tilde{\alpha}_{j,1/2}(r, R)^2 - \alpha_{j,1/2}^{an}(r, R)^2 = \text{Var} \left(\mathbf{P}_{1/2}^\eta [\mathbf{A}_j(r, R)] \right) \leq Cr^2 \alpha_{4,1/2}^{an}(1, r)^2 \alpha_{j,1/2}^{an}(r, R)^2.$$

En particulier, il existe $C' = C'(j) < +\infty$ telle que :

$$\alpha_{j,1/2}^{an}(r, R) \leq \tilde{\alpha}_{j,1/2}(r, R) \leq C' \alpha_{j,1/2}^{an}(r, R). \quad (6.2)$$

Avant d'expliquer les intuitions et les idées des preuves des Théorèmes 6.9 et 6.11, donnons quelques motivations derrière ces résultats.

Motivations derrière les Théorèmes 6.9 et 6.11. Expliquons en premier lieu pourquoi l'inégalité (6.2) est utile afin d'obtenir des résultats annealed grâce à l'inégalité de BK-Reimer quenched. De même que dans la Section 5.1, notons $A \square B$ l'occurrence disjointe d'événements qui est l'événement que A et B soient réalisés sur deux ensembles disjoints de cellules. Plus précisément, $A \square B$ est réalisé si A et B sont réalisés et s'il existe deux ensembles I_1 et I_2 de cellules tels que : i) si on ne change pas le processus de points sous-jacent η ni les couleurs des cellules de I_1 , alors A est toujours réalisé quelles que soient les couleurs des cellules de I_1^c et ii) on la même propriété pour B et I_2 . Les mesures quenched \mathbf{P}_p^η étant des mesures produit, l'inégalité de Reimer (voir la Section 5.1) est vraie au niveau quenched. Cependant, **elle n'est pas vraie au niveau annealed**.¹⁹ En effet, si A est un événement mesurable par rapport à η , alors $A \square A = A$. Si de plus $\mathbb{P}[A] \in]0, 1[$ on a donc $\mathbb{P}[A \square A] = \mathbb{P}[A] > \mathbb{P}[A]^2$. Ceci suggère que si l'on veut qu'une inégalité de Reimer annealed approximative soit vraie, il faut que les événements que l'on considère **ne dépendent pas trop de η** , ce qui est le cas des événements de croisement et des événements à j bras d'après les Théorèmes 6.2, 6.9 et 6.11. Ainsi, on a :

$$\begin{aligned} & \alpha_{2j+1,1/2}^{an}(r, R) \\ &= \mathbb{E} \left[\mathbf{P}_{1/2}^\eta [\mathbf{A}_1(r, R) \square \mathbf{A}_{2j}(r, R)] \right] \\ &\leq \mathbb{E} \left[\mathbf{P}_{1/2}^\eta [\mathbf{A}_1(r, R)] \mathbf{P}_{1/2}^\eta [\mathbf{A}_{2j}(r, R)] \right] \text{ par l'inégalité de Reimer au niveau quenched} \\ &\leq \sqrt{\mathbb{E} \left[\mathbf{P}_{1/2}^\eta [\mathbf{A}_1(r, R)]^2 \right] \mathbb{E} \left[\mathbf{P}_{1/2}^\eta [\mathbf{A}_{2j}(r, R)]^2 \right]} \text{ par l'inégalité de Cauchy-Schwarz} \\ &\leq O(1) \alpha_{2j,1/2}^{an}(r, R) \alpha_{1,1/2}^{an}(r, R) \text{ par (6.2)}. \end{aligned}$$

Finalement, on a obtenu (à une constante près) l'analogue de l'inégalité (5.5), qui semble difficile à obtenir sans utiliser l'inégalité de Reimer quenched et (6.2). En appliquant notamment des techniques similaires, on peut obtenir l'analogue de l'inégalité (5.6) i.e. :

$$\alpha_{4,1/2}^{an}(r, R) \alpha_{1,1/2}^{an}(r, R) (r/R)^\varepsilon \geq \varepsilon (r/R)^2$$

(voir la Proposition 5.1 du Chapitre 6). De même qu'en Section 5, cette inégalité associée aux relations d'échelle permet de montrer que (dans la phase sur-critique) $\theta^{an}(p)$ est minoré par $\varepsilon(p - 1/2)^{1-\varepsilon}$ pour un certain $\varepsilon > 0$, ce qui est le Théorème 1.9.

¹⁹Notons toutefois qu'une inégalité de BK - i.e. une inégalité de Reimer pour les événements croissants - annealed est vraie au paramètre $p = 1/2$; c'est d'ailleurs une inégalité clef dans la preuve du Théorème 6.2. Le fait que cette inégalité soit vraie ou non pour les autres paramètres n'est pas clair.

Donnons brièvement deux autres motivations pour les Théorèmes 6.9 et 6.11. La première est que l'inégalité (6.2) est très importante dans l'étude de modèle de percolation de Voronoi dynamiques ; nous renvoyons à la Section 7.4 pour plus de précisions. La deuxième est que, si l'on trouve une borne supérieure pour $\text{Var} \left(\mathbf{P}_{1/2}^\eta [\text{Cross}(2R, R)] \right)$ de l'ordre de $R^{-4-\varepsilon}$, cela implique que les probabilités $\mathbb{P}_{1/2}^{an} [\text{Cross}(2R, R)]$ (et de la même façon les probabilités de croisement pour n'importe quel rectangle) convergent. Nous expliquons ceci plus précisément dans la Section 8. Si on ne s'attend pas du tout à ce que le Théorème 6.9 implique une telle inégalité (car il est conjecturé que $\alpha_{4,1/2}^{an}(1, R) = R^{-5/4+o(1)}$), ceci constitue toutefois une motivation derrière l'étude quantitative de $\text{Var} \left(\mathbf{P}_{1/2}^\eta [\text{Cross}(2R, R)] \right)$.

B. Idées de preuve des Théorèmes 6.9 et 6.11. Étudions tout d'abord la preuve (par Ahlberg, Griffiths, Morris et Tassion) du Théorème 6.2 (dont nous rappelons que le Théorème 6.9 est une version plus quantitative). Pour cela, il est utile de se souvenir de l'inégalité d'Efron-Stein i.e. de la Proposition 2.15. Pour simplifier, appliquons cette inégalité dans le cas où, étant donné un entier $n \in \mathbb{N}^*$, η n'est plus un processus de Poisson dans le plan mais un ensemble de $2n^2$ points indépendants de loi uniforme dans le rectangle $[0, 2n] \times [0, n]$ que nous notons $\eta_1, \dots, \eta_{2n^2}$. Pour tout $i \in \{1, \dots, 2n^2\}$, notons $\eta^{(i)}$ la configuration de points obtenue à partir de η en rééchantillonnant la position du $i^{\text{ème}}$ point. D'après la Proposition 2.15 :

$$\text{Var} \left(\mathbf{P}_{1/2}^\eta [\text{Cross}(2R, R)] \right) \leq \frac{1}{2} \sum_{i=1}^{2n^2} \mathbb{E} \left[\left(\mathbf{P}_{1/2}^\eta [\text{Cross}(2R, R)] - \mathbf{P}_{1/2}^{\eta^{(i)}} [\text{Cross}(2R, R)] \right)^2 \right]. \quad (6.3)$$

Comme $\eta^{(i)} = (\eta \setminus \{\eta_i\}) \cup \{\eta_i^{(i)}\}$, on peut s'attendre à ce que la quantité

$$\left| \mathbf{P}_{1/2}^\eta [\text{Cross}(2R, R)] - \mathbf{P}_{1/2}^{\eta^{(i)}} [\text{Cross}(2R, R)] \right|$$

soit inférieure à la probabilité (quenched) que η_i ou $\eta_i^{(i)}$ soit pivot pour l'événement de croisement. Comme on s'attend par ailleurs à ce que les événements pivots soient contrôlés par les événements à 4 bras, cela suggère que :

$$\text{Var} \left(\mathbf{P}_{1/2}^\eta [\text{Cross}(2R, R)] \right) \leq O(1) n^2 \mathbb{E} \left[\mathbf{P}_{1/2}^\eta [\mathbf{A}_4(1, n)]^2 \right] = O(1) n^2 \tilde{\alpha}_{4,1/2}(1, n)^2. \quad (6.4)$$

Les auteurs de [AGMT16] n'ont cependant pas étudié le lien entre points pivots et événements à 4 bras mais ont plutôt utilisé un théorème de Schramm et Steif (voir le Théorème 7.9) pour estimer les influences quenched qui apparaissent dans la méthode résumée ci-dessus.

Pour notre part, nous avons montré que l'inégalité (6.4) était vraie. Nous renvoyons au Chapitre 6 pour la preuve. Mentionnons tout de même que, afin de prouver cette inégalité, il nous a d'abord fallu prouver que la propriété de quasi-multiplicativité était **aussi vraie pour les quantités** $\tilde{\alpha}_{j,1/2}(r, R)$.

Une fois que l'on a obtenu (6.4), le Théorème 6.9 n'est plus qu'une conséquence de l'estimation (6.2) du Théorème 6.11 i.e. du fait que :

$$\tilde{\alpha}_{j,1/2}(r, R) \asymp \alpha_{j,1/2}^{an}(r, R). \quad (6.5)$$

Terminons donc cette section en donnant une idée de la preuve de cette inégalité. Remarquons tout d'abord que :

$$0 \leq \tilde{\alpha}_{j,1/2}(r, R)^2 - \alpha_{j,1/2}^{an}(r, R) = \text{Var} \left(\mathbf{P}_{1/2}^\eta [\mathbf{A}_j(r, R)] \right).$$

Par des observations similaires à celles qui ont suggéré que (6.4) était vraie (voir le Chapitre 6 pour plus de précisions), on peut s'attendre à ce que :

$$\text{Var} \left(\mathbf{P}_{1/2}^\eta [\mathbf{A}_j(r, R)] \right) \leq O(1) \tilde{\alpha}_{j,1/2}(r, R)^2 r^2 \tilde{\alpha}_{4,1/2}(1, r)^2. \quad (6.6)$$

Ainsi :

$$\tilde{\alpha}_{j,1/2}(r, R)^2 - \alpha_{j,1/2}^{an}(r, R) \leq O(1) \tilde{\alpha}_{j,1/2}(r, R)^2 r^2 \tilde{\alpha}_{4,1/2}(1, r)^2$$

et donc :

$$\alpha_{j,1/2}^{an}(r, R) \geq \tilde{\alpha}_{j,1/2}(r, R)^2 (1 - O(1) r^2 \tilde{\alpha}_{4,1/2}(1, r)^2).$$

Ceci ne donne a priori aucun résultat lorsque r est proche de 1. Cependant, on peut montrer que $r^2 \tilde{\alpha}_{4,1/2}(1, r)^2$ tend vers 0 lorsque r tend vers $+\infty$ (voir la Proposition D.11 du Chapitre 5). Ceci permet de conclure que (6.5) est vraie dès que r est assez grand, ce qui implique le résultat pour tout r par des arguments de quasi-multiplicativité. Finalement, cela permet de montrer le Théorème 6.9 ainsi que - en combinant (6.5) et (6.6) - le Théorème 6.11.

7 Des modèles de percolation dynamique

7.1 La sensibilité au bruit

Dans la Section 1.3.1, nous avons défini des modèles de percolation de Bernoulli dynamique et énoncé des résultats d'existence de temps exceptionnels. Ces différents résultats sont tous fortement liés à la notion de **sensibilité au bruit des fonctions booléennes** qui est le sujet de cette section. Considérons (comme dans la Section 2.2) l'hypercube $\Omega_n = \{-1, 1\}^n$ et munissons-le de la mesure uniforme $\mathbb{P}_{1/2}^n$. Une **fonction booléenne** est une fonction de Ω_n vers $\{0, 1\}$. La notion de sensibilité au bruit des fonctions booléennes a été introduite par Benjamini, Kalai et Schramm dans [BKS99].

Définition 7.1. Soit $(m_n)_{n \in \mathbb{N}}$ une suite d'entiers naturels tendant vers $+\infty$ et soit, pour tout $n \in \mathbb{N}$, $h_n : \Omega_{m_n} \rightarrow \{0, 1\}$ une fonction booléenne. Étant donné un paramètre $\varepsilon \in [0, 1]$ et une configuration ω_n de loi $\mathbb{P}_{1/2}^{m_n}$, notons ω_n^ε la configuration obtenue à partir de ω en rééchantillonnant la valeur de chaque coordonnée avec probabilité ε . On dit que la suite $(h_n)_{n \in \mathbb{N}}$ est sensible au bruit si pour tout $\varepsilon \in]0, 1]$ on a :

$$\text{Cov}(h_n(\omega_n), h_n(\omega_n^\varepsilon)) = \mathbb{E}[h_n(\omega_n)h_n(\omega_n^\varepsilon)] - \mathbb{E}[h_n(\omega_n)]^2 \xrightarrow{n \rightarrow +\infty} 0.$$

Remarque 7.2. Étant donné une configuration $\omega_n(0)$ de loi $\mathbb{P}_{1/2}^{m_n}$, on peut définir un processus dynamique $(\omega_n(t))_{t \in \mathbb{R}_+}$ comme au début de la Section 1.3.1 i.e. en rééchantillonnant la valeur de chaque coordonnée à taux 1. On peut remarquer que, si $\varepsilon = 1 - e^{-t}$ et si on utilise les notations de la Définition 7.1, $(\omega_n(0), \omega_n(t))$ a la même loi que $(\omega_n, \omega_n^\varepsilon)$.

On peut probablement dire que l'idée de sensibilité au bruit a un lien à la fois intuitif et formel avec la notion de temps exceptionnel introduite dans la Section 1.3.1. Commençons par le lien intuitif et intéressons-nous pour cela à la sensibilité au bruit d'événements de croisement en percolation de Bernoulli. L'idée est que, si de tels événements sont sensibles au bruit, alors après une petite perturbation les événements de croisement deviennent "presque indépendants". En particulier, on peut s'attendre à ce que, au cours de la dynamique, des croisements se font et se défont à très grande fréquence. Si de tels phénomènes se produisent à toutes les échelles, on peut imaginer qu'à des temps exceptionnels il y a suffisamment de croisements pour créer un cluster infini. Si cette idée peut guider l'intuition, on ne connaît cependant pas de preuve d'existence de temps exceptionnels utilisant de telles observations géométriques.

Passons maintenant au lien plus formel. Celui-ci apparaît par exemple à travers le lemme suivant par lequel débutent toutes les preuves connues d'existence de temps exceptionnels.

Lemme 7.3 ([HPS97]). Soit $(\omega(t))_{t \in \mathbb{R}_+}$ un processus de percolation dynamique comme défini en Section 1.3.1. Pour tout $R \in [1, +\infty[$ notons :

$$X_R = \int_0^1 \mathbb{1}_{0 \leftrightarrow R}(\omega(t)) dt.$$

S'il existe une constante $C < +\infty$ telle que pour tout $R \in [1, +\infty[$ on a :

$$\mathbb{E} [X_R^2] \leq C \mathbb{E} [X_R]^2,$$

alors presque sûrement il existe des temps $t \in \mathbb{R}_+$ tels que $\omega(t)$ possède un cluster infini.

Démonstration. D'après l'inégalité de Cauchy-Schwarz :

$$\mathbb{P} \left[\exists t \in [0, 1], 0 \overset{\omega(t)}{\longleftrightarrow} R \right] = \mathbb{P} [X_R > 0] \geq \frac{\mathbb{E} [X_R^2]}{\mathbb{E} [X_R]^2}.$$

Ainsi, la probabilité qu'il y existe un temps $t \in [0, 1]$ tel qu'il y a un chemin noir de 0 jusqu'à distance R dans $\omega(t)$ est uniformément minorée. On peut conclure en faisant tendre R vers $+\infty$ et en utilisant un argument de compacité (voir [HPS97] pour les détails). \square

En utilisant le lemme Fubini, il n'est pas difficile de montrer que l'inégalité du second moment du Lemme 7.3 est satisfaite si et seulement si :

$$\int_0^1 \mathbb{E} [\mathbb{1}_{0 \leftrightarrow R}(\omega(0)) \mathbb{1}_{0 \leftrightarrow R}(\omega(t))] \leq O(1) \mathbb{P}_{1/2} [0 \leftrightarrow R]^2. \quad (7.1)$$

On peut ainsi voir le lien formel entre la preuve d'existence de temps exceptionnels et la notion de sensibilité au bruit, l'inégalité ci-dessus étant vérifiée si des covariances entre la configuration au temps 0 et la configuration au temps t est suffisamment petite.

Dans cette section, nous notons g_n l'événement de croisement du carré $[-n, n]^2$ (pour la percolation sur \mathbb{Z}^2 ou sur \mathcal{T}). Énonçons un premier théorème de sensibilité au bruit :

Théorème 7.4 ([BKS99]). La suite $(g_n)_{n \in \mathbb{N}}$ est sensible au bruit.

La preuve de ce théorème se repose sur le théorème général suivant :

Théorème 7.5 ([BKS99]). Soient $(m_n)_{n \in \mathbb{N}}$ et $(h_n)_{n \in \mathbb{N}}$ comme dans la Définition 7.1. Pour tout $i \in \{1, \dots, n\}$, notons $I_i(h_n) = I_i^{1/2}(h_n)$ l'influence de i sur h_n sous $\mathbb{P}_{1/2}^{m_n}$ i.e. :

$$I_i(h_n) = \mathbb{P}_{1/2}^{m_n} [\text{Changer la coordonnée } i \text{ modifie } h_n(\omega)].$$

Supposons que :

$$\sum_{i=1}^{m_n} I_i(h_n)^2 \xrightarrow{n \rightarrow +\infty} 0.$$

Alors, $(h_n)_{n \in \mathbb{N}}$ est sensible au bruit. Par ailleurs, la réciproque est vraie si les fonctions h_n sont monotones.

Comment en déduire le Théorème 7.4? Notons tout d'abord que, en utilisant que les événements pivots sont contrôlés par les événements à 4 bras, il est possible de montrer que la somme des carrés des influences de g_n est de l'ordre de $n^2 \alpha_{4,1/2}(1, n)^2$ (voir la Définition 5.1 pour cette notation). Or, d'après (5.2), cette quantité converge vers 0 quand n tend vers $+\infty$.

La preuve du Théorème 7.5 repose sur des arguments d'hypercontractivité et sur la décomposition de Fourier des fonctions booléennes. Essayons ici de voir apparaître des carrés d'influence autrement. Soit $\varepsilon > 0$. On peut tout d'abord remarquer que (voir la Section 2 de [BKS99]) :

$$\text{Cov} (h_n(\omega_n), h_n(\omega_n^\varepsilon)) = \text{Var} \left(\mathbb{E} \left[h_n(\omega_n) \mid \omega_n^\varepsilon \right] \right).$$

Ainsi, $(h_n)_{n \in \mathbb{N}}$ est sensible au bruit si et seulement si **la connaissance de la configuration bruitée ne donne asymptotiquement pas d'information sur la réalisation de h_n** . Même si les observations ci-dessous peuvent se faire pour n'importe quel événement, plaçons-nous pour simplifier dans le cas des événements de croisement g_n sur \mathbb{Z}^2 . Ainsi, m_n est le nombre d'arêtes du réseau carré incluses dans $[0, n]^2$. Définissons un graphe aléatoire $\mathcal{G}_n^\varepsilon$ à partir du réseau \mathbb{Z}^2 intersecté avec $[0, n]^2$. Pour cela, pour chaque arête e de ce graphe, effaçons e avec probabilité $(1 - \varepsilon)/2$, contractons les extrémités de e en un point avec probabilité $(1 - \varepsilon)/2$, et ne modifions pas e avec probabilité ε . Il n'est pas difficile de montrer que :

$$\mathbb{E} \left[g_n(\omega_n) \mid \omega_n^\varepsilon \right] \stackrel{(\text{loi})}{=} \mathbb{P}_{1/2}^{\mathcal{G}_n^\varepsilon} [\text{Cross}^\varepsilon(n, n)] ,$$

où $\text{Cross}^\varepsilon(n, n)$ est l'événement de croisement du côté gauche au côté droit dans le graphe $\mathcal{G}_n^\varepsilon$ et $\mathbb{P}_{1/2}^{\mathcal{G}_n^\varepsilon}$ est la probabilité de percolation de paramètre $1/2$ sur ce graphe. Ainsi, $(g_n)_{n \in \mathbb{N}}$ est sensible au bruit si et seulement si

$$\text{Var} \left(\mathbb{P}_{1/2}^{\mathcal{G}_n^\varepsilon} [\text{Cross}^\varepsilon(n, n)] \right) \tag{7.2}$$

converge vers 0. La variance ci-dessus est l'analogue de la variance de la probabilité quenched de croisement en percolation de Voronoi (voir par exemple le Théorème 6.2). Comme nous l'avons vu dans la Section 6.2, il est utile pour estimer de telles variances d'avoir l'inégalité d'Efron-Stein (Proposition 2.15) à l'esprit. Si on suit la même heuristique, on peut s'attendre à ce que (7.2) soit bornée par l'espérance d'une **somme de carrés d'influences quenched**. Cependant, la géométrie des graphes $\mathcal{G}_n^\varepsilon$ n'étant pas facile à étudier a priori, il semble compliqué d'estimer de telles influences quenched. On peut peut-être finalement traduire l'énoncé Théorème 7.5 de la façon suivante : Pour montrer que $(g_n)_{n \in \mathbb{N}}$ est sensible au bruit, il n'est en fait pas nécessaire d'étudier la somme des carrés des influences quenched mais il suffit de montrer que la somme des carrés des influences **annealed** tend vers 0.

Arrêtons ici les heuristiques derrière le Théorème 7.5 et notons toujours g_n l'événement de croisement de $[0, n]^2$. Mentionnons que Benjamini, Kalai et Schramm ont aussi obtenu un résultat de sensibilité au bruit quantitatif qui dit que, si ε_n décroît vers 0 à vitesse logarithmique, la convergence vers 0 de $\text{Cov}(g_n(\omega_n^{\varepsilon_n}), g_n(\omega_n))$ est toujours vraie. Ce résultat a été amélioré par Schramm et Steif :

Théorème 7.6 ([SS10]). *Il existe $a > 0$ tel que $(g_n)_n$ est sensible au bruit même si $\varepsilon = \varepsilon_n$ décroît vers 0 à vitesse n^{-a} .*

Garban, Pete et Schramm ont ensuite montré que la bonne vitesse à étudier est donnée par l'espérance du nombre de points pivots i.e. par quantité $n^2 \alpha_{4,1/2}(n)$. L'idée générale est que le bruit n'a des conséquences sur la réalisation de g_n que s'il atteint des points pivots (cependant, cette idée seule ne permet de s'attaquer qu'au cas $\varepsilon_n n^2 \alpha_{4,1/2}(1, n)$).

Théorème 7.7 ([GPS10]). *Si $\varepsilon_n n^2 \alpha_{4,1/2}(1, n) \xrightarrow{n \rightarrow +\infty} +\infty$ alors $\text{Cov}(g_n(\omega_n^{\varepsilon_n}), g_n(\omega_n))$ tend vers 0 mais ce n'est pas le cas si $\varepsilon_n n^2 \alpha_{4,1/2}(1, n) \xrightarrow{n \rightarrow +\infty} 0$.*

7.2 La décomposition de Fourier des fonctions Booléennes

Comme dans la Définition 7.1, donnons-nous une suite d'entiers naturels $(m_n)_{n \in \mathbb{N}}$ convergeant vers $+\infty$ et des fonctions booléennes $h_n : \Omega_{m_n} \rightarrow \{0, 1\}$. Commençons par définir base de Fourier-Walsh.

Définition 7.8. Si $S \subseteq \{1, \dots, m_n\}$, notons $\chi_S \in L^2(\Omega_{m_n}, \mathbb{P}_{1/2}^{m_n})$ la fonction :

$$\chi_S : \omega \in \Omega_{m_n} \mapsto \prod_{i \in S} \omega_i .$$

Ces fonctions forment une base orthonormée de $L^2(\Omega_{m_n}, \mathbb{P}_{1/2}^{m_n})$. Par ailleurs, la décomposition de h_n sur cette base, notée $(\widehat{h}_n(S))_{S \subseteq \{1, \dots, m_n\}}$ est appelée **décomposition de Fourier-Walsh** (en particulier, $\widehat{h}_n(\emptyset) = \mathbb{E}_{1/2}^{m_n}[h_n]$).

Cette base est particulièrement appropriée à l'étude de la percolation dynamique et de la sensibilité au bruit car elle **diagonalise la dynamique** définie en Section 1.3.1. Soient $\omega_n(0)$ et ω_n deux variables aléatoires de loi $\mathbb{P}_{1/2}^{m_n}$. Comme dans la Section 7.1, notons $(\omega_n(t))_{t \in \mathbb{R}_+}$ le processus obtenu en rééchantillonnant à taux 1 la valeur de chaque coordonnée et, étant donné un paramètre $\varepsilon \in [0, 1]$, notons ω_n^ε la configuration obtenue à partir de ω_n en rééchantillonnant la valeur de chaque coordonnée avec probabilité ε . Il n'est pas difficile de montrer que, si $S, S' \subseteq \{1, \dots, m_n\}$, alors :

$$\mathbb{E}[\chi_S(\omega_n(t))\chi_{S'}(\omega_n(t))] = e^{-t|S|} \mathbf{1}_{S=S'}.$$

En particulier, la quantité $\chi_S(\omega_n(t))$ fluctue entre 1 et -1 avec une fréquence typique de l'ordre de $|S|$. Notons que cette égalité implique que :

$$\mathbb{E}[h_n(\omega_n(0))h_n(\omega_n(t))] = \sum_{S \subseteq \{1, \dots, m_n\}} \widehat{h}_n(S)^2 e^{-t|S|} \quad (7.3)$$

et donc (si $\varepsilon = 1 - e^{-t}$) :

$$\text{Cov}(h_n(\omega_n^\varepsilon), h_n(\omega_n)) = \text{Cov}(h_n(\omega_n(0)), h_n(\omega_n(t))) = \sum_{\emptyset \neq S \subseteq \{1, \dots, m_n\}} \widehat{h}_n(S)^2 e^{-t|S|}. \quad (7.4)$$

Ainsi, $(h_n)_{n \in \mathbb{N}}$ est sensible au bruit si et seulement si ses coefficients de Fourier-Walsh sont **concentrés sur les hautes fréquences** i.e. si pour tout $k \in \mathbb{N}^*$ la quantité $\sum_{|S|=k} \widehat{h}_n(S)^2$ converge vers 0. On peut aussi remarquer que la quantité (7.4) converge vers 0 pour un certain $\varepsilon \in]0, 1[$ si et seulement si elle converge vers 0 pour tout $\varepsilon \in]0, 1[$.

Nous pouvons maintenant énoncer le théorème de Schramm et Steif qui est l'élément principal de leur preuve d'existence de temps exceptionnels et de sensibilité au bruit quantitative. Rappelons que les notions d'algorithme et de *revelment*²⁰ ont été introduites en Section 2.2.

Théorème 7.9 ([SS10]). *Soient \mathcal{A} un algorithme déterminant h_n et $\delta_i(\mathcal{A})$ le *revelment* de \mathcal{A} (pour la mesure $\mathbb{P}_{1/2}^n$). Alors, pour tout $k \in \mathbb{N}^*$:*

$$\sum_{\substack{S \subseteq \{1, \dots, n\} \\ |S|=k}} \widehat{h}_n(S)^2 \leq k \mathbb{E}_{1/2}^n [h_n^2] \max_{i=1}^n \delta_i(\mathcal{A}).$$

Ainsi, si le maximum des *revelments* d'une suite de fonctions booléennes converge vers 0, alors cette suite est sensible au bruit. Nous renvoyons à [SS10, GS14] pour des détails sur l'application du Théorème 7.9 (et pour sa preuve).

L'échantillon spectral. Dans cette thèse, nous avons utilisé les outils spectraux développés par Garban, Pete et Schramm. Les auteurs de [GPS10] ont introduit ces outils afin de démontrer les Théorèmes 1.5 et 7.7. Ils ont adopté un point de vue plus géométrique en considérant l'objet suivant :

Définition 7.10. Un **échantillon spectral** de la fonction booléenne h_n est une variable aléatoire \mathcal{S}_{h_n} à valeurs dans les sous-ensembles de $\{1, \dots, m_n\}$ telle que :

$$\forall S \subseteq \{1, \dots, m_n\}, \mathbb{P}[\mathcal{S}_{h_n} = S] = \frac{\widehat{h}_n(S)^2}{\mathbb{E}_{1/2}^{m_n}[h_n^2]} = \frac{\widehat{h}_n(S)^2}{\sum_{S' \subseteq \{1, \dots, m_n\}} \widehat{h}_n(S')^2}.$$

²⁰L'algorithme et le *revelment* de h_n sont définis comme ceux de l'événement $h_n^{-1}(1)$.

Notons $\widehat{\mathbb{P}}_{h_n}$ la loi de \mathcal{S}_{h_n} et $\widehat{\mathbb{Q}}_{h_n}$ la mesure non renormalisée définie par :

$$\forall S \subseteq \{1, \dots, m_n\}, \widehat{\mathbb{Q}}_{h_n}[\{S\}] = \widehat{h}_n(S)^2.$$

Considérons maintenant les cas particuliers qui nous intéressent, à savoir l'événement de croisement du carré $[0, n]^2$ - que nous notons ici g_n - et l'événement à 1 bras $\{0 \leftrightarrow R\}$ - que nous notons f_R . Dans ces cas, l'échantillon spectral est un **sous-ensemble aléatoire d'arêtes de \mathbb{Z}^2 ou de sites de \mathcal{T}** .

Comment l'échantillon spectral peut-il nous aider à démontrer que g_n est sensible au bruit mais aussi à montrer l'existence de temps exceptionnels pour la percolation dynamique ? Comme la constante de renormalisation de $\widehat{\mathbb{P}}_{g_n}$ est $\mathbb{P}_{1/2}[\text{Cross}(n, n)] = 1/2$, l'identité (7.4) implique que :

$$\text{Cov}(g_n(\omega_n), g_n(\omega_n^\varepsilon)) = 2 \sum_{k \in \mathbb{N}^*} \widehat{\mathbb{P}}_{g_n}[|S| = k] (1 - \varepsilon)^k.$$

Souvenons-nous par ailleurs que, d'après (7.1), il suffit, afin de prouver qu'il existe des temps exceptionnels pour la percolation dynamique critique, de montrer que :

$$\int_0^1 \mathbb{E}[f_R(\omega(0))f_R(\omega(t))] \leq O(1) \mathbb{E}_{1/2}[f_R]^2 = O(1) \alpha_{1,1/2}(1, R)^2,$$

où $(\omega(t))_{t \in \mathbb{R}_+}$ est un processus de percolation dynamique sur \mathbb{Z}^2 ou \mathcal{T} . Comme la constante de renormalisation de $\widehat{\mathbb{P}}_{f_R}$ est $\alpha_{1,1/2}(1, R)$, d'après (7.3) cela revient à montrer que :

$$\sum_{k \in \mathbb{N}} \int_0^1 \widehat{\mathbb{P}}_{f_R}[|S| = k] e^{-kt} dt \leq O(1) \alpha_{1,1/2}(1, R).$$

Ainsi, si l'on veut montrer que $(g_n)_n$ est sensible au bruit ou qu'il existe des temps exceptionnels, il suffit de montrer (suffisamment quantitativement en ce qui concerne f_R) que **l'échantillon spectral est grand ou vide avec grande probabilité**. C'est ce que Garban, Pete et Schramm ont montré. Plus précisément, ils ont obtenu le résultat suivant, dont il n'est plus très difficile de montrer qu'il implique les Théorèmes 1.5 et 7.7 (nous renvoyons pour cela à [GPS10, GS14] ainsi qu'à [SS10] en ce qui concerne le calcul de la dimension de Hausdorff) :

Théorème 7.11 ([GPS10]). *Il existe $C < +\infty$ telle que, si $n \in \mathbb{N}^*$ et $R \in [1, +\infty[$:*

$$\forall r \in [1, n], \mathbb{P}[0 < |\mathcal{S}_{g_n}| < r^2 \alpha_{4,1/2}(1, r)] \leq C \frac{n^2}{r^2} \alpha_{4,1/2}(r, n)^2;$$

$$\forall r \in [1, R], \mathbb{P}[0 < |\mathcal{S}_{f_R}| < r^2 \alpha_{4,1/2}(1, r)] \leq C \alpha_{4,1/2}(r, R).$$

(Rappelons que, d'après (5.3), $R^2 \alpha_{4,1/2}(1, R)$ converge vers $+\infty$ quand R tend vers $+\infty$.) Terminons cette section en mentionnant quelques idées derrière ces estimations. Commençons par le lemme suivant qui permet de lier l'échantillon spectral à l'ensemble des pivots.

Lemme 7.12 (Voir le Chapitre IV de [GS14]). *La mesure spectrale et l'ensemble pivot ont (à une constante près) les mêmes marginales de dimension 1 :*

$$\forall i \in \{1, \dots, m_n\}, \widehat{\mathbb{Q}}_{h_n}[i \in S] = \frac{1}{2} I_i(h_n).$$

Comme remarqué par Kalai, c'est aussi le cas des marginales de dimension 2, mais pas des marginales de dimensions supérieures en général.

Ceci permet en particulier d'exprimer l'espérance de la taille des échantillons spectraux en fonction de l'espérance du nombre de points pivots. Ainsi, on peut en déduire que $\mathbb{E}[|\mathcal{S}_{g_n}|] \asymp n^2 \alpha_{4,1/2}(1, n)$ et $\mathbb{E}[|\mathcal{S}_{f_R}|] \asymp R^2 \alpha_{4,1/2}(1, R)$. Le Théorème 7.11 nous dit donc que **la taille des échantillons spectraux de la percolation est typiquement de l'ordre de sa moyenne** (s'ils ne sont pas vides).

La preuve du Théorème 7.11 repose sur plusieurs idées ; on peut essentiellement la découper en trois étapes comme nous l'expliquons dans la Section 5 du Chapitre 4 (voir aussi le Chapitre X de [GS14]). Rappelons que le but est de montrer que l'échantillon spectral est typiquement grand ou vide. Nous ne nous concentrons ici que sur l'une des étapes qui consiste à montrer que l'échantillon spectral n'est pas typiquement constitué d'un ou de plusieurs petits morceaux isolés, ce qui serait pour lui une façon d'être petit mais non vide (voir la Figure 7.2). Pour expliquer l'idée principale de cette étape, énonçons tout d'abord un autre résultat liant l'échantillon spectral aux pivots.

Lemme 7.13 ([GPS10]). *Soit $J \subseteq \{1, \dots, m_n\}$. Nous disons que J est pivot pour h_n si l'on peut modifier $h_n(\omega)$ en changeant la configuration dans J . Notons $\mathbf{Piv}_J(h_n)$ cet événement. Soit de plus $W \subseteq \{1, \dots, m_n\}$ n'intersectant pas J . Alors :*

$$\widehat{\mathbb{Q}}_{h_n} [S \cap J \neq \emptyset = S \cap W] \leq 4 \mathbb{E}_{1/2}^{m_n} \left[\mathbb{P}_{1/2}^{m_n} [\mathbf{Piv}_J(h_n) \mid \omega_{|W^c}]^2 \right]. \quad (7.5)$$

En particulier :

$$\widehat{\mathbb{Q}}_{h_n} [\emptyset \neq S \subseteq J] \leq 4 \mathbb{P}_{1/2}^{m_n} [\mathbf{Piv}_J(h_n)]^2 ; \quad (7.6)$$

$$\widehat{\mathbb{Q}}_{h_n} [S \cap J \neq \emptyset] \leq 4 \mathbb{P}_{1/2}^{m_n} [\mathbf{Piv}_J(h_n)]. \quad (7.7)$$

Plaçons-nous dans le cas de l'événement à 1 bras f_R (les idées sont similaires dans le cas de g_n) et considérons un anneau A inclus dans $[-R, R]^2$. Notons D le disque intérieur et supposons que ni D ni A ne contient 0. Remarquons que l'événement $\mathbf{Piv}_D(f_R)$ implique l'existence d'un événement à 4 bras dans A (voir la Figure 7.1). En utilisant (7.5) en notant $\mathbf{A}_4(A)$ l'événement à 4 bras dans A , on en déduit que :

$$\widehat{\mathbb{Q}}_{f_R} [S \cap D \neq \emptyset = S \cap A] \leq 4 \mathbb{E}_{1/2} \left[\mathbb{P}_{1/2} [\mathbf{A}_4(A) \mid \omega_{|A^c}]^2 \right] = 4 \mathbb{P}_{1/2} [\mathbf{A}_4(A)]^2. \quad (7.8)$$

(Lorsque A est centré en 0 on a une formule analogue avec l'événement à 1 bras plutôt que l'événement à 4 bras.)

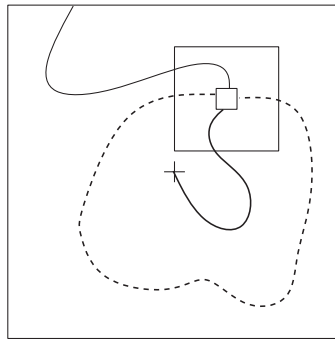

FIGURE 7.1 – L'événement $\mathbf{Piv}_D(f_R)$.

Il s'avère que ce résultat est aussi vrai si on considère plusieurs anneaux :

Lemme 7.14 ([GPS10]). *Soient $l \in \mathbb{N}^*$ et $A_1, \dots, A_l, A_{l+1}, \dots, A_m$ des anneaux disjoints inclus dans $[-R, R]^2$ tels que : i) ni les anneaux A_1, \dots, A_l ni leurs disques intérieurs ne*

contiennent 0 et ii) A_{l+1}, \dots, A_m sont centrés en 0 (un tel ensemble d'anneaux est appelé **structure d'anneaux**). Un ensemble $S \subseteq [-R, R]^2$ est dit compatible avec cette structure d'anneaux si $S \cup \{0\}$ n'intersecte aucun des anneaux mais intersecte le disque intérieur de chacun d'eux. On a :

$$\widehat{\mathbb{Q}}_{f_R}[S \text{ est compatible avec } A_1, \dots, A_m] \leq \prod_{i=1}^l 4\mathbb{P}_{1/2}[\mathbf{A}_4(A_i)]^2 \prod_{i=l+1}^m 4\mathbb{P}_{1/2}[\mathbf{A}_1(A_i)]^2 .$$

Comme expliqué dans la Figure 7.2, ce lemme suggère que l'échantillon spectral n'est pas typiquement constitué de plusieurs "petits morceaux". Nous renvoyons à la Section 4 de [GPS10] pour des résultats combinatoires reposant sur le Lemme 7.14.

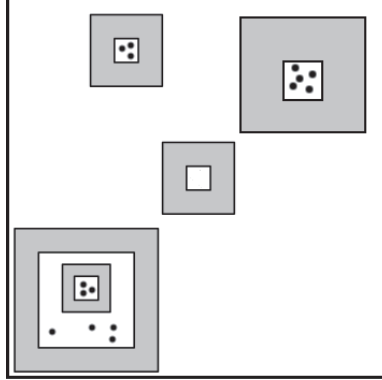

FIGURE 7.2 – Pour contrôler le cas où \mathcal{S}_{f_R} est constitué de plusieurs petits morceaux - ce qui est une façon pour lui d'être petit et non vide - on peut isoler ceux-ci à l'intérieur d'une structure d'anneaux et appliquer le Lemme 7.14.

7.3 La percolation dynamique conservative

Comme expliqué dans la Section 1.3.1, le Chapitre 4 de cette thèse a pour sujet la **percolation dynamique conservative**. Rappelons qu'il s'agit ici de faire évoluer la configuration de percolation selon une dynamique d'exclusion. Nous utilisons les mêmes notations qu'en Section 1.3.1 et nous plaçons au point critique. Ainsi, K est un noyau de Markov symétrique sur l'ensemble \mathcal{I} des arêtes de \mathbb{Z}^2 ou des sites de \mathcal{T} et $(\omega_K(t))_{t \in \mathbb{R}_+}$ est un processus d'exclusion de noyau K et de paramètre $p = 1/2$. La percolation dynamique conservative a été introduite par Broman, Garban et Steif qui ont étudié un analogue de la sensibilité au bruit pour cette dynamique et ont entre autres obtenu le résultat suivant :

Théorème 7.15 ([BGS13]). *Restreignons-nous au carré $[0, n]^2$ et considérons l'événement de croisement g_n . Considérons aussi un réel $\alpha \in]0, 1[$ et le noyau K_n^α sur $\mathcal{I} \cap [0, n]^2$ tel que, pour tout $i \in \mathcal{I}$, $K_n^\alpha(i, \cdot)$ est la mesure de probabilité uniforme sur l'ensemble $\{j \in \mathcal{I} : |i - j| \leq n^\alpha\}$.²¹ Soit $(\omega_{K_n^\alpha}(t))_{t \in \mathbb{R}_+}$ un processus d'exclusion de noyau K_n^α . Les événements de croisement sont sensibles à l'exclusion de noyau K_n^α dans le sens que :*

$$\forall t \in]0, +\infty[, \text{Cov}(g_n(\omega_{K_n^\alpha}(0)), g_n(\omega_{K_n^\alpha}(t))) \xrightarrow{n \rightarrow +\infty} 0 .$$

Il est conjecturé dans [BGS13] que ce théorème est toujours vrai dans le cas limite $\alpha = 0$ i.e. pour une **dynamique d'exclusion à plus proches voisins**.

Pour des liens généraux entre la sensibilité au bruit et la sensibilité par exclusion - et pour des liens entre les sensibilité par exclusion selon différents noyaux, nous renvoyons à [BGS13] et [For16].

²¹Il faut en fait modifier un petit peu ce noyau pour le rendre symétrique.

La base de Fourier étudiée dans la Section 7.2 - et cruciale dans l'étude de la sensibilité au bruit - diagonalisait le processus de dynamique "indépendant". Il est donc naturel ici de chercher des bases diagonalisant les processus d'exclusion. Cependant, même si l'existence de telles bases est connue (voir [For16] pour des propriétés utiles de celles-ci), elles ne sont pas explicites et il ne paraît pas envisageable d'étudier la décomposition d'événements de croisement selon ces bases. Broman, Garban et Steif ont donc étudié le comportement de la base de Fourier - et plus particulièrement de l'échantillon spectral - sous les dynamiques d'exclusion. Pour cela, ils ont utilisé une "formule de dualité" des processus d'exclusion.

Dans notre preuve d'existence de temps exceptionnels pour les dynamiques d'exclusion à grande portée (Théorème 1.6), nous utilisons aussi ces techniques. Présentons-les donc dans le cadre de la preuve du Théorème 1.6. Rappelons que les noyaux considérés sont les noyaux K^α définis par $K^\alpha(i, j) = c_\alpha |i - j|^{-(2+\alpha)}$. Considérons tout d'abord un noyau quelconque K . De plus, comme dans la Section 7.2, notons f_R l'événement à 1 bras. La première partie de la preuve d'existence de temps exceptionnels est exactement la même que pour la dynamique indépendante i.e. elle est constituée par le lemme suivant qui est l'analogue du Lemme 7.3 (et dont la preuve est la même ; voir aussi (7.1)).

Lemme 7.16. *Supposons qu'il existe une constante $C = C(K) < +\infty$ telle que pour tout $R \in [1, +\infty[$ on a :*

$$\int_0^1 \mathbb{E} [f_R(\omega_K(0))f_R(\omega_K(t))] \leq O(1) \mathbb{E}_{1/2} [f_R]^2 = O(1) \alpha_{1,1/2}(1, R)^2.$$

Alors, il existe des temps t avec un cluster infini dans $\omega_K(t)$.

Afin de contrôler la quantité $\mathbb{E} [f_R(\omega_K(0))f_R(\omega_K(t))]$, étudions le comportement de la base de Fourier sous la dynamique d'exclusion. Si S et S' sont des sous-ensembles finis de \mathcal{I} , notons $K_t(S, S')$ la probabilité que, après la dynamique d'exclusion de noyau K , les points de S se retrouvent en S' au temps t . En utilisant le fait que les noyaux sont symétriques (qui est ainsi crucial pour toute la preuve), on peut facilement obtenir la formule suivante qui est souvent appelée formule de dualité :

$$\mathbb{E} [\chi_S(\omega_K(0))\chi_{S'}(\omega_K(t))] = K_t(S, S').$$

Par conséquent, on a :

$$\mathbb{E} [f_R(\omega_K(0))f_R(\omega_K(t))] = \sum_{S, S' \text{ sous-ensembles finis de } \mathcal{I}} \widehat{f}_R(S) K_t(S, S') \widehat{f}_R(S').$$

Notons, contrairement à la formule analogue de la Section 7.2, la présence de **termes non diagonaux**. Toutefois, on a $K_t(S, S') = 0$ si $|S| \neq |S'|$. Rappelons que $\widehat{\mathbb{Q}}_{f_R}$ est la mesure spectrale non renormalisée de la Définition 7.10. En majorant chaque terme de la somme ci-dessus par sa valeur absolue, on obtient que :

$$\mathbb{E} [f_R(\omega_K(0))f_R(\omega_K(t))] \leq \sum_{S, S' \text{ sous-ensembles finis de } \mathcal{I}} \sqrt{\widehat{\mathbb{Q}}_{f_R}[\{S\}]} \sqrt{\widehat{\mathbb{Q}}_{f_R}[\{S'\}]} K_t(S, S'),$$

que l'on peut écrire formellement :

$$\left\langle \sqrt{\widehat{\mathbb{Q}}_{f_R}}, K_t \star \sqrt{\widehat{\mathbb{Q}}_{f_R}} \right\rangle.$$

La constante de renormalisation de la loi de l'échantillon spectral $\widehat{\mathbb{P}}_{f_R}$ étant $\mathbb{E}_{1/2} [f_R] = \alpha_{1,1/2}(1, R)$, il est finalement suffisant - pour obtenir l'existence de temps exceptionnels - de montrer que :

$$\int_0^1 \left\langle \sqrt{\widehat{\mathbb{P}}_{f_R}}, K_t \star \sqrt{\widehat{\mathbb{P}}_{f_R}} \right\rangle dt \leq O(1) \alpha_{1,1/2}(1, R).$$

Ainsi, notre but est de montrer (quantitativement !) que si \mathcal{S}_{f_R} est un échantillon spectral (indépendant de la dynamique d'exclusion) qu'on laisse diffuser sous un processus d'exclusion de noyau K , **cet ensemble devient très vite très différent d'un échantillon spectral**. Expliquons maintenant comment démontrer l'existence d'un tel phénomène. Notre résultat principal dans ce but, obtenu avec Christophe Garban dans [V4], est le suivant. Il peut être vu comme une propriété de **localisation** de l'échantillon spectral.

Théorème 7.17 (Théorème 2.8 du Chapitre 4 et discussion sous celui-ci, en commun avec Christophe Garban). *Il existe un exposant $\varepsilon_0 > 0$ tel que, pour tous $1 \leq r \leq r_0 \leq R$:*

$$\widehat{\mathbb{P}}_{f_R} \left[S \not\subseteq [-r_0, r_0]^2 \mid 0 < |S| < r^2 \alpha_{4,1/2}(1, r) \right] \leq O(1) \left(\frac{r}{r_0} \right)^{\varepsilon_0}.$$

Ainsi, si l'on suppose que l'échantillon spectral est de taille bien plus petite que $r^2 \alpha_{4,1/2}(1, r)$, alors il est localisé dans la boîte $[-r, r]^2$ avec grande probabilité.

Expliquons comment utiliser ce résultat pour conclure la preuve d'existence de temps exceptionnels (Théorème 1.6). Rappelons que nous considérons un noyau K^α avec α suffisamment petit, i.e. un noyau à **grande portée**. Donnons-nous un échantillon spectral \mathcal{S}_{f_R} et laissons le évoluer selon une dynamique d'exclusion de noyau K^α . Supposons que \mathcal{S}_{f_R} est de taille $r^2 \alpha_{4,1/2}(1, r)$ pour un certain r . Alors, avec grande probabilité, il est inclus dans la boîte $[-r, r]^2$ d'après le Théorème 7.17. Comme α est supposé très petit, on peut s'attendre qu'avec grande probabilité les points de \mathcal{S}_{f_R} sautent si loin que très rapidement cet ensemble n'est plus inclus dans $[-r, r]^2$ et ne ressemble ainsi plus à un échantillon spectral (voir la Figure 7.3). Si l'on quantifie suffisamment ce phénomène on peut en déduire le Théorème 1.6. Notons que l'on peut voir dans cette heuristique la raison pour laquelle nous n'avons pas réussi à montrer l'existence de temps exceptionnels pour des dynamiques à petite portée.

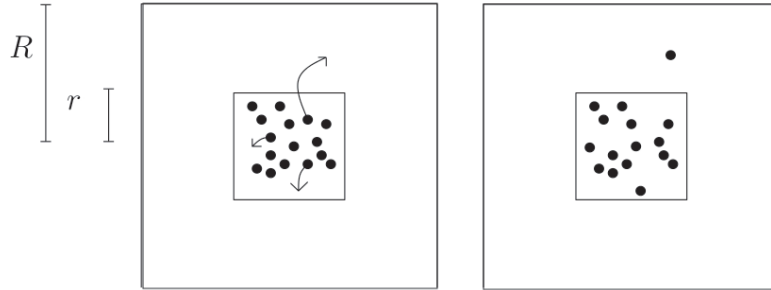

FIGURE 7.3 – Un échantillon spectral de taille $r^2 \alpha_{4,1/2}(1, r)$ avant et après diffusion.

La structure globale de la preuve du Théorème 7.17 est la même que celle du Théorème 7.11 (qui contrôle la taille des échantillons spectraux). Rappelons qu'une des idées derrière le Théorème 7.11 était qu'un échantillon spectral n'était typiquement pas constitué de "plusieurs petits morceaux isolés". Pour prouver le Théorème 7.17, il nous a fallu plutôt estimer la probabilité - étant donné un certain r_0 - que l'échantillon spectral **restreint à $([-r_0, r_0]^2)^c$** n'est pas constitué de plusieurs petits morceaux isolés. L'idée générale est la même - i.e. nous utilisons des "structures d'anneaux" - mais s'avère plus technique lorsqu'il faut contrôler la partie du spectre proche de $\partial[-r_0, r_0]^2$, voir la Figure 7.4. Nous renvoyons à la Section 5.2.1 du Chapitre 4 pour plus de détails.

7.4 Dynamiques en percolation de Voronoi

Notre principale motivation dans l'étude de la percolation de Voronoi (voir la Section 6) était de fournir des outils permettant d'adapter les résultats spectraux des Sections 7.2 et 7.3 afin

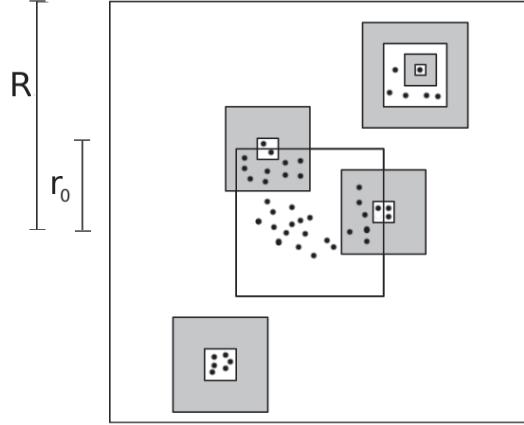

FIGURE 7.4 – Pour contrôler le cas où \mathcal{S}_{f_R} restreint à $([-r_0, r_0]^2)^c$ est constitué de plusieurs petits morceaux, on peut isoler ceux-ci à l’intérieur d’une structure d’anneaux comme de façon similaire au contrôle effectué à la Section 7.2. Comme dans l’événement que l’on veut estimer on n’impose aucune contrainte sur le spectre dans $[-r_0, r_0]^2$, les estimations données par les anneaux au voisinage de $\partial[-r_0, r_0]^2$ seront plus faibles que pour les autres anneaux, voir la Section 5.2.1 du Chapitre 4.

d’étudier les modèles de percolation de Voronoi dynamique définis dans la Section 1.3.2 et en particulier des démontrer les résultats d’existence de temps exceptionnels énoncés dans le Théorème 1.10. La preuve de ce théorème est écrite dans le Chapitre 7. Dans ce chapitre, nous démontrons aussi un résultat de sensibilité au bruit quantitative. Rappelons que dans la Section 1.3.2 nous avons défini une percolation dynamique de Voronoi gelée - dans laquelle le processus de point η ne change pas mais les couleurs des points évoluent à taux 1 - et une percolation dynamique mouvante - dans laquelle la couleur des points ne change pas mais les points de η évoluent selon des processus de Lévy. Comme dans les Sections 7.1, 7.2 et 7.3, notons g_n l’événement de croisement de $[0, n]^2$ et f_R l’événement à 1 bras (mais cette fois pour la percolation de Voronoi).

Commençons cette section sur un état de l’art concernant la sensibilité au bruit de la percolation de Voronoi. Pour un résultat analogue en percolation booléenne (qui est un autre modèle de percolation continue), voir [ABGM14]. Le premier résultat de sensibilité au bruit pour la percolation de Voronoi est dû à Ahlberg, Griffiths, Morris et Tassion :

Théorème 7.18 ([AGMT16]). *Plaçons-nous au point critique $p = 1/2$ et considérons un processus de percolation dynamique de Voronoi gelée $(\omega^{gel}(t))_{t \in \mathbb{R}_+}$. Notons Cov^η la covariance conditionnelle par η . Alors, $(g_n)_{n \in \mathbb{N}}$ est sensible au bruit à la fois aux niveaux quenched et annealed i.e. :*

$$\text{presque sûrement, } \forall t \in]0, +\infty[, \text{Cov}^\eta \left(g_n(\omega^{gel}(0)), g_n(\omega^{gel}(t)) \right) \xrightarrow[n \rightarrow +\infty]{} 0$$

et :

$$\forall t \in]0, +\infty[, \text{Cov} \left(g_n(\omega^{gel}(0)), g_n(\omega^{gel}(t)) \right) \xrightarrow[n \rightarrow +\infty]{} 0.$$

De plus, il existe une constante $a > 0$ telle que ces résultats sont encore vrais si $t = t_n = n^{-a}$.

Ahlberg et Baldasso ont quant à eux étudié d’une perturbation plus géométrique obtenue en relocalisant les points de η . Ils ont obtenu entre autres le résultat suivant :

Théorème 7.19 ([AB17]). *Considérons un modèle de percolation de Voronoi de paramètre $1/2$ restreint à $[0, n]^2$ défini en choisissant que η est un ensemble de n^2 points indépendants de loi*

uniforme dans $[0, n]^2$. Donnons-nous un paramètre $\varepsilon \in]0, 1[$ et bruitons la configuration de percolation de Voronoi soit en rééchantillonnant la position de chaque point de η avec probabilité ε soit en rééchantillonnant à la fois la position et la couleur de chaque point avec probabilité ε . Notons ω et ω^ε les configurations initiale et bruitée respectivement. Les événements de croisement sont sensibles au bruit pour chacune de ces deux perturbations i.e. :

$$\forall t \in]0, +\infty[, \text{Cov}(g_n(\omega), g_n(\omega^\varepsilon)) \xrightarrow[n \rightarrow +\infty]{} 0.$$

Nous avons obtenu le résultat quantitatif suivant concernant la sensibilité au bruit pour la percolation dynamique gelée (mais nos techniques ne permettent pas d'obtenir un tel résultat pour des dynamiques dans lesquelles les couleurs n'évoluent pas). Rappelons que la probabilité annealed des événements à j bras au paramètre $p = 1/2$ est notée $\alpha_{j,1/2}^{an}(\cdot, \cdot)$.

Théorème 7.20 (Théorème 1.7 du Chapitre 7). *L'analogue du Théorème 7.7 est vrai pour la percolation de Voronoi dynamique gelée i.e. $\text{Cov}(g_n(\omega^{gel}(0)), g_n(\omega^{gel}(t_n)))$ converge vers 0 si on a $t_n n^2 \alpha_4^{an}(1, n) \xrightarrow[n \rightarrow +\infty]{} +\infty$ mais ce n'est pas le cas si $t_n n^2 \alpha_4^{an}(1, n) \xrightarrow[n \rightarrow +\infty]{} 0$.*

Idées de preuves et échantillon spectral annealed. Concentrons-nous maintenant sur la preuve du Théorème 7.20 et sur celles de l'existence de temps exceptionnels (Théorème 1.10). Comme pour les résultats analogues en percolation de Bernoulli, les preuves d'existence de temps exceptionnels commencent par un lemme du second moment. Soit $(\omega(t))_{t \in \mathbb{R}_+}$ un processus de percolation dynamique de Voronoi gelée ou un processus de percolation de Voronoi mouvante, dans les deux cas au paramètre $p = 1/2$. Rappelons que f_R est l'événement à 1 bras. Avec une preuve similaire (quoiqu'un peu plus technique) on peut montrer que s'il existe une constante $C < +\infty$ vérifiant :

$$\forall R \in [1, +\infty[, \int_0^1 \mathbb{E}[f_R(\omega(0))f_R(\omega(t))] dt \leq O(1) \mathbb{E}_{1/2}^{an}[f_R]^2 = C \alpha_{1,1/2}^{an}(1, R)^2, \quad (7.9)$$

alors il existe des temps exceptionnels. (Voir le Lemme 2.10 du Chapitre 7.)

Comme dans le cas de la percolation de Bernoulli, nous avons utilisé des outils spectraux pour prouver le Théorème 7.20 et pour montrer qu'il existe une constante C telle que (7.9) est vraie. Plus précisément, nous avons défini un **échantillon spectral annealed** qui joue le même rôle que l'échantillon spectral introduit par Garban, Pete et Schramm. Notons Ω' l'ensemble de tous les sous-ensembles dénombrables de \mathbb{R}^2 qui sont localement finis (ainsi, η est une variable aléatoire dans Ω'). Notons de plus \mathcal{F}' la tribu classique définie sur Ω' (voir par exemple [DVJ03]) et $\Omega = \cup_{\eta \in \Omega'} \{-1, 1\}^{\eta}$ (ainsi, ω est une variable aléatoire à valeurs dans Ω).

Définition 7.21. Soit $h : \Omega \rightarrow \{0, 1\}$ telle que presque sûrement h^η ne dépend que d'un nombre fini de points, où h^η est la restriction de h à $\{-1, 1\}^\eta$. Un échantillon spectral annealed de h est une variable aléatoire \mathcal{S}_h^{an} à valeurs dans Ω' qui est presque sûrement finie et vérifie :

$$\forall A \in \mathcal{F}', \mathbb{P}[\mathcal{S}_h^{an} \in A] \propto \mathbb{E} \left[\sum_{S \subseteq_f \eta: S \in A} \widehat{h}^\eta(S)^2 \right],$$

où $S \subseteq_f \eta$ signifie que S est un sous-ensemble fini de η . Ainsi :

$$\forall A \in \mathcal{F}', \mathbb{P}[\mathcal{S}_h^{an} \in A] \propto \mathbb{E} \left[\widehat{\mathbb{Q}}_{h^\eta} [S \in A] \right],$$

où $\widehat{\mathbb{Q}}_{h^\eta}$ est la mesure spectrale sur les sous-ensembles finis de η de la Définition 7.10. Notons $\widehat{\mathbb{Q}}_h^{an}$ la mesure spectrale annealed non renormalisée i.e. définie par :

$$\widehat{\mathbb{Q}}_h^{an} [S \in A] = \mathbb{E} \left[\widehat{\mathbb{Q}}_{h^\eta} [S \in A] \right].$$

L'échantillon spectral semble être le bon objet pour l'étude de la percolation de Voronoi gelée. En effet, si $(\omega^{gel}(t))_{t \in \mathbb{R}_+}$ est un tel processus dynamique, on a l'analogue suivant des formules vues en Section 7.2 :

$$\mathbb{E} [h(\omega^{an}(0))h(\omega^{an}(t))] = \sum_{k \in \mathbb{N}} \widehat{\mathbb{Q}}_h^{an} [|S| = k] e^{-tk}.$$

(Voir le Lemme 2.3 du Chapitre 7.) Notre but est donc encore de montrer que l'échantillon spectral est grand avec grande probabilité. Dans le cas de la percolation de Voronoi mouvante, on peut faire des observations similaires à celles déjà faites dans l'étude de la dynamique conservative (voir la Section 7.3). Ainsi on a montré dans le Chapitre 7 qu'il suffisait, pour prouver l'existence de temps exceptionnels pour un modèle de percolation de Voronoi mouvante, de montrer (quantitativement !) que **si on laisse les points d'un échantillon spectral annealed évoluer selon le processus de Lévy considéré, alors très vite il ne ressemble plus à échantillon spectral annealed.** (Voir le Lemme 2.4 du Chapitre 7.)

Finalement, notre but est uniquement de montrer les analogues des résultats sur les échantillons spectraux de la percolation de Bernoulli i.e. les analogues du Théorème 7.11 (qui contrôle la taille des échantillons spectraux des événements de croisement et à 1 bras) et du Théorème 7.17 (qui énonce une propriété de localisation de l'échantillon spectral de l'événement à 1 bras). Nous avons obtenu les estimations suivantes :

Théorème 7.22 (Théorèmes 2.5, 2.7 et 2.8 du Chapitre 7). *Il existe $C < +\infty$ telle que, si $n \in \mathbb{N}^*$ et $R \in [1, +\infty[$:*

$$\forall r \in [1, n], \mathbb{P} \left[0 < |\mathcal{S}_{g_n}^{an}| < r^2 \alpha_{4,1/2}^{an}(1, r) \right] \leq C \left(\frac{n^2}{r^2} \alpha_{4,1/2}^{an}(r, n)^2 + \frac{1}{n} \right); \quad (7.10)$$

$$\forall r \in [1, R], \mathbb{P} \left[0 < |\mathcal{S}_{f_R}^{an}| < r^2 \alpha_{4,1/2}^{an}(1, r) \right] \leq C \alpha_{4,1/2}^{an}(r, R).$$

On a aussi un résultat de localisation du spectre analogue au Théorème 7.17 (mais un petit peu plus compliqué à énoncer, voir le Théorème 2.8 du Chapitre 7).

On peut remarquer le terme $\frac{1}{n}$ dans (7.10) qui n'est pas présent dans le résultat similaire dans le cas de la percolation de Bernoulli. Le résultat est probablement vrai sans ce terme qui apparaît lors de notre contrôle du spectre **à l'extérieur de la boîte** (ce contrôle n'est pas nécessaire dans le cas de la percolation de Bernoulli).

Pourquoi étudier un échantillon spectral annealed plutôt qu'un échantillon spectral quenched ? La raison principale pour laquelle nous n'avons pas étudié un échantillon spectral quenched est que le modèle quenched n'est pas invariant translation. Or, l'invariance par translation est une propriété clef dans l'étude spectrale de [GPS10] dont nous nous inspirons. Cependant, comme nous l'expliquons ci-dessous, nous utiliserons dans le Chapitre 7 de nombreuses propriétés de la théorie de Fourier discrète en écrivant que :

$$\widehat{\mathbb{Q}}_h^{an} [\cdot] = \mathbb{E} \left[\widehat{\mathbb{Q}}_{h^\eta} [\cdot] \right].$$

La stratégie générale des preuves sera ainsi d'appliquer des résultats de théorie de Fourier discrète à la mesure quenched $\widehat{\mathbb{Q}}_{h^\eta}$ puis d'en déduire des résultats pour la mesure annealed $\widehat{\mathbb{Q}}_h^{an}$. Les difficultés techniques viendront essentiellement des nombreux va-et-vient entre les niveaux quenched et annealed. Pour ne pas trop perdre en précision lors de ces va-et-vient, nous nous reposerons beaucoup sur les estimations du Chapitre 6, énoncés dans la Section 6.2 de cette introduction. Rappelons que ces résultats disent essentiellement que les probabilités quenched d'événements à j bras ne dépendent pas beaucoup de l'environnement. Nous expliquons plus précisément ci-dessous pourquoi les résultats du Chapitre 6 sont importants dans l'étude de l'échantillon spectral annealed.

Comment prouver le Théorème 7.22 ? Essayons de donner les raisons principales pour lesquelles les preuves vues dans le cas de la percolation de Bernoulli s’adaptent à la percolation de Voronoi. Mentionnons pour commencer qu’une étape clef de l’article de [GPS10] (dont nous n’avons pas parlé dans cette introduction ; voir le Chapitre 5 de [GPS10] ou [GS14]) est une **généralisation de la propriété de quasi-multiplicativité**. Notre étude de la propriété de quasi-multiplicativité pour la percolation de Voronoi (voir la Section 6.1) a été très importante à cette étape de la preuve.

Rappelons que, comme expliqué en Sections 7.2 et 7.3, une partie importante de la preuve des estimations sur les échantillons spectraux est la preuve que ceux-ci ne sont pas typiquement constitués de “petits morceaux isolés”. Nous avons prouvé les résultats analogues dans le cas des échantillons spectraux annealed dans la Section 3.2 du Chapitre 7. Terminons cette section en expliquant seulement pourquoi, dans la preuve de telles propriétés, les **estimations de probabilités quenched d’événements à j bras** vues dans la Section 6.2 sont cruciales. Rappelons que nous avons vu dans la Section 7.2 que le contrôle de l’échantillon spectral pouvait se faire à l’aide de “structures d’anneaux”. Plaçons-nous ici dans le cas plus simple où on isole l’échantillon spectral dans un unique anneau. Soit donc A un anneau dont nous notons D le disque intérieur. Supposons que $0 \notin A \cup D$. Rappelons que les notations d’événements pivots-quenched et pivots-annealed sont introduites dans la Définition 6.7. Si on applique l’inégalité (7.6) du Lemme 7.13 à la mesure spectrale quenched $\widehat{\mathbb{Q}}_{f_R}^\eta$, on obtient que :

$$\widehat{\mathbb{Q}}_{f_R}^\eta [\emptyset \neq S \subseteq D] \leq 4 \mathbf{P}_{1/2}^\eta [\mathbf{Piv}_D^{\text{quen}}(f_R)]^2 .$$

Ainsi :

$$\widehat{\mathbb{Q}}_{f_R}^{\text{an}} [\emptyset \neq S \subseteq D] \leq 4 \mathbb{E} \left[\mathbf{P}_{1/2}^\eta [\mathbf{Piv}_D^{\text{quen}}(f_R)]^2 \right] \leq 4 \mathbb{E} \left[\mathbf{P}_{1/2}^\eta [\mathbf{Piv}_D^{\text{an}}(f_R)]^2 \right] .$$

De façon similaire, si on applique l’inégalité (7.7) du Lemme 7.13, on obtient que :

$$\widehat{\mathbb{Q}}_{f_R}^\eta [S \cap D \neq \emptyset] \leq 4 \mathbf{P}_{1/2}^\eta [\mathbf{Piv}_D^{\text{quen}}(f_R)] ,$$

et donc :

$$\widehat{\mathbb{Q}}_{f_R}^{\text{an}} [S \cap D \neq \emptyset] \leq 4 \mathbb{E} \left[\mathbf{P}_{1/2}^\eta [\mathbf{Piv}_D^{\text{quen}}(f_R)] \right] \leq 4 \mathbb{P}_{1/2}^{\text{an}} [\mathbf{Piv}_D^{\text{an}}(f_R)] .$$

Rappelons que dans la Section 6.2 nous avons étudié les événements à j bras quenched. En particulier, le Théorème 6.11 nous dit que :

$$\widetilde{\alpha}_{j,1/2}(\cdot, \cdot) \asymp \alpha_{j,1/2}^{\text{an}}(\cdot, \cdot) , \quad (7.11)$$

où $\widetilde{\alpha}_{j,1/2}(\cdot, \cdot) = \sqrt{\mathbb{E} \left[\mathbf{P}_{1/2}^\eta [\mathbf{A}_j(\cdot, \cdot)]^2 \right]}$. Notons ρ_1 et ρ_2 les rayons interne et externe de l’anneau A . Si on utilise des propriétés des événements pivots et à j bras prouvées dans les Chapitres 5 et 6 (i.e. des estimations du type de celles énoncées dans les Sections 6.1 et 6.2 de cette introduction) on peut montrer que :

$$\mathbb{E} \left[\mathbf{P}_{1/2}^\eta [\mathbf{Piv}_D^{\text{an}}(f_R)]^2 \right] \leq O(1) \widetilde{\alpha}_{4,1/2}(\rho_1, \rho_2)^2 ,$$

et :

$$\mathbb{P}_{1/2}^{\text{an}} [\mathbf{Piv}_D^{\text{an}}(f_R)] \leq O(1) \alpha_{4,1/2}^{\text{an}}(\rho_1, \rho_2) .$$

(Si ρ_2 n’est pas de l’ordre de R , la probabilité d’un événement à 1 bras intervient aussi dans ces expressions, nous omettons ce terme pour simplifier les expressions.) Ainsi, on a :

$$\begin{aligned} \widehat{\mathbb{Q}}_{f_R}^{\text{an}} [\emptyset \neq S \subseteq D] &\leq O(1) \widetilde{\alpha}_{4,1/2}(\rho_1, \rho_2)^2 ; \\ \widehat{\mathbb{Q}}_{f_R}^{\text{an}} [S \cap D \neq \emptyset] &\leq O(1) \alpha_{4,1/2}^{\text{an}}(\rho_1, \rho_2) . \end{aligned}$$

On voit ici l’importance de l’inégalité 7.11. Cette inégalité est cruciale dans toute l’étude des échantillons spectraux et permet de **comparer les différentes estimations** que l’on obtient au cours des preuves. Ceci constituait notre principale motivation derrière le Théorème 6.11.

8 Miscellaneous sur les limites d'échelles

Comme mentionné dans la Section 2.1, l'existence des limites des probabilités de croisement n'est connue que pour le modèle de percolation par sites sur \mathcal{T} . Il semble difficile d'adapter la preuve de ce résultat à d'autres réseaux du fait d'une propriété combinatoire spécifique à \mathcal{T} (voir [Bef08] pour des pistes et résultats allant dans cette direction et pour les explications de ces difficultés). Dans cette section, nous expliquons une autre idée générale de preuve de convergence des probabilités de croisement (qui n'a pas encore abouti!) et qui provient de [BKS99]. Avant cela, plaçons-nous dans le cas de la percolation sur \mathcal{T} et faisons un très bref tour des conséquences du théorème d'invariance conforme prouvé par Smirnov (Théorème 2.2).

Le Théorème 2.2 implique que les probabilités de croisement convergent, mais comment en déduire l'existence d'une limite d'échelle de la configuration? Et surtout, quel sens donner à une telle limite d'échelle dans sa totalité? Dans quel espace serait-il pertinent de se placer? On peut en premier lieu étudier les interfaces, i.e. les frontières entre les régions noires et blanches. En se reposant sur le Théorème 2.2, Smirnov [Smi07] et Camia et Newman [CN07] (voir aussi [Wer07]) ont montré que les interfaces convergeaient vers le **SLE de paramètre 6**. Voir la Figure 8.1). Les processus SLE ont été introduits par Schramm dans [Sch00] comme candidats pour les limites d'échelle d'interfaces intervenant dans des modèles de physique statistique planaire (voir aussi [Wer04, Law08]). L'étude de ceux-ci à l'aide d'outils d'analyse complexe et de calcul stochastique permet de calculer les exposants critiques ζ_j des événements à j bras que nous avons rencontrés dans la Section 5.2 (voir [LSW02, SW01]).

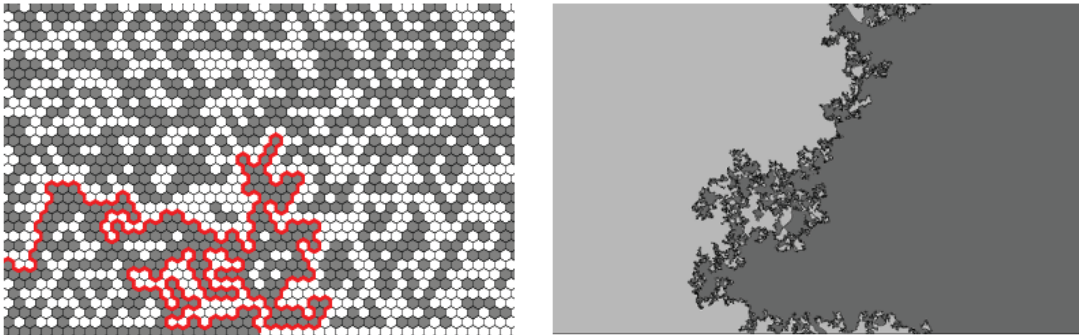

FIGURE 8.1 – Une interface de percolation critique converge vers un SLE de paramètre 6, simulation par Vincent Beffara.

Les processus SLE permettent ainsi de décrire de façon précise la limite d'échelle d'un modèle de physique statistique planaire. Toutefois, un unique processus ne contient pas toute l'information de la limite d'échelle, mais seulement d'une unique interface. Divers travaux ont permis de démontrer l'existence de limite d'échelle **globale**. On peut par exemple mentionner la construction d'une limite comme soule de boucles dont chacune est la limite d'une interface (voir [CN06]). Nous renvoyons à [SS11] pour la description d'autres approches. Dans cet article, Schramm et Smirnov proposent aussi une façon de décrire la limite d'échelle globale de la percolation. Un modèle de percolation γ est défini comme un ensemble de quads. Plus précisément, une configuration de percolation est identifiée à l'ensemble de tous les quads qui sont croisés pour ce modèle. Il s'avère que des distances naturelles sur cet espace peuvent en faire un espace compact appelé maintenant **espace de Schramm-Smirnov**. Il est connu que la percolation critique a une limite d'échelle dans l'espace de Schramm-Smirnov (voir [GPS13a]). Par ailleurs, Garban, Pete et Schramm ont montré dans [GPS13a, GPS13b] que le modèle de percolation dynamique avait une limite d'échelle dans cet espace.

Une méthode alternative en vue de montrer la convergence des probabilités de croisement. Terminons cette introduction en mentionnant une méthode de preuve provenant de [BKS99] qui a été développée dans le but de montrer l'existence d'une limite des probabilités de convergence. L'idée générale est que, si l'on veut comparer les probabilités de croisement de deux rectangles de tailles m et n différentes **mais proches**, on peut considérer deux graphes aléatoires \mathcal{G}^m et \mathcal{G}^n tels que : i) la moyenne de la probabilité de croisement sur \mathcal{G}^m est égale à la probabilité de croisement du rectangle de taille m et de même pour le graphe \mathcal{G}^n , ii) avec probabilité non négligeable, les deux graphes aléatoires sont très proches et : iii) la variance des probabilités de croisement sur les graphes aléatoires est petite. Ainsi, l'idée est de considérer deux modèles en milieu aléatoire tels que **les probabilités de croisement dépendent peu de l'environnement** et tels qu'on peut comparer le modèle m au modèle n **au niveau quenched**. Considérons deux modèles en milieu aléatoires. Le premier est celui proposé par Benjamini, Kalai et Schramm et issu de la théorie de la sensibilité au bruit. Pour simplifier, restreignons au cas des croisements de rectangles $2n \times n$ en percolation de Bernoulli critique sur \mathbb{Z}^2 . Considérons les rectangles $[0, 2n] \times [0, n]$ et $[0, 4n] \times [0, 2n]$ et essayons de montrer que :

$$\left| \mathbb{P}_{1/2} [\text{Cross}(2n, n)] - \mathbb{P}_{1/2} [\text{Cross}(4n, 2n)] \right| \xrightarrow{n \rightarrow +\infty} 0.$$

L'idée est tout d'abord de considérer un paramètre $\alpha \in [0, 1[$ et d'écrire que

$$\left| \mathbb{P}_{1/2} [\text{Cross}(2n, n)] - \mathbb{P}_{1/2} [\text{Cross}(4n, 2n)] \right|$$

est inférieure ou égale à :

$$\sum_{k=1}^{n^{1-\alpha}} \left| \mathbb{P}_{1/2} [\text{Cross}(2(n + (k-1)n^\alpha), n + (k-1)n^\alpha)] - \mathbb{P}_{1/2} [\text{Cross}(2(n + kn^\alpha), n + kn^\alpha)] \right|.$$

Essayons de montrer que les termes de la somme ci-dessus sont bien plus petits que $n^{\alpha-1}$. Plaçons-nous pour simplifier dans le cas $k = 1$ et essayons de montrer que :

$$\left| \mathbb{P}_{1/2} [\text{Cross}(2n, n)] - \mathbb{P}_{1/2} [\text{Cross}(2(n + n^\alpha), n + n^\alpha)] \right| \ll n^{\alpha-1}. \quad (8.1)$$

Afin d'étudier cette question, utilisons le graphe aléatoire²² $\mathcal{G}_n^\varepsilon$ construit dans la Section 7.1 (voir la discussion sous le Théorème 7.5). Rappelons que la sensibilité au bruit des événements de croisement est équivalente au fait que la variance de la probabilité de croisement pour la percolation sur $\mathcal{G}_n^\varepsilon$ tend vers 0.

Supposons maintenant que ε_n est choisi de telle façon que l'on peut montrer que les graphes aléatoires $\mathcal{G}_n^{\varepsilon_n}$ et $\mathcal{G}_{n+n^\alpha}^{\varepsilon_{n+n^\alpha}}$ sont très proches avec probabilité non négligeable - imaginons même pour simplifier l'heuristique que l'on peut montrer que :

$$\mathbb{P} [\mathcal{G}_{n+n^\alpha}^{\varepsilon_{n+n^\alpha}} = \mathcal{G}_n^{\varepsilon_n}] \geq \Omega(1). \quad (8.2)$$

Notons $\mathbb{P}_{1/2}^G$ la mesure de percolation par arêtes de paramètre 1/2 sur un graphe G et supposons aussi que l'on peut montrer la propriété de sensibilité au bruit suivante :

$$\text{Var} \left(\mathbb{P}_{1/2}^{\mathcal{G}_n^{\varepsilon_n}} [\text{Cross}(2n, n)] \right) \ll n^{2(\alpha-1)}. \quad (8.3)$$

L'inégalité (8.1) est une conséquence directe de (8.2) et (8.3).

Si on utilise la valeur des exposants critiques (calculés pour la percolation par sites sur \mathcal{T} , voir la Section 5) et les résultats de sensibilité au bruit de [GPS10], on s'attend à ce que, si $\gamma \in]0, 3/4[$ et $\varepsilon_n = n^{-\gamma}$, alors :

$$\text{Var} \left(\mathbb{P}_{1/2}^{\mathcal{G}_n^{\varepsilon_n}} [\text{Cross}(2n, n)] \right) \leq O(1) n^{\frac{3}{4}(1-\frac{4}{3}\gamma)+o(1)}.$$

²²Dans la Section 7.1, ce graphe est construit à partir de $\mathbb{Z}^2 \cap [0, n]^2$; comme ici nous considérons les croisements de $[0, 2n] \times [0, n]$, nous construisons ce graphe de la même façon mais à partir de $\mathbb{Z}^2 \cap [0, 2n] \times [0, n]$.

Toutefois, la preuve d'un résultat du type de (8.2) (ou au moins la preuve du fait que la probabilité de croisement pour la percolation sur $\mathcal{G}_{n+n^\alpha}^{\varepsilon_{n+n^\alpha}}$ est proche de celle sur $\mathcal{G}_n^{\varepsilon_n}$ avec probabilité non négligeable pour un bon choix de α) semble très difficile car on a très peu d'informations sur la géométrie ou la combinatoire des graphes $\mathcal{G}_n^{\varepsilon_n}$. C'est une des raisons pour lesquelles cette méthode n'a pour le moment pas abouti.

Essayons maintenant d'appliquer cette méthode à la percolation de Voronoi.²³ On verra ainsi pourquoi il semble important de trouver des estimations précises de la quantité

$$\text{Var} \left(\mathbb{P}_{1/2}^{an} [\text{Cross}(2R, R)] \right)$$

des Théorèmes 6.2 et 6.9. Choisissons $\alpha = 0$. Comme ci-dessus, remarquons que :

$$\begin{aligned} & \left| \mathbb{P}_{1/2}^{an} [\text{Cross}(2n, n)] - \mathbb{P}_{1/2}^{an} [\text{Cross}(4n, 2n)] \right| \\ & \leq \sum_{k=1}^n \left| \mathbb{P}_{1/2}^{an} [\text{Cross}(2(n+(k-1)), n+(k-1))] - \mathbb{P}_{1/2}^{an} [\text{Cross}(2(n+k), n+k)] \right| \end{aligned}$$

et essayons de montrer que :

$$\left| \mathbb{P}_{1/2}^{an} [\text{Cross}(2n, n)] - \mathbb{P}_{1/2}^{an} [\text{Cross}(2(n+1), n+1)] \right| \ll \frac{1}{n}. \quad (8.4)$$

Adoptons un point de vue un petit peu différent sur le modèle de percolation de Voronoi et considérons deux processus de Poisson η_1 d'intensité respective R^2 et $(R+1)^2$. Rappelons que η est un processus d'intensité 1 et notons que $\mathbf{P}_{1/2}^\eta [\text{Cross}(2R, R)]$ a la même loi que $\mathbf{P}_{1/2}^{\eta_1} [\text{Cross}(2, 1)]$ et que $\mathbf{P}_{1/2}^\eta [\text{Cross}(2(R+1), R+1)]$ a la même loi que $\mathbf{P}_{1/2}^{\eta_2} [\text{Cross}(2, 1)]$. Notons par ailleurs que l'on peut coupler η_1 et η_2 de telle façon à ce qu'ils soient égaux avec probabilité plus grande qu'une constante strictement positive (ce résultat est essentiellement le théorème central limite pour les variables de Poisson). Ceci nous fournit l'analogie de (8.2). Par conséquent, pour montrer (8.4) - et donc montrer que les probabilités annealed de croisement convergent - il suffit de montrer l'analogie de (8.3) i.e. :

$$\text{Var} \left(\mathbf{P}_{1/2}^\eta [\text{Cross}(2n, n)] \right) \ll \frac{1}{n^2}.$$

Rappelons que le Théorème 6.9 implique que :

$$\text{Var} \left(\mathbf{P}_{1/2}^\eta [\text{Cross}(2n, n)] \right) \leq O(1) n^2 \alpha_{4,1/2}^{an}(1, n)^2,$$

et que l'on s'attend à ce que $n^2 \alpha_{4,1/2}^{an}(1, n)^2 = n^{2(1-\zeta_4)+o(1)} = n^{-1/2+o(1)}$. Nous sommes donc encore loin de la preuve de (8.3). Si l'on veut améliorer le Théorème 6.9, il faut probablement montrer que la quantité du type $\mathbb{E} \left[\left(\mathbf{P}_{1/2}^\eta [\text{Cross}(2n, n)] - \mathbf{P}_{1/2}^{\eta^{(i)}} [\text{Cross}(2n, n)] \right)^2 \right]$ de (6.3) n'est pas seulement plus petite que $O(1) \alpha_{4,1/2}^{an}(1, n)^2$ mais **bien plus petite** (et même bien plus petite que $n^{-3/2} \alpha_{4,1/2}(1, n)^2$). Ceci paraît - au moins à première vue - d'un niveau de difficulté analogue à celui de l'adaptation de la preuve d'invariance conforme de Smirnov à d'autres réseaux que \mathcal{T} (voir [Bef08]).

²³Nous remercions Vincent Tassion pour nous avoir fait remarquer que cette méthode générale de preuve pourrait aussi s'appliquer à ce modèle.

Première partie

Percolation de lignes nodales

Quasi-indépendance pour les lignes nodales

Travail en commun avec Alejandro Rivera

Ce chapitre est, à des détails mineurs près, la reproduction de l'article [V1], intitulé "Quasi-independence for nodal lines", disponible sur Hal et Arxiv et à paraître aux Annales de l'Institut Henri Poincaré.

Résumé en français. Dans ce chapitre, nous démontrons des résultats de quasi-indépendance pour des événements mesurables par rapport aux lignes de niveau de champs gaussiens planaires de covariance $(x, y) \mapsto \kappa(x - y)$. Nous appliquons ceux-ci au modèle de percolation de lignes nodales étudié dans [BG16]. Dans cet article, Beffara et Gayet utilisent une méthode due à Tassion [Tas16] pour montrer des propriétés de croisement de boîtes lorsque $\kappa \geq 0$ et $\kappa(x) \leq O(1)|x|^{-325}$. Nous montrons que ce résultat est encore vrai si $\kappa(x) \leq O(1)|x|^{-(4+\varepsilon)}$. Nous appliquons aussi nos résultats de quasi-indépendance aux événements dénombrant les lignes nodales et en déduisons un résultat de concentration par le bas de la densité de celles-ci autour de la constante de Nazarov et Sodin [NS16].

English abstract. In this chapter, we prove a quasi-independence result for level sets of a planar centered stationary Gaussian field with covariance $(x, y) \mapsto \kappa(x - y)$, with only mild conditions on the regularity of κ . As a first application, we study percolation for nodal lines in the spirit of [BG16]. In the said article, Beffara and Gayet rely on Tassion's method ([Tas16]) to prove that, under some assumptions on κ , most notably that $\kappa \geq 0$ and $\kappa(x) = O(|x|^{-325})$, the nodal set satisfies a box-crossing property. In the present work we lower this exponent to $4 + \varepsilon$ thanks to a new approach towards quasi-independence for crossing events. Our quasi-independence result also applies to events counting nodal components and we obtain a lower concentration result for the density of nodal components around the Nazarov and Sodin constant from [NS16].

Contents

1	Introduction	64
2	Quasi-independence for Gaussian vectors	71
3	Quasi-independence for planar Gaussian fields: the proof of Theorem 1.12	73
3.1	The proof of Theorem 1.12 in the case of crossing and circuit events	74
3.2	Pivotal sites imply exceptional geometric events	76
3.3	End of the proof of Proposition 3.4 via Kac-Rice estimates	79
3.4	Completing the proof of Theorem 1.12	81
4	Tassion’s RSW theory: the proof of Theorem 1.1	84
5	Concentration from below of the number of nodal lines: the proof of Theorem 1.4	88
A	Classical tools	90
A.1	Classical results for Gaussian vectors and fields	90
A.2	Transversality of the level set and a non-quantitative discretization lemma	92
B	A uniform discrete RSW estimate	94

1 Introduction

In this chapter, we prove a quasi-independence result for level lines of planar Gaussian fields and present two applications of this result. First, we use it to revisit and generalize the results by Gayet and Boffarda [BG16] who initiated the study of large scale connectivity properties for nodal lines and nodal domains of planar Gaussian fields. Second, we apply it to the study of the concentration of the number of nodal lines around the Nazarov and Sodin constant (the constant ν of Theorem 1 of [NS16]). Let f be a planar centered Gaussian field. The **covariance function** of f is the function $K : \mathbb{R}^2 \times \mathbb{R}^2 \rightarrow \mathbb{R}$ defined by:

$$\forall x, y \in \mathbb{R}^2, K(x, y) = \mathbb{E}[f(x)f(y)].$$

We assume that f is normalized so that for each $x \in \mathbb{R}^2$, $K(x, x) = \text{Var}(f(x)) = 1$, that it is non-degenerate (i.e. for any pairwise distinct $x_1, \dots, x_k \in \mathbb{R}^2$, $(f(x_1), \dots, f(x_k))$ is non-degenerate), and that it is a.s. continuous and stationary. In particular, there exists a strictly positive definite continuous function $\kappa : \mathbb{R}^2 \rightarrow [-1, 1]$ such that $\kappa(0) = 1$ and, for each $x, y \in \mathbb{R}^2$, $K(x, y) = \kappa(x - y)$. We will also refer to κ as covariance function when there is no possible ambiguity. For each $p \in \mathbb{R}$ we call **level set** of f the random set $\mathcal{N}_p := f^{-1}(-p)$ and **excursion set** of f the random set $\mathcal{D}_p := f^{-1}([-p, +\infty])$.¹ Let us first state our result regarding planar box-crossing properties.

Box crossing estimates for planar Gaussian fields. In [BG16], the authors give conditions under which such sets satisfy a box-crossing property at $p = 0$. We say that random sets satisfy a box-crossing property if for any quad (i.e. a topological rectangle with two opposite distinguished sides) \mathcal{Q} there exists a positive constant c such that for any (potentially sufficiently large) scale s , there is a crossing of $s\mathcal{Q}$ between distinguished sides by the random set with probability larger than c . The study of the case $p = 0$ is natural since this is the level at which duality arises, see for instance Remark A.11 in our appendix. The most important conditions

¹This convention, while it may seem counterintuitive, is convenient because it makes \mathcal{D}_p increasing both in f and in p . See Chapter 2.

asked in [BG16] were some symmetry conditions, the fact that f is positively correlated (which means that the covariance function κ takes only non-negative values) and a sufficiently fast decay for $\kappa(x)$ as $|x|$ does to $+\infty$, namely $\kappa(x) = O(|x|^{-325})$. In [BM18], Beliaev and Muirhead have lowered the exponent 325 to any $\alpha > 16$. In the present chapter, we lower this exponent to any $\alpha > 4$, thus obtaining the following result:

Theorem 1.1. *Assume that f is a non-degenerate, centered, normalized, continuous, stationary, positively correlated planar Gaussian field that satisfies the symmetry assumption Condition 1.8 below. Assume also that κ satisfies the differentiability assumption Condition 1.10 below and that $\kappa(x) \leq C|x|^{-\alpha}$ for some $C < +\infty$ and $\alpha > 4$. Let \mathcal{Q} be a quad, i.e. a simply connected bounded open subset of \mathbb{R}^2 whose boundary $\partial\mathcal{Q}$ is piecewise smooth boundary with two distinguished disjoint segments on $\partial\mathcal{Q}$. Then, there exists $c = c(\kappa, \mathcal{Q}) > 0$ such that for each $s \in]0, +\infty[$, the probability that there is a continuous path in $\mathcal{D}_0 \cap s\mathcal{Q}$ joining one distinguished side to the other is at least c . Moreover, there exists $s_0 < +\infty$ such that the same result holds for \mathcal{N}_0 as long as $s \geq s_0$.*

Lowering the exponent α below 4, if at all possible, would require new ideas (see Remark 1.13). This result is the analog of the Russo-Seymour-Welsh theorem for planar percolation from [Rus78, SW78], see also Lemma 4 of Chapter 3 of [BR06b], Theorem 11.70 and Equation 11.72 of [Gri99] or Theorem 5.31 of [Gri10]. For more about the links between connectivity properties of nodal lines and domains and percolation, see [MS83a, MS83b, MS86], [Ale96a], [BS07], [BG16], [BM18], [BMW17]. Box-crossing estimates have previously been extended to some other dependent models, see [BR06a, DCHN11, Tas16, ATT16] and also to some non-planar models, see [BS17, NTW17]. It seems also relevant to mention the recent work [BG17], in which the authors prove that the box-crossing property is stable by perturbations for sufficiently decorrelated discrete Gaussian fields. In particular, they obtain analogs of Theorem 1.1 for many discrete Gaussian fields that are not positively associated.

The result analogous to Theorem 1.1 in [BG16] is Theorem 4.9. In [BM18], this is Theorem 1.7. Note that our assumptions about the differentiability and the non-degeneracy of κ are different from those in [BG16] and [BM18]. Still, we see them essentially as technical conditions, whereas the question of the optimal exponent α seems to be of much more interest.

While our proof differs from the one in [BG16, BM18] in some key steps, the initial idea is the same, i.e. the use of Tassion's general method to prove box-crossing estimates which goes back to [Tas16]. Let us first be a little more precise about the proof in [BG16, BM18]. The three main ingredients are: i) a quantitative version of Tassion's method (see Section 2 of [BG16], ii) a quasi-independence result for finite dimensional Gaussian fields (see Theorem 4.3 of [BG16] and Proposition C.1 of [BM18]) and iii) a quantitative approximation result (see Theorem 1.5 of [BG16] and Theorems 1.3 and 1.5 of [BM18]). Steps i) and ii) imply a discrete version of a RSW theorem and Step iii) is then used to deduce a RSW theorem for the continuous model. The most important contribution of [BM18] is an improvement of the approximation result. Another way to prove the box-crossing property is to use prove a quasi-independence in the continuum and then apply Tassion's method (not necessarily in a quantitative way). This strategy was also suggested in [BMW17], where Beliaev, Muirhead and Wigman prove a box-crossing estimate for random Gaussian fields on the sphere and the torus. More precisely, they used analogs of steps ii) and iii) above to prove such a quasi-independence result, see their Proposition 3.4. In the present work, we also prove a quasi-independence result in the continuum (see Theorem 1.12) and then apply Tassion's method. However, the way we prove such a quasi-independence result is very different from [BMW17]. In particular, *we do not rely on any quantitative approximation result* and we rather prove a quasi-independence result *uniform in the discretization mesh* (see Proposition 3.4). Moreover, our techniques, together with the quantitative adaptation of [Tas16] presented in [BG16] yield a uniform discrete RSW-estimate without any constraints on the mesh (see Proposition B.2). This result is quite handy when using discrete techniques to study

continuous fields, see Chapter 2. The proof of Theorem 1.1 is written in Section 4 by relying only on our Sections 2 and 3 (but not on Subsection 3.4) and on [Tas16]. For other works relying on Tassion’s method for box crossing estimates, see [ATT16, DCTT16].

Before stating our quasi-independence results, let us state our result regarding the concentration of the number of nodal components of planar Gaussian fields.

A concentration from below around the Nazarov and Sodin constant for the number of nodal components. In [NS09], Nazarov and Sodin prove that, if g is a random spherical harmonic of degree n on the 2-dimensional sphere and if $N_0(n)$ is the number of nodal components (i.e. connected components of the 0-level set) of g , then there exists a constant $c_{NS} \in]0, +\infty[$ such that, for every $\varepsilon > 0$, there exists $C = C(\varepsilon) < +\infty$ and $c = c(\varepsilon) > 0$ such that for every $n \in \mathbb{N}$:

$$\mathbb{P} \left[\left| \frac{N_0(n)}{n^2} - c_{NS} \right| \geq \varepsilon \right] \leq C \exp(-cn). \quad (1.1)$$

In other words, the number of nodal components divided by n^2 concentrates exponentially around a constant. In [NS16], the same authors consider a much larger family of fields and obtain the much more general following result but without concentration.

Theorem 1.2 (Theorem 1 of [NS16]). *Assume that f is a normalized, continuous, stationary planar Gaussian field which satisfies the spectral hypotheses Condition 1.11 below. Then, there exists a constant $c_{NS} = c_{NS}(\kappa) \in]0, +\infty[$ such that, if $N_0(s)$ is the number of connected components of the nodal set \mathcal{N}_0 contained in the box $[-s/2, s/2]^2$, then $N_0(s)/s^2$ goes to c_{NS} as s goes to $+\infty$ a.s. and in L^1 .*

Remark 1.3. Their result is actually more general: they obtain a result for families of Gaussian fields on manifolds with translation-invariant local limits (see Subsection 1.2 of [NS16]).

Theorem 1.2 and the quasi-independence results of the present chapter enable us to obtain a concentration result **from below** of $N_0(s)/s^2$ around c_{NS} :

Theorem 1.4. *Assume that f is a normalized, continuous, stationary and non-degenerate planar Gaussian field which satisfies the spectral hypotheses Condition 1.11 below and the differentiability assumption Condition 1.10 below. With the same notations as Theorem 1.2, we have the following:*

1. *if there exists $C < +\infty$ and $c > 0$ such that for every $x \in \mathbb{R}^2$ we have $|\kappa(x)| \leq C \exp(-c|x|^2)$, then for every $\varepsilon > 0$ there exists $C_0 = C_0(\kappa, \varepsilon) < +\infty$ and $c_0 = c_0(\kappa, \varepsilon)$ such that for each $s \in]0, +\infty[$:*

$$\mathbb{P} \left[\frac{N_0(s)}{s^2} \leq c_{NS} - \varepsilon \right] \leq C_0 \exp(-c_0 s);$$

2. *if there exists $C < +\infty$ and $\alpha > 4$ such that for every $x \in \mathbb{R}^2$ we have $|\kappa(x)| \leq C|x|^{-\alpha}$, then for every $\delta > 0$ and every $\varepsilon > 0$, there exists $C_0 = C_0(\kappa, \alpha, \delta, \varepsilon) < +\infty$ such that for each $s \in]0, +\infty[$:*

$$\mathbb{P} \left[\frac{N_0(s)}{s^2} \leq c_{NS} - \varepsilon \right] \leq C_0 s^{4-\alpha+\delta}.$$

An important example of a Gaussian field which satisfies the decorrelation hypothesis of Item 1 above is the **Bargmann-Fock field** which is the analytic Gaussian field $:\mathbb{R}^2 \rightarrow \mathbb{R}$ with covariance function $(x, y) \in (\mathbb{R}^2)^2 \mapsto \kappa(x-y) = \exp(-\frac{1}{2}|x-y|^2)$. In some sense, this field is the local limit of the **Kostlan polynomials** which are random homogeneous polynomials on the sphere which arise naturally from real algebraic geometry, see for instance the introduction of [BG16]

or that of [BMW17]. The analogue of Theorem 1.2 is known for these polynomials (see [NS16]), but the concentration inequality (1.1) is not known (neither from below nor from above). There are however two relevant results in this direction. The first, Corollary 1.10 of [Let18], proves that the probability that there are no components in a prescribed region decays polynomially fast. The second, Theorem 1 of [GW11], deals with the other extreme and proves that polynomials of degree $d \gg 1$ whose number of nodal components is maximal up to a linear term in d are exponentially rare in d . We hope that the proof of Theorem 1.4 can be adapted in order to get the lower concentration part of (1.1) with $n = \sqrt{d}$ for Kostlan polynomials of degree $d \gg 1$.

Remark 1.5. In [NS16], the authors obtain Theorem 1.2 in any dimension. We believe that our techniques could be extended to higher dimensions (probably with additional technicalities).

Remark 1.6. As explained in the paragraph above about RSW results and as suggested in [BMW17], another way of obtaining quasi-independence results for nodal lines of planar Gaussian fields is to use the quasi-independence results for finite dimensional vectors and the quantitative discretization results, both from [BG16, BM18]. One could probably deduce Theorem 1.4 from either [BG16] or [BM18], though with slightly different assumptions, and more to the point, with a weaker Item 2 (more precisely, we believe that the exponent in the right hand side would be $16 - \alpha + \delta$ instead).

Before stating our quasi-independence results, we list the conditions on the Gaussian fields under which we work in this chapter.

Conditions on the planar Gaussian fields. We will assume that Condition 1.7 is true in all the present chapter. Then, Condition 1.8 will be useful to apply classical percolation arguments, Conditions 1.9 and 1.10 will be useful to obtain quasi-independence results, and finally Condition 1.11 is the assumptions by Nazarov and Sodin to obtain their convergence result.

Conditions 1.7. The field f is non-degenerate (i.e. for any pairwise distinct $x_1, \dots, x_k \in \mathbb{R}^2$, $(f(x_1), \dots, f(x_k))$ is non-degenerate), centered, normalized, continuous, and stationary. In particular, there exists a strictly positive definite continuous function $\kappa : \mathbb{R}^2 \rightarrow [-1, 1]$ such that $K(x, y) := \mathbb{E}[f(x)f(y)] = \kappa(y - x)$ and $\kappa(0) = 1$.

Conditions 1.8 (Useful to apply percolation arguments.). The field f is positively correlated, invariant by $\frac{\pi}{2}$ -rotation, and reflection through the horizontal axis.

Conditions 1.9 (Useful to have quasi-independence. Depends on a parameter $\alpha > 0$). There exists $C < +\infty$ such that for each $x \in \mathbb{R}^2$, $|\kappa(x)| \leq C|x|^{-\alpha}$.

Conditions 1.10 (Technical conditions to have quasi-independence.). The function κ is C^8 and for each $\beta \in \mathbb{N}^2$ with $\beta_1 + \beta_2 \leq 2$, $\lim_{x \rightarrow \infty} \partial^\beta \kappa(x) = 0$.

Conditions 1.11 (Condition from [NS16]). Let ρ be the spectral measure of f which exists by Bochner's theorem (see [NS16]). Then: i) $\int_{\mathbb{R}^2} |\lambda|^4 \rho(d\lambda) < +\infty$, ii) ρ has no atom, iii) ρ is not supported on a linear hyperplane and iv) there exists a compactly supported signed measure μ whose support is included in the support of ρ and a bounded domain $D \subseteq \mathbb{R}^2$ such that $\mathcal{F}(\mu)$ (the Fourier transform of μ) restricted to ∂D is non-positive and there exists $u_0 \in D$ such that $\mathcal{F}(\mu)(u_0) > 0$.

Note that, in the case of the Bargmann-Fock field, the spectral measure is simply a standard Gaussian measure, so this field satisfies Condition 1.11 (for the case iv), see Appendix C of [NS16]). Moreover, f is not degenerate since the Fourier transform of a continuous and integrable function $:\mathbb{R}^2 \rightarrow \mathbb{R}_+$ which is not 0 is strictly positive definite, see for instance Theorem 3 of Chapter 13 of [CL09] (which is the strictly positive definite version of the easy part of Bochner theorem). Finally, the Bargmann-Fock field satisfies all the conditions above (and for every $\alpha > 0$).

The quasi-independence result. Theorem 1.12 below is our quasi-independence result for level lines of planar Gaussian fields. We first need a few more notations. Consider the following setup: let $k_1, k_2 \in \mathbb{Z}_{>0}$ and let $(\mathcal{E}_i)_{1 \leq i \leq k_1+k_2}$ be a collections of either rectangles of the form $[a, b] \times [c, d]$ for some $a \leq b$ and $c \leq d$ or annuli of the form $x + [-a, a]^2 \setminus]-b, b[$ for some $x \in \mathbb{R}^2$ and $a \geq b$. We say that a rectangle is crossed from left to right above (resp. below) $-p$ if there is a continuous path in \mathcal{D}_p (resp. \mathcal{D}_p^c) included in this rectangle that joins its left side to its right side. Of course, an analogous definition holds for top-bottom crossings. Moreover, we say that there is a circuit above (resp. below) $-p$ in an annulus if there is circuit included in \mathcal{D}_p (resp. \mathcal{D}_p^c) included in this annulus that separates its inner boundary from its outer boundary. Furthermore, for each $i \in \{1, \dots, k_1 + k_2\}$, we let $N_p(i)$ denote the number of connected components of the level set \mathcal{N}_p which are included in \mathcal{E}_i . We write $\mathcal{K}_1 = \cup_{i=1}^{k_1} \mathcal{E}_i$, $\mathcal{C}_1 = \cup_{i=1}^{k_2} \partial \mathcal{E}_i$, $\mathcal{K}_2 = \cup_{j=k_1+1}^{k_1+k_2} \mathcal{E}_j$, and $\mathcal{C}_2 = \cup_{j=k_1+1}^{k_1+k_2} \partial \mathcal{E}_j$.

Theorem 1.12. *Let f be a Gaussian field satisfying Conditions 1.7 and 1.10 and consider the above setup. There exist $d = d(\kappa) < +\infty$ and $C = C(\kappa) < +\infty$ such that we have the following: let $p \in \mathbb{R}$. Let A (resp. B) be an event in the σ -algebra generated by the crossings above $-p$ and below $-p$ of rectangles among the $(\mathcal{E}_i)_{1 \leq i \leq k_1}$ (resp. $(\mathcal{E}_j)_{k_1+1 \leq j \leq k_1+k_2}$), the circuits above $-p$ and below $-p$ in annuli among the $(\mathcal{E}_i)_{1 \leq i \leq k_1}$ (resp. $(\mathcal{E}_j)_{k_1+1 \leq j \leq k_1+k_2}$) and the variables $N_p(i)$ for $i \in \{1, \dots, k_1\}$ (resp. $i \in \{k_1 + 1, \dots, k_1 + k_2\}$). Let $\eta = \sup_{x \in \mathcal{K}_1, y \in \mathcal{K}_2} |\kappa(x - y)|$. If \mathcal{K}_1 and \mathcal{K}_2 are at distance greater than d , then:*

$$|\mathbb{P}[A \cap B] - \mathbb{P}[A]\mathbb{P}[B]| \leq \frac{C \eta}{\sqrt{1 - \eta^2}} (1 + |p|)^4 e^{-p^2} \prod_{i=1}^2 (\text{Area}(\mathcal{K}_i) + \text{Length}(\mathcal{C}_i) + k_i) .$$

Note that in Theorem 1.12 we can consider crossing of rectangles (and similarly circuit in annuli) by **level lines**. Indeed, by Remark A.11, given a rectangle and for each $p \in \mathbb{R}$, a.s. there is a crossing of a rectangle included in \mathcal{N}_p if and only if there is such a crossing above $-p$ and a crossing below $-p$. The proof of Theorem 1.12 follows a perturbative technique applied to a discrete approximation of our model (see Section 2). To quantify the perturbation we control certain ‘‘pivotal’’ events using geometric techniques and the Kac-Rice formula (see Section 3).

Remark 1.13. If the perimeter of each of the rectangles and annuli of Theorem 1.12 is at most s , if \mathcal{K}_1 and \mathcal{K}_2 are at distance more than s and if $\kappa(x) = O(|x|^{-\alpha})$ then the right-hand-side of the estimates of Theorem 1.12 is:

$$O \left(s^{4-\alpha} \left(1 + \frac{k_1 + k_2}{s} + \frac{k_1 k_2}{s^2} \right) \right) = O(k_1 k_2 s^{4-\alpha}) ,$$

uniformly in p as $s \rightarrow +\infty$ with k_1 and k_2 fixed. Here we see how our condition $\alpha > 4$ from Theorems 1.1 and 1.4 appears: 4 equals 2 times the dimension. It seems that it would require new ideas to cross this value.

Remark 1.14. After the elaboration of this manuscript, the following works were brought to our attention:

- Piterbarg’s mixing inequality (see for instance Theorem 1.2 of [Pit96]). This inequality is a more general version of our Proposition 2.4 below. We have chosen to keep it in the main body of the proof because we interpret and present it with a different point of view. See also Remark 2.5.
- An almost independence result from [NSV07, NSV08, NS11]. In Theorem 3.1 of [NS11] (see also Theorem 3.2 of [NSV07] and Lemma 5 of [NSV08]), the authors derive a quasi-independence result for Gaussian entire functions. The result states roughly that a Gaussian entire function f , when restricted to a disjoint union of compact subsets of \mathbb{C} not

too large and far enough from each other, can be realized as a sum of independent copies of itself on each compact subset and a small perturbation. While the result is proved only for Gaussian entire functions, we believe it could apply to general Gaussian fields with sufficient decorrelation and regularity properties. To deduce a result similar to our Theorem 1.12 from Theorem 3.1 of [NS11], one would need to understand how a perturbation of the field affects the events that we consider.

Remark 1.15. At least one of the terms $\text{Length}(\mathcal{C}_i)$ and k_i on the right-hand-side of the inequality in Theorem 1.12 must be present for the inequality to hold. Indeed, in their absence, we would have a quasi-independence result uniform in the choice (and number) of rectangles involved in the events A and B as long as these rectangles stay within prescribed sets \mathcal{K}_1 and \mathcal{K}_2 . Moreover the excursion set \mathcal{D}_p is measurable with respect to the σ -algebra generated by the crossings of rectangles. Hence, we would have obtained the following result: let $\mathcal{K}_1, \mathcal{K}_2$ be two open subsets of the plane far enough from each other, let $p \in \mathbb{R}$ and let A (resp. B) be an event measurable with respect to the excursion set $\mathcal{D}_p \cap \mathcal{K}_1$ (resp. $\mathcal{D}_p \cap \mathcal{K}_2$). Also, let $\eta = \sup_{x \in \mathcal{K}_1, y \in \mathcal{K}_2} |\kappa(x - y)|$ and assume that $\eta \leq 1/2$, then:

$$|\mathbb{P}[A \cap B] - \mathbb{P}[A]\mathbb{P}[B]| \leq C' \eta \text{Area}(\mathcal{K}_1) \text{Area}(\mathcal{K}_2). \quad (1.2)$$

But this cannot be true in full generality. Indeed, let f be the Bargmann-Fock field² described above, that is, the analytic Gaussian field with covariance $K(x, y) = e^{-\frac{1}{2}|x-y|^2}$. Then it is easy to see that f satisfies Conditions 1.7 and 1.10 so Theorem 1.12 applies. For each $s \in]0, +\infty[$, let A_s (resp. B_s) be the event that there is a continuous path in \mathcal{N}_0 from $\partial[-s, s]^2$ (resp. $\partial[-3s, 3s]^2$) to $\partial[-4s, 4s]^2$. But f is analytic and \mathcal{N}_0 is a.s. smooth (see Lemma A.9) so A_s is measurable³ with respect to $\mathcal{D}_0 \cap [-2s, 2s]^2$. On the other hand, B_s is measurable with respect to $\mathcal{D}_0 \cap ([-4s, 4s]^2 \setminus]-3s, 3s]^2)$. But A_s implies B_s . Hence, if Equation (1.2) were valid, we would have

$$O\left(s^4 e^{-s^2/2}\right) = |\mathbb{P}(A_s \cap B_s) - \mathbb{P}(A_s)\mathbb{P}(B_s)| = \mathbb{P}(A_s)\mathbb{P}(B_s^c).$$

But the Bargmann-Fock field satisfies the hypotheses of Theorem 1.1 so both A_s and B_s^c have probability bounded from below as $s \rightarrow +\infty$.

Extension of the above results. We believe that Theorem 1.12 above can be extended, in at least three directions. First, instead of considering rectangles and square annuli, one could consider quads (i.e. topological rectangles) and more general annuli. It seems that the treatment of the phenomena at the boundary will add new technical difficulties and we believe that, if we considered quads with piecewise smooth boundaries, then we might have obtained the same estimate as in Theorem 1.12 but with the following right hand side:

$$\frac{C\eta}{\sqrt{1-\eta^2}}(1+|p|)^4 e^{-p^2} \prod_{i=1}^2 \left(\text{Area}(\mathcal{K}_i) + \int_{\mathcal{C}_i} (1+|\mathbf{k}|(t))dt + k_i \right),$$

where dt is the length measure on the boundaries of the quads and $|\mathbf{k}|$ is the curvature (which is a Dirac mass at non-smooth points).

A second extension would be an extension to higher dimensions. We believe that the techniques of the present chapter (except when we study the box-crossing property) are not restricted to the planar case. However, it seems that an extension to higher dimensions would add technical difficulties in intermediate lemmas of Section 3.

A third extension would be to a larger class of events. It seems to be an interesting question to characterize a class of events for which our methods from Sections 2 and 3 work.

²For more information concerning the Bargmann-Fock field, we refer the reader to [BG16].

³Indeed, a connected component of \mathcal{N}_0 is a deterministic function of any segment of this component by unique analytic continuation and by the analytic implicit function theorem.

Proof Sketch. The proof of Theorem 1.12 relies on an abstract quasi-independence result for threshold events of Gaussian vectors, namely Proposition 2.4. In this proposition, given a Gaussian vector X and two “threshold events” $\{X \in A\}$ and $\{X \in B\}$ measurable with respect to disjoint sets of coordinates (e.g. discrete crossing events of disjoint rectangles), we define a new Gaussian vector Y whose covariance is close to that of X such that $\{Y \in A\}$ and $\{Y \in B\}$ are independent. Next, we create a path $(X_t)_t$ of Gaussian vectors with $X_0 = X$ and $X_1 = Y$ and control the derivative of $\mathbb{P}[X_t \in A \cap B]$ with respect to t via “pivotal” events associated to A and B . The path method we have just sketched is inspired by Slepian’s proof of the normal comparison inequality (see Lemma 1 of [Sle62]). The only novelty so far is the interpretation of the quantities which arise as **probabilities of pivotal events**.

Once this core result is established, in Section 3, we fix A and B as in⁴ the statement of Theorem 1.12. Then, we discretize $\mathcal{K}_1 \cup \mathcal{K}_2$ and approximate A and B by some discrete events $A^\varepsilon, B^\varepsilon$. We then prove the estimate of Theorem 1.12 for A^ε and B^ε with uniform bounds on ε and let ε go to 0. This is the object of Proposition 3.4. In order to prove the discrete inequality we first use Proposition 2.4 for X equal to f restricted to the discretization, with $U = A^\varepsilon$ and $V = B^\varepsilon$. The right hand side is similar to the right hand side in Proposition 3.4. The key is then to find good enough bounds for the probabilities of pivotal events. This is the object of Proposition 3.10, at least for crossing events. The general case is dealt with in Subsection 3.4. Roughly speaking, if x is an interior point, to be pivotal it must have four neighbors of alternating signs, so there is an ε -approximate saddle point near x , which has probability $O(\varepsilon^2)$. If x is on the boundary (but not a corner), to be pivotal, it must have two neighbors with the same sign separated by a third neighbor with the opposite sign, all three on the same side of a line passing through x . We interpret this as a condition for the tangent of the nodal set at x to belong to an angle of size ε , which has probability $O(\varepsilon)$. The proof of Proposition 3.10 is divided in two steps. The first is to show that pivotal events imply the existence of zeros of certain fixed derivatives of f . The arguments are of geometric nature and are presented in Subsection 3.2. The second part is to prove that these events are indeed exceptional using Kac-Rice type arguments. This is done in Subsection 3.3.

Outline. In Section 2 we recall the key estimate needed to establish Theorem 1.12, namely Proposition 2.4. We prove Theorem 1.12 (the quasi-independence theorem for nodal lines) in Section 3. More precisely, in Subsections 3.1, 3.2 and 3.3 we prove this theorem in the case where A and B are generated by crossing events and then in Subsection 3.4 we explain how to take into account the number of level lines components. In Section 4, we combine Theorem 1.12 (in the case of crossings) with Tassion’s method (from [Tas16]) to obtain Theorem 1.1. In Section 5, we use this theorem (in the case of number of nodal components) to obtain Theorem 1.4 (concerning the lower concentration of the number of nodal components). Finally, in Appendix A we recall classical results about Gaussian fields and in Appendix B we prove a discrete box-crossing estimate uniform on the mesh, see Proposition B.2.

Acknowledgements:

We are grateful to Christophe Garban and Damien Gayet for their helpful comments on the organization of the manuscript. We are also thankful for the stimulating discussions we had with them and with Vincent Beffara. Moreover, we would like to thank Stephen Muirhead for pointing to us the work by Piterbarg (after the elaboration of this manuscript).

⁴Actually, for simplicity, we begin with the case where A and B are crossing and circuit events. Once the proof is complete, we explain how to deal with the general case in Subsection 3.4.

2 Quasi-independence for Gaussian vectors

In this section, we reinterpret a classical quasi-independence formula of Gaussian vectors, namely Proposition 2.4 below, which is at the heart of the proof of Theorem 1.12. We first need to introduce some notation.

Notation 2.1. For any subset $U \subseteq \mathbb{R}^n$, write:

$$\text{Piv}_i(U) = \left\{ (x_1, \dots, x_n) \in \mathbb{R}^n : \exists y_1, y_2 \in \mathbb{R}, \begin{array}{l} (x_1, \dots, x_{i-1}, y_1, x_{i+1}, \dots, x_n) \in U, \\ (x_1, \dots, x_{i-1}, y_2, x_{i+1}, \dots, x_n) \notin U \end{array} \right\}.$$

Remark 2.2. Note that $\text{Piv}_i(U)$ is a subset of \mathbb{R}^n that does not depend on the i^{th} coordinate. Hence, we will sometimes see $\text{Piv}_i(U)$ as a subset of \mathbb{R}^{n-1} by forgetting the i^{th} coordinate.

Remark 2.3. For any $U, V \subseteq \mathbb{R}^n$ and any $i \in \{1, \dots, n\}$, we have:

$$\text{Piv}_i(U) = \text{Piv}_i(U^c) \text{ and } \text{Piv}_i(U \cap V) \cup \text{Piv}_i(U \cup V) \subseteq \text{Piv}_i(U) \cup \text{Piv}_i(V).$$

Proposition 2.4. Let $k_1, k_2 \in \mathbb{Z}_{>0}$, let X be a non-degenerate centered Gaussian vector of dimension $k_1 + k_2$, and write Σ for the covariance matrix of X . Assume that, for each $i \in \{1, \dots, k_1 + k_2\}$, $\Sigma_{ii} = 1$. Moreover, let Y be a centered Gaussian vector of dimension $k_1 + k_2$ independent of X such that $(Y_i)_{1 \leq i \leq k_1}$ has the same law as $(X_i)_{1 \leq i \leq k_1}$, $(Y_j)_{k_1+1 \leq j \leq k_1+k_2}$ has the same law as $(X_j)_{k_1+1 \leq j \leq k_1+k_2}$, and the vectors $(Y_i)_{1 \leq i \leq k_1}$ and $(Y_j)_{k_1+1 \leq j \leq k_1+k_2}$ are independent. For all $t \in [0, 1]$, let $X_t = \sqrt{t}X + \sqrt{1-t}Y$. Furthermore, let $\vec{q} \in \mathbb{R}^{k_1+k_2}$ let U (resp. V) belong to the sub- σ -algebra of $\mathcal{B}(\mathbb{R}^{k_1+k_2})$ generated by the sets $\{x_i \geq q_i\}$ for any $i \in \{1, \dots, k_1\}$ (resp. $i \in \{k_1+1, \dots, k_1+k_2\}$). Then, we have:

$$\begin{aligned} & \left| \mathbb{P}[X \in U \cap V] - \mathbb{P}[X \in U] \mathbb{P}[X \in V] \right| \\ & \leq \sum_{\substack{i \in \{1, \dots, k_1\}, \\ j \in \{k_1+1, \dots, k_1+k_2\}}} |\Sigma_{ij}| \int_0^1 \mathbb{P} \left[X_t \in \text{Piv}_i(U) \cap \text{Piv}_j(V) \mid X_t(i) = q_i, X_t(j) = q_j \right] dt \\ & \qquad \qquad \qquad \times \frac{1}{2\pi\sqrt{1-\Sigma_{ij}^2}} \exp \left(-\frac{q_i^2 + q_j^2}{2} \right). \end{aligned}$$

Remark 2.5. Proposition 2.4 is a reinterpretation of a classical quasi-independence formula for Gaussian vectors used in quantitative versions of Slepian's Lemma (see [Sle62] and Chapter 1 of [Pit96], especially Theorem 1.1). The proof presented here is very close to that of [Pit96] except that we work in a level of generality more adapted to our purposes and that we introduce the notion of pivotal events, which are central in the proof of Theorem 1.12. Later, we use this definition to show that these probabilities are small for discrete approximations of crossing events.

Remark 2.6. The proof of Proposition 2.4 is an interpolation argument. The path X_t defined in the statement is an interpolation between X and Y . By construction of Y , $\mathbb{P}[Y \in U \cap V] = \mathbb{P}[X \in U] \mathbb{P}[X \in V]$ so the left hand side of the inequality can be written as

$$\int_0^1 \frac{d}{dt} \mathbb{P}[X_t \in U \cap V] dt$$

if you admit that the probability is differentiable. Now the first order of variation of this probability should correspond to how likely the events $X_t \in U$ and $X_t \in V$ are to change when X_t one perturbs one of the $X_{t,i}$ and $X_{t,j}$ jointly, by a bump that depends on the shift in the covariance, which here is Σ_{ij} if $i \leq k_1 < j$ and 0 otherwise. But this is precisely what is expressed in the right hand side of the inequality.

Lemma 2.7. Fix $n \in \mathbb{Z}_{>0}$, $\vec{q} \in \mathbb{R}^n$ and let U belong to the sub- σ -algebra of $\mathcal{B}(\mathbb{R}^n)$ generated by the sets $\{x_i \geq q_i\}$ for $i \in \{1, \dots, n\}$. Also, let φ be a function which belongs to the Schwartz space $\mathcal{S}(\mathbb{R}^n)$. Then, for each $i \in \{1, \dots, n\}$, there exists a measurable function $\epsilon_i = \epsilon_i(\varphi, U) : \mathbb{R}^{n-1} \rightarrow \{-1, 0, 1\}$ such that:

$$\int_U \frac{\partial \varphi}{\partial x_i}(x) dx = \int_{\text{Piv}_i(U)} \epsilon_i(x_1, \dots, x_{i-1}, x_{i+1}, \dots, x_n) \varphi(x_1, \dots, x_{i-1}, q_i, x_{i+1}, \dots, x_n) \prod_{j \neq i} dx_j.$$

Proof. For each $\tilde{x} = (x_1, \dots, x_{i-1}, x_{i+1}, \dots, x_n) \in \mathbb{R}^{n-1}$, let $U_i(\tilde{x})$ be the set of $y \in \mathbb{R}$ such that $(x_1, \dots, x_{i-1}, y, x_{i+1}, \dots, x_n) \in U$. By Fubini's theorem:

$$\int_U \frac{\partial \varphi}{\partial x_i}(x) dx = \int_{\mathbb{R}^{n-1}} \int_{U_i(\tilde{x})} \frac{\partial \varphi}{\partial x_i}(x) dx_i d\tilde{x}.$$

Now, note that, for each \tilde{x} , $U_i(\tilde{x})$ equals either \emptyset , \mathbb{R} , $] - \infty, q_i[$, or $[q_i, +\infty[$. Moreover, if $\tilde{x} \notin \text{Piv}_i(U)$, then $U_i(\tilde{x}) = \mathbb{R}$ or \emptyset . Let $\epsilon_i(\tilde{x})$ be 1 if $U_i(\tilde{x}) =] - \infty, q_i[$, -1 if $U_i(\tilde{x}) = [q_i, +\infty[$, and 0 otherwise. By the fundamental theorem of analysis:

$$\begin{aligned} \int_{\mathbb{R}^{n-1}} \int_{U_i(\tilde{x})} \frac{\partial \varphi}{\partial x_i}(x) dx_i d\tilde{x} &= \int_{\mathbb{R}^{n-1}} \epsilon_i(\tilde{x}) \varphi(x_1, \dots, x_{i-1}, q_i, x_{i+1}, \dots, x_n) d\tilde{x} \\ &= \int_{\text{Piv}_i(U)} \epsilon_i(\tilde{x}) \varphi(x_1, \dots, x_{i-1}, q_i, x_{i+1}, \dots, x_n) d\tilde{x}. \end{aligned}$$

Note that Fubini's theorem and the fundamental theorem of analysis can be applied since $\varphi \in \mathcal{S}(\mathbb{R}^n)$. \square

Proof of Proposition 2.4. Note that we have:

$$\begin{aligned} \mathbb{P}[X \in U \cap V] - \mathbb{P}[X \in U] \mathbb{P}[X \in V] &= \mathbb{P}[X \in U \cap V] - \mathbb{P}[Y \in U \cap V] \\ &= \mathbb{P}[X_1 \in U \cap V] - \mathbb{P}[X_0 \in U \cap V]. \end{aligned}$$

Hence, it is sufficient to prove that, for each $t \in [0, 1]$, we have:

$$\begin{aligned} \left| \frac{d}{dt} \mathbb{P}[X_t \in U \cap V] \right| &\leq \sum_{\substack{i \in \{1, \dots, k_1\}, \\ j \in \{k_1+1, k_1+k_2\}}} |\Sigma_{ij}| \mathbb{P} \left[X_t \in \text{Piv}_i(U) \cap \text{Piv}_j(V) \mid X_t(i) = q_i, X_t(j) = q_j \right] \\ &\quad \times \frac{1}{2\pi \sqrt{1 - \Sigma_{ij}^2}} \exp \left(-\frac{q_i^2 + q_j^2}{2} \right). \end{aligned} \quad (2.1)$$

Note that since X and Y are non-degenerate and independent, for every $t \in [0, 1]$, X_t is non-degenerate. Moreover, X_t has covariance Σ_t defined as follows: $\Sigma_{t,ij} = \Sigma_{ij}$ if either $1 \leq i, j \leq k_1$ or $k_1 + 1 \leq i, j \leq k_1 + k_2$, and $\Sigma_{t,ij} = t \Sigma_{ij}$ otherwise. Let $\Gamma : S_n^{++}(\mathbb{R}) \times \mathbb{R}^n \rightarrow \mathbb{R}$ be⁵ the map that associates to a matrix $\Sigma \in S_n^{++}(\mathbb{R})$ and a point $x \in \mathbb{R}^n$ the Gaussian density at x of a centered gaussian vector of covariance Σ . The function Γ is C^∞ and, for every $1 \leq i < j \leq n$, we have:⁶

$$\frac{\partial \Gamma}{\partial \Sigma_{i,j}} = \frac{\partial^2 \Gamma}{\partial x_i \partial x_j}. \quad (2.2)$$

⁵Here $S_n^{++}(\mathbb{R})$ is the set of positive definite symmetric matrices of size n , that we see as the corresponding open subset of $\mathbb{R}^{\frac{n(n+1)}{2}} = \{(\Sigma_{i,j})_{1 \leq i < j \leq n}\}$.

⁶This is a classical property of Gaussian densities which follows immediately by application of the Fourier transform, see for instance Equation (2.3) of [AW09].

Hence, by using dominated convergence and the chain rule:

$$\begin{aligned} \frac{d}{dt} \mathbb{P}[X_t \in U \cap V] &= \sum_{1 \leq i \leq j \leq k_1 + k_2} \frac{d\Sigma_{t,ij}}{dt} \int_{U \cap V} \frac{\partial}{\partial \Sigma_{ij}} \Gamma(\Sigma_t, x) dx \\ &= \sum_{\substack{i \in \{1, \dots, k_1\}, \\ j \in \{k_1 + 1, k_1 + k_2\}}} \Sigma_{ij} \int_{U \cap V} \frac{\partial^2}{\partial x_i \partial x_j} \Gamma(\Sigma_t, x) dx \text{ by 2.2.} \end{aligned} \quad (2.3)$$

Since U depends only on the first k_1 coordinates and V depends only on the k_2 last coordinates, we can apply Lemma 2.7 first to $(U, i, \frac{\partial}{\partial x_i} \Gamma(\Sigma_t, \cdot))$ and then to $(V, j, \Gamma(\Sigma_t, \cdot))$. We obtain that:

$$\begin{aligned} &\left| \int_{U \cap V} \frac{\partial \Gamma}{\partial x_i \partial x_j}(\Sigma_t, x) dx \right| \\ &\leq \int_{\text{Piv}_i(U) \cap \text{Piv}_j(V)} \Gamma(\Sigma_t, x_1, \dots, x_{i-1}, q_i, x_{i+1}, \dots, x_{j-1}, q_j, x_{j+1}, \dots, x_{k_1 + k_2}) \prod_{\substack{l \in \{1, \dots, k_1 + k_2\}, \\ l \notin \{i, j\}}} dx_l \\ &= \mathbb{P}\left[X_t \in \text{Piv}_i(U) \cap \text{Piv}_j(V) \mid X_t(i) = q_i, X_t(j) = q_j\right] \gamma_t(i, j), \end{aligned} \quad (2.4)$$

where $\gamma_t(i, j)$ is the density of $(X_t(i), X_t(j))$ at (q_i, q_j) . Note that:

$$\gamma_t(i, j) \leq \frac{1}{2\pi \sqrt{1 - (t\Sigma_{ij})^2}} \exp\left(-\frac{q_i^2 + q_j^2}{2(1 - t|\Sigma_{ij}|)}\right) \leq \frac{1}{2\pi \sqrt{1 - \Sigma_{ij}^2}} \exp\left(-\frac{q_i^2 + q_j^2}{2}\right). \quad (2.5)$$

Here, in the first inequality, we used the fact that if A is a positive definite symmetric matrix, for any vector X , $\langle X, AX \rangle \geq \min \text{sp}(A) \|X\|^2$. If we combine (2.3), (2.4) and (2.5), we obtain (2.1) and we are done. \square

3 Quasi-independence for planar Gaussian fields: the proof of Theorem 1.12

In this section, we prove Theorem 1.12. The steps of the proof are the following: we discretize our model, we apply Proposition 2.4 to the discrete model, and then we estimate the probability of pivotal events that appear in the proposition. We refer the reader to the introduction for a rough sketch of the proof. Let us now introduce the discretization procedure (by following [BG16]).

We work with the face-centered square lattice (see Figure 3.1) that we denote by \mathcal{T} . We denote by \mathcal{T}^ε this lattice scaled by a factor ε and we denote by \mathcal{V}^ε the vertex set of \mathcal{T}^ε . Given a realization of our Gaussian field f , some $p \in \mathbb{R}$ and some $\varepsilon > 0$, the signs of the values of $f + p$ on the sites of \mathcal{T}^ε is a site percolation model on \mathcal{T}^ε . It induces a random coloring of the plane defined as follows: For each $x \in \mathbb{R}^2$, if $x \in \mathcal{V}^\varepsilon$ and $f(x) \geq -p$ or if x belongs to an edge of \mathcal{T}^ε whose two extremities y_1, y_2 satisfy $f(y_1) \geq -p$ and $f(y_2) \geq -p$, then x is colored black. Otherwise, x is colored white. In other words, we study a **correlated site percolation model** on \mathcal{T}^ε . We also need the following definition.

Definition 3.1. Given $\varepsilon > 0$, an ε -drawn rectangle is a rectangle of the form $[a, b] \times [c, d]$ where $a \leq b$ and $c \leq d$ are four integer multiples of ε . An integer annulus is an annulus of the form $x + [-a, a]^2 \setminus]-b, b]^2$ where $x \in (\varepsilon\mathbb{Z})^2$ and $a \leq b$ are two positive integer multiples of ε .

The specific choice of the face-centered square lattice is not very important. We will essentially use the following facts: i) \mathcal{T} is a triangulation, so we have nice duality arguments, see Remark 3.3 below, ii) \mathcal{T} is translation invariant, iii) any ε -drawn rectangle and any ε -annulus can be drawn by using the edges of \mathcal{T} , and iv) \mathcal{T} has nice symmetry properties. Actually, we will use the

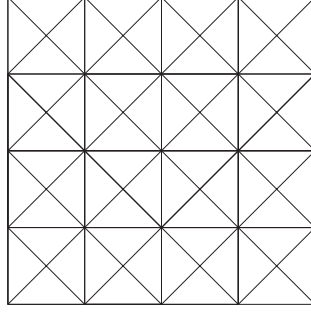

Figure 3.1 – The face-centered square lattice (the vertices are the points of \mathbb{Z}^2 and the centers of the squares of the \mathbb{Z}^2 -lattice).

point iv) only in Section B, but the results of this latter section are not used in the rest of the chapter.

We start the proof of Theorem 1.12 by showing the result in the case where A and B are generated by crossing and circuit events since the proof is a little less technical in this case. This first part of proof is written in Subsections 3.1, 3.2 and 3.3. Note that this partial result is already sufficient to prove Theorem 1.1. We complete the proof of Theorem 1.12 by considering also the number of level lines components in Subsection 3.4.

3.1 The proof of Theorem 1.12 in the case of crossing and circuit events

In this subsection, we work only in the case of crossing and circuit events, we state Proposition 3.4, a discrete analog of Theorem 1.12 with constants *uniform in the mesh* ε , and we deduce Theorem 1.12 (in the case of crossing and circuit events) from Proposition 3.4. The proof of Proposition 3.4 is written in Subsections 3.2 and 3.3. Before stating this proposition, we need a definition:

Definition 3.2. Let $\varepsilon > 0$, $p \in \mathbb{R}$, and consider the above discrete percolation model. Also, let \mathcal{E} be a rectangle and \mathcal{A} be an annulus. We say that there is a left-right ε -crossing of \mathcal{E} above (resp. below) $-p$ if there is a continuous black (resp. white) path included in \mathcal{E} from the left side of \mathcal{E} to its right side. We define top-bottom ε -crossings similarly. We say that there is an ε -circuit in \mathcal{A} above (resp. below) $-p$ if there is a continuous black (resp. white) path separating the inner boundary of \mathcal{A} from its outer boundary.

Remark 3.3. We will use the following duality argument which follows from the fact that \mathcal{T} is a triangulation and that any ε -drawn rectangle and any ε -drawn annulus can be drawn by using edges of \mathcal{T}^ε (see Definition 3.1). Let $\varepsilon > 0$, let \mathcal{E} be an ε -drawn rectangle. Then, there is left-right crossing of \mathcal{E} above level p if and only if there is no top-bottom crossing of \mathcal{E} below level p .

Proposition 3.4. *Let f be a Gaussian field satisfying Conditions 1.7 and 1.10. There exists $d = d(\kappa) < +\infty$ and $C = C(\kappa) < +\infty$ such that we have the following: Let $p \in \mathbb{R}$ and $\varepsilon \in]0, 1]$. Also, let $k_1, k_2 \in \mathbb{Z}_{>0}$ and let $(\mathcal{E}_i)_{1 \leq i \leq k_1+k_2}$ be a collections of either ε -drawn rectangles or ε -drawn annuli. Let*

$$\mathcal{K}_1 = \cup_{i=1}^{k_1} \mathcal{E}_i, \mathcal{C}_1 = \cup_{i=1}^{k_2} \partial \mathcal{E}_i, \mathcal{K}_2 = \cup_{j=k_1+1}^{k_1+k_2} \mathcal{E}_j, \mathcal{C}_2 = \cup_{j=k_1+1}^{k_1+k_2} \partial \mathcal{E}_j.$$

Let A^ε (resp. B^ε) be an event in the Boolean algebra generated by the left-right and top-bottom ε -crossings above $-p$ and below $-p$ of rectangles among the $(\mathcal{E}_i)_i$ for $1 \leq i \leq k_1$ (resp. $(\mathcal{E}_j)_j$ for $k_1 + 1 \leq j \leq k_1 + k_2$) and the ε -circuits above $-p$ and below $-p$ in annuli among the $(\mathcal{E}_i)_i$ for

$1 \leq i \leq k_1$ (resp. $(\mathcal{E}_j)_j$ for $k_1 + 1 \leq j \leq k_1 + k_2$). Let $\eta = \sup_{x \in \mathcal{K}_1, y \in \mathcal{K}_2} |\kappa(x - y)|$. If \mathcal{K}_1 and \mathcal{K}_2 are at distance greater than d , then:

$$|\mathbb{P}[A^\varepsilon \cap B^\varepsilon] - \mathbb{P}[A^\varepsilon]\mathbb{P}[B^\varepsilon]| \leq \frac{C\eta}{\sqrt{1-\eta^2}}(1+|p|)^4 e^{-p^2} \prod_{i=1}^2 (\text{Area}(\mathcal{K}_i) + \text{Length}(\mathcal{C}_i) + k_i).$$

Note that the constant C in Proposition 3.4 does not depend on ε . Let us first show how Theorem 1.12 follows from Proposition 3.4 in the case where the events A and B are generated by crossing and circuit events. Also, here and in all the rest of Section 3, we assume that each of the \mathcal{E}_i 's are rectangles. The proof adapts easily to the case where the \mathcal{E}_i 's can also be annuli, but would be tedious to spell out.

Proof of Theorem 1.12: Part 1 of 2, The case of crossings. We assume that the events A and B are generated by crossing and circuit events. Also, we assume that each \mathcal{E}_i is a rectangle since the proof with annuli is exactly the same. First of all, using Lemma A.9 and reasoning by approximation⁷, it is enough to prove the result for rectangles whose sides are integer multiples of some fixed $\eta > 0$. But this is a direct consequence of Proposition 3.4 with $\varepsilon_k = \eta/k$, with the same family of rectangles, and by taking the limit as k goes to $+\infty$. Indeed, using Lemma A.9 once more, it is easy to show that, if there is a (left-right, say) crossing of a rectangle above (resp. below) $-p$ in the continuum then a.s. there exists (a random) $\delta > 0$ such that this crossing belongs to a tube of width δ included in \mathcal{D}_p (resp. \mathcal{D}_p^c). Hence, such a crossing in the continuum implies the analogous crossing in the discrete as long as $\varepsilon_k < \delta$ and $\mathbb{1}_{A \setminus A^{\varepsilon_k}}$ (resp. $\mathbb{1}_{B \setminus B^{\varepsilon_k}}$) converges a.s. to 0 as $k \rightarrow +\infty$. If there is no left-right crossing of a rectangle above (resp. below) $-p$, then (by Remark A.11) a.s. there is a top-bottom crossing below (resp. above) $-p$ of this rectangle so $\mathbb{1}_{A^{\varepsilon_k} \setminus A}$ (resp. $\mathbb{1}_{B^{\varepsilon_k} \setminus B}$) converges a.s. to 0 as $k \rightarrow +\infty$. Thus, we have shown Theorem 1.12 in the case where A and B are generated by crossing (and circuit) events. \square

To prove Proposition 3.4, we are going to use Proposition 2.4. We first define a Gaussian vector X_t^ε for each $t \in [0, 1]$ in the spirit of the Gaussian vector X_t from Proposition 2.4. Since we will apply intermediate lemmas to the underlying continuous Gaussian fields, we first define a field f_t for every $t \in [0, 1]$ as follows:

Notation 3.5. Let f , $(\mathcal{E}_i)_{1 \leq i \leq k_1+k_2}$, \mathcal{K}_1 , \mathcal{K}_2 , \mathcal{C}_1 and \mathcal{C}_2 be as in Proposition 3.4. Let \mathcal{U}_1 and \mathcal{U}_2 be disjoint neighborhoods of \mathcal{K}_1 and \mathcal{K}_2 respectively. Let g be a continuous Gaussian field indexed⁸ by $\mathcal{U}_1 \cup \mathcal{U}_2$ independent of f such that g restricted to either of the \mathcal{U}_i 's has the same law as f restricted to \mathcal{U}_i and such that g restricted to \mathcal{U}_1 is independent of g restricted to \mathcal{U}_2 . For each $t \in [0, 1]$, let $f_t = \sqrt{t}f + \sqrt{1-t}g$. Note that (since f is centered and non-degenerate) for each $t \in [0, 1]$, f_t is a non-degenerate centered Gaussian field whose covariance function is:

$$\begin{cases} \mathbb{E}[f_t(x)f_t(y)] = \kappa(x-y) & \text{if } x, y \in \mathcal{U}_1 \text{ or } x, y \in \mathcal{U}_2, \\ \mathbb{E}[f_t(x)f_t(y)] = t\kappa(x-y) & \text{otherwise.} \end{cases}$$

Also, for each $i \in \{1, 2\}$, let $\mathcal{V}_i^\varepsilon = \mathcal{K}_i \cap \mathcal{V}^\varepsilon$, and let X^ε (resp. X_t^ε) be f (resp. f_t) restricted to $\mathcal{V}_1^\varepsilon \cup \mathcal{V}_2^\varepsilon$.

We need one last notation before beginning the proof:

⁷Indeed, Lemma A.9 implies that crossing events for a given rectangle can be approximated by crossing events for approximations of this rectangle. Since A and B are generated by a finite boolean algebra of crossings, they can be obtained by a finite number of intersections and unions of crossings. Approximating each crossing and applying the same operations thus yields an approximation of A and B .

⁸The reason we extend g to open neighborhoods of \mathcal{K}_1 and \mathcal{K}_2 is largely technical and can be ignored during first reading.

Notation 3.6. Given $\varepsilon, p, (\mathcal{E}_i)_{1 \leq i \leq k_1+k_2}, A^\varepsilon$ and B^ε as in Proposition 3.4, we write $\mathcal{V}_1^\varepsilon$ and $\mathcal{V}_2^\varepsilon$ as in Notation 3.5 and we write U^ε and V^ε for the corresponding Borelian subsets of $\mathbb{R}^{\mathcal{V}_1^\varepsilon \cup \mathcal{V}_2^\varepsilon}$ i.e. the elements of the Boolean algebra generated by the sets $\{x_i \geq -p\}$ for any $i \in \mathcal{V}_1^\varepsilon \cup \mathcal{V}_2^\varepsilon$ such that:

$$A^\varepsilon = \{X^\varepsilon \in U^\varepsilon\} \text{ and } B^\varepsilon = \{X^\varepsilon \in V^\varepsilon\}.$$

Let us now start the proof of Proposition 3.4. By applying Proposition 2.4 to X^ε (which is centered, normalized and non-degenerate since f is centered, normalized and non-degenerate), U^ε and V^ε , it is sufficient to prove that there exists $C = C(\kappa) < +\infty$ and $d = d(\kappa) < +\infty$ such that, if \mathcal{K}_1 and \mathcal{K}_2 are at distance greater than d then for each $t \in [0, 1]$ we have:

$$\begin{aligned} \sum_{\substack{x \in \mathcal{V}_1^\varepsilon \\ y \in \mathcal{V}_2^\varepsilon}} \mathbb{P} \left[X_t^\varepsilon \in \text{Piv}_x(U^\varepsilon) \cap \text{Piv}_y(V^\varepsilon) \mid f_t(x) = f_t(y) = -p \right] \\ \leq C (1 + |p|)^4 e^{-p^2} \prod_{i=1}^2 (\text{Area}(\mathcal{K}_i) + \text{Length}(\mathcal{C}_i) + k_i). \end{aligned} \quad (3.1)$$

To prove (3.1), we need to find good enough bounds for the probabilities of pivotal events. This is the purpose of Subsections 3.2 and 3.3. The proof sketch provided in the introduction can be a useful guide to read the following subsections. Remember also that we have assumed that all of the \mathcal{E}_i 's are rectangles.

3.2 Pivotal sites imply exceptional geometric events

In this subsection, we fix a point x on the ε -lattice and explain how the fact that x is pivotal for the discretized event U^ε implies the cancellation of certain derivatives of the field. The results are combined in three lemmas that we state together before proving them for future reference. Each proof is independent from the rest.

In the first lemma, we show that, roughly speaking, on the neighbors of a pivotal point x , the field must have alternating signs relative to p .

Lemma 3.7. *We use the same notations as in Notation 3.6 (remember in particular that $\mathcal{K}_1 = \cup_{i=1}^{k_1} \mathcal{E}_i$ and $\mathcal{C}_1 = \cup_{i=1}^{k_1} \partial \mathcal{E}_i$). Let $x \in \mathcal{V}_1^\varepsilon$, let $\omega^\varepsilon \in \text{Piv}_x(U^\varepsilon) \subseteq \mathbb{R}^{\mathcal{V}_1^\varepsilon \cup \mathcal{V}_2^\varepsilon}$ and call black (resp. white) a vertex $y \in \mathcal{V}_1^\varepsilon \cup \mathcal{V}_2^\varepsilon$ such that $\omega^\varepsilon(y) \geq -p$ (resp. $\omega^\varepsilon(y) < -p$). If the point x belongs to $\mathcal{K}_1 \setminus \mathcal{C}_1$, then it has four neighbors x_1, x_2, x_3, x_4 in anti-clockwise order around x and of alternating color. If the point x belongs to \mathcal{C}_1 and is the corner of none of the \mathcal{E}_i 's, then x has three neighbors x_1, x_2, x_3 in anti-clockwise order around x belonging to a common half-plane bounded by a line through x and of alternating color.*

In the last two lemmas, we explain how the information obtained in Lemma 3.7 implies the cancellation of certain derivatives of the field on fixed segments. The arguments are entirely deterministic.

Lemma 3.8. *Consider $\varphi \in C^1(\mathbb{R}^2)$ and $x, x_1, x_2, x_3 \in \mathbb{R}^2$. Assume that any two distinct vectors $x - x_i$ for $i = 1, 2, 3$ do not point in the same direction and that the x_i are numbered in anti-clockwise order around x . Assume that*

- *We have $\varphi(x) = 0, \varphi(x_1), \varphi(x_3) \geq 0$ and $\varphi(x_2) \leq 0$.*
- *There is a closed half plane H such that $x \in \partial H$ and $x_1, x_2, x_3 \in H$.*

Then, there exists $i \in \{1, 2, 3\}$ such that if $l = [x, x_i]$ has tangent vector v , $\partial_v \varphi$ has a zero on l .

Lemma 3.8 essentially states the following: If x is a point on the boundary of the rectangle such that $\varphi(x) = 0$ and such that, as one goes around x along a small half circle inside the rectangle, one encounters alternating color, then, the tangent vector of the nodal line of φ containing x must take some specific values near x . We formalize this by saying that restrictions of φ to certain small segments near x must have critical points.

Lemma 3.9. *Consider $\varphi \in C^1(\mathbb{R}^2)$ and $x, x_1, x_2, x_3, x_4 \in \mathbb{R}^2$. Assume that two vectors $x - x_i$ $i = 1, 2, 3, 4$ do not point in the same direction and that the x_i 's are numbered in anti-clockwise order around x . Assume also that:*

$$\text{We have } \varphi(x) = 0, \varphi(x_1), \varphi(x_3) \geq 0 \text{ and } \varphi(x_2), \varphi(x_4) \leq 0.$$

Let d_0 denote the diameter of $\{x, x_1, \dots, x_4\}$. Then, there exist a finite set \mathfrak{V} of unit vectors and a constant $C_0 < +\infty$ both depending only on the angles between the segments $[x, x_i]$'s such that the following holds: There exist two segments l_1 and l_2 with non-colinear unit tangent vectors $v_1, v_2 \in \mathfrak{V}$, of length at most $C_0 d_0$ and both passing through at least one of the points x, x_1, \dots, x_4 such that $\partial_{v_1}\varphi$ has a zero on l_1 and $\partial_{v_2}\varphi$ has a zero on l_2 .

Lemma 3.9 roughly says that if φ changes signs four times when going around x along a small circle, then it must have an approximate saddle point at x . We formalize the notion of approximate saddle point by saying that there are two non-colinear segments of length ε on which the function φ has a vanishing derivative. In the proof we distinguish several cases depending on the relative positions of the x_i 's and the gradient of φ at x . This reduces the proof to a planar euclidean geometry problem.

Proof of Lemma 3.7. By Remark 2.3 we may assume that there exists $i_0 \in \{1, \dots, k_1\}$ such that U^ε is the Borelian subset of $\mathbb{R}^{\mathcal{V}_1^\varepsilon \cup \mathcal{V}_2^\varepsilon}$ which corresponds to the left-right crossing of \mathcal{E}_{i_0} . If $x \notin \mathcal{E}_{i_0}$ then $\text{Piv}_x(U^\varepsilon)$ is empty. If $x \in \mathcal{E}_{i_0} \setminus \partial\mathcal{E}_{i_0}$ and $\omega^\varepsilon \in \text{Piv}_x(U^\varepsilon)$, then there are two paths made of black vertices connecting x to left and right sides of \mathcal{E}_{i_0} and two white paths made of white vertices connecting x to the top and bottom sides of \mathcal{E}_{i_0} . These paths are necessarily of alternating color around x , so in particular it has four neighbors of alternating color. This proves the first assertion. Let $x \in \mathcal{C}_1 \cap \mathcal{E}_{i_0}$ such that x is not a corner. If $x \notin \partial\mathcal{E}_{i_0}$ then, as before, x must have four neighbors of alternating color. But then among these, there must be three neighbors belonging to the same half-space bounded by x with the properties required by the second assertion. On the other hand, if $x \in \partial\mathcal{E}_{i_0}$, then there must be a path of one color starting at a neighbor of x and reaching the opposite side of the rectangle and two additional paths of the opposite color connecting neighbors of x to each of the adjacent sides to the one containing x . But then, the three neighbors at which these paths start are in the configuration announced by the second assertion. \square

Proof of Lemma 3.8. See Figure 3.2 (a) for a snapshot of the proof. If $\nabla\varphi(x) = 0$ then the result is trivial so assume that $\nabla\varphi(x) \neq 0$. Then, this gradient separates the plane into two closed half-spaces H_+ and H_- such that $x \in \partial H_+ = \partial H_-$, $\nabla\varphi(x)$ is orthogonal to this boundary, and $\nabla\varphi(x)$ points toward H_+ . We distinguish between two cases: i) There exists $i_0 \in \{1, 3\}$ such that $x_{i_0} \in H_-$. In this case, let $l = [x, x_{i_0}]$ with unit vector v . Then, $\partial_v\varphi(x) \leq 0$, $\varphi(x) = 0$ and $\varphi(x_{i_0}) \geq 0$. Therefore, $\partial_v f$ must vanish somewhere on l . ii) The point x_2 belongs to H_+ (which happens if the case i) does not hold by the existence of the half-plane H and since the x_i 's are in anti-clockwise order around x). In this case, the same argument works with $l = [x, x_2]$. \square

Proof of Lemma 3.9. See Figure 3.2 (b) for an illustration of the proof. For each $i \in \{1, 2, 3, 4\}$, let L_i be the line $[x, x + C_0(x - x_i)]$ for some $C_0 > 0$ to be chosen later. If the anti-clockwise angle θ_i between L_{i-1} and L_{i+1} is less than π (the indices should be read modulo 4), set $\tilde{L}_i := [x_{i-1}, x_{i+1}]$ and define \hat{L}_i to be the segment intersecting the bisector of θ_i orthogonally at

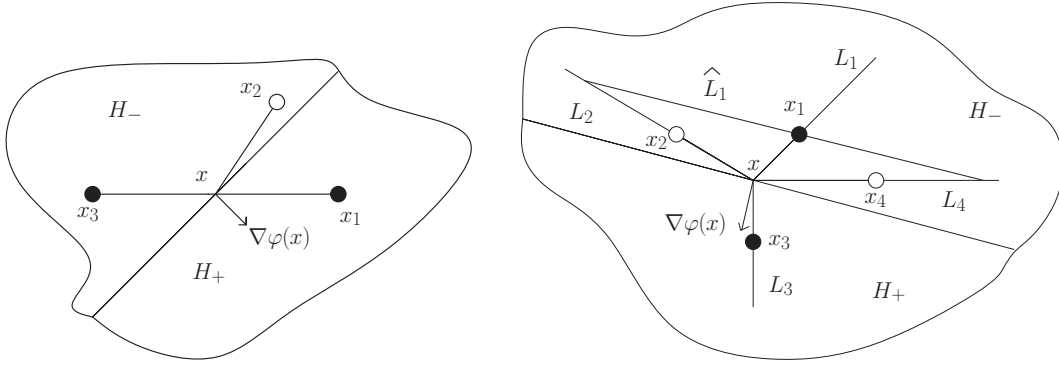

Figure 3.2 – (a) The proof of Lemma 3.8, more particularly the case i) with $i_0 = 3$. (b) The proof of Lemma 3.9, more particularly the case ii).

x_i and whose extremities belong to L_{i-1} and L_{i+1} . We fix C_0 large enough so that whenever θ_i is indeed less than π , L_i is long enough to intersect \tilde{L}_i . We will choose l_1 and l_2 among the L_i 's, the \hat{L}_i 's and the \tilde{L}_i 's. The choice will follow by considering several distinct cases. In each case, the critical point will be detected either by finding three consecutive points on the segment on which φ takes alternating signs, or by finding a point on the segment where φ vanishes and has, say, a positive derivative, and proving that φ takes a negative value further along the segment. In both cases, the existence of the critical point follows by Rolle's theorem.

As in the proof of Lemma 3.8, note that if $\nabla\varphi(x) = 0$ then the result is trivial so assume that $\nabla\varphi(x) \neq 0$. Then, this gradient separates the plane into two closed half-spaces H_+ and H_- such that $x \in \partial H_+ = \partial H_-$, $\nabla\varphi(x)$ is orthogonal to this boundary, and $\nabla\varphi(x)$ points toward H_+ . Note that there are at least two consecutive points among the x_i 's in H_- or two consecutive points in H_+ , such that they do not both belong to $\partial H_- = \partial H_+$. Without loss of generality, assume that $x_1, x_2 \in H_-$ and that they do not belong both to ∂H_- . Then, along the segment L_1 , φ starts at x with value 0 and a non-positive derivative and $\varphi(x_1) \geq 0$. In particular, its derivative along this segment must vanish. We now distinguish between two cases:

- Assume that there exists $i \in \{2, 3, 4\}$ with $x_i \in H_-$ such that, first, x_1 and x_i are not both on ∂H_- , and second, $f(x') \geq 0$ for some $x' \in L_i$. Then $\{l_1, l_2\} = \{L_1, L_i\}$ satisfies the required conditions (indeed, with the same argument as for L_1 , the derivative of φ vanishes along L_i).
- Otherwise, since $\varphi(x_3) \geq 0$, then on the one hand x_3 necessarily belongs to H_+ (possibly on its common boundary with H_-) and on the other hand φ is necessarily negative on L_2 . We distinguish between four subcases: (a) Assume that $x_4 - x$ points in the direction opposite to $x_1 - x$ and that there exists $x' \in L_3$ such that $\varphi(x') \leq 0$. Then L_3 is not colinear to L_1 and $\{l_1, l_2\} = \{L_1, L_3\}$ satisfies the required conditions. (b) Assume that $x_4 - x$ points in the direction opposite to $x_1 - x$ and that there is no $x' \in L_3$ such that $\varphi(x') \leq 0$. Then, the anticlockwise angle θ_3 between L_2 and L_4 is less than π . Let x' be the intersection of \tilde{L}_3 with L_3 . Then, $\varphi(x_4) \leq 0$, $\varphi(x_2) \leq 0$ and $\varphi(x') \geq 0$ since $x' \in L_3$ so $\{l_1, l_2\} = \{L_1, \tilde{L}_3\}$ satisfies the required conditions (in particular the two segments are not colinear). (c) Assume now that $x_4 - x$ does not point in the opposite direction to $x_1 - x$ and that either $x_4 \in H_+$ or $x_4 \notin H_+$ and there is $x' \in L_4$ such that $\varphi(x') \geq 0$ then, as before, one can consider $\{l_1, l_2\} = \{L_1, L_4\}$. (d) Assume finally that $x_4 - x$ does not point in the opposite direction to $x_1 - x$, that $x_4 \notin H_+$ and that there is no $x' \in L_4$ such that $\varphi(x') \geq 0$. Then, the anti-clockwise angle θ_1 between L_4 and L_2 is less than π and one can consider $\{l_1, l_2\} = \{L_1, \hat{L}_1\}$. Indeed, remember that φ is negative on L_2 . Finally, \hat{L}_1 goes through x_1 at which φ is non-negative, and φ is negative at both ends of \hat{L}_1 .

This completes the proof. \square

3.3 End of the proof of Proposition 3.4 via Kac-Rice estimates

In this subsection we use results from Subsection 3.2 and Kac-Rice estimates to prove Proposition 3.4. The only remaining step is the following proposition:

Proposition 3.10. *Let f be as in the statement of Proposition 3.4. We use Notations 3.5 and 3.6. There exist $C_1 = C_1(\kappa) < +\infty$, $d_1 = d_1(\kappa) < +\infty$ and $\varepsilon_0 = \varepsilon_0(\kappa) \in]0, 1]$ such that, for all $p \in \mathbb{R}$ and $t \in [0, 1]$, if $\varepsilon \in]0, \varepsilon_0]$ and if $x \in \mathcal{V}_1^\varepsilon$, $y \in \mathcal{V}_2^\varepsilon$ are such that $|x - y| \geq d_1$ then:*

- If neither $x \notin \mathcal{C}_1$ nor $y \notin \mathcal{C}_2$ then

$$\mathbb{P} \left[X_t \in \text{Piv}_x(U^\varepsilon) \cap \text{Piv}_y(V^\varepsilon) \mid X_t(x) = X_t(y) = -p \right] \leq C_1(1 + |p|)^4 \varepsilon^4.$$

- If among x and y one does not belong to $\mathcal{C}_1 \cup \mathcal{C}_2$ and the other belongs to $\mathcal{C}_1 \cup \mathcal{C}_2$ but is the corner of none of the \mathcal{E}_i 's then:

$$\mathbb{P} \left[X_t \in \text{Piv}_x(U^\varepsilon) \cap \text{Piv}_y(V^\varepsilon) \mid X_t(x) = X_t(y) = -p \right] \leq C_1(1 + |p|)^3 \varepsilon^3.$$

- If x and y both belong to $\mathcal{C}_1 \cup \mathcal{C}_2$ but are the corner of none of the \mathcal{E}_i 's or if at least one of them does not belong to $\mathcal{C}_1 \cup \mathcal{C}_2$ then:

$$\mathbb{P} \left[X_t \in \text{Piv}_x(U^\varepsilon) \cap \text{Piv}_y(V^\varepsilon) \mid X_t(x) = X_t(y) = -p \right] \leq C_1(1 + |p|)^2 \varepsilon^2.$$

- If x or y belongs to $\mathcal{C}_1 \cup \mathcal{C}_2$ but is the corner of none of the \mathcal{E}_i 's then:

$$\mathbb{P} \left[X_t \in \text{Piv}_x(U^\varepsilon) \cap \text{Piv}_y(V^\varepsilon) \mid X_t(x) = X_t(y) = -p \right] \leq C_1(1 + |p|)\varepsilon.$$

Let us first wrap up the proof of Proposition 3.4.

Proof of Proposition 3.4. Remember that it is enough to prove (3.1). First note that if $\varepsilon \in]\varepsilon_0, 1]$ (where ε_0 is as in Proposition 3.10) then the result is easily obtained by bounding the probabilities by 1. Now, assume that $\varepsilon \in]0, \varepsilon_0]$. Then, by using Proposition 3.10, we obtain that for the $O(\varepsilon^{-4} \text{Area}(\mathcal{K}_1) \text{Area}(\mathcal{K}_2))$ couples (x, y) such that $x \in \mathcal{V}_1^\varepsilon \setminus \mathcal{C}_1$ and $y \in \mathcal{V}_2^\varepsilon \setminus \mathcal{C}_1$, the quantity $\mathbb{P} \left[X_t^\varepsilon \in \text{Piv}_x(U^\varepsilon) \cap \text{Piv}_y(V^\varepsilon) \mid f_t(x) = f_t(y) = -p \right]$ is bounded by $C_1(1 + |p|)\varepsilon^4$. Consequently, the sum over of all of these couples (x, y) is bounded by $O(\varepsilon^{-4} \text{Area}(\mathcal{K}_1) \text{Area}(\mathcal{K}_2))(1 + |p|)^4$. We reason similarly by also including the points on the boundary (which corresponds to $O(\varepsilon^{-1} \text{Length}(\mathcal{C}_1))$ points $x \in \mathcal{C}_1$ and $O(\varepsilon^{-1} \text{Length}(\mathcal{C}_2))$ points $x \in \mathcal{C}_2$) and at the corners (which correspond to $O(k_1)$ points $x \in \mathcal{V}_1^\varepsilon$ and $O(k_2)$ points $y \in \mathcal{V}_2^\varepsilon$). \square

We now prove Proposition 3.10.

Proof of Proposition 3.10. We prove the first item since the proof of the others is the same (possibly by using Lemma 3.8 instead of Lemma 3.9). Fix $t \in [0, 1]$. Throughout the proof, the bounds will be uniform with respect to t . By combining Lemmas 3.7 and 3.9, we obtain that there exist a finite set of unit vectors \mathfrak{V} independent of everything else, an absolute constant $C_0 < +\infty$, and a finite set of 4-uples of segments $\mathcal{L} = \mathcal{L}(x, y, \varepsilon)$ such that $\text{Card} \mathcal{L} \leq C_0$ and such that:

- For every $(l_1, l_2, l'_1, l'_2) \in \mathcal{L}$ we have: The segments l_1, l_2 have non-colinear unit vectors $v_1, v_2 \in \mathfrak{V}$, are of length at most $C_0\varepsilon$, and are at distance at most C_0 from x . Moreover, the same holds for l'_1, l'_2 near y and with non-colinear unit vectors $v'_1, v'_2 \in \mathfrak{V}$.

- The probability of the first item of Proposition 3.10 is no greater than the sum over all $(l_1, l_2, l'_1, l'_2) \in \mathcal{L}$ of the expectation of:

$$\text{Card}\{(a_1, a_2, b_1, b_2) \in l_1 \times l_2 \times l'_1 \times l'_2 : \forall i, j \in \{1, 2\}, \partial_{v_i} f_t(a_i) = \partial_{v_j} f_t(b_j) = 0\}.$$

To control this expectation, we wish to apply the Kac-Rice formula. In order to do so we introduce the following notation. For each $(a_1, a_2, b_1, b_2) \in l_1 \times l_2 \times l'_1 \times l'_2$, let

$$\begin{aligned}\Phi_t &= \Phi_t(a_1, a_2, b_1, b_2) = (\partial_{v_1}^2 f_t(a_1), \partial_{v_2}^2 f_t(a_2), \partial_{v'_1}^2 f_t(b_1), \partial_{v'_2}^2 f_t(b_2)), \\ \Psi_t &= \Psi_t(x, y) = (f_t(x), f_t(y)), \\ \Upsilon_t &= \Upsilon_t(a_1, a_2, b_1, b_2) = (\partial_{v_1} f_t(a_1), \partial_{v_2} f_t(a_2), \partial_{v'_1} f_t(b_1), \partial_{v'_2} f_t(b_2)).\end{aligned}$$

Since κ satisfies Condition 1.10, then the covariance:

$$D_t = D_t(a_1, a_2, b_1, b_2) = \begin{pmatrix} D_t^{11} & D_t^{12} \\ D_t^{21} & D_t^{22} \end{pmatrix}$$

of (Ψ_t, Υ_t) converges as $\varepsilon \rightarrow 0$ and $|x - y| \rightarrow +\infty$, at a rate depending only on κ , to the following covariance:

$$D_* = \begin{pmatrix} D_*^{11} & D_*^{12} \\ D_*^{21} & D_*^{22} \end{pmatrix} = \begin{pmatrix} I_2 & 0 \\ 0 & D_*^{22} \end{pmatrix}$$

where:

$$D_*^{22} = \begin{pmatrix} -\partial_{v_1}^2 \kappa(0) & -\partial_{v_1} \partial_{v_2} \kappa(0) & 0 & 0 \\ -\partial_{v_1} \partial_{v_2} \kappa(0) & -\partial_{v_2}^2 \kappa(0) & 0 & 0 \\ 0 & 0 & -\partial_{v'_1}^2 \kappa(0) & -\partial_{v'_1} \partial_{v'_2} \kappa(0) \\ 0 & 0 & -\partial_{v'_1} \partial_{v'_2} \kappa(0) & -\partial_{v'_2}^2 \kappa(0) \end{pmatrix}.$$

Here we used Lemma A.1 and Remark A.2. Since v_1 and v_2 (resp. v'_1 and v'_2) are non-colinear, the vectors $(\partial_{v_1} f(0), \partial_{v_2} f(0))$ and $(\partial_{v'_1} f(0), \partial_{v'_2} f(0))$ are non-degenerate (see Remark A.3) so D_* is non-degenerate. Consequently, there exist $C_2 = C_2(v_1, v_2, v'_1, v'_2, \kappa) \in]0, +\infty[$, $d_1 = d_1(v_1, v_2, v'_1, v'_2, \kappa) < +\infty$ and $\varepsilon_0 = \varepsilon_0(v_1, v_2, v'_1, v'_2, \kappa) \in]0, 1]$ such that, if $\varepsilon \in]0, \varepsilon_0]$ and $|x - y| \geq d_1$ then:

- the matrix D_t^{11} is non-degenerate;
- the matrix $\tilde{D}_t = D_t^{22} - D_t^{21}(D_t^{11})^{-1}D_t^{12}$ is non-degenerate;
- $\det(\tilde{D}_t) \geq C_2^{-1}$;
- the coefficients of D_t^{-1} are no greater than C_2 .

In addition, κ is of class C^8 so Theorem A.8 applies to the field Υ_t conditioned on $\Psi_t = (-p, -p)$. Since conditioning and differentiation 'commute' (see Remark A.7), we obtain that the aforementioned expectation is no greater than:

$$\int_{l_1 \times l_2 \times l'_1 \times l'_2} \frac{\mathbb{E} \left[\prod_{i=1}^4 |(\Phi_t)_i(a_1, a_2, b_1, b_2)| \mid \Psi_t(x, y) = (-p, -p), \Upsilon_t(a_1, a_2, b_1, b_2) = 0 \right]}{(2\pi)^2 \sqrt{\det(\tilde{D}_t(a_1, a_2, b_1, b_2))}} da db.$$

The denominator is uniformly bounded from below by the previous discussion. We claim that if $\varepsilon \leq \varepsilon_0$ and $|x - y| \geq d_1$, the numerator is $O((1 + |p|)^4)$. To prove this, notice first that D_t is non-degenerate so Lemma A.6 applies. Moreover, the variance of the entries of Φ_t depends only on κ . All that remains is to bound its conditional mean. Firstly, the covariances of the entries

of Φ_t and those of (Ψ_t, Υ_t) are bounded⁹ by constants depending only on the derivatives up to order three of κ at 0. Moreover, D_t^{-1} has bounded coefficients so the conditional mean of Φ_t is $O(|p|)$. Hence, by Lemma A.6, the numerator is $O((1 + |p|)^4)$. Finally, the integration domain has volume $O(\varepsilon^4)$. \square

3.4 Completing the proof of Theorem 1.12

In this subsection we explain how to complete the proof of Theorem 1.12 to take into account events measurable with respect to the number of level lines components inside the rectangles \mathcal{E}_i . In particular, this subsection is of no use for the proof of the RSW estimate Theorem 1.1. The part of the proof of Theorem 1.12 detailed in Subsections 3.2 and 3.3 hinges on the two following ideas: first, that the crossing events can be approximated by discrete events and second, that the fact that a point x is pivotal for a crossing events implies certain exceptional conditions on its neighbors whose probabilities are easy to control. To complete the proof of Theorem 1.2, we justify that the discretization of the additional events is valid in Lemma 3.14 which in turn relies on Lemma 3.12. Then, we prove that the additional pivotal events imply the cancellation of certain derivatives in Lemma 3.16 and Lemma 3.17. The rest of the proof relies on results from Section 3.

Remark 3.11. Lemmas 3.12 and 3.14 below could be deduced from Proposition 6.1 of [BM18] and Theorem 1.5 of [BM18] respectively. However, since we do not need to control the rate of convergence when $\varepsilon \rightarrow 0$, we do not need a quantitative discretization scheme so instead we present a simpler proof relying only on transversality arguments.

Lemma 3.12. *Let $\mathcal{E} \subseteq \mathbb{R}^2$ be a rectangle. Assume that the Gaussian field f satisfies Condition 1.7 and that κ is C^6 . Fix $p \in \mathbb{R}$. Then, a.s. there exists a (random) constant $\varepsilon_0 > 0$ such that for a.e. $\varepsilon \leq \varepsilon_0$, we have:*

- i) \mathcal{T}^ε and \mathcal{N}_p intersect transversally,
- ii) each edge of \mathcal{T}^ε inside \mathcal{E} has at most two intersection points,
- iii) any two distinct intersection points of a common edge e are connected by a smooth path in \mathcal{N}_p inside the union of the two faces adjacent to e ,
- iv) for each connected component \mathcal{C} of \mathcal{N}_p there exists an edge e of \mathcal{T}^ε such that \mathcal{C} intersects e exactly once and e has no other intersection with the nodal set,
- v) there is no edge of \mathcal{T}^ε included in the boundary of \mathcal{E}^ε that is intersected twice by \mathcal{N}_p , where \mathcal{E}^ε is (one of) the largest rectangle whose sides are integer multiples of ε such that $\mathcal{E}^\varepsilon \subseteq \mathcal{E}$.

Proof of Lemma 3.12. By Lemma A.9, \mathcal{N}_p is a.s. smooth and intersects $\partial\mathcal{E}$ transversally. Let w be a unit vector tangent to an edge of the lattice. We apply Lemma A.10 to $T = \mathcal{E}$, $g = (f, \partial_w f, \partial_w^2 f)$ and $v = (0, 0, 0)$ (g has bounded density by Remark A.3 and by stationarity). This shows that the set of points $x \in \mathcal{N}_p$ such that $T_x \mathcal{N}_p$ is tangent to w is a.s. discrete. We then simply apply Lemma A.13 to \mathcal{C} the union of connected components of \mathcal{N}_p intersecting \mathcal{E} (who are a.s. in finite number and a.s. do not intersect 0, possibly modifying them outside of \mathcal{E} to make \mathcal{C} compact). This establishes assertions i), ii) and iii).

To show iv), first take ε smaller than the distance between any two distinct connected components of \mathcal{N}_p intersecting \mathcal{E} so that each edge e can intersect at most one connected component. Assume that \mathcal{C} intersects each edge an even number of times. Then, it must stay in a union of a face and its three adjacent faces. If ε^2 is much smaller than the area of the smallest connected component of $\mathcal{E} \setminus \mathcal{N}_p$ this cannot happen so iv) is satisfied.

In order to show v), use once again Lemma A.9 in order to obtain that \mathcal{N}_p intersects the boundary of \mathcal{E} transversally and only finitely many times. This completes the proof. \square

⁹Indeed, this follows from Lemma A.1 and the fact that for any two L^2 random variables ξ_1 and ξ_2 , $|\mathbb{E}[\xi_1 \xi_2]| \leq \frac{1}{2} (\mathbb{E}[\xi_1^2] + \mathbb{E}[\xi_2^2])$.

In the arguments below, we will need to discretize level lines of the field. To this end, let us introduce some notations.

Notation 3.13. Let $\varepsilon > 0$, $p \in \mathbb{R}$ and $(\mathcal{E}_i)_{1 \leq i \leq k_1+k_2}$, \mathcal{K}_1 , \mathcal{K}_2 , \mathcal{C}_1 , \mathcal{C}_2 and $N_p(i)$ be as in Theorem 1.12. Let $\mathcal{V}_1^\varepsilon$ and $\mathcal{V}_2^\varepsilon$ as in Notation 3.5. Color the plane as explained at the beginning of Section 3. Given such a coloring, each face has either zero or two sides whose ends have opposite colors. If a face has two such sides, draw a segment joining the middle of these two sides. This produces a collection of polygonal lines on the plane. We denote by $\mathcal{N}_p^\varepsilon$ the union of these lines. For each $i \in \{1, \dots, k_1 + k_2\}$, let $\mathcal{E}_i^\varepsilon$ be (one of) the largest rectangle whose sides are integer multiples of ε and such that $\mathcal{E}_i^\varepsilon \subseteq \mathcal{E}_i$, let $N_p^\varepsilon(i)$ be the number of connected components of $\mathcal{N}_p^\varepsilon$ contained in $\mathcal{E}_i^\varepsilon$. Let A be an event in the σ -algebra defined by events of the form $\{N_p(i) = m\}$ where $i \in \{1, \dots, k_1\}$ and $m \in \mathbb{N}$. Let A^ε be the same event as A but with the $N_p(i)$'s replaced by the $N_p^\varepsilon(i)$'s. There exists $U^\varepsilon \subseteq \mathbb{R}^{\mathcal{V}_1^\varepsilon \cup \mathcal{V}_2^\varepsilon}$ (resp. $V^\varepsilon \subseteq \mathbb{R}^{\mathcal{V}_1^\varepsilon \cup \mathcal{V}_2^\varepsilon}$) such that $A^\varepsilon = \{X^\varepsilon \in U^\varepsilon\}$. Note that by construction, the events A and B belong to the Boolean algebra generated by events of the form $\{N_p(i) \in S\}$ where $S \subseteq \mathbb{N}$.

Lemma 3.14. *Assume that the Gaussian field f satisfies Condition 1.7 and that κ is C^6 . We use Notation 3.13. Then,*

$$\limsup_{\varepsilon \rightarrow 0} \mathbb{P} [\forall i \in \{1, \dots, k_1 + k_2\}, N_p(i) = N_p^\varepsilon(i)] = 1.$$

Proof. We start with the following claim.

Claim 3.15. *For each $i \in \{1, \dots, k_1 + k_2\}$ a.s., for Lebesgue-a.e. small enough $\varepsilon > 0$, $N_p(i) = N_p^\varepsilon(i)$.*

Proof. Fix $i \in \{1, \dots, k_1 + k_2\}$. By points i) to iv) of Lemma 3.12, a.s., for a.e. $\varepsilon > 0$ small enough, \mathcal{N}_p intersects $\partial\mathcal{E}_i$ and \mathcal{T}^ε transversally, each edge of \mathcal{T}^ε included in $\mathcal{E}_i^\varepsilon$ is crossed at most twice and any two intersection points of the same edge are connected by \mathcal{N}_p inside one of its adjacent faces. Also, each connected component of \mathcal{N}_p must intersect an edge which is crossed exactly once by \mathcal{N}_p .

In particular, the following is an equivalent definition of $N_p^\varepsilon(i)$ for a.e. $\varepsilon > 0$ small enough: i) Let F be a face of the lattice with two sides e, e' that are intersected by \mathcal{N}_p exactly once and consider a path γ included in $F \cap \mathcal{N}_p$ that connects e and e' . Then, replace γ by a straight line as in Figure 3.3 (case 1). ii) Let F be a face of the lattice with two sides e, e' that are intersected by \mathcal{N}_p exactly once, let e'' the third edge adjacent to F and let F' be the other face adjacent to e'' . Also, consider a path γ included in $(F \cup F') \cap \mathcal{N}_p$ that connects e and e' and intersects e'' twice. Then, replace γ by a straight line in Figure 3.3 (case 2).

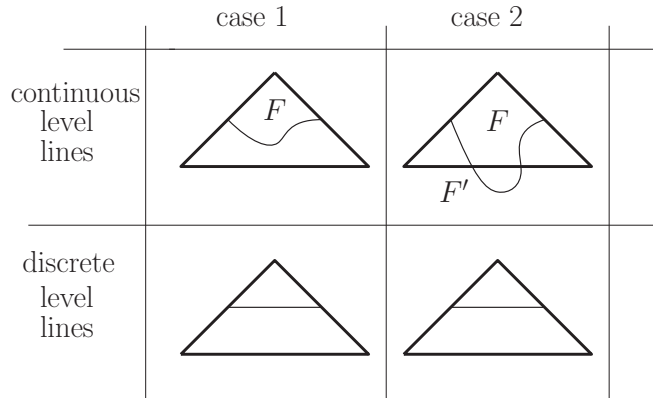

Figure 3.3 – An alternative definition of $N_p^\varepsilon(i)$ when the conclusion of Lemma 3.12 holds.

One can see that, doing so, we redefine $\mathcal{N}_p^\varepsilon$ and this alternate definition shows that its connected components are naturally in bijection with those of \mathcal{N}_p . Moreover, for all $\varepsilon > 0$ small enough, connected components of \mathcal{N}_p included in \mathcal{E}_i are also included in $\mathcal{E}_i^\varepsilon$ so that $N_p(i) \leq N_p^\varepsilon(i)$. On the other hand, if a continuous connected component gives rise to a discrete connected component included in $\mathcal{E}_i^\varepsilon$, it cannot cross edges of $\partial\mathcal{E}_i^\varepsilon$ once. But it cannot cross them twice either by point v of Lemma 3.12. As a result, $N_p^\varepsilon(i) \leq N_p(i)$. \square

Let $\Xi(\varepsilon)$ be the event that for all $i \in \{1, \dots, k_1 + k_2\}$, $N_p(i) = N_p^\varepsilon(i)$. Now, by Claim 3.15, for each $\delta > 0$ there exists $\tau = \tau(\delta) > 0$ such that, with probability at least $1 - \delta$, for Lebesgue-a.e. $\varepsilon \leq \tau$, $\Xi(\varepsilon)$ is satisfied. Moreover, τ can be chosen so that $\lim_{\delta \rightarrow 0} \tau(\delta) = 0$. In particular,

$$\mathbb{E} \left[\int_0^\tau \mathbf{1}_{\Xi(\varepsilon)} d\lambda(\varepsilon) \right] \geq \tau(1 - \delta).$$

By Fubini's theorem, we deduce that

$$\int_0^\tau \mathbb{P}[\Xi(\varepsilon)] d\lambda(\varepsilon) \geq \tau(1 - \delta).$$

In particular, there exists $\varepsilon = \varepsilon(\delta) \in]0, \tau(\delta)[$ such that $\mathbb{P}[\Xi(\varepsilon)] \geq 1 - 2\delta$. Since this holds for any $\delta > 0$, the proof is complete. \square

Lemma 3.16. *Use Notation 3.13 and, for each $x \in \mathcal{V}_1^\varepsilon$, let $\omega^\varepsilon \in \text{Piv}_x(U^\varepsilon)$. Color the edges $e = (x, y)$ of \mathcal{T}^ε such that $\omega^\varepsilon(x), \omega^\varepsilon(y) \geq -p$ in black and color the rest of the plane in white. Then:*

1. *if x belongs to $\mathcal{K}_1 \setminus \mathcal{C}_1$ then either the neighbors of x are all of the same color or x has (at least) four neighbors that have alternating color when listed in anti-clockwise order;*
2. *if x belongs to \mathcal{C}_1 but is not a corner, then it has three neighbors of alternating color when listed in anti-clockwise order.*

Proof. By Remark 2.3, we may assume that $A^\varepsilon = \{N_p^\varepsilon(i) = m\}$ for some $i \in \{1, \dots, k_1\}$ and $m \in \mathbb{N}$. Fix $\varepsilon > 0$, $x \in \mathcal{V}_1^\varepsilon$ and fix a value of X^ε . If the set of neighbors has exactly one black connected component and one white component, then changing the color of x does not change $N_p^\varepsilon(i)$. Therefore x being pivotal for U^ε implies the two items. \square

The following lemma is a trivial application of Rolle's theorem.

Lemma 3.17. *Let $\varphi \in C^1(\mathbb{R}^2)$. Fix $x \in \mathbb{R}^2$ and assume that $\varphi(x) = 0$. Then:*

1. *if there exist $x_1, x_2 \in \mathbb{R}^2$ such that for each $i \in \{1, 2\}$, $\varphi(x_i) \leq 0$ and such that $x \in]x_1, x_2[$, then $\varphi|_{[x_1, x_2]}$ has a critical point;*
2. *if there exist $x_1, x_2, x_3, x_4 \in \mathbb{R}^2$ such that for each $i \in \{1, 2, 3, 4\}$, $\varphi(x_i) \leq 0$ and such that $l_1 = [x_1, x_3]$ and $l_2 = [x_2, x_4]$ intersect in their interior at x , then $\varphi|_{l_1}$ and $\varphi|_{l_2}$ have a critical point.*

We now complete the proof of Theorem 1.12.

Proof of Theorem 1.12: Part 2 of 2 Allowing components as well as crossings. We use Notations 3.5 and 3.13. According to Lemma 3.14

$$\limsup_{\varepsilon \rightarrow 0} \mathbb{P}[\forall i \in \{1, \dots, k_1 + k_2\}, N_p(i) = N_p^\varepsilon(i)] = 1.$$

We take a subsequence $(\varepsilon_k)_{k \geq 1}$ along which the lim sup is reached. Approximating crossings of the \mathcal{E}_i by discrete crossings of the $\mathcal{E}_i^{\varepsilon_k}$ we get $\lim_{k \rightarrow +\infty} \mathbb{P}[A^{\varepsilon_k} \triangle A] = 0$. Therefore, it is enough to show that for ε small enough

$$|\mathbb{P}[A^\varepsilon \cap B^\varepsilon] - \mathbb{P}[A^\varepsilon] \mathbb{P}[B^\varepsilon]| \leq \frac{C}{\sqrt{1-\eta^2}} (1+|p|)^4 e^{-p^2} \prod_{i=1}^2 (\text{Area}(\mathcal{K}_i) + \text{Length}(C_i) + 1)$$

for some constant $C = C(\kappa) < +\infty$. Here, unlike in Proposition 3.4, A and B are events generated not only by crossing and circuit events but also by the $N_p(i)$'s. Nonetheless the proof is quite similar. Indeed, notice that Proposition 3.4 follows from Proposition 3.10 which in turn uses only the fact that for two points x, y to be pivotal, certain derivatives of f_t must vanish on certain deterministic segments. This is proved in Lemmas 3.7, 3.9 and 3.8. In our case, first, we combine Lemma 3.7 with Lemma 3.16 using Remark 2.3. Then, we use Lemma 3.17 in addition to Lemmas 3.9 and 3.8. The rest of the proof of Proposition 3.4 applies as is. \square

4 Tassion's RSW theory: the proof of Theorem 1.1

In this section, we prove Theorem 1.1 by relying on Sections 2 and 3 (but not on Subsection 3.4) and on [Tas16]. Our proof follows [Tas16] so instead of writing the details of each proof, we point out the steps of the original proof that need to be modified to work in our setting. We expect the reader to be familiar with [Tas16] and suggest that this section be read with said work at hand. Note that this simplifies the proof of [BG16] since we can directly apply Tassion's method in the continuum instead of applying it to different discretizations of the model at each scale. We first prove the following weaker result:

Proposition 4.1. *Let f be a Gaussian field satisfying Conditions 1.7, 1.8, 1.10 as well as Condition 1.9 for some $\alpha > 4$. Let $\rho > 0$. There exists $c = c(\kappa, \rho) > 0$ such that, for each $s > 0$, the probability that there is a left-right crossing of $[0, \rho s] \times [0, s]$ in \mathcal{D}_0 is at least c .*

Throughout the proof, in [Tas16], Tassion uses symmetries of the model such as stationarity (which is satisfied here by Condition 1.7), symmetries, and the FKG inequality (which are also valid here by Condition 1.8 and Lemma A.12). The final ingredient of the proof is a quasi-independence lemma, which we will state when needed. Otherwise, the proof carries over with only minor changes due to the specificities of the model.

Proof. Step 1: By Remark A.11, the probability that there is a left-right crossing of $[-s, s]^2$ is $1/2$ for any $s \in]0, +\infty[$. In particular, it is uniformly bounded from below by some constant $c_0 > 0$, which is just Equation (1) of [Tas16]. In other words

$$\forall s > 0, \mathbb{P}[\text{Cross}_0(s, s)] \geq c_0. \quad (4.1)$$

Step 2: Given $s \in]0, +\infty[$ and $\alpha, \beta \in [0, s/2]$ such that $\alpha < \beta$, we define the events $\mathcal{H}_s(\alpha, \beta)$ and $\mathcal{X}_s(\alpha)$ as follows (see Figure 4.1 below): The event $\mathcal{H}_s(\alpha, \beta)$ is satisfied whenever there is a continuous path in $[-s/2, s/2]^2 \cap \mathcal{D}_0$ connecting $\{-s/2\} \times [-s, s]$ to $\{s/2\} \times [\alpha, \beta]$. The event $\mathcal{X}_s(\alpha)$ is the event that there is a path γ_1 in $[-s/2, s/2]^2 \cap \mathcal{D}_0$ connecting $\{-s/2\} \times [-s/2, -\alpha]$ to $\{-s/2\} \times [\alpha, s/2]$, a path γ_2 in $[-s/2, s/2]^2 \cap \mathcal{D}_0$ connecting $\{s/2\} \times [-s/2, -\alpha]$ to $\{s/2\} \times [\alpha, s/2]$ and a path in $[-s/2, s/2]^2 \cap \mathcal{D}_0$ connecting γ_1 to γ_2 . As in [Tas16], we define $\phi_s : [0, s/2] \rightarrow [-1, 1]$ as

$$\phi_s(\alpha) = \mathbb{P}[\mathcal{H}_s(0, \alpha)] - \mathbb{P}[\mathcal{H}_s(\alpha, s/2)].$$

Then, Lemma 2.1 of [Tas16], says that for each $s \in]0, +\infty[$, there is $\alpha_s \in [0, s/2]$ such that, for some $c_1 > 0$ independent of s ,

$$\forall \alpha \in [0, \alpha_s], \mathbb{P}[\mathcal{X}_s(\alpha)] \geq c_1; \forall \alpha \in [\alpha_s, s/2], \mathbb{P}[\mathcal{H}_s(0, \alpha)] \geq c_0/4 + \mathbb{P}[\mathcal{H}_s(\alpha, s/2)]. \quad (4.2)$$

To establish this inequality, Tassion uses the fact that ϕ_s is continuous and increasing and defines α_s using the preimage of ϕ_s of a certain value. Here, the continuity of ϕ_s follows easily from the fact the f is a.s. continuous and that for each $x \in \mathbb{R}^2$, $\text{Var}(f(x)) > 0$. Moreover, the fact that ϕ_s is non-decreasing is immediate from its definition and this is sufficient for us since the argument works if one replaces $\min\{\phi_s^{-1}(s/4), s/4\}$ by $\sup\{\alpha \in]0, s/4[: \phi_s(\alpha) \leq c_0/4\}$. The rest of the proof of Lemma 2.1 uses only symmetries, the FKG inequality and Equation 4.1 and works as is.

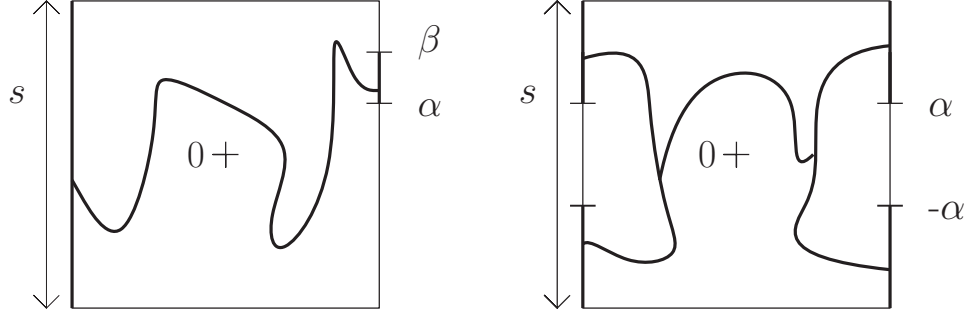

Figure 4.1 – The events $\mathcal{H}_s(\alpha, \beta)$ (left-hand-side) and $\mathcal{X}_s(\alpha)$ (right-hand-side). For every $\alpha \in [0, s/2]$, we let $\phi_s(\alpha) = \mathbb{P}[\mathcal{H}_s(0, \alpha)] - \mathbb{P}[\mathcal{H}_s(\alpha, s/2)]$.

Step 3: For each $0 < r < s$, let $\text{Circ}_0(r, s)$ be the event that there is a circuit above level 0 in the annulus $[-s, s]^2 \setminus]-r, r[$ separating $[-s, s]^2$ from infinity. In Lemmas 2.2 and 3.1 of [Tas16], Tassion shows that there exist constants $c_2, c_3 \in]0, 1[$ such that

$$\forall s \geq 2, \alpha_s \leq 2\alpha_{2s/3} \Rightarrow \mathbb{P}[\text{Circ}_0(s, 2s)] \geq c_2 \quad (4.3)$$

and

$$\forall s \geq 1, t \geq 4s, \mathbb{P}[\text{Circ}_0(s, 2s)] \geq c_2 \text{ and } \alpha_t \leq s \Rightarrow \mathbb{P}[\text{Circ}_0(t, 2t)] \geq c_3. \quad (4.4)$$

The proof of these two lemmas relies only on the FKG, symmetries and Equations 4.2 so it carries over to our setting.

Step 4: This is the step where Tassion uses a quasi-independence lemma. In our case, we will use the following direct consequence of Theorem 1.12:

Corollary 4.2. *There exists a constant $C_0 = C_0(\kappa) < +\infty$ such that, for every integer N larger than 1, for every $s \in [1, +\infty[$, for every $1 \leq r_1 \leq \dots \leq r_N < +\infty$ such that $r_2 \geq r_1 + s$, and for every B which belongs to the Boolean algebra generated by the events $\text{Circ}_0(r_i, 2r_i)$, $i = 2, \dots, N$, we have:*

$$|\mathbb{P}[\text{Circ}_0(r_1, 2r_1) \cap B] - \mathbb{P}[\text{Circ}_0(r_1, 2r_1)] \mathbb{P}[B]| \leq C_0 N r_N^4 s^{-\alpha}.$$

Using this corollary, we prove an analog of Lemma 3.2 of [Tas16]. Let us first introduce some notation. Given c_0 as in Step 1 and c_2 and c_3 as in Step 3, let $C_1 < +\infty$ be such that $(1 - c_3)^{\lfloor C_1/2 \rfloor} < c_0/8$ and let $s_0 < +\infty$ be such that for each $s \geq s_0$, $\frac{C_0}{c_3} \lfloor \log_5(C_1/2) \rfloor (C_1 s)^4 s^{-\alpha} < c_0/8$ (where C_0 is as in Corollary 4.2). Then, we prove the following:

Lemma 4.3. *Let $s \geq s_0$ such that $\mathbb{P}[\text{Circ}_0(s, 2s)] \geq c_2$, then, there exists $s' \in [4s, C_1 s]$ such that $\alpha_{s'} > s$.*

Proof. In the proof of his Lemma 3.2, Tassion uses FKG and the symmetry properties, as well as what we call Equations 4.2 and 4.3. The only place where he uses a quasi-independence property is where he proves that, if $\mathbb{P}[\text{Circ}_0(5^i s, 2 \cdot 5^i s)] \geq c_3$ for any $i \in \{0, \dots, \lfloor \log_5(C_1/2) \rfloor\}$ and if $s \geq s_0$, then:

$$\mathbb{P}[\text{Circ}_0(s, C_1 s)] > 1 - c_0/4.$$

In what follows, we prove such a result and we refer to [Tas16] for the rest of the proof. First note that:

$$\text{Circ}_0(s, C_1 s) \subseteq \bigcup_{i=0}^{\lfloor \log_5(C_1/2) \rfloor} \text{Circ}_0(5^i s, 2 \cdot 5^i s).$$

Now, by Corollary 4.2 applied $\lfloor \log_5(C_1/2) \rfloor - 1$ times:

$$\begin{aligned} & \mathbb{P} \left[\left(\bigcup_{i=0}^{\lfloor \log_5(C_1/2) \rfloor} \text{Circ}_0(5^i s, 2 \cdot 5^i s) \right)^c \right] \\ &= \mathbb{P} \left[\bigcap_{i=0}^{\lfloor \log_5(C_1/2) \rfloor} \text{Circ}_0(5^i s, 2 \cdot 5^i s)^c \right] \\ &\leq (1 - c_3) \times \mathbb{P} \left[\bigcap_{i=1}^{\lfloor \log_5(C_1/2) \rfloor} \text{Circ}_0(5^i s, 2 \cdot 5^i s)^c \right] - C_0 \lfloor \log_5(C_1/2) \rfloor (C_1 s)^4 s^{-\alpha} \\ &\leq \dots \\ &\leq (1 - c_3)^{\lfloor \log_5(C_1/2) \rfloor} + C_0 \left(\sum_{j \geq 0} (1 - c_3)^j \right) \lfloor \log_5(C_1/2) \rfloor (C_1 s)^4 s^{-\alpha} \\ &\leq (1 - c_3)^{\lfloor \log_5(C_1/2) \rfloor} + \frac{C_0}{c_3} \lfloor \log_5(C_1/2) \rfloor (C_1 s)^4 s^{-\alpha} \\ &< c_0/4, \end{aligned}$$

where the last inequality follows from the definition of C_1 and the fact that $s \geq s_0$. \square

Step 5: As explained in the proof of Lemma 3.3 of [Tas16] and the final comment that follows it, Proposition 4.1 now follows for s large enough from Equations (4.2) and (4.3) and Lemma 4.3 as well as standard gluing constructions that use only the FKG inequality and from symmetries. By the FKG inequality¹⁰ Theorem A.4 applied to events of the form $\{f \geq 1 \text{ on } B \text{ translated by some vector}\}$, we obtain that, for each $s > 0$, f takes only values larger than or equal to 1 on $[-s, s]^2$ with positive probability. \square

We now prove Theorem 1.1.

Proof of Theorem 1.1. We prove the result for \mathcal{N}_0 . This is sufficient since $\mathcal{N}_0 \subseteq \mathcal{D}_0$ and since the result for \mathcal{D}_0 for s less than some fixed constant can easily be proved as in the end of Proposition 4.1.

Let \mathcal{Q} be a quad and note that there exist $\delta = \delta(\mathcal{Q}) > 0$, $n = n(\mathcal{Q}), m = m(\mathcal{Q}) \in \mathbb{Z}_{>0}$ and two sequences $(\mathcal{E}_i)_{i=1}^n$ and $(\mathcal{E}'_j)_{j=1}^m$ of $2\delta \times \delta$ and $\delta \times 2\delta$ rectangles such that: i) if each \mathcal{E}_i (resp. \mathcal{E}'_j) is crossed lengthwise then \mathcal{Q} is crossed and ii) $\inf_{x \in \bigcup_{i=1}^n \mathcal{E}_i, y \in \bigcup_{j=1}^m \mathcal{E}'_j} |x - y| \geq \delta$. For each $s > 0$, write

A_s (resp. B_s) for the event that each $s\mathcal{E}_i$ is crossed (resp. each $s\mathcal{E}'_j$ is dual-crossed) lengthwise. By stationarity, $\frac{\pi}{2}$ -rotation invariance and Remark A.11, the crossing events of each of the rectangles above and below 0 are bounded from below by the constant $c = c(\kappa, 2) > 0$ from Proposition 4.1. Consequently, by Lemma A.12, for each $s > 0$, $\mathbb{P}[A_s] \geq c^n$ and $\mathbb{P}[B_s] \geq c^m$. But now, by Theorem 1.12, there exists $C = C(\kappa) < +\infty$ such that, for each $s > 0$:

$$\mathbb{P}[A_s \cap B_s] \geq \mathbb{P}[A_s] \mathbb{P}[B_s] - C(\delta s + 1)^{4-\alpha} nm.$$

Since, $\alpha > 4$ we have $C(\delta s + 1)^{4-\alpha} nm \xrightarrow{s \rightarrow +\infty} 0$ so the left-hand-side is bounded from below by a positive constant for s sufficiently large. But $A_s \cap B_s$ clearly implies the crossing of $s\mathcal{Q}$ by \mathcal{N}_0 . \square

Now that we have established Theorem 1.1, we apply it to obtain two results which are well known in Bernoulli percolation. Namely, the polynomial decay of the one-arm event: Proposition 4.5, and the absence of unbounded clusters at criticality: Proposition 4.6. We are going to use the following notation:

¹⁰More precisely, the events $\{f \geq 1 \text{ on } B\}$ can be approximated by increasing events depending on a finite sets of points, to which one can apply the FKG inequality.

Notation 4.4. If $0 < r < s < +\infty$, we write $\mathcal{A}(r, s) = [-s, s]^2 \setminus]-r, r[$ and we write $\text{Arm}_0(r, s)$ (resp. $\text{Arm}_0^*(r, s)$) the event that there is a continuous path in $\mathcal{D}_0 \cap \mathcal{A}(r, s)$ (resp. in $\mathcal{A}(r, s) \setminus \mathcal{D}_0$) from the inner boundary of $\mathcal{A}(r, s)$ to its outer boundary.

We start with the following result:

Proposition 4.5. *Let f be a Gaussian field that satisfying Conditions 1.7, 1.8, 1.10 as well as Condition 1.9 for some $\alpha > 4$. There exists $C = C(\kappa) < +\infty$ and $\eta = \eta(\kappa) > 0$ such that, for each $1 \leq r < s < +\infty$:*

$$\mathbb{P}[\text{Arm}_0(r, s)] = \mathbb{P}[\text{Arm}_0^*(r, s)] \leq C (r/s)^\eta.$$

Proof. Remark A.11 and the fact that f is centered imply that $\mathbb{P}[\text{Arm}_0(r, s)] = \mathbb{P}[\text{Arm}_0^*(r, s)]$. So let us prove the result only for $\text{Arm}_0^*(r, s)$. First fix $h \in [1/2, 1[$ to be determined later. For each $i \in \{0, \dots, \lfloor \log_5(\frac{s^h}{2 \cdot r^{1-h}}) \rfloor\}$, let $\text{Circ}_0(i)$ denote the event that there is a circuit at level 0 in the annulus $\mathcal{A}(5^i(rs)^{1-h}, 2 \cdot 5^i(rs)^{1-h})$. Note that:

$$\text{Arm}_0^*(r, s) \subseteq \bigcap_{i=0}^{\lfloor \log_5(\frac{s^h}{2 \cdot r^{1-h}}) \rfloor} \text{Circ}_0(i)^c.$$

Next, note that by Theorem 1.1 and by the FKG inequality Lemma A.12, there exists $c = c(\kappa) \in]0, 1[$ such that for each $i \in \{0, \dots, \lfloor \log_5(\frac{s^h}{2 \cdot r^{1-h}}) \rfloor\}$, $\mathbb{P}[\text{Circ}_0(i)] \geq c$. Next, use the quasi-independence result Theorem 1.12 $\lfloor \log_5(\frac{s^h}{2 \cdot r^{1-h}}) \rfloor$ times to obtain that, for some $C' = C'(\kappa) < +\infty$ we have:

$$\begin{aligned} & \mathbb{P} \left[\bigcap_{i=0}^{\lfloor \log_5(\frac{s^h}{2 \cdot r^{1-h}}) \rfloor} \text{Circ}_0(i)^c \right] \\ & \leq (1 - c) \times \mathbb{P} \left[\bigcap_{i=1}^{\lfloor \log_5(\frac{s^h}{2 \cdot r^{1-h}}) \rfloor} \text{Circ}_0(i)^c \right] - C' \lfloor \log_5(\frac{s^h}{2 \cdot r^{1-h}}) \rfloor (1 + s^4) (rs)^{-\alpha(1-h)} \\ & \leq \dots \\ & \leq (1 - c)^{\lfloor \log_5(\frac{s^h}{2 \cdot r^{1-h}}) \rfloor} + C' \left(\sum_{j \geq 0} (1 - c)^j \right) \lfloor \log_5(\frac{s^h}{2 \cdot r^{1-h}}) \rfloor (1 + s^4) (rs)^{-\alpha(1-h)} \\ & \leq (1 - c)^{\lfloor \log_5(\frac{s^h}{2 \cdot r^{1-h}}) \rfloor} + \frac{C'}{c} \lfloor \log_5(\frac{s^h}{2 \cdot r^{1-h}}) \rfloor (1 + s^4) (rs)^{-\alpha(1-h)}. \end{aligned}$$

Since $\alpha > 4$, we can find h sufficiently small to obtain what we want. \square

From Proposition 4.5 we get the following analog of the celebrated theorem by Harris [Har60] (which states that, for Bernoulli percolation on \mathbb{Z}^2 with parameter $1/2$, there is no infinite cluster). This result was also obtained by Alexander in [Ale96a] for stationary ergodic planar fields satisfying an FKG-type inequality under some mild non-degeneracy assumptions.

Proposition 4.6. *With the same hypotheses as Proposition 4.5, a.s. every connected component of \mathcal{D}_0 is bounded.*

Proof. By a union-bound and translation invariance, it is enough to prove that a.s. there is no unbounded component of \mathcal{D}_0 which intersects $[-1, 1]^2$, which is the case since by Proposition 4.5, $\mathbb{P}[\text{Arm}_0(1, s)]$ goes to 0 as s goes to $+\infty$. \square

The natural question arising from this proposition is whether or not this remains true for \mathcal{D}_p with $p > 0$. This is the object of Chapter 2 where we prove that, for the Bargmann-Fock field, there is a unique unbounded connected component in \mathcal{D}_p as soon as $p > 0$, thus obtaining the analogue of Kesten's famous theorem [Kes80] (which states that the critical point for Bernoulli percolation on \mathbb{Z}^2 is $1/2$).

5 Concentration from below of the number of nodal lines: the proof of Theorem 1.4

In this section, we prove Theorem 1.4 by using Theorem 1.2 and our quasi-independence result Theorem 1.12. The idea of the proof is the following. Let $\varepsilon > 0$. We first tile the square $[-s/2, s/2]^2$ with $(r/s)^2$ mesoscopic squares of size r . Then, we use Theorem 1.2 and our quasi-independence result Theorem 1.12 to prove that the density of $r \times r$ squares containing less than $r^2(c_{NS} - \varepsilon)$ nodal components is asymptotically small. More precisely, we will note that, if the number of such squares is greater than $\delta(s/r)^2$, then there exist $\delta(s/r)^2/8$ such squares that are at distance at least r from each other. By Theorem 1.12, this has probability $\mathbb{P}\left[\frac{N_0(r)}{r^2} - c_{NS} \leq -\varepsilon\right]^{\delta(s/r)^2/8}$ up to errors involving terms of the form $\sup_{x:|x|\geq r} |\kappa(x)|$. The last step is an optimization on the choice of r .

Upper concentration on the other hand seems to require some control of the tail of the density of nodal components. For the moment, it is not even known whether this density is L^2 . This type of information seems necessary for the following reason. In Item (1) of Theorem 1.4, for instance, we consider exponential concentration of the density of components. To this end we write the number of components as a sum of quasi-independent random variables. But a direct consequence of Cramér's theorem is that, if X_1, X_2, \dots are i.i.d. L^1 positive random variables such that $\mathbb{E}[e^{\theta X_1}] = +\infty$ for every $\theta > 0$, then $\left(\frac{X_1 + \dots + X_n}{n}\right)_n$ does not have exponential concentration around its mean. Note finally that to have an upper bound concentration, we need to take care of the mesoscopic components that intersect several $r \times r$ squares. However, these do not add any difficulty. Indeed, by [NS16], if we write $N'(r)$ for the number of nodal components which *intersect* a $r \times r$ box (and are not just included) then Theorem 1.2 also holds for $N'(r)$ (with the same constant c_{NS}).

Proof of Theorem 1.4. Assume that f is a planar Gaussian field satisfying Conditions 1.7, 1.10 and 1.11. First note that it is sufficient to prove the result for ε sufficiently small and fix $\varepsilon \in]0, c_{NS}/2[$. Let $1 \leq r \leq s$ be such that $s \in r\mathbb{N}$ and tile the square $[-s/2, s/2]^2$ with $(s/r)^2$ $r \times r$ squares $S_1, \dots, S_{(s/r)^2}$. Throughout the proof, we take the liberty of omitting floor functions. For each $t \in [0, +\infty[$, write $\kappa_t = \sup\{|\kappa(x)| : |x| \geq t\}$.

By Theorem 1.2, for each $h \in]0, 1/2[$, there exist $r_0 = r_0(\varepsilon, h) < +\infty$ such that, if $r \geq r_0$, then:

$$\mathbb{P}\left[\frac{N_0(r)}{r^2} \leq c_{NS} - \varepsilon\right] \leq h, \quad (5.1)$$

We also assume that r_0 is sufficiently big so that $\kappa_{r_0} \leq 1/2$ and we assume that $r \geq r_0$. For every $i \in \{1, \dots, (s/r)^2\}$, write N_0^i for the number of connected components of \mathcal{N}_0 included in S_i and note that, if $\frac{N_0(s)}{s^2} \leq c_{NS} - 2\varepsilon$, then there exist $(s/r)^2 \frac{\varepsilon}{c_{NS} - \varepsilon}$ squares S_i such that $\frac{N_0^i}{r^2} \leq c_{NS} - \varepsilon$. As a result, if $\eta = \eta(\varepsilon) = \frac{1}{8} \times \frac{\varepsilon}{c_{NS} - \varepsilon}$, there exist $\eta \cdot (s/r)^2$ squares S_i at distance at least r from each other and such that $\frac{N_0^i}{r^2} \leq c_{NS} - \varepsilon$. Let S_{i_1}, \dots, S_{i_n} be $\eta \cdot (s/r)^2$ pairwise distinct squares among the $(s/r)^2$ squares at distance at least r from each other. In the following, we estimate the probability that for each $j \in \{1, \dots, \eta \cdot (s/r)^2\}$, $\frac{N_0^{i_j}}{r^2} \leq c_{NS} - \varepsilon$. Recall that $h < 1/2$ and that $0 < \varepsilon < c_{NS}/2$ so $0 < \eta < 1/8$. By Theorem 1.12 applied $\eta \cdot (s/r)^2 - 1$ times, by translation

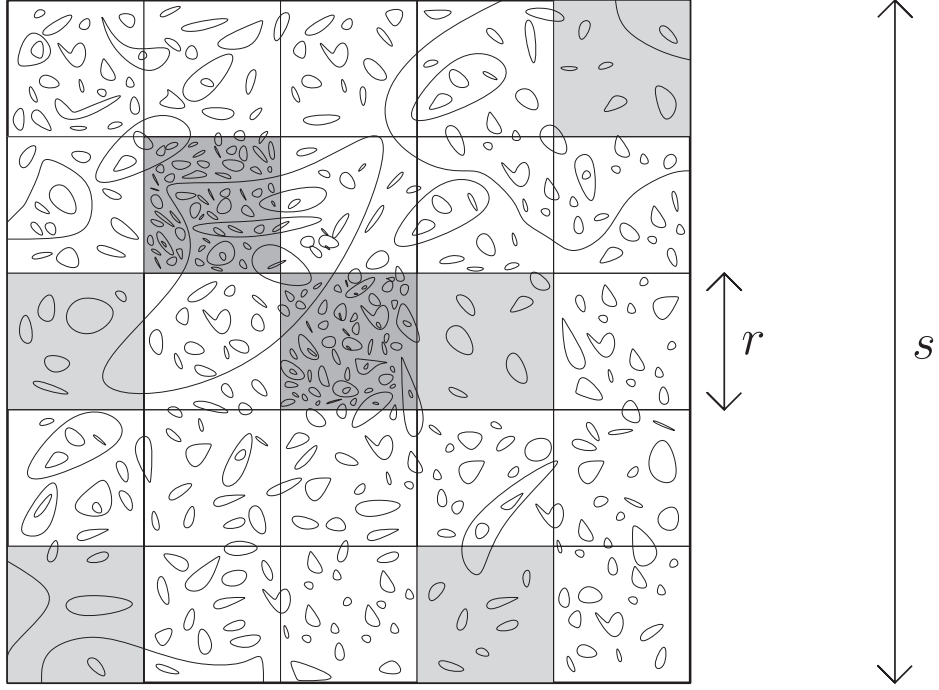

Figure 5.1 – The components of \mathcal{N}_0 in $[-s/2, s/2]^2$. In light gray: the $r \times r$ squares in which the density of components is smaller than expected. Combining Theorem 1.2 with Theorem 1.12, we prove that that with high probability there are not too many such squares. In dark gray, the $r \times r$ squares in which the number of components is much greater than expected. Since we do not know whether or not the density of nodal component has an heavy tail, it is very hard to control these exceptional squares.

invariance and by (5.1):

$$\begin{aligned}
& \mathbb{P} \left[\forall j \in \{1, \dots, \eta \cdot (s/r)^2\}, \frac{N_0^{ij}}{r^2} \leq c_{NS} - \varepsilon \right] \\
& \leq h \times \mathbb{P} \left[\forall j \in \{2, \dots, \eta \cdot (s/r)^2\}, \frac{N_0^{ij}}{r^2} \leq c_{NS} - \varepsilon \right] + O(\kappa_r r^2 (s^2 + \eta \cdot (s/r)^2)) \\
& \leq h \times \mathbb{P} \left[\forall j \in \{2, \dots, \eta \cdot (s/r)^2\}, \frac{N_0^{ij}}{r^2} \leq c_{NS} - \varepsilon \right] + O(\kappa_r r^2 s^2) \\
& \leq \dots \\
& \leq h^{\eta \cdot (s/r)^2} + \left(\sum_{j \geq 0} h^j \right) O(\kappa_r r^2 s^2) = h^{\eta \cdot (s/r)^2} + O(\kappa_r r^2 s^2) \\
& \leq h^{\eta \cdot (s/r)^2} + \frac{1}{1-h} O(\kappa_r r^2 s^2) = h^{\eta \cdot (s/r)^2} + O(\kappa_r r^2 s^2) .
\end{aligned}$$

where the constants in the O 's depend only on κ . As a result :

$$\begin{aligned}
\mathbb{P} \left[\frac{N_0(s)}{s^2} \leq c_{NS} - 2\varepsilon \right] & \leq \binom{(s/r)^2}{\eta \cdot (s/r)^2} \left(h^{\eta \cdot (s/r)^2} + O(\kappa_r r^2 s^2) \right) \\
& \leq (2h^\eta)^{(s/r)^2} + O\left(2^{(s/r)^2} \kappa_r r^2 s^2\right) .
\end{aligned} \tag{5.2}$$

Let us first treat the case of Item 1 i.e. assume that there exists $C < +\infty$ and $c > 0$ such that

$\kappa_r \leq C \exp(-cr^2)$. Then, the right hand side of (5.2) is

$$(2h^\eta)^{(s/r)^2} + O\left(\exp\left((s/r)^2 \log(2) - cr^2 + 4 \log(s)\right)\right).$$

Taking $h = h(\eta)$ small enough and $r = M\sqrt{s}$ for $M = M(c)$ large enough, this quantity is exponentially small in s so we are done.

Let us now treat the case of Item 2 i.e. assume that there exists $C < +\infty$ and $\alpha > 4$ such that $\kappa_r \leq Cr^{-\alpha}$. Then, the right hand side of (5.2) is

$$(2h^\eta)^{(s/r)^2} + O\left(2^{(s/r)^2} s^2 r^{2-\alpha}\right).$$

Fix $\delta > 0$. Choosing $r = s/\sqrt{a \log_2(s)}$ for $a = a(\delta) > 0$ small enough, the second term in the sum is $O(s^{4-\alpha+\delta})$. Having chosen a , we choose $h = h(a, \eta)$ such that the first term is also $O(s^{4-\alpha+\delta})$. Since this is true for any $\varepsilon \in]0, c_{NS}/2[$ and any $\delta > 0$, we are done. \square

Remark 5.1. Note that we have used Theorem 1.2 only to obtain (5.1). Hence, our lower concentration result Theorem 1.4 holds if, instead of Condition 1.11 (which is the assumption to apply Theorem 1.2), we assume that there exists a constant $c_{NS} = c_{NS}(\kappa) \in]0, +\infty[$ such that, for each $\varepsilon > 0$, $\mathbb{P}\left[\frac{N_0(s)}{s^2} \leq c_{NS} - \varepsilon\right]$ goes to 0 as s goes to $+\infty$.

A Classical tools

In this section we present classical or elementary results about Gaussian vectors and fields.

A.1 Classical results for Gaussian vectors and fields

Differentiating Gaussian fields. When one consider derivatives of Gaussian fields, it is important to have the following in mind (see for instance Appendices A.3 and A.9 of [NS16]):

Lemma A.1. *Let f be an a.s. continuous Gaussian field with covariance¹¹ $K \in C^{k+1, k+1}(\mathbb{R}^n \times \mathbb{R}^n)$ and mean $\mu \in C^k(\mathbb{R}^n)$. Then, f is almost surely C^k . Conversely, if a.s. f is C^k , then $K \in C^{k, k}$, $\mu \in C^k$ and for every multi-indices $\beta, \gamma \in \mathbb{N}^2$ such that $\beta_1 + \dots + \beta_n \leq k$ and $\gamma_1 + \dots + \gamma_n \leq k$, we have:*

$$\text{Cov}\left(\partial^\beta f(x), \partial^\gamma f(y)\right) = \mathbb{E}\left[(\partial^\beta f(x) - \partial^\beta \mu(x))(\partial^\gamma f(y) - \partial^\gamma \mu(y))\right] = \partial_x^\beta \partial_y^\gamma K(x, y).$$

Remark A.2. Lemma A.1 has the following consequence: if f satisfies Condition 1.7 and is a.s. C^1 then, for each $\beta \in \mathbb{N}^2$ such that $\beta_1 + \beta_2$ is odd, $\partial^\beta \kappa(0) = 0$.

Remark A.3. Another consequence of Lemma A.1 is that if f is a.s. C^1 and satisfies Condition 1.7 then for each $x \in \mathbb{R}^2$ and for v, w non-colinear unit vectors, the Gaussian vector $(\partial_v f(x), \partial_w f(x))$ is non-degenerate. Indeed, if this was not the case, then we would obtain the existence of some non-zero vector u such that $\partial_u f$ would a.s. vanish identically, which would contradict the fact that f is non-degenerate. Similarly, if f is a.s. C^2 and satisfies Condition 1.7 then for each $x \in \mathbb{R}^2$ and each non-zero vector $w \in \mathbb{R}^2$, $(f(x), \partial_w f(x), \partial_w^2 f(x))$ is non-degenerate. Indeed, $\partial_w f(x)$ is independent of the two other coordinate by Remark A.2 and if $(f(x), \partial_w^2 f(x))$ were degenerate then as above this would contradict the fact that f is non-degenerate.

¹¹Here and below, $C^{l, l}$ means that all partial derivatives of K which include at most l differentiations in the first variable and l differentiations in the second variable exist and are continuous.

A FKG inequality for Gaussian vectors. The following result by [Pit82] says that positively correlated Gaussian vectors satisfy positive association. This is a key result when one wants to use Russo-Seymour-Welsh type techniques. We first need to introduce the following terminology: if I is some set and $A \subseteq \mathbb{R}^I$ then we say that A is increasing if for every $\omega \in A$ and every $\omega' \in \mathbb{R}^I$ such that $\omega'(i) \geq \omega(i)$ for every $i \in I$, we have $\omega' \in A$.

Theorem A.4 ([Pit82]). *Let $(X_k)_{1 \leq k \leq n}$ be a Gaussian vector such that, for every $k, l \in \{1, \dots, n\}$, $\mathbb{E}[X_k X_l] \geq 0$. Then, For every $A, B \subseteq \mathbb{R}^n$ increasing Borel subsets:*

$$\mathbb{P}[X \in A \cap B] \geq \mathbb{P}[X \in A] \mathbb{P}[X \in B].$$

This type of inequality is known as the **Fortuyn-Kasteleyn-Ginibre** (or **FKG**) inequality. Pitt's result easily generalizes to crossing and circuits events by approximation, one just needs to take care that the approximating events are increasing, see Lemma A.12.

Some basic lemmas. The following lemma is useful to bound the expectation of the product of Gaussian variables. The first lemma is known as the regression formula and is quite classical in the field.

Lemma A.5 (Proposition 1.2 of [AW09]). *Let (X, Y) be an $n + m$ -dimensional centered Gaussian vector with covariance*

$$\begin{pmatrix} A & B \\ B^t & D \end{pmatrix}$$

where A (resp. D) is the covariance of X (resp. Y). Assume Y is non-degenerate. Then, the law of X conditioned on Y is that of a Gaussian vector with covariance $A - BD^{-1}B^t$ and mean $BD^{-1}Y$.

The next lemma is a simple application of the regression formula to the computation of conditional moments of Gaussian vectors.

Lemma A.6. *Let (X, Y) be a centered Gaussian vector in $\mathbb{R}^n \times \mathbb{R}^m$ with covariance*

$$\begin{pmatrix} A & B \\ B^t & D \end{pmatrix}.$$

Assume that D is non-degenerate. Let $\mu \in \mathbb{R}^m$. Then, there exists $C = C(n) < +\infty$ such that

$$\mathbb{E} \left[\prod_{i=1}^n |X_i| \mid Y = \mu \right] \leq C \max_{i \in \{1, \dots, n\}; j, k \in \{1, \dots, m\}} \left(\sqrt{A_{ii}} \vee |B_{ik} D_{kj}^{-1} \mu_j| \right)^n$$

Proof. By the regression formula (Lemma A.5), X conditioned on $Y = \mu$ has the law of a Gaussian vector Z with covariance $\tilde{A} = A - BD^{-1}B^t$ and mean $\tilde{\mu} = BD^{-1}\mu$. Note that $BD^{-1}B^t$ is symmetric semi-definite. Therefore, its diagonal coefficients must be non-negative. Therefore, for each $i \in \{1, \dots, n\}$, $\tilde{A}_{ii} \leq A_{ii}$. Moreover, for each $i \in \{1, \dots, n\}$, $|\tilde{\mu}_i| \leq n^2 \max_{j, k \in \{1, \dots, m\}} |B_{ik} D_{kj}^{-1} \mu_j|$. The lemma then follows from the elementary observation that for each $n \geq 1$ there exists $C = C(n) < +\infty$ such that for each Gaussian vector Z with covariance \tilde{A} and mean $\tilde{\mu}$,

$$\mathbb{E} \left[\prod_{i=1}^n |Z_i| \right] \leq C \max_{i \in \{1, \dots, n\}} \left(\sqrt{\tilde{A}_{ii}} \vee |\tilde{\mu}_i| \right)^n.$$

□

Remark A.7. From Lemmas A.5 and A.1 we deduce that if f is an a.s. continuous and non-degenerate Gaussian field on \mathbb{R}^n with $C^{k+1, k+1}$ covariance and C^k mean and if $x_1, \dots, x_k \in \mathbb{R}^n$ are such that $(f(x_1), \dots, f(x_k))$ is a non-degenerate Gaussian vector, then, for each $v \in \mathbb{R}^n$ conditionally on $(f(x_1), \dots, f(x_k)) = v$, f is a Gaussian field with $C^{k+1, k+1}$ covariance and C^k mean. Moreover, the covariance (resp. mean) of the derivatives of the conditional field is equal to the covariance (resp. mean) of the derivatives of the field under the same conditioning.

A Kac-Rice formula. The following result is a Kac-Rice type formula, which is for instance a particular case of Theorem 6.2 of [AW09] (together with Proposition 6.5 therein):

Theorem A.8. *Let $\varepsilon \in]0, +\infty[$, let $n \in \mathbb{Z}_{>0}$, and let Φ_1, \dots, Φ_n denote n continuous Gaussian fields $: [0, \varepsilon] \rightarrow \mathbb{R}$ that are a.s. C^2 on $]0, \varepsilon[$ and such that, for every $s \in [0, \varepsilon]^n$, $\Phi(s) = (\Phi_1(s_1), \dots, \Phi_n(s_n))$ is non-degenerate. Then*

$$\mathbb{E}[\text{Card}\{s \in [0, \varepsilon]^n : \Phi(s) = 0\}]$$

equals:

$$\int_{]0, \varepsilon[^n} \varphi(s) \mathbb{E} \left[\prod_{i=1}^n |\Phi'_i(s_i)| \mid \Phi(s) = 0 \right] ds,$$

where $\varphi(s)$ is the density of $\Phi(s)$ evaluated at 0.

A.2 Transversality of the level set and a non-quantitative discretization lemma

In this subsection, we state transversality results which are quite classical in the field and which are very helpful to obtain some continuity results about crossing events. We also prove a non-quantitative discretization lemma useful to justify discrete approximation of certain events.

Lemma A.9. *Assume that f satisfies Condition 1.7 and that κ is C^6 . Fix $p \in \mathbb{R}$ and fix $(\gamma(t))_{t \in [0,1]}$ a smooth path in the plane. Then:*

1. *A.s. $f^{-1}(]-p, +\infty[) =: \mathcal{D}_p$ and $f^{-1}(]-\infty, -p])$ are two 2-dimensional smooth sub-manifolds of \mathbb{R}^2 with boundary. Moreover, a.s. their boundaries are equal and are the whole set \mathcal{N}_p .*
2. *A.s., \mathcal{N}_p intersects γ transversally.*

To prove Lemma A.9, we can use the following lemma:

Lemma A.10 (see Lemma 11.2.10 of [AT07]). *Let $n \in \mathbb{N}$. Let T be a compact subset of \mathbb{R}^n with Hausdorff dimension $k \in \mathbb{N}$. Let $g = (g_j)_{1 \leq j \leq k+1} : \mathbb{R}^n \rightarrow \mathbb{R}^{k+1}$ be a Gaussian field that is a.s. C^1 . Assume also that g has a bounded density on T . Then, for each $v \in \mathbb{R}^{k+1}$, $g^{-1}(v) \cap T$ is a.s. empty.*

Proof of Lemma A.9. First note that the fact that κ is C^6 implies that f is C^2 by Lemma A.1. To prove the first part of the lemma, we fix $R \in]0, +\infty[$ and $p \in \mathbb{R}$ and apply Lemma A.10 to $T = [-R, R]^2$ (of Hausdorff dimension 2) and $g = (f, \partial_1 f, \partial_2 f)$ with $v = (-p, 0, 0)$. For every x , we have the following: i) by Remark A.2, $f(x)$ is independent of $(\partial_1 f(x), \partial_2 f(x))$ and ii) by Remark A.3, $(\partial_1 f(x), \partial_2 f(x))$ is non-degenerate. As a result, $g(x)$ is non-degenerate. Since g is stationary, this implies that g has bounded density. We obtain that a.s. f vanishes transversally on $\mathcal{N}_p \cap [-R, R]^2$. By taking the intersection of such events for $R = 1, 2, \dots$ we end the proof of the first statement. For the second part of the statement, we apply Lemma A.10, this time for $T = \{\gamma(t)\}_{t \in [0,1]}$ (of Hausdorff dimension 1) and $g(t) = ((f \circ \gamma)(t), (f \circ \gamma)'(t))$ with $v = (-p, 0)$. As before, for every t , $g(t)$ is non-degenerate. By continuity of the covariances, this implies that g restricted to T has bounded density, so Lemma A.10 does apply. \square

Remark A.11. The following can easily be deduced from Lemma A.9: Assume that f satisfies Condition 1.7 and that κ is C^3 . Fix $p \in \mathbb{R}$ and let $\mathcal{Q} \subseteq \mathbb{R}^2$ be a quad (i.e. a region of the plane homeomorphic to a disk, with two distinguished disjoint segments on its boundary). Then a.s. either all or none of the following events hold: (a) there is a continuous path included in $\mathcal{D}_p \cap \mathcal{Q}$ which joins one distinguished side of \mathcal{Q} to the other, (b) there is such a continuous path in $f^{-1}(]-p, +\infty[) \cap \mathcal{Q}$ which joins one non-distinguished side of \mathcal{Q} to the other and (c) there is no continuous path included in $f^{-1}(]-\infty, -p]) \cap \mathcal{Q}$ which joins one non-distinguished side of \mathcal{Q} to the other and (d) there is no such path in $f^{-1}(]-\infty, -p])$.

Similarly, if \mathcal{A} is an annulus, then a.s. either all of none of the following events hold: (a) there is a continuous path included in $\mathcal{D}_p \cap \mathcal{A}$ which separates the inner boundary of \mathcal{A} from its outer boundary, (b) there is such a path in $f^{-1}(] - p, +\infty[)$, (c) there is no continuous path in $f^{-1}(] - \infty, -p]) \cap \mathcal{A}$ which joins the inner boundary of \mathcal{A} to its outer boundary and (d) there is no such path in $f^{-1}(] - \infty, -p])$.

A consequence of these properties and of the fact that f is centered is that, if we assume furthermore that f is invariant by $\frac{\pi}{2}$ -rotation, then the probability that there is a left-right crossing at level 0 of the square $[0, s]^2$ is $1/2$ for any $s \in]0, +\infty[$.

The following lemma is a consequence of Lemma A.9 and of Theorem A.4 and is crucial in the proof of box-crossing results.

Lemma A.12 (FKG). *Let f be a Gaussian field on \mathbb{R}^2 satisfying Condition 1.7 such that κ is C^6 . Let $p \in \mathbb{R}$. Assume that for each $x \in \mathbb{R}^2$, $\kappa(x) \geq 0$. Let A, B be obtained by taking as unions and intersections of a finite number of crossings of quads and circuits in annuli above level $-p$. Then,*

$$\mathbb{P}[A \cap B] \geq \mathbb{P}[A]\mathbb{P}[B].$$

Proof. It suffices to approximate the events by increasing events that depend on f restricted to a finitely many points and using Theorem A.4. This can easily be done by considering the discrete model introduced in Section 3 and by using Lemma A.9 to prove that the discrete crossing events indeed approximate the continuous crossing events (for a similar argument, see the proof of Theorem 1.12 in Subsection 3.1). \square

The following lemma is useful to show that certain discrete approximations of events do converge a.s. to continuous geometric events. In the lemma we refer to the face-centered square lattice defined before (see Figure 3.1). We use this lemma only to study nodal components (see Subsection 3.4), but we do not need it in order to study crossing events.

Lemma A.13. *Let $\mathcal{C} \subseteq \mathbb{R}^2 \setminus \{0\}$ be a compact smooth one-dimensional submanifold of \mathbb{R}^2 that intersects the axes $\{0\} \times \mathbb{R}$ and $\mathbb{R} \times \{0\}$ transversally. Assume that there is a finite number of $x \in \mathcal{C}$ such that $T_x\mathcal{C}$ is colinear to an edge of the face-centered square lattice. Then, for a.e. small enough $\varepsilon > 0$, we have:*

1. *the set \mathcal{C} does not intersect the vertex set and intersects each edge of \mathcal{T}^ε transversally;*
2. *each edge of \mathcal{T}^ε is intersected at most twice and any two distinct intersection points of e are connected by a path in \mathcal{C} inside the union of the two faces adjacent to e .*

Proof. By simple application of Sard's theorem, the first property holds for a.e. $\varepsilon > 0$. We now take $\varepsilon > 0$ such that the first property holds and prove that the second property holds for $\varepsilon > 0$ small enough. We begin by defining some constants depending on \mathcal{C} that will determine how small the ε 's need to be to satisfy the second property.

- Since there are a finite number of points $x \in \mathcal{C}$ such that $T_x\mathcal{C}$ is colinear to an edge of the lattice, there exists $c_1 > 0$ such that any two such distinct points are at distance greater than $4c_1$.
- The distance between any two distinct components of \mathcal{C} is bounded from below by a constant $c_2 > 0$.
- Each component of \mathcal{C} is the image of some smooth embedding $\gamma : S^1 \rightarrow \mathbb{R}^2$ with unit speed such that for each distinct $s, t \in S^1$, $|\gamma(s) - \gamma(t)| \geq \lambda_0 \text{dist}_{S^1}(s, t)$ (here and below, dist_{S^1} denotes the distance function on S^1). Let $\|\mathbf{k}\|_\infty < +\infty$ be the maximum of the curvature $|\mathbf{k}|$ on \mathcal{C} and let $c' > 0$ be such that for any two points x, y on a common edge e and any point z outside of the union of the two faces adjacent to e , the unit vectors v_1 and v_2 pointing in the directions of $z - x$ and $y - z$ satisfy $|v_1 - v_2| \geq c'$. Let $c_3 = c' \lambda_0 / \|\mathbf{k}\|_\infty \in]0, +\infty[$.

We take $\varepsilon < \min(c_1, c_2, c_3)$ and prove that the second property holds.

Fix e an edge of \mathcal{T}^ε . Let us prove that any two intersection points on e must be connected by a smooth arc inside the union F of the two faces adjacent to e . If e is intersected at least twice, say at $x, y \in e$, then, x, y are at distance less than c_2 so they must belong to the same component \mathcal{C} . This component is parametrized by a smooth embedding $\gamma : S^1 \rightarrow \mathbb{R}^2$ with unit speed so there are $s, t \in S^1$, such that $\gamma(s) = x$ and $\gamma(t) = y$. By assumption, $\varepsilon \geq |x - y| \geq \lambda_0 \text{dist}_{S^1}(s, t)$. Assume that x and y are not connected by γ inside the union F of the two faces adjacent to e . Then, there exists $r \in S^1$ belonging to one of the shortest paths between s and t in S^1 such that $\gamma(r) = z \notin F$. We denote by $]s, t[$ the open interval in S^1 containing r , and denote by $]s, r[$ and $]r, t[$ the open sub-intervals with extremities s and r and r and t respectively. Let v_1 and v_2 be the unit tangent vectors pointing in the same directions as $z - x$ and $y - x$ respectively. By construction, $|v_1 - v_2| \geq c'$. By Rolle's theorem, there exist $u_1 \in]s, r[$ and $u_2 \in]r, t[$ such that $\gamma'(u_1) = v_1$ and $\gamma'(u_2) = v_2$. Moreover, by assumption, $\text{dist}_{S^1}(u_1, u_2) \leq \lambda_0^{-1} \varepsilon$. But this means that there exists $u_3 \in]u_1, u_2[$ such that

$$\|\mathbf{k}\|_\infty \geq |\mathbf{k}(\gamma(u_3))| = |\gamma''(u_3)| \geq \lambda_0 c' \varepsilon^{-1}.$$

Consequently, $\varepsilon \geq \lambda_0 c' / \|\mathbf{k}\|_\infty = c_3$ which contradicts our assumption. Therefore, x and y must be connected by a smooth arc.

Now, by Rolle's theorem, for any two distinct intersection points of e connected by a smooth arc inside F , there must be a point x on this connecting arc such that $T_x \mathcal{C}$ is colinear to e . Thus, if e contains three distinct intersection points, then there are two distinct points $x, y \in F$ such that $T_x \mathcal{C}$ and $T_y \mathcal{C}$ are colinear to e . But $x, y \in F$ so they must be at distance at most $4\varepsilon \leq 4c_1$ which contradicts the definition of c_1 . Hence, $|\mathcal{C} \cap e| \leq 2$ and we are done. \square

B A uniform discrete RSW estimate

In this section, we prove a RSW result for the discrete models studied in [BG16]. As explained in Section 1, contrary to [BG16], we do not use any discrete RSW estimate to deduce the continuous RSW estimate. However, a discrete RSW estimate uniform in the mesh ε can be useful if one wants to apply tools from discrete percolation to our model. The results of this section rely heavily on [BG16]. We also make a small correction in the arguments made therein. For these reasons, this Appendix should be read as a companion text to [BG16]. We would like to stress the fact that **the results presented here are not used in the rest of the chapter**. We first introduce the following notations:

Notation B.1. Consider the discretized model introduced in the beginning of Section 3 and remember Definition 3.2. If \mathcal{Q} is a quad, write $\text{Cross}_0^\varepsilon(\mathcal{Q})$ for the event that \mathcal{Q} is ε -crossed at level 0.

We have the following result.

Proposition B.2. *Let f be a Gaussian field satisfying Conditions 1.7, 1.8, 1.10 as well as Condition 1.9 for some $\alpha > 4$. For every quad \mathcal{Q} , there exist $s_0 = s_0(\kappa, \mathcal{Q}) \in]0, +\infty[$ and $c = c(\kappa, \mathcal{Q}) > 0$ such that for each $s \in [s_0, +\infty[$ and each $\varepsilon \in]0, 1[$ we have:*

$$\mathbb{P}[\text{Cross}_0^\varepsilon(s\mathcal{Q})] \geq c.$$

Note that the constant c above does not depend on ε . As in the continuous case, the first result of this kind can be found in [BG16] by combining Theorem 2.2 of [BG16] with their Section 4. The novelty here is that the result holds for any $\alpha > 4$ and without any constraint on (s, ε) . As in the proof of Theorem 1.1, we need a quasi-independence result to prove Proposition B.2. We are going to use Proposition 3.4 where the quasi-independence estimate is uniform in ε .

Proof of Proposition B.2. As in Section 4, we follow Tassion's strategy from [Tas16]. However, since we need a constant c which is uniform in ε , it is more suitable to follow the quantitative version of Tassion's method presented in Section 2 of [BG16].

Before going into the proof, let us warn the reader that in Section 4 we have used the notations from [Tas16] while in the present appendix we use the notations from [BG16]. In particular, the notation ϕ_s has two different meanings; we hope that this will not confuse the reader.

We first assume that $\varepsilon^{-1} \in \mathbb{Z}_{>0}$ so that our model is \mathbb{Z}^2 -periodic. As noted in [BG16], by a simple duality argument (which works since our lattice is a triangulation), we obtain that the probability that there is a left-right crossing of $[-s/2, s/2]^2$ made of black edges of \mathcal{T}^ε is $1/2$ for any $s \in 2\mathbb{Z}_{>0}$. Hence we have the existence of some $c_0 \in]0, 1[$ such that the probability of this event is at least c_0 for any $s \in 2\mathbb{Z}_{>0}$ as assumed in Condition 3 of Definition 2.1 in [BG16]. We first prove the following lemma analogous to Lemma 2.7 of [BG16]. Our way to state this lemma is a little different from [BG16] since we think that, for the proof of this lemma to be correct, one has to consider variants of the event $\mathcal{H}_s(\cdot, \cdot)$ as we do below. The reason why we need to make such a change is that the models are not continuous, which implies that the function ψ_s (which is defined in the proof) is not continuous, so the proof written in [Tas16] does not work as is. Let us stress that, once one has made this small correction, all the other results of [BG16] hold without any modification.

Lemma B.3. *For any $s \geq 1$, $-s/2 \leq \alpha \leq \beta \leq s/2$, let $\mathcal{H}_s(\alpha, \beta)$ (resp. $\tilde{\mathcal{H}}^1(\alpha, \beta)$, $\tilde{\mathcal{H}}^2(\alpha, \beta)$) be the event that there is a path in $[-s/2, s/2]^2$ from the left side to $\{s/2\} \times [\alpha, \beta]$ (resp. to $\{s/2\} \times]\alpha, \beta]$, to $\{s/2\} \times [\alpha, \beta[$) made of black edges of \mathcal{T}^ε . Also, let $\mathcal{X}_s(\alpha)$ be defined exactly as in [Tas16, BG16] (see for instance Figure 2.2 of [BG16]). There exists a universal polynomial $Q_1 \in \mathbb{R}[X]$, positive on $]0, 1[$, such that for every $s \in 2\mathbb{Z}_{>0}$, there exists $\alpha_s = \alpha_s(\varepsilon, \kappa) \in [0, s/4]$ satisfying the following properties:*

$$(P1) \quad \mathbb{P}[\mathcal{X}_s(\alpha_s)] \geq Q_1(c_0).$$

$$(P2) \quad \text{If } \alpha_s < s/4, \text{ then } \mathbb{P}[\mathcal{H}_s(0, \alpha_s)] \geq c_0/4 + \mathbb{P}[\tilde{\mathcal{H}}_s^1(\alpha_s, s/2)].$$

Proof. For every $\alpha \in [0, s/2]$, write:

$$\psi_s(\alpha) = \psi_s(\kappa, \varepsilon, \alpha) = \mathbb{P}[\mathcal{H}_s(0, \alpha)] - \mathbb{P}[\mathcal{H}_s(\alpha, s/2)],$$

$$\tilde{\psi}_s^1(\alpha) = \tilde{\psi}_s^1(\kappa, \varepsilon, \alpha) = \mathbb{P}[\mathcal{H}_s(0, \alpha)] - \mathbb{P}[\tilde{\mathcal{H}}_s^1(\alpha, s/2)],$$

and

$$\tilde{\psi}_s^2(\alpha) = \tilde{\psi}_s^2(\kappa, \varepsilon, \alpha) = \mathbb{P}[\tilde{\mathcal{H}}_s^2(0, \alpha)] - \mathbb{P}[\mathcal{H}_s(\alpha, s/2)].$$

Note that:

$$\forall \alpha \in [0, s/2[, \lim_{\substack{\alpha' \rightarrow \alpha, \\ \alpha' > \alpha}} \psi_s(\alpha') = \tilde{\psi}_s^1(\alpha); \forall \alpha \in]0, s/2], \lim_{\substack{\alpha' \rightarrow \alpha, \\ \alpha' < \alpha}} \psi_s(\alpha') = \tilde{\psi}_s^2(\alpha).$$

Now, if $\Psi_s(s/4) > c_0/4$, then let α_s be the infimum over every $\alpha \in [0, s/4]$ such that $\psi_s(\alpha) > c_0/4$; otherwise let $\alpha_s = s/4$. Then, we have $\tilde{\psi}_s^2(\alpha_s) \leq c_0/4$ and, if $\alpha_s < s/4$, we have $\tilde{\psi}_s^1(\alpha_s) \geq c_0/4$. Thus, (P2) is satisfied. Concerning (P1), similarly as in Lemma 2.1 of [Tas16] we have:

$$\begin{aligned} c_0 &\leq 2\mathbb{P}[\tilde{\mathcal{H}}_s^2(0, \alpha_s)] + 2\mathbb{P}[\mathcal{H}_s(\alpha_s, s/2)] \\ &\leq 4\mathbb{P}[\mathcal{H}_s(\alpha_s, s/2)] + 2\tilde{\psi}_s^2(\alpha_s) \\ &\leq 4\mathbb{P}[\mathcal{H}_s(\alpha_s, s/2)] + c_0/2. \end{aligned}$$

Finally, $\mathbb{P}[\mathcal{H}_s(\alpha_s, s/2)] \geq c_0/8$ thus as noted in [Tas16], by a simple construction and by the FKG inequality we obtain that $\mathbb{P}[\mathcal{X}(\alpha_s)] \geq c_0 \times (c_0/8)^4$. \square

Next, Lemmas 2.8 and 2.9 of [BG16] apply readily. Now, define the universal function τ_1 as in (2.5) of [BG16] and define the following function:

$$\phi_s = \phi_s(\kappa, \varepsilon) = \sup |\mathbb{P}[A \cap B] - \mathbb{P}[A]\mathbb{P}[B]|,$$

where the supremum is over any event A of the form $\text{Circ}^\varepsilon(\mathcal{A})$ where \mathcal{A} is an ε -drawn annulus centered at 0 and included in $[-s, s]^2$, and any event B which is the intersection of at most $\log(s)$ events of the form $\text{Circ}^\varepsilon(\mathcal{A})$ where \mathcal{A} is an ε -drawn annulus centered at 0 and included in $[-s \log(s), s \log(s)]^2 \setminus]-5s, 5s[^2$. Next, write:

$$\hat{s} = \hat{s}(\kappa, \varepsilon) = \max\{s \in \mathbb{Z}_{>0} : s \geq \exp(\tau_1(c_0)) \text{ and } \phi_s \geq \frac{c_0}{16} Q_3(c_0)\},$$

where Q_3 is the universal positive function that comes from Lemma 2.9 of [BG16]. We have the following lemma analogous to Lemma 2.10 of [BG16], where for any $0 < r < s < +\infty$, $\text{Circ}_0^\varepsilon(r, s)$ denotes the event that there is an ε -circuit at level 0 in the annulus $[-r, r]^2 \setminus]-s, s[^2$, and where Q_2 is the universal positive function defined as in Lemma 2.8 of [BG16].

Lemma B.4. *For any $s \in \mathbb{Z}_{>0}$, $s \geq \hat{s}$, if $\mathbb{P}[\text{Circ}_0^\varepsilon(s, 2s)] \geq Q_2(c_0)$, then there exists $s' \in [4s, \tau_1(c_0)s] \cap \mathbb{Z}_{>0}$ such that $\alpha_{s'} \geq s$.*

Proof. As noted in [BG16], since the rest of the proof is exactly the same as in [Tas16], it is sufficient to prove that, if $s \geq \hat{s}$, then:

$$\mathbb{P} \left[\bigcap_{i=1}^{\lfloor \log_5(\tau_1) \rfloor} \text{Circ}_0^\varepsilon(5^i s, 2 \cdot 5^i s)^c \right] < c_0/4. \quad (\text{B.1})$$

The proof is the same as in [BG16] since by our definition of \hat{s} , if $s \geq \hat{s}$ and if $i_0 \in \{1, \dots, \lfloor \log_5(\tau_1) \rfloor - 1\}$, we have:

$$\begin{aligned} & \mathbb{P} \left[\bigcap_{i=i_0}^{\lfloor \log_5(\tau_1) \rfloor} \text{Circ}_0^\varepsilon(\mathcal{A}_{5^i s, 2 \cdot 5^i s} 0)^c \right] \\ & \leq \mathbb{P} [\text{Circ}_0^\varepsilon(\mathcal{A}_{5^{i_0} s, 2 \cdot 5^{i_0} s})^c] \mathbb{P} \left[\bigcap_{i=i_0+1}^{\lfloor \log_5(\tau_1) \rfloor} \text{Circ}_0^\varepsilon(\mathcal{A}_{5^i s, 2 \cdot 5^i s})^c \right] + \frac{c_0}{16} Q_3. \end{aligned}$$

Note that here the fact that (P2) in Lemma B.3 is written with $\tilde{\mathcal{H}}_s^1(\alpha_s, s/2)$ instead of $\mathcal{H}_s(\alpha_s, s/2)$ does not change the proof at all. \square

Now, define $\gamma(\nu)$, $t_\nu = t_\nu(\kappa, \varepsilon)$ and $s_\nu = s_\nu(\kappa, \varepsilon)$ as in (2.8), (2.9) and (2.10) of [BG16] with \hat{s} instead of $s(\Omega)$ i.e.:

$$\begin{aligned} \gamma(\nu) &= 1 + \log_{4/(3+2\nu)}(3/2 + \nu) > 1, \\ s_\nu &= \max(\hat{s}, \lfloor 6/\nu \rfloor + 1), \\ t_\nu &= (3/2 + \nu) s_\nu^{\gamma(\nu)} \alpha_{s_\nu}^{1-\gamma(\nu)}. \end{aligned}$$

Then, the proof of Lemma 2.11 of [BG16] applies readily with our definitions. Finally, as in the proof of Theorem 2.2 of [BG16], we obtain that for every $\nu \in]0, 1/2[$, there exists a universal positive continuous function P_ν defined on $[1, +\infty[\times]0, 1[$ such that, for every $\rho \geq 1$ and every $s \in \mathbb{Z}_{>0}$ such that $s \geq t_\nu$, the probability that there is a black path in $[0, \rho s] \times [0, s]$ from the left side to the right side is at least $P_\nu(\rho, c_0)$.

At this point, we want to have an upper bound on $t_\nu = t_\nu(\varepsilon)$ independent on ε , i.e. we want to have an upper bound $\hat{s} = \hat{s}(\varepsilon)$ and a lower bound on $\alpha_{s_\nu(\varepsilon)}(\varepsilon)$ that do not depend on ε . To this

purpose, first note that the functions Q_2 , Q_3 and P_ν are continuous functions of Q_1 and that, as explained in Lemma 4.6 of [BG16], there exists $a = a(\kappa) > 0$ and $b = b(\kappa) > 0$ such that, if one replace the universal function Q_1 by the function aQ_1 that depends only on κ , then we have $\alpha_s = \alpha_s(\kappa, \varepsilon) \geq b$ for every s . More precisely, we can choose any $a \in]0, 1[$ and $b \in]0, 1/2[$ so that, for every s , the probability that f is positive both in the $4b \times 4b$ box centered at $(-s/2, 0)$ and the $4b \times 4b$ box centered at $(s/2, 0)$ is at least a . Such quantities exist since f is a.s. continuous and thanks to FKG. Secondly, note that, by Proposition 3.4, ϕ_s is at most:

$$C \log(s) (\log(s)s)^2 s^2 s^{-\alpha}.$$

for some $C = C(\kappa) < +\infty$. Hence (and since $\alpha > 4$) \hat{s} is less than some finite constant $M = M(\kappa)$ does not depend on ε . Finally, t_ν is less than some finite constant that does not depend on ε , and we have obtained Proposition B.2 for $\varepsilon^{-1} \in \mathbb{Z}_{>0}$ and when the quad is a rectangle $[0, \rho] \times [0, 1]$.

To end the proof, first note one can easily extend the result to any quad by reasoning as in the proof of Theorem 1.1. Finally, to extend the result to any $\varepsilon \in]0, 1]$, fix such an ε , let $\lambda \in [1/2, 2]$ such that $(\lambda\varepsilon)^{-1} \in \mathbb{Z}_{>0}$ and define the planar Gaussian field $f_\lambda : x \mapsto f(\lambda x)$ with covariance function $(x, y) \mapsto \kappa_\lambda(x - y)$. For any $\varepsilon' > 0$ and any quad \mathcal{Q} , write $\text{Cross}_0^{\varepsilon', \lambda}(\mathcal{Q})$ for the event $\text{Cross}_0^{\varepsilon'}(\mathcal{Q})$ but with f_λ instead of f . Note that we have:

$$\text{Cross}_0^{\varepsilon}(\mathcal{Q}) = \text{Cross}_0^{\lambda\varepsilon, \lambda}(\mathcal{Q}).$$

Moreover, it is not difficult to see that, since λ belongs to the compact subset of $]0, +\infty[, [1/2, 2]$, one can find constant $a = a(\kappa_\lambda)$, $b = b(\kappa_\lambda)$ and $M = M(\kappa_\lambda, c_0)$ as above that are uniform in λ . This ends the proof. \square

As in the continuous case, we can deduce that the one-arm event decreases polynomially fast. We first need a notation.

Notation B.5. If $0 < r < s < +\infty$, we write $\mathcal{A}(r, s) = [-s, s]^2 \setminus]-r, r[$ and we write $\text{Arm}_0^\varepsilon(r, s)$ (resp. $\text{Arm}_0^{*, \varepsilon}(r, s)$) for the event that there is an ε -black path from the inner boundary of $\mathcal{A}(r, s)$ to its outer boundary made of black edges (resp. that lives in the white region of the plane) in the discrete percolation model of mesh ε defined in the beginning of Section 3 with $p = 0$.

Proposition B.6. *Assume that f satisfies Conditions 1.7, 1.8, 1.10 as well as Condition 1.9 for some $\alpha > 4$. There exists $C = C(\kappa) < +\infty$ and $\eta = \eta(\kappa) > 0$ such that, for each $\varepsilon \in]0, 1]$, for each $s \in [1, +\infty[$ and $r \in [1, s[$:*

$$\mathbb{P} [\text{Arm}_0^\varepsilon(r, s)], \mathbb{P} [\text{Arm}_0^{*, \varepsilon}(r, s)] \leq C (r/s)^\eta.$$

Proof. First note that, since f and $-f$ have the same law, we have:¹²

$$(\mathbb{P} [\text{Arm}_0^{\varepsilon, *}(r + \varepsilon, s - \varepsilon)] \leq) \mathbb{P} [\text{Arm}_0^\varepsilon(r, s)] \leq \mathbb{P} [\text{Arm}_0^{\varepsilon, *}(r, s)].$$

So it is sufficient to prove the result for $\text{Arm}_0^{*, \varepsilon}(r, s)$. The proof is roughly the same as the proof of Proposition 4.5 except that we use Propositions B.2 and 3.4 instead of Theorem 1.1 and Theorem 1.12. The only difference is that we have to consider only ε -annuli, but that is not a problem. The constants do not depend on ε since the constants in Propositions B.2 and 3.4 do not. \square

As in the continuous case, the following is a direct consequence of Proposition B.6:

Proposition B.7. *With the same hypotheses as Proposition B.6, for each $\varepsilon \in]0, 1]$ a.s. there is no unbounded black component in the discrete percolation model of mesh ε defined in the beginning of Section 3 with $p = 0$.*

¹²These inequalities are not equalities only because black and white regions of the plane are not totally dual. These would be equalities if we had $\varepsilon^{-1}r \in \mathbb{N}$ and $\varepsilon^{-1}s \in \mathbb{N}$.

Le niveau critique pour la percolation de Bargmann-Fock

Travail en commun avec Alejandro Rivera

Ce chapitre est, à des détails mineurs près, la reproduction de l'article suivant [V2], intitulé "The critical threshold for Bargmann-Fock percolation" et disponible sur Hal et Arxiv.

Résumé en français. Dans ce chapitre, nous étudions les ensembles d'excursions $\mathcal{D}_p = f^{-1}([-p, +\infty[)$ où f est le champ de Bargmann-Fock. Alexander a montré que, si $p \leq 0$, il n'y avait presque sûrement aucune composante connexe infinie dans \mathcal{D}_p . Nous montrons qu'au contraire, si $p > 0$, il existe une (unique) composante connexe infinie dans \mathcal{D}_p . Par conséquent, le niveau critique de ce modèle de percolation est 0. Nous démontrons aussi que les probabilités de connexion décroissent exponentiellement vite dans la phase sous-critique. Pour montrer ces résultats, nous utilisons des estimations de croisement de boîtes dues à Beffara et Gayet. Nous développons par ailleurs divers outils, notamment un résultat de type KKL pour des vecteurs gaussiens corrélés (dont la preuve repose sur le résultat analogue dans le cas produit démontré par Keller, Mossel et Sen) et une procédure de sprinkling.

English abstract. In this chapter, we study the excursion sets $\mathcal{D}_p = f^{-1}([-p, +\infty[)$ where f is the Bargmann-Fock field. Alexander has proved that, if $p \leq 0$, then a.s. \mathcal{D}_p has no unbounded component. We show that conversely, if $p > 0$, then a.s. \mathcal{D}_p has a unique unbounded component. As a result, the critical level of this percolation model is 0. We also prove exponential decay of crossing probabilities under the critical level. To show these results, we rely on a box-crossing estimate by Beffara and Gayet. We also develop several tools including a KKL-type result for biased Gaussian vectors (based on the analogous result for product Gaussian vectors by Keller, Mossel and Sen) and a sprinkling procedure.

Contents

1	Main results	100
2	Proof strategy and intermediate results	105
2.1	Some ingredients for the proof of Kesten’s theorem	106
2.2	Conditions on the Gaussian fields	107
2.3	A box-crossing criterion	108
2.4	A discretization procedure and a discrete phase transition theorem for more general fields	108
2.5	Sharp threshold at the discrete level	112
2.5.1	The FKG inequality for Gaussian vectors	112
2.5.2	A differential formula	112
2.5.3	A KKL-KMS (Kahn-Kalai-Linial – Keller-Mossel-Sen) theorem for non-product Gaussian vectors	114
2.5.4	Polynomial decay of influences	115
2.5.5	A bound on the infinite norm of the square root matrix	115
2.5.6	Combining all the above results	116
2.6	From discrete to continuous	117
3	Proofs of the phase transition theorems and of the exponential decay	118
3.1	Proof of the phase transition theorems	118
3.2	Proof of the exponential decay	123
4	Percolation arguments	125
4.1	Proof of Lemma 2.9	125
4.2	Proof of Proposition 2.20	126
5	A KKL theorem for biased Gaussian vectors: the proof of Theorem 2.19	128
5.1	Sub-linearity of influences implies Theorem 2.19	128
5.2	Sub-linearity of influences for monotonic events	130
6	An estimate on the infinite operator norm of square root of infinite matrices: the proof of Proposition 2.21	132
7	Sprinkling discretization scheme	136
A	An additional sub-linearity result for influences	138

1 Main results

In this chapter, we study the geometry of excursion sets of a planar centered Gaussian field f . The **covariance function** of f is the function $K : \mathbb{R}^2 \times \mathbb{R}^2 \rightarrow \mathbb{R}$ defined by:

$$\forall x, y \in \mathbb{R}^2, K(x, y) = \mathbb{E}[f(x)f(y)].$$

We assume that f is normalized so that for each $x \in \mathbb{R}^2$, $K(x, x) = \text{Var}(f(x)) = 1$, that it is non-degenerate (i.e. for any pairwise distinct $x_1, \dots, x_k \in \mathbb{R}^2$, $(f(x_1), \dots, f(x_k))$ is non-degenerate), and that it is a.s. continuous and stationary. In particular, there exists a strictly positive definite continuous function $\kappa : \mathbb{R}^2 \rightarrow [-1, 1]$ such that $\kappa(0) = 1$ and, for each $x, y \in \mathbb{R}^2$, $K(x, y) = \kappa(x - y)$. For our main results (though not for all the intermediate results), we will also assume that f is positively correlated, which means that κ takes only non-negative values. We will also refer to κ as covariance function when there is no possible ambiguity. For each

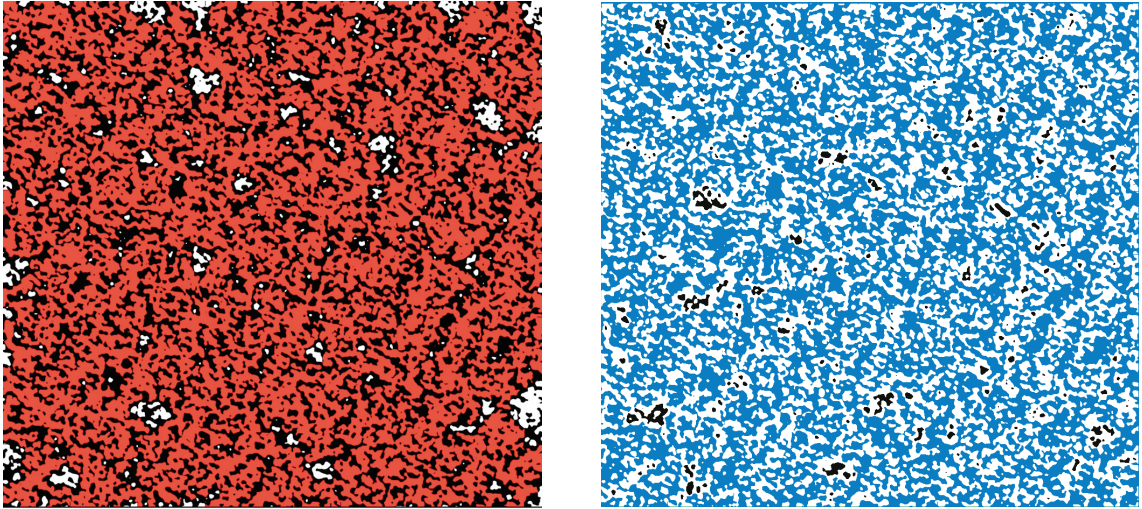

Figure 0.1 – Percolation for an approximation of the Bargmann-Fock field f . On the left hand side, the region $f \geq 0.1$ is colored in black, the small components of the region $f < 0.1$ are colored in white, and the giant component of the region $f < 0.1$ is colored in red. On the right hand side, the small components of the region $f \geq -0.1$ are colored in black, the giant component of the region $f \geq -0.1$ is colored in blue, and the region $f < -0.1$ is colored in white. The two pictures correspond to the same sample of f .

$p \in \mathbb{R}$ we call **level set** of f the random set $\mathcal{N}_p := f^{-1}(-p)$ and **excursion set** of f the random set $\mathcal{D}_p := f^{-1}([-p, +\infty[)$.¹

These sets have been studied through their connections to percolation theory (see [MS83a, MS83b, MS86], [Ale96a], [BS07], [BG16], [BM18], [BMW17]). In this theory, one wishes to determine whether or not there exist unbounded connected components of certain random sets. So far, we know that \mathcal{D}_0 has a.s. only bounded components for a very large family of positively correlated Gaussian fields:

Theorem 1.1 (Theorem 2.2 of [Ale96a]). *Assume that for each $x \in \mathbb{R}^2$, $\kappa(x) \geq 0$, that f is a.s. C^1 and ergodic with respect to translations. Assume also that for each $p \in \mathbb{R}$, f has a.s. no critical points at level p . Then, a.s. all the connected components of \mathcal{D}_0 are bounded.*

Proof. By [Pit82], the fact that κ is non-negative implies that f satisfies the FKG inequality so we can apply Theorem 2.2 of [Ale96a]. Hence, all its level lines are bounded. By ergodicity, \mathcal{D}_0 has either a.s. only bounded connected components or a.s. at least one unbounded connected component. Since f has a.s. no critical points at level 0, a.s., the boundary of \mathcal{D}_0 equals \mathcal{N}_0 and is a C^1 submanifold of \mathbb{R}^2 . If \mathcal{D}_0 had a.s. an unbounded connected component, then, by symmetry (since f is centered) this would also be the case for $\mathbb{R}^2 \setminus \mathcal{D}_0$. But this would imply that \mathcal{N}_0 has an unbounded connected component, thus contradicting Theorem 2.2 of [Ale96a].-
□

More recently, Beffara and Gayet [BG16] have proved a more quantitative version of Theorem 1.1 which holds for a large family of positively correlated stationary Gaussian fields such that $\kappa(x) = O(|x|^{-\alpha})$ for some α sufficiently large. In Chapter 1, we have revisited the results by [BG16] and weaken the assumptions on α . More precisely, we have the following:

Theorem 1.2 ([BG16] for α sufficiently large, Chapter 1).² *Assume that f is a non-degenerate,*

¹This convention, while it may seem counterintuitive, is convenient because it makes \mathcal{D}_p increasing both in f and in p . See Section 2 for more details.

²More precisely, this is Propositions 4.5 and 4.6 of Chapter 1. Moreover, this is Theorem 5.7 of [BG16] for α sufficiently large and with slightly different assumptions on the differentiability and on the non-degeneracy of κ .

centered, normalized, continuous, stationary, positively correlated planar Gaussian field that satisfies the symmetry assumption Condition 2.2 below. Assume also that κ satisfies the differentiability assumption Condition 2.4 below and that $\kappa(x) \leq C|x|^\alpha$ for some $C < +\infty$ and $\alpha > 4$. Then, there exist $C' = C'(\kappa) < +\infty$ and $\delta = \delta(\kappa) > 0$ such that for each $r > 0$, the probability that there exists a connected component of \mathcal{D}_0 which connects 0 to a point at distance r is at most $C'r^{-\delta}$. In particular, a.s. all the connected components of \mathcal{D}_0 are bounded.

A remaining natural question is whether or not, for $p > 0$, the excursion set \mathcal{D}_p has an unbounded component. Our main result (Theorem 1.3 below) provides an answer to this question for a specific, natural choice of f , arising naturally from real algebraic geometry: the Bargmann-Fock model, that we now introduce. **The planar Bargmann-Fock field** is defined as follows. Let $(a_{i,j})_{i,j \in \mathbb{N}}$ be a family of independent centered Gaussian random variables of variance 1. For each $x = (x_1, x_2) \in \mathbb{R}^2$, the Bargmann-Fock field at x is:

$$f(x) = e^{-\frac{1}{2}|x|^2} \sum_{i,j \in \mathbb{N}} a_{i,j} \frac{x_1^i x_2^j}{\sqrt{i!j!}}.$$

The sum converges a.s. in $C^\infty(\mathbb{R}^2)$ to a random analytic function. Moreover, for each $x, y \in \mathbb{R}^2$:

$$K(x, y) = \mathbb{E}[f(x)f(y)] = \exp\left(-\frac{1}{2}|x - y|^2\right).$$

For a discussion of the relation of the Bargmann-Fock field with algebraic geometry, we refer the reader to the introduction of [BG16]. Theorem 1.2 applies to the Bargmann-Fock model (see Subsection 2.2 for the non-degeneracy condition). Hence, if $p \leq 0$ then a.s. all the connected components of \mathcal{D}_p are bounded. In this chapter, we prove that on the contrary if $p > 0$ then a.s. \mathcal{D}_p has a unique unbounded component, thus obtaining the following result:

Theorem 1.3. *Let f be the planar Bargmann-Fock field. Then, the probability that \mathcal{D}_p has an unbounded connected component is 1 if $p > 0$, and 0 otherwise. Moreover, if it exists, such a component is a.s. unique.*

As a result, the ‘‘critical threshold’’ of this continuum percolation model is $p = 0$. Before saying a few words about the proof of Theorem 1.3, let us state the result which is at the heart of the proof of Theorem 1.2, both in [BG16] and in Chapter 1. This result is a **box-crossing estimate**, which is an analog of the classical Russo-Seymour-Welsh theorem for planar percolation. This was proved in [BG16] for a large family of positively correlated stationary Gaussian fields such that $\kappa(x) = O(|x|^{-325})$. In [BM18], Beliaev and Muirhead have lowered the exponent $\alpha = 325$ to any $\alpha > 16$. In Chapter 1, we have obtained that such a result holds with any exponent $\alpha > 4$. More precisely, we have the following:

Theorem 1.4 ([BG16] for $\alpha > 325$, [BM18] for $\alpha > 16$, Chapter 1). ³ *With the same hypotheses as Theorem 1.2, for every $\rho \in]0, +\infty[$ there exists $c = c(\rho, \kappa) > 0$ such that for each $R \in]0, +\infty[$, the probability that there is a continuous path in $\mathcal{D}_0 \cap [0, \rho R] \times [0, R]$ joining the left side of $[0, \rho R] \times [0, R]$ to its right side is at least c . Moreover, there exists $R_0 = R_0(\kappa) < +\infty$ such that the same result holds for \mathcal{N}_0 as long as $R \geq R_0$.*

In order to prove our main result Theorem 1.3, we will use a discrete analog of this box-crossing estimate which goes back to [BG16] (see Theorem 2.13 below). In Section 2, we expose the general strategy of the proof of Theorem 1.3. This proof can be summed up as follows: i) we discretize our model as was done in [BG16], ii) we prove that there is a sharp threshold

³More precisely, this is Theorem 1.1 of Chapter 1. Moreover, this is Theorem 4.9 of [BG16] (resp. Theorem 1.7 of [BM18]) for $\alpha \geq 325$ (resp. $\alpha > 16$) and with slightly different assumptions on the differentiability and on the non-degeneracy of κ .

phenomenon at $p = 0$ in the discrete model, iii) we return to the continuum. The results at the heart of our proof of a sharp threshold phenomenon for the discrete model are on the one hand Theorem 2.13 (the discrete version of Theorem 1.4) and on the other hand a Kahn-Kalai-Linial (KKL)-type estimate for biased Gaussian vectors (see Theorem 2.19) that we show by using the analogous estimate for product Gaussian vectors proved by Keller, Mossel and Sen in [KMS12] (the idea to use a KKL theorem to compute the critical point of a percolation model goes back to Bollobás and Riordan [BR06a, BR06d], see Subsection 2.1 for more details). To go back to the continuum, we apply a sprinkling argument to a discretization procedure tailor-made for our setting (see Proposition 2.22). This step is especially delicate since Theorem 2.19 gives no relevant information when the discretization mesh is too fine (see Subsection 2.4 for more details).

Most of the intermediate results that we will prove work in a much wider setting, see in particular Proposition 3.5 where we explain how, for a large family of Gaussian fields f , the proof of an estimate on the correlation function would imply that Theorem 1.3 also holds for f . See also Theorem 2.13 which is a discrete analog of Theorem 1.3 for more general Gaussian fields.

As in [BG16], we are inspired by tools from percolation theory. Before going any further, let us make a short detour to present the results of planar percolation we used to guide our research. It will be helpful to have this analogy in mind to appreciate our results.

Planar Bernoulli percolation is a statistical mechanics model defined on a planar lattice, say \mathbb{Z}^2 , depending on a parameter $p \in [0, 1]$. Consider a family of independent Bernoulli random variables $(\omega_e)_e$ of parameter p indexed by the edges of the graph \mathbb{Z}^2 . We say that an edge e is black if the corresponding random variable ω_e equals 1 and white otherwise. The analogy with our model becomes apparent when one introduces the following classical coupling of the $(\omega_e)_e$ for various values of p . Consider a family $(U_e)_e$ of independent uniform random variables in $[0, 1]$ indexed by the set of edges of \mathbb{Z}^2 . For each $p \in [0, 1]$, let $\omega_e^p = \mathbf{1}_{\{U_e \geq 1-p\}}$. Then, the family $((\omega_e^p)_e)_p$ forms a coupling of Bernoulli percolation with parameters in $[0, 1]$. In this coupling, black edges are seen as excursion sets of the random field $(U_e)_e$. Theorem 1.4 is the analog of the Russo-Seymour-Welsh (RSW) estimates first proved for planar Bernoulli percolation in [Rus78, SW78] (see also Lemma 4 of Chapter 3 of [BR06b], Theorem 11.70 and Equation 11.72 of [Gri99] or Theorem 5.31 of [Gri10]). We now state the main result of percolation theory on \mathbb{Z}^2 , a celebrated theorem due to Kesten. Chapter 3 of [BR06b], Chapter 11 of [Gri99] and Chapter 5 of [Gri10] present different approaches to prove this result.

Theorem 1.5 (Kesten’s Theorem, [Kes80]). *Consider planar Bernoulli percolation of parameter $p \in [0, 1]$ on \mathbb{Z}^2 . If $p > 1/2$, then a.s. there exists an unbounded connected component made of black edges. On the other hand, if $p \leq 1/2$ then a.s. there is no unbounded connected component made of black edges.*

The parameter $p_c = 1/2$ is said to be critical for planar Bernoulli percolation on \mathbb{Z}^2 . It is also known that, if such an unbounded connected component exists, it is a.s. unique. In Theorem 1.5, the case where $p = 1/2$ goes back to Harris [Har60] and also follows easily from the RSW estimate. Next, the coupling constructed above yields the result for $p < 1/2$. See Subsection 2.1 where we explain which are the main ingredients of a proof of Kesten’s theorem that will inspire us.

Kesten’s theorem is closely linked with another, more quantitative result:

Theorem 1.6 (Exponential decay, [Kes80]). *Consider planar Bernoulli percolation with parameter $p > 1/2$ on \mathbb{Z}^2 . Then, for each $\rho > 0$, there exists a constant $c = c(p, \rho) > 0$ such that for each $R > 0$, the probability that there is a continuous path made of black edges in $[0, \rho R] \times [0, R]$ joining the left side of $[0, \rho R] \times [0, R]$ to its right side is at least $1 - e^{-cR}$.*

The value $p = 1/2$ is significant because with this choice of parameter, the induced percolation model on the dual graph of \mathbb{Z}^2 has the same law as the initial one (for more details see Lemma 1

of Chapter 3 of [BR06b] and the preceding discussion, or Chapter 11 of [Gri99]). For this reason, $1/2$ is called the self-dual point. In the case of our planar Gaussian model, self-duality arises at the parameter $p = 0$ (see for instance Remark A.11 of Chapter 1). The results on Bernoulli percolation lead us to the following conjecture:

Conjecture 1.7. *For centered, normalized, non-degenerate, sufficiently smooth, stationary, isotropic, and positively correlated random fields on \mathbb{R}^2 with sufficient correlation decay, the probability that \mathcal{D}_p has an unbounded connected component is 1 if $p > 0$, and 0 otherwise.*

Of course, our Theorem 1.3 is an answer to the above conjecture for a particular model. We also have the following analog for Theorem 1.6 that we prove in Subsection 3.2.

Theorem 1.8. *Consider the Bargmann-Fock field and let $p > 0$. Then, for each $\rho > 0$ there exists a constant $c = c(p, \rho) > 0$ such that for each $R > 0$, the probability that there is a continuous path in $\mathcal{D}_p \cap [0, \rho R] \times [0, R]$ joining the left side of $[0, \rho R] \times [0, R]$ to its right side is at least $1 - e^{-cR}$.*

Contrary to the other results of this chapter, the fact that the correlation function of the Bargmann-Fock field decreases more than exponentially fast is crucial to prove Theorem 1.8.

Organization of the chapter. The chapter is organized as follows:

- In Section 2, we explain the general strategy of the proof of our phase transition result Theorem 1.3. In particular, we explain the discretization we use and we state the main intermediate results including the KKL-type inequality for biased Gaussian vectors mentioned above.
- In Section 3, we combine all these intermediate results to prove Theorems 1.3 and 2.13.
- In Sections 4 to 7, we prove these intermediate results.

Related works. As explained above, the present chapter is in the continuity of [BG16] where the authors somewhat initiate the study of a rigorous connection between percolation theory and the behaviour of nodal lines. In [BM18], the authors optimize the results from [BG16] and the authors of the present chapter optimize them further in Chapter 1. See also [BMW17] where the authors prove a box-crossing estimate for Gaussian fields on the sphere or the torus by adapting the strategy of [BG16]. In [BG16, BM18, BMW17] and in Chapter 1 (while the approaches differ in some key places), the initial idea is the same, namely to use Tassion’s general method to prove box-crossing estimates, which goes back to [Tas16]. To apply such a method, we need to have in particular a positive association property and a quasi-independence property. In Chapter 1, we have proved such a quasi-independence property for planar Gaussian fields that we will also use in the present chapter, see Claim 3.7. We will also rely to other results from Chapter 1, in particular we will rely on a discrete RSW estimate. As we will explain in Subsection 2.4, we could have rather referred to the slightly weaker analogous results from [BG16], which would have been sufficient in order to prove our main result Theorem 1.3.

The use of a KKL theorem to prove our main result Theorem 1.3 shows that our work falls within the approach of recent proofs of phase transition that mix tools from percolation theory and tools from the theory of Boolean functions. See [GS14] for a book about how these theory can combine. Below, we list some related works in this spirit.

- During the elaboration of the present work, Duminil-Copin, Raoufi and Tassion have developed novel techniques based on the theory of randomized algorithms and have proved new sharp threshold results, see [DCRT17b, DCRT17a]. This method has proved robust enough to work in a variety of settings: discrete and continuous (the Ising model and

Voronoi percolation), with dependent models (such as FK-percolation) and in any dimension. It seems worthwhile to note that the present model resists direct application. At present, we see at least two obstacles: first of all the influences that arise in our setting are not the same as those of [DCRT17b, DCRT17a] (more precisely, the influences studied by Duminil-Copin, Raoufi and Tassion can be expressed as covariances while ours cannot exactly, see Remark 2.18). Secondly, right now it is not obvious for us whether or not our measures are monotonic.

- Another related work whose strategy is closer to the present chapter is [Rod15], where the author studies similar questions for the d -dimensional discrete (massive) Gaussian free field. Some elements of said work apply to general Gaussian fields. More precisely, following the proof of Proposition 2.2 of [Rod15], one can express the derivative probability with respect to the threshold p as a sum of covariances, which seems promising, especially in view of [DCRT17b, DCRT17a]. However, each covariance is weighted with a sum of coefficients of the inverse covariance matrix of the discretized field and at present we do not know how to deal with these sums. In [Rod15], these coefficients are very simple because we are dealing with the Gaussian free field.
- The idea to use a KKL inequality to compute the critical point of a planar percolation model comes from [BR06d, BR06c, BR06a]. See also [BDC12, DCRT16] where such an inequality is used to study FK percolation. In [BDC12, Rod15, DCRT16], the authors use a KKL inequality for monotonic measures proved by Graham and Grimmett [GG06, GG11]. The same obstacles as in Item 1 above prevented us to use this KKL inequality.

A note on vocabulary. We end the first section by a remark on vocabulary on positive definite matrices and functions.

Remark 1.9. In all this chapter, we are going to deal with positive definite functions and matrices. The convention seems to be that, on the one hand positive definite matrices are invertible whereas semi-positive definite matrices are not necessarily. On the other hand, a function g is said strictly positive definite if for any $n \in \mathbb{Z}_{>0}$ and any x_1, \dots, x_n , $(g(x_i - x_j))_{1 \leq i, j \leq n}$ is a positive definite matrix while g is said positive definite if the matrices $(g(x_i - x_j))_{1 \leq i, j \leq n}$ are semi-positive definite. We will follow these conventions and hope this remark will clear up any ambiguities.

Acknowledgments:

We are grateful to Christophe Garban and Damien Gayet for many fruitful discussions and for their advice in the organization of the manuscript. We would also like to thank Vincent Beffara for his helpful comments. Finally, we are thankful to Thomas Letendre for pointing out useful references about Gaussian fields and for his help regarding Fourier techniques.

2 Proof strategy and intermediate results

In this section, we explain the global strategy of the proof of our main result Theorem 1.3. Since the case $p \leq 0$ is already known (see the beginning of Section 1), we focus to the case $p > 0$. We first discuss briefly some aspects of the analogous result for Bernoulli percolation: Kesten's theorem. Next, we give an informal explanation of our proof and state the main intermediate results. More precisely, we explain the discretization procedure used in our proof in Subsection 2.4. Then, we state the main intermediate results at the discrete level in Subsection 2.5, and in Subsection 2.6 we explain how to go from the discrete to the continuum.

2.1 Some ingredients for the proof of Kesten's theorem

Several proofs of Kesten's theorem (Theorem 1.5) are known (see [Gri10, BR06b]). Let us fix a parameter $p \in [0, 1]$ and consider Bernoulli percolation on \mathbb{Z}^2 with parameter p . As explained before, we are mainly interested in the proof of existence of an unbounded component, i.e. when $p > 1/2$. One possible proof of Kesten's theorem uses the following ingredients, that we will try to adapt to our setting.

- *A box-crossing criterion:* For all $\rho_1, \rho_2 > 0$, let $\text{Cross}_p^{\text{perco}}(\rho_1, \rho_2)$ denote the event that there is a continuous path of black edges that crosses the rectangle $[0, \rho_1] \times [0, \rho_2]$ from left to right, and assume that:

$$\sum_{k \in \mathbb{N}} \mathbb{P} \left[\neg \text{Cross}_p^{\text{perco}}(2^{k+1}, 2^k) \right] < +\infty.$$

Then, a.s. there exists an infinite black component.

- *The RSW (Russo-Seymour-Welsh) theorem* (see Lemma 4 of Chapter 3 of [BR06b], Theorem 11.70 and Equation 11.72 of [Gri99] or Theorem 5.31 of [Gri10]) which implies that, for every $\rho > 0$, there exists a constant $c = c(\rho) > 0$ such that, for every $R > 0$, $\mathbb{P} \left[\text{Cross}_{1/2}^{\text{perco}}(\rho R, R) \right] \geq c(\rho)$.
- *The FKG-Harris inequality* (see [Gri99, BR06b]) that says that increasing events are positively correlated.
- *Russo's differential formula* ([Gri99, BR06b]): Let $n \in \mathbb{N}_+$, $\mathbb{P}_p^n := (p\delta_1 + (1-p)\delta_0)^{\otimes n}$ and $A \subseteq \{0, 1\}^n$. For every $i \in \{1, \dots, n\}$, let $\text{Infl}_i^p(A)$ denote the influence of i on A at the parameter p , which is the probability that changing the value of the coordinate i modifies $\mathbb{1}_A$. If A is increasing, then we have the following differential formula:

$$\frac{d}{dp} \mathbb{P}_p^n [A] = \sum_{i=1}^n \text{Infl}_i^p(A).$$

- *A KKL (Kahn-Kalai-Linial) theorem* (see Theorem 4.29 of [Gri10], Theorem 12 of Chapter 2 of [BR06b] or Theorems 1.16 and 3.4 of [GS14]): The sum of influences can be estimated thanks to the celebrated KKL theorem. Here, we present the version of the KKL theorem that implies that, if all the influences are small, then the sum of the influences is large. A qualitative version of this principle was proved by Russo in [Rus82]. The KKL theorem, proved in [KKL88] for $p = 1/2$ and generalized in [BKK⁺92, Tal94] to every p , is a quantitative version of [Rus82]. Let \mathbb{P}_p^n be as above. There exists an absolute constant $c > 0$ such that, for every $p \in [0, 1]$, every $n \in \mathbb{N}_+$ and every $A \subseteq \{0, 1\}^n$, we have:

$$\sum_{i=1}^n \text{Infl}_i^p(A) \geq c \mathbb{P}_p^n [A] \cdot (1 - \mathbb{P}_p^n [A]) \cdot \log \left(\frac{1}{\max_i \text{Infl}_i^p(A)} \right).$$

The idea to use a KKL theorem to prove Kesten's theorem comes from [BR06d]. These five ingredients can be used as follows to prove that there exists an infinite black component when $p > 1/2$ (for more details, see for instance Section 3.4 of [BR06b], Section 5.8 of [Gri99] or Section 3.4 of [GS14]): the RSW theorem and the FKG-Harris inequality can be used to prove that the influences of the crossing events decrease polynomially fast in R . Thanks to this polynomial decay, Russo's formula, the RSW theorem and the KKL theorem, one can prove that, for every $p > 1/2$, $\mathbb{P} \left[\text{Cross}_p^{\text{perco}}(2R, R) \right] \geq 1 - R^{-a}$ for some $a = a(p) > 0$ (actually, with a bit more work, one can deduce exponential decay, see for instance Section 3.5 of [BR06b]). Thus, the box-crossing criterion is satisfied and we are done.

Our global strategy to prove Theorem 1.3 will be based on similar ingredients and on a discretization procedure used in [BG16, BM18] (together with a sprinkling argument). Some of these ingredients are already known, the others will be proved in this chapter. We list them in the remaining subsections of Section 2, and in Section 3.1 we will explain how we can combine all these ingredients to prove Theorem 1.3.

Since most of our intermediate results work in a much wider setting, we first state the conditions on the planar Gaussian field f under which we work.

2.2 Conditions on the Gaussian fields

First, we state Condition 2.1 that we will assume during all the work:

Conditions 2.1. The field f is non-degenerate (i.e. for any pairwise distinct $x_1, \dots, x_k \in \mathbb{R}^2$, $(f(x_1), \dots, f(x_k))$ is non-degenerate), centered, normalized, continuous, and stationary. In particular, there exists a strictly positive definite continuous function $\kappa : \mathbb{R}^2 \rightarrow [-1, 1]$ such that $K(x, y) := \mathbb{E}[f(x)f(y)] = \kappa(y - x)$ and $\kappa(0) = 1$.

Depending on the intermediate results we prove, we will also need to assume some of the following additional conditions:

Conditions 2.2 (Useful to apply percolation arguments.). The field f is positively correlated, invariant by $\frac{\pi}{2}$ -rotation, and reflection through the horizontal axis.

Conditions 2.3 (Useful to have quasi-independence.). Depends on a parameter $\alpha > 0$.] There exists $C < +\infty$ such that for each $x \in \mathbb{R}^2$, $|\kappa(x)| \leq C|x|^{-\alpha}$.

Conditions 2.4 (Technical conditions to have quasi-independence, see Chapter 1.). The function κ is C^8 and for each $\beta \in \mathbb{N}^2$ with $\beta_1 + \beta_2 \leq 2$, $\partial^\beta \kappa(x) \xrightarrow{|x| \rightarrow +\infty} 0$.

Conditions 2.5 (Useful to do Fourier calculations on the correlation function. Depends on a parameter $\alpha > 0$.). The Fourier transform of κ takes only positive values. Moreover, κ is C^3 and there exists $C < +\infty$ such that for every $\beta \in \mathbb{N}^2$ with $\beta_1 + \beta_2 \leq 3$, we have:

$$|\partial^\beta \kappa(x)| \leq C|x|^{-\alpha}.$$

We will often suppose regularity conditions on f and κ . It will be interesting to have the following in mind (see for instance Appendices A.3 and A.9 of [NS16]):

Lemma 2.6. *Assume that f satisfies Condition 2.1. Let $k \in \mathbb{N}$. If κ is $C^{2(k+1)}$, then a.s. f is C^k . Conversely, if a.s. f is C^k , then κ is C^{2k} and for every multi-indices $\beta, \gamma \in \mathbb{N}^2$ such that $\beta_1 + \beta_2 \leq k$ and $\gamma_1 + \gamma_2 \leq k$, we have:*

$$\text{Cov} \left(\partial^\beta f(x), \partial^\gamma f(y) \right) = \mathbb{E} \left[\partial^\beta f(x) \partial^\gamma f(y) \right] = (-1)^{|\gamma|} \partial^{\beta+\gamma} \kappa(x - y).$$

It is easy to check that the conditions are all satisfied by the Bargmann-Fock field (see Lemma 2.7 for the non-degeneracy condition). In particular, Conditions 2.4 and 2.5 hold for any $\alpha > 0$. Also, the Bargmann-Fock field is a.s. analytic and its covariance is analytic.

An other example of Gaussian fields in the plane that satisfy the above conditions (with the parameter α which depends on the parameter n) is the field with correlation function:

$$\kappa : x = (x_1, x_2) \in \mathbb{R}^2 \mapsto \left(\frac{1}{(1+x_1^2)(1+x_2^2)} \right)^n, \quad (2.1)$$

where $n \in \mathbb{Z}_{>0}$. This is indeed a strictly positive definite function by the following lemma.

Lemma 2.7. *The Fourier transform of a continuous and integrable function $\mathbb{R}^2 \rightarrow \mathbb{R}_+$ which is not 0 is strictly positive definite. In particular, the Gaussian function $x \mapsto \exp(-\frac{1}{2}|x|^2)$ and the function (2.1) (for any $n \in \mathbb{Z}_{>0}$) are strictly positive definite.*

Proof. This is a direct consequence of Theorem 3 of Chapter 13 of [CL09] (which is the strictly positive definite version of the easy part of Bochner theorem). We can apply this to the Bargmann-Fock field and to (2.1) since the Fourier transform of a Gaussian function is still a Gaussian function and since the Fourier transform of $x \mapsto \frac{1}{(1+x_1^2)(1+x_2^2)}$ is $\xi \mapsto \text{cst} \exp(-(|\xi_1| + |\xi_2|))$, hence $x \in \mathbb{R}^2 \mapsto \left(\frac{1}{(1+x_1^2)(1+x_2^2)}\right)^n$ is the Fourier transform of the function $\xi \mapsto \text{cst} \exp(-(|\xi_1| + |\xi_2|))$ convoluted n times, see Paragraph 1.2.3 of [Rud62]. \square

If one wants to consider a large family of examples of planar Gaussian fields, one can consider a function $\rho : \mathbb{R}^2 \rightarrow \mathbb{R}_+$ sufficiently smooth, that is not 0 and such that ρ and its derivatives decay sufficiently fast. One can note that $\kappa = \rho * \rho$ has the same properties and is strictly positive definite by Lemma 2.7 since $\hat{\kappa} = (\hat{\rho})^2$. Moreover, if ρ has sufficiently many symmetries, then the Gaussian field with covariance κ above satisfies Conditions from 2.1 to 2.5. Now, if W is a two-dimensional white noise, that is, the free field associated to the Hilbert space $L^2(\mathbb{R}^2)$ (see Definition 2.5 of [She07]), then (if ρ is even)

$$f = \rho * W$$

defines a Gaussian field on \mathbb{R}^2 with covariance κ .

We now list the main intermediate results of our proof.

2.3 A box-crossing criterion

As in the strategy of the proof of Kesten's theorem presented in Subsection 2.1, our goal will be to prove a box-crossing criterion. We start by introducing the following notation.

Notation 2.8. For each $\rho_1, \rho_2 > 0$ and each $p \in \mathbb{R}$, we write $\text{Cross}_p(\rho_1, \rho_2)$ for the event that there is a continuous path in $\mathcal{D}_p \cap [0, \rho_1] \times [0, \rho_2]$ joining the left side of $[0, \rho_1] \times [0, \rho_2]$ to its right side.

In Subsection 4.1, we will prove the following proposition.

Lemma 2.9. *Assume that f satisfies Condition 2.1 and that κ is invariant by $\frac{\pi}{2}$ -rotations. Let $p > 0$ and assume that:*

$$\sum_{k \in \mathbb{N}} \mathbb{P} \left[-\text{Cross}_p(2^{k+1}, 2^k) \right] < +\infty. \quad (2.2)$$

Then, a.s. there exists a unique unbounded component in \mathcal{D}_p .

Thus, our goal turns to prove that, if $p > 0$, then $\mathbb{P}[\text{Cross}_p(2R, R)]$ goes to 1 as R goes to $+\infty$, sufficiently fast so that the above sum is finite. In order to prove such a result, we will show a Russo-type formula and a KKL-type theorem for discrete Gaussian fields. To apply such result, we first need to discretize our model, as it was done in [BG16].

2.4 A discretization procedure and a discrete phase transition theorem for more general fields

We consider the following discrete percolation model: let $\mathcal{T} = (\mathcal{V}, \mathcal{E})$ be the face-centered square lattice defined in Figure 2.1. Note that the exact choice of lattice is not essential in most of our arguments. We mostly use the fact that it is a periodic triangulation with nice symmetries. However, we do need a little more information to apply Theorem 2.13 (see the beginning of

Section 3 of Chapter 1) and in Section 6 of the present work we use the fact that the sites of \mathcal{T} are the vertices of a rotated and rescaled \mathbb{Z}^2 -lattice. We will denote by $\mathcal{T}^\varepsilon = (\mathcal{V}^\varepsilon, \mathcal{E}^\varepsilon)$ this lattice scaled by a factor ε . Given a realization of our Gaussian field f and some $\varepsilon > 0$, we color the plane as follows: For each $x \in \mathbb{R}^2$, if $x \in \mathcal{V}^\varepsilon$ and $f(x) \geq -p$ or if x belongs to an edge of \mathcal{E}^ε whose two extremities y_1, y_2 satisfy $f(y_1) \geq -p$ and $f(y_2) \geq -p$, then x is colored black. Otherwise, x is colored white. In other words, we study a **correlated site percolation model** on \mathcal{T}^ε .

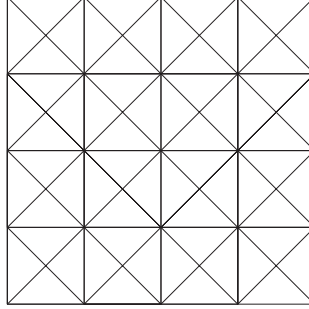

Figure 2.1 – The face-centered square lattice (the vertices are the points of \mathbb{Z}^2 and the centers of the squares of the \mathbb{Z}^2 -lattice).

We will use the following notation analogous to Notation 2.8.

Notation 2.10. Let $\varepsilon > 0$, $p \in \mathbb{R}$, and consider the above discrete percolation model. For every $\rho_1, \rho_2 > 0$, write $\text{Cross}_p^\varepsilon(\rho_1, \rho_2)$ for the event that there is a continuous black path in $[0, \rho_1] \times [0, \rho_2]$ joining the left side of $[0, \rho_1] \times [0, \rho_2]$ to its right side.

As explained in Subsection 2.3, we want to estimate the quantities $\mathbb{P}[\text{Cross}_p(2R, R)]$ for $p > 0$. However, the tools that we develop in this chapter are suitable to study the quantities $\mathbb{P}[\text{Cross}_p^\varepsilon(2R, R)]$. We will thus have to choose ε so that, on the one hand, we can find nice estimates at the discrete level and, on the other hand, the discrete field is a good approximation of the continuous field. As a reading guide for the global strategy, we list below what are the constraints on ε for our intermediate results to hold. See also Figure 2.2. We write them for the Bargmann-Fock field. Actually, most of the intermediate results including Item 2 below hold for more general fields, see the following subsections for more details.

1. We want to establish a lower bound for $\mathbb{P}[\text{Cross}_p^\varepsilon(2R, R)]$ that goes (sufficiently fast for us) to 1 as R goes to $+\infty$. Our techniques work as long as the number of vertices is not too large (see in particular Subsection 2.5.5). They yield such a bound provided that there exists $\delta > 0$ such that (R, ε) satisfy the condition:

$$\varepsilon \geq \log^{-(1/2-\delta)}(R). \quad (2.3)$$

See Subsubsection 2.5.6.

2. Then, we will have to estimate how much $\text{Cross}_p^\varepsilon(2R, R)$ approximates well $\text{Cross}_p(2R, R)$. At this point, it seems natural to use the quantitative approximation results from [BG16, BM18]. In particular, as explained briefly in Subsection 2.6, it seems that results from [BM18] (based on discretization schemes that generalize the methods in [BG16]) imply that the event $\text{Cross}_p^\varepsilon(2R, R)$ approximates $\text{Cross}_p(2R, R)$ well if:

$$\varepsilon \leq R^{-(1+\delta)}, \quad (2.4)$$

for some $\delta > 0$. Unfortunately, this constraint is not compatible with the constraint (2.3). For this reason, we will instead use a sprinkling discretization procedure. More precisely,

we will see in Proposition 2.22 that $\text{Cross}_{p/2}^\varepsilon(2R, R)$ implies $\text{Cross}_p(2R, R)$ with high probability if (R, ε) satisfy the following condition:

$$\varepsilon \geq \log^{-(1/4+\delta)}(R) \tag{2.5}$$

for some $\delta > 0$. This time, the constraint combines very well with the constraint (2.3) and we will be able to conclude.

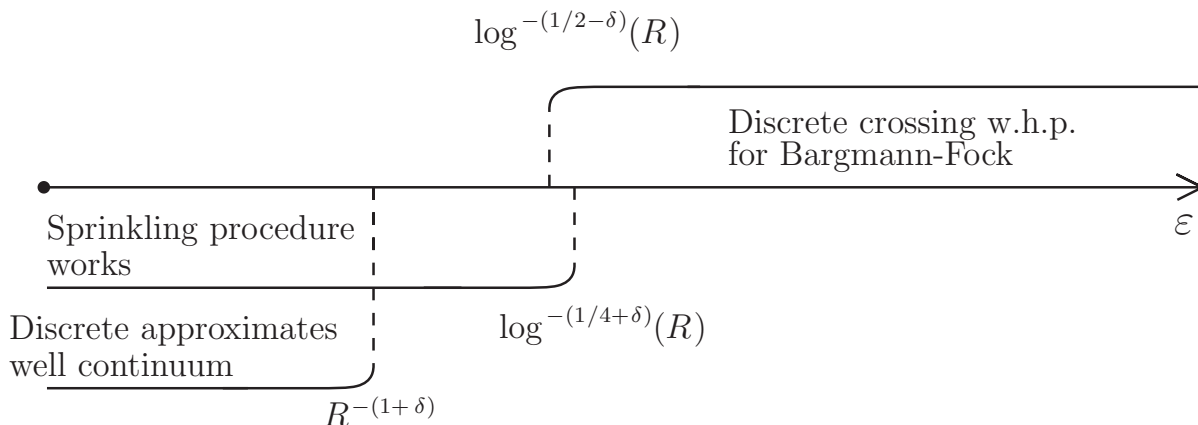

Figure 2.2 – The different constraints on (R, ε) .

If we work with the Bargmann-Fock field and if we choose for instance $\varepsilon = \varepsilon(R) = \log^{-1/3}(R)$ then, as shown in Figure 2.2, we obtain that $\text{Cross}_p^\varepsilon(2R, R)$ holds with high probability and that the sprinkling discretization procedure works. As explained in Section 3.1, we will thus obtain that $\sum_{k \in \mathbb{N}} \mathbb{P}[\neg \text{Cross}_p(2^{k+1}, 2^k)] < +\infty$ and conclude thanks to Lemma 2.9. See also Figure 2.3.

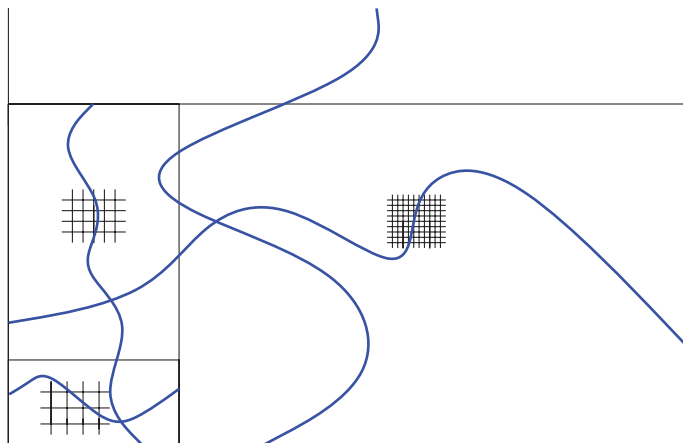

Figure 2.3 – A right choice of ε is $\varepsilon = \log^{-1/3}(R)$ with whom we will be able to prove that $\mathbb{P}[\text{Cross}(2R, R)]$ goes sufficiently fast to 1 so that the box-crossing criterion of Lemma 2.9 is satisfied. As we will see in the proof of this lemma, this criterion implies that, for a well-chosen of rectangles $(Q_k)_k$ of typical length R_k , a.s. all the Q_k 's for k sufficiently large are crossed, which implies that there exists an infinite path. The idea is that, for each k , we study the probability that it is crossed by comparing the continuous event with the discrete event with mesh $\varepsilon = \log^{-1/3}(R_k)$.

Note that Item 1 above implies in particular that, if we work with the Bargmann-Fock field and if we fix $\varepsilon \in]0, 1]$,⁴ then for $p > 0$, $\mathbb{P}[\text{Cross}_p^\varepsilon(2R, R)]$ goes to 1 (sufficiently fast for us) as R goes to $+\infty$. We will actually obtain such a result for more general fields, which will enable us to prove that a discrete box-crossing criterion analogous to Lemma 2.9 is satisfied and deduce the following in Section 3.1:

Theorem 2.11. *Suppose that f satisfies Conditions 2.1 and 2.2 and Condition 2.5 for some $\alpha > 5$ (thus in particular Condition 2.3 is satisfied for some $\alpha > 5$). Then, for each $\varepsilon \in]0, 1]$, the critical threshold of the discrete percolation model on \mathcal{T}^ε defined in the present subsection is 0. More precisely: the probability that there is an unbounded black connected component is 1 if $p > 0$, and 0 otherwise. Moreover, if it exists, such a component is a.s. unique. In particular, this result holds when f is the Bargmann-Fock field or the centered Gaussian field with covariance given by (2.1) with $n \geq 3$.*

As in the continuous setting, the case $p \leq 0$ of Theorem 2.11 goes back to [BG16], at least for α large enough. In Chapter 1, we have optimized this result and obtain the following:

Theorem 2.12 ([BG16] for α sufficiently large, Chapter 1).⁵ *Assume that f satisfies Conditions 2.1, 2.2, 2.4 as well as Condition 2.3 for some $\alpha > 4$. Let $\varepsilon \in]0, 1]$ and consider the discrete percolation model on \mathcal{T}^ε defined in the present subsection with parameter $p = 0$. Then, a.s. there is no infinite connected black component.*

Again as in the continuous case, this result heavily relies on a RSW estimate, which we state below (see Theorem 2.13). This estimate is a uniform lower bound on the crossing probability of a quad scaled by R on a lattice with mesh ε . The proof of such an estimate goes back to [BG16] (for $\alpha > 16$) and was later optimized to $\alpha > 8$ in [BM18]. The key property in this estimate is that the lower bound of the crossing properties does not depend on the choice of the mesh ε . To obtain such a result, the authors of [BG16] had to impose some conditions on (R, ε) . For instance, if we consider the Bargmann-Fock field, the constraint was $\varepsilon \geq C \exp(-cR^2)$ where $C < +\infty$ and $c > 0$ are fixed. Actually, it seems likely that, one could deduce a discrete RSW estimate with no constraint on (R, ε) by using their quantitative approximation results. In Chapter 1, we prove such a discrete RSW estimate with no constraint on (R, ε) and without using quantitative discretization estimates, but rather by using new quasi-independence results. Note that to prove our main result Theorem 1.3, it would not have been a problem for us to rather use the result by Beffara and Gayet with constraints on (R, ε) since, as explained above, we will use results from the discrete model with $\varepsilon = \varepsilon(R) = \log^{-1/3}(R)$ - which of course satisfies the condition $\varepsilon \geq C \exp(-cR^2)$. We have the following:

Theorem 2.13 ([BG16] for $\alpha > 16$, [BM18] for $\alpha > 8$, Chapter 1).⁶ *Assume that f satisfies Conditions 2.1, 2.2, 2.4 as well as Condition 2.3 for some $\alpha > 4$. For every $\rho \in]0, +\infty[$, there exists a constant $c = c(\kappa, \rho) > 0$ such that the following holds: let $\varepsilon \in]0, 1]$, and consider the discrete percolation model on \mathcal{T}^ε defined in the present subsection with parameter $p = 0$. Then, for every $R \in]0, +\infty[$ we have:*

$$\mathbb{P}[\text{Cross}_0^\varepsilon(\rho R, R)] \geq c.$$

⁴In this chapter, we only look at the case $\varepsilon \in]0, 1]$ though a lot of results could probably be extended to any $\varepsilon > 0$.

⁵More precisely, this is Proposition B.7 of Chapter 1. Moreover, this can be extracted from the proof of Theorem 5.7 of [BG16] for α sufficiently large and with slightly different assumptions on the differentiability and the non-degeneracy of κ .

⁶More precisely, this is Proposition B.2 of Chapter 1. Moreover, this is Theorem 2.2 from [BG16] combined with the results of their Section 4 (resp. this is Appendix C of [BM18]) for $\alpha > 16$ (resp. $\alpha > 8$), with some constraints on (R, ε) , and with slightly different assumptions on the differentiability and the non-degeneracy of κ .

What remains to prove in order to show Theorem 2.11 is that, if $p > 0$, a.s. there is a unique infinite black component. Exactly as in the continuum, our goal will be to show that a box-crossing criterion is satisfied. The following lemma is proved in Subsection 4.1.

Lemma 2.14. *Assume that f satisfies Condition 2.1 and that κ is invariant by $\frac{\pi}{2}$ -rotations. Let $\varepsilon > 0$, let $p \in \mathbb{R}$ and suppose that:*

$$\sum_{k \in \mathbb{N}} \mathbb{P} \left[\neg \text{Cross}_p^\varepsilon(2^{k+1}, 2^k) \right] < +\infty. \quad (2.6)$$

Then, a.s. there exists a unique unbounded black component in the discrete percolation model defined in the present subsection.

2.5 Sharp threshold at the discrete level

We list the intermediate results at the discrete level. Among all the following results (and actually among all the intermediate results of the chapter) the only result specific to the Bargmann-Fock field is the second result of Proposition 2.21. All the others work in a quite general setting.

2.5.1 The FKG inequality for Gaussian vectors

The FKG inequality is a crucial tool to apply percolation arguments. We say that a Borel subset $A \subseteq \mathbb{R}^n$ is **increasing** if for each $x \in A$ and $y \in \mathbb{R}^n$ such that $y_i \geq x_i$ for every $i \in \{1, \dots, n\}$, we have $y \in A$. We say that A is decreasing if the complement of A is increasing. The FKG inequality for Gaussian vectors was proved by Pitt and can be stated as follows.

Theorem 2.15 ([Pit82]). *Let $X = (X_1, \dots, X_n)$ be a n -dimensional Gaussian vector whose correlation matrix has non-negative entries. Then, for every increasing Borel subsets $A, B \subseteq \mathbb{R}^n$, we have:*

$$\mathbb{P}[X \in A \cap B] \geq \mathbb{P}[X \in A] \cdot \mathbb{P}[X \in B].$$

This result is the reason why we work with positively correlated Gaussian fields. Indeed, the FKG inequality is a crucial ingredient in the proof of RSW-type results. Note however that the very recent [BG17] proves a box-crossing property without this inequality, albeit only in a discrete setting.

2.5.2 A differential formula

As in the case of Bernoulli percolation, we need to introduce a notion of influence. This notion of influence is inspired by the **geometric influences** studied by Keller, Mossel and Sen in the case of product spaces [KMS12, KMS14]. (For more about the relations between the geometric influences and the influences of Definition 2.16 below - which are roughly the same in the case of product measures - see Subsection 5.1.)

Definition 2.16. Let μ be a finite Borel measure on \mathbb{R}^n , let $v \in \mathbb{R}^n$, and let A be a Borel subset of \mathbb{R}^n . The influence of v on A under μ is:

$$I_{v,\mu}(A) := \liminf_{r \downarrow 0} \frac{\mu(A + [-r, r]v) - \mu(A)}{r} \in [0, +\infty].$$

Write (e_1, \dots, e_n) for the canonical basis of \mathbb{R}^n . We will use the following simplified notations:

$$I_{i,\mu}(A) := I_{e_i,\mu}(A).$$

The events we are interested in are “threshold events” and the measures we are interested in are Gaussian distributions: Let $X = (X_1, \dots, X_n)$ be a n -dimensional non-degenerate centered Gaussian vector, write μ_X for the law of X and, for every $\vec{p} = (p_1, \dots, p_n) \in \mathbb{R}^n$ and every $i \in \{1, \dots, n\}$, write:

$$\omega_i^{\vec{p}} := \mathbb{1}_{\{X_i \geq -p_i\}}.$$

This defines a random variable $\omega^{\vec{p}}$ with values in $\{0, 1\}^n$. If $B \subseteq \{0, 1\}^n$, we call the event $\{\omega^{\vec{p}} \in B\}$ a **threshold event**. For every $i \in \{1, \dots, n\}$, we let $\text{Piv}_i^{\vec{p}}(B)$ denote the event that changing the value of the bit i in $\omega^{\vec{p}}$ modifies $\mathbb{1}_B(\omega^{\vec{p}})$. In other words,

$$\text{Piv}_i^{\vec{p}}(B) = \{(\omega_1^{\vec{p}}, \dots, \omega_{i-1}^{\vec{p}}, 0, \omega_{i+1}^{\vec{p}}, \dots, \omega_n^{\vec{p}}) \in B\} \Delta \{(\omega_1^{\vec{p}}, \dots, \omega_{i-1}^{\vec{p}}, 1, \omega_{i+1}^{\vec{p}}, \dots, \omega_n^{\vec{p}}) \in B\},$$

where $E \Delta F := (E \setminus F) \cup (F \setminus E)$. Such an event is called a **pivotal event**. We say that a subset $B \subseteq \{0, 1\}^n$ is **increasing** if for every $\omega \in B$ and $\omega' \in \{0, 1\}^n$, the fact that $\omega'_i \geq \omega_i$ for every i implies that $\omega' \in B$. Moreover, if $p \in \mathbb{R}$, we write $\mathbf{p} = (p, \dots, p) \in \mathbb{R}^n$ and we use the following notations:

$$\omega^p := \omega^{\mathbf{p}} \quad \text{and} \quad \text{Piv}_i^p(B) := \text{Piv}_i^{\mathbf{p}}(B).$$

Proposition 2.17. *Assume that X is a n -dimensional non-degenerate centered Gaussian vector and let Σ be its covariance matrix. Let B be an increasing subset of $\{0, 1\}^n$. Then:*

$$\frac{\partial \mathbb{P}[\omega^{\vec{p}} \in B]}{\partial p_i} = I_{i, \mu_X}(\omega^{\vec{p}} \in B) = \mathbb{P}[\text{Piv}_i^{\vec{p}}(B) \mid X_i = -p_i] \frac{1}{\sqrt{2\pi\Sigma_{i,i}}} \exp\left(-\frac{1}{2\Sigma_{i,i}}p_i^2\right).$$

In particular, if $p \in \mathbb{R}$, then:

$$\frac{d \mathbb{P}[\omega^p \in B]}{dp} = \sum_{i=1}^n I_{i, \mu_X}(\omega^p \in B) = \sum_{i=1}^n \mathbb{P}[\text{Piv}_i^p(B) \mid X_i = -p] \frac{1}{\sqrt{2\pi\Sigma_{i,i}}} \exp\left(-\frac{1}{2\Sigma_{i,i}}p^2\right).$$

Remark 2.18. With the same hypotheses as in Proposition 2.17: For $\epsilon \in \{0, 1\}$, let $B_\epsilon^i = \{\omega \in \{0, 1\}^n : (\omega_1, \dots, \omega_{i-1}, \epsilon, \omega_{i+1}, \dots, \omega_n) \in B\}$. Note that we have:

$$\mathbb{P}[\text{Piv}_i^{\vec{p}}(B) \mid X_i = -p_i] = \mathbb{P}[\omega^{\vec{p}} \in B_1^i \mid X_i = -p_i] - \mathbb{P}[\omega^{\vec{p}} \in B_0^i \mid X_i = -p_i].$$

Hence the form of our influences is close to the covariance between $\mathbb{1}_{\{\omega_i^{\vec{p}}=1\}}$ and $\mathbb{1}_{\{\omega^{\vec{p}} \in B\}}$ but is not exactly a covariance. This is important to have in mind if one wants to try to apply techniques from [DCRT17b, DCRT17a] in future.

Since the proof of Proposition 2.17 is rather short, we include this here. The reader essentially interested in the strategy of proof can skip this in a first reading.

Proof of Proposition 2.17. Without loss of generality, we assume that $i = n$. For any $C \subseteq \{0, 1\}^n$, let $C^{\vec{p}} \subseteq \mathbb{R}^n$ be the preimage of C by the map $x \in \mathbb{R}^n \mapsto (\mathbb{1}_{x_i \geq -p_i})_{i \in \{1, \dots, n\}} \in \{0, 1\}^n$. Let $e_n = (0, \dots, 0, 1) \in \mathbb{R}^n$, $h > 0$, let $B \subseteq \{0, 1\}^n$ be an increasing event, and let $\tilde{X} = (X_i)_{1 \leq i \leq n-1}$. Then:

$$\mathbb{P}[\omega^{\vec{p}+he_n} \in B] = \mathbb{P}[X \in B^{\vec{p}+he_n}] = \mathbb{P}[X + he_n \in B^{\vec{p}}] = \mathbb{P}[(\tilde{X}, X_n + h) \in B^{\vec{p}}],$$

$$\text{and } \mathbb{P}[\omega^{\vec{p}} \in B] = \mathbb{P}[(\tilde{X}, X_n) \in B^{\vec{p}}].$$

Also:

$$\begin{aligned} \mathbb{P}[(\tilde{X}, X_n + h) \in B^{\vec{p}}] - \mathbb{P}[(\tilde{X}, X_n) \in B^{\vec{p}}] &= \mathbb{P}[(\tilde{X}, X_n + h) \in B^{\vec{p}}, (\tilde{X}, X_n) \notin B^{\vec{p}}] \\ &= \mathbb{P}[\text{Piv}_n^{\vec{p}}(B), X_n \in [-p_n - h, -p_n]]. \end{aligned}$$

Since Σ is positive definite, the Gaussian measure has smooth density with respect to the Lebesgue measure. Taking the difference of the two probabilities and letting $h \downarrow 0$, we get:

$$\begin{aligned} & h^{-1} \left(\mathbb{P} \left[\omega^{\vec{p} + h e_n} \in B \right] - \mathbb{P} \left[\omega^{\vec{p}} \in B \right] \right) \\ &= h^{-1} \mathbb{P} \left[\text{Piv}_n^{\vec{p}}(B), X_n \in [-p_n - h, -p_n[\right] \\ &= \frac{1}{h \sqrt{2\pi \Sigma_{n,n}}} \int_{-p_n - h}^{-p_n} \mathbb{P} \left[\text{Piv}_n^{\vec{p}}(B) \mid X_n = t \right] \exp \left(-\frac{1}{2\Sigma_{n,n}} t^2 \right) dt \\ &\xrightarrow{h \downarrow 0} \mathbb{P} \left[\text{Piv}_n^{\vec{p}}(B) \mid X_n = -p_n \right] \frac{1}{\sqrt{2\pi \Sigma_{n,n}}} \exp \left(-\frac{1}{2\Sigma_{n,n}} p_n^2 \right). \end{aligned}$$

In the last step we use the continuity of the conditional probability of a threshold event with respect to the conditioning value. This is an easy consequence of Proposition 1.2 of [AW09]. The calculation for $h < 0$ is analogous, hence we are done. \square

2.5.3 A KKL-KMS (Kahn-Kalai-Linial – Keller-Mossel-Sen) theorem for non-product Gaussian vectors

One of the contributions of this chapter is the derivation of a KKL theorem for biased Gaussian vectors, namely Theorem 2.19, based on a similar result for product Gaussian vectors by Keller, Mossel and Sen, [KMS12]. (This similar result by [KMS12] is stated in Theorem 5.1 of this chapter⁷.) Actually, with our techniques of Section 5, most of the results from [KMS12] could be extended to non-product Gaussian vectors (and to monotonic or semi-algebraic events).

Theorem 2.19. *There exists an absolute constant $c > 0$ such that the following holds: Let $n \in \mathbb{Z}_{>0}$, let Σ be a $n \times n$ symmetric positive definite matrix⁸ and let $\mu = \mathcal{N}(0, \Sigma)$. Also, let $\sqrt{\Sigma}$ be a symmetric square root of Σ and write $\|\sqrt{\Sigma}\|_{\infty, op}$ for the operator norm of $\sqrt{\Sigma}$ for the infinite norm⁹ on \mathbb{R}^n . For every A either monotonic or semi-algebraic¹⁰ Borel subset of \mathbb{R}^n we have:*

$$\sum_{i=1}^n I_{i, \mu}(A) \geq c \|\sqrt{\Sigma}\|_{\infty, op}^{-1} \mu(A) (1 - \mu(A)) \sqrt{\log_+ \left(\frac{1}{\|\sqrt{\Sigma}\|_{\infty, op} \cdot \max_{i \in \{1, \dots, n\}} I_{i, \mu}(A)} \right)}.$$

This theorem probably holds for a wider class of sets. Since we need it only for monotonic events, we did not try to identify the weakest possible assumptions for the property to hold. In particular, we have not found any examples of Borel sets for which the theorem does not hold.

A way to understand the constant $\|\sqrt{\Sigma}\|_{\infty, op}$ is to see what happens in the extreme cases:

- If Σ is the identity matrix, then $\|\sqrt{\Sigma}\|_{\infty, op} = 1$ and the above result corresponds to the product case from [KMS12].
- If $\Sigma_{i,j} = 1$ for every i, j (which corresponds to the fact that, if $X \sim \Sigma$, then $X_i = X_j$ for every i, j) then $\|\sqrt{\Sigma}\|_{\infty, op} = n$ which is coherent since there is no threshold phenomenon for a single variable.

⁷As we will explain, Theorem 5.1 a simple consequence of Item (1) of Theorem 1.5 of [KMS12].

⁸Remember Remark 1.9: this means in particular that Σ is non-degenerate.

⁹I.e. $\|\sqrt{\Sigma}\|_{\infty, op} = \sup_{x \in \mathbb{R}^n \setminus \{0\}} \frac{|\sqrt{\Sigma}(x)|_{\infty}}{|x|_{\infty}}$. Equivalently, $\|\sqrt{\Sigma}\|_{\infty, op} = \max_{i \in \{1, \dots, n\}} \sum_{j=1}^n |\sqrt{\Sigma}(i, j)|$.

¹⁰We say that a set $A \subset \mathbb{R}^n$ is semi-algebraic if it belongs to the Boolean algebra generated by sets of the form $P^{-1}([0, +\infty[)$ where $P \in \mathbb{R}[X_1, \dots, X_n]$.

The proof of Theorem 2.19 is organized as follows: In Subsection 5.1, we explain how to deduce Theorem 2.19 from a sub-linear property of the influences (see Proposition 5.3) and from the results of [KMS12]. In Subsection 5.2 (respectively in Appendix A), we prove the sub-linearity property for monotonic (respectively semi-algebraic) subsets. The reason why we postpone the proof in the semi-algebraic case to the appendix is that the events that will interest us (namely, the events $\text{Cross}_p^\varepsilon(2R, R)$) are both monotonic and semi-algebraic (indeed, any threshold event is semi-algebraic). Hence it is enough for our purpose to prove Theorem 2.19 only for A monotonic or A semi-algebraic (and the monotonic case is easier).

Remember that we want to prove that $\mathbb{P}[\text{Cross}_p(2R, R)]$ is close to 1 and that our first step is to prove that it is the case for $\mathbb{P}[\text{Cross}_p^\varepsilon(2R, R)]$. To do so, we use that for $p = 0$ this probability is bounded from below (by Theorem 2.13) and we differentiate the probability with respect to p using Proposition 2.17. We then apply Theorem 2.19 to the right-hand side so that it is sufficient to prove that the maximum of the corresponding influences is small and that the operator norm for the infinite norm of the correlation matrix of our model is not too large. In the two following subsections, we state results in this spirit.

2.5.4 Polynomial decay of influences

Thanks to the RSW estimate and quasi-independence results, one can obtain that the probability of “discrete arm events” decay polynomially fast, see Subsection 5.3 of [BG16] and Proposition B.6 of Chapter 1. Such a result together with monotonic arguments imply that we have a polynomial bound on the influences for crossing events. We state this bound here and we prove it in Subsection 4.2. We first need some notations. Let $\mathcal{V}_R^\varepsilon$ denote the set of vertices $x \in \mathcal{V}^\varepsilon$ that belong to an edge that intersects $[0, 2R] \times [0, R]$, and let X be our Gaussian field f restricted to $\mathcal{V}_R^\varepsilon$. Thus, X is a finite dimensional Gaussian field. For every $p \in \mathbb{R}$, $x \in \mathcal{V}_R^\varepsilon$ and $B \subseteq \mathbb{R}^{\mathcal{V}_R^\varepsilon}$, we use the notations ω_x^p and $\text{Piv}_x^p(B)$ from Subsubsection 2.5.2. In particular, for every $x \in \mathcal{V}_R^\varepsilon$ and every $p \in \mathbb{R}$ we write:

$$\omega_x^p = \mathbb{1}_{\{X_x \geq -p\}} = \mathbb{1}_{\{f(x) \geq -p\}}.$$

Also, we write $\text{Cross}^\varepsilon(2R, R)$ for the subset of $\{0, 1\}^{\mathcal{V}_R^\varepsilon}$ that corresponds to the crossing from left to right of $[0, 2R] \times [0, R]$. Note that $\text{Cross}_p^\varepsilon(2R, R) = \{\omega^p \in \text{Cross}^\varepsilon(2R, R)\}$. We have the following result (see Proposition 2.17 for its link with the influences):

Proposition 2.20. *Assume that f satisfies Conditions 2.1, 2.2, 2.4 as well as Condition 2.3 for some $\alpha > 4$. Then, there exist constants $\eta = \eta(\kappa) > 0$ and $C = C(\kappa) < +\infty$ such that, for every $\varepsilon \in]0, 1]$, every $R \in]0, +\infty[$, every $x \in \mathcal{V}_R^\varepsilon$ and every $p \in [-1, 1]$ we have:*

$$\mathbb{P} \left[\text{Piv}_x^p(\text{Cross}^\varepsilon(2R, R)) \mid f(x) = -p \right] \leq C R^{-\eta}.$$

Note that the constants in Proposition 2.20 do not depend on p (as long p belongs to a bounded interval, in our proof we have chosen $[-1, 1]$).

2.5.5 A bound on the infinite norm of the square root matrix

In order to use Theorem 2.19, it is important to control the quantity $\|\sqrt{\Sigma}\|_{\infty, op}$. We are interested in the case $\Sigma = K_R^\varepsilon :=$ the correlation matrix K restricted to $\mathcal{V}_R^\varepsilon$ (see Subsubsection 2.5.4 the notation $\mathcal{V}_R^\varepsilon$). However, we were not able to estimate $\|\sqrt{K_R^\varepsilon}\|_{\infty, op}$. Instead, we obtained estimates on $\|\sqrt{K^\varepsilon}\|_{\infty, op}$ where K^ε is K restricted to \mathcal{V}^ε , by using Fourier techniques (which work only in a translation invariant setting, hence not for K_R^ε). Here, K^ε is an infinite matrix, so let us be more precise about what we mean by square root of K^ε : To define the product of two infinite matrices, we ask the infinite sums that arise to be absolutely convergent. A square root of K^ε is simply an infinite matrix $\sqrt{K^\varepsilon}$ such that in this sense we have $\sqrt{K^\varepsilon}^2 = K^\varepsilon$. It

may be that classical spectral theory arguments imply that such a square root exists. However, we will not need such arguments since we will have to construct quite explicitly $\sqrt{K^\varepsilon}$ in order to estimate its infinite operator norm (where as in the finite dimensional case we let $\|\sqrt{K^\varepsilon}\|_{\infty,op} := \max_i \sum_j |\sqrt{K^\varepsilon}(i,j)|$, one difference being that this sum might be infinite). Let us also note that the matrices $\sqrt{K^\varepsilon}$ that we will construct will be positive definite in the sense that their restriction to finite sets of indices is positive definite. By spectral theory arguments it may be that only one such matrix exists. However, we do not need such a result either.

Note that, since Theorem 2.19 is stated for finite dimensional Gaussian fields, it would have been better to have an estimate on $\|\sqrt{K_R^\varepsilon}\|_{\infty,op}$. See Lemma 3.1 for more details on this issue.

We will prove the following in Section 6. The reason why our main result Theorem 1.3 is only proved for the Bargmann-Fock model is that we were unable to find a general estimate on $\|\sqrt{K^\varepsilon}\|_{\infty,op}$ with explicit dependence on ε as $\varepsilon \downarrow 0$ (this is the only place where we prove a result only for the Bargmann-Fock field). If one could prove a bound by $C\varepsilon^{-2+\delta}$ for some $\delta > 0$ and $C < +\infty$ for another process (which also satisfies some of the conditions of Subsection 2.2), the rest of the proof of Theorem 1.3 would piece together and yield the same result for this process. See Proposition 3.5.

Proposition 2.21. *Assume that f satisfies Condition 2.1 and Condition 2.5 for some $\alpha > 5$. Then, for all $\varepsilon > 0$, there exists a symmetric square root $\sqrt{K^\varepsilon}$ of K^ε such that:*

$$\|\sqrt{K^\varepsilon}\|_{\infty,op} < +\infty.$$

Assume further that $\kappa(x) = \exp(-\frac{1}{2}|x|^2)$ (which is the covariance kernel function of the Bargmann-Fock field). Then, there exist $\varepsilon_0 > 0$ and $C < +\infty$ such that, for all $\varepsilon \in]0, \varepsilon_0]$, there exists a symmetric square root $\sqrt{K^\varepsilon}$ of K^ε such that:

$$\|\sqrt{K^\varepsilon}\|_{\infty,op} \leq C \frac{1}{\varepsilon} \log\left(\frac{1}{\varepsilon}\right).$$

2.5.6 Combining all the above results

The following Equation (2.7) is not used anywhere in this chapter though it appears implicitly in Lemma 3.1. However, since it sums up the crux of the proof, we state it here as a guide to the reader. Its proof could easily be extracted from the arguments below (see Remark 3.4).

As we will explain in Section 3.1, by combining the results of Subsubsections 2.5.2, 2.5.3, 2.5.4 and 2.5.5, we can obtain the following: Consider the Bargmann-Fock field and let $p \in]0, 1]$. There exists $C < +\infty$ such that, if $\varepsilon \in]0, 1]$ and $R \in]0, +\infty[$, then:

$$\mathbb{P}[\text{Cross}_p^\varepsilon(2R, R)] \geq 1 - C_1 \exp\left(-p c_2 \frac{\varepsilon}{\log(\frac{1}{\varepsilon})} \sqrt{\log_+\left(C_1 R^{-\eta} \frac{\log(\frac{1}{\varepsilon})}{\varepsilon}\right)}\right), \quad (2.7)$$

where $C_1 < +\infty$ and $c_2 > 0$ are some absolute constants. One can deduce from (2.7) that, if $\varepsilon = \varepsilon(R) \geq \log^{-(1/2-\delta)}(R)$, then $\mathbb{P}[\text{Cross}_p^\varepsilon(2R, R)]$ goes to 1 as R goes to $+\infty$ (sufficiently fast so that $\sum_k \mathbb{P}[\text{Cross}_p^{\varepsilon(2^k)}(2^{k+1}, 2^k)] < +\infty$ as required, see (2.3)).

We will also obtain results analogous to Equation (2.7) for more general fields and with $\|\sqrt{K^\varepsilon}\|_{\infty,op}$ instead of $\frac{1}{\varepsilon} \log(\frac{1}{\varepsilon})$, which will enable us to prove (2.6) and thus obtain Theorem 2.11.

2.6 From discrete to continuous

It is helpful to keep in mind in this subsection that, as explained above, in the case of the Bargmann-Fock field, the quantity $\mathbb{P}[\text{Cross}_p^\varepsilon(2R, R)]$ goes to 1 as $R \rightarrow +\infty$ if $\varepsilon = \varepsilon(R) \geq \log^{-(1/2-\delta)}(R)$. In order to obtain an analogous result for the continuum model, we need to measure the extent to which $\mathbb{P}[\text{Cross}_p^\varepsilon(2R, R)]$ approximates $\mathbb{P}[\text{Cross}_p(2R, R)]$. To this purpose, it seems natural to use the approximation estimates based on the discretization schemes of [BG16] which have been generalized in [BM18]. More precisely, we think that the following can easily be extracted from [BM18] (however, we do not write a formal proof since we will not need such a result):¹¹ Assume that f satisfies Condition 2.1 and that κ is C^6 . Then, for every $p \in \mathbb{R}$ and $\delta > 0$, there exists $C = C(\kappa, p, \delta) < +\infty$ such that for each $\varepsilon \in]0, 1]$ and each $R \in \varepsilon\mathbb{Z}_{>0}$ we have:

$$\mathbb{P}[\text{Cross}_p^\varepsilon(2R, R) \triangle \text{Cross}_p(2R, R)] \leq C\varepsilon^{2-\delta}R^2. \quad (2.8)$$

This would imply in particular that, for every sequence $(\varepsilon(R))_{R>0}$ such that: (i) for each $R > 0$, $R \in \varepsilon(R)\mathbb{Z}_{>0}$ and: (ii) $\varepsilon(R) = O(R^{-(1+\delta)})$ for some $\delta > 0$, we have:

$$\mathbb{P}[\text{Cross}_p^{\varepsilon(R)}(2R, R) \triangle \text{Cross}_p(2R, R)] \xrightarrow{R \rightarrow +\infty} 0.$$

Unfortunately, the constraint $\varepsilon \leq R^{-(1+\delta)}$ is incompatible with $\varepsilon \geq \log^{-(1/2-\delta)}(R)$. To solve this quandary, we will replace the discretization result with a sprinkling argument.

Let $p > 0$. The idea is to compare the probability of a continuum crossing at parameter p to the probability of a discrete crossing at parameter $p/2$. Instead of using the discretization results of [BG16, BM18], we will use the following result, which we prove in Subsection 7. For references about the strategy of sprinkling in the context of Bernoulli percolation, see the notes on Section 2.6 of [Gri99].

Proposition 2.22. *Assume that f satisfies Conditions 2.1 and that it is a.s. C^2 . Let $p > 0$. Then, there exist constants $C_1 < +\infty$ and $c_2 = c_2(\kappa, p) > 0$ as well as $\varepsilon_0 = \varepsilon_0(\kappa, p) > 0$ such that for each $\varepsilon \in]0, \varepsilon_0]$ and $R > 1$:*

$$\mathbb{P}[\text{Cross}_{p/2}^\varepsilon(2R, R) \setminus \text{Cross}_p(2R, R)] \leq C_1R^2\varepsilon^{-2}\exp(-c_2\varepsilon^{-4}).$$

In particular, for every sequence $(\varepsilon(R))_{R>0}$ such that $\varepsilon(R) \geq \log^{-(1/4+\delta)}(R)$ for some $\delta > 0$, we have:

$$\mathbb{P}[\text{Cross}_{p/2}^\varepsilon(2R, R) \setminus \text{Cross}_p(2R, R)] \xrightarrow{R \rightarrow +\infty} 0.$$

Remark 2.23. While this estimate may seem stronger than (2.8), we wish to emphasize that it only shows that discretization is legitimate in one direction and also involves a change in threshold from $-p/2$ to $-p$.

If we choose for instance $\varepsilon = \varepsilon(R) = \log^{-1/3}(R)$, then:

$$\log^{-(1/2-\delta)}(R) \ll \varepsilon(R) \ll \log^{-(1/4+\delta)}(R)$$

for any $\delta > 0$ small enough. Hence, with this choice of ε and for the Bargmann-Fock field, on the one hand for any $p > 0$ we have a lower bound on $\mathbb{P}[\text{Cross}_{p/2}^\varepsilon(2R, R)]$ which is close to 1 (see Subsubsection 2.5.6), and on the other hand we can use Proposition 2.22 to go back to the

¹¹Let us be a little more precise here: one can use for instance Propositions 6.1 and 6.3 of [BM18] and (more classical) results about the regularity of \mathcal{D}_p as for instance Lemma A.10 of Chapter 1.

continuum and obtain a lower bound on $\mathbb{P}[\text{Cross}_p(2R, R)]$ which is close to 1. More precisely, we will see in Section 3.1 that we can obtain:

$$\mathbb{P}[\text{Cross}_p(2R, R)] \geq 1 - \exp\left(-c \log^{1/7}(R)\right),$$

for some $c = c(p) > 0$, which implies that the box-crossing criterion of Lemma 2.9 is satisfied, and ends the proof of our main result Theorem 1.3.

3 Proofs of the phase transition theorems and of the exponential decay

3.1 Proof of the phase transition theorems

In this subsection, we combine the results stated in Section 2 in order to prove Theorem 1.3. We also prove Theorem 2.11. Most of the proof of the former carries over to that of the latter. The first half of the proof is the following lemma, in which we work with the following function:

$$g_R^\varepsilon : p \longmapsto \log\left(\frac{\mathbb{P}[\text{Cross}_p^\varepsilon(2R, R)]}{1 - \mathbb{P}[\text{Cross}_p^\varepsilon(2R, R)]}\right). \quad (3.1)$$

Lemma 3.1. *There exists an absolute constant $c > 0$ such that the following holds: Assume that f satisfies Condition 2.1, and fix $\varepsilon > 0$ and $R > 0$. Moreover, let μ_R^ε be the law of f restricted to $\mathcal{V}_R^\varepsilon$ (defined in Subsubsection 2.5.4) and let K^ε be K restricted to \mathcal{V}^ε . Assume that there exists a symmetric square root $\sqrt{K^\varepsilon}$ of K^ε . Then:*

$$\forall p \in [0, 1], \quad \frac{d}{dp} g_R^\varepsilon(p) \geq c \|\sqrt{K^\varepsilon}\|_{\infty, op}^{-1} \sqrt{\log_+ \left(\frac{1}{\|\sqrt{K^\varepsilon}\|_{\infty, op} \cdot \max_{x \in \mathcal{V}_R^\varepsilon} I_{x, \mu_R^\varepsilon}(\text{Cross}_p^\varepsilon(2R, R))} \right)}. \quad (3.2)$$

Here, square root and infinite norm of an infinite matrix have the same meaning as in Subsubsection 2.5.5.

This lemma is mostly a consequence of Theorem 5.1. The only difficulty comes from the fact that, while Theorem 2.19 deals with finite dimensional Gaussian fields, the correlation matrix on the right hand side of Equation (3.2) is the infinite matrix K^ε (which we need to apply Proposition 2.21 later in this section). To overcome such issues, we proceed by approximation and, instead of dealing with a μ_R^ε variable directly, we apply Theorem 2.19 to a Gaussian vector defined using $\sqrt{K^\varepsilon}$ (namely, the Gaussian vector $Y^{\varepsilon, \rho}$ below).

Proof of Lemma 3.1. Fix $\varepsilon > 0$ and $R > 0$. For each $\rho > 0$, let $H^{\varepsilon, \rho}$ be $\sqrt{K^\varepsilon}$ restricted to $\mathcal{V}^\varepsilon \cap [-\rho, \rho]^2$, let $K^{\varepsilon, \rho} = (H^{\varepsilon, \rho})^2$, and let $Y^{\varepsilon, \rho} \sim \mathcal{N}(0, K^{\varepsilon, \rho}) =: \mu^{\varepsilon, \rho}$. A simple computation shows that since K^ε is non-degenerate,¹² so is its square root. Restriction preserves non-degeneracy so $Y^{\varepsilon, \rho}$ is indeed non-degenerate and we can apply Theorem 2.19 to $\mu^{\varepsilon, \rho}$ and the (increasing) event $\text{Cross}_p^\varepsilon(2R, R)$. We obtain that, if ρ is sufficiently large:

$$\begin{aligned} \sum_{i \in \mathcal{V}_R^\varepsilon} I_{i, \mu^{\varepsilon, \rho}}(\text{Cross}_p^\varepsilon(2R, R)) &\geq c \|H^{\varepsilon, \rho}\|_{\infty, op}^{-1} \mu^{\varepsilon, \rho}(\text{Cross}_p^\varepsilon(2R, R)) (1 - \mu^{\varepsilon, \rho}(\text{Cross}_p^\varepsilon(2R, R))) \\ &\times \sqrt{\log_+ \left(\frac{1}{\|H^{\varepsilon, \rho}\|_{\infty, op} \max_{i \in \mathcal{V}_R^\varepsilon} I_{i, \mu^{\varepsilon, \rho}}(\text{Cross}_p^\varepsilon(2R, R))} \right)}. \end{aligned} \quad (3.3)$$

¹²Meaning that for any non-zero finitely supported $v \in \mathbb{R}^{\mathcal{V}^\varepsilon}$, $K^\varepsilon v \neq 0$.

Here we use the fact that, since $\text{Cross}_p^\varepsilon(2R, R)$ depends only on the sites of $\mathcal{V}_R^\varepsilon$, the influences on this event of all the sites outside of this box vanish. Now, observe that:

$$\frac{d}{dp} g_R^\varepsilon(p) = \frac{d}{dp} \mathbb{P} [\text{Cross}_p^\varepsilon(2R, R)] \cdot \frac{1}{\mathbb{P} [\text{Cross}_p^\varepsilon(2R, R)] (1 - \mathbb{P} [\text{Cross}_p^\varepsilon(2R, R)])}.$$

By Proposition 2.17,

$$\frac{d}{dp} g_R^\varepsilon(p) = \frac{\exp(-p^2/2)}{\sqrt{2\pi} \mathbb{P} [\text{Cross}_p^\varepsilon(2R, R)] (1 - \mathbb{P} [\text{Cross}_p^\varepsilon(2R, R)])} \sum_{i \in \mathcal{V}_R^\varepsilon} I_{i, \mu_R^\varepsilon} (\text{Cross}_p^\varepsilon(2R, R)). \quad (3.4)$$

Also, by definition of $\|\cdot\|_\infty$, for every ρ , we have:

$$\|H^{\varepsilon, \rho}\|_{\infty, op} \leq \|\sqrt{K^\varepsilon}\|_{\infty, op}. \quad (3.5)$$

In view of Equations (3.3), (3.4) and (3.5), we are done as long as we prove that:

1. $\mu^{\varepsilon, \rho} (\text{Cross}_p^\varepsilon(2R, R)) \xrightarrow{\rho \rightarrow +\infty} \mu_R^\varepsilon (\text{Cross}_p^\varepsilon(2R, R)) (= \mathbb{P} [\text{Cross}_p^\varepsilon(2R, R)])$ and:
2. $\forall i \in \mathcal{V}_R^\varepsilon, I_{i, \mu^{\varepsilon, \rho}} (\text{Cross}_p^\varepsilon(2R, R)) \xrightarrow{\rho \rightarrow +\infty} I_{i, \mu_R^\varepsilon} (\text{Cross}_p^\varepsilon(2R, R)).$

To this purpose, we need the following elementary lemma:

Lemma 3.2. *Let $(Y_\rho)_{\rho>0}$ be a sequence of non-degenerate Gaussian vectors in \mathbb{R}^n with covariance Σ_ρ and mean m_ρ , assume that Σ_ρ converges to some invertible matrix Σ as ρ goes to $+\infty$, and that m_ρ converges to some $m \in \mathbb{R}^n$ as ρ goes to $+\infty$. Let $Y \sim \mathcal{N}(m, \Sigma)$. Then, for any Borel subset $A \subset \mathbb{R}^n$, any $i \in \{1, \dots, n\}$ and any $q \in \mathbb{R}$, we have:*

$$\begin{aligned} \mathbb{P}[Y_\rho \in A] &\xrightarrow{\rho \rightarrow +\infty} \mathbb{P}[Y \in A], \\ \mathbb{P}[Y_\rho \in A \mid Y_\rho(i) = q] &\xrightarrow{\rho \rightarrow +\infty} \mathbb{P}[Y \in A \mid Y(i) = q]. \end{aligned}$$

Proof. For the first statement, just notice that the density function of a non-degenerate Gaussian vector is a continuous function of its covariance and of its mean, and apply dominated convergence. By Proposition 1.2 of [AW09], the law of Y_ρ conditioned on the value of $Y_\rho(i)$ is that of a Gaussian vector whose mean and covariance depend continuously on Σ_ρ and m_ρ . Note also that the law $(Y_\rho(j))_{j \neq i}$ when we condition on $\{Y_\rho(i) = q\}$ (respectively the law $(Y(j))_{j \neq i}$ when we condition on $\{Y(i) = q\}$) is still non-degenerate.¹³ We conclude by applying the first statement. \square

Item 1 above is a direct consequence of the first part of Lemma 3.2. Regarding Item 2, note that, since $\text{Cross}_p^\varepsilon(2R, R)$ is an increasing threshold event, by Proposition 2.17, we have the following equalities:

$$\begin{aligned} I_{i, \mu^{\varepsilon, \rho}} (\text{Cross}_p^\varepsilon(2R, R)) \\ = \mathbb{P} \left[Y^{\varepsilon, \rho} \in \text{Piv}_i (\text{Cross}_p^\varepsilon(2R, R)) \mid Y^{\varepsilon, \rho}(i) = -p \right] \frac{1}{\sqrt{2\pi K^{\varepsilon, \rho}(i, i)}} e^{-p^2/(2K^{\varepsilon, \rho}(i, i))}, \end{aligned}$$

and:

$$\begin{aligned} I_{i, \mu_R^\varepsilon} (\text{Cross}_p^\varepsilon(2R, R)) \\ = \mathbb{P} \left[Y_R^\varepsilon \in \text{Piv}_i (\text{Cross}_p^\varepsilon(2R, R)) \mid Y_R^\varepsilon(i) = -p \right] \frac{1}{\sqrt{2\pi K_{\rho, R}^\varepsilon(i, i)}} e^{-p^2/(2K_{\rho, R}^\varepsilon(i, i))}, \end{aligned}$$

where $Y_R^\varepsilon \sim \mathcal{N}(0, K_R^\varepsilon)$. We conclude by applying the second part of Lemma 3.2. \square

¹³To see this, complete the vector e_i into an orthogonal basis for Σ_ρ (respectively Σ) and express Y_ρ (respectively Y) in this basis.

We are now ready to prove our main result.

Proof of Theorem 1.3. We consider the Bargmann-Fock field f . By Theorem 1.2, for every $p \leq 0$, a.s. there is no unbounded connected component in \mathcal{D}_p . We henceforth consider some parameter $p_0 \in]0, 1]$. By Lemma 2.9, it is enough to prove that f satisfies criterion (2.2) (note that if we prove that this criterion is satisfied for every $p_0 \in]0, 1]$ then we obtain the result for every p_0 since the quantities $\mathbb{P}[-\text{Cross}_{p_0}(2R, R)]$ are non-increasing in p_0). To this end we first fix $R_0 < +\infty$ to be determined later, we let $R > R_0$, and we use the discretization procedure introduced in Subsection 2.4 with:

$$\varepsilon = \varepsilon(R) = \log^{-1/3}(R).$$

Let $g_R := g_R^{\varepsilon(R)}$ be as in (3.1). We are going to apply Lemma 3.1. Let us estimate the quantities that appear in this lemma. By Proposition 2.21, there exists a constant $C < +\infty$ independent of R such that:

$$\|\sqrt{K^{\varepsilon(R)}}\|_{\infty, op} \leq C \frac{1}{\varepsilon(R)} \log\left(\frac{1}{\varepsilon(R)}\right).$$

Moreover by Propositions 2.17 and 2.20, if R_0 is large enough, there exists $\eta > 0$ independent of $R > R_0$ and of $p \in [-1, 1]$ such that:

$$\forall x \in \mathcal{V}_R^{\varepsilon(R)}, I_{x, \mu_R^{\varepsilon(R)}}\left(\text{Cross}_p^{\varepsilon(R)}(2R, R)\right) \leq R^{-\eta}. \quad (3.6)$$

In particular, $\|\sqrt{K^{\varepsilon(R)}}\|_{\infty, op} \cdot \max_{x \in \mathcal{V}_R^{\varepsilon(R)}} I_{x, \mu_R^{\varepsilon(R)}}\left(\text{Cross}_p^{\varepsilon(R)}(2R, R)\right) < 1$ if R_0 is large enough, and by applying Lemma 3.1 we obtain:

$$\begin{aligned} \frac{d}{dp} g_R(p) &\geq \frac{c}{C} \varepsilon(R) \log^{-1}\left(\frac{1}{\varepsilon(R)}\right) \sqrt{\eta \log(R) - \log\left(\frac{1}{C\varepsilon(R)}\right) - \log\left(\log\left(\frac{1}{\varepsilon(R)}\right)\right)} \\ &\geq \frac{c}{3C} \log^{-1/3}(R) \log^{-1}(\log(R)) \sqrt{\eta \log(R) - \frac{1}{3} \log\left(\frac{\log(R)}{C}\right) - \log(3 \log(\log(R)))} \\ &\geq \frac{c}{3C} \sqrt{\eta/2} \log^{1/6}(R) \log^{-1}(\log(R)) \\ &\geq \frac{c}{C} \sqrt{\eta/2} \log^{1/7}(R). \end{aligned}$$

By integrating from 0 to $p_0/2$, we get:

$$\begin{aligned} \log\left(\frac{1}{1 - \mathbb{P}\left[\text{Cross}_{p_0/2}^{\varepsilon(R)}(2R, R)\right]}\right) &\geq \log\left(\frac{\mathbb{P}\left[\text{Cross}_{p_0/2}^{\varepsilon(R)}(2R, R)\right]}{1 - \mathbb{P}\left[\text{Cross}_{p_0/2}^{\varepsilon(R)}(2R, R)\right]}\right) \\ &\geq \frac{p_0}{2} \frac{c}{C} \sqrt{\eta/2} \log^{1/7}(R) + \log\left(\frac{\mathbb{P}\left[\text{Cross}_0^{\varepsilon(R)}(2R, R)\right]}{1 - \mathbb{P}\left[\text{Cross}_0^{\varepsilon(R)}(2R, R)\right]}\right). \end{aligned}$$

By Theorem 2.13, if R_0 is large enough, there exists $C' < +\infty$ independent of $R > R_0$ such that:

$$\log\left(\frac{\mathbb{P}\left[\text{Cross}_0^{\varepsilon(R)}(2R, R)\right]}{1 - \mathbb{P}\left[\text{Cross}_0^{\varepsilon(R)}(2R, R)\right]}\right) \geq -C'.$$

Therefore:

$$\mathbb{P}\left[\text{Cross}_{p_0/2}^{\varepsilon(R)}(2R, R)\right] \geq 1 - \exp\left(-\frac{c}{2C} \sqrt{\eta/2} p_0 \log^{1/7}(R) + C'\right). \quad (3.7)$$

Now:

$$\mathbb{P}[\text{Cross}_{p_0}(2R, R)] \geq \mathbb{P}[\text{Cross}_{p_0/2}^{\varepsilon(R)}(2R, R)] - \mathbb{P}[\text{Cross}_{p_0/2}^{\varepsilon(R)}(2R, R) \setminus [\text{Cross}_{p_0}(2R, R)]],$$

and by Proposition 2.22, if R_0 is large enough, there exist constants $c_1 > 0$ and $C_2 = C_2(p_0) < +\infty$ independent of $R > R_0$ such that:

$$\begin{aligned} \mathbb{P}[\text{Cross}_{p_0/2}^{\varepsilon(R)}(2R, R) \setminus [\text{Cross}_{p_0}(2R, R)]] &\leq C_2 R^2 \varepsilon(R)^{-2} \exp(-c_1 \varepsilon(R)^{-4}) \\ &\leq C_2 \exp\left(2 \log(R) + (2/3) \log(\log(R)) - c_1 \log^{4/3}(R)\right) \\ &\leq C_2 \exp\left(-\frac{c_1}{2} \log^{4/3}(R)\right). \end{aligned}$$

Combining this estimate with Equation (3.7) we get:

$$\mathbb{P}[\text{Cross}_{p_0}(2R, R)] \geq 1 - \exp\left(-\frac{c}{2C} \sqrt{\eta/2} p_0 \log^{1/7}(R) + C'\right) - C_2 \exp\left(-\frac{c_1}{2} \log^{4/3}(R)\right).$$

All in all, for a large enough choice of R_0 , there exists $c_3 = c_3(p_0) > 0$ such that for each $R > R_0$,

$$\mathbb{P}[\text{Cross}_{p_0}(2R, R)] \geq 1 - \exp\left(-c_3 \log^{1/7}(R)\right).$$

Hence, criterion 2.2 is satisfied and we are done. \square

Remark 3.3. Note that this proof also implies that:

$$\forall p > 0, \lim_{R \rightarrow +\infty} \text{Cross}_p(2R, R) = 1, \quad (3.8)$$

which will be useful for the proof of Theorem 1.8.

Remark 3.4. Note that if we follow the above proof without taking $\varepsilon = \log^{-1/3}(R)$ but by taking any $\varepsilon \in]0, 1]$ and R larger than some constant that does not depend on ε , we obtain (2.7).

The only result that we have used in the proof of Theorem 1.3 and that we have managed to prove only for the Bargmann-Fock field is the $\frac{1}{\varepsilon} \log\left(\frac{1}{\varepsilon}\right)$ estimate on the infinite operator norm of $\sqrt{K^\varepsilon}$. We have the following more general result:

Proposition 3.5. *Assume that f satisfies Conditions 2.1, 2.2, 2.4 as well as Condition 2.3 for some $\alpha > 4$. Assume also that there exist $\delta > 0$ and $C < +\infty$ such that for every ε sufficiently small K^ε admits a symmetric square root and:*

$$\|\sqrt{K^\varepsilon}\|_{\infty, op} \leq C \frac{1}{\varepsilon^{2-\delta}}. \quad (3.9)$$

Then the critical threshold for the continuous percolation model induced by f is 0. More precisely, the probability that \mathcal{D}_p has an unbounded connected component is 1 if $p > 0$, and 0 if $p \leq 0$. Moreover, in the case where $p > 0$, if it exists, such a component is a.s. unique.

Remark 3.6. A way to prove that (3.9) is to use our results of Section 6 (where we assume that f satisfies Condition 2.1 and Condition 2.5 for some $\alpha > 5$): Define the quantity $\Upsilon(\varepsilon)$ as in Lemma 6.3. If one proves that there exists $\delta > 0$ and $C_1 < +\infty$ such that, for every ε sufficiently small, we have $\Upsilon(\varepsilon) \leq C_1 \varepsilon^{-1+\delta}$, then one obtains that there exists $C_2 < +\infty$ such that, for every ε sufficiently small:

$$\|\sqrt{K^\varepsilon}\|_{\infty, op} \leq C_2 \frac{1}{\varepsilon^{2-\delta}} \log\left(\frac{1}{\varepsilon}\right).$$

Proof of Proposition 3.5. The proof is almost identical to that of Theorem 1.3 so we will not detail elementary computations. First fix some $h > 0$ such that:

$$(-1/4 - h)(2 - \delta) + 1/2 > 0. \quad (3.10)$$

By Theorem 1.2, for every $p \leq 0$, a.s. there is no unbounded connected component in \mathcal{D}_p . We henceforth consider some parameter $p_0 \in]0, 1]$. Fix $R_0 < +\infty$ to be determined later, and let:

$$\varepsilon = \varepsilon(R) = \log^{-1/4-h}(R).$$

By Propositions 2.17 and 2.20 if R_0 is large enough, there exists $\eta > 0$ independent of $R > R_0$ and of $p \in [-1, 1]$ such that:

$$\forall x \in \mathcal{V}_R^{\varepsilon(R)}, I_{x, \mu_R^{\varepsilon(R)}} \left(\text{Cross}_p^{\varepsilon(R)}(2R, R) \right) \leq R^{-\eta}.$$

Hence, by Lemma 3.1, if R_0 is large enough:

$$\frac{d}{dp} g_R(p) \geq \frac{c}{C} \log^{(-1/4-h)(2-\delta)+1/2}(R) \sqrt{\eta/2} \log^{1/2}(R).$$

By Theorem 2.13, if R_0 is large enough, there exists $C' < +\infty$ independent of $R > R_0$ such that:

$$\log \left(\frac{\mathbb{P} \left[\text{Cross}_0^{\varepsilon(R)}(2R, R) \right]}{1 - \mathbb{P} \left[\text{Cross}_0^{\varepsilon(R)}(2R, R) \right]} \right) \geq -C'.$$

Integrating from 0 to $p_0/2$ we get:

$$\mathbb{P} \left[\text{Cross}_{p_0/2}^{\varepsilon(R)}(2R, R) \right] \geq 1 - \exp \left(-\frac{c}{2C} \frac{p_0}{2} \log^{(-1/4-h)(2-\delta)+1/2}(R) \sqrt{\eta/2} + C' \right).$$

Now, if we apply Proposition 2.22, we obtain that, if R_0 is large enough, there exist constants $c_1 = c_1(\kappa) > 0$ and $C_2 = C_2(\kappa, p_0) < +\infty$ independent of $R > R_0$ such that:

$$\begin{aligned} & \mathbb{P} [\text{Cross}_{p_0}(2R, R)] \\ & \geq \mathbb{P} \left[\text{Cross}_{p_0/2}^{\varepsilon(R)}(2R, R) \right] - C_2 \exp \left(-c_1 \log^{1+4h}(R) \right) \\ & \geq 1 - \exp \left(-\frac{c}{2C} p_0 \log^{(-1/4-h)(2-\delta)+1/2}(R) \sqrt{\eta/2} + C' \right) - C_2 \exp \left(-c_1 \log^{1+4h}(R) \right). \end{aligned}$$

Since (by (3.10)) we have $(-1/4 - h)(2 - \delta) + 1/2 > 0$, the criterion of Lemma 2.9 is satisfied and we obtain that a.s. \mathcal{D}_{p_0} has a unique unbounded component. \square

The following proof is also almost identical to that of Theorem 1.3 except that we do not have to use discretization estimates to conclude.

Proof of Theorem 2.11. Fix $\varepsilon \in]0, 1]$. By Theorem 2.12, for every $p \leq 0$, a.s., there is no unbounded black component. From now on, we fix some $p_0 \in]0, 1]$. By Lemma 2.14, it is enough to prove that f satisfies criterion (2.6). To this end we first fix $R_0 > 0$ to be determined later and we let $R > R_0$. By Proposition 2.21, there exists $C = C(\kappa, \varepsilon) < +\infty$ such that:

$$\|\sqrt{K^\varepsilon}\|_{\infty, op} \leq C.$$

Moreover by Propositions 2.17 and 2.20 if R_0 is large enough, there exists $\eta > 0$ independent of $R > R_0$ and $p \in [-1, 1]$ such that:

$$\forall x \in \mathcal{V}_R^\varepsilon, I_{x, \mu_R^\varepsilon} \left(\text{Cross}_p^\varepsilon(2R, R) \right) \leq R^{-\eta}.$$

Hence, by Lemma 3.1, if R_0 is large enough:

$$\frac{d}{dp}g_R(p) \geq \frac{c}{C} \sqrt{\frac{\eta}{2} \log(R)}.$$

By Theorem 2.13, if R_0 is large enough, there exists $C' < +\infty$ independent of $R > R_0$ such that:

$$\log \left(\frac{\mathbb{P}[\text{Cross}_0^\varepsilon(2R, R)]}{1 - \mathbb{P}[\text{Cross}_0^\varepsilon(2R, R)]} \right) \geq -C'.$$

Integrating from 0 to p_0 we get:

$$\mathbb{P}[\text{Cross}_{p_0}^\varepsilon(2R, R)] \geq 1 - \exp \left(-\frac{c}{C} p_0 \sqrt{\frac{\eta}{2} \log(R)} + C' \right).$$

Hence, f satisfies criterion 2.6 and we are done. \square

3.2 Proof of the exponential decay

In this subsection, we prove Theorem 1.8 by following classical arguments of planar percolation that involve a recursion on crossing probabilities. In order to start the induction, we use the following property: According to Equation (3.8), if f is the Bargmann-Fock field, then:

$$\forall p > 0, \mathbb{P}[\text{Cross}_p(2R, R)] \xrightarrow{R \rightarrow +\infty} 1. \quad (3.11)$$

Proof of Theorem 1.8. Let f be the Bargmann-Fock field. Let us prove that for every $p > 0$, there exists $c = c(p) > 0$ such that for every $R > 0$ we have:

$$\mathbb{P}[\text{Cross}_p(2R, R)] \geq 1 - \exp(-cR). \quad (3.12)$$

Theorem 1.8 will follow from (3.12). Indeed, by a simple gluing argument, for every $\rho_1 > 1$ and $\rho_2 > 0$, there exists $N = N(\rho_1, \rho_2) \in \mathbb{Z}_{>0}$ such that, for every $R > 0$, there exist N $\rho_1 R \times R$ rectangles such that if these rectangles are crossed lengthwise then $[0, \rho_2 R] \times [0, R]$ is also crossed lengthwise.

In order to prove (3.12), we follow classical ideas in planar percolation theory, see for instance the second version of the proof of Theorem 10 in [BR06b] or the proof of Proposition 3.1 in [ATT16]. To begin with, define the sequence $(r_k)_{k \geq 0}$ as follows. $r_0 = 1$ and for each $k \in \mathbb{N}$,

$$r_{k+1} = 2r_k + \sqrt{r_k}.$$

From this definition it easily follows that for each k , $r_k \geq 2^k$, which in turn implies that $r_{k+1} \leq (2 + 2^{-k/2})r_k$. Using this last relation one can easily show that $r_k = O(2^k)$ so that there exists $C < +\infty$ such that for each $k \in \mathbb{N}$,

$$2^k \leq r_k \leq C2^k. \quad (3.13)$$

Write:

$$a_k = 1 - \mathbb{P}[\text{Cross}_p(2r_k, r_k)] + \exp\left(-\frac{r_k}{10}\right).$$

We will show that there exists $k_0 = k_0(p) < +\infty$ such that for any $k \geq k_0$:

$$a_{k+1} \leq 49a_k^2. \quad (3.14)$$

By Equation (3.11), $\lim_{k \rightarrow +\infty} a_k = 0$. This observation combined with Equation (3.14) yields (3.12) for $R = r_k$ with $k \geq k_0$ by an elementary induction argument. But since by (3.13), the sequence $(r_k)_{k \geq 0}$, grows geometrically, one then obtains (3.12) for any $R > 0$ by elementary gluing arguments.

In order to prove Equation (3.14) we first introduce two events, see Figure 3.1. First, the event $\text{FiveCross}_p(k)$ is the event that:

- the $2r_k \times r_k$ rectangles $[(ir_k, (i+2)r_k] \times [0, r_k]$ for $i = 0, 1, 2, 3$ are crossed from left to right by a continuous path in \mathcal{D}_p ;
- the $r_k \times r_k$ squares $[jr_k, (j+1)r_k] \times [0, r_k]$ for $j = 1, 2, 3$ are crossed from top to bottom by a continuous path in \mathcal{D}_p .

Second, the event $\text{FiveCross}'_p(k)$ is the event $\text{FiveCross}_p(k)$ translated by $(0, r_k + \sqrt{r_k})$. Note that $\text{FiveCross}_p(k) \cup \text{FiveCross}'_p(k) \subseteq \text{Cross}_p(5r_k, 2r_k + \sqrt{r_k})$. Moreover, there exists $k_1 < +\infty$ such that for each $k \geq k_1$, $5r_k \geq 2r_{k+1} = 4r_{k+1} + 2\sqrt{r_k}$ so that $\text{Cross}_p(5r_k, 2r_k + \sqrt{r_k}) \subseteq \text{Cross}_p(2r_{k+1}, r_{k+1})$. Hence, for each $k \geq k_1$:

$$\mathbb{P}[\text{Cross}_p(2r_{k+1}, r_{k+1})] \geq 1 - \mathbb{P}[\neg \text{FiveCross}_p(k) \cap \neg \text{FiveCross}'_p(k)]. \quad (3.15)$$

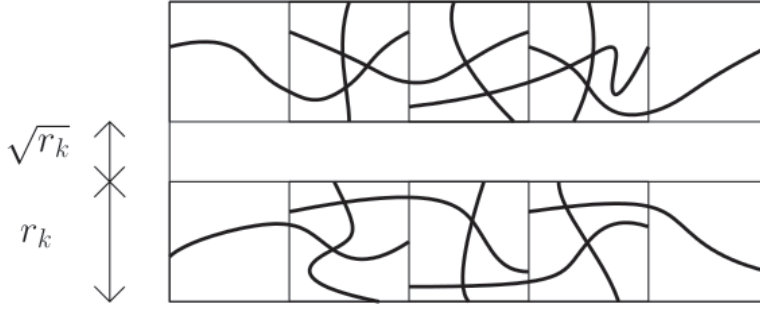

Figure 3.1 – The events $\text{FiveCross}_p(k)$ and $\text{FiveCross}'_p(k)$.

We claim that the events $\text{FiveCross}_p(k)$ and $\text{FiveCross}'_p(k)$ are asymptotically independent. More precisely, the following is a direct consequence of Theorem 1.12 from Chapter 1.

Claim 3.7. *There exists $k_2 < +\infty$ such that, for every $p \in \mathbb{R}$ and every $k \geq k_2$:*

$$\begin{aligned} |\mathbb{P}[\neg \text{FiveCross}_p(k) \cap \neg \text{FiveCross}'_p(k)] - \mathbb{P}[\neg \text{FiveCross}_p(k)] \mathbb{P}[\neg \text{FiveCross}'_p(k)]| \\ \leq O(r_k^4) e^{-\frac{\sqrt{r_k}^2}{2}} \leq e^{-\frac{r_k}{4}}. \end{aligned}$$

Let $k \geq \max\{k_1, k_2\}$. Applying Claim 3.7 in Equation (3.15), we get:

$$\begin{aligned} \mathbb{P}[\text{Cross}_p(2r_{k+1}, r_{k+1})] &\geq 1 - \mathbb{P}[\neg \text{FiveCross}_p(k)] \cdot \mathbb{P}[\neg \text{FiveCross}'_p(k)] - e^{-\frac{r_k}{4}} \\ &= 1 - \mathbb{P}[\neg \text{FiveCross}_p(k)]^2 - e^{-\frac{r_k}{4}} \quad (\text{by stationarity}). \end{aligned}$$

By a union bound we have:

$$\mathbb{P}[\neg \text{FiveCross}_p(k)] \leq 4(1 - \mathbb{P}[\text{Cross}_p(2r_k, r_k)]) + 3(1 - \mathbb{P}[\text{Cross}_p(r_k, r_k)]) \leq 7(1 - \mathbb{P}[\text{Cross}_p(2r_k, r_k)]).$$

Thus:

$$1 - \mathbb{P}[\text{Cross}_p(2r_{k+1}, r_{k+1})] \leq (7(1 - \mathbb{P}[\text{Cross}_p(2r_k, r_k)]))^2 + e^{-\frac{r_k}{4}},$$

and:

$$\begin{aligned} 49(a_k)^2 &\geq (7(1 - \mathbb{P}[\text{Cross}_p(2r_k, r_k)]))^2 + 49e^{-\frac{2r_k}{10}} \\ &\geq 1 - \mathbb{P}[\text{Cross}_p(2r_{k+1}, r_{k+1})] + 49e^{-\frac{2r_k}{10}} - e^{-\frac{r_k}{4}} \\ &\geq 1 - \mathbb{P}[\text{Cross}_p(2r_{k+1}, r_{k+1})] + e^{-\frac{2r_k + \sqrt{r_k}}{10}} \quad \text{if } k \text{ is sufficiently large} \\ &= a_{k+1}. \end{aligned}$$

This is exactly Equation (3.14). \square

4 Percolation arguments

In this section we prove Lemma 2.9 and Proposition 2.20. In doing so we also obtain Lemma 2.14.

For every $x \in \mathbb{R}^2$ and every $\rho > 0$, we set $B(x, \rho) = x + [-\rho, \rho]^2$. For every $x \in \mathbb{R}^2$ $0 < \rho_1 \leq \rho_2$, we set:

$$\text{Ann}(\rho_1, \rho_2) = [-\rho_2, \rho_2]^2 \setminus]\rho_1, \rho_2[^2,$$

and $\text{Ann}(x, \rho_1, \rho_2) = x + \text{Ann}(\rho_1, \rho_2)$.

4.1 Proof of Lemma 2.9

In this subsection, we prove Lemma 2.9. The proof of Lemma 2.9 also works for Lemma 2.14 with only a few obvious changes. For the proofs of these results, we never use the fact that our Gaussian field is non-degenerate.

Proof of Lemma 2.9. In this proof, we write $\text{Cross}_p(k) = \text{Cross}_p(2^{k+1}, 2^k)$ and we write $\text{Cross}'_p(k)$ for the event that there is a continuous path joining the bottom side of the rectangle $[0, 2^k] \times [0, 2^{k+1}]$ to its top side in $\mathcal{D}_p \cap [0, 2^k] \times [0, 2^{k+1}]$. By translation invariance and $\frac{\pi}{2}$ -rotation invariance, $\mathbb{P}[\text{Cross}'_p(k)] = \mathbb{P}[\text{Cross}_p(k)]$ for every k . Thus:

$$\sum_{k \in \mathbb{N}} \mathbb{P}[\neg(\text{Cross}_p(k) \cap \text{Cross}'_p(k))] \leq 2 \sum_{k \in \mathbb{N}} \mathbb{P}[\neg \text{Cross}_p(k)] < +\infty \text{ by assumption.}$$

Together with Borel-Cantelli lemma, it implies that a.s. there exists $k_0 \in \mathbb{N}$ such that, for every $k \geq k_0$, $\text{Cross}_p(k) \cap \text{Cross}'_p(k)$ is satisfied. Note that any crossing from left to right of $[0, 2^{k+1}] \times [0, 2^k]$ and any crossing from top to bottom of $[0, 2^{k+1}] \times [0, 2^{k+2}]$ must intersect. Similarly, any crossing from top to bottom of $[0, 2^k] \times [0, 2^{k+1}]$ and any crossing from left to right of $[0, 2^{k+2}] \times [0, 2^{k+1}]$ must intersect. All these intersecting crossings then form an unbounded connected component in \mathcal{D}_p .

Let us end the proof by showing that this unbounded component is a.s. unique. The proof follows the same overall structure: First, write $\text{Circ}_p(k)$ for the event that there is a circuit in $\mathcal{D}_p \cap \text{Ann}(2^k, 2^{k+1})$ surrounding the square $[-2^k, 2^k]^2$. Note that, if eight well-chosen $2^{k+1} \times 2^k$ rectangles are crossed lengthwise, two well-chosen $2^k \times 2^k$ squares are crossed from left to right, and two well-chosen $2^k \times 2^k$ squares are crossed from top to bottom, then $\text{Circ}_p(k)$ holds (see Figure 4.1 where we already used such a property). Since the probability that a $2^k \times 2^k$ square is crossed is at least equal to the probability that a $2^{k+1} \times 2^k$ rectangle is crossed lengthwise, we get:

$$\mathbb{P}[\neg \text{Circ}_p(k)] \leq 12\mathbb{P}[\neg \text{Cross}_p(k)].$$

Thus, as before,

$$\sum_{k \in \mathbb{N}} \mathbb{P}[\neg \text{Circ}_p(k)] < +\infty,$$

and Borel-Cantelli lemma implies that a.s. there exists k_0 such that, for every $k \geq k_0$, $\text{Circ}_p(k)$ holds. Now, note that, for any unbounded connected component, there exists k_1 such that this component crosses the annuli $\text{Ann}(2^k, 2^{k+1})$ for every $k \geq k_1$. Thus, this component contains any circuit of this annulus for every $k \geq k_0 \vee k_1$. In particular, it must be unique. \square

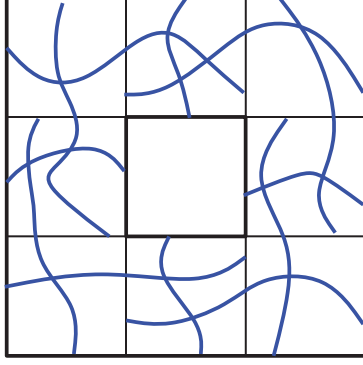

Figure 4.1 – If eight $2^{k+1} \times 2^k$ well chosen rectangles and four well chosen $2^k \times 2^k$ squares are crossed, then there is a circuit in $\text{Ann}(2^k, 2^{k+1})$.

4.2 Proof of Proposition 2.20

The goal of this subsection is to prove Proposition 2.20. To this purpose, we use the following result from Chapter 1 which is a consequence of the discrete RSW estimate and quasi-independence. Such a result goes back to [BG16] for $\alpha > 16$. Let $\varepsilon > 0$ and consider the discrete percolation model defined in Subsection 2.4. Let $\text{Arm}_p^\varepsilon(R)$ (respectively $\text{Arm}_p^{\varepsilon,*}(R)$) be the event that in this model there is a black (respectively white) path in the annulus $\text{Ann}(1, R)$ from the inner boundary of this annulus to its outer boundary. We have the following:

Proposition 4.1 ([BG16] for $\alpha > 16$, Chapter 1). ¹⁴ Assume that f satisfies Conditions 2.1, 2.2, 2.4 as well as Condition 2.3 for some $\alpha > 4$. Then, there exists $C = C(\kappa) < +\infty$ and $\eta = \eta(\kappa) > 0$ such that, for each $\varepsilon \in]0, 1]$, for each $R \in]0, +\infty[$:

$$\mathbb{P}[\text{Arm}_0^\varepsilon(R)], \mathbb{P}[\text{Arm}_0^{*,\varepsilon}(R)] \leq C R^{-\eta}.$$

To deduce Proposition 2.20 from Proposition 4.1, we need the following lemma and more particularly its consequence Corollary 4.3.

Lemma 4.2. Let $\Sigma = (\Sigma(i, j))_{0 \leq i, j \leq n}$ be a $(n+1) \times (n+1)$ symmetric positive definite matrix, let $(m_0, m) = (m_0, m_1, \dots, m_n) \in \mathbb{R}^{n+1}$ and let $(X_0, X) = (X_0, X_1, \dots, X_n) \sim \mathcal{N}((m_0, m), \Sigma)$. Assume that $\Sigma(0, i) \geq 0$ for every $i \in \{1, \dots, n\}$. Then, for every non-decreasing¹⁵ function $\varphi : \mathbb{R}^n \rightarrow \mathbb{R}$, the following quantity is non-decreasing in q :

$$\mathbb{E}[\varphi(X) \mid X_0 = q].$$

Similarly, if φ is non-increasing, then this quantity is non-increasing in q .

Proof. This is a direct consequence of the following result (see for instance Proposition 1.2 of [AW09]): Under the probability measure $\mathbb{P}[\cdot \mid X_0 = q]$, X is a Gaussian vector whose covariance matrix does not depend on q and whose mean is:

$$m + (q - m_0)v,$$

where $v = \left(\frac{\Sigma(0, i)}{\Sigma(0, 0)} \right)_{1 \leq i \leq n}$ (which has only non-negative entries). □

¹⁴More precisely, this is Proposition B.6 of Chapter 1. Moreover, this can be extracted from the proof of Theorem 5.7 of [BG16] for $\alpha > 16$ and with slightly different assumptions on the differentiability and the non-degeneracy of κ .

¹⁵For the partial order $(x_1, \dots, x_n) \leq (y_1, \dots, y_n)$ if $x_i \leq y_i$ for every $i \in \{1, \dots, n\}$.

From this lemma we deduce the following:

Corollary 4.3. *Let (X_0, X) be as in Lemma 4.2 and let $\varphi : \mathbb{R}^n \rightarrow \mathbb{R}$ be a non-decreasing function. Then, for every $p \in \mathbb{R}$ we have:*

$$\mathbb{E} \left[\varphi(X) \mid X_0 = -p \right] \leq \mathbb{E} \left[\varphi(X) \mid X_0 \geq -p \right].$$

Similarly, if φ is non-increasing, then:

$$\mathbb{E} \left[\varphi(X) \mid X_0 = -p \right] \leq \mathbb{E} \left[\varphi(X) \mid X_0 \leq -p \right].$$

Proof. Assume that φ is non-decreasing and let γ_0 be the density of X_0 , which exists because Σ is positive definite. We have :

$$\begin{aligned} \mathbb{E} \left[\varphi(X) \mid X_0 \geq -p \right] &= \frac{1}{\mathbb{P}[X_0 \geq -p]} \int_{-p}^{+\infty} \mathbb{E} \left[\varphi(X) \mid X_0 = t \right] \gamma_0(t) dt \\ &\geq \frac{1}{\mathbb{P}[X_0 \geq -p]} \mathbb{E} \left[\varphi(X) \mid X_0 = -p \right] \int_{-p}^{+\infty} \gamma_0(t) dt \\ &= \mathbb{E} \left[\varphi(X) \mid X_0 = -p \right] \end{aligned}$$

where the inequality comes from Lemma 4.2 applied with $q = -p$. \square

We are now ready to prove Proposition 2.20. As usual in percolation theory, we are going to control our p -dependent probabilities by probabilities at the self-dual point $p = 0$.

Proof of Proposition 2.20. Fix $R \geq 2$ and $\varepsilon \in]0, 1]$. Let us prove the proposition in the case $p \geq 0$. Let $x \in \mathcal{V}_R^\varepsilon$ and let $\text{Arm}_p^{\varepsilon,*}(x, R/2)$ be the event that there is a white path in $\text{Ann}(x, 1, R/2)$ from $\partial B(x, 1)$ to $\partial B(x, R/2)$. We claim that $\text{Piv}_x^p(\text{Cross}^\varepsilon(2R, R)) \subseteq \text{Arm}_p^{\varepsilon,*}(x, R/2)$. Indeed, $\text{Piv}_x^p(\text{Cross}^\varepsilon(2R, R))$ is the event that there are two white paths from the top and bottom sides of the rectangle $[0, 2R] \times [0, R]$ to two neighbors of x and two black paths from the left and right sides of $[0, 2R] \times [0, R]$ to two other neighbors of x (with an exception when x does not belong to $[0, 2R] \times [0, R]$ but is a neighbor of a point $y \in [0, 2R] \times [0, R]$ such that the edge between x and y crosses the left or right side of $[0, 2R] \times [0, R]$; in this case $\text{Piv}_x^p(\text{Cross}^\varepsilon(R))$ is the event that there is a white path from top to bottom that goes through y and a black path from y to the opposite side). In particular, at least one black path reaches a point at distance at least $R/2$ of x .

Since $\text{Arm}_p^{\varepsilon,*}(x, R/2)$ is decreasing and does not depend on $f(x)$, then (by Corollary 4.3 and with $a := \mathbb{P}[Z \leq -1]$ where $Z \sim \mathcal{N}(0, 1)$):

$$\begin{aligned} \mathbb{P} \left[\text{Arm}_p^{\varepsilon,*}(x, R/2) \mid f(x) = -p \right] &\leq \mathbb{P} \left[\text{Arm}_p^{\varepsilon,*}(x, R/2) \mid f(x) \leq -p \right] \\ &\leq \frac{\mathbb{P} \left[\text{Arm}_p^{\varepsilon,*}(x, R/2) \right]}{\mathbb{P} \left[f(x) \leq -p \right]} \\ &\leq a^{-1} \mathbb{P} \left[\text{Arm}_p^{\varepsilon,*}(x, R/2) \right] \text{ since } p \leq 1 \\ &\leq a^{-1} \mathbb{P} \left[\text{Arm}_0^{\varepsilon,*}(x, R/2) \right] \text{ since } p \geq 0. \end{aligned}$$

The result follows from Proposition 4.1 (and stationarity). The case $p \leq 0$ is treated similarly (by noting that $\text{Piv}_x^p(\text{Cross}^\varepsilon(2R, R)) \subseteq \text{Arm}_p^\varepsilon(x, R/2)$ and by studying this increasing event exactly as above). \square

5 A KKL theorem for biased Gaussian vectors: the proof of Theorem 2.19

In this section we prove Theorem 2.19. The proofs presented here do not rely on any results of the other sections. Recall that we use the following definition for influence. Given a vector $v \in \mathbb{R}^n$ and a Borel probability measure μ on \mathbb{R}^n the influence of v on A under μ is

$$I_{v,\mu}(A) = \liminf_{r \downarrow 0} \frac{\mu(A + [-r, r]v) - \mu(A)}{r} \in [0, +\infty].$$

5.1 Sub-linearity of influences implies Theorem 2.19

The aim of this subsection is to prove Theorem 2.19. That this theorem holds for product Gaussian measures is a result by Keller, Mossel and Sen, [KMS12] (see Corollary 5.2 below). In order to extend this result to general Gaussian measures, we use a sub-linearity property for influences. In the present subsection, we state this property and use it to derive Theorem 2.19 from the product case. In Subsection 5.2 (respectively in Appendix A), we prove the sub-linearity property for monotonic (respectively semi-algebraic) sets.

A KKL theorem for product Gaussian vectors The authors of [KMS12] introduce and study the notion of *geometric influences* which are defined as follows: Let ν be a probability measure on \mathbb{R} and let A be a Borel subset of \mathbb{R}^n . If $i \in \{1, \dots, n\}$, let:

$$A_i^x := \{y \in \mathbb{R} : (x_1, \dots, x_{i-1}, y, x_{i+1}, \dots, x_n) \in A\}.$$

The geometric influence of i on A under the measure $\nu^{\otimes n}$ is:

$$I_{i,\nu}^{\mathcal{G}}(A) := \mathbb{E}_{x \sim \nu^{\otimes n}} [\nu^+(A_i^x)] \in [0, +\infty],$$

where ν^+ is the lower Minkowski content, defined as follows: for all $B \subseteq \mathbb{R}$ Borel,

$$\nu^+(B) := \liminf_{r \downarrow 0} \frac{\nu(B + [-r, r]) - \nu(B)}{r} \in [0, +\infty].$$

In the case where $\mu = \nu^{\otimes n}$, $I_{i,\nu}^{\mathcal{G}}$ and $I_{i,\mu}$ are closely related. Indeed, firstly, by Fubini's Theorem and Fatou's lemma, for each Borel subset $A \subset \mathbb{R}^n$ and each $i \in \{1, \dots, n\}$,

$$I_{i,\nu^{\otimes n}}(A) = \liminf_{r \downarrow 0} \mathbb{E}_{x \sim \nu^{\otimes n}} \left[\frac{\nu(A_i^x + [-r, r]) - \nu(A)}{r} \right] \geq I_{i,\nu}^{\mathcal{G}}(A). \quad (5.1)$$

While the reverse inequality seems not true in general, we expect it to hold for a wide class of events. In particular, our Lemma 5.5 and (2.6) from [KMS12] imply that this is the case for monotonic events. Since it is not useful to us, we do not investigate this matter any further.

We will need the following result, which is a direct consequence of Item (1) of Theorem 1.5 of [KMS12]. Several results of this type can also be found in the more recent [CEL12] (see for instance the paragraph above Corollary 7 therein).

Theorem 5.1. *There exists an absolute constant $c > 0$ such that the following holds: Let $\nu = \mathcal{N}(0, 1)$ and let A be a Borel measurable subset of \mathbb{R}^n . Then:*

$$\sum_{i=1}^n I_{i,\nu}^{\mathcal{G}}(A) \geq c \nu^{\otimes n}(A) (1 - \nu^{\otimes n}(A)) \sqrt{\log_+ \left(\frac{1}{\max_{i \in \{1, \dots, n\}} I_{i,\nu}^{\mathcal{G}}(A)} \right)}.$$

Corollary 5.2. *Let ν and A be as in Theorem 5.1. Then:*

$$\sum_{i=1}^n I_{i,\nu^{\otimes n}}(A) \geq c\nu^{\otimes n}(A) (1 - \nu^{\otimes n}(A)) \sqrt{\log_+ \left(\frac{1}{\max_{i \in \{1, \dots, n\}} I_{i,\nu^{\otimes n}}(A)} \right)}.$$

Proof. This is a direct consequence of Theorem 5.1 and Equation (5.1). \square

Now, let us state a sub-linearity property for the influences that we will be proved in Subsection 5.2 and Appendix A.

Proposition 5.3. *Let Σ be a $n \times n$ symmetric positive definite matrix, let $\mu \sim \mathcal{N}(0, \Sigma)$ and let (e_1, \dots, e_n) be the canonical basis of \mathbb{R}^n . Also, let $v = \sum_{j=1}^n v_j e_j \in \mathbb{R}^n$. For every $i \in \{1, \dots, n\}$ and every A Borel subset of \mathbb{R}^n which is monotonic or semi-algebraic,¹⁶ we have:*

$$I_{v,\mu}(A) \leq \sum_{i=1}^n |v_i| I_{i,\mu}(A). \quad (5.2)$$

We expect the above result to hold for a larger class of Borel subsets A (in particular, we have not found any examples of Borel sets for which this does not hold) and not only for the decomposition on the canonical basis (see in particular Proposition A.1).

Let us now derive Theorem 2.19 from Corollary 5.2 using Proposition 5.3.

Proof of Theorem 2.19. Let $\sqrt{\Sigma}$ be a symmetric square root of Σ and let $\nu = \mathcal{N}(0, 1)$. Then, $\mu = \mathcal{N}(0, \Sigma)$ is the pushforward measure of $\nu^{\otimes n}$ by $\sqrt{\Sigma}$. Thanks to Corollary 5.2 (applied to the event $\sqrt{\Sigma}^{-1}(A)$), it is sufficient to prove the following claim. \square

Claim 5.4. *Let $\nu = \mathcal{N}(0, 1)$. We have:*

$$\max_{j \in \{1, \dots, n\}} I_{j,\nu^{\otimes n}}(\sqrt{\Sigma}^{-1}(A)) \leq \|\sqrt{\Sigma}\|_{\infty, op} \cdot \max_{i \in \{1, \dots, n\}} I_{i,\mu}(A). \quad (5.3)$$

Moreover:

$$\sum_{j=1}^n I_{j,\nu^{\otimes n}}(\sqrt{\Sigma}^{-1}(A)) \leq \|\sqrt{\Sigma}\|_{\infty, op} \cdot \sum_{i=1}^n I_{i,\mu}(A). \quad (5.4)$$

Proof. For each $j \in \{1, \dots, n\}$:

$$\begin{aligned} I_{j,\nu^{\otimes n}}(\sqrt{\Sigma}^{-1}(A)) &= \liminf_{r \downarrow 0} \frac{\nu^{\otimes n}(\sqrt{\Sigma}^{-1}(A) + [-r, r] e_j) - \nu^{\otimes n}(\sqrt{\Sigma}^{-1}(A))}{r} \\ &= \liminf_{r \downarrow 0} \frac{\mu(A + [-r, r] \sqrt{\Sigma} \cdot e_j) - \mu(A)}{r} \\ &= I_{\sqrt{\Sigma} \cdot e_j, \mu}(A). \end{aligned}$$

By using Proposition 5.3, we obtain that:

$$I_{j,\nu^{\otimes n}}(\sqrt{\Sigma}^{-1}(A)) \leq \sum_{i=1}^n |\sqrt{\Sigma}(i, j)| I_{i,\mu}(A). \quad (5.5)$$

Hence:

$$I_{j,\nu^{\otimes n}}(\sqrt{\Sigma}^{-1}(A)) \leq \sum_{i=1}^n |\sqrt{\Sigma}(i, j)| \max_{i \in \{1, \dots, n\}} I_{i,\mu}(A) \leq \|\sqrt{\Sigma}\|_{\infty, op} \max_{i \in \{1, \dots, n\}} I_{i,\mu}(A).$$

¹⁶See Appendix A for the definition of semi-algebraic sets.

Since $\sqrt{\Sigma}$ is symmetric, we obtain (5.3) by taking the supremum over j . Inequality (5.5) also implies that:

$$\begin{aligned} \sum_{j=1}^n I_{\sqrt{\Sigma} \cdot e_j, \mu}(A) &\leq \sum_{j=1}^n \sum_{i=1}^n |\sqrt{\Sigma}(i, j)| I_{i, \mu}(A) \\ &= \sum_{i=1}^n I_{i, \mu}(A) \sum_{j=1}^n |\sqrt{\Sigma}(i, j)| \\ &\leq \|\sqrt{\Sigma}\|_{\infty, op} \cdot \sum_{i=1}^n I_{i, \mu}(A), \end{aligned}$$

which is (5.4). \square

5.2 Sub-linearity of influences for monotonic events

The proof of Proposition 5.3 for monotonic events relies on the following lemma.

Lemma 5.5. *Let Σ be a $n \times n$ symmetric positive definite matrix and let $\mu = \mathcal{N}(0, \Sigma)$. Moreover, let $v \in \mathbb{R}^n$. For every A monotonic Borel subset of \mathbb{R}^n and every $i \in \{1, \dots, n\}$, we have:*

$$\exists \lim_{r \downarrow 0} \frac{\mu(A + [-r, r]e_i + [-r, r]v) - \mu(A + [-r, r]v)}{r} = I_{i, \mu}(A).$$

We first prove Proposition 5.3 using Lemma 5.5.

Proof of Proposition 5.3 in the monotonic case. Let A be a monotonic Borel subset of \mathbb{R}^n and fix $v \in \mathbb{R}^n$. Let $v^i = \sum_{k=i}^n v_k e_k$. We will prove that, for every $i \in \{1, \dots, n-1\}$:

$$I_{v^i, \mu}(A) \leq |v_i| I_{i, \mu}(A) + I_{v^{i+1}, \mu}(A). \quad (5.6)$$

The result will then follow directly by induction. For any $w_1, w_2 \subseteq \mathbb{R}^n$, we have $[-r, r](w_1 + w_2) \subseteq [-r, r]w_1 + [-r, r]w_2$. Hence:

$$\begin{aligned} \mu(A + [-r, r]v^i) &= \mu(A + [-r, r](v_i e_i + v^{i+1})) \\ &\leq \mu(A + [-|v_i|r, |v_i|r]e_i + [-r, r]v^i) \\ &= \mu(A + [-|v_i|r, |v_i|r]e_i + [-r, r]v^{i+1}) \\ &\quad - \mu(A + [-r, r]v^{i+1}) + \mu(A + [-r, r]v^{i+1}). \end{aligned}$$

By Lemma 5.5 we have:

$$\frac{\mu(A + [-|v_i|r, |v_i|r]e_i + [-r, r]v^{i+1}) - \mu(A + [-r, r]v^i)}{r} \xrightarrow{r \downarrow 0} |v_i| I_{i, \mu}(A).$$

Equation (5.6) follows. \square

Proof of Lemma 5.5. We are inspired by the proof of Proposition 1.3 in [KMS12]. We write the proof for A decreasing since the proof for A increasing is identical. Also, we prove the result in the case $i = n$. We write \tilde{x} for the first $(n-1)$ coordinates of any $x \in \mathbb{R}^n$. Let $A_r = A + [-r, r]v$, note that A_r is decreasing, and write for any $\tilde{x} \in \mathbb{R}^{n-1}$:

$$\begin{aligned} s(\tilde{x}) &:= \sup\{x_n \in \mathbb{R} : (\tilde{x}, x_n) \in A\} \in [-\infty, +\infty], \\ s_r(\tilde{x}) &:= \sup\{x_n \in \mathbb{R} : (\tilde{x}, x_n) \in A_r\} \in [-\infty, +\infty]. \end{aligned}$$

Let λ be the density function of μ . Since A and A_r are decreasing, we have:

$$\begin{aligned}\frac{\mu(A + [-r, r]e_n) - \mu(A)}{r} &= \frac{1}{r} \int_{\mathbb{R}^{n-1}} \left(\int_{s(\tilde{x})}^{s(\tilde{x})+r} \lambda(\tilde{x}, x_n) dx_n \right) d\tilde{x}, \\ \frac{\mu(A_r + [-r, r]e_n) - \mu(A_r)}{r} &= \frac{1}{r} \int_{\mathbb{R}^{n-1}} \left(\int_{s_r(\tilde{x})}^{s_r(\tilde{x})+r} \lambda(\tilde{x}, x_n) dx_n \right) d\tilde{x},\end{aligned}\quad (5.7)$$

where by convention $\int_{-\infty}^{-\infty+r} = \int_{+\infty}^{+\infty+r} = 0$. For each $\tilde{x} \in \mathbb{R}^{n-1}$ let:

$$g_1(\tilde{x}) = \sup_{x_n \in \mathbb{R}} \lambda(\tilde{x}, x_n); \quad g_2(\tilde{x}) = \sup_{x_n \in \mathbb{R}} \left| \frac{\partial \lambda}{\partial x_n}(\tilde{x}, x_n) \right|.$$

Direct computation shows that $g_1, g_2 \in L^1(\mathbb{R}^{n-1})$. By the mean value inequality, for each $\tilde{x} \in \mathbb{R}^{n-1}$:

$$\left| \frac{1}{r} \left(\int_{s(\tilde{x})}^{s(\tilde{x})+r} \lambda(\tilde{x}, x_n) dx_n \right) - \lambda(\tilde{x}, s(\tilde{x})) \right| + \left| \frac{1}{r} \left(\int_{s_r(\tilde{x})}^{s_r(\tilde{x})+r} \lambda(\tilde{x}, x_n) dx_n \right) - \lambda(\tilde{x}, s_r(\tilde{x})) \right|$$

is no greater than $2rg_2(\tilde{x})$. Combining this with Equation (5.7) we get:

$$\begin{aligned}\left| \frac{\mu(A + [-r, r]e_n) - \mu(A)}{r} - \frac{\mu(A_r + [-r, r]e_n) - \mu(A_r)}{r} \right| \\ \leq \left| \int_{\mathbb{R}^{n-1}} \lambda(\tilde{x}, s(\tilde{x})) - \lambda(\tilde{x}, s_r(\tilde{x})) d\tilde{x} \right| + 2r \int_{\mathbb{R}^{n-1}} g_2(\tilde{x}) d\tilde{x}.\end{aligned}$$

Since $g_2 \in L^1(\mathbb{R}^{n-1})$, the second integral in the last inequality is finite and independent of r . Moreover:

$$\int_{\mathbb{R}^{n-1}} \lambda(\tilde{x}, s_r(\tilde{x})) - \lambda(\tilde{x}, s(\tilde{x})) d\tilde{x} = \int_{\mathbb{R}^{n-1}} \int_{s(\tilde{x})}^{s_r(\tilde{x})} \frac{\partial \lambda}{\partial x_n}(\tilde{x}, x_n) dx_n d\tilde{x}.$$

Since $\frac{\partial \lambda}{\partial x_n} \in L^1(\mathbb{R}^n)$, by dominated convergence, all that remains is to show that for a.e. $\tilde{x} \in \mathbb{R}^{n-1}$: $s_r(\tilde{x}) \xrightarrow[r \downarrow 0]{} s(\tilde{x})$. Since for each \tilde{x} the sequence $s_r(\tilde{x})$ is decreasing, it converges to some $s_\infty(\tilde{x}) \geq s(\tilde{x})$. Let us prove that, for a.e. $\tilde{x} \in \mathbb{R}^{n-1}$, $s_\infty(\tilde{x}) = s(\tilde{x})$. To do so, first note that, since A is decreasing, we have:

$$0 \leq \mu(A_r) - \mu(A) \leq \mathbb{P} \left[X - \sum_{i=1}^n r|v_i|e_i \in A \right] - \mathbb{P}[X \in A],$$

where $X \sim \mathcal{N}(0, \Sigma)$. By dominated convergence, the right hand side tends to 0 when $r \rightarrow 0$. Now, note that:

$$\mu(A_r) - \mu(A) = \int_{\mathbb{R}^{n-1}} \int_{s(\tilde{x})}^{s_r(\tilde{x})} \lambda(\tilde{x}, x_n) dx_n d\tilde{x}.$$

Hence, by Fatou's lemma:

$$0 = \int_{\mathbb{R}^{n-1}} \int_{s(\tilde{x})}^{s_\infty(\tilde{x})} \lambda(\tilde{x}, x_n) dx_n d\tilde{x}.$$

Since the λ takes only positive values, this implies that for a.e. $\tilde{x} \in \mathbb{R}^{n-1}$, $s_\infty(\tilde{x}) = s(\tilde{x})$. \square

6 An estimate on the infinite operator norm of square root of infinite matrices: the proof of Proposition 2.21

The goal of this section is to prove Proposition 2.21. We assume that f satisfies Condition 2.1 and Condition 2.5 for some $\alpha > 5$. In particular, the Fourier transform of κ takes only positive values. Moreover, we assume that κ is C^3 and there exists $C < +\infty$ such that for every $\beta \in \mathbb{N}^2$ such that $\beta_1 + \beta_2 \leq 3$, we have:

$$|\partial^\beta \kappa(x)| \leq C|x|^{-\alpha}, \quad (6.1)$$

for some $\alpha > 5$. In this subsection, we never use the fact that our Gaussian field is non-degenerate.

Recall that for each $\varepsilon > 0$, \mathcal{T}^ε is the lattice \mathcal{T} scaled by a factor ε , that \mathcal{V}^ε is the set of vertices of \mathcal{T}^ε , and that K^ε is the restriction of K to \mathcal{V}^ε . We begin by observing that the face-centered square lattice \mathcal{T} , when rotated by $\frac{\pi}{4}$ and rescaled by $\sqrt{2}$, has the same vertices as \mathbb{Z}^2 . Since by Condition 2.5 our field is invariant by $\frac{\pi}{4}$ -rotation, **we will simply replace \mathcal{T} by \mathbb{Z}^2 throughout the rest of this section.**

Let \mathbb{T}^2 be the flat 2D torus corresponding to the circle of length 2π . Throughout this section, we will identify $\lambda\mathbb{Z}^2$ -periodic functions on \mathbb{R}^2 (for some $\lambda > 0$) with functions on $\lambda\mathbb{T}^2$ and their integrals over the box $[-\lambda\pi, \lambda\pi]^2$ with integrals over $\lambda\mathbb{T}^2$. We will use the following convention for the Fourier transform:

$$\forall \xi \in \mathbb{R}^2, \hat{\kappa}(\xi) = \frac{1}{4\pi^2} \int_{\mathbb{R}^2} e^{-i\langle \xi, x \rangle} \kappa(x) dx.$$

Let us begin with a sketch of the construction of the square root $\sqrt{K^\varepsilon}$:

1. First note that if we find some symmetric function $\eta_\varepsilon : \mathbb{Z}^2 \rightarrow \mathbb{R}^2$ such that:

$$\forall m \in \mathbb{Z}^2, \eta_\varepsilon * \eta_\varepsilon(m) := \sum_{m' \in \varepsilon\mathbb{Z}^2} \eta_\varepsilon(m') \eta_\varepsilon(m - m') = \kappa(\varepsilon m),$$

then $(\varepsilon m_1, \varepsilon m_2) \in \varepsilon\mathbb{Z}^2 \mapsto \eta_\varepsilon(m_1 - m_2)$ is a symmetric square root of K^ε .

2. Let κ_ε be κ restricted to $\varepsilon\mathbb{Z}^2$ and let us try to construct η_ε above. The first idea is that, if $\eta_\varepsilon * \eta_\varepsilon = \kappa_\varepsilon$, then the Fourier transform of η_ε should be the square root of the Fourier transform of κ_ε . In other words:

$$F(\eta_\varepsilon) = \sqrt{F(\kappa_\varepsilon)},$$

where $F(\eta_\varepsilon)(\xi) = \sum_{m \in \varepsilon\mathbb{Z}^2} \eta_\varepsilon(m) e^{-i\langle \xi, m \rangle}$ and similarly for $F(\kappa_\varepsilon)$.

3. Thus:

$$\begin{aligned} \eta_\varepsilon(m) &= F^{-1} \left(\sqrt{F(\kappa_\varepsilon)} \right) \\ &= \frac{1}{4\pi^2} \int_{\mathbb{T}^2} \sqrt{F(\kappa_\varepsilon)}(\xi) d\xi. \end{aligned}$$

4. In the expression above, it seems difficult to deal with the term $F(\kappa_\varepsilon)$. To simplify the expression, we can use the Poisson summation formula and deduce that:

$$F(\kappa_\varepsilon)(\xi) = 4\pi^2 \varepsilon^{-2} \sum_{m \in \mathbb{Z}^2} \hat{\kappa}(\varepsilon^{-1}(2\pi m - \xi)).$$

For the Bargmann-Fock process, $\hat{\kappa}$ is well known since κ is simply the Gaussian function.

There will be two main steps in the proof of Proposition 2.21. First, we will make the above construction of η_ε rigorous by considering the four items above in the reverse order. More precisely, we will first set λ_ε as in Lemma 6.1 below, then we will apply the Poisson summation formula to prove that $2\pi\varepsilon^{-1}\lambda_\varepsilon = \sqrt{F(\kappa_\varepsilon)}$. Next, we will define η_ε as in Lemma 6.1, we will show that $F(\eta_\varepsilon) = \sqrt{F(\kappa_\varepsilon)}$, and we will conclude that η_ε is a convolution square root of κ_ε . All of this will be done in the proof Lemma 6.1. Secondly, we will prove estimates on $\sum_{m \in \mathbb{Z}^2} |\eta_\varepsilon(m)|$ when $\kappa(x) = e^{-\frac{1}{2}|x|^2}$. This will be the purpose of Lemma 6.2 (and most of the proof of this lemma will be written in a more general setting than $\kappa(x) = e^{-\frac{1}{2}|x|^2}$).

In the proofs, we will use a subscript ε to denote functions $: \mathbb{Z}^2 \rightarrow \mathbb{R}$ or to denote functions defined on \mathbb{T}^2 (or equivalently functions $2\pi\mathbb{Z}^2$ -periodic). On the other hand, we will use a superscript ε to denote functions $: \varepsilon^{-1}\mathbb{Z}^2 \rightarrow \mathbb{R}$ or to denote functions defined on $\varepsilon^{-1}\mathbb{T}^2$ (or equivalently functions $2\pi\varepsilon^{-1}\mathbb{Z}^2$ -periodic).

Proposition 2.21 is a direct consequence of the following Lemmas 6.1 and 6.2.

Lemma 6.1. *Assume that f satisfies Condition 2.1 as well as Condition 2.2 for $\alpha > 5$. Fix $\varepsilon > 0$ and let:*

$$\lambda_\varepsilon : \xi \in \mathbb{R}^2 \mapsto \sqrt{\sum_{m \in \mathbb{Z}^2} \hat{\kappa}(\varepsilon^{-1}(\xi - 2\pi m))}.$$

Then, λ_ε is a C^3 , positive, even and $2\pi\varepsilon^{-1}\mathbb{Z}^2$ -periodic function. Next, define:

$$\eta_\varepsilon : m \in \mathbb{Z}^2 \mapsto \frac{1}{\varepsilon(2\pi)} \int_{\mathbb{T}^2} e^{i\langle m, \xi \rangle} \lambda_\varepsilon(\xi) d\xi.$$

Then, $(\varepsilon m_1, \varepsilon m_2) \in \varepsilon\mathbb{Z}^2 \mapsto \eta_\varepsilon(m_1 - m_2)$ is a symmetric square root of K^ε and we have:

$$\sum_{m \in \mathbb{Z}^2} |\eta_\varepsilon(m)| < +\infty.$$

Lemma 6.2. *Assume that $\kappa(x) = e^{-\frac{1}{2}|x|^2}$. Then, there exist constants $C_0 < +\infty$ and $\varepsilon_0 > 0$ such that for $\varepsilon \in]0, \varepsilon_0]$:*

$$\sum_{m \in \mathbb{Z}^2} |\eta_\varepsilon(m)| \leq C_0 \frac{1}{\varepsilon} \log \left(\frac{1}{\varepsilon} \right).$$

Proof of Lemma 6.1. First note that (6.1) implies that $\hat{\kappa}$ is C^3 and that for every $\beta \in \mathbb{N}^2$ such that $\beta_1 + \beta_2 \leq 3$, we have:

$$|\partial^\beta \hat{\kappa}(\xi)| \leq C' |\xi|^{-3}, \tag{6.2}$$

for some $C' = C'(\kappa) < +\infty$. This implies that the series under the square root of the definition of λ_ε converges in C^3 -norm towards a C^3 function. Moreover, this series is clearly $2\pi\mathbb{Z}^2$ -periodic, even, and positive (since $\hat{\kappa}$ takes only positive values). Thus, λ_ε is well defined and also satisfies these properties.

Let us now prove the second part of the lemma. For each $\varepsilon > 0$ let $\kappa_\varepsilon : \mathbb{Z}^2 \rightarrow \mathbb{R}$ be defined as $\kappa_\varepsilon(m) = \kappa(\varepsilon m)$. The discrete Fourier transform of κ_ε is:

$$F(\kappa_\varepsilon) : \xi \in \mathbb{T}^2 \mapsto \sum_{m \in \mathbb{Z}^2} \kappa_\varepsilon(m) e^{-i\langle \xi, m \rangle}$$

(since κ and its derivatives of order up to 3 decay polynomially fast with an exponent larger than 5, the above series converges in C^3 -norm). Now, since κ and $\hat{\kappa}$ decay polynomially fast with

an exponent larger than 2, we can apply the Poisson summation formula (see¹⁷ Theorem 3.1.17 of [Gra09]) which implies that:

$$\forall \xi \in \mathbb{T}^2, F(\kappa_\varepsilon)(\xi) = 4\pi^2 \varepsilon^{-2} \sum_{m \in \mathbb{Z}^2} \hat{\kappa}(\varepsilon^{-1}(2\pi m - \xi)) = 4\pi^2 \varepsilon^{-2} \lambda_\varepsilon(\xi)^2.$$

As a result:

$$\eta_\varepsilon(m) = \frac{1}{4\pi^2} \int_{\mathbb{T}^2} \sqrt{F(\kappa_\varepsilon)}(\xi) e^{i\langle m, \xi \rangle} d\xi.$$

In other words, the $\eta_\varepsilon(m)$'s are the Fourier coefficients of the C^3 , positive and $2\pi\mathbb{Z}^2$ -periodic function $\sqrt{F(\kappa_\varepsilon)}$, which implies in particular that $|\eta_\varepsilon(m)| \leq C''|m|^{-3}$ for some $C'' = C''(\kappa, \varepsilon) < +\infty$. As a result:

$$\sum_{m \in \mathbb{Z}^2} |\eta_\varepsilon(m)| < +\infty. \quad (6.3)$$

Thanks to (6.3), we can apply the Fourier inversion formula (see for instance Proposition 3.1.14 of [Gra09]) which implies that:

$$F(\eta_\varepsilon) = \sqrt{F(\kappa_\varepsilon)}. \quad (6.4)$$

Now, let us use the convolution formula (see for instance Paragraph 1.3.3 of [Rud62]). Since $\sum_{m \in \mathbb{Z}^2} |\eta_\varepsilon(m)| < +\infty$, we have:

$$\sum_{m \in \mathbb{Z}^2} \sum_{m' \in \mathbb{Z}^2} |\eta_\varepsilon(m') \eta_\varepsilon(m - m')| < +\infty, \quad (6.5)$$

and:

$$F(\eta_\varepsilon * \eta_\varepsilon) = F(\eta_\varepsilon)^2, \quad (6.6)$$

where $\eta_\varepsilon * \eta_\varepsilon : m \in \mathbb{Z}^2 \mapsto \sum_{m' \in \mathbb{Z}^2} \eta_\varepsilon(m') \eta_\varepsilon(m - m')$.

We deduce from (6.4) and (6.6) that $F(\eta_\varepsilon * \eta_\varepsilon) = F(\kappa_\varepsilon)$. Since, by the dominated convergence theorem, the Fourier coefficients of $F(\eta_\varepsilon * \eta_\varepsilon)$ are the $\eta_\varepsilon * \eta_\varepsilon(m)$'s and the Fourier coefficients of $F(\kappa_\varepsilon)$ are the $\kappa_\varepsilon(m)$'s, we obtain that:

$$\eta_\varepsilon * \eta_\varepsilon = \kappa_\varepsilon.$$

This is equivalent to saying that $(\varepsilon m_1, \varepsilon m_2) \in \varepsilon\mathbb{Z}^2 \mapsto \eta_\varepsilon(m_1 - m_2)$ is a symmetric square root of K^ε . \square

The proof of Lemma 6.2 is split into two sub-lemmas:

Lemma 6.3. *Assume that f satisfies Condition 2.1 and Condition 2.2 for $\alpha > 5$. In this lemma, we work with the function:*

$$\rho^\varepsilon : \xi \in \mathbb{R}^2 \mapsto \lambda(\varepsilon\xi) = \sqrt{\sum_{m \in \mathbb{Z}^2} \hat{\kappa}(\xi - 2\pi\varepsilon^{-1}m)}.$$

For each $\varepsilon > 0$, let:

$$\Upsilon(\varepsilon) = \max \left(\int_{\varepsilon^{-1}\mathbb{T}^2} |\rho^\varepsilon(\xi)| d\xi, \int_{\varepsilon^{-1}\mathbb{T}^2} |\Delta \rho^\varepsilon(\xi)| d\xi, \int_{\varepsilon^{-1}\mathbb{T}^2} |\partial_1 \Delta \rho^\varepsilon(\xi)| + |\partial_2 \Delta \rho^\varepsilon(\xi)| d\xi \right).$$

Then, for every $\varepsilon > 0$, $\Upsilon(\varepsilon) < +\infty$. Moreover, there exist an absolute constants $C_1 < +\infty$ and a constant $\varepsilon_1 = \varepsilon_1(\kappa) > 0$ such that for every $\varepsilon \in]0, \varepsilon_1]$ we have:

$$\sum_{m \in \mathbb{Z}^2} |\eta_\varepsilon(m)| \leq C_1 \Upsilon(\varepsilon) \frac{1}{\varepsilon} \log \left(\frac{1}{\varepsilon} \right).$$

¹⁷Be aware that the conventions used in [Gra09] are different from ours.

Lemma 6.4. *Assume that $\kappa(x) = e^{-\frac{1}{2}|x|^2}$. Then, there exists $\varepsilon_2 > 0$ such that $\sup_{\varepsilon \in]0, \varepsilon_2]} \Upsilon(\varepsilon) < +\infty$.*

Lemma 6.3 follows easily from appropriate integration by parts. The proof of Lemma 6.4 is just straightforward elementary computation and uses very crude estimates throughout.

Proof of Lemma 6.3. First note that $\Upsilon(\varepsilon) < +\infty$ comes from the fact that (by Lemma 6.1) $\lambda_\varepsilon \in C^3(\mathbb{T}^2)$, hence $\rho^\varepsilon \in C^3(\varepsilon^{-1}\mathbb{T}^2)$. Next, note that by an obvious change of variable, we have:

$$\eta_\varepsilon(m) = \frac{\varepsilon}{2\pi} \int_{\varepsilon^{-1}\mathbb{T}^2} e^{i\langle \varepsilon m, \xi \rangle} \rho^\varepsilon(\xi) d\xi.$$

Hence, $\eta_\varepsilon(0) \leq \frac{\varepsilon}{2\pi} \int_{\varepsilon^{-1}\mathbb{T}^2} |\mu_\varepsilon(\xi)| d\xi \leq \frac{\varepsilon}{2\pi} \Upsilon(\varepsilon)$. Now, let $m \neq 0$. By integration by parts, we have:

$$\eta_\varepsilon(m) = \frac{1}{2\pi\varepsilon|m|^2} \int_{\varepsilon^{-1}\mathbb{T}^2} \Delta \rho^\varepsilon(\xi) e^{i\langle \varepsilon m, \xi \rangle} d\xi, \quad (6.7)$$

and:

$$\eta^\varepsilon(m) = \frac{1}{i2\pi\varepsilon^2|m|^2(m_1 \pm m_2)} \int_{\varepsilon^{-1}\mathbb{T}^2} (\partial_1 \pm \partial_2) \Delta \rho^\varepsilon(\xi) e^{i\langle \varepsilon m, \xi \rangle} d\xi. \quad (6.8)$$

In (6.8), since $m \neq 0$, at least one of the two expressions is well defined. Thus, for each $m \in \mathbb{Z}^2$:

$$|\eta_\varepsilon(m)| \leq \frac{1}{\varepsilon} \frac{1}{2\pi} \Upsilon(\varepsilon) \min\left(\varepsilon^2, \frac{1}{|m|^2}, \frac{1}{\varepsilon|m|^2(|m_1| + |m_2|)}\right).$$

This implies that:

$$\begin{aligned} \sum_{m \in \mathbb{Z}^2} |\eta_\varepsilon(m)| &= |\eta_\varepsilon(0)| + \sum_{m \in \mathbb{Z}^2, 0 < |m| \leq \varepsilon^{-1}} |\eta_\varepsilon(m)| + \sum_{m \in \mathbb{Z}^2, |m| > \varepsilon^{-1}} |\eta_\varepsilon(m)| \\ &\leq \frac{1}{\varepsilon} \frac{1}{2\pi} \Upsilon(\varepsilon) \left(\varepsilon + \frac{1}{\varepsilon} \sum_{0 < |m| \leq \varepsilon^{-1}} \frac{1}{|m|^2} + \frac{1}{\varepsilon^2} \sum_{|m| > \varepsilon^{-1}} \frac{1}{|m|^2(|m_1| + |m_2|)} \right) \\ &\leq C'' \Upsilon(\varepsilon) \left(\varepsilon + \frac{1}{\varepsilon} \log\left(\frac{1}{\varepsilon}\right) + \frac{1}{\varepsilon} \right), \end{aligned}$$

for some $C'' < +\infty$, all this being valid for small enough values of $\varepsilon > 0$. □

Proof of Lemma 6.4. Since $\kappa(x) = e^{-\frac{1}{2}|x|^2}$ the Fourier transform of κ is

$$\hat{\kappa} : \xi \in \mathbb{R}^2 \mapsto \frac{1}{4\pi^2} \int_{\mathbb{R}^2} e^{-i\langle \xi, x \rangle} \kappa(x) dx = \frac{1}{2\pi} e^{-\frac{1}{2}|\xi|^2},$$

so that

$$\rho^\varepsilon(\xi) = \sqrt{\sum_{m \in \mathbb{Z}^2} e^{-\frac{1}{2}|\xi - 2\pi\varepsilon^{-1}m|^2}}.$$

Let $P_1 = Id$, $P_2 = \Delta$ and $P_3 = 2\partial_1\Delta$. Then:

$$\Upsilon(\varepsilon) = \max\left(\int_{\varepsilon^{-1}\mathbb{T}^2} |P_1\rho^\varepsilon(\xi)| d\xi, \int_{\varepsilon^{-1}\mathbb{T}^2} |P_2\rho^\varepsilon(\xi)| d\xi, \int_{\varepsilon^{-1}\mathbb{T}^2} |P_3\rho^\varepsilon(\xi)| d\xi\right).$$

For the last argument of the max we use the fact that ρ^ε remains unchanged when switching the two coordinates of \mathbb{R}^2 . We begin by justifying the following claim:

Claim 6.5. *There exists $C' < +\infty$ such that for each $\xi \in \varepsilon^{-1}\mathbb{T}^2$ and each $j \in \{1, 2, 3\}$,*

$$|P_j\rho^\varepsilon(\xi)| \leq C' \left(\sum_{m \in \mathbb{Z}^2} e^{-\frac{1}{13}|\xi - 2\pi\varepsilon^{-1}m|^2} \right)^3.$$

Proof. Elementary algebra shows that for each $j \in \{1, 2, 3\}$, there exists a polynomial function $Q_j : \mathbb{R}^2 \times \mathbb{R}^2 \times \mathbb{R}^2 \rightarrow \mathbb{R}$ of degree at most j such that for each $\xi \in \varepsilon^{-1}\mathbb{T}^2$, $\rho^\varepsilon(\xi)^5 P_j \rho^\varepsilon(\xi)$ equals:

$$\sum_{m_1, m_2, m_3 \in \mathbb{Z}^2} Q_j(\xi - 2\pi\varepsilon^{-1}m_1, \xi - 2\pi\varepsilon^{-1}m_2, \xi - 2\pi\varepsilon^{-1}m_3) \prod_{i=1}^3 e^{-\frac{1}{2}|\xi - 2\pi\varepsilon^{-1}m_i|^2}. \quad (6.9)$$

By using the very crude bound $\forall m \in \mathbb{Z}^2, \rho^\varepsilon(\xi) \geq e^{-\frac{1}{4}|\xi - 2\pi\varepsilon^{-1}m|^2}$, we obtain that for each $\xi \in \varepsilon^{-1}\mathbb{T}^2$, $|P_j \rho^\varepsilon(\xi)|$ is at most:

$$\begin{aligned} & \sum_{m_1, m_2, m_3 \in \mathbb{Z}^2} |Q_j(\xi - 2\pi\varepsilon^{-1}m_1, \xi - 2\pi\varepsilon^{-1}m_2, \xi - 2\pi\varepsilon^{-1}m_3)| \prod_{i=1}^3 e^{-(\frac{1}{2} - \frac{5}{3} \times \frac{1}{4})|\xi - 2\pi\varepsilon^{-1}m_i|^2} \\ &= \sum_{m_1, m_2, m_3 \in \mathbb{Z}^2} |Q_j(\xi - 2\pi\varepsilon^{-1}m_1, \xi - 2\pi\varepsilon^{-1}m_2, \xi - 2\pi\varepsilon^{-1}m_3)| \prod_{i=1}^3 e^{-\frac{1}{12}|\xi - 2\pi\varepsilon^{-1}m_i|^2}. \end{aligned}$$

Now, note that there exists a constant $C' < +\infty$ such that, for each $j \in \{1, 2, 3\}$, for each $m_1, m_2, m_3 \in \mathbb{Z}^2$, and for each $\xi \in \mathbb{R}^2$:

$$\left| Q_j(\xi - 2\pi\varepsilon^{-1}m_1, \xi - 2\pi\varepsilon^{-1}m_2, \xi - 2\pi\varepsilon^{-1}m_3) \prod_{i=1}^3 e^{-\frac{1}{12}|\xi - 2\pi\varepsilon^{-1}m_i|^2} \right| \leq C' \prod_{i=1}^3 e^{-\frac{1}{13}|\xi - 2\pi\varepsilon^{-1}m_i|^2},$$

and we are done. \square

Let us use the claim to conclude. Let $m \in \mathbb{Z}^2$ be such that $|m| \geq 2$ and $\xi \in [-\varepsilon^{-1}\pi, \varepsilon^{-1}\pi]^2$. Then, $|\xi - 2\pi\varepsilon^{-1}m| \geq \pi\varepsilon^{-1}|m|$. Therefore:

$$\begin{aligned} \sum_{m \in \mathbb{Z}^2, |m| \geq 2} e^{-\frac{1}{13}|\xi - 2\pi\varepsilon^{-1}m|^2} &\leq \sum_{m \in \mathbb{Z}^2, |m| \geq 2} e^{-\frac{\pi}{13}\varepsilon^{-2}|m|^2} \\ &\leq C'' e^{-\frac{4\pi}{13}\varepsilon^{-2}}, \end{aligned}$$

for some $C'' < +\infty$ and if ε is sufficiently small. Moreover, $\sum_{m \in \mathbb{Z}^2, |m| \leq 1} e^{-\frac{1}{13}|\xi - 2\pi\varepsilon^{-1}m|^2} \leq 5$, hence by expanding the cubed sum in Claim 6.5, we obtain that if ε is sufficiently small, then:

$$|P_j \rho^\varepsilon(\xi)| \leq C''' \left(e^{-\frac{4\pi}{13}\varepsilon^{-2}} + \sum_{m \in \mathbb{Z}^2, |m| \leq 1} e^{-\frac{1}{13}|\xi - 2\pi\varepsilon^{-1}m|^2} \right),$$

for some $C''' < +\infty$. Finally:

$$\begin{aligned} \Upsilon(\varepsilon) &\leq C''' \int_{\varepsilon^{-1}\mathbb{T}^2} \left(e^{-\frac{4\pi}{13}\varepsilon^{-2}} + \sum_{m \in \mathbb{Z}^2, |m| \leq 1} e^{-\frac{1}{13}|\xi - 2\pi\varepsilon^{-1}m|^2} \right) d\xi \\ &\leq C''' (2\pi\varepsilon)^2 e^{-\frac{4\pi}{13}\varepsilon^{-2}} + 5C''' \int_{\mathbb{R}^2} e^{-\frac{1}{13}|\xi|^2} d\xi, \end{aligned}$$

which is less than some absolute constant since we consider only ε small. \square

7 Sprinkling discretization scheme

In this section, we prove Proposition 2.22. We do not rely on arguments from other sections. Recall that $\mathcal{T} = (\mathcal{V}, \mathcal{E})$ is the square face-centered lattice and that $\mathcal{T}^\varepsilon = (\mathcal{V}^\varepsilon, \mathcal{E}^\varepsilon)$ denotes \mathcal{T} scaled by ε . Given an edge $e = (x, y)$, we take the liberty of writing “ $z \in e$ ” as a shorthand for

“ $\exists t \in [0, 1]$ such that $z = ty + (1 - t)x$ ”. For each $R > 0$ and $\varepsilon > 0$, let $\mathcal{T}_R^\varepsilon = (\mathcal{E}_R^\varepsilon, \mathcal{V}_R^\varepsilon)$ denote the sublattice of \mathcal{T}^ε generated by the edges e that intersect $[0, 2R] \times [0, R]$.

In this section, we never use the fact that our Gaussian field is non-degenerate. As we shall see at the end of this section, Proposition 2.22 is an easy consequence of the following approximation estimate.

Proposition 7.1. *Assume that f satisfies Condition 2.2 and that it is a.s. C^2 . Let $p > 0$. Given $\varepsilon > 0$ and $e = (x, y) \in \mathcal{E}^\varepsilon$, we call $\text{Fold}(e)$ the event that there exists $z \in e$ such that $f(x) \geq -\frac{p}{2}$, $f(y) \geq -\frac{p}{2}$, and $f(z) < -p$. There exist constants $c_2 = c_2(\kappa, p) > 0$ and $\varepsilon_0 = \varepsilon_0(\kappa, p) > 0$ such that for each $\varepsilon \in]0, \varepsilon_0]$ we have:*

$$\forall e \in \mathcal{E}^\varepsilon, \mathbb{P}[\text{Fold}(e)] \leq C_1 \exp(-c_2 \varepsilon^{-4}).$$

A key ingredient in proving this inequality will be the Borell-Tsirelson-Ibragimov-Sudakov (or BTIS) inequality (see Theorem 2.9 of [AW09]).

Proof of Proposition 7.1. Let us fix $e = (x, y) \in \mathcal{E}^\varepsilon$ and consider the vector v defined by $\varepsilon v = y - x$. On the event $\text{Fold}(e, \varepsilon)$, by Taylor’s inequality applied to f between points x, z and y , there exist $w_1, w_2 \in e$ such that $\partial_v f(w_1) > \frac{p|v|}{2\varepsilon}$ and $\partial_v f(w_2) < -\frac{p|v|}{2\varepsilon}$. Applying Taylor’s estimate to $\partial_v f$ between w_1 and w_2 we conclude that there exists $w_3 \in e$ such that $|\partial_{v,v}^2 f(w_3)| > \frac{p|v|}{\varepsilon^2}$. Hence:

$$\mathbb{P}[\text{Fold}(e)] \leq \mathbb{P}\left[\sup_{w \in e} |\partial_{v,v}^2 f(w)| > \frac{p|v|}{\varepsilon^2}\right].$$

Let $x_t = \varepsilon tv$ and $g_\varepsilon^v(t) = \partial_{v,v}^2 f(x_t)$. By translation invariance of f , we have:

$$\mathbb{P}\left[\sup_{w \in e} |f_{vv}(w)| > \frac{p|v|}{\varepsilon^2}\right] = \mathbb{P}\left[\sup_{t \in [0, 1]} |g_\varepsilon^v(t)| > \frac{p|v|}{\varepsilon^2}\right].$$

The strategy is to apply the BTIS inequality to g_ε^v . Note that g_ε^v is a centered Gaussian field on $[0, 1]$ which is a.s. bounded. Hence, by Theorem 2.9 of [AW09], $\mathbb{E}\left[|\sup_{t \in [0, 1]} g_\varepsilon^v(t)|\right] < +\infty$. Note that $\mathbb{E}\left[|\sup_{t \in [0, 1]} g_\varepsilon^v(t)|\right]$ is non-decreasing in ε , let $C_4 = \max_{v' \in \Gamma} \mathbb{E}\left[|\sup_{t \in [0, 1]} g_1^{v'}(t)|\right]$, and choose $\varepsilon_0 \in]0, 1]$ sufficiently small so that $\min_{v' \in \Gamma} \frac{p|v'|}{\varepsilon_0^2} > 2C_4$. Note that, by translation invariance:

$$\sigma^2 := \sup_{t \in [0, 1]} \text{Var}(g_\varepsilon^v(t)) = \text{Var}(g_\varepsilon^v(0)) = \partial_{v,v,v,v}^4 \kappa(0).$$

If $\partial_{v,v,v,v}^4 \kappa(0) = 0$, then $g_\varepsilon^v \equiv 0$ a.s. and we are done. Assume now that $\partial_{v,v,v,v}^4 \kappa(0) > 0$. Then, by the BTIS inequality (see Theorem 2.9 in [AW09]), for each $\varepsilon \in]0, \varepsilon_0]$:

$$\begin{aligned} \mathbb{P}\left[\sup_{t \in [0, 1]} |g_\varepsilon^v(t)| > \frac{p|v|}{\varepsilon^2}\right] &\leq 2\mathbb{P}\left[\sup_{t \in [0, 1]} g_\varepsilon^v(t) > \frac{p|v|}{\varepsilon^2}\right] \\ &\leq 2\mathbb{P}\left[\left|\sup_{t \in [0, 1]} g_\varepsilon^v(t) - \mathbb{E}\left[\sup_{t \in [0, 1]} g_\varepsilon^v(t)\right]\right| > \frac{p|v|}{2\varepsilon^2}\right] \\ &\leq 4 \exp\left(-\frac{1}{2\sigma^2} \left(\frac{p|v|}{2\varepsilon^2}\right)^2\right). \end{aligned}$$

Since v can take only finitely many values, we have obtain what we want. \square

Proof of Proposition 2.22. By Proposition 7.1 (and by a simple union bound), it is enough to prove that $\text{Cross}_{p/2}^\varepsilon(2R, R) \cap (\cup_e \text{Fold}(e))^c \subseteq \text{Cross}_p(2R, R)$, where the union is over each $e \in \mathcal{E}_R^\varepsilon$. Assume that for every $e \in \mathcal{E}$ $\text{Fold}(e)$ is not satisfied. Then, for each edge $e = (x, y) \in \mathcal{E}_R^\varepsilon$ which

is colored black in the discrete model of parameter $p/2$, and for each $z \in e$, we have $f(z) \geq -p$. In other words, each black edge is contained in \mathcal{D}_p . If in addition $\text{Cross}_{p/2}^\varepsilon(2R, R)$ is satisfied, then there exists a crossing of $[0, 2R] \times [0, R]$ from left to right made up of black edges. This crossing belongs to \mathcal{D}_p so that $\text{Cross}_p(2R, R)$ is satisfied. \square

A An additional sub-linearity result for influences

In this section, we prove that geometric influences are sub-linear for semi-algebraic sets. The following results are not useful for the proof of the main results of the chapter. However, they are useful for the proof of Theorem 2.19 in the case of semi-algebraic sets. This case is included in the theorem in order to provide a more complete picture of the range of application of Theorem 2.19.

Let us first recall their definition. Given $A \subseteq \mathbb{R}^n$, we denote by ∂A its topological boundary. Moreover, for each $k \in \mathbb{N}$, we denote by \mathcal{H}^k the k -dimensional Hausdorff measure. We say that A is semi-algebraic if it belongs to the Boolean algebra generated by sets B of the form $P^{-1}(]0, +\infty[)$ where $P \in \mathbb{R}[X_1, \dots, X_n]$.

We say that A has piecewise C^1 -boundary if there exists $E \subseteq \partial A$ satisfying $\mathcal{H}^{n-1}(E) = 0$ such that for each $x \in \partial A \setminus E$ there exists an open neighborhood $U \subseteq \mathbb{R}^n$ of x and a C^1 -diffeomorphism from U to an open subset $V \subseteq \mathbb{R}^n$ sending $A \cap U$ to the intersection of V and the closed upper-half plane.

The goal of this subsection is to prove the following proposition.

Proposition A.1. *Let Σ be a symmetric positive definite $n \times n$ matrix. Let $\mu = \mathcal{N}(0, \Sigma)$ and let λ be density of μ . Let $A \subseteq \mathbb{R}^n$ be a semi-algebraic set. Then, for each $v \in \mathbb{R}^n$:*

$$\exists \lim_{r \downarrow 0} \frac{1}{r} \int_{A+[-r,r]v \setminus A} \lambda(x) dx = I_{v,\mu}(A),$$

and we have the following properties.¹⁸

$$\begin{aligned} \forall r \in \mathbb{R}, v \in \mathbb{R}^n, I_{rv,\mu}(A) &= |r| I_{v,\mu}(A), \\ \forall u, v \in \mathbb{R}^n, I_{u+v,\mu}(A) &\leq I_{u,\mu}(A) + I_{v,\mu}(A). \end{aligned}$$

The semi-algebraic case of Proposition 5.3 follows directly from this result. We prove Proposition A.1 at the end of this subsection.

Remark A.2. As is apparent in its proof, the assumptions made in Proposition A.1 can be substantially weakened. For the sake of simplicity, we did not attempt to prove it in full generality.

Definition A.3. Let $\varphi : \mathbb{R}^n \rightarrow \mathbb{R}$ be a measurable function. For any $\delta > 0$, we denote by $\bar{\varphi}_\delta$ the function defined by $\forall x \in \mathbb{R}^n, \bar{\varphi}_\delta(x) = \sup_{|y-x| < \delta} |\varphi(y)|$. A set $A \subseteq \mathbb{R}^n$ will be called φ -tame if A has piecewise C^1 -boundary and if there exists $\delta > 0$ such that:

$$\int_{\partial A} \bar{\varphi}_\delta(x) d\mathcal{H}^{n-1}(x) < +\infty.$$

Here, the integral coincides with the usual surface-area integral $\int \bar{\varphi}_\delta d\sigma_S$ on S the C^1 part of ∂A .

A key step in the proof of Proposition A.1 is the following result.

¹⁸These properties amount to saying that $v \mapsto I_{v,\mu}(A)$ defines a seminorm on \mathbb{R}^n .

Proposition A.4. Fix $\varphi \in C(\mathbb{R}^n, \mathbb{R})$. Let $A \subseteq \mathbb{R}^n$ be a φ -tame set. Let ν be the outward normal vector of A defined \mathcal{H}^{n-1} -almost everywhere on ∂A . Then, for each $v \in \mathbb{R}^n$:

$$J_{v,\varphi}(A) := \lim_{r \downarrow 0} r^{-1} \int_{(A+[-r,r]v) \setminus A} \varphi(x) dx = \int_{\partial A} |v \cdot \nu(x)| \varphi(x) d\mathcal{H}^{n-1}(x).$$

The following result is an immediate consequence of the proposition.

Corollary A.5. Fix $\varphi \in C(\mathbb{R}^n, \mathbb{R}_+)$. Let $A \subseteq \mathbb{R}^n$ be a φ -tame set. Then, we have the following relations.

$$\begin{aligned} \forall \lambda \in \mathbb{R}^n, v \in \mathbb{R}^n, J_{\lambda v, \varphi}(A) &= |\lambda| J_{v, \varphi}(A), \\ \forall u, v \in \mathbb{R}^n, J_{u+v, \varphi}(A) &\leq J_{u, \varphi}(A) + J_{v, \varphi}(A). \end{aligned}$$

In order to prove Proposition A.4, we introduce the following notation. Let $\pi_1 : \mathbb{R}^n \rightarrow \mathbb{R}^{n-1}$ (respectively $\pi_2 : \mathbb{R}^n \rightarrow \mathbb{R}$) be the projection on the first $n-1$ coordinates (respectively last coordinate). Given $x \in \mathbb{R}^n$, we write $\tilde{x} := \pi_1(x)$. Given $A \subseteq \mathbb{R}^n$ and $\tilde{x} \in \mathbb{R}^{n-1}$ and $r > 0$, we write $A_r(\tilde{x}) = \pi_2(\pi_1^{-1}(\tilde{x}) \cap ((A + [-r, r]e_n) \setminus A)) = \{x_n \in \mathbb{R} : (\tilde{x}, x_n) \in (A + [-r, r]e_n) \setminus A\}$.

The proof of Proposition A.4 will rely on two lemmas which we state along the way and prove at the end of the subsection.

Proof of Proposition A.4. First note that it is enough to prove the result for φ non-negative and for $v \in \mathbb{S}^{n-1}$. Since the statement is invariant by rotations, it is enough to prove the result for $v = e_n := (0, \dots, 0, 1)$.

Next, we introduce some notation. From this point on, we assume that A has piecewise C^1 -boundary. Let $E \subseteq \partial A$ such that $\mathcal{H}^{n-1}(E) = 0$ and $S = \partial A \setminus E$ is a C^1 -hypersurface of \mathbb{R}^n . Since π_1 is a Lipschitz map, $\mathcal{H}^{n-1}(\pi_1(E)) = 0$. Let $\pi = \pi_1|_S$. This function is of class C^1 so by Sard's lemma the set $\text{Crit}_{val}(\pi)$ of its critical values has measure 0 in \mathbb{R}^{n-1} . For each $x \in S$, write $B_r(x) = \pi_2(\pi_1^{-1}(\{x\} + [-r, r]e_n) \setminus A)$. Finally, for any $r > 0$ let:

$$\begin{aligned} F_r : \mathbb{R}^{n-1} &\rightarrow [0, +\infty] \\ \tilde{x} &\mapsto r^{-1} \int_{A_r(\tilde{x})} \varphi(\tilde{x}, t) dt. \end{aligned}$$

For any $r > 0$, by Fubini's theorem,

$$r^{-1} \int_{(A+[-r,r]e_n) \setminus A} \varphi(x) dx = \int_{\mathbb{R}^{n-1}} \left[r^{-1} \int_{A_r(\tilde{x})} \varphi(\tilde{x}, t) dt \right] d\tilde{x} = \int_{\mathbb{R}^{n-1}} F_r(\tilde{x}) d\tilde{x}. \quad (\text{A.1})$$

In order to prove Proposition A.4 we will apply the dominated convergence theorem to the sequence $(F_r)_{r>0}$ as $r \downarrow 0$. In order to do so, we begin by finding a uniform bound on the sequence $(F_r)_{r>0}$ by an integrable function. Let us make two observations:

- Each $\tilde{x} \in \mathbb{R}^{n-1} \setminus (\pi_1(E) \cup \text{Crit}_{val}(\pi))$, \tilde{x} is a regular value of π so: for each $x \in \pi^{-1}(\tilde{x})$, $e_n \notin T_x S$ and there exists $r' = r'(x) > 0$ such that for each $r \in]0, r']$:

$$B_r(x) =]x_n, x_n + r] \text{ or } [x_n - r, x_n[\quad (\text{A.2})$$

and

$$\forall y \in \pi^{-1}(\tilde{x}) \setminus \{x\}, B_r(x) \cap B_r(y) = \emptyset.$$

(In particular, $\pi^{-1}(\tilde{x})$ is countable and has no accumulation point.)

- For each $\tilde{x} \in \mathbb{R}^{n-1} \setminus (\pi_1(E) \cup \text{Crit}_{\text{val}}(\pi))$ and each $r > 0$, since $\varphi \geq 0$ and $A_r(\tilde{x}) = \cup_{x \in \pi^{-1}(\tilde{x})} B_r(x) \subseteq \pi_2(\pi^{-1}(\tilde{x}) + [-r, r]e_n)$, we have:

$$F_r(\tilde{x}) = r^{-1} \int_{A_r(\tilde{x})} \varphi(\tilde{x}, t) dt \leq \sum_{x \in \pi^{-1}(\tilde{x})} r^{-1} \int_{B_r(x)} \varphi(\tilde{x}, t) dt \quad (\text{A.3})$$

$$\leq 2 \sum_{x \in \pi^{-1}(\tilde{x})} \bar{\varphi}_r(x) =: 2G_r(\tilde{x}). \quad (\text{A.4})$$

By construction, the sequence $(G_r)_{r>0}$ is pointwise non-increasing in r . We wish to prove that G_r is integrable for r small enough. To do so, we use the following lemma, which is a direct application of the coarea formula.

Lemma A.6. *For any non-negative measurable function $\psi : S \rightarrow \mathbb{R}$, the function $\tilde{x} \mapsto \sum_{x \in \pi^{-1}(\tilde{x})} \psi(x)$ is measurable on $\mathbb{R}^{n-1} \setminus \text{Crit}_{\text{val}}(\pi)$ with values in $[0, +\infty]$ and satisfies:*

$$\int_{\mathbb{R}^{n-1}} \sum_{x \in \pi^{-1}(\tilde{x})} \psi(x) d\tilde{x} = \int_S |\nu(x) \cdot e_n| \psi(x) d\sigma_S(x),$$

where $d\sigma_S$ is the standard surface-area measure on S .

By Lemma A.6, for each $r > 0$ and almost each $\tilde{x} \in \mathbb{R}^{n-1}$:

$$\int_{\mathbb{R}^{n-1}} G_r(\tilde{x}) d\tilde{x} = \int_S |\nu(x) \cdot e_n| \bar{\varphi}_r(x) d\mathcal{H}^{n-1}(x)$$

(remember Definition A.3: the integral above coincide with the integral under $d\sigma_S$). Moreover, since A is φ -tame, there exists $r_0 > 0$ such that:

$$\int_S |\nu(x) \cdot e_n| \bar{\varphi}_{r_0}(x) d\mathcal{H}^{n-1}(x) \leq \int_S \bar{\varphi}_{r_0}(x) |d\mathcal{H}^{n-1}(x)| < +\infty.$$

In summary, for each $r \in]0, r_0]$ and almost every $\tilde{x} \in \mathbb{R}^{n-1}$, by (A.4) we have:

$$F_r(\tilde{x}) \leq 2G_r(\tilde{x}) \leq 2G_{r_0}(\tilde{x}). \quad (\text{A.5})$$

Moreover, G_{r_0} is integrable. This will allow us to apply the dominated convergence theorem once we have established pointwise convergence, which is given by the following lemma:

Lemma A.7. *For a.e. $\tilde{x} \in \mathbb{R}^{n-1}$,*

$$F_r(\tilde{x}) \xrightarrow{r \downarrow 0} \sum_{x \in \pi^{-1}(\tilde{x})} \varphi(x).$$

By Lemma A.6, the limit $\sum_{x \in \pi^{-1}(\tilde{x})} \varphi(x)$ is a measurable function of \tilde{x} . By Equation (A.5), the family $(F_r)_{r>0}$ is pointwise bounded for $r \in]0, r_0]$ by an integrable function, namely G_{r_0} . By dominated convergence,

$$\int_{\mathbb{R}^{n-1}} F_r(\tilde{x}) d\tilde{x} \xrightarrow{r \downarrow 0} \int_{\mathbb{R}^{n-1}} \sum_{x \in \pi^{-1}(\tilde{x})} \varphi(x) d\tilde{x}.$$

We replace the left-hand side using Equation (A.1) and the right-hand side using Lemma A.6 to get:

$$\int_{A+[-r,r]e_n \setminus A} \varphi(x) dx \xrightarrow{r \downarrow 0} \int_S |\nu(x) \cdot e_n| \varphi(x) |dV_S|(x) = \int_{\partial A} |\nu(x) \cdot e_n| \varphi(x) d\mathcal{H}^{n-1}(x).$$

□

Proof of Lemma A.6. Let $\psi : S \rightarrow \mathbb{R}$ be a measurable non-negative function. As a C^1 -hypersurface of \mathbb{R}^n , S is naturally endowed with a Riemannian metric by restriction of the Euclidean scalar product. By the coarea formula (see Corollary 13.4.6 of [BZ88]) applied to π , the function

$$\begin{aligned} \mathbb{R}^{n-1} &\rightarrow \mathbb{R} \\ \tilde{x} &\mapsto \sum_{x \in \pi^{-1}(\tilde{x})} \psi(x) \end{aligned}$$

is measurable, and:

$$\int_{\mathbb{R}^{n-1}} \sum_{x \in \pi^{-1}(\tilde{x})} \psi(x) d\tilde{x} = \int_S |J_\pi(x)| \psi(x) d\mathcal{H}^{n-1}(x),$$

where $J_\pi(x)$ is the determinant of the matrix of $d_x\pi$ between orthonormal bases of T_xS and \mathbb{R}^{n-1} . The map $d_x\pi$ is the projection on the first $n-1$ coordinates. Based on this information, we claim that $J_\pi(x) = \pm\nu_n(x) = \pm\nu(x) \cdot e_n$. If $T_xS = \mathbb{R}^{n-1} \times \{0\}$ then $d_x\pi$ acts as the identity so $J_\pi(x) = 1$. On the other hand, if $T_xS \neq \mathbb{R}^{n-1} \times \{0\}$, then the intersection of these two hyperplanes is a linear subspace $H_x \subseteq \mathbb{R}^n$ of dimension $n-2$. Let $u(x)$ (respectively $v(x)$) be a unit vector spanning the orthogonal to H_x in T_xS (respectively $\mathbb{R}^{n-1} \times \{0\}$). Since $d_x\pi$ is an orthogonal projection, it preserves H_x as well as its orthogonal, so $J_\pi(x) = \pm d_x\pi(u(x)) \cdot v(x) = \pm u(x) \cdot v(x)$. Note that the vectors $u(x), \nu(x), e_n, v(x)$ all belong to the plane orthogonal to H_x in \mathbb{R}^n . Since $v(x)$ is orthogonal to e_n and $u(x)$ is orthogonal to $\nu(x)$, $u(x) \cdot v(x) = \pm\nu(x) \cdot e_n$. Thus, $J_\pi(x) = \pm\nu(x) \cdot e_n$ as announced. Hence,

$$\int_{\mathbb{R}^{n-1}} \sum_{x \in \pi^{-1}(\tilde{x})} \psi(x) d\tilde{x} = \int_S |e_n \cdot \nu(x)| \psi(x) d\mathcal{H}^{n-1}(x).$$

□

Proof of Lemma A.7. First note that, by Equation (A.2) (and since φ is continuous), for each $\tilde{x} \in \mathbb{R}^{n-1} \setminus (\pi_1(E) \cup \text{Crit}_{val}(\pi))$:

$$r^{-1} \int_{B_r(x)} \varphi(\tilde{x}, t) dt \xrightarrow[r \downarrow 0]{} \varphi(x). \quad (\text{A.6})$$

Let us use (A.6) and (A.3) to prove that if for a.e. $\tilde{x} \in \mathbb{R}^{n-1} \setminus (\pi_1(E) \cup \text{Crit}_{val}(\pi))$, we have:

$$\limsup_{r \downarrow 0} r^{-1} \int_{A_r(\tilde{x})} \varphi(\tilde{x}, t) dt \leq \sum_{x \in \pi^{-1}(\tilde{x})} \varphi(x). \quad (\text{A.7})$$

To prove the above, one can use the dominated convergence theorem, which can be applied by noting that for every $r \in]0, r_0]$, $r^{-1} \int_{B_r(x)} \varphi(\tilde{x}, t) dt \leq \bar{\varphi}_{r_0}(x)$ and that $\sum_{x \in \pi^{-1}(\tilde{x})} \bar{\varphi}_{r_0}(x) = G_{r_0}(\tilde{x})$ is a.e. finite since it is integrable.

Let us now study the liminf. Equation (A.2) implies that, for each $\tilde{x} \in \mathbb{R}^{n-1} \setminus \text{Crit}_{val}(\pi)$ and each $y_1, \dots, y_k \in \pi^{-1}(x)$, there exists $r_1 > 0$ such that for each $r \in]0, r_1]$, the intervals $B_r(y_j)$ for $j = 1, \dots, k$ have length r and are pairwise disjoint. Hence, for each $r \in]0, r_1]$,

$$r^{-1} \int_{A_r(\tilde{x})} \varphi(\tilde{x}, t) dt \geq \sum_{j=1}^k r^{-1} \int_{B_r(y_j)} \varphi(\tilde{x}, t) dt.$$

Taking the liminf followed by the supremum over all such y_1, \dots, y_k we have, by Equation (A.6):

$$\liminf_{r \downarrow 0} r^{-1} \int_{A_r(\tilde{x})} \varphi(\tilde{x}, t) dt \geq \sum_{x \in \pi^{-1}(\tilde{x})} \varphi(x).$$

Together with Equation (A.7) this concludes the proof of the lemma. □

We are now ready to prove Proposition [A.1](#)

Proof of Proposition [A.1](#). Let $P \in \mathbb{R}[X_1, \dots, X_n]$ and let $A = P^{-1}(]0, +\infty[)$. Then A has piecewise C^1 -boundary $\tilde{Y} := \partial A = P^{-1}(0)$, which is the image of a projective algebraic hypersurface $Y \subseteq \mathbb{R}P^n$ by a standard chart.¹⁹ Let $g \in C^\infty(\mathbb{R}^n)$ be the density of the Fubini-Study volume measure on $\mathbb{R}P^n$ when read in a canonical chart. Since \tilde{Y} is piecewise C^1 , we have:

$$\int_{\tilde{Y}} g(x) d\mathcal{H}^{n-1}(x) = \int_{\tilde{Y}} g(y) d\sigma(y) = \text{Vol}_{\mathbb{R}}(Y) < +\infty,$$

where $\text{Vol}_{\mathbb{R}}(Y)$ is the volume of Y with respect to the Fubini-Study measure (which is finite: see for instance [[Mon12](#)], Corollary [A.2](#)) and $d\sigma$ is the usual area measure (see Theorem [3.2.3](#) of [[Fed69](#)]). For each $x \in \mathbb{R}^n$, $g(x) = \frac{4}{(1+|x|^2)^2}$. In particular, for each $\delta > 0$ there exists $C_\delta < +\infty$ such that $\bar{g}_\delta \leq C_\delta g$. This shows that A is g -tame. Moreover, note that there exists a constant $C < +\infty$ such that $0 \leq \lambda \leq Cg$, where λ is the density of our Gaussian measure μ . Thus, A is λ -tame. Since this is valid for any set of the form $P^{-1}(]0, +\infty[)$ and since the set of tame sets is clearly stable by complement, finite union and finite intersection, any semi-algebraic set is λ -tame. We conclude by applying Corollary [A.5](#) to $\varphi = \lambda$. \square

¹⁹Indeed, \tilde{Y} is a finite union of irreducible components each of whose singular set is a proper algebraic variety, and thus has (algebraic) dimension at most $n - 2$. Moreover the intersection of two such components has also at most dimension $n - 2$. By induction, each of these algebraic submanifolds is a finite union of smooth manifolds of dimension $\leq n - 2$ and so has Hausdorff dimension $\leq n - 2$.

Transition de phase pour la percolation de lignes de niveau de champs gaussiens planaires lisses

Travail en commun avec Stephen Muirhead

Ce chapitre est, à des détails mineurs près, la reproduction de l'article [V3], intitulé "The sharp phase transition for level set percolation of smooth planar Gaussian fields" et disponible sur Hal et Arxiv.

Résumé en français. Nous démontrons l'existence d'un phénomène de transition de phase pour les propriétés de connexion de lignes de niveau d'une grande classe de champs gaussiens planaires. En plus d'hypothèses de positivité des corrélations, nous supposons que la covariance de ces champs décroît à vitesse polynomiale avec un exposant strictement plus grand que 2. Nous montrons par ailleurs que la transition de phase est "nette" dans le sens que, dans la phase sous-critique, les probabilités de connexion convergent vers 0 à vitesse sur-polynomiale. Dans nos preuves, nous utilisons de façon centrale l'écriture des champs gaussiens à l'aide d'un bruit blanc planaire. Cette écriture nous permet de développer de nouvelles méthodes de preuve de quasi-indépendance inspirées par la théorie des fonctions booléennes. Par ailleurs, la structure produit du bruit blanc nous permet d'utiliser l'inégalité d'OSSS et ainsi d'appliquer les méthodes d'étude des transitions de phase développées par Duminil-Copin, Raoufi et Tassion.

English abstract. We prove that the connectivity of the level sets of a wide class of smooth centred planar Gaussian fields exhibits a phase transition at the zero level that is analogous to the phase transition in Bernoulli percolation. In addition to symmetry, positivity and regularity conditions, we assume only that correlations decay polynomially with exponent larger than two. We also prove that the phase transition is *sharp*, demonstrating, without any further assumption on the decay of correlations, that in the sub-critical regime crossing probabilities decay faster than any polynomial. Key to our methods is the white-noise representation of a Gaussian field; we use this on the one hand to prove new quasi-independence results, inspired by the notion of influence from Boolean functions, and on the other hand to establish sharp thresholds via the OSSS inequality for i.i.d. random variables, following the recent approach of Duminil-Copin, Raoufi and Tassion.

Contents

1	Introduction	144
1.1	Gaussian fields and percolation	145
1.2	Statement of the main results	146
1.3	A family of examples	151
1.4	The percolation universality class	152
1.5	Overview of rest of the chapter	152
1.6	Acknowledgments	152
2	Overview of our methods and outline of the proof	153
2.1	Truncation and discretisation	153
2.2	The OSSS inequality	155
2.3	Outline of the proof	157
3	Gaussian techniques	158
3.1	Notation for sub- σ -algebras	158
3.2	Consequences of the assumptions	158
3.3	Varying the level via the Cameron–Martin theorem	161
3.4	Comparison to truncated and discretised versions of the field	165
4	Quasi-independence and RSW estimates	167
5	A first description of the phase transition	171
5.1	Sprinkling	171
5.2	Connecting Russo’s formula to the OSSS influences	172
5.3	Applying the OSSS inequality	174
6	Proof of the main results	177

1 Introduction

In recent years the strong links between the geometry of smooth planar Gaussian fields and percolation have become increasingly apparent, and it is now believed that the connectivity of the level sets of a wide class of smooth, stationary planar Gaussian fields exhibits a sharp phase transition that is analogous to the phase transition in, for instance, Bernoulli percolation.

To discuss these links more precisely, let us fix notation. Let f be a stationary, centred, continuous Gaussian field on \mathbb{R}^2 with covariance kernel

$$\kappa(x) = \mathbb{E}[f(0)f(x)] , \quad x \in \mathbb{R}^2.$$

The level sets and (upper-)excursion sets of f will be denoted

$$\mathcal{L}_\ell = \{x : f(x) = -\ell\} \quad \text{and} \quad \mathcal{E}_\ell = \{x : f(x) \geq -\ell\} , \quad \ell \in \mathbb{R};$$

the use of $-\ell$ instead of ℓ in these definitions is solely for convenience – in particular \mathcal{E}_ℓ is then increasing in both f and ℓ – and makes no difference to the content of our results.

In percolation theory, one is interested in the geometry of macroscopic components in random sets. A question of major interest is the existence of an unbounded connected component (when such a component exists, one says that the random set *percolates*). By analogy with other planar percolation models, it is natural to expect that the model exhibits a phase transition at the critical level $\ell_c = 0$ (since f is centred, $\ell = 0$ is the ‘self-dual’ point). More precisely, if f is ergodic one expects the following phase transition at criticality:

- If $\ell \leq 0$, then almost surely the connected components of \mathcal{E}_ℓ are bounded;
- If $\ell > 0$, then almost surely \mathcal{E}_ℓ has a unique unbounded connected component.

A rough analogy is that of water flooding the infinite landscape formed by the graph of f : if $\ell < 0$ then the landscape consists of an infinite landmass that contains lakes, whereas if $\ell > 0$ then instead it consists of islands surrounded by an infinite ocean. See Figure 1.1 for a simulation of the excursion sets of a stationary planar Gaussian field at (i) the zero level, and (ii) a level slightly above zero, illustrating the dramatic change in the connectivity.

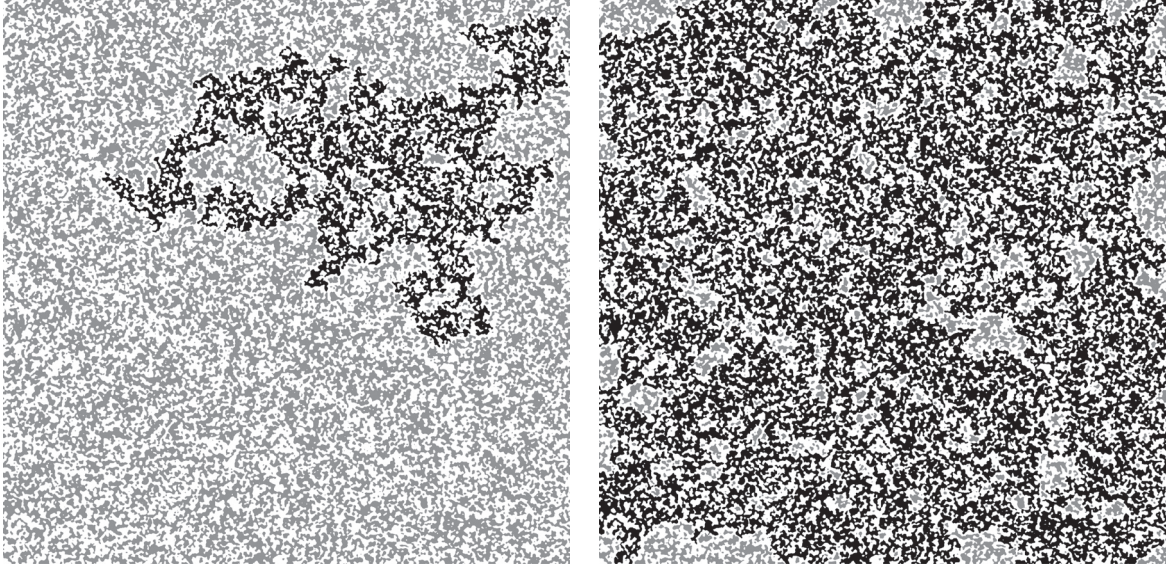

Figure 1.1 – A simulation of the excursion set \mathcal{E}_ℓ of the *Bargmann-Fock* field restricted to a large square (in grey) at (i) the zero level $\ell = 0$ (left figure), at (ii) the level $\ell = 0.1$ (right figure), with the connected component of greatest area distinguished (in black). The Bargmann-Fock field is the stationary, centred Gaussian field with covariance kernel $\kappa(x) = e^{-|x|^2/2}$. Credit: Dmitry Beliaev.

The primary aim of this chapter is to establish, under mild conditions on f , the existence of such a phase transition at the zero level. This is the analogue, for smooth planar Gaussian fields, of the celebrated result of Kesten [Kes80] establishing the phase transition for (Bernoulli) bond percolation on the square lattice.

We further establish a quantitative description of the phase transition, demonstrating that it is *sharp*. More precisely, if $\ell < 0$ we give bounds on how rapidly crossing probabilities decay on large scales – the decay is faster than any polynomial without any further assumptions, and is exponential if correlations decay fast enough – and also show that the ‘near-critical window’ is polynomial in size.

1.1 Gaussian fields and percolation

Early works to consider rigorously the connections between the geometry of planar Gaussian fields and percolation focused mainly on (i) the zero level $\ell = 0$, and (ii) very high levels $\ell \gg 1$. To the best of our knowledge the first such works were [MS83a, MS83b, MS86], in which it was shown that if κ is sufficiently smooth and absolutely integrable then there exists a $\ell^* \in \mathbb{R}$ such that almost surely there is an unbounded component in \mathcal{E}_ℓ at every level $\ell \geq \ell^*$. Later it was shown [Ale96a], using very different techniques, that under the assumptions of ergodicity (implied by the absolute integrability of κ) and positive correlations (i.e. $\kappa \geq 0$) the level sets never percolate, i.e. almost surely there is no unbounded component in \mathcal{L}_ℓ for any $\ell \in \mathbb{R}$.

Given these results, and by analogy with Bernoulli percolation (see below), it was natural to expect that under mild conditions (for instance if κ is positive, integrable and sufficiently smooth) the connectivity of the level sets undergoes a phase transition at the zero level as described above. In Chapter 2 this conjecture was established for the *Bargmann-Fock* field, whose covariance kernel is a Gaussian function and in particular decays extremely rapidly. In this work the exact form of the covariance kernel was crucial, since the proof required explicit Fourier-type calculations to be performed.¹ As mentioned above, one of the main results of the present chapter is to establish the conjecture under mild conditions on the covariance kernel; indeed we use only slightly stronger conditions than those mentioned above (to be precise, we require a ‘strong’ positivity assumption, sufficient symmetry, polynomial decay of correlations with exponent $\beta > 2$, and sufficient smoothness).

In classical percolation theory the phase transition is often described in a more quantitative manner. For example, if the percolation model is critical then so-called *Russo-Seymour-Welsh estimates* (RSW) hold, which are bounds on the probability that a domain is crossed that are uniform in the scale of the domain. On the other hand, if the model is sub-critical then crossing probabilities decay exponentially in the scale of the domain – this is often referred to as the *sharpness* of the phase transition.

Recently, such statements have been proven also for the level sets and excursion sets of smooth planar Gaussian fields. The pioneering work was [BG16] in which it was shown that, assuming correlations decay polynomially with exponent at least $\beta \approx 325$, both \mathcal{L}_0 and \mathcal{E}_0 satisfy equivalents of the RSW estimates. Although the necessary decay assumptions on κ have been progressively weakened (see [BM18] and Chapter 1), the state of the art still requires correlations to decay polynomially with exponent $\beta > 4$, much faster than that implied by the mere integrability of the covariance kernel (which corresponds roughly to $\beta > 2$). For sub-critical levels $\ell < 0$, Chapter 2 established the exponential decay of crossing probabilities in the special case of the Bargmann-Fock field.

A secondary aim of this chapter is to establish quantitative descriptions of the phase transition. In particular, working under the same mild conditions as mentioned above (in particular, under the assumption $\beta > 2$), we show that if $\ell < 0$ then domains are crossed by \mathcal{E}_ℓ with probability that decays, in the scale of the domain, faster than any polynomial (the precise rate depends on our assumptions, and is exponential if correlations decay fast enough), whereas if $\ell = 0$ then RSW estimates hold. We remark that, although our results are inspired by the works mentioned above, our methods are completely independent and quite distinct (except for the use of Tassion’s method [Tas16]); see Section 2 for an overview of our methods, and how they relate to previous work.

1.2 Statement of the main results

Recall that f denotes a stationary, centred planar Gaussian field with covariance kernel κ (we exclude the degenerate case $f \equiv 0$). To state the additional assumptions that we impose on f we introduce the *spectral measure* μ , defined as the Fourier transform of the covariance kernel κ :

$$\kappa(x) = \int e^{2\pi i \langle x, s \rangle} d\mu(s);$$

such a measure always exists by Bochner’s theorem, and satisfies $\mu(-A) = \mu(A)$ for all Borel sets A (since κ is stationary), and $\int d\mu = \kappa(0)$.

¹More precisely, in Chapter 2 the phase transition at the zero level was established for the continuous Bargmann-Fock field, as well as for discrete, stationary, positively correlated Gaussian fields whose covariance decays polynomially with exponent $\beta > 4$.

Henceforth we shall always work under the assumption that μ is absolutely continuous with respect to the Lebesgue measure; we denote by ρ^2 the density of μ , and refer to this as the *spectral density*. Note that $\rho \in L^2(\mathbb{R}^2)$ since $\|\rho\|_{L^2} = \int d\mu = \kappa(0) \in (0, \infty)$.

The existence of the spectral density ρ^2 guarantees that f is ergodic [NS16, Appendix B], and also that $\kappa(x) \rightarrow 0$ as $|x| \rightarrow \infty$ (by the Riemann-Lebesgue lemma). On the other hand, in the context of previous results this assumption is not so strong, being for instance weaker than the condition that the covariance kernel κ is absolutely integrable (and so also weaker than the condition that correlations decay polynomially with exponent $\beta > 2$), a key assumption in previous works.

The existence of the spectral density is fundamental for our analysis because it is equivalent to the existence of the *white-noise representation* of f , i.e. the fact that

$$f \stackrel{d}{=} q \star W \tag{1.1}$$

for q a non-zero function in $L^2(\mathbb{R}^2)$ satisfying $q(-x) = q(x)$, where \star denotes convolution and W is a planar white-noise; we give more details on this representation in Sections 2 and 3.2 below. To relate (1.1) to the existence of the spectral density ρ^2 , note that we can define

$$q = \mathcal{F}[\rho] \tag{1.2}$$

where $\mathcal{F}[\cdot]$ denotes the Fourier transform; it is simple to check that q possesses the required properties, namely that $q(-x) = \mathcal{F}[\rho](-x) = \mathcal{F}[\rho](x) = q(x)$, and $\|q\|_{L^2} = \|\rho\|_{L^2} = \|\rho^2\|_{L^1}$.

Conversely, if $q(-x) = q(x)$ and $q \in L^2$, then we can define $f = q \star W$ and $\rho = \mathcal{F}[q]$, which ensures that f is a stationary, centred planar Gaussian field with spectral density ρ^2 and covariance kernel²

$$\kappa = \mathcal{F}[\rho^2] = \mathcal{F}[\rho \cdot \rho] = \mathcal{F}[\rho] \star \mathcal{F}[\rho] = q \star q.$$

Henceforth it will be convenient to work with (1.1) as the *definition* of f and with $\rho = \mathcal{F}[q]$ as the definition of ρ . To ensure f enjoys some additional properties, we need to impose certain regularity conditions on q , which we take to hold throughout the chapter:

Assumption 1.1 (Regularity). The function q is not identically zero, is in L^2 , and for every $x \in \mathbb{R}^2$, $q(-x) = q(x)$. Moreover, q is C^3 and there exist $\varepsilon, c > 0$ such that, for every multi-index α such that $|\alpha| \leq 3$, $|\partial^\alpha q(x)| \leq c|x|^{-(1+\varepsilon)}$. Finally, the support of $\rho = \mathcal{F}[q]$ contains an open set.

We collect important consequences of Assumption 1.1 in Section 3.2. Here we simply mention that this assumption ensures (by dominated convergence) that $\kappa = q \star q$ is C^6 which permits us to define f as a continuous modification of $q \star W$ (indeed f will be almost surely C^2), and also guarantees that, for each $\ell \in \mathbb{R}$, the level set \mathcal{L}_ℓ almost surely consists of a collection of simple curves.

Remark 1.2. In addition to f , we shall also consider in this chapter *uncountable* families of Gaussian fields f_r, f_r^ε and f^ε , indexed by $r \geq 1$ and $\varepsilon > 0$, constructed using the white-noise W . Although the existence of a *simultaneous* modifications of these fields such that they are *all* continuous is not obvious, this is not essential for us since we will only ever consider either: i) fixed parameters r and ε ; or ii) limits as $r \rightarrow \infty$ or $\varepsilon \rightarrow 0$ in order to deduce a result for f , for which we can always work with countable subsequences.

For our main results to hold, we shall need some or all of the following additional assumptions on q :

²Indeed, we use the following definition of the planar white noise: W is a centred Gaussian field indexed by $L^2(\mathbb{R}^2)$ such that $\mathbb{E} \left[\int q_1(y) dW(y) \int q_2(y) dW(y) \right] = \int q_1(y) q_2(y) dy$.

Assumption 1.3 (D_4 Symmetry). The function q is symmetric under both (i) reflection in the x -axis, and (ii) rotation by $\pi/2$ about the origin.

Assumption 1.4 (Weak or strong positivity).

1. (Weak positivity) $\kappa = q \star q \geq 0$;
2. (Strong positivity) $q \geq 0$.

Assumption 1.5 (Polynomial or strong exponential decay of correlations).

1. (Polynomial decay with exponent $\beta > 0$) There exists a constant $c > 0$ such that, for every $|x| > 1$ and multi-index α such that $|\alpha| \leq 1$,

$$|\partial^\alpha q(x)| < c|x|^{-\beta}; \quad (1.3)$$

2. (Strong exponential decay) There exists constants $c > 0$ such that, for every $x \in \mathbb{R}^2$ and multi-index α such that $|\alpha| \leq 1$,

$$|\partial^\alpha q(x)| < ce^{-|x| \log^2(|x|)}.$$

We emphasise that the polynomial decay condition (1.3) is a slightly stronger version of the assumption, appearing in previous works, that $\kappa(x) = O(|x|^{-\beta})$. Moreover, these assumptions are equivalent for $\beta > 2$ if $q \geq 0$ is also assumed. Observe also that Assumption 1.1 implies that (1.3) holds for some $\beta > 1$, and on the other hand, if (1.3) holds for $\beta > 2$, then $\rho = F[q]$ contains an open set since it is continuous and not identically zero.

Although we have chosen to state Assumptions 1.3 and 1.4 in terms of q , they have natural analogues for the spectral measure μ . First, the weak positivity condition in Assumption 1.4 is equivalent to the spectral density ρ^2 being positive-definite, whereas strong positivity is equivalent to ρ being positive-definite. Second, Assumption 1.3 is equivalent to any of ρ , μ , κ or the law of f satisfying the same symmetries. We remark also that sufficient conditions for Assumptions 1.1 and 1.5 could be given in terms of the spectral density ρ^2 using classical results from Fourier analysis.

We are now ready to state our first theorem, establishing the phase transition at the zero level under the above conditions:

Theorem 1.6 (The phase transition at the zero level). *Suppose that Assumptions 1.1 and 1.3 hold, that the strong positivity condition in Assumption 1.4 holds, and also that Assumption 1.5 holds for a given $\beta > 2$. Then the following are true:*

- If $\ell \leq 0$, then almost surely the connected components of \mathcal{E}_ℓ are bounded;
- If $\ell > 0$, then almost surely \mathcal{E}_ℓ has a unique unbounded connected component.

Since $f = -f$ in law, the same result holds for \mathcal{E}_ℓ^c , the complement of the excursion set. We can also state a version of the result for ‘thickenings’ of the zero level set, i.e. $\mathcal{L}_0^\varepsilon = \{x : |f(x)| \leq \varepsilon\}$:

Theorem 1.7 (The phase transition for thickened zero level sets). *Under the same conditions as in Theorem 1.6:*

- If $\varepsilon = 0$, then almost surely the connected components of $\mathcal{L}_0^\varepsilon$ are bounded;
- If $\varepsilon > 0$, then almost surely $\mathcal{L}_0^\varepsilon$ has a unique unbounded connected component.

Remark 1.8. Our assumptions are stronger than in the early works [MS83a, MS83b, Ale96a] described in Section 1.1, and so Theorem 1.6 was already known for $\ell \leq 0$ and for ℓ sufficiently large. What is new is the statement that \mathcal{E}_ℓ percolates at *every* positive level $\ell > 0$, which was previously only known in the case of the Bargmann-Fock field, see Chapter 2.

This statement is the analogue, for smooth planar Gaussian fields, of Kesten’s celebrated result for (Bernoulli) bond percolation on the square lattice, which we recall now. Fix $p \in [0, 1]$ and colour each edge of the square lattice \mathbb{Z}^2 black independently with probability p . Harris [Har60] showed that at the ‘self-dual’ point, $p = 1/2$, there are almost surely no unbounded black clusters (i.e. unbounded components of the sub-graph of black edges). Much later, Kesten famously proved [Kes80] the existence of a phase transition at the ‘self-dual’ point, i.e. showed that if $p > 1/2$ then almost surely there is a (unique) unbounded black cluster.

Remark 1.9. Theorems 1.6 and 1.7 require the strong positivity condition $q \geq 0$, which can be contrasted with previous works (see the discussion in Section 1.1) that assumed only weak positivity $\kappa \geq 0$. We do not believe strong (as opposed to weak) positivity to be fundamental to the result, and in fact we suspect it could be removed (at the expense of the full strength of Theorem 1.15 below), although we do not pursue this here. In fact, strong positivity is only used at a single place in the proof (see the discussion in Section 5.2).

We also remark that an (apparently) even stronger positivity condition (often called *total positivity*) holds for the discrete planar Gaussian free field (GFF), and was a crucial ingredient in recently obtained results that bare some similarities to ours [Rod15] (although in a very different setting).

Remark 1.10. Our techniques and results likely extend to the setting of sequences of smooth Gaussian fields on compact manifolds such as the sphere or flat torus, as in [BMW17], although additional technical difficulties may arise. Similar results likely hold also for many classes of non-Gaussian fields (e.g. chi-squared fields, shot-noise etc.), which could have potential applications in physics [Wei82] and in the statistical testing of spatial noise [BEL17]. However, many of our techniques are tailored to the Gaussian setting, so would not immediately apply to other classes of fields.

We next turn to a quantitative description of the phase transition, and show in particular that it is *sharp*. For this we need to introduce notation for *crossing events*. For each $r > 0$ and $x \in \mathbb{R}^2$, let $B_r(x) = \{y \in \mathbb{R}^2 : |x - y| \leq r\}$ denote the Euclidean ball with radius r centred at x , and abbreviate $B_r = B_r(0)$. Define a *quad* Q to be a simply-connected piece-wise smooth compact domain $D \subset \mathbb{R}^2$ together with two disjoint boundary arcs γ and γ' . One can take, for instance, D to be a rectangle and γ and γ' to be opposite edges.

For each quad Q and level ℓ , let $\text{Cross}_\ell(Q)$ denote the event that there is a connected component of \mathcal{E}_ℓ that crosses Q , i.e., whose intersection with Q intersects both γ and γ' . Similarly, for $0 < r_1 < r_2$, let $\text{Arm}_\ell(r_1, r_2)$ denote the event that there is a connected component of \mathcal{E}_ℓ that intersects both ∂B_{r_1} and ∂B_{r_2} . Note that our assumptions on f and Q ensure that each of these events is measurable.

Theorem 1.11 (Sharpness of the phase transition). *Suppose that Assumptions 1.1 and 1.3 hold, that the weak positivity condition in Assumption 1.4 holds, and that Assumption 1.5 holds for a given $\beta > 2$. Then for every quad Q*

$$\inf_{s>0} \mathbb{P}(f \in \text{Cross}_0(sQ)) > 0 \quad \text{and} \quad \sup_{s>0} \mathbb{P}(f \in \text{Cross}_0(sQ)) < 1,$$

and moreover there exist $c_1, c_2 > 0$ such that, for each $0 < r < R$,

$$\mathbb{P}(f \in \text{Arm}_0(r, R)) < c_1 \left(\frac{r}{R}\right)^{c_2}.$$

Suppose in addition that the strong positivity condition in Assumption 1.4 holds. Then the following are true:

- If $\ell < 0$, then for every quad Q there exist $c_1, c_2 > 0$ such that, for all $s \geq 1$,

$$\mathbb{P}(f \in \text{Cross}_\ell(sQ)) < c_1 e^{-c_2 \log^2(s)}. \quad (1.4)$$

- If $\ell > 0$, then for every quad Q there exist $c_1, c_2 > 0$ such that, for all $s \geq 1$,

$$\mathbb{P}(f \in \text{Cross}_\ell(sQ)) > 1 - c_1 e^{-c_2 \log^2(s)}. \quad (1.5)$$

Suppose, moreover, that the strong exponential decay condition of Assumption 1.5 holds. Then (1.4) and (1.5) remain valid with $c_1 e^{-c_2 \log^2(s)}$ replaced by $c_1 e^{-c_2 s}$.

Remark 1.12. The first statement of Theorem 1.11 gives analogues of the RSW estimates in critical percolation theory (see for instance [Gri99, BR06b]), which have previously been established under stronger conditions on the decay of correlations (roughly corresponding to $\beta > 4$, see Chapter 1). The statement about $\text{Arm}(r, R; \mathcal{G})$ is the analogue of the *one-arm decay* in percolation theory, and follows in a straightforward way from the RSW estimates (at least, if a preliminary ‘quasi-independence’ property has been established; see Theorem 4.2). Remark that for these statements we need only the weak positivity condition $\kappa \geq 0$.

Remark 1.13. The second and third statements of Theorem 1.11 give quantitative bounds on crossing probabilities in ‘non-critical’ regimes; previously such bounds had only been established for the Bargmann-Fock field, see Chapter 2.

In the case $\ell < 0$, the statement is a bound on the decay of crossing probabilities in the sub-critical regime, showing in particular that sub-critical crossing probabilities decay faster than any polynomial, and decay exponentially under the ‘strong exponential decay’ assumption. In the setting of Bernoulli percolation, sub-critical crossing probabilities are known to decay exponentially (for bond percolation on the square lattice this is also due to Kesten [Kes80]). While we suspect that sub-critical crossing probabilities also decay exponentially even if correlations decay only polynomially, we were unable to deduce this from our proof.

In the case $\ell > 0$, the second statement is a quantitative description of the claim in Theorem 1.6 that \mathcal{E}_ℓ percolates, and in fact we use this statement to infer the percolation of \mathcal{E}_ℓ via a simple Borel-Cantelli argument.

Finally, we remark that if correlations decay at an intermediate rate between polynomial and exponential, our proof would yield bounds in (1.4) and (1.5) that lie between $c_1 e^{-c_2 \log^2(s)}$ and $c_1 e^{-c_2 s}$, but for simplicity we prefer not to work at this level of generality.

Remark 1.14. Similar results to those in Theorem 1.11 could also be deduced for the level sets \mathcal{L}_ℓ – i.e. defining the crossing events $\text{Cross}_\ell(sQ)$ relative to \mathcal{L}_ℓ rather than \mathcal{E}_ℓ – but we have chosen to omit such results. A notable exception is (1.5), which does not hold for \mathcal{L}_ℓ .

One consequence of Theorem 1.11 is that, for each $\ell > 0$ and quad Q ,

$$\mathbb{P}[f \in \text{Cross}_\ell(sQ)] \rightarrow 1 \quad \text{as } s \rightarrow \infty. \quad (1.6)$$

A natural question is to determine how slowly a positive sequence $\ell_s \rightarrow 0$ must decay in order to ensure that (1.6) still holds for $\ell = \ell_s$; in other words, to quantify the size of the *near-critical window*. Our next result shows that this window is of polynomial size, just as it is for Bernoulli percolation.

Theorem 1.15 (Polynomial bounds on the near-critical window). *Suppose that Assumptions 1.1 and 1.3 hold, that the weak positivity condition in Assumption 1.4 holds, and that Assumption 1.5 holds for a given $\beta > 2$. Then for each $c_1 > 1$ and every quad Q ,*

$$\limsup_{s \rightarrow \infty} \mathbb{P}[f \in \text{Cross}_{s^{-c_1}}(sQ)] < 1.$$

Suppose in addition that the strong positivity condition in Assumption 1.4 holds. Then there exists a $c_2 > 0$ such that, for every quad Q ,

$$\lim_{s \rightarrow \infty} \mathbb{P}[f \in \text{Cross}_{s^{-c_2}}(sQ)] = 1.$$

Remark 1.16. Again by analogy with Bernoulli percolation, it is natural to conjecture that the near-critical window is of polynomial size with exponent exactly $3/4$, i.e. the conclusion of Theorem 1.15 is true for every $0 < c_2 < 3/4 < c_1$. Our result shows that the exponent is strictly positive and at most 1. This is comparable to what is known for bond percolation on the square lattice, for which the exponent has been shown to be strictly positive and *strictly* less than 1, see [Kes87] (on the other hand, for site percolation on the triangular lattice the conjecture is known in full [SW01]).

1.3 A family of examples

In this section we introduce a family of smooth planar Gaussian fields that illustrates the generality and scope of our results.

Consider the *rational quadratic* kernel (sometimes also called the *Student-t* kernel)

$$\text{RQ}_\beta(r) = (1 + |r|^2)^{-\beta/2}, \quad \beta > 2,$$

which is continuous, isotropic and positive-definite on \mathbb{R}^2 ; this kernel is extensively used in the modelling of spatial data, see, e.g., [RW06, Chapter 4].

Fix a value of the parameter $\beta > 2$ and let $q = \text{RQ}_\beta$, which satisfies the necessary conditions for the white-noise representation to be valid. The Fourier transform of q is known [Pou99, Chapter 17], and is given by

$$\rho(x) = \mathcal{F}[q](x) \propto |x|^{\beta/2-1} K_{\beta/2-1}(|x|),$$

where $K_n(z)$ is the modified Bessel function of the second kind. Hence, for each value of the parameter $\beta > 2$, $f = q \star W$ is a stationary planar Gaussian field with spectral density

$$\rho^2(x) = (\mathcal{F}[q])^2(x) \propto |x|^{\beta-2} K_{\beta/2-1}^2(|x|).$$

Observe that each of Assumptions 1.1 and 1.3, and the strong positivity condition in Assumption 1.4, are easily verified. Moreover, one can check that the decay condition in Assumption 1.5 is satisfied for β .

Given the discussion above, we see that our results apply to this planar Gaussian field for all valid settings of the parameter $\beta > 2$. On the other hand, the covariance kernel of this field satisfies

$$\kappa(x) \sim c|x|^{-\beta}, \quad \text{as } |x| \rightarrow \infty,$$

and so none of the previous results in the literature apply to this field unless $\beta > 4$, and even then only the RSW estimates of Theorem 1.11 were known, see Chapter 1. In particular, the results in Theorems 1.6 and 1.11 in the case $\ell > 0$, and the result in Theorem 1.15, were not previously known for *any* value of $\beta > 2$.

1.4 The percolation universality class

A major unresolved question raised by our work is to determine how rapidly correlations must decay in order for the connectivity of the level sets of a smooth Gaussian field to be well-described on large scales by Bernoulli percolation, i.e. to determine the boundary of the ‘percolation universality class’.

In the physics literature, the ‘Harris criterion’ (see, e.g., [Wei84]) is a well-known heuristic that determines whether long-range correlations influence large scale properties of discrete percolation models. Translated to our setting, the criterion suggests that the percolation universality class is determined by the convergence of

$$\frac{1}{R^{5/2}} \int_{x \in B_R} \int_{y \in B_R} \kappa(x - y) dx dy,$$

which is roughly equivalent to demanding that κ has polynomial decay with exponent $\beta > 3/2$ (compared to $\beta > 2$ that is required in our results). It is an interesting question whether the Harris criterion can be formalised into a rigorous description of the universality class.

Further, the analogy with Bernoulli percolation should go beyond even the results in Theorems 1.6, 1.11 and 1.15. For instance, one might expect that the zero level sets \mathcal{L}_0 should, on large scales, behave similarly to the so-called SLE_6 process (or, more precisely, the CLE_6 loop ensemble [She09]), which is widely-believed to describe the scaling limit of the boundaries of clusters in Bernoulli percolation. This has been conjectured in particular for the random plane wave (RPW) [BDS07], which is a universal Gaussian model for eigenfunctions of the Laplacian on generic (i.e. chaotic) smooth manifolds. The RPW has correlations that decay extremely slowly – only at rate $1/\sqrt{R}$ – but since the correlations are highly oscillatory, the Harris criterion is nevertheless still satisfied [BS07].

There are also certain Gaussian fields for which the level sets are known not to resemble percolation clusters on large scales. For example, it is known that the ‘level lines’ of the planar GFF are SLE_4 processes [SS99], and so the GFF lies in an entirely different universality class to percolation.

1.5 Overview of rest of the chapter

In Section 2 we present an overview of our methods and give a general outline of the proof of the main results. In Section 3 we collect the arguments that are particular to the Gaussian setting of our work. In Section 4 we establish the crucial ‘quasi-independence’ property for crossing events, and use it to deduce the RSW estimates for $\ell = 0$ that comprise the first statement of Theorem 1.11. We also deduce from the RSW estimates the first statement of Theorem 1.15. In Section 5 we begin our study of the sharp phase transition, establishing a qualitative description of the phase transition for crossings of a fixed rectangle at large scales. Finally, in Section 6 we bootstrap the aforementioned result to complete the proof of the main results.

1.6 Acknowledgments

The authors are grateful to Dmitry Beliaev and Alejandro Rivera for many fruitful discussions, and to Dmitry Beliaev in particular for suggesting Kolmogorov’s theorem as a way to prove Lemma 3.12, and also for kindly allowing the use of his simulations in Figures 1.1 and 5.1. Additionally the first author would like to thank Jeremiah Buckley, Naomi Feldheim, Michael McAuley and Mihail Poplavskiy, and the second author would like to thank Vincent Beffara, Charles-Édouard Bréhier, Hugo Duminil-Copin, Thibault Espinasse, Christophe Garban, Damien Gayet, Thomas Letendre, Aran Raoufi, Avelio Sepúlveda and Vincent Tassion, who all assisted with helpful discussions.

2 Overview of our methods and outline of the proof

Compared to previous works on the links between Gaussian fields and percolation, our methods contain several new techniques that we emphasise here:

- First, our overarching methodology is to work *directly in the continuum*, rather than restricting the Gaussian field to a lattice as was done in all previous works on the topic (with the exception of [Ale96a]). This opens up new techniques, such as our application of the Cameron–Martin theorem to control the effect of varying the level (this is inspired by similar arguments in the analysis of Boolean functions, see Section 3.3). On the other hand, we do ‘discretise’ the field by approximating it by a random variable taking values in finite dimensional subspaces of the set of continuous planar functions.
- Second, we exploit heavily the white-noise representation of a Gaussian field in (1.1). Even though this representation is well-known in other contexts (see, e.g., [Hig02], or [Mal69, Cuz76] for a closely-related representation), as far as we know it has never been used to study the connectivity of level sets. We give more details on how we use this representation immediately below.
- Third, we establish the sharpness of the phase transition by appealing to recent advances in the study of randomised algorithms, and in particular the development of the *OSSS inequality*; this is inspired by recent applications of similar ideas to various discrete models [AB17, DCRT17a, DCRT17b, DCRT18]. Again we give more details immediately below.

In the rest of this section we (i) describe how we exploit the white-noise representation, (ii) explain the OSSS inequality and how we apply it, and (iii) give a brief outline of the proof.

2.1 Truncation and discretisation

The white-noise representation is useful because of two operations – *truncation* and *discretisation* – that allow us to couple f to other Gaussian fields which are close to f with high probability but have desirable properties.

Truncation. Recall that we take (1.1) to be the definition of f . For each $r \geq 1$, let $\chi_r : \mathbb{R}^2 \rightarrow [0, 1]$ be a smooth isotropic approximation of the radial cut-off function $\mathbb{1}_{|\cdot| \leq r/2}$. More precisely, we ask that χ_r is smooth, isotropic, and satisfies

$$\chi_r(x) = \begin{cases} 1, & \text{if } |x| \leq r/2 - 1/4, \\ 0, & \text{if } |x| \geq r/2, \end{cases}$$

and that the k^{th} derivatives of χ_r , for all $k \geq 1$, are uniformly bounded in $x \in \mathbb{R}^2$ and $r \geq 1$. Abbreviate $q_r = q\chi_r$, and observe that q_r satisfies Assumption 1.1, for all $r \geq 1$, whenever q does (except for the fact that q_r may be identically zero for small r). Hence, for each $r \geq 1$ we can define the stationary centred planar Gaussian field

$$f_r = q_r \star W.$$

We call this the *r-truncation* of f , and note that it is an r -dependent centred Gaussian field, meaning that

$$\mathbb{E}[f_r(0)f_r(x)] = 0, \quad \text{for all } |x| \geq r.$$

Moreover, we have good control on the difference $f - f_r$ since, by definition,

$$(f - f_r)(\cdot) = ((q - q_r) \star W)(\cdot) = \int (q - q_r)(\cdot - u) dW(u).$$

As we show in Section 3, under Assumptions 1.1 and 1.5 we can control this difference well in the sup-norm on compact sets, which is what we shall need for our application to crossing events (see Section 2.3 for more detail on this application).

Discretisation. Next, for each $\varepsilon > 0$ we couple the white-noise W to a discretised version W^ε at scale ε by setting

$$\eta_v = \varepsilon^{-1} \int_{x \in v + [-\varepsilon/2, \varepsilon/2]^2} dW(x), \quad v \in \varepsilon\mathbb{Z}^2,$$

and defining

$$W^\varepsilon(x) = \varepsilon^{-1} \sum_{v \in \varepsilon\mathbb{Z}^2} \eta_v \mathbb{1}_{x \in v + [-\varepsilon/2, \varepsilon/2]^2}.$$

Note that the η_v are distributed as i.i.d. standard Gaussian variables. As we show in Proposition 3.3, under suitable assumptions on q each $\varepsilon > 0$ gives rise to a planar Gaussian field via

$$f^\varepsilon = q \star W^\varepsilon.$$

We call this the ε -discretisation of f , and note that it is *stationary with respect to lattice shifts* $x \mapsto x + v$, $v \in \varepsilon\mathbb{Z}^2$.

Similarly as for f_r , in Section 3 we show how Assumption 1.1 allows us to control the sup-norm of $f - f^\varepsilon$. To give an idea how this is done, let us rewrite the map $x \mapsto f^\varepsilon(x)$ in a slightly different form. For each continuous function $g : \mathbb{R}^2 \rightarrow \mathbb{R}$ and each $\varepsilon > 0$ and $x \in \mathbb{R}^2$, let $g^{x,\varepsilon}$ be defined by setting, for each $v \in \varepsilon\mathbb{Z}^2$ and $u \in v + [-\varepsilon/2, \varepsilon/2]^2$,

$$g^{x,\varepsilon}(x + u) = \varepsilon^{-2} \int_{w \in v + [-\varepsilon/2, \varepsilon/2]^2} g(x + w) dw. \quad (2.1)$$

i.e. $g^{x,\varepsilon}$ is a piece-wise constant function that takes its average value on each face of the shifted lattice $x + (\varepsilon/2, \varepsilon/2) + \varepsilon\mathbb{Z}^2$; we call $g^{x,\varepsilon}$ the *piece-wise constant approximation of g* . With this definition, we can express $f^\varepsilon(x)$ as

$$\begin{aligned} f^\varepsilon(x) &= (q \star W^\varepsilon)(x) = \varepsilon^{-1} \sum_{v \in \varepsilon\mathbb{Z}^2} \eta_v \int_{u \in v + [-\varepsilon/2, \varepsilon/2]^2} q(x - u) du \\ &= \sum_{v \in \varepsilon\mathbb{Z}^2} \left(\int_{u \in v + [-\varepsilon/2, \varepsilon/2]^2} dW(u) \right) \left(\varepsilon^{-2} \int_{u \in v + [-\varepsilon/2, \varepsilon/2]^2} q(x - u) du \right) \\ &= \sum_{v \in \varepsilon\mathbb{Z}^2} \int_{u \in v + [-\varepsilon/2, \varepsilon/2]^2} q^{x,\varepsilon}(x - u) dW(u) \\ &= \int q^{x,\varepsilon}(x - u) dW(u) = (q^{x,\varepsilon} \star W)(x). \end{aligned}$$

The interchange of sum and integral is proved by computing

$$\mathbb{E} \left[\left(\sum_{v \in (\varepsilon\mathbb{Z}^2) \cap [-n, n]^2} \int_{u \in v + [-\varepsilon/2, \varepsilon/2]^2} q^{x,\varepsilon}(x - u) dW(u) - \int q^{x,\varepsilon}(x - u) dW(u) \right)^2 \right],$$

which goes to 0 as $n \rightarrow \infty$ by definition of W and the fact that $q^{x,\varepsilon}(x - \cdot) \in L^2$ (which is a direct consequence of Assumption 1.1). Finally, the point-wise difference between f and f^ε can be expressed as

$$(f - f^\varepsilon)(x) = ((q - q^{x,\varepsilon}) \star W)(x).$$

To avoid confusion, we remark that the description of f^ε as *discrete* refers to the discrete white-noise W^ε and not the field f^ε itself, which is a continuous random field. This distinguishes our

discretisation procedure from the discretisation procedures used in previous works on this topic, which consisted of restricting f to the vertices of a lattice (see [BG16, BM18] and Chapters 1 and 2). On the other hand, the field f^ε is approximately *finite-dimensional*. To explain this, observe that by combining the above ideas we can define, for each $r > 0$ and $\varepsilon > 0$, the field

$$f_r^\varepsilon := q_r \star W^\varepsilon.$$

This field is finite-dimensional on any compact domain D , meaning that we can write

$$f_r^\varepsilon|_D = G(\eta_1, \dots, \eta_N)$$

for a function G and $N \in \mathbb{N}$, where η_i are standard i.i.d. Gaussian variables. This finite-dimensional approximation of f is useful for applying the OSSS inequality, which we explain next.

2.2 The OSSS inequality

The OSSS inequality originated in [OSSS05] in the study of the complexity of algorithms; we refer to [DCRT17b] and [GS14, Chapter 12] for more about its origins. In the present chapter we are solely interested in the recent applications of this inequality to establish sharp phase transitions in many important models of statistical physics (e.g. FK-cluster, Voronoi percolation, Poisson-Boolean percolation; see [DCRT17a, DCRT17b, DCRT18, AB17]).

Let us first recall the OSSS inequality. Let Λ be a finite set, let μ be a probability measure on a measurable space (E, \mathcal{E}) , and consider the product probability space $(E^\Lambda, \mathcal{E}^{\otimes \Lambda}, \mu^{\otimes \Lambda})$. Given any $A \in \mathcal{E}^{\otimes \Lambda}$ of this product space and a coordinate $i \in \Lambda$, the *influence* $I_i^\mu(A)$ of the i^{th} coordinate on A is defined as the probability that resampling the i^{th} coordinate modifies $\mathbb{1}_A$, i.e.,

$$I_i^\mu(A) = \mathbb{P}[\mathbb{1}_A(\omega) \neq \mathbb{1}_A(\tilde{\omega})],$$

where $\omega \sim \mu^{\otimes \Lambda}$ and where $\tilde{\omega} = \omega$ except that ω_i is resampled independently.

Now, let \mathcal{A} be a *random algorithm* that determines A ; this means that \mathcal{A} is a procedure that reveals step-by-step the coordinates of ω and stops once the value of $\mathbb{1}_A(\omega)$ is known, and for which the choice of the next coordinate to be revealed depends only on (i) a *random seed* that is initialised once and for all at the start of the algorithm, (ii) the coordinates that have already been revealed, (iii) the value of ω on these coordinates. The *revelment* $\delta_i^\mu(\mathcal{A})$ of the i^{th} coordinate for the algorithm \mathcal{A} is the probability that ω_i is revealed by the algorithm.

The OSSS inequality (originally proven for E finite [OSSS05] but which also holds in the general³ case [DCRT17a, Remark 5]) can be stated as follows:

Theorem 2.1 (OSSS inequality). *For every $A \in \mathcal{E}^{\otimes \Lambda}$ and algorithm \mathcal{A} that determines A ,*

$$\text{Var}_\mu(\mathbb{1}_A(\omega)) \leq \sum_{i \in \Lambda} \delta_i^\mu(\mathcal{A}) I_i^\mu(A).$$

Let us explain briefly, in the setting of bond percolation on the square lattice, how the OSSS inequality can be used to establish the existence of a phase transition. Set Λ to be the set of edges of the lattice and let $E = \{0, 1\}$, where 1 represents the colour black. For each $R > 0$ let $\text{Cross}(R)$ denote the event that there is a black crossing of a square of size R . By duality properties, we know that $\mathbb{P}_{1/2}(\text{Cross}(R)) = 1/2$ for each $R > 0$, where \mathbb{P}_p is the measure associated to the model with probability p . Once this has been observed, the first step in the

³In both [OSSS05] and [DCRT17a] the OSSS inequality is written without randomness on the initial seed but the case of a random seed is a direct consequence of the totally deterministic case.

proof of the phase transition is *Russo's formula* (see for instance [Gri99, BR06b]) which implies that

$$\frac{d}{dp} \mathbb{P}_p [\text{Cross}(R)] = \frac{1}{2p(1-p)} \sum_{i \in \Lambda} I_i^{\mu_p}(\text{Cross}(R)), \quad (2.2)$$

where $\mu_p = p\delta_1 + (1-p)\delta_{-1}$. Note that the factor $1/(2p(1-p))$ arises since the notion of influence that one would usually use in order to write Russo's formula in the Boolean case $E = \{0, 1\}$ is

$$\mathbb{P} [\mathbb{1}_A(\omega) \neq \mathbb{1}_A(\hat{\omega})]$$

where $\hat{\omega} = \omega$ except that we change (and *not* resample) the i^{th} coordinate. Applying the OSSS inequality, we have

$$\frac{d}{dp} \mathbb{P}_p [\text{Cross}(R)] \geq \frac{1}{2p(1-p)} \frac{\text{Var}_{\mu_p}(\mathbb{1}_{\text{Cross}}(R))}{\sup_i \delta_i^{\mu_p}(\text{Cross}(R))}.$$

Hence, in order to demonstrate a phase transition, for instance to show that

$$\left. \frac{d}{dp} \mathbb{P}_p [\text{Cross}(R)] \right|_{p=1/2} \rightarrow \infty, \quad \text{as } R \rightarrow \infty,$$

it is sufficient to show that

$$\sup_i \delta_i^{\mu_{1/2}}(\text{Cross}(R)) \rightarrow 0, \quad \text{as } R \rightarrow \infty.$$

This latter step can be done by noting that, if the algorithm is suitably chosen, the revealments can be controlled by the probability of the one-arm event, i.e. the event that there is a black path from 0 to distance R (see [BKS99] and [SS10] where such algorithms are used to study noise sensitivity questions). In turn, this is precisely what can be deduced from the RSW estimates at the critical level $p = 1/2$.

In the above argument the OSSS inequality was applied to crossing events of squares, whereas the control of the revealments δ_i was achieved by analysing one-arm events; this is roughly how we shall apply the OSSS inequality (see also [AB17] where this argument is carried out for planar Voronoi percolation). In [DCRT17a, DCRT17b, DCRT18] the OSSS inequality is instead applied to *one-arm events directly*, a powerful approach that ultimately yields the phase transition *in all dimensions* for a wide class of models. In our setting there are obstacles to applying the OSSS inequality to the one-arm events directly (explained in more detail in Remark 5.5), but if these could be overcome one might hope to be able to study also the phase transition for smooth Gaussian fields in dimensions $d \geq 3$.

Let us now explain how we apply the OSSS inequality in our setting. Since the OSSS inequality as stated above applies only to product measures, our strategy is to exploit the discrete approximation of the white-noise representation introduced in the preceding section. More precisely, for suitably chosen $r, \varepsilon > 0$ that depend on a scale $R > 0$, we study crossing events on the scale R for the truncated and discretised field

$$f_r^\varepsilon = q_r \star W^\varepsilon$$

by applying the OSSS inequality to the independent Gaussian variables $(\eta_v)_{v \in \varepsilon \mathbb{Z}^2}$ that define the discrete white-noise W^ε . We then compare the truncated and discretised field f_r^ε to our original field f via a 'sprinkling' procedure.

The next task is to link the OSSS inequality to a Russo-type formula. As explained in the preceding section, when restricted to any compact domain f_r^ε is finite-dimension, and hence crossing events are measurable with respect to the finite-dimensional i.i.d. Gaussian vector

of relevant white-noise coordinates η_v . In this setting there is a simple Russo-type formula (see (5.1)) except, just as in the Boolean setting, the ‘influences’ that arise *are not the same as those which appear in the OSSS formula*. Indeed, in the Gaussian setting these influences are only comparable for events A that are *increasing with respect to the variables η_v* . Since in general this is only true for crossing events if $q \geq 0$, this requires us to impose the strong positivity condition (and is the only place this condition is used).

We end this discussion with an observation about a possible alternate, and in some sense more natural, way to apply the OSSS inequality. In [DCRT17b], the authors extend the OSSS inequality, in the Boolean setting, to *monotonic measures* (here the correct notion of influences are *covariances* between coordinates and events, see [GG06] where similar influences arise). This gives hope that the OSSS inequality could be applied directly to the field f , rather than to the white-noise coordinates η_v .

To do so, one would first discretise the field by restricting it to a lattice (as in [BG16] for instance), and view crossings of quads as paths on this lattice. One might then hope to apply the non-product OSSS inequality directly to the (finite) family of Gaussian variables $f(v)$ that determine each crossing event. However, there are at least two sources of difficulty in realising this approach:

- It is not clear that the resulting measures are monotonic in the appropriate sense under the assumption $q \geq 0$; indeed we suspect that ‘monotonicity’ requires the Gaussian field to be *totally positive* (also known as ‘ MTP_2 ’), which is true in the case of the discrete GFF [Rod15], but is a much stronger assumption than the condition $q \geq 0$.
- The influences that appear in Russo’s formula seem hard to compare to the covariances that appear in the monotonic OSSS formula.

2.3 Outline of the proof

The overall structure of our proof is similar to that used in previous work (see Chapters 1 and 2), and consists of three main steps:

1. (Quasi-independence) Show that crossing events on domains of scale R separated by a distance R are asymptotically independent as $R \rightarrow \infty$;
2. (RSW estimates) Apply Tassion’s general argument [Tas16] to deduce the RSW estimates at the zero level $\ell = 0$;
3. (Sharpness) Combine quasi-independence, the RSW estimates, and the OSSS inequality to deduce the existence of the sharp phase transition.

However, we emphasise that our techniques in steps (1) and (3) are completely different from previous approaches, and only the argument in step (2) is unchanged (and borrowed directly from [Tas16]).

To show quasi-independence, we start from the fact that, for the truncated field f_R , the crossing events on domains separated by distance R are genuinely independent. Then we combine our control of the truncation difference $f - f_R$ with an argument based on the Cameron–Martin theorem that bounds the effect of small perturbations on monotonic events, to deduce the approximate independence of these events for f . This technique, inspired by the notion of influences (see Section 3.3), ends up being much simpler than previous approaches to showing quasi-independence based on lattice discretisation. We remark that our proof of quasi-independence requires only that $\rho(0) > 0$ (implied by $\kappa \geq 0$) and that Assumption 1.5 holds for a given $\beta > 2$, with β controlling how quickly the correlations between crossing events converge to zero. This part of the argument also generalises immediately to higher dimensions.

To establish the sharp phase transition we use a three-step procedure. As mentioned above, we consider the truncated discretised field f_r^ε (for well-chosen $r = r(R)$ and $\varepsilon = \varepsilon(R)$ that are, respectively, growing and decaying polynomially in R) and apply the OSSS inequality to the product space induced by the discrete white-noise variables η_v . The first step is then to have RSW and one-arm event estimates for f_r^ε . While this could probably be done by suitably modifying the argument from [Tas16], since the law of f_r^ε is only translation invariant on a lattice (and since we want to have estimate uniform in R), we instead use a sprinkling procedure to deduce these estimates for f_r^ε for small levels $\ell = \ell(R) > 0$ from the analogous RSW estimates for f . The second step is the application of the OSSS inequality to f_r^ε , which is done by revealing the white-noise coordinates η_v one-by-one following a classical algorithm that determines a crossing event (see, e.g., [SS10] in the case of Bernoulli percolation). This yields a ‘qualitative’ description of the phase transition for a fixed rectangle at large scales. The third and final step is rather standard, and consists in bootstrapping the initial ‘qualitative’ description of the phase transition to complete the proof of the main results.

3 Gaussian techniques

In this section we collect the arguments that rely on the Gaussian setting of our work. This includes our use of the Cameron–Martin theorem to control the effect of varying the level, and our use of the white-noise representation (1.1) to compare f to truncated and discretised versions (see Section 2 above).

We assume throughout this section (and the remainder of the chapter) that Assumption 1.1 holds; whenever we need Assumptions 1.3–1.5 in addition to this we will make this explicit.

3.1 Notation for sub- σ -algebras

We begin by introducing notation for certain sub- σ -algebras that we use in the remainder of the chapter:

Definition 3.1. We write \mathcal{F} for the classical σ -algebra on the set $C(\mathbb{R}^2)$ of continuous functions from \mathbb{R}^2 to \mathbb{R} , i.e. the σ -algebra generated by the norm $\sum_{k=1}^{\infty} \|\cdot\|_{\infty, B_k}$, where $\|\cdot\|_{\infty, B_k}$ is the sup-norm on functions restricted to B_k , the ball of radius k . For any Borel set $D \subseteq \mathbb{R}^2$, we define the following sub- σ -algebra of \mathcal{F} :

$$\mathcal{F}_D = \{A \in \mathcal{F} : \text{if } g \in A \text{ and } h|_D = g|_D \text{ then } h \in A\}.$$

Moreover, for $R > 0$ we abbreviate $\mathcal{F}_R = \mathcal{F}_{B_R}$.

3.2 Consequences of the assumptions

We next collect some important consequences of Assumptions 1.1 and 1.4 for the fields f and f^ε . Note that, since for each $r \geq 1$ the function q_r defined in Section 2.1 satisfies Assumptions 1.1–1.5 whenever q does, these consequences apply equally to the field f_r .

We begin by stating some standard facts about Gaussian fields and their derivatives:

Lemma 3.2.

1. Let f be a centred, almost surely continuous, planar Gaussian field with covariance⁴ $K \in C^{k+1, k+1}(\mathbb{R}^2 \times \mathbb{R}^2)$. Then, f is almost surely C^k , $(f, \partial^\alpha f)_{\alpha: |\alpha| \leq k}$ is a centred Gaussian field, and for all multi-indices α_1, α_2 such that $|\alpha_1| \leq k$ and $|\alpha_2| \leq k$ and for every $x, y \in \mathbb{R}^2$, we have

$$\mathbb{E}[\partial^{\alpha_1} f(x) \partial^{\alpha_2} f(y)] = \partial^{\alpha_1} \partial^{\alpha_2} K(x, y).$$

⁴The notation $K \in C^{m, m}$ means that all partial derivatives of K which include at most m differentiations in the first variable and m differentiations in the second variable exist and are continuous.

2. If f is a planar Gaussian field with covariance $K \in C^{1,1}(\mathbb{R}^2 \times \mathbb{R}^2)$, then there exists a modification of f which is continuous.
3. Let f be a centred, almost surely continuous, planar Gaussian field with covariance $K \in C^{2,2}(\mathbb{R}^2, \mathbb{R}^2)$, let g be a centred planar L^2 field, and define $\tilde{K}(x, y) = \mathbb{E}[f(x)g(y)]$. Then, for every multi-index α such that $|\alpha| \leq 1$ and for every $x, y \in \mathbb{R}^2$, $\partial_x^\alpha \tilde{K}(x, y)$ exists and satisfies

$$\mathbb{E}[\partial^\alpha f(x)g(y)] = \partial_x^\alpha \tilde{K}(x, y).$$

Proof. The first and second statements can be found in Appendices A.3 and A.9 of [NS16]. For the last statement, note that the first statement implies that f is C^1 . Moreover, we have:

$$\begin{aligned} \mathbb{E}[\partial^{(1,0)} f(x)g(y)] &= \mathbb{E}\left[\lim_{h \rightarrow 0} \frac{f(x_1 + h, x_2) - f(x)}{h} g(y)\right] \\ &= \lim_{h \rightarrow 0} \mathbb{E}\left[\frac{f(x_1 + h, x_2) - f(x)}{h} g(y)\right] \\ &= \lim_{h \rightarrow 0} \frac{\tilde{K}((x_1 + h, x_2), y) - \tilde{K}(x, y)}{h}. \end{aligned}$$

The second inequality comes from the fact that: i) the almost sure convergence of the Gaussian variables $\frac{f(x_1+h, x_2) - f(x)}{h}$ is equivalent to the L^2 convergence, and ii) $g(y)$ is L^2 . This completes the proof in the case $\alpha = (1, 0)$, with the other case identical. \square

We next use Lemma 3.2 to deduce some consequences of Assumption 1.1. Let us stress that, thanks to this assumption, we can use dominated convergence in order to exchange derivatives and convolution of $\kappa = q \star q$ for derivatives of order at most 3, a fact we use below without mentioning it explicitly.

For each quad $Q = (D; \gamma, \gamma')$, let Q^* denote the quad with domain D and boundary arcs η, η' defined so that $\eta \cup \eta' = \partial D \setminus \overline{\gamma \cup \gamma'}$. For instance, if D is a rectangle and γ and γ' are the ‘left’ and ‘right’ edges, then η and η' consist of the ‘top’ and ‘bottom’ edges. Let $\text{Cross}_\ell^*(Q)$ denote the crossing event for the quad Q^* and the set \mathcal{E}_ℓ^c , i.e. the event that there is a connected component of \mathcal{E}_ℓ^c whose intersection with Q^* intersects both η and η' .

Proposition 3.3.

- Fix $\varepsilon > 0$. Then there exist continuous modifications of $f = q \star W$ and $f^\varepsilon = q \star W^\varepsilon$. Moreover, f and f^ε are almost surely C^2 and, for every multi-index α such that $|\alpha| \leq 1$,

$$\partial^\alpha f = (\partial^\alpha q) \star W \quad \text{and} \quad \partial^\alpha f^\varepsilon = (\partial^\alpha q) \star W^\varepsilon \quad (3.1)$$

- The field f is non-degenerate, meaning that, for each $k \in \mathbb{N}$ and distinct points $x_1, \dots, x_k \in \mathbb{R}^2$, $(f(x_1), \dots, f(x_k))$ is a non-degenerate Gaussian vector.
- For each $\ell \in \mathbb{R}$, the level set \mathcal{L}_ℓ almost surely consists of a collection of simple curves. Moreover, for each $\ell \in \mathbb{R}$ and quad Q , almost surely

$$\{f \in \text{Cross}_\ell(Q)\} = \{f \notin \text{Cross}_\ell^*(Q)\}.$$

Proof. (1). We first consider $f = q \star W$. Since $q \in L^2$, and by the definition of the white-noise W , $q \star W$ is a stationary planar Gaussian field with covariance $\kappa = q \star q$. Since Assumption 1.1 implies that κ is C^6 (i.e. the covariance of f is $C^{3,3}$), the first two statements of Lemma 3.2 guarantee the existence of a continuous modification of f that is almost surely C^2 . Concerning (3.1), Assumption 1.1 ensures that $\partial^\alpha q \in L^2$, and so $(\partial^\alpha q) \star W$ is well-defined. Then we use dominated convergence (to exchange derivatives and convolution), the definition of W , and the first and

third statements of Lemma 3.2 to verify that $\mathbb{E} [(\partial^\alpha f - (\partial^\alpha q) \star W)^2] = 0$. To be more precise, by the first statement of Lemma 3.2 and by the definition W ,

$$\begin{aligned} & \mathbb{E} \left[(\partial^\alpha f(x) - ((\partial^\alpha q) \star W)(x))^2 \right] \\ &= \partial^{2\alpha} \kappa(0) - 2\mathbb{E} [\partial^\alpha f(x) ((\partial^\alpha q) \star W)(x)] + (\partial^\alpha q) \star (\partial^\alpha q)(0) \\ &= (\partial^\alpha q) \star (\partial^\alpha q)(0) - 2\mathbb{E} [\partial^\alpha f(x) ((\partial^\alpha q) \star W)(x)] + (\partial^\alpha q) \star (\partial^\alpha q)(0). \end{aligned}$$

Moreover, by the third statement of Lemma 3.2,

$$\mathbb{E} [\partial^\alpha f(x) (\partial^\alpha q) \star W(x)] = \partial_x^\alpha (q \star (\partial^\alpha q)(x - y))|_{x=y} = (\partial^\alpha q) \star (\partial^\alpha q)(0).$$

As a result, $\mathbb{E} [(\partial^\alpha f(x) - (\partial^\alpha q) \star W(x))^2] = 0$ for every x . Hence, by considering a continuous modification of $(\partial^\alpha q) \star W$, we have (3.1).

Turning to $f^\varepsilon = q \star W^\varepsilon$, Assumption 1.1 ensures that both q and $\partial^\alpha q$, restricted to the lattice $\varepsilon\mathbb{Z}^2$, are square-summable, which ensures that $f^\varepsilon = q \star W^\varepsilon$ and $\partial^\alpha q \star W^\varepsilon$ are well defined stationary Gaussian fields. The remainder of the proof is essentially the same as in the first case.

(2). The non-degeneracy of f follows from the fact that the support of ρ (and hence also the support of the spectral measure μ) contains an open set [Wen05, Theorem 6.8].

(3). For this, we refer to [AT07] or to Remark A.11 of Chapter 1. □

To finish, we state some consequences of Assumption 1.4.

Proposition 3.4. *The strong positivity condition in Assumption 1.4 implies the weak positivity condition $\kappa \geq 0$. In turn, the weak positivity condition is equivalent to the FKG inequality for finite-dimensional projections of the field f , i.e., for every $k \in \mathbb{N}$, every $\{x_1, \dots, x_k\} \subset \mathbb{R}^2$ and every increasing Borel sets $A, B \subset \mathbb{R}^n$:*

$$\mathbb{P}(f|_{x_1, \dots, x_k} \in A \cap B) \geq \mathbb{P}(f|_{x_1, \dots, x_k} \in A) \mathbb{P}(f|_{x_1, \dots, x_k} \in B). \quad (3.2)$$

Moreover, the weak positivity condition implies that $\rho(0) \neq 0$, and if we assume furthermore that Assumption 1.5 holds for some $\beta > 2$, then there exists a neighbourhood V of 0 such that $\inf_V |\rho| > 0$.

Proof. Clearly $q \geq 0$ implies that $\kappa = q \star q \geq 0$. Moreover, (3.2) is well-known to be equivalent to $\kappa \geq 0$ by a result of Pitt [Pit82]. Finally, since $\rho^2 = \mathcal{F}[\kappa]$ and κ is non-negative and not identically zero, $\rho^2(0) > 0$. If we assume furthermore that $\beta > 2$, then ρ is continuous (by dominated convergence), which gives the last property. □

Remark 3.5. By approximation arguments (see, e.g., Appendix A.2 of Chapter 1), (3.2) implies the positive association of each of the compactly-supported increasing events that we consider in this chapter, i.e. for every compact $D \subset \mathbb{R}^2$ and every increasing $A, B \in \mathcal{F}_D$ that is mentioned in this chapter,

$$\mathbb{P}(f \in A \cap B) \geq \mathbb{P}(f \in A) \mathbb{P}(f \in B). \quad (3.3)$$

While we actually believe that (3.2) implies (3.3) for *all* compactly supported increasing events, we are unaware of any such statement in the literature.

3.3 Varying the level via the Cameron–Martin theorem

In this section we show how to control the effect of varying the level on monotonic events, in particular giving a bound in terms of the spectral density ρ contained in a small annulus centred at the origin. For each $0 < r_1 < r_2$, let Ann_{r_1, r_2} denote the Euclidean annulus centred at the origin with radii r_1 and r_2 .

Proposition 3.6. *There exist absolute constants $c_1, c_2 > 0$ such that, for each $R > 0$, monotonic event $A \in \mathcal{F}_R$, and $t \in \mathbb{R}$,*

$$|\mathbb{P}[\{f \in A\}] - \mathbb{P}[\{f - t \in A\}]| \leq \frac{c_1 R |t|}{\inf\{|\rho(x)| : x \in \text{Ann}_{c_2/R, 2c_2/R}\}} \sqrt{\mathbb{P}[f \in A]}.$$

In particular, if $\gamma \geq 0$ is such that $\rho(x) > c_3 |x|^\gamma$ for a constant $c_3 > 0$ and sufficiently small $|x|$, then there exist $c, R_0 > 0$ such that, for every $R > R_0$, monotonic event $A \in \mathcal{F}_R$, and $t \in \mathbb{R}$,

$$|\mathbb{P}[\{f \in A\}] - \mathbb{P}[\{f - t \in A\}]| \leq c R^{1+\gamma} |t| \sqrt{\mathbb{P}[f \in A]}.$$

The above proposition has an easy corollary in the case that $\rho(0) > 0$, which is what we apply in the sequel. We apply this corollary both to events with moderate probability, and also to events with very small probability; of course, only in the second case is the term $\sqrt{\mathbb{P}[f \in A]}$ helpful.

Corollary 3.7. *Suppose that there exists a neighbourhood V of 0 such that $\inf_V |\rho| > 0$. Then, there exist $c, R_0 > 0$ such that, for every $R > R_0$, monotonic event $A \in \mathcal{F}_R$, constants $\varepsilon, \delta \geq 0$, and continuous planar random field g such that $\mathbb{P}[\|f - g\|_{\infty, B_R} \geq \varepsilon] \leq \delta$,*

$$\mathbb{P}[\{f \in A\} \triangle \{g \in A\}] \leq c R \varepsilon \sqrt{\mathbb{P}[f \in A]} + \delta.$$

Assume furthermore that $\beta > 2$. Then (by dominated convergence applied to the spectral density), there exists $r_0 > 0$ such that, when this statement is applied to the fields f_r in place of f , the constants $c, R_0 > 0$ can be taken to be uniformly for all $r \geq r_0$.

Remark 3.8. Proposition 3.6 can be viewed as the analogue, in the Gaussian setting, of well-known inequalities that hold for Boolean functions. Let $n \in \mathbb{N}$ and consider the product space $\Omega_n = \{-1, 1\}^n$ equipped with the product probability measure $\mathbb{P}_p^n = (p\delta_1 + (1-p)\delta_{-1})^{\otimes n}$. Then for every $\varepsilon > 0$ there is a $c > 0$ such that for every $A \subseteq \Omega_n$ and $\varepsilon \leq p \leq q \leq 1 - \varepsilon$,

$$|\mathbb{P}_p[A] - \mathbb{P}_q[A]| \leq c |p - q| \sqrt{n} \sqrt{\mathbb{P}_p^n[A]}. \quad (3.4)$$

The proof of (3.4) goes as follows. Define the functions

$$\chi_i^p : \omega \in \Omega_n \mapsto \sqrt{\frac{1-p}{p}} \mathbf{1}_{\omega_i=1} - \sqrt{\frac{p}{1-p}} \mathbf{1}_{\omega_i=-1},$$

which form an orthonormal set of centred variables of the L^2 space $L^2(\Omega_n, \mathbb{P}_p^n)$. Applying a differential formula, whose proof is similar to the classical Russo's formula (2.2), we obtain

$$\frac{d}{dp} \mathbb{P}_p^n[A] = \frac{1}{2\sqrt{p(1-p)}} \sum_{i=1}^n \mathbb{E}_p^n[\chi_i^p(\omega) \mathbf{1}_A].$$

By the Cauchy–Schwarz inequality, we deduce that

$$\left| \sum_{i=1}^n \mathbb{E}_p^n[\chi_i^p(\omega) \mathbf{1}_A] \right| \leq \sqrt{n} \left(\sum_{i=1}^n \mathbb{E}_p^n[\chi_i^p(\omega) \mathbf{1}_A]^2 \right)^{1/2}. \quad (3.5)$$

Since the functions χ_i^p form an orthonormal set, Parseval's formula gives that

$$\sum_{i=1}^n \mathbb{E}_p^n [\chi_i^p(\omega) \mathbf{1}_A]^2 \leq \mathbb{E}_p^n [\mathbf{1}_A^2] = \mathbb{P}_p^n [A],$$

which ends the proof. Note that, when A is increasing, $\mathbb{E}_p^n [\chi_i^p \mathbf{1}_A]$ is a constant (that depends on p) times the influence of A (see Section 2.2 for the notion of influence of Boolean events). Hence, one interpretation of (3.5) is that the total influence (i.e. the sum of all influences) is of order at most \sqrt{n} ; this idea guides us also in establishing Proposition 3.6. We can also find this idea in the paper [BS98] where Benjamini and Schramm study conformal invariance of Voronoi percolation and use an analogue control of the influences in order to control a 'number of defects' (see their Section 8.1).

With a very similar proof (more precisely, by noting that, if X_1, \dots, X_n are i.i.d. standard Gaussian variables with mean ℓ , then the random variables $(X_1 - \ell, \dots, X_n - \ell)$ form an orthonormal set of the underlying L^2 space), we obtain the following. Let ν_ℓ^n denote the law of n i.i.d. Gaussian variables of mean ℓ and let A be a Borelian subset of \mathbb{R}^n . Then, for each $\ell_1, \ell_2 \in \mathbb{R}$,

$$|\nu_{\ell_1}^n(A) - \nu_{\ell_2}^n(A)| \leq \sqrt{n} |\ell_1 - \ell_2| \sqrt{\nu_{\ell_1}^n(A)}.$$

Proposition 3.6 can be viewed as a generalisation of this statement to continuous Gaussian fields, taking $\text{area}(B_R)$ as the analogue of the n .

To prove Proposition 3.6 we shall need to introduce some of the standard theory of Gaussian fields, and in particular the Cameron–Martin theorem; for this we refer to [Jan97, Chapters VIII and XIV].

Recall that to our Gaussian field f we can associate a Hilbert space of functions $H \subset C(\mathbb{R}^2)$ known as the *Cameron–Martin space*, defined in the following way. First, let G denote the Hilbert space of centred Gaussian random variables that is the closure in L^2 of the linear span of $\{f(x)\}_{x \in \mathbb{R}^2}$, i.e. the set

$$\sum_{i \in \mathbb{N}} a_i f(x_i), \quad x_i \in \mathbb{R}^2, a_i \in \mathbb{R}, \sum_i a_i a_j K(x_i, x_j) < \infty.$$

Then define the (injective) linear map $P : G \rightarrow C(\mathbb{R}^2)$ by

$$\xi \mapsto P(\xi)(\cdot) := \langle \xi, f(\cdot) \rangle_G = \mathbb{E}[\xi f(\cdot)].$$

The function space $H = P(G) \subset C(\mathbb{R}^2)$, equipped with the inner product

$$\langle h_1, h_2 \rangle_H = \langle P^{-1}(h_1), P^{-1}(h_2) \rangle_G = \mathbb{E}[P^{-1}(h_1) P^{-1}(h_2)],$$

is a Hilbert space known as the *Cameron–Martin space*; by construction, P defines an isometry between G and H .

An equivalent description of H is as the completion of the space of finite linear combinations of the covariance kernel K

$$\sum_{1 \leq i \leq n} a_i K(s_i, \cdot), \quad a_i \in \mathbb{R}, s_i \in \mathbb{R}^2,$$

equipped with the inner product

$$\left\langle \sum_{1 \leq i \leq n} a_i K(s_i, \cdot), \sum_{1 \leq i' \leq n} a_{i'} K(s_{i'}, \cdot) \right\rangle_H = \sum_{1 \leq i, j \leq n} a_i a_{j'} K(s_i, s_{j'}). \quad (3.6)$$

This latter construction emphasises the role of the covariance kernel K in the construction of H ; indeed one sees that H is the (unique) *reproducing kernel Hilbert space* associated to K , i.e., for any $h \in H$ and $x \in \mathbb{R}^2$,

$$\langle h(\cdot), K(x, \cdot) \rangle_H = h(x). \quad (3.7)$$

Let us now state the well-known *Cameron–Martin theorem*, which describes how the law of f changes under translation by an element of H .

Theorem 3.9 (Cameron–Martin; see [Jan97, Theorems 14.1 and 3.33]). *Suppose $h \in H$. Then the law of $f + h$ equals the law of f with Radon–Nikodym derivative*

$$\exp \left\{ P^{-1}(h) - \frac{1}{2} \mathbb{E}[P^{-1}(h)^2] \right\}.$$

In particular, for each $A \in \mathcal{F}$,

$$\mathbb{P}[f + h \in A] = \mathbb{E} \left[\exp \left\{ P^{-1}(h) - \frac{1}{2} \mathbb{E}[P^{-1}(h)^2] \right\} \mathbb{1}_{f \in A} \right].$$

Note that the map $P^{-1}(\cdot)$ plays the central role in the Cameron–Martin theorem; this is often called the *Paley–Weiner map* and one of its key properties is that, since P is an isometry, its image $P^{-1}(h)$ is a random variable with distribution $\mathcal{N}(0, \|h\|_H^2)$.

We next state a corollary of the Cameron–Martin theorem that is all that we shall need to prove Proposition 3.6; since we were unable to find this statement in the literature, we give a short proof.

Corollary 3.10. *For every $h \in H$ and $A \in \mathcal{F}$:*

$$|\mathbb{P}[f \in A] - \mathbb{P}[f - h \in A]| \leq \frac{\|h\|_H \sqrt{\mathbb{P}[f \in A]}}{\sqrt{\log 2}}.$$

Proof. Abbreviate $X = P^{-1}(h)$. By Theorem 3.9 and the linearity of R

$$\mathbb{P}[f \in A] - \mathbb{P}[f - h \in A] = \mathbb{E} \left[\left(1 - \exp \left\{ -X - \frac{1}{2} \mathbb{E}[X^2] \right\} \right) \mathbb{1}_{f \in A} \right], \quad (3.8)$$

which, by the Cauchy–Schwarz inequality, is in absolute value at most

$$\left(\mathbb{E} \left[\left(1 - \exp \left\{ -X - \frac{1}{2} \mathbb{E}[X^2] \right\} \right)^2 \right] \mathbb{P}[f \in A] \right)^{1/2};$$

this bound is analogous to the bounds in Remark 3.8 above that hold in the context of Boolean functions. Since X is distributed as $\mathcal{N}(0, \|h\|_H^2)$, and by standard properties of the normal distribution,

$$\begin{aligned} \mathbb{E} \left[\left(1 - \exp \left\{ -X - \frac{1}{2} \mathbb{E}[X^2] \right\} \right)^2 \right] &= \mathbb{E} \left[1 - 2e^{-X - \frac{1}{2} \mathbb{E}[X^2]} + e^{-2X - \mathbb{E}[X^2]} \right] \\ &= 1 - 2 + e^{\mathbb{E}[X^2]} = e^{\|h\|_H^2} - 1, \end{aligned}$$

and hence we have shown that

$$|\mathbb{P}[f \in A] - \mathbb{P}[f - h \in A]| \leq \min \left\{ \sqrt{e^{\|h\|_H^2} - 1}, 1 \right\}.$$

To conclude we use the fact that

$$\min \{ \sqrt{e^{x^2} - 1}, 1 \} \leq x / \sqrt{\log 2}$$

for all $x \geq 0$, which is simple to verify (by the convexity of $\sqrt{e^{x^2} - 1}$ for instance). \square

To complete the proof of Proposition 3.6, we need one additional element of the theory of Cameron–Martin spaces that is specific to the setting of stationary Gaussian fields (see, e.g., [BTA04, Eq.(2.4), p.67] or [KW70, Lemma 3.1]). Recall the spectral density ρ^2 , and let $S = \text{supp}(\rho)$. An alternative description of the Cameron–Martin space H is as the set

$$\bar{H} = \mathcal{F}[g\rho], \quad g \in L^2_{\text{sym}}(S), \quad (3.9)$$

equipped with the inner product inherited from L^2_{sym} , where $L^2_{\text{sym}}(S)$ denotes the set of complex Hermitian L^2 functions supported on S . To see why this is true, observe that the map $g \mapsto \mathcal{F}[g\rho]$ defines an isometry between $L^2_{\text{sym}}(S)$ and \bar{H} , and so the latter is a Hilbert space. By the uniqueness of the RKHS [Jan97, Theorem F.7], it remains to verify the reproducing kernel property (3.7), i.e. for every $F[g\rho] \in \bar{H}$ and $x \in \mathbb{R}^2$ we verify that

$$\langle \mathcal{F}[g\rho](\cdot), \kappa(\cdot - x) \rangle_{\bar{H}} = \langle \mathcal{F}[g\rho](\cdot), \mathcal{F}[\rho^2](\cdot - x) \rangle_{\bar{H}} = \langle g, \rho e^{-2\pi i \langle s, x \rangle} \rangle_{L^2_{\text{sym}}} = \mathcal{F}[g\rho](x),$$

where in the second equality we used the translation identity for the Fourier transform.

One consequence of the representation in (3.9) is the identity

$$\|h\|_H^2 = \int_{x \in \mathbb{R}^2} |\hat{h}(x)|^2 / \rho^2(x) dx$$

valid for any $h \in H$ such that $\hat{h} = \mathcal{F}[h]$ is defined. In particular, if $\text{supp}(|\hat{h}|)$ has finite area we have the bound

$$\|h\|_H^2 \leq \frac{\sup\{|\hat{h}(x)|^2 : x \in \text{supp}(|\hat{h}|)\} \text{Area}(\text{supp}(|\hat{h}|))}{\inf\{\rho^2(x) : x \in \text{supp}(|\hat{h}|)\}}. \quad (3.10)$$

Proof of Proposition 3.6. Without loss of generality we take A increasing and $t \leq 0$. Since A is increasing and belongs to \mathcal{F}_R ,

$$0 \leq \mathbb{P}[f \in A] - \mathbb{P}[f + t \in A] \leq \mathbb{P}[f \in A] - \mathbb{P}[f + th \in A]$$

for each $h \geq \mathbb{1}_{B_R}$. In light of Corollary 3.10, it remains only to show that

$$\inf_{h \in H : h \geq \mathbb{1}_{B_R}} \|h\|_H \leq \frac{c_1 R}{\inf\{|\rho(x)| : x \in \text{Ann}_{c_2/R, 2c_2/R}\}}$$

for suitable $c_1, c_2 > 0$. For this fix $c > 0$ sufficient small so that the Fourier transform of the (normalised) identify function on the annulus $\text{Ann}_{c, 2c}$ is larger than $\mathbb{1}_{B_1}$, i.e.

$$\mathcal{F}[c^{-2} \mathbb{1}_{\text{Ann}_{c, 2c}}] \geq \mathbb{1}_{B_1};$$

such a $c > 0$ is easily checked to exist. Then define

$$h = \mathcal{F}[R^2 c^{-2} \mathbb{1}_{\text{Ann}_{c/R, 2c/R}}],$$

which by the scaling of the Fourier transform satisfies $h \geq \mathbb{1}_{B_R}$ for all $R > 0$. By (3.10),

$$\|h\|_H^2 \leq \frac{R^2 c^{-2}}{\inf\{\rho^2(x) : x \in \text{Ann}_{c/R, 2c/R}\}},$$

which completes the proof. \square

3.4 Comparison to truncated and discretised versions of the field

We now show how to compare the field f to its truncated and discretised versions f_r and f^ε introduced in Section 2. Our comparison is in terms of the sup-norm, since this is enough for our application to crossing events, but stronger comparisons would be easy to prove using similar methods (strengthening the assumptions as appropriate).

Proposition 3.11. *Suppose that (1.3) holds for $\beta > 1$. Then there exist $c_1, c_2 > 0$ such that, for all $\varepsilon > 0$ and $R, r \geq 1$,*

$$\mathbb{P}[\|f - f^\varepsilon\|_{\infty, B_R} + \|f_r - f_r^\varepsilon\|_{\infty, B_R} \geq c_1(\log R)\varepsilon] \leq c_1 e^{-c_2 \log^2(R)}.$$

Moreover, there exist $c_1, c_2 > 0$ such that, for all $R, r \geq 1$,

$$\mathbb{P}[\|f - f_r\|_{\infty, B_R} \geq c_1(\log R)r^{1-\beta}] \leq c_1 e^{-c_2 \log^2(R)}.$$

Suppose in addition that the strong exponential decay condition of Assumption 1.5 holds. Then there exist $c_1, c_2 > 0$ such that, for all $R, r \geq 1$,

$$\mathbb{P}[\|f - f_r\|_{\infty, B_R} \geq c_1 \sqrt{R} e^{-c_2 r \log^2(r)}] \leq c_1 e^{-c_2 R}.$$

The proof of Proposition 3.11 will be a straight-forward combination of the following lemmas:

Lemma 3.12. *There exists an absolute constant $c > 0$ such that, for every C^1 planar Gaussian field g , and for all $R_1 \geq c$ and $R_2 \geq \log R_1$,*

$$\mathbb{P}[\|g\|_{\infty, B_{R_1}} \geq m R_2] \leq e^{-R_2^2/c},$$

where

$$m = \left(\sup_{x \in \mathbb{R}^2} \sup_{|\alpha| \leq 1} \mathbb{E}[(\partial^\alpha g)^2(x)] \right)^{1/2}. \quad (3.11)$$

Lemma 3.13. *Suppose $G : \mathbb{R}^+ \rightarrow \mathbb{R}^+$ is such that, for all $x \in \mathbb{R}^2$ and $|\alpha| \leq 1$,*

$$|\partial^\alpha q(x)| < G(|x|). \quad (3.12)$$

Suppose also that $\int_{s>1} sG(s)^2 ds < \infty$. Then there exists a $c > 0$ such that, for all $r \geq 1$,

$$\sup_{x \in \mathbb{R}^2} \sup_{|\alpha| \leq 1} \mathbb{E}[(\partial^\alpha (f - f_r))^2(x)] < c \int_{s>r} sG(s)^2 ds.$$

Lemma 3.14. *There exists a $c > 0$ such that, for all $\varepsilon > 0$ and $r \geq 1$,*

$$\sup_{x \in \mathbb{R}^2} \sup_{|\alpha| \leq 1} \mathbb{E}[(\partial^\alpha (f - f^\varepsilon))^2(x)] + \mathbb{E}[(\partial^\alpha (f - f_r^\varepsilon))^2(x)] < c\varepsilon^2.$$

Before proving these lemmas, let us complete the proof of Proposition 3.11.

Proof of Proposition 3.11. We prove only the second and third statements; the first is proven similarly. By assumption there are $c_1, c_2 > 0$ such that (3.12) holds with

$$G(x) = c_1 x^{-\beta}, \quad \beta > 1,$$

and, in the case that the strong exponential decay condition holds,

$$G(x) = c_1 e^{-c_2 x \log^2(\max\{1, x\})}.$$

Evaluating the integral $\int_{s>r} sG(s)^2 ds < \infty$, by Lemma 3.13 there are $c_3, c_4 > 0$ such that, for $r \geq 1$,

$$\sup_{x \in \mathbb{R}^2} \sup_{|\alpha| < 1} \mathbb{E}[(\partial^\alpha(f - f_r))^2(x)] < \begin{cases} c_3 r^{2(1-\beta)}, & \text{in the case } \beta > 1, \\ c_3 e^{-c_4 r \log^2(r)}, & \text{if the strong exponential decay condition holds.} \end{cases}$$

Applying Lemma 3.12 we have the result as long as R is sufficiently large. We deduce the result for all $R \geq 1$ by replacing c_1 with a suitably large constant. \square

We now turn to the proof of Lemmas 3.12–3.14. The proof of Lemma 3.12 is an easy consequence of two classical results: Kolmogorov’s theorem [NS16, A.9] and the Borell–TIS inequality (see [AW09, Theorem 2.9] and [AT07]).

Proof of Lemma 3.12. By stationarity and Kolmogorov’s theorem, there is an absolute constant $c_1 > 0$ such that

$$\mathbb{E}[\|g\|_{\infty, B_1}] < c_1 m,$$

where m is the constant defined in (3.11). Moreover, by definition we have $\sup_{x \in B_1} \mathbb{E}[g(x)^2] \leq m^2$. An application of the Borell–TIS inequality to the field $g|_{B_1}$ yields that, for each $u > 0$,

$$\mathbb{P}[\|g\|_{\infty, B_1} \geq c_1 m + u] \leq e^{-u^2/(2c_1^2 m^2)}.$$

Setting $u = m(R_2 - c_1)$ and tiling B_{R_1} with $\asymp R_1^2$ disjoint boxes of size 1 (since we can assume that $R_1 \geq 1$) yields, by stationarity and the union bound, that there exists $c_2 > 0$ such that

$$\mathbb{P}[\|g\|_{\infty, B_{R_1}} \geq mR_2] \leq c_2 R_1^2 e^{-(R_2 - c_1)^2/(2c_1^2)}.$$

Setting $c_3 > 0$ to be sufficiently large such that for all $R_1 > c_2$ and for all $R_2 \geq \log R_1$,

$$\frac{(R_2 - c_1)^2}{2c_1^2} - \log(c_2 R_1^2) > \frac{R_2^2}{4c_1^2},$$

we have the result for c the maximum of $4c_1^2$ and c_2 . \square

Proof of Lemma 3.13. By stationarity, it is sufficient to prove the result for $x = 0$. Recall from Section 2 and Proposition 3.3 that $f - f_r = (q - q_r) \star W$, where $q_r = q\chi_r$, and also that

$$\partial^\alpha(f - f_r) = (\partial^\alpha(q - q_r)) \star W = \int (\partial^\alpha(q - q_r))(\cdot - u) dW(u). \quad (3.13)$$

By standard properties of white-noise, the second moment of the integral in (3.13) is

$$\int (\partial^\alpha(q - q_r))^2(\cdot - u) du.$$

Since G is defined to satisfy, for all $x \in \mathbb{R}^2$,

$$\sup_{|\alpha| \leq 1} |\partial^\alpha q(x)| < G(|x|),$$

and since the function $(1 - \chi_r)$ and all its derivatives are equal to zero on B_r and uniformly bound elsewhere, this integral is at most

$$c \int_{|u| > r} G(|u|)^2 du$$

for a certain constant $c > 0$. After switching to polar coordinates, we have the result. \square

Finally, for the proof of the Lemma 3.14 we shall need the following auxiliary lemma:

Lemma 3.15 (Piece-wise constant approximation). *Let $g : \mathbb{R}^2 \rightarrow \mathbb{R}$ be a C^1 function in H^1 (where H^k denotes the usual Sobolev space, i.e. $g \in H^k$ means that, for every multi-index α such that $|\alpha| \leq k$, $\partial^\alpha g \in L^2$). Recall, for each $x \in \mathbb{R}^2$ and $\varepsilon > 0$, the piece-wise constant approximation $g^{x,\varepsilon}$ defined in (2.1). Then there exists a constant $c > 0$, depending only $\|g\|_{H^1}$, such that, for all $\varepsilon > 0$,*

$$\sup_{x \in \mathbb{R}^2} \|g - g^{x,\varepsilon}\|_2^2 < c\varepsilon^2.$$

Proof. Fix $x \in \mathbb{R}^2$ and $\varepsilon > 0$. For each $v \in \varepsilon\mathbb{Z}^2$ define the lattice box $D_v = x + v + [-\varepsilon/2, \varepsilon/2]^2$. Since $g^{x,\varepsilon}$ is the mean of g on D_v , the Poincaré–Wirtinger inequality implies the existence of an absolute constant $c' > 0$ such that

$$\int_{u \in D_v} (g - g^{x,\varepsilon})^2 du \leq c'\varepsilon^2 \int_{u \in D_v} |\nabla g|^2 du. \quad (3.14)$$

Summing (3.14) over $v \in \varepsilon\mathbb{Z}^2$ yields the result, since $g \in H^1$. \square

Proof of Lemma 3.14. Recall from Section 2 that we can express

$$(f - f^\varepsilon)(x) = \int (q - q^{x,\varepsilon})(x - u) dW(u).$$

Moreover, by Proposition 3.3 we have

$$\begin{aligned} (\partial^\alpha f - \partial^\alpha f^\varepsilon)(x) &= \int \partial q(x - u) dW(u) - \int \partial q(x - u) dW^\varepsilon(u) \\ &= \int ((\partial^\alpha q) - (\partial^\alpha q)^{x,\varepsilon})(x - u) dW(u), \end{aligned}$$

where $(\partial^\alpha q)^{x,\varepsilon}$ denotes the piece-wise constant approximation of the function $\partial^\alpha q$ defined in (2.1). The second moment of this quantity is equal to

$$\|\partial^\alpha q - (\partial^\alpha q)^{x,\varepsilon}\|_2^2.$$

Since $\partial^\alpha q \in H^1$, applying Lemma 3.15 yields the result. Moreover, since the constant in Lemma 3.15 depends only on $\|\cdot\|_{H^1}$, and since $\|q_r\|_{H^1}$ is uniformly bounded over $r \geq 1$ by the assumptions on χ_r , the same proof works also for $f_r - f_r^\varepsilon$. \square

4 Quasi-independence and RSW estimates

In this section we show how the white-noise representation for the field, combined with the Gaussian estimates in the previous section, provide a simple route to establishing quasi-independence for monotonic events. Using the approach of Tassion [Tas16], we then deduce RSW estimates at the zero level, i.e. the first statement of Theorem 1.11. These estimates are also already enough to prove the first statement of Theorem 1.15. Recall that we assume throughout that Assumption 1.1 holds, which guarantees in particular that (1.3) holds for a given $\beta > 1$.

We begin by stating a general comparison result that is a simple combination of Corollary 3.7 and Proposition 3.11 (see Definition 3.1 for the notation for sub- σ -algebras):

Proposition 4.1. *Suppose that (1.3) holds for $\beta > 2$, and suppose that $\rho(0) \neq 0$. Then there exist $c_1, c_2, r_0 > 0$ such that, for every $R \geq 1$, every $r \geq r_0$, every Borel set $D \subset \mathbb{R}^2$ of diameter at most R , every monotonic event $A \in \mathcal{F}_D$, and every $r_1, r_2 \in [r, \infty]$,*

$$|\mathbb{P}[f_{r_1} \in A] - \mathbb{P}[f_{r_2} \in A]| \leq c_1 R \log(R) r^{1-\beta} \sqrt{\mathbb{P}[f_{r_1} \in A]} + c_1 e^{-c_2 \log^2(R)}, \quad (4.1)$$

where we define $f_\infty := f$. Suppose in addition that the strong exponential decay condition in Assumption 1.5 holds. Then (4.1) is valid with the right-hand side replaced by

$$c_1 R^{3/2} e^{-c_2 r \log^2(r)} \sqrt{\mathbb{P}[f_{r_1} \in A]} + c_1 e^{-c_2 R}.$$

Proof. By Proposition 3.11, there exist $c_1, c_2 > 0$ such that,

$$\mathbb{P}\left[\|f_{r_1} - f_{r_2}\|_{\infty, B_R} \geq c_1(\log R)r^{1-\beta}\right] \leq c_1 e^{-c_2 \log^2(R)},$$

and applying Corollary 3.7 we have the result for R sufficiently large. We deduce the result for all $R \geq 1$ by taking c_1 suitably large. The result in the case of strong exponential decay follows in an identical way. \square

We now state our main quasi-independence result:

Theorem 4.2 (Quasi-independence). *Suppose that (1.3) holds for $\beta > 1$, and suppose that there exists a neighbourhood V of 0 such that $\inf_V |\rho| > 0$. Then there exist $c_1, c_2 > 0$ such that, for every $R_1, R_2, r \geq 1$, every pair of Borel sets $D_1 \subset \mathbb{R}^2$ (resp. D_2) of diameter at most R_1 (resp. R_2) and such that $r = \text{dist}(D_1, D_2)$, every pair of monotonic events $A \in \mathcal{F}_{D_1}$ and $B \in \mathcal{F}_{D_2}$,*

$$\begin{aligned} & |\mathbb{P}[f \in A \cap B] - \mathbb{P}[f \in A] \mathbb{P}[f \in B]| \\ & \leq c_1 R_1 \log(R_1) r^{1-\beta} + c_1 e^{-c_2 \log^2(R_1)} + c_1 R_2 \log(R_2) r^{1-\beta} + c_1 e^{-c_2 \log^2(R_2)}. \end{aligned} \quad (4.2)$$

Suppose in addition that the strong exponential decay condition in Assumption 1.5 holds. Then (4.2) is valid with the right-hand side replaced by

$$c_1 R_1^{3/2} e^{-c_2 r \log^2(r)} + c_1 e^{-c_2 R_1} + c_1 R_2^{3/2} e^{-c_2 r \log^2(r)} + c_1 e^{-c_2 R_2}.$$

Remark 4.3. In the special case that R_1, R_2 and r are all of the same order $\Theta(R)$ yields a simple bound on $|\mathbb{P}[f \in A \cap B] - \mathbb{P}[f \in A] \mathbb{P}[f \in B]|$ of order at most

$$R^{2-\beta} \log R.$$

In particular, if Assumption 1.5 holds for a given $\beta > 2$, (4.2) tends to zero as $R \rightarrow \infty$, and hence (4.2) is a description of ‘asymptotic independence’.

Remark 4.4. Theorem 4.2 can be compared to other similar quasi-independence results that have appeared previously, both in the study of the components of the zero level set of Gaussian entire functions [NSV07, NSV08, NS11], and also in the study of crossing events for smooth Gaussian fields (see [BG16, BMW17, BM18] and Chapter 1).

Whereas the approaches to quasi-independence from [BG16, BMW17, BM18] and Chapter 1 have proceeded by restricting the field to a lattice, deducing quasi-independence for this discrete field and then deducing a result in the continuum, our approach in the present chapter is to work directly in the continuum, first approximating by a field with exact independence, and then studying of the effect of the approximation on the probability of the events we are interested in. This two step approximation procedure can also be found in [NSV07, NSV08, NS11], but the approach and the events considered therein are very different.

Moreover, whereas the previous best known sufficient condition for quasi-independence was polynomial decay with exponent $\beta > 4$ (see Chapter 1) we deduce asymptotic independence as long as correlations decay (roughly speaking) polynomially with exponent $\beta > 2$. More precisely (in the case $r = R_1 = R_2 = R$), Chapter 1 roughly implies that (4.2) holds for crossing events with the right-hand-side replaced by $cR^{-\beta} \times (\text{Total influence})^2$ where the term ‘Total influence’ is the sum of R^2 influences defined in the spirit of the influences from Section 2.2. In Chapter 1, this sum of influences was bounded by R^2 , although heuristics as in Remark 3.8 of the present chapter suggest that this sum might be bounded by R . This is the idea that has guided us, even if we have followed an approach completely different from Chapter 1.

Theorem 4.2 is a direct consequence of the following more general proposition:

Proposition 4.5. *Suppose that (1.3) holds for $\beta > 1$, and suppose that there exists a neighbourhood V of 0 such that $\inf_V |\rho| > 0$. Then, there exist $c_1, c_2 > 0$ such that, for every $R_1, R_2, r \geq 1$, every pair of Borel sets $D_1 \subset \mathbb{R}^2$ (resp. D_2) of diameter at most R_1 (resp. R_2) and such that $r = \text{dist}(D_1, D_2)$, every $n_1, n_2 \in \mathbb{N}$, all sets of monotonic events $A_1, \dots, A_{n_1} \in \mathcal{F}_{D_1}$ and $B_1, \dots, B_{n_2} \in \mathcal{F}_{D_2}$ and every event A (resp. B) in the Boolean algebra generated by A_1, \dots, A_{n_1} (resp. B_1, \dots, B_{n_2}),*

$$\begin{aligned} & |\mathbb{P}[f \in A \cap B] - \mathbb{P}[f \in A]\mathbb{P}[f \in B]| \\ & \leq c_1 \sum_{i=1}^{n_1} \left(R_1 \log(R_1) r^{1-\beta} \sqrt{\mathbb{P}[f \in A_i]} + e^{-c_2 \log^2(R_1)} \right) \\ & \quad + c_1 \sum_{j=1}^{n_2} \left(R_2 \log(R_2) r^{1-\beta} \sqrt{\mathbb{P}[f \in B_j]} + e^{-c_2 \log^2(R_2)} \right). \end{aligned} \quad (4.3)$$

Suppose in addition that the strong exponential decay condition in Assumption 1.5 holds. Then (4.3) is valid with the right-hand side replaced by

$$c_1 \sum_{i=1}^{n_1} \left(R_1^{3/2} e^{-c_2 r \log^2(r)} \sqrt{\mathbb{P}[f \in A_i]} + e^{-c_2 R_1} \right) + c_1 \sum_{j=1}^{n_2} \left(R_2^{3/2} e^{-c_2 r \log^2(r)} \sqrt{\mathbb{P}[f \in B_j]} + e^{-c_2 R_2} \right).$$

Remark 4.6. Although in the present chapter we do not need Proposition 4.5 in full generality, we believe it to be of independent interest, for instance it could be useful if one needs quasi-independence for non-monotonic events which are measurable with respect to a moderate number of monotonic events, or if one needs quasi-independence for events of small probability.

Proof of Proposition 4.5. We prove only the case in which (1.3) holds for $\beta > 1$, since the proof in the case of strong exponential decay is identical.

Consider the truncated field f_r , for which $\{f_r \in A\}$ is independent of $\{f_r \in B\}$ by the definition of the events A and B , i.e.,

$$\mathbb{P}[f_r \in A \cap B] = \mathbb{P}[f_r \in A] \mathbb{P}[f_r \in B].$$

Then

$$\begin{aligned} & |\mathbb{P}[f \in A \cap B] - \mathbb{P}[f \in A]\mathbb{P}[f \in B]| \\ & = |\mathbb{P}[f \in A \cap B] - \mathbb{P}[f_r \in A \cap B] + \mathbb{P}[f_r \in A]\mathbb{P}[f_r \in B] - \mathbb{P}[f \in A]\mathbb{P}[f \in B]| \\ & \leq |\mathbb{P}[f \in A \cap B] - \mathbb{P}[f_r \in A \cap B]| + |\mathbb{P}[f_r \in A] - \mathbb{P}[f \in A]| + |\mathbb{P}[f_r \in B] - \mathbb{P}[f \in B]| \end{aligned}$$

(indeed, if $a, b, a', b' \in [0, 1]$ then $|aa' - bb'| \leq |a - a'| + |b - b'|$). Now, note that

$$\{f \in A \cap B\} \Delta \{f_r \in A \cap B\} \subseteq (\{f \in A\} \Delta \{f_r \in A\}) \cup (\{f \in B\} \Delta \{f_r \in B\}),$$

and so

$$|\mathbb{P}[f \in A \cap B] - \mathbb{P}[f \in A]\mathbb{P}[f \in B]| \leq 2\mathbb{P}[f \in A \Delta f_r \in A] + 2\mathbb{P}[f \in B \Delta f_r \in B].$$

Similarly, note that

$$\mathbb{P}[f \in A \Delta f_r \in A] \leq \sum_{i=1}^{n_1} \mathbb{P}[f \in A_i \Delta f_r \in A_i],$$

and analogously for $\mathbb{P}[f \in B \triangle f_r \in B]$. As a result

$$|\mathbb{P}[f \in A \cap B] - \mathbb{P}[f \in A] \mathbb{P}[f \in B]| \leq 2 \sum_{i=1}^{n_1} \mathbb{P}[f \in A_i \triangle f_r \in A_i] + 2 \sum_{i=j}^{n_2} \mathbb{P}[f \in B_{ij} \triangle f_r \in B_j].$$

Applying Proposition 4.1, and since A, B are monotonic, we have

$$\mathbb{P}[f \in A_i \triangle f_r \in A_i] \leq c_1 R_1 \log(R_1) r^{1-\beta} \sqrt{\mathbb{P}[f \in A_i]} + c_1 e^{-c_1 \log^2(R_1)},$$

and similarly for $\mathbb{P}[f \in B_j \triangle f_r \in B_j]$, which completes the proof. \square

To finish the section we use Theorem 4.2 to deduce RSW estimates for the zero $\ell = 0$ in the case that, additionally, Assumption 1.3 and the weak positivity condition in Assumption 1.4 holds. For this we rely on the strategy of [Tas16] (see Section 4 of Chapter 1 for more detail). These estimates constitute the first statement of Theorem 1.11.

Theorem 4.7 (RSW estimates). *Suppose that Assumption 1.3 holds, that the weak positivity condition in Assumption 1.4 holds, and that Assumption 1.5 holds for a given $\beta > 2$. Then for each quad Q ,*

$$\inf_{s>0} \mathbb{P}(f \in \text{Cross}_0(sQ)) > 0 \quad \text{and} \quad \sup_{s>0} \mathbb{P}(f \in \text{Cross}_0(sQ)) < 1,$$

and moreover there exist $c, d > 0$ such that, for each $1 \leq r \leq R$,

$$\mathbb{P}(f \in \text{Arm}_0(r, R)) < c \left(\frac{r}{R}\right)^d.$$

Proof. Given that quasi-independence holds by Theorem 4.2 (recall that the fact that there exists a neighbourhood V of 0 such that $\inf_V |\rho| > 0$ is implied by weak positivity and $\beta > 2$; see Proposition 3.4), this follows directly from the arguments in [Tas16]. More precisely, Tassion's argument relies on three conditions being satisfied (see Section 4 of Chapter 1 and [BG16, Section 4.2] for details):

1. The FKG inequality for crossing-type events (that holds since $\kappa \geq 0$);
2. Sufficient symmetry, which is guaranteed by Assumption 1.3; and
3. At only one place in the proof, the following quasi-independence property (see Lemma 4.3 of Chapter 1): For every $\delta > 0$ and $C > 0$ there exists $s_0 > 0$ such that, for every $s > s_0$, every pair D_1 and D_2 of Borel subsets of the plane of diameter at most Cs and at distance at least s from each other, and every pair of monotonic events $A \in \mathcal{F}_{D_1}$ and $B \in \mathcal{F}_{D_2}$,

$$|\mathbb{P}[f \in A \cap B] - \mathbb{P}[f \in A] \mathbb{P}[f \in B]| \leq \delta. \quad (4.4)$$

Since (4.4) is implied by Theorem 4.2 (recall that we assume $\beta > 2$), these conditions are satisfied and Tassion's arguments are valid. \square

Remark 4.8. As shown in [BG16, Section 4.2], in light of Theorem 4.7 and the quasi-independence in Theorem 4.2, the zero level set \mathcal{L}_0 also satisfies equivalents of the RSW estimates.

We finish this section by showing how to deduce the first statement of Theorem 1.15 from the RSW estimates and our analysis in Section 3.

Proof of the first statement of Theorem 1.15. Let $c_1 > 1$ be given. By Corollary 3.7, for each quad Q there exists a constant $c_2 > 0$ such that for each $s > 0$,

$$0 \leq \mathbb{P}[\text{Cross}_0(sQ)] - \mathbb{P}_{s^{-c_1}}[\text{Cross}(sQ)] < c_2 s^{1-c_1},$$

and so, in particular, as $s \rightarrow \infty$,

$$|\mathbb{P}[\text{Cross}_0(sQ)] - \mathbb{P}[\text{Cross}_{s^{-c_1}}(sQ)]| \rightarrow 0.$$

Combining with the RSW estimates in Theorem 4.7, we have the result. \square

5 A first description of the phase transition

In this section we begin our study of the sharp phase transition, establishing a first description of the phase transition for a single rectangle at levels $\ell > 0$ which are polynomially small in the scale of the rectangle; in the final section we will bootstrap this to complete the main results. Throughout this section we suppose that Assumptions 1.1 and 1.3 hold, that the strong positivity condition in Assumption 1.4 holds, and that Assumption 1.5 holds for a given $\beta > 2$ that is henceforth fixed.

Let us begin by introducing streamlined notation for crossing events involving rectangles. For $\rho_1, \rho_2 > 0$, let $\text{Cross}_\ell(\rho_1, \rho_2)$ denote the crossing event $\text{Cross}_\ell(Q)$ in the case that $Q = (D; \gamma_1, \gamma_2)$, where D is the rectangle $[0, \rho_1] \times [0, \rho_2]$ and γ_1 and γ_2 are respectively the left and right sides $\{0\} \times [0, \rho_2]$ and $\{\rho_1\} \times [0, \rho_2]$. We also define $\text{Cross}_\ell^*(\rho_1, \rho_2)$ for the crossing event $\text{Cross}_\ell^*(Q)$ introduced in Section 3 that corresponds to this quad.

Recall also that, as in the statement of Proposition 4.1, we identify $f = f_r$ for the setting $r = \infty$.

The main result of this section is the following:

Theorem 5.1. *There exists a constant $\theta > 0$ such that, as $R \rightarrow \infty$,*

$$\inf_{\bar{r} \in [R^{-\theta}, \infty]} \mathbb{P}[f_{\bar{r}} \in \text{Cross}_{R^{-\theta}}(2R, R)] \rightarrow 1.$$

As described in Section 2, we prove Theorem 5.1 by applying the OSSS inequality to (the white-noise representation of) the truncated discretised field f_r^ε and the complement of the event $\text{Cross}_\ell^*(2R, R)$, where $r = R^h$ and $\varepsilon = R^{-\gamma}$ for $h, \gamma > 0$ well-chosen constants. While it would have been more natural to work with the event $\text{Cross}_\ell(2R, R)$, and although we expect that the events $\{f_r^\varepsilon \notin \text{Cross}_\ell^*(2R, R)\}$ and $\{f_r^\varepsilon \in \text{Cross}_\ell(2R, R)\}$ are equal almost surely (as is the case for f and f_r for instance; see Proposition 3.3), since we lack a proof of this (the field f_r^ε is degenerate and is not stationary, so standard arguments do not apply), we must take care to distinguish these events.

5.1 Sprinkling

We begin the proof of Theorem 5.1 with a ‘sprinkling’ procedure that yields RSW-type estimates for the excursion set \mathcal{E}_ℓ of f_r^ε at polynomially-small levels.

For each $0 < \rho_1 < \rho_2$ and $x \in \mathbb{R}^2$, let $\text{Arm}_\ell(x; \rho_1, \rho_2)$ (resp. $\text{Arm}_\ell^*(x; \rho_1, \rho_2)$) denote the event that there is a connected component of \mathcal{E}_ℓ (resp. \mathcal{E}_ℓ^c) that intersects both $\partial B_{\rho_1}(x)$ and $\partial B_{\rho_2}(x)$.

Proposition 5.2. *We have the following two ‘sprinkling’ properties:*

- i) Let d be the constant appearing in Theorem 4.7. There exist constants $c_1, c_2 > 0$ such that, for each $h, \gamma > 0$ and each $\theta \in]0, \min\{\gamma, (\beta - 1)h\}]$, there is a constant $R_0 \geq 1$ such that the following holds: For every $R \geq R_0$, $1 \leq \rho_1 \leq \rho_2 \leq R$, $x \in \mathbb{R}^2$, and $\ell \geq R^{-\theta}$,*

$$\mathbb{P}\left[f_{R^h}^{R^{-\gamma}} \notin \text{Cross}_\ell^*(2R, R)\right] > c_1, \quad \mathbb{P}\left[f_{R^h}^{R^{-\gamma}} \in \text{Arm}_\ell^*(x; \rho_1, \rho_2)\right] < c_2 \left(\frac{\rho_1}{\rho_2}\right)^d.$$

- ii) Moreover, for each $h, \gamma > 0$ and each $\theta \in]0, \min\{\gamma, (\beta - 1)h\}]$,*

$$\sup_{\ell \geq R^{-\theta}} \sup_{\bar{r} \in [R^h, \infty]} \mathbb{P}\left[\{f_{R^h}^{R^{-\gamma}} \notin \text{Cross}_\ell^*(2R, R)\} \setminus \{f_{\bar{r}} \in \text{Cross}_{2\ell}(2R, R)\}\right] \xrightarrow{R \rightarrow \infty} 0.$$

Proof. The proof is based on the simple fact that, if A is an increasing event that depends only on B_R , and if f and g are random fields satisfying

$$\mathbb{P}[f \in A] > c \quad \text{and} \quad \mathbb{P}(\|f - g\|_{\infty, B_R} > \ell) < \delta$$

for some constants $c, \ell, \delta > 0$, then $\mathbb{P}[g + \ell \in A] > c - \delta$, and similarly for A decreasing.

Now let $h, \gamma > 0$ be given. By Proposition 3.11 there exist $c_3, c_4 > 0$ such that, for each $R \geq 1$,

$$\sup_{\bar{r} \in [R^h, \infty]} \mathbb{P} \left(\|f_{\bar{r}} - f_{R^h}^{R^{-\gamma}}\|_{\infty, B_R} > c_3(\log R)(R^{-(\beta-1)h} + R^{-\gamma}) \right) < c_3 e^{-c_4(\log R)^2}.$$

Since $\theta < \min\{\gamma, (\beta-1)h\}$, this implies that, for all $\ell \geq R^{-\theta}$,

$$\sup_{\bar{r} \in [R^h, \infty]} \mathbb{P} \left(\|f_{\bar{r}} - f_{R^h}^{R^{-\gamma}}\|_{\infty, B_R} > \ell \right) < c_5 e^{-c_6(\log R)^2}$$

for constants $c_5, c_6 > 0$. Since the right-hand side of the above tends to zero as $R \rightarrow \infty$ (faster than R^{-d}), and since $\text{Cross}_{\ell}^*(\rho_1, \rho_2)$ and $\text{Arm}_{\ell}^*(x; \rho_1, \rho_2)$ are decreasing events, combining with the RSW estimates in Theorem 4.7 gives the first two results as well as the third result with $\{f_{\bar{r}} \in \text{Cross}_{2\ell}(2R, R)\}$ replaced by $\{f_{\bar{r}} \notin \text{Cross}_{2\ell}^*(2R, R)\}$. In light of the second statement of Proposition 3.3 we are done. \square

5.2 Connecting Russo's formula to the OSSS influences

The next step is to give a Russo-type formula that is applicable in our setting, and then to show that the ‘influences’ that appear in this formula are comparable to the influences that appear in the OSSS inequality (see Section 2 where we introduce this inequality).

We begin by considering the case of a standard n -dimensional Gaussian vector X , for which we have the following Russo-type formula: For every Borel set $A \subset \mathbb{R}^n$ and $\ell \in \mathbb{R}$,

$$\frac{d}{d\ell} \mathbb{P}[(X_1 + \ell, \dots, X_n + \ell) \in A] = \sum_{i=1}^n \mathbb{E}[X_i \mathbb{1}_{(X_1 + \ell, \dots, X_n + \ell) \in A}]. \quad (5.1)$$

By analogy with the Boolean Russo formula (2.2), the summands $\mathbb{E}[X_i \mathbb{1}_A]$ can be considered as the ‘influence’ of each coordinate i on the event A ; in the case that A is increasing, these are always positive.

We next connect the above notion of influence to the ‘resampling’ influences I_i that appear in the OSSS inequality, defined in Section 5. For each increasing Borel set $A \subseteq \mathbb{R}^n$ and $i \in \{1, \dots, n\}$, let $Y_i^A \in [-\infty, \infty]$ be the random variable, depending on all coordinates except the i^{th} , such that, for every $x < Y_i^A$, $(X_1, \dots, X_{i-1}, x, X_i, \dots, X_n) \notin A$ and, for every $x > Y_i^A$, $(X_1, \dots, X_{i-1}, x, X_i, \dots, X_n) \in A$; in other words, Y_i^A is the *threshold* for the event A with respect to the i^{th} coordinate. Then, by symmetry,

$$\mathbb{E}[X_i \mathbb{1}_{X \in A}] = \mathbb{E}[X_i \mathbb{1}_{X_i \geq Y_i^A}] = \mathbb{E}[X_i \mathbb{1}_{X_i \geq |Y_i^A|}].$$

Now, let $\tilde{X} = X$ except that the i^{th} coordinate is resampled independently. Then we can define the influence of each $i \in \{1, \dots, n\}$ on A as in Section 2.2, i.e.,

$$I_i(A) := I_i^{\mathcal{N}(0,1)}(A) = \mathbb{P}[\mathbb{1}_A(X) \neq \mathbb{1}_A(\tilde{X})],$$

(we shall use the abbreviation $I_i := I_i^{\mathcal{N}(0,1)}$ throughout Section 5). Note that we have

$$\begin{aligned} I_i(A) &= 2\mathbb{P}[X_i \leq Y_i^A \leq \tilde{X}_i] \leq 2\mathbb{P}[X_i \geq |Y_i^A|] \\ &\leq c_{\text{Rus}} \mathbb{E}[X_i \mathbb{1}_{X_i \geq |Y_i^A|}] = c_{\text{Rus}} \mathbb{E}[X_i \mathbb{1}_{X \in A}], \end{aligned} \quad (5.2)$$

where $c_{\text{Rus}} > 0$ denotes the absolute constant

$$c_{\text{Rus}} = \sup_{a \geq 0} \mathbb{P}[Z \geq a] / \mathbb{E}[Z \mathbb{1}_{Z \geq a}] < \infty, \quad (5.3)$$

for Z a standard normal random variable. In other words, the ‘influences’ in Russo’s formula are comparable to the resampling influences, just as they are in the Boolean setting of percolation (as discussed in Section 2). Note that the fact that A was increasing was crucial in attaining (5.2).

We now return to the setting of smooth Gaussian fields. Fix $\varepsilon > 0$ and consider the discretised field $f^\varepsilon = q \star W^\varepsilon$, where for the purposes of this discussion we assume only that Assumption 1.5 holds for $\beta > 1$ rather than $\beta > 2$ (we also do not need Assumption 1.3 here). Let $r \geq 1$, let D be a bounded Borel subset of \mathbb{R}^2 and let $\mathcal{D} = \{x \in \mathbb{Z}^2 : \text{dist}(x, D) \leq r\}$, where dist is the Euclidean distance. Also, let $A \in \mathcal{F}_D$ (see Definition 3.1 for the notations of σ -algebras) and, for each $\ell \in \mathbb{R}$, let \tilde{A}_ℓ be the Borelian subset of $\mathbb{R}^{\mathcal{D}}$ such that

$$\{f_r^\varepsilon + \ell \in A\} = \{(\eta_v)_{v \in \mathcal{D}} \in \tilde{A}_\ell\}.$$

Observe that, if A is increasing and $q \geq 0$, \tilde{A}_ℓ is increasing with respect to $(\eta_v)_{v \in \mathcal{D}}$. This observation allows us to deduce a Russo-type formula in terms of the ‘resampling’ influences that appear in the OSSS inequality:

Proposition 5.3 (Russo’s formula in terms of the OSSS influences). *Fix $\varepsilon > 0$, let D be a bounded Borel subset of \mathbb{R}^2 and let $A \in \mathcal{F}_D$ be increasing. Define \mathcal{D} and \tilde{A}_ℓ as above. Then, for each $\ell \in \mathbb{R}$,*

$$\frac{d}{d\ell} \mathbb{P}[f^\varepsilon + \ell \in A] = \frac{\varepsilon}{\|q\|_{L^1}} \sum_{v \in \mathcal{D}} \mathbb{E}[\eta_v \mathbb{1}_{f^\varepsilon + \ell \in A}] \geq \frac{c_{\text{Rus}} \varepsilon}{\|q\|_{L^1}} \sum_{v \in \mathcal{D}} I_v(\tilde{A}_\ell), \quad (5.4)$$

where $c_{\text{Rus}} > 0$ is the absolute constant defined in (5.3).

Proof. First recall that

$$f^\varepsilon(x) = \frac{1}{\varepsilon} \sum_{v \in \mathcal{D}} \eta_v \int_{u \in v + [-\varepsilon/2, \varepsilon/2]^2} q(x - u) du,$$

and that $q \in L^1$. Hence, for every $x \in \mathbb{R}^2$,

$$\begin{aligned} f^\varepsilon(x) + \ell &= \frac{1}{\varepsilon} \sum_{v \in \mathcal{D}} \left(\eta_v + \ell \frac{\varepsilon}{\int_{\mathbb{R}^2} q(x - u) du} \right) \int_{u \in v + [-\varepsilon/2, \varepsilon/2]^2} q(x - u) du \\ &= \frac{1}{\varepsilon} \sum_{v \in \mathcal{D}} \left(\eta_v + \ell \frac{\varepsilon}{\|q\|_{L^1}} \right) \int_{u \in v + [-\varepsilon/2, \varepsilon/2]^2} q(x - u) du. \end{aligned}$$

As a result, we have

$$\{f^\varepsilon + \ell \in A\} = \left\{ \left(\eta_v + \ell \frac{\varepsilon}{\|q\|_{L^1}} \right)_{v \in \mathcal{D}} \in \tilde{A}_0 \right\},$$

and so, by (5.1), we have the equality in (5.4). The inequality then follows from (5.2). Indeed, the fact that A is increasing and that $q \geq 0$ imply that \tilde{A}_ℓ is increasing for every ℓ . Note that this is the only part of the chapter where the strong positivity condition $q \geq 0$ is required. \square

5.3 Applying the OSSS inequality

We are now in a position to apply the OSSS inequality, and complete the proof of Theorem 5.1.

Proof of Theorem 5.1. Let $d > 0$ denote the constant appearing in Proposition 5.2; we can and will assume that $d < 1$. Fix $\gamma, h > 0$ such that $\gamma < 1, d(1 - h)$, and fix a $\theta > 0$ such that

$$\theta < \min\{\gamma, (\beta - 1)h, d(1 - h) - \gamma\},$$

which satisfies in particular the restriction on θ in the statement of Proposition 5.2. For the remainder of the proof we abbreviate $\varepsilon = \varepsilon(R) = R^{-\gamma}$ and $r = r(R) = R^h$.

In the sequel we let $\Omega(1)$ and $O(1)$ denote constants, that may depend on the parameters, but with the properties that (i) $\Omega(1)$ is bounded above and away from zero in R , and $O(1)$ is bounded above in R , and (ii) $\Omega(1)$ and $O(1)$ are independent of ℓ .

Define the (finite) set of vertices

$$\mathcal{D}_R = \varepsilon\mathbb{Z}^2 \cap [-r, 2R + r] \times [-r, R + r].$$

For every $\ell \in \mathbb{R}$ and $R \geq 1$, let $\widetilde{\text{Cross}}_\ell(2R, R)$ be the increasing Borel subset of $\mathbb{R}^{\mathcal{D}_R}$ such that

$$\{f_r^\varepsilon \notin \text{Cross}_\ell^*(2R, R)\} = \{(\eta_v)_{v \in \mathcal{D}_R} \in \widetilde{\text{Cross}}_\ell(2R, R)\}.$$

Our strategy will be to apply OSSS to the event $\{f_r^\varepsilon \notin \text{Cross}_\ell^*(2R, R)\}$; this part of the argument is valid for all $R \geq 1$ and $\ell \in \mathbb{R}$. By the discussion in Section 5.1, we have the following differential formula in terms of the resampling influences I_v :

Claim 5.4. *For every $\ell \in \mathbb{R}$,*

$$\frac{d}{d\ell} \mathbb{P}[f_r^\varepsilon \notin \text{Cross}_\ell^*(2R, R)] \geq \Omega(1) \varepsilon \sum_{v \in \mathcal{D}_R} I_v(\widetilde{\text{Cross}}_\ell(2R, R)). \quad (5.5)$$

Proof. Since $q_r \geq 0$ and $\|q_r\|_{L^1} \leq \|q\|_{L^1} < \infty$ (since Assumption 1.5 holds for $\beta > 2$), this is an application of Proposition 5.3 to the field f_r^ε and the event $A = \text{Cross}_0(2R, R)$. \square

Let us now apply the OSSS inequality to the right-hand side of (5.5). For this we define an algorithm \mathcal{A} that reveals sequentially the values of $(\eta_v)_{v \in \mathcal{D}_R}$ such that (i) \mathcal{A} determines the event $\{f_r^\varepsilon \notin \text{Cross}_\ell^*(2R, R)\}$, and (ii) the revealment $\delta_v(\mathcal{A})$ for every vertex $v \in \mathcal{D}_R$ is small. Our algorithm is adapted from [AB17] (using ideas that take their root in [BKS99] and [SS10]); the basic idea is to explore each of the connected components of \mathcal{E}_ℓ^c that intersects a (randomly chosen) horizontal line-segment L across the rectangle $[0, 2R] \times [0, R]$, and determine whether any of these components join the top and bottom sides of the rectangle, and hence validate the event $\{f_r^\varepsilon \in \text{Cross}_\ell^*(2R, R)\}$ (see Figure 5.1 for an illustration).

Abbreviate $D = [0, 2R] \times [0, R]$. We call a point $x \in D$ *safe* if every vertex $v \in \mathcal{D}_R$ within a distance r of x has been revealed (of course, this set will change during the running of the algorithm, but it is always non-decreasing), and let $\mathcal{S} \subset D$ denote the set of safe points. We call a path in D a *safe blocking path* if it lies in $\mathcal{S} \cap \mathcal{E}_\ell^c$; note that since f_r^ε is an r -dependent field, the value of the field f_r^ε is known precisely on the set of safe points \mathcal{S} , so the existence of a safe blocking path is measurable with respect to the revealed η_v .

The algorithm \mathcal{A} is defined as follows:

Combining Claim 5.4, the OSSS inequality in Theorem 2.1 and the bound on the revealments in (5.6), we obtain

$$\frac{d}{d\ell} \mathbb{P}[f_r^\varepsilon \notin \text{Cross}_\ell^*(2R, R)] \geq \frac{\Omega(1) \varepsilon \text{Var}(f_r^\varepsilon \notin \text{Cross}_\ell^*(2R, R))}{\lfloor R/r \rfloor^{-1} \left(1 + \sum_{k=1}^{\lfloor R/r \rfloor} \mathbb{P}[f_r^\varepsilon \in \text{Arm}_\ell^*(v; 2r, kr)]\right)}. \quad (5.7)$$

At this point we restrict the analysis to R sufficiently large and levels $\ell \geq R^{-\theta}$. With the bound on arm events given in Proposition 5.2, there exists $R_0 > 0$ such that, if $R \geq R_0$ and $\ell \geq R^{-\theta}$,

$$\begin{aligned} \lfloor R/r \rfloor^{-1} \left(1 + \sum_{k=1}^{\lfloor R/r \rfloor} \mathbb{P}[f_r^\varepsilon \in \text{Arm}_\ell^*(v; 2r, kr)]\right) &\leq O(1) \lfloor R/r \rfloor^{-1} \left(1 + \sum_{k=1}^{\lfloor R/r \rfloor} k^{-d}\right) \\ &\leq O(1) \lfloor R/r \rfloor^{-d} \leq O(1) R^{-d(1-h)}. \end{aligned} \quad (5.8)$$

Since $\varepsilon = R^{-\gamma}$, equations (5.7) and (5.8) imply that

$$\frac{d}{d\ell} \mathbb{P}[f_r^\varepsilon \notin \text{Cross}_\ell^*(2R, R)] \geq \Omega(1) R^{d(1-h)-\gamma} \text{Var}(f_r^\varepsilon \notin \text{Cross}_\ell^*(2R, R)).$$

Now, let $\delta > 0$ and let us show that, if R is sufficiently large, then

$$\mathbb{P}[f_r^\varepsilon \notin \text{Cross}_\ell^*(2R, R)] \geq 1 - \delta. \quad (5.9)$$

Note that combined with the final statement of Proposition 5.2, this is enough to conclude the proof of Theorem 5.1 (with $4R^{-\theta}$ instead of $R^{-\theta}$ but then one can replace θ by $\theta + \varepsilon$ for any $\varepsilon > 0$).

We prove (5.9) as follows. First we note that, thanks to the first statement of Proposition 5.2, if R is sufficiently large and $\ell \geq R^{-\theta}$ then

$$\text{Var}(f_r^\varepsilon \notin \text{Cross}_\ell^*(2R, R)) \geq \Omega(1) (1 - \mathbb{P}[f_r^\varepsilon \notin \text{Cross}_\ell^*(2R, R)]).$$

Now, assume that R is such that $\mathbb{P}[f_r^\varepsilon \notin \text{Cross}_\ell^*(2R, R)] < 1 - \delta$. It is then sufficient to prove that this implies that R cannot be too large. For this purpose, we note that this implies that

$$\text{Var}(f_r^\varepsilon \notin \text{Cross}_\ell^*(2R, R)) > \Omega(1)\delta.$$

Hence

$$\frac{d}{d\ell} \mathbb{P}[f_r^\varepsilon \notin \text{Cross}_\ell^*(2R, R)] > \Omega(1)\delta R^{d(1-h)-\gamma}.$$

Integrating from $R^{-\theta}$ to $2R^{-\theta}$, we obtain that

$$\mathbb{P}[f_r^\varepsilon \notin \text{Cross}_\ell^*(2R, R)] > \Omega(1)\delta R^{d(1-h)-\gamma-\theta}.$$

Since $\mathbb{P}[f_r^\varepsilon \notin \text{Cross}_\ell^*(2R, R)] \leq 1$ and since $d(1-h) - \gamma - \theta > 0$, this implies that R cannot be too large and we have proved (5.9). \square

Remark 5.5. In [DCRT17b, DCRT18] the OSSS inequality was applied to one-arm events rather than to crossing events as we do here; for many discrete models, this yields a differential inequality that implies the sharpness of phase transition in any dimension. While it is possible such an approach would also work in our setting, it seems likely that it would require new ideas to implement. The main difficulty comes from the fact that, if we want the algorithm \mathcal{A} to determine the value of $f_r^\varepsilon(x)$ for some x , then \mathcal{A} must reveal *all* of the white-noise coordinates in the ball $B_r(x)$ of *growing* radius $r \gg 1$, which results in a differential inequality that is not strong enough to deduce the phase transition.

6 Proof of the main results

The remainder of our results can all be deduced from Theorem 5.1 via classical gluing and bootstrapping techniques. Since some of the arguments in this section are rather standard, we skip many of the details and instead refer to relevant literature. Throughout this section, $Q = (D; \gamma_1, \gamma_2)$ will denote the quad for which D is the rectangle $[0, 2] \times [0, 1]$ and γ_1 and γ_2 are respectively the left and right sides of D .

The proof of the second statement of Theorem 1.15 is straightforward:

Proof of the second statement of Theorem 1.15. For the quad Q , the required statement is a direct consequence of Theorem 5.1. Standard gluing arguments (see [BG16, Section 4.2] for details) allow the conclusion to be extended to every quad. \square

The main technical novelty in this section is to deduce from Theorem 5.1 a version of the third statement of Theorem 1.11 for the quad Q :

Theorem 6.1. *Suppose that Assumptions 1.1–1.3 hold, that the strong positivity condition in Assumption 1.4 holds, and that Assumption 1.5 holds for a given $\beta > 2$. Then for every $\ell > 0$ there exist $c_1, c_2 > 0$ such that, for all $R \geq 1$,*

$$\mathbb{P}(f \in \text{Cross}_\ell(2R, R)) > 1 - c_1 e^{-c_2 \log^2(R)}.$$

Suppose in addition that the strong exponential decay condition of Assumption 1.5 holds. Then the above conclusion remains valid with $c_1 e^{-c_2 \log^2(R)}$ replaced by $c_1 e^{-c_2 R}$.

Before proving Theorem 6.1 we state two auxiliary lemmas on the decay of real functions that satisfy certain functional inequalities; we defer the proof of these lemmas until the end of the section.

Lemma 6.2. *Let $(a_R)_{R \geq 0}$ be a positive function such that $a_R \rightarrow 0$ and for which there exist $c_1, c_2, R_0 > 0$ such that, for all $R \geq R_0$,*

$$a_{2(R+R/\log^2(R))} \leq c_1 a_R^2 + e^{-c_2 R}.$$

Then there exist $c_3, c_4 > 0$ and a positive sequence $(m_n)_{n \geq 1}$ such that, for all $n \geq 1$,

$$2^n \leq m_n \leq c_3 2^n \quad \text{and} \quad a_{m_n} \leq e^{-c_4 m_n}.$$

Remark 6.3. Lemma 6.2 would still be true if $\log^2(R)$ was replaced by $\log^{1+\varepsilon}(R)$ for any $\varepsilon > 0$, but would be false for $\varepsilon = 0$; this is the origin of the ‘log-squared’ factor in the super exponential decay condition in Assumption 1.5 (which we could relax to any power strictly larger than one).

Lemma 6.4. *Let $(a_R)_{R \geq 0}$ be a positive function such that $a_R \rightarrow 0$ and for which there exist $c_1, c_2, R_0 > 0$ such that, for all $R \geq R_0$,*

$$a_{3R} \leq c_1 a_R^2 + R^{-c_2} a_R + e^{-c_2 \log^2(R)}. \tag{6.1}$$

Then there exist $c_3, R_1 > 0$ such that the sequence $m_n = R_1 3^n$ satisfies, for every $n \geq 1$,

$$a_{m_n} \leq e^{-c_3 \log^2(m_n)}.$$

Proof of Theorem 6.1. Let the level $\ell > 0$ be given. We first prove the result in the case that the strong exponential decay condition of Assumption 1.5 holds. Note that by gluing arguments and duality it is sufficient to prove the result for $\mathbb{P}[f \in \text{Cross}_\ell(2R, R)]$, that is, defining

$$a_R = \mathbb{P}[f \notin \text{Cross}_\ell(2R, R)],$$

it is sufficient to prove the existence of a $c_1 > 0$ such that, for sufficiently large $R \geq 1$,

$$a_R \leq e^{-c_1 R}. \quad (6.2)$$

We deduce (6.2) from the following functional inequality for a_R , proved immediately below: There exists a $c_1 > 0$ such that, for sufficiently large $R \geq 1$,

$$a_{2(R+R/\log^2(R))} \leq 49a_R^2 + e^{-c_1 R}. \quad (6.3)$$

Recalling that Theorem 5.1 implies that $a_R \rightarrow 0$, an application of Lemma 6.2 then yields the existence of constants $c_2, c_3 > 0$ and a positive subsequence $(m_n)_{n \geq 1}$ such that, for all $n \geq 1$,

$$2^n \leq m_n \leq c_2 2^n \quad \text{and} \quad a_{m_n} \leq e^{-c_3 m_n}.$$

This implies (6.2) for $R \in \{m_n\}_{n \geq 1}$, which can be extended to all $R \geq 0$ by standard gluing arguments.

To prove (6.3) we introduce two ‘multiple crossing’ events:

- $\text{MultiCross}_\ell(R)$, which is the union of the following seven events: (i-iv) $\text{Cross}_\ell(2R, R)$, and copies of this event translated by $(R, 0)$, $(2R, 0)$ and $(3R, 0)$, and (v-vii) $\text{Cross}_\ell(R, R)$ translated by $(R, 0)$ and rotated by $\pi/2$, and copies of this event translated by $(R, 0)$ and $(2R, 0)$. This event is depicted at the bottom of Figure 6.1.
- $\text{MultiCross}'_\ell(R)$, which is the event $\text{FiveCross}_\ell(R)$ translated by $(0, R + 2R/\log^2(R))$. This event is depicted at the top of Figure 6.1.

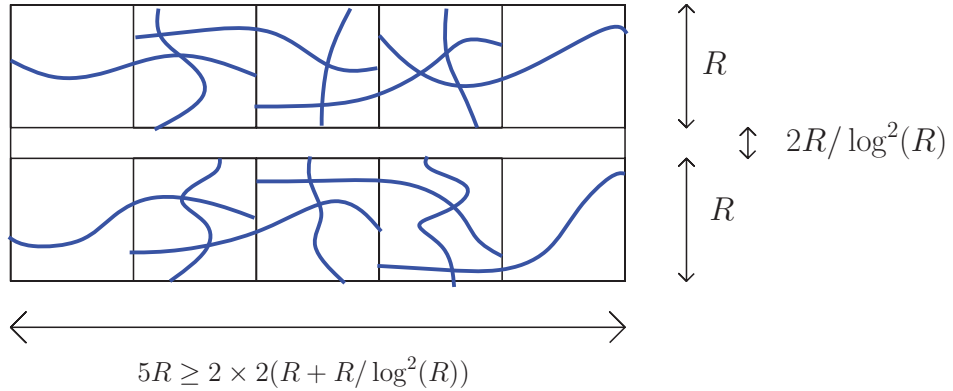

Figure 6.1 – The events $\text{MultiCross}_\ell(R)$ (along the bottom) and $\text{MultiCross}'_\ell(R)$ (along the top), in the case of strong exponential decay of correlations.

We also introduce the scales

$$b_R = \mathbb{P}[f \notin \text{MultiCross}_\ell(R)] \quad \text{and} \quad b'_R = \mathbb{P}[f \notin \text{MultiCross}_\ell(R) \cup \text{MultiCross}'_\ell(R)].$$

Now observe the following three facts:

1. By stationarity and the union bound, $b_R \leq 7a_R$;
2. By stationarity and the quasi-independence in Theorem 4.2, there exists $c_1 > 0$ such that, for sufficiently large $R \geq 1$,

$$b'_R \leq b_R^2 + R^{3/2} e^{-(c_1/2)(R/\log^2(R)) \log^2(R/\log^2(R))} + e^{(c_1/2)R} \leq b_R^2 + e^{-c_1 R};$$

3. For sufficiently large $R \geq 1$,

$$\text{MultiCross}_\ell(R) \cup \text{MultiCross}'_\ell(R) \subseteq \text{Cross}_\ell(4(R + R/\log^2(R)), 2(R + R/\log^2(R))),$$

and so $a_{2(R+R/(\log R)^2)} \leq b'_R$.

Putting these together yields (6.3).

We now turn to the case in which Assumption 1.5 holds for a given $\beta > 2$. In this case we work instead with $3R \times R$ rectangles, and define

$$a_R = \mathbb{P}[f_R \notin \text{Cross}_\ell(3R, R)].$$

We then claim that there exist $c_1, c_2 > 0$ such that, for sufficiently large R ,

$$a_{3R} \leq c_1 a_R^2 + R^{-c_2} a_R + e^{-c_2 \log^2(R)}. \quad (6.4)$$

Since Theorem 5.1 implies that $a_R \rightarrow 0$, an application of Lemma 6.4 yields the existence of $c_4, R_1 > 0$ such that the sequence $m_n = R_1 3^n$ satisfies, for all $n \geq 1$,

$$a_{m_n} \leq e^{-c_3 \log^2(m_n)}.$$

As in the previous case, simple gluing arguments then yield the same inequality for all $R \geq 1$, which implies the claimed result after an application of Proposition 4.1 (and since a left-right crossing of $[0, 3R] \times [0, R]$ implies a left-right crossing of $RQ = [0, 2R] \times [0, R]$).

To prove (6.4) we introduce slight variations on the ‘multiple crossing’ events:

- $\text{MultiCross}_\ell(R)$, which is the union of the following seven events: (i-iv) $\text{Cross}_\ell(3R, R)$, and copies of this event translated by $(2R, 0)$, $(4R, 0)$ and $(6R, 0)$, and (v-vii) $\text{Cross}_\ell(R, R)$ translated by $(2R, 0)$ and rotated by $\pi/2$, and copies of this event translated by $(2R, 0)$ and $(4R, 0)$. This event is depicted at the bottom of Figure 6.2.
- $\text{MultiCross}'_\ell(R)$, which is the event $\text{MultiCross}_\ell(R)$ translated by $(0, R)$. This event is depicted at the top of Figure 6.2.

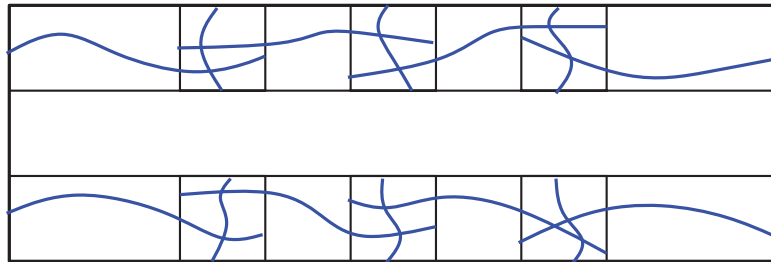

Figure 6.2 – The events $\text{MultiCross}_\ell(R)$ (along the bottom) and $\text{MultiCross}'_\ell(R)$ (along the top), in the case of polynomial decay of correlations.

We also redefine the scales

$$b_R = \mathbb{P}[f_R \notin \text{MultiCross}_\ell(R)] \quad \text{and} \quad b'_R = \mathbb{P}[f_R \notin \text{MultiCross}_\ell(R) \cup \text{MultiCross}'_\ell(R)],$$

and introduce the new scale

$$b''_R = \mathbb{P}[f_{3R} \notin \text{MultiCross}_\ell(R) \cup \text{MultiCross}'_\ell(R)].$$

Note that, unlike in the previous case, we always consider $\text{MultiCross}_\ell(R)$ and $\text{MultiCross}'_\ell(R)$ relative to the truncated fields f_R and f_{3R} rather than the field f . Arguing as in the previous case,

$$b_R \leq 7a_R, \quad b'_R = b_R^2 \quad \text{and} \quad a_{3R} \leq b''_R,$$

where the second equality holds since the events

$$\{f_R \notin \text{MultiCross}_\ell(R)\} \quad \text{and} \quad \{f_R \notin \text{MultiCross}'_\ell(R)\}$$

are independent. Moreover, applying Proposition 4.1 there exist $c_3, c_4 > 0$ such that, if R is sufficiently large:

$$b''_R \leq b'_R + c_3 R^{2-\beta} (\log R) \sqrt{b'_R} + c_3 e^{-c_4 \log^2(R)}.$$

Putting these together yields (6.4). \square

We deduce the remainder of our results from Theorem 6.1, namely Theorem 1.6, Theorem 1.7, and the second and third statements of Theorem 1.11 (the first statement of this theorem is given by Theorem 4.7).

Proof of the second and third statements of Theorem 1.11. The result in the case $\ell > 0$ is a consequence of Theorem 6.1 by standard gluing techniques, and the result in the case $\ell < 0$ then follows since f is equal to $-f$ in law. \square

Proof of Theorem 1.6. The result in the case $\ell \leq 0$ follows from the fact that $\mathbb{P}[f \in \text{Arm}_0(1, R)]$ decays to 0 as R goes to ∞ (see the first statement of Theorem 1.11). The result in the case $\ell > 0$ is a consequence of the second statement of Theorem 1.11 by standard gluing techniques (see Lemma 2.9 of Chapter 2 for details). Indeed, we have

$$\sum_{k \in \mathbb{N}} \mathbb{P} \left[\text{Cross}_\ell(2^{k+1}R, 2^k R) \right] < \infty,$$

and we conclude, by the Borel-Cantelli lemma, that there exists an unbounded connected component (with uniqueness following easily from these arguments as well). \square

Proof of Theorem 1.7. The result in the case $\varepsilon = 0$ is immediate since, by Theorem 1.6, \mathcal{E}_0 does not percolate. In the case $\varepsilon > 0$, we first deduce that, for every quad Q , the probability of the crossing sQ by the set $\mathcal{L}_0^\varepsilon$ tends to one at the same rate (given in Theorem 1.11) as for the event $\text{Cross}_{-\varepsilon}(sQ)$. This is since a crossing of sQ by $\mathcal{L}_0^\varepsilon$ can only not occur if the complementary crossing event for the quad sQ^* occurs for *either* the set $\mathcal{E}_{-\varepsilon}$ *or* the set $\mathcal{E}_\varepsilon^c$ (which have the same probability). As in the proof of Theorem 1.6, standard gluing techniques then give the result (in particular, these gluing arguments do not rely on the FKG inequality in (3.3), which is important since $\mathcal{L}_0^\varepsilon$ does not enjoy positive associations). \square

To finish the section, we prove the auxiliary lemmas used in the proof of Theorem 6.1:

Proof of Lemma 6.2. Without loss of generality we assume that $c_1 > 1$. Define $a'_R = c_1 a_R + e^{-(c_2/4)R}$; we prove the result for a'_R , which is sufficient since $a_R \leq a'_R$.

We claim that there exists an $R_1 > 1$ such that $a_{R_1} < 1$ and, for each $R \geq R_1$,

$$a'_{2(R+R/\log^2(R))} \leq (a'_R)^2. \tag{6.5}$$

Such an R_1 exists since, for sufficiently large $R \geq 1$ (and since $a_R \rightarrow 0$),

$$\begin{aligned} a'_{2(R+R/\log^2(R))} &= c_1 a_{2(R+R/\log^2(R))} + e^{-(c_2/4)2(R+R/\log^2(R))} \\ &\leq c_1^2 a_R^2 + c_1 e^{-c_1 R} + e^{-(c_2/2)R} e^{-(c_2/2)R/\log^2(R)} \\ &= (c_1 a_R)^2 + (e^{-(c_2/4)R})^2 + c_1 e^{-c_2 R} - e^{-(c_2/2)R} (1 - e^{-(c_2/2)R/\log^2(R)}) \\ &\leq (c_1 a_R)^2 + (e^{-(c_2/4)R})^2 \leq (a'_R)^2. \end{aligned}$$

Now define $m_1 = R_1$ and $m_{n+1} = 2(m_n + m_n/\log^2(m_n))$. By (6.5) we have, for each $n \geq 1$, $a'_{m_n} \leq (a'_{R_1})^{2^n}$. Moreover, observe that there exists $c_1 > 0$ such that $2^n \leq m_n \leq c_1 2^n$, which is easily seen by noting that

$$\frac{m_{n+1}}{2^{n+1}} - \frac{m_n}{2^n} = \frac{m_n}{2^n} \frac{1}{\log^2(m_n)}.$$

Combining these we have the result. \square

Proof of Lemma 6.4. Without loss of generality we assume that $c_1 > 1$. Define $a'_R = a_R + e^{-(c_2/2)\log^2(R)}$; we prove the result for a'_R , which is sufficient since $a_R \leq a'_R$.

The proof consists of three steps. In the first step we claim that, for sufficiently large $R \geq 1$,

$$a'_{3R} \leq c_1 (a'_R)^2 + R^{-c_2} a'_R. \quad (6.6)$$

To see this observe that

$$\begin{aligned} a'_{3R} &= a_{3R} + e^{-(c_2/2)(\log 3R + \log 3)^2} \\ &\leq c_1 a_R^2 + R^{-c_2} a_R + e^{-c_2 \log^2(R)} + e^{-c_2(\log 3)^2/2} R^{-(\log 3)c_2} e^{-(c_2/2)\log^2(R)} \\ &\leq c_1 (a_R^2 + e^{-c_2 \log^2(R)}) + R^{-c_2} (a_R + e^{-(c_2/2)\log^2(R)}) \\ &\leq c_1 (a'_R)^2 + R^{-c_2} a'_R, \end{aligned}$$

with the second inequality holding since $c_1 > 1$ and since, for sufficiently large R ,

$$e^{-c_2(\log 3)^2/2} R^{-(\log 3)c_2} \leq R^{-c_2}.$$

For the second step, fix an arbitrary $0 < c_3 < c_2$; we claim that there exist $c_4, R_1 > 0$ such that, for every $n \geq 1$,

$$a'_{3^n R_1} \leq c_4 (3^n R_1)^{-c_3}. \quad (6.7)$$

For this define $a''_R = a'_R + R^{-c_3}$ and consider that, for sufficiently large $R \geq 1$ (and since $a'_R \rightarrow 0$),

$$\begin{aligned} a''_{3R} &= a'_{3R} + 3^{-c_3} R^{-c_3} \\ &\leq c_1 (a'_R)^2 + R^{-c_2} a'_R + 3^{-c_3} R^{-c_3} \\ &\leq 3^{-c_3} a'_R + 3^{-c_3} R^{-c_3} = 3^{-c_3} a''_R. \end{aligned}$$

Choosing R_1 such that the above holds and $a'_{R_1} < 1$, for all $n \geq 1$ we have that

$$a'_{3^n R_1} \leq a''_{3^n R_1} \leq (3^n)^{-c_3},$$

which implies (6.7) by choosing $c_4 > 0$ large enough.

For the final step, define $m_n = R_1 3^n$ and use (6.7) to bound one factor of a'_R in the $(a'_R)^2$ term of the right-hand side of (6.6); this yields

$$\log a'_{m_{n+1}} - \log a'_{m_n} \leq \log (c_1 c_4 m_n^{-c_3} + m_n^{-c_2}) \leq c_5 - c_6 n$$

for sufficiently large $c_5 > 0$ and $c_6 = c_3 \log 3$. Telescoping this inequality,

$$\log a'_{m_n} \leq \log a'_{m_1} + c_6(n-1) - c_7 n(n-1)/2 \leq -c_7 \log^2(R 3^n) = -c_7 \log^2(m_n)$$

for sufficiently small $c_7 > 0$, which completes the proof. \square

Deuxième partie

Dynamiques et percolation de Voronoi

 Temps exceptionnels pour la percolation sous une dynamique d'exclusion

Travail en commun avec Christophe Garban

Ce chapitre est, à des détails mineurs près, la reproduction de l'article [V4], intitulé "Exceptional times for percolation under exclusion dynamics", disponible sur Hal et Arxiv et à paraître aux Annales scientifiques de l'École Normale Supérieure.

Résumé en français. Ce chapitre a pour sujet une version conservative du modèle de la percolation dynamique. Le modèle se définit de la façon suivante : on tire une configuration de percolation initiale $\omega(t = 0)$ puis on fait évoluer cette configuration selon un processus d'exclusion simple de noyau symétrique $K(x, y)$. Nous commençons le chapitre par une étude générale (en suivant [HPS97]) du processus $t \mapsto \omega_K(t)$ que nous appelons percolation dynamique sous K -exclusion. Nous analysons ensuite de façon détaillée le cas bi-dimensionnel au point critique pour des noyaux en loi de puissance $K^\alpha(x, y) \propto \frac{1}{\|x-y\|_2^{2+\alpha}}$. Nous montrons que si l'exposant $\alpha > 0$ est suffisamment petit, il existe des temps exceptionnels t pour lesquels une composante connexe infinie se forme dans $\omega_{K^\alpha}(t)$. Afin de contrôler la dynamique ci-dessus du type K -exclusion, nous approfondissons l'analyse spectrale de la sensibilité au bruit sous exclusion initiée dans le travail [BGS13].

English abstract. We analyse in this paper a conservative analogue of the model of dynamical percolation. It is defined as follows : start with an initial percolation configuration $\omega(t = 0)$. Let this configuration evolve in time according to a simple exclusion process with symmetric kernel $K(x, y)$. We start with a general investigation (following [HPS97]) of this dynamical process $t \mapsto \omega_K(t)$ which we call K -exclusion dynamical percolation. We then proceed with a detailed analysis of the planar case at the critical point where we consider the power-law kernels $K^\alpha(x, y) \propto \frac{1}{\|x-y\|_2^{2+\alpha}}$. We prove that if $\alpha > 0$ is chosen small enough, there exist exceptional times t for which an infinite cluster appears in $\omega_{K^\alpha}(t)$. In order to handle such a K -exclusion dynamics, we push further the spectral analysis of exclusion noise sensitivity which has been initiated in [BGS13].

Contents

1	Introduction	186
1.1	Dynamical percolation	186
1.2	Percolation under exclusion dynamics	187
1.3	Main results	189
2	Background and outline of proof	191
2.1	Arm events and some other notations	191
2.2	Second moment method and exclusion sensitivity	192
2.3	The spectral sample in the i.i.d. setting	194
2.4	Spectral representation of correlations in the conservative case	196
2.5	Outline of proof and new spectral estimates	196
3	Warm-up without spectral analysis: proofs of Propositions 1.3 and 1.4	201
4	Exceptional times at criticality: proofs of Theorem 1.5 and Proposition 1.6	204
5	Clustering effect for the spectral sample	212
5.1	The proof of Proposition 2.10	212
5.2	Small residual spectral mass away from the origin	212
5.2.1	A combinatorial result in the flavour of Section 4 of [GPS10]	213
5.2.2	The proof of Theorem 2.8	226
6	Open questions	228
A	Graphical construction (à la Harris) of exclusion dynamics	229
B	The proof of Lemma 5.7	230
C	The 4-arm event conditioned on the configuration in a half-plane	231

1 Introduction

1.1 Dynamical percolation

We consider bond percolation on an infinite, countable, connected, locally finite graph $G = (V, E)$. We write \mathbb{P}_p for the probability measure of (bond) **percolation of parameter p** on G i.e. the probability measure on $\Omega = \{-1, 1\}^E$ obtained by declaring each edge **open** with probability p and **closed** with probability $1 - p$, independently of the others (1 means open and -1 means closed). More formally, \mathbb{P}_p is the product measure $(p\delta_1 + (1 - p)\delta_{-1})^{\otimes E}$ on Ω equipped with the product σ -algebra. An element $\omega \in \Omega$ is called a **percolation configuration**. Moreover, a connected component of the graph obtained by keeping only the open edges is called a **cluster**. It is a simple consequence of Kolmogorov's 0-1 law that, for each p , $\mathbb{P}_p[\exists \text{ an infinite cluster}] \in \{0, 1\}$. Moreover, it is well known (see for instance [Gri99] or [BR06b]) that there exists a **critical point** $p_c = p_c(G) \in [0, 1]$ such that:

$$\begin{aligned} \forall p \in [0, p_c), \mathbb{P}_p[\exists \text{ an infinite cluster}] &= 0, \\ \forall p \in (p_c, 1], \mathbb{P}_p[\exists \text{ an infinite cluster}] &= 1. \end{aligned}$$

The most studied model is bond percolation on the Euclidean lattice \mathbb{Z}^d , $d \geq 2$. For this model, it is known that $p_c = p_c(d) \in (0, 1)$. In other words, there exists a phase transition. Moreover, it is a celebrated theorem by Kesten [Kes80] that $p_c(2) = 1/2$ and it is conjectured that, for any $d \geq 2$, $\mathbb{P}_{p_c}[\exists \text{ an infinite cluster}] = 0$. This last property has been proved for $d = 2$ ([Har60]) and $d \geq 11$ (see [HS94, FvdH15]).

In [HPS97], Häggström, Peres and Steif define and study the model of **dynamical** (bond) **percolation** (this model was invented independently by Benjamini). Dynamical percolation of parameter $p \in [0, 1]$ is defined very easily as follows: we sample a percolation configuration $\omega(0)$ according to some initial law and we then let evolve each edge independently of each other according to Poisson point processes: at rate one, the states of edges are resampled using $p\delta_1 + (1-p)\delta_{-1}$. We obtain this way a càdlàg Markov process $(\omega(t))_{t \geq 0}$ on the space Ω (seen as the compact metric product space) with \mathbb{P}_p as (unique) invariant probability measure. The main question is whether, if $\omega(0) \sim \mathbb{P}_p^1$, there exist **exceptional times** for which the percolation configuration is very atypical. Exceptional times are defined as follows: if $\mathbb{P}_p[\exists \text{ an infinite cluster}] = 0$, then an exceptional time is a time for which there is an infinite cluster. On the other hand, if $\mathbb{P}_p[\exists \text{ an infinite cluster}] = 1$, then it is a time for which there is no infinite cluster.

From now on, we assume that $\omega(0) \sim \mathbb{P}_p$. Since \mathbb{P}_p is an invariant measure, then (by Fubini) a.s. Leb-a.e. there is no exceptional time (where Leb is the Lebesgue measure on \mathbb{R}_+). This does not imply that a.s. there does not exist any exceptional time. However, this is the case away from the critical point: the authors of [HPS97] have proved that, for any graph G , if $p \neq p_c$ then a.s. there is no exceptional time (see their Proposition 1.1).

The case $p = p_c$ is in general much more difficult. First, let us note that, for bond percolation on the Euclidean lattice \mathbb{Z}^d , this is for now interesting only for $d = 2$ and $d \geq 11$ since these are the only dimensions for which we know what happens at criticality. For $d \geq 11$, thanks to a result proved in [HS94] for $d \geq 19$ (and extended very recently to $d \geq 11$ in [FvdH15]), the authors of [HPS97] have proved that, even at criticality, a.s. there is no exceptional time (see their Theorem 1.3). However, for $d = 2$, the following is proved in [GPS10] (Theorem 1.4):

For dynamical bond percolation on \mathbb{Z}^2 , a.s. there are exceptional times if $p = p_c = 1/2$.

Such a result had been proved earlier in [SS10] for the model of **site percolation on the triangular lattice**. Let \mathbb{T} denote the (planar) triangular lattice and let \mathbb{P}_p denote the probability measure of site percolation on \mathbb{T} (this is the analogous model where the sites - i.e. the vertices of \mathbb{T} - are open or closed; in this context a cluster is a connected component of the graph obtained by keeping only the open sites). Kesten's work also implies that $p_c = 1/2$ for this model. Of course, one can define dynamical site percolation on \mathbb{T} in the same way as for dynamical bond percolation i.e. by associating exponential clocks to the sites of \mathbb{T} . Much more is known for site percolation on \mathbb{T} than for bond percolation on \mathbb{Z}^2 . Indeed conformal invariance (as the mesh goes to zero) has been proved by Smirnov in [Smi01], and the exact value of several critical exponents (see Subsection 2.1) has been derived in [LSW02, SW01] using the **Schramm Loewner Evolution (SLE)** processes introduced by Schramm. Using the knowledge of these critical exponents, the following is proved in [SS10] (Theorem 1.3):

For dynamical site percolation on \mathbb{T} , a.s. there are exceptional times if $p = p_c = 1/2$.

Finally, let us mention that in [GPS10] it is shown that, for critical site percolation on \mathbb{T} , the Hausdorff dimension of the set of exceptional times is a.s. $31/36$. For other results, see for instance [HPS⁺15] where the authors show that typical exceptional times are intimately related to the so-called Incipient Infinite Cluster introduced by Kesten.

In both [SS10] and [GPS10], the main methods are related to the theory of **Fourier decomposition of Boolean functions**. In the present chapter, we will also rely extensively on such tools, see Subsections 2.3 and 2.4.

1.2 Percolation under exclusion dynamics

We study in this chapter the same question of existence of exceptional times but with a different underlying dynamical process: we let the configuration evolve according to a **symmetric**

¹Where $X \sim P$ means that P is the distribution of the random variable X .

exclusion process. Percolation evolving according to an exclusion process has already been studied by Broman, the first author and Steif in [BGS13] where the authors introduce and study the notion of **exclusion sensitivity**. (We will say more about this notion in Section 2, see also [For15, For16].) To define and study a symmetric exclusion process (which is a Feller Markov process), the most efficient way is to rely on its infinitesimal generator, see [Lig05]. However, we will sometimes need to use a more explicit construction of this dynamics, usually called a **graphical construction** after [Har78]. We provide such a construction in Appendix A.

Definition 1.1. Consider a symmetric transition matrix K on the set of edges E . Sample a percolation configuration $\omega_K(0)$ according to some initial law. To each pair of edges $\{e, f\}$, associate an exponential clock of parameter $K(e, f) = K(f, e)$ independent of the others and $\omega_K(0)$. When the clock of a pair $\{e, f\}$ rings, exchange the states of the two edges. This way, we obtain a càdlàg Markov process $(\omega_K(t))_{t \geq 0}$ on the space Ω that is called a K -(symmetric) exclusion process. For every $p \in [0, 1]$, \mathbb{P}_p is an invariant measure for this process. In the following, we will always consider the case $\omega_K(0) \sim \mathbb{P}_p$ for some $p \in [0, 1]$, and we will call the corresponding process a **K -exclusion dynamical percolation of parameter p** . (Of course, a similar definition holds for a dynamics on site-configurations.)

For more clarity, we call the dynamical percolation process of [HPS97] (defined in Subsection 1.1) **i.i.d. dynamical percolation** (indeed, in this process, the states of the edges evolve independently of each other and according to the same law).

Following [BGS13], our main motivation in this chapter is guided by the following observation. For an exclusion process of parameter p which starts at equilibrium, one has $\omega_K(t) \sim \mathbb{P}_p$ for all $t \geq 0$. As such, one may ask the same natural questions as for the i.i.d. dynamical process. In particular, we define exceptional times exactly in the same way. We shall consider in this chapter the following families of symmetric transition kernels K .

Definition 1.2 (Symmetric transition kernels K considered in this work).

1. First, we shall analyse what happens away from the critical point $p_c = p_c(G)$ for any graph G and at p_c for percolation on \mathbb{Z}^d with $d \geq 11$ (see Propositions 1.3 and 1.4). The proofs in these cases are very close to the i.i.d. setting and work for **any** symmetric kernel K .
2. Then, we focus on what happens at the critical point in the planar setting (critical bond percolation on \mathbb{Z}^2 or critical site percolation on \mathbb{T}). The most natural and most studied conservative dynamics in this case is certainly the **nearest-neighbour simple exclusion process** which on the triangular lattice \mathbb{T} corresponds to the following kernel:

$$K(v, w) := \frac{1}{6} \mathbf{1}_{v \sim w} .$$

(For bond percolation on \mathbb{Z}^2 , one may consider several natural versions of nearest-neighbour exclusion process acting on edges.) As we shall explain later, we are far from being able to prove the existence of exceptional times (even on the triangular lattice \mathbb{T}) for this classical dynamics. This is why we consider the following kernels which in some sense interpolate between the i.i.d. case and the nearest-neighbour dynamics.

3. The main class of dynamics that we will analyse are the following **power-law kernels**. For any $\alpha \in (0, +\infty)$, let

$$\begin{cases} K^\alpha(v, v) & := 0 \\ K^\alpha(v, w) & := c_\alpha \frac{1}{\|v-w\|_2^{2+\alpha}} \text{ if } v \neq w, \end{cases}$$

where c_α is a normalization factor so that K^α is a transition kernel (i.e. $\sum_w K^\alpha(v, w) = 1$). For bond percolation on \mathbb{Z}^2 , one measures the Euclidean distance between two edges as the distance between their mid-points. The shape of the decay (in $r^{-(2+\alpha)}$) is chosen here in such a way that particles move at large scales according to **α -stable** processes. Note that by letting $\alpha \searrow 0$, one recovers in some sense an i.i.d. dynamics, while $\alpha \rightarrow +\infty$ converges to the nearest-neighbour simple exclusion process.

4. Finally, the last family of kernels that we shall investigate are the following ones which are designed to be **super-heavy-tailed** (or in other words, they induce a very long-range exclusion process). The reason to consider these long-range dynamics is that the spectral analysis will be much simpler in this case than for the power-law kernels K^α . Consider for any $a \in (0, +\infty)$,

$$\begin{cases} K_{\log}^a(v, v) & := 0 \\ K_{\log}^a(v, w) & := c_a \frac{1}{\|v-w\|_2^2 \log(\|v-w\|_2+1)^{1+a}} \text{ if } v \neq w. \end{cases}$$

We now list the main results proved in this chapter.

1.3 Main results

Our first two results are the direct analogues for exclusion dynamics of the main results on i.i.d. dynamics proved in the seminal paper on dynamical percolation [HPS97]. The proofs follow very closely the ideas from [HPS97] and do not require any assumption on the symmetric kernel K .

Proposition 1.3. *For any graph G and any symmetric transition matrix K on the edges of G , if $p \neq p_c$ then a.s. there is no exceptional time for the K -exclusion dynamical percolation of parameter p . (This result is also true for site percolation and the proof is the same.)*

Proposition 1.4. *Let $d \geq 11$.² Then, for any symmetric transition matrix K on the edges of the Euclidean lattice \mathbb{Z}^d , a.s. there is no exceptional time for the K -exclusion dynamical percolation of parameter p even if $p = p_c = p_c(d)$.*

Let us now state the main theorem of this chapter (which answers a question that motivated [BGS13]).

Theorem 1.5. *Let K^α be the transition matrix from Definition 1.2 on the edges of \mathbb{Z}^2 or on the sites of \mathbb{T} . If $\alpha > 0$ is sufficiently small, then a.s. there exist exceptional times for the K^α -exclusion dynamical percolation of parameter $p = p_c = 1/2$.*

Moreover, in the case of dynamics on the sites of \mathbb{T} , one has the following explicit lower-bound (as a function of α) on the Hausdorff dimension of exceptional times. Let

$$d(\alpha) := 1 - \frac{5}{36} \left(1 - \frac{68}{21}\alpha \right)^{-1}.$$

*The Hausdorff dimension of the set of exceptional times of a K^α -exclusion dynamical percolation of parameter $p_c = 1/2$ is an a.s. constant that lies in $[d(\alpha), 31/36]$. See Figure 1.1 for a plot of this estimate. In particular, we see that we obtain the existence of exceptional times for any $\alpha < \alpha_0 = 217/816$.³ Note also that our lower-bound $d(\alpha)$ converges to $31/36$ as $\alpha \searrow 0$, which is known to be the Hausdorff dimension of exceptional times for the **i.i.d. dynamical percolation** ([GPS10]).*

²This estimate $d \geq 11$ follows from the recent strengthening [FvdH15] of [HS94] which would have given $d \geq 19$ instead.

³The proof we will need for \mathbb{Z}^2 implies that one can go in fact slightly above this threshold α_0 . See the upper-bound given by (4.15).

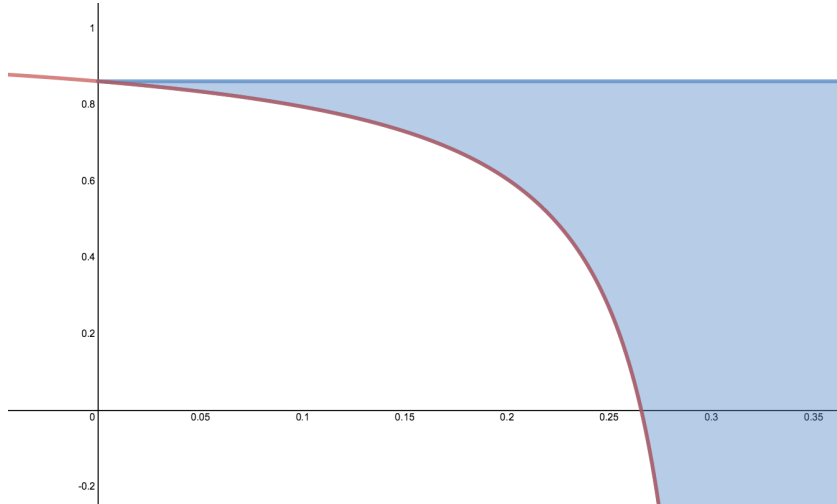

Figure 1.1 – The red curve represents the lower-bound $\alpha \mapsto d(\alpha)$ we obtain in Theorem 1.5 on the Hausdorff dimension of exceptional times for the power law kernels $K^\alpha(x, y) \propto \|x - y\|^{-(2+\alpha)}$. As we see from this plot, we obtain in particular the existence of exceptional times for all $\alpha < \alpha_0 = 217/816 \approx 0.266$. The blue curve on the top is the (much easier to obtain) upper-bound equal to $31/36$. We conjecture that the dimension is a.s. equal to this value of $31/36$ for any $\alpha \in (0, +\infty]$ where “ $\alpha = +\infty$ ” would be the nearest-neighbour case.

Theorem 1.5 will be proved in Section 4 (thanks to a result on a clustering effect for spectral sets of percolation whose proof will be postponed to Section 5). The proof will deeply use the fact that the dynamics we consider are not very localized. With this in mind, it is not surprising that the proof is simpler (and gives a more precise estimate about the Hausdorff dimension) if we let $K = K_{\log}^a$ be the **long-range** symmetric transition matrix introduced in Definition 1.2 (on the edges of \mathbb{Z}^2 or on the sites of \mathbb{T}).

Proposition 1.6. *Take any $a > 0$. Then a.s. there exist exceptional times for the K_{\log}^a -exclusion dynamical percolation of parameter $p = p_c = 1/2$. Moreover, in the case of dynamics on the sites of \mathbb{T} , a.s. the Hausdorff dimension of this set of times equals $31/36$.*

Proposition 1.6 will be proved in Section 4. As mentioned above, our proof does not work for very localized dynamics (and in particular not for the nearest-neighbour process). Still we conjecture:

Conjecture 1.7. *Take any symmetric transition matrix K on the edges of \mathbb{Z}^2 or on the sites of \mathbb{T} . Assume that K equals 0 on the diagonal. Then a.s. there are exceptional times for the K -exclusion dynamical percolation of parameter $p = p_c = 1/2$. Moreover, a.s. the Hausdorff dimension of this set of times equals $31/36$.*

Remark 1.8. As suggested by the above conjecture, in some sense any symmetric exclusion dynamical percolation should “behave like the i.i.d. dynamical percolation” at the critical point. While the proofs of Theorem 1.5 and Proposition 1.6 heavily rely on the “not localized” properties of the chosen dynamics, we have other clues to support this assertion. This is actually the purpose of an ongoing work where we plan to prove that in some sense for any symmetric and translation invariant kernel K on the sites of \mathbb{T} (that equals 0 on the diagonal), the K -exclusion dynamical percolation of parameter $p_c = 1/2$ has a limit in the continuum that (if we change the time by only a constant factor) is the same as the limit of the i.i.d. process (this last limit has been proved to exist and studied in [GPS13a] and [GPS13b]). That would in particular imply that, for any such K , “Conjecture 1.7 is true in the continuum”.

To conclude this section on main results, let us stress that another important contribution of this chapter is a strengthening of some of the spectral estimates on the Fourier spectrum of critical percolation obtained in [GPS10]. It would be too early at this stage to state these results, but Theorem 2.8 will be an example of this.

Organization of the chapter. This Chapter is organized as follows: In Section 2, we provide an outline of the proof of our main result Theorem 1.5. In particular, we discuss clustering effects for the spectral sets of percolation. Next, Section 3 is devoted to the proof of Propositions 1.3 and 1.4. In this section we do not use any spectral analysis tool and we follow the seminal paper [HPS97]. Then, in Sections 4 and 5, we focus on the planar case at the critical point. Our main goal is to prove Theorem 1.5. As explained at the end of Subsection 2.5, there are two steps in the proof of this theorem: (a) showing a result about a clustering effect for spectral sets of percolation. The proof of this last result - in the spirit of [GPS10] - is written in Section 5. (b) Showing that this clustering effect implies a singularity property for the spectral sets of percolation when we let them evolve under our exclusion dynamics. This last step is the subject of Section 4.

Acknowledgments:

We wish to thank Cédric Bernardin for useful discussions on exclusion processes and duality formulas as well as Jeff Steif for pointing to us very useful references. Finally we wish to thank both anonymous referees for their very helpful and detailed comments.

2 Background and outline of proof

2.1 Arm events and some other notations

In this subsection, we list some classical notations/inequalities on (static) **critical** percolation. We refer for example to [GPS10, Wer07] for more background. We will focus from now on (except in Section 3) on two models: bond percolation on \mathbb{Z}^2 and site percolation on \mathbb{T} . In both cases, we think about percolation configurations $\omega \in \Omega$ as colourings of the plane.⁴ Also, we let $\{0 \leftrightarrow R\}$ denote the event that there is an open path from 0 to $\partial[-R, R]^2$.

The **tile** of a site/edge is the set of all points of the plane whose colour is determined by this site/edge. Let $R \geq 0$. In the context of site percolation of \mathbb{T} , we let \mathcal{I}_R denote the set of all sites whose tile intersects $[-R, R]^2$. In the context of bond percolation on \mathbb{Z}^2 , we let \mathcal{I}_R denote the set of the midpoints of all edges whose tile intersects $[-R, R]^2$ (we choose the midpoints only to obtain a discrete set). We then define $\Omega_R = \{-1, 1\}^{\mathcal{I}_R}$. In other words, Ω_R is the set of percolation configurations restricted to the window $[-R, R]^2$. We also write $\mathcal{I} = \cup_{R \geq 0} \mathcal{I}_R$. We say that two disjoint subsets A and B of the plane are **percolation disjoint** if there is no tile that intersects both A and B .

Arm events. An annulus of the form $(x + [-R, R]^2) \setminus (x + (-r, r)^2)$ (where $0 \leq r \leq R$ and $x \in \mathbb{R}^2$) is called a square annulus. The square $x + [-R, R]^2$ (respectively $x + (-r, r)^2$) is called the outer square (respectively the inner square); R and r are called the outer radius and the inner radius. If A is a square annulus, the k -arm event in A is the event that there exist k paths (included in A) of alternating colours from the boundary of the inner square of A to the boundary of the outer square of A . Let $1 \leq r < R$. We write $\alpha_k(r, R)$ for the probability

⁴Consider a site percolation configuration on \mathbb{T} and a hexagon H of the hexagonal lattice dual to \mathbb{T} . We colour H white (respectively black) if the corresponding site of \mathbb{T} is open (respectively closed) in ω . See Subsection 2.1 of [GPS10] for the colouring of the plane induced by a percolation configuration on the edges of \mathbb{Z}^2 . In both cases, an open (respectively a dual) path is a continuous path included in the white (respectively black) region of the plane.

of this event with $A = [-R, R]^2 \setminus (-r, r)^2$ and $p = p_c = 1/2$. We will also need the notion of k -arm events in the half-plane. We use the same definitions except that we ask that the paths live in the annulus intersected with the upper half-plane $\mathbb{R} \times \mathbb{R}_+$ (and the estimates that we are going to state below are also true for the lower, right and left half-planes). Finally, we will need the notion of k -arm event in the quarter plane that is the obvious analogue in the quarter-plane. The analogues of $\alpha_k(r, R)$ in the half-plane and in the quarter-plane are denoted (following [GPS10]) by $\alpha_k^+(r, R)$ and $\alpha_k^{++}(r, R)$.

We write $\alpha_1(R)$ for the probability of $\{0 \leftrightarrow R\}$. Note that $\alpha_1(R) \asymp \alpha_1(1, R)$. Also, we write $\alpha_k(R) := \alpha_k(1, R)$ for any $k \geq 2$. If $r \geq R$, we let $\alpha_k(r, R) := 1$.

By using RSW techniques, one can prove that there exists $C = C(k) \in [1, +\infty)$ such, that for all $R \geq r$ large enough:

$$\frac{1}{C} \left(\frac{r}{R}\right)^C \leq \alpha_k(r, R) \leq C \left(\frac{r}{R}\right)^{1/C}. \quad (2.1)$$

The obvious analogous results for $\alpha_k^+(r, R)$ and $\alpha_k^{++}(r, R)$ also hold. An important property (also true for $\alpha_k^+(\cdot, \cdot)$ and $\alpha_k^{++}(\cdot, \cdot)$) is the **quasi-multiplicativity** property (see [Kes87], the Appendix of [SS10] or Section 4 of [Nol08]): there exists $C = C(k) \in [1, +\infty)$ such that, for all $r_3 \geq r_2 \geq r_1 \geq 1$:

$$\frac{1}{C} \alpha_k(r_1, r_2) \alpha_k(r_2, r_3) \leq \alpha_k(r_1, r_3) \leq C \alpha_k(r_1, r_2) \alpha_k(r_2, r_3). \quad (2.2)$$

In this chapter, we will only use α_4 , α_2 , α_1 , α_3^+ and α_3^{++} (for this last quantity, we will actually only use that $\alpha_3^{++}(r, R) \leq \alpha_3^+(r, R)$). For site percolation on \mathbb{T} it is proved in [LSW02] and [SW01] that:

$$\alpha_1(r, R) = (r/R)^{5/48+o(1)}, \quad (2.3)$$

$$\alpha_2(r, R) = (r/R)^{1/4+o(1)}, \quad (2.4)$$

$$\alpha_4(r, R) = (r/R)^{5/4+o(1)}, \quad (2.5)$$

where $R \geq r \geq 1$ and $o(1) \rightarrow 0$ as $r/R \rightarrow 0$.

Contrary to the above arm-exponents, the exponent of the 3-arm event in the half-plane has been computed (thanks to RSW techniques) for both models: Let $R \geq r \geq 1$. It has been shown by Aizenman (see for example [Wer07]) that, for site percolation on \mathbb{T} and for bond percolation on \mathbb{Z}^2 :

$$\alpha_3^+(r, R) \asymp (r/R)^2. \quad (2.6)$$

For bond percolation on \mathbb{Z}^2 , we have the following weaker estimates on $\alpha_4(r, R)$: there exists $C < +\infty$ and $\epsilon > 0$ such that for all $R \geq r \geq 1$:

$$\epsilon \frac{1}{\alpha_1(r, R)} \left(\frac{r}{R}\right)^{2-\epsilon} \leq \alpha_4(r, R) \leq C \frac{r}{R} \sqrt{\alpha_2(r, R)}. \quad (2.7)$$

See the appendix of [GPS10] for the left-hand inequality of (2.7) and Lemma B.1 of [SS11] for the right-hand inequality (this is not exactly the content of this lemma but this is a direct consequence of its proof since the inequality (B.6) can be replaced by $\mathbb{E}[Y_j] \lesssim \alpha_2(r, R)$). See Chapter 6 of [GS14] for more references about such inequalities.

2.2 Second moment method and exclusion sensitivity

In what follows, we fix a symmetric transition kernel K from Definition 1.2 on the sites of \mathbb{T} or on the edges of \mathbb{Z}^2 and **we work at the critical point $p = p_c = 1/2$** . We shall always denote the associated exclusion dynamical percolation process by $(\omega_K(t))_{t \geq 0}$. Inspired by the case of **i.i.d. dynamical percolation** from [HPS97, SS10, GPS10], the only strategy which is known so far to identify the existence of exceptional times is to rely on the classical second moment method. In the present setting (see for example [SS10, GPS10, GS14]), it boils down to proving the following estimate:

Proposition 2.1. *Let $f_R : \Omega_R \rightarrow \{0, 1\}$ be the indicator function of the radial event $\{0 \leftrightarrow R\}$ (f_R is well defined since this event only depends on the state of the sites/edges in \mathcal{I}_R , see Subsection 2.1 for the definitions of Ω_R and \mathcal{I}_R). To prove that a.s. there exist exceptional times for the K -exclusion dynamical percolation (of parameter $p_c = 1/2$), it is sufficient to prove that there exists a constant $C = C(K) < +\infty$ such that, for all $R \geq 1$:*

$$\int_0^1 \mathbb{E} [f_R(\omega_K(0)) f_R(\omega_K(t))] dt \leq C\alpha_1(R)^2, \quad (2.8)$$

where $f_R(\omega_K(t))$ means that we apply f_R to the restriction of $\omega_K(t)$ to the sites/edges in \mathcal{I}_R .

Proof (sketch). First note that it follows from Kolmogorov 0-1 law that either a.s. there are exceptional times or a.s. there is no exceptional time. Hence, it is sufficient to prove that (2.8) implies that there are exceptional times with positive probability. As explained in the i.i.d. case in [SS10] (in the paragraph above Lemma 5.1, see also Proposition 11.3 in [GS14]), this is a simple consequence of a second moment inequality. The only properties of the dynamical process that are used in the paragraph above Lemma 5.1 in [SS10] are: (a) the fact that $\mathbb{P}_{1/2}$ is an invariant measure and (b) a topological property about the set of exceptional times. This topological property is Lemma 3.2 of [HPS97], that we state below in the case of the exclusion process and whose proof is exactly the same as for the i.i.d. process. \square

Lemma 2.2. *Let $(\bar{\omega}_K(t))_{t \geq 0}$ be obtained from $(\omega_K(t))_{t \geq 0}$ by setting, for every $i \in \mathcal{I}$ (i.e. every edge or every site depending on the model), the set $\{t \geq 0 : \bar{\omega}_K(t)_i = 1\}$ to be the closure of $\{t \geq 0 : \omega_K(t)_i = 1\}$. Then a.s.:*

$$\{t : 0 \xleftrightarrow{\bar{\omega}_K(t)} \infty\} = \{t : 0 \xleftrightarrow{\omega_K(t)} \infty\}.$$

From now on, for any $R \geq 1$, f_R will always be the indicator function of $\{0 \leftrightarrow R\}$ (defined on Ω_R).

In Theorem 1.5 and Proposition 1.6, we are also interested in the Hausdorff dimension of the set of exceptional times. We have the following proposition similar to Proposition 2.1 which provides lower-bound estimates on the Hausdorff dimension (upper-bounds are much easier to obtain, see Proposition 3.3).

Proposition 2.3. *Let $d \in [0, 1]$. To prove that the Hausdorff dimension of the set of exceptional times of a K -exclusion dynamical percolation (of parameter $p_c = 1/2$) is an a.s. constant larger than or equal to d , it is sufficient to show that for any $\gamma < d$ there exists a constant $C = C(K, \gamma)$ such that, for all $R \geq 1$:*

$$\int_0^1 \left(\frac{1}{t}\right)^\gamma \mathbb{E} [f_R(\omega_K(0)) f_R(\omega_K(t))] dt \leq C\alpha_1(R)^2. \quad (2.9)$$

Proof (sketch). The fact that the Hausdorff dimension of the set of exceptional times is an a.s. constant follows from Kolmogorov 0-1 law. So, it is sufficient to prove that if (2.9) holds for any $\gamma < d$, then the Hausdorff dimension of the set of exceptional times is at least d with positive probability. The analogous result for the i.i.d. process is proved in Section 6 of [SS10], where the authors use compactness arguments and the classical Frostman's criterion. Since the proof is exactly the same in our case, we refer to [SS10]. \square

As one can see in estimates (2.8) and (2.9), proving the existence of exceptional times (and estimating their "size") thus requires to obtain good enough quantitative estimates on the correlations

$$(R, t) \mapsto \mathbb{E} [f_R(\omega_K(0)) f_R(\omega_K(t))].$$

Usually in this situation, a legitimate intermediate problem is to analyse the **noise sensitivity** of non-degenerate percolation events (such as left-right crossing events of rectangles whose probability do not degenerate to zero as for the events $\{0 \leftrightarrow R\}$). Identifying noise sensitivity is only an intermediate step as it is far from being quantitative enough in general to imply existence of exceptional times. For example, the seminal work [BKS99] on noise sensitivity was not sufficient to imply the existence of exceptional times, which was achieved only later in [SS10]. In [BKS99], Benjamini, Kalai and Schramm consider the so-called left-right crossing events of the square $[-n, n]^2$ which are Boolean functions $g_n : \{-1, 1\}^{\Omega_n} \rightarrow \{0, 1\}$ (see [BKS99, SS10, GPS10]). Their main theorem is to show that for any fixed $t > 0$, if one runs an **i.i.d. dynamics**, then:

$$\text{Cov}(g_n(\omega(0)), g_n(\omega(t))) \xrightarrow[n \rightarrow +\infty]{} 0.$$

In order to identify existence of exceptional times with a conservative dynamics such as $(\omega_K(t))_{t \geq 0}$, a legitimate first step (analogous to [BKS99] in the i.i.d. setting) is therefore to identify noise sensitivity of Boolean functions such as g_n under exclusion dynamics. This is exactly what was achieved in [BGS13] where Broman, the first author and Steif study the **exclusion sensitivity of Boolean functions**. Let us say a few words about it. Consider a sequence of Boolean functions $h_R : \Omega_R = \{-1, 1\}^{\mathcal{I}_R} \rightarrow \{0, 1\}$ (see Subsection 2.1 for the definition of \mathcal{I}_R). The notion of exclusion sensitivity is defined as the analogue of the notion of noise sensitivity ([BKS99]) in the context of exclusion processes. More precisely, the sequence $(h_R)_R$ is **K-exclusion sensitive** if, for all $t > 0$:

$$\text{Cov}(h_R(\omega_K(0)), h_R(\omega_K(t))) \xrightarrow[R \rightarrow +\infty]{} 0,$$

where $h_R(\omega_K(t))$ means that we apply h_R to the restriction of $\omega_K(t)$ to the sites/edges in \mathcal{I}_R . In [BGS13], it is proved that, if g_n is the above left-right crossing event of the square $[-n, n]^2$ and if $K = K^\alpha$ is an α -power law kernel on the sites of \mathbb{T} with α sufficiently small (see Definition 1.2), then $(g_n)_n$ is K^α -exclusion sensitive. (Actually, the matrices studied in [BGS13] are not exactly the α -stable matrices from Definition 1.2 but their methods apply to these last matrices at least with α small.) As we shall see in the next subsections, both for i.i.d. and exclusion dynamics, the main technology behind identifying noise sensitivity and exceptional times turns out to be a careful spectral analysis of Boolean functions such as g_n and f_R . As we will see in more details, it is useful to keep in mind the following informal distinction between the two:

- i) Identifying **noise sensitivity** corresponds to proving that most of the spectral mass of g_n or f_R is supported on large frequencies (possibly in a quantitative manner, i.e. most of the spectral mass is supported on sets of size n^α for example).
- ii) While identifying **exceptional times** requires a much more delicate analysis of the spectral mass: quantitative upper-bounds on the **lower tail** of \widehat{f}_R are required (see [SS10, GPS10]).

2.3 The spectral sample in the i.i.d. setting

Our main goal is to prove that (2.8) holds (for the transition kernels of Theorem 1.5 and Proposition 1.6). To this purpose, we analyse the quantities $\mathbb{E}[f_R(\omega_K(0)) f_R(\omega_K(t))]$, first by following ideas of [BGS13], and next by applying results on the **spectral sample** of f_R . In order to define the spectral sample and explain its links with the correlations $\mathbb{E}[f_R(\omega_K(0)) f_R(\omega_K(t))]$, we first need to introduce the notion of **Fourier decomposition of Boolean functions** that is used to study percolation in the seminal work [BKS99] (see also [GS14]). In this context, we see f_R as an element of $L^2(\Omega_R, \mathbb{P}_{1/2})$ which is the space of functions from Ω_R to \mathbb{R} endowed with the scalar product $\langle h, h' \rangle = \mathbb{E}_{1/2}[h(\omega)h'(\omega)]$. (The probability measure $\mathbb{P}_{1/2}$ can be

seen equivalently as the restriction to Ω_R of the usual $\mathbb{P}_{1/2}$ defined on $\Omega = \{-1, 1\}^{\mathcal{I}}$ or as the uniform measure on Ω_R .) For every $S \subseteq \mathcal{I}_R$ and every $\omega \in \Omega_R$, let:

$$\chi_S(\omega) = \prod_{i \in S} \omega_i.$$

(In particular χ_\emptyset is the constant function 1.) It is not difficult to check that $(\chi_S)_{S \subseteq \mathcal{I}_R}$ is an orthonormal basis of $L^2(\Omega_R, \mathbb{P}_{1/2})$. Therefore, for any function $h = h_R \in L^2(\Omega_R, \mathbb{P}_{1/2})$ we can define the Fourier decomposition of h as the unique family of real numbers $(\widehat{h}(S))_{S \subseteq \mathcal{I}_R}$ such that:

$$h = \sum_{S \subseteq \mathcal{I}_R} \widehat{h}(S) \chi_S.$$

(Note that $\widehat{h}(\emptyset) = \mathbb{E}_{1/2}[h(\omega)]$.) The reason to introduce this orthonormal basis is that it diagonalizes the i.i.d. dynamics $t \mapsto \omega(t)$:

$$\mathbb{E}[\chi_S(\omega(0))\chi_{S'}(\omega(t))] = \delta_{S,S'} e^{-t|S|}.$$

As a result, we have:

$$\mathbb{E}[h(\omega(0))h(\omega(t))] = \sum_{S \subseteq \mathcal{I}_R} \widehat{h}(S)^2 e^{-t|S|}.$$

To gain more geometric intuitions, it is interesting to view the coefficients $\widehat{h}(S)^2$ as weights of a probability measure on the sets $S \subseteq \mathcal{I}_R$. This is the approach followed in [GPS10]:

Definition 2.4 ([GPS10]). Let $R \geq 1$ and $h \in L^2(\Omega_R, \mathbb{P}_{1/2}) \setminus \{0\}$. A **spectral sample** of h is a random variable on the sets $S \subseteq \mathcal{I}_R$ whose distribution $\widehat{\mathbb{P}}_h$ is given by:

$$\widehat{\mathbb{P}}_h[\{S\}] = \frac{\widehat{h}(S)^2}{\mathbb{E}_{1/2}[h(\omega)^2]}. \quad (2.10)$$

We write $\widehat{\mathbb{E}}_h$ for the corresponding expectation. Note that if $h = f_R$ then $\mathbb{E}_{1/2}[h(\omega)^2] = \alpha_1(R)$. We will sometimes work with the unnormalized measure $\widehat{\mathbb{Q}}_h$ given by:

$$\widehat{\mathbb{Q}}_h[\{S\}] = \widehat{h}(S)^2.$$

For some ideas behind the study of the spectral sample and its links with the pivotal set, we refer to [GS14] (Chapters 9 and 10). We now state one of the main theorems from [GPS10] which quantifies exactly what is the **lower tail** of the spectral measure of the above radial functions $f_R : \Omega_R \rightarrow \{0, 1\}$. This theorem holds for our two models: site percolation on \mathbb{T} and bond percolation on \mathbb{Z}^2 .

Theorem 2.5 (Theorem 7.3 of [GPS10], see also Theorem 10.22 in [GS14] and Exercise 10.7 of [GS14] for the lower-bound part). *Let $R \geq r \geq 1$, then:*

$$\widehat{\mathbb{P}}_{f_R}[|S| < r^2 \alpha_4(r)] \asymp \frac{\alpha_1(R)}{\alpha_1(r)}.$$

Let $\rho(l) = \inf\{r : r^2 \alpha_4(r) \geq l\}$. The above estimate implies that there exists some $C < +\infty$ such that, for all $l \in \mathbb{N}_+$ and all $R \geq 1$:

$$\widehat{\mathbb{P}}_{f_R}[|S| < l] \leq C \frac{\alpha_1(R)}{\alpha_1(\rho(l))}.$$

Using this spectral estimate (which is highly non-trivial), it is not very hard to deduce the existence of exceptional times for **i.i.d. dynamical percolation** on \mathbb{T} and \mathbb{Z}^2 at $p = p_c$. Indeed writing:

$$\mathbb{E}[f_R(\omega(0))f_R(\omega(t))] = \sum_{S \subseteq \mathcal{I}_R} \widehat{f}_R(S)^2 e^{-t|S|} = \widehat{\mathbb{E}}_{f_R} [e^{-t|S|}]$$

and using the above theorem, it is rather straightforward to check that the hypothesis from Propositions 2.1 and 2.3 are satisfied (see [GPS10, GS14]).

2.4 Spectral representation of correlations in the conservative case

In order to apply the above strategy to a **K-exclusion dynamics**, the first natural idea would be to decompose the Boolean functions f_R and g_n on an appropriate basis which diagonalizes the dynamics $t \mapsto \omega_K(t)$. Unfortunately, such basis are both non-local and non-explicit. Therefore, we still project the Boolean functions f_R on the above basis $\{\chi_S\}_S$, at the cost of having additional non-diagonal terms. As observed in [BGS13], for all $S, S' \subseteq \mathcal{I}_R$ one has the following simple correlation structure

$$\mathbb{E}[\chi_S(\omega_K(0))\chi_{S'}(\omega_K(t))] = K_t(S, S'), \quad (2.11)$$

where the transition matrix K_t on sets $S \subseteq \mathcal{I}_R$ is defined as follows.

Definition 2.6. If S and S' are two finite subsets of E we write:

$$K_t(S, S') = \mathbb{P}[\pi_t(S) = S'], \quad (2.12)$$

where π_t is the random permutation used in Appendix A to obtain a graphical construction of the exclusion process $t \mapsto \omega_K(t)$. It is not difficult to see that K_t is a symmetric transition matrix and that $K_t(S, S') = 0$ if $|S| \neq |S'|$. Hence, for any non-negative integers $k \leq l$, K_t restricted to $\{S \subseteq \mathcal{I}_R : |S| \in [k, l]\}$ is still a symmetric transition matrix.

Remark 2.7. The correlation formula (2.11) is used throughout in [BGS13]. It is reminiscent of the so-called **duality formula** for exclusion processes. Note that our assumption that the kernels K from Definition 1.2 are **symmetric** is crucial if one wants to rely on (2.11).

The importance of this duality formula (as used in [BGS13]) is due to its following consequence. One has for any Boolean function $h = h_R : \Omega_R = \{-1, 1\}^{\mathcal{I}_R} \rightarrow \{0, 1\}$:

$$\mathbb{E}[h(\omega_K(0))h(\omega_K(t))] = \sum_{S, S' \subseteq \mathcal{I}_R} \widehat{h}(S)\widehat{h}(S')K_t(S, S'). \quad (2.13)$$

2.5 Outline of proof and new spectral estimates

Let us now give a short outline of the proof of our main result Theorem 1.5, and of its easier analogue Proposition 1.6. In order to prove that there exist exceptional times, it is sufficient to show (combining Proposition 2.1 with equation (2.13)) that there exists $C = C(K) < +\infty$ such that, uniformly in $R \geq 1$:

$$\int_0^1 \sum_{S, S' \subseteq \mathcal{I}_R} \sqrt{\widehat{\mathbb{P}}_{f_R}[\{S\}]} \sqrt{\widehat{\mathbb{P}}_{f_R}[\{S'\}]} K_t(S, S') dt \leq C \alpha_1(R). \quad (2.14)$$

(The fact that it is $\alpha_1(R)$ on the right-hand side instead of $\alpha_1(R)^2$ as in (2.8) is due to the fact that the spectral measure $\widehat{\mathbb{P}}_{f_R}$ is renormalized by $\alpha_1(R)$, see equation (2.10).) To obtain

a lower-bound on the Hausdorff dimension of these exceptional times, one needs to show the following strengthening: there exists $C = C(K, \gamma) < +\infty$ such that for all $R \geq 1$:

$$\int_0^1 \left(\frac{1}{t}\right)^\gamma \sum_{S, S' \subseteq \mathcal{I}_R} \sqrt{\widehat{\mathbb{P}}_{f_R}[\{S\}]} \sqrt{\widehat{\mathbb{P}}_{f_R}[\{S'\}]} K_t(S, S') dt \leq C \alpha_1(R). \quad (2.15)$$

As in Proposition 2.3, the larger the value of γ is, the better the lower-bound on the Hausdorff dimension is.

In order to explain the intuition which underlies our proofs, let us write informally the above sum as “ $\left\langle \sqrt{\widehat{\mathbb{P}}_{f_R}}, K_t \star \sqrt{\widehat{\mathbb{P}}_{f_R}} \right\rangle$ ”. With this in mind, our purpose becomes to show **quantitatively** that “ $\sqrt{\widehat{\mathbb{P}}_{f_R}}$ and $K_t \star \sqrt{\widehat{\mathbb{P}}_{f_R}}$ are asymptotically singular”. One way to interpret this is as follows: if we let a spectral sample (of f_R) evolve under a K -exclusion process for some time $t > 0$, then it does not look like a spectral sample any more. In other words, if we sample a spectral sample $\mathcal{S} \sim \widehat{\mathbb{P}}_{f_R}$ independently of our exclusion process and if we let π_t be the permutations defined in (A.1), then, for any fixed $t > 0$ and any R sufficiently large, $\pi_t(\mathcal{S})$ does not look like a typical spectral sample any more. In order to prove this, one needs to identify “almost sure” properties of the spectral sample $\mathcal{S} \sim \widehat{\mathbb{P}}_{f_R}$ which will no longer hold (with high probability) for $\pi_t(\mathcal{S})$, namely after diffusion. The main mathematical issue we face here is that the actual purpose of the previous works about the spectral sample was to estimate its size (as one can see for example from the above Theorem 2.5 from [GPS10]). This is not interesting for our purpose since \mathcal{S} and $\pi_t(\mathcal{S})$ have equal size. What will help us is that the strategy in [GPS10] is to study closely the geometry of the spectral sample. As such, our strategy will consist in identifying “almost sure” geometric properties of $\mathcal{S} \sim \widehat{\mathbb{P}}_{f_R}$ which will no longer hold for $\pi_t(\mathcal{S})$.

This strategy is close to the strategy of [BGS13] for the proof of exclusion sensitivity of the left-right crossing events. There is a significant difference though (very similar to the difference between [BKS99] and [SS10]) as we need to obtain quantitative bounds essentially on the “**lower tail**” (i.e. on the atypically small spectral samples $|\mathcal{S}| \ll \widehat{\mathbb{E}}_{f_R}[|\mathcal{S}|]$). The difficulty behind this is that we will need to find singularities for all sizes of spectral samples. More precisely, let g_n be the indicator function of the crossing of $[-n, n]^2$ from left to right. In order to prove that $(g_n)_n$ is K -exclusion sensitivity, the authors of [BGS13] had to show that:

$$\sum_{\emptyset \neq S, S' \subseteq \mathcal{I}_n} \sqrt{\widehat{\mathbb{P}}_{g_n}[\{S\}]} \sqrt{\widehat{\mathbb{P}}_{g_n}[\{S'\}]} K_t(S, S') \xrightarrow{n \rightarrow +\infty} 0.$$

Thanks to [GPS10], Theorem 1.1 (and thanks to the Cauchy-Schwarz inequality and the Markov property of $K_t(S, \cdot)$), it is easy to see that:

$$\sum_{\substack{\emptyset \neq S, S' \subseteq \mathcal{I}_n : \\ |S|=|S'| \ll \widehat{\mathbb{E}}_{g_n}[|\mathcal{S}|] \text{ or } |S|=|S'| \gg \widehat{\mathbb{E}}_{g_n}[|\mathcal{S}|]}} \sqrt{\widehat{\mathbb{P}}_{g_n}[\{S\}]} \sqrt{\widehat{\mathbb{P}}_{g_n}[\{S'\}]} K_t(S, S') \xrightarrow{n \rightarrow +\infty} 0.$$

This way, the authors of [BGS13] only had to take into account the sets S whose size is roughly $\widehat{\mathbb{E}}_{g_n}[|\mathcal{S}|]$. This made the analysis in [BGS13] easier as in this regime, the spectral sample $\mathcal{S} \sim \widehat{\mathbb{P}}_{g_n}$ is known to be essentially “fractal”. In our present setting, one cannot avoid a detailed analysis of what happens in the lower tail. Indeed if one were to apply the same trick (Cauchy-Schwarz and Markov property) to small spectral sets of size $|\mathcal{S}| < r^2 \alpha_4(r)$ with $r \ll R$ and $\mathcal{S} \sim \widehat{\mathbb{P}}_{f_R}$, then one would obtain thanks to Theorem 2.5 the following bound: For all $t > 0$,

$$\sum_{\substack{\emptyset \neq S, S' \subseteq \mathcal{I}_R : \\ |S|=|S'| < r^2 \alpha_4(r)}} \sqrt{\widehat{\mathbb{P}}_{f_R}[\{S\}]} \sqrt{\widehat{\mathbb{P}}_{f_R}[\{S'\}]} K_t(S, S') \leq O(1) \frac{\alpha_1(R)}{\alpha_1(r)}.$$

Clearly, such a bound is not quantitative enough to imply what we need, namely:

$$\int_0^1 \sum_{S, S' \subseteq \mathcal{I}_R} \sqrt{\widehat{\mathbb{P}}_{f_R}[\{S\}]} \sqrt{\widehat{\mathbb{P}}_{f_R}[\{S'\}]} K_t(S, S') dt \leq O(1) \alpha_1(R).$$

Because of this, we are required to identify a geometric singularity between $\mathcal{S} \sim \widehat{\mathbb{P}}_{f_R}$ and $\pi_t(\mathcal{S})$ even when \mathcal{S} is atypically small. In other words, we need to quantify the singularity between the sub-probability measures (when $r \ll R$):

$$\mathbf{1}_{|S| < r^2 \alpha_4(r)} \widehat{\mathbb{P}}_{f_R}(dS) \quad \text{and} \quad K_t \star \left[\mathbf{1}_{|S| < r^2 \alpha_4(r)} \widehat{\mathbb{P}}_{f_R}(dS) \right].$$

Imagine for a second that such small spectral sets typically looked (under the conditional measure $\widehat{\mathbb{P}}_{f_R}[\cdot \mid |S| < r^2 \alpha_4(r)]$) like macroscopic ‘‘Poissonian clouds’’ of points. In that case, the above sub-probability measures would even be ‘‘absolutely continuous’’ with respect to each other. To prevent this, the geometric feature of these small spectral sets which will help us detecting singularity is a certain **clustering effect** which will be proved and made quantitative in this chapter (see Theorem 2.8 below). More precisely, under the conditional measure $\widehat{\mathbb{P}}_{f_R}[\cdot \mid |S| < r^2 \alpha_4(r)]$, spectral sets tend to be of ‘‘small’’ diameter. Note that such a clustering effect is far from being obvious (techniques from [GPS10] are not well designed for such properties) and it is still an open-problem for the left-right crossing events g_n , see Conjecture 6.2. Summarising the above discussion, our proof of Theorem 1.5 is divided into the following two independent steps (see also Figure 2.1).

- A. **Clustering property for small radial spectral sets.** This step corresponds to Theorem 2.8 below (and its Corollary 2.9). Note that this step of the proof is purely *static* (no dynamics here). It will be the purpose of Section 5.
- B. **From clustering to singularity to exceptional times.** The second step of the proof consists in implementing the above clustering property into a sufficiently quantitative singular behaviour in order to obtain existence of exceptional times (main Theorem 1.5). This second step will be the purpose of Section 4.

We end this subsection with more details for steps A and B.

A. Clustering property. Our main result on the clustering property of the spectral sample of the **radial crossing event** f_R can be stated as follows. In this result, we estimate the probability of a small residual spectral mass away from the origin.

Theorem 2.8. *There exist an exponent $\epsilon > 0$ and a constant $C < +\infty$ such that, for all $1 \leq r \leq r_0 \leq R/2$:*

$$\widehat{\mathbb{P}}_{f_R} [0 < |S \setminus (-r_0, r_0)^2| < r^2 \alpha_4(r)] \leq C \frac{\alpha_1(R)}{\alpha_1(r_0)} \left(\frac{r_0}{r} \right)^{1-\epsilon} \alpha_4(r, r_0).$$

(As explained in Remark 4.3, this exponent $\epsilon > 0$ even very small is crucial for the existence of exceptional times on \mathbb{Z}^2 . It is related to the geometric event discussed in Appendix C, see also Remark 5.12.)

Theorem 2.8 will be proved in Subsection 5.2. Its proof is mostly inspired by the global proof in [GPS10]. There are three main steps in [GPS10], which correspond to Sections 4, 5 and 6. We will adapt the first step and then use the two other steps identically to Sections 5 and 6 of [GPS10]. As the treatment of the first step differs in at least three key places, we provide a reasonably self-contained proof in Subsection 5.2.1. To help identifying the differences with the proof in Section 4 of [GPS10], here are the three main ones:

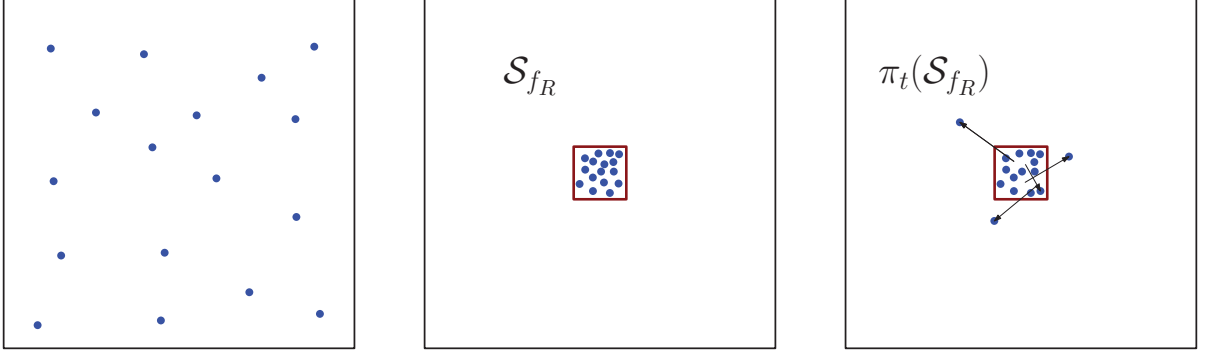

Figure 2.1 – This picture illustrates our strategy for our spectral analysis of the lower tail under a K^α -exclusion dynamics. If spectral samples of radial events f_R were to look like “sparse” random subsets of \mathcal{I}_R as pictured on the left, it would be very hard to detect any singular behaviour between \mathcal{S} and $\pi_t(\mathcal{S})$. This is why we provide a quantitative clustering property in Theorem 2.8 and Corollary 2.9 which shows that small spectral samples are with high probability concentrated in small balls (middle square). Once we combine all quantitative estimates, one can show that when the exponent α is chosen small enough, this clustering property does not hold any more after diffusion for $\pi_t(\mathcal{S})$ as pictured on the right square. This is how we manage to detect the desired (quantitative) singularity.

1. First, one needs to introduce a new combinatorial **annulus structure** which is designed to analyse the spectral sample outside of some mesoscopic scale $(-r_0, r_0)^2$.
2. In order to analyse this modified annulus structure, we need to introduce a new geometric percolation exponent (which is the exponent of the “4-arm event conditioned on the percolation configuration in a half-plane”, see Lemma C.1 and Lemma C.2). This conditioned percolation event is at the root of the exponent $\varepsilon > 0$ in Theorem 2.8 and will play a significant role while analysing the modified annulus structure. A key estimate on this conditioned percolation event which is also valid on \mathbb{Z}^2 is proved in Lemma C.1. See Remark 5.12 for the link between ε and this conditioned event and Remark 4.3 for the importance of $\varepsilon > 0$ in our proof of existence of exceptional times on \mathbb{Z}^2 .
3. Finally, we need to adapt the useful spectral estimate Lemma 4.8 of [GPS10] to our annulus structure. That is the purpose of Lemma 5.5 and Appendix B.

We shall also use extensively in Section 4 the following immediate corollary of Theorem 2.8, where we analyse the circumstance of a spectral sample of atypically high diameter given its size (see after the proof of Corollary 2.9 for a further discussion):

Corollary 2.9. *Let ϵ be the same constant as in Theorem 2.8. Then:*

1. *There exists a constant $C < +\infty$ such that, for all $1 \leq r \leq r_0$ and all $R \geq 1$:*

$$\widehat{\mathbb{P}}_{f_R} [|S| < r^2 \alpha_4(r), S \not\subseteq (-r_0, r_0)^2] \leq C \frac{\alpha_1(R)}{\alpha_1(r_0)} \left(\frac{r_0}{r} \right)^{1-\epsilon} \alpha_4(r, r_0).$$

We will use this result as follows:

2. *Consider $\beta > 1$ such that there exists some $\bar{k} = \bar{k}(\beta)$ such that for all $k \geq \bar{k}$ we have $\rho(2^{k+1}) \leq 2^{k\beta}$ (see Theorem 2.5 for the definition of ρ). Then, there exists a constant $C = C(\beta) < +\infty$ such that, for all $k \in \mathbb{N}$ and all $R \geq 1$:*

$$\widehat{\mathbb{P}}_{f_R} [|S| < 2^{k+1}, S \not\subseteq (-2^{k\beta}, 2^{k\beta})^2] \leq C \frac{\alpha_1(R)}{\alpha_1(2^{k\beta})} \left(\frac{2^{k\beta}}{\rho(2^k)} \right)^{1-\epsilon} \alpha_4(\rho(2^k), 2^{k\beta}).$$

Proof. We first prove item 1. We distinguish between three cases : (a) If $r_0 \leq R/2$, then this is a direct consequence of Theorem 2.8 since:

$$\{|S| < r^2 \alpha_4(r), S \not\subseteq (-r_0, r_0)^2\} \subseteq \{0 < |S \setminus (-r_0, r_0)^2| < r^2 \alpha_4(r)\} .$$

(We may have lost a lot in this inclusion, see Conjecture 6.1.) (b) If $r_0 > R+2$ then the left-hand side equals 0 (since we have $\mathcal{I}_R \subseteq [-(R+2), R+2]^2$). (c) If $R/2 < r_0 \leq R+2$, then this is a simple consequence of the case $r_0 = R/2$ (together with the quasi-multiplicativity property and (2.1)) since we have:

$$\{|S| < r^2 \alpha_4(r), S \not\subseteq (-r_0, r_0)^2\} \subseteq \{|S| < r^2 \alpha_4(r), S \not\subseteq (-R/2, R/2)^2\} .$$

Let us now prove item 2. We distinguish between two cases: (a) if $k < \bar{k}$, such an estimate is a direct consequence of Theorem 2.5. (b) We now assume that $k \geq \bar{k}$. Then, this is a direct consequence of item 1 since we have $1 \leq \rho(2^{k+1}) \leq 2^{k\beta}$ and $\rho(2^{k+1})^2 \alpha_4(\rho(2^{k+1})) \geq 2^{k+1}$ (actually, it is not difficult to see that this last inequality is an equality). Note also that we have used the fact that $\rho(2^{k+1}) \leq O(1)\rho(2^k)$, which is a simple consequence of the quasi-multiplicativity property and the left-hand inequality of (2.7). \square

At the level of this outline, let us analyse a little more the results of Theorem 2.8 and Corollary 2.9. These results imply that if the spectral sample is small then it is "localized in the neighbourhood of the origin":

Let us estimate $\widehat{\mathbb{P}}_{f_R} \left[S \subseteq (-r_0, r_0)^2 \mid 0 < |S| < r^2 \alpha_4(r) \right]$. Thanks to Theorem 2.5 and Corollary 2.9 (together with the quasi-multiplicativity property), we have:

$$\begin{aligned} \widehat{\mathbb{P}}_{f_R} \left[S \not\subseteq (-r_0, r_0)^2 \mid 0 < |S| < r^2 \alpha_4(r) \right] &\leq O(1) \frac{\alpha_1(r)}{\alpha_1(r_0)} \left(\frac{r_0}{r} \right)^{1-\epsilon} \alpha_4(r, r_0) \\ &\leq O(1) \frac{\alpha_4(r, r_0)}{\alpha_1(r, r_0)} \left(\frac{r_0}{r} \right)^{1-\epsilon} . \end{aligned}$$

The right-hand inequality of (2.7) and the FKG inequality imply that the above is at most $O(1) \left(\frac{r_0}{r} \right)^{-\epsilon} \frac{\sqrt{\alpha_2(r, r_0)}}{\alpha_1(r, r_0)} \leq O(1) \left(\frac{r_0}{r} \right)^{-\epsilon}$ ⁵, which goes to 0 as r/r_0 goes to 0. (In the case of \mathbb{T} , thanks to the computation of the critical exponents we even know that $\frac{\alpha_4(r, r_0)}{\alpha_1(r, r_0)} \left(\frac{r_0}{r} \right)^{1-\epsilon} = \left(\frac{r_0}{r} \right)^{-7/48-\epsilon+o(1)}$.)

We now state the (easier) analogue of Corollary 2.9 which will be relevant for the long-range dynamics K_{\log}^a , namely to prove Proposition 1.6:

Proposition 2.10. *For all $\epsilon_0 > 0$ there exists a constant $C = C(\epsilon_0) < +\infty$ such that, for all $k \in \mathbb{N}_+$ and all $R \geq 1$:*

$$\widehat{\mathbb{P}}_{f_R} \left[|S| < k, S \not\subseteq (-\exp(k^{\epsilon_0}), \exp(k^{\epsilon_0}))^2 \right] \leq C \alpha_1(R) \exp(-k^{\epsilon_0}/C) .$$

Proposition 2.10 is a simple consequence of Corollary 2.9 (and of Theorem 2.5 for k small), but is also a direct consequence of some results of Section 4 of [GPS10], see Subsection 5.1.

B. From clustering to singularity. Let us give a short heuristics which explains how to derive our main result Theorem 1.5 using the above clustering property. Let $\mathcal{S} \sim \widehat{\mathbb{P}}_{f_R}$ be a spectral sample independent of our exclusion process. Remember that we want to show that for all $t > 0$ if R is sufficiently large, then $\pi_t(\mathcal{S})$ does not look like a spectral sample with high probability. Corollary 2.9 implies that, if β is large enough, then \mathcal{S} is included in the square $(-|\mathcal{S}|^\beta, |\mathcal{S}|^\beta)^2$ with high probability. Remember the definition of the transition matrices K^α in

⁵Here we can see the importance of the constant ϵ in Theorem 1.5, even very small.

Definition 1.2: each point of \mathcal{S} has roughly probability $t/|\mathcal{S}|^{\alpha\beta}$ to “jump” a distance greater than $3|\mathcal{S}|^\beta$. So, if $\alpha \ll 1/\beta$ then with high probability there exists a particle which has jumped a distance greater than $3|\mathcal{S}|^\beta$, and we have what we want: $\pi_t(\mathcal{S})$ is not included in $(-|\mathcal{S}|^\beta, |\mathcal{S}|^\beta)^2$, hence it is very different from a typical spectral sample (in particular, if $|\mathcal{S}|^\beta$ is larger than $R+2$, then with high probability there even exists a particle which has jumped outside the domain of $\widehat{\mathbb{P}}_{f_R}$). We see from this heuristics why our bounds are worse and worse as the exponent α increases.

In order to derive our main result (Theorem 1.5) we need a quantitative (and rigorous) version of this heuristics. This is the purpose of Section 4.

3 Warm-up without spectral analysis: proofs of Propositions 1.3 and 1.4

In this section, we prove Propositions 1.3 and 1.4. As mentioned in Subsection 1.2, the general ideas are the same as for the analogous results of [HPS97]. However, there is a slightly new difficulty due to the lack of independence and that is the reason why we need the following two lemmas.

Lemma 3.1. *Let K be a symmetric transition matrix on the edges of a graph $G = (V, E)$. Consider a law μ on the set of bond percolation configurations $\Omega = \{-1, 1\}^E$ that satisfies the following: there exists $p_0 \in [0, 1]$ such that, for any $n \in \mathbb{N}$, any e_1, \dots, e_{n+1} distinct edges and any $i_1, \dots, i_n \in \{-1, 1\}$, we have:*

$$\mu[\omega(e_1) = i_1, \dots, \omega(e_n) = i_n] > 0$$

and:

$$\mu[\omega(e_{n+1}) = 1 \mid \omega(e_1) = i_1, \dots, \omega(e_n) = i_n] \leq p_0.$$

Then, for any increasing event $A \in \mathcal{F}$ (i.e. an event such that, if $\omega \leq \omega'$ and $\omega \in A$, then $\omega' \in A$) that depends on only finitely many edges, we have $\mu[A] \leq \mathbb{P}_{p_0}[A]$.

The proof of this lemma is straightforward. It is applied in our context as follows: since our graphs are locally finite, the lemma holds with:

$$A = A_n(v) := \{\exists \text{ a self avoiding path starting at } v, \text{ of length } n, \text{ and made of open edges}\}.$$

As a result, it is also true with $A = \{v \leftrightarrow \infty\}$ since we have $\{v \leftrightarrow \infty\} = \bigcap_{m \in \mathbb{N}} \downarrow A_m(v)$. We deduce that, if $p_0 < p_c$, then for all v , μ -a.s. v is not in an infinite cluster. Therefore, $\mu[\exists \text{ an infinite cluster}] = 0$ (remember that the vertex set is countable).

Lemma 3.2. *Let $p \in (0, 1)$ and let $(\omega_K(t))_{t \geq 0}$ be a K -exclusion dynamical percolation of parameter p . Write $\omega_K^{(\epsilon)}$ for the configuration that equals $\omega_K(0)$ except that we set $\omega_K(0)_e = 1$ for every edge e such that a clock associated to e has rung between time 0 and time ϵ . If e_1, \dots, e_{n+1} are distinct edges and $i_1, \dots, i_n \in \{-1, 1\}$, then:*

$$\mathbb{P}[\omega_K^{(\epsilon)}(e_{n+1}) = 1 \mid \omega_K^{(\epsilon)}(e_1) = i_1, \dots, \omega_K^{(\epsilon)}(e_n) = i_n] \leq p + \frac{1-p}{p}\epsilon.$$

Proof. Define the event $C_{e,f}^{(\epsilon)}$ as follows:

$$C_{e,f}^{(\epsilon)} = \{\text{the clock of } \{e, f\} \text{ has rung between time 0 and time } \epsilon\}.$$

Consider e_1, \dots, e_{n+1} and i_1, \dots, i_n as in the statement of the lemma. Note that $\omega_K(0)_{e_{n+1}}$ is independent of $\{\omega_K^{(\epsilon)}(e_1) = i_1, \dots, \omega_K^{(\epsilon)}(e_n) = i_n\}$ and of this event intersected with $\{\exists f \in$

$E, C_{e_{n+1},f}^{(\epsilon)}$. So, if we distinguish between the two cases $\omega(0)_{e_{n+1}} = 1$ and $\omega(0)_{e_{n+1}} = -1$, we obtain:

$$\begin{aligned} & \mathbb{P} \left[\omega_K^{(\epsilon)}(e_{n+1}) = 1 \mid \omega_K^{(\epsilon)}(e_1) = i_1, \dots, \omega_K^{(\epsilon)}(e_n) = i_n \right] \\ &= p + (1-p) \mathbb{P} \left[\exists f \in E, C_{e_{n+1},f}^{(\epsilon)} \mid \omega_K^{(\epsilon)}(e_1) = i_1, \dots, \omega_K^{(\epsilon)}(e_n) = i_n \right] \\ &\leq p + (1-p) \sum_{f \in E} \mathbb{P} \left[C_{e_{n+1},f}^{(\epsilon)} \mid \omega_K^{(\epsilon)}(e_1) = i_1, \dots, \omega_K^{(\epsilon)}(e_n) = i_n \right]. \end{aligned}$$

If $f \notin \{e_1, \dots, e_n\}$, then $C_{e_{n+1},f}^{(\epsilon)}$ is independent of $\{\omega_K^{(\epsilon)}(e_1) = i_1, \dots, \omega_K^{(\epsilon)}(e_n) = i_n\}$. Moreover, if $f = e_j$ and $C_{e_{n+1},f}^{(\epsilon)}$ holds, then $\omega_K^{(\epsilon)}(e_j) = 1$. Therefore, the above equals:

$$\begin{aligned} & p + (1-p) \left(\sum_{f \notin \{e_1, \dots, e_n\}} \mathbb{P} \left[C_{e_{n+1},f}^{(\epsilon)} \right] \right. \\ & \left. + \sum_{\substack{j \in \{1, \dots, n\}: \\ i_j = 1}} \frac{\mathbb{P} \left[C_{e_{n+1},e_j}^{(\epsilon)}, \forall k \in \{1, \dots, n\} \setminus \{j\}, \omega_K^{(\epsilon)}(e_k) = i_k \right]}{\mathbb{P} \left[\omega_K^{(\epsilon)}(e_1) = i_1, \dots, \omega_K^{(\epsilon)}(e_n) = i_n \right]} \right) \\ &= p + (1-p) \left(\sum_{f \notin \{e_1, \dots, e_n\}} \left(1 - \exp(-\epsilon K(e_{n+1}, f)) \right) \right. \\ & \left. + \sum_{\substack{j \in \{1, \dots, n\}: \\ i_j = 1}} \left(1 - \exp(-\epsilon K(e_{n+1}, f)) \right) \frac{\mathbb{P} \left[\forall k \in \{1, \dots, n\} \setminus \{j\}, \omega_K^{(\epsilon)}(e_k) = i_k \right]}{\mathbb{P} \left[\omega_K^{(\epsilon)}(e_1) = i_1, \dots, \omega_K^{(\epsilon)}(e_n) = i_n \right]} \right). \quad (3.1) \end{aligned}$$

Using that $\omega_K(0)_{e_j}$ is independent of $\{\forall k \in \{1, \dots, n\} \setminus \{j\}, \omega_K^{(\epsilon)}(e_k) = i_k\}$, we obtain that, for all j such that $i_j = 1$:

$$\begin{aligned} & \mathbb{P} \left[\omega_K^{(\epsilon)}(e_1) = i_1, \dots, \omega_K^{(\epsilon)}(e_n) = i_n \right] \\ & \geq \mathbb{P} \left[\omega_K(0)_{e_j} = 1, \forall k \in \{1, \dots, n\} \setminus \{j\}, \omega_K^{(\epsilon)}(e_k) = i_k \right] \\ & = p \mathbb{P} \left[\forall k \in \{1, \dots, n\} \setminus \{j\}, \omega_K^{(\epsilon)}(e_k) = i_k \right]. \end{aligned}$$

Therefore, (3.1) is smaller than or equal to:

$$\begin{aligned} & p + (1-p) \sum_{f \notin \{e_1, \dots, e_n\}} \left(1 - \exp(-\epsilon K(e_{n+1}, f)) \right) + (1-p) \sum_{\substack{j \in \{1, \dots, n\}: \\ i_j = 1}} \frac{1 - \exp(-\epsilon K(e_{n+1}, e_j))}{p} \\ & \leq p + (1-p) \sum_{f \in E} \frac{1 - \exp(-\epsilon K(e_{n+1}, e_j))}{p} \leq p + \frac{1-p}{p} \sum_{f \in E} \epsilon K(e_{n+1}, f) = p + \frac{1-p}{p} \epsilon \end{aligned}$$

(since K is a symmetric transition matrix). \square

Proof of Proposition 1.3. We follow the ideas of [HPS97], proof of Proposition 1.1. Let $p < p_c$. Note that: (a) For any edge e , if there exists some time t in $[0, \epsilon]$ such that e is open at time t , then e is open in $\omega_K^{(\epsilon)}$. (b) The event $\{\exists \text{ an infinite cluster}\}$ is increasing. Therefore, if there exists an exceptional time between time 0 and time ϵ , then there is an infinite cluster in $\omega_K^{(\epsilon)}$. Furthermore, Lemma 3.2 implies that if ϵ is sufficiently small, then there exists $p_0 < p_c$ such that the distribution of $\omega_K^{(\epsilon)}$ satisfies the hypotheses of Lemma 3.1. We deduce that, if ϵ is

sufficiently small, then a.s. there is no exceptional time between times 0 and ϵ , which easily implies the result.

If $p > p_c$, then the same proof works with results analogous to Lemma 3.1 and Lemma 3.2 (with opposite inequalities). \square

Proof of Proposition 1.4. We follow the ideas of [HPS97], proof of Theorem 1.3. Consider a graph G , a symmetric transition matrix K on the edges of G and a parameter $p \in (0, 1)$ such that $\mathbb{P}_p[\exists \text{ an infinite cluster}] = 0$. Let $(\omega_K(t))_{t \geq 0}$ be a K -exclusion dynamical percolation of parameter p . Let v be a vertex of G and write $N(v) \in \mathbb{N} \cup \{+\infty\}$ for the number of times $t \in [0, 1]$ such that $\{v \xleftrightarrow{\omega_K(t)} \infty\}$ holds. As explained in [HPS97] in the case of i.i.d. dynamical percolation, we can show that either $\mathbb{E}[N(v)] = 0$ or $\mathbb{E}[N(v)] = +\infty$. This is actually a consequence of general results about reversible Markov processes - see Lemma 2.3 of [PS98] - and these results are also true for our K -exclusion processes. (For more explanations and further references, see [PS98]; note that the fact that we consider symmetric matrices is important here since it implies that our exclusion processes are reversible.)

Now, take $d \geq 11$, let K be a symmetric transition matrix on the edges of the Euclidean lattice \mathbb{Z}^d , and let $(\omega_K(t))_{t \geq 0}$ be a K -exclusion dynamical percolation of parameter $p_c = p_c(d)$ (if $p \neq p_c$ then the result is a direct consequence of Proposition 1.3). The above observation implies that, in order to prove Proposition 1.4, it is sufficient to show that, for every $v \in \mathbb{Z}^d$, $\mathbb{E}[N(v)] < +\infty$. That is the purpose of what follows.

It is known (see [HS94] for $d \geq 19$ and the recent work [FvdH15] for the extension to $d \geq 11$) that there exists $C = C(d) < +\infty$ such that, for all $p \geq p_c = p_c(d)$:

$$\mathbb{P}_p[v \leftrightarrow \infty] \leq C(p - p_c). \quad (3.2)$$

For each $m \in \mathbb{N}_+$, write $N_m(v)$ for the number of intervals of the form $I_k^m = [k/m, (k+1)/m]$, $k \in \{0, \dots, m-1\}$, such that there exists $t \in I_k^m$ for which $\{v \xleftrightarrow{\omega_K(t)} \infty\}$ holds. Lemmas 3.1 and 3.2 (with $\epsilon = 1/m$) imply that:

$$\mathbb{P}\left[\exists t \in I_0^m, v \xleftrightarrow{\omega_K(t)} \infty\right] \leq \mathbb{P}_{p_c + C'/m}[v \leftrightarrow \infty],$$

where $C' = (1 - p_c)/p_c$. Using (3.2) we obtain:

$$\mathbb{P}\left[\exists t \in I_0^m, v \xleftrightarrow{\omega_K(t)} \infty\right] \leq CC'/m.$$

Since our process is time-stationary, the above is also true for any I_k^m . Therefore, $\mathbb{E}[N_m(v)] \leq mCC'/m = CC' < +\infty$ and by Fatou's lemma we are done since $N(v) \leq \liminf_{m \rightarrow +\infty} N_m(v)$. \square

Kesten and Zhang [KZ87] have proved that (3.2) is not true when $d = 2$. For site percolation on \mathbb{T} , it has even been proved in [SW01] (see also [Wer07]) that:

$$\mathbb{P}_p[v \leftrightarrow \infty] = (p - 1/2)^{5/36 + o(1)}, \quad (3.3)$$

where $o(1)$ goes to 0 as $p \searrow 1/2$. If we follow the proof of Proposition 1.4 with (3.3) instead of (3.2), we obtain the following: For any symmetric transition matrix K on the sites of \mathbb{T} , any site $v \in \mathbb{T}$, and any $\delta > 0$, there exists a constant $C = C(\delta) < +\infty$ such that:

$$\mathbb{E}[N_m(v)] \leq C m.m^{\delta-5/36} = C m^{\delta+31/36}, \quad (3.4)$$

for the K -exclusion dynamical percolation of parameter $p_c = 1/2$. The analogue of (3.4) for i.i.d. dynamical percolation is shown in [SS10] in the proof of their Theorem 6.3. Moreover, this is the only property that they use to prove that a.s. the Hausdorff dimension of the set of exceptional times is at most $31/36$. Therefore, we have the following result (and we refer to [SS10] for more details):

Proposition 3.3. *Let K be any symmetric transition matrix on the sites of \mathbb{T} and consider a K -exclusion dynamical percolation of parameter $p = p_c = 1/2$. Then, a.s. the Hausdorff dimension of the set of exceptional times is at most $31/36$.*

4 Exceptional times at criticality: proofs of Theorem 1.5 and Proposition 1.6

We need the following lemma (which is a quantitative version of Lemma 7.1 in [BGS13]):

Lemma 4.1. *Let (E, ν) be a countable set endowed with a sub-probability measure $\nu \neq 0$. Furthermore, let P be a symmetric sub-transition matrix on E . Let $F \subseteq E$ and define δ, η as follows: $\nu(F) = (1 - \delta)\nu(E)$; $\eta = \max_{x \in F} P(x, F)$. We have:*

$$\sum_{x, y \in E} \sqrt{\nu(x)} \sqrt{\nu(y)} P(x, y) \leq \nu(E)(\eta + 2\sqrt{\delta}).$$

Proof. Since P is symmetric, we have the following inequality:

$$\begin{aligned} \sum_{x, y \in E} \sqrt{\nu(x)} \sqrt{\nu(y)} P(x, y) &\leq \sum_{x \in F, y \in F} \sqrt{\nu(x)} \sqrt{\nu(y)} P(x, y) \\ &\quad + 2 \sum_{x \in E, y \in E \setminus F} \sqrt{\nu(x)} \sqrt{\nu(y)} P(x, y). \end{aligned}$$

Write A_1 and A_2 for the two sums of the right-hand side of the above inequality. Let us show that $A_1 \leq \nu(E)\eta$ and $A_2 \leq \nu(E)\sqrt{\delta}$. We have (by using the Cauchy-Schwarz inequality for the measure $(x, y) \mapsto P(x, y)$):

$$\begin{aligned} A_1 &\leq \sqrt{\sum_{x \in F, y \in F} \nu(x) P(x, y)} \sqrt{\sum_{x \in F, y \in F} \nu(y) P(x, y)} \\ &= \sqrt{\sum_{x \in F} \nu(x) P(x, F)} \sqrt{\sum_{y \in F} \nu(y) P(y, F)} \quad (\text{since } P \text{ is symmetric}) \\ &\leq \nu(F)\eta \leq \nu(E)\eta. \end{aligned}$$

Moreover, by using the Cauchy-Schwarz inequality twice (first for the sub-probability measures $P(\cdot, y)$ then for the counting measure), we obtain:

$$\begin{aligned} A_2 &= \sum_{y \in E \setminus F} \sqrt{\nu(y)} \sum_{x \in E} \sqrt{\nu(x)} P(x, y) \\ &\leq \sum_{y \in E \setminus F} \sqrt{\nu(y)} \sqrt{\sum_{x \in E} \nu(x) P(x, y)} \\ &\leq \sqrt{\sum_{y \in E \setminus F} \nu(y)} \sqrt{\sum_{y \in E \setminus F} \left(\sum_{x \in E} \nu(x) P(x, y) \right)} \\ &= \sqrt{\nu(E)\delta} \sqrt{\sum_{x \in E} \nu(x) \left(\sum_{y \in E \setminus F} P(x, y) \right)}. \end{aligned}$$

We are done since $\sum_{x \in E} \nu(x) \left(\sum_{y \in E \setminus F} P(x, y) \right) \leq \sum_{x \in E} \nu(x) = \nu(E)$. \square

Now, we use Lemma 4.1, Theorem 2.5, and Corollary 2.9 in order to prove Theorem 1.5. Remember (2.14) and (2.15): we need to study the following quantities:

$$\sum_{S, S' \subseteq \mathcal{I}_R} \sqrt{\widehat{\mathbb{P}}_{f_R}[\{S\}]} \sqrt{\widehat{\mathbb{P}}_{f_R}[\{S'\}]} K_t^\alpha(S, S').$$

Proof of Theorem 1.5. Let $\beta > 1$ and $\alpha > 0$. For any $k \in \mathbb{N}$, let $E = E_k = E_k(R) = \{S \subseteq \mathcal{I}_R : |S| \in [2^k, 2^{k+1} - 1]\}$ and:

$$\begin{aligned} F &= F_k = F_k(\beta, R) = \left\{ S \in E_k : S \subseteq (-2^{k\beta}, 2^{k\beta})^2 \right\} \\ &= \left\{ S \subseteq \mathcal{I}_R : |S| \in [2^k, 2^{k+1} - 1] \text{ and } S \subseteq (-2^{k\beta}, 2^{k\beta})^2 \right\}. \end{aligned}$$

Let $\nu = \nu_k = \nu_k(R)$ be $\widehat{\mathbb{P}}_{f_R}$ restricted to E_k . Also, let $P = P_k^\alpha(t) = P_k^\alpha(t, R)$ be K_t^α restricted to E_k . Finally, let $\delta = \delta_k = \delta_k(\beta, R)$ and $\eta = \eta_k^\alpha(t) = \eta_k^\alpha(\beta, R, t)$ be as in Lemma 4.1 (if $\nu_k = 0$ for some k then we let $\delta_k = \eta_k^\alpha(t) = 0$).

Remember that, if $|S| \neq |S'|$, then $K_t^\alpha(S, S') = 0$. Thus:

$$\begin{aligned} \sum_{S, S' \subseteq \mathcal{I}_R} \sqrt{\widehat{\mathbb{P}}_{f_R}[\{S\}]} \sqrt{\widehat{\mathbb{P}}_{f_R}[\{S'\}]} K_t^\alpha(S, S') \\ = \alpha_1(R) + \sum_{k \in \mathbb{N}} \sum_{S, S' \in E_k} \sqrt{\nu_k(S)} \sqrt{\nu_k(S')} P_k^\alpha(t)(S, S'). \end{aligned}$$

(The term $\alpha_1(R)$ is just the contribution of $S = S' = \emptyset$.) By applying Lemma 4.1 for each k , we obtain:

$$\sum_{S, S' \subseteq \mathcal{I}_R} \sqrt{\widehat{\mathbb{P}}_{f_R}[\{S\}]} \sqrt{\widehat{\mathbb{P}}_{f_R}[\{S'\}]} K_t^\alpha(S, S') \leq \alpha_1(R) + \sum_{k \in \mathbb{N}} \widehat{\mathbb{P}}_{f_R}[E_k] \left(\eta_k^\alpha(t) + 2\sqrt{\delta_k} \right). \quad (4.1)$$

Theorem 2.5 gives good estimates for $\widehat{\mathbb{P}}_{f_R}[E_k]$. It thus remains to estimate δ_k and $\eta_k^\alpha(t)$.

An estimate for δ_k . In this paragraph, we assume that β satisfies the hypothesis of Corollary 2.9. We have the following estimate on δ_k which is a direct consequence of Corollary 2.9 since $\widehat{\mathbb{P}}_{f_R}[E_k] \delta_k = \widehat{\mathbb{P}}_{f_R}[|S| \in [2^k, 2^{k+1} - 1], S \not\subseteq (-2^{k\beta}, 2^{k\beta})^2]$.

Lemma 4.2. *There exists a constant $C = C(\beta) < +\infty$ such that, for all $k \in \mathbb{N}$:*

$$\widehat{\mathbb{P}}_{f_R}[E_k] \delta_k \leq C \frac{\alpha_1(R)}{\alpha_1(2^{k\beta})} \left(\frac{2^{k\beta}}{\rho(2^k)} \right)^{1-\epsilon} \alpha_4(\rho(2^k), 2^{k\beta}),$$

where ϵ is the constant of Theorem 2.8.

Thanks to Theorem 2.5, Lemma 4.2, and the quasi-multiplicativity property, we have:

$$\begin{aligned} & \sum_{k \in \mathbb{N}} \widehat{\mathbb{P}}_{f_R}[E_k] \sqrt{\delta_k} \\ &= \sum_{k \in \mathbb{N}} \sqrt{\widehat{\mathbb{P}}_{f_R}[E_k]} \sqrt{\widehat{\mathbb{P}}_{f_R}[E_k] \delta_k} \\ &\leq \sum_{k \in \mathbb{N}} \sqrt{\widehat{\mathbb{P}}_{f_R}[|S| < 2^{k+1}]} \sqrt{\widehat{\mathbb{P}}_{f_R}[E_k] \delta_k} \\ &\leq O(1) \sum_{k \in \mathbb{N}} \sqrt{\frac{\alpha_1(R)}{\alpha_1(\rho(2^k))}} \sqrt{\frac{\alpha_1(R)}{\alpha_1(2^{k\beta})} \left(\frac{2^{k\beta}}{\rho(2^k)} \right)^{1-\epsilon} \alpha_4(\rho(2^k), 2^{k\beta})} \\ &\leq O(1) \alpha_1(R) \sum_{k \in \mathbb{N}} \sqrt{\frac{1}{\alpha_1(\rho(2^k)) \rho(2^k)^{1-\epsilon} \alpha_4(\rho(2^k))} \frac{2^{k\beta(1-\epsilon)} \alpha_4(2^{k\beta})}{\alpha_1(2^{k\beta})}}. \end{aligned} \quad (4.2)$$

Thanks to (2.1) we know that (for $r \geq 1$):

$$\frac{1}{\alpha_1(\rho(r)) \rho(r)^{1-\epsilon} \alpha_4(\rho(r))} \leq O(1) r^{O(1)}. \quad (4.3)$$

Thanks to the right-hand inequality of (2.7) (that is stated for (r, R) but that we use for $(1, r)$) and thanks to the FKG-inequality (which implies that $\alpha_2(r) \leq O(1) \alpha_1(r)^2$), we have:

$$\frac{r^{1-\epsilon} \alpha_4(r)}{\alpha_1(r)} \leq O(1) \frac{r^{1-\epsilon} \alpha_4(r)}{\sqrt{\alpha_2(r)}} \leq O(1) r^{-\epsilon}. \quad (4.4)$$

Currently, there is no better estimate than (4.4) for bond percolation on \mathbb{Z}^2 : for this model, it is only known that $\frac{r \alpha_4(r)}{\alpha_1(r)} \leq O(1)$ (in particular it is not proved that $\alpha_2(r) \leq O(1) r^{-h} \alpha_1(r)^2$ for some fixed $h > 0$, see (9.2) in [SS10] for more about this inequality). However, for site percolation on \mathbb{T} , it is known that $\frac{r \alpha_4(r)}{\alpha_1(r)} = r^{-7/48+o(1)}$.

From (4.3) and (4.4), we deduce that there exist some constants $\beta_0 < +\infty$ and $c_3 > 0$ such that, for all $\beta' \geq \beta_0$ (and for all $r \geq 1$), we have:

$$\frac{1}{\alpha_1(\rho(r)) \rho(r) \alpha_4(\rho(r))} \frac{r^{\beta'(1-\epsilon)} \alpha_4(r^{\beta'})}{\alpha_1(r^{\beta'})} \leq \frac{1}{c_3} r^{-c_3}. \quad (4.5)$$

Hence, we have the following: If β satisfies the hypothesis of Corollary 2.9 and is larger than or equal to β_0 , then:

$$\sum_{k \in \mathbb{N}} \widehat{\mathbb{P}}_{f_R}[E_k] \sqrt{\delta_k} \leq O(1) \alpha_1(R) \sum_{k \in \mathbb{N}} \sqrt{\frac{1}{c_3} 2^{-kc_3}} \leq O(1) \alpha_1(R). \quad (4.6)$$

Remark 4.3. We see from the proof of (4.6) (see in particular (4.4) and the small paragraph below it) that the exponent ϵ in Theorem 2.8 is crucial for our proof to work. Notice in particular the nice decoupling of scales in (4.2) (under the square root). Even if the exponent ϵ is very small, one can tune β to be large enough so that the right-hand side in (4.2) wins against the left-hand side. This is the main constraint which will prevent us from obtaining exceptional times for larger values of α (see Figure 1.1 for the range of α we manage to cover with these estimates in the case of site percolation on \mathbb{T}).

An estimate for $\eta_k^\alpha(t)$. In this paragraph, we assume that $1 - \alpha\beta > 0$. We first prove the following lemma:

Lemma 4.4. *There exists $c_1 = c_1(\alpha, \beta) > 0$ such that, for all $t \in [0, 1]$ and all $k \in \mathbb{N}$:*

$$\eta_k^\alpha(t) \leq \frac{1}{c_1} \exp\left(-c_1 t 2^{k(1-\alpha\beta)}\right).$$

Proof. Let S be a finite subset of \mathcal{I} , see S as a set of $|S|$ particles, and construct an interacting particles system as follows: Associate to each particle of S an exponential clock of parameter 1, independent of the other clocks. If the clock of a particle rings and if its current location is $x \in \mathcal{I}$, then the particle attempts to jump to $y \in \mathcal{I}$ with probability $K^\alpha(x, y)$. If there is another particle at y , then the particle stays at x , while if there is no other particle at y then the particle jumps to y . This way, we obtain for each $s \geq 0$ a random set $\tilde{\pi}_s(S) \subseteq \mathcal{I}$ of $|S|$ particles. It is not difficult to see that, while each particle do not evolve exactly like in our Definition 1.1, the **whole set** of particles do evolve like in this definition. More precisely:

$$(\tilde{\pi}_s(S))_{s \geq 0} \stackrel{(d)}{=} (\pi_s(S))_{s \geq 0},$$

where π is defined in Appendix A.

In particular, Lemma 4.4 is equivalent to the following statement: There exists $c_1 = c_1(\alpha, \beta) > 0$ such that, for all $t \in [0, 1]$ and all $k \in \mathbb{N}$:

$$\max_{S \in F_k} \mathbb{P}[\tilde{\pi}_t(S) \in F_k] \leq \frac{1}{c_1} \exp\left(-c_1 t 2^{k(1-\alpha\beta)}\right). \quad (4.7)$$

Let us prove (4.7). Fix $S \in F_k$ and let $U \subseteq S$ be the random subset of all the particles whose clock has rung exactly one time between time 0 and time t , which happens with probability $\asymp t$ for each particle (remember that $t \in [0, 1]$). By independence and by classical estimates on Binomial distributions, we obtain that there exists $c_2 > 0$ such that, with probability at least $\frac{1}{c_2} e^{-c_2 t|S|}$, the size of U is at least $c_2 t|S|$. Write $U = \{u_1, \dots, u_{|U|}\}$, where the particles u_i are indexed so that the clock of u_i has rung before the clock of u_{i+1} . Also, write $\tau_i < t$ for the first time the clock of u_i has rung, and write V_i for the location to which the particle initially located at u_i has attempted to jump at time τ_i (remember that V_i follows the probability law $K^\alpha(u_i, \cdot)$).

Now, **condition on U and on $\tau_1, \dots, \tau_{|U|}$** , and write $\tilde{\mathbb{P}}$ for the conditional probability measure. Let \mathcal{F}_i denote the σ -algebra generated by what happens strictly before time τ_i . Also, write $S_i \subseteq ((-2^{k\beta}, 2^{k\beta})^2)^c$ for the set of particles that are outside of $(-2^{k\beta}, 2^{k\beta})^2$ at time τ_i^- . Note that S_i and V_{i-1} are measurable with respect to \mathcal{F}_i while V_i is independent of \mathcal{F}_i . Let us estimate $\tilde{\mathbb{P}}[\tilde{\pi}_t(S) \in F_k]$. To do so, note that $\{\tilde{\pi}_t(S) \in F_k\}$ holds if there exists $u_i \in U$ such that the particle initially located at u_i has jumped outside $(-2^{k\beta}, 2^{k\beta})^2$ at time τ_i (indeed, since the clock of u_i has rung only one time before time t , the particle cannot go back to $(-2^{k\beta}, 2^{k\beta})^2$). Moreover, the particle initially located at u_i has jumped outside $(-2^{k\beta}, 2^{k\beta})^2$ at time τ_i if and only if $V_i \notin (-2^{k\beta}, 2^{k\beta})^2 \cup S_i$. Let us estimate the quantity $\tilde{\mathbb{P}}[V_i \notin (-2^{k\beta}, 2^{k\beta})^2 \cup S_i \mid \mathcal{F}_i]$. To this purpose, observe that there exists a constant $c_3 = c_3(\alpha) > 0$ such that, for every $y \in A_k^\beta := [-2^{k\beta+10}, 2^{k\beta+10}]^2 \setminus (-2^{k\beta}, 2^{k\beta})^2$ and every $x \in S$, we have:

$$K^\alpha(x, y) \geq \frac{c_3}{2^{k\beta(2+\alpha)}}.$$

Observe also that $|\mathcal{I} \cap A_k^\beta| \geq 2 \times 2^{2k\beta} \geq 2^{2k\beta} + |S|$ for every $S \in F_k$. Hence:

$$\begin{aligned} \tilde{\mathbb{P}}[V_i \notin (-2^{k\beta}, 2^{k\beta})^2 \cup S_i \mid \mathcal{F}_i] &\geq (|\mathcal{I} \cap A_k^\beta| - |S_i|) \times \frac{c_3}{2^{k\beta(2+\alpha)}} \\ &\geq (|\mathcal{I} \cap A_k^\beta| - |S|) \times \frac{c_3}{2^{k\beta(2+\alpha)}} \\ &\geq \frac{c_3}{2^{k\alpha\beta}}. \end{aligned}$$

We obtain that $\tilde{\mathbb{P}}[\tilde{\pi}_t(S) \in F_k]$ is at most:

$$\begin{aligned} &\tilde{\mathbb{P}}[\forall i \in \{1, \dots, |U|\}, V_i \in (-2^{k\beta}, 2^{k\beta})^2 \cup S_i] \\ &= \tilde{\mathbb{E}}\left[\tilde{\mathbb{P}}[\forall i \in \{1, \dots, |U|\}, V_i \in (-2^{k\beta}, 2^{k\beta})^2 \cup S_i \mid \mathcal{F}_{|U|}]\right] \\ &= \tilde{\mathbb{E}}\left[\mathbf{1}_{\{\forall i \in \{1, \dots, |U|-1\}, V_i \in (-2^{k\beta}, 2^{k\beta})^2 \cup S_i\}} \tilde{\mathbb{P}}[V_{|U|} \in (-2^{k\beta}, 2^{k\beta})^2 \cup S_{|U|} \mid \mathcal{F}_{|U|}]\right] \\ &\leq \tilde{\mathbb{P}}[\forall i \in \{1, \dots, |U|-1\}, V_i \in (-2^{k\beta}, 2^{k\beta})^2 \cup S_i] \left(1 - \frac{c_3}{2^{k\alpha\beta}}\right) \\ &\leq \dots \\ &\leq \left(1 - \frac{c_3}{2^{k\alpha\beta}}\right)^{|U|}. \end{aligned}$$

Finally, we have:

$$\mathbb{P}[\tilde{\pi}_t(S) \in F_k] \leq \mathbb{P}[U < c_2 t|S|] + \left(1 - \frac{c_3}{2^{k\alpha\beta}}\right)^{c_2 t|S|},$$

where c_2 was chosen so that $\mathbb{P}[U < c_2 t | S] \leq \frac{1}{c_2} e^{-c_2 t |S|}$. Since $2^k \leq |S|$ we have:

$$\mathbb{P}[\tilde{\pi}_t(S) \in F_k] \leq \frac{1}{c_2} e^{-c_2 t 2^k} + \left(1 - \frac{c_3}{2^{k\alpha\beta}}\right)^{c_2 t 2^k},$$

which implies (4.7). \square

We now combine Lemma 4.4 and Theorem 2.5. First, note that the left-hand inequality of (2.7) (that is stated for (r, R) but that we use for $(1, \rho(l))$) implies that:

$$\frac{1}{\alpha_1(\rho(l))} \leq \frac{1}{c_2} (\rho(l)^2 \alpha_4(\rho(l))) \rho(l)^{-c_2} = \frac{1}{c_2} l \rho(l)^{-c_2},$$

for some $c_2 > 0$ (we have also used that $\rho(l)^2 \alpha_4(\rho(l)) = l$, which is a simple consequence of the definition of ρ). Note also that $\rho(l) \geq \sqrt{l}$ (since $r^2 \alpha_4(r) \leq r^2$). Therefore, by using Theorem 2.5 we obtain that there exists some $\epsilon_1 > 0$ such that, for all $l \in \mathbb{N}_+$:

$$\widehat{\mathbb{P}}_{f_R}[|S| < l] \leq \frac{1}{\epsilon_1} \alpha_1(R) (l/2)^{1-\epsilon_1}, \quad (4.8)$$

where the constant 2 is included to simplify the calculations below. We fix such an ϵ_1 for the rest of the proof. We can (and do) assume that $\epsilon_1 \in (0, 1)$. Remember that we have assumed that $1 - \alpha\beta > 0$. We have:

$$\begin{aligned} \sum_{k \in \mathbb{N}} \widehat{\mathbb{P}}_{f_R}[E_k] \eta_k^\alpha(t) &\leq \frac{1}{c_1} \sum_{k \in \mathbb{N}} \widehat{\mathbb{P}}_{f_R}[E_k] \exp\left(-c_1 t 2^{k(1-\alpha\beta)}\right) \\ &= \frac{1}{c_1} \sum_{k' \in \mathbb{N}} \sum_{j \in \mathbb{N}: \left(\frac{2^{k'+1}-1}{c_1 t}\right)^{\frac{1}{1-\alpha\beta}} \leq 2^j < \left(\frac{2^{k'+1}-1}{c_1 t}\right)^{\frac{1}{1-\alpha\beta}}} \widehat{\mathbb{P}}_{f_R}[E_j] \exp\left(-c_1 t 2^{j(1-\alpha\beta)}\right) \\ &\leq \frac{1}{c_1} \sum_{k' \in \mathbb{N}} \widehat{\mathbb{P}}_{f_R}\left[|S| < 2 \left(\frac{2^{k'+1}-1}{c_1 t}\right)^{1/(1-\alpha\beta)}\right] \exp\left(-(2^{k'} - 1)\right). \end{aligned}$$

We now use (4.8). It implies that the above is at most:

$$\frac{1}{\epsilon_1 c_1} \alpha_1(R) \sum_{k' \in \mathbb{N}} \left(\frac{2^{k'+1}-1}{c_1 t}\right)^{(1-\epsilon_1)/(1-\alpha\beta)} \exp\left(-(2^{k'} - 1)\right).$$

Hence, there exists a constant $C' = C'(\alpha, \beta) < +\infty$ such that, if $1 - \alpha\beta > 0$, then:

$$\sum_{k \in \mathbb{N}} \widehat{\mathbb{P}}_{f_R}[E_k] \eta_k^\alpha(t) \leq C' \alpha_1(R) \left(\frac{1}{t}\right)^{(1-\epsilon_1)/(1-\alpha\beta)}. \quad (4.9)$$

Remark 4.5. Notice from the above inequalities that it was important to obtain a relatively sharp upper-bound on $\eta_k^\alpha(t)$ in Lemma 4.4 in order to optimise the exponent of $(1/t)$ in (4.9).

End of the proof of existence of exceptional times. We are now in shape to prove that, if α is sufficiently small, then a.s. there are exceptional times for the K^α -exclusion dynamical percolation of parameter $p = 1/2$. Thanks to (2.14), we know that it is sufficient to prove that there exists a constant $C = C(\alpha) < +\infty$ such that, for all $R \geq 1$:

$$\int_0^1 \sum_{S, S' \subseteq \mathcal{I}_R} \sqrt{\widehat{\mathbb{P}}_{f_R}[\{S\}]} \sqrt{\widehat{\mathbb{P}}_{f_R}[\{S'\}]} K_t^\alpha(S, S') dt \leq C \alpha_1(R). \quad (4.10)$$

Fix a constant β_0 that satisfies (4.5) and choose $\beta \geq \beta_0$ that satisfies the hypothesis of Corollary 2.9. Next, choose $\alpha > 0$ sufficiently small so that $0 < (1 - \epsilon_1)/(1 - \alpha\beta) < 1$ (so, in particular, $1 - \alpha\beta > 0$). Now, note that (4.1) implies that - in order to prove (4.10) - it is sufficient to show the following inequalities:

$$\int_0^1 \sum_{k \in \mathbb{N}} \widehat{\mathbb{P}}_{f_R} [E_k] \sqrt{\delta_k} dt \leq O(1) \alpha_1(R), \quad (4.11)$$

and:

$$\int_0^1 \sum_{k \in \mathbb{N}} \widehat{\mathbb{P}}_{f_R} [E_k] \eta_k^\alpha(t) dt \leq O(1) \alpha_1(R) \quad (4.12)$$

(where the constants in the $O(1)$'s may depend on α). The inequality (4.11) is a direct consequence of (4.6) since β satisfies the hypothesis of Corollary 2.9 and $\beta \geq \beta_0$ (note that, in (4.11), the quantities do not depend on α). On the other hand, the inequality (4.12) is a direct consequence of (4.9). Indeed, since $(1 - \epsilon_1)/(1 - \alpha\beta) < 1$, we have:

$$\int_0^1 \left(\frac{1}{t}\right)^{(1-\epsilon_1)/(1-\alpha\beta)} dt < +\infty.$$

The constant $\alpha_0 = 217/816$. In this paragraph, we prove the following quantitative result: For site percolation on \mathbb{T} , there exist exceptional times for any $\alpha < \alpha_0 := 217/816$. We only work with site percolation on \mathbb{T} and we use the computations of the arm-exponents (see Subsection 2.1). Thanks to these computations (which imply in particular that $\rho(l) = l^{4/3+o(1)}$) we can say that:

1. The hypothesis on β in Corollary 2.9 is satisfied for any $\beta > 4/3$.
2. Any $\beta_0 > (17/36) \cdot (48/7) = 68/21$ satisfies (4.5) (with $c_3 = c_3(\beta_0)$). Let us detail a little this result: it comes from the two following calculations:

$$\begin{aligned} \frac{1}{\alpha_1(\rho(r)) \rho(r) \alpha_4(\rho(r))} &= r^{(5/48) \cdot (4/3) - 4/3 + (5/4) \cdot (4/3) + o(1)} \\ &= r^{17/36 + o(1)}, \end{aligned}$$

and:

$$\begin{aligned} \frac{r^{1-\epsilon} \alpha_4(r)}{\alpha_1(r)} &\leq \frac{r \alpha_4(r)}{\alpha_1(r)} \\ &= r^{1-5/4+5/48+o(1)} \\ &= r^{-7/48+o(1)}. \end{aligned} \quad (4.13)$$

3. The inequality (4.8) can be replaced by the following quantitative estimate: For all $l \in \mathbb{N}_+$:

$$\widehat{\mathbb{P}}_{f_R} [|S| < l] \leq \frac{1}{\epsilon_1} \alpha_1(R) (l/2)^{5/36+o(1)},$$

where $o(1) \searrow 0$ as $l \rightarrow +\infty$. This implies that, in (4.9), the exponent $1 - \epsilon_1$ can be replaced by any $\zeta > 5/36$: Let $\zeta > 5/36$ and assume that $1 - \alpha\beta > 0$. Then, there exists a constant $C' = C'(\alpha, \beta, \zeta)$ such that:

$$\sum_{k \in \mathbb{N}} \widehat{\mathbb{P}}_{f_R} [E_k] \eta_k^\alpha(t) \leq C' \alpha_1(R) \left(\frac{1}{t}\right)^{\frac{\zeta}{1-\alpha\beta}}. \quad (4.14)$$

If we use items 1 and 2 above, we deduce that (4.6) is true for any $\beta > 68/21 \vee 4/3 = 68/21$. Hence, (4.11) is true for any $\beta > 68/21$ (remember that the quantities in (4.6) and (4.11) do not depend on α). Fix such a β and let $\zeta > 5/36$. Let $\alpha > 0$ such that $0 < \zeta/(1 - \alpha\beta) < 1$. By using (4.14), we obtain that (4.12) is true with these choices of α and β . Finally, for any $\beta > 68/21$ and any $\zeta > 5/36$, we have the following: Let $\alpha > 0$ such that $0 < \zeta/(1 - \alpha\beta) < 1$. Then, there exist exceptional times for the K^α -exclusion process of parameter $p = 1/2$. As such, we have obtained that our result of existence of exceptional times holds for any $\alpha > 0$ such that $(5/36)/(1 - 68\alpha/21) < 1$ i.e. for any $\alpha \in (0, \alpha_0)$ with $\alpha_0 = 217/816$.

Actually, we can do a little better:⁶ Note that, in (4.13), we have used the rough estimate $r^{-\epsilon} \leq 1$. Let us take into account the exponent ϵ . Thanks to Remark 5.12, we know that Theorem 2.8 holds with any $\epsilon < (-5/4 + \zeta_4^{|\mathbb{H}|}) \wedge 1/4$, where $\zeta_4^{|\mathbb{H}|}$ is defined in Proposition C.2. Therefore, any β_0 larger than

$$\frac{17}{36} \cdot \left(\frac{7}{48} + \left(\left(-\frac{5}{4} + \zeta_4^{|\mathbb{H}|} \right) \wedge \frac{1}{4} \right) \right)^{-1} < \frac{68}{21}$$

satisfies (4.5) if ϵ is well chosen. Let:

$$\theta := \left(\frac{17}{36} \cdot \left(\frac{7}{48} + \left(\left(-\frac{5}{4} + \zeta_4^{|\mathbb{H}|} \right) \wedge \frac{1}{4} \right) \right)^{-1} \right) \vee (4/3).$$

Finally, our result of existence of exceptional times for site percolation on \mathbb{T} holds for any α such that:

$$\frac{5}{36} \cdot \frac{1}{1 - \alpha\theta} < 1,$$

i.e. for any α less than:

$$\frac{31}{36\theta} > \frac{217}{816}. \quad (4.15)$$

The Hausdorff dimension of the set of exceptional times. In this paragraph, we also only work with site percolation on \mathbb{T} and we prove lower-bounds estimates on the Hausdorff dimension of the set of exceptional times (for upper-bounds, see Proposition 3.3). Let us introduce the function:

$$d(\alpha) := 1 - \frac{5}{36} \frac{1}{1 - \frac{68}{21}\alpha},$$

which was plotted in Figure 1.1. Also, let:

$$d(\alpha, \beta, \zeta) := 1 - \frac{\zeta}{1 - \alpha\beta}.$$

Thanks to (2.15), we know that, in order to prove that the Hausdorff dimension of set of exceptional times for the K^α -exclusion process is at least $d(\alpha)$, it is sufficient to prove the following: Let $\zeta > 5/36$ and $\beta > 68/21$. Also, let $\alpha > 0$ be such that $1 - d(\alpha, \beta, \zeta) > 0$, and let $\gamma < d(\alpha, \beta, \zeta)$. Then, there exists a constant $C = C(\alpha, \beta, \zeta, \gamma) < +\infty$ such that, for all $R \geq 1$:

$$\int_0^1 \left(\frac{1}{t} \right)^\gamma \sum_{S, S' \subseteq \mathcal{I}_R} \sqrt{\widehat{\mathbb{P}}_{f_R}[\{S\}]} \sqrt{\widehat{\mathbb{P}}_{f_R}[\{S'\}]} K_t^\alpha(S, S') dt \leq C \alpha_1(R).$$

The inequality (4.1) implies that it is actually sufficient to prove that, for any α, β, ζ and γ as above, we have:

$$\int_0^1 \left(\frac{1}{t} \right)^\gamma \sum_{k \in \mathbb{N}} \widehat{\mathbb{P}}_{f_R}[E_k] \sqrt{\delta_k} dt \leq O(1) \alpha_1(R), \quad (4.16)$$

⁶This observation can be skipped at first reading.

and:

$$\int_0^1 \left(\frac{1}{t}\right)^\gamma \sum_{k \in \mathbb{N}} \widehat{\mathbb{P}}_{f_R} [E_k] \eta_k^\alpha(t) dt \leq O(1) \alpha_1(R), \quad (4.17)$$

where the constants in the $O(1)$'s may depend on α , β , ζ and γ . Since $\widehat{\mathbb{P}}_{f_R} [E_k] \sqrt{\delta_k}$ does not depend on t and since $\gamma < 1$, (4.16) is actually equivalent to:

$$\sum_{k \in \mathbb{N}} \widehat{\mathbb{P}}_{f_R} [E_k] \sqrt{\delta_k} \leq O(1) \alpha_1(R). \quad (4.18)$$

The fact that (4.18) holds when $\beta > 68/21$ has been proved in the paragraph about the constant $\alpha_0 = 217/816$ (this was a consequence of items 1 and 2 of this last paragraph). Now, let us concentrate on (4.17). If we use (4.14), we obtain that:

$$\int_0^1 \left(\frac{1}{t}\right)^\gamma \sum_{k \in \mathbb{N}} \widehat{\mathbb{P}}_{f_R} [E_k] \eta_k^\alpha(t) dt \leq O(1) \alpha_1(R) \int_0^1 \left(\frac{1}{t}\right)^{\gamma + \frac{\zeta}{1-\alpha\beta}} dt,$$

and we are done since $\gamma + \frac{\zeta}{1-\alpha\beta} = \gamma + 1 - d(\alpha, \beta, \zeta) < 1$. \square

Remark 4.6. Actually, by taking into account the ϵ of Theorem 2.8, we can go slightly above the quantity $d(\alpha)$: we can prove that the Hausdorff dimension of the set of exceptional times belongs to $(d(\alpha), 31/36]$.

We now use Lemma 4.1, Theorem 2.5 and Proposition 2.10 in order to prove Proposition 1.6.

Proof of Proposition 1.6. Consider $a > 0$. The steps are exactly the same as in the proof of Theorem 1.5, with the following analogous definitions (where $\epsilon_0 > 0$ is such that $1 - \epsilon_0(1+a) > 0$): $E_k = \{S \subseteq \mathcal{I}_R : |S| = k\}$, $F_k = \{S \in E_k : S \subseteq (-\exp((k+1)^{\epsilon_0}), \exp((k+1)^{\epsilon_0}))^2\}$, $\nu_k = \widehat{\mathbb{P}}_{f_R}$ restricted to E_k , $P_k^a(t) = K_{\log, t}^a$ restricted to E_k . We write δ_k and $\eta_k^a(t)$ as in Lemma 4.1. If we follow the proof of Lemma 4.4, we obtain that there exists $c_1 = c_1(a, \epsilon_0) > 0$ such that:

$$\eta_k^a(t) \leq \frac{1}{c_1} \exp\left(-c_1 t k^{1-\epsilon_0(1+a)}\right).$$

Moreover, if we follow the proof of (4.9), we obtain that there exists a constant $C' = C'(a, \epsilon_0) < +\infty$ such that:

$$\sum_{k \in \mathbb{N}} \widehat{\mathbb{P}}_{f_R} [E_k] \eta_k^a(t) \leq C' \alpha_1(R) \left(\frac{1}{t}\right)^{(1-\epsilon_1)/(1-\epsilon_0(1+a))},$$

where ϵ_1 is the constant of (4.8).

To estimate δ_k , we use Proposition 2.10 and, since $\exp(k^{\epsilon_0}/C)$ is super-polynomial, we easily obtain that:

$$\sum_{k \in \mathbb{N}} \widehat{\mathbb{P}}_{f_R} [E_k] \sqrt{\delta_k} \leq C'' \alpha_1(R),$$

for some $C'' = C''(a, \epsilon_0) < +\infty$.

Finally note that: (a) for the two models, ϵ_0 can be chosen as small as we want and: (b) for site percolation on \mathbb{T} , we can replace the exponent $1 - \epsilon_1$ by any $\zeta > 5/36$. We conclude exactly as in the proof of Theorem 1.5. \square

5 Clustering effect for the spectral sample

In this section, we prove Theorem 2.8 and Proposition 2.10. We are mostly inspired by the proof of the upper-bound part of Theorem 2.5 as found in [GPS10]. This proof is divided into three steps. The first step shows that there exists a constant $\theta < +\infty$ such that the following holds: For every $S \subseteq \mathcal{I}_R$, let S_r be the set of the $r \times r$ squares of the grid $r\mathbb{Z}^2$ which intersect S . Then, for all $k \in \mathbb{N}_+$ we have:

$$\widehat{\mathbb{P}}_{f_R} [|S_r| = k] \leq g(k) \frac{\alpha_1(R)}{\alpha_1(r)}, \quad (5.1)$$

where $g(k) = 2^{\theta \log_2^2(k+2)}$. This is Proposition 4.7 in [GPS10] (with $l = 1$), see Subsection 5.2 for a little discussion about the two other steps.

As mentioned in Subsection 2.5, the proof of Proposition 2.10 is easier than the proof of Theorem 2.8. More precisely, Proposition 2.10 is a direct consequence of the proof of (5.1) as found in Section 4 of [GPS10], whereas to prove Theorem 2.8 we will need to (a) prove an analogue of (5.1) and (b) use the two other steps of the proof of the upper-bound part of Theorem 2.5 identically to [GPS10]. See Subsection 2.5 for a discussion (and a list) of the differences with the proof in [GPS10].

Remember that $\widehat{\mathbb{Q}}_{f_R} = \alpha_1(R) \widehat{\mathbb{P}}_{f_R}$. For some proofs of Section 5, it will be more convenient to deal with $\widehat{\mathbb{Q}}_{f_R}$ than with $\widehat{\mathbb{P}}_{f_R}$.

5.1 The proof of Proposition 2.10

Proposition 2.10 is a simple consequence of Corollary 2.9. As explained above, this is also a direct consequence of the proofs of Section 4 of [GPS10]. Let us say a little more about this. Consider $\epsilon_0 > 0$. What we want to prove is the existence of some $C = C(\epsilon_0) < +\infty$ such that, for all $k \in \mathbb{N}_+$:

$$\widehat{\mathbb{Q}}_{f_R} [|S| < k, S \not\subseteq (-\exp(k^{\epsilon_0}), \exp(k^{\epsilon_0}))^2] \leq C \alpha_1(R)^2 \exp(-k^{\epsilon_0}/C).$$

In Subsection 4.2 of [GPS10] the authors prove an analogue of (5.1) for the indicator function of the crossing of the square g_n while (5.1) itself is proved in Subsection 4.4 of [GPS10]. In Remark 4.5 of [GPS10], it is explained that the proof written in their Subsection 4.2 implies a clustering effect for the spectral sample of g_n conditioned to be of size less than $\log(n)$. With same ideas, a clustering effect for the spectral sample of f_R conditioned to be of atypically small size can be extracted from Subsection 4.4 of [GPS10], and we can thus obtain Proposition 2.10.

5.2 Small residual spectral mass away from the origin

Let us recall what are the three main steps in [GPS10] in order to prove the upper-bound part of Theorem 2.5:

1. The estimate (5.1) on the probability of a very small spectrum.
2. The following result on the independence structure of the spectral sample (this is not exactly the result stated in [GPS10] but its proof is exactly the same):

Proposition 5.1 (Proposition 5.12 in [GPS10]). *Let $1 \leq r \leq R$ and let \mathcal{S}_{f_R} be a spectral sample of f_R . Also, let $W \subseteq \mathcal{I}_R$ and let $B \subseteq \mathbb{R}^2$ be an $l \times l'$ rectangle such that: (a) $r \leq l, l' \leq 2r$ and (b) $W \cap B = \emptyset$. Let $B' \subset B$ be the $r/3 \times r/3$ -square which has the same center as B . Suppose that $B' \subset [-R, R]^2$ and $B \cap [-4r, 4r]^2 = \emptyset$. We also assume that $r \geq \bar{r}$, where $\bar{r} < +\infty$ is some universal constant. Finally, let $\mathcal{Z} = \mathcal{Z}_r$ be a random subset of \mathcal{I}_R that is independent of \mathcal{S}_{f_R} , where each element of \mathcal{I}_R is in \mathcal{Z} with probability*

$(r^2\alpha_4(r))^{-1}$ independently of the others. Then, there exists a universal constant $a > 0$ such that:

$$\mathbb{P} \left[\mathcal{S}_{f_R} \cap B' \cap \mathcal{Z} \neq \emptyset \mid \mathcal{S}_{f_R} \cap B \neq \emptyset = \mathcal{S}_{f_R} \cap W \right] \geq a.$$

Let us emphasize the fact that in the conditioning we cannot have $\mathcal{S}_{f_R} \cap W' \neq \emptyset$ for some $W' \subseteq \mathcal{I}_R$. In other words, we can only deal with **negative information** about the spectral sample.

3. A large deviation result:

Proposition 5.2 (Proposition 6.1 in [GPS10]). *Take $I \neq \emptyset$ a finite set. Let x and y be $\{0, 1\}^I$ -valued random variables such that a.s. $y_i \leq x_i$ for all $i \in I$. We write $X = \sum_{i \in I} x_i$ and $Y = \sum_{i \in I} y_i$. Suppose that there exists a constant $a \in (0, 1]$ such that, for each $i \in I$ and every $J \subseteq I \setminus \{i\}$:*

$$\mathbb{P} \left[y_i = 1 \mid y_j = 0 \forall j \in J \right] \geq a \mathbb{P} \left[x_i = 1 \mid y_j = 0 \forall j \in J \right].$$

Then:

$$\mathbb{P} \left[Y = 0 \mid X > 0 \right] \leq \frac{1}{a} \mathbb{E} \left[\exp(-aX/e) \mid X > 0 \right].$$

These results combine well to prove the upper-bound part of Theorem 2.5 (i.e. Theorem 7.3 in [GPS10]). In order to prove Theorem 2.8, we will use Propositions 5.1 and 5.2 and we will need an analogue of the estimate (5.1) where we only look at the part of the spectral sample that is outside of the box of radius r_0 . In the following subsection, we state and prove this analogous result.

5.2.1 A combinatorial result in the flavour of Section 4 of [GPS10]

The aim of this section is to prove the following result. This is the more technical part of the chapter and we have chosen to: (a) divide the proof in three paragraphs and (b) at the beginning of each paragraph, explain what is similar to (and different from) Section 4 of [GPS10].

Proposition 5.3. *If $S \subseteq \mathcal{I}_R$, write $S_r^{r_0}$ for the set of the squares of the grid $r\mathbb{Z}^2$ that intersect $S \setminus (-r_0, r_0)^2$. Then, there exist constants $\theta < +\infty$ and $\epsilon > 0$ such that, for all $k \in \mathbb{N}_+$ and all $1 \leq r \leq r_0 \leq R/2$:*

$$\widehat{\mathbb{P}}_{f_R} [|S_r^{r_0}| = k] \leq g(k) \frac{\alpha_1(R)}{\alpha_1(r_0)} \left(\frac{r_0}{r} \right)^{1-\epsilon} \alpha_4(r, r_0),$$

where $g(k) = 2^{\theta \log_2^2(k+2)}$.

Proof. We will prove the equivalent inequality:

$$\widehat{\mathbb{Q}}_{f_R} [|S_r^{r_0}| = k] \leq g(k) \frac{\alpha_1(R)^2}{\alpha_1(r_0)} \left(\frac{r_0}{r} \right)^{1-\epsilon} \alpha_4(r, r_0). \quad (5.2)$$

A. The r_0 -decorated centered annulus structures. As in Section 4 of [GPS10], we begin with some definitions concerning annulus structures. More precisely, we first state the definition of centered annulus structures from Section 4 of [GPS10], and we recall the main preliminary result of [GPS10] about these objects (see (5.3)). We then explain how to construct annulus structures more suitable for our work: the r_0 -decorated centered annulus structures, that will be helpful when we want to take into account what happens near the boundary of the square $(-r_0, r_0)^2$. The proof of the result analogous to (5.3) (see Lemma 5.5) will be a little more difficult than the proof (in [GPS10]) of (5.3), and we will need to rely on a general property of spectral samples: Lemma 5.7. The proof of Lemma 5.7, based on ideas that come from Section 2 of [GPS10], is postponed to Appendix B.

Definition 5.4 (Section 4 of [GPS10]). Consider $(\mathcal{A}, r_{\mathcal{A}})$ where $r_{\mathcal{A}} \in [0, R]$ and \mathcal{A} is a collection of mutually percolation disjoint square annuli A that satisfy:

1. either A is included in $[-R, R]^2$ and is centered at 0. Such A are called **centered annuli**,
2. or A is included in $[-R, R]^2$ and the outer square of A does not contain 0. Such A are called **interior annuli**,
3. or A is centered at a point of a side of $[-R, R]^2$ that is at distance at least the outer radius of A from the other sides. Such A are called **side annuli**,
4. or A is centered at a corner of $[-R, R]^2$ and the outer radius of A is less than or equal to R . Such A are called **corner annuli**. (Distinguishing between corner and interior annuli was interesting in [GPS10] for the study of the indicator function of the crossing of the square g_n . In our case - where we are only interesting in f_R - it will not be very useful but we have kept this distinction since: (a) it does not add any technical difficulty and (b) it will make it easier when referring to [GPS10].)

Suppose also that the annuli and $[-r_{\mathcal{A}}, r_{\mathcal{A}}]^2$ are percolation disjoint. Then, $(\mathcal{A}, r_{\mathcal{A}})$ is called a **centered annulus structure**. For each $A \in \mathcal{A}$ we write $h(A)$ for the probability of having the 1-arm event in A if A is a centered annulus, the 4-arm event in A if it is an interior annulus, the half-plane 3-arm event (in A intersected with $[-R, R]^2$) if it is a side annulus and the quarter-plane 3-arm event (in A intersected with $[-R, R]^2$) if it is a corner annulus. We will often write \mathcal{A} instead of $(\mathcal{A}, r_{\mathcal{A}})$. Finally, a subset $S \subseteq \mathcal{I}_R$ is called **compatible** with \mathcal{A} if (a) for each non-centered annulus $A \in \mathcal{A}$ there exists $i \in S \cap B(A)$ where $B(A)$ is the inner square of A (more precisely, there exists $i \in S$ whose tile is included in $B(A)$) and (b) there is no $i \in S$ whose tile intersects $\bigcup_{A \in \mathcal{A}} A$ (see Figure 5.1). (In [GPS10] it is also asked that S intersects $B(A)$ when A is a centered annulus. That is the reason why the estimate (5.3) below is written with S whereas the same result in [GPS10] is written with $S \cup \{0\}$.)

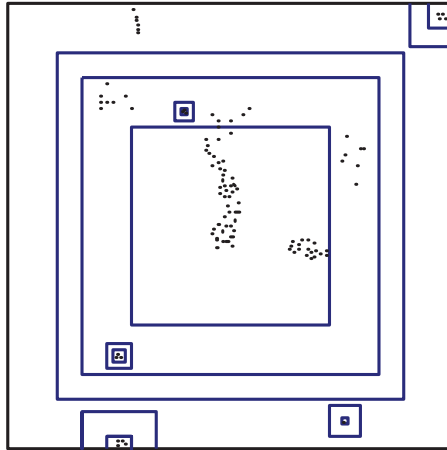

Figure 5.1 – A set S compatible with a centered annulus structure.

The following is Lemma 4.8 in [GPS10]: if \mathcal{A} is a centered annulus structure, then:

$$\widehat{\mathbb{Q}}_{f_R}[S \text{ is compatible with } \mathcal{A}] \leq \alpha_1(r_{\mathcal{A}}) \prod_{A \in \mathcal{A}} h(A)^2. \quad (5.3)$$

We want to generalise this by adding some annuli centered on the boundary of $[-r_0, r_0]^2$. Consider \mathcal{A} a centered annulus structure such that $r_{\mathcal{A}} = r_0$. Let $n \in \mathbb{N}$ and let A_1, \dots, A_n be some mutually percolation disjoint interior annuli which are percolation disjoint from all the annuli of \mathcal{A} . We also assume that, for all $j \in \{1, \dots, n\}$, A_j is centered at a point of $\partial[-r_0, r_0]^2$

and is percolation disjoint from $[-r_0/2, r_0/2]^2$. Let $\tilde{\mathcal{A}} = \mathcal{A} \cup \{A_1, \dots, A_n\}$. We call such a set of annuli a **r_0 -decorated centered annulus structure**.

We say that a subset $S \subseteq \mathcal{I}_R$ is compatible with $\tilde{\mathcal{A}}$ if (a) S is compatible with \mathcal{A} , (b) for all $j \in \{1, \dots, n\}$, there exists $i \in S$ such that the tile of i is included in the inner square of A_j , and (c) there is no $i \in S \setminus (-r_0, r_0)^2$ whose tile intersects A_j . Note that there may exist $i \in S \cap (-r_0, r_0)^2$ whose tile intersects A_j , see Figure 5.2.

In order to generalize (5.3) to these r_0 -decorated centered annulus structures, we need to introduce a new notation. First, if $B \subseteq \mathcal{I}_R$, we write \mathcal{F}_B for the σ -field of subsets of $\{-1, 1\}^{\mathcal{I}_R}$ generated by the restriction of ω to the bits in B . Next, for any $j \in \{1, \dots, n\}$, we write $h^{r_0}(A_j)$ for the non-negative real number such that:

$$h^{r_0}(A_j)^2 = \mathbb{E}_{1/2} \left[\mathbb{P}_{1/2} \left[4\text{-arm event in } A_j \mid \mathcal{F}_{\mathcal{I}_R \cap (-r_0, r_0)^2} \right]^2 \right].$$

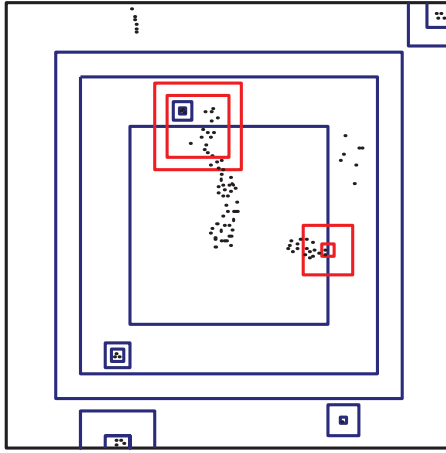

Figure 5.2 – A set S compatible with a r_0 -decorated centered annulus structure.

We now state the following analogue of (5.3), whose proof is **one of the main steps in the present subsection that differs from [GPS10]** (and the main part of its proof is postponed to Appendix B).

Lemma 5.5. *Let \mathcal{A} and $\tilde{\mathcal{A}}$ be as above. We have:*

$$\widehat{\mathbb{Q}}_{f_R} \left[S \text{ is compatible with } \tilde{\mathcal{A}} \right] \leq \alpha_1(r_0/2) \prod_{j=1}^n (4h^{r_0}(A_j)^2) \prod_{A \in \mathcal{A}} (4h(A)^2).$$

In order to prove this lemma, we first need a general property about the spectral sample. In order to state this property, we need the following definition:

Definition 5.6. Let $h : \Omega_R = \{-1, 1\}^{\mathcal{I}_R} \rightarrow \mathbb{R}$. Also, let $J \subseteq \mathcal{I}_R$, and let J_1, \dots, J_n be mutually disjoint subsets of \mathcal{I}_R . We say that J is **pivotal** for h and some configuration $\omega \in \Omega_R$ if changing the values of the sites/edges in J can change the value of h . We say that J_1, \dots, J_n are **jointly pivotal** for h and some configuration ω if, for every $j_0 \in \{1, \dots, n\}$, there is a choice of configuration in $\cup_{j \neq j_0} J_j$ making J_{j_0} pivotal. We will use the following notation:

$$(\text{Jointly Pivotal})_{J_1, \dots, J_n}(h) = JP_{J_1, \dots, J_n}(h) = \{J_1, \dots, J_n \text{ are jointly pivotal for } h\}.$$

Note that $JP_{J_1, \dots, J_n}(h)$ is an event measurable with respect to the configuration outside $\cup_j J_j$.

The proof of the following lemma is postponed to Appendix B.

Lemma 5.7. *Let h be as above. Let $n \in \mathbb{N}_+$ and let J_1, \dots, J_n, W be mutually disjoint subsets of \mathcal{I}_R . Then:*

$$\widehat{\mathbb{Q}}_h [\forall j, S \cap J_j \neq \emptyset, S \cap W = \emptyset] \leq 4^n \|h\|_\infty^2 \mathbb{E}_{1/2} \left[\mathbb{P}_{1/2} \left[JP_{J_1, \dots, J_n}(h) \mid \mathcal{F}_{W^c} \right]^2 \right],$$

where, for every $B \subseteq \mathcal{I}_R$, \mathcal{F}_B is the σ -field of subsets of $\{-1, 1\}^{\mathcal{I}_R}$ generated by the restriction of ω to the sites/edges in B .

Proof of Lemma 5.5. If there are only centered annuli in $\tilde{\mathcal{A}}$ (and more generally if $n = 0$) then this is a direct consequence of (5.3) (and we obtain the result without the factors 4; see also the end of the proof for another approach). Hence, we can assume that there exist non-centered annuli in $\tilde{\mathcal{A}}$. Also, we write W for the set of the $i \in \mathcal{I}_R$ whose tile intersects some $A \in \mathcal{A}$ and of the $i \in \mathcal{I}_R \setminus (-r_0, r_0)^2$ whose tile intersects some $A_j, j \in \{1, \dots, n\}$. If A is some annulus, let $B(A)$ be the set of the $i \in \mathcal{I}_R$ such that the tile of i is included in the inner square of A . Also, let $\tilde{\mathcal{A}}'$ be the subset of $\tilde{\mathcal{A}}$ whose elements are the non-centered annuli $A \in \tilde{\mathcal{A}}$ such that the inner square of A does not contain any other annulus of $\tilde{\mathcal{A}}$. We have:

$$\widehat{\mathbb{Q}}_{f_R} [S \text{ is compatible with } \tilde{\mathcal{A}}] = \widehat{\mathbb{Q}}_{f_R} [\forall A \in \tilde{\mathcal{A}}', S \cap B(A) \neq \emptyset, S \cap W = \emptyset].$$

We now use Lemma 5.7 (which is the main step in this proof). It implies that the above is at most:

$$4^{|\tilde{\mathcal{A}}'|} \mathbb{E}_{1/2} \left[\mathbb{P}_{1/2} \left[JP_{B(A)_{A \in \tilde{\mathcal{A}}'}}(f_R) \mid \mathcal{F}_{W^c} \right]^2 \right] \leq 4^{|\tilde{\mathcal{A}}'|} \mathbb{E}_{1/2} \left[\mathbb{P}_{1/2} \left[JP_{B(A)_{A \in \tilde{\mathcal{A}}'}}(f_R) \mid \mathcal{F}_{W^c} \right]^2 \right].$$

Since our annuli are mutually percolation disjoint and are percolation disjoint from the square $[-r_0/2, r_0/2]^2$, the event $JP_{B(A)_{A \in \tilde{\mathcal{A}}'}}(f_R)$ implies the 4-arm event in every interior annulus $A \in \mathcal{A}$ and in A_j for all $j \in \{1, \dots, n\}$. Moreover, it implies the 3-arm event in A intersected with $[-R, R]^2$ for every side or corner annulus $A \in \mathcal{A}$, the 1-arm event in any centered annulus $A \in \mathcal{A}$ and the event $\{0 \leftrightarrow r_0/2\}$. For any interior annulus $A \in \mathcal{A}$ we have:

$$\mathbb{E}_{1/2} \left[\mathbb{P}_{1/2} \left[4\text{-arm event in } A \mid \mathcal{F}_{W^c} \right]^2 \right] = h(A)^2,$$

since the 4-arm event in A is independent of the configuration restricted to W^c . The analogous equalities hold for side, corner and centered annuli. Similarly, it is not difficult to see that for all $j \in \{1, \dots, n\}$ we have:

$$\mathbb{E}_{1/2} \left[\mathbb{P}_{1/2} \left[4\text{-arm event in } A_j \mid \mathcal{F}_{W^c} \right]^2 \right] = h^{r_0}(A_j)^2.$$

Finally, note that:

$$\mathbb{E}_{1/2} \left[\mathbb{P}_{1/2} \left[0 \leftrightarrow r_0/2 \mid \mathcal{F}_{W^c} \right]^2 \right] = \mathbb{P}_{1/2} [0 \leftrightarrow r_0/2] = \alpha_1(r_0/2).$$

By spatial independence, we are done. (We could have treated the case where there are only centered annuli in $\tilde{\mathcal{A}}$ by very similar ideas but by using (2.9) from [GPS10] instead of Lemma 5.7. It is actually easier than the above case.) \square

Let $j \in \{1, \dots, n\}$ and let ρ_j and ρ'_j be the inner and outer radii of A_j . It is not difficult to see that there exists a (upper, lower, left or right, depending on j) half-plane H_j such that the center of A_j belongs to the boundary of H_j and $(-r_0, r_0)^2 \subseteq H_j$. Note that, for any $B_1 \subseteq B_2 \subseteq \mathcal{I}_R$ and any function $h : \Omega_R \rightarrow \mathbb{R}$, we have:

$$\mathbb{E}_{1/2} \left[\mathbb{E}_{1/2} \left[h \mid \mathcal{F}_{B_1} \right]^2 \right] \leq \mathbb{E}_{1/2} \left[\mathbb{E}_{1/2} \left[h \mid \mathcal{F}_{B_2} \right]^2 \right].$$

Let $\mathbb{H}_j = H_j \cap \mathcal{I}_{\mathcal{R}}$. The above implies that:

$$h^{r_0}(A_j)^2 \leq \mathbb{E}_{1/2} \left[\mathbb{P}_{1/2} \left[4\text{-arm event in } A_j \mid \mathcal{F}_{\mathbb{H}_j} \right]^2 \right].$$

Together with Lemma C.1, this implies that there exist $\epsilon > 0$ and $C < +\infty$ such that:

$$h^{r_0}(A_j) \leq C \alpha_4(\rho_j, \rho'_j) \left(\frac{\rho'_j}{\rho_j} \right)^{-\epsilon}. \quad (5.4)$$

By possibly decreasing ϵ , we assume the following technical condition (for every $1 \leq \rho_1 \leq \rho_2$):

$$\left(\alpha_4(\rho_1, \rho_2) \frac{\rho_2}{\rho_1} \right)^2 \leq O(1) \alpha_4(\rho_1, \rho_2) \left(\frac{\rho_2}{\rho_1} \right)^{1-\epsilon}. \quad (5.5)$$

(This is possible since $\alpha_4(\rho_1, \rho_2) \frac{\rho_2}{\rho_1}$ is polynomially small in $\frac{\rho_1}{\rho_2}$, see the right-hand inequality of (2.7).) We also assume the following stronger condition: There exists $c > 0$ such that:

$$\left(\alpha_4(\rho_1, \rho_2) \frac{\rho_2}{\rho_1} \right)^2 \leq \frac{1}{c} \left(\alpha_4(\rho_1, \rho_2) \left(\frac{\rho_2}{\rho_1} \right)^{1-\epsilon} \right)^{1.01} \left(\frac{\rho_2}{\rho_1} \right)^{-c}. \quad (5.6)$$

(This is possible since $\left(\alpha_4(\rho_1, \rho_2) \frac{\rho_2}{\rho_1} \right)^{0.99}$ is polynomially small in $\frac{\rho_1}{\rho_2}$. Moreover, this is a stronger condition than (5.5) since $\alpha_4(\rho_1, \rho_2) \left(\frac{\rho_2}{\rho_1} \right)^{1-\epsilon}$ is polynomially small in $\frac{\rho_1}{\rho_2}$.) See Remark 5.9 below where we explain the reason why we need (5.5) and (5.6).

We now write $h(\tilde{\mathcal{A}}) = \prod_{A \in \mathcal{A}} h(A) \prod_{j \in \{1, \dots, n\}} h^{r_0}(A_j)$. More generally, for any $\tilde{\mathcal{A}}' \subseteq \tilde{\mathcal{A}}$, we write $h(\tilde{\mathcal{A}}')$ for the obvious analogue where we only consider the annuli in $\tilde{\mathcal{A}}'$.

Let us fix $1 \leq r \leq r_0 \leq R/2$ and $k \in \mathbb{N}_+$ for the rest of the proof. Recall that for any $\theta < +\infty$, we defined in the statement of Proposition 5.3 $g(k) := 2^{\theta \log_2^2(k+2)}$. Thanks to Lemma 5.5, we have the following:

Lemma 5.8. *To prove Proposition 5.3, it sufficient to show that there exists an absolute constant $\theta < +\infty$ such that, if $g(k) \frac{\alpha_1(R)}{\alpha_1(r_0)} \left(\frac{r_0}{r} \right)^{1-\epsilon} \alpha_4(r, r_0) \leq 1$ (where ϵ is as in inequalities (5.4), (5.5) and (5.6)), then there exists a set \mathfrak{U}_k of r_0 -decorated centered annulus structures such that: (a) for all S that satisfies $|S_{r_0}^r| = k$, there exists $\tilde{\mathcal{A}} \in \mathfrak{U}_k$ compatible with S , and (b):*

$$\sum_{\tilde{\mathcal{A}} \in \mathfrak{U}_k} 4^{|\tilde{\mathcal{A}}|} \alpha_1(r_0/2) h(\tilde{\mathcal{A}})^2 \leq g(k) \frac{\alpha_1(R)^2}{\alpha_1(r_0)} \left(\frac{r_0}{r} \right)^{1-\epsilon} \alpha_4(r, r_0). \quad (5.7)$$

(If $g(k) \frac{\alpha_1(R)}{\alpha_1(r_0)} \left(\frac{r_0}{r} \right)^{1-\epsilon} \alpha_4(r, r_0) > 1$ then (5.2) is trivial since $\alpha_1(R)$ is the total mass of $\hat{\mathbb{Q}}_{f_R}$.)

Remark 5.9. The reason why we need conditions (5.5) and (5.6) on ϵ can be explained as follows: in the next paragraph, we will construct our sets of r_0 -decorated centered annulus structures \mathfrak{U}_k . Then, we will estimate the quantities $\sum_{\tilde{\mathcal{A}} \in \mathfrak{U}_k} 4^{|\tilde{\mathcal{A}}|} \alpha_1(r_0/2) h(\tilde{\mathcal{A}})^2$ of (5.7) by induction. At each step of the induction, the annuli centered on the boundary of $[-r_0, r_0]^2$ will induce estimates of the form $\left(\frac{r_0}{r} \right)^{1-\epsilon} \alpha_4(r, r_0)$ and the other interior annuli will induce estimates of the form $\left(\frac{r_0}{r} \right)^2 \alpha_4(r, r_0)^2$. Since we will deal a lot with such terms, it will be useful to know which of them is the dominant term, and that is why we assume in (5.5) that ϵ is sufficiently small so that $\left(\frac{r_0}{r} \alpha_4(r, r_0) \right)^2 \leq O(1) \alpha_4(r, r_0) \left(\frac{r_0}{r} \right)^{1-\epsilon}$.

The reason why we need the existence of the exponents c (even very small) and 1.01 in the stronger assumption (5.6) is that, at each step of the induction, we want to have some room to manoeuvre. Actually, we could have chosen any number $1 + a \in (1, 2)$ instead of 1.01 and the

proof would have been exactly the same by only replacing all the exponents 1.01 by $1 + a$ (in particular in the estimate (5.10) below). The reason why we have chosen 1.01 is only that it is nice to think of a as being very small so that we can have precise estimates about the exponent ϵ that we are able to consider. See Remark 5.12 for more about this.

At some point of the proof, it will probably be more natural to work with an exponent $1 + a$ close to 2 instead of 1.01 (in the same spirit as the exponent 1.99 that appears in Section 4 of [GPS10]) since the exponent will be extracted from a geometric sum of the form $\sum_{d=2}^{k'} \gamma^d$ (see for instance the proof of (5.10) below). With the above explanations, we hope that the fact that we have chosen $1 + a = 1.01$ will not confuse the reader.

We now proceed to the construction of the sets \mathfrak{U}_k .

B. The construction of the r_0 -decorated centered annulus structures. Contrary to Paragraph A, the novelty of this paragraph in comparison to [GPS10] is only that we extend some definitions to what happens near the boundary of the box $(-r_0, r_0)^2$. Still, this paragraph is crucial to define carefully the sets \mathfrak{U}_k (in particular, we will specify how we associate an annulus to the singleton $\{\{0\}\}$ and how we define the quantities $\gamma_{\rho_1}^{r_0}(\rho_2)$).

In Section 4 of [GPS10], the authors explain how we can classify the annulus structures. We will follow the same ideas to classify our r_0 -decorated centered annulus structures. Let $S \subseteq \mathcal{I}_R$ be such that $|S_r^{r_0}| = k$. Let $j \in \mathbb{N}$. If $j \geq 1$, we define G_j as the graph with vertices the elements of $S_r^{r_0} \cup \{0\}$ and with edges present between any two points with Euclidean distance from one to the other at most $2^j r$ (say for instance that the distance between two sets is the infimum distance between these two sets - the fact that the vertices are squares except $\{0\}$ that is a point will not be a problem). For the case $j = 0$, G_j is simply the graph with vertices the elements of $S_r^{r_0} \cup \{0\}$ and with no edge. The authors of [GPS10] explain how to construct annuli around the connected components of the G_j 's. Let us explain it (the difference will be that we will need to change the definition for annuli close to $\partial[-r_0, r_0]^2$):

Let $\bar{j} = \lfloor \log_2 \left(\frac{R}{kr} \right) \rfloor - 5$ and $J = \{0, \dots, \bar{j}\}$. Take $j \in \{1, \dots, \bar{j}\}$. A connected component of G_j is called an **interior cluster at level j** if it does not contain $\{0\}$, it is not a connected component of G_{j-1} and its distance to $\partial[-r_0, r_0]^2 \cup \partial[-R, R]^2$ is larger than $2^j r$. A connected component of G_j is a **centered cluster at level j** if it contains $\{0\}$ and it is not a connected component of G_{j-1} . We define by induction on $j \in \{1, \dots, \bar{j}\}$ the other clusters: a connected component of G_j is a **side cluster at level j** if it is within distance $2^j r$ of precisely one of the boundary edges of $[-R, R]^2$ and it is not a side cluster at level j' for any $j' \in \{1, \dots, j-1\}$. A connected component of G_j is a **corner cluster at level j** if it is within distance $2^j r$ of precisely two adjacent boundary edges of $[-R, R]^2$ and it is not a corner cluster at level j' for any $j' \in \{1, \dots, j-1\}$. A connected component of G_j is a **r_0 -cluster at level j** if it does not contain $\{0\}$, it is within distance $2^j r$ of $\partial[-r_0, r_0]^2$ and it is not a r_0 -cluster at level j' for any $j' \in \{1, \dots, j-1\}$. Furthermore, a connected component of G_0 (i.e. a singleton) that is not $\{\{0\}\}$ is an interior cluster at level 0 and the singleton $\{\{0\}\}$ is a centered cluster at level 0. Finally, we define a unique cluster at level $\bar{j} + 1$ that is the entire set $S_r^{r_0} \cup \{0\}$ and is called the **top cluster**.

With these definitions, for any $j \in J$ and any connected component C of G_j , there exists $j' \in J$ such that C is a cluster at level j' of one of the types described above. Moreover, for any type (i.e. interior, centered, side, corner, r_0 - or top) of cluster there exists at most one level $j' \in J$ such that C is a cluster at level j' of this type, and for any level $j' \in J$ there exists at most one type of cluster such that C is a cluster at level j' of this type.

For a cluster C of any type, we write $j(C)$ for the level of C .

We want to define a tree structure for our clusters. Let C be a cluster of some type at some level $j \in J$. The parent of C is either C itself if C is also a cluster of some other type at some level

$j' > j$ (and we choose the smallest level j' if there are more than one choice) or the smallest cluster that properly contains C otherwise (and we also choose the smallest level $j' > j$). We write C^p for the parent of C . For instance, the children of a r_0 -cluster can only be interior and r_0 -clusters; moreover, a r_0 -cluster at level $j > 0$ either has a single child that is an interior cluster or has at least two children.

Now, for any of the clusters C described above (except for the top cluster), we define an annulus A_C . The inner radius of this annulus will be $2^{j(C)+4}|C|$ and the outer radius will be $2^{j(C^p)-4}$. The center will be 0 if C is a centered cluster and the corner associated to C if C is a corner cluster. In the other cases, we use some deterministic law to choose a vertex $v = v(C)$ of C and we choose the center of the annulus as follows: If C is an interior cluster, we decide that the center of A_C is the (or one of the) nearest point(s) of v whose coordinates are divided by $2^{j(C)}r$. If C is a side cluster, the center of A_C is the (or one of the) nearest point(s) of v that is on $\partial[-R, R]^2$ and whose coordinate that is not R is divided by $2^{j(C)}r$. We do exactly the same thing with r_0 -clusters but now **we center the annulus on $\partial[-r_0, r_0]^2$** . (When the outer radius is larger than the inner radius, A_C is the empty annulus.)

There is only **one exception**: if C is the singleton $\{\{0\}\}$, we decide that the inner radius is $2^4r \vee (r_0 + 2)$ instead of 2^4r (and the outer radius is still $2^{j(C^p)-4}$).

All these annuli define a r_0 -decorated centered annulus structure $\tilde{\mathcal{A}}_1(S)$ compatible with S (to see this, write A_1, \dots, A_n for the annuli associated to the r_0 -clusters). Let us for instance check that the annuli associated to the r_0 -clusters are percolation disjoint from $[-r_0/2, r_0/2]^2$. Let C be a r_0 -cluster at level j . Some vertex of C is at distance less than or equal to $2^j r$ of $\partial[-r_0, r_0]^2$ and $\{0\} \notin C$, so $2^{j(C^p)}r \leq 2(\sqrt{2}r_0 + 2^j r)$ i.e. $2^{j(C^p)-4}r \leq r_0/2^{2.5} + 2^{j-3}r$. Therefore, if the annulus associated to C is not empty, then $2^{j+4}r \leq 2^{j+4}r|C| \leq 2^{j(C^p)-4}r \leq r_0/2^{2.5} + 2^{j-3}r$ so $2^{j-3}r \leq r_0/2^{8.5}$ and the outer radius is $2^{j(C^p)-4} < r_0/2^{2.5} + r_0/2^{8.5} \leq r_0/4$. So, if r_0 is sufficiently large (for instance if $r_0 \geq 8$) then the annulus is percolation disjoint from $[-r_0/2, r_0/2]^2$. If $r_0 < 8$, it is not difficult to see (with very similar arguments) that any annulus associated to a r_0 -cluster is empty.

For the other conditions that we have to check to prove that $\tilde{\mathcal{A}}_1(S)$ is a r_0 -decorated centered annulus structure compatible with S , we use similar arguments (see also Section 4 of [GPS10] where the authors explain some similar results).

Actually, since we have defined these sets of annuli for every S such that $|S_r^{r_0}| = k$, we have defined too many different r_0 -decorated centered annulus structures and that would make the sum in (5.7) much bigger than we would like (see Section 4 of [GPS10] for more about such a problem). So, we need a few other definitions. Consider four positive real numbers $+\infty > \theta > \theta^* > \theta^{r_0} > \theta' > 1$ that we will determine later. We define g', g^{r_0} and g^* like g but with θ', θ^{r_0} and θ^* instead of θ . We also define:

$$\begin{aligned}\gamma_{\rho_1}(\rho_2) &= \left(\frac{\rho_2}{\rho_1} \alpha_4(\rho_1, \rho_2) \right)^2, \\ \gamma_{\rho_1}^{r_0}(\rho_2) &= \left(\frac{\rho_2}{\rho_1} \right)^{1-\epsilon} \alpha_4(\rho_1, \rho_2)\end{aligned}$$

(where ϵ is the constant in (5.4), (5.5), and (5.6)),

$$\gamma^*(\rho_1, \rho_2) = \alpha_1(\rho_1, \rho_2)^2,$$

and $\bar{\gamma}_{\rho_1}(\rho_2) = \inf_{\rho' \in [1, \rho_2]} \gamma_{\rho_1}(\rho')$, and $\bar{\gamma}_{\rho_1}^{r_0}(\rho_2) = \inf_{\rho' \in [1, \rho_2]} \gamma_{\rho_1}^{r_0}(\rho')$. Note that:

$$\bar{\gamma}_{\rho_1}(\rho_2) \asymp \gamma_{\rho_1}(\rho_2), \tag{5.8}$$

and similarly for $\bar{\gamma}^{r_0}$. (The quantities $\bar{\gamma}$ and $\bar{\gamma}^{r_0}$ are defined in order to work with decreasing functions in ρ_2 , note that γ^* is already decreasing in ρ_2).

Now, if C is an interior, side or corner cluster then we say that C is **overcrowded** if we have $g'(|C|)\bar{\gamma}_r(2^{j(C)}r) > 1$. If C is a r_0 -cluster then we say that C is overcrowded if $g^{r_0}(|C|)\bar{\gamma}_r^{r_0}(2^{j(C)}r) > 1$. Finally, if C is centered then we say that C is overcrowded if $g^*(|C|)\gamma_{r_0}^*(2^{j(C)}r)\bar{\gamma}_r^{r_0}(2^{j(C)}r) > 1$. Note that all clusters at level 0 are overcrowded. We define a r_0 -decorated centered annulus structure $\tilde{\mathcal{A}}(S)$ by **removing from $\tilde{\mathcal{A}}_1(S)$ every annulus that corresponds to a proper descendent of an overcrowded cluster**. The r_0 -decorated centered annulus structure $\tilde{\mathcal{A}}(S)$ is still compatible with S and we can define:

$$\mathfrak{U}_k = \left\{ \tilde{\mathcal{A}}(S) : S \subseteq \mathcal{I}_R \text{ such that } |S_r^{r_0}| = k \right\}.$$

Note that from the definition of the r_0 -decorated centered annulus structures and from the construction above, we have the following: Let $S \subseteq \mathcal{I}_R$ be such that $|S_r^{r_0}| = k$. Let A_1, \dots, A_n be the annuli associated to the r_0 -clusters of S and that have not been removed from $\tilde{\mathcal{A}}_1(S)$. Also, let $\mathcal{A}(S) = \tilde{\mathcal{A}}(S) \setminus \{A_1, \dots, A_n\}$. Then:

$$h(\tilde{\mathcal{A}}(S))^2 = \prod_{j=1}^n h^{r_0}(A_j)^2 \prod_{A \in \mathcal{A}(S)} h(A)^2.$$

C. Summations on the annulus structures. This paragraph is analogous to the most technical parts of Section 4 of [GPS10]. The calculations are of the same flavour as in [GPS10], but they require to deal with new quantities: those related to the r_0 -clusters. In particular, we will have to deal with the exponent ϵ of (5.4) (and (5.5), (5.6)).

C.1. Some estimates proved inductively. The strategy is to prove some estimates inductively and then conclude thanks to these estimates. Remember that we want to prove (5.7). We need a few last notations. Remember that we have fixed r, R and k . Let $S \subseteq \mathcal{I}_R$ be such that $|S_r^{r_0}| = k$ and let C be a cluster of $S_r^{r_0} \cup \{0\}$ (of any level and any type). We write $\tilde{\mathcal{A}}'(C)$ for the subset of $\tilde{\mathcal{A}}(S)$ that corresponds to the proper descendants of C .

Take $k' \in \mathbb{N}_+$ and $j \in J$. Let B be a square such that there exists a set $S \subseteq \mathcal{I}_R$ with $|S_r^{r_0}| = k$ and an interior cluster C of $S_r^{r_0} \cup \{0\}$ such that: (a) the level of C is j , (b) $|C| = k'$ and (c) B is the inner square of the annulus associated to C . We also ask that the annulus A_C has not been removed from $\tilde{\mathcal{A}}_1(S)$ - i.e. we ask that C is not a proper descendant of an overcrowded cluster. We define:

$$\mathfrak{U}^{int}(B, k', j) = \left\{ \tilde{\mathcal{A}}'(C) : C \text{ as above} \right\}$$

(note that $\tilde{\mathcal{A}}'(C)$ does not depend on the choice of the set S such that C is a cluster of $S_r^{r_0} \cup \{0\}$) and:

$$H^{int}(j, k') = \sup_{B \text{ as above}} \sum_{\tilde{\mathcal{A}}' \in \mathfrak{U}^{int}(B, k', j)} 4^{|\tilde{\mathcal{A}}'|} h(\tilde{\mathcal{A}}')^2.$$

We do exactly the same thing for centered, side, corner and r_0 -clusters and define respectively $H^*(j, k')$, $H^+(j, k')$, $H^{++}(j, k')$ and $H^{r_0}(j, k')$ (if there is no such B , then the supremum is 0).

We want to show by induction on j that, if θ' , θ^{r_0}/θ' and θ^*/θ^{r_0} are sufficiently large, then the following inequalities hold for any $j \in J$ and $k' \in \mathbb{N}_+$:

$$\forall \text{ symbol } \mathfrak{h} \in \{int, +, ++\}, H^{\mathfrak{h}}(j, k') \leq g'(k')\bar{\gamma}_r(2^j r), \quad (5.9)$$

$$H^{r_0}(j, k') \leq (g^{r_0}(k')\bar{\gamma}_r^{r_0}(2^j r))^{1.01}, \quad (5.10)$$

$$H^*(j, k') \leq g^*(k')\gamma_{r_0}^*(2^j r)\bar{\gamma}_r^{r_0}(2^j r). \quad (5.11)$$

First, note that, due to the definition of overcrowded clusters, if $j \leq J'(k') := \max\{j \in \mathbb{N} : g'(k')\bar{\gamma}_r(2^j r) > 1\}$ then inequalities (5.9) are trivially true, if $j \leq J^{r_0}(k') := \max\{j \in \mathbb{N} : g^{r_0}(k')\bar{\gamma}_r^{r_0}(2^j r) > 1\}$ then inequality (5.10) is trivially true, and if $j \leq J^*(k') := \max\{j \in \mathbb{N} : g^*(k')\gamma_{r_0}^*(2^j r)\bar{\gamma}_r^{r_0}(2^j r) > 1\}$ then it is the case for (5.11).

Remark 5.10. Assume that inequalities (5.9), (5.10) and (5.11) hold. Then, they are still true if we raise the right-hand side to any power in $[0, 1]$ (distinguish between the two cases $j \leq J^{\natural}(k')$ and $j > J^{\natural}(k')$ for any symbol $\natural \in \{int, +, ++, r_0, *\}$). For instance, we will also use (5.10) with exponent 1 instead of 1.01.

Remark 5.11. Until the end of proof, we will often use the quasi-multiplicativity property and (2.1). We will also use that, for any j_0 and any $a > 0$:

$$\sum_{j' \geq j_0} \bar{\gamma}_r^{r_0} (2^{j'} r)^a \asymp \bar{\gamma}_r^{r_0} (2^{j_0} r)^a$$

(where the constant in \asymp may only depend on a). Of course, the analogous properties are also true for γ^* and $\bar{\gamma}$.

The estimates (5.9) are proved in Section 4 of [GPS10] (actually, in [GPS10] there is not the $4^{|\tilde{\mathcal{A}}|}$ term in the definition of the H 's but that does not change the calculations since, at each step of the induction, the factors 4 corresponding to the annuli we add are absorbed in the other $O(1)$ terms). Note that in these estimates neither r_0 -clusters nor centered clusters play a role since the descendants of interior, side and corner clusters cannot be neither centered nor r_0 -clusters. The idea of the proof of (5.10) is very similar. Let us prove this result. We proceed by induction on j . If $j = 0$ and $k' \in \mathbb{N}_+$ then we are done (and more generally if $j \leq J^{r_0}(k')$). We take some $j \in J$ and $k' \in \mathbb{N}_+$ such that $j > J^{r_0}(k')$, we assume that (5.10) is true for every (k'', j') with $k'' \in \mathbb{N}_+$ and $j' \in \{0, \dots, j-1\}$, and we want to prove it for (k', j) .

Consider some B as in the definition of $H^{r_0}(j, k')$ (if there is no such B then we are done since in this case $H^{r_0}(j, k') = 0$). The square B is the inner square of the annulus associated to some r_0 -cluster C at level j such that: (a) $|C| = k'$ and (b) **C is neither overcrowded nor the proper descendant of an overcrowded cluster**. Let C_1, \dots, C_d be the children of C , let A_{C_1}, \dots, A_{C_d} be the annuli associated to C_1, \dots, C_d (that have not been removed by the observation (b) above) and let B_1, \dots, B_d be the inner squares of these annuli. Note that either $d = 1$ and C_1 is an interior cluster or $d \geq 2$ and the C_i 's are either interior or r_0 -clusters. Moreover, if we know that C_i is an interior (respectively r_0 -) cluster at level j_i , then there are at most $O(1) (k' 2^j r / (2^{j_i} r))^2 = O(1) (k' 2^{j-j_i})^2$ (respectively $O(1) k' 2^j r / (2^{j_i} r) = O(1) k' 2^{j-j_i}$) possible choices for B_i . Furthermore, if k_i is the cardinal of C_i then the inner radius of A_{C_i} is $k_i 2^{j_i+4} r$ and its outer radius is $2^{j-4} r$. Hence, if C_i is an interior cluster, then $h(A_{C_i})^2 = \alpha_4 (k_i 2^{j_i+4} r, 2^{j-4} r)^2$. Moreover, (5.4) implies that if C_i is a r_0 -cluster, then we have $h^{r_0}(A_{C_i})^2 \leq O(1) \alpha_4 (k_i 2^{j_i+4} r, 2^{j-4} r) (2^{j-4} r / (k_i 2^{j_i+4} r))^{-\epsilon}$.

If we distinguish between the cases $d = 1$ and $d \geq 2$, we obtain that:

$$H^{r_0}(j, k') \leq O(1) \sum_{j_1 < j} (k' 2^{j-j_1})^2 \alpha_4 (k' 2^{j_1+4} r, 2^{j-4} r)^2 H^{int}(j_1, k') \quad (5.12)$$

$$+ \sum_{d=2}^{k'} \sum_{j_1, \dots, j_d < j} \sum_{\substack{k_1, \dots, k_d \in \mathbb{N}_+ \\ k_1 + \dots + k_d = k'}} \prod_{i=1}^d \left(O(1) (k' 2^{j-j_i})^2 \alpha_4 (k_i 2^{j_i+4} r, 2^{j-4} r)^2 H^{int}(j_i, k_i) \right) \quad (5.13)$$

$$+ O(1) k' 2^{j-j_i} \alpha_4 (k_i 2^{j_i+4} r, 2^{j-4} r) \left(\frac{2^{j-4} r}{k_i 2^{j_i+4} r} \right)^{-\epsilon} H^{r_0}(j_i, k_i) \Big). \quad (5.14)$$

By using (5.9) (with $\natural = int$), (5.8), the quasi-multiplicativity property, and (2.1), we obtain

that the first sum of the above inequality (i.e. the right-hand side of (5.12)) is at most:

$$\begin{aligned}
& O(1) k'^{O(1)} \sum_{j_1 \leq j} (2^{j-j_1} \alpha_4(2^{j_1} r, 2^j r))^2 g'(k') \bar{\gamma}_r(2^{j_1} r) \\
& \leq O(1) k'^{O(1)} \sum_{j_1 \leq j} \frac{\bar{\gamma}_r(2^j r)}{\bar{\gamma}_r(2^{j_1} r)} g'(k') \bar{\gamma}_r(2^{j_1} r) \\
& \leq O(1) k'^{O(1)} g'(k') j \bar{\gamma}_r(2^j r). \tag{5.15}
\end{aligned}$$

Let $c > 0$ be the constant of (5.6). In terms of $\bar{\gamma}$ and $\bar{\gamma}^{r_0}$, (5.6) can be stated as follows:

$$\bar{\gamma}_r(2^j r) \leq O(1) \bar{\gamma}_r^{r_0}(2^j r)^{1.01} 2^{-cj}.$$

Hence, (5.15) is at most:

$$O(1) k'^{O(1)} g'(k') \bar{\gamma}_r^{r_0}(2^j r)^{1.01} j 2^{-cj} \leq O(1) k'^{O(1)} g'(k') \bar{\gamma}_r^{r_0}(2^j r)^{1.01},$$

which is smaller than or equal to:

$$1/2 (g^{r_0}(k') \bar{\gamma}_r^{r_0}(2^j r))^{1.01},$$

if θ^{r_0}/θ' is sufficiently large.

Let us now concentrate on the second sum (i.e. the quantity of lines (5.13) and (5.14)). As above, we have:

$$(k' 2^{j-j_i})^2 \alpha_4(k_i 2^{j_i+4} r, 2^{j-4} r)^2 H^{int}(j_i, k_i) \leq O(1) k'^{O(1)} g'(k_i) \bar{\gamma}_r(2^j r). \tag{5.16}$$

If we use our induction hypothesis on the $H^{r_0}(j_i, k_i)$'s (with an exponent 1 instead of 1.01, see Remark 5.10), we obtain that:

$$k' 2^{j-j_i} \alpha_4(k_i 2^{j_i+4} r, 2^{j-4} r) \left(\frac{2^{j-4} r}{k_i 2^{j_i+4} r} \right)^{-\epsilon} H^{r_0}(j_i, k_i) \leq O(1) k'^{O(1)} g^{r_0}(k_i) \bar{\gamma}_r^{r_0}(2^j r). \tag{5.17}$$

The inequality (5.5) (which implies that $\bar{\gamma}_r(2^j r) \leq O(1) \bar{\gamma}_r^{r_0}(2^j r)$) and the fact that $\theta^{r_0} > \theta'$ imply that the right-hand side of (5.17) is at least $O(1) k'^{O(1)}$ times the right-hand side of (5.16). In other words, our estimate on the terms that come from the r_0 -clusters dominate our estimates on the terms that come from the interior clusters. We obtain that the second sum is at most:

$$\begin{aligned}
& \sum_{d=2}^{k'} \sum_{j_1, \dots, j_d \leq j} \sum_{\substack{k_1, \dots, k_d \in \mathbb{N}_+ \\ k_1 + \dots + k_d = k'}} \prod_{i=1}^d \left(O(1) k'^{O(1)} g^{r_0}(k_i) \bar{\gamma}_r^{r_0}(2^j r) \right) \\
& \leq \sum_{d=2}^{k'} \left(O(1) k'^{O(1)} j \bar{\gamma}_r^{r_0}(2^j r) \right)^d \sum_{\substack{k_1, \dots, k_d \in \mathbb{N}_+ \\ k_1 + \dots + k_d = k'}} \prod_{i=1}^d g^{r_0}(k_i).
\end{aligned}$$

Since \log_2^2 is concave and increasing, the above is at most:

$$\sum_{d=2}^{k'} \left(O(1) k'^{O(1)} j \bar{\gamma}_r^{r_0}(2^j r) \right)^d k'^d g^{r_0}(k'/d)^d \leq \sum_{d=2}^{k'} \left(O(1) k'^{O(1)} j g^{r_0}(k'/2) \bar{\gamma}_r^{r_0}(2^j r) \right)^d.$$

We can show that, if θ^{r_0} is sufficiently large, then the hypothesis $j > J^{r_0}(k)$ implies that:

$$O(1) k'^{O(1)} j g^{r_0}(k'/2) \bar{\gamma}_r^{r_0}(2^j r) \leq 1/2 (g^{r_0}(k') \bar{\gamma}_r^{r_0}(2^j r))^{0.505} (\leq 1/2). \tag{5.18}$$

(This is the exact analogue of Lemma 4.4 of [GPS10] - with $\epsilon = 0.495$ - and we refer to this paper for more details.) So, the second sum is smaller than or equal to:

$$\begin{aligned} \frac{\left(1/2 (g^{r_0}(k') \bar{\gamma}_r^{r_0}(2^j r))^{0.505}\right)^2}{1 - 1/2 (g^{r_0}(k') \bar{\gamma}_r^{r_0}(2^j r))^{0.505}} &\leq \frac{(1/2)^2}{1 - 1/2} (g^{r_0}(k') \bar{\gamma}_r^{r_0}(2^j r))^{2 \times 0.505} \\ &= 1/2 (g^{r_0}(k') \bar{\gamma}_r^{r_0}(2^j r))^{1.01}. \end{aligned}$$

Finally:

$$H^{r_0}(j, k') \leq 2 \times 1/2 (g^{r_0}(k') \bar{\gamma}_r^{r_0}(2^j r))^{1.01} = (g^{r_0}(k') \bar{\gamma}_r^{r_0}(2^j r))^{1.01}.$$

Now, let us prove (5.11). Let $j \in J$ and $k' \in \mathbb{N}_+$. First note that we can take $h \in (0, 1/4)$ such that, for all $1 \leq \rho_1 \leq \rho_2$:

$$\bar{\gamma}_{\rho_1}^{r_0}(\rho_2)^{1-2h} \leq \frac{1}{h} \gamma_{\rho_1}^*(\rho_2)^h.$$

Consider some B as in the definition of $H^*(j, k')$. The square B is the inner square of the annulus associated to some centered cluster C at level j with $|C| = k'$. If $j = 0$ and $k' \in \mathbb{N}_+$ then we are done (and more generally if $j \leq J^*(k')$). We assume that $j > J^*(k')$ and we prove the result by induction on j . Let C_1, \dots, C_d be the children of C . Note that $d \geq 2$ and that exactly one of the C_i 's is centered, say that it is C_1 .

Remember Remark 5.10: the induction hypothesis implies that the following is true for any $k'' \in \mathbb{N}_+$ and $j' \in \{0, \dots, j-1\}$:

$$\begin{aligned} H^*(j', k'') &\leq \left(g^*(k'') \gamma_{r_0}^*(2^{j'} r) \bar{\gamma}_r^{r_0}(2^{j'} r)\right)^{1-h} \\ &= g^*(k'')^{1-h} \gamma_{r_0}^*(2^{j'} r)^{1-h} \bar{\gamma}_r^{r_0}(2^{j'} r)^{1-2h} \bar{\gamma}_r^{r_0}(2^{j'} r)^h \\ &\leq g^*(k'')^{1-h} \frac{1}{h} \gamma_{r_0}^*(2^{j'} r) \bar{\gamma}_r^{r_0}(2^{j'} r)^h. \end{aligned} \tag{5.19}$$

(In the last line we have used that $r \leq r_0$.) Note that, for any $i \geq 2$, C_i is either an interior cluster or a r_0 -cluster. As above, thanks to (5.5), our estimates on the r_0 -clusters dominate our estimates on the interior clusters. Let us also recall that the way to associate an annulus to the singleton $\{\{0\}\}$ is different from the other clusters, that is why " $\vee(r_0 + 2)$ " appears in the estimate below. We have:

$$\begin{aligned} H^*(j, k') &\leq \sum_{d=2}^{k'} \sum_{j_1, \dots, j_d < j} \sum_{\substack{k_1, \dots, k_d \in \mathbb{N}_+ \\ k_1 + \dots + k_d = k'}} O(1) \alpha_1 \left((k_1 2^{j_1+4} r) \vee (r_0 + 2), 2^{j-4} r \right)^2 H^*(j_1, k_1) \\ &\times \prod_{i=2}^d \left(O(1) k' 2^{j-j_i} \alpha_4(k_i 2^{j_i+4} r, 2^{j-4} r) \left(\frac{2^{j-4} r}{k_i 2^{j_i+4} r} \right)^{-\epsilon} (g^{r_0}(k_i) \bar{\gamma}_r^{r_0}(2^{j_i} r))^{1.01} \right) \end{aligned}$$

(the second line of the expression above comes from the fact that the estimates on the r_0 -clusters dominate our estimates on the interior clusters; the term $(g^{r_0}(k_i) \bar{\gamma}_r^{r_0}(2^{j_i} r))^{1.01}$ comes from (5.10)). We continue the calculation: by using (5.19) to deal with $H^*(j_1, k_1)$ (and also by using that $\alpha_1 \left((k_1 2^{j_1+4} r) \vee (r_0 + 2), 2^{j-4} r \right)^2 \gamma_{r_0}^*(2^{j_1} r) \leq O(1) k_1^{O(1)} \gamma_{r_0}^*(2^{j_1} r)$), we find that the

above is at most:

$$\begin{aligned}
& \sum_{d=2}^{k'} \sum_{j_1, \dots, j_d < j} \sum_{\substack{k_1, \dots, k_d \in \mathbb{N}_+ \\ k_1 + \dots + k_d = k'}} O(1) k_1^{O(1)} g^*(k_1)^{1-h} \frac{1}{h} \gamma_{r_0}^*(2^j r) \bar{\gamma}_r^{r_0}(2^{j_1} r)^h \\
& \times \prod_{i=2}^d \left(O(1) k_i^{O(1)} g^{r_0}(k_i)^{1.01} \bar{\gamma}_r^{r_0}(2^j r) \bar{\gamma}_r^{r_0}(2^{j_i} r)^{0.01} \right) \\
& \leq \gamma_{r_0}^*(2^j r) g^*(k')^{1-h} \sum_{d=2}^{k'} \left(\sum_{j_1 \in \mathbb{N}} \bar{\gamma}_r^{r_0}(2^{j_1} r)^h \right) \\
& \times \sum_{\substack{k_1, \dots, k_d \in \mathbb{N}_+ \\ k_1 + \dots + k_d = k'}} \prod_{i=2}^d \left(O(1) k_i^{O(1)} g^{r_0}(k_i)^{1.01} \bar{\gamma}_r^{r_0}(2^j r) \sum_{j' \in \mathbb{N}} \bar{\gamma}_r^{r_0}(2^{j'} r)^{0.01} \right) \\
& \leq \gamma_{r_0}^*(2^j r) g^*(k')^{1-h} \sum_{d=2}^{k'} \left(O(1) k_i^{O(1)} g^{r_0}(k')^{1.01} \bar{\gamma}_r^{r_0}(2^j r) \right)^{d-1}
\end{aligned}$$

(since $\sum_{j_1 \in \mathbb{N}} \bar{\gamma}_r^{r_0}(2^{j_1} r)^h \leq O(1)$ and $\sum_{j' \in \mathbb{N}} \bar{\gamma}_r^{r_0}(2^{j'} r)^{0.01} \leq O(1)$). Next, note that, if θ^*/θ^{r_0} is sufficiently large, then the hypothesis $j > J^*(k')$ implies that:

$$O(1) k'^{O(1)} g^{r_0}(k')^{1.01} \bar{\gamma}_r^{r_0}(2^j r) \leq 1/2$$

(indeed, there exists $a > 0$ such that, if $j > J^*(k')$, then $\frac{1}{a} g^*(k') 2^{-aj} = \frac{1}{a} g^{r_0}(k')^{\theta^*/\theta^{r_0}} 2^{-aj}$ is smaller than or equal to 1). As a result, if θ^*/θ^{r_0} is sufficiently large, then:

$$H^*(j, k') \leq \gamma_{r_0}^*(2^j r) g^*(k')^{1-h} O(1) k'^{O(1)} g^{r_0}(k')^{1.01} \bar{\gamma}_r^{r_0}(2^j r).$$

Now, note that, again if θ^*/θ^{r_0} is sufficiently large, we have:

$$O(1) k'^{O(1)} g^{r_0}(k')^{1.01} \leq g^*(k')^h,$$

hence:

$$H^*(j, k') \leq \gamma_{r_0}^*(2^j r) g^*(k') \bar{\gamma}_r^{r_0}(2^j r),$$

which is what we want.

C.2. End of the proof. All that remains to prove is that (5.9), (5.10) and (5.11) imply Proposition 5.3. Remember that it is sufficient to prove (5.7). Remember also the definition of \bar{j} . By using the quasi-multiplicativity property and (2.1), we obtain that it is sufficient to prove that there exists an absolute constant $\theta < +\infty$ such that, if:

$$g(k) \sqrt{\gamma_{r_0}^*(2^{\bar{j}} r) \bar{\gamma}_r^{r_0}(r_0)} \leq 1, \quad (5.20)$$

then:

$$\sum_{\tilde{\mathcal{A}} \in \mathfrak{A}_k} 4^{|\tilde{\mathcal{A}}|} h(\tilde{\mathcal{A}})^2 \leq g(k) \gamma_{r_0}^*(2^{\bar{j}} r) \bar{\gamma}_r^{r_0}(r_0). \quad (5.21)$$

Assume that (5.20) holds, let S be some set such that $|S^{r_0}| = k$, and let C be the top cluster of S . Also, let C_1, \dots, C_d be the children of C . Note that exactly one of the C_i 's is centered, say that it is C_1 . The other C_i 's can be of any other type (and d may equal 1). As above (and thanks to (2.6)), our estimates on the r_0 -clusters will dominate the estimates on the interior, side and corner clusters. Note also that, if $d = 1$, then C_1 contains $\{0\}$ and also at least one

$r \times r$ square not included in $(-r_0, r_0)^2$, so $\log_2(r_0/(2r)) \leq j(C_1)$. We have (the terms $k+1$ and k_1+1 come only from the fact that $|C| = |S_r^{r_0} \cup \{0\}| = k+1$):

$$\begin{aligned} & \sum_{\tilde{A} \in \mathcal{U}_k} 4^{|\tilde{A}|} h(\tilde{A})^2 \leq \sum_{\log_2(r_0/(2r)) \leq j_1 \leq \bar{j}} \left(\alpha_1((k+1)2^{j_1+4}r, 2^{\bar{j}+1-4}r)^2 H^*(j_1, k+1) \right) \\ & + \sum_{d=2}^k \sum_{\substack{k_1, \dots, k_d: \\ k_1 + \dots + k_d = k}} \sum_{j_1, \dots, j_d \leq \bar{j}} \left(\alpha_1 \left(((k_1+1)2^{j_1+4}r) \vee (r_0+2), 2^{\bar{j}+1-4}r \right)^2 H^*(j_1, k_1+1) \right. \\ & \left. \times \prod_{i=2}^d \left(O(1) k^{O(1)} \frac{R}{2^{j_i} r} \alpha_4(k_i 2^{j_i+4}r, 2^{\bar{j}+1-4}r) \left(\frac{2^{\bar{j}+1-4}}{k_i 2^{j_i+4}} \right)^{-\epsilon} (g^{r_0}(k_i) \bar{\gamma}_r^{r_0}(2^{j_i}r))^{1.01} \right) \right). \end{aligned}$$

We now use (5.9), (5.10) and (5.11) to conclude. The first sum above is smaller than or equal to:

$$\begin{aligned} & \sum_{\log_2(r_0/(2r)) \leq j_1 \leq \bar{j}} O(1) k^{O(1)} \gamma_{r_0}^*(2^{\bar{j}}r) g^*(k) \bar{\gamma}_r^{r_0}(2^{j_1}r) \\ & \leq O(1) k^{O(1)} g^*(k) \gamma_{r_0}^*(2^{\bar{j}}r) \sum_{\log_2(r_0/(2r)) \leq j_1} \bar{\gamma}_r^{r_0}(2^{j_1}r) \\ & \leq O(1) k^{O(1)} g^*(k) \gamma_{r_0}^*(2^{\bar{j}}r) \bar{\gamma}_r^{r_0}(r_0) \\ & \leq 1/2 g(k) \gamma_{r_0}^*(2^{\bar{j}}r) \bar{\gamma}_r^{r_0}(r_0), \end{aligned}$$

if θ/θ^* is sufficiently large. Let us now estimate the second sum. This sum is smaller than or equal to:

$$\begin{aligned} & \sum_{d=2}^k \sum_{\substack{k_1, \dots, k_d: \\ k_1 + \dots + k_d = k}} \sum_{j_1, \dots, j_d \leq \bar{j}} O(1) k^{O(1)} \gamma_{r_0}^*(2^{\bar{j}}r) g^*(k) \bar{\gamma}_r^{r_0}(2^{j_1}r) \\ & \times \left(\prod_{i=2}^d O(1) k^{O(1)} g^{r_0}(k_i)^{1.01} \bar{\gamma}_r^{r_0}(2^{\bar{j}}r) \bar{\gamma}_r^{r_0}(2^{j_i}r)^{0.01} \right) \\ & \leq g^*(k) \gamma_{r_0}^*(2^{\bar{j}}r) \sum_{d=2}^k \left(O(1) k^{O(1)} \left(\sum_{j' \in \mathbb{N}} \bar{\gamma}_r^{r_0}(2^{j'}r)^{0.01} \right) g^{r_0}(k)^{1.01} \bar{\gamma}_r^{r_0}(2^{\bar{j}}r) \right)^{d-1} \\ & \leq g^*(k) \gamma_{r_0}^*(2^{\bar{j}}r) \sum_{d=2}^k \left(O(1) k^{O(1)} g^{r_0}(k)^{1.01} \bar{\gamma}_r^{r_0}(2^{\bar{j}}r) \right)^{d-1}. \end{aligned}$$

Note that, if θ/θ^{r_0} is sufficiently large, then (5.20) and the fact that $r_0 \leq R/2 \leq O(1) k^{O(1)} 2^{\bar{j}}r$ imply that:

$$O(1) k^{O(1)} g^{r_0}(k)^{1.01} \bar{\gamma}_r^{r_0}(2^{\bar{j}}r) \leq 1/2,$$

hence the second sum is at most:

$$g^*(k) \gamma_{r_0}^*(2^{\bar{j}}r) O(1) k^{O(1)} g^{r_0}(k)^{1.01} \bar{\gamma}_r^{r_0}(2^{\bar{j}}r).$$

By using once again that $r_0 \leq O(1) k^{O(1)} 2^{\bar{j}}r$, we obtain that the above is at most:

$$g^*(k) \gamma_{r_0}^*(2^{\bar{j}}r) O(1) k^{O(1)} g^{r_0}(k)^{1.01} \bar{\gamma}_r^{r_0}(r_0).$$

Next, note that, if θ/θ^{r_0} and θ/θ^* are sufficiently large, then:

$$g^*(k) O(1) k^{O(1)} g^{r_0}(k)^{1.01} \leq 1/2 g(k),$$

and the second sum is at most:

$$1/2 g(k) \gamma_{r_0}^* (2^{\bar{j}} r) \bar{\gamma}_r^{r_0}(r_0).$$

Finally:

$$\sum_{\tilde{\mathcal{A}} \in \mathcal{U}_k} 4^{|\tilde{\mathcal{A}}|} h(\tilde{\mathcal{A}})^2 \leq 2 \times 1/2 g(k) \gamma_{r_0}^* (2^{\bar{j}} r) \bar{\gamma}_r^{r_0}(r_0) = g(k) \gamma_{r_0}^* (2^{\bar{j}} r) \bar{\gamma}_r^{r_0}(r_0).$$

This ends the proof of (5.21) and therefore of Proposition 5.3. \square

5.2.2 The proof of Theorem 2.8

We now combine Propositions 5.1, 5.2 and 5.3 in order to prove Theorem 2.8.

Proof of Theorem 2.8. The proof is very similar to the proof of Theorem 7.3 of [GPS10] (which is Theorem 2.5 of the present chapter). Consequently, we will omit some details. The main difference is that we have to use Proposition 5.3 instead of the estimate (5.1).

Note that we can assume that $r \geq \bar{r}$ for some absolute constant \bar{r} (if $r < \bar{r}$ then Theorem 2.8 is a direct consequence of Proposition 5.3 applied itself with $r = 1$ since $|\mathcal{S}_1^{r_0}| \asymp |\mathcal{S} \setminus (-r_0, r_0)^2|$). Let $(B_i)_i$ be a tiling of the annulus $[-(R+2), R+2]^2 \setminus (-r_0, r_0)^2$ by $l_i \times l'_i$ rectangles with $r \leq l_i, l'_i \leq 2r$ for every i (for instance, we can tile with $r \times r$ squares except near $\partial[-(R+2), (R+2)]^2$ where we use rectangles so that we perfectly tile the annulus). Also, let $\mathcal{S} = \mathcal{S}_{f_R}$ be a spectral sample of f_R and $\mathcal{Z} = \mathcal{Z}_r$ be a random subset of $\{i \in \mathcal{I}_R : i \notin (-r_0, r_0)^2\}$ that is independent of \mathcal{S}_{f_R} , where each element of $\{i \in \mathcal{I}_R : i \notin (-r_0, r_0)^2\}$ is in \mathcal{Z} with probability $\frac{1}{r^2 \alpha_4(r)}$ independently of the others.

It is sufficient to prove that (for some $\epsilon > 0$ and $C < +\infty$):

$$\mathbb{P}[\mathcal{S} \cap \mathcal{Z} = \emptyset \neq \mathcal{S} \setminus (-r_0, r_0)^2] \leq C \frac{\alpha_1(R)}{\alpha_1(r_0)} \left(\frac{r_0}{r}\right)^{1-\epsilon} \alpha_4(r, r_0).$$

We first assume that $r < r_0/4$. Let x_i be the indicator function of $\{\mathcal{S} \cap B_i \neq \emptyset\}$ and y_i the indicator function of $\{\mathcal{S} \cap B_i \cap \mathcal{Z} \neq \emptyset\}$. Let X and Y be as in Proposition 5.2. The hypothesis of Proposition 5.2 is given by Proposition 5.1. We will also use that $\frac{1}{C_1} |\mathcal{S}_r^{r_0}| \leq X \leq C_1 |\mathcal{S}_r^{r_0}|$ for some absolute constant $C_1 \in (0, +\infty)$. By using Proposition 5.2, we obtain:

$$\begin{aligned} \mathbb{P}[\mathcal{S} \cap \mathcal{Z} = \emptyset \neq \mathcal{S} \setminus (-r_0, r_0)^2] &= \mathbb{P}[Y = 0 < X] \\ &\leq \frac{1}{a} \mathbb{E}[\exp(-aX/e) \mathbb{1}_{X>0}] \\ &\leq \frac{1}{a} \mathbb{E}\left[\exp(-a|\mathcal{S}_r^{r_0}|/(C_1 e)) \mathbb{1}_{\mathcal{S}_r^{r_0} \neq \emptyset}\right]. \end{aligned}$$

Then, Proposition 5.3 implies that:

$$\begin{aligned} \mathbb{P}[\mathcal{S} \cap \mathcal{Z} = \emptyset \neq \mathcal{S} \setminus (-r_0, r_0)^2] &\leq \frac{1}{a} \sum_{k \in \mathbb{N}_+} \exp(-ak/(C_1 e)) g(k) \frac{\alpha_1(R)}{\alpha_1(r_0)} \left(\frac{r_0}{r}\right)^{1-\epsilon} \alpha_4(r, r_0) \\ &= C_2 \frac{\alpha_1(R)}{\alpha_1(r_0)} \left(\frac{r_0}{r}\right)^{1-\epsilon} \alpha_4(r, r_0), \end{aligned}$$

for some constant $C_2 < +\infty$ since g is sub-exponential.

We now assume that $r \geq r_0/4$. We keep the notations X and Y . The problem is that we cannot use Proposition 5.1 for the rectangles B_i that intersect $[-4r, 4r]^2$. However, the number of such

rectangles is at most 100. We write $J = \{i : B_i \text{ does not intersect } [-4r, 4r]^2\}$, $\tilde{X} = \sum_{i \notin J} x_i$ and $\tilde{Y} = \sum_{i \notin J} y_i$. We have:

$$\begin{aligned} \mathbb{P}[\mathcal{S} \cap \mathcal{Z} = \emptyset \neq \mathcal{S} \setminus (-r_0, r_0)^2] &= \mathbb{P}[Y = 0 < X] \\ &\leq \mathbb{P}[0 < X \leq 100] + \mathbb{P}[\tilde{Y} = 0 < \tilde{X}]. \end{aligned}$$

By using Proposition 5.2 for \tilde{X} and \tilde{Y} , we obtain that the above is at most:

$$\begin{aligned} \mathbb{P}[0 < X \leq 100] + \frac{1}{a} \mathbb{E} \left[\exp(-a\tilde{X}/e) \mathbf{1}_{\tilde{X} > 0} \right] \\ \leq \mathbb{P}[0 < X \leq 100] + \frac{1}{a} \mathbb{E} \left[\exp(-a(X - 100)/e) \mathbf{1}_{X > 0} \right]. \end{aligned}$$

We now conclude as in the case $r < r_0/4$, i.e. by using the fact that $X \asymp |S_r^{r_0}|$ and Proposition 5.3. \square

Remark 5.12. In this remark, we try to be more quantitative about the ϵ of Theorem 2.8 in the case of site percolation on \mathbb{T} , by using the computation of the arm-exponent (see Subsection 2.1): As pointed out in Remark 5.9, we can replace all the exponents 1.01 that appear in the proof of Proposition 5.3 by $1 + a$ for any $a \in (0, 1)$. Now, remember that the conditions about ϵ were that (5.5) and (5.6) are satisfied and that:

$$\mathbb{E}_{1/2} \left[\mathbb{P}_{1/2} \left[\mathbf{A}_4(r_1, r_2) \mid \mathcal{F}_{\mathbb{H}} \right]^2 \right] \leq O(1) \alpha_4(r_1, r_2) \left(\frac{r_2}{r_1} \right)^{-\epsilon},$$

where $\mathbf{A}_4(r_1, r_2)$ is the 4-arm event in the annulus $[-r_2, r_2] \setminus (-r_1, r_1)^2$ and \mathbb{H} is the (lower, upper, left or right) half-plane. In the case of site percolation on \mathbb{T} , this last condition holds for any $\epsilon < -5/4 + \zeta_4^{|\mathbb{H}|}$ (see Proposition C.2). Finally, by combining this with (5.5) and (5.6), we obtain that Proposition 5.3 is true for any $\epsilon < (-5/4 + \zeta_4^{|\mathbb{H}|}) \wedge 1/4$. Consequently, this is also the case for Theorem 2.8.

Remark 5.13. The fact that we had to deal with $|S_r^{r_0}|$ instead of $|S_r|$ in Proposition 5.3 is a **new difficulty** compared to the proof of (5.1) in Section 4 of [GPS10], and that is the reason why we had to introduce the r_0 -decorated centered annulus structures and deal with the “4-arm event conditioned on the configuration in a half-plane”. Now, imagine that we want to deal with Conjecture 6.1 (stated below) instead of Theorem 2.8. Then, we would have to consider the whole spectral sample so we would not need the notion of r_0 -decorated centered annulus structures any more, but only the notion of centered annulus structures of [GPS10]. Let us be more precise: If we follow [GPS10] (Subsection 4.4) with another choice for the definition of overcrowded centered clusters (a centered cluster would be overcrowded if $\gamma_r^*(2^{j(C)}r)g^*(|C|)\bar{\gamma}_r(2^{j(C)}r) > 1$) then we would obtain the following:

For every $S \subseteq \mathcal{I}_R$, let S_r be the set of the $r \times r$ squares of the grid $r\mathbb{Z}^2$ which intersect S . There exists some $\theta < +\infty$ such that, for all $k \in \mathbb{N}_+$ and for all $1 \leq r \leq r_0 \leq R/2$:

$$\hat{\mathbb{P}}_{f_R} [|S_r| = k, S \not\subseteq (-r_0, r_0)^2] \leq g(k) \frac{\alpha_1(R)}{\alpha_1(r)} \left(\frac{r_0}{r} \alpha_4(r, r_0) \right)^2,$$

where $g(k) = 2^{\theta \log_2^2(k+2)}$.

With this result, it seems that we can prove Conjecture 6.1 exactly as we have proved Theorem 2.8 i.e. by using Propositions 5.1 and 5.2. Here, x_i would be the indicator functions of the event $\{\mathcal{S}_{f_R} \cap B_i \neq \emptyset, S \not\subseteq (-r_0, r_0)^2\}$, and y_i would be the indicator function of the event $\{\mathcal{S}_{f_R} \cap B_i \cap \mathcal{Z} \neq \emptyset, S \not\subseteq (-r_0, r_0)^2\}$. However, this strategy does not work since the event

$\{S \not\subseteq (-r_0, r_0)^2\}$ represents some **positive information** when we visit the rectangles B_i that are included in $(-r_0, r_0)^2$. Therefore, Proposition 5.1 can no longer guarantee that the hypothesis of Proposition 5.2 is true. So, in order to prove Conjecture 6.1, we would need an analogue of Proposition 5.1 where in the conditioning we can add the event $\{S \not\subseteq (-r_0, r_0)^2\}$. Techniques from [GPS10] are not suitable for such a conditioning, which explains why we cannot prove at the moment the better upper-bound given by Conjecture 6.1.

6 Open questions

Here is a list of a few open problems.

1. **Asymmetric exclusion dynamics.** Our hypothesis that the underlying exclusion dynamics is symmetric (i.e. K is symmetric) is crucial in our proofs. Indeed the duality formula (2.11) is no longer valid in the asymmetric setting. A natural question is thus to ask whether the results of the present chapter still hold by relaxing the symmetry condition.
2. **Handling more local dynamics.** Our techniques brake when α becomes too large (the best value of α can be found in equation (4.15)). The most extreme (and most interesting) case would be the nearest-neighbour simple exclusion process. We are very far at this point of being able to prove the existence of exceptional times in this case.
3. **Sharp clustering effect for the radial spectral sample.** In the proof of Corollary 2.9 (which is our key estimate in Theorem 1.5), we used the crude upper-bound:

$$\widehat{\mathbb{P}}_{f_R} [|S| < r^2 \alpha_4(r), S \not\subseteq (-r_0, r_0)^2] \leq \widehat{\mathbb{P}}_{f_R} [0 < |S \setminus (-r_0, r_0)^2| < r^2 \alpha_4(r)].$$

We believe we have lost a lot in this inequality and we make the following conjecture (see Remark 5.13):

Conjecture 6.1. *There exists a constant $C < +\infty$ such that, for all $1 \leq r \leq r_0$ and all $R \geq 1$:*

$$\widehat{\mathbb{P}}_{f_R} [|S| < r^2 \alpha_4(r), S \not\subseteq (-r_0, r_0)^2] \leq C \frac{\alpha_1(R)}{\alpha_1(r)} \left(\frac{r_0}{r} \alpha_4(r, r_0) \right)^2.$$

Note that if we had proved this conjecture then we would have obtained a bigger α_0 in Theorem 1.5.

4. **Clustering effect for left-right crossing events.** One of the main side technical contributions of this chapter is our clustering result Theorem 2.8. Even though it does not give a sharp estimate on $\widehat{\mathbb{P}}_{f_R} [|S| < r^2 \alpha_4(r), S \not\subseteq (-r_0, r_0)^2]$ as discussed in the item above, it provides the first polynomial clustering estimate on the spectral sample of the one-arm event f_R . Indeed, such a *clustering effect* had already been analysed in [GPS10], but it only gave rather weak (logarithmic) bounds. See Remark 4.5 in [GPS10]. Now, if g_n is the indicator function of the left-right crossing of $[-n, n]^2$, a similar polynomial clustering effect should hold as $n \rightarrow +\infty$. More precisely, the following analogue of Conjecture 6.1 for the functions g_n should hold:

Conjecture 6.2. *There exists a constant $C < +\infty$ such that, for all $1 \leq r \leq r_0$ and all $n \geq 1$:*

$$\widehat{\mathbb{P}}_{g_n} [|S| < r^2 \alpha_4(r), \text{diam}(S) \geq r_0] \leq C \left(\frac{n}{r} \alpha_4(r, n) \right)^2 \left(\frac{r_0}{r} \alpha_4(r, r_0) \right)^2.$$

Somewhat surprisingly, it turns out to be easier for such clustering effects to deal with degenerate Boolean functions such as f_R rather than left-right crossing events g_n . This is due to the fact that we know in the case of $\widehat{\mathbb{P}}_{f_R}$ that the spectral sample will most likely localize in a ball centered at the origin. The additional flexibility corresponding to where in $[-n, n]^2$ the spectral sample of g_n will choose to localize adds new difficulties.

A Graphical construction (à la Harris) of exclusion dynamics

In this appendix, we give a proper graphical construction of the exclusion dynamics we need. This is in the spirit of the graphical constructions of particle systems initiated by Harris, see for example [Har78]. The content of this appendix is very basic and will probably be considered “folklore” by specialists. Yet, as we could not localize a reference, we include it here.

Let us then define properly the K -exclusion process, for instance for dynamics on the edges of a graph $G = (V, E)$. First, we sample a percolation configuration $\omega_K(0)$ according to some initial law. Next, to each pair $\{e, f\}$ of edges, we associate an exponential clock of parameter $K(e, f) = K(f, e)$ (independent of the others and $\omega_K(0)$). We define the càdlàg process $(\omega_K(t))_{t \geq 0}$ on the space $\Omega := \{-1, 1\}^E$ (seen as the compact metric product space) as follows:

1. First, we want to define a (random) dynamical permutation of E . Take $e \in E$. Let $\tau_1(e)$ be the first time a clock associated to e (i.e. the clock associated to $\{e, f\}$ for some edge f) has rung and let e_1 be the other edge associated to this clock. Define recursively $\tau_{n+1}(e)$ to be the first time larger than $\tau_n(e)$ such that a clock associated to e_n has rung and let e_{n+1} be the other edge associated to this clock. Now, for each $t \geq 0$, let $n_t(e) = \sup \{n : \tau_n(e) \leq t\}$ (with $\sup \emptyset = 0$) and let π_t be the (random) permutation of E defined by:

$$\pi_t(e) = e_{n_t(e)} \tag{A.1}$$

(with $e_0 := e$).

Note that a.s., for all t and e , $\pi_t(e)$ is well defined since a.s. for all t and all e :

- (a) there exists at most one edge e' such that the clock associated to $\{e, e'\}$ has rung at time t ,
- (b) $n_t(e)$ is finite.

Let us prove that a.s. π_t is indeed a permutation:

2. To this purpose, we define a function that will turn out to be the reciprocal function of π_t . To do so, we follow the same steps as for the definition of π_t but we start from time t and look back in time. More precisely, if e is some edge, we denote by $\widehat{\tau}_1(e)$ the largest time less than or equal to t such that a clock associated to e has rung. If such a time does not exist, we write $\widehat{\tau}_1(e) = -\infty$. Otherwise, we write \widehat{e}_1 for the other edge associated to this clock. Then, recursively, if $\widehat{\tau}_n(e) \neq -\infty$, we write $\widehat{\tau}_{n+1}(e)$ for the largest time less than $\widehat{\tau}_n(e)$ such that a clock associated to \widehat{e}_n has rung. If such a time does not exist, we write $\widehat{\tau}_{n+1}(e) = -\infty$. Otherwise, we write \widehat{e}_{n+1} for the other edge associated to the clock. Let $\widehat{n}_t(e)$ be the first $k \in \mathbb{N}_+$ such that $\widehat{\tau}_k(e) = -\infty$. It is not difficult to show that a.s. for all t the function $e \mapsto \widehat{e}_{\widehat{n}_t(e)-1}$ (with $\widehat{e}_0 := e$) is well defined and is the reciprocal function of π_t .
3. Now, we can define $\omega_K(t)$ stating that the state of the edge $\pi_t(e)$ at time t is the state of the edge e at time 0. In other words, the configuration at time t is:

$$\omega_K(t) : e \longmapsto \omega(0)_{\pi_t^{-1}(e)}.$$

Using item 2 above (that defines explicitly $\pi_t^{-1}(e)$), it is not difficult to show that we have obtained a càdlàg Markov process and that the probability measures \mathbb{P}_p are invariant measures for this process.

B The proof of Lemma 5.7

In this appendix, we prove Lemma 5.7. First, we prove by induction on $n \geq 1$ that:

$$\begin{aligned} & \widehat{\mathbb{Q}}_h [\forall j \in \{1, \dots, n\}, S \cap J_j \neq \emptyset, S \cap W = \emptyset] \\ &= \sum_{k=0}^n (-1)^k \sum_{1 \leq j_1 < \dots < j_k \leq n} \mathbb{E}_{1/2} \left[\mathbb{E}_{1/2} \left[h \mid \mathcal{F}_{(\cup_{i=1}^k J_{j_i} \cup W)^c} \right]^2 \right]. \end{aligned} \quad (\text{B.1})$$

If $n = 1$ this is equation (2.14) in the proof of Lemma 2.2 of [GPS10]. We also follow the proof of this lemma for $n \geq 2$. Take $n \in \mathbb{N}_+$, assume that the result is true for any J'_1, \dots, J'_n and W' mutually disjoint subsets of \mathcal{I}_R , and let J_1, \dots, J_{n+1} and W be mutually disjoint subsets of \mathcal{I}_R . We have:

$$\begin{aligned} & \widehat{\mathbb{Q}}_h [\forall j \in \{1, \dots, n+1\}, S \cap J_j \neq \emptyset, S \cap W = \emptyset] \\ &= \widehat{\mathbb{Q}}_h [\forall j \in \{1, \dots, n\}, S \cap J_j \neq \emptyset, S \cap W = \emptyset] \\ &\quad - \widehat{\mathbb{Q}}_h [\forall j \in \{1, \dots, n\}, S \cap J_j \neq \emptyset, S \cap (W \cup J_{n+1}) = \emptyset] \\ &= \sum_{k=0}^n (-1)^k \sum_{1 \leq j_1 < \dots < j_k \leq n} \mathbb{E}_{1/2} \left[\mathbb{E}_{1/2} \left[h \mid \mathcal{F}_{(\cup_{i=1}^k J_{j_i} \cup W)^c} \right]^2 \right] \\ &\quad - \sum_{k=0}^n (-1)^k \sum_{1 \leq j_1 < \dots < j_k \leq n} \mathbb{E}_{1/2} \left[\mathbb{E}_{1/2} \left[h \mid \mathcal{F}_{(\cup_{i=1}^k J_{j_i} \cup J_{n+1} \cup W)^c} \right]^2 \right] \\ &= \sum_{k=0}^{n+1} (-1)^k \sum_{1 \leq j_1 < \dots < j_k \leq n+1} \mathbb{E}_{1/2} \left[\mathbb{E}_{1/2} \left[h \mid \mathcal{F}_{(\cup_{i=1}^k J_{j_i} \cup W)^c} \right]^2 \right], \end{aligned}$$

and the induction is over.

Now, we prove Lemma 5.7, also by induction on n .

If $n = 1$, this is Lemma 2.2 of [GPS10]. We assume that Lemma 5.7 holds for some $n \in \mathbb{N}_+$ and we want to prove it for $n+1$. Thanks to (B.1), it is sufficient to study the quantity $\sum_{k=0}^{n+1} (-1)^k \sum_{1 \leq j_1 < \dots < j_k \leq n+1} \mathbb{E}_{1/2} \left[\mathbb{E}_{1/2} \left[h \mid \mathcal{F}_{(\cup_{i=1}^k J_{j_i} \cup W)^c} \right]^2 \right]$, which equals:

$$\begin{aligned} & \sum_{k=0}^n (-1)^k \sum_{1 \leq j_1 < \dots < j_k \leq n} \left(\mathbb{E}_{1/2} \left[\mathbb{E}_{1/2} \left[h \mid \mathcal{F}_{(\cup_{i=1}^k J_{j_i} \cup W)^c} \right]^2 \right] \right. \\ & \quad \left. - \mathbb{E}_{1/2} \left[\mathbb{E}_{1/2} \left[h \mid \mathcal{F}_{(\cup_{i=1}^k J_{j_i} \cup J_{n+1} \cup W)^c} \right]^2 \right] \right). \end{aligned}$$

Note that:

$$\begin{aligned} & \mathbb{E}_{1/2} \left[\mathbb{E}_{1/2} \left[h \mid \mathcal{F}_{(\cup_{i=1}^k J_{j_i} \cup W)^c} \right]^2 \right] - \mathbb{E}_{1/2} \left[\mathbb{E}_{1/2} \left[h \mid \mathcal{F}_{(\cup_{i=1}^k J_{j_i} \cup J_{n+1} \cup W)^c} \right]^2 \right] \\ &= \mathbb{E}_{1/2} \left[\left(\mathbb{E}_{1/2} \left[h \mid \mathcal{F}_{(\cup_{i=1}^k J_{j_i} \cup W)^c} \right] - \mathbb{E}_{1/2} \left[h \mid \mathcal{F}_{(\cup_{i=1}^k J_{j_i} \cup J_{n+1} \cup W)^c} \right] \right)^2 \right]. \end{aligned}$$

Moreover, since $\mathbb{P}_{1/2}$ is the uniform measure, we have:

$$\mathbb{E}_{1/2} \left[h \mid \mathcal{F}_{(\cup_{i=1}^k J_{j_i} \cup J_{n+1} \cup W)^c} \right] = \mathbb{E}_{1/2} \left[\mathbb{E}_{1/2} \left[h \mid \mathcal{F}_{J_{n+1}^c} \right] \mid \mathcal{F}_{(\cup_{i=1}^k J_{j_i} \cup W)^c} \right].$$

Therefore:

$$\begin{aligned} & \sum_{k=0}^{n+1} (-1)^k \sum_{1 \leq j_1 < \dots < j_k \leq n+1} \mathbb{E}_{1/2} \left[\mathbb{E}_{1/2} \left[h \mid \mathcal{F}_{(\cup_{i=1}^k J_{j_i} \cup W)^c} \right]^2 \right] \\ &= \sum_{k=0}^n (-1)^k \sum_{1 \leq j_1 < \dots < j_k \leq n} \mathbb{E}_{1/2} \left[\mathbb{E}_{1/2} \left[h - \mathbb{E}_{1/2} \left[h \mid \mathcal{F}_{J_{n+1}^c} \right] \mid \mathcal{F}_{(\cup_{i=1}^k J_{j_i} \cup W)^c} \right]^2 \right]. \end{aligned}$$

By using (B.1) and the induction hypothesis for $h - \mathbb{E}_{1/2} [h \mid J_{n+1}^c]$, we obtain that the above equals:

$$\begin{aligned} & \widehat{\mathbb{Q}}_{h - \mathbb{E}_{1/2} [h \mid \mathcal{F}_{J_{n+1}^c}]} [\forall j \in \{1, \dots, n\}, S \cap J_j \neq \emptyset, S \cap W = \emptyset] \\ & \leq 4^n \left\| h - \mathbb{E}_{1/2} [h \mid \mathcal{F}_{J_{n+1}^c}] \right\|_{\infty}^2 \mathbb{E}_{1/2} \left[\mathbb{P}_{1/2} \left[JP_{J_1, \dots, J_n} \left(h - \mathbb{E}_{1/2} [h \mid \mathcal{F}_{J_{n+1}^c}] \right) \mid \mathcal{F}_{W^c} \right]^2 \right] \\ & \leq 4^{n+1} \|h\|_{\infty}^2 \mathbb{E}_{1/2} \left[\mathbb{P}_{1/2} \left[JP_{J_1, \dots, J_n} \left(h - \mathbb{E}_{1/2} [h \mid \mathcal{F}_{J_{n+1}^c}] \right) \mid \mathcal{F}_{W^c} \right]^2 \right]. \end{aligned}$$

The proof is over since:

$$JP_{J_1, \dots, J_n} \left(h - \mathbb{E}_{1/2} [h \mid \mathcal{F}_{J_{n+1}^c}] \right) \subseteq JP_{J_1, \dots, J_{n+1}}(h).$$

C The 4-arm event conditioned on the configuration in a half-plane

Consider bond percolation on \mathbb{Z}^2 or site percolation on \mathbb{T} and see Lemma 5.7 for the notation \mathcal{F}_B .

Lemma C.1. *Let $r_2 \geq r_1 \geq 1$, let H be the lower half plane and let $\mathbb{H} = H \cap \mathcal{I}$. There exists an absolute constant $C < +\infty$ such that:*

$$\mathbb{E}_{1/2} \left[\mathbb{P}_{1/2} \left[\mathbf{A}_4(r_1, r_2) \mid \mathcal{F}_{\mathbb{H}} \right]^2 \right] \leq C \alpha_4(r_1, r_2) \left(\frac{r_2}{r_1} \right)^{-1/C},$$

where $\mathbf{A}_4(r_1, r_2)$ is the 4-arm event in the annulus $[-r_2, r_2] \setminus (-r_1, r_1)^2$. (Such an estimate is also true with the right, left or upper half-plane and the proof is the same.)

Proof. As pointed out in the beginning of Subsection 5.3 in [GPS10] for analogous events, it is not difficult to see that, if ω and ω' are two critical percolation configurations which coincide on \mathbb{H} but are independent on \mathbb{H}^c , then:

$$\mathbb{E}_{1/2} \left[\mathbb{P}_{1/2} \left[\mathbf{A}_4(r_1, r_2) \mid \mathcal{F}_{\mathbb{H}} \right]^2 \right] = \mathbb{P} [\omega, \omega' \in \mathbf{A}_4(r_1, r_2)]. \quad (\text{C.1})$$

Let $M \geq 100$ that we will choose later. First note that it is sufficient to prove the lemma for $r_1 < r_2$ of the form $\rho_l = M^l$ for some $l \in \mathbb{N}_+$. Let $1 \leq i < j$ be such that $r_1 = \rho_i = M^i$ and $r_2 = \rho_j = M^j$. Let $B(k) = B(k, M)$ be the event that there exist open paths in the annulus $[-\rho_{k+1}, \rho_{k+1}]^2 \setminus (-\rho_k, \rho_k)^2$ as in Figure C.1. By the FKG-inequality and the RSW-estimate, there exists $c = c(M) > 0$ such that for all k we have $\mathbb{P}_{1/2} [B(k)] \geq c$. Given a realization of our variables ω and ω' , we write $i \leq k_1 < \dots < k_N \leq j - 1$ the k 's such that $B(k)$ is satisfied in ω (note that the random variables N and (k_1, \dots, k_N) are measurable with respect to ω and are independent of ω'). Note also that (by classical properties of the Binomial distribution and thanks to the existence of the above $c > 0$) there exists $a = a(M) \in (0, 1)$ such that the probability of the event $\{N \leq a \log_M(r_2/r_1)\}$ is less than or equal to $\frac{1}{a}(1 - a)^{\log_M(r_2/r_1)}$.

Next, condition on $B(k)$ and on the upper open paths that cross the rectangle $[\rho_k + 2\rho_k/10, \rho_{k+1} - 2\rho_k/10] \times [\rho_k/10, 2\rho_k/10]$ and the rectangle $[-(\rho_k + 2\rho_k/10), -(\rho_{k+1} - 2\rho_k/10)] \times [\rho_k/10, 2\rho_k/10]$. Write γ_1 and γ_2 for these two paths. Note that, if $\mathbf{A}_4(\rho_k + 10, \rho_{k+1})$ holds, then there is a 3-arm event in the region of the annulus $[-(\rho_{k+1} - 3\rho_k/10), \rho_{k+1} - 3\rho_k/10]^2 \setminus (-\rho_k + 3\rho_k/10, \rho_k + 3\rho_k/10)^2$ that is below γ_1 and γ_2 , see Figure C.2. The percolation configuration in this region is not biased by the conditionings. Consequently, we can use (2.6) to obtain that there exist two absolute constants $C_0, C_1 < +\infty$ such that, for all $k \in \{1, \dots, j-1\}$, we have:

$$\mathbb{P}_{1/2} \left[\mathbf{A}_4(\rho_k + 10, \rho_{k+1}) \mid B(k) \right] \leq C_0 \left(\frac{\rho_k + 3\rho_k/10}{\rho_{k+1} - 3\rho_k/10} \right)^2 \leq C_1 M^{-2}. \quad (\text{C.2})$$

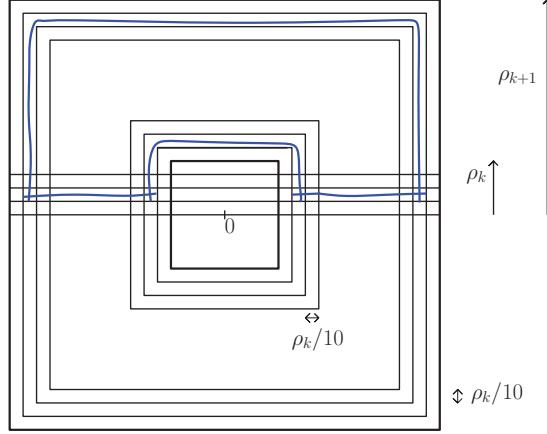

Figure C.1 – A realization of the event $B(k)$.

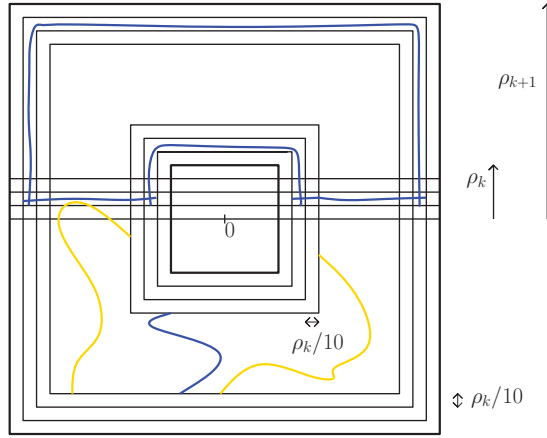

Figure C.2 – A realization of the event $B(k)$ and of the 4-arm event implies the realization of a 3-arm event in a half-plane.

Now, we simply use that $\{\omega, \omega' \in \mathbf{A}_4(r_1, r_2)\} \subseteq \{\omega \in \mathbf{A}_4(r_1, r_2)\} \cup \{\omega' \in \mathbf{A}_4(r_1, r_2)\}$, and we choose to look only at ω in the annuli where $\omega \in B(k)$ and to look only at ω' in the other annuli. More precisely, for any $m \in \mathbb{N}$ and $i \leq l_1 < \dots < l_m \leq j-1$, by spatial independence we have:

$$\begin{aligned} & \mathbb{P} \left[\omega, \omega' \in \mathbf{A}_4(r_1, r_2) \mid N = m, k_1 = l_1, \dots, k_m = l_m \right] \leq \mathbb{P} \left[\omega' \in \mathbf{A}_4(r_1, \rho_{l_1}) \right] \\ & \times \prod_{q=1}^{m-1} \left(\mathbb{P} \left[\omega \in \mathbf{A}_4(\rho_{l_q} + 10, \rho_{l_{q+1}}) \mid \omega \in B(l_q) \right] \mathbb{P} \left[\omega' \in \mathbf{A}_4(\rho_{l_{q+1}} + 10, \rho_{l_{q+1}}) \right] \right) \\ & \times \mathbb{P} \left[\omega \in \mathbf{A}_4(\rho_{l_m} + 10, \rho_{l_{m+1}}) \mid \omega \in B(l_m) \right] \mathbb{P} \left[\omega' \in \mathbf{A}_4(\rho_{l_{m+1}} + 10, r_2) \right]. \end{aligned}$$

Next, (C.2) implies that the above is at most:

$$\begin{aligned} & \alpha_4(r_1, \rho_{l_1}) \prod_{q=1}^{m-1} \left(\frac{C_1}{M^2} \alpha_4(\rho_{l_q+1} + 10, \rho_{l_{q+1}}) \right) \frac{C_1}{M^2} \alpha_4(\rho_{l_{m+1}} + 10, r_2) \\ &= \alpha_4(r_1, \rho_{l_1}) \prod_{q=1}^{m-1} \left(\alpha_4(\rho_{l_q}, \rho_{l_q+1} + 10) \alpha_4(\rho_{l_q+1} + 10, \rho_{l_{q+1}}) \frac{C_1}{M^2 \alpha_4(\rho_{l_q}, \rho_{l_q+1} + 10)} \right) \\ & \times \alpha_4(\rho_{l_m}, \rho_{l_m+1} + 10) \alpha_4(\rho_{l_m+1} + 10, r_2) \frac{C_1}{M^2 \alpha_4(\rho_{l_m}, \rho_{l_m+1} + 10)}. \end{aligned}$$

The quasi-multiplicativity property implies that there exists a constant $C_2 < +\infty$ such that the above is at most:

$$C_2 \alpha_4(r_1, r_2) \prod_{q=1}^m \frac{C_2}{M^2 \alpha_4(\rho_{l_q}, \rho_{l_q+1})}. \quad (\text{C.3})$$

Thanks to the left-hand inequality of (2.7) we know that there exists some $\epsilon_2 > 0$ such that for all $l \in \mathbb{N}$:

$$\alpha_4(\rho_l, \rho_{l+1}) \geq \frac{1}{\epsilon_2} M^{-2+\epsilon_2}.$$

We deduce that we can choose $100 \leq M < +\infty$ such that for all $l \in \mathbb{N}$:

$$\frac{C_2}{M^2 \alpha_4(\rho_l, \rho_{l+1})} \leq 1/2. \quad (\text{C.4})$$

We fix such an M . Then, (C.3) and (C.4) imply that:

$$\mathbb{P} \left[\omega, \omega' \in \mathbf{A}_4(r_1, r_2) \mid N = m, k_1 = l_1, \dots, k_m = l_m \right] \leq C_2 \alpha_4(r_1, r_2) / 2^m. \quad (\text{C.5})$$

Now, we write:

$$\begin{aligned} \mathbb{P} \left[\omega, \omega' \in \mathbf{A}_4(r_1, r_2) \right] & \leq \mathbb{P} \left[N \leq a \log_M(r_2/r_1), \omega' \in \mathbf{A}_4(r_1, r_2) \right] \\ & \quad + \mathbb{P} \left[N \geq a \log_M(r_2/r_1), \omega, \omega' \in \mathbf{A}_4(r_1, r_2) \right], \end{aligned} \quad (\text{C.6})$$

where the constant $a = a(M)$ comes from the beginning of the proof.

By independence of ω and ω' on \mathbb{H}^c we can say that the first term of the right-hand side of (C.6) equals:

$$\begin{aligned} \mathbb{P} \left[N \leq a \log_M(r_2/r_1) \right] \mathbb{P} \left[\omega' \in \mathbf{A}_4(r_1, r_2) \right] & \leq \frac{1}{a} (1-a)^{\log_M(r_2/r_1)} \alpha_4(r_1, r_2) \\ & \leq \frac{C}{2} \left(\frac{r_2}{r_1} \right)^{-1/C} \alpha_4(r_1, r_2), \end{aligned}$$

for some $C < +\infty$.

Thanks to (C.5) we know that the second term of the right-hand side of (C.6) is also less than or equal to $\frac{C}{2} \left(\frac{r_2}{r_1} \right)^{-1/C} \alpha_4(r_1, r_2)$ if C is sufficiently large. And the proof is over thanks to (C.1). \square

Lemma C.2. *For site percolation on \mathbb{T} , there exists $\zeta_4^{\mathbb{H}} \in (5/4, 5/2]$ such that:*

$$\beta_4^{\mathbb{H}}(r_1, r_2) := \mathbb{E}_{1/2} \left[\mathbb{P}_{1/2} \left[\mathbf{A}_4(r_1, r_2) \mid \mathcal{F}_{\mathbb{H}} \right]^2 \right] = \left(\frac{r_1}{r_2} \right)^{\zeta_4^{\mathbb{H}} + o(1)},$$

where $r_2 \geq r_1 \geq 1$ and $o(1) \rightarrow 0$ as $r_1/r_2 \rightarrow 0$.

Proof. We shall only sketch the proof here. To prove that this exponent exists on \mathbb{T} (without necessarily computing its value), one proceeds as with classical exponents which describe critical percolation in two steps (see [LSW02, SW01, Wer07]):

1. First, one needs to show that for any fixed $r < R$, the quantity $\beta_4^{\mathbb{H}}(\lambda r, \lambda R)$ converges as $\lambda \rightarrow +\infty$ to a limiting real number which is expressible in terms of the continuum scaling limit of percolation. For usual *arm-exponents*, these limiting numbers are given by SLE_6 computable quantities. In the present case, these limiting real numbers are instead described in terms of the continuum scaling limit of percolation introduced by Schramm-Smirnov [SS11]. The proof follows very similar lines as the proof of Theorem 10.1 in [GPS10]. Let us be a little more precise here: In order to prove Theorem 10.1 in [GPS10], two results are used: (a) the existence and uniqueness of the continuum scaling limit of percolation (see Subsection 2.3 of [GPS13a] for the uniqueness part) and (b) a “mesh independent gluing property for crossing of quads” which is Proposition 10.3 of [GPS10] and Proposition 4.1 of [SS11]. The only difference in our case is that we need a gluing property for the 4-arm event instead of the crossing of quads. Such a result follows easily from the gluing properties for crossing of quads, and from results about the scaling limit of arm events from Subsection 2.4 of [GPS13a] (see in particular (2.3) of this last paper).
2. Then one needs to prove that the quantity $\beta_4^{\mathbb{H}}(r_1, r_2)$ satisfies a **quasi-multiplicativity property** (see [Wer07]). This is Proposition 5.1 of [GPS10] (with $W = \mathbb{H}^c$).

Once $\zeta_4^{\mathbb{H}}$ is proved to exist, the fact that it belongs to $(5/4, 5/2]$ follows directly from Lemma C.1 and the computation of the critical exponents. □

Relations d'échelle annealed pour la percolation de Voronoi

Ce chapitre est, à des détails mineurs près, la reproduction de l'article [V5], intitulé “Annealed scaling relations for Voronoi percolation” et disponible sur Hal et Arxiv.

Résumé en français. Dans ce chapitre, nous démontrons des relations d'échelle annealed pour la percolation de Voronoi dans le plan. Notre principale source d'inspiration est la preuve du résultat analogue en percolation de Bernoulli par Kesten [Kes87]. Au cours de la preuve, nous démontrons une propriété de quasi-multiplicativité annealed en nous reposant sur des estimations de croisements de boîtes quenched démontrées par Ahlberg, Griffiths, Morris et Tassion [AGMT16]. Nous étudions aussi des notions d'ensembles pivots quenched et annealed et généralisons les propriétés de croisements de boîtes quenched de [AGMT16] à la phase presque-critique.

English abstract. In this chapter, we prove annealed scaling relations for planar Voronoi percolation. We are mostly inspired by the proof of scaling relations for Bernoulli percolation by Kesten [Kes87]. Along the way, we show an annealed quasi-multiplicativity property by relying on the quenched box-crossing property proved by Ahlberg, Griffiths, Morris and Tassion [AGMT16]. Intermediate results also include the study of quenched and annealed notions of pivotal events and the extension of the quenched box-crossing property of [AGMT16] to the near-critical regime.

Contents

1	The model and the main result	237
1.1	Percolation on planar lattices	237
1.2	Planar Voronoi percolation	237
1.3	The main result: annealed scaling relations for Voronoi percolation	240
1.4	Estimates on the 4-arm events, $\theta^{an}(p)$, and $L^{an}(p)$	242
1.5	Quenched or annealed results?	242
2	Strategy and organization of the chapter	243
2.1	Some notations	243
2.2	Correlation inequalities for Voronoi percolation	243
2.3	Consequences of the annealed quasi-multiplicativity property	244
2.4	Some important events: the pivotal events and the “good” events	246
2.4.1	Pivotal events	246
2.4.2	The events Dense, QBC and GI	247
2.5	Organization of the chapter and interdependence of the sections	248
2.6	Some ideas of proof	248
2.6.1	The quasi-multiplicativity property (at $p = 1/2$)	248
2.6.2	The annealed scaling relations	250
3	Preliminary results	250
3.1	Warm-up: proof of (1.1) and of the quasi-multiplicativity property for $j = 1$	250
3.2	A generalization of Theorem 1.4 to a family of quads	253
3.3	“Strong” well-separateness of interfaces	254
4	Pivotal events and some estimates on arm events	256
4.1	The case of the bulk	256
4.2	An estimate on the 4-arm event	262
4.3	Pivotal events for crossing events and arm events	264
5	Extension of the results to the near-critical phase	270
5.1	Extension of the annealed and quenched box-crossing properties	270
5.2	Extension of the results of Sections 3, 4 and 7	272
6	Proof of the annealed scaling relations	273
7	The quasi-multiplicativity property	276
7.1	The case j even	276
7.1.1	What does “looking good” means for the Voronoi percolation configurations	276
7.1.2	Extension of the arms when the configuration is good	278
7.1.3	The probability to look good if the 4-arm event holds	282
7.1.4	Proof of the quasi-multiplicativity property	283
7.2	A consequence of the quasi-multiplicativity property	287
7.3	Arm events in the half-plane	287
7.4	The case j odd	288
A	An extension of Schramm and Steif’s algorithm theorem	289
B	The proof of the quenched box-crossing property in [AGMT16]	291
C	Pivotal events for $A_j(1, R)$ when j is odd	293
D	The quantities $\mathbb{E} \left[\mathbf{P}^\eta [A_j(r, R)]^2 \right]$	294
D.1	The quasi-multiplicativity property	294
D.2	Pivotal events	298

1 The model and the main result

1.1 Percolation on planar lattices

Consider bond percolation on the square lattice \mathbb{Z}^2 or site percolation on the planar triangular lattice \mathbb{T} . In these models, each edge or site is open (respectively closed) with probability p (respectively $1 - p$) independently of the others. Let $\theta(p)$ be the probability that there is an infinite open path starting from 0. It is well known (see for instance [Gri99, BR06b]) that there exists a critical point $p_c \in (0, 1)$ such that:

- i) $\forall p \in [0, p_c), \theta(p) = 0,$
- ii) $\forall p \in (p_c, 1], \theta(p) > 0.$

It is a theorem by Kesten [Kes80] that $p_c = 1/2$ for these two models. Moreover, it has been proved by Harris [Har60] that $\theta(1/2) = 0$. Let us say a little more about the behaviour of this model at and near the critical point: Thanks to the Russo-Seymour-Welsh (RSW) theory and the study of interfaces between open and dual paths, one can obtain the so-called quasi-multiplicativity property of arm events and derive estimates on “pivotal events” (see [Kes87, Wer07, Nol08, SS10, Man12]). Both are important tools in order to:

- (a) obtain the **scaling relations** proved by Kesten (see [Kes87, Wer07, Nol08]),
- (b) study dynamical percolation and **noise sensitivity** of percolation, see [BKS99, SS10, GPS10, BGS13, GS14, HPS⁺15],
- (c) study the **scaling limits** of percolation, near-critical percolation, and dynamical percolation, see [SS11, GPS13a, GPS13b].

The goal of this paper is twofold: (1) We prove the quasi-multiplicativity property (and some estimates on “pivotal events”) for planar Voronoi percolation, which is a continuum percolation model. (2) We prove two scaling relations for Voronoi percolation.

Before recalling the definition of Voronoi percolation, let us note that the authors of [AGMT16] and [AB17] have proved noise sensitivity results for Voronoi percolation by following ideas from [BKS99, SS10, ABGM14]. We also see the present chapter as a first step in order to be able to apply the more quantitative noise sensitivity methods from [GPS10]. Indeed, to apply methods from [GPS10], one needs to have good controls on the probabilities of arm events and pivotal events.

1.2 Planar Voronoi percolation

In this subsection, we introduce the model of Voronoi percolation. We refer to Section 8.3 of [BR06b] for more details.

A. Voronoi percolation. Let us define planar Voronoi percolation. To this purpose, let us consider a homogeneous Poisson process of intensity 1 in \mathbb{R}^2 , that we denote by η . For each point $x \in \eta$, the **Voronoi cell** of x , denoted by $C(x)$, is the set of all points $u \in \mathbb{R}^2$ such that for all $x' \in \eta$, $\|u - x\|_2 \leq \|u - x'\|_2$. We say that x is the center of $C(x)$. Also, we say that two points of η are adjacent if their cells intersect each other. It is not difficult to see that a.s. all the cells are bounded convex polygons. Now, let us consider some parameter $p \in [0, 1]$ and, given η , let us declare each $x \in \eta$ open (we will choose to say that “we color the point **black**”) with probability p and closed (**white**) with probability $1 - p$, independently of the other points of η . Let $\omega \in \{-1, 1\}^\eta$ be the coloured configuration we thus obtain (where 1 means black and -1 means white).¹

¹There is no problem of measurability here: ω can be seen for instance as a point process with values in $\mathbb{R}^2 \times \{-1, 1\}$ whose intensity is $\text{Leb}_{\mathbb{R}^2} \otimes (p\delta_1 + (1 - p)\delta_{-1})$, where $\text{Leb}_{\mathbb{R}^2}$ is the Lebesgue measure in the plane.

We will always write η for the non-coloured point process and ω for the coloured point process. The distribution of ω will be denoted by \mathbb{P}_p .

Given the configuration ω , we define a colouring of the plane as follows: each point $u \in \mathbb{R}^2$ is coloured black if it is contained in the cell of a black point $x \in \eta$ and is coloured white if it is contained in the cell of a white point $x \in \eta$ (note that the points on the boundary of the cells may be coloured both black and white but this is not important in this chapter). Moreover, we call black (respectively white) path a continuous path included in the black (respectively white) region of the plane.

B. The critical point. Let $\{0 \leftrightarrow +\infty\}$ be the event that there is a black path from the origin to infinity and let $\theta^{an}(p) = \mathbb{P}_p[0 \leftrightarrow \infty]$ denote the (annealed) percolation function. The critical point p_c is defined as follows:

$$p_c := \inf \{p \in [0, 1] : \theta^{an}(p) > 0\} .$$

It has been proved by Zvavitch [Zva96] that $\theta^{an}(1/2) = 0$ - hence $p_c \geq 1/2$ - and it is a result of Bollobás and Riordan [BR06a] that $p_c = 1/2$. A crucial fact for this result is the so-called self-duality property of the model: a.s., a rectangle is crossed lengthwise by a black path if and only if it is not crossed widthwise by a white path (see for instance Lemma 12 in Chapter 8 of [BR06b]). An important step to show the result of Bollobás and Riordan is the proof of a weak box-crossing property. A stronger version has more recently been proved by Tassion [Tas16] and has led to the derivation of **quenched crossing estimates** in [AGMT16] that will be crucial in the present chapter. Before stating these box-crossing results, let us note that an alternative proof of $p_c = 1/2$ can be found in the recent paper [DCRT17a]. In the said article, Duminil-Copin, Raoufi and Tassion prove the exponential decay of connection probabilities for subcritical Voronoi percolation in any dimension.

C. Box-crossing properties. We first need two definitions/notations:

Definition 1.1. Given η , we write \mathbf{P}_p^η for the conditional distribution of ω given η (which is simply the product law $(p\delta_1 + (1-p)\delta_{-1})^{\otimes \eta}$). More generally, if E is a countable set, we write $\mathbf{P}_p^E = (p\delta_1 + (1-p)\delta_{-1})^{\otimes E}$.

Definition 1.2. For any $\rho_1, \rho_2 > 0$, $\text{Cross}(\rho_1, \rho_2)$ (respectively $\text{Cross}^*(\rho_1, \rho_2)$) denotes the event that there is a black (respectively white) path included in $[-\rho_1, \rho_1] \times [-\rho_2, \rho_2]$ that connects the left side of this rectangle to its right side.

Now, we can state the annealed box-crossing property obtained by Tassion and the quenched box-crossing property obtained by Ahlberg, Griffiths, Morris and Tassion. An important step in the present chapter is the extension of these results to the “near-critical regime”, see Subsection 5.1.

Theorem 1.3 (Theorem 3 of [Tas16]). *Let $\rho > 0$. There exists a constant $c = c(\rho) \in (0, 1)$ such that, for every $R \in (0, +\infty)$:*

$$c \leq \mathbb{P}_{1/2}[\text{Cross}(\rho R, R)] \leq 1 - c .$$

Theorem 1.4 (Theorem 1.4 of [AGMT16] and the paragraph below it. See also our Appendix B where we recall the main ingredients of the proof of this theorem.²). *Let $\rho > 0$.*

²Actually, in Appendix B we will modify a little the proof of [AGMT16] so that this proof will be easier to adapt to the near-critical phase.

i) There exists an absolute constant $\epsilon > 0$ and a constant $C = C(\rho) < +\infty$ such that, for every $R \in (0, +\infty)$:

$$\text{Var} \left(\mathbf{P}_{1/2}^\eta [\text{Cross}(\rho R, R)] \right) \leq C R^{-\epsilon}.$$

This implies the following estimate:

ii) For every $\gamma \in (0, +\infty)$, there exists a positive constant $c = c(\rho, \gamma) \in (0, 1)$ such that, for every $R \in (0, +\infty)$:

$$\mathbb{P} \left[c \leq \mathbf{P}_{1/2}^\eta [\text{Cross}(\rho R, R)] \leq 1 - c \right] \geq 1 - R^{-\gamma}.$$

D. Arm events. Once we have such crossing properties, a natural goal is to study arm events. Let us first define these events:

Definition 1.5 (*j*-arm events). Let $j \in \mathbb{N}^*$ and $0 \leq r \leq R$. The *j*-arm event between scales r and R is the event that there exist *j* paths of alternating colors in the annulus $[-R, R]^2 \setminus [-r, r]^2$ from $\partial[-r, r]^2$ to $\partial[-R, R]^2$ (if *j* is odd, we ask that there are: (a) *j* − 1 paths of alternating colors, and: (b) one additional black path such that there is no Voronoi cell intersected by both this additional path and one of the *j* − 1 other paths). Let $\mathbf{A}_j(r, R)$ denote this event. We write the **annealed** probability of this event as follows:

$$\alpha_{j,p}^{an}(r, R) = \mathbb{P}_p [\mathbf{A}_j(r, R)].$$

We write $\alpha_{j,p}^{an}(R) = \alpha_{j,p}^{an}(1, R)$ for any $j \in \mathbb{N}^*$. If $r > R$, we choose that $\alpha_{j,p}^{an}(r, R) = 1$. Also, we will often use the following simplified notation:

$$\alpha_j^{an}(r, R) = \alpha_{j,1/2}^{an}(r, R).$$

An important property of the quantities $\alpha_{j,1/2}^{an}(r, R)$ is that they decay polynomially fast: There exists a constant $C = C(j) \in [1, +\infty)$ such that, for every $1 \leq r \leq R$:

$$\frac{1}{C} \left(\frac{r}{R} \right)^C \leq \alpha_{j,1/2}^{an}(r, R) \leq C \left(\frac{r}{R} \right)^{1/C}. \quad (1.1)$$

The right-hand-inequality is proved in [Tas16] (Item 2 of Theorem 3) and we prove the left-hand-inequality in Subsection 3.1. In the present chapter, we prove the **annealed quasi-multiplicativity property** for the quantities $\alpha_{j,1/2}^{an}(r, R)$. This is the most delicate part of the chapter. Even if this is an annealed result, the quenched box-crossing property Theorem 1.4 will be a crucial ingredient of the proof.

Proposition 1.6 (Annealed quasi-multiplicativity property). *Let $j \in \mathbb{N}^*$. There exists a constant $C = C(j) \in [1, +\infty)$ such that, for all $1 \leq r_1 \leq r_2 \leq r_3$:*

$$\frac{1}{C} \alpha_{j,1/2}^{an}(r_1, r_3) \leq \alpha_{j,1/2}^{an}(r_1, r_2) \alpha_{j,1/2}^{an}(r_2, r_3) \leq C \alpha_{j,1/2}^{an}(r_1, r_3). \quad (1.2)$$

Remark 1.7. In Proposition 1.6, the case $j = 1$ is easier. More precisely, the right-hand-inequality in this case is a direct consequence of the box-crossing property Theorem 1.3 and of the (annealed) FKG-Harris inequality (stated in Subsection 2.2). Moreover, the proof of the left-hand-inequality in the case $j = 1$ is written in Subsection 3.1.

Remark 1.8. Our choice to impose that the radii r_i are at least 1 is arbitrary. In fact, we could have chosen any $a > 0$ and rather asked that $a \leq r_1 \leq r_2 \leq r_3$. We would have obtained the same result with some constant $C = C(j, a)$.

The main difficulty in the study of arm events (compared to crossing events for instance) is that they are **degenerate events**. As a result, it could a priori be the case that if $r \ll R$ and if we condition on $\mathbf{A}_j(r, R)$, then with high probability the point process η is very degenerate at scale r , see Figure 1.1. We refer to Subsection 2.3 for some key properties and some tools developed to overcome this difficulty (see in particular Propositions 2.4 and 2.5).

Let us now state the main result of our chapter.

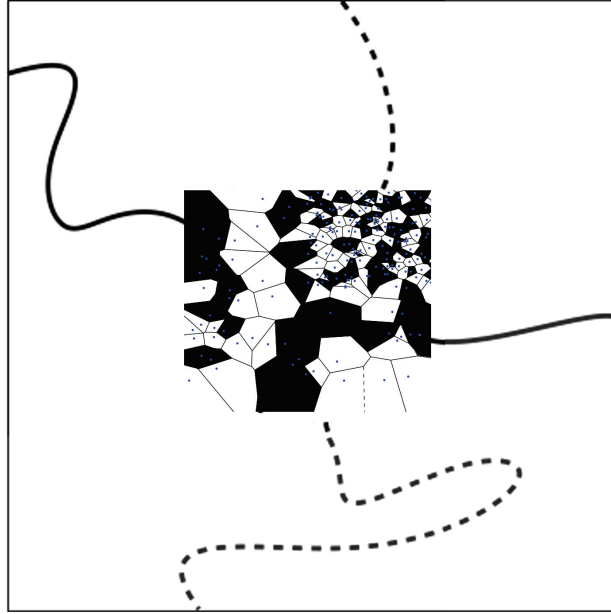

Figure 1.1 – In this chapter, we deal with degenerate events: the j -arm events $\mathbf{A}_j(r, R)$. It is not clear that, when conditioning on $\mathbf{A}_j(r, R)$ with $r \ll R$, the random environment at scale r is not typically degenerate. An example of a degenerate environment is illustrated in the figure: the Voronoi tiling is extremely dense in some regions and not dense at all in some other regions. In the region where the Voronoi tiling is extremely dense, it might be very costly to extend the arms to other scales. The biggest issue comes from the regions where the Voronoi tiling is not dense at all. In these regions, there are a lot of spatial dependences.

1.3 The main result: annealed scaling relations for Voronoi percolation

It is believed that, for a wide class of percolation models, the evolution as p goes to $p_c = 1/2$ of some key quantities is determined by some **critical exponents**. Such quantities are for instance the percolation function, the correlation length and the probabilities of arm events. The famous **scaling relations** proved by Kesten [Kes87] are simple relations between these exponents. More precisely, Kesten proved that, for bond percolation on the square lattice (and site percolation on the triangular lattice): i) if we assume that these key quantities are indeed described by exponents, then these exponents satisfy the relations predicted by theoretical physicists in the 70's (we refer to [Kes87] for references concerning these predictions), and ii) even if we do not assume that these exponents exist, the corresponding relations between the percolation function, the correlation length etc hold. There is only one planar percolation model for which it is known that such exponents exist: site percolation on the triangular lattice, that is the only model for which conformal invariance has been proved, see the proof by Smirnov [Smi01]. These exponents have even been computed thanks to the theory of SLE's (Schramm Loewner Evolution), see [SW01, LSW02, Wer07].

Let us go back to Voronoi percolation. For this model, the existence of these exponents is not known (conformal invariance is not proved for this model even if a first important step has been made in this direction by Benjamini and Schramm [BS98]). To state our main result, let us define the annealed correlation length.

Definition 1.9. Let $\epsilon_0 \in (0, 1)$ be sufficiently small³ and let $p \in (1/2, 1]$. The **annealed**

³More precisely, we need that $1 - 2\epsilon_0 > \mathbb{P}_{1/2}[\text{Cross}(2R, R)]$ for every $R \geq 1$ - which is possible thanks to Theorem 1.3 - and that ϵ_0 is sufficiently small so that a Peierls argument works - see the proof of Lemma 6.2 for more about this second condition.

correlation length at parameter p , denoted by $L^{an}(p) = L^{an, \epsilon_0}(p)$, is defined as follows:

$$L^{an}(p) = \inf \{R \geq 1 : \mathbb{P}_p[\text{Cross}(2R, R)] \geq 1 - \epsilon_0\} .$$

An important property is that, for every $p > 1/2$, $L^{an}(p) < +\infty$, see Lemma 5.1. The idea behind the definition of the correlation length is that this is the larger scale such that the percolation configuration at this scale “looks critical”. In particular, we prove in Subsection 5.1 that the annealed and quenched box-crossing properties Theorems 1.3 and 1.4 are also true for $p > 1/2$ as soon as we work at scales smaller than the correlation length (i.e. as soon as we work in the “near-critical phase”). Moreover, we prove the following result in Section 6.

Proposition 1.10. *Let⁴ $p \in (1/2, 3/4]$ and let ϵ_0 be the parameter of Definition 1.9. Also, let $j \in \mathbb{N}^*$. There exists a constant $C = C(\epsilon_0, j) \in [1, +\infty)$ such that, for every $1 \leq r \leq R \leq L^{an}(p)$:*

$$\frac{1}{C} \alpha_{j,1/2}^{an}(r, R) \leq \alpha_{j,p}^{an}(r, R) \leq C \alpha_{j,1/2}^{an}(r, R) .$$

In the present chapter, we focus on the following exponents: It is believed that there exist $\nu \in (0, +\infty)$, $\beta \in (0, +\infty)$ and $\zeta_j \in (0, +\infty)$ such that:

$$\begin{aligned} \forall p \in (1/2, 1), \theta^{an}(p) &= (p - 1/2)^{\beta+o(1)} , \\ \forall p \in (1/2, 1), L^{an}(p) &= (p - 1/2)^{-\nu+o(1)} , \\ \forall j \in \mathbb{N}^* \text{ and } \forall 1 \leq r \leq R, \alpha_{j,1/2}^{an}(r, R) &= \left(\frac{r}{R}\right)^{\zeta_j+o(1)} , \end{aligned}$$

where $o(1)$ goes to 0 as p goes to $1/2$ (respectively as r/R goes to 0). Moreover, it is believed that the following relations hold between these exponents:

$$\beta = \nu \zeta_1 ; \nu = \frac{1}{2 - \zeta_4} .$$

The main results of the present chapter is that, if these exponents exist, then these two scaling relations hold. As in [Kes87], we also prove that, even if we do not assume that the exponents exist, then the corresponding relations between the percolation function, the correlation length and the probabilities of arm events hold. More precisely, we obtain the following:

Theorem 1.11. *Let $p \in (1/2, 3/4]$ and let ϵ_0 be the parameter of Definition 1.9. There exists a constant $C = C(\epsilon_0) \in [1, +\infty)$ such that:*

$$\frac{1}{C} \alpha_{1,1/2}^{an}(L^{an}(p)) \leq \theta^{an}(p) \leq C \alpha_{1,1/2}^{an}(L^{an}(p)) , \tag{1.3}$$

and:

$$\frac{1}{C} \frac{1}{p - 1/2} \leq L^{an}(p)^2 \alpha_{4,1/2}^{an}(L^{an}(p)) \leq C \frac{1}{p - 1/2} . \tag{1.4}$$

Proposition 1.10 and Theorem 1.11 are proved in Section 6 by relying on all the other sections.

Remark 1.12. Note that (1.3) (together with the quasi-multiplicativity property and (1.1)) implies that for every $\epsilon'_0 > \epsilon_0 > 0$ sufficiently small, there exist $c = c(\epsilon_0, \epsilon'_0) > 0$ such that, for every $p \in (1/2, 3/4]$:

$$cL^{an, \epsilon_0}(p) \leq L^{an, \epsilon'_0}(p) \leq L^{an, \epsilon_0}(p) .$$

In [Kes87], Kesten also proves other scaling relations. We believe that, with the results of the present chapter, analogues of these other scaling relations can also be proved, but we have restricted ourself to the two scaling relations (1.3) and (1.4).

⁴The number $3/4$ does not have to be taken seriously, we consider $p \in (1/2, 3/4]$ only to avoid problems with p close to 1.

1.4 Estimates on the 4-arm events, $\theta^{an}(p)$, and $L^{an}(p)$

In the present chapter, we prove some estimates on arm events. In particular, we obtain the following estimates on the 4-arm events in Subsections 4.1 and 4.2:

Proposition 1.13. *There exists an absolute constant $\epsilon > 0$ such that:*

i) For every $R \in [1, +\infty)$:

$$\alpha_{4,1/2}^{an}(R) \leq \frac{1}{\epsilon} R^{-(1+\epsilon)}.$$

ii) For every $1 \leq r \leq R$:

$$\alpha_{4,1/2}^{an}(r, R) \geq \epsilon \left(\frac{r}{R}\right)^{2-\epsilon}.$$

If we apply the first part of Proposition 1.13 to the scaling relation (1.4) of Theorem 1.11, then we obtain that:

$$L^{an}(p) \geq \epsilon (p - 1/2)^{-(1+\epsilon)},$$

for some $\epsilon > 0$. If we rather use the second part of Proposition 1.13, then we obtain that:

$$L^{an}(p) \leq C(p - 1/2)^{-C},$$

for some $C < +\infty$. As a result, if the exponent ν exists, then $\nu \in (1, +\infty)$ (which is exactly - as far as we know - what is known for Bernoulli percolation on \mathbb{Z}^2 , see [Kes87]). By using the polynomial decay property (1.1) and the scaling relation (1.3) of Theorem 1.11, we deduce from this that:

$$\epsilon (p - 1/2)^C \leq \theta^{an}(p) \leq C (p - 1/2)^\epsilon, \quad (1.5)$$

for some $C < +\infty$ and $\epsilon > 0$. In [KZ87], Kesten and Zhang have proved the following for Bernoulli percolation on \mathbb{Z}^2 :

$$\theta(p) \geq \epsilon (p - 1/2)^{1-\epsilon}. \quad (1.6)$$

In the case of Bernoulli percolation on the triangular lattice, it is known (see [LSW02] and [SW01]) that:

$$L(p) = (p - 1/2)^{-4/3+o(1)}$$

and:

$$\theta(p) = (p - 1/2)^{5/36+o(1)},$$

where $o(1) \rightarrow 0$ as $p \searrow 1/2$. The estimate (1.5) is strengthened in the two following works:

- In Chapter 6, we prove that $\theta^{an}(p) \geq \epsilon(p - 1/2)^{1-\epsilon}$ (by relying a lot on the present chapter and in particular on Appendix D).
- In [DCRT17a] Duminil-Copin, Raoufi and Tassion use the OSSS inequality to prove that, for Voronoi percolation in any dimension $d \geq 2$, there exists $c = c(d) > 0$ such that, for any $p > p_c = p_c(d)$:

$$\theta^{an}(p) \geq c(p - p_c).$$

1.5 Quenched or annealed results?

In the present chapter, our main goal is to prove **annealed** properties. The most important ones are the annealed scaling relations (Theorem 1.11) and the annealed quasi-multiplicativity property (Proposition 1.6). However, the **quenched** property Theorem 1.4 will be one of our main tools. The multiple passages from quenched to annealed properties will be rather technical, see in particular Section 7. As a result, it seems at first sight that it would be easier to prove quenched properties. We indeed believe that one could use Theorem 1.4 to prove a quenched quasi-multiplicativity property (with a less technical proof than the annealed quasi-multiplicativity property). However, proving scaling relations at the quenched level seems much more complicated than proving them at the annealed level since the classical methods (that we follow in the present paper) deeply rely on **translation invariance** properties.

Acknowledgments: I would like to thank Christophe Garban for many helpful discussions and for his comments on earlier versions of the manuscript. I would also like to thank Vincent Tassion for fruitful discussions and for having welcomed me in Zürich several times.

2 Strategy and organization of the chapter

2.1 Some notations

Before stating the main intermediate results and explaining the global strategy, let us introduce some notations.

Boxes, annuli and quads. In all the chapter, we will write $B_R = [-R, R]^2$ and we will write $A(r, R) = [-R, R]^2 \setminus (-r, r)^2$. Also, for every $y \in \mathbb{R}^2$, we will write $B_r(y) = y + B_r$ and $A(y; r, R) = y + A(r, R)$. A quad Q is a topological rectangle in the plane with two distinguished opposite sides. Also, a black (respectively white) path included in Q that joins one distinguished side to the other is called a crossing (respectively dual crossing). The event that Q is crossed (respectively dual-crossed) will be written $\text{Cross}(Q)$ (respectively $\text{Cross}^*(Q)$).

Other notations. In all the chapter, we will use the following notations: (a) $O(1)$ is a positive bounded function, (b) $\Omega(1)$ is a positive function bounded away from 0 and (c) if f and g are two non-negative functions, then $f \asymp g$ means $\Omega(1)f \leq g \leq O(1)f$.

We will also use the following notation: Let $(\Omega, \mathcal{F}, \mathbb{P})$ be a probability space. If $\mathcal{G} \subseteq \mathcal{F}$ is a σ -field, B is some event such that $\mathbb{P}[B] > 0$, and A is some event, then:

$$\mathbb{P}[A \mid B, \mathcal{G}] := \frac{\mathbb{P}[A \cap B \mid \mathcal{G}]}{\mathbb{P}[B \mid \mathcal{G}]} \mathbb{1}_{\{\mathbb{P}[B \mid \mathcal{G}] > 0\}}.$$

Note that, $\mathbb{P}[\cdot \mid B]$ -a.s., we have: $\mathbb{P}[A \mid B, \mathcal{G}]$ is the conditional expectation of A with respect to \mathcal{G} and under $\mathbb{P}[\cdot \mid B]$.

2.2 Correlation inequalities for Voronoi percolation

In this subsection, we recall two very useful families of correlation inequalities: the FKG-Harris inequalities and the BK inequalities, which are inequalities for increasing events. First, let us define what is an increasing event in our context. Since we work in random environment, it is interesting to consider quenched and annealed notions of increasing events.

Definition 2.1. i) First, we recall the classical notion of increasing events. Let E be a countable set. An event A of the product σ -algebra on $\{-1, 1\}^E$ is increasing if for any $\omega, \omega' \in \{-1, 1\}^E$ such that $\omega \leq \omega'$ and $\omega \in A$, we have $\omega' \in A$.

ii) An event A measurable with respect to the coloured configuration ω is quenched-increasing if, for every point configuration of the plane η and every $\omega, \omega' \in \{-1, 1\}^\eta$ such that $\omega \in A$ and $\omega \leq \omega'$, we have $\omega' \in A$.

iii) An event A is annealed-increasing if, for any coloured configuration $\omega \in A$ and any ω' obtained from ω by adding black points or deleting white points, we have $\omega' \in A$.

Note that, if A is annealed-increasing, then A is quenched-increasing.

The FKG-Harris inequalities.

- i) The classical FKG-Harris inequality is the following (see [Gri99, BR06b]): Let E be a countable set. Remember that we write $\mathbf{P}_p^E := (p\delta_1 + (1-p)\delta_{-1})^{\otimes E}$. Let A and B be increasing events. Then, for every p we have:

$$\mathbf{P}_p^E [A \cap B] \geq \mathbf{P}_p^E [A] \cdot \mathbf{P}_p^E [B] .$$

- ii) In the quenched case, the FKG-Harris inequality is a direct consequence of the above inequality and can be stated as follows: Let A and B be two quenched-increasing events. Then, for every point configuration of the plane η and every p we have:

$$\mathbf{P}_p^\eta [A \cap B] \geq \mathbf{P}_p^\eta [A] \cdot \mathbf{P}_p^\eta [B] .$$

- iii) In the annealed case, we have: Let A and B be two annealed-increasing events. Then, for every p :

$$\mathbb{P}_p [A \cap B] \geq \mathbb{P}_p [A] \cdot \mathbb{P}_p [B] .$$

See Lemma 14 in Chapter 8 of [BR06b] for the proof of this inequality. (Note that this does not hold in general for quenched-increasing events; indeed if A depends only on η and if $\mathbb{P}[A] \in]0, 1[$ then A and A^c are quenched-increasing and $0 = \mathbb{P}[A \cap A^c] < \mathbb{P}[A] \mathbb{P}[A^c]$.)

The BK inequalities. Let A and B be two quenched increasing events measurable with respect to ω restricted to a bounded domain. Define the disjoint occurrence of A and B as follows (where, for every coloured configuration ω , we write $\eta(\omega)$ for the underlying (non-coloured) point configuration):

$$A \square B = \{ \omega \in \Omega : \exists I_1, I_2 \text{ finite disjoint subsets of } \eta(\omega), \omega^{I_1} \in A \text{ and } \omega^{I_2} \in B \} , \quad (2.1)$$

where Ω is the set of all coloured configurations and, if $I \subseteq \eta(\omega)$, $\omega^I \subseteq \{-1, 1\}^{\eta(\omega)}$ is the set of all ω' such that $\omega'_i = \omega_i$ for every $i \in I$.

We will use the following quenched BK inequality which is a direct consequence of the classical BK inequality (see for instance [Gri99] or [BR06b]): For every η and every p we have:

$$\mathbf{P}_p^\eta [A \square B] \leq \mathbf{P}_p^\eta [A] \cdot \mathbf{P}_p^\eta [B] . \quad (2.2)$$

Unfortunately, the annealed-version of the BK-inequality is only known for $p = 1/2$ (and it seems actually not clear whether or not it should be true for $p \neq 1/2$). This will cause some difficulties when we want to extend some results to the near-critical phase, see Section 5.

Proposition 2.2 (Lemma 3.4 of [AGMT16],[Joo12] - both refer to van den Berg). *Let A and B be two annealed increasing events measurable with respect to the coloured configuration ω restricted to a bounded domain. Then:*

$$\mathbb{P}_{1/2} [A \square B] \leq \mathbb{P}_{1/2} [A] \cdot \mathbb{P}_{1/2} [B] .$$

2.3 Consequences of the annealed quasi-multiplicativity property

In this subsection, we discuss important consequences of the (annealed) quasi-multiplicativity property Proposition 1.6. As mentioned in Subsection 1.2, Proposition 1.6 is the most technical result of the chapter. For this reason, we have chosen to postpone its proof to the final section: Section 7. We will use this property in most of the other sections of the chapter (for more about which section depends on which other section, see the beginning of Subsection 2.5). Let us state some results that will be useful all along the chapter and which are consequences of the quasi-multiplicativity property (and of intermediate results from Section 7). These results are essentially useful to **overcome the spatial dependencies of the model** and will be crucial in Section 4 where we deal with “pivotal events”. We first need a definition.

Definition 2.3. We let:

$$\widehat{\mathbf{A}}_j(r, R) = \left\{ \mathbb{P} \left[\mathbf{A}_j(r, R) \mid \omega \cap A(r, R) \right] > 0 \right\}.$$

In words, $\widehat{\mathbf{A}}_j(r, R)$ is the event that, conditionally on the coloured configuration in the annulus $A(r, R)$, the arm event $\mathbf{A}_j(r, R)$ holds with positive probability.

What is interesting with $\widehat{\mathbf{A}}_j(r, R)$ is that **it is measurable with respect to $\omega \cap A(r, R)$** . Note also that a.s. $\mathbf{A}_j(r, R) \subseteq \widehat{\mathbf{A}}_j(r, R)$ (i.e. $\mathbb{P} \left[\mathbf{A}_j(r, R) \setminus \widehat{\mathbf{A}}_j(r, R) \right] = 0$).⁵ The following result will be proved in Subsection 7.2:

Proposition 2.4. *Let $j \in \mathbb{N}^*$, let $1 \leq r \leq R$, and write:*

$$f_j(r, R) = f_{j,1/2}(r, R) := \mathbb{P}_{1/2} \left[\widehat{\mathbf{A}}_j(r, R) \right]. \quad (2.3)$$

There exists a constant $C = C(j) < +\infty$ such that:

$$\alpha_{j,1/2}^{an}(r, R) \leq f_j(r, R) \leq C \alpha_{j,1/2}^{an}(r, R).$$

The following is a consequence of Proposition 2.4 and illustrates how this last proposition can help us to overcome spatial dependency problems.

Proposition 2.5. *Let $j \in \mathbb{N}^*$. For every $h \in (0, 1)$, there exists a constant $\epsilon = \epsilon(j, h) \in (0, 1)$ such that, for every $1 \leq r \leq R$ and for every event G which is measurable with respect to $\omega \setminus A(2r, R/2)$ and satisfies $\mathbb{P}_{1/2} [G] \geq 1 - \epsilon$, we have:*

$$\mathbb{P}_{1/2} [\mathbf{A}_j(r, R) \cap G] \geq (1 - h) \alpha_{j,1/2}^{an}(r, R).$$

Proof. We have:

$$\begin{aligned} \mathbb{P}_{1/2} [\mathbf{A}_j(r, R) \setminus G] &\leq \mathbb{P}_{1/2} \left[\widehat{\mathbf{A}}_j(2r, R/2) \setminus G \right] \\ &= f_j(2r, R/2) \cdot \mathbb{P}_{1/2} [\neg G], \end{aligned}$$

by spatial independence. Proposition 2.4 implies that $f_j(2r, R/2) \asymp \alpha_j^{an}(r/2, 2R)$. Moreover, the quasi-multiplicativity property and (1.1) imply that $\alpha_{j,1/2}^{an}(r/2, 2R) \asymp \alpha_{j,1/2}^{an}(r, R)$, which ends the proof. \square

Remark 2.6. Note that, with essentially the same proof, we obtain the following result: Let $j \in \mathbb{N}^*$. For every $h \in (0, 1)$, there exists a constant $\epsilon = \epsilon(j, h) \in (0, 1)$ such that, for every $1 \leq r \leq \rho \leq R$ and for every event G which is measurable with respect to $\omega \setminus (A(2r, \rho/2) \cup A(2\rho, R/2))$ and satisfies $\mathbb{P}_{1/2} [G] \geq 1 - \epsilon$, we have:

$$\mathbb{P}_{1/2} [\mathbf{A}_j(r, R) \cap G] \geq (1 - h) \alpha_{j,1/2}^{an}(r, R).$$

In Section 7, we also use the quasi-multiplicativity property to compute universal arm exponents. For every $1 \leq r \leq R$, let $\alpha_{j,1/2}^{an,+}(r, R)$ denote the probability of the j -event in the half plane (i.e. the event that there are j paths of alternating colors from ∂B_r to ∂B_R that live in the upper half-plane). See Subsection 7.3: the quasi-multiplicativity property can also be proved for these quantities. We have the following:

Proposition 2.7. *The computation of the universal arm-exponents by Aizenman holds for Voronoi percolation: Let $1 \leq r \leq R$, we have:*

⁵To prove this, use for instance the following result with $X = \mathbb{1}_{\mathbf{A}_j(r, R)}$ and $\mathcal{G} = \sigma(\omega \cap A(r, R))$: Let X be a non-negative random variable and let \mathcal{G} be a sub- σ -field of the underlying σ -field. Then, a.s. we have: $\mathbb{E} \left[X \mid \mathcal{G} \right] = 0 \Rightarrow X = 0$.

$$\text{i) } \alpha_{2,1/2}^{an,+}(r, R) \asymp r/R,$$

$$\text{ii) } \alpha_{3,1/2}^{an,+}(r, R) \asymp (r/R)^2,$$

$$\text{iii) } \alpha_{5,1/2}^{an}(r, R) \asymp (r/R)^2.$$

Items i) and ii) of Proposition 2.7 are proved in Subsection 7.3 while Item iii) is proved in Subsection 7.4.

2.4 Some important events: the pivotal events and the “good” events

2.4.1 Pivotal events

A crucial step in the proof of the scaling relations is the study of pivotal events for crossing and arm events. In the present work, we introduce **a quenched and an annealed definitions for pivotal events**. Let us begin with a classical definition: Let E be a countable set and let A be an event of the product σ -algebra on $\{-1, 1\}^E$. A point $i \in E$ is pivotal for a configuration $\omega \in \{-1, 1\}^E$ and the event A if changing the value of ω_i changes the value of $\mathbb{1}_A(\omega)$. We write $\mathbf{Piv}_i^E(A)$ for the event that i is pivotal for A (if $E = \{1, \dots, n\}$, we denote this event by $\mathbf{Piv}_i^n(A)$). More generally, if I is a finite subset of E , we say that I is pivotal for ω and A if there exists $\omega' \in \{-1, 1\}^E$ such that ω and ω' coincide outside of I and $\mathbb{1}_A(\omega') \neq \mathbb{1}_A(\omega)$. We denote by $\mathbf{Piv}_I^E(A)$ the corresponding event. Let us now introduce a quenched and an annealed notions of pivotal sets. The quenched version is very similar to the above notion:

Definition 2.8. Let A be an event measurable with respect to the coloured configuration ω and let η be the underlying (non-coloured) point configuration. A bounded Borel set D is quenched-pivotal for ω and A if there exists $\omega' \in \{-1, 1\}^\eta$ (note that ω' has the same underlying point configuration as ω) such that ω and ω' coincide on $\eta \cap D^c$ and $\mathbb{1}_A(\omega') \neq \mathbb{1}_A(\omega)$. We write $\mathbf{Piv}_D^q(A)$ for the event that D is quenched-pivotal for A .

We also use the following terminology: if $x \in \eta$, we say that x is quenched-pivotal for A if changing the color of x modifies the value of $\mathbb{1}_A$. If we work conditionally on η and if $x \in \eta$, then $\{x \text{ is quenched-pivotal for } A\}$ is an event of the product space $\{-1, 1\}^\eta$, and we denote this event by $\mathbf{Piv}_x^q(A)$.

Definition 2.9. A bounded Borel set D is annealed-pivotal for some coloured configuration ω and some event A if both $\mathbb{P}_p[A | \omega \setminus D]$ and $\mathbb{P}_p[\neg A | \omega \setminus D]$ are positive. We write $\mathbf{Piv}_D(A)$ for the event that D is annealed-pivotal for A (note that we omit the parameter p in the notation; actually, as far as $p \in (0, 1)$ and since D is bounded, the event $\mathbf{Piv}_D(A)$ does not depend on p).

We have the following link between annealed and quenched pivotal events: Let $p \in (0, 1)$, let D be a bounded Borel set, and let A be an event measurable with respect to the coloured configuration ω . Then, a.s. we have $\mathbf{Piv}_D^q(A) \subseteq \mathbf{Piv}_D(A)$, i.e. $\mathbb{P}_p[\mathbf{Piv}_D^q(A) \setminus \mathbf{Piv}_D(A)] = 0$. This is an easy consequence⁶ of the fact that, if D is quenched-pivotal for A , then a.s. (since $\eta \cap D$ is finite) $\mathbb{P}[A | \omega \setminus D, \eta \cap D]$ and $\mathbb{P}[\neg A | \omega \setminus D, \eta \cap D]$ are positive.

Let Q be a quad. The event that some box is (quenched or annealed) pivotal for the event $\text{Cross}(Q)$ is closely related to arm events and particularly to the 4-arm events. We prove estimates in this spirit in Subsections 4.1 and 4.3.

⁶Use for instance the following result with $X = \mathbb{1}_A$, $\mathcal{G}_1 = \sigma(\omega \setminus D)$ and $\mathcal{G}_2 = \sigma(\eta, \omega \setminus D)$: Let X be a non-negative random variable and let $\mathcal{G}_1 \subseteq \mathcal{G}_2$ be two sub- σ -fields of the underlying σ -field. Then, a.s. we have: $\mathbb{E}[X | \mathcal{G}_1] = 0 \Rightarrow \mathbb{E}[X | \mathcal{G}_2] = 0$.

2.4.2 The events Dense, QBC and GI

In this subsection, we define three “good” events that we will use all along the chapter. Their introduction is motivated by the three following observations: i) There are less spatial dependencies when the point configuration η is sufficiently dense. ii) It is often interesting to condition on η since the conditional measure is the product measure $\mathbb{P}_p^\eta = (p\delta_1 + (1-p)\delta_{-1})^{\otimes \eta}$. To apply geometric arguments under this quenched measure, we need $\mathbb{P}_p^\eta[\text{Cross}(Q)]$ to be non-negligible for a large family of quads Q . iii) It is easier to deal with arm events when the arms are well separated.

Definition 2.10. Let D be a bounded subset of the plane and let $\delta \in (0, 1)$. We denote by $\text{Dense}_\delta(D)$ the event that, for every point $u \in D$, there exists $x \in \eta \cap D$ such that $\|x - u\|_2 \leq \delta \cdot \text{diam}(D)$.

Lemma 2.11. Let $R \geq 1$ and $\delta \in (0, 1)$. We have:

$$\mathbb{P}[\text{Dense}_\delta(B_R)] \geq 1 - O(1)\delta^{-2} \exp\left(-\frac{(\delta \cdot R)^2}{2}\right).$$

Proof. This lemma can be obtained by covering B_R by a family $(S_i)_{1 \leq i \leq N}$ of $N \asymp \delta^{-2}$ squares of side-length $\delta \cdot R/\sqrt{2}$ and by observing that:

$$\text{Dense}_\delta(B_R) \supseteq \{\forall i, \eta \cap S_i \neq \emptyset\}$$

and:

$$\forall i, \mathbb{P}[\eta \cap S_i = \emptyset] = \exp\left(-\frac{(\delta \cdot R)^2}{2}\right).$$

See Lemma 18 in Chapter 8 of [BR06b] for the proof of a similar result. \square

In the following, we restrict ourselves to the case $p = 1/2$. See Subsection 5.2 for the extension of the results to the near-critical phase.

Definition 2.12. Let D be a subset of the plane and let $\delta \in (0, 1)$. We denote by $\mathcal{Q}'_\delta(D)$ the set of all quads $Q \subseteq D$ which are drawn on the grid $(\delta \text{diam}(D)) \cdot \mathbb{Z}^2$ (i.e. whose sides are included in the edges of $(\delta \text{diam}(D)) \cdot \mathbb{Z}^2$ and whose corners are vertices of $(\delta \text{diam}(D)) \cdot \mathbb{Z}^2$). Also, we denote by $\mathcal{Q}_\delta(D)$ the set of all quads $Q \subseteq D$ such that there exists a quad $Q' \in \mathcal{Q}'_\delta(D)$ satisfying $\text{Cross}(Q') \subseteq \text{Cross}(Q)$.

The following result will be proved in Subsection 3.2 by using Theorem 1.4.

Proposition 2.13. There is an absolute constant $C < +\infty$ such that the following holds: Let $\delta \in (0, 1)$ and $\gamma \in (0, +\infty)$. There exists a constant $c = c(\delta, \gamma) \in (0, 1)$ such that, for every bounded subset of the plane D that satisfies $\text{diam}(D) \geq \delta^{-2}/100$, we have:

$$\mathbb{P}[\text{QBC}_\delta^\gamma(D)] \geq 1 - C\text{diam}(D)^{-\gamma},$$

where:

$$\text{QBC}_\delta^\gamma(D) = \left\{ \forall Q \in \mathcal{Q}_\delta(D), \mathbf{P}_{1/2}^\eta[\text{Cross}(Q)] \geq c(\delta, \gamma) \right\}.$$

The notation QBC means “Quenched Box-Crossing property”.

Let us end this subsection by defining quantities related to the well-separateness of interfaces. Let $\delta \in (0, 1)$, let $1 \leq r \leq R$, and let β_1, \dots, β_k be the interfaces from ∂B_r to ∂B_R (an interface is a continuous path β drawn on the edges of the Voronoi tiling and such that one side of β is black and its other side is white). Also, let z_i^{ext} (respectively z_i^{int}) denote the endpoint on ∂B_R (respectively on ∂B_r) of β_i , and let $s^{\text{ext}}(r, R)$ (resp. $s^{\text{int}}(r, R)$) be the least distance between z_i^{ext} (respectively z_i^{int}) and $\cup_{j \neq i} \beta_j$.

Let $\text{GI}_\delta^{\text{ext}}(R)$ (for “Good Interfaces”) be the event that there does not exist $y \in \partial B_R$ such that the 3-arm event in $A(y; 10\delta R, R/4) \cap B_R$ holds. Note that, if $r \leq 3R/4$, then:

$$\text{GI}_\delta^{\text{ext}}(R) \subseteq \{s^{\text{ext}}(r, R) \geq 10\delta R\}.$$

This inclusion will be very useful. Note that $\{s^{\text{ext}}(r, R) \geq 10\delta R\}$ is not monotonic in r . This is actually the reason why we have introduced the event $\text{GI}_\delta^{\text{ext}}(R)$: this event “depends only on the crossings in $A(3R/4, R)$ ” and is included in $\{s^{\text{ext}}(r, R) \geq 10\delta R\}$ (for $r \leq 3R/4$).

Similarly, let $\text{GI}_\delta^{\text{int}}(r)$ be the event that there does not exist $y \in \partial B_r$ such that the 3-arm event in $A(y; 10\delta r, r/2) \setminus B_r$ holds. Note that, if $R \geq 3r/2$:

$$\text{GI}_\delta^{\text{int}}(r) \subseteq \{s^{\text{int}}(r, R) \geq 10\delta r\}.$$

We will prove the following lemma in Subsection 3.3:

Lemma 2.14. *Let $\delta \in (0, 1)$ and let $r, R \geq 100\delta^{-1}$. There exist absolute constants $C < +\infty$ and $\epsilon > 0$ such that:*

$$\mathbb{P}_{1/2} [\text{GI}_\delta^{\text{ext}}(R)] \geq 1 - C\delta,$$

and:

$$\mathbb{P}_{1/2} [\text{GI}_\delta^{\text{int}}(r)] \geq 1 - C\delta^\epsilon.$$

2.5 Organization of the chapter and interdependence of the sections

As explained in Subsection 2.3, we postpone the proof of the quasi-multiplicativity property to the final section: Section 7. We summarize the interdependence of the sections of the chapter in Figures 2.1 and 2.2.

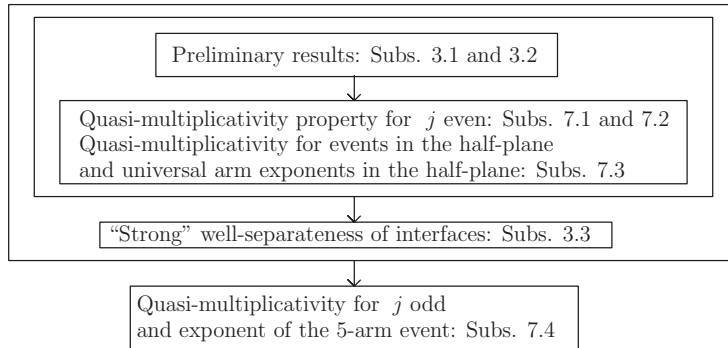

Figure 2.1 – Interdependence between Sections 3 and 7

2.6 Some ideas of proof

Let us end Section 2 by giving a few more details about our strategies of proofs.

2.6.1 The quasi-multiplicativity property (at $p = 1/2$)

In this subsection, we work at the parameter $p = 1/2$, and we explain ideas behind the proof of the quasi-multiplicativity property Proposition 1.6 in the case $j \geq 2$ (see Subsection 3.1 for the proof of the easier case $j = 1$). The proof is written in Section 7. We begin with two observations that illustrate the new difficulties compared to the study of Bernoulli percolation on a deterministic lattice.

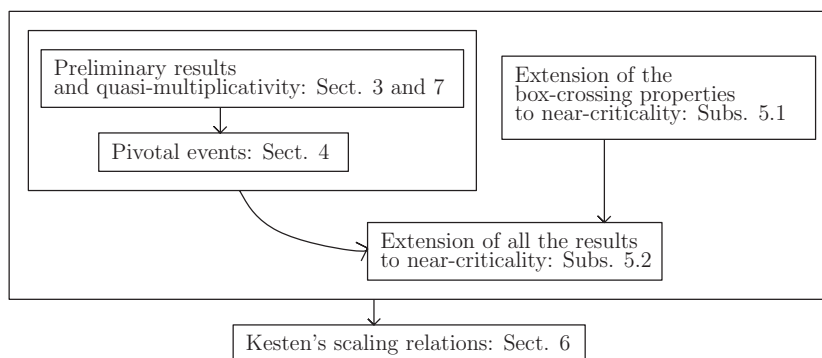

Figure 2.2 – Interdependence between Sections 3 to 7

- (a) The first observation is that, for Voronoi percolation, the following result does not seem easier to prove than the quasi-multiplicativity property itself: There exists a constant $C = C(j)$ such that, for every $R \geq 100$:

$$\alpha_{j,1/2}^{an}(100, R) \leq C \alpha_{j,1/2}^{an}(10, R).$$

A first idea to prove the above would be to condition on the event $\mathbf{A}_j(100, R)$ and on the coloured configuration outside of B_{100} and then extend the arms to ∂B_{10} “by hands”. The problem is that $\mathbf{A}_j(100, R)$ is a degenerated event and thus, as already suggested in Figure 1.1, it does not seem obvious at all that the following does not happen: “If we condition on $\mathbf{A}_j(100, R)$, then, with high probability, the point configuration in the neighbourhood of ∂B_{100} is very dense”. This may be a problem since it is difficult to extend the arms “by hands” when the point configuration is very dense.

- (b) For Bernoulli percolation on a deterministic lattice, the left-hand-inequality of the quasi-multiplicativity property is an easy consequence of the independence on disjoint sets. For Voronoi percolation, even the following does not seem easy to prove: There exists $C = C(j) < +\infty$ such that, for every $1 \leq r_1 \leq r_2 \leq r_3/2$: $\alpha_j^{an}(r_1, r_3) \leq C \alpha_j^{an}(r_1, r_2) \alpha_j^{an}(2r_2, r_3)$. However, one can note that the left-hand-inequality of the quasi-multiplicativity property is a direct consequence of Proposition 2.4 (which enables to use spatial independence properties). Actually, our strategy will be the following: we will first prove Lemma 7.7 and Corollary 7.8 which are results analogous to Proposition 2.4. Then, we will prove the quasi-multiplicativity property, and finally we will prove Proposition 2.4.

Now, let us be a little more precise about the proof of the quasi-multiplicativity property. In the spirit of [Kes87, Wer07, Nol08, SS10], we will prove that:

- i) If $\mathbf{A}_j(r, R)$ holds and if the configuration “looks good” near ∂B_R , then we can extend the arms at larger scale, see Lemma 7.6.
- ii) If we condition on $\mathbf{A}_j(r, R)$, then the configuration near ∂B_R “looks good” with non-negligible probability, see Lemma 7.7.

A difference with the case of Bernoulli percolation on a deterministic lattice is that, in the notion of “looking good”, we will have to ask that **both the random tiling and the random colouring** look good. Concerning the random colouring: As in the case of Bernoulli percolation on \mathbb{Z}^2 or on \mathbb{T} , we will ask that the interfaces between black and white crossings are well separated so that we can use box-crossing estimates. Concerning the random tiling: (1) To avoid spatial dependence problems, we will ask that $\text{Dense}_\delta(A(R/2, 2R))$ (see Definitions 2.10) holds for some well-chosen $\delta > 0$. (2) In order to use box-crossing estimates when we condition

on η , we will ask that $\text{QBC}_\delta^1(A(R))$ (see Proposition 2.13) holds for some well-chosen annulus $A(R)$ at scale R and $\delta > 0$. The idea is that, if the interfaces are well separated, if the two conditions (1) and (2) above are satisfied, and if we condition on η and on the interfaces, then we can extend the arms by using box-crossing techniques and the (quenched) Harris-FKG inequality. As we will see in Section 7, we will have to consider events a little more complicated because we will want the events to be **measurable with respect to $\omega \cap A(R/2, 2R)$** .

Also, we will see that, for technical reasons, we will have to consider different notions of well-separateness of interfaces. More precisely, we will first prove the quasi-multiplicativity property in the case j even (in Subsection 7.1) and by using the following definition of well-separateness: two interfaces are well separated if their end-points are. By following the same proof, we will also obtain the quasi-multiplicativity property for j -arm events in the half-plane (with j either even or odd). Thanks to this last property, we will be able to compute the universal exponent of the 3-arm event in the half-plane. Then, it will be possible (by using our knowledge on $\alpha_{3,1/2}^+(r, R)$) to deal with the following slightly different definition of well-separateness of interfaces: two interfaces are well separated if the end-point of each of them is far enough from the union of the other interfaces (and not only far enough from the other end-points). This other notion of well-separateness is the one defined in Subsection 2.4.2, and we will need this notion to prove the quasi-multiplicativity property in the case j odd (see Subsection 7.4).

2.6.2 The annealed scaling relations

Once we have proved the quasi-multiplicativity property and all the results stated in Section 2, the ideas for the proof of the annealed scaling relations are the same as in the original paper of Kesten [Kes87] (see also [Wer07, Nol08]). The only difference is that we will need to combine quenched and annealed notions of pivotal events.

3 Preliminary results

In this section, we only work at the parameter $p = 1/2$, hence we intentionally forget the subscript p in the notations.

3.1 Warm-up: proof of (1.1) and of the quasi-multiplicativity property for $j = 1$

In this subsection, we prove that the probabilities of arm events decay polynomially fast, i.e. we prove (1.1) (this can be seen as an illustration of how we use the events $\text{Dense}(\cdot)$ from Definition 2.10). We also prove the quasi-multiplicativity property in the case $j = 1$ (this can be seen as an illustration of how we use the events $\text{Dense}(\cdot)$ and events of the kind $\widehat{\mathbf{A}}_j(r, R)$ from Definition 2.3). To prove these inequalities, we do not rely on any result proved in this chapter but only on the (annealed) FKG property and on the (annealed) box-crossing property Theorem 1.3.

Proof of (1.1). As explained below (1.1), the upper-bound is proved in [Tas16]. Let us prove the lower-bound. First, note that we can choose a constant $M = M(j) \in [10, +\infty)$ such that we can define j sets of $2n \asymp \log(R/r)$ rectangles: $\{Q_i^1 \cdots, Q_i^{2n}\}$, $i = 0, \dots, j - 1$ that satisfy:

- (a) For every $i \in \{0, \dots, j - 1\}$ and every $l \in \{1, \dots, n\}$, Q_i^{2l-1} and Q_i^{2l} are $(2^l r) \times (2^{l-M} r)$ rectangles;
- (b) For all $i \neq i' \in \{0, \dots, j - 1\}$ and all $l, l' \in \{1, \dots, 2n\}$, Q_i^l is at distance at least $\max(2^{l-M} r, 2^{l'-M} r)$ from $Q_{i'}^{l'}$;

- (c) If for every $l \in \{1, \dots, 2n\}$ and every $i \in \{0, \dots, j-1\}$ even (respectively odd) the rectangle Q_i^l is crossed lengthwise (respectively dual-crossed lengthwise), then $\mathbf{A}_j(r, R)$ holds. (See Figure 3.1.)

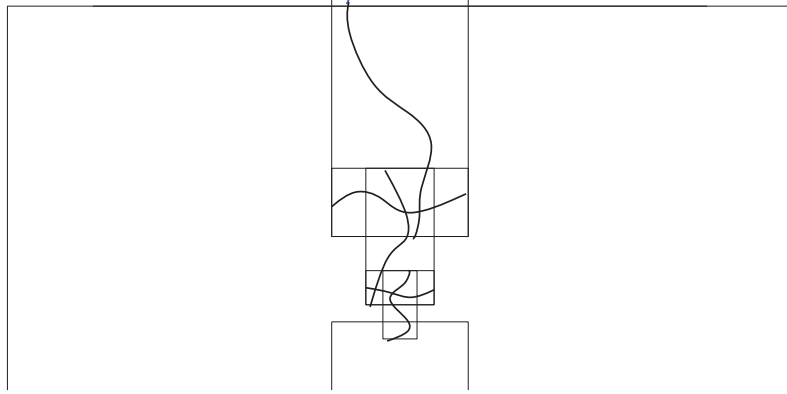

Figure 3.1 – The rectangles Q_i^l for some i .

Let $i \in \{0, \dots, j-1\}$ even (respectively odd), and let $\widetilde{\text{Dense}}(Q_i^l)$ be the event that, for any $u \in Q_i^l$, there exists a black (respectively white) point $x \in \eta \cap Q_i^l$ at Euclidean distance less than $2^{l-2M}r$ from x . Note that the event $\widetilde{\text{Dense}}(Q_i^l)$ is slightly different from the event $\text{Dense}(Q_i^l)$ of Definition 2.10; in particular, it is annealed increasing (respectively annealed decreasing) if i is even (respectively odd).

We have:

$$\alpha_j^{an}(r, R) \geq \mathbb{P} \left[\bigcap_{i,l} \text{Cross}(Q_i^l) \right] \geq \mathbb{P} \left[\bigcap_{i,l} \text{Cross}(Q_i^l) \cap \widetilde{\text{Dense}}(Q_i^l) \right].$$

Next, note that the j events $\bigcap_{l=1}^{2n} \left(\text{Cross}(Q_i^l) \cap \widetilde{\text{Dense}}(Q_i^l) \right)$ are independent. As a result the above equals:

$$\prod_{i=0}^{j-1} \mathbb{P} \left[\bigcap_{l=1}^{2n} \text{Cross}(Q_i^l) \cap \widetilde{\text{Dense}}(Q_i^l) \right].$$

We can now use the (annealed) FKG-Harris inequality. Indeed, for every i even (respectively odd) and every $l \in \{1, \dots, 2n\}$, the event $\text{Cross}(Q_i^l) \cap \widetilde{\text{Dense}}(Q_i^l)$ is annealed increasing (respectively annealed decreasing). We thus obtain that the above is at least:

$$\prod_{i=0}^{j-1} \prod_{l=1}^{2n} \mathbb{P} \left[\text{Cross}(Q_i^l) \cap \widetilde{\text{Dense}}(Q_i^l) \right].$$

By the same proof as Lemma 2.11, we have: $\mathbb{P} \left[\widetilde{\text{Dense}}(Q_i^l) \right] \geq 1 - C \exp(-c2^{2l})$, for some $C = C(M) < +\infty$ and $c = c(M) > 0$. By using this estimate and the box-crossing property Theorem 1.3, we obtain that there exists a constant $c' = c'(M) > 0$ such that, for every l large enough (larger than some $l_0(M)$, say) and every i , $\mathbb{P}_{1/2} \left[\text{Cross}(Q_i^l) \cap \widetilde{\text{Dense}}(Q_i^l) \right] \geq c'$. Moreover, it is easy to see that, for every $i \in \{0, \dots, j-1\}$ and every $l \in \{1, \dots, l_0\}$, we have $\mathbb{P}_{1/2} \left[\text{Cross}(Q_i^l) \cap \widetilde{\text{Dense}}(Q_i^l) \right] \geq c''$ for some $c'' = c''(M, l_0) > 0$. Thus, we have:

$$\alpha_j^{an}(r, R) \geq (\min\{c', c''\})^{2nj},$$

which ends the proof. \square

Proof of the quasi-multiplicativity property in the case $j = 1$. As pointed out in Remark 1.7, if $j = 1$ then the right-hand-inequality of the quasi-multiplicativity property is a direct consequence of the annealed FKG-Harris inequality and of the annealed box-crossing result Theorem 1.3. Here, we prove the left-hand-inequality (by relying on the right-hand-inequality). The main difficulty is the lack of spatial independence. To overcome it, we work with the following events and quantities (analogous to those introduced in Subsection 2.3). Let $1 \leq r \leq R$ and:

$$\begin{aligned}\widehat{\mathbf{A}}_1^{ext}(r, R) &:= \left\{ \mathbb{P} \left[\mathbf{A}_1(r, R) \mid \omega \cap B_R \right] > 0 \right\}, \\ \widehat{\mathbf{A}}_1^{int}(r, R) &:= \left\{ \mathbb{P} \left[\mathbf{A}_1(r, R) \mid \omega \setminus B_r \right] > 0 \right\}, \\ f_1^{ext}(r, R) &:= \mathbb{P} \left[\widehat{\mathbf{A}}_1^{ext}(r, R) \right], \\ f_1^{int}(r, R) &:= \mathbb{P} \left[\widehat{\mathbf{A}}_1^{int}(r, R) \right].\end{aligned}$$

Note that $\alpha_1^{an}(r, R) \leq f_1^{ext}(r, R)$ and $\alpha_1^{an}(r, R) \leq f_1^{int}(r, R)$. What is interesting with these events is that, if $1 \leq r_1 \leq r_2 \leq r_3$, then $\widehat{\mathbf{A}}_1^{ext}(r_1, r_2)$ and $\widehat{\mathbf{A}}_1^{int}(r_2, r_3)$ are independent (indeed, the first one is measurable with respect to $\omega \cap B_{r_2}$ while the second one is measurable with respect to $\omega \setminus B_{r_2}$). Hence we have:

$$\begin{aligned}\alpha_1^{an}(r_1, r_3) &\leq \mathbb{P} \left[\widehat{\mathbf{A}}_1^{ext}(r_1, r_2) \cap \widehat{\mathbf{A}}_1^{int}(r_2, r_3) \right] \\ &= f_1^{ext}(r_1, r_2) f_1^{int}(r_2, r_3).\end{aligned}$$

As a result, it is sufficient to prove that $f_1^{ext}(r, R), f_1^{int}(r, R) \leq O(1) \alpha_1^{an}(r, R)$. We prove this only for $f_1^{int}(r, R)$ since the proof for $f_1^{ext}(r, R)$ is the same.

Let $\text{Dense}(r) := \text{Dense}_{1/100}(A(r/2, 2r))$ where $\text{Dense}_\delta(D)$ is defined in Definition 2.10. With the same proof as Lemma 2.11, we have: $\mathbb{P}[\text{Dense}(r)] \geq 1 - O(1) \exp(-\Omega(1)r^2)$. If $\text{Dense}(r)$ holds, then we have the following: if $x \in \eta$ is such that the Voronoi cell of x intersects $A(2r, R)$, then $x \notin B_r$. As a result, $\widehat{\mathbf{A}}_1^{int}(r, R) \cap \text{Dense}(r) \subseteq \mathbf{A}_1(2r, R)$. So:

$$f_1^{int}(r, R) \leq \alpha_1^{an}(2r, R) + \mathbb{P} \left[\widehat{\mathbf{A}}_1^{int}(r, R) \setminus \text{Dense}(r) \right].$$

Moreover, by using the fact that $\text{Dense}(r)$ and $\widehat{\mathbf{A}}_1^{int}(2r, R)$ are independent (the first one is measurable with respect to $\eta \cap A(r/2, 2r)$ while the second one is measurable with respect to $\omega \setminus B_{2r}$), we obtain that $f_1^{int}(r, R)$ is at most:

$$\begin{aligned}\alpha_1^{an}(2r, R) + \mathbb{P} \left[\widehat{\mathbf{A}}_1^{int}(r, R) \setminus \text{Dense}(r) \right] &\leq \alpha_1^{an}(2r, R) + \mathbb{P} \left[\widehat{\mathbf{A}}_1^{int}(2r, R) \setminus \text{Dense}(r) \right] \\ &= \alpha_1^{an}(2r, R) + f_1^{int}(2r, R) (1 - \mathbb{P}[\text{Dense}(r)]) \\ &\leq \alpha_1^{an}(2r, R) + f_1^{int}(2r, R) O(1) \exp(-\Omega(1)r^2).\end{aligned}$$

By iterating the above inequality, we obtain that:

$$\begin{aligned}f_1^{int}(r, R) &\leq \alpha_1^{an}(2r, R) + O(1) \sum_{i=0}^{\lfloor \log_2(R/r) \rfloor - 2} \left(\alpha_1^{an}(2^{i+2}r, R) \exp(-\Omega(1)(2^i r)^2) \right) \\ &\quad + O(1) \exp\left(-\Omega(1)(2^{\lfloor \log_2(R/r) \rfloor - 1} r)^2\right).\end{aligned}$$

We now use the right-hand-inequality of the quasi-multiplicativity property and (1.1), which imply that there exists a constant $C_1 < +\infty$ such that, for every $i \in \{1, \dots, \lfloor \log_2(R/r) \rfloor + 1\}$, we have:

$$\alpha_1^{an}(2^i r, R) \leq C_1^i \alpha_1^{an}(r, R).$$

We finally obtain:

$$f_1^{\text{int}}(r, R) \leq O(1) \alpha_1^{\text{an}}(r, R) \times \left(C_1 + \sum_{i=0}^{\lfloor \log_2(R/r) \rfloor - 2} (C_1^{i+2} \exp(-\Omega(1)(2^i r)^2)) + C_1^{\lfloor \log_2(R/r) \rfloor + 1} \exp(-\Omega(1)(2^{\lfloor \log_2(R/r) \rfloor - 1} r)^2) \right).$$

This ends the proof since the quantity between parentheses can be bounded by some absolute constant. \square

3.2 A generalization of Theorem 1.4 to a family of quads

The fact that we can choose any $\gamma > 0$ in the quenched box-crossing property Theorem 1.4 is crucial for us. In particular, this implies that the quenched box crossing property is true **for a lot of quads simultaneously** with high probability. In this subsection, we use the notations from Definition 2.12 and Proposition 2.13 and we prove Proposition 2.13.

Proof of Proposition 2.13. Let $(Q_i)_{i \in \{1, \dots, N(D, \delta)\}}$ be an enumeration of all $2\delta \text{diam}(D) \times \delta \text{diam}(D)$ rectangles that intersect D and that are drawn on the grid $(\delta \text{diam}(D)) \cdot \mathbb{Z}^2$. Note that, if $Q \in \mathcal{Q}_\delta(D)$, then:

$$\bigcap_{i=1}^{N(D, \delta)} \{Q_i \text{ is crossed lengthwise}\} \subseteq \text{Cross}(Q).$$

The (quenched) FKG-Harris inequality implies that, for every $Q \in \mathcal{Q}_\delta(D)$ and for every η we have:

$$\prod_{i \in \{1, \dots, N(D, \delta)\}} \mathbf{P}^\eta [Q_i \text{ is crossed lengthwise}] \leq \mathbf{P}^\eta [\text{Cross}(Q)]. \quad (3.1)$$

Now, let $\gamma' > 0$ to be fixed later. Theorem 1.4 implies that there exists a constant $c_0 = c_0(\gamma') \in (0, 1)$ such that:

$$\forall i, \mathbb{P} [\mathbf{P}^\eta [Q_i \text{ is crossed lengthwise}] \geq c_0] \geq 1 - (\delta \text{diam}(D))^{-\gamma'}.$$

By a union bound we obtain that:

$$\begin{aligned} \mathbb{P} [\forall i, \mathbf{P}^\eta [Q_i \text{ is crossed lengthwise}] \geq c_0] &\geq 1 - O(1) N(D, \delta) (\delta \text{diam}(D))^{-\gamma'} \\ &\geq 1 - O(1) \delta^{-2} (\delta \text{diam}(D))^{-\gamma'}. \end{aligned}$$

Together with (3.1), this implies that:

$$\mathbb{P} \left[\forall Q \in \mathcal{Q}_\delta(D), \mathbf{P}^\eta [\text{Cross}(Q)] \geq c_0^{N(D, \delta)} \right] \geq 1 - O(1) \delta^{-2} (\delta \text{diam}(D))^{-\gamma'}.$$

We now use the fact that $\text{diam}(D) \geq \delta^{-2}/100$ and we choose $\gamma' = 2 + 4\gamma$. We have:

$$\begin{aligned} \delta^{-2} (\delta \text{diam}(D))^{-\gamma'} &= \delta^{-2-\gamma'} \text{diam}(D)^{-\gamma'} \\ &\leq (100)^{1+\gamma'/2} \text{diam}(D)^{1-\gamma'/2} = (100)^{2(1+\gamma)} \text{diam}(D)^{-2\gamma}. \end{aligned}$$

This ends the result if $\text{diam}(D)$ is sufficiently large (e.g. $\text{diam}(D) \geq (100)^2$) and if $c = c_0^{\sup_D N(D, \delta)} (= c_0^{O(1)\delta^{-2}})$. If $\text{diam}(D) \leq (100)^2$ then the proof is easy. \square

In Section 7, we will work with the following family of quads.

Definition 3.1. Let $\tilde{\mathcal{Q}}'_\delta(D)$ be the set of all quads $Q \subseteq D$ such that there exists $k \in \mathbb{N}$ such that Q is drawn on the grid $(2^k \delta \text{diam}(D)) \cdot \mathbb{Z}^2$ and the length of each side of Q is less than $100 \cdot 2^k \delta \text{diam}(D)$. Also, let $\tilde{\mathcal{Q}}_\delta(D)$ be the set of all quads $Q \subseteq D$ such that there exists a quad $Q' \in \tilde{\mathcal{Q}}'_\delta(D)$ satisfying $\text{Cross}(Q') \subseteq \text{Cross}(Q)$.

Proposition 3.2. *Let $\delta \in (0, 1)$ and $\gamma \in (0, +\infty)$. There exists $\tilde{c} = \tilde{c}(\gamma) \in (0, 1)$ such that,⁷*

⁷The fact that \tilde{c} does not depend on δ will be crucial.

for every bounded subset of the plane D satisfying $\text{diam}(D) \geq \delta^{-2}/100$, we have:

$$\mathbb{P} \left[\forall Q \in \tilde{\mathcal{Q}}_\delta(D), \mathbf{P}^\eta [\text{Cross}(Q)] \geq \tilde{c} \right] \geq 1 - O(1) \text{diam}(D)^{-\gamma},$$

where the constants in $O(1)$ are absolute constants.

Remark 3.3. One could use Proposition 3.2 and gluing arguments to prove Proposition 2.13 (with $c(\delta, \gamma) = \tilde{c}(\gamma)^{O(1)\delta^{-2}}$) but since we will essentially use Proposition 2.13 we have chosen to write the proof of this proposition and then mimic it in order to obtain Proposition 3.2.

Proof of Proposition 3.2. First, we work with the following set of quads: Let $\hat{\mathcal{Q}}_\delta(D) \subseteq \mathcal{Q}_\delta(D)$ be the set of all quads $Q \subseteq D$ drawn on the grid $(\delta \text{diam}(D)) \cdot \mathbb{Z}^2$ such that the length of each side of Q is less than $100 \cdot \delta \text{diam}(D)$. We have:

$$\tilde{\mathcal{Q}}_\delta(D) = \bigcup_{k=0}^{+\infty} \hat{\mathcal{Q}}_{2^k \delta}(D).$$

By following the proof of Proposition 2.13 we obtain that there exists $c_0 = c_0(\gamma) \in (0, 1)$ such that:

$$\mathbb{P} \left[\forall Q \in \hat{\mathcal{Q}}_\delta(D), \mathbf{P}^\eta [\text{Cross}(Q)] \geq c_0^{O(1)} \right] \geq 1 - O(1) \text{diam}(D)^{-\gamma}. \quad (3.2)$$

The fact that we have $c_0^{O(1)}$ instead of $c_0^{O(1)\delta^{-2}}$ comes from the fact that we only consider quads of side length $\leq 100 \cdot \delta \text{diam}(D)$. Now, note that the sets $\hat{\mathcal{Q}}_{2^k \delta}(D)$ are empty when $k > -\log_2(\delta)$, hence:

$$\tilde{\mathcal{Q}}_\delta(D) = \bigcup_{k=0}^{-\log_2(\delta)} \hat{\mathcal{Q}}_{2^k \delta}(D).$$

Note also that $-\log_2(\delta) \leq O(1) \log_2(\text{diam}(D))$ since $\text{diam}(D) \geq \delta^{-2}/100$. Let us apply (3.2) to $\hat{\mathcal{Q}}_{2^k \delta}(D)$ for every $k \in \{0, \dots, -\log_2(\delta)\}$ and with $\gamma + 1$ instead of γ . A union bound implies that there exists a constant $\tilde{c} = \tilde{c}(\gamma) > 0$ such that:

$$\begin{aligned} \mathbb{P} \left[\forall Q \in \tilde{\mathcal{Q}}_\delta(D), \mathbf{P}^\eta [\text{Cross}(Q)] \geq \tilde{c} \right] &\geq 1 - O(1) \log_2(\text{diam}(D)) \text{diam}(D)^{-(\gamma+1)} \\ &\geq 1 - O(1) \text{diam}(D)^{-\gamma}. \end{aligned}$$

□

3.3 “Strong” well-separateness of interfaces

In this subsection, we prove Lemma 2.14 i.e. we prove that the interfaces are well separated with high probability. Subsections 3.1 and 3.2 do not depend on the other subsections of the chapter but this is not the case of the present subsection. Indeed, we are going to rely on the results of Subsections 7.1, 7.2 and 7.3 where the quasi-multiplicativity property is proved in the case of an even number of arms and in the case of arm events in the half-plane, and where the exponent of the 3-arm event in the half-plane is computed.

Remark 3.4. In Subsection 7.1 we will prove another “well-separateness of interfaces lemma”: Lemma 7.4; but the notion of well-separateness of Lemma 7.4 is weaker than the one in Lemma 2.14. Lemma 7.4 is actually enough to deal with an even number of arms or with arm events restricted to a wedge, but is not enough to deal with an odd number of arms.

Proof of Lemma 2.14. First, note that there exist $\asymp \delta^{-1}$ points $y \in \partial B_R$ such that, if the event $\text{GI}_\delta^{\text{ext}}(R)$ does not hold, then there is a 3-arm event in one of the sets $A(y; 20\delta R, R/4) \cap B_R$. Note

also that, if $y \in \partial B_R$, then $A(y; 20\delta R, R/4) \cap B_R$ is included in a half-plane whose boundary contains y . Together with Item ii) of Proposition 2.7, this implies that:

$$\mathbb{P}[\text{GI}_\delta^{\text{ext}}(R)] \geq 1 - O(1)\delta^{-1} \left(\frac{\delta R}{R}\right)^2 = 1 - O(1)\delta.$$

Now, let us study $\text{GI}_\delta^{\text{int}}(r)$. As above, there exist $\asymp \delta^{-1}$ points $y \in \partial B_r$ such that, if the event $\text{GI}_\delta^{\text{int}}(r)$ does not hold, then there is a 3-arm event in one of the sets $A(y; 20\delta r, r/2) \setminus B_r$. However, it is not true that, for every $y \in \partial B_r$, $A(y; 20\delta r, r/2) \setminus B_r$ is included in a half-plane whose boundary contains y (there are problems at the corners of B_r). This is why we need the following result:

Claim 3.5. *Let $y \in \partial B_r$ and let ρ be such that y is at distance at least ρ from the corners of B_r . Assume that $\rho \in [20\delta r, r/2]$. Then, there exists a constant $\epsilon > 0$ such that:*

$$\mathbb{P}[\text{3-arm event in } A(y; 20\delta r, r/2) \setminus B_r] \leq O(1) \left(\frac{\delta r}{\rho}\right)^2 \left(\frac{\rho}{r}\right)^\epsilon.$$

Proof. Note that $A(y; 20\delta r, \rho) \setminus B_r$ is included in a half-plane whose boundary contains y . Write $\mathbf{A}_3^+(y; 20\delta r, \rho)$ for the 3-arm event in $A(y; 20\delta r, \rho) \setminus B_r$ and let:

$$\widehat{\mathbf{A}}_3^+(y; 20\delta r, \rho) = \left\{ \mathbb{P} \left[\mathbf{A}_3^+(y; 20\delta r, \rho) \mid \omega \cap A(y; 20\delta r, \rho) \right] > 0 \right\}.$$

Let y_0 be the corner of B_r closest to y , let $\mathbf{A}_3(y_0; 2\rho, r/2)$ be the 3-arm event $\mathbf{A}_3(2\rho, r/2)$ translated by y_0 , and let:

$$\widehat{\mathbf{A}}_3(y_0; 2\rho, r/2) = \left\{ \mathbb{P} \left[\mathbf{A}_3(y_0; 2\rho, r/2) \mid \omega \cap A(y_0; 2\rho, r/2) \right] > 0 \right\}.$$

The events $\widehat{\mathbf{A}}_3^+(y; 20\delta r, \rho)$ and $\widehat{\mathbf{A}}_3(y_0; 2\rho, r/2)$ are independent. Moreover, if the 3-arm event in $A(y; 20\delta r, r/2) \setminus B_r$ holds then both these events hold. Remember that in the present subsection we rely on the results of Subsections 7.1, 7.2 and 7.3 where the quasi-multiplicativity property and its consequences (e.g. Proposition 2.4) are proved for j odd and also for arm events in the half plane for any j . We apply Proposition 2.4 to the 2-arm event in the whole plane and to the 3-arm event in the half-plane. We obtain that:

$$\mathbb{P} \left[\widehat{\mathbf{A}}_3(y_0; 2\rho, r/2) \right] \leq \mathbb{P} \left[\widehat{\mathbf{A}}_2(y_0; 2\rho, r/2) \right] \asymp \alpha_2^{an}(2\rho, r/2)$$

and:

$$\mathbb{P} \left[\widehat{\mathbf{A}}_3^+(y; 20\delta r, \rho) \right] \asymp \alpha_3^{an,+}(20\delta r, \rho).$$

If we combine these estimates with (1.1) and with the computation of the 3-arm event in the half-plane (Item ii) of Proposition 2.7), we obtain that $\mathbb{P} \left[\widehat{\mathbf{A}}_3(y_0; 2\rho, r/2) \right] \leq O(1) \left(\frac{\rho}{r}\right)^{\Omega(1)}$ and $\mathbb{P} \left[\widehat{\mathbf{A}}_3^+(y; 20\delta r, \rho) \right] \asymp \left(\frac{\delta r}{\rho}\right)^2$. Finally:

$$\begin{aligned} \mathbb{P}[\text{3-arm event in } A(y; 20\delta r, r/2) \setminus B_r] &\leq \mathbb{P} \left[\widehat{\mathbf{A}}_3^+(y; 20\delta r, \rho) \cap \widehat{\mathbf{A}}_3(y_0; 2\rho, r/2) \right] \\ &\leq O(1) \left(\frac{\delta r}{\rho}\right)^2 \left(\frac{\rho}{r}\right)^{\Omega(1)}, \end{aligned}$$

which ends the proof. \square

We can (and do) assume that the constant ϵ of the claim is in $(0, 1)$. Now, note that there exist $N(\delta) \asymp \log_2(\delta^{-1})$ finite subsets of ∂B_r : $Y_1, \dots, Y_{N(\delta)}$ such that: (a) $|Y_i| \asymp 2^i$, (b) for every $y \in Y_i$, there exists a corner of B_r at distance $\asymp 2^i \delta r$ from y and (c) if $\text{GI}_\delta^{\text{int}}(r)$ does not hold, then there exists $y \in \cup_{i=1}^{N(\delta)} Y_i$ such that the 3-arm event in $A(y; 20\delta r, r/2) \setminus B_r$ holds. Combined with the claim, this observation implies that:

$$\begin{aligned} \mathbb{P}[\text{GI}_\delta^{\text{int}}(r)] &\leq O(1) \sum_{i=1}^{N(\delta)} 2^i \left(\frac{\delta r}{2^i \delta r}\right)^2 \left(\frac{2^i \delta r}{r}\right)^\epsilon \\ &\leq O(1) \delta^\epsilon \sum_{i=1}^{N(\delta)} 2^{i(\epsilon-1)} \\ &= O(1) \delta^\epsilon. \end{aligned}$$

□

4 Pivotal events and some estimates on arm events

In this section, we only work at the parameter $p = 1/2$, hence we intentionally forget the subscript p in the notations. We will rely on the quasi-multiplicativity property (proved in Section 7), on its consequences Propositions 2.4 and 2.5, and on the preliminary results from Section 3. Our goal is to estimate pivotal events. We refer to Subsection 2.4.1 for the notations we use for these events. Our main goal is to prove the following result:

Proposition 4.1. *Let $\rho \geq 1$ and $R \geq 100\rho$. We have:⁸*

$$\sum_{S \text{ square of the grid } (2\rho\mathbb{Z})^2} \mathbb{P}_{1/2}[\mathbf{Piv}_S(\text{Cross}(R, 2R))] \asymp \left(\frac{R}{\rho}\right)^2 \alpha_{4,1/2}^{\text{an}}(\rho, R).$$

The event $\mathbf{Piv}_S(\text{Cross}(R, 2R))$ is an annealed-pivotal event. We will also prove similar bounds for quenched-pivotal events, see Lemma 4.6. Let us make two observations in order to illustrate the difficulties that will arise in the proof of Proposition 4.1. Let S be a square of the grid $2\rho\mathbb{Z}^2$.

- i) Even if S is far-away from $[-2R, 2R] \times [-R, R]$, we have $\mathbb{P}_{1/2}[\mathbf{Piv}_S(\text{Cross}(2R, R))] > 0$.
- ii) Assume that $S \subseteq [-2R, 2R] \times [-R, R]$ and let $\mathbf{A}_4^\square(S, R)$ denote the event that there are two black arms included in $[-2R, 2R] \times [-R, R] \setminus S$ from ∂S to the left and right sides of $[-2R, 2R] \times [-R, R]$ and two white arms included in $[-2R, 2R] \times [-R, R] \setminus S$ from ∂S to the top and bottom sides of B_R . The events $\mathbf{Piv}_S(\text{Cross}(2R, R))$ and $\mathbf{A}_4^\square(S, R)$ are closely related. However, we do not have $\mathbf{A}_4^\square(S, R) = \mathbf{Piv}_S(\text{Cross}(2R, R))$ (contrary to Bernoulli percolation on \mathbb{Z}^2).

Remark 4.2. Proposition 4.1 is stated for the crossing events $\text{Cross}(2R, R)$ since we will apply this result to $2R \times R$ rectangles, but of course the proof works for any shape of rectangle.

4.1 The case of the bulk

Let $1 \leq \rho \leq R/10 \leq R$, let y be a point of the plane and let $S = B_\rho(y)$ be the square of size length 2ρ centered at y . In this subsection, we use the quasi-multiplicativity property and its consequences to estimate the probability of $\mathbf{Piv}_S(\text{Cross}(2R, R))$ when S is “in the bulk”. We start with the following lemma:

⁸The constant 2 in “ $2\rho\mathbb{Z}^2$ ” does not have to be taken seriously. The reason why we look at grids of mesh ≥ 2 is only that we have stated the quasi-multiplicativity property Proposition 1.6 for $1 \leq r_1 \leq r_2 \leq r_3$ i.e. for arm events around boxes of side length at least 2.

Lemma 4.3. *Let ρ , R and S be as above, and assume that S is at distance at least $R/3$ from the sides of the rectangle $[-2R, 2R] \times [-R, R]$. Also, let $\mathbf{A}_4^\square(S, R)$ be the event that there are two black arms in $[-2R, 2R] \times [-R, R] \setminus S$ from ∂S to the left and right sides of $[-2R, 2R] \times [-R, R]$ and two white arms in $[-2R, 2R] \times [-R, R] \setminus S$ from ∂S to the top and bottom sides of $[-2R, 2R] \times [-R, R]$. Then:*

$$\mathbb{P}[\mathbf{A}_4^\square(S, R)] \asymp \alpha_4^{an}(\rho, R),$$

where the constants in \asymp are absolute constants.

Proof. The proof of the inequality $\mathbb{P}[\mathbf{A}_4^\square(S, R)] \leq O(1) \alpha_4^{an}(\rho, R)$ is a direct consequence of the quasi-multiplicativity property (and of (1.1)). Let us prove the other inequality. We write the proof only for $y = 0$ (i.e. for $S = B_\rho$) since the proof for other values of y is the same. Note that it is sufficient to prove the result for R sufficiently large. Let $\delta \in (0, 1)$ to be determined later and assume that $R \geq \delta^{-2}$. Consider the following events (see Definition 2.10 and Proposition 2.13):

$$\text{Dense}_\delta(R) := \text{Dense}_{\delta/100}(A(R/4, 2R)),$$

$$\text{QBC}_\delta(R) := \text{QBC}_\delta^1(A(3R/8, 2R)),$$

and let $\text{GI}_\delta^{ext}(R/2)$ be defined as in Subsection 2.4.2.

Note that the event $\text{Dense}_\delta(R) \cap \text{QBC}_\delta(R) \cap \text{GI}_\delta^{ext}(R/2)$ is measurable with respect to $\omega \setminus B_{R/4}$. With exactly the same proof as Lemma 2.11, we obtain that $\mathbb{P}[\text{Dense}_\delta(R)] \geq 1 - O(1) \delta^{-2} \exp(-\Omega(1) (\delta \cdot R)^2) \geq 1 - O(1) \exp(-\Omega(1) \delta^{-2})$ (since $R \geq \delta^{-2}$). Moreover, Proposition 2.13 implies that $\mathbb{P}[\text{QBC}_\delta(R)] \geq 1 - O(1) R^{-1} \geq 1 - O(1) \delta^2$ and Lemma 2.14 implies that $\mathbb{P}[\text{GI}_\delta^{ext}(R/2)] \geq 1 - O(1) \delta$. Therefore, $\mathbb{P}[\text{Dense}_\delta(R) \cap \text{QBC}_\delta(R) \cap \text{GI}_\delta^{ext}(R/2)]$ can be made as close to 1 as we want provided that we take δ sufficiently small. Hence, we can use Proposition 2.5 (which is the key result here) to say that, if δ is sufficiently small, then:

$$\mathbb{P}[\mathbf{A}_4(\rho, R/2) \cap \text{Dense}_\delta(R) \cap \text{QBC}_\delta(R) \cap \text{GI}_\delta^{ext}(R/2)] \geq \alpha_4^{an}(\rho, R/2)/2 \geq \alpha_4^{an}(\rho, R)/2.$$

See Subsection 2.4.2: we have $\{s^{ext}(\rho, R/2) \geq 5\delta R\} = \{s^{ext}(\rho, R/2) \geq 10\delta R/2\} \supseteq \text{GI}_\delta^{ext}(R/2)$. Hence, we also have:

$$\mathbb{P}[\mathbf{A}_4(\rho, R/2) \cap \text{Dense}_\delta(R) \cap \text{QBC}_\delta(R) \cap \{s^{ext}(\rho, R/2) \geq 5\delta R\}] \geq \alpha_4^{an}(\rho, R)/2. \quad (4.1)$$

Let $\eta \in \text{Dense}_\delta(R) \cap \text{QBC}_\delta(R)$ be such that $\mathbf{P}^\eta[\mathbf{A}_4(\rho, R/2) \cap \{s^{ext}(\rho, R/2) \geq 5\delta R\}] > 0$ and write $\beta_0, \dots, \beta_{k-1}$ for the interfaces that cross $A(\rho, R)$ (in counter-clockwise order and such that the right-hand-side of β_0 - when going from ∂S to ∂B_R - is black, say). First, we work under the following conditional probability measure:

$$\begin{aligned} & \nu_{\rho, R, (\beta_j)_j}^\eta \\ & := \mathbf{P}^\eta \left[\cdot \mid \mathbf{A}_4(\rho, R/2) \cap \text{Dense}_\delta(R) \cap \text{QBC}_\delta(R) \cap \{s^{ext}(\rho, R/2) \geq 5\delta R\}, \beta_0, \dots, \beta_{k-1} \right]. \end{aligned}$$

Thanks to (4.1), it is sufficient to prove that there exists a constant $c = c(\delta) > 0$ such that:

$$\nu_{\rho, R, (\beta_j)_j}^\eta[\mathbf{A}_4^\square(S, R)] \geq c.$$

Since $\eta \in \text{Dense}_\delta(R) \cap \{s^{ext}(\rho, R/2) \geq 5\delta R\}$, we can choose four quads $Q(\beta_j)$, $j \in \{0, \dots, 3\}$ such that:

- (a) For every $j \in \{0, \dots, 3\}$, $Q(\beta_j) \in \mathcal{Q}_\delta(A(3R/8, 2R))$;
- (b) For every $j \in \{0, \dots, 3\}$, one of the distinguished sides of $Q(\beta_j)$ is included in β_j ;
- (c) The other distinguished side of $Q(\beta_0)$ (respectively $Q(\beta_1)$, $Q(\beta_2)$ and $Q(\beta_3)$) is included in the right (respectively top, left and bottom) side of $[-2R, 2R] \times [-R, R]$;

- (d) For every $j \in \{0, \dots, 3\}$, $Q(\beta_j) \cap B_{R/2}$ is included in the region between β_j and β_{j-1} (where $\beta_{-1} := \beta_{k-1}$);
- (e) If $0 \leq i \neq j \leq 3$, then there is no Voronoi cell that intersects both $Q(\beta_i)$ and $Q(\beta_j)$.

See Figure 4.1. Let F be the event that, for every $j \in \{0, \dots, 3\}$, $Q(\beta_j)$ is crossed (respectively dual-crossed) when j is even (respectively odd). Note that conditioning on $(\beta_j)_j$ affects the percolation process as follows: if j is even (respectively odd) then there is a black (respectively white) crossing from β_j to β_{j-1} . Hence, by using the fact that $\eta \in \text{QBC}_\delta(R)$ and by applying the (quenched) Harris-FKG inequality, we obtain that there exists $c = c(\delta) > 0$ such that:

$$\nu_{\rho, R, (\beta_j)_j}^\eta [F] \geq c > 0.$$

This ends the proof since $F \subseteq \mathbf{A}_4^\square(\rho, R)$. □

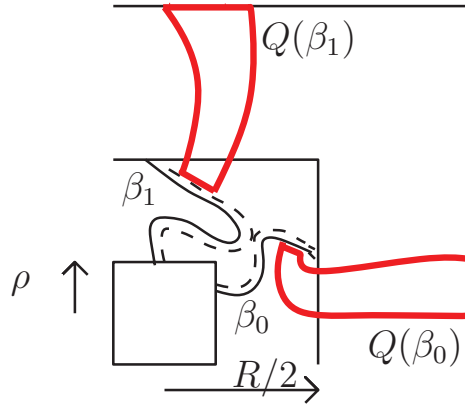

Figure 4.1 – The quads $Q(\beta_1)$ and $Q(\beta_2)$.

We have the following strengthening of Lemma 4.3, in the spirit of Proposition 2.5:

Corollary 4.4. *There exists an absolute constant $\epsilon \in (0, 1)$ such that, for every event G measurable with respect to $\omega \setminus A(y; 2\rho, R/6)$ that satisfies $\mathbb{P}[G] \geq 1 - \epsilon$, we have:*

$$\mathbb{P}[\mathbf{A}_4^\square(S, R) \cap G] \geq \epsilon \alpha_4^{an}(\rho, R).$$

Proof. The proof is exactly the same as the similar result Proposition 2.5. More precisely, this is a direct consequence of Lemma 4.3 and Proposition 2.4. □

Now, let us prove the following result:

Lemma 4.5. *Let ρ, R and S be as in Lemma 4.3. Then:*

$$\mathbb{P}[\mathbf{Piv}_S(\text{Cross}(2R, R))] \asymp \alpha_4^{an}(\rho, R).$$

Proof. The fact that $\mathbb{P}[\mathbf{Piv}_S(\text{Cross}(2R, R))] \geq \Omega(1)\alpha_4^{an}(\rho, R)$ is a direct consequence of Lemma 4.3. Indeed, (except on a zero probability set) we have:⁹

$$\mathbf{A}_4^\square(S, R) \subseteq \mathbf{Piv}_S(\text{Cross}(2R, R)).$$

⁹Consider a configuration for which $\mathbf{A}_4^\square(S, R)$ holds. If we replace the configuration restricted to S by a sufficiently dense set of black (respectively white) points then $\text{Cross}(2R, R)$ is satisfied (respectively not satisfied).

Now, let us prove that $\mathbb{P}[\mathbf{Piv}_S(\text{Cross}(2R, R))] \leq O(1) \alpha_4^{an}(\rho, R)$. We write the proof in the case $y = 0$. For every $\rho' > 0$, let $\text{Dense}(\rho') := \text{Dense}_{1/100}(A(\rho', 2\rho'))$ (remember Definition 2.10). Note that we have:

$$\mathbf{Piv}_S(\text{Cross}(2R, R)) \subseteq \mathbf{A}_4(2\rho, R) \cup (\mathbf{Piv}_S(\text{Cross}(2R, R)) \setminus \text{Dense}(\rho)).$$

More generally, for all $k \in \{0, \dots, \lfloor \log_2(\frac{R}{4\rho}) \rfloor =: k_0\}$ we have:

$$\mathbf{Piv}_S(\text{Cross}(2R, R)) \subseteq \mathbf{A}_4(2^{k+1}\rho, R) \cup (\mathbf{Piv}_S(\text{Cross}(2R, R)) \setminus \text{Dense}(2^k\rho)), \quad (4.2)$$

which implies that $\mathbf{Piv}_S(\text{Cross}(2R, R))$ is included in:

$$\begin{aligned} & \mathbf{A}_4(2\rho, R) \cup \left(\bigcup_{k=0}^{k_0} \mathbf{A}_4(2^{k+2}\rho, R) \setminus \text{Dense}(2^k\rho) \right) \cup \neg\text{Dense}(2^{k_0+1}\rho) \\ & \subseteq \widehat{\mathbf{A}}_4(2\rho, R) \cup \left(\bigcup_{k=0}^{k_0} \widehat{\mathbf{A}}_4(2^{k+2}\rho, R) \setminus \text{Dense}(2^k\rho) \right) \cup \neg\text{Dense}(2^{k_0+1}\rho), \end{aligned} \quad (4.3)$$

where the events $\widehat{\mathbf{A}}_4(\cdot, \cdot)$ are the events defined in Definition 2.3. By using Proposition 2.4 and the fact that $\widehat{\mathbf{A}}_4(2^{k+2}\rho, R)$ and $\text{Dense}(2^k\rho)$ are independent, we obtain that, for each $k \in \{0, \dots, k_0\}$:

$$\mathbb{P} \left[\widehat{\mathbf{A}}_4(2^{k+2}\rho, R) \setminus \text{Dense}(2^k\rho) \right] \leq \alpha_4^{an}(2^{k+2}\rho, R) \mathbb{P} \left[\neg\text{Dense}(2^k\rho) \right].$$

With the same proof as Lemma 2.11, we obtain that:

$$\mathbb{P} \left[\neg\text{Dense}(2^k\rho) \right] \leq O(1) e^{-\Omega(1)(2^k\rho)^2}. \quad (4.4)$$

Note also that the quasi-multiplicativity property and (1.1) imply that:

$$\alpha_4^{an}(2^{k+2}\rho, R) \leq O(1) 2^{O(1)k} \alpha_4^{an}(\rho, R).$$

Therefore:

$$\mathbb{P} \left[\widehat{\mathbf{A}}_4(2^{k+2}\rho, R) \setminus \text{Dense}(2^k\rho) \right] \leq O(1) \alpha_4^{an}(\rho, R) 2^{O(1)k} e^{-\Omega(1)(2^k\rho)^2}. \quad (4.5)$$

Similarly, $1 \leq O(1) \alpha_4^{an}(\rho, 2^{k_0}\rho) 2^{O(1)k_0}$, hence:

$$\begin{aligned} \mathbb{P} \left[\text{Dense}(2^{k_0+1}\rho) \right] & \leq O(1) \alpha_4^{an}(\rho, 2^{k_0}\rho) 2^{O(1)k_0} e^{-\Omega(1)(2^{k_0}\rho)^2} \\ & \leq O(1) \alpha_4^{an}(\rho, R) 2^{O(1)k_0} e^{-\Omega(1)(2^{k_0}\rho)^2}. \end{aligned} \quad (4.6)$$

Now, we can conclude by applying the union-bound to (4.3) and by using the inequalities (4.5) and (4.6). \square

We still consider the case where S is in the bulk. We end this subsection by showing another result which will be useful in the proof of the annealed scaling relations. The difference with Lemma 4.5 is that we study **quenched** pivotal events (see Subsection 2.4.1 for the definition of these pivotal events).

Lemma 4.6. *Let R and S be as in Lemma 4.3, and assume that $\rho = 1$ (i.e. S is a 2×2 square). We have:*

$$\mathbb{P} \left[\{|\eta \cap S| = 1\} \cap \mathbf{Piv}_S^q(\text{Cross}(2R, R)) \right] \geq \Omega(1) \alpha_4^{an}(R).$$

Before proving Lemma 4.6, let us note this lemma together with results from [AGMT16] implies that $\alpha_4^{gn}(R) \leq O(1) R^{-(1+\epsilon)}$ for some $\epsilon > 0$, which is the first part of Proposition 1.13:

Proof of the first part of Proposition 1.13. By [AGMT16], if we let \mathbf{S}_1 be the set of all the squares of the grid $2\mathbb{Z}^2$ that are included in $[-2R, 2R] \times [-R, R]$ and at distance less than $R/3$ from the sides of $[-2R, 2R] \times [-R, R]$, then:

$$\mathbb{E} \left[\sum_{S \in \mathbf{S}_1} \sum_{x \in \eta \cap S} \mathbf{P}^\eta [\mathbf{Piv}_x^q(\text{Cross}(2R, R))]^2 \right] \leq O(1) R^{-\Omega(1)}. \quad (4.7)$$

See the end of Appendix B where we recall how the authors of [AGMT16] have obtained this estimate. (The definition of \mathbf{S}_1 is not the same as in Appendix B but the proof is exactly the same with the present definition.) The left-hand-side of (4.7) is at least:

$$\begin{aligned} \sum_{S \in \mathbf{S}_1} \mathbb{E} \left[\mathbf{P}^\eta [\mathbf{Piv}_S^q(\text{Cross}(2R, R))]^2 \mathbf{1}_{|\eta \cap S|=1} \right] \\ \geq \sum_{S \in \mathbf{S}_1} \mathbb{P} [\{|\eta \cap S| = 1\} \cap \mathbf{Piv}_S^q(\text{Cross}(2R, R))]^2 \quad (\text{by Jensen}). \end{aligned}$$

We conclude by applying Lemma 4.6. □

The difficulty in the proof of Lemma 4.6 is that it is not obvious that, if $\mathbf{A}_4(100, R)$ holds (for instance), then we can easily extend the arms until scale 1. We overcome this difficulty by considering the event that the Voronoi tiling near 0 “looks like the hexagonal lattice”.

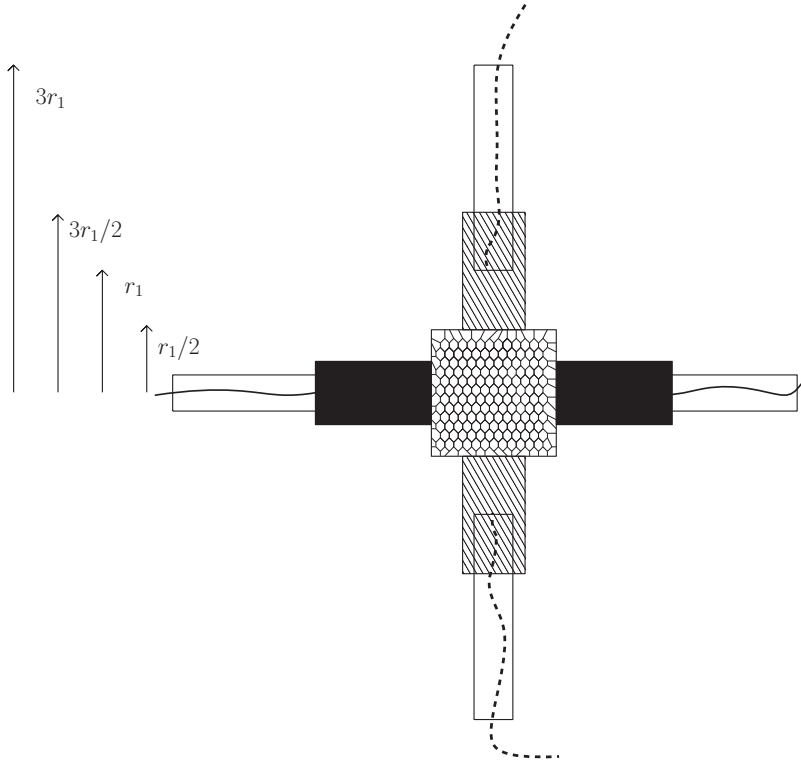

Figure 4.2 – The proof of Lemma 4.6.

Proof of Lemma 4.6. We write the proof in the case $y = 0$ (i.e. $S = B_\rho = B_1$). The strategy is illustrated in Figure 4.2. Note that it is sufficient to prove the result for R larger than some constant. Let $r_1 \geq 1000$ to be determined later and assume that $R \geq 10r_1$.

We first need the following definition. Let $r \in [1, R/10]$. The event $\tilde{\mathbf{A}}_4^\square(B_r, R)$ is the event that i) there are two black paths γ_0 and γ_2 in $[-2R, 2R] \times [-R, R] \setminus B_r$ from ∂B_r to the left and right sides of $[-2R, 2R] \times [-R, R]$, ii) there are two white paths γ_1 and γ_3 in $[-2R, 2R] \times [-R, R] \setminus B_r$ from ∂B_r to the top and bottom sides of $[-2R, 2R] \times [-R, R]$, iii) we can choose the four paths such that, for every $i \in \{0, \dots, 3\}$, $\gamma_i \cap A(r, 2r) \subseteq Q_i$ where the rectangles $Q_i = Q_i(r)$ are defined in Figure 4.3.

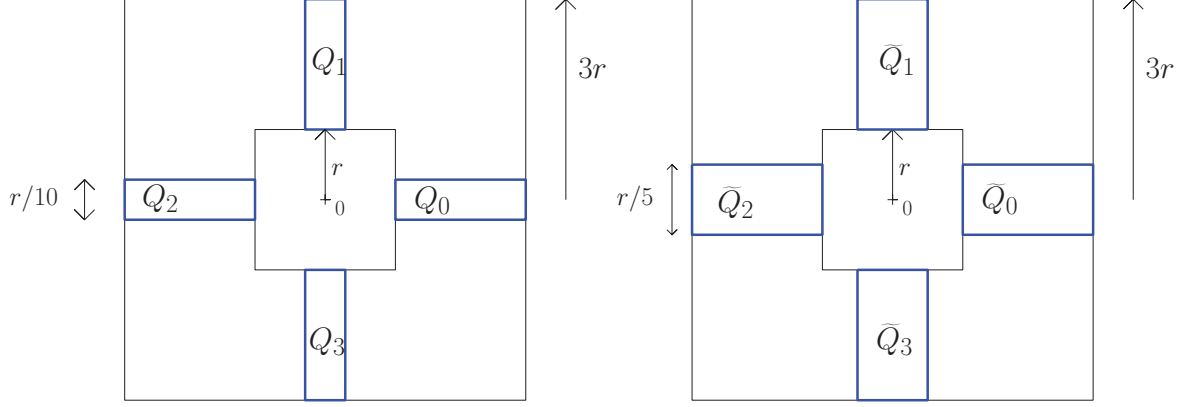

Figure 4.3 – The rectangles $Q_i = Q_i(r)$ and the rectangles $\tilde{Q}_i = \tilde{Q}_i(r)$.

With the same proof as Lemma 4.3 (except that we have to work both at scale r and at scale R instead of working only at scale R) we obtain that, if $r \leq R/10$ and if r is sufficiently large, then:

$$\mathbb{P} \left[\tilde{\mathbf{A}}_4^\square(B_r, R) \right] \geq \Omega(1) \alpha_4^{an}(r, R).$$

As in Corollary 4.4, we also have the following stronger result: There exist $r_0 \geq 1$ and $\epsilon \in (0, 1)$ such that, if $r \in [r_0, R/10]$ and if G is an event measurable with respect to $\omega \setminus A(2r, R/6)$ that satisfies $\mathbb{P}[G] \geq 1 - \epsilon$, then:

$$\mathbb{P} \left[\tilde{\mathbf{A}}_4^\square(B_r, R) \cap G \right] \geq \epsilon \alpha_4^{an}(r, R). \quad (4.8)$$

Now, for any $r \geq 1$ and any $N \in \mathbb{N}$, write $\text{Dense}^N(r)$ for the event that $\text{Dense}_{1/100}(A(r/2, 2r))$ holds and that $|\eta \cap A(r/2, 2r)| \leq N$. This event is a little different from the other events “Dense” that we study in this chapter since this is an event that η is sufficiently dense **but not too much**. Let $\epsilon > 0$ as above and note that there exist $r_1 \geq r_0$ and $N \in \mathbb{N}$ such that $\mathbb{P}[\text{Dense}^N(r_1)] \geq 1 - \epsilon$. Fix such an r_1 and an N . By the above, we have:

$$\mathbb{P} \left[\tilde{\mathbf{A}}_4^\square(B_{r_1}, R) \cap \text{Dense}^N(r_1) \right] \geq \epsilon \alpha_4^{an}(r_1, R) \geq \Omega(1) \alpha_4^{an}(R). \quad (4.9)$$

The event $\text{Dense}^N(r_1)$ provides sufficiently spatial independence so that, given a coloured configuration that satisfies $\tilde{\mathbf{A}}_4^\square(B_{r_1}, R) \cap \text{Dense}^N(r_1)$, one can extend the four arms until scale 1 with probability larger than some constant independent of R . This can be done for instance as follows:

Let $\text{Color}(r)$ denote the event that each point of $\eta \cap \tilde{Q}_i$ is black (respectively white) if i is even (respectively odd), where the $\tilde{Q}_i = \tilde{Q}_i(r)$ ’s are the rectangles defined in Figure 4.3. Note that:

- i) By the quenched FKG-Harris inequality (for the first inequality) and (4.9) (for the second

inequality), we have:

$$\begin{aligned}
& \mathbb{P} \left[\tilde{\mathbf{A}}_4^\square(B_{r_1}, R) \cap \text{Dense}^N(r_1) \cap \text{Color}(r_1/2) \right] \\
&= \mathbb{E} \left[\mathbf{P}^\eta \left[\tilde{\mathbf{A}}_4^\square(B_{r_1}, R) \cap \text{Color}(r_1/2) \right] \mathbb{1}_{\text{Dense}^N(r_1)} \right] \\
&\geq \frac{1}{2^N} \mathbb{E} \left[\mathbf{P}^\eta \left[\tilde{\mathbf{A}}_4^\square(B_{r_1}, R) \right] \mathbb{1}_{\text{Dense}^N(r_1)} \right] \\
&= \frac{1}{2^N} \mathbb{P} \left[\tilde{\mathbf{A}}_4^\square(B_{r_1}, R) \cap \text{Dense}^N(r_1) \right] \geq c_1 \alpha_4^{an}(R),
\end{aligned}$$

where $c_1 > 0$ is a constant that depends only on r_1 and N .

ii) The event:

$$\tilde{\mathbf{A}}_4^\square(B_{r_1}, R) \cap \text{Dense}^N(r_1) \cap \text{Color}(r_1/2)$$

is independent of $\omega \cap B_{r_1/2}$.

As a result, for any event A measurable with respect to $\omega \cap B_{r_1/2}$ we have:

$$\mathbb{P} \left[\tilde{\mathbf{A}}_4^\square(B_{r_1}, R) \cap \text{Dense}^N(r_1) \cap \text{Color}(r_1/2) \cap A \right] \geq c_1 \mathbb{P}[A] \alpha_4^{an}(R),$$

So it is sufficient for our purpose to find an event A measurable with respect to $\omega \cap B_{r_1/2}$ such that $\mathbb{P}[A] > 0$ and:

$$\begin{aligned}
& \mathbb{P} \left[\{|\eta \cap S| = 1\} \cap \mathbf{Piv}_S^q(\text{Cross}(2R, R)) \right] \\
&\geq \Omega(1) \mathbb{P} \left[\tilde{\mathbf{A}}_4^\square(B_{r_1}, R) \cap \text{Dense}^N(r_1) \cap \text{Color}(r_1/2) \cap A \right], \quad (4.10)
\end{aligned}$$

where the constants in $\Omega(1)$ only depend on r_1 . We choose $A = \text{Hex}(r_1/2)$ where $\text{Hex}(r)$ is the event (measurable with respect to $\omega \cap B_r$) that the Voronoi diagram “looks like the hexagonal lattice” in B_r . More precisely, we let \mathbb{T} denote the triangular lattice of mesh size 2 and we define $\text{Hex}(r)$ as the event that there exists a bijection $f : \mathbb{T} \cap B_r \rightarrow \eta \cap B_r$ such that $|f(y) - y| \leq 1/100$ for every y . On the event $\text{Hex}(r_1/2)$, we have $|\eta \cap S| = 1$. It is easy to see that $\mathbb{P}[\text{Hex}(r_1/2)] > 0$ and that, if we condition on the event $\tilde{\mathbf{A}}_4^\square(B_{r_1}, R) \cap \text{Dense}^N(r_1) \cap \text{Color}(r_1/2) \cap \text{Hex}(r_1/2)$, then we can extend the four arms “by hand” until the Voronoi cell of $f(0)$ (where f is the above bijection) with probability larger than some constant that depends only on r_1 (see Figure 4.2). Hence, (4.10) holds and we are done. \square

4.2 An estimate on the 4-arm event

Thanks to Proposition 2.7 (whose proof is written in Section 7), we have the following: Let $1 \leq r \leq R$, then:

$$\alpha_3^{an,+}(r, R) \asymp \left(\frac{r}{R}\right)^2 \asymp \alpha_5^{an}(r, R) \leq \alpha_4^{an}(r, R). \quad (4.11)$$

We now prove that $\alpha_4^{an}(r, R) \geq \Omega(1)(r/R)^{2-\epsilon}$ for some $\epsilon > 0$ (which strengthens the above inequality) i.e. we prove the second part of Proposition 1.13. In the case of percolation on \mathbb{Z}^2 or on the triangular lattice, the analogue of this proposition is a direct consequence of Reimer’s inequality ([Rei00]). In the context of Voronoi percolation, it seems a priori natural to try to prove the following annealed Reimer’s inequality: Let A and B be two events measurable with respect to ω restricted to a bounded domain, and define the disjoint occurrence of A and B as in (2.1); then, $\mathbb{P}[A \square B] \leq \mathbb{P}[A] \mathbb{P}[B]$. Unfortunately, this inequality is not true in general since it is not true as soon as $A = B$, A depends only on η , and $\mathbb{P}[A] \in]0, 1[$.

Proof of the second part of Proposition 1.13. Let $M \in [100, +\infty)$ to be determined later. We are inspired by the proof (by Beffara) of Proposition A.1 of [GPS10]. For any $\rho \geq M$, let $\text{Dense}(\rho) := \text{Dense}_{1/100}(A(\rho, 2\rho))$ (remember Definition 2.10). Also, let $\text{Circ}(r_1, r_2)$ denote the event that there is a black circuit in $A(r_1, r_2)$ and, for any $c \in (0, 1)$, let:

$$\text{QAC}_c(\rho) = \{\mathbf{P}^\eta[\text{Circ}(\rho, 2\rho)] \geq c\}$$

(for ‘‘Quenched Annulus Circuit’’). Theorem 1.4 (applied for instance to four rectangles that surround the origin) and the (quenched) Harris-FKG inequality imply that there exists a constant $c \in (0, 1)$ such that, for every ρ :

$$\mathbb{P}[\text{QAC}_c(\rho)] \geq 1 - \rho^{-3}. \quad (4.12)$$

Fix such a constant c . Now, let $\text{GP}(\rho, M)$ (for ‘‘Good Point configuration’’) be the following event:

$$\bigcap_{k=0}^{\lfloor \log_5(M) \rfloor - 1} \text{Dense}(5^k \rho) \cap \text{QAC}_c(5^k \rho).$$

If we use (a direct analogue of) Lemma 2.11 and (4.12), we obtain that:

$$\mathbb{P}[\text{GP}(\rho, M)] \geq 1 - \sum_{k=0}^{\lfloor \log_5(M) \rfloor - 1} \left(O(1) e^{-\Omega(1)(5^k \rho)^2} + (5^k \rho)^{-3} \right) \geq 1 - O(1) \rho^{-3}.$$

Now, let $\eta \in \text{GP}(\rho, M)$ be such that $\mathbf{P}^\eta[\mathbf{A}_5(\rho, M\rho)] > 0$. Also, let $\beta_0, \beta_1, \beta_2$ be three simple paths drawn in the Voronoi grid, included in $A(\rho, M\rho)$, that go from ∂B_ρ to $\partial B_{M\rho}$, and that can arise as three consecutive interfaces. Write $S_{\beta_0, \beta_1, \beta_2}$ for the region between β_0 and β_2 that does not contain β_1 . Write $\mathcal{A}_{\beta_0, \beta_1, \beta_2}$ for the event that $\beta_0, \beta_1, \beta_2$ are indeed consecutive interfaces, and write $\mathcal{B}_{\beta_0, \beta_1, \beta_2}$ for the event that $\mathcal{A}_{\beta_0, \beta_1, \beta_2}$ holds and that there is an additional (i.e. disjoint from the Voronoi cells adjacent to $\beta_0 \cup \beta_1 \cup \beta_2$) black path in $S_{\beta_0, \beta_1, \beta_2}$. Observe that, since $\eta \in \text{Dense}(2^k \rho)$, the $\lfloor \log_5(M) \rfloor$ events

$\{\exists \text{ a black path in } S_{\beta_0, \beta_1, \beta_2} \cap A(5^k \rho, 2 \cdot 5^k \rho) \text{ from a cell adjacent to } \beta_0 \text{ to a cell adjacent to } \beta_2\}$, for $k = 0, \dots, \lfloor \log_5(M) \rfloor - 1$, are independent under \mathbf{P}^η . Therefore:

$$\mathbf{P}^\eta \left[\mathcal{B}_{\beta_0, \beta_1, \beta_2} \mid \mathcal{A}_{\beta_0, \beta_1, \beta_2} \right] \leq (1 - c)^{\lfloor \log_5(M) \rfloor}.$$

Since $\mathbf{A}_5(\rho, M\rho)$ is the union over every possible $\beta_0, \beta_1, \beta_2$ of $\mathcal{B}_{\beta_0, \beta_1, \beta_2}$, we have:

$$\mathbf{P}^\eta[\mathbf{A}_5(\rho, M\rho)] \leq (1 - c)^{\lfloor \log_5(M) \rfloor} \mathbf{E}^\eta[Y^3 \mathbf{1}_{Y \geq 4}],$$

where $Y = Y(\rho, M)$ is the number of interfaces from ∂B_ρ to $\partial B_{M\rho}$. By taking the expectation, we obtain that:

$$\begin{aligned} \alpha_5^{an}(\rho, M\rho) &\leq (1 - c)^{\lfloor \log_5(M) \rfloor} \mathbb{E}[Y^3 \mathbf{1}_{Y \geq 4}] + \mathbb{P}[-\text{GP}(\rho, M)] \\ &\leq (1 - c)^{\lfloor \log_5(M) \rfloor} \mathbb{E}[Y^3 \mathbf{1}_{Y \geq 4}] + O(1) \rho^{-3}. \end{aligned}$$

Now, we use the annealed BK inequality Proposition 2.2. Since $\mathbf{A}_{2j}(\rho, M\rho)$ is included in the j -disjoint occurrence of $\mathbf{A}_1(\rho, M\rho)$, we have:

$$\mathbb{P}[Y \geq 2j] = \alpha_{2j}^{an}(\rho, M\rho) \leq \alpha_1^{an}(\rho, M\rho)^j.$$

The above together with (1.1) imply that $\mathbb{P}[Y \geq j] \leq O(1) M^{-ja}$ for some $a > 0$. Moreover, $\mathbb{P}[Y \geq 4] = \alpha_4^{an}(\rho, M\rho) \geq \Omega(1) M^{-b}$ for some $b < +\infty$. Hence:

$$\mathbb{E}[Y^3 \mathbf{1}_{Y \geq 4}] \leq O(1) \alpha_4^{an}(\rho, M\rho).$$

Therefore:

$$\alpha_5^{an}(\rho, M\rho) \leq O(1) (1-c)^{\lfloor \log_5(M) \rfloor} \alpha_4^{an}(\rho, M\rho) + O(1) \rho^{-3}.$$

Remember that $\rho \geq M$. By using the fact that the exponent of the 5-arm event is 2 (see Proposition 2.7), we obtain that, if M is sufficiently large, then

$$\alpha_5^{an}(\rho, M\rho) - O(1) \rho^{-3} \geq \Omega(1) M^{-2} - O(1) M^{-3} \geq \Omega(1) M^{-2}.$$

Hence, if M is sufficiently large then for every $\rho \geq M$ we have:

$$M^{-2} \leq O(1) (1-c)^{\lfloor \log_5(M) \rfloor} \alpha_4^{an}(\rho, M\rho) \leq M^{-2\epsilon} \alpha_4^{an}(\rho, M\rho), \quad (4.13)$$

for some $\epsilon > 0$.

Let us end the proof. Let $C = C(j = 4)$ be the constant that appears in the statement of the quasi-multiplicativity property Proposition 1.6 and fix $M \geq 100$ sufficiently large so that (4.13) holds and so that $M^\epsilon \geq C$. First, note that it is sufficient to prove the result for quantities of the form $\alpha_4^{an}(M^i, M^j)$, where $j \geq i$ are positive integers. Next, note that the quasi-multiplicativity property implies that:

$$\alpha_4^{an}(M^i, M^j) \geq C^{-(j-i)} \prod_{k=i}^{j-1} \alpha_4^{an}(M^k, M^{k+1}).$$

If we use (4.13), we obtain that:

$$\alpha_4^{an}(M^i, M^j) \geq C^{-(j-i)} M^{(-2+2\epsilon)(j-i)},$$

which is at least $M^{(-2+\epsilon)(j-i)}$ since $M^\epsilon \geq C$. This ends the proof. \square

4.3 Pivotal events for crossing events and arm events

In this subsection, we prove Proposition 4.1. Note that, if in this proposition we had summed only on the squares S in the ‘‘bulk’’ of the rectangle $[-2R, 2R] \times [-R, R]$, it would have been a direct consequence of Lemma 4.5. We now have to deal with all the other squares. This is essentially technical so the reader can skip this whole subsection in a first reading and only keep in mind that we also prove the following analogue of Proposition 4.1 for arm events:

Proposition 4.7. *Let $\rho \geq 1$ and let $R \geq 100\rho$. Also, let $j \in \mathbb{N}^*$. Then:*

$$\sum_{S \text{ square of the grid } (2\rho\mathbb{Z})^2} \mathbb{P}[\mathbf{Piv}_S(\mathbf{A}_j(1, R))] \leq O(1) \alpha_j^{an}(\rho, R) + O(1) \alpha_j^{an}(R) \left(\frac{R}{\rho}\right)^2 \alpha_4^{an}(\rho, R),$$

where the constants in the $O(1)$'s may only depend on j . Note that, if $\rho = 1$ (and since $R^2 \alpha_4^{an}(R) \geq \Omega(1)$ by (4.11)), we have the following simpler formula:

$$\sum_{S \text{ square of the grid } (2\rho\mathbb{Z})^2} \mathbb{P}[\mathbf{Piv}_S(\mathbf{A}_j(1, R))] \leq O(1) \alpha_j^{an}(R) R^2 \alpha_4^{an}(R).$$

In order to prove Proposition 4.1, we first pursue the analysis of Subsection 4.1. To deal with the spatial dependencies of the model, we first need to introduce the notation $\mathbf{Piv}_D^E(A)$ which in words denotes the event that, conditionally on the coloured configuration in the set E , the probability that the set D is annealed-pivotal for A is positive. We introduce this quantity since it is measurable with respect to E . We will often let E be an annulus which surrounds the set D . Let D be a bounded Borel set, let A be an event measurable with respect to the coloured configuration ω and let E be a Borel set. We write:

$$\mathbf{Piv}_D^E(A) := \left\{ \mathbb{P} \left[\mathbf{Piv}_D(A) \mid \omega \cap E \right] > 0 \right\}.$$

Let $1 \leq \rho \leq R/10 \leq R$, let y be a point of the plane and let $S = B_\rho(y)$ be the square of side length 2ρ centered at y .

Lemma 4.8. *Let y, ρ, R and $S = B_\rho(y)$ be as above. Let $\rho_1 \in [\rho, +\infty)$ and $\rho_2 \in [\rho_1, +\infty)$ and assume that S is included in the bounded connected component of $A(y; \rho_1, \rho_2)^c$ and that $A(y; \rho_1, \rho_2) \subseteq [-2R, 2R] \times [-R, R]$ (in particular, $y \in [-2R, 2R] \times [-R, R]$). Then:*

$$\mathbb{P} \left[\mathbf{Piv}_S^{A(y; \rho_1, \rho_2)} (\text{Cross}(2R, R)) \right] \leq O(1) \alpha_4^{an}(\rho_1, \rho_2).$$

Proof. We write the proof for $y = 0$ since the proof in the other cases is the same. The proof is very similar to the proof of the inequality $\mathbb{P} [\mathbf{Piv}_S(\text{Cross}(2R, R))] \leq O(1) \alpha_4^{an}(\rho, R)$ of Lemma 4.5. Hence, we choose to indicate what is the result analogous to (4.2) (that is the key estimate in the proof of Lemma 4.5) and to omit the rest of the proof. For $0 < \rho' \leq \rho''$, let:

$$\text{Dense}(\rho', \rho'') := \text{Dense}_{1/100} (A(\rho', 2\rho')) \cap \text{Dense}_{1/100} (A(\rho'', 2\rho'')) .$$

Then, for every $k \in \{0, \dots, \lfloor \log_2(\rho_2/(4\rho_1)) \rfloor\}$, $\mathbf{Piv}_S^{A(\rho_1, \rho_2)} (\text{Cross}(2R, R))$ is included in:

$$\mathbf{A}_4(2^{k+1}\rho_1, \rho_2/2) \cup \left(\mathbf{Piv}_S^{A(\rho_1, \rho_2)} (\text{Cross}(2R, R)) \setminus \text{Dense}(2^k\rho_1, \rho_2/2) \right) .$$

□

We now use Lemma 4.8 to estimate the quantity $\mathbb{P} [\mathbf{Piv}_S(\text{Cross}(2R, R))]$ when S intersects the rectangle $[-2R, 2R] \times [-R, R]$ (for instance when S is included in this rectangle). We first need the following notations: Let $d_0 = d_0(S)$ be the distance between S and the closest side of $[-2R, 2R] \times [-R, R]$ and let y_0 be the orthogonal projection of y on this side. Also, let $d_1 = d_1(S) \geq d_0$ be the distance between y_0 and the closest corner of $[-2R, 2R] \times [-R, R]$ and let y_1 be this corner. Write $\alpha_j^{an, ++}(\cdot, \cdot)$ for the probability of the j -arm event in the quarter plane. The following lemma is a generalization of Lemma 4.5.

Lemma 4.9. *Let $1 \leq \rho \leq R/10$, let y be a point of the plane and let $S = B_\rho(y)$. Assume that S intersects the rectangle $[-2R, 2R] \times [-R, R]$. We have:*

$$\mathbb{P} [\mathbf{Piv}_S(\text{Cross}(2R, R))] \leq O(1) \alpha_2^{an, ++}(d_1 + \rho, R) \alpha_3^{an, +}(d_0 + \rho, d_1) \alpha_4^{an}(\rho, d_0) .$$

Proof. We use the notations from above the lemma and we let $S_0 = B_{10(d_0+\rho)}(y_0)$ and $S_1 = B_{100(d_1+\rho)}(y_1)$. We also consider the annuli $A(y; \rho, (\rho + d_0)/10)$ and $A(y_0; 10(d_0 + \rho), d_1)$ (note that these annuli may be empty), see Figure 4.4. Since $S \subseteq S_0 \subseteq S_1$, $\mathbf{Piv}_S(\text{Cross}(2R, R))$ is included in the following event:

$$\begin{aligned} \mathbf{Piv}_{S_1}(\text{Cross}(2R, R)) \cap \mathbf{Piv}_{S_0}^{A(y_0; 10(d_0+\rho), d_1)}(\text{Cross}(2R, R)) \\ \cap \mathbf{Piv}_S^{A(y; \rho, (\rho+d_0)/10)}(\text{Cross}(2R, R)) . \end{aligned}$$

Note furthermore that: i) S is the inner square of $A(y; \rho, (\rho + d_0)/10)$, ii) $A(y; \rho, (\rho + d_0)/10)$ is included in S_0 , iii) S_0 is the inner square of $A(y_0; 10(d_0 + \rho), d_1)$ and iv) $A(y_0; 10(d_0 + \rho), d_1)$ is included in S_1 . Note also that:

- i) $\mathbf{Piv}_S^{A(y; \rho, (\rho+d_0)/10)}(\text{Cross}(2R, R))$ is measurable with respect to $\omega \cap A(y; \rho, (\rho + d_0)/10)$,
- ii) $\mathbf{Piv}_{S_0}^{A(y_0; 10(d_0+\rho), d_1)}(\text{Cross}(2R, R))$ is measurable with respect to $\omega \cap A(y_0; 10(d_0 + \rho), d_1)$,
- iii) $\mathbf{Piv}_{S_1}(\text{Cross}(2R, R))$ is measurable with respect to $\omega \setminus S_1$.

Hence, by spatial independence, $\mathbb{P} [\mathbf{Piv}_S(\text{Cross}(2R, R))]$ is at most:

$$\begin{aligned} \mathbb{P} [\mathbf{Piv}_{S_1}(\text{Cross}(2R, R))] \times \mathbb{P} \left[\mathbf{Piv}_{S_0}^{A(y_0; 10(d_0+\rho), d_1)}(\text{Cross}(2R, R)) \right] \\ \times \mathbb{P} \left[\mathbf{Piv}_S^{A(y; \rho, (\rho+d_0)/10)}(\text{Cross}(2R, R)) \right] . \end{aligned}$$

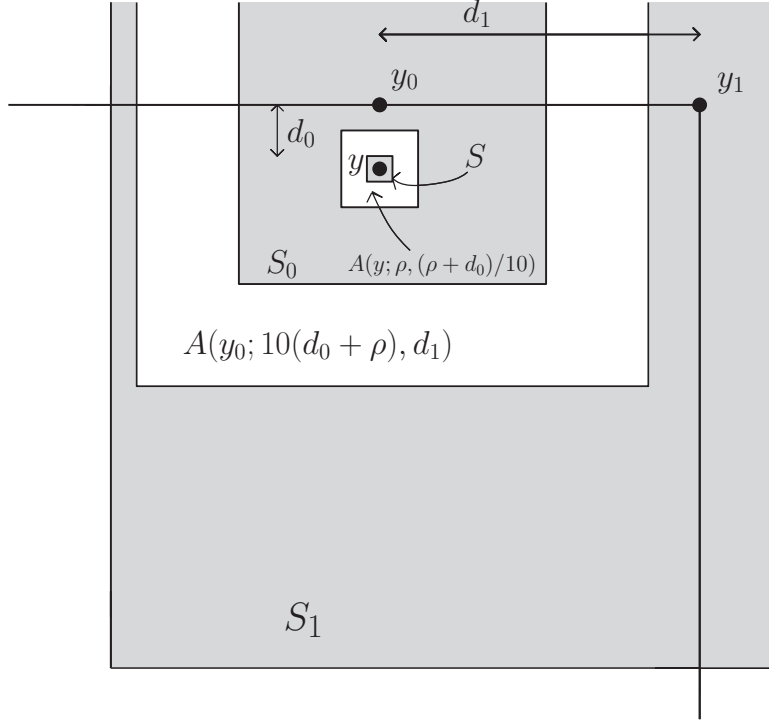

Figure 4.4 – The points y , y_0 and y_1 , the boxes S , S_0 and S_1 , and some annuli centered at y or y_0 .

Lemma 4.8 implies that:

$$\mathbb{P} \left[\mathbf{Piv}_S^{A(y; \rho, (\rho + d_0)/10)}(\text{Cross}(2R, R)) \right] \leq O(1) \alpha_4^{an}(\rho, \rho + d_0).$$

Moreover, by the quasi-multiplicativity property and (1.1), we have $\alpha_4^{an}(\rho, \rho + d_0) \leq O(1) \alpha_4^{an}(\rho, d_0)$.

By exactly the same proof as Lemma 4.8, we have:

$$\mathbb{P} \left[\mathbf{Piv}_{S_0}^{A(y_0; 10(d_0 + \rho), d_1)}(\text{Cross}(2R, R)) \right] \leq O(1) \alpha_3^{an, +}(d_0 + \rho, d_1)$$

and:

$$\mathbb{P} [\mathbf{Piv}_{S_1}(\text{Cross}(2R, R))] \leq O(1) \alpha_2^{an, ++}(d_1 + \rho, R),$$

which ends the proof. \square

Let us now prove an estimate about the probability that boxes outside of $[-2R, 2R] \times [-R, R]$ are pivotal. Roughly speaking, this estimate implies that, if we want to bound

$$\sum_{S \text{ square of the grid } 2\rho\mathbb{Z}^2 \text{ not included in } [-2R, 2R] \times [-R, R]} \mathbb{P} [\mathbf{Piv}_S(\text{Cross}(2R, R))] ,$$

then it is enough to control the sum over the squares S that **intersect** $\partial([-2R, 2R] \times [-R, R])$.

Lemma 4.10. *Let $\rho \geq 1$ and let $R \geq 100\rho$. Also, let S be a square of the grid $2\rho\mathbb{Z}^2$ that intersects $\partial([-2R, 2R] \times [-R, R])$. Moreover, let \mathbf{S} be the set of all squares S' of the grid $2\rho\mathbb{Z}^2$ that do not intersect $[-2R, 2R] \times [-R, R]$ and are such that S is the argmin of $S'' \mapsto \text{dist}(S'', S')$ where S'' ranges over the set of squares of the grid $2\rho\mathbb{Z}^2$ that intersect $\partial([-2R, 2R] \times [-R, R])$. Then:*

$$\sum_{S' \in \mathbf{S}} \mathbb{P} [\mathbf{Piv}_{S'}(\text{Cross}(2R, R))] \leq O(1) \alpha_2^{an, ++}(d_1 + \rho, R) \alpha_3^{an, +}(d_0 + \rho, d_1) \alpha_4^{an}(\rho, d_0),$$

where $d_0 = d_0(S)$ and $d_1 = d_1(S)$ are the distances defined above Lemma 4.9.

Proof. If $S' \in \mathbf{S}$, we let d' be the distance between S' and $[-2R, 2R] \times [-R, R]$. We first observe that, if we sum only on the squares S' that are at distance at least $R/1000$ from $[-2R, 2R] \times [-R, R]$, then the result is easy. Indeed, $\mathbf{Piv}_{S'}(\text{Cross}(2R, R))$ implies that, given $\eta \setminus S'$, the probability that a Voronoi cell intersects both S' and $[-2R, 2R] \times [-R, R]$ is positive, which is an event of probability less than $O(1) \exp(-\Omega(1)(d')^2)$ if d' is at least of order R . Thus, the sum over such squares S' is less than $O(1) \exp(-\Omega(1)R^2)$, which is much less than the desired bound.

Now, let $S' \in \mathbf{S}$ be such that $d' \leq R/1000$. Let y be the center of S and let $S'' = B_{3(\rho+d)}(y)$. Note that $S'' \supseteq S, S'$. In particular, $\mathbf{Piv}_{S'}(\text{Cross}(2R, R)) \subseteq \mathbf{Piv}_{S''}(\text{Cross}(2R, R))$. Let $\rho'' = 3(\rho + d')$. Since $\rho'' \leq R/10$ (this comes from the fact that $d' \leq R/1000$), we can apply Lemma 4.9 to S'' and we obtain that:

$$\mathbb{P}[\mathbf{Piv}_{S''}(\text{Cross}(2R, R))] \leq O(1) \alpha_2^{an,++}(d_1'' + \rho'', R) \alpha_3^{an,+}(d_0'' + \rho'', d_1'') \alpha_4^{an}(\rho'', d_0''), \quad (4.14)$$

where $d_0'' = d_0(S'')$ and $d_1'' = d_1(S'')$. Note that d_0'' and d_1'' satisfy $|d_0 - d_0''| \leq O(1)(\rho + d')$ and $|d_1 - d_1''| \leq O(1)(\rho + d')$.

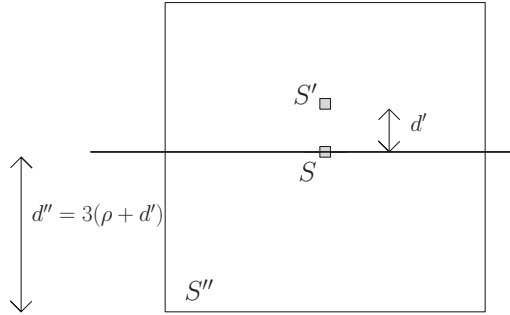

Figure 4.5 – The boxes S , S' and S'' when d' is at least of the order of ρ .

We now distinguish between the two cases $d' \leq 4\rho$ and $d' \in [4\rho, R/1000]$:

- If $d' \leq 4\rho$, then $|\rho'' - \rho|$, $|d_1'' - d_1|$ and $|d_0'' - d_0|$ are less than $O(1)\rho$. As a result, the quasi-multiplicativity property and (4.14) imply that:

$$\mathbb{P}[\mathbf{Piv}_{S''}(\text{Cross}(2R, R))] \leq O(1) \alpha_2^{an,++}(d_1 + \rho, R) \alpha_3^{an,+}(d_0 + \rho, d_1) \alpha_4^{an}(\rho, d_0).$$

Since there are $O(1)$ squares $S' \in \mathbf{S}$ such that $d' \leq 4\rho$, the proof is over in this case.

- Assume that $d' \in [4\rho, R/1000]$ and observe that $\mathbf{Piv}_{S'}(\text{Cross}(2R, R))$ is included in the intersection of the two independent events $\mathbf{Piv}_{S''}(\text{Cross}(2R, R))$ and $\neg \text{Dense}_{1/100}(S'' \setminus S)$ (indeed, if $\text{Dense}_{1/100}(S'' \setminus S)$ holds, then there cannot exist a Voronoi cell that intersects both S' and $[-2R, 2R] \times [-R, R]$, see Figure 4.5). By using (4.14) and the fact that:

$$\mathbb{P}[\neg \text{Dense}_{1/100}(S'' \setminus S)] \leq O(1) \exp(-\Omega(1)(d')^2),$$

we obtain that $\mathbb{P}[\mathbf{Piv}_{S'}(\text{Cross}(2R, R))]$ is at most:

$$O(1) \exp(-\Omega(1)(d')^2) \alpha_2^{an,++}(d_1'' + \rho'', R) \alpha_3^{an,+}(d_0'' + \rho'', d_1'') \alpha_4^{an}(\rho'', d_0'').$$

By the quasi-multiplicativity property and since $\exp(-\Omega(1)(d')^2)$ decays super-polynomially fast, the above at most:

$$O(1) \exp(-\Omega(1)(d')^2) \alpha_2^{an,++}(d_1 + \rho, R) \alpha_3^{an,+}(d_0 + \rho, d_1) \alpha_4^{an}(\rho, d_0).$$

Let us now sum over each S' such that $d' \in [4\rho, R/1000]$. Since, for each integer $k \in [\log_2(4\rho), \log_2(R/1000)]$, there exist at most $O(1) 2^{2k}$ squares S' such that $d' \in [2^k, 2^{k+1}]$, the sum is at most:

$$\begin{aligned} O(1) \sum_{k=\log_2(4\rho)}^{\log_2(R/1000)} 2^{2k} \exp(-\Omega(1)2^{2k}) \alpha_2^{an,++}(d_1 + \rho, R) \alpha_3^{an,+}(d_0 + \rho, d_1) \alpha_4^{an}(\rho, d_0) \\ \leq O(1) \alpha_2^{an,++}(d_1 + \rho, R) \alpha_3^{an,+}(d_0 + \rho, d_1) \alpha_4^{an}(\rho, d_0). \end{aligned}$$

This ends the proof. \square

Now, we can prove Proposition 4.1.

Proof of Proposition 4.1. Let \mathbf{S}_1 be the set of squares of the grid $(2\rho\mathbb{Z})^2$ that are included in $[-2R, 2R] \times [-R, R]$ and are at distance at most $R/3$ from the sides of this rectangle, and let $\mathbf{S}_2 \supseteq \mathbf{S}_1$ be the set of squares of the grid $(2\rho\mathbb{Z})^2$ that intersect $[-2R, 2R] \times [-R, R]$. First, note that if we use Lemma 4.5, we obtain that:

$$\sum_{S \in \mathbf{S}_1} \mathbb{P}[\mathbf{Piv}_S(\text{Cross}(2R, R))] \asymp \left(\frac{R}{\rho}\right)^2 \alpha_4^{an}(\rho, R).$$

Hence, it is sufficient to prove that:

$$\sum_{S \text{ square of the grid } (2\rho\mathbb{Z})^2} \mathbb{P}[\mathbf{Piv}_S(\text{Cross}(2R, R))] \leq O(1) \left(\frac{R}{\rho}\right)^2 \alpha_4^{an}(\rho, R).$$

Moreover, by Lemma 4.10, it is sufficient to prove the estimate by summing only on \mathbf{S}_2 . Let $S \in \mathbf{S}_2$. By using Lemma 4.9 combined with the estimates (4.11) (to control $\alpha_3^{an,+}(\cdot, \cdot)$) and (1.1) (to control $\alpha_2^{an,++}(\cdot, \cdot)$), we obtain that there exists an exponent $a > 0$ such that:

$$\mathbb{P}[\mathbf{Piv}_S(\text{Cross}(2R, R))] \leq O(1) \left(\frac{d_1 + \rho}{R}\right)^a \alpha_4^{an}(\rho, d_0) \alpha_4^{an}(d_0 + \rho, d_1).$$

The quasi-multiplicativity property (together with (1.1)) implies that:

$$\alpha_4^{an}(\rho, d_0) \alpha_4^{an}(d_0 + \rho, d_1) \leq O(1) \alpha_4^{an}(\rho, d_0 + \rho) \alpha_4^{an}(d_0 + \rho, d_1 + \rho) \leq O(1) \alpha_4^{an}(\rho, d_1 + \rho).$$

If we use once again the quasi-multiplicativity property and the estimate (4.11), we obtain that:

$$\mathbb{P}[\mathbf{Piv}_S(\text{Cross}(2R, R))] \leq O(1) \left(\frac{d_1 + \rho}{R}\right)^a \left(\frac{R}{d_1 + \rho}\right)^2 \alpha_4^{an}(\rho, R).$$

Now, note that the number of squares $S \in \mathbf{S}_2$ such that $d_1 + \rho \in [(2^k - 1)\rho, 2^{k+1}\rho]$ is 0 if $k \geq \log_2(R/\rho)$ and is at most $O(1) 2^{2k}$ otherwise. Therefore:

$$\begin{aligned} \sum_{S \in \mathbf{S}_2} \mathbb{P}[\mathbf{Piv}_S(\text{Cross}(2R, R))] &\leq O(1) \alpha_4^{an}(\rho, R) \sum_{k=0}^{\lfloor \log_2(R/\rho) \rfloor} 2^{2k} \left(\frac{2^k \rho}{R}\right)^{a-2} \\ &\leq O(1) \alpha_4^{an}(\rho, R) \left(\frac{\rho}{R}\right)^{a-2} \sum_{k=0}^{\lfloor \log_2(R/\rho) \rfloor} 2^{ka} \\ &\leq O(1) \alpha_4^{an}(\rho, R) \left(\frac{\rho}{R}\right)^{a-2} \left(\frac{R}{\rho}\right)^a \\ &= O(1) \alpha_4^{an}(\rho, R) \left(\frac{R}{\rho}\right)^2, \end{aligned}$$

which is the desired result. \square

Now, let us discuss the same kind of questions for arm events instead of crossing events, i.e. let us prove Proposition 4.7. The main difference is that we will have to use Item (ii) of Proposition 1.13 instead of the weaker estimate (4.11). As previously, let y be a point of the plane, let $\rho \geq 1$ let $S = B_\rho(y)$ and let $R \in [10\rho, +\infty)$. Also, let $j \in \mathbb{N}^*$. We will need the following lemmas which are similar to Lemmas 4.5, 4.9 and 4.10.

Lemma 4.11. *Let y, ρ, R and $S = B_\rho(y)$ as above and assume that $S \subseteq A(R/4, R/2)$. Then:*

$$\mathbb{P}[\mathbf{Piv}_S(\mathbf{A}_j(1, R))] \leq O(1) \alpha_j^{an}(R) \alpha_4^{an}(\rho, R).$$

The following is a generalization of Lemma 4.11.

Lemma 4.12. *Let y, ρ, R and $S = B_\rho(y)$ as above and assume that $S \subseteq B_{R/2}$. Also, let d be the distance between y and 0. Then:*

$$\mathbb{P}[\mathbf{Piv}_S(\mathbf{A}_j(1, R))] \leq O(1) \alpha_j^{an}(R) \alpha_4^{an}(\rho, d) \quad \text{if } d \geq 2\rho,$$

and:

$$\mathbb{P}[\mathbf{Piv}_S(\mathbf{A}_j(1, R))] \leq O(1) \alpha_j^{an}(\rho, R) \quad \text{otherwise.}$$

Let $d_0 = d_0(S)$ and $d_1 = d_1(S)$ be defined as in the study of $\text{Cross}(2R, R)$, except that we consider distances to the box B_R instead of the rectangle $[-2R, 2R] \times [-R, R]$.

Lemma 4.13. *Let y, ρ, R and $S = B_\rho(y)$ as above and assume that $S \cap A(R/2, R) \neq \emptyset$. Then:*

$$\mathbb{P}[\mathbf{Piv}_S(\mathbf{A}_j(1, R))] \leq O(1) \alpha_j^{an}(R) \alpha_3^{an,++}(d_1 + \rho, R) \alpha_3^{an,+}(d_0 + \rho, d_1) \alpha_4^{an}(\rho, d_0).$$

The following lemma is the analogue of Lemma 4.10:

Lemma 4.14. *Let $\rho \geq 1$ and let $R \geq 100\rho$. Also, let S be a square of the grid $2\rho\mathbb{Z}^2$ that intersects ∂B_R . Moreover, let \mathbf{S} be the set of all squares S' of the grid $2\rho\mathbb{Z}^2$ that do not intersect B_R and are such that S is the argmin of $S'' \mapsto \text{dist}(S'', S)$ where S'' ranges over the squares of the grid $2\rho\mathbb{Z}^2$ that intersect ∂B_R . Then:*

$$\sum_{S' \in \mathbf{S}} \mathbb{P}[\mathbf{Piv}_{S'}(\text{Cross}(2R, R))] \leq O(1) \alpha_j^{an}(R) \alpha_3^{an,++}(d_1 + \rho, R) \alpha_3^{an,+}(d_0 + \rho, d_1) \alpha_4^{an}(\rho, d_0).$$

Proof of Lemmas 4.11, 4.12, 4.13 and 4.14. The proof of these lemmas is very similar to the proof of the analogous results for crossing events (Lemmas 4.5, 4.9 and 4.10). However, there is a new difficulty when j is odd and larger than 1. More precisely, if some box in the bulk is pivotal (and if η is sufficiently dense around this box) then there is a 4-arm event around this box if j is even and there is either a 4-arm event or a 6-arm event if j is odd. For more details, see Appendix C. See also [Nol08] (e.g. Figure 12 therein) where Nolin deals with the same problem for Bernoulli percolation on the triangular lattice. \square

Proof of Proposition 4.7. Let \mathbf{S}_1 be the set of squares of the grid $(2\rho\mathbb{Z})^2$ that intersect $B_{R/2}^c$. By using Lemmas 4.13 and 4.14 and by following the proof of Proposition 4.1, we obtain that:

$$\sum_{S \in \mathbf{S}_1} \mathbb{P}[\mathbf{Piv}_S(\mathbf{A}_j(1, R))] \leq O(1) \alpha_j^{an}(R) \left(\frac{R}{\rho}\right)^2 \alpha_4^{an}(\rho, R).$$

Let \mathbf{S}_2 be the set of squares of the grid $(2\rho\mathbb{Z})^2$ that are included in $B_{R/2}$. Lemma 4.12 implies that:

$$\sum_{S \in \mathbf{S}_2} \mathbb{P}[\mathbf{Piv}_S(\mathbf{A}_j(1, R))] \leq O(1) \alpha_j^{an}(\rho, R) + O(1) \alpha_j^{an}(R) \sum_{k=0}^{\lfloor \log_2(\frac{R}{\rho}) \rfloor} 2^{2k} \alpha_4^{an}(\rho, 2^k \rho).$$

The quasi-multiplicativity property and the fact that $\alpha_4^{an}(2^k \rho, R) \geq \Omega(1) (2^k \rho / R)^{2-\epsilon}$ (see Item (ii) of Proposition 1.13) imply that:

$$\alpha_4^{an}(\rho, 2^k \rho) \leq O(1) \alpha_4^{an}(\rho, R) \left(\frac{R}{2^k \rho} \right)^{2-\epsilon}.$$

Therefore, $\sum_{S \in \mathbf{S}_2} \mathbb{P}[\mathbf{Piv}_S(\mathbf{A}_j(1, R))]$ is less than or equal to:

$$\begin{aligned} O(1) \alpha_j^{an}(\rho, R) + O(1) \alpha_j^{an}(R) \alpha_4^{an}(\rho, R) \sum_{k=0}^{\lfloor \log_2 \left(\frac{R}{\rho} \right) \rfloor} 2^{2k} \left(\frac{R}{2^k \rho} \right)^{2-\epsilon} \\ \leq O(1) \alpha_j^{an}(\rho, R) + O(1) \alpha_j^{an}(R) \alpha_4^{an}(\rho, R) \left(\frac{R}{\rho} \right)^2. \end{aligned}$$

We are done since $\mathbf{S}_1 \cup \mathbf{S}_2 = \{\text{squares of the grid } (2\rho\mathbb{Z})^2\}$. \square

5 Extension of the results to the near-critical phase

In this section, we extend the results of other sections to the near-critical phase. Remember the definition of the correlation length $L^{an}(p)$ from Definition 1.9. Let us first prove the following result.

Lemma 5.1. *For every $p > 1/2$, $L^{an}(p) < +\infty$.*

Proof. This is a simple consequence of the exponential decay property Theorem 2 of [BR06a] or Theorem 1 of [DCRT17a]: for every $p < 1/2$, there exists a constant $c = c(p) > 0$ such that:

$$\alpha_{1,p}^{an}(R) \leq \exp(-c(p)R).$$

Indeed, by duality, this implies that for every $p > 1/2$ there exists a constant $c' = c'(p) > 0$ such that:

$$\mathbb{P}_p[\text{Cross}(2R, R)] \geq 1 - \exp(-c'(p)R).$$

\square

5.1 Extension of the annealed and quenched box-crossing properties

Let us use the idea of Lemma 4.17 of [ATT16] in order to extend the annealed box-crossing property to the near-critical regime.

Proposition 5.2. *Let $\rho > 0$. There exists a constant $c = c(\rho) \in (0, 1)$ such that, for every $p \in (1/2, 3/4]$ and every $R \in (0, L^{an}(p))$:*

$$c \leq \mathbb{P}_p[\text{Cross}(\rho R, R)] \leq 1 - c.$$

The constants C and c may also depend on ϵ_0 in the definition of $L^{an}(p)$.

Proof. The left-hand-inequality is a direct consequence of Theorem 1.3 (and is true for any $R \in (0, +\infty)$). Let us prove the right-hand-inequality. Let $\text{Circ}(r_1, r_2)$ be the event that there is a black circuit in the annulus $A(r_1, r_2)$. Note that this event holds if and only if there is no white path from ∂B_{r_1} to ∂B_{r_2} . Thanks to (1.1), we know that there exists $h > 0$ such that $\mathbb{P}_{1/2}[\text{Circ}(\rho, M\rho)] \geq 1 - \frac{1}{h} M^{-h}$ for any $\rho \geq 1$ and $M \geq 1$. Fix some $N \in \mathbb{N}^*$ such that:

$$\left(1 - \frac{1}{h} N^{-h} \right)^3 \leq (1 - \epsilon_0)^{1/2},$$

where ϵ_0 is the constant used to define $L^{an}(p)$. Next, fix some constant $\bar{c} \in (0, 1)$ sufficiently small so that:

$$\left(1 - \bar{c}^{\frac{1}{(4N)^2}}\right)^4 \geq (1 - \epsilon_0)^{1/2}.$$

By gluing arguments, it is sufficient to prove that for every $r \in [N, \frac{L^{an}(p)}{2}]$ we have:

$$\mathbb{P}_p[\text{Cross}^*(2r, r)] = 1 - \mathbb{P}_p[\text{Cross}(r, 2r)] \geq \bar{c}.$$

Assume (for a contradiction) that there exists $r \in [N, \frac{L^{an}(p)}{2}]$ such that $\mathbb{P}_p[\text{Cross}(r, 2r)] > 1 - \bar{c}$. By the standard square-root trick, this implies that there exist a segment I_r included in the left side of $[-r, r] \times [-2r, 2r]$ and a segment I'_r included in the right side of $[-r, r] \times [-2r, 2r]$ such that: (a) the length of I_r and I'_r is r/N and (b) the probability (under \mathbb{P}_p) that there is black path in $[-r, r] \times [-2r, 2r]$ from I_r to I'_r is at least $1 - \bar{c}^{\frac{1}{(4N)^2}}$. Let $\text{Cross}(I_r, I'_r)$ denote this last event.

Now, note that there exist four events obtained by applying a translation or a reflection symmetry to $\text{Cross}(I_r, I'_r)$ and three events obtained by applying a translation to $\text{Circ}(r/N, r)$ such that, if these seven events hold, then $\text{Cross}(4r, 2r)$ holds, see Figure 5.1. By applying the (annealed) FKG-Harris inequality, we obtain that:

$$\mathbb{P}_p[\text{Cross}(4r, 2r)] \geq \left(1 - \bar{c}^{\frac{1}{(4N)^2}}\right)^4 \left(1 - \frac{1}{h}N^{-h}\right)^3 \geq (1 - \epsilon_0)^{1/2} (1 - \epsilon_0)^{1/2} = 1 - \epsilon_0,$$

which is a contradiction since $2r \leq L^{an}(p)$. Note that we have used that (since $p > 1/2$):

$$\mathbb{P}_p[\text{Circ}(r/N, r)] \geq \mathbb{P}_{1/2}[\text{Circ}(r/N, r)].$$

□

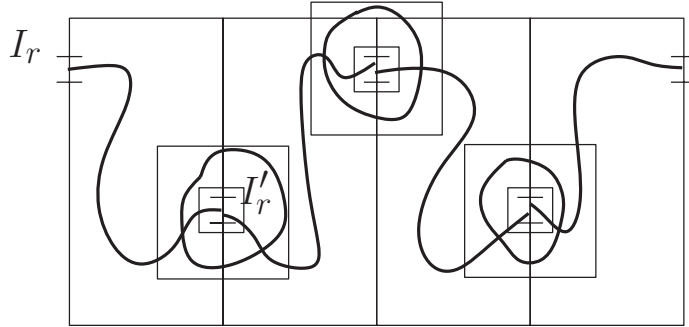

Figure 5.1 – Seven events to obtain $\text{Cross}(4r, 2r)$.

Now, we extend the quenched box-crossing result Theorem 1.4.

Proposition 5.3. *Let $\rho > 0$. We have the following:*

- i) *There exist an absolute constant $\epsilon > 0$ and a constant $C = C(\rho) < +\infty$ such that, for every $p \in (1/2, 3/4]$ and every $R \in (0, +\infty)$ we have:*

$$\text{Var}(\mathbf{P}_p^\eta[\text{Cross}(\rho R, R)]) \leq C R^{-\epsilon}.$$

This implies the following estimate:

- ii) *For every $\gamma \in (0, +\infty)$, there exists a positive constant $c = c(\rho, \gamma) \in (0, 1)$ such that, for every $p \in (1/2, 3/4]$ and every $R \in (0, L^{an}(p))$:*

$$\mathbb{P}[c \leq \mathbf{P}_p^\eta[\text{Cross}(\rho R, R)] \leq 1 - c] \geq 1 - R^{-\gamma}.$$

The constants C and c may also depend on ϵ_0 in the definition of $L^{an}(p)$.

Proof. The way we obtain Item ii) from Item i) is exactly the same as in the proof of Theorem 1.4 (see [AGMT16]) except that we use Proposition 5.2 instead of Theorem 1.3. So, let us prove Item i). To this purpose, we rely on Appendix B where we recall the main steps of the proof of Theorem 1.4. In the case $p > 1/2$, the first step is exactly the same and we obtain that:

$$\text{Var} \left(\mathbf{P}_p^\eta [\text{Cross}(\rho R, R)] \right) \leq \mathbb{E} \left[\sum_{x \in \eta} \mathbf{P}_p^q [\mathbf{Piv}_x^\eta(\text{Cross}(\rho R, R))]^2 \right]. \quad (5.1)$$

For the second step, we cannot use the BK inequality in the case $p > 1/2$ since we do not know whether this inequality is true or not. So we prove the result corresponding to this step for $p > 1/2$ by using the analogous result for $p = 1/2$. More precisely, since $p > 1/2$, we have the following:

$$\mathbb{P} \left[\mathbf{P}_p^\eta \left[\mathbf{A}_1^{*,\text{cell}}(S, R) \right] \geq R^{-\epsilon} \right] \leq \mathbb{P} \left[\mathbf{P}_{1/2}^\eta \left[\mathbf{A}_1^{*,\text{cell}}(S, R) \right] \geq R^{-\epsilon} \right], \quad (5.2)$$

where S is the 1×1 square centered at 0 and $\mathbf{A}_1^{*,\text{cell}}(S, R)$ is the event defined in the paragraph above (B.3). Thanks to (5.2), the following is a direct consequence of (B.3): For every $\gamma > 0$, there exists $\epsilon > 0$ such that the following holds:

$$\mathbb{P} \left[\mathbf{P}_p^\eta \left[\mathbf{A}_1^{*,\text{cell}}(S, R) \right] \geq R^{-\epsilon} \right] \leq \frac{1}{\epsilon} R^{-\gamma}.$$

This ends the second step. The third and last step is exactly the same as in Appendix B. (Here we use that the theorems by Schramm and Steif stated in Appendix A - and more precisely Corollary A.4 which is the inequality that we need - hold for every p . The only dependence on p in Corollary A.4 is a factor $\frac{1}{2\sqrt{p(1-p)}}$, but this is not problem since we have restricted ourself to the case $p \in (1/2, 3/4]$.) This ends the proof. \square

Remark 5.4. Now, we can explain the reason why, in Appendix B, we have (slightly) changed the algorithm used to estimate the sum $\mathbb{E} \left[\sum_{x \in \eta} \mathbf{P}_p^q [\mathbf{Piv}_x^\eta(\text{Cross}(\rho R, R))]^2 \right]$. The reason is that we wanted to bound the revealment of the algorithm with a quantity that involves **only white arms** (so that we can use the obvious inequality 5.2), which is not possible with the algorithm chosen in [AGMT16].

5.2 Extension of the results of Sections 3, 4 and 7

Before proving the annealed scaling relations, we need to prove that the results of Sections 3, 4 and 7 are also true in the near-critical phase. More precisely, we need to prove that these results are also true for $p \in (1/2, 3/4]$, providing that we assume that every length is less than or equal to the correlation length $L^{an}(p)$. An important fact is that the different constants (e.g. the constant $C = C(j)$ of the quasi-multiplicativity property Proposition 1.6) will **not depend on p** but only on the parameter ϵ_0 from the definition of the correlation length.

In Subsection 5.1, we have proved that the annealed and quenched box crossing estimates also hold in the near-critical phase. In Sections 3, 4 and 7, we use only two properties specific to the parameter $p = 1/2$:

- **The annealed BK inequality** (see Subsection 2.2). The only place where we have used this inequality is in the proof of the second part of Proposition 1.13 (see Subsection 4.2). In this proof, we have used this inequality and the fact that $\mathbf{A}_{2j}(r_1, r_2)$ is included in the j -disjoint occurrence of $\mathbf{A}_1(r_1, r_2)$ to prove that:

$$\alpha_{2j,1/2}^{an}(r_1, r_2) \leq \left(\alpha_{1,1/2}^{an}(r_1, r_2) \right)^j.$$

Let $\mathbf{A}_1^*(r_1, r_2)$ denote the event that there is a white path from ∂B_{r_1} to ∂B_{r_2} . Note that $\mathbf{A}_{2j}(r_1, r_2)$ is also included in the j -disjoint occurrence of $\mathbf{A}_1^*(r_1, r_2)$, hence:

$$\alpha_{2j,p}^{an}(r_1, r_2) \leq \mathbb{P}_p [\mathbf{A}_1^*(r_1, r_2)^{\square j}] \leq \mathbb{P}_{1/2} [\mathbf{A}_1^*(r_1, r_2)^{\square j}] \leq \mathbb{P}_{1/2} [\mathbf{A}_1^*(r_1, r_2)]^j,$$

since $p > 1/2$ and by the annealed BK inequality at $p = 1/2$. Hence, there exists $a > 0$ such that $\alpha_{2j,p}^{an}(r_1, r_2) \leq O(1) (r_1/r_2)^a$, which is exactly what we needed in the proof of the second part of Proposition 1.13.

- The fact that **the model is self-dual**. We have actually used this property implicitly all along Sections 4 and 7. If Q is a quad, let $\text{Cross}^*(Q)$ be the event that there is a crossing of Q by a **white** path. We have used a lot Proposition 2.13 both for the event $\text{Cross}(Q)$ and the event $\text{Cross}^*(Q)$ although we have proved this proposition only for the event $\text{Cross}(Q)$. When $p = 1/2$, this is not a problem since $\text{Cross}(Q)$ and $\text{Cross}^*(Q)$ have the same $\mathbf{P}_{1/2}^\eta$ -probabilities; but when $p > 1/2$ we need to prove that Proposition 2.13 also holds with $\text{Cross}^*(Q)$ instead of $\text{Cross}(Q)$ as soon as we consider a domain D such that $\text{diam}(D) \leq L^{an}(p)$. The proof is actually exactly the same except that we have to use Proposition 5.3 instead of Theorem 1.4.

6 Proof of the annealed scaling relations

In this section, we prove our main result Theorem 1.11 by using the results of all the other sections. We first prove Proposition 1.10 and the scaling relation (1.4) of Theorem 1.11. We follow the classical strategy developed by Kesten [Kes87] for Bernoulli percolation, see also [Wer07, Nol08]. The main difference is that we deal with both the annealed notion and the quenched notion of pivotal events. We refer to Subsection 2.4.1 for these two notions of pivotal events. Let us recall that, as explained in Section 5, all our results on arm and pivotal events also hold for $p \in (1/2, 3/4]$ (with constants that do not depend on p) as soon as we work under the correlation length $L^{an}(p)$.

Proof of Proposition 1.10 and of (1.4) from Theorem 1.11. We will need the following lemma:

Lemma 6.1. *Let $p \in (1/2, 3/4]$ and $R \in [1, L^{an}(p)]$. We have:*

$$\frac{d}{dp} \mathbb{P}_p [\text{Cross}(2R, R)] \asymp R^2 \alpha_{4,p}^{an}(R), \quad (6.1)$$

$$\forall j \in \mathbb{N}^*, \left| \frac{d}{dp} \log(\alpha_{j,p}^{an}(R)) \right| \leq O(1) R^2 \alpha_{4,p}^{an}(R). \quad (6.2)$$

The constants in \asymp and $O(1)$ may only depend on the choice of ϵ_0 in Definition 1.9 (and on j for $O(1)$).

Before proving Lemma 6.1, let us explain why this lemma implies Proposition 1.10 and (1.4). If we integrate (6.1) from $1/2$ to p , we obtain that:

$$\int_{1/2}^p R^2 \alpha_{4,u}^{an}(R) du \asymp \mathbb{P}_p [\text{Cross}(2R, R)] - \mathbb{P}_{1/2} [\text{Cross}(2R, R)] \leq 1.$$

Moreover, if we integrate (6.2) from $1/2$ to p , we obtain that:

$$\left| \log(\alpha_{j,p}^{an}(R)) - \log(\alpha_{j,1/2}^{an}(R)) \right| \leq O(1) \int_{1/2}^p R^2 \alpha_{4,u}^{an}(R) du.$$

Hence: $\left| \log(\alpha_{j,p}^{an}(R)) - \log(\alpha_{j,1/2}^{an}(R)) \right| \leq O(1)$ i.e. $\alpha_{j,p}^{an}(R) \asymp \alpha_{j,1/2}^{an}(R)$. Together with the quasi-multiplicativity property, this implies Proposition 1.10.

Now, let us integrate (6.1) from $1/2$ to p with the choice $R = L^{an}(p)$. If we use Proposition 1.10 with $j = 4$, we obtain that:

$$\begin{aligned} (p - 1/2) L^{an}(p)^2 \alpha_{4,1/2}^{an}(L^{an}(p)) \\ \asymp \mathbb{P}_p [\text{Cross}(2L^{an}(p), L^{an}(p))] - \mathbb{P}_{1/2} [\text{Cross}(2L^{an}(p), L^{an}(p))] \\ \in [1 - \epsilon_0 - \mathbb{P}_{1/2} [\text{Cross}(2L^{an}(p), L^{an}(p))], 1], \end{aligned}$$

which implies the scaling relation (1.4) from Theorem 1.11 since ϵ_0 is sufficiently small.

Proof of Lemma 6.1. One of Kesten's ideas is to use Russo's differential formula (see for instance Theorem 2.25 in [Gri99]) that can be stated as follows: Let $n \in \mathbb{N}^*$ and let $A \subseteq \{-1, 1\}^n$ be an increasing event. Also, let $\mathbf{P}_p^n = (p\delta_1 + (1-p)\delta_{-1})^{\otimes n}$. Then:

$$\frac{d}{dp} \mathbf{P}_p^n [A] = \sum_{i=1}^n \mathbf{P}_p^n [\mathbf{Piv}_i^n(A)].$$

(See Subsection 2.4.1 for our notations for pivotal events.) To use this formula, we have to work at the quenched level. Note that a.s. the number of points of η whose cell intersects $[-2R, 2R] \times [-R, R]$ is finite. Hence, if we condition on η , the event $\text{Cross}(2R, R)$ depends on finitely many points. So, we can use Russo's formula and we obtain that:

$$\frac{d}{dp} \mathbf{P}_p^\eta [\text{Cross}(2R, R)] = \sum_{x \in \eta} \mathbf{P}_p^\eta [\mathbf{Piv}_x^\eta(\text{Cross}(2R, R))].$$

Now, let $R \in [1, L^{an}(p)]$ and let $(S_i)_{i \in \mathbb{N}}$ be an enumeration of the squares of the grid \mathbb{Z}^2 . For all i , let $N_i(\text{Cross}(2R, R))$ be the number of points $x \in \eta \cap S_i$ which are quenched-pivotal for $\text{Cross}(2R, R)$. Note that, if one fixes R and let $M > 0$ then:

$$\text{Card}\{x : \mathbf{P}_p^\eta [\mathbf{Piv}_x^\eta(\text{Cross}(2R, R))] > 0\}$$

is larger than M with probability less than $O(1)e^{-\Omega(1)M^2}$. This implies that one can use dominated convergence and obtain that:

$$\frac{d}{dp} \mathbb{P}_p [\text{Cross}(2R, R)] = \sum_{i \in \mathbb{N}} \mathbb{E}_p [N_i(\text{Cross}(2R, R))]. \quad (6.3)$$

By using the fact that a.s. $\mathbf{Piv}_{S_i}^q(\text{Cross}(2R, R)) \subseteq \mathbf{Piv}_{S_i}(\text{Cross}(2R, R))$ and that $\mathbf{Piv}_{S_i}(\text{Cross}(2R, R))$ is independent of the configuration in S_i we obtain that:

$$\begin{aligned} \mathbb{E}_p [N_i(\text{Cross}(2R, R))] &\leq \mathbb{E}_p \left[|\eta \cap S_i| \mathbf{1}_{\mathbf{Piv}_{S_i}^q(\text{Cross}(2R, R))} \right] \\ &\leq \mathbb{E}_p \left[|\eta \cap S_i| \mathbf{1}_{\mathbf{Piv}_{S_i}(\text{Cross}(2R, R))} \right] \\ &= \mathbb{E}_p [|\eta \cap S_i|] \mathbb{P}_p [\mathbf{Piv}_{S_i}(\text{Cross}(2R, R))] \\ &\leq O(1) \mathbb{P}_p [\mathbf{Piv}_{S_i}(\text{Cross}(2R, R))]. \end{aligned}$$

If we combine the above with (6.3) and if we use Proposition 4.1 (or rather the analogous result in the near-critical regime), we obtain that:

$$\frac{d}{dp} \mathbb{P}_p [\text{Cross}(2R, R)] \leq O(1) \sum_{i \in \mathbb{N}} \mathbb{P}_p [\mathbf{Piv}_{S_i}(\text{Cross}(2R, R))] \asymp O(1) R^2 \alpha_{4,p}^{an}(R),$$

which is the upper-bound of (6.1). The lower-bound is a simple consequence of Lemma 4.6. Indeed, this lemma implies that, if S_i is in the "bulk" of $[-2R, 2R] \times [-R, R]$, then:

$$\mathbb{E}_p [N_i(\text{Cross}(2R, R))] \geq \mathbb{P}_p \left[\{|\eta \cap S_i| = 1\} \cap \mathbf{Piv}_{S_i}^q(\text{Cross}(2R, R)) \right] \geq \Omega(1) \alpha_{4,p}^{an}(R).$$

Now, let us prove (6.2) for $j = 1$. Since $\mathbf{A}_1(R)$ is also an increasing event, by the same techniques as above we have:

$$\frac{d}{dp} \alpha_{1,p}^{an}(R) \leq O(1) \sum_{i \in \mathbb{N}} \mathbb{P}_p [\mathbf{Piv}_{S_i}(\mathbf{A}_1(R))] .$$

Together with Proposition 4.7, this implies (6.2) for $j = 1$.

Let us now prove (6.2) for $j \geq 2$. In this case, the events $\mathbf{A}_j(R)$ are not monotonic. In particular, we cannot use Russo's formula. We rather use the following inequality that holds for any event and whose prove is exactly the same as Russo's formula: Let $n \in \mathbb{N}^*$ and $A \subseteq \{-1, 1\}^n$. Then:

$$\left| \frac{d}{dp} \mathbf{P}_p^n [A] \right| \leq \sum_{i=1}^n \mathbf{P}_p^n [\mathbf{Piv}_i^n(A)] .$$

Thus, the proof of (6.2) in the case $j \geq 2$ is the same as in the case $j = 1$. \square

This ends the proof of Proposition 1.10 and of the scaling relation (1.4) from Theorem 1.11. \square

It only remains to prove the scaling relation (1.3) from Theorem 1.11. Thanks to Proposition 1.10 applied to $j = 1$, it is sufficient to prove the following lemma:

Lemma 6.2. *Let $p \in (1/2, 3/4]$. We have:*

$$\theta^{an}(p) \asymp \alpha_{1,p}^{an}(L^{an}(p)) ,$$

where the constants in \asymp may only depend on the constant ϵ_0 in the definition of $L^{an}(p)$.

Proof. First, note that it is sufficient to prove the result for $p \in (1/2, p_0)$ for some $p_0 \in (1/2, 3/4]$. For every bounded Borel subset of the plane D , let $\widetilde{\text{Dense}}(D)$ be the event that, for any $u \in D$, there exists $x \in \eta \cap D$ that is **black** and satisfies $\|x - u\|_2 \leq \text{diam}(D)/100$ (we study this event since it is annealed increasing). With the same proof as Lemma 2.11, we can easily obtain that, if $p \in (1/2, 3/4]$ and if R is sufficiently large ($R \geq R_0 \geq 1000$, say), then:

$$\mathbb{P} \left[\widetilde{\text{Dense}}([-2R, 2R] \times [-R, R]) \right] \geq 1 - \epsilon_0 .$$

Let p_0 be the larger parameter $p \in [1/2, 3/4]$ such that $L^{an}(p) \geq R_0$. Note that $p_0 > 1/2$. Consider some parameter $p \in (1/2, p_0)$. We now apply a Peierls argument. If Q is a $4L^{an}(p) \times 2L^{an}(p)$ rectangle, then we say that Q is **good** if: i) Q is crossed lengthwise, ii) the two $2L^{an}(p) \times 2L^{an}(p)$ squares whose union is Q are crossed from top to bottom and from left to right and iii) $\widetilde{\text{Dense}}(Q)$ holds. Note that $\mathbb{P}[Q \text{ is good}] \geq 1 - 4\epsilon_0$ by definition of the correlation length and that $\{Q \text{ is good}\}$ is annealed-increasing.

Now, let $\mathcal{L}(p)$ be the square lattice times $2L^{an}(p)$. We say that an edge $e = \{x, y\}$ of this lattice is good if the $4L^{an}(p) \times 2L^{an}(p)$ rectangle which is the union of the two $2L^{an}(p) \times 2L^{an}(p)$ squares centered at x and y is good. Note that we have defined a 2-dependent percolation model on $\mathcal{L}(p)$ with parameter at least $1 - 4\epsilon_0$. A standard Peierls argument implies that, if ϵ_0 is small enough, the probability that there is an infinite good path starting from 0 is larger than some positive constant that depends only on ϵ_0 .

Now, note that if the two following properties hold then the event $\{0 \leftrightarrow \infty\}$ holds: (a) in the 2-dependent percolation model on $\mathcal{L}(p)$, the twelve edges of $\mathcal{L}(p)$ closest to 0 are good and there is an infinite path made of good edges starting from 0; (b) $\mathbf{A}_1(1, 3L^{an}(p))$ holds and $B_1 = [-1, 1]^2$ is entirely colored black. This observation and the above paragraph (together with the annealed FKG-Harris inequality) imply the lemma. \square

7 The quasi-multiplicativity property

In this section, we only work at $p = 1/2$, hence we forget the subscript p in the notations. In Subsections 7.1, 7.2 and 7.3, we only rely on the results of Subsections 3.1 and 3.2. In Subsections 7.4, we also use the results of Subsection 3.3 which are consequences of Subsections 7.1, 7.2 and 7.3.

7.1 The case j even

In this subsection, we prove the quasi-multiplicativity property Proposition 1.6 in the case j even:

Proposition 7.1. *Let $j \in \mathbb{N}^*$ even. There exists a constant $C = C(j) \in [1, +\infty)$ such that, for all $1 \leq r_1 \leq r_2 \leq r_3$:*

$$\frac{1}{C} \alpha_j^{an}(r_1, r_3) \leq \alpha_j^{an}(r_1, r_2) \alpha_j^{an}(r_2, r_3) \leq C \alpha_j^{an}(r_1, r_3). \quad (7.1)$$

Remark 7.2. As we will see in Subsection 7.3, the same proof will imply the quasi-multiplicativity property for the quantities $\alpha_j^{an,+}(\cdot, \cdot)$, for any j .

As explained in Subsection 2.6.1, we first need to define what is a “good percolation configuration” (i.e. a configuration for which it is not difficult to extend the j arms). **We write the proof of Proposition 7.1 for $j = 4$ since the proof for other even integers is the same.**

7.1.1 What does “looking good” means for the Voronoi percolation configurations

The point configuration. We consider $\delta \in (0, 1/1000)$ and $R \in [\delta^{-2}, +\infty)$. In the proof of Proposition 7.1, we use the following notations (the notations from the right-hand-side are those from Definition 2.10 and Proposition 2.13):

$$\begin{aligned} \text{Dense}_\delta(R) &:= \text{Dense}_\delta(A(R/2, 2R)) , \\ \text{QBC}_\delta(R) &:= \text{QBC}_\delta^1(A(3R/4, 3R/2)) , \\ \text{QBC}^{ext}(R) &:= \text{QBC}_{1/100}^1(A(R, 4R)) \cap \text{Dense}_{1/100}(A(R, 4R)) , \\ \text{QBC}^{int}(R) &:= \text{QBC}_{1/100}^1(A(R/4, R)) \cap \text{Dense}_{1/100}(A(R/4, R)) . \end{aligned}$$

Mind the presence of the events “Dense(\cdot)” in the definition of $\text{QBC}^{ext}(R)$ and $\text{QBC}^{int}(R)$ (to simplify the notations). Next, we define the two following events:

$$\text{GP}_\delta^{ext}(R) := \left\{ \mathbb{P} \left[\text{Dense}_\delta(R) \cap \text{QBC}_\delta(R) \cap \text{QBC}^{ext}(R) \mid \eta \cap A(R/2, 2R) \right] \geq 3/4 \right\} \quad (7.2)$$

and :

$$\text{GP}_\delta^{int}(R) := \left\{ \mathbb{P} \left[\text{Dense}_\delta(R) \cap \text{QBC}_\delta(R) \cap \text{QBC}^{int}(R) \mid \eta \cap A(R/2, 2R) \right] \geq 3/4 \right\} \quad (7.3)$$

(for “Good Point configuration”). In words, $\text{GP}_\delta^{ext}(R)$ (respectively $\text{GP}_\delta^{int}(R)$) is the event that, conditionally on $\eta \cap A(R/2, 2R)$, the probability that $\text{Dense}_\delta(R) \cap \text{QBC}_\delta(R) \cap \text{QBC}^{ext}(R)$ (respectively $\text{Dense}_\delta(R) \cap \text{QBC}_\delta(R) \cap \text{QBC}^{int}(R)$) holds is at least $3/4$. Note that, if $\text{Dense}_\delta(R)$ holds and if the Voronoi cell of some $x \in \eta$ intersects $A(3R/4, 3R/2)$, then $x \in A(R/2, 2R)$. Hence, $\text{Dense}_\delta(R) \cap \text{QBC}_\delta(R)$ is measurable with respect to $\eta \cap A(R/2, 2R)$. As a result we have:

$$\text{GP}_\delta^{ext}(R) = \text{Dense}_\delta(R) \cap \text{QBC}_\delta(R) \cap \left\{ \mathbb{P} \left[\text{QBC}^{ext}(R) \mid \eta \cap A(R/2, 2R) \right] \geq 3/4 \right\} ,$$

and the analogous property for $\text{GP}_\delta^{int}(R)$. The reason why we do not choose to define $\text{GP}_\delta^{ext}(R) = \text{Dense}_\delta(R) \cap \text{QBC}_\delta(R) \cap \text{QBC}^{ext}(R)$ is that we want $\text{GP}_\delta^{ext}(R)$ to be measurable with respect to $\eta \cap A(R/2, 2R)$ (and similarly for $\text{GP}_\delta^{int}(R)$). This will be crucial in the whole proof.

The interfaces. In Subsection 3.3, we have estimated the events $\text{GI}_\delta^{\text{ext}}(R)$ and $\text{GI}_\delta^{\text{int}}(R)$ which are events that “the interfaces are well separated”. In particular, we have proved Lemma 2.14 by using that the exponent of the 3-arm event in the half-plane is 2. As we will see in Subsection 7.3, the quasi-multiplicativity is a crucial ingredient in the computation of this exponent. Consequently, we cannot use Lemma 2.14 in the present proof. We rather choose to consider a variant of the quantities $s^{\text{ext}}(r, R)$ and $s^{\text{int}}(r, R)$. More precisely:

We still consider $\delta \in (0, 1/1000)$ and $R \in [\delta^{-2}, +\infty)$. We also consider some $r \in [1, R]$. Following the appendix of [SS10], we let $\tilde{s}^{\text{ext}}(r, R)$ be the least distance between any pair of endpoints on ∂B_R of two interfaces that go from ∂B_r to ∂B_R . We write $\widetilde{\text{GI}}_\delta^{\text{ext}}(R) = \{\tilde{s}^{\text{ext}}(3R/4, R) \geq 10\delta R\}$ and:

$$G_\delta^{\text{ext}}(R) = \text{GP}_\delta^{\text{ext}}(R) \cap \widetilde{\text{GI}}_\delta^{\text{ext}}(R).$$

Note that the event $\text{Dense}_\delta(R) \cap \widetilde{\text{GI}}_\delta^{\text{ext}}(R)$ is measurable with respect to $\omega \cap A(R/2, 2R)$. Therefore, $G_\delta^{\text{ext}}(R)$ is measurable with respect to $\omega \cap A(R/2, 2R)$.

Similarly, we let $\tilde{s}^{\text{int}}(r, R)$ be the least distance between any pair of endpoints on ∂B_r of two interfaces that go from ∂B_R to ∂B_r and we write $\widetilde{\text{GI}}_\delta^{\text{int}}(R) = \{\tilde{s}^{\text{int}}(R, 3R/2) \geq 10\delta R\}$. We write $G_\delta^{\text{int}}(R) = \text{GP}_\delta^{\text{int}}(R) \cap \widetilde{\text{GI}}_\delta^{\text{int}}(R)$. The event $G_\delta^{\text{int}}(R)$ is measurable with respect to $\omega \cap A(R/2, 2R)$.

Remark 7.3. As noted above, conditioning on $\text{Dense}_\delta(R)$ implies nice spatial independence properties. In what follows, we will often work with quads Q and Q' at distance more than δR from each other and we will often use implicitly that, if we condition on $\text{Dense}_\delta(R)$, then there is no Voronoi cell that intersects the two quads, which implies that the events $\text{Cross}(Q)$ and $\text{Cross}^*(Q')$ are (conditionally) independent.

We have the following estimates:

Lemma 7.4. *There exists $\epsilon > 0$ such that, for every $\delta \in (0, 1/1000)$ and every $R \in [\delta^{-2}, +\infty)$ we have:*

$$\mathbb{P} [G_\delta^{\text{ext}}(R)] \geq 1 - \frac{1}{\epsilon} \delta^\epsilon \tag{7.4}$$

and:

$$\mathbb{P} [G_\delta^{\text{int}}(R)] \geq 1 - \frac{1}{\epsilon} \delta^\epsilon. \tag{7.5}$$

Proof. We write only the proof of (7.4) since the proof of (7.5) is exactly the same. With the same proof as Lemma 2.11 and thanks to Proposition 2.13 we have:

$$\mathbb{P} [\text{Dense}_\delta(R) \cap \text{QBC}_\delta(R)] \geq 1 - O(1) (\delta^{-2} \exp(-\Omega(1)(\delta R)^2) + R^{-1}).$$

Since $R \geq \delta^{-2}$, the above is at least:

$$1 - O(1) (\delta^{-2} \exp(-\Omega(1)\delta^{-2}) + \delta^2) \geq 1 - O(1) \delta^2.$$

If we apply Lemma 2.11 and Proposition 2.13 once again, we obtain that $\mathbb{P} [\text{QBC}^{\text{ext}}(R)] \geq 1 - O(1) R^{-1}$. Therefore, with probability at least $1 - O(1) R^{-1}$, we have:

$$\mathbb{P} [\text{QBC}^{\text{ext}}(R) \mid \eta \cap A(R/2, 2R)] \geq 3/4.$$

As a result:

$$\mathbb{P} [\text{GP}_\delta^{\text{ext}}(R)] \geq 1 - O(1) (R^{-1} + \delta^2) \geq 1 - O(1) \delta^2.$$

It only remains to prove that $\mathbb{P} [\widetilde{\text{GI}}_\delta^{\text{ext}}(R)] \geq 1 - O(1) \delta^\epsilon$ for some $\epsilon > 0$. To this purpose, we follow the proof of Lemma A.2 in [SS10] (which is written for site percolation on \mathbb{T}). First, we let $\alpha \subseteq \partial B_R$ be an arc of diameter $R/8$ and we let Y be the set of points in B_R at distance at most $R/8$ from α . Let α_1 be one of the two arcs in $(\partial Y \cap \partial B_R) \setminus \alpha$. Let k be the number of

interfaces crossing from $\partial Y \setminus \partial B_R$ to α and let β_1, \dots, β_k be these interfaces ordered in a way that, if $i_1 < i_2$, β_{i_1} separates α_1 from β_{i_2} in Y (we will say that “ β_{i_2} is on the right-hand-side of β_{i_1} ” and we will write Y_i for the component of $Y \setminus \beta_i$ separated from α_1 by β_i). Let z_i denote the endpoint of β_i on α . We want to prove that there exists an absolute constant $\epsilon > 0$ such that:

$$\mathbb{P}[\forall i \in \{1, \dots, k-1\}, |z_i - z_{i+1}| \geq 10\delta R] \geq 1 - O(1)\delta^\epsilon. \quad (7.6)$$

The strategy in [SS10] is to condition on $\{i \leq k\}$ and on β_i , use the fact that the percolation configuration on the right-hand-side of β_i remains unbiased and finally conclude thanks to the box-crossing property. The fact that the (conditioned) configuration on the right-hand-side of β_i is unbiased is not true in the case of Voronoi percolation since it gives information about the structure of the random tiling.

The strategy we choose is to condition on some η such that $\text{Dense}_\delta(R) \cap \widetilde{\text{QBC}}_\delta(R)$ holds where:

$$\widetilde{\text{QBC}}_\delta(R) := \{\forall Q \in \widetilde{\mathcal{Q}}_\delta(A(R/2, 2R)), \mathbf{P}^\eta[\text{Cross}(Q)] \geq \tilde{c}(1)\}$$

(see Definition 3.1 for the definition of the set of quads $\widetilde{\mathcal{Q}}_\delta(D)$; the constant $\tilde{c}(1)$ is the constant that comes from Proposition 3.2). Now, since η is fixed, if we condition on $\{i \leq k\}$ and on β_i , then the (conditioned) configuration on the right-hand-side of β_i remains unbiased. Moreover, the fact that $\widetilde{\text{QBC}}_\delta(R)$ holds implies that we can use the box-crossing properties that are used in the proof of Lemma A.2 of [SS10]. Finally (and we refer to [SS10] for more details), we obtain that, for some absolute constant $\tilde{\epsilon} > 0$ and for any $\eta \in \text{Dense}_\delta(R) \cap \widetilde{\text{QBC}}_\delta(R)$, we have:

$$\mathbf{P}^\eta[\forall i \in \{1, \dots, k-1\}, |z_i - z_{i+1}| \geq 10\delta R] \geq 1 - O(1)\delta^{\tilde{\epsilon}}.$$

(The fact that $\tilde{\epsilon}$ does not depend on δ is crucial and comes from the fact that $\tilde{c}(1)$ does not depend on δ .) Next, note that Lemma 2.11 and Proposition 3.2 imply that:

$$\begin{aligned} \mathbb{P}\left[\text{Dense}_\delta(R) \cap \widetilde{\text{QBC}}_\delta(R)\right] &\geq 1 - O(1)\left(\delta^{-2} \exp(-\Omega(1)(\delta R)^2) + R^{-1}\right) \\ &\geq 1 - O(1)\delta^2. \end{aligned}$$

So, we have obtained (7.6) (with $\epsilon = \tilde{\epsilon} \wedge 2$). It is not difficult to see (by choosing an appropriate covering of ∂B_R by $O(1)$ arcs α) that this implies that:

$$\mathbb{P}\left[\widetilde{\text{GI}}_\delta^{\text{ext}}(R)\right] = \mathbb{P}\left[\tilde{s}^{\text{ext}}(3R/4, R) \geq 10\delta R\right] \geq 1 - O(1)\delta^\epsilon.$$

□

7.1.2 Extension of the arms when the configuration is good

Lemma 7.6 below is the analogue of Lemma A.3 of [SS10] and roughly says that if the 4-arm event holds at some scale and if the configuration is good at this scale then we can extend the four arms to a larger scale with non-negligible probability. If $\delta \in (0, 1/1000)$, $R \in [\delta^{-2}, +\infty)$ and $r \in [1, R]$, we write:

$$g_{4,\delta}^{\text{ext}}(r, R) = \mathbb{P}\left[\mathbf{A}_4(r, R) \cap G_\delta^{\text{ext}}(R)\right].$$

Similarly, if $\delta \in (0, 1/1000)$, $r \in [\delta^{-2}, +\infty)$ and $R \in [r, +\infty)$, we write:

$$g_{4,\delta}^{\text{int}}(r, R) = \mathbb{P}\left[\mathbf{A}_4(r, R) \cap G_\delta^{\text{int}}(r)\right].$$

Remark 7.5. Note that (1.1) implies that there exists a constant $c > 0$ such that, for all $1 \leq \rho_1 \leq \rho_2$ that satisfy $\rho_1 \geq \rho_2/4^3$, we have $\alpha_4^{\text{an}}(\rho_1, \rho_2) \geq c$. Together with Lemma 7.4, this implies that, if $\delta \in (0, 1/1000)$ is sufficiently small, then for all $R \in [\delta^{-2}, +\infty)$ and all $r \in [R/4^3, R]$ we have:

$$g_{4,\delta}^{\text{ext}}(r, R) \geq c/2.$$

Similarly, if $\delta \in (0, 1/1000)$ is sufficiently small, then for all $r \in [\delta^{-2}, +\infty)$ and all $R \in [r, 4^3 r]$ we have:

$$g_{4,\delta}^{int}(r, R) \geq c/2.$$

Lemma 7.6. *There exists $\bar{\delta} \in (0, 1/1000)$ such that, for any $\delta \in (0, 1/1000)$, there is some constant $a = a(\delta) \in (0, 1)$ satisfying:*

1. *For every $R \in [(\bar{\delta} \vee \delta)^{-2}, +\infty)$ and every $r \in [1, R/4]$ we have:*

$$g_{4,\bar{\delta}}^{ext}(r, 4R) \geq a g_{4,\delta}^{ext}(r, R). \quad (7.7)$$

2. *For every $r \in [4(\bar{\delta} \vee \delta)^{-2}, +\infty)$ and every $R \in [4r, +\infty)$ we have:*

$$g_{4,\bar{\delta}}^{int}(r/4, R) \geq a g_{4,\delta}^{int}(r, R). \quad (7.8)$$

Moreover, we can (and do) assume that $\bar{\delta}$ is sufficiently small so that Remark 7.5 holds with $\delta = \bar{\delta}$.

Proof of Lemma 7.6. Let us first prove (7.7). Let $\bar{\delta} \in (0, 1/1000)$ to be determined later and consider R, r and δ as in the statement of the lemma. We write $\mathbf{P}_{B_{2R}}^\eta$ for the probability measure \mathbb{P} conditioned on $\eta \cap B_{2R}$. Note that this is the probability measure obtained by colouring $\eta \cap B_{2R}$ uniformly and by sampling (independently of the colouring of $\eta \cap B_{2R}$) a coloured Poisson point process in $\mathbb{R}^2 \setminus B_{2R}$ of intensity $\text{Leb}_{\mathbb{R}^2 \setminus B_{2R}} \otimes \left(\frac{\delta_{-1} + \delta_1}{2}\right)$.

Fix some $\eta \in \text{GP}_\delta^{ext}(R)$ such that $\mathbf{P}_{B_{2R}}^\eta [\mathbf{A}_4(r, R) \cap \{\tilde{s}^{ext}(r, R) \geq 10\delta R\}] > 0$ and write $\beta_0, \dots, \beta_{k-1}$ for the interfaces that cross $A(r, R)$ in counter-clockwise order. We assume that the right-hand-side of β_0 (if one goes from ∂B_r to ∂B_R) is black. First, we work under the following conditional probability measure:

$$\nu_{r,R,(\beta_j)_j}^\eta := \mathbf{P}_{B_{2R}}^\eta \left[\cdot \mid \mathbf{A}_4(r, R) \cap \text{GP}_\delta^{ext}(R) \cap \{\tilde{s}^{ext}(r, R) \geq 10\delta R\}, \beta_0, \dots, \beta_{k-1} \right].$$

We keep such an η fixed until we explicitly say that we take the expectation under \mathbb{P} (see below (7.13)). Let us define four rectangles $Q^{ext}(R, 0), \dots, Q^{ext}(R, 3)$ (which belong to the set of quads $\mathcal{Q}_{1/100}(A(R, 4R))$ from Definition 2.12) in Figure 7.1.

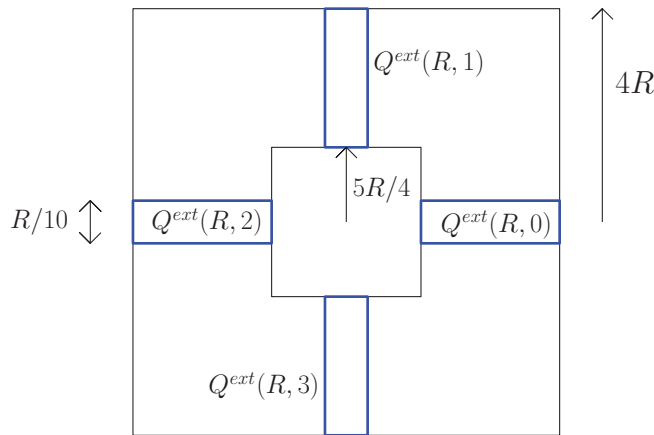

Figure 7.1 – The quads $Q^{ext}(R, 0), \dots, Q^{ext}(R, 3)$.

It is not difficult to see that we can choose four quads $Q(\beta_i) \in \mathcal{Q}_\delta(A(3R/4, 3R/2))$, $i \in \{0, \dots, 3\}$, such that: (a) the intersection of $Q(\beta_i)$ and $\beta_{i-1} \cup \beta_i$ is one of the two distinguished sides of $Q(\beta_i)$, (b) $Q(\beta_i) \cap B_R$ is in the region between β_{i-1} and β_i , (c) if $Q(\beta_i)$ is crossed, then

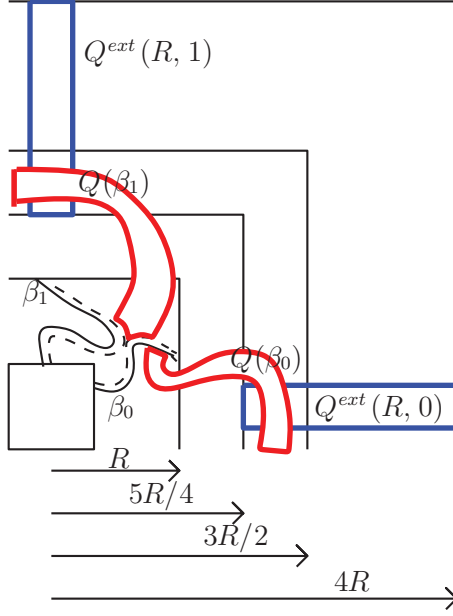

Figure 7.2 – The quads $Q(\beta_1)$ and $Q(\beta_2)$.

$Q^{ext}(R, i)$ is crossed widthwise, (d) if $0 \leq i \neq j \leq 3$, then there is no Voronoi cell that intersects both $Q(\beta_i)$ and $Q^{ext}(R, j)$, (e) if $0 \leq i \neq j \leq 3$, then there is no Voronoi cell that intersects both $Q(\beta_i)$ and $Q(\beta_j)$. See Figure 7.2.

Note that, since the quads $Q(\beta_i)$ belong to the set $\mathcal{Q}_\delta(A(3R/4, 3R/2))$, then the probability under $\nu_{r,R,(\beta_j)_j}^\eta$ that $Q(\beta_i)$ is crossed is at least $c(\delta, 1)$, where $c(\delta, 1)$ is the constant of Proposition 2.13. (Note that we have implicitly used the (quenched) Harris-FKG inequality since conditioning on $(\beta_j)_j$ affects the percolation process as follows: if the right-hand-side of β_j is black (respectively white) then there is a black (respectively white) crossing from β_j to β_{j-1} .) Now, let $F = F(\beta_0, \dots, \beta_{k-1})$ denote the event that there are black crossings in $Q(\beta_0)$ and $Q(\beta_2)$ and white crossings in $Q(\beta_1)$ and $Q(\beta_3)$. We have:

$$\nu_{r,R,(\beta_j)_j}^\eta [F] \geq c(\delta, 1)^4. \quad (7.9)$$

Our next goal is to prove the following:

$$\nu_{r,R,(\beta_j)_j}^\eta \left[\text{QBC}^{ext}(R) \mid F \right] \geq 3/4. \quad (7.10)$$

To this purpose, remember that

$$\text{GP}_\delta^{ext}(R) = \text{Dense}_\delta(R) \cap \text{QBC}_\delta(R) \cap \left\{ \mathbb{P} \left[\text{QBC}^{ext}(R) \mid \eta \cap A(R/2, 2R) \right] \geq 3/4 \right\}.$$

Since $\sigma(\text{QBC}^{ext}(R), \eta \cap A(R/2, 2R))$ is independent of $\eta \cap B_{R/2}$, we have:

$$\mathbb{P} \left[\text{QBC}^{ext}(R) \mid \eta \cap A(R/2, 2R) \right] = \mathbf{P}_{B_{2R}}^\eta \left[\text{QBC}^{ext}(R) \right].$$

Moreover, i) $\nu_{r,R,(\beta_j)_j}^\eta [\cdot \mid F]$ is the probability measure $\mathbf{P}_{B_{2R}}^\eta$ conditioned on $\text{GP}_\delta^{ext}(R)$ and on other events which are measurable with respect to $\omega \cap B_{2R}$ and ii) $\text{QBC}^{ext}(R)$ is $\mathbf{P}_{B_{2R}}^\eta$ -independent of $\omega \cap B_{2R}$. This implies (7.10).

We are now in shape to extend the arms to scale $4R$ since $\text{QBC}^{ext}(R)$ gives quenched box crossing estimates for enough quads in $A(R, 4R)$. If F holds and if there are black crossings of $Q^{ext}(R, 0)$ and $Q^{ext}(R, 2)$ and white crossings of $Q^{ext}(R, 1)$ and $Q^{ext}(R, 3)$, then $\mathbf{A}_4(r, 4R)$

holds. As a result, the (quenched) Harris-FKG inequality implies that there exists an absolute constant $c' > 0$ such that:

$$\nu_{r,R,(\beta_j)_j}^\eta \left[\mathbf{A}_4(r, 4R) \mid F \cap \text{QBC}^{ext}(R), \eta \right] \geq c',$$

hence:

$$\nu_{r,R,(\beta_j)_j}^\eta \left[\mathbf{A}_4(r, 4R) \mid F \cap \text{QBC}^{ext}(R) \right] \geq c'. \quad (7.11)$$

Let us use once again that $\nu_{r,R,(\beta_j)_j}^\eta$ is the probability measure $\mathbf{P}_{B_{2R}}^\eta$ conditioned on events measurable with respect to $\omega \cap B_{2R}$. Let us also use that (under $\nu_{r,R,(\beta_j)_j}^\eta$) the event F is measurable with respect to $\omega \cap B_{2R}$. Moreover, $G_{\bar{\delta}}^{ext}(4R)$ is measurable with respect to $\omega \setminus B_{2R}$. Together with Lemma 7.4, this implies that:

$$\nu_{r,R,(\beta_j)_j}^\eta \left[G_{\bar{\delta}}^{ext}(4R) \mid F \right] \geq 1 - \frac{1}{\epsilon} \bar{\delta}^\epsilon. \quad (7.12)$$

If we combine (7.10), (7.11) and (7.12), we obtain that:

$$\nu_{r,R,(\beta_j)_j}^\eta \left[\mathbf{A}_4(r, 4R) \cap G_{\bar{\delta}}^{ext}(4R) \mid F \right] \geq 3c'/4 - \frac{1}{\epsilon} \bar{\delta}^\epsilon.$$

We choose $\bar{\delta}$ sufficiently small so that $3c'/4 - \frac{1}{\epsilon} \bar{\delta}^\epsilon \geq c'/2$ (here the fact that c' does not depend on δ is crucial). Now, by combining the above inequality with (7.9) we obtain that:

$$\nu_{r,R,(\beta_j)_j}^\eta \left[\mathbf{A}_4(r, 4R) \cap G_{\bar{\delta}}^{ext}(4R) \right] \geq \frac{c(\delta, 1)^4 c'}{2}. \quad (7.13)$$

If we take the expectation under $\mathbf{P}_{B_{2R}}^\eta$ and then under \mathbb{P} , we obtain that:

$$\begin{aligned} g_{4,\delta}^{ext}(r, 4R) &= \mathbb{P} \left[\mathbf{A}_4(r, 4R) \cap G_{\bar{\delta}}^{ext}(4R) \right] \\ &\geq \frac{c(\delta, 1)^4 c'}{2} \mathbf{P} \left[\mathbf{A}_4(r, R) \cap \text{GP}_{\bar{\delta}}^{ext}(R) \cap \{\tilde{s}^{ext}(r, R) \geq 10\delta R\} \right]. \end{aligned}$$

Note that, if $1 \leq r_1 \leq r_2 \leq r_3$, then $\tilde{s}^{ext}(r_1, r_3) \geq \tilde{s}^{ext}(r_2, r_3)$, hence:

$$\mathbb{P} \left[\mathbf{A}_4(r, R) \cap \text{GP}_{\bar{\delta}}^{ext}(R) \cap \{\tilde{s}^{ext}(r, R) \geq 10\delta R\} \right] \geq g_{4,\delta}^{ext}(r, R).$$

Finally, we have obtained (7.7) (with $a = a(\delta) = c(\delta, 1)^4 c'/2$).

Note that we have obtained the following more precise result: Let $\tilde{\mathbf{A}}_4^{ext}(r, R)$ denote the event that there are four arms of alternating colors $\gamma_0, \dots, \gamma_3$ from ∂B_r to ∂B_R such that $\gamma_i \cap A(R/2, R) \subseteq Q^{ext}(R/4, i)$ (see Figure 7.1 for the definition of these rectangles). Let δ, r and R be as in the statement of Item 1 of Lemma 7.6. Then:

$$\mathbb{P} \left[\tilde{\mathbf{A}}_4^{ext}(r, 4R) \cap G_{\bar{\delta}}^{ext}(4R) \right] \geq a g_{4,\delta}^{ext}(r, R).$$

Actually, if we follow the proof we can see that we also have the following: Let F_R be an event measurable with respect to $\omega \setminus B_{2R}$ such that $\mathbb{P}[F_R] \geq 1 - c'/4$. Then:

$$\mathbb{P} \left[\tilde{\mathbf{A}}_4^{ext}(r, 4R) \cap G_{\bar{\delta}}^{ext}(4R) \cap F_R \right] \geq \frac{a}{2} g_{4,\delta}^{ext}(r, R).$$

The proof of (7.8) is exactly the same. As in the case of (7.7), we can also obtain a stronger result: Let $Q^{int}(r, 0), \dots, Q^{int}(r, 3)$ be the four rectangles defined on Figure 7.3 and write $\tilde{\mathbf{A}}_4^{int}(r, R)$ for the event that there are four arms of alternating colors $\gamma_0, \dots, \gamma_3$ from ∂B_r to ∂B_R such that $\gamma_i \cap A(r, 2r) \subseteq Q^{int}(4r, i)$. If $\bar{\delta}$ is sufficiently small and if δ, r and R are as in Item 2 of Lemma 7.6, then the following holds: There exists $a = a(\delta) > 0$ and $c' > 0$ such that, for every event F_r measurable with respect to $\omega \cap B_{r/2}$ that satisfies $\mathbb{P}[F_r] \geq 1 - c'$, we have:

$$\mathbb{P} \left[\tilde{\mathbf{A}}_4^{int}(r/4, R) \cap G_{\bar{\delta}}^{int}(r/4) \cap F_r \right] \geq a g_{4,\delta}^{int}(r, R). \quad (7.14)$$

□

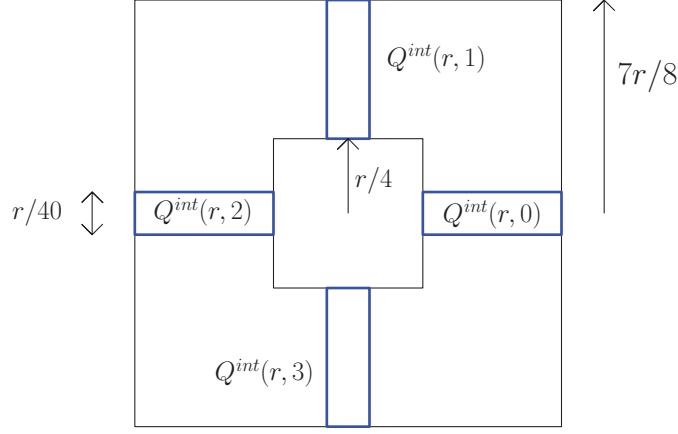

Figure 7.3 – The quads $Q^{int}(r, 0), \dots, Q^{int}(r, 3)$.

7.1.3 The probability to look good if the 4-arm event holds

We now consider the events:

$$\begin{aligned}\widehat{\mathbf{A}}_4^{ext}(r, R) &= \left\{ \mathbb{P} \left[\mathbf{A}_4(r, R) \mid \omega \cap B_R \right] > 0 \right\}, \\ \widehat{\mathbf{A}}_4^{int}(r, R) &= \left\{ \mathbb{P} \left[\mathbf{A}_4(r, R) \mid \omega \setminus B_r \right] > 0 \right\},\end{aligned}$$

and the two following quantities:

$$f_4^{ext}(r, R) = \mathbb{P} \left[\widehat{\mathbf{A}}_4^{ext}(r, R) \right]; \quad f_4^{int}(r, R) = \mathbb{P} \left[\widehat{\mathbf{A}}_4^{int}(r, R) \right].$$

We want to prove that the quantities $\alpha_4^{an}(r, R)$, $g_{4, \bar{\delta}}^{ext}(r, R)$, $g_{4, \bar{\delta}}^{int}(r, R)$, $f_4^{ext}(r, R)$ and $f_4^{int}(r, R)$ are of the same order. We have the following result (where $\bar{\delta}$ is the constant of Lemma 7.6):

Lemma 7.7. *There exist $C_1 \in [1, +\infty)$ and $\bar{r} \in [\bar{\delta}^{-2}, +\infty)$ such that, for every $r \in [\bar{r}, +\infty)$ and $R \in [16r, +\infty)$:*

$$g_{4, \bar{\delta}}^{ext}(r, R) \geq f_4^{ext}(r, R)/C_1, \quad (7.15)$$

and:

$$g_{4, \bar{\delta}}^{int}(r, R) \geq f_4^{int}(r, R)/C_1. \quad (7.16)$$

We have the following corollary (which is a direct consequence of Lemma 7.7 and Remark 7.5):

Corollary 7.8. *There exists a constant $C_2 \in [1, +\infty)$ such that, for every $r \in [\bar{r}, +\infty)$ and every $R \in [r, +\infty)$:*

$$g_{4, \bar{\delta}}^{ext}(r, R) \leq \alpha_4^{an}(r, R) \leq f_4^{ext}(r, R) \leq C_2 g_{4, \bar{\delta}}^{ext}(r, R),$$

and:

$$g_{4, \bar{\delta}}^{int}(r, R) \leq \alpha_4^{an}(r, R) \leq f_4^{int}(r, R) \leq C_2 g_{4, \bar{\delta}}^{int}(r, R).$$

Proof of Lemma 7.7. We only prove (7.15) since the the proof of (7.16) is essentially the same. Let $\delta \in (0, \bar{\delta})$ to be chosen later, let $\bar{r} = 4^3 \delta^{-2}$, and let r and R be as in the statement of the lemma. First, note that if $\text{Dense}_\delta(R/4)$ holds then every $x \in \eta$ whose Voronoi cell intersects $A(r, R/4)$ is in B_R . Hence, $\widehat{\mathbf{A}}_4^{ext}(r, R) \cap \text{Dense}_\delta(R/4) \subseteq \mathbf{A}_4(r, R/4)$. Remember that $\text{Dense}_\delta(R/4) \subseteq G_\delta^{ext}(R/4)$. As a result:

$$\begin{aligned}\widehat{\mathbf{A}}_4^{ext}(r, R) &\subseteq \left(\mathbf{A}_4(r, R/4) \cap G_\delta^{ext}(R/4) \right) \cup \left(\widehat{\mathbf{A}}_4^{ext}(r, R) \setminus G_\delta^{ext}(R/4) \right) \\ &\subseteq \left(\mathbf{A}_4(r, R/4) \cap G_\delta^{ext}(R/4) \right) \cup \left(\widehat{\mathbf{A}}_4^{ext}(r, R/16) \setminus G_\delta^{ext}(R/4) \right).\end{aligned}$$

As a result, $f_4^{ext}(r, R)$ is smaller than or equal to:

$$\begin{aligned} & \mathbb{P} [\mathbf{A}_4(r, R/4) \cap G_\delta^{ext}(R/4)] + \mathbb{P} [\widehat{\mathbf{A}}_4^{ext}(r, R/16) \setminus G_\delta^{ext}(R/4)] \\ &= g_{4,\delta}^{ext}(r, R/4) + \mathbb{P} [\widehat{\mathbf{A}}_4^{ext}(r, R/16) \setminus G_\delta^{ext}(R/4)]. \end{aligned}$$

Remember that $G_\delta^{ext}(R/4)$ is measurable with respect to $\omega \cap A(R/8, R/2)$ and that $\widehat{\mathbf{A}}_4^{ext}(r, R/16)$ is measurable with respect to $\omega \cap B_{R/16}$. Hence, by spatial independence, the above equals:

$$g_{4,\delta}^{ext}(r, R/4) + f_4^{ext}(r, R/16) \cdot \mathbb{P} [-G_\delta^{ext}(R/4)]. \quad (7.17)$$

Since $R/4 \geq \delta^{-2}$, Lemma 7.4 implies that:

$$f_4^{ext}(r, R) \leq g_{4,\delta}^{ext}(r, R/4) + \frac{1}{\epsilon} \delta^\epsilon f_4^{ext}(r, R/16).$$

By repeating the above argument, we obtain that $f_4^{ext}(r, R)$ is at most:

$$\sum_{i=0}^{l-1} \left(\left(\frac{1}{\epsilon} \delta^\epsilon \right)^i g_{4,\delta}^{ext} \left(r, \frac{R}{4 \cdot 16^i} \right) \right) + \left(\frac{1}{\epsilon} \delta^\epsilon \right)^l,$$

where $l = \lfloor \log_{16}(R/r) \rfloor$. Lemma 7.6 then implies that that the above is at most:

$$\sum_{i=0}^{l-1} \left(\left(\frac{1}{\epsilon} \delta^\epsilon \right)^i a(\delta)^{-1} a(\bar{\delta})^{-2i} g_{4,\bar{\delta}}^{ext}(r, R) \right) + \left(\frac{1}{\epsilon} \delta^\epsilon \right)^l. \quad (7.18)$$

Lemma 7.6 also implies the following inequality:

$$g_{4,\bar{\delta}}^{ext}(r, R) \geq a(\bar{\delta})^{2l-1} g_{4,\bar{\delta}}^{ext} \left(r, \frac{R}{4 \cdot 16^{l-1}} \right). \quad (7.19)$$

Remember Remark 7.5: there exists an absolute constant $c > 0$ such that:

$$g_{4,\bar{\delta}}^{ext} \left(r, \frac{R}{4 \cdot 16^{l-1}} \right) \geq c. \quad (7.20)$$

Let us end the proof: We choose $\delta \in (1, \bar{\delta})$ small enough so that $\frac{1}{\epsilon} \delta^\epsilon a(\bar{\delta})^{-2} \leq 1/2$. If we combine (7.18), (7.19) and 7.20 we obtain that:

$$\begin{aligned} f_4^{ext}(r, R) &\leq g_{4,\bar{\delta}}^{ext}(r, R) \sum_{i=0}^{+\infty} \left(\left(\frac{1}{\epsilon} \delta^\epsilon \right)^i a(\delta)^{-1} a(\bar{\delta})^{-2i} \right) + g_{4,\bar{\delta}}^{ext}(r, R) \left(\frac{1}{\epsilon} \delta^\epsilon \right)^l a(\bar{\delta})^{-(2l-1)} (c')^{-1} \\ &\leq g_{4,\bar{\delta}}^{ext}(r, R) \left(\frac{2}{a(\delta)} + \frac{a(\bar{\delta})}{c} \right), \end{aligned}$$

which ends the proof. \square

7.1.4 Proof of the quasi-multiplicativity property

We are now in shape to prove Proposition 7.1. We first prove it for r_1 sufficiently large and we prove separately the left-hand and right-hand inequalities. Below, \bar{r} is the constant of Lemma 7.7. Remember that $\bar{r} \geq \bar{\delta}^{-2}$ where $\bar{\delta}$ is the constant of Lemma 7.6.

Proof of the left-hand-inequality of Proposition 7.1 in the case $r_1 \geq \bar{r}$. We have:

$$\begin{aligned}\alpha_4^{an}(r_1, r_3) &\leq \mathbb{P}[\mathbf{A}_4(r_1, r_2) \cap \mathbf{A}_4(r_2, r_3)] \\ &\leq \mathbb{P}[\widehat{\mathbf{A}}_4^{ext}(r_1, r_2) \cap \widehat{\mathbf{A}}_4^{int}(r_2, r_3)] \\ &= \mathbb{P}[\widehat{\mathbf{A}}_4^{ext}(r_1, r_2)] \cdot \mathbb{P}[\widehat{\mathbf{A}}_4^{int}(r_2, r_3)],\end{aligned}$$

by spatial independence. The above inequality can be rewritten:

$$\alpha_4^{an}(r_1, r_3) \leq f_4^{ext}(r_1, r_2) f_4^{int}(r_2, r_3),$$

so Corollary 7.8 implies the desired result. \square

Proof of the right-hand-inequality of Proposition 7.1 in the case $r_1 \geq 16\bar{r}$. We distinguish between four cases:

1. Assume that $r_1 \geq r_2/16$ and $r_2 \geq r_3/16$. Then, this is a direct consequence of (1.1).
2. Assume that $r_1 \geq r_2/16$ and $r_2 \leq r_3/16$. By Corollary 7.8, we have:

$$\alpha_4^{an}(r_1, r_2) \alpha_4^{an}(r_2, r_3) \leq \alpha_4^{an}(r_2, r_3) \leq O(1) g_{4,\bar{\delta}}^{int}(r_2, r_3).$$

By applying Lemma 7.6 (here, we use that $r_2 \geq 16\bar{r} \geq 16\bar{\delta}^{-2}$ since $r_1 \geq 16\bar{r}$), we obtain that the above is at most $O(1) \alpha_4^{an}(r_2/16, r_3)$ (which is at most $O(1) \alpha_4^{an}(r_1, r_3)$ since $r_1 \geq r_2/4$).

3. The case “ $r_1 \leq r_2/16$ and $r_2 \geq r_3/16$ ” is treated similarly.
4. Now, we treat the case $r_1 \leq r_2/16$ and $r_2 \leq r_3/16$. First, we write the simple inequality:

$$\alpha_4^{an}(r_1, r_2) \alpha_4^{an}(r_2, r_3) \leq \alpha_4^{an}\left(r_1, \frac{r_2}{3}\right) \alpha_4^{an}(3r_2, r_3).$$

Corollary 7.8 implies that:

$$\alpha_4^{an}\left(r_1, \frac{r_2}{3}\right) \alpha_4^{an}(3r_2, r_3) \leq O(1) g_{4,\bar{\delta}}^{ext}\left(r_1, \frac{r_2}{3}\right) g_{4,\bar{\delta}}^{int}(3r_2, r_3). \quad (7.21)$$

Now, the proof is very similar to the one of Lemma 7.6. However, we have to be a little more careful because we have to deal with the interactions between scales $r_2/3$ and $3r_2$. First, as it is explained in the paragraph below (7.10), we can write the events $\text{GP}_{\bar{\delta}}^{ext}(R)$ (and similarly $\text{GP}_{\bar{\delta}}^{int}(R)$) a little differently. More precisely, we have:

$$\begin{aligned}\text{GP}_{\bar{\delta}}^{ext}(r_2/3) &= \text{Dense}_{\bar{\delta}}(r_2/3) \cap \text{QBC}_{\bar{\delta}}(r_2/3) \cap \left\{ \mathbb{P} \left[\text{QBC}^{ext}(r_2/3) \mid \eta \cap B_{2r_2/3} \right] \geq 3/4 \right\} \quad (7.22)\end{aligned}$$

and similarly:

$$\begin{aligned}\text{GP}_{\bar{\delta}}^{int}(3r_2) &= \text{Dense}_{\bar{\delta}}(3r_2) \cap \text{QBC}_{\bar{\delta}}(3r_2) \cap \left\{ \mathbb{P} \left[\text{QBC}^{int}(3r_2) \mid \eta \setminus B_{3r_2/2} \right] \geq 3/4 \right\}. \quad (7.23)\end{aligned}$$

Since $\text{QBC}^{ext}(\cdot)$ and $\text{QBC}^{int}(\cdot)$ do not depend on the colouring, we actually have:

$$\mathbb{P} \left[\text{QBC}^{ext}(r_2/3) \mid \eta \cap B_{2r_2/3} \right] = \mathbb{P} \left[\text{QBC}^{ext}(r_2/3) \mid \omega \cap B_{2r_2/3} \right] \text{ and}$$

$$\mathbb{P} \left[\text{QBC}^{int}(3r_2) \mid \eta \setminus B_{3r_2/2} \right] = \mathbb{P} \left[\text{QBC}^{int}(3r_2) \mid \omega \setminus B_{3r_2/2} \right].$$

As a result, (7.21) can be rewritten as follows:

$$\begin{aligned} & \alpha_4^{an}(r_1, \frac{r_2}{3}) \alpha_4^{an}(3r_2, r_3) \\ & \leq O(1) \mathbb{P} \left[\mathbf{A}_4(r_1, r_2/3) \cap \widetilde{\text{GI}}_{\bar{\delta}}^{ext}(r_2/3) \cap \text{Dense}_{\bar{\delta}}(r_2/3) \cap \text{QBC}_{\bar{\delta}}(r_2/3) \right. \\ & \quad \left. \cap \left\{ \mathbb{P} \left[\text{QBC}^{ext}(r_2/3) \mid \omega \cap B_{2r_2/3} \right] \geq 3/4 \right\} \right] \\ & \times \mathbb{P} \left[\mathbf{A}_4(3r_2, r_3) \cap \widetilde{\text{GI}}_{\bar{\delta}}^{int}(3r_2) \cap \text{Dense}_{\bar{\delta}}(3r_2) \cap \text{QBC}_{\bar{\delta}}(3r_2) \right. \\ & \quad \left. \cap \left\{ \mathbb{P} \left[\text{QBC}^{int}(3r_2) \mid \omega \setminus B_{3r_2/2} \right] \geq 3/4 \right\} \right]. \end{aligned}$$

We need the following lemma:

Lemma 7.9. *Let \mathcal{F} and \mathcal{G} be two sub- σ -algebras, let $A_1 \in \mathcal{F}$, $A_2 \in \mathcal{G}$, and let B_1 and B_2 be two events such that $\sigma(B_1, \mathcal{F})$ is independent of \mathcal{G} and $\sigma(B_2, \mathcal{G})$ is independent of \mathcal{F} . Then:*

$$\mathbb{P}[A_1 \cap B_1 \cap A_2 \cap B_2] \geq \frac{1}{2} \mathbb{P} \left[A_1 \cap \left\{ \mathbb{P} \left[B_1 \mid \mathcal{F} \right] \geq 3/4 \right\} \right] \mathbb{P} \left[A_2 \cap \left\{ \mathbb{P} \left[B_2 \mid \mathcal{G} \right] \geq 3/4 \right\} \right].$$

Proof. We have:

$$\begin{aligned} & \mathbb{P}[A_1 \cap B_1 \cap A_2 \cap B_2] \\ & \geq \mathbb{E} \left[\mathbb{1}_{A_1 \cap B_1 \cap A_2 \cap B_2} \mathbb{1}_{\{\mathbb{P}[B_1 \mid \mathcal{F} \vee \mathcal{G}] \geq 3/4\}} \mathbb{1}_{\{\mathbb{P}[B_2 \mid \mathcal{F} \vee \mathcal{G}] \geq 3/4\}} \right] \\ & = \mathbb{E} \left[\mathbb{1}_{A_1 \cap A_2} \mathbb{E} \left[\mathbb{1}_{B_1 \cap B_2} \mid \mathcal{F} \vee \mathcal{G} \right] \mathbb{1}_{\{\mathbb{P}[B_1 \mid \mathcal{F} \vee \mathcal{G}] \geq 3/4\}} \mathbb{1}_{\{\mathbb{P}[B_2 \mid \mathcal{F} \vee \mathcal{G}] \geq 3/4\}} \right] \\ & \geq \frac{1}{2} \mathbb{E} \left[\mathbb{1}_{A_1} \mathbb{1}_{\{\mathbb{P}[B_1 \mid \mathcal{F} \vee \mathcal{G}] \geq 3/4\}} \mathbb{1}_{A_2} \mathbb{1}_{\{\mathbb{P}[B_2 \mid \mathcal{F} \vee \mathcal{G}] \geq 3/4\}} \right]. \end{aligned}$$

But, since $\sigma(B_1, \mathcal{F})$ is independent of \mathcal{G} , we have:

$$\mathbb{P} \left[B_1 \mid \mathcal{F} \vee \mathcal{G} \right] = \mathbb{P} \left[B_1 \mid \mathcal{F} \right].$$

Similarly:

$$\mathbb{P} \left[B_2 \mid \mathcal{F} \vee \mathcal{G} \right] = \mathbb{P} \left[B_2 \mid \mathcal{G} \right].$$

This implies the result since \mathcal{F} is independent of \mathcal{G} . □

If we apply this lemma to $\mathcal{F} = \sigma(\omega \cap B_{2r_2/3})$, $\mathcal{G} = \sigma(\omega \setminus B_{3r_2/2})$, $A_1 = \mathbf{A}_4(r_1, r_2/3) \cap \widetilde{\text{GI}}_{\bar{\delta}}^{ext}(r_2/3) \cap \text{Dense}_{\bar{\delta}}(r_2/3) \cap \text{QBC}_{\bar{\delta}}(r_2/3)$, $A_2 = \mathbf{A}_4(3r_2, r_3) \cap \widetilde{\text{GI}}_{\bar{\delta}}^{int}(3r_2) \cap \text{Dense}_{\bar{\delta}}(3r_2) \cap \text{QBC}_{\bar{\delta}}(3r_2)$, $B_1 = \text{QBC}^{ext}(r_2/3)$ and $B_2 = \text{QBC}^{int}(3r_2)$, we obtain that:

$$\begin{aligned} & \alpha_4^{an}(r_1, \frac{r_2}{3}) \alpha_4^{an}(3r_2, r_3) \\ & \leq O(1) \mathbb{P} \left[\mathbf{A}_4(r_1, r_2/3) \cap \widetilde{\text{GI}}_{\bar{\delta}}^{ext}(r_2/3) \cap \text{Dense}_{\bar{\delta}}(r_2/3) \cap \text{QBC}_{\bar{\delta}}(r_2/3) \cap \text{QBC}^{ext}(r_2/3) \right. \\ & \quad \left. \cap \mathbf{A}_4(3r_2, r_3) \cap \widetilde{\text{GI}}_{\bar{\delta}}^{int}(3r_2) \cap \text{Dense}_{\bar{\delta}}(3r_2) \cap \text{QBC}_{\bar{\delta}}(3r_2) \cap \text{QBC}^{int}(3r_2) \right]. \end{aligned}$$

Now, we can condition on η and on the interfaces and conclude (with arguments similar to the proof of Lemma 7.6) that the above is at most $O(1) \alpha_4^{an}(r_1, r_3)$. □

We have obtained the quasi-multiplicativity property for $r_1 \geq 16\bar{r}$: there exists a constant $C' \in [1, +\infty)$ such that, for every $16\bar{r} \leq r_1 \leq r_2 \leq r_3$:

$$\frac{1}{C'} \alpha_4^{an}(r_1, r_3) \leq \alpha_4^{an}(r_1, r_2) \alpha_4^{an}(r_2, r_3) \leq C' \alpha_4^{an}(r_1, r_3). \quad (7.24)$$

In order to obtain the full result, we need the following lemma:

Lemma 7.10. *For every \bar{r} sufficiently large, there exists a constant $C_3 = C_3(\bar{r}) < +\infty$ such that, for every $r \in [1, \bar{r}]$ and every $R \in [\bar{r}, +\infty)$, we have:*

$$\alpha_4^{an}(\bar{r}, R) \leq C_3 \alpha_4^{an}(r, R).$$

Before proving this lemma, let us explain why it enables us to conclude the proof of Proposition 7.1. Fix a quantity $\bar{r} \geq 16\bar{r}$ sufficiently large so that Lemma 7.10 holds. Let $r_1 \leq \bar{r}$, $r_2 \in [r_1, +\infty)$ and $r_3 \in [r_2, +\infty)$. We distinguish between three cases:

1. If $r_3 \leq \bar{r}$ we are done thanks to (1.1).
2. If $r_3 \geq \bar{r} \geq r_2$ then we can use Lemma 7.10 to obtain that:

$$\begin{aligned} \alpha_4^{an}(r_1, r_3) &\leq \alpha_4^{an}(r_2, r_3) \\ &= \frac{1}{\alpha_4^{an}(r_1, r_2)} \alpha_4^{an}(r_1, r_2) \alpha_4^{an}(r_2, r_3) \\ &\leq \frac{1}{\alpha_4^{an}(1, \bar{r})} \alpha_4^{an}(r_1, r_2) \alpha_4^{an}(r_2, r_3) \\ &\leq \frac{1}{\alpha_4^{an}(1, \bar{r})} \alpha_4^{an}(r_2, r_3) \\ &\leq \frac{1}{\alpha_4^{an}(1, \bar{r})} \alpha_4^{an}(\bar{r}, r_3) \\ &\leq \frac{C_3}{\alpha_4^{an}(1, \bar{r})} \alpha_4^{an}(r_1, r_3). \end{aligned}$$

The above implies the left-hand and right-hand sides of the quasi-multiplicativity property.

3. If $r_2 \geq \bar{r}$, we can use Lemma 7.10 and (7.24) to obtain that:

$$\begin{aligned} \alpha_4^{an}(r_1, r_3) &\leq \alpha_4^{an}(\bar{r}, r_3) \\ &\leq C' \alpha_4^{an}(\bar{r}, r_2) \alpha_4^{an}(r_2, r_3) \\ &\leq C' C_3 \alpha_4^{an}(r_1, r_2) \alpha_4^{an}(r_2, r_3) \\ &\leq C' C_3 \alpha_4^{an}(\bar{r}, r_2) \alpha_4^{an}(r_2, r_3) \\ &\leq C' C_3 C' \alpha_4^{an}(\bar{r}, r_3) \\ &\leq C' C_3 C' C_3 \alpha_4^{an}(r_1, r_3), \end{aligned}$$

and we are done.

Sketch of proof of Lemma 7.10. The proof is very similar to the proof of Lemma 4.6. Therefore, we only sketch it. Let $\text{Dense}^N(r)$ be the event defined in the proof of Lemma 4.6. Corollary 7.8 and the inequality (7.14) imply that there exists an absolute constant $c \in (0, 1)$ such that, for every r sufficiently large, there exists $N = N(r)$ satisfying:

$$\forall R \geq 4r, \mathbb{P} \left[\tilde{\mathbf{A}}_4^{int}(r, R) \cap \text{Dense}^N(r) \right] \geq c \alpha_4^{an}(r, R),$$

where $\tilde{\mathbf{A}}_4^{int}(r, R)$ is the event defined above (7.14). Now, if we follow the proof of Lemma 4.6, we obtain that we can extend the four arms with probability larger than some constant that

depends only on r and N . More precisely, we obtain that there exists a constant $c' = c'(r, N)$ such that:

$$\alpha_4^{an}(R) \geq c' \mathbb{P} \left[\tilde{\mathbf{A}}_4^{int}(r, R) \cap \text{Dense}^N(r) \right].$$

This ends the proof. \square

7.2 A consequence of the quasi-multiplicativity property

In this subsection, we prove Proposition 2.4 (where, instead of the events $\widehat{\mathbf{A}}_j^{ext}(r, R)$ and $\widehat{\mathbf{A}}_j^{int}(r, R)$ studied in Subsection 7.1, we consider the analogous event $\widehat{\mathbf{A}}_j(r, R)$). We prove it only in the case j even. See Subsection 7.4 for the case j odd.

Proof of Proposition 2.4 in the case j even. We write the proof for $j = 4$ since the proof for any $j \in \mathbb{N}^*$ even is essentially the same. Let $\text{Dense}(R) = \text{Dense}_{1/100}(A(R/2, 2R))$. We have:

$$\widehat{\mathbf{A}}_4(r, R) \subseteq \widehat{\mathbf{A}}_4^{int}(r, R/2) \cup (\widehat{\mathbf{A}}_4(r, R) \setminus \text{Dense}(R)).$$

Hence:

$$f_4(r, R) \leq f_4^{int}(r, R/2) + \mathbb{P}[-\text{Dense}(R)].$$

By Corollary 7.8, if r is sufficiently large, then $f_4^{int}(r, R/2) \asymp \alpha_4^{an}(r, R/2)$. Moreover, thanks to the quasi-multiplicativity property, $\alpha_4^{an}(r, R/2) \asymp \alpha_4^{an}(r, R)$. Furthermore, $\mathbb{P}[-\text{Dense}(R)] \leq O(1) \exp(-\Omega(1)R^2)$ while $\alpha_4^{an}(r, R)$ decays polynomially fast in $r/R \geq 1/R$. Hence, if r sufficiently large ($r \geq r_0$, say) and if $R \in [r, +\infty)$, then:

$$f_4(r, R) \leq O(1) \alpha_4^{an}(r, R).$$

If $1 \leq r \leq r_0$, then we have:

$$f_4(r, R) \leq f_4(r_0, R) \leq O(1) \alpha_4^{an}(r_0, R) \leq O(1) \alpha_4^{an}(r, R),$$

where the last inequality follows from the quasi-multiplicativity property. This ends the proof. \square

7.3 Arm events in the half-plane

In this subsection, we study j -arm events in the half-plane for any $j \in \mathbb{N}^*$.

Remark 7.11. In Subsection 7.1, we have restricted ourself to the case j even since we wanted to deal with arms of alternating colors. In the case of the half-plane, whatever j is odd or even, the arms are of alternating colors. As a result, if we follow the arguments of Subsection 7.1, we obtain the quasi-multiplicativity property for j -arm events in the half-plane for any $j \in \mathbb{N}^*$. We also obtain the analogues of Propositions 2.4 and 2.5. (Of course, the proofs also work for arm events in a wedge, for instance in the quarter-plane.)

We now use the quasi-multiplicativity property to compute the exponents of the 2 and 3-arm events in the half-plane.

Proof of Items i) and ii) of Proposition 2.7. (We follow [Wer07], first exercise sheet.) First, note that thanks to the quasi-multiplicativity property, it is sufficient to prove the result for $r = 1$ and for $R \geq 1$ sufficiently large. We define the two following events (where \mathbb{H} is the upper half-plane):

1. For every $j \in \mathbb{Z}$, let $I_j = [j, j+1] \times \{0\}$ and write $F_j^{2,+}(R)$ for the event that there exist $y \in I_j$ and γ_1, γ_2 two paths such that: (a) γ_1 and γ_2 are included in $B_R(y) \cap \mathbb{H}$, (b) γ_1 and γ_2 join y to $\partial B_R(y)$, (c) γ_1 is black and γ_2 is white and (d) γ_1 is on the right-hand-side of γ_2 . (Note that this implies in particular that y belongs to the intersection of two Voronoi cells.)

2. Let S be a 1×1 square of the grid \mathbb{Z}^2 and write $F_S^{3,+}(R)$ for the event that there exists $y \in S$ that is the lowest point in $B_R(y)$ of a black component that intersects $\partial B_R(y)$.

Let $\eta \in \text{Dense}_{1/100}(B_{2R}) \cap \text{QBC}_{1/100}^3(B_{2R})$ (see Subsection 2.4.2 for the definition of these events). If we follow the first exercise sheet of [Wer07] (in this exercise sheet, one has to use the BK inequality; this is not a problem since we work at the quenched level), we obtain that there exists a constant $C \in [1, +\infty)$ such that:¹⁰

$$\frac{1}{C} \leq \sum_{j: I_j \cap B_{R/2} \neq \emptyset} \mathbf{P}^\eta \left[F_j^{2,+}(R) \right] \leq C,$$

and:

$$\frac{1}{C} \leq \sum_{S: S \cap B_{R/2} \neq \emptyset} \mathbf{P}^\eta \left[F_S^{3,+}(R) \right] \leq C. \quad (7.25)$$

Lemma 2.11 and Proposition 2.13 imply that:

$$\mathbb{P} \left[\text{Dense}_{1/100}(B_{2R}) \cap \text{QBC}_{1/100}^3(B_{2R}) \right] \geq 1 - \left(O(1) e^{-\Omega(1)R^2} + O(1) R^{-3} \right) \geq 1 - O(1) R^{-3}.$$

Let us conclude the proof in the case of the 3-arm event (the case of the 2-arm event is treated similarly). If we combine the above estimate with (7.25), we obtain that:

$$\begin{aligned} \frac{1}{C} (1 - O(1) R^{-3}) &\leq \sum_{S: S \cap B_{R/2} \neq \emptyset} \mathbb{P} \left[F_S^{3,+}(R) \right] \\ &\leq C + O(1) R^{-3} \text{Card}\{S : S \cap B_{R/2} \neq \emptyset\} \leq C + O(1) R^{-1}. \end{aligned}$$

Since the annealed model is translation invariant, $\mathbb{P} \left[F_S^{3,+}(R) \right]$ does not depend on S , and if R is sufficiently large we have:

$$\mathbb{P} \left[F_S^{3,+}(R) \right] \asymp R^{-2}.$$

Therefore, it is sufficient to prove that, for every R sufficiently large:

$$\alpha_3^{an,+}(R) \asymp \mathbb{P} \left[F_S^{3,+}(R) \right].$$

- i) The proof that $\mathbb{P} \left[F_S^{3,+}(R) \right] \leq O(1) \alpha_3^{an,+}(R)$ is essentially the same as the one of the inequality $\mathbb{P} \left[\mathbf{A}_4^\square(S, R) \right] \leq O(1) \alpha_4^{an}(\rho, R)$ of Proposition 4.3. Hence, we leave it to the reader.
- ii) We also leave the proof that $\mathbb{P} \left[F_S^{3,+}(R) \right] \geq \Omega(1) \alpha_3^{an,+}(R)$ to the reader since one can show this by extending the arms “by hands” exactly as in the proof of Lemma 7.10.

This ends the proof. □

7.4 The case j odd

Let us prove the quasi-multiplicativity property in the case j odd.

Proof of Proposition 1.6 in the case j odd. To deal with an odd number of arms, it is not sufficient to work with the events $\widetilde{\text{GI}}_\delta^{ext}(R)$ and $\widetilde{\text{GI}}_\delta^{int}(r)$ that we have studied in Subsection 7.1. More precisely, in order to extend two consecutive arms of the same color, we need to work with

¹⁰Actually, for the 3-arm event the proof in the case of Voronoi percolation is easier than in the case of Bernoulli percolation since, for Voronoi percolation, a.s. a cluster cannot have two lowest points.

a configuration of interfaces that satisfy the following condition: “the endpoints are far away from the other interfaces” (and not only “the endpoints are far away from each other”). In other words, we need to work with a configuration of interfaces that satisfy the event $\text{GI}_\delta^{\text{ext}}(R)$ (or $\text{GI}_\delta^{\text{int}}(r)$) defined above Lemma 2.14. Since the proof of Lemma 2.14 (that gives estimates on the quantities $\mathbb{P}[\text{GI}_\delta^{\text{ext}}(R)]$ and $\mathbb{P}[\text{GI}_\delta^{\text{int}}(r)]$) only relies on Subsections 7.1, 7.2 and 7.3, we can now use this result.

If we modify the definition of $G_\delta^{\text{ext}}(R)$ and let

$$G_\delta^{\text{ext}}(R) = \text{GP}_\delta^{\text{ext}}(R) \cap \text{GI}_\delta^{\text{ext}}(R)$$

instead of

$$G_\delta^{\text{ext}}(R) = \text{GP}_\delta^{\text{ext}}(R) \cap \widetilde{\text{GI}}_\delta^{\text{ext}}(R),$$

and if we define similarly $G_\delta^{\text{int}}(R) = \text{GP}_\delta^{\text{int}}(R) \cap \text{GI}_\delta^{\text{int}}(R)$, then the proof of the quasi-multiplicativity property in the case j odd is the same as in the case j even (except that we now need Lemma 2.14 to prove the analogue of Lemma 7.4). \square

We end this subsection by noting that: (a) now, the proof of Proposition 2.4 in the case j odd is the same as in the case j even and (b) we can compute the universal arm-exponent for the 5-arm event. Let us be a little more precise about the computation of this exponent:

Proof of Item iii) of Proposition 2.7. We work with the following event:

Let S be a 1×1 square of the grid \mathbb{Z}^2 and write $F_S^5(R)$ for the event that there exists a point $x \in \eta \cap S$ such that: (a) the cell of x is white, (b) there exist five paths $\gamma_1, \dots, \gamma_5$ (in counter-clockwise order, say) that join the cell of x to $\partial B_R(x)$, (c) γ_i is white (respectively black) if i is odd (respectively even) and (d) if $i \neq j$ then there is no Voronoi cell that is intersected by γ_i and γ_j .

If we follow the proof of Items i) and ii) of Proposition 2.7 (see Subsection 7.3), we obtain that it is sufficient to prove that for every $R \geq 1$ sufficiently large we have:

$$\alpha_5^{\text{an}}(R) \asymp \mathbb{P}[F_S^5(R)].$$

The proof of this estimate is the same as the one of the analogous estimates proved in Subsection 7.3. \square

A An extension of Schramm and Steif’s algorithm theorem

In this appendix, we state an extension of Schramm and Steif’s algorithm theorem that has been proved by Roberts and Sengul in [RS16]. We first need the following definition: Let $n \in \mathbb{N}$ and let $f : \{-1, 1\}^n \rightarrow \mathbb{R}$. An **algorithm** that determines f is a procedure that asks the values of the bits step by step where at each step the algorithm can ask for the value of one or several bits and the choice of the new bit(s) to ask is based on the values of the bits previously queried. We also ask that the algorithm stops once f is determined. We denote by \mathbf{P}_p^n the probability measure on $\Omega^n := \{-1, 1\}^n$ defined by

$$\mathbf{P}_p^n = (p\delta_1 + (1-p)\delta_{-1})^{\otimes n}.$$

A crucial quantity is the revelation of an algorithm \mathcal{A} . This is defined as follows:

$$\delta_{\mathcal{A}}^p = \max_{i \in \{1, \dots, n\}} \mathbf{P}_p^n [i \text{ is queried by } \mathcal{A}].$$

To state Schramm and Steif’s result, we also need to introduce the notion of discrete Fourier decomposition: Let $S \subseteq \{1, \dots, n\}$ and let $\omega \in \Omega^n$. We write:

$$\chi_S^p(\omega) = \prod_{i \in S} \left(\sqrt{\frac{1-p}{p}} \mathbb{1}_{\omega_i=1} - \sqrt{\frac{p}{1-p}} \mathbb{1}_{\omega_i=-1} \right).$$

Note that $(\chi_S^p)_{S \subseteq \{1, \dots, n\}}$ is an orthonormal family of $L^2(\Omega^n, \mathbf{P}_p^n)$, thus we can define $(\widehat{f}_S^p)_S$, the Fourier coefficients of $f : \Omega^n \rightarrow \mathbb{R}$ at level p , as follows:

$$f = \sum_{S \subseteq \{1, \dots, n\}} \widehat{f}^p(S) \chi_S^p.$$

The result by Schramm and Steif is the following (they proved it for $p = 1/2$ but the proof for any p is the same):

Theorem A.1 (Theorem 1.8 of [SS10]). *For every $f : \Omega^n \rightarrow \mathbb{R}$, every algorithm \mathcal{A} that determines f and every $k \in \mathbb{N}^*$ we have:*

$$\sum_{S \subseteq \{1, \dots, n\}: |S|=k} \widehat{f}^p(S)^2 \leq \delta_{\mathcal{A}}^p k \mathbf{E}_p^n [f^2].$$

We need the following extension of this theorem: Let $I \subseteq \{1, \dots, n\}$ and, if \mathcal{A} is some algorithm, let us write:

$$\delta_{\mathcal{A}}^p(I) = \max_{i \in I} \mathbf{P}_p^n [i \text{ is queried by } \mathcal{A}].$$

Proposition A.2 (Theorem 2.3 of [RS16]). *For every $f : \Omega^n \rightarrow \mathbb{R}$, every algorithm \mathcal{A} that determines f , every $I \subseteq \{1, \dots, n\}$ and every $k \in \mathbb{N}^*$ we have:*

$$\sum_{S \subseteq I: |S|=k} \widehat{f}^p(S)^2 \leq \delta_{\mathcal{A}}^p(I) k \mathbf{E}_p^n [f^2].$$

Proof. The proof is very close to the proof of Theorem 1.8 of [SS10], except that we need to (slightly) change the definition of the function g therein. More precisely, we need to work with:

$$g : \omega \mapsto \sum_{S \subseteq I: |S|=k} \widehat{f}^p(S) \chi_S^p(\omega).$$

See [RS16] for more details. □

The reason why we are interested in the above theorem is the following property (see Subsection 2.4.1 for the definition of the pivotal event $\mathbf{Piv}_i^n(A)$):

Proposition A.3. *Let $A \subseteq \Omega^n$ be an increasing event. Also, let f be the ± 1 -indicator function of A (i.e. $f = 2\mathbb{1}_A - 1$). Then, for every $i \in \{1, \dots, n\}$, we have:*

$$\widehat{f}^p(\{i\}) = 2\sqrt{p(1-p)} \mathbf{P}_p^n [\mathbf{Piv}_i^n(A)].$$

Proof. The proof is exactly the same as in the case $p = 1/2$, which can be found for instance in [GS14], Proposition 4.5. □

The two above propositions imply the following corollary, which is the result that we will need:

Corollary A.4. *Let $A \subseteq \Omega^n$ be an increasing event. Then, for every algorithm \mathcal{A} that determines $\mathbb{1}_A$ and every $I \subseteq \{1, \dots, n\}$, we have:*

$$\sum_{i \in I} \mathbf{P}_p^n [\mathbf{Piv}_i^n(A)]^2 \leq \frac{1}{2\sqrt{p(1-p)}} \delta_{\mathcal{A}}^p(I).$$

B The proof of the quenched box-crossing property in [AGMT16]

In this section, we only work at $p = 1/2$, hence we forget the subscript p in the notations. We recall the main steps of the proof of Theorem 1.4 by Ahlberg, Griffiths, Morris and Tassion (which is Theorem 1.4 in [AGMT16]). There are two reasons why we need to recall this proof: i) In [AGMT16], the theorem is proved for the analogous model in which η is a family of n points sampled uniformly and independently in some fixed rectangle. As pointed out in [AGMT16] (below the statement of their Theorem 1.4) the proof in the case we are interested in (i.e. in which η is a Poisson process in the whole plane) is essentially the same. We explain briefly why. ii) In order to extend this result to $p > 1/2$ (in Subsection 5.1) we have to modify a little the end of the proof.

Let us first note that (as it explained at the end of the paper [AGMT16]) Item ii) of Theorem 1.4 is an easy consequence of Item i) of this theorem. As a result, we only explain the strategy in order to obtain Item i).

A. A martingale estimate. First, the authors of [AGMT16] prove a martingale estimate. Let $\rho, R > 0$. Also, let $N \in \mathbb{N}^*$ and consider η_N a configuration of $4e^{2N}$ points sampled uniformly in $[-e^N, e^N]^2$, independently of each other. Remember the definition of pivotal events from Subsection 2.4.1. The following is not exactly Theorem 2.1 of [AGMT16] but the proof is the same:

$$\text{Var}(\mathbf{P}^{\eta_N}[\text{Cross}(\rho R, R)]) \leq \mathbb{E} \left[\sum_{x \in \eta_N} \mathbf{P}^{\eta_N} [\mathbf{Piv}_x^{\eta_N}(\text{Cross}(\rho R, R))]^2 \right], \quad (\text{B.1})$$

where $\mathbf{P}^{\eta_N} := \left(\frac{\delta_1}{2} + \frac{\delta_{-1}}{2} \right)^{\eta_N}$. (Note that the point process η_N is a.s. finite, hence we have only finitely many Voronoi cells.) Now, note that we can couple η_N with a Poisson process of intensity 1 in the plane (denoted by η) so that, with probability going to 1 as N goes to $+\infty$ superpolynomially fast in N , we have:¹¹

$$\eta \cap [-N, N]^2 = \eta_N \cap [-N, N]^2.$$

Since the event $\text{Cross}(\rho R, R)$ depends only on the points of $\eta \cap [-N, N]^2$ with probability that goes to 1 as N goes to $+\infty$ superpolynomially fast in N , the above together with (B.1) implies that:

$$\text{Var}(\mathbf{P}^\eta[\text{Cross}(\rho R, R)]) \leq \mathbb{E} \left[\sum_{x \in \eta} \mathbf{P}^\eta [\mathbf{Piv}_x^q(\text{Cross}(\rho R, R))]^2 \right]. \quad (\text{B.2})$$

(See Subsection 2.4.1 for the definition of $\mathbf{Piv}_x^q(\cdot)$.)

B. An estimate on the 1-arm event. The next result we need is an analogue of Proposition 3.11 of [AGMT16]. This proposition is proved in the case where η is a set of n independent points sampled uniformly in a rectangle but with exactly the same proof we obtain the following result:

Let S be the 1×1 square centered at some point y and let $\mathbf{A}_1^{*,\text{cell}}(S, r)$ be the event that there exists a point $x \in \eta \cap S$ such that there is a white path from the cell of x to a cell that

¹¹This is for instance a consequence of Le Cam's identity which implies that:

$$\sum_{k=0}^{+\infty} |\mathbb{P} [|\eta_N \cap [-N, N]^2| = k] - \mathbb{P} [|\eta \cap [-N, N]^2| = k]| \leq 2 \times 4N^2 \frac{4N^2}{4e^{2N}} \leq e^{-\Omega(1)}.$$

intersects $\partial B_r(y)$ (note that the cell of x is not necessarily white). For every $\gamma > 0$, there exists $\epsilon = \epsilon(\gamma) > 0$ such that the following holds:

$$\mathbb{P} \left[\mathbf{P}^\eta \left[\mathbf{A}_1^{*,\text{cell}}(S, r) \right] \geq r^{-\epsilon} \right] \leq \frac{1}{\epsilon} r^{-\gamma}. \quad (\text{B.3})$$

(Note that we have decided to study white arms instead of black arms. It will make sense in Subsection 5.1.)

C. A Schramm and Steif’s algorithm method. The last step of the proof relies on a theorem from [SS10]. In our case, we are going to use the extension of Schramm-Steif result discussed in Appendix A. Let \mathbf{S}_1 (respectively \mathbf{S}_2) be the subset of all the 1×1 squares of the grid \mathbb{Z}^2 that are below (respectively above) the line $\mathbb{R} \times \{0\}$ and that are at distance at most $(\rho + 1)R$ from the rectangle $[-\rho R, \rho R] \times [-R, R]$ (we include the squares that intersect $\mathbb{R} \times \{0\}$ in both \mathbf{S}_1 and \mathbf{S}_2). Also, let \mathbf{S}_3 be all the remaining 1×1 squares of the grid \mathbb{Z}^2 . The following is a direct consequence of (B.2) (and of the symmetries of the model):

$$\begin{aligned} & \text{Var}(\mathbf{P}^\eta [\text{Cross}(\rho R, R)]) \\ & \leq \sum_{k=1}^3 \mathbb{E} \left[\sum_{S \in \mathbf{S}_k} \sum_{x \in \eta \cap S} \mathbf{P}^\eta [\mathbf{Piv}_x^q(\text{Cross}(\rho R, R))]^2 \right] \\ & = 2 \mathbb{E} \left[\sum_{S \in \mathbf{S}_1} \sum_{x \in \eta \cap S} \mathbf{P}^\eta [\mathbf{Piv}_x^q(\text{Cross}(\rho R, R))]^2 \right] + \mathbb{E} \left[\sum_{S \in \mathbf{S}_3} \sum_{x \in \eta \cap S} \mathbf{P}^\eta [\mathbf{Piv}_x^q(\text{Cross}(\rho R, R))]^2 \right]. \end{aligned}$$

Let us first deal with the sum over \mathbf{S}_3 . This sum is less than or equal to the expectation of the number of points which are at distance at least $(\rho + 1)R$ from the rectangle $[-\rho R, \rho R] \times [-R, R]$ but whose cell intersects this rectangle. It is not difficult to see that this quantity is less than $O(1) e^{-\Omega(1)R^2}$ (where the constants in $O(1)$ and $\Omega(1)$ may depend on ρ).

Now, let us bound the sum over \mathbf{S}_1 . Here, we follow the ideas of [AGMT16] but we use a slightly different algorithm, which can be defined as follows: (we use the same notations as [ABGM14] where the authors use this kind of algorithm to study the Boolean model): Let Q_0 denote the set of all $x \in \eta$ whose cell intersects the set $(\mathbb{R} \times \{R\}) \cap ([-\rho R, \rho R] \times [-R, R])$. Also, let A_0 be the set of all $x \in Q_0$ which are white. For each $k \in \mathbb{N}^*$, we define A_k and Q_k (for “active” and “queried” sets) inductively as follows:

- i) Let Q_k be the set of all points $x \in \eta$ such that: (a) the cell of x is adjacent to the cell of some $y \in A_{k-1}$ and (b) the cell of x intersects the rectangle $[-\rho R, \rho R] \times [-R, R]$. Reveal the colour of each point of Q_k .
- ii) Let A_k be the set of all $x \in Q_k$ which are white.
- iii) Stop if $A_k = A_{k-1}$.

Note that this algorithm (that we denote by \mathcal{A}_R) determines the event that there is a white top-bottom crossing of $[-\rho R, \rho R] \times [-R, R]$ which is the complement of the event $\text{Cross}(\rho R, R)$. As a result, this algorithm determines $\text{Cross}(\rho R, R)$. Corollary A.4 implies that:

$$\mathbb{E} \left[\sum_{S \in \mathbf{S}_1} \sum_{x \in \eta \cap S} \mathbf{P}^\eta [\mathbf{Piv}_x^q(\text{Cross}(\rho R, R))]^2 \right] \leq \delta_{\mathcal{A}_R}(\mathbf{S}_1),$$

where:

$$\delta_{\mathcal{A}_R}(\mathbf{S}_1) = \max_{S \in \mathbf{S}_1} \max_{x \in \eta} \mathbf{P}^\eta [x \text{ is queried by } \mathcal{A}_R].$$

It remains to show that this last quantity is at least polynomially small in R . This can be done by noting that:

$$\max_{S \in \mathbf{S}_1} \max_{x \in \eta} \mathbf{P}^\eta [x \text{ is queried by } \mathcal{A}_R] \leq \max_{S \in \mathbf{S}_1} \mathbf{P}^\eta \left[\mathbf{A}_1^{*,\text{cell}}(S, R-1) \right].$$

The fact that the above quantity is at least polynomially small in R is an easy consequence of (B.3) (for instance with $\gamma = 3$). We refer to [AGMT16] for more details.

C Pivotal events for $\mathbf{A}_j(1, R)$ when j is odd

In this appendix, we prove Lemmas 4.11, 4.12, 4.13 and 4.14 in the case j odd. We do not need them in order to prove our main result Theorem 1.11. However, we need them in order to prove that Propositions 4.7 and 1.10 also hold when j is odd. Let $S \subseteq A(R/4, R/2)$ be a $2\rho \times 2\rho$ square centered at some point y , let $\text{Dense}(y, \rho') = \text{Dense}_{1/100}(A(y; \rho', 2\rho'))$, and assume that $\mathbf{Piv}_S(\mathbf{A}_j(1, R)) \cap \text{Dense}(y; 2^k \rho)$ holds for some $k \in \{0, \dots, \lfloor \log_2 \left(\frac{R}{16\rho} \right) \rfloor =: k_0\}$. This implies that $\mathbf{A}_j(1, R/8)$ holds. In the case j even, this also implies that the 4-arm event $\mathbf{A}_4(y; 2^{k+1}\rho, 2^{k_0}\rho)$ holds, where $\mathbf{A}_4(y; 2^{k+1}\rho, 2^{k_0}\rho)$ is $\mathbf{A}_4(2^{k+1}\rho, 2^{k_0}\rho)$ translated by y . If j is odd, this rather implies that the following more complicated event holds:

$$\bigcup_{l=k}^{k_0-1} \left(\tilde{\mathbf{A}}_4(y; 2^{k+1}\rho, 2^{l+1}\rho) \cap \tilde{\mathbf{A}}_5(y; 2^{l+2}\rho, 2^{k_0}\rho) \right),$$

where: i) $\tilde{\mathbf{A}}_4(y; \rho', \rho'')$ is the event that there is a point $x \in \eta$ such that: (a) $C(x)$ (the Voronoi cell of x) intersects $A(y; \rho''/2, 2\rho'')$ and (b) there are four arms of alternating colours in $A(y; \rho', 2\rho'')$ from $\partial B_{\rho'}(y)$ to $\partial B_{\rho''}(y) \cup \partial C(x)$ and ii) $\tilde{\mathbf{A}}_5(y; \rho', \rho'')$ is the event that there is a point $x \in \eta$ such that: (a) $C(x)$ intersects $A(y; \rho'/2, 2\rho')$ and (b) there are five arms of alternating colours in $A(y; \rho'/2, \rho'')$ from $\partial B_{\rho'}(y) \cup \partial C(x)$ to $\partial B_{\rho''}(y)$. (Actually, instead of the 5-arm event, we could have asked that a 6-arm event with colors following the order (B, B, W, B, B, W) holds, where B =black and W =white.) See [Nol08] (for instance Figure 12 therein) for a similar observation in the case of Bernoulli percolation on the triangular lattice. Now, write:

$$\widehat{\mathbf{A}}_4(y; \rho', \rho'') = \left\{ \mathbb{P} \left[\tilde{\mathbf{A}}_4(y; \rho', \rho'') \mid \omega \cap A(y; \rho', \rho'') \right] > 0 \right\},$$

and:

$$\widehat{\mathbf{A}}_5(y; \rho', \rho'') = \left\{ \mathbb{P} \left[\tilde{\mathbf{A}}_5(y; \rho', \rho'') \mid \omega \cap A(y; \rho', \rho'') \right] > 0 \right\}.$$

By spatial independence and by a union-bound, we have:

$$\begin{aligned} \mathbb{P} \left[\bigcup_{l=k}^{k_0-1} \left(\widehat{\mathbf{A}}_4(y; 2^{k+1}\rho, 2^{l+1}\rho) \cap \widehat{\mathbf{A}}_5(y; 2^{l+2}\rho, 2^{k_0}\rho) \right) \right] \\ \leq \sum_{l=k}^{k_0-1} \mathbb{P} \left[\widehat{\mathbf{A}}_4(y; 2^{k+1}\rho, 2^{l+1}\rho) \right] \cdot \mathbb{P} \left[\widehat{\mathbf{A}}_5(y; 2^{l+2}\rho, 2^{k_0}\rho) \right]. \end{aligned}$$

By using arguments very similar to those of the proof of $\mathbb{P}[\mathbf{Piv}_S(\text{Cross}(2R, R))] \leq O(1) \alpha_4^{an}(\rho, R)$ in Lemma 4.5 and of the proof of Lemma 4.8, we obtain that:

$$\mathbb{P} \left[\widehat{\mathbf{A}}_4(y; \rho', \rho'') \right] \leq O(1) \alpha_4^{an}(\rho', \rho''),$$

and:

$$\mathbb{P} \left[\widehat{\mathbf{A}}_5(y; \rho', \rho'') \right] \leq O(1) \alpha_5^{an}(\rho', \rho'').$$

Proposition 1.13 and Item iii) of Proposition 2.7 then imply that:

$$\alpha_5^{an}(\rho_1, \rho_2) \leq O(1) \left(\frac{\rho_1}{\rho_2} \right)^\epsilon \alpha_4^{an}(\rho_1, \rho_2). \quad (\text{C.1})$$

Together with the above results and the quasi-multiplicativity property, this implies that:

$$\sum_{l=k}^{k_0-1} \mathbb{P} \left[\widehat{\mathbf{A}}_4(y; 2^{k+1}\rho, 2^{l+1}\rho) \right] \cdot \mathbb{P} \left[\widehat{\mathbf{A}}_5(y; 2^{l+2}\rho, 2^{k_0}\rho) \right] \leq O(1) \alpha_4^{an}(\rho, R).$$

Finally, if we had said that the event $\mathbf{Piv}_S(\mathbf{A}_j(1, R)) \cap \text{Dense}(y; 2^k\rho)$ implied that the 4-arm event $\mathbf{A}_4(y; 2^{k+1}\rho, R/8)$ held, then it would have given a true estimate. Now, the proof of Lemma 4.11 is very similar to the proof of the inequality $\mathbb{P}[\mathbf{Piv}_S(\text{Cross}(2R, R))] \leq O(1) \alpha_4^{an}(\rho, R)$ of Lemma 4.5. To obtain the other lemmas, we need to make similar observations for arm events near ∂B_R . The only difference is that, instead of using the estimate (C.1), we need to use the following similar results (whose proofs are exactly the same as the proof of the second part of Proposition 1.13 written in Subsection 4.2):

$$\alpha_4^{an,+}(\rho', \rho'') \leq O(1) \left(\frac{\rho'}{\rho''} \right)^\epsilon \alpha_3^{an,+}(\rho', \rho''),$$

and:

$$\alpha_4^{an,++}(\rho', \rho'') \leq O(1) \left(\frac{\rho'}{\rho''} \right)^\epsilon \alpha_3^{an,++}(\rho', \rho'').$$

We leave the details to the reader.

D The quantities $\mathbb{E} \left[\mathbf{P}^\eta [\mathbf{A}_j(r, R)]^2 \right]$

In this appendix, we only work at $p = 1/2$, hence we forget the subscript p in the notations. We study the quantities:

$$\tilde{\alpha}_j(r, R) := \sqrt{\mathbb{E} \left[\mathbf{P}^\eta [\mathbf{A}_j(r, R)]^2 \right]}.$$

More precisely, we prove that some of the results that we have proved for the quantities $\alpha_j^{an}(r, R)$ are also true for the $\tilde{\alpha}_j(r, R)$'s. We actually do not need the results of this appendix in the present chapter but we include them here since there will be crucial in Chapter 6 where we prove in particular that:

$$\tilde{\alpha}_j(r, R) \asymp \alpha_j^{an}(r, R). \quad (\text{D.1})$$

We refer to Chapter 6 for the motivations behind (D.1).

Let us start the study of the quantities $\tilde{\alpha}_j(r, R)$. First note that, by Jensen's inequality, we have:

$$\tilde{\alpha}_j(r, R)^2 \leq \alpha_j^{an}(r, R) \leq \tilde{\alpha}_j(r, R). \quad (\text{D.2})$$

As a result, the following polynomial decay property is a direct consequence of (1.1):

$$\frac{1}{C} \left(\frac{r}{R} \right)^C \leq \tilde{\alpha}_j(r, R) \leq C \left(\frac{r}{R} \right)^{1/C}. \quad (\text{D.3})$$

D.1 The quasi-multiplicativity property

In this subsection, we explain how the proof of the quasi-multiplicativity property written in Section 7 can be adapted in order to prove the following:

Proposition D.1. *The quasi-multiplicativity property also holds for the quantities $\tilde{\alpha}_j(r, R)$ i.e. there exists $C = C(j) \in [1, +\infty)$ such that, for every $1 \leq r_1 \leq r_2 \leq r_3$,*

$$\frac{1}{C} \tilde{\alpha}_j(r_1, r_3) \leq \tilde{\alpha}_j(r_1, r_2) \tilde{\alpha}_j(r_2, r_3) \leq C \tilde{\alpha}_j(r_1, r_3).$$

Proof. The proof is very close to the proof of Proposition 1.6. To simplify the notations, we write the proof in the case $j = 4$. The proof for any other even integer is the same and the proof for any odd integer requires the same modifications as in Subsection 7.4. We use the same notations as in Subsection 7.1 (remember in particular the definition of the events $G_\delta^{ext}(R)$ and $G_\delta^{int}(r)$ in the beginning of this section).

Let us first state and prove an analogue of Lemma 7.6. We need the following notation: If $\delta \in (0, 1/1000)$, $R \in [\delta^{-2}, +\infty)$ and $r \in [1, R]$ we write:

$$\tilde{g}_{4,\delta}^{ext}(r, R) = \sqrt{\mathbb{E} \left[\mathbf{P}^\eta \left[\mathbf{A}_4(r, R) \cap G_\delta^{ext}(R) \right]^2 \right]}.$$

Similarly, if $\delta \in (0, 1/1000)$, $r \in [\delta^{-2}, +\infty)$ and $R \in [r, +\infty)$ we write:

$$\tilde{g}_{4,\delta}^{int}(r, R) = \sqrt{\mathbb{E} \left[\mathbf{P}^\eta \left[\mathbf{A}_4(r, R) \cap G_\delta^{int}(r) \right]^2 \right]}.$$

Lemma D.2. *There exists $\bar{\delta} \in (0, 1/1000)$ such that, for any $\delta \in (0, 1/1000)$, there is some constant $a = a(\delta) \in (0, 1)$ satisfying:*

1. *For every $R \in [\bar{\delta}^{-2} \vee \delta^{-2}, +\infty)$ and every $r \in [1, R/4]$ we have:*

$$\tilde{g}_{4,\bar{\delta}}^{ext}(r, 4R) \geq a \tilde{g}_{4,\delta}^{ext}(r, R). \quad (\text{D.4})$$

2. *For every $r \in [4(\bar{\delta}^{-2} \vee \delta^{-2}), +\infty)$ and every $R \in [4r, +\infty)$ we have:*

$$\tilde{g}_{4,\bar{\delta}}^{int}(r/4, R) \geq a \tilde{g}_{4,\delta}^{int}(r, R). \quad (\text{D.5})$$

Proof. We write only the proof of (D.4) since the proof of (D.5) is the same. We use exactly the same notations as in the proof of Lemma 7.6. By (7.13), if $\bar{\delta}$ is sufficiently small then:

$$\nu_{r,R,(\beta_j)_j}^\eta \left[\mathbf{A}_4(r, 4R) \cap G_{\bar{\delta}}^{ext}(4R) \right] \geq c,$$

for some constant $c = c(\delta) > 0$. If we take the expectation under $\mathbf{P}_{B_{2R}}^\eta$, we obtain that:

$$\begin{aligned} \mathbf{P}_{B_{2R}}^\eta \left[\mathbf{A}_4(r, 4R) \cap G_{\bar{\delta}}^{ext}(4R) \right] &\geq \mathbf{P}_{B_{2R}}^\eta \left[\mathbf{A}_4(r, R) \cap \text{GP}_{\bar{\delta}}^{ext}(R) \cap \{\tilde{s}^{ext}(r, R) \geq 10\delta R\} \right] \\ &\geq \mathbf{P}_{B_{2R}}^\eta \left[\mathbf{A}_4(r, R) \cap G_{\bar{\delta}}^{ext}(R) \right]. \end{aligned}$$

We then conclude by using both the following martingale inequality:

$$\tilde{g}_{4,\bar{\delta}}^{ext}(r, 4R)^2 = \mathbb{E} \left[\mathbf{P}^\eta \left[\mathbf{A}_4(r, 4R) \cap G_{\bar{\delta}}^{ext}(4R) \right]^2 \right] \geq \mathbb{E} \left[\mathbf{P}_{B_{2R}}^\eta \left[\mathbf{A}_4(r, 4R) \cap G_{\bar{\delta}}^{ext}(4R) \right]^2 \right],$$

and the following pointwise equality:

$$\mathbf{P}^\eta \left[\mathbf{A}_4(r, R) \cap G_{\bar{\delta}}^{ext}(R) \right] = \mathbf{P}_{B_{2R}}^\eta \left[\mathbf{A}_4(r, R) \cap G_{\bar{\delta}}^{ext}(R) \right].$$

□

Remark D.3. Note that Remark 7.5 and Jensen's inequality imply the following: There exists $c' > 0$ such that, if $\delta \in (0, 1/1000)$ is sufficiently small, then for all $R \in [\delta^{-2}, +\infty)$ and all $r \in [R/4^3, R]$ we have:

$$\tilde{g}_{4,\delta}^{ext}(r, R) \geq c'.$$

Similarly, if $\delta \in (0, 1/1000)$ is sufficiently small, then for all $r \in [\delta^{-2}, +\infty)$ and all $R \in [r, 4^3 r]$ we have:

$$\tilde{g}_{4,\delta}^{int}(r, R) \geq c'.$$

We can (and do) assume that the quantity $\bar{\delta}$ of Lemma D.2 is sufficiently small so that the above holds with $\delta = \bar{\delta}$.

We now state and prove an analogue of Lemma 7.7. We first need the two following notations:

$$\tilde{f}_4^{ext}(r, R) = \sqrt{\mathbb{E} \left[\mathbf{P}^\eta \left[\widehat{\mathbf{A}}_4^{ext}(r, R) \right]^2 \right]}; \quad \tilde{f}_4^{int}(r, R) = \sqrt{\mathbb{E} \left[\mathbf{P}^\eta \left[\widehat{\mathbf{A}}_4^{int}(r, R) \right]^2 \right]}.$$

Lemma D.4. *There exist $C_1 \in [1, +\infty)$ and $\bar{r} \in [\bar{\delta}^{-2}, +\infty)$ such that, for every $r \in [\bar{r}, +\infty)$ and $R \in [16r, +\infty)$:*

$$\tilde{g}_{4,\bar{\delta}}^{ext}(r, R) \geq \tilde{f}_4^{ext}(r, R)/C_1, \quad (\text{D.6})$$

and:

$$\tilde{g}_{4,\bar{\delta}}^{int}(r, R) \geq \tilde{f}_4^{int}(r, R)/C_1. \quad (\text{D.7})$$

We have the following corollary (which is a direct consequence of Lemma D.4 and Remark D.3):

Corollary D.5. *There exists a constant $C_2 \in [1, +\infty)$ such that, for every $r \in [\bar{r}, +\infty)$ and every $R \in [r, +\infty)$:*

$$\tilde{g}_{4,\bar{\delta}}^{ext}(r, R) \leq \tilde{\alpha}_4(r, R) \leq \tilde{f}_4^{ext}(r, R) \leq C_2 \tilde{g}_{4,\bar{\delta}}^{ext}(r, R),$$

and:

$$\tilde{g}_{4,\bar{\delta}}^{int}(r, R) \leq \tilde{\alpha}_4(r, R) \leq \tilde{f}_4^{int}(r, R) \leq C_2 \tilde{g}_{4,\bar{\delta}}^{int}(r, R).$$

Proof of Lemma D.4. Let us prove (D.6) (the proof of (D.7) is essentially the same). As noted in the proof of Lemma 7.7, we have:

$$\widehat{\mathbf{A}}_4^{ext}(r, R) \subseteq (\mathbf{A}_4(r, R/4) \cap G_\delta^{ext}(R/4)) \cup (\widehat{\mathbf{A}}_4^{ext}(r, R/16) \setminus G_\delta^{ext}(R/4)).$$

This implies that $\tilde{f}_4^{ext}(r, R)^2$ is smaller than or equal to:

$$\begin{aligned} & \mathbb{E} \left[\left(\mathbf{P}^\eta \left[\mathbf{A}_4(r, R/4) \cap G_\delta^{ext}(R/4) \right] + \mathbf{P}^\eta \left[\widehat{\mathbf{A}}_4^{ext}(r, R/16) \setminus G_\delta^{ext}(R/4) \right] \right)^2 \right] \\ &= \tilde{g}_{4,\bar{\delta}}^{ext}(r, R/4)^2 + 2\mathbb{E} \left[\mathbf{P}^\eta \left[\mathbf{A}_4(r, R/4) \cap G_\delta^{ext}(R/4) \right] \cdot \mathbf{P}^\eta \left[\widehat{\mathbf{A}}_4^{ext}(r, R/16) \setminus G_\delta^{ext}(R/4) \right] \right] \\ &+ \mathbb{E} \left[\mathbf{P}^\eta \left[\widehat{\mathbf{A}}_4^{ext}(r, R/16) \setminus G_\delta^{ext}(R/4) \right]^2 \right] \\ &\leq \tilde{g}_{4,\bar{\delta}}^{ext}(r, R/4)^2 + 3\mathbb{E} \left[\mathbf{P}^\eta \left[\widehat{\mathbf{A}}_4^{ext}(r, R/16) \right] \cdot \mathbf{P}^\eta \left[\widehat{\mathbf{A}}_4^{ext}(r, R/16) \setminus G_\delta^{ext}(R/4) \right] \right] \\ &= \tilde{g}_{4,\bar{\delta}}^{ext}(r, R/4)^2 + 3\tilde{f}_4^{ext}(r, R/16)^2 \cdot \mathbb{P} \left[\neg G_\delta^{ext}(R/4) \right], \end{aligned}$$

by spatial independence. This inequality is the analogue of (7.17) in the proof of Lemma 7.7. Now, the proof is exactly the same as the one of Lemma 7.7. \square

We are now in shape to prove Proposition D.1. We first prove it for r_1 sufficiently large.

Proof of the left-hand-inequality in the case $r_1 \geq \bar{r}$. Thanks to Corollary D.5, the proof is the same as in Subsection 7.1. \square

Proof of the right-hand-inequality in the case $r_1 \geq 16\bar{r}$. If we do not have both $r_1 \leq r_2/6$ and $r_2 \leq r_3/6$ then the proof is exactly the same as in Subsection 7.1, so let us assume that $r_1 \leq r_2/6$ and $r_2 \leq r_3/6$. By Corollary D.5, we have:

$$\tilde{\alpha}_4(r_1, \frac{r_2}{3}) \tilde{\alpha}_4(3r_2, r_3) \leq O(1) \tilde{g}_{4,\bar{\delta}}^{ext}(r_1, \frac{r_2}{3}) \tilde{g}_{4,\bar{\delta}}^{int}(3r_2, r_3).$$

By (7.22) and (7.23), $(\tilde{g}_{4,\bar{\delta}}^{ext}(r_1, \frac{r_2}{3}) \tilde{g}_{4,\bar{\delta}}^{int}(3r_2, r_3))^2$ equals:

$$\begin{aligned} & \mathbb{E} \left[\mathbf{P}^\eta \left[\mathbf{A}_4(r_1, r_2/3) \cap \widetilde{\text{GI}}_{\bar{\delta}}^{ext}(r_2/3) \cap \text{Dense}_{\bar{\delta}}(r_2/3) \cap \text{QBC}_{\bar{\delta}}(r_2/3) \right. \right. \\ & \quad \left. \left. \cap \left\{ \mathbb{P} \left[\text{QBC}^{ext}(r_2/3) \mid \eta \cap B_{2r_2/3} \right] \geq 3/4 \right\} \right]^2 \right] \\ & \times \mathbb{E} \left[\mathbf{P}^\eta \left[\mathbf{A}_4(3r_2, r_3) \cap \widetilde{\text{GI}}_{\bar{\delta}}^{int}(3r_2) \cap \text{Dense}_{\bar{\delta}}(3r_2) \cap \text{QBC}_{\bar{\delta}}(3r_2) \right. \right. \\ & \quad \left. \left. \cap \left\{ \mathbb{P} \left[\text{QBC}^{int}(3r_2) \mid \eta \setminus B_{3r_2/2} \right] \geq 3/4 \right\} \right]^2 \right]. \end{aligned}$$

Write $X_1 = \mathbf{P}^\eta \left[\mathbf{A}_4(r_1, r_2/3) \cap \widetilde{\text{GI}}_{\bar{\delta}}^{ext}(r_2/3) \right]$, $A_1 = \text{Dense}_{\bar{\delta}}(r_2/3) \cap \text{QBC}_{\bar{\delta}}(r_2/3)$, $B_1 = \text{QBC}^{ext}(r_2/3)$, $X_2 = \mathbf{P}^\eta \left[\mathbf{A}_4(3r_2, r_3) \cap \widetilde{\text{GI}}_{\bar{\delta}}^{int}(3r_2) \right]$, $A_2 = \text{Dense}_{\bar{\delta}}(3r_2) \cap \text{QBC}_{\bar{\delta}}(3r_2)$ and $B_2 = \text{QBC}^{int}(3r_2)$. Then, the above equals:

$$\mathbb{E} \left[X_1^2 \mathbb{1}_{A_1} \mathbb{1}_{\{\mathbb{P}[B_1 \mid \eta \cap B_{2r_2/3}] \geq 3/4\}} \right] \mathbb{E} \left[X_2^2 \mathbb{1}_{A_2} \mathbb{1}_{\{\mathbb{P}[B_2 \mid \eta \setminus B_{3r_2/2}] \geq 3/4\}} \right].$$

Let us use the following lemma whose proof is the same as Lemma 7.9.

Lemma D.6. *Let \mathcal{F} and \mathcal{G} be two sub- σ -algebras, let $A_1 \in \mathcal{F}$, $A_2 \in \mathcal{G}$, let X_1 be an \mathcal{F} -measurable random variable, X_2 a \mathcal{G} -measurable random variable, and let B_1 and B_2 be two events such that $\sigma(B_1, \mathcal{F})$ is independent of \mathcal{G} and $\sigma(B_2, \mathcal{G})$ is independent of \mathcal{F} . Then:*

$$\mathbb{E} \left[(X_1 X_2)^2 \mathbb{1}_{A_1 \cap B_1 \cap A_2 \cap B_2} \right] \geq \frac{1}{2} \mathbb{E} \left[X_1^2 \mathbb{1}_{A_1} \mathbb{1}_{\{\mathbb{P}[B_1 \mid \mathcal{F}] \geq 3/4\}} \right] \cdot \mathbb{E} \left[X_2^2 \mathbb{1}_{A_2} \mathbb{1}_{\{\mathbb{P}[B_2 \mid \mathcal{G}] \geq 3/4\}} \right].$$

If we apply this lemma to $\mathcal{F} = \sigma(\eta \cap B_{2r_2/3})$ and $\mathcal{G} = \sigma(\eta \setminus B_{3r_2/2})$, we obtain that $\tilde{\alpha}_4(r_1, \frac{r_2}{3}) \tilde{\alpha}_4(3r_2, r_3)$ is less than or equal to:

$$\begin{aligned} & O(1) \mathbb{E} \left[\mathbf{P}^\eta \left[\mathbf{A}_4(r_1, r_2/3) \cap \widetilde{\text{GI}}_{\bar{\delta}}^{ext}(r_2/3) \right]^2 \mathbb{1}_{\text{Dense}_{\bar{\delta}}(r_2/3) \cap \text{QBC}_{\bar{\delta}}(r_2/3) \cap \text{QBC}^{ext}(r_2/3)} \right. \\ & \quad \left. \times \mathbf{P}^\eta \left[\mathbf{A}_4(3r_2, r_3) \cap \widetilde{\text{GI}}_{\bar{\delta}}^{int}(3r_2) \right]^2 \mathbb{1}_{\text{Dense}_{\bar{\delta}}(3r_2) \cap \text{QBC}_{\bar{\delta}}(3r_2) \cap \text{QBC}^{int}(3r_2)} \right], \end{aligned}$$

that equals:

$$\begin{aligned} & O(1) \mathbb{E} \left[\mathbf{P}^\eta \left[\mathbf{A}_4(r_1, r_2/3) \cap \widetilde{\text{GI}}_{\bar{\delta}}^{ext}(r_2/3) \cap \text{Dense}_{\bar{\delta}}(r_2/3) \cap \text{QBC}_{\bar{\delta}}(r_2/3) \cap \text{QBC}^{ext}(r_2/3) \right. \right. \\ & \quad \left. \left. \cap \mathbf{A}_4(3r_2, r_3) \cap \widetilde{\text{GI}}_{\bar{\delta}}^{int}(3r_2) \cap \text{Dense}_{\bar{\delta}}(3r_2) \cap \text{QBC}_{\bar{\delta}}(3r_2) \cap \text{QBC}^{int}(3r_2) \right]^2 \right]. \end{aligned}$$

Now, by ‘‘gluing’’ arguments, the above is at most $O(1) \tilde{\alpha}_4(r_1, r_3)^2$ and we are done. \square

We have obtained the quasi-multiplicativity property for $r_1 \geq 16\bar{r}$, so (as in Subsection 7.1) it only remains to prove the following lemma, which is the analogue of Lemma 7.10.

Lemma D.7. *For every \bar{r} sufficiently large, there exists a constant $C_3 = C_3(\bar{r}) < +\infty$ such that, for every $r \in [1, \bar{r}]$ and every $R \in [\bar{r}, +\infty)$, we have:*

$$\tilde{\alpha}_4(\bar{r}, R) \leq C_3 \tilde{\alpha}_4(r, R).$$

Sketch of proof of Lemma D.7. First note that, by making observations similar to the end of the proof of Lemma 7.6 and by following the proof of Lemma D.2, we obtain the following result: Let $\tilde{\mathbf{A}}_4^{\text{int}}(r, R)$ be the event defined at the end of the proof of Lemma 7.6. Then, if $\bar{\delta}$ is sufficiently small and if δ, r and R are as in Item 2 of Lemma D.2, then the following holds: there exists $a = a(\delta) > 0$ and $c > 0$ such that, for every event F_r measurable with respect to $\omega \cap B_{r/2}$ such that $\mathbb{P}[F_r] \geq 1 - c$:

$$\mathbb{E} \left[\mathbf{P}^\eta \left[\tilde{\mathbf{A}}_4^{\text{int}}(r/4, R) \cap G_{\bar{\delta}}^{\text{int}}(r/4) \cap F_r \right]^2 \right] \geq a \tilde{g}_{4,\delta}^{\text{int}}(r, R)^2.$$

Let $\text{Dense}^N(r)$ be the event defined in the proof of Lemma 4.6. Corollary D.5 and the above inequality imply that there exists an absolute constant $c \in (0, 1)$ such that, for every r sufficiently large, there exists $N = N(r)$ satisfying:

$$\forall R \geq 4r, \mathbb{E} \left[\mathbf{P}^\eta \left[\tilde{\mathbf{A}}_4^{\text{int}}(r, R) \cap \text{Dense}^N(r) \right]^2 \right] \geq \Omega(1) \tilde{\alpha}_4(r, R)^2.$$

Now, if we follow the proof of Lemma 4.6, we obtain that there exists a constant $c' = c'(r, N)$ such that:

$$\tilde{\alpha}_4(R)^2 \geq \Omega(1) \mathbb{E} \left[\mathbf{P}^\eta \left[\tilde{\mathbf{A}}_4^{\text{int}}(r, R) \cap \text{Dense}^N(r) \right]^2 \right],$$

which ends the proof. □

This also ends the proof of Proposition D.1. □

We also have the following analogues of Propositions 2.4 and 2.5 (with the same proofs):

Proposition D.8. *Let $j \in \mathbb{N}^*$, let $1 \leq r \leq R$, and write:*

$$\tilde{f}_j(r, R) = \sqrt{\mathbb{E} \left[\mathbf{P}^\eta \left[\hat{\mathbf{A}}_j(r, R) \right]^2 \right]}. \quad (\text{D.8})$$

There exists a constant $C = C(j) < +\infty$ such that:

$$\tilde{\alpha}_j(r, R) \leq \tilde{f}_j(r, R) \leq C \tilde{\alpha}_j(r, R).$$

Proposition D.9. *Let $j \in \mathbb{N}^*$. For every $h \in (0, 1)$, there exists a constant $\epsilon = \epsilon(j, h) \in (0, 1)$ such that, for every $1 \leq r \leq R$ and for every event G which is measurable with respect to $\omega \setminus A(2r, R/2)$ and that satisfies $\mathbb{P}[G] \geq 1 - \epsilon$, we have:*

$$\mathbb{E} \left[\mathbf{P}^\eta \left[\mathbf{A}_j(r, R) \cap G \right]^2 \right] \geq (1 - h) \tilde{\alpha}_j(r, R)^2.$$

D.2 Pivotal events

Let us first prove the following lemma which is the analogue of Lemma 4.6.

Lemma D.10. *Let $R \geq 1$ and let S be a 2×2 square included in $[-2R, 2R] \times [-R, R]$ and at distance at least $R/3$ from the sides of this rectangle. Then:*

$$\mathbb{E} \left[\mathbf{P}^\eta \left[\mathbf{Piv}_S^q(\text{Cross}(2R, R)) \right]^2 \mathbb{1}_{|\eta \cap S|=1} \right] \geq \Omega(1) \tilde{\alpha}_4(R)^2.$$

Proof. With exactly the same proof as in Subsection 4.1 (but by using Proposition D.1 instead of Proposition 1.6, Proposition D.8 instead of Proposition 2.4, and Proposition D.9 instead of Proposition 2.5), we have the following: There exists $r_0 \geq 1$ and $\epsilon \in (0, 1)$ such that, for every $r \geq r_0$ and for every event G measurable with respect to $\omega \setminus A(2r, R/2)$ that satisfies $\mathbb{P}[G] \geq 1 - \epsilon$:

$$\mathbb{E} \left[\mathbf{P}^\eta \left[\tilde{\mathbf{A}}_4^\square(B_r, R) \cap G \right]^2 \right] \geq \epsilon \tilde{\alpha}_4(r, R)^2,$$

where $\tilde{\mathbf{A}}_4^\square(B_r, R)$ is the event defined in the beginning of the proof of Lemma 4.6. Now, the proof is exactly the same as the one of Lemma 4.6. \square

The following is a direct consequence of Lemma D.10 and of results from [AGMT16]:

Corollary D.11. *There exists $\epsilon > 0$ such that, for every $R \in (0, +\infty)$:*

$$\tilde{\alpha}_4(R) \leq \frac{1}{\epsilon} R^{1+\epsilon}.$$

Proof. In the proof of the first part of Proposition 1.13, we have explained how to prove the analogous result for $\alpha_4^{gn}(R)$. In this proof (written in Subsection 4.1), we have used the following result from [AGMT16]:

$$\sum_S \mathbb{E} \left[\mathbf{P}^\eta \left[\mathbf{Piv}_S^q(\text{Cross}(R, R))^2 \mathbf{1}_{|\eta \cap S|=1} \right] \right] \leq O(1) R^{-\Omega(1)},$$

where the sum is over all the squares of the grid \mathbb{Z}^2 included in $[-2R, 2R] \times [-R, R]$ and at distance at least $R/3$ from the sides of this rectangle. We have then used Jensen's inequality and Lemma 4.6. If we do not use Jensen's inequality and if we use Lemma D.10 instead of Lemma 4.6, we obtain the desired result. \square

As in Subsection 4.2, we prove an estimate about the 4 and 5-arm events. Note that we know that $\alpha_5^{gn}(r, R) \asymp \left(\frac{r}{R}\right)^2$ but this does not imply that $\tilde{\alpha}_5(r, R) \asymp (r/R)^2$ (we will prove this last estimate in Chapter 6). We have the following:

Proposition D.12. *There exists an absolute constant $\epsilon > 0$ such that, for every $1 \leq r \leq R$:*

$$\tilde{\alpha}_5(r, R) \leq \frac{1}{\epsilon} \tilde{\alpha}_4(r, R) \left(\frac{r}{R}\right)^\epsilon.$$

Proof. First, fix some $N \in \mathbb{N}^*$ sufficiently large so that:

$$\tilde{\alpha}_5(\rho, \rho')^2 \geq \frac{1}{N} \left(\frac{\rho}{\rho'}\right)^{N-1}.$$

Let $M \geq 100$, $\rho \geq M$ and:

$$\text{GP}(\rho, M) = \bigcap_{k=0}^{\lfloor \log_2(M) \rfloor - 1} \text{Dense}_{1/100}(A(2^k \rho, 5 \cdot 2^k \rho)) \cap \text{QBC}_{1/100}^N(A(2^k \rho, 5 \cdot 2^k \rho)).$$

Note that:

$$\mathbb{P}[\text{GP}(\rho, M)] \geq 1 - O(1) \rho^{-N} \geq 1 - O(1) M^{-N}.$$

As in the proof of the second part of Proposition 1.13 (written in Subsection 4.2), there exists a constant $c \in (0, 1)$ such that if $\eta \in \text{GP}(\rho, M)$ then:

$$\mathbf{P}^\eta [\mathbf{A}_5(\rho, M\rho)] \leq (1 - c)^{\log(M)} \mathbf{E}^\eta [Y^3 \mathbf{1}_{Y \geq 4}],$$

where Y is the number of interfaces from ∂B_ρ to $\partial B_{M\rho}$. By Reimer's inequality [Rei00], we have $\mathbf{P}^\eta [Y \geq j] \leq \mathbf{P}^\eta [\mathbf{A}_1(\rho, M\rho)]^j$. If $\eta \in \text{GP}(\rho, M)$, then $\mathbf{P}^\eta [\mathbf{A}_1(\rho, M\rho)] \leq (1-a)^{\log(M)}$ for some $a \in (0, 1)$. Moreover, if $\eta \in \text{GP}(\rho, M)$, then $\mathbf{P}^\eta [Y \geq 4] = \mathbf{P}^\eta [\mathbf{A}_4(\rho, M\rho)] \geq M^{-b}/b$ for some $b \in (0, +\infty)$. Hence:

$$\mathbf{E}^\eta [Y^3 \mathbf{1}_{Y \geq 4}] \leq d \mathbf{P}^\eta [\mathbf{A}_4(\rho, M\rho)] ,$$

for some $d \in (0, +\infty)$. As a result:

$$\tilde{\alpha}_5(\rho, M\rho)^2 \leq O(1) (1-c)^{2\log(M)} \tilde{\alpha}_4(\rho, M\rho)^2 + O(1) M^{-N} .$$

Now, the proof is essentially the same as the proof of the second part of Proposition 1.13 (except that we use Proposition D.1 instead of Proposition 1.6). \square

In Chapter 6, we will need results similar to the results of Subsections 4.1 and 4.3 but for the quantity $\mathbb{E} \left[\mathbf{P}^\eta [\mathbf{Piv}_S(A)]^2 \right]$ instead of $\mathbb{P} [\mathbf{Piv}_S(A)]$ (where A is a crossing or an arm event). In particular, we will need the following lemma whose proof is very closed to the proof of Lemma 4.5 and of the different lemmas of Subsection 4.3.

Lemma D.13. *Define $\mathbf{Piv}_D^E(A)$ as in the beginning of Subsection 4.3. Let $\rho, r, R \in [1, +\infty]$ such that $\rho \leq r/10$ and $r \leq R/2$, let y be a point of the plane, and let $S = B_\rho(y)$ be the $2\rho \times 2\rho$ square centered at y . We have the following:*

i) *Let $\rho_1 \in [\rho, +\infty)$ and $\rho_2 \in [\rho_1, +\infty)$ and assume that $B_{\rho_2}(y) \subseteq A(r, R)$. Then:*

$$\mathbb{E} \left[\mathbf{P}^\eta \left[\mathbf{Piv}_S^{A(y; \rho_1, \rho_2)} (\mathbf{A}_j(r, R)) \right]^2 \right] \leq O(1) \tilde{\alpha}_4(\rho_1, \rho_2)^2 .$$

ii) *Let $\rho_1 \in [1, R/4]$ and assume that $S \subseteq A(\rho_1, 4\rho_1)$. Then:*

$$\mathbb{E} \left[\mathbf{P}^\eta \left[\mathbf{Piv}_S^{A(r, \rho_1) \cup A(4\rho_1, R)} (\mathbf{A}_j(r, R)) \right]^2 \right] \leq O(1) \tilde{\alpha}_j(r, R)^2 .$$

Proof. We prove only i) since the proof of ii) is essentially the same (actually, in the case j odd, the proof of i) is slightly more technical). We first prove i) in the case j even and then in the case j odd. We use the following notation, where $0 < \rho' \leq \rho''$:

$$\text{Dense}(\rho', \rho'') = \text{Dense}_{1/100}(A(y; \rho', 2\rho')) \cap \text{Dense}_{1/100}(A(y; \rho'', 2\rho'')) .$$

Since j is even, then for any $k \in \{0, \dots, \lfloor \log_2(\rho_2/(4\rho_1)) \rfloor =: k_0\}$, $\mathbf{Piv}_S^{A(y; \rho_1, \rho_2)} (\mathbf{A}_j(r, R))$ is included in:

$$\mathbf{A}_4(y; 2^{k+1}\rho_1, \rho_2/2) \cup \left(\mathbf{Piv}_S^{A(y; \rho_1, \rho_2)} (\mathbf{A}_j(r, R)) \setminus \text{Dense}(2^k \rho_1, \rho_2/2) \right) ,$$

where $\mathbf{A}_4(y; \cdot, \cdot)$ is the 4-arm event translated by y . As a result, $\mathbf{Piv}_S^{A(y; \rho_1, \rho_2)} (\mathbf{A}_j(r, R))$ is also included in:

$$\begin{aligned} & \mathbf{A}_4(y; 2\rho_1, \rho_2/2) \cup \left(\bigcup_{k=0}^{k_0} \mathbf{A}_4(y; 2^{k+2}\rho_1, \rho_2/2) \setminus \text{Dense}(2^k \rho_1, \rho_2/2) \right) \cup \neg \text{Dense}(2^{k_0+1} \rho_1, \rho_2/2) \\ & \subseteq \widehat{\mathbf{A}}_4(y; 2\rho_1, \rho_2/2) \cup \left(\bigcup_{k=0}^{k_0} \widehat{\mathbf{A}}_4(y; 2^{k+2}\rho_1, \rho_2/2) \setminus \text{Dense}(2^k \rho_1, \rho_2/2) \right) \cup \neg \text{Dense}(2^{k_0+1} \rho_1, \rho_2/2) , \end{aligned}$$

where

$$\widehat{\mathbf{A}}_4(y; \rho', \rho'') = \left\{ \mathbb{P} \left[\mathbf{A}_4(y; \rho', \rho'') \mid \omega \cap A(y; \rho', \rho'') \right] > 0 \right\} .$$

By σ -additivity, $\mathbf{P}^\eta \left[\mathbf{Piv}_S^{A(y; \rho_1, \rho_2)}(\mathbf{A}_j(r, R)) \right]$ is less than or equal to:

$$\mathbf{P}^\eta \left[\widehat{\mathbf{A}}_4(y; 2\rho_1, \rho_2/2) \right] + \sum_{k=0}^{k_0} \mathbf{P}^\eta \left[\widehat{\mathbf{A}}_4(y; 2^{k+2}\rho_1, \rho_2/2) \right] \mathbb{1}_{\text{-Dense}(2^k \rho_1, \rho_2/2)} + \mathbb{1}_{\text{-Dense}(2^{k_0+1} \rho_1, \rho_2/2)}.$$

Now, note that, for every $k \in \{0, \dots, k_0\}$:

- $\mathbf{P}^\eta \left[\widehat{\mathbf{A}}_4(y; 2^{k+2}\rho_1, \rho_2/2) \right]$ is independent of $\mathbb{1}_{\text{-Dense}(2^k \rho_1, \rho_2/2)}$.
- $\mathbb{E} \left[\mathbf{P}^\eta \left[\widehat{\mathbf{A}}_4(y; 2^{k+2}\rho_1, \rho_2/2) \right]^2 \right] \leq C(2^k)^C \tilde{\alpha}_4(y; \rho_1, \rho_2)$ for some $C < +\infty$ by Propositions D.8 and D.1.
- $\mathbb{P} \left[\text{Dense}(2^k \rho_1, \rho_2/2) \right] \leq O(1) \exp(-\Omega(1)(2^k \rho_1)^2)$.

Note also that:

- $\mathbb{E} \left[\mathbf{P}^\eta \left[\widehat{\mathbf{A}}_4(y; 2\rho_1, \rho_2/2) \right]^2 \right] \leq C \tilde{\alpha}_4(\rho_1, \rho_2)$ and:
- $\mathbb{P} \left[\text{Dense}(2^{k_0+1} \rho_1, \rho_2/2) \right] \leq O(1) \exp(-\Omega(1)(2^{k_0} \rho_1)^2)$.

Let us end the proof by showing that:

$$\mathbb{E} \left[\left(\mathbf{P}^\eta \left[\widehat{\mathbf{A}}_4(y; 2\rho_1, \rho_2/2) \right] + \sum_{k=0}^{k_0} \mathbf{P}^\eta \left[\widehat{\mathbf{A}}_4(y; 2^{k+2}\rho_1, \rho_2/2) \right] \mathbb{1}_{\text{-Dense}(2^k \rho_1, \rho_2/2)} + \mathbb{1}_{\text{-Dense}(2^{k_0+1} \rho_1, \rho_2/2)} \right)^2 \right]$$

is at most $O(1) \tilde{\alpha}_4(y; \rho_1, \rho_2)^2$. If we expand the above square, apply the Cauchy-Schwarz inequality to each of the 2^{k_0+3} terms and use the five items above, then we obtain the desired result since:

$$\sum_{k,l} \sqrt{(2^k)^C \exp(-\Omega(1)(2^k \rho_1)^2) (2^l)^C \exp(-\Omega(1)(2^l \rho_1)^2)} < +\infty.$$

Let us now assume that j is odd. In this case, as explained in Appendix C, the pivotal event can be described for instance by using the 4 and the 5-arm events (and not only the 4-arm event). As in Appendix C, the result is obtained by using a comparison estimate between the 4 and 5-arm events. The only difference is that in the present case we use Proposition D.12 instead of the analogous comparison estimate between $\alpha_4^{an}(\cdot, \cdot)$ and $\alpha_5^{an}(\cdot, \cdot)$. \square

 Estimations quenched quantitatives pour la percolation de Voronoi

Ce chapitre est très fortement inspiré de l'article [V6], intitulé “Quantitative quenched Voronoi percolation and applications” et disponible sur Hal et Arxiv. Par ailleurs, en plus de quelques modifications mineures, la Section 2 de cet article (qui est une section sur les motivations de ce travail) a été retirée car une section très similaire a été placée dans le Chapitre 7.

Résumé en français. Ahlberg, Griffiths, Morris et Tassion ont montré que, asymptotiquement presque sûrement, les probabilités de croisement quenched pour la percolation de Voronoi critique ne dépendaient pas de l’environnement. Dans ce chapitre, nous montrons un résultat analogue pour les événements à j bras. En particulier, nous prouvons que la variance des probabilités quenched d’événements à j bras est au plus de l’ordre du carré de la probabilité annealed. Les deux principales nouvelles difficultés sont que les événements à j bras sont dégénérés et non monotones. Nous utilisons ces résultats et ceux du Chapitre 5 pour montrer qu’il existe $\epsilon > 0$ tel que la fonction de percolation annealed vérifie :

$$\forall p > 1/2, \theta^{an}(p) \geq \epsilon(p - 1/2)^{1-\epsilon}.$$

La principale motivation de ce chapitre est de fournir des outils pour l’étude des modèles de percolation de Voronoi dynamiques du Chapitre 7.

English abstract. Ahlberg, Griffiths, Morris and Tassion have proved that, asymptotically almost surely, the quenched crossing probabilities for critical planar Voronoi percolation do not depend on the environment. We prove an analogous result for arm events; in particular, we prove that the variance of the quenched probability of an arm event is at most a constant times the square of the annealed probability. The fact that the arm events are degenerate and non-monotonic add two major difficulties. As an application, we prove that there exists $\epsilon > 0$ such that the following holds for the annealed percolation function θ^{an} :

$$\forall p > 1/2, \theta^{an}(p) \geq \epsilon(p - 1/2)^{1-\epsilon}.$$

The main motivation of this chapter is to provide tools to study the Voronoi percolation dynamical processes of Chapter 7.

Contents

1	Introduction	304
1.1	Main results	304
1.2	An application: Reimer’s inequality and the annealed percolation function	306
1.3	Ideas of proof	307
2	The martingale method	309
3	First estimates on arm and pivotal events	311
3.1	Arm-events and pivotal events	311
3.2	The “good” events	313
3.3	A quenched quasi-multiplicativity property	314
4	Proof that $\alpha_j^{an}(r, R) \asymp \tilde{\alpha}_j(r, R)$	316
5	Strict inequality for the exponent of the annealed percolation function	318
6	Other estimates on arm events	319
7	Quantitative quenched estimates	322

1 Introduction

1.1 Main results

Planar Voronoi percolation is a percolation model in random environment defined as follows (for more details, see for instance [BR06a, BR06b] or the introduction of Chapter 5):

Let $p \in [0, 1]$ and let η be a homogeneous Poisson point process in \mathbb{R}^2 with intensity 1. For each $x \in \eta$, let $C(x) = \{u \in \mathbb{R}^2 : \forall y \in \eta, \|x - u\|_2 \leq \|y - u\|_2\}$ be the Voronoi cell of x . Note that a.s. all the Voronoi cells are bounded convex polygons. Given η , colour each cell in black with probability p and in white with probability $1 - p$, independently of the other cells. One thus obtains a random colouring of the plane. We write $\omega \in \{-1, 1\}^\eta$ for the corresponding coloured configuration where 1 means black and -1 means white and we let \mathbb{P}_p be the law of ω . Also, we write $\{0 \leftrightarrow \infty\}$ for the event that there is a black path from 0 to ∞ and we let $\theta^{an}(p)$ denote the **annealed percolation function** i.e.:

$$\theta^{an}(p) = \mathbb{P}_p [0 \leftrightarrow \infty] .$$

The critical point of Voronoi percolation is:

$$p_c = \inf\{p : \theta^{an}(p) > 0\} .$$

Bollobás and Riordan [BR06a] have proved that $p_c = 1/2$. Duminil-Copin, Raoufi and Tassion [DCRT17a] have recently given an alternative proof of this result (and have even proved sharpness of Voronoi percolation in any dimension). The proof by Bollobás and Riordan highly relies on a “weak” box-crossing property. A stronger box-crossing property has then been obtained by Tassion [Tas16], see Theorem 1.2 below. In [BKS99], Benjamini, Kalai and Schramm have conjectured that, with high probability, the quenched crossing probabilities are very close to the annealed crossing probabilities. Ahlberg, Griffiths, Morris and Tassion have answered positively this conjecture in [AGMT16], see Theorem 1.3 below. The results from [AGMT16] provide very useful tools, that were for instance crucial in Chapter 5 in which we have proved some scaling relations for Voronoi percolation. In the present chapter, we pursue the work of [AGMT16] by proving an analogue of their main theorem for **arm events** and by improving their main result.

Let us state the box-crossing results from [Tas16] and [AGMT16].

Definition 1.1. i) For any $\lambda_1, \lambda_2 > 0$, $\text{Cross}(\lambda_1, \lambda_2)$ is the event that there is a black crossing of the rectangle $[-\lambda_1, \lambda_1] \times [-\lambda_2, \lambda_2]$ from left to right.

ii) Given η , \mathbf{P}_p^η is the conditional distribution of ω given η i.e. $\mathbf{P}_p^\eta = (p\delta_1 + (1-p)\delta_{-1})^{\otimes \eta}$. More generally, if E is a countable set, we write $\mathbf{P}_p^E = (p\delta_1 + (1-p)\delta_{-1})^{\otimes E}$.

The following result is the annealed box-crossing property proved by Tassion:

Theorem 1.2 (Theorem 3 of [Tas16]). *For every $\lambda \in (0, +\infty)$, there exists $c = c(\lambda) \in (0, 1)$ such that, for every $R \in (0, +\infty)$:*

$$c \leq \mathbb{P}_{1/2}[\text{Cross}(\lambda R, R)] \leq 1 - c.$$

In [AGMT16], the authors prove a quenched box-crossing property in the case where η is obtained by sampling n independent uniform points in a rectangle. As mentioned in [AGMT16] (see also Appendix B of Chapter 5), the proof in the case where η is a Poisson point process in \mathbb{R}^2 is essentially the same and we have the following:

Theorem 1.3 ([AGMT16]). *Let $\lambda > 0$. There exists an absolute constant $\epsilon > 0$ and a constant $C = C(\lambda) < +\infty$ such that, for every $R \in (0, +\infty)$:*

$$\text{Var} \left(\mathbf{P}_{1/2}^\eta [\text{Cross}(\lambda R, R)] \right) \leq CR^{-\epsilon}.$$

Main results. In the present chapter, we prove an analogue of Theorem 1.3 for arm events. Let us first define these events: Let $j \in \mathbb{N}^*$ and $0 \leq r \leq R$. The j -arm event from distance r to distance R is the event that there exist j paths of alternating colors in the annulus $[-R, R]^2 \setminus [-r, r]^2$ from $\partial[-r, r]^2$ to $\partial[-R, R]^2$ (if j is odd, we ask that there are: (a) $j - 1$ paths of alternating color, and: (b) one additional black path such that there is no Voronoi cell intersected by both this additional path and one of the $j - 1$ other paths). Let $\mathbf{A}_j(r, R)$ denote this event. The annealed probability of $\mathbf{A}_j(r, R)$ is denoted by

$$\alpha_{j,p}^{an}(r, R) = \mathbb{P}_p[\mathbf{A}_j(r, R)].$$

We will use the simplified notation $\alpha_{j,p}^{an}(R) = \alpha_{j,p}^{an}(1, R)$. Our main theorem is the following:

Theorem 1.4. *Let $j \in \mathbb{N}_+$. There exists a constant $C = C(j) < +\infty$ such that, for every $r, R \in [1, +\infty)$ such that $r \leq R$, we have:*

$$\alpha_{j,1/2}^{an}(r, R)^2 \leq \mathbb{E} \left[\mathbf{P}_{1/2}^\eta [\mathbf{A}_j(r, R)]^2 \right] \leq C \alpha_{j,1/2}^{an}(r, R)^2. \quad (1.1)$$

Let also $a \in]0, 1[$. There exists a constant $C' = C'(j, a) < +\infty$ such that, if we assume furthermore that $r \leq aR$, then:

$$\begin{aligned} \mathbb{E} \left[\mathbf{P}_{1/2}^\eta [\mathbf{A}_j(r, R)]^2 \right] - \alpha_{j,1/2}^{an}(r, R)^2 &= \text{Var} \left(\mathbf{P}_{1/2}^\eta [\mathbf{A}_j(r, R)] \right) \\ &\leq C' \alpha_{j,1/2}^{an}(r, R)^2 r^2 \alpha_{4,1/2}^{an}(r)^2. \end{aligned} \quad (1.2)$$

Remark 1.5. The estimate (1.1) of Theorem 1.4 is a direct consequence of (1.2) and of an estimate on the 4-arm events proved in Chapter 5 (see Proposition 3.3 of the present chapter). However, our strategy will be to first prove (1.1) and then deduce (1.2).

The new difficulties compared to the work of [ABGM14] are the fact that the arm events are **degenerate** and (except for $j = 1$) **non-monotonic**. The fact that the crossing events are monotone was crucial in [AGMT16], especially in Section 2 where the authors prove an Efron-Stein estimate by revealing the position of the points of η one by one, and in their final section where they use Schramm-Steif randomized algorithm theorem in order to estimate the sum of squares of influences. To deal with these new difficulties, we will have to use very precise estimates on the **pivotal events**. By doing so, we will also obtain the following more quantitative version of Theorem 1.3:

Theorem 1.6. *Let $\lambda > 0$. There exists a constant $C = C(\lambda) < +\infty$ such that, for every $R \in (0, +\infty)$:*

$$\text{Var} \left(\mathbf{P}_{1/2}^\eta [\text{Cross}(\lambda R, R)] \right) \leq CR^2 \alpha_{4,1/2}^{\text{an}}(R)^2. \quad (1.3)$$

We refer to Subsection 1.3 for both an explanation of the intuition behind Theorems 1.4 and 1.6 and for some ideas of proofs.

Remark 1.7. An interesting questions is whether or not Theorems 1.4 and 1.6 are optimal: Is Theorem 1.4 (respectively Theorem 1.6) still true with $r^{2-\epsilon}$ (respectively $R^{2-\epsilon}$) instead of r^2 (respectively R^2)? It is likely that the general martingale estimate Proposition 2.1 is not optimal at all in the case of crossing (and arm) events.

1.2 An application: Reimer's inequality and the annealed percolation function

In this subsection, we explain how one can use (1.1) in order to obtain estimates on annealed probabilities of arm events. We first need to define the disjoint occurrence of two events. If ω is a coloured configuration, we write $\eta(\omega)$ for the underlying non-coloured point process. If A and B are two events measurable with respect to the coloured configuration ω restricted to a bounded domain, we write:

$$A \square B = \{ \omega \in \Omega : \exists I_1, I_2 \text{ finite disjoint subsets of } \eta(\omega), \omega^{I_1} \subseteq A \text{ and } \omega^{I_2} \subseteq B \}, \quad (1.4)$$

where Ω is the set of all coloured configurations and, if $I \subseteq \eta(\omega)$, $\omega^I \subseteq \{1, -1\}^{\eta(\omega)}$ is the set of all ω' such that $\omega'_i = \omega_i$ if $i \in I$. By Reimer's inequality [Rei00] (which generalizes the BK inequality to non-necessarily monotonic events, see for instance [Gri99, BR06b]), we have the following quenched inequality:

$$\mathbf{P}_p^\eta [A \square B] \leq \mathbf{P}_p^\eta [A] \mathbf{P}_p^\eta [B].$$

However, the analogous annealed property is not true: if A depends only on η and satisfies $\mathbb{P}[A] \in]0, 1[$ then $\mathbb{P}[A] = \mathbb{P}[A \square A] > \mathbb{P}[A]^2$. Let us note that, if A and B are annealed increasing (which means that they are stable under addition of black points or delition of white points) and if $p = 1/2$ then this is true and known as the annealed BK inequality, see Lemma 3.4 of [AGMT16] or [Joo12].

We can see the identity (1.1) as an estimate that implies that the quenched probabilities of arm events are **sufficiently independent of η** so that the quenched Reimer inequality enables to prove annealed estimates. Indeed, we have for instance (where $j \in \mathbb{N}^*$):

$$\begin{aligned} & \alpha_{2j+1,1/2}^{\text{an}}(r, R) \\ &= \mathbb{E} \left[\mathbf{P}_{1/2}^\eta [\mathbf{A}_1(r, R) \square \mathbf{A}_{2j}(r, R)] \right] \\ &\leq \mathbb{E} \left[\mathbf{P}_{1/2}^\eta [\mathbf{A}_1(r, R)] \mathbf{P}_{1/2}^\eta [\mathbf{A}_{2j}(r, R)] \right] \text{ by Reimer's inequality} \\ &\leq \sqrt{\mathbb{E} \left[\mathbf{P}_{1/2}^\eta [\mathbf{A}_1(r, R)]^2 \right] \mathbb{E} \left[\mathbf{P}_{1/2}^\eta [\mathbf{A}_{2j}(r, R)]^2 \right]} \text{ by the Cauchy-Schwarz inequality} \\ &\leq O(1) \alpha_{2j,1/2}^{\text{an}}(r, R) \alpha_{1,1/2}^{\text{an}}(r, R) \text{ by (1.1)}. \end{aligned}$$

It seems complicated to prove this estimate without relying on (1.1). Actually, still by relying on (1.1), we will prove in Section 5 that $\alpha_{2j+1,1/2}^{\text{an}}(r, R) \leq O(1) \left(\frac{r}{R}\right)^\epsilon \alpha_{2j,1/2}^{\text{an}}(r, R) \alpha_{1,1/2}^{\text{an}}(r, R)$. This identity will be a key result in order to prove the following strict inequality for the annealed percolation function, which is analogous to the result obtained by Kesten and Zhang in [KZ87]:

Theorem 1.8. *There exists a constant $\epsilon > 0$ such that, for every $p > 1/2$ we have:*

$$\theta^{\text{an}}(p) \geq \epsilon (p - 1/2)^{1-\epsilon}.$$

Let us note that the authors of [DCRT17a] have obtained that $\theta^{an}(p) \geq \epsilon(p - 1/2)$ **in any dimension**. Theorem 1.8 is proved in Section 5. In order to prove this result, we also rely on the two following annealed scaling relations (analogous to the scaling relations proved by Kesten for Bernoulli percolation on \mathbb{Z}^2 , see [Kes87]) that we have proved in Chapter 5:

Theorem 1.9 (Theorem 1.11 of Chapter 5). *For every $p \in (1/2, 3/4]$, let $L^{an}(p)$ denote the annealed correlation length, i.e.:*

$$L^{an}(p) = \inf\{R \geq 1 : \mathbb{P}_p[\text{Cross}(2R, R)] \geq 1 - \epsilon_0\} < +\infty,$$

for some fixed sufficiently small ϵ_0 . Then, for every $p \in (1/2, 3/4]$:

$$\theta^{an}(p) \asymp \alpha_{1,1/2}^{an}(L^{an}(p))$$

and:

$$L^{an}(p)^2 \alpha_{4,1/2}^{an}(L(p)) \asymp \frac{1}{p - 1/2},$$

where the constants in the \asymp 's only depend on ϵ_0 .

1.3 Ideas of proof

Let us now give a few ideas of the proof of our main result Theorem 1.4. Let us first briefly give an intuition behind the estimates of Theorems 1.4 and 1.6 by relying on an estimate from [AGMT16]. In the said paper, the authors prove a martingale estimate that enables to bound the variance of a crossing event by the expectation of the sum of squares of quenched influences of this event, where the influence of a point $x \in \eta$ is the probability that changing the colour of x modifies the indicator function of the event. If one forgets about the fact that quenched and annealed probabilities are not the same a priori and thinks about sum of squares of influences in the case of Bernoulli percolation on \mathbb{Z}^2 for instance, then one could suggest that this sum is of the order R^2 times the square of the probability of $\mathbf{A}_4(1, R)$. (See for instance Chapter 6 of [GS14] for this kind of calculations.) This is the analogue of what we have in Theorem 1.6.

If one rather studies the variance of the j -arm event $\mathbf{A}_j(r, R)$ and still compares the sum of squares of quenched influences with the analogous quantity on \mathbb{Z}^2 , then one could suggest that this sum is of the order r^2 times the square of the probability of $\mathbf{A}_4(1, r)$ times the square of the probability of $\mathbf{A}_j(r, R)$. This is the analogue of what we have in (the second part of) Theorem 1.4.

In order to give more precise ideas of proof, let us first simplify the notations:

Notation 1.10. In this chapter, we will only work at the parameter $p = 1/2$ (the scaling relations of Theorem 1.9 enables us to estimate $\theta(p)$ with $p > 1/2$ by working at $p = 1/2$). Hence, we will use the following simplified notations:

- $\mathbb{P} := \mathbb{P}_{1/2}$, $\mathbf{P}^\eta := \mathbf{P}_{1/2}^\eta$ and $\mathbf{P}^E := \mathbf{P}_{1/2}^E$,
- $\alpha_j^{an}(r, R) := \alpha_{j,1/2}^{an}(r, R)$.

Also, we will use the following notation:

$$\tilde{\alpha}_j(r, R) = \sqrt{\mathbb{E} \left[\mathbf{P}^\eta \left[\mathbf{A}_j(r, R) \right]^2 \right]}. \quad (1.5)$$

By Jensen's inequality, $\tilde{\alpha}_j(r, R) \geq \alpha_j^{an}(r, R)$. One of the main goal of the present chapter is to prove (1.1) of Theorem 1.4 i.e. to prove that the other inequality is true up to a constant. In order to explain the general strategy, we need to introduce an annealed and a quenched notions of pivotal events (that we have used in Chapter 5):

Definition 1.11. Let A be an event measurable with respect to the coloured configuration ω and let η be the underlying (non-coloured) point configuration. Also, let D be a bounded Borel subset of the plane.

- The subset D is said quenched-pivotal for ω and A if there exists $\omega' \in \{-1, 1\}^\eta$ such that ω and ω' coincide on $\eta \cap D^c$ and $\mathbb{1}_A(\omega') \neq \mathbb{1}_A(\omega)$. We write $\mathbf{Piv}_D^q(A)$ for the event that D is quenched-pivotal for A .
- The subset set D is said annealed-pivotal for some Voronoi percolation configuration ω and some event A if both $\mathbb{P}[A | \omega \setminus D]$ and $\mathbb{P}[\neg A | \omega \setminus D]$ are positive. We write $\mathbf{Piv}_D(A)$ for the event that D is annealed-pivotal for A .

Note that we have $\mathbb{P}[\mathbf{Piv}_D^q(A) \setminus \mathbf{Piv}_D(A)] = 0$ for any A and D as above.

Let us first explain the ideas behind the proof of the first part of Theorem 1.4, i.e. the proof that $\tilde{\alpha}_j(r, R) \asymp \alpha_j^{an}(r, R)$. In order to prove this result, we will begin with the following elementary but crucial identity:

$$\text{Var}(\mathbf{P}^\eta[\mathbf{A}_j(r, R)]) = \tilde{\alpha}_j(r, R)^2 - \alpha_j^{an}(r, R)^2,$$

and we will try to estimate this variance. As in [AGMT16], we will use a martingale method in order to bound $\text{Var}(\mathbf{P}^\eta[\mathbf{A}_j(r, R)])$. The difference with [AGMT16] is that we will prove an estimate that also holds for non-monotonic events. This estimate is written in Proposition 2.1 and implies that:

$$\text{Var}(\mathbf{P}^\eta[\mathbf{A}_j(r, R)]) \leq \sum_S \mathbb{E}[\mathbf{P}^\eta[\mathbf{Piv}_S(\mathbf{A}_j(r, R))]^2],$$

where S ranges for instance over all the squares of the grid \mathbb{Z}^2 .

We will then have to estimate the quantities $\mathbb{E}[\mathbf{P}^\eta[\mathbf{Piv}_S(\mathbf{A}_j(r, R))]^2]$. To this purpose, we will use a lot of estimates from Chapter 5. More precisely, in Chapter 5, we have proved estimates on quantities of the kind $\mathbb{P}[\mathbf{Piv}_S(\mathbf{A}_j(r, R))]$ and we have explained in Appendix D of the said chapter how we can adapt most of the proofs in order to obtain similar estimates on $\mathbb{E}[\mathbf{P}^\eta[\mathbf{Piv}_S(\mathbf{A}_j(r, R))]^2]$. In Section 4, we will use these estimates in order to prove that:

$$\tilde{\alpha}_j(r, R)^2 - \alpha_j^{an}(r, R)^2 = \text{Var}(\mathbf{P}^\eta[\mathbf{A}_j(r, R)]) \leq O(1) r^{-\epsilon} \tilde{\alpha}_j(r, R)^2$$

for some $\epsilon > 0$. As a result, if r sufficiently large, then:

$$\tilde{\alpha}_j(r, R)^2 \leq 2\alpha_j^{an}(r, R)^2.$$

We will thus obtain the desired result for r sufficiently large and we will conclude that it holds for every r thanks to the quasi-multiplicativity property for arm-events (see Proposition 3.1).

Once the first part of Theorem 1.4 is proved, we know that $\tilde{\alpha}_j(r, R)$ and $\alpha_j^{an}(r, R)$ are of the same order, which gives us better estimates on the quantities $\mathbb{E}[\mathbf{P}^\eta[\mathbf{Piv}_S(\mathbf{A}_j(r, R))]^2]$ and finally implies the more quantitative inequalities (1.2) and (1.3). See Section 7.

Let us end this part on the strategy of proofs by the following remark: As mentioned above, in order to prove our main results, we will have to prove estimates on the probabilities of arm events. To this purpose, our strategy will often consist in: i) defining a “good” event $G(r, R)$ and then ii) using the trivial bound:

$$\alpha_j^{an}(r, R) \leq \mathbb{P}[\mathbf{A}_j(r, R) \mid G(r, R)] + \mathbb{P}[\neg G(r, R)].$$

Of course, we will define $G(r, R)$ so that it is easier to study $\mathbf{A}_j(r, R)$ under $\mathbb{P}[\cdot | G(r, R)]$ than under \mathbb{P} . The problem here is that we will have estimates of the kind:

$$\mathbb{P}[\neg G(r, R)] \leq \varepsilon_1(r)$$

and

$$\mathbb{P}[\mathbf{A}_j(r, R)] \leq \varepsilon_2(R/r)$$

for some functions ε_1 and ε_2 that go to 0 at infinity. So this strategy is not useful at all when R/r is extremely large compared to r . To overcome this difficulty, our strategy will often be to fix some $M \gg 1$, prove estimates on quantities of the form $\alpha_j^{an}(\rho, \rho M)$ for any $\rho \geq M$, and then deduce estimates that hold for $\alpha_j^{an}(r, R)$ for any $r \leq R$ by using the quasi-multiplicativity property. See in particular the proofs of Propositions 5.1 and 6.2. Note that this strategy is closed to the strategy from [LSW02] and [SW01] where the authors compute the arm exponents for critical percolation on the triangular lattice by estimating the probabilities of non-degenerate arm events and then deducing the result for all arm-events by using the quasi-multiplicativity property.

Notation 1.12. Let us end this section by some general notations that we will use all along the chapter:

- We write $B_R = [-R, R]^2$ and we write $A(r, R)$ for the annulus which is the adherence of $B_R \setminus B_r$. Also, for every $y \in \mathbb{R}^2$, we write $B_r(y) = y + B_r$ and $A(y; r, R) = y + A(r, R)$.
- A quad Q is a topological rectangle in the plane with two distinguished opposite sides. Also, a crossing of Q is a black path included in Q that joins one distinguished side to the other. The event that Q is crossed is written $\text{Cross}(Q)$.
- We use the following notations: (a) $O(1)$ is a positive bounded function, (b) $\Omega(1)$ is a positive function bounded away from 0 and (c) if f and g are two non-negative functions, then $f \asymp g$ means $\Omega(1)f \leq g \leq O(1)f$.

Acknowledgments: I would like to thank Christophe Garban for many helpful discussions and for his comments on earlier versions of the manuscript. I would also like to thank Vincent Tassion for fruitful discussions and for having welcomed me in Zürich several times.

2 The martingale method

In this section, we follow the ideas of Section 2 of [AGMT16] where the authors use a martingale method in order to bound a variance by a sum involving squares of quenched probabilities of pivotal points. Their main idea is to discover one by one the points of the Poisson process. In the present chapter, we will rather discover one by one the boxes of a grid (i.e. at each step we will discover all the points of the Poisson process that belong to one box). Remember the definition of pivotal events from Definition 1.11.

Proposition 2.1. *Let $\rho > 0$, let E be an event measurable with respect to our Voronoi percolation configuration, and let $(S_m^\rho)_{m \in \mathbb{N}}$ be an enumeration of the $\rho \times \rho$ squares of the grid $\rho\mathbb{Z}^2$. Then:*

$$\text{Var}(\mathbf{P}^\eta[E]) \leq \sum_{m \in \mathbb{N}} \mathbb{E} \left[\mathbf{P}^\eta [\text{Piv}_{S_m^\rho}(E)]^2 \right].$$

Proof. The proof is very similar to the proof of Theorem 2.1 in [AGMT16]. We write h for the indicator function of E and we use the following notations:

$$q^\eta = \mathbf{P}^\eta[E];$$

$$\forall m \in \mathbb{N} \cup \{-1\}, \quad q_m = \mathbb{P} \left[E \mid \eta \cap (\cup_{k=0}^m S_k^\rho) \right] = \mathbb{E} \left[q^\eta \mid \eta \cap (\cup_{k=0}^m S_k^\rho) \right].$$

Note that $(q_m)_m$ is a bounded martingale that converges in L^2 to q^η . Note also that $q_{-1} = \mathbb{E} [q^\eta]$. Hence we have:

$$\text{Var} (q^\eta) = \lim_{M \rightarrow +\infty} \text{Var} \left(\sum_{m=0}^M q_m - q_{m-1} \right) = \sum_{m \in \mathbb{N}} \text{Var} (q_m - q_{m-1}).$$

It is thus sufficient to prove that for all $m \in \mathbb{N}$ we have:

$$\text{Var} (q_m - q_{m-1}) \leq \mathbb{E} \left[\mathbf{P}^\eta \left[\mathbf{Piv}_{S_m^\rho} (E) \right]^2 \right]. \quad (2.1)$$

To this purpose, let q_m^- be obtained from q_m by deleting $\eta \cap S_m^\rho$ and let us prove the following:

$$\text{Var} (q_m - q_{m-1}) \leq \mathbb{E} \left[(q^\eta - q^{\eta^-})^2 \right]. \quad (2.2)$$

Proof of (2.2). We follow the proof of Lemma 2.4 in [AGMT16] where the authors use the conditional variance formula.¹ Since $\mathbb{E} [q_m - q_{m-1} \mid \eta \cap (\cup_{k=0}^{m-1} S_k^\rho)] = 0$, this formula implies that:

$$\text{Var} (q_m - q_{m-1}) = \mathbb{E} \left[\text{Var} \left(q_m \mid \eta \cap (\cup_{k=0}^{m-1} S_k^\rho) \right) \right].$$

By using the fact that $(q^{\eta^-}, \cup_{k=0}^{m-1} \eta \cap S_k^\rho)$ is independent of $\eta \cap S_m^\rho$, we obtain that $\mathbb{E} [q^{\eta^-} \mid \eta \cap (\cup_{k=0}^{m-1} S_k^\rho)] = \mathbb{E} [q^{\eta^-} \mid \eta \cap (\cup_{k=0}^m S_k^\rho)]$, hence $\text{Var} \left(q_m \mid \eta \cap (\cup_{k=0}^{m-1} S_k^\rho) \right)$ equals:

$$\begin{aligned} & \text{Var} \left(\mathbb{E} [q^\eta \mid \eta \cap (\cup_{k=0}^m S_k^\rho)] \mid \eta \cap (\cup_{k=0}^{m-1} S_k^\rho) \right) \\ &= \text{Var} \left(\mathbb{E} [q^\eta \mid \eta \cap (\cup_{k=0}^m S_k^\rho)] - \mathbb{E} [q^{\eta^-} \mid \eta \cap (\cup_{k=0}^{m-1} S_k^\rho)] \mid \eta \cap (\cup_{k=0}^{m-1} S_k^\rho) \right) \\ &= \text{Var} \left(\mathbb{E} [q^\eta - q^{\eta^-} \mid \eta \cap (\cup_{k=0}^m S_k^\rho)] \mid \eta \cap (\cup_{k=0}^{m-1} S_k^\rho) \right) \\ &\leq \mathbb{E} \left[\mathbb{E} [q^\eta - q^{\eta^-} \mid \eta \cap (\cup_{k=0}^m S_k^\rho)]^2 \mid \eta \cap (\cup_{k=0}^{m-1} S_k^\rho) \right] \text{ since } \text{Var}(\cdot) \leq \mathbb{E} [\cdot^2] \\ &\leq \mathbb{E} \left[(q^\eta - q^{\eta^-})^2 \mid \eta \cap (\cup_{k=0}^{m-1} S_k^\rho) \right] \text{ by Jensen inequality.} \end{aligned}$$

This ends the proof. \square

Let us end the proof by studying the quantity $\mathbb{E} [(q^\eta - q^{\eta^-})^2]$. Remember that we write $h = \mathbf{1}_E$.

We have (where h^η is the restriction of h to $\{-1, 1\}^\eta$ and h^{η^-} is the restriction of h to $\{-1, 1\}^{\eta^-}$ and is seen as a function on $\{-1, 1\}^\eta$ by ignoring the bits ω_x for every $x \in \eta \cap S_m^\rho$):

$$-\mathbf{1}_{\{h^\eta=0 < 1=h^{\eta^-}\}} \leq q^\eta - q^{\eta^-} \leq \mathbf{1}_{\{h^\eta=1 > 0=h^{\eta^-}\}},$$

hence:

$$|q^\eta - q^{\eta^-}| \leq \mathbf{1}_{\{h^\eta \neq h^{\eta^-}\}}.$$

It is not difficult to see that:

$$\mathbb{P}\text{-a.s.}, \{h^\eta \neq h^{\eta^-}\} \subseteq \mathbf{Piv}_{S_m^\rho} (E),$$

hence:

$$\mathbb{E} [(q^\eta - q^{\eta^-})^2] \leq \mathbb{E} \left[\mathbf{P}^\eta \left[\mathbf{Piv}_{S_m^\rho} (E) \right]^2 \right].$$

Together with (2.2), this implies (2.1) and ends the proof. \square

¹The conditional variance is: $\text{Var}(X \mid Y) = \mathbb{E} [X^2 \mid Y] - \mathbb{E} [X \mid Y]^2 = \mathbb{E} [(X - \mathbb{E} [X \mid Y])^2 \mid Y]$. The conditional covariance formula is: $\text{Var}(X) = \text{Var}(\mathbb{E} [X \mid Y]) + \mathbb{E} [\text{Var}(X \mid Y)]$.

3 First estimates on arm and pivotal events

3.1 Arm-events and pivotal events

As one can see in Proposition 2.1, one way to estimate $\text{Var}(\mathbf{P}^\eta[\mathbf{A}_j(r, R)])$ is to find upper bounds for the quantities $\mathbb{E}[\mathbf{P}^\eta[\mathbf{Piv}_S(\mathbf{A}_j(r, R))]^2]$. In Chapter 5 (see in particular Appendix D therein), we have proved such upper bounds with the help of the quantities $\tilde{\alpha}_4(r, R)$.

Below, we list the results from Chapter 5 about the quantities $\tilde{\alpha}_j(r, R)$ and $\alpha_j^{an}(r, R)$ that we use in the present chapter. First, we have the following polynomial decay property (see (1.1) and (D.3) in Chapter 5): For every $j \in \mathbb{N}^*$, there exists $C = C(j) \in [1, +\infty)$ such that, for every $1 \leq r \leq R < +\infty$:

$$\frac{1}{C} \left(\frac{r}{R}\right)^C \leq \alpha_j^{an}(r, R) \leq \tilde{\alpha}_j(r, R) \leq C \left(\frac{r}{R}\right)^{1/C}. \quad (3.1)$$

An important result is the quasi-multiplicativity property:

Proposition 3.1 (Propositions 1.6 and D.1 of Chapter 5). *Let $j \in \mathbb{N}_+$. There exists a constant $C = C(j) \in [1, +\infty)$ such that, for every $1 \leq r_1 \leq r_2 \leq r_3$,*

$$\frac{1}{C} \alpha_j^{an}(r_1, r_3) \leq \alpha_j^{an}(r_1, r_2) \alpha_j^{an}(r_2, r_3) \leq C \alpha_j^{an}(r_1, r_3).$$

and:

$$\frac{1}{C} \tilde{\alpha}_j(r_1, r_3) \leq \tilde{\alpha}_j(r_1, r_2) \tilde{\alpha}_j(r_2, r_3) \leq C \tilde{\alpha}_j(r_1, r_3).$$

We have the following estimates on 4-arm events:

Proposition 3.2 (Corollary D.11 of Chapter 5). *There exists $\epsilon > 0$ such that, for every $R \in [1, +\infty)$:*

$$\alpha_4^{an}(R) \leq \tilde{\alpha}_4(R) \leq \frac{1}{\epsilon} R^{-(1+\epsilon)}.$$

We will prove a multiscale version of Proposition 3.2 in Section 6.

Proposition 3.3 (Proposition 1.13 of Chapter 5). *There exists $\epsilon > 0$ such that, for every $1 \leq r \leq R < +\infty$:*

$$\tilde{\alpha}_4(r, R) \geq \alpha_4^{an}(r, R) \geq \epsilon \left(\frac{r}{R}\right)^{2-\epsilon}.$$

We will improve Proposition 3.3 in Section 5.

Let us write $\mathbf{A}_j^+(r, R)$ for the j -arm event in the half-plane, whose definition is the same as the definition of $\mathbf{A}_j(r, R)$ except that we ask that the arms live in the (upper, say) half-plane.

We also write $\alpha_j^{an,+}(r, R) = \mathbb{P}[\mathbf{A}_j^+(r, R)]$ and $\tilde{\alpha}_j^+(r, R) = \sqrt{\mathbb{E}[\mathbf{P}^\eta[\mathbf{A}_j^+(r, R)]^2]}$. We have the following:

Proposition 3.4 (Proposition 2.7 of Chapter 5). *The computation of the universal arm exponents holds for annealed Voronoi percolation: Let $1 \leq r \leq R$, then:*

- i) $\alpha_2^{an,+}(r, R) \asymp r/R$, hence $\Omega(1)(r/R) \leq \tilde{\alpha}_2^+(r, R) \leq O(1)(r/R)^{1/2}$ by Jensen inequality,
- ii) $\alpha_3^{an,+}(r, R) \asymp (r/R)^2$, hence $\Omega(1)(r/R)^2 \leq \tilde{\alpha}_3^+(r, R) \leq O(1)r/R$,
- iii) $\alpha_5^{an}(r, R) \asymp (r/R)^2$, hence $\Omega(1)(r/R)^2 \leq \tilde{\alpha}_5(r, R) \leq O(1)r/R$.

Remark 3.5. Thanks to (1.1) (from Theorem 1.4), we will be able to deduce from Proposition 3.4 that:

$$\tilde{\alpha}_2^+(r, R) \asymp r/R, \tilde{\alpha}_3^+(r, R) \asymp (r/R)^2 \text{ and } \tilde{\alpha}_5(r, R) \asymp (r/R)^2. \quad (3.2)$$

However, in order to prove (1.1), we will only be able to rely on the weaker estimates from Proposition 3.4. The reason why we have not managed to prove (3.2) without relying on (1.1) is that the computation of these universal exponents uses crucially the translation invariance properties of the **annealed** model.

In Appendix D of Chapter 5, we have proved upper bounds for the quantities:

$$\mathbb{E} \left[\mathbf{P}^\eta [\mathbf{Piv}_S(\mathbf{A}_j(r, R))]^2 \right] \quad (3.3)$$

where S is a square included in the annulus $A(r, R)$. Here, we state five lemmas (that are consequences of the results from Chapter 5 or that can be proved by using methods from Chapter 5, see the sketch of proof below) that give upper bounds for (3.3) when S is respectively in the bulk of $A(r, R)$, near the outer boundary of this annulus, in the unbounded connected component of $\mathbb{R}^2 \setminus A(r, R)$, near the inner boundary of this annulus, and in the bounded component of $\mathbb{R}^2 \setminus A(r, R)$.

Let y be a point of the plane, let $\rho \geq 1$ let $S := B_\rho(y)$ and let r, R be such that $\rho \leq r/10$ and $r \leq R/2$. Also, let $j \in \mathbb{N}^*$.

Lemma 3.6. *Let y, ρ, r, R and $S = B_\rho(y)$ be as above. Assume that $S \subseteq A(2r, R/2)$ and let $d \geq r$ be the distance between y and 0. Then:*

$$\mathbb{E} \left[\mathbf{P}^\eta [\mathbf{Piv}_S(\mathbf{A}_j(r, R))]^2 \right] \leq O(1) (\tilde{\alpha}_j(r, R) \tilde{\alpha}_4(\rho, d))^2.$$

If $S \cap A(R/2, R) \neq \emptyset$ then we use the following notations: Let $d_0 = d_0(S)$ be the distance between S and the closest side of B_R and let y_0 be the orthogonal projection of y on this side. Also, let $d_1 = d_1(S) \geq d_0$ be the distance between y_0 and the closest corner of B_R . Write

$\mathbf{A}_j^{++}(\cdot, \cdot)$ for the j -arm event in the quarter plane and let $\tilde{\alpha}_j^{++}(\cdot, \cdot) := \sqrt{\mathbb{E} \left[\mathbf{P}^\eta \left[\mathbf{A}_j^{++}(\cdot, \cdot) \right]^2 \right]}$.

We have the following:

Lemma 3.7. *Let y, ρ, r, R and $S = B_\rho(y)$ be as above. Assume that $S \cap A(R/2, R) \neq \emptyset$. Then:*

$$\mathbb{E} \left[\mathbf{P}^\eta [\mathbf{Piv}_S(\mathbf{A}_j(r, R))]^2 \right] \leq O(1) (\tilde{\alpha}_j(r, R) \tilde{\alpha}_3^{++}(d_1 + \rho, R) \tilde{\alpha}_3^+(d_0 + \rho, d_1) \tilde{\alpha}_4(\rho, d_0))^2.$$

The following lemma roughly says that, if we want to use our bounds to estimate the sum:

$$\sum_{S \text{ square of the grid } 2\rho\mathbb{Z}^2} \mathbb{E} \left[\mathbf{P}^\eta [\mathbf{Piv}_S(\mathbf{A}_j(r, R))]^2 \right],$$

and if we forget the terms corresponding to the squares S that are in the unbounded component of $\mathbb{R}^2 \setminus A(r, R)$, then this does not change the order of the estimate.

Lemma 3.8. *Let $\rho \geq 1$ and let r, R be such that $\rho \leq r/100$ and $r \leq R/2$. Also, let S be a square of the grid $2\rho\mathbb{Z}^2$ that intersects ∂B_R . Moreover, let \mathbf{S} be the set of all squares S' of the grid $2\rho\mathbb{Z}^2$ that do not intersect B_R and are such that S is the argmin of $\text{dist}(S'', S')$ where S'' ranges over the set of squares of the grid $2\rho\mathbb{Z}^2$ that intersect ∂B_R . Then:*

$$\sum_{S' \in \mathbf{S}} \mathbb{E} \left[\mathbf{P}^\eta [\mathbf{Piv}_{S'}(\mathbf{A}_j(r, R))]^2 \right] \leq O(1) (\tilde{\alpha}_j(r, R) \tilde{\alpha}_3^{++}(d_1 + \rho, R) \tilde{\alpha}_3^+(d_0 + \rho, d_1) \tilde{\alpha}_4(\rho, d_0))^2.$$

Let us now study the quantity $\mathbb{E} \left[\mathbf{P}^\eta [\mathbf{Piv}_S(\mathbf{A}_j(r, R))]^2 \right]$ when S is at distance less than $2r$ from 0 . If $S \cap A(r, 2r) \neq \emptyset$, we use the following notations: Let $d_0 = d_0(S)$ be the distance between S and the closest side of B_r and let y_0 be the orthogonal projection of y on this side. Also, let $d_1 = d_1(S) \geq d_0$ be the distance between y_0 and the closest corner of B_r . Write $\mathbf{A}_j^{(++)^c}(\cdot, \cdot)$ for the j -arm event in the plane without the quarter plane and let $\tilde{\alpha}_j^{(++)^c}(\cdot, \cdot) = \sqrt{\mathbb{E} \left[\mathbf{P}^\eta \left[\mathbf{A}_j^{(++)^c}(\cdot, \cdot) \right]^2 \right]}$.

Lemma 3.9. *Let y, ρ, r, R and $S = B_\rho(y)$ be as above. Assume that $S \cap A(r, 2r) \neq \emptyset$. Remember that $\rho \leq r/10$ and $r \leq R/2$. Then:*

$$\mathbb{E} \left[\mathbf{P}^\eta [\mathbf{Piv}_S(\mathbf{A}_j(r, R))]^2 \right] \leq O(1) \left(\tilde{\alpha}_j(r, R) \tilde{\alpha}_3^{(++)^c}(d_1 + \rho, r) \tilde{\alpha}_3^+(d_0 + \rho, d_1) \tilde{\alpha}_4(\rho, d_0) \right)^2.$$

Lemma 3.10. *Let $\rho \geq 1$ and let r, R be such that $\rho \leq r/100$ and $r \leq R/2$. Also, let S be a square of the grid $2\rho\mathbb{Z}^2$ that intersects ∂B_r . Moreover, let \mathbf{S} be the set of all squares S' of the grid $2\rho\mathbb{Z}^2$ that are included in B_r and are such that S is the argmin of $\text{dist}(S'', S)$ where S'' spans over the set of squares of the grid $2\rho\mathbb{Z}^2$ that intersects ∂B_r . Then:*

$$\sum_{S' \in \mathbf{S}} \mathbb{E} \left[\mathbf{P}^\eta [\mathbf{Piv}_{S'}(\mathbf{A}_j(r, R))]^2 \right] \leq O(1) \left(\tilde{\alpha}_j(r, R) \tilde{\alpha}_3^{(++)^c}(d_1 + \rho, r) \tilde{\alpha}_3^+(d_0 + \rho, d_1) \tilde{\alpha}_4(\rho, d_0) \right)^2.$$

Proof of Lemmas 3.6 to 3.10. In Section 4.3 of Chapter 5, we have proved analogous estimates for the quantities $\mathbb{P}[\mathbf{Piv}_S(\mathbf{A}_j(1, R))]$. Moreover, Lemma D.13 of Chapter 5 gives estimates on the quantities $\mathbb{E} \left[\mathbf{P}^\eta [\mathbf{Piv}_S(\mathbf{A}_j(r, R))]^2 \right]$ when S is in the “bulk” of B_R . In particular, this lemma implies Lemma 3.6. The proof of Lemmas 3.7 and 3.9 is very similar except that we have to take care about boundary issues. The way to adapt the proofs in the case where S is in the bulk to the case where S is close to the boundary is the same as in Section 4.3 of Chapter 5, so we leave the details to the reader. Similarly, the way we deduce Lemmas 3.8 and 3.10 from respectively Lemmas 3.7 and 3.9 is the same as for the analogous results from Section 4.3 of Chapter 5. \square

3.2 The “good” events

Since we study a model in random environment, it is important to have estimates on some “good” events measurable with respect to η . The definitions and the estimates that we state in this section are from Chapter 5. We first define the “dense” events that help us to have spatial independence properties.

Definition 3.11. If $\delta \in (0, 1)$ and D is a bounded Borel subset of the plane, we write $\text{Dense}_\delta(D)$ for the event that, for every $u \in D$, there exists $x \in \eta \cap D$ such that $\|x - u\|_2 < \delta \cdot \text{diam}(D)$.

Lemma 3.12 (e.g. Lemma 2.11 of Chapter 5). *Let $R \geq 1$ and $\delta \in (0, 1)$. We have:*

$$\mathbb{P}[\text{Dense}_\delta(B_R)] \geq 1 - O(1) \delta^{-2} \exp\left(-\frac{(\delta \cdot R)^2}{2}\right).$$

We now define some sets of quads and state a result from Chapter 5 that roughly says that, with high probability, the quenched crossing probabilities of all the quads in these sets are non-negligible. The main tool in the proof of this result was the quenched box-crossing result of [AGMT16].

Definition 3.13. Let D be a bounded Borel subset of the plane and let $\delta \in (0, 1)$. We denote by $\mathcal{Q}'_\delta(D)$ the set of all quads $Q \subseteq D$ which are drawn on the grid $(\delta \text{diam}(D)) \cdot \mathbb{Z}^2$ (i.e. whose sides

are included in the edges of $(\delta \operatorname{diam}(D)) \cdot \mathbb{Z}^2$ and whose corners are vertices of $(\delta \operatorname{diam}(D)) \cdot \mathbb{Z}^2$. Also, we denote by $\mathcal{Q}_\delta(D)$ the set of all quads $Q \subseteq D$ such that there exists a quad $Q' \in \mathcal{Q}'_\delta(D)$ satisfying $\operatorname{Cross}(Q') \subseteq \operatorname{Cross}(Q)$.

Moreover, we let $\tilde{\mathcal{Q}}'_\delta(D) \subseteq \mathcal{Q}'_\delta(D)$ be the set of all quads $Q \subseteq D$ such that there exists $k \in \mathbb{N}$ such that Q is drawn on the grid $(2^k \delta \operatorname{diam}(D)) \cdot \mathbb{Z}^2$ and the length of each side of Q is less than $100 \cdot 2^k \delta \operatorname{diam}(D)$. Also, we write $\tilde{\mathcal{Q}}_\delta(D)$ for the set of all quads $Q \subseteq D$ such that there exists a quad $Q' \in \tilde{\mathcal{Q}}'_\delta(D)$ satisfying $\operatorname{Cross}(Q') \subseteq \operatorname{Cross}(Q)$.

Proposition 3.14 (Proposition 3.2 of Chapter 5). *Let $\delta \in (0, 1)$ and $\gamma \in (0, +\infty)$. There exist an absolute constant $C < +\infty$ and a constant $\tilde{c} = \tilde{c}(\gamma) \in (0, 1)$ that does not depend on δ such that, for every bounded subset of the plane D that satisfies $\operatorname{diam}(D) \geq \delta^{-2}/100$, we have:*

$$\mathbb{P} \left[\widetilde{\operatorname{QBC}}_\delta^\gamma(D) \right] \geq 1 - C \operatorname{diam}(D)^{-\gamma},$$

where:

$$\widetilde{\operatorname{QBC}}_\delta^\gamma(D) = \left\{ \forall Q \in \tilde{\mathcal{Q}}_\delta(D), \mathbf{P}^\eta [\operatorname{Cross}(Q)] \geq \tilde{c}(\gamma) \right\}.$$

(The notation QBC means “Quenched Box Crossings”.)

Remark 3.15. Note that, by gluing arguments, there exists a constant $C_1 \in (0, +\infty)$ such that, if $c = c(\delta, \gamma) := \tilde{c}(\gamma)^{C_1 \delta^{-2}}$ then:

$$\operatorname{QBC}_\delta^\gamma(D) \subseteq \bigcap_{k \in \mathbb{N}} \widetilde{\operatorname{QBC}}_{2^k \delta}^\gamma(D) \subseteq \widetilde{\operatorname{QBC}}_\delta^\gamma(D),$$

where:

$$\operatorname{QBC}_\delta^\gamma(D) = \left\{ \forall Q \in \mathcal{Q}_\delta(D), \mathbf{P}^\eta [\operatorname{Cross}(Q)] \geq c(\delta, \gamma) \right\}.$$

In particular, there exist an absolute constant $C < +\infty$ such that, for every $\delta \in (0, 1)$, every $\gamma \in (0, +\infty)$, and every bounded subset of the plane D satisfying $\operatorname{diam}(D) \geq \delta^{-2}/100$, we have:

$$\mathbb{P} [\operatorname{QBC}_\delta^\gamma(D)] \geq 1 - C \operatorname{diam}(D)^{-\gamma}.$$

3.3 A quenched quasi-multiplicativity property

We do not need the results of the present subsection until Section 6. In particular, we do not need them to prove of (1.1) of Theorem 1.4, so the reader can skip this subsection at first reading. In Chapter 5, we have proved the quasi-multiplicativity property for the quantities $\alpha_j^{\text{an}}(r, R)$ and $\tilde{\alpha}_j(r, R)$ (see Proposition 3.1 of the present chapter). The proof was rather technical because of the multiple passages from quenched to annealed estimates. The proof of the following property is much easier.

Proposition 3.16. *For every $\gamma > 0$ and every $j \in \{1\} \cup 2\mathbb{N}^*$, there exists $C = C(\gamma, j) \in [1, +\infty)$ such that, for every $r_0 \in [1, +\infty)$, the following holds with probability larger than $1 - Cr_0^{-\gamma}$: For every $r_1, r_2, r_3 \in [r_0, +\infty)$ that satisfy $r_1 \leq r_2 \leq r_3$, we have:*

$$\frac{1}{C} \mathbf{P}^\eta [\mathbf{A}_j(r_1, r_3)] \leq \mathbf{P}^\eta [\mathbf{A}_j(r_1, r_2)] \mathbf{P}^\eta [\mathbf{A}_j(r_2, r_3)] \leq C \mathbf{P}^\eta [\mathbf{A}_j(r_1, r_3)]. \quad (3.4)$$

Proof. Fix $\gamma > 0$. We write the proof for $j = 4$ since the proof is the same for other even values of j and is simpler for $j = 1$. Let $\delta_0 \in (0, 1/1000)$, let $A_n(r_0)$ be the annulus $A(5^{n-2}r_0, \cdot 5^{n+2}r_0)$, and consider the event:

$$\operatorname{GP}_{\delta_0}^\gamma(r_0) = \bigcap_{n \geq 0} \operatorname{Dense}_{\delta_0}(A_n(r_0)) \cap \widetilde{\operatorname{QBC}}_{\delta_0}^\gamma(A_n(r_0)). \quad (3.5)$$

(Where GP means “Good Point process”.) If we follow the classical proofs of the quasi-multiplicativity property on non-random lattices, we obtain that (3.4) holds if $\eta \in \text{GP}_{\delta_0}^\gamma(r_0)$ with δ_0 sufficiently small. Let us be more precise: let $\eta \in \text{GP}_{\delta_0}^\gamma(r_0)$ and let us follow Appendix A of [SS10], where the quasi-multiplicativity property is proved for bond percolation on \mathbb{Z}^2 and site percolation on the triangular lattice. All the independence properties that are needed in this appendix hold since we work at the quenched level and since $\eta \in \cap_{n \geq 0} \text{Dense}_{\delta_0}(A_n(r_0))$. There are three steps in the proof from [SS10] (which correspond respectively to Lemmas A.2, A.3 and A.3 therein):

1. In the first step, the authors prove (by using box-crossing arguments) that there exist $C < +\infty$ and $\epsilon > 0$ such that, for every $R \geq 1$, the probability that there exist interfaces that cross the annulus $A(R, 2R)$ and whose endpoints are at distance less than $R\delta$ from each other is less than $C\delta^\epsilon$. Since $\eta \in \cap_{n \geq 0} \widetilde{\text{QBC}}_{\delta_0}^\gamma(A_n(r_0))$, we can use the same box-crossing arguments to prove that the analogous result holds as soon as $R \geq r_0$ and $\delta \geq \delta_0$ (note that here it is important that the constant \tilde{c} from Proposition 3.14 does not depend on δ).
2. In the second step, the authors of [SS10] prove that there exists $\bar{\delta} > 0$ such that, for each $\delta > 0$ and each $r, R \geq 1$ satisfying $r \leq R/2$, there exists $a = a(\delta) > 0$ such that we have the following: Let $s(r, R)$ be the minimal distance between the endpoints on ∂B_R of two interfaces that cross $A(r, R)$. If we condition on $\mathbf{A}_4(r, R) \cap \{s(r, R) > \delta R\}$, then the probability of $\mathbf{A}_4(r, 4R) \cap \{s(r, 4R) > \bar{\delta} R\}$ is larger than a . Since $\eta \in \cap_{n \geq 0} \widetilde{\text{QBC}}_{\delta_0}^\gamma(A_n(r_0))$ and since:²

$$\widetilde{\text{QBC}}_{\delta_0}^\gamma(A_n(r_0)) \subseteq \bigcap_{k \geq 0} \text{QBC}_{2^k \delta_0}^\gamma(A_n(r_0)),$$

we can use the same box-crossing arguments as in [SS10] to prove that there exists $\bar{\delta}$ such that, if $\delta_0 \leq \bar{\delta}$, then the analogous result holds for any $\delta \geq \delta_0$ and any $r, R \geq 1$ such that $r \leq R/2$ and $R \geq r_0$. Let us be a little more precise. Let r, R be such that $r \leq R$ and $R \geq r_0$ and assume that $\mathbf{A}_4(r, R) \cap \{s(r, R) \geq \delta R\}$ holds (we keep the same notation as in the case of Bernoulli percolation). Moreover, let $k \in \mathbb{N}$ is such that $2^k \delta_0 \leq \delta \leq 2^{k+1} \delta_0$ and $n \in \mathbb{N}$ is such that $5^{n-1} r_0 \leq R \leq 5^n r_0$. Then, we can use the box-crossing estimates given by $\text{QBC}_{2^k \delta_0}^\gamma(A_n(r_0))$ to extend the four arms with probability larger than some constant a that depends only on δ and γ .

3. The third step is a combination of the two first steps and works in great generality.

Finally, the quasi-multiplicativity property holds for every $r_1, r_2, r_3 \geq r_0$ as soon as $\eta \in \text{GP}_{\delta_0}^\gamma(r_0)$ for some δ_0 sufficiently small, so it only remains to prove that for every δ_0 we have:

$$\mathbb{P} \left[\text{GP}_{\delta_0}^\gamma(r_0) \right] \geq 1 - O(1) r_0^{-\gamma},$$

where the constants in the $O(1)$ only depend on δ_0 and γ . This is actually a direct consequence of (an analogue of) Lemma 3.12 and of Proposition 3.14. \square

Remark 3.17. We have stated Proposition 3.16 only for $j = 1$ and j even since the proof is less technical in these cases and since we will use this proposition only for $j = 4$.

In Section 5, we will need the following quenched estimate whose proof is roughly the same as Proposition 3.16. We first need to introduce a notation: If Q is a $r \times r$ square and $\alpha > 0$, we let αQ be the square concentric to Q with side length αr and we let $\text{Circ}_\delta(Q)$ be the event that there is a black circuit in the annulus $(1 - \delta)Q \setminus (1 - 2\delta)Q$ and no white circuit in this annulus.

²See Remark 3.15.

Lemma 3.18. *Let $\gamma > 0$. There exists $\tilde{\delta} = \tilde{\delta}(\gamma) > 0$ such that, for every $\delta \in (0, \tilde{\delta}]$, there exist $C = C(\delta, \gamma) < +\infty$, $c = c(\gamma) > 0$ and $c' = c'(\delta, \gamma) > 0$ such that, for every $r, R \geq 1$, the following holds: Let Q be a $2r \times 2r$ square included in B_R and at distance at least $R/3$ from the sides of B_R and let x denote the center of Q . Also, let X be the ± 1 indicator function of $\text{Cross}(R, R)$. Then, with probability larger than $1 - Cr^{-\gamma}$ we have:*

- i) $\mathbf{P}^\eta \left[\mathbf{Piv}_Q^q(\text{Cross}(R, R)) \right] \geq c\mathbf{P}^\eta [\mathbf{A}_4(x; r, R)]$, where $\text{Arm}_4(x; r, R)$ is the 4-arm event translated by x ,
- ii) $\mathbf{P}^\eta [\text{Circ}_\delta(Q)] \geq c'$,
- iii) $\mathbf{E}^\eta \left[X \mid \text{Circ}_\delta(Q) \cap \mathbf{Piv}_Q^q(\text{Cross}(R, R)) \right] > 1/4$,
- iv) $\mathbf{E}^\eta \left[X \mid \neg \text{Circ}_\delta(Q) \cap \mathbf{Piv}_Q^q(\text{Cross}(R, R)) \right] < -1/4$.

Proof. Let $\delta > 0$ and let $\delta_0 \in]0, \delta/100[$ to be determined later. We write the proof for Q centered at 0 (i.e. $Q = B_r$) to simplify the notations, and we define $\text{GP}_{\delta_0}^\gamma(\cdot)$ as in (3.5). Also, we let $B_{r,R}^{\delta_0}$ be the event that the starting points of the interfaces that cross $A(r, R)$ are at distance at least $\delta_0 r$ from each other.

By box-crossing properties, it is clear that Item ii) holds for some $c' = c'(\delta, \gamma)$ as soon as $\eta \in \text{GP}_{\delta_0}^\gamma(r)$. Moreover, by following the proof of Proposition 3.16 (i.e. by using classical separation of arms arguments) we obtain that Item i) holds if $\eta \in \text{GP}_{\delta_0}^\gamma(r)$ for δ_0 sufficiently small. Next, if we use once again classical separation of arms arguments and if we use Item i), we obtain that for every $\epsilon > 0$, if δ_0 is chosen sufficiently small then:

$$\mathbf{P}^\eta \left[B_{r,R}^{\delta_0} \mid \mathbf{Piv}_Q^q(\text{Cross}(R, R)) \right] \geq 1 - \epsilon.$$

Together with classical box-crossing arguments, this implies that Items iii) and iv) hold as soon as δ_0/δ is sufficiently small and $\eta \in \text{GP}_{\delta_0}^\gamma(r)$. This ends the proof since, as noted in the proof of Proposition 3.16, $\mathbb{P} \left[\text{GP}_{\delta_0}^\gamma(r) \right] \geq 1 - Cr^{-\gamma}$ for some $C = C(\delta_0, \gamma) < +\infty$. \square

4 Proof that $\alpha_j^{an}(r, R) \asymp \tilde{\alpha}_j(r, R)$

In this section, we prove (1.1) of Theorem 1.4 i.e. we show that there exists a constant $C = C(j) < +\infty$ such that, for every $1 \leq r \leq R < +\infty$:

$$\alpha_j^{an}(r, R) \leq \tilde{\alpha}_j(r, R) \leq C \alpha_j^{an}(r, R).$$

Proof of (1.1) of Theorem 1.4. Let us first note that, by the quasi-multiplicativity property and (3.1), it is sufficient to prove the result for r sufficiently large and $r \leq R/2$. Let $j \in \mathbb{N}^*$ and let $r_0 = r_0(j) < +\infty$ to be fixed later. We actually prove the following stronger result: There exist $h = h(j) > 0$ and $C = C(j) < +\infty$ such that, if r_0 is sufficiently large and if $r_0 \leq r \leq R/2$, then:

$$0 \leq \tilde{\alpha}_j(r, R)^2 - \alpha_j^{an}(r, R)^2 \leq Cr^{-h} \alpha_j^{an}(r, R)^2. \quad (4.1)$$

First note that it is sufficient to prove that there exists $C' = C'(j) < +\infty$ such that, if r_0 is sufficiently large and if $r_0 \leq r \leq R/2$, then:

$$0 \leq \tilde{\alpha}_j(r, R)^2 - \alpha_j^{an}(r, R)^2 \leq C' r^{-h} \tilde{\alpha}_j(r, R)^2. \quad (4.2)$$

Indeed, this implies (4.1) with $C = 2C'$ if r_0 satisfies $C' r_0^{-h} \leq 1/2$.

Let us prove (4.2). If we apply Proposition 2.1 to $E = \mathbf{A}_j(r, R)$ and $\rho = 2$, we obtain that:

$$\text{Var}(\mathbf{P}^\eta[\mathbf{A}_j(r, R)]) \leq O(1) \sum_{S \text{ square of the grid } \mathbb{Z}^2} \mathbb{E} \left[\mathbf{P}^\eta [\mathbf{Piv}_S(\mathbf{A}_j(r, R))]^2 \right].$$

Let us use Lemmas 3.6 to 3.10 to estimate the right-hand-side of this inequality. We will also need the three following estimates on arm events (see Propositions 3.2, 3.4 and 3.1):

$$\tilde{\alpha}_4(\rho) \leq O(1) \rho^{-(1+\epsilon)}, \quad (4.3)$$

$$\tilde{\alpha}_3^{++}(\rho, \rho') \leq \tilde{\alpha}_3^+(\rho, \rho') \leq O(1) \frac{\rho}{\rho'}, \quad (4.4)$$

$$\tilde{\alpha}_3^{(++)^c}(\rho, \rho') \leq O(1) \left(\frac{\rho}{\rho'} \right)^{\epsilon/2}. \quad (4.5)$$

We can (and do) assume that $\epsilon < 1/2$, which will make the calculations easier. Below, we use several times the quasi-multiplicativity property Proposition 3.1 and the polynomial decay property (3.1) without mentioning it. Note that a difference compared to similar calculations for Bernoulli percolation on \mathbb{Z}^2 or on the triangular lattice is that we do not know that the contribution of the 3-arm event in the half-plane from scale ρ to scale ρ' is $(\rho/\rho')^2$: we only have the upper bound (4.4).

By Lemma 3.6, the contribution of the boxes S in $A(2r, R/2)$ is at most (where 2^k has to be thought as the order of the distance between the box and 0):

$$\sum_{k=\log_2(r)}^{\log_2(R)} 2^{2k} \tilde{\alpha}_j(r, R)^2 \tilde{\alpha}_4(2^k)^2 \leq O(1) \tilde{\alpha}_j(r, R)^2 r^{-2\epsilon} \text{ (by (4.3))}.$$

By Lemma 3.8, we can estimate the contribution of the boxes outside of $B_{R/2}$ by summing only on the boxes that intersect $A(R/2, R)$. By Lemma 3.7, the contribution of such boxes is at most (where 2^k has to be thought as the order of the distance between the box and ∂B_R):

$$\begin{aligned} & \sum_{k=0}^{\log_2(R)} 2^k R \tilde{\alpha}_j(r, R)^2 \tilde{\alpha}_4(2^k)^2 \tilde{\alpha}_3^+(2^k, R)^2 \\ & \leq O(1) \tilde{\alpha}_j(r, R)^2 \sum_{k=0}^{\log_2(R)} 2^k R 2^{-2k(1+\epsilon)} \left(\frac{2^k}{R} \right)^2 \text{ (by (4.3) and (4.4))} \\ & \leq O(1) \tilde{\alpha}_j(r, R)^2 \sum_{k=0}^{\log_2(R)} \frac{2^{k(1-2\epsilon)}}{R} \\ & \leq O(1) \tilde{\alpha}_j(r, R)^2 R^{-2\epsilon}. \end{aligned}$$

The contribution of the boxes in B_{2r} is a little more difficult to estimate. By Lemma 3.10, we can estimate the contribution of these boxes by summing only on the boxes that intersect $A(r, 2r)$. To estimate the contribution of such boxes, we can use Lemma 3.9 and we obtain the following: (here, 2^k has to be thought as the order of the distance between the box and ∂B_r

and $2^j \geq 2^k$ has to be thought as the distance between the box and the nearest corner of B_r):

$$\begin{aligned}
& \sum_{k=0}^{\log_2(r)} \sum_{j=k}^{\log_2(r)} 2^{k+j} \tilde{\alpha}_j(r, R)^2 \tilde{\alpha}_4(2^k)^2 \tilde{\alpha}_3^+(2^k, 2^j)^2 \tilde{\alpha}_3^{(++)^c}(2^j, r)^2 \\
& \leq O(1) \tilde{\alpha}_j(r, R)^2 \sum_{k=0}^{\log_2(r)} 2^k 2^{-2k(1+\epsilon)} \sum_{j=k}^{\log_2(r)} 2^j \left(\frac{2^k}{2^j}\right)^2 \left(\frac{2^j}{r}\right)^\epsilon \quad (\text{by (4.3), (4.4) and (4.5)}) \\
& \leq O(1) \tilde{\alpha}_j(r, R)^2 r^{-\epsilon} \sum_{k=0}^{\log_2(r)} 2^k 2^{-2k(1+\epsilon)} 2^{k(1+\epsilon)} \\
& = O(1) \tilde{\alpha}_j(r, R)^2 r^{-\epsilon} \sum_{k=0}^{\log_2(r)} 2^{-k\epsilon} \\
& \leq O(1) \tilde{\alpha}_j(r, R)^2 r^{-\epsilon}.
\end{aligned}$$

Finally:

$$\tilde{\alpha}_j(r, R)^2 - \alpha_j^{an}(r, R)^2 = \text{Var}(\mathbf{P}^\eta[\mathbf{A}_j(r, R)]) \leq O(1) \tilde{\alpha}_j(r, R)^2 r^{-\epsilon},$$

and thus the estimate (4.2) is proved, which ends the proof. \square

Remark 4.1. By exactly the same proof (i.e. by proving analogues of Lemmas 3.6 to 3.10 for arm events in a wedge), we obtain (1.1) of Theorem 1.4 also for the quantities $\alpha_k^+(\cdot, \cdot)$, $\alpha_k^{++}(\cdot, \cdot)$ and $\alpha_k^{(++)^c}(\cdot, \cdot)$.

5 Strict inequality for the exponent of the annealed percolation function

Let us prove Theorem 1.8 by using the scaling relations from Chapter 5 and the estimate (1.1) from Theorem 1.4. The estimate (1.1) will be used to prove the following:

Proposition 5.1. *There exists $\epsilon > 0$ such that, for every $1 \leq r \leq R < +\infty$:*

$$\alpha_4^{an}(r, R) \geq \epsilon \frac{1}{\alpha_1^{an}(r, R)} \left(\frac{r}{R}\right)^{2-\epsilon}.$$

Let us first explain why Proposition 5.1 (with $r = 1$) and Theorem 1.9 imply Theorem 1.2.

Proof of Theorem 1.8. By the two scaling relations of Theorem 1.9, we have:

$$\theta(p) \frac{1}{p-1/2} \asymp \alpha_1^{an}(L(p)) L(p)^2 \alpha_4^{an}(L(p)).$$

Since we know that $L(p)$ goes to $+\infty$ polynomially fast in $\frac{1}{p-1/2}$ as p goes to $1/2$ (see Subsection 1.4 of Chapter 5), it is sufficient to prove that $\alpha_1^{an}(L(p)) L(p)^2 \alpha_4^{an}(L(p)) \geq \Omega(1) L(p)^\epsilon$ for some $\epsilon > 0$, which is given by Proposition 5.1. \square

Proof of Proposition 5.1. We follow Appendix A of [GPS10], where the analogous result is proved for Bernoulli percolation on \mathbb{Z}^2 by Beffara. Let $M \geq 100$ and let $\rho \geq M$. Also, let $\text{GP}(\rho, M)$ be defined as follows:

$$\text{GP}(\rho, M) = \bigcap_{k=0}^{\lfloor \log_5(M) \rfloor - 1} \text{Dense}_{1/100} \left(A(5^k \rho, 10 \cdot 5^k \rho) \right) \cap \text{QBC}_{1/100}^3 \left(A(5^k \rho, 10 \cdot 5^k \rho) \right)$$

(where the events “Dense” and “QBC” are the events defined in Subsection 3.2; GP means “Good Point process”). By Lemma 3.12 and Remark 3.15, we have:

$$\mathbb{P}[\text{GP}(\rho, M)] \geq 1 - O(1)\rho^{-3}.$$

If $\eta \in \text{GP}(\rho, M)$ and if we follow the beginning of Appendix A of [GPS10] (where the authors study the winding number of 1-arms), we obtain that (if M is sufficiently large):

$$\mathbf{P}^\eta[\mathbf{A}_5(\rho, M\rho)] \leq M^{-\epsilon} \mathbf{P}^\eta[\mathbf{A}_1(\rho, M\rho)] \mathbf{E}^\eta[Y^3 \mathbf{1}_{Y \geq 4}],$$

where Y is the number of interfaces from ∂B_ρ to $\partial B_{M\rho}$ and where $\epsilon \in (0, 1)$ depends only on the box-crossing constant $c = c(1/100, 3)$ from Remark 3.15. Indeed, the fact that $\eta \in \text{GP}(\rho, M)$ implies that we can apply the independence arguments and the box-crossing arguments from Appendix A of [GPS10].

Still as in Appendix A of [GPS10], we have $\mathbf{E}^\eta[Y^3 \mathbf{1}_{Y \geq 4}] \leq C \mathbf{P}^\eta[\mathbf{A}_4(\rho, M\rho)]$ for some $C < +\infty$ that depends only on the constant $c = c(1/100, 3)$ from Remark 3.15. Indeed, what is used in [GPS10] to prove this estimate is Reimer’s inequality (that holds for the quenched probability measure \mathbf{P}^η) and the fact that i) $\mathbf{P}^\eta[\mathbf{A}_1(\rho, M\rho)] \leq M^{-a}$ and ii) $\mathbf{P}^\eta[\mathbf{A}_4(\rho, M\rho)] \geq M^{-b}$ for some $a, b \in (0, +\infty)$. The properties i) and ii) follow from classical box-crossing arguments that we can use since $\eta \in \text{GP}(\rho, M)$. Finally:

$$\alpha_5^{an}(\rho, M\rho) = \mathbb{E}[\mathbf{P}^\eta[\mathbf{A}_5(\rho, M\rho)]] \leq CM^{-\epsilon} \mathbb{E}[\mathbf{P}^\eta[\mathbf{A}_1(\rho, M\rho)] \mathbf{P}^\eta[\mathbf{A}_4(\rho, M\rho)]] + O(1)\rho^{-3}.$$

If we apply the Cauchy-Schwarz inequality and if we use Proposition 3.4 to estimate the probability of the 5-arm event, we obtain that:

$$\begin{aligned} M^{-2} \asymp \alpha_5^{an}(\rho, M\rho) &\leq CM^{-\epsilon} \sqrt{\mathbb{E}[\mathbf{P}^\eta[\mathbf{A}_1(\rho, M\rho)]^2] \mathbb{E}[\mathbf{P}^\eta[\mathbf{A}_4(\rho, M\rho)]^2]} + O(1)\rho^{-3} \\ &= CM^{-\epsilon} \tilde{\alpha}_1(\rho, M\rho) \tilde{\alpha}_4(\rho, M\rho) + O(1)\rho^{-3}. \end{aligned}$$

By (1.1) of Theorem 1.4, the quantities $\alpha_j^{an}(\cdot, \cdot)$ are of same order as the quantities $\tilde{\alpha}_j(\cdot, \cdot)$; hence, the above implies that there exists $\epsilon' > 0$ such that, if M is sufficiently large, then for every $\rho \geq M$:

$$M^{-2} \leq M^{-\epsilon'} \alpha_1^{an}(\rho, M\rho) \alpha_4^{an}(\rho, M\rho).$$

Now, the proof is a direct consequence of the quasi-multiplicativity property. \square

Remark 5.2. Note that, if we follow the proof of Proposition 5.1, we obtain the following for every $j \in \mathbb{N}^*$: $\alpha_{2j+1}^{an}(r, R) \leq O(1) \left(\frac{r}{R}\right)^{\Omega(1)} \alpha_1^{an}(r, R) \alpha_{2j}^{an}(r, R)$, where the constants in $O(1)$ and $\Omega(1)$ only depend on j .

6 Other estimates on arm events

The last goal of this chapter is to obtain the quantitative estimates (1.2) from Theorem 1.4 and (1.3) from Theorem 1.6. In order to prove these results, we need two other estimates on arm events that we prove in this section. In order to prove these two estimates, we do not use any result of the present chapter, but rather the results from Chapter 5 that we have recalled in Section 3. We have (see Section 3 for the notation $\alpha_3^{an, (++)^c}(r, R)$):

Lemma 6.1. *Let $1 \leq r \leq R$. Then:*

$$\alpha_3^{an, (++)^c}(r, R) \leq O(1) \frac{r}{R}.$$

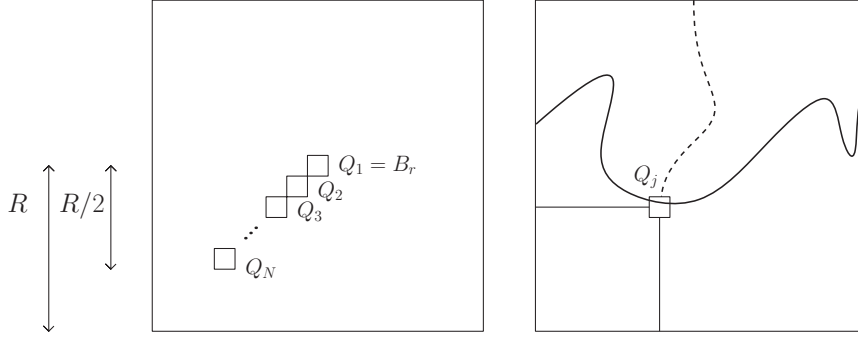

Figure 6.1 – The $2r \times 2r$ squares Q_j and the events $B(r, R; j)$.

Proof. Let $N = \lfloor R/(4r) \rfloor$ and let $Q_1 = B_r, Q_2, \dots, Q_N$ be the $2r \times 2r$ squares defined in Figure 6.1 (note that these squares are included in $B_{R/2}$). For every $j \in \{1, \dots, N\}$, we define the following event: $B(r, R; j)$ is the event that there exist paths γ_1 and γ_2 such that: i) γ_1 is a black path included in B_R from the left side of B_R to its right side, ii) γ_2 is a white path included in B_R from ∂Q_j to the top side of B_R , iii) γ_1 and γ_2 do not intersect the quarter plane $\{x_j + (a, b) : a, b \leq 0\}$ where x_j is the center of Q_j .

Note that the events $B(r, R; 1), \dots, B(r, R; N)$ are pairwise disjoint, hence:

$$\inf_{j=1}^N \mathbb{P} [B(r, R; j)] \leq \frac{1}{N}.$$

As a result, it is sufficient for our purpose to prove that $\mathbb{P} [B(r, R; j) \geq \Omega(1)\alpha_3^{(++)^c}(r, R)]$ where the constants in $\Omega(1)$ are absolute constants. For Bernoulli percolation on \mathbb{Z}^2 or on the triangular lattice, this comes from separation of arms results. For Voronoi percolation, we have proved separation of arm results in Chapter 5 and we have deduced for instance that $\alpha_4^{an}(r, R)$ is at most some constant times the probability that there exist two black paths from ∂B_r to the left and right sides of B_R and two white paths from ∂B_r to the top and bottom sides of B_R (see Lemma 4.1 therein). Since the proof that $\mathbb{P} [B(r, R; j) \geq \Omega(1)\alpha_3^{(++)^c}(r, R)]$ is the same, we refer to Chapter 5 and leave the details to the reader (the only difference is that we need to use Proposition 2.5 of Chapter 5 for arm events in the plane without we quarter plane instead of for arm events in the plane, but this proposition also holds if we ask that the arms live in a prescribed edge and the proof is the same). \square

To prove the following result, we rely a lot on the quenched estimates from Section 3.

Proposition 6.2. *For every $\epsilon > 0$ there exists $C = C(\epsilon) < +\infty$ such that for every $1 \leq r \leq R$ we have:*

$$\alpha_4^{an}(r, R) \leq C \left(\frac{r}{R}\right)^{1-\epsilon} \sqrt{\alpha_2^{an}(r, R)}.$$

In particular, there exists $\delta > 0$ such that for every $1 \leq r \leq R$ we have:

$$\alpha_4^{an}(r, R) \leq \frac{1}{\delta} \left(\frac{r}{R}\right)^{1+\delta}.$$

Proof. We follow the proof of the analogous result for bond percolation on \mathbb{Z}^2 by Garban from Appendix B of [SS11]. To this purpose, we use both the annealed quasi-multiplicativity property Proposition 3.1 and the quenched properties from Subsection 3.3. We let $M \in [100, +\infty)$ to be fixed later and we consider some $\rho \in [10M, +\infty)$. Note that, by the annealed quasi-multiplicativity property, it is sufficient to prove that, if M is sufficiently large, then:

$$\alpha_4^{an}(\rho, \rho M) \leq O(1) M^{-1} \sqrt{\alpha_2^{an}(\rho, \rho M)}. \quad (6.1)$$

Let us prove this estimate. We need the following notations: we let $(Q_j)_{1 \leq j \leq N}$ be the $N \asymp M^2$ squares of the grid $\rho\mathbb{Z}^2$ that are included in the square $B_{\rho M}$ and are at distance at least $\rho M/3$ from the sides of this square. We also write X for the ± 1 indicator function of $\text{Cross}(\rho M, \rho M)$. If $\alpha \in (0, 1)$, we let αQ_j denote the square concentric to Q_j with side length $\alpha\rho$. Also for $\delta \in (0, 1)$, we let $C_\delta(j)$ denote the random variable that equals:

- 1 if there is a black circuit in the annulus $A_j(\delta) := (1 - \delta)Q_j \setminus (1 - 2\delta)Q_j$ and no white circuit in $A_j(\delta)$,
- -1 if there is a white circuit in the annulus $A_j(\delta) := (1 - \delta)Q_j \setminus (1 - 2\delta)Q_j$ and no black circuit in $A_j(\delta)$,
- 0 otherwise.

Note that $\mathbf{E}^\eta [C_\delta(j)] = 0$ for every j and η . Let γ be some sufficiently large constant to be fixed later. Write x_j for the center of Q_j and, for every $x \in \mathbb{R}^2$ and every $k \in \mathbb{N}^*$, let $\mathbf{A}_k(x; \cdot, \cdot)$ be the k -arm event $\mathbf{A}_k(\cdot, \cdot)$ translated by x . By Lemma 3.18 (and by σ -additivity), we can choose δ sufficiently small so that, with probability at least $1 - CM^2\rho^{-\gamma}$, for every j we have:

$$\mathbf{P}^\eta \left[\mathbf{Piv}_{Q_j}^q(\text{Cross}(\rho M, \rho M)) \right] \geq c\mathbf{P}^\eta [\mathbf{A}_4(x_j; \rho, \rho M)] , \quad (6.2)$$

$$\mathbf{P}^\eta [C_\delta(j) = -1] = \mathbf{P}^\eta [C_\delta(j) = 1] \geq c' , \quad (6.3)$$

$$\mathbf{E}^\eta \left[X \mid \{C_\delta(j) = 1\} \cap \mathbf{Piv}_{Q_j}^q(\text{Cross}(\rho M, \rho M)) \right] > 1/4 , \quad (6.4)$$

$$\mathbf{E}^\eta \left[X \mid \{C_\delta(j) = -1\} \cap \mathbf{Piv}_{Q_j}^q(\text{Cross}(\rho M, \rho M)) \right] < -1/4 , \quad (6.5)$$

for some constants $C = C(\delta, \gamma)$, $c = c(\gamma)$ and $c' = c'(\delta, \gamma)$. We fix such a δ . Below, the constants in the $O(1)$'s and $\Omega(1)$'s may depend on δ and γ . Next, we define the following event:

$$\text{Dense}_\delta(\rho, M) = \bigcap_{Q \text{ square of the grid } \rho\mathbb{Z}^2 \text{ included in } B_{\rho M}} \text{Dense}_{\delta/100}(Q) .$$

By Lemma 3.12, $\mathbb{P}[\text{Dense}_\delta(\rho, M)] \geq 1 - O(1)M^2 \exp(-\Omega(1)\rho^2)$. Now, assume that $\eta \in \text{Dense}_\delta(\rho, M)$ and that η is such that (6.2) to (6.5) hold, and let us explain how we can follow Appendix B of [SS11] in order to obtain that:

$$\sum_j \mathbf{P}^\eta [\mathbf{A}_4(x_j, \rho, \rho M)] \leq O(1) \sqrt{\sum_j \mathbf{P}^\eta [\mathbf{A}_2(x_j, 3\rho, \rho M/3)]} . \quad (6.6)$$

Proof of (6.6). As in Appendix B of [SS11], we look at the interface that goes from the cell that contains the top-right corner of $B_{\rho M}$ to the cell that contains the bottom-right corner of this square, with black boundary conditions on the right side and white boundary conditions on the other sides. Moreover, we let Y_j be the event that the distance between the interface and Q_j is at most ρ . Since $\eta \in \text{Dense}_\delta(\rho, M)$, X is independent of $C_\delta(j)$ on $\{Y_j = 0\}$ and $C_\delta(j)$ is independent of Y_j , hence:

$$\mathbf{E}^\eta [XC_\delta(j)Y_j] = \mathbf{E}^\eta [XC_\delta(j)] .$$

Moreover, X is independent of $C_\delta(j)$ on $\{\neg \mathbf{Piv}_{Q_j}^q(\text{Cross}(\rho M, \rho M))\}$ and $C_\delta(j)$ is independent of $\mathbf{Piv}_{Q_j}^q(\text{Cross}(\rho M, \rho M))$, hence:

$$\mathbf{E}^\eta [XC_\delta(j)] = \mathbf{P}^\eta \left[\mathbf{Piv}_{Q_j}^q(\text{Cross}(\rho M, \rho M)) \right] \mathbf{E}^\eta \left[XC_\delta(j) \mid \mathbf{Piv}_{Q_j}^q(\text{Cross}(\rho M, \rho M)) \right] .$$

By (6.2) to (6.5), this implies that:

$$\mathbf{E}^\eta [XC_\delta(j)Y_j] \geq \Omega(1)\mathbf{P}^\eta [\mathbf{A}_4(x_j, \rho, \rho M)] .$$

As in [SS11], one also has:

$$\mathbf{E}^\eta [C_\delta(i)Y_i C_\delta(j)Y_j] = 0 \text{ if } i \neq j.$$

Indeed, we can let $k \in \{i, j\}$ be such that the interface reaches the ρ -neighbourhood of Q_k before the ρ -neighbourhood of Q_l where $l = \{i, j\} \setminus \{k\}$, we can write \mathcal{G} for the σ -algebra generated by the colours of the Voronoi cells visited by the interface until it reaches the ρ -neighbourhood of Q_l and by the colours of the Voronoi cells in Q_k , and we can note that $Y_i, Y_j, C_\delta(k)$ are \mathcal{G} -measurable and that $C_\delta(l)$ is \mathbf{P}^η -independent of \mathcal{G} . As in [SS11], we can then apply the Cauchy-Schwarz inequality to obtain that:

$$\sum_j \mathbf{E}^\eta [X C_\delta(j)Y_j] \leq O(1) \sqrt{\sum_j \mathbf{P}^\eta [Y_j]}.$$

This ends the proof since $\mathbf{P}^\eta [Y_j] \leq \mathbf{P}^\eta [\mathbf{A}_2(x_j, 3\rho, \rho M/3)]$. \square

If we take the expectation of the left and right sides of (6.6), we obtain that:

$$\begin{aligned} & \sum_j \mathbb{E} [\mathbf{P}^\eta [\mathbf{A}_4(x_j; \rho, \rho M)]] \\ & \leq O(1) \mathbb{E} \left[\sum_j \sqrt{\mathbf{P}^\eta [\mathbf{A}_2(x_j, 3\rho, \rho M/3)]} \right] + O(1) M^2 \rho^{-\gamma} + O(1) M^2 \exp(-\Omega(1)\rho^2). \end{aligned}$$

By Jensen's inequality and since $\rho \geq M$, we have:

$$\begin{aligned} & \sum_j \mathbb{E} [\mathbf{P}^\eta [\mathbf{A}_4(x_j; \rho, \rho M)]] \\ & \leq O(1) \sqrt{\sum_j \mathbb{E} [\mathbf{P}^\eta [\mathbf{A}_2(x_j, 3\rho, \rho M/3)]]} + O(1) M^{2-\gamma} + O(1) M^2 \exp(-\Omega(1)M^2) \end{aligned}$$

i.e. (by translation invariance of the annealed probability measure):

$$M^2 \alpha_4^{an}(\rho, \rho M) \leq O(1) M \sqrt{\alpha_2^{an}(3\rho, \rho M/3)} + O(1) M^{2-\gamma} + O(1) M^2 \exp(-\Omega(1)M^2).$$

Since the probabilities of arm event decay polynomially fast (see (3.1)), we can choose γ sufficiently large so that for every sufficiently large M we have $O(1) M^{-\gamma} + O(1) \exp(-\Omega(1)M^2) \leq O(1) M^{-1} \sqrt{\alpha_2^{an}(2\rho, \rho M/3)}$. For these choices of M and γ we obtain:

$$\alpha_4^{an}(\rho, \rho M) \leq O(1) M^{-1} \sqrt{\alpha_2^{an}(3\rho, \rho M/3)} \leq O(1) M^{-1} \sqrt{\alpha_2^{an}(\rho, \rho M)},$$

where the second inequality is a direct consequence of (3.1) and of the quasi-multiplicativity property. This implies (6.1) and ends the proof of the proposition. \square

7 Quantitative quenched estimates

Let us now prove (1.2) of Theorem 1.4 by using (1.1) and the estimates from Section 6.

Proof of (1.2) of Theorem 1.4. The proof is very close to the proof of (1.2) of Theorem 1.4. The difference is that now we can use that the quantities $\tilde{\alpha}_k(\cdot, \cdot)$ are of the same order as the quantities $\alpha_k^{an}(\cdot, \cdot)$. As a result, we can use Lemmas 3.6 to 3.10 with $\alpha_k^{an}(\cdot, \cdot)$ instead of $\tilde{\alpha}_k(\cdot, \cdot)$. The estimates on arm events that we are going to use are the following (see Propositions 6.2, 3.3 and 3.4 and Lemma 6.1):

$$\alpha_4^{an}(\rho, \rho') \leq O(1) \left(\frac{\rho}{\rho'} \right)^{1+\epsilon}, \quad (7.1)$$

$$\alpha_3^{an,++}(\rho, \rho') \leq \alpha_3^{an,+}(\rho, \rho') \asymp \left(\frac{\rho}{\rho'}\right)^2 \leq O(1) \alpha_4^{an}(\rho, \rho') \left(\frac{\rho}{\rho'}\right)^\epsilon, \quad (7.2)$$

$$\alpha_3^{an,(++)^c}(\rho, \rho') \leq O(1) \frac{\rho}{\rho'}, \quad (7.3)$$

for some $\epsilon > 0$.

If we apply Proposition 2.1 to $E = \mathbf{A}_j(r, R)$ and $\rho = 2$, we obtain that:

$$\text{Var}(\mathbf{P}^\eta[\mathbf{A}_j(r, R)]) \leq O(1) \sum_{S \text{ square of the grid } 2\mathbb{Z}^2} \mathbb{E} \left[\mathbf{P}^\eta[\mathbf{Piv}_S(\mathbf{A}_j(r, R))]^2 \right].$$

Let us now use Lemmas 3.6 to 3.10 with $\alpha_k^{an}(\cdot, \cdot)$ instead of $\tilde{\alpha}_k(\cdot, \cdot)$. As in the proof of (1.2) of Theorem 1.4, we use the quasi-multiplicativity property and the polynomial decay property without mentioning it. By same considerations as in the proof of this last result, we obtain that the contribution of the boxes S in $A(2r, R/2)$ is at most:

$$\begin{aligned} \sum_{k=\log_2(r)}^{\log_2(R)} 2^{2k} \alpha_j^{an}(r, R)^2 \alpha_4^{an}(2^k)^2 &\leq O(1) \alpha_j^{an}(r, R)^2 \alpha_4(r)^2 \sum_{k=\log_2(r)}^{\log_2(R)} 2^{2k} \alpha_4(r, 2^k)^2 \\ &\leq O(1) \alpha_j^{an}(r, R)^2 \alpha_4(r)^2 r^2 \text{ by (7.1)}. \end{aligned}$$

(Note that, in order to obtain the above estimate, Proposition 3.2 is not enough and we need the multiscale estimate Proposition 5.1.) The contribution of the boxes outside of $B_{R/2}$ is at most:

$$\begin{aligned} \sum_{k=0}^{\log_2(R)} 2^k R \alpha_j^{an}(r, R)^2 \alpha_4^{an}(2^k)^2 \alpha_3^{an,+}(2^k, R)^2 \\ \leq O(1) \alpha_j^{an}(r, R)^2 \alpha_4^{an}(R)^2 \sum_{k=0}^{\log_2(R)} 2^k R \frac{1}{\alpha_4^{an}(2^k, R)^2} \alpha_3^{an,+}(2^k, R)^2 \\ \leq O(1) \alpha_j^{an}(r, R)^2 \alpha_4^{an}(R)^2 \sum_{k=0}^{\log_2(R)} 2^k R \left(\frac{2^k}{R}\right)^{2\epsilon-4} \left(\frac{2^k}{R}\right)^4 \\ \leq O(1) \alpha_j^{an}(r, R)^2 R^2 \alpha_4^{an}(R)^2. \end{aligned}$$

The contribution of the boxes in B_{2r} is at most:

$$\begin{aligned} \sum_{k=0}^{\log_2(r)} \sum_{j=k}^{\log_2(r)} 2^{k+j} \alpha_j^{an}(r, R)^2 \alpha_4^{an}(2^k)^2 \alpha_3^{an,+}(2^k, 2^j)^2 \alpha_3^{an,(++)^c}(2^j, r)^2 \\ \leq O(1) \alpha_j^{an}(r, R)^2 \sum_{k=0}^{\log_2(r)} 2^k \sum_{j=k}^{\log_2(r)} 2^j \alpha_4^{an}(2^j)^2 \frac{\alpha_3^{an,+}(2^k, 2^j)^2}{\alpha_4^{an}(2^k, 2^j)^2} \alpha_3^{an,(++)^c}(2^j, r)^2 \\ \leq O(1) \alpha_j^{an}(r, R)^2 \sum_{k=0}^{\log_2(r)} 2^k \sum_{j=k}^{\log_2(r)} 2^j \alpha_4^{an}(2^j)^2 \left(\frac{2^k}{2^j}\right)^{2\epsilon} \left(\frac{2^j}{r}\right)^2 \end{aligned}$$

$$\begin{aligned}
&= O(1) r^{-2} \alpha_j^{an}(r, R)^2 \sum_{k=0}^{\log_2(r)} 2^{k(1+2\epsilon)} \sum_{j=k}^{\log_2(r)} 2^{j(3-2\epsilon)} \alpha_4^{an}(2^j)^2 \\
&= O(1) r^{-2} \alpha_j^{an}(r, R)^2 \sum_{j=0}^{\log_2(r)} 2^{j(3-2\epsilon)} \alpha_4^{an}(2^j)^2 \sum_{k=0}^j 2^{k(1+2\epsilon)} \\
&\leq O(1) r^{-2} \alpha_j^{an}(r, R)^2 \sum_{j=0}^{\log_2(r)} 2^{4j} \alpha_4^{an}(2^j)^2 \\
&\leq O(1) \alpha_j^{an}(r, R)^2 r^2 \alpha_4^{an}(r)^2.
\end{aligned}$$

Finally:

$$\begin{aligned}
\text{Var}(\mathbf{P}^\eta[\mathbf{A}_j(r, R)]) &\leq O(1) \alpha_j^{an}(r, R)^2 (r^2 \alpha_4^{an}(r)^2 + R^2 \alpha_4^{an}(R)^2) \\
&\leq O(1) \alpha_j^{an}(r, R)^2 r^2 \alpha_4^{an}(r)^2,
\end{aligned}$$

which ends the proof. \square

We end the chapter by proving the quantitative quenched estimate Theorem 1.6.

Proof of Theorem 1.6. If we apply Proposition 2.1 to $E = \text{Cross}(\lambda R, R)$ and $\rho = 2$ we obtain that:

$$\text{Var}(\mathbf{P}^\eta[\text{Cross}(\lambda R, R)]) \leq O(1) \sum_{S \text{ square of the grid } 2\mathbb{Z}^2} \mathbb{E} \left[\mathbf{P}^\eta[\mathbf{Piv}_S(\text{Cross}(\lambda R, R))]^2 \right].$$

By using analogues of Lemmas 3.6, 3.7, 3.8, 3.9 and 3.10 for crossing events and by using the fact that we know that the quantities $\tilde{\alpha}_k(\cdot, \cdot)$ are of the same order as the quantities $\alpha_k^{an}(\cdot, \cdot)$ (i.e. by following the proof of Theorem 1.4), we obtain that this sum is less than or equal to:

$$O(1) R^2 \alpha_4^{an}(R)^2,$$

which ends the proof. \square

L'échantillon spectral annealed de la percolation de Voronoi

Ce chapitre est une version préliminaire [V7] de la preuve d'existence de temps exceptionnels pour des modèles de percolation de Voronoi dynamique (et n'est donc pas encore disponible sur Hal ou Arxiv).

Résumé en français. Dans ce chapitre, nous étudions deux modèles de percolation de Voronoi dynamique au point critique. Dans le premier modèle, les cellules de Voronoi n'évoluent pas au cours du temps mais leur couleur change à taux 1. Dans le second modèle, les couleurs des cellules ne changent pas au cours du temps mais les points du processus de Poisson sous-jacent se déplacent selon des processus de Lévy α -stables avec α petit. Nous montrons que, dans les deux cas, il existe presque sûrement des temps exceptionnels avec une composante noire infinie. Dans ce but, nous étudions l'échantillon spectral annealed de la percolation de Voronoi, qui est un processus de points continu dont la définition est inspirée par l'échantillon spectral de la percolation de Bernoulli introduit par Garban, Pete et Schramm.

English abstract. We study two models of dynamical critical Voronoi percolation in the plane. In the first model, the Voronoi tiling do not evolve in time while the colours of the cells are resampled at rate 1. In the second model, the centers of the cells move according to (independent) α -stable Lévy processes with α small but the colours do not evolve in time. We prove that for these two dynamical processes there exist almost surely exceptional times with an unbounded monochromatic component. To this purpose, we study the annealed spectral sample of Voronoi percolation which is a continuous and finite point process in \mathbb{R}^2 whose definition is inspired by the spectral sample introduced in [GPS10].

Contents

1	Introduction	326
1.1	Models and main results	326
1.2	Noise sensitivity for Voronoi percolation	328
1.3	Estimates on arm events	330
2	The annealed spectral sample of Voronoi percolation	332
2.1	Definition of the annealed spectral sample and links to the dynamics	332
2.2	Why don't we study a quenched spectral sample?	335
2.3	Main results on the annealed spectral sample	336
2.4	Proofs of existence of exceptional times	338
3	Proofs of the spectral estimates	340
3.1	Preliminary results and pivotal sets	340
3.2	Proof of the main estimates on the annealed spectral sample	342
3.3	Quasi-multiplicativity properties for the annealed spectral sample	350
A	Simple properties of the μ-dynamical processes	358
B	The 2^{nd} moment method	360
C	Absence of noise sensitivity for t_n sufficiently small	361
D	The probability of a 4-arm event conditioned on the configuration in a half-plane	362

1 Introduction

1.1 Models and main results

In this chapter, we study two models of planar **dynamical Voronoi percolation** at criticality and we prove results of existence of exceptional times with unbounded clusters. Let us first define the model of static planar Voronoi percolation. To this purpose, we first need a Poisson point process η of intensity 1 in the plane. The **Voronoi cells** of the points $x \in \eta$ are the sets $C(x) = \{u \in \mathbb{R}^2 : \forall x' \in \eta, \|x - u\|_2 \leq \|x' - u\|_2\}$. It is not difficult to show that a.s. all the cells are bounded convex polygons. Let now $p \in [0, 1]$. Given η , we construct a colouring of the plane in black and white as follows: Each cell is coloured in black with probability p and in white with probability $1 - p$, (conditionally) independently of the other cells. Note that with this definition the points which are at the boundary of a black and a white cell are coloured in black **and** white. This does not change anything in the proofs and results for static Voronoi percolation but this will help us in the study of some dynamical models (we actually use this only in Appendix B). We write $\omega \in \{-1, 1\}^\eta$ for the corresponding coloured point process, where 1 means black and -1 means white. The distribution of ω will be denoted by \mathbb{P}_p . Note that, given η , the distribution of ω is $\mathbf{P}_p^\eta := (p\delta_1 + (1 - p)\delta_{-1})^{\otimes \eta}$.

Let us be a little more precise about measurability questions: We let Ω' denote the set of locally finite subsets of \mathbb{R}^2 and we equip Ω' with the σ -algebra generated by the functions $\bar{\eta} \in \Omega' \mapsto |\bar{\eta} \cap A|$ where A spans the Borel subsets of the plane. The probability measure \mathbb{P} is defined on this σ -algebra. Also, we let $\Omega = \cup_{\bar{\eta} \in \Omega'} \{-1, 1\}^{\bar{\eta}}$ and we equip Ω with the σ -algebra generated by the functions $\bar{\omega} \in \Omega \mapsto |\bar{\omega}^{-1}(1) \cap A|$ and $\bar{\omega} \in \Omega \mapsto |\bar{\omega}^{-1}(-1) \cap A|$ where A still spans the Borel subsets of the plane. The measure \mathbb{P}_p is defined on this σ -algebra.

The **critical parameter** of planar Voronoi percolation is defined as follows:

$$p_c = \inf\{p \in [0, 1] : \mathbb{P}_p[0 \leftrightarrow \infty] > 0\},$$

where $\{0 \leftrightarrow \infty\}$ is the event that there is a black path from 0 to infinity. It has been shown by Bollobás and Riordan [BR06a] that $p_c = 1/2$ (see [DCRT17a] for a more recent proof). More precisely, if $p \leq 1/2$ then a.s. there is no unbounded black component while if $p > 1/2$ then a.s. there exists a unique unbounded black component.¹

In this chapter, we are only interested in the model at the critical point, so **we fix $p = p_c = 1/2$ once and for all**. Let us now define the two dynamical models that we study. Both these models will be Markov processes whom $\mathbb{P}_{1/2}$ is an invariant measure. In all the chapter, we will sample them initially according this measure. We define the notion of **exceptional times** exactly as in the case of dynamical Bernoulli percolation (see [HPS97]): a time $t \in \mathbb{R}_+$ is exceptional if **there exists an unbounded black component** at time t . Note that if we fix some t then a.s. it is not exceptional. The question we are interested in is whether or not there exist (random) exceptional times.

The first model is defined analogously to the model of dynamical percolation from [HPS97]. In the said paper, one considers a bond percolation configuration on some graph and let the state of each bond be resampled at rate 1. In our case, we sample a Voronoi percolation model of parameter $1/2$ (i.e. we sample the variables η and $\omega \in \{-1, 1\}^\eta$ from above) and, given η , we let the colour of each point be resampled at rate 1. In particular, **η does not change in time**. We obtain a dynamical process $(\omega^{froz}(t))_{t \in \mathbb{R}_+}$ that we call **frozen dynamical Voronoi percolation**. This is a Markov càdlàg process with values in Ω (for the metric defined in Appendix A), so $(\omega^{froz}(t))_{t \in \mathbb{R}_+}$ can be seen as a random variable with values in the Skorokhod space on Ω . This implies that the event of existence of exceptional times is measurable with respect to (the completion) of the Skorokhod σ -algebra. Moreover, Kolmogorov 0-1 law implies that either a.s. there is no exceptional time or a.s. for every open non empty interval $J \subseteq \mathbb{R}_+$ there are infinitely many exceptional times in J . We refer to [HPS97] for similar observations.

The second model we study is of different flavour since in this model the points of η move and the colours do not evolve in time. Let μ be the law of a planar Lévy process² starting from 0, sample a Voronoi percolation model of parameter $1/2$ as above, and let each point $x \in \eta$ evolve (conditionally) independently of the other points according to a process of law μ . We obtain a dynamical process $(\omega^\mu(t))_{t \in \mathbb{R}_+}$ that we call **μ -dynamical Voronoi percolation**. This is also a Markov càdlàg process (still for the metric defined in Appendix A). We denote the non-coloured dynamical point configuration by $(\eta^\mu(t))_{t \in \mathbb{R}_+}$. See Appendix A for a more precise construction of $(\omega^\mu(t))_{t \in \mathbb{R}_+}$.

Let us note that an analogous model has been studied by van den Berg, Meester and White in [BMW97] for the Boolean model, which is another continuous percolation model. However, they study the model in any dimension and away from criticality, so this is very different from the present work.

We prove the two following results:

Theorem 1.1. *Consider frozen dynamical Voronoi percolation. A.s. there exist exceptional times at which there is an unbounded black component.*

Theorem 1.2. *There exists $\alpha_0 \in]0, +\infty[$ such that the following holds: Let μ be the law of a planar Lévy process such that there exists $\alpha \in]0, \alpha_0]$ satisfying:*

$$\exists c > 0, \forall L \in [1, +\infty[, \forall t \in [0, 1], \mathbb{P}[\|X_t\|_2 \geq L] \geq c \frac{t}{L^\alpha}, \quad (1.1)$$

where $X \sim \mu$. Also, let $(\omega^\mu(t))_{t \in \mathbb{R}_+}$ be a μ -dynamical Voronoi percolation process. Then, a.s. there exist exceptional times t at which there is an unbounded black component in $\omega^\mu(t)$.

¹The proof of the result for $p \leq 1/2$ goes back to the work by Zvavitch [Zva96].

²One could probably define and study this process where the points move according to some processes which are not Lévy. But we were not interested in this question and we have studied Lévy processes to gain simplicity.

The **α -stable Lévy processes** satisfy (1.1). Thus, our result applies to α -stable processes with sufficiently large range but it does not apply if α is too large and in particular it does not apply to the Brownian motion. However (by analogy with dynamical Bernoulli percolation models), we expect this result to be true for any Lévy process (that is not the zero process).

We can also consider another dynamical model by “mixing” the two dynamics that we have already defined. We have the following result whose proof is essentially the same as Theorem 1.1.

Theorem 1.3. *Let μ be the distribution of a planar Lévy process, consider a Voronoi percolation configuration of parameter $1/2$, and define a dynamical process by letting each point move (conditionally) independently according to a Lévy process of law μ and also resampling the color of each point at rate 1. Then, there exist exceptional times with a black unbounded component.*

(In particular, the above holds when the Lévy process is a Brownian motion.)

Theorem 1.1 is analogous to the results of existence of exceptional times for dynamical Bernoulli percolation on the triangular lattice \mathcal{T} and the square lattice \mathbb{Z}^2 that have been proved by Schramm and Steif [SS10] and Garban, Pete and Schramm [GPS10]. Theorem 1.2 is analogous to the result of existence of exceptional times for Bernoulli percolation evolving according to an exclusion process that has been proved in Chapter 4 (such a dynamical model has been introduced in [BGS13] where the authors study the notion of exclusion sensitivity). More precisely, in Chapter 4, we prove with Christophe Garban that, if we let a critical percolation configuration on \mathcal{T} or \mathbb{Z}^2 diffuse under a symmetric exclusion process with polynomial jumps with exponent α sufficiently close to 0, then there exist exponential times. The movement of the particles in such an exclusion process is a discrete version of α -Lévy processes. In the present chapter, we are extremely inspired by the methods from [GPS10] and from Chapter 4 (in the said chapter, the methods from [GPS10] were also central). Before going into the proofs, let us focus on the related notion of **noise sensitivity**.

1.2 Noise sensitivity for Voronoi percolation

The notion of **noise sensitivity** is intimately related to the question of existence exceptional times. This notion has been introduced by Benjamini, Kalai and Schramm in [BKS99] and has then been extensively studied (see [BKS99, SS10, GPS10] for noise sensitivity results for crossing events of Bernoulli percolation, see also [GS14] for a book on the subject). For each $n \in \mathbb{N}$, equip $\{-1, 1\}^n$ with the uniform measure $\mathbf{P}_{1/2}^n$, let $\omega_n(0) \sim \mathbf{P}_{1/2}^n$ and define the dynamical process $(\omega_n(t))_{t \in \mathbb{R}_+}$ by resampling each coordinate at rate $1/2$. We recall that, given a sequence of positive integers $(m_n)_{n \in \mathbb{N}}$ that goes to $+\infty$, a sequence of functions $h_n : \{-1, 1\}^{m_n} \rightarrow \{0, 1\}$ is noise sensitive if, for every $t \in]0, +\infty[$:

$$\text{Cov}(h_n(\omega_n(0)), h_n(\omega_n(t))) \xrightarrow[n \rightarrow +\infty]{} 0.$$

Noise sensitivity has already been studied for continuum percolation models:

- In [ABGM14], the authors prove that the Boolean model is noise sensitive at criticality.
- In [AGMT16], the authors study quenched Voronoi percolation and answer a conjecture from [BKS99] related to the notion of noise sensitivity: they prove that, asymptotically almost surely, the quenched probabilities of crossing event do not depend on η . They also prove a quenched and an annealed noise sensitivity results for frozen dynamical Voronoi percolation, see Theorem 1.4 below.
- In [AB17], the authors prove noise sensitivity results for dynamical models obtained by relocating the position of points, see Theorem 1.5 below. Note that these dynamics are much less local than the μ -dynamical process that we have defined above, even for long range Lévy processes.

Remember that Ω is the set of all coloured configurations. If E is a countable set, we write $\Omega_E = \{-1, 1\}^E$. Thus, $\Omega = \cup_{\eta \in \Omega'} \Omega_\eta$. Below, we let $g_n : \Omega \rightarrow \{0, 1\}$ be the event that there is a black path from left to right in the square $[0, n]^2$.

Theorem 1.4 ([AGMT16]). *The crossing events are noise sensitive for frozen dynamical Voronoi percolation i.e. :*

$$\forall t \in]0, +\infty[, \text{Cov} \left(g_n(\omega^{\text{froz}}(0)), g_n(\omega^{\text{froz}}(t)) \right) \xrightarrow{n \rightarrow +\infty} 0.$$

The crossing events are also a.s. **quenched noise sensitive** in the sense that:

$$\text{a.s.}, \mathbf{Cov}^\eta \left(g_n(\omega^{\text{froz}}(0)), g_n(\omega^{\text{froz}}(t)) \right) \xrightarrow{n \rightarrow +\infty} 0,$$

where \mathbf{Cov}^η is the covariance conditioned on η . Moreover, there exists a constant $a > 0$ such that these annealed and quenched noise sensitivity results also holds if $t = t_n = n^{-a}$.

Theorem 1.5 ([AB17]). *Consider the Voronoi percolation model in the bounded box $[0, n]^2$ defined like in the present chapter except that η is a set of n^2 independent points uniformly distributed in $[0, n]^2$. Still write ω for the model at parameter $1/2$ and g_n for the crossing events of $[0, n]^2$. Define the two following ε -noises on the Voronoi model: i) Resample the localisation of each point of η with probability ε ; ii) Resample (at the same time) the localisation and the colour of each point of η with probability ε . The crossing events are sensitive for these two noises, i.e.:*

$$\text{Cov} (g_n(\omega), g_n(\omega^\varepsilon)) \xrightarrow{n \rightarrow +\infty} 0,$$

where ω^ε is the ε -perturbation of ω .

In [GPS10], Garban, Pete and Schramm define the so-called **spectral sample** of percolation and study precisely this random variable. Their results on the spectral sample imply that there exist exceptional for dynamical Bernoulli percolation on \mathbb{Z}^2 and also imply quantitative noise sensitivity results. In the present chapter, we study an analogue of the spectral sample that we call the **annealed spectral sample of Voronoi percolation**, see Subsection 2.1. This object is a variable with values in the finite subsets of \mathbb{R}^2 . The results we prove on this object imply quantitative noise sensitive results such as Theorem 1.7 below. In order to state this theorem, we need to introduce the notion of **arm events**.

Definition 1.6. Let $r, R \in [1, +\infty[$ such that $r \leq R$ and $j \in \mathbb{N}^*$. The j -arm event $\mathbf{A}_j(r, R)$ is the event that there are j paths of alternating colour in the annulus $[-R, R]^2 \setminus]-r, r[^2$ from $\partial[-r, r]^2$ to $\partial[-R, R]^2$. We write $\alpha_j^{\text{an}}(r, R)$ for the annealed probability of this event i.e.:

$$\alpha_j^{\text{an}}(r, R) = \mathbb{P}_{1/2} [\mathbf{A}_j(r, R)].$$

Also, we write $\alpha_j^{\text{an}}(R) = \alpha_j^{\text{an}}(1, R)$. If $r > R$, we let $\alpha_j^{\text{an}}(r, R) = 1$.

By Proposition 1.12, the quantity $n^2 \alpha_4(n)$ goes to $+\infty$ as n goes to $+\infty$. We have the following result:

Theorem 1.7. *Consider frozen dynamical Voronoi percolation and let g_n be the crossing event of $[0, n]^2$. The covariance*

$$\text{Cov} \left(g_n(\omega^{\text{froz}}(0)), g_n(\omega^{\text{froz}}(t_n)) \right)$$

goes to 0 as n goes to $+\infty$ if $t_n n^2 \alpha_4(n)$ goes to $+\infty$ while this quantity is greater than a positive constant if $t_n n^2 \alpha_4(n)$ goes to 0.

We think that this result also holds for the μ -dynamical processes where μ is the law of a (non zero) planar Lévy process and for the dynamics considered in Theorem 1.5. However, our methods are not quantitative enough to imply this.

Some notations. In all the chapter, we will use the following notations: (a) $O(1)$ is a positive bounded function, (b) $\Omega(1)$ is a positive function bounded away from 0 and (c) if f and g are two non-negative functions, then $f \asymp g$ means $\Omega(1)f \leq g \leq O(1)f$. Also :

- i) We write $B(x, r) = x + [-r, r]^2$ for any $x \in \mathbb{R}^2$ and $r \in \mathbb{R}_+$.
- ii) We let $A(x; r, R) = x + [-R, R]^2 \setminus]-r, r[$ for any $x \in \mathbb{R}^2$ and $r, R \in]0, +\infty[$ that satisfy $r \leq R$. Moreover, we let $A(r, R) = A(0; r, R)$.

We end Section 1 by stating some results on arm events that we will use throughout this chapter.

1.3 Estimates on arm events

The results stated in this subsection are proved in Chapters 5 and 6. In these chapters, we rely on the annealed and quenched box-crossing properties proved in [AGMT16, Tas16]. Let us first state these two properties.

Definition 1.8. Given $\rho_1, \rho_2 \in]0, +\infty[$, the crossing event $\text{Cross}(\rho_1, \rho_2)$ is the event that there is a black path in the rectangle $[0, \rho_1] \times [0, \rho_2]$ from its left side to its right side.

By duality, $\mathbb{P}_{1/2}[\text{Cross}(n, n)] = 1/2$. Tassion has proved that the crossing probabilities for other shapes of rectangles are non-degenerate i.e. he has proved the following annealed box-crossing property:

Theorem 1.9 ([Tas16]). *For every $\rho \in]0, +\infty[$ there exists $c = c(\rho) \in]0, 1[$ such that, for every $R \in]0, +\infty[$:*

$$c \leq \mathbb{P}_{1/2}[\text{Cross}(\rho R, R)] \leq 1 - c.$$

Ahlberg, Griffiths, Morris and Tassion have proved that the quenched crossing probabilities asymptotically do not depend on the environment η :

Theorem 1.10 ([AGMT16]). *There exists $\varepsilon > 0$ such that the following holds: For every $\rho \in]0, +\infty[$ there exists a constant $C = C(\rho) < +\infty$ such that, for every $R \in]0, +\infty[$:*

$$\text{Var} \left(\mathbf{P}_{1/2}^\eta[\text{Cross}(\rho R, R)] \right) \leq CR^{-\varepsilon}.$$

Let us now focus on the arm events. In Chapter 5, we have proved that the arm events decay polynomially fast:

$$\forall j \in \mathbb{N}^*, \exists C = C(j) \in [1, +\infty[, \forall 1 \leq r \leq R, \frac{1}{C} \left(\frac{r}{R}\right)^C \leq \alpha_j^{\text{an}}(r, R) \leq C \left(\frac{r}{R}\right)^{1/C}. \quad (1.2)$$

Moreover, we have proved that the quantities $\alpha_j^{\text{an}}(r, R)$ satisfy a quasi-multiplicativity property:

Proposition 1.11 (Proposition 1.6 of Chapter 5). *For every $j \in \mathbb{N}^*$, there exists $C = C(j) \in [1, +\infty[$ such that, for every $r_1, r_2, r_3 \in [1, +\infty[$ satisfying $r_1 \leq r_2 \leq r_3$, we have:*

$$\frac{1}{C} \alpha_j^{\text{an}}(r_1, r_3) \leq \alpha_j^{\text{an}}(r_1, r_2) \alpha_j^{\text{an}}(r_2, r_3) \leq C \alpha_j^{\text{an}}(r_1, r_3).$$

We have the following estimates on the 4-arm event:

Proposition 1.12 (Proposition 6.2 of Chapter 6). *For every $\varepsilon > 0$, there exists $C = C(\varepsilon) < +\infty$ such that, for every $1 \leq r \leq R < +\infty$:*

$$\alpha_4^{\text{an}}(r, R) \leq C \sqrt{\alpha_2^{\text{an}}(r, R)} \left(\frac{r}{R}\right)^{1-\varepsilon}.$$

Moreover, there exists $\varepsilon > 0$ such that, for every $1 \leq r \leq R < +\infty$:

$$\alpha_4^{\text{an}}(r, R) \geq \varepsilon \left(\frac{r}{R}\right)^{2-\varepsilon} \frac{1}{\alpha_1^{\text{an}}(r, R)}.$$

By the (annealed) FKG property (see Lemma 14 of Chapter 8 of [BR06a]), the first part of Proposition 1.12 implies the following:

Corollary 1.13. *For every $\varepsilon > 0$, there exists $C = C(\varepsilon) < +\infty$ such that, for every $1 \leq r \leq R < +\infty$:*

$$\alpha_4^{an}(r, R) \leq C\alpha_1^{an}(r, R) \left(\frac{r}{R}\right)^{1-\varepsilon}.$$

We also have the following estimates on the “universal” arm events:

Proposition 1.14 (Proposition 2.7 of Chapter 5). *For every $j \in \mathbb{N}^*$, let $\mathbf{A}_j^+(r, R)$ denote the j -arm event in the half-plane and let $\alpha_j^{an,+}(r, R) = \mathbb{P}_{1/2} \left[\mathbf{A}_j^+(r, R) \right]$. We have:*

$$\alpha_2^{+,an}(r, R) \asymp r/R \text{ and } \alpha_3^{an,+}(r, R) \asymp \alpha_5^{an}(r, R) \asymp (r/R)^2.$$

In Chapter 6, inspired by the techniques developed in [AGMT16], we have studied **quenched arm events**, and roughly proved that with high probability the quenched probabilities do not depend on the environment η (up to a constant). In particular, we have the following, where we use the notation:

$$\tilde{\alpha}_j(r, R) = \sqrt{\mathbb{E} \left[\mathbf{P}_{1/2}^\eta \left[\mathbf{A}_j(r, R) \right]^2 \right]}.$$

Theorem 1.15 (Theorem 1.4 of Chapter 6). *For every $j \in \mathbb{N}^*$, there exists $C = C(j) < +\infty$ such that, for every $1 \leq r \leq R < +\infty$:*

$$\alpha_j^{an}(r, R) \leq \tilde{\alpha}_j(r, R) \leq C\alpha_j^{an}(r, R).$$

We refer to Subsections 2.2 and 3.1 for an idea behind the importance of Theorem 1.15 in the present chapter (see also the proofs - written in Subsection 2.4 - of Theorems 1.1 and 1.2).

In Chapter 5, we have studied the events $\widehat{\mathbf{A}}_j(r, R)$ that are useful to apply spatial independence arguments:

Definition 1.16. If $j \in \mathbb{N}^*$ and $1 \leq r \leq R < +\infty$, we let:³

$$\widehat{\mathbf{A}}_j(r, R) = \left\{ \mathbb{P}_{1/2} \left[\mathbf{A}_j(r, R) \mid \omega \cap A(r, R) \right] > 0 \right\}.$$

(Remember that $A(r, R)$ is the annulus $[-R, R]^2 \setminus]-r, r[$.)

We have the following estimate:

Proposition 1.17 (Propositions 2.4 and D.8 of Chapter 5 together with Theorem 1.15 of the present chapter). *For every $j \in \mathbb{N}^*$, there exists $C = C(j) \in [1, +\infty[$ such that, for every $1 \leq r \leq R < +\infty$:*

$$\alpha_j^{an}(r, R) \leq \mathbb{P}_{1/2} \left[\widehat{\mathbf{A}}_j(r, R) \right] \leq \sqrt{\mathbb{E} \left[\mathbf{P}_{1/2}^\eta \left[\widehat{\mathbf{A}}_j(r, R) \right]^2 \right]} \leq C\alpha_j^{an}(r, R).$$

In the present work, we will use a lot the events $\widehat{\mathbf{A}}_j(r, R)$, see in particular Subsection 3.3 where we prove a quasi-multiplicativity property for coupled Voronoi percolation configurations by following [GPS10] and Chapter 5. In this subsection, the events $\widehat{\mathbf{A}}_j(r, R)$ (and analogues of these events) will provide enough independence to adapt the methods from the said works.

Let us finally note that (1.2), the quasi-multiplicativity property, Theorem 1.15 and Proposition 1.17 also apply to arm events in the half-plane (and the proofs are exactly the same).

³In Section 2, we introduce spectral objects $\widehat{h}(S)$ where h is a function. The hat symbol in $\widehat{\mathbf{A}}_j(r, R)$ is not at all a spectral notation, but we have chosen to keep this notation to facilitate references to Chapters 5 and 6. We hope it will not confuse the reader.

2 The annealed spectral sample of Voronoi percolation

2.1 Definition of the annealed spectral sample and links to the dynamics

In this section, we explain the main ideas of proofs. We start with the definition of the main object: the annealed spectral sample. In order to define this object, we recall the definition of the spectral sample of a Boolean function from [GPS10]. To this purpose, we first need to recall what is the **Fourier decomposition of Boolean functions**. Consider a countable set E and equip the set $\Omega_E = \{-1, 1\}^E$ with the product “uniform” measure $\mathbf{P}_{1/2}^E = \left(\frac{\delta_1 + \delta_{-1}}{2}\right)^{\otimes E}$. For every S finite subset of E , define the following function on Ω_E :

$$\chi_S^E : \omega_E \in \Omega_E \mapsto \prod_{i \in S} \omega_E(i). \quad (2.1)$$

The functions χ_S^E form an orthonormal set of $L^2(\Omega_E, \mathbf{P}_{1/2}^E)$. If h is a function from Ω_E to \mathbb{R} that depends on only finitely many coordinates, we can decompose h on this orthonormal set:

$$h = \sum_{S \text{ finite subset of } E} \widehat{h}(S) \chi_S^E,$$

where $\widehat{h}(S) = \mathbf{E}_{1/2}^E [h \chi_S^E]$ (in particular, $\widehat{h}(S) = 0$ if there exists $i \in S$ such that h does not depend on the value of the coordinate i). The vector $(\widehat{h}(S))_S$ is called the Fourier decomposition of h . The idea to use this decomposition in order to prove noise sensitivity results goes back to [BKS99]. This decomposition is central in all the known proofs of noise sensitivity of percolation models. The reason for this is that the Fourier basis diagonalises the independent dynamics: Let $\omega_E(0) \sim \mathbf{P}_{1/2}^E$ and define the dynamical process $(\omega_E(t))_{t \in \mathbb{R}_+}$ by resampling each coordinate at rate 1. Then:

$$\mathbb{E} [\chi_S^E(\omega_E(0)) \chi_{S'}^E(\omega_E(t))] = \mathbf{1}_{S=S'} e^{-t|S|}.$$

As a result:

$$\text{Cov}(h(\omega_E), h(\omega_E(t))) = \sum_{\emptyset \neq S \text{ finite subset of } E} \widehat{h}(S)^2 e^{-t|S|}. \quad (2.2)$$

In [GPS10], the authors introduce a geometrical object: the spectral sample.

Definition 2.1. [GPS10] Let h be a measurable function from Ω_E to \mathbb{R} that is not the zero function and that depends only on a finite subset $F \subset E$. The spectral sample of h is a random variable with values in the subsets of F whose law $\widehat{\mathbb{P}}_h$ is given by:

$$\forall S \subseteq F, \widehat{\mathbb{P}}_h[\{S\}] = \frac{\widehat{h}(S)^2}{\sum_{S' \subseteq F} \widehat{h}(S')^2} = \frac{\widehat{h}(S)^2}{\mathbf{E}_{1/2}^E [h^2]}.$$

Moreover, the un-normalized spectral measure $\widehat{\mathbb{Q}}_h$ is defined by $\widehat{\mathbb{Q}}_h[\{S\}] = \widehat{h}(S)^2$.

With this notion, proving noise sensitivity of a Boolean function (at least for non-degenerate functions) is equivalent to proving that the cardinality of the spectral sample is **large or empty with high probability**.

Let us now go back to the model of Voronoi percolation and introduce an annealed version of the spectral sample. Remember the definition of the sets Ω' and Ω from Subsection 1.1. We need three other notations: (a) For every measurable function h from Ω to \mathbb{R} and for every $\bar{\eta} \in \Omega'$, we write $h^{\bar{\eta}}$ for the restriction of h to $\Omega_{\bar{\eta}} = \{-1, 1\}^{\bar{\eta}}$; (b) we write $S \subseteq_f E$ if S is a finite subset of E , (c) we let \mathcal{F}' be the (classical) σ -algebra defined on Ω' in Subsection 1.1.

Definition 2.2. Let h be a bounded measurable function from Ω to \mathbb{R} which is not the zero function and assume that a.s. h^η depends on finitely many points of η . An **annealed spectral sample** of h is a random variables \mathcal{S}_h^{an} with values in Ω' and whose distribution is defined by:

$$\forall A \in \mathcal{F}', \widehat{\mathbb{P}}_h^{an} [A] = \frac{\mathbb{E} \left[\sum_{S \subseteq_f \eta, S \in A} \widehat{h^\eta}(S)^2 \right]}{\mathbb{E} \left[\sum_{S \subseteq_f \eta} \widehat{h^\eta}(S)^2 \right]} = \frac{\mathbb{E} \left[\sum_{S \subseteq_f \eta, S \in A} \widehat{h^\eta}(S)^2 \right]}{\mathbb{E} [h^2]},$$

where the coefficients $(\widehat{h^\eta}(S))_{S \subseteq_f \eta}$ are the Fourier coefficients of h^η . Also, we define the un-normalized measure $\widehat{\mathbb{Q}}_h^{an}$ on Ω' as follows:

$$\widehat{\mathbb{Q}}_h^{an} [A] = \mathbb{E} \left[\sum_{S \subseteq_f \eta, S \in A} \widehat{h^\eta}(S)^2 \right],$$

i.e.:

$$\widehat{\mathbb{Q}}_h^{an} [A] = \mathbb{E} \left[\widehat{\mathbb{Q}}_{h^\eta} [A \cap \Omega_\eta] \right],$$

where $\widehat{\mathbb{Q}}_{h^\eta}$ is the measure on the finite subsets of Ω_η from Definition 2.1.

The annealed spectral sample is thus a continuous point process. The following is the analogue of (2.2).

Lemma 2.3. Take h as in Definition 2.2 and let $(\omega^{froz}(t))_{t \geq 0}$ be a frozen dynamical Voronoi percolation. Then, for all $t \geq 0$:

$$\mathbb{E} \left[h(\omega^{froz}(0)) h(\omega^{froz}(t)) \right] = \sum_{k \in \mathbb{N}} \widehat{\mathbb{Q}}_h^{an} [|S| = k] e^{-kt}.$$

Proof. Let η be the underlying point configuration. Given η and $S \subseteq_f \eta$, we write χ_S^η for the Fourier function defined on Ω_η as in (2.1). We have:

$$\begin{aligned} \mathbb{E} \left[h(\omega^{froz}(0)) h(\omega^{froz}(t)) \right] &= \mathbb{E} \left[\left(\sum_{S \subseteq_f \eta} \widehat{h^\eta}(S) \chi_S^\eta(\omega^{froz}(0)) \right) \times \left(\sum_{S \subseteq_f \eta} \widehat{h^\eta}(S) \chi_S^\eta(\omega^{froz}(t)) \right) \right] \\ &= \mathbb{E} \left[\sum_{S, S' \subseteq_f \eta} \widehat{h^\eta}(S) \widehat{h^\eta}(S') \chi_S^\eta(\omega^{froz}(0)) \chi_{S'}^\eta(\omega^{froz}(t)) \right] \\ &= \mathbb{E} \left[\mathbf{E}^\eta \left[\sum_{S, S' \subseteq_f \eta} \widehat{h^\eta}(S) \widehat{h^\eta}(S') \chi_S^\eta(\omega^{froz}(0)) \chi_{S'}^\eta(\omega^{froz}(t)) \right] \right] \\ &= \mathbb{E} \left[\sum_{S \subseteq_f \eta} \widehat{h^\eta}(S)^2 e^{-t|S|} \right] \\ &= \sum_{k \in \mathbb{N}} \widehat{\mathbb{Q}}_h^{an} [|S| = k] e^{-kt}. \end{aligned}$$

□

Let us now explain how we can use the annealed spectral sample in order to study the μ -dynamical Voronoi percolation processes, where μ is the distribution of a Lévy process. The formula from Lemma 2.3 comes from the fact that the Fourier basis diagonalises the independent dynamics. We do not have such property for the μ -dynamical process. The same kind of difficulty arised in the study of exclusion dynamics, see [BGS13] and Chapter 4. The following lemma is inspired by Lemma 7.1 of [BGS13] and by Lemma 4.1 of Chapter 4. Remember that, given a distribution μ of a planar Lévy process, we let $(\omega^\mu(t))_{t \in \mathbb{R}_+}$ be a μ -dynamical Voronoi percolation process and we let $(\eta^\mu(t))_{t \in \mathbb{R}_+}$ be the underlying (non-coloured) point process.

Lemma 2.4. Take h as in Definition 2.2 and let μ be the distribution of a planar Lévy process. For every $S \subseteq \eta^\mu(0)$, let S_t be the corresponding subset of $\eta^\mu(t)$. Moreover, let \mathcal{F}' be the (classical) σ -algebra defined on Ω' in Subsection 1.1, let $B_1, B_2, \dots \in \mathcal{F}'$ be disjoint sets such that $\cup_{i \geq 1} B_i = \{\text{non empty finite sets of } \mathbb{R}^2\}$, and let $A_1, A_2, \dots \in \mathcal{F}'$ satisfying $A_i \subseteq B_i$ for every $i \geq 1$. Assume that for each $i \geq 1$ and each $t \geq 0$ we have $S \in B_i$ if and only if $S_t \in B_i$. Also, for each $i \geq 1$ and each $t \geq 0$, let $\delta_1(i, t), \delta_2(i) > 0$ be such that the three following properties hold:

- i) $\max_{S \in A_i} \mathbb{P} \left[S_t \in A_i \mid S_0 = S \right] \leq \delta_1(i, t),$
- ii) $\max_{S \in A_i} \mathbb{P} \left[S_0 \in A_i \mid S_t = S \right] \leq \delta_1(i, t),$
- iii) $\widehat{\mathbb{Q}}_h^{an} [A_i] \geq (1 - \delta_2(i)) \widehat{\mathbb{Q}}_h^{an} [B_i].$

Then, for every $t \geq 0$:

$$\mathbb{E} [h(\omega^\mu(0))h(\omega^\mu(t))] \leq \mathbb{E} \left[\mathbf{E}_{1/2}^\eta [h]^2 \right] + \sum_{i=1}^{+\infty} \widehat{\mathbb{Q}}_h^{an} [B_i] (\delta_1(i, t) + 2\sqrt{\delta_2(i)}).$$

Proof. To simplify the notations, we write $\eta(t) := \eta^\mu(t)$. The quantity $\mathbb{E} [h(\omega^\mu(0))h(\omega^\mu(t))]$ equals:

$$\begin{aligned} & \mathbb{E} \left[\left(\sum_{S \subseteq_f \eta(0)} \widehat{h^{\eta(0)}}(S) \chi_S^{\eta(0)}(\omega^\mu(0)) \right) \times \left(\sum_{S \subseteq_f \eta(t)} \widehat{h^{\eta(t)}}(S) \chi_S^{\eta(t)}(\omega^\mu(t)) \right) \right] \\ &= \mathbb{E} \left[\mathbb{E} \left[\sum_{S \subseteq_f \eta(0), S' \subseteq_f \eta(t)} \widehat{h^{\eta(0)}}(S) \widehat{h^{\eta(t)}}(S') \chi_S^{\eta(0)}(\omega^\mu(0)) \chi_{S'}^{\eta(t)}(\omega^\mu(t)) \mid (\eta(s))_{s \geq 0} \right] \right] \\ &= \mathbb{E} \left[\sum_{S \subseteq_f \eta(0), S' \subseteq_f \eta(t)} \widehat{h^{\eta(0)}}(S) \widehat{h^{\eta(t)}}(S') \mathbb{E} \left[\chi_S^{\eta(0)}(\omega^\mu(0)) \chi_{S'}^{\eta(t)}(\omega^\mu(t)) \mid (\eta(s))_{s \geq 0} \right] \right] \\ &= \mathbb{E} \left[\sum_{S \subseteq_f \eta(0), S' \subseteq_f \eta(t)} \widehat{h^{\eta(0)}}(S) \widehat{h^{\eta(t)}}(S') \mathbb{1}_{S'=S_t} \right] \\ &= \mathbb{E} \left[\sum_{S \subseteq_f \eta(0)} \widehat{h^{\eta(0)}}(S) \widehat{h^{\eta(t)}}(S_t) \right] \\ &= \mathbb{E} \left[\widehat{h^{\eta(0)}}(\emptyset) \widehat{h^{\eta(t)}}(\emptyset) + \sum_{i=1}^{+\infty} \sum_{S \subseteq_f \eta(0), S \in B_i} \widehat{h^{\eta(0)}}(S) \widehat{h^{\eta(t)}}(S_t) \right] \\ &= \mathbb{E} \left[\widehat{h^{\eta(0)}}(\emptyset) \widehat{h^{\eta(t)}}(\emptyset) \right] + \sum_{i=1}^{+\infty} \mathbb{E} \left[\sum_{S \subseteq_f \eta(0), S \in B_i} \widehat{h^{\eta(0)}}(S) \widehat{h^{\eta(t)}}(S_t) \right] \quad (\text{by dominated convergence}). \end{aligned}$$

Since by the Cauchy-Schwarz inequality we have $\mathbb{E} \left[\widehat{h^{\eta(0)}}(\emptyset) \widehat{h^{\eta(t)}}(\emptyset) \right] \leq \mathbb{E} \left[\mathbf{E}_{1/2}^\eta [h]^2 \right]$, it is now sufficient to prove that, for every $i \geq 1$:

$$\mathbb{E} \left[\sum_{S \subseteq_f \eta(0), S \in B_i} \widehat{h^{\eta(0)}}(S) \widehat{h^{\eta(t)}}(S_t) \right] \leq \widehat{\mathbb{Q}}_h^{an} [B_i] (\delta_1(i, t) + 2\sqrt{\delta_2(i)}). \quad (2.3)$$

Let us divide the above sum into three sums:

$$\begin{aligned} \mathbb{E} \left[\sum_{S \subseteq_f \eta(0), S \in B_i} \widehat{h^{\eta(0)}}(S) \widehat{h^{\eta(t)}}(S_t) \right] &= \mathbb{E} \left[\sum_{S \subseteq_f \eta(0), S \in A_i} \widehat{h^{\eta(0)}}(S) \widehat{h^{\eta(t)}}(S_t) \mathbb{1}_{S_t \in A_i} \right] \\ &+ \mathbb{E} \left[\sum_{S \subseteq_f \eta(0), S \in A_i} \widehat{h^{\eta(0)}}(S) \widehat{h^{\eta(t)}}(S_t) \mathbb{1}_{S_t \notin A_i} \right] + \mathbb{E} \left[\sum_{S \subseteq_f \eta(0), S \in B_i \setminus A_i} \widehat{h^{\eta(0)}}(S) \widehat{h^{\eta(t)}}(S_t) \right]. \end{aligned}$$

Let us write Σ_1 , Σ_2 and Σ_3 for the three terms of the right-hand-side of the above equality and let us first deal with Σ_1 . By the Cauchy-Schwarz inequality (applied to the counting measure and then to \mathbb{E}), we have:

$$\begin{aligned} \Sigma_1 &\leq \mathbb{E} \left[\left(\sum_{S \subseteq_f \eta(0), S \in A_i} \widehat{h^{\eta(0)}}(S)^2 \mathbb{1}_{S_t \in A_i} \right)^{1/2} \left(\sum_{S \subseteq_f \eta(0), S \in A_i} \widehat{h^{\eta(t)}}(S_t)^2 \mathbb{1}_{S_t \in A_i} \right)^{1/2} \right] \\ &\leq \left(\mathbb{E} \left[\sum_{S \subseteq_f \eta(0), S \in A_i} \widehat{h^{\eta(0)}}(S)^2 \mathbb{1}_{S_t \in A_i} \right] \mathbb{E} \left[\sum_{S \subseteq_f \eta(0), S \in A_i} \widehat{h^{\eta(t)}}(S_t)^2 \mathbb{1}_{S_t \in A_i} \right] \right)^{1/2} \\ &\leq \left(\sqrt{\delta_1(i, t) \widehat{\mathcal{Q}}_h^{an} [A_i]} \right)^2 \leq \delta_1(i, t) \widehat{\mathcal{Q}}_h^{an} [B_i], \end{aligned}$$

where the second to last inequality is proved by conditioning on $\eta(0)$ or $\eta(t)$. Let us now deal with the terms Σ_2 and Σ_3 . By applying the Cauchy-Schwarz inequality once again, we obtain that:

$$\begin{aligned} \Sigma_2 &\leq \left(\mathbb{E} \left[\sum_{S \subseteq_f \eta(0), S \in A_i} \widehat{h^{\eta(0)}}(S)^2 \right] \mathbb{E} \left[\sum_{S \subseteq_f \eta(0), S \in A_i} \widehat{h^{\eta(t)}}(S_t)^2 \mathbb{1}_{S_t \notin A_i} \right] \right)^{1/2} \\ &= \left(\widehat{\mathcal{Q}}_h^{an} [A_i] \widehat{\mathcal{Q}}_h^{an} [B_i \setminus A_i] \right)^{1/2} \leq \sqrt{\delta_2(i)} \widehat{\mathcal{Q}}_h^{an} [B_i]. \end{aligned}$$

By the same calculations, we prove that $\Sigma_3 \leq \sqrt{\delta_2(i)} \widehat{\mathcal{Q}}_h^{an} [B_i]$, which implies (2.3) and ends the proof. \square

We now state the results on the annealed spectral sample that will enable us to prove that there exist exceptional times.

2.2 Why don't we study a quenched spectral sample?

Why do we need to define an **annealed** spectral sample? At first sight, it may seem to be easier to work with a quenched spectral sample, which could be defined exactly as in [GPS10]. However, the quenched model is not translation invariant (which is very important in [GPS10]) and we do not have strong enough quenched quasi-multiplicativity properties to be able to follow the strategy of Garban, Pete and Schramm at the quenched level.

This is why we have chosen to introduce an annealed analogue of the spectral sample. It is important to keep in mind that this is a **continuous** point process. In particular, we will study events of the kind:

$$\{\mathcal{S}_h^{an} \cap B \neq \emptyset = \mathcal{S}_h^{an} \cap W\},$$

where B and W are two Borel subsets of the plane. Events of the kind

$$\{\mathcal{S}_h^{an} \cap B' \neq \emptyset = \mathcal{S}_h^{an} \cap W'\},$$

where B' and W' are subsets of η (which seem at first sight to be the natural analogues of the events studied in [GPS10]) would not make any sense since we have not coupled the spectral sample with η .

However, we will also need to work at the quenched level to apply discrete Fourier techniques. Remember that the un-normalized measure of the spectral sample is:

$$\widehat{\mathbb{Q}}_h^{an}[\cdot] = \mathbb{E} \left[\widehat{\mathbb{Q}}_{h^\eta}[\cdot] \right].$$

The strategy will consist in applying discrete Fourier results to $\widehat{\mathbb{Q}}_{h^\eta}$ and then deducing results for $\widehat{\mathbb{Q}}_h^{an}$. The technical difficulties will come from the **multiple passages from quenched to annealed measures**. To overcome these difficulties, the key result will be Theorem 1.15. Let us recall that this theorem says that:

$$\tilde{\alpha}_j(r, R) := \sqrt{\mathbb{E} \left[\mathbf{P}_{1/2}^\eta [\mathbf{A}_j(r, R)]^2 \right]} \asymp \alpha_j^{an}(r, R).$$

In other words:

$$\text{Var} \left(\mathbf{P}_{1/2}^\eta [\mathbf{A}_j(r, R)] \right) \leq O(1) \mathbb{P}_{1/2} [\mathbf{A}_j(r, R)] = O(1) \alpha_j^{an}(r, R).$$

Therefore, this theorem roughly means that the arm events do not depend too much on the environment. Thanks to this result, we will not loose too much each time we go from quenched to annealed measures. For a more precise explanation of the importance of Theorem 1.15, we refer to Subsection 3.1.

2.3 Main results on the annealed spectral sample

Let us now state the main results on the annealed spectral sample, which are the analogues of results from [GPS10] and Chapter 4.

Theorem 2.5. *For every $n \in \mathbb{N}^*$, let g_n denote the crossing event of $[0, n]^2$. There exists $C < +\infty$ such that for every $r \in [1, n]$ we have:*

$$\mathbb{P} \left[0 < |\mathcal{S}_{g_n}^{an}| < r^2 \alpha_4^{an}(r) \right] \leq C \left(\frac{n}{r} \alpha_4^{an}(r, n) \right)^2 + \frac{C}{n}.$$

Remark 2.6. The term $\frac{1}{n}$ is not present in the analogous result from [GPS10]. We will see that this term comes from the contribution of the boxes outside of $[0, n]^2$. Actually, since it is conjectured that $\left(\frac{n}{r} \alpha_4^{an}(r, n) \right)^2 = (r/n)^{1/2+o(1)}$, the result should be true without this term.

It is not difficult to deduce Theorem 1.7 from Theorem 2.5. As one can see below, the quenched estimate Theorem 1.10 by Ahlberg, Griffiths, Morris and Tassion is also a key result of the proof.

Proof of Theorem 1.7 using Theorem 2.5. Let us first consider the case where $t_n n^2 \alpha_4(n)$ goes to $+\infty$. Remember that the renormalisation constant in the definition of the distribution $\widehat{\mathbb{P}}_{g_n}^{an}$ of $\mathcal{S}_{g_n}^{an}$ is $\mathbb{E}_{1/2} [g_n] = \mathbb{P}_{1/2} [\text{Cross}(n, n)] (= 1/2)$. Hence, Lemma 2.3 implies that:

$$\begin{aligned} \text{Cov} \left(g_n(\omega^{froz}(0)), g_n(\omega^{froz}(t_n)) \right) &= \sum_{k \geq 1} \mathbb{P} \left[|\mathcal{S}_{g_n}^{an}| = k \right] \mathbb{P}_{1/2} [\text{Cross}(n, n)] e^{-kt_n} \\ &\quad + \mathbb{P} \left[|\mathcal{S}_{g_n}^{an}| = 0 \right] \mathbb{P}_{1/2} [\text{Cross}(n, n)] - \mathbb{P}_{1/2} [\text{Cross}(n, n)]^2. \end{aligned}$$

Since $\mathbb{P} \left[|\mathcal{S}_{g_n}^{an}| = 0 \right] \mathbb{P}_{1/2} [\text{Cross}(n, n)] = \mathbb{E} \left[\mathbf{P}_{1/2}^\eta [\text{Cross}(n, n)]^2 \right]$, the quenched estimate Theorem 1.10 implies that

$$\mathbb{P} \left[|\mathcal{S}_{g_n}^{an}| = 0 \right] \mathbb{P}_{1/2} [\text{Cross}(n, n)] - \mathbb{P}_{1/2} [\text{Cross}(n, n)]^2$$

goes to 0 as n goes to $+\infty$. It is now sufficient to prove that

$$\sum_{k \geq 1} \mathbb{P} [|\mathcal{S}_{g_n}^{an}| = k] \mathbb{P}_{1/2} [\text{Cross}(n, n)] e^{-kt_n} = \frac{1}{2} \sum_{k \geq 1} \mathbb{P} [|\mathcal{S}_{g_n}^{an}| = k] e^{-kt_n} \quad (2.4)$$

goes to 0 as n goes to $+\infty$. This is actually a direct consequence of Theorem 2.5. For details, we refer to Section 8.1 of [GPS10] where Garban, Pete and Schramm prove the analogue of (2.4) by using the analogue of Theorem 2.5. In the said article, the authors use the following properties of the probabilities of arm events of Bernoulli percolation $\alpha_j(\cdot, \cdot)$: i) they decay polynomially fast, ii) they satisfy the quasi-multiplicativity property, iii) $\alpha_4(n) \leq n^{-1-\Omega(1)}$. All these properties also hold for the quantities $\alpha_j^{an}(\cdot, \cdot)$ (see Subsection 1.3).

It thus only remains to prove the result in the case $\varepsilon_n n^2 \alpha_4^{an}(n) \ll 1$. This does not rely on Theorem 2.5 but only on estimates on “annealed pivotal events”, see Appendix C for the proof. \square

Let us now state the main results about the annealed spectral sample of the 1-arm event. Below, we let f_R denote the 1-arm event i.e. $f_R = \mathbb{1}_{\mathbf{A}_1(1, R)}$.

Theorem 2.7. *There exists $C < +\infty$ such that if $R \in [1, +\infty[$ and $r \in [1, R]$ then:*

$$\mathbb{P} [0 < |\mathcal{S}_{f_R}^{an}| \leq r^2 \alpha_4^{an}(r)] \leq C \alpha_1^{an}(r, R).$$

In Subsection 2.4, we explain how to deduce Theorem 1.1 from Theorem 2.7.

Theorem 2.8. *There exists $\varepsilon_0 > 0$ and $C < +\infty$ such that, for every $1 \leq r \leq r_0 \leq R/2 < +\infty$:*

$$\mathbb{P} [0 < |\mathcal{S}_{f_R}^{an} \setminus [-r_0, r_0]^2| < r^2 \alpha_4^{an}(r)] \leq C \alpha_1^{an}(r_0, R) \left(\frac{r_0}{r}\right)^{1-\varepsilon_0} \alpha_4^{an}(r, r_0).$$

In Subsection 2.4, we explain how to deduce Theorem 1.2 from Theorem 2.8. We will actually rely on the following corollary of Theorem 2.8:

Corollary 2.9. *Let ε_0 be the constant of Theorem 2.8. There exists a constant $C < +\infty$ such that, for all $1 \leq r \leq r_0 < +\infty$ and all $R \in [1, +\infty[$:*

$$\mathbb{P} [|\mathcal{S}_{f_R}^{an}| < r^2 \alpha_4^{an}(r), \mathcal{S}_{f_R}^{an} \not\subseteq [-r_0, r_0]^2] \leq C \alpha_1^{an}(r_0, R) \left(\frac{r_0}{r}\right)^{1-\varepsilon_0} \alpha_4^{an}(r, r_0).$$

Proof of Corollary 2.9 using Theorem 2.8. If $r_0 \geq 2R$ we have:

$$\begin{aligned} \mathbb{P} [\mathcal{S}_{f_R}^{an} \not\subseteq [-r_0, r_0]^2] &= \frac{\mathbb{E} [\widehat{\mathbb{Q}}_{f_R}^\eta [S \not\subseteq [-r_0, r_0]^2]]}{\mathbb{E}_{1/2} [f_R]} \\ &\leq \frac{\mathbb{P} [f_R^\eta \text{ depends on some points outside of } [-2R, 2R]^2]}{\mathbb{E}_{1/2} [f_R]}. \end{aligned}$$

The result now follows from the fact that $\mathbb{E}_{1/2} [f_R] = \alpha_{1,1/2}^{an}(R)$ decays polynomially fast while $\mathbb{P} [f_R^\eta \text{ depends on some points outside of } [-2R, 2R]^2]$ decays super-exponentially fast. Indeed, if f_R^η depends on some points outside of $[-2R, 2R]^2$ then there is a Voronoi cell that intersects both $\partial B(0, R)$ and $\partial B(0, 2R)$, which has probability less than $O(1) \exp(-\Omega(1)R^2)$ by simple properties of Poisson point processes.

If $r_0 \leq R/2$, then the result is a direct consequence of Theorem 2.8 since:

$$\{|\mathcal{S}_{f_R}^{an}| < r^2 \alpha_4^{an}(r), \mathcal{S}_{f_R}^{an} \not\subseteq [-r_0, r_0]^2\} \subseteq \{0 < |\mathcal{S}_{f_R}^{an} \setminus [-r_0, r_0]^2| < r^2 \alpha_4^{an}(r)\}.$$

If $r_0 \in [R/2, 2R]$, then this is direct consequence of the quasi-multiplicativity property (and of (1.2)) and of the result for $r_0 = R/2$ since:

$$\{|\mathcal{S}_{f_R}^{an}| < r^2 \alpha_4^{an}(r), \mathcal{S}_{f_R}^{an} \not\subseteq [-r_0, r_0]^2\} \subseteq \{|\mathcal{S}_{f_R}^{an}| < r^2 \alpha_4^{an}(r), \mathcal{S}_{f_R}^{an} \not\subseteq [-R/2, R/2]^2\}.$$

This ends the proof. \square

2.4 Proofs of existence of exceptional times

We now prove the results of existence of exceptional times by using Theorems 2.7 and 2.8. In this subsection, we assume that the reader has read Section 8 of [GPS10] and Section 4 of Chapter 4 where results of existence of exceptional times are proved by using analogues of Theorems 2.7 and 2.8.

We start with the following lemma that takes its roots in [HPS97]. Let μ be the distribution of a planar Lévy process, and let $(\omega(t))_{t \geq 0}$ be either a frozen dynamical Voronoi percolation process or a μ -dynamical Voronoi percolation process. Remember that $f_R = \mathbb{1}_{\mathbf{A}_1(1,R)}$ and let

$$X_R = \int_0^1 f_R(\omega(t)) dt.$$

Lemma 2.10. *Assume that there exists a constant $C < +\infty$ such that for all $R \in [1, +\infty[$ we have:*

$$\mathbb{E} [X_R^2] \leq C \mathbb{E} [X_R]^2.$$

Then a.s. there are exceptional times for which there is an unbounded black component.

Lemma 2.10 is proved in Appendix B. Let us now use this lemma to show that Theorems 2.7 (resp. Theorem 2.8) implies Theorem 1.1 (resp. Theorem 1.2). To this purpose, let us study $\mathbb{E} [X_R]$ and $\mathbb{E} [X_R^2]$. First note that:

$$\mathbb{E} [X_R] = \alpha_1^{an}(R). \tag{2.5}$$

and (by Fubini):

$$\begin{aligned} \mathbb{E} [X_R^2] &= \int_0^1 \int_0^1 \mathbb{E} [f_R(\omega(s)) f_R(\omega(t))] ds dt \\ &\leq 2 \int_0^1 \mathbb{E} [f_R(\omega(0)) f_R(\omega(t))] dt. \end{aligned} \tag{2.6}$$

Proof of Theorem 1.1 using Theorem 2.7. By Lemmas 2.3 and 2.10 (and (2.5) and (2.6)), it is sufficient to show that:

$$\mathbb{P} [|\mathcal{S}_{f_R}^{an}| = 0] + \int_0^1 \sum_{k \geq 1} \mathbb{P} [|\mathcal{S}_{f_R}^{an}| = k] e^{-kt} dt \leq O(1) \alpha_1^{an}(R).$$

(Indeed, the renormalisation constant in the distribution $\widehat{\mathbb{P}}_{f_R}^{an}$ of $\mathcal{S}_{f_R}^{an}$ is $\mathbb{E}_{1/2} [f_R] = \alpha_1^{an}(R)$, this is why there is $\alpha_1^{an}(R)$ instead of $\alpha_1^{an}(R)^2$ on the right-hand-side.)

Let us first explain why $\mathbb{P} [|\mathcal{S}_{f_R}^{an}| = 0] \leq O(1) \alpha_1^{an}(R)$. To this purpose, note that:

$$\mathbb{P} [|\mathcal{S}_{f_R}^{an}| = 0] = \frac{\mathbb{E} [\widehat{f_R^\eta}(\emptyset)^2]}{\alpha_1^{an}(R)} = \frac{\widetilde{\alpha}_1(R)^2}{\alpha_1^{an}(R)},$$

where the notation $\widetilde{\alpha}_1(R)$ comes from Subsection 1.3. The fact that the above is at most of the order of $\alpha_1^{an}(R)$ is given by Theorem 1.15.

Let us end the proof by showing that:

$$\int_0^1 \sum_{k \geq 1} \mathbb{P} [|\mathcal{S}_{f_R}^{an}| = k] e^{-kt} dt \leq O(1) \alpha_1^{an}(R).$$

The proof of the analogous estimate (by using the analogue of Theorem 2.7) for Bernoulli percolation on \mathbb{Z}^2 is written in Section 9 of [GPS10] (see also Section 6 of Chapter XI of [GS14]). In the said article, the authors use the following properties of the probabilities of arm events of Bernoulli percolation $\alpha_j(\cdot, \cdot)$: i) they decay polynomially fast, ii) they satisfy the quasi-multiplicativity property, iii) $\Omega(1)\alpha_1(R)(R)^{-(2-\Omega(1))} \leq \alpha_4(R) \leq O(1)(R)^{-(1+\Omega(1))}$. All these properties hold for the quantities $\alpha_j^{an}(\cdot, \cdot)$ (see Subsection 1.3), so the proof adapts readily. \square

Proof of Theorem 1.3 using Theorem 2.7. If we follow the proof of Lemma 2.3 and the beginning of the proof of Lemma 2.4 we obtain that, if $(\omega(t))_{t \in \mathbb{R}_+}$ is the process from Theorem 1.3 then:

$$\mathbb{E} [f_R(\omega(0))f_R(\omega(t))] = \mathbb{E} \left[\sum_{S \subseteq_f \eta(0)} \widehat{f_R^{\eta(0)}}(S) \widehat{f_R^{\eta(t)}}(S_t) e^{-t|S|} \right].$$

(where for every $S \subseteq \eta(0)$, S_t is the corresponding subset of $\eta(t)$). By the Cauchy-Schwarz inequality twice, this is less than or equal to:

$$\begin{aligned} \mathbb{E} \left[\sqrt{\sum_{S \subseteq_f \eta(0)} \widehat{f_R^{\eta(0)}}(S)^2 e^{-2|S|}} \sqrt{\sum_{S \subseteq_f \eta(t)} \widehat{f_R^{\eta(t)}}(S_t)^2 e^{-2|S_t|}} \right] \\ \leq \mathbb{E} \left[\sum_{S \subseteq_f \eta(0)} \widehat{f_R^{\eta(0)}}(S)^2 e^{-|S|} \right] = \mathbb{E} [f_R(\omega^{froz}(0))f_R(\omega^{froz}(t))], \end{aligned}$$

where $(\omega^{froz}(t))_{t \in \mathbb{R}_+}$ is the frozen dynamical process. As a result, the proof of Theorem 1.3 is the same as the proof of Theorem 1.1 provided that the second moment result Lemma 2.10 also applies in the case of $(\omega(t))_{t \in \mathbb{R}_+}$. It indeed does, and the proof is exactly the same as for the μ -dynamical processes (see Appendix B). \square

Proof of Theorem 1.2 using Theorem 2.7 and Corollary 2.9. For every $i \in \mathbb{N}^*$, let $A_i, B_i \subseteq \Omega'$ be defined as follows, where $\beta \in]1, +\infty[$ will be chosen later.

$$B_i = \{\bar{\eta} \in \Omega' : |\bar{\eta}| \in [2^i, 2^{i+1} - 1]\}$$

and:

$$A_i = \{\bar{\eta} \in B_i : \bar{\eta} \subseteq [-2^{i\beta}, 2^{i\beta}]^2\} \subseteq B_i.$$

Let $\delta_1(i, t)$ and $\delta_2(i)$ be defined by:

$$\delta_1(i, t) = \max \left\{ \max_{S \in A_i} \mathbb{P} [S_t \in A_i \mid S_0 = S], \max_{S \in A_i} \mathbb{P} [S_0 \in A_i \mid S_t = S] \right\}$$

and:

$$\delta_2(i) = 1 - \frac{\widehat{\mathbb{P}}_{f_R}^{an} [A_i]}{\widehat{\mathbb{P}}_{f_R}^{an} [B_i]}.$$

By Lemmas 2.4 and 2.10, it is sufficient to prove that:

$$\int_0^1 \left(\frac{\mathbb{E} [\mathbf{E}_{1/2}^\eta [f_R]^2]}{\alpha_1^{an}(R)} + \sum_{i \geq 1} \widehat{\mathbb{P}}^{an} [B_i] (\delta_1(i, t) + 2\sqrt{\delta_2(i)}) \right) dt \leq O(1) \alpha_1^{an}(R). \quad (2.7)$$

By Theorem 1.10, we have $\mathbb{E} [\mathbf{E}_{1/2}^\eta [f_R]^2] = \tilde{\alpha}_1(R)^2 \leq O(1) \alpha_1^{an}(R)^2$ so it only remains to estimate the sum. Remember that the Lévy processes X (of distribution μ) we consider satisfy

that, for each $L \in [1, +\infty[$ and $t \in [0, 1]$, $\mathbb{P}[\|X_t\|_2 \geq L] \geq ctL^{-\alpha}$ for some $c > 0$. This implies that:

$$\delta_1(i, t) \leq \exp(-c't(2^i)^{1-\alpha\beta}) \quad (2.8)$$

for some $c' > 0$. It thus remains to prove that, if α is sufficiently small, then we can choose $\beta \in]1, +\infty[$ so that we both have:

$$\int_0^1 \sum_{i \geq 1} \widehat{\mathbb{P}}^{an} [B_i] \exp(-c't(2^i)^{1-\alpha\beta}) dt \leq O(1) \alpha_1^{an}(R) \quad (2.9)$$

and:

$$\sum_{i \geq 1} \widehat{\mathbb{P}}^{an} [B_i] \sqrt{\delta_2(i)} \leq O(1) \alpha_1^{an}(R). \quad (2.10)$$

The quantity $\widehat{\mathbb{P}}^{an} [B_i]$ can be estimated by using Theorem 2.7 and the quantity

$$\widehat{\mathbb{P}}^{an} [B_i] \delta_2(i) = \mathbb{P} \left[|\mathcal{S}_{f_R}^{an}| \in [2^i, 2^{i+1} - 1], \mathcal{S}_{f_R}^{an} \not\subseteq [-2^{\beta i}, 2^{\beta i}]^2 \right]$$

can be estimated by using Corollary 2.9.

In Section 4 of Chapter 4, we have proved with Christophe Garban that if α is sufficiently small then there exists $\beta \in]1, +\infty[$ such that the analogues of (2.9) and (2.10) hold for Bernoulli percolation. In the said chapter, we have used the analogues of Theorem 2.7 and Corollary 2.9 and the following properties of the probabilities of arm events: i) they decay polynomially fast, ii) they satisfy the quasi-multiplicativity property. iii) $\Omega(1)\alpha_1(R)^{-1}R^{-(2-\Omega(1))} \leq \alpha_4(R) \leq O(1)R^{-1}\alpha_1(R)$. By the results of Subsection 1.3, the model of Voronoi percolation satisfy all these properties, except maybe $\alpha_4^{an}(R) \leq O(1)R^{-1}\alpha_1^{an}(R)$. However, Corollary 1.13 implies that $\alpha_4^{an}(R) \leq O(1)R^{-(1-\varepsilon)}\alpha_1^{an}(R)$ for any $\varepsilon > 0$. Actually, this property would have been enough in Chapter 4 (and would not have required any change in the proof). We refer to Section 4 of Chapter 4 for more details (the reader do not have to read the proofs of Lemmas 4.1 and 4.4 therein since they are the analogues of Lemma 2.4 and of (2.8) respectively; moreover, the reader can stop just before the paragraph ‘‘The constant $\alpha_0 = 217/816$ ’’). \square

3 Proofs of the spectral estimates

3.1 Preliminary results and pivotal sets

In this subsection, we state some preliminary results that illustrate the importance of Theorem 1.15 in the study of the annealed spectral sample. We first state a result from [GPS10]:

Lemma 3.1 (Consequence of Lemma 2.2 of [GPS10]). *Let E be a countable set and $h : \Omega_E = \{-1, 1\}^E \rightarrow \{0, 1\}$ be a function that depends on finitely many coordinates. Then, for any $G \subseteq_f E$, we have:*

$$\widehat{\mathbb{Q}}_h [S \cap G \neq \emptyset] \leq 4\mathbf{P}_{1/2}^E [\text{Piv}_G^E(h)] \quad \text{and} \quad \widehat{\mathbb{Q}}_h [\emptyset \neq S \subseteq G] \leq 4\mathbf{P}_{1/2}^E [\text{Piv}_G^E(h)]^2,$$

where:

$$\text{Piv}_G^E(h) = \{\omega_E \in \{-1, 1\}^E : \exists \omega'_E \in \{-1, 1\}^E, (\omega'_E)_{|G^c} = (\omega_E)_{|G^c} \text{ and } h(\omega'_E) \neq h(\omega_E)\}.$$

In order to state a consequence of Lemma 3.1 for the annealed spectral sample, we need the two following definitions of pivotal events (that come from Chapter 5):

Definition 3.2. Let A be an event measurable with respect to the coloured configuration ω . Also, let D be a bounded Borel subset of the plane.

- Let $\bar{\omega} \in \Omega$ and let $\bar{\eta} \in \Omega'$ be the underlying (non-coloured) point configuration. The subset D is said **quenched-pivotal** for $\bar{\omega}$ and A if there exists $\bar{\omega}' \in \{-1, 1\}^{\bar{\eta}}$ such that $\bar{\omega}$ and $\bar{\omega}'$ coincide on $\bar{\eta} \cap D^c$ and $\mathbb{1}_A(\bar{\omega}') \neq \mathbb{1}_A(\bar{\omega})$. We write $\text{Piv}_D^q(A)$ for the event that D is quenched-pivotal for A . Moreover, if we work under the probability measure $\mathbf{P}_{1/2}^\eta$ and if $x \in \eta$, we let $\text{Piv}_x^q(A)$ be the event that changing the colour of x modifies $\mathbb{1}_A$.
- The event that D is **annealed-pivotal** for A is the event:

$$\text{Piv}_D(A) := \{\mathbb{P}[A | \omega \setminus D] \in]0, 1[\}.$$

Note that we have $\mathbb{P}[\text{Piv}_D^q(A) \setminus \text{Piv}_D(A)] = 0$ for any A and D as above. If h is a measurable function from Ω to $\{0, 1\}$, we write $\text{Piv}_D(h) = \text{Piv}_D(h^{-1}(1))$ and $\text{Piv}_D^q(h) = \text{Piv}_D^q(h^{-1}(1))$.

Let h be a measurable function from Ω to $\{0, 1\}$ such that a.s. h^η depends on finitely many points of η . Remember that the annealed non-normalized spectral measure is $\widehat{\mathbb{Q}}_h^{an}[\cdot] = \mathbb{E}[\widehat{\mathbb{Q}}_{h^\eta}[\cdot]]$. Thus, Lemma 3.1 implies that, for every D bounded Borel subset of the plane:

$$\widehat{\mathbb{Q}}_h^{an}[S \cap D \neq \emptyset] \leq 4\mathbb{P}_{1/2}[\text{Piv}_D^q(h)] \leq 4\mathbb{P}_{1/2}[\text{Piv}_D(h)]$$

and:

$$\widehat{\mathbb{Q}}_h^{an}[\emptyset \neq S \subseteq D] \leq 4\mathbb{E}[\mathbf{P}_{1/2}^\eta[\text{Piv}_D^q(h)]^2] \leq 4\mathbb{E}[\mathbf{P}_{1/2}^\eta[\text{Piv}_D(h)]^2].$$

In the case where $h = g_n$ (which is the crossing event of $[0, n]^2$), we have proved (see respectively⁴ Lemmas 4.5 and D.13 of Chapter 5) that, if B is a 1×1 box included in $[0, n]^2$ and at distance at least $n/3$ from the sides of this square, then:

$$\mathbb{P}_{1/2}[\text{Piv}_B^q(g_n)] \asymp \alpha_4^{an}(n)$$

and:

$$\mathbb{E}[\mathbf{P}_{1/2}^\eta[\text{Piv}_B(g_n)]^2] \leq O(1) \tilde{\alpha}_4(n)^2.$$

Theorem 1.15 enables to compare the quantities $\alpha_4^{an}(n)$ and $\tilde{\alpha}_4(n)^2$ that appear naturally in the study of the annealed spectral sample, which will be crucial for us, for instance in ‘‘Step 1’’ of the proof written in Subsection 3.2.

Before writting the proofs of the main results on the annealed spectral sample (i.e. Theorems 2.5, 2.7 and 2.8), let us state another lemma that links the spectral sample to the pivotal sets. To this purpose, we need the following definition:

Definition 3.3. Let E be a countable set and $h : \Omega_E \rightarrow \{0, 1\}$ a function that depends on finitely many coordinates. If $n \in \mathbb{N}^*$ and J_1, \dots, J_n are mutually disjoint finite subsets of E , we say that J_1, \dots, J_n are jointly pivotal for h and some $\omega_E \in \Omega_E$ if for every $j_0 \in \{1, \dots, n\}$ there exists $\omega'_E \in \Omega_E$ such that ω_E and ω'_E coincide outside of $\cup_{j=1}^n J_j$ and $\omega'_E \in \text{Piv}_{J_{j_0}}^E(h)$. We write $JP_{J_1, \dots, J_n}^E(h)$ for the event that J_1, \dots, J_n are jointly pivotal.

Lemma 3.4 (Lemma 2.2 of [GPS10] for $n = 1$, Lemma 5.7 of Chapter 4 for the general case). *Let E be a countable set and $h : \Omega_E \rightarrow \{0, 1\}$ a function that depends on finitely many coordinates. Also, let $n \in \mathbb{N}^*$ and let J_1, \dots, J_n be mutually disjoint finite subsets of E . If $W \subseteq E$ satisfies $W \cap J_i = \emptyset$ for every $i \in \{1, \dots, n\}$, then:*

$$\widehat{\mathbb{Q}}_h[\forall i \in \{1, \dots, n\}, S \cap J_i \neq \emptyset = S \cap W] \leq 4^n \mathbf{E}_{1/2}^E \left[\mathbf{P}_{1/2}^E \left[JP_{J_1, \dots, J_n}^E(h) \mid (\omega_E)_{|W^c} \right]^2 \right].$$

Remark 3.5. If $n = 0$ we have the following (see (2.9) of [GPS10]):

$$\widehat{\mathbb{Q}}_h[S \cap W = \emptyset] = \mathbf{E}_{1/2}^E \left[\mathbf{E}_{1/2}^E \left[h(\omega_E) \mid (\omega_E)_{|W^c} \right]^2 \right].$$

⁴The results of Lemma D.13 of Chapter 5 are stated in the case h is the 1-arm event f_R but the proof of analogous results in the case $h = g_n$ is exactly the same.

3.2 Proof of the main estimates on the annealed spectral sample

In this subsection, we write the proofs of Theorems 2.5, 2.7 and 2.8. The proof of these three theorems follows the general method in three steps from [GPS10] (which is also used in Chapter 4). In this section, we assume that the reader has read Sections 4, 5, 6 and 7 of [GPS10] and Section 5 of Chapter 4.

We start by a 0th step in order to deal with the spectral mass of g_n and f_R outside of $[0, n]^2$ and $[-R, R]^2$ respectively.

Step 0. In this step, we prove the following estimate:

Lemma 3.6. *We have the following:*

$$\mathbb{P} [\mathcal{S}_{g_n}^{an} \setminus [0, n]^2 \neq \emptyset] \leq O(1) \frac{1}{n} \text{ and } \mathbb{P} [\mathcal{S}_{f_R}^{an} \setminus [-R, R]^2 \neq \emptyset] \leq O(1) \frac{1}{R}.$$

Proof. Let $(B_k)_{k \in \mathbb{N}}$ be an enumeration of the 1×1 boxes of the grid \mathbb{Z}^2 that are not included in $[0, n]^2$ (respectively $[-R, R]^2$). Then, by the first part of Lemma 3.1:

$$\begin{aligned} \mathbb{P} [\mathcal{S}_{g_n}^{an} \setminus [0, n]^2 \neq \emptyset] &\leq \sum_{k \in \mathbb{N}} \frac{\mathbb{E} [\widehat{\mathcal{Q}}_{g_n} [S \cap B_k \neq \emptyset]]}{\mathbb{E}_{1/2} [g_n]} \\ &\leq \sum_{k \in \mathbb{N}} 4 \frac{\mathbb{P}_{1/2} [\text{Piv}_{B_k}^q (g_n)]}{\mathbb{P}_{1/2} [\text{Cross}(n, n)]} \\ &\leq \sum_{k \in \mathbb{N}} 8 \mathbb{P}_{1/2} [\text{Piv}_{B_k} (g_n)], \end{aligned}$$

and similarly:

$$\mathbb{P} [\mathcal{S}_{f_R}^{an} \setminus [-R, R]^2 \neq \emptyset] \leq \sum_{k \in \mathbb{N}} \frac{\mathbb{P}_{1/2} [\text{Piv}_{B_k} (f_R)]}{\alpha_1^{an}(R)}.$$

In Section 4 of Chapter 5, we have estimated these sums (by using the computation of the 3-arm event in the half-plane). By following Section 4.3 of Chapter 5, one obtains that they are less than $O(1) n^{-1}$ (respectively $O(1) R^{-1}$). \square

Step 1. The first step is a combinatorial step that enables to estimate $\mathbb{P} [|\mathcal{S}_h^{an}| = k]$ for k sufficiently small (where h is the crossing event g_n or the 1-arm event f_R). For every $S \subseteq \mathbb{R}^2$ and $r \in]0, +\infty[$, we write $S(r)$ for the set of boxes of the grid $r\mathbb{Z}^2$ that intersect S . We will use the three following estimates to prove Theorems 2.5, 2.7 and 2.8 respectively.

Proposition 3.7. *There exists $\theta < +\infty$ such that, for every $1 \leq r \leq n < +\infty$ and every $k \in \mathbb{N}^*$:*

$$\mathbb{P} [|\mathcal{S}_{g_n}^{an}| = k, \mathcal{S}_{g_n}^{an} \subseteq [0, n]^2] \leq e^{-\theta \log^2(k+2)} \left(\frac{n}{r} \alpha_4^{an}(r, n) \right)^2.$$

Proposition 3.8. *There exists $\theta < +\infty$ such that, for every $1 \leq r \leq R < +\infty$ and every $k \in \mathbb{N}^*$:*

$$\mathbb{P} [|\mathcal{S}_{f_R}^{an}| = k, \mathcal{S}_{f_R}^{an} \subseteq [-R, R]^2] \leq e^{-\theta \log^2(k+2)} \alpha_1^{an}(r, R).$$

Proposition 3.9. *There exists $\varepsilon_1 > 0$ and $\theta < +\infty$ such that, for every $1 \leq r \leq r_0 \leq R/2 < +\infty$ and every $k \in \mathbb{N}^*$:*

$$\mathbb{P} [|\mathcal{S}_{f_R}^{an} \setminus [-r_0, r_0]^2| = k, \mathcal{S}_{f_R}^{an} \subseteq [-R, R]^2] \leq e^{-\theta \log^2(k+2)} \alpha_1^{an}(r_0, R) \left(\frac{r_0}{r} \right)^{1-\varepsilon_1} \alpha_4^{an}(r, r_0).$$

Let us prove these three propositions. The proofs follow [GPS10] and Chapter 4. We first need to prove an **annulus-structures** estimate. To this purpose, let us define three different annulus-structures. In these annulus structures, the A_i are annuli of the form $A_i = A(x_i, \rho_1(i), \rho_2(i)) = x_i + [-\rho_2(i), \rho_2(i)]^2 \setminus [-\rho_1(i), \rho_1(i)]^2$.

- An annulus structure for g_n is a collection of mutually disjoint annuli $\mathcal{A} = \{A_1, \dots, A_l\}$. An annulus A_i is called **interior** if it is contained in $[0, n]^2$, **side** if it is centered at a point of $\partial[0, n]^2$ and is at distance at least its outer radius from the other sides and **corner** if it is centered at a corner of $[0, n]^2$ and its outer radius is at most $n/2$. We assume that each A_i is an annulus of one of these kinds. For each $i \in \{1, \dots, l\}$, we let $h(A_i)$ be the annealed probability of the 4-arm event in A_i if A_i is interior, of the 3-arm event in $A_i \setminus [0, n]^2$ if it is side and of the 2-arm event in $A_i \setminus [0, n]^2$ if it is corner.
- An annulus structure for f_R is given by a collection $\mathcal{A} = \{A_1, \dots, A_l; r_{\mathcal{A}}\}$ where $r_{\mathcal{A}} \in \mathbb{R}_+$ and A_1, \dots, A_l are mutually disjoint annuli of the form $A_i = A(x_i, \rho_1(i), \rho_2(i))$ such that for each $i \in \{1, \dots, l\}$, A_i does not intersect $[-r_{\mathcal{A}}, r_{\mathcal{A}}]^2$. We define interior, side and corner annuli similarly as above except that the box $[0, n]^2$ is replaced by $[-R, R]^2$ and that we ask that the inner boxes of these annuli do not contain 0. We also need the notion of centered annuli: an annulus A_i is called **centered** if it is centered at 0 and included in $[-R, R]^2$. We assume that each A_i is an annulus of one of these kinds. For each $i \in \{1, \dots, l\}$, we let $h(A_i)$ be as above; if A_i is centered, we let $h(A_i)$ be the annealed probability of the 1-arm event in A_i .
- An r_0 -decorated annulus structure for f_R is a collection of mutually disjoint annuli $\mathcal{A} = \{A_1, \dots, A_l, A_{l+1}, \dots, A_m\}$ such that $\{A_1, \dots, A_l; r_0\}$ is an annulus structure for f_R and A_l, \dots, A_{l+1} are centered at a point of $\partial[-r_0, r_0]^2$ and have outer radius less than $r_0/2$. The annuli A_{l+1}, \dots, A_m are called **r_0 -annuli**. For each $i \in \{1, \dots, l\}$, we write $h(A_i)$ as above. For each $i \in \{l+1, \dots, m\}$, we let $h^{\varepsilon_1}(A_i)$ be the annealed probability of the 4-arm event in A_i times $(\rho_1(i)/\rho_2(i))^{\varepsilon_1}$ where ε_1 is the constant of Lemma D.5.

If \mathcal{A} is an annulus structure of g_n or f_R and if $S \subseteq \mathbb{R}^2$, we say that S is **compatible** with \mathcal{A} if S intersects the inner square of all the non-centered annuli and if S does not intersect any of the annuli. If \mathcal{A} is an r_0 -annulus structure and if $S \subseteq \mathbb{R}^2$, we say that S is **compatible** with \mathcal{A} if S intersects the inner square of all the non-centered annuli and if S does not intersect any of the sets $A_i \setminus [-r_0, r_0]^2$. Note that $A_i \cap [-r_0, r_0]^2 \neq \emptyset$ if and only if A_i is an r_0 -annulus. We have the following result:

Lemma 3.10. *In the case of an annulus structure of g_n , we have:*

$$\widehat{\mathbb{Q}}_{g_n}^{an} [S \text{ is compatible with } \mathcal{A}] \leq \prod_{i=1}^l O(1) h(A_i)^2. \quad (3.1)$$

In the case of an annulus structure of f_R , we have:

$$\widehat{\mathbb{Q}}_{f_R}^{an} [S \text{ is compatible with } \mathcal{A}] \leq O(1) \alpha_1^{an}(r_{\mathcal{A}}) \prod_{i=1}^l O(1) h(A_i)^2. \quad (3.2)$$

In the case of an r_0 -decorated annulus structure of f_R , we have:

$$\widehat{\mathbb{Q}}_{f_R}^{an} [S \text{ is compatible with } \mathcal{A}] \leq O(1) \alpha_1^{an}(r_0) \prod_{i=1}^l O(1) h(A_i)^2 \prod_{i=l+1}^m O(1) h^{\varepsilon_1}(A_i). \quad (3.3)$$

Proof. In this proof, we use the following definition:

Definition 3.11. If D_1, D_2 are two disjoint bounded Borel sets included in \mathbb{R}^2 and if h is a function from Ω to $\{0, 1\}$, we let:

$$\text{Piv}_{D_1}^{D_2}(h) = \left\{ \mathbb{P}_{1/2} \left[\text{Piv}_{D_1}(h) \mid \omega \cap D_2 \right] > 0 \right\}.$$

Let us first deal with (3.1). Let $W = \cup_{i=1}^l A_i$. Let B_i denote the inner box of A_i and let B'_1, \dots, B'_l be the inner boxes that do not contain any other inner box. Note that:

$$\{S \text{ is compatible with } \mathcal{A}\} = \{B'_1 \cap S, \dots, B'_l \cap S \neq \emptyset = W \cap S\}.$$

Remember that $\widehat{\mathbb{Q}}_{g_n}^{an}[\cdot] = \mathbb{E} \left[\widehat{\mathbb{Q}}_{g_n}^\eta[\cdot] \right]$. Lemma 3.4 implies that:

$$\begin{aligned} \widehat{\mathbb{Q}}_{g_n}^{an} [S \text{ is compatible with } \mathcal{A}] &\leq 4^l \mathbb{E} \left[\mathbf{P}_{1/2}^\eta \left[JP_{B'_1, \dots, B'_l}^\eta(g_n) \mid \omega \setminus W \right]^2 \right] \\ &\leq 4^l \mathbb{E} \left[\mathbf{P}_{1/2}^\eta \left[JP_{B'_1, \dots, B'_l}^\eta(g_n) \mid \omega \setminus W \right]^2 \right]. \end{aligned}$$

Note furthermore that:

$$JP_{B'_1, \dots, B'_l}^\eta(g_n) \subseteq \cap_{i=1}^l \text{Piv}_{B_i}^{A_i}(g_n).$$

Since $\text{Piv}_{B_i}^{A_i}(g_n)$ is measurable with respect to $\omega \cap A_i$ and by spatial independence, we have:

$$\widehat{\mathbb{Q}}_{g_n}^{an} [S \text{ is compatible with } \mathcal{A}] \leq \mathbb{E} \left[\prod_{i=1}^l 4 \mathbf{P}_{1/2}^\eta \left[\text{Piv}_{B_i}^{A_i}(g_n) \right]^2 \right] = \prod_{i=1}^l 4 \mathbb{E} \left[\mathbf{P}_{1/2}^\eta \left[\text{Piv}_{B_i}^{A_i}(g_n) \right]^2 \right].$$

Let $\rho_1(i)$ and $\rho_2(i)$ be the inner and outer radii of A_i . In Chapter 5 (Lemma D.13), we have proved that

$$\mathbb{E} \left[\mathbf{P}_{1/2}^\eta \left[\text{Piv}_{B_i}^{A_i}(g_n) \right]^2 \right] \leq O(1) \mathbb{E} \left[\mathbf{P}_{1/2}^\eta \left[\mathbf{A}_4(\rho_1(i), \rho_2(i)) \right]^2 \right]$$

when A_i is an interior annuli and for $\text{Piv}_{B_i}^{A_i}(f_R)$ instead of $\text{Piv}_{B_i}^{A_i}(g_n)$. The proof in the case of $\text{Piv}_{B_i}^{A_i}(g_n)$ is exactly the same. Moreover, Theorem 1.15 implies that:

$$\mathbb{E} \left[\mathbf{P}_{1/2}^\eta \left[\mathbf{A}_4(\rho_1(i), \rho_2(i)) \right]^2 \right] \asymp h(A_i)^2.$$

The case of side and corner annuli is treated exactly in the same way. This ends the proof of (3.1).

Let us now prove (3.2). Still write $W = \cup_{i=1}^l A_i$. Let B'_1, \dots, B'_l be the inner boxes of the non-centered annuli such that B'_i does not contain any other inner box. Note that $JP_{B'_1, \dots, B'_l}^\eta(f_R)$ is included in:

$$\widehat{\mathbf{A}}_1(1, r_{\mathcal{A}}) \cap \bigcap_{i=1}^l \text{Piv}_{B'_i}^{A_i}(f_R),$$

where $\widehat{\mathbf{A}}_1(\cdot, \cdot)$ is the event defined in Definition 1.16. By Proposition 1.17:

$$\mathbb{E} \left[\mathbf{P}_{1/2}^\eta \left[\widehat{\mathbf{A}}_1(1, r_{\mathcal{A}}) \mid \omega \setminus W \right]^2 \right] = \mathbb{P}_{1/2} \left[\widehat{\mathbf{A}}_1(1, r_{\mathcal{A}}) \right] \leq O(1) \alpha_1^{an}(r_{\mathcal{A}});$$

Now, the proof is the same as the proof of (3.1).

Let us now prove (3.3). In this case, we let $W = \cup_{i=1}^m A_i \setminus [-r_0, r_0]^2$. Moreover, let $B'_1, \dots, B'_{m'}$ be the inner boxes of the non-centered annuli such that B'_i does not contain any other inner box. Note that:

$$\{S \text{ is compatible with } \mathcal{A}\} = \{B'_1 \cap S, \dots, B'_{m'} \cap S \neq \emptyset = W \cap S\}$$

and:

$$JP_{B'_1, \dots, B'_{m'}}^\eta(f_R) \subseteq \widehat{\mathbf{A}}_1(1, r_0/2) \cap \bigcap_{i=1}^m \text{Piv}_{B'_i}^{A_i}(f_R).$$

Note also that $A_i \cap [-r_0/2, r_0/2]^2 = \emptyset$ for every $i \in \{1, \dots, m\}$. The fact that S may intersect the sets $A_i \cap [-r_0, r_0]^2$ adds a new difficulty. If we follow the proof of (3.2), it only remains to deal with the annuli that intersect $[-r_0, r_0]^2$ - i.e. the r_0 -annuli - and prove that for these annuli:

$$\mathbb{E} \left[\mathbf{P}_{1/2}^\eta \left[\text{Piv}_{B'_i}^{A_i}(f_R) \mid \omega \setminus W \right]^2 \right] \leq O(1) \alpha_4^{an}(\rho_1(i), \rho_2(i)) \left(\frac{\rho_1(i)}{\rho_2(i)} \right)^{\varepsilon_1},$$

where $\varepsilon_1 > 0$ is the constant of Lemma D.5. To prove it, first note that:

$$\mathbb{E} \left[\mathbf{P}_{1/2}^\eta \left[\text{Piv}_{B'_i}^{A_i}(f_R) \mid \omega \setminus W \right]^2 \right] = \mathbb{E} \left[\mathbf{P}_{1/2}^\eta \left[\text{Piv}_{B'_i}^{A_i}(f_R) \mid \omega \cap [-r_0, r_0]^2 \right]^2 \right]$$

since $\text{Piv}_{B'_i}^{A_i}(f_R)$ is measurable with respect to $\omega \cap A_i$. Note also that there exists a (closed) half plane H_i that contains $[-r_0, r_0]^2$ and whose boundary contains the center of A_i and is parallel to the x or y axis. Note furthermore that:

$$\mathbb{E} \left[\mathbf{P}_{1/2}^\eta \left[\text{Piv}_{B'_i}^{A_i}(f_R) \mid \omega \cap [-r_0, r_0]^2 \right]^2 \right] \leq \mathbb{E} \left[\mathbf{P}_{1/2}^\eta \left[\text{Piv}_{B'_i}^{A_i}(f_R) \mid \omega \cap H_i \right]^2 \right].$$

Now, we can end the proof by applying Lemma D.5. \square

Proof of Propositions 3.7, 3.8 and 3.9. Once Lemma 3.10 is proved, the proofs of Propositions 3.7 and 3.8 (respectively Proposition 3.9) are exactly the same as the proof of Propositions 4.1 and 4.7 of [GPS10] (respectively Proposition 5.3 of Chapter 4) if one uses the estimates on arm events from Subsection 1.3. Therefore, we refer to these papers for the proofs. \square

Step 2. In this section, we prove the two following results. In these results, \mathcal{Z}_r is a random subset of the plane. More precisely, this is a union of boxes of the grid $r\mathbb{Z}^2$, each box of this grid being included in \mathcal{Z}_r with probability $(r^2 \alpha_4^{an}(r))^{-1}$, independently of the other boxes.

Proposition 3.12. *Let $r \in [1, n]$ and let $\mathcal{S}_{g_n}^{an}$ be a spectral sample of g_n independent of \mathcal{Z}_r . Let B be a box of radius r and let B' be the concentric box with radius $r/3$. We assume that $B' \subseteq [0, n]^2$. Also, let W be a Borel subset of the plane such that $W \cap B = \emptyset$. There exist two absolute constants $\bar{r} < +\infty$ and $a > 0$ such that if $r \geq \bar{r}$ then:*

$$\mathbb{P} \left[\mathcal{S}_{g_n}^{an} \cap B' \cap \mathcal{Z}_r \neq \emptyset \mid \mathcal{S}_{g_n}^{an} \cap B \neq \emptyset = \mathcal{S}_{g_n}^{an} \cap W \right] \geq a.$$

Proposition 3.13. *Let $r \in [1, R]$ and let $\mathcal{S}_{f_R}^{an}$ be a spectral sample of f_R independent of \mathcal{Z}_r . Let B be a box of radius r and let B' be the concentric box with radius $r/3$. We assume that $B' \subseteq [-R, R]^2$ and $B \cap [-4r, 4r]^2 = \emptyset$. Also, let W be a Borel subset of the plane such that $W \cap B = \emptyset$. There exist two absolute constants $\bar{r} < +\infty$ and $a > 0$ such that if $r \geq \bar{r}$ then:*

$$\mathbb{P} \left[\mathcal{S}_{f_R}^{an} \cap B' \cap \mathcal{Z}_r \neq \emptyset \mid \mathcal{S}_{f_R}^{an} \cap B \neq \emptyset = \mathcal{S}_{f_R}^{an} \cap W \right] \geq a.$$

Remark 3.14. With exactly the same proofs, we can also obtain the analogues of Propositions 3.12 and 3.13 where B and B' are not squares but rectangles of shape not too degenerate. More precisely, these proposition hold with the same hypothesis except that we can ask for instance that B is of the form $x + [0, \rho_1] \times [0, \rho_2]$ and $B' \subseteq B$ is of the form $x' + [0, \rho'_1] \times [0, \rho'_2]$, where $\frac{r}{2} \leq \rho'_1, \rho'_2 \leq 2r$, $\frac{r}{6} \leq \rho_1, \rho_2 \leq r$ and where B' is at distance at least $\frac{r}{6}$ from the sides of B .

Propositions 3.12 and 3.13 follow from a second and a first moment estimates. Let us fix two boxes B and B' like in these propositions. In Subsection 5.7 of [GPS10], the authors explain how one can adapt the proof of the analogue of Proposition 3.12 (which is Proposition 5.1 of [GPS10]) in order to obtain the analogue of Proposition 3.13 (which is Proposition 5.12 of [GPS10]). The way to adapt the proof in our case is exactly the same so we only write the proof of Proposition 3.12.

A second moment estimate.

Lemma 3.15. *Let \square_1 and \square_2 be two 1×1 squares of the grid \mathbb{Z}^2 included in B' . Then:*

$$\begin{aligned} \mathbb{P} [\mathcal{S}_{g_n}^{an} \cap \square_1 \neq \emptyset, \mathcal{S}_{g_n}^{an} \cap \square_2 \neq \emptyset, \mathcal{S}_{g_n}^{an} \cap W = \emptyset] \\ \leq O(1) \alpha_4^{an} (\text{dist}(\square_1, \square_2)) \alpha_4^{an}(r) \mathbb{E} \left[\mathbf{P}_{1/2}^\eta \left[\text{Piv}_B(g_n) \mid \omega \setminus W \right]^2 \right], \end{aligned}$$

where $\text{dist}(\square_1, \square_2)$ is the Euclidean distance between the two squares.

Proof. All the annuli considered in these proofs are of the form $A(x; \rho_1, \rho_2)$. Let A_1 (respectively A_2) be an annulus co-centered with \square_1 (respectively \square_2) of inner-radius 1 and of outer radius $\text{dist}(\square_1, \square_2)/2$. Also, let A_3 be the annulus centered at a point at distance $\text{dist}(\square_1, \square_2)/2$ from both \square_1 and \square_2 , of inner radius $\text{dist}(\square_1, \square_2)$ and of outer radius $r/3$. Note that $JP_{\square_1, \square_2}^\eta(g_n)$ is included in $\text{Piv}_{\square_1}^{A_1}(g_n) \cap \text{Piv}_{\square_1}^{A_2}(g_n) \cap \text{Piv}_{\square_3}^{A_3}(g_n) \cap \text{Piv}_B(g_n)$, where \square_3 is the inner square of A_3 . By spatial independence, by using that W does not intersects B and by Lemma 3.4 we have:

$$\begin{aligned} \widehat{\mathbb{Q}}_{g_n}^{an} [S \cap \square_1 \neq \emptyset, S \cap \square_2 \neq \emptyset, S \cap W = \emptyset] \\ \leq 4^2 \mathbb{E} \left[\mathbf{P}_{1/2}^\eta \left[\text{Piv}_B(g_n) \mid \omega \setminus W \right]^2 \right] \prod_{i=1}^3 \mathbb{E} \left[\mathbf{P}_{1/2}^\eta \left[\text{Piv}_{\square_i}^{A_i}(g_n) \right] \right] \\ \leq 4^2 \mathbb{E} \left[\mathbf{P}_{1/2}^\eta \left[\text{Piv}_B(g_n) \mid \omega \setminus W \right]^2 \right] \prod_{i=1}^3 \mathbb{P}_{1/2} \left[\text{Piv}_{\square_i}^{A_i}(g_n) \right]. \end{aligned}$$

By Lemma 4.9 of Chapter 5 we have:

$$\prod_{i=1}^3 \mathbb{P}_{1/2} \left[\text{Piv}_{\square_i}^{A_i}(g_n) \right] \leq O(1) \alpha_4^{an} (\text{dist}(\square_1, \square_2))^2 \alpha_4^{an} (\text{dist}(\square_1, \square_2), r).$$

By the quasi-multiplicativity property, we have:

$$\alpha_4^{an} (\text{dist}(\square_1, \square_2))^2 \alpha_4^{an} (\text{dist}(\square_1, \square_2), r) \leq O(1) \alpha_4^{an}(r) \alpha_4^{an} (\text{dist}(\square_1, \square_2)).$$

This ends the proof since the distribution of $\mathcal{S}_{g_n}^{an}$ is:

$$\frac{\widehat{\mathbb{Q}}_{g_n}^{an} [\cdot]}{\mathbb{P}_{1/2} [\text{Cross}(n, n)]} = 2 \widehat{\mathbb{Q}}_{g_n}^{an} [\cdot].$$

□

A first moment estimate.

Lemma 3.16. *Let \square be a 1×1 square of the grid \mathbb{Z}^2 included in B' . Then:*

$$\mathbb{P} [\mathcal{S}_{g_n}^{an} \cap \square \neq \emptyset = \mathcal{S}_{g_n}^{an} \cap W] \geq \Omega(1) \alpha_4^{an}(r) \mathbb{E} \left[\mathbf{P}_{1/2}^\eta \left[\text{Piv}_B(g_n) \mid \omega \setminus W \right]^2 \right].$$

Before proving Lemma 3.16, let us explain how to deduce Proposition 3.12 from Lemmas 3.15 and 3.16.

Proof of Proposition 3.12. Remember that, if $S \subseteq \mathbb{R}^2$ and $r \in \mathbb{R}_+$, $\mathcal{S}(r)$ denotes the set of all squares of the grid $r\mathbb{Z}^2$ that intersect S . Let $Y = |\mathcal{S}_{g_n}^{an}(1) \cap B' \cap \mathcal{Z}_r| \mathbf{1}_{\mathcal{S}_{g_n}^{an} \cap W = \emptyset}$. Lemma 3.16 implies that (by definition of \mathcal{Z}_r and since it is independent of the annealed spectral sample):

$$\mathbb{E}[Y] \geq \Omega(1) \mathbb{E} \left[\mathbf{P}_{1/2}^\eta \left[\text{Piv}_B(g_n) \mid \omega \setminus W \right]^2 \right].$$

Moreover, Lemma 3.15 implies that (by distinguishing between diagonal and non-diagonal terms):

$$\begin{aligned} \mathbb{E}[Y^2] &\leq O(1) \mathbb{E} \left[\mathbf{P}_{1/2}^\eta \left[\text{Piv}_B(g_n) \mid \omega \setminus W \right]^2 \right] \\ &\quad + \mathbb{E} \left[\mathbf{P}_{1/2}^\eta \left[\text{Piv}_B(g_n) \mid \omega \setminus W \right]^2 \right] \frac{1}{\alpha_4^{an}(r)^2 r^4} \sum \alpha_4^{an}(\text{dist}(\square_1, \square_2)) \alpha_4^{an}(r), \end{aligned}$$

where the sum is over every 1×1 squares $\square_1 \neq \square_2$ of the grid \mathbb{Z}^2 that are included in B' . By the quasi-multiplicativity property, we have:

$$\begin{aligned} \sum \alpha_4^{an}(\text{dist}(\square_1, \square_2)) \alpha_4^{an}(r) &\leq O(1) r^2 \sum_{k=0}^{\log_2(r)} 2^{2k} \alpha_4^{an}(2^k) \alpha_4^{an}(r) \\ &\leq O(1) r^2 \alpha_4^{an}(r)^2 \sum_{k=0}^{\log_2(r)} 2^{2k} \alpha_4^{an}(2^k, r)^{-1}. \end{aligned}$$

By using the fact that (for all $r' \leq r$) $\alpha_4^{an}(r', r) \geq O(1) (r'/r)^{2-\Omega(1)}$, it is not difficult to see that the above is at most:

$$r^4 \alpha_4^{an}(r)^2.$$

As a result:

$$\mathbb{E}[Y^2] \leq O(1) \mathbb{E} \left[\mathbf{P}_{1/2}^\eta \left[\text{Piv}_B(g_n) \mid \omega \setminus W \right]^2 \right].$$

Next, note that (by Lemma 3.4 with $n = 1$):

$$\begin{aligned} \mathbb{P} [\mathcal{S}_{g_n}^{an} \cap B \neq \emptyset = \mathcal{S}_{g_n}^{an} \cap W] &= \frac{\mathbb{E} \left[\widehat{\mathcal{Q}}_{g_n}^\eta [S \cap B \neq \emptyset = S \cap W] \right]}{\mathbb{P}_{1/2} [\text{Cross}(n, n)]} \\ &\leq 8 \mathbb{E} \left[\mathbf{P}_{1/2}^\eta \left[\text{Piv}_B^q(g_n) \mid \omega \setminus W \right]^2 \right] \\ &\leq 8 \mathbb{E} \left[\mathbf{P}_{1/2}^\eta \left[\text{Piv}_B(g_n) \mid \omega \setminus W \right]^2 \right]. \end{aligned}$$

As a result:

$$\mathbb{P} \left[\mathcal{S}_{g_n}^{an} \cap B' \cap \mathcal{Z}_r \neq \emptyset \mid \mathcal{S}_{g_n}^{an} \cap B \neq \emptyset = \mathcal{S}_{g_n}^{an} \cap W \right] \geq \frac{\mathbb{P}[Y > 0]}{8 \mathbb{E} \left[\mathbf{P}_{1/2}^\eta \left[\text{Piv}_B(g_n) \mid \omega \setminus W \right]^2 \right]}.$$

By the Cauchy-Schwarz inequality, we have

$$\mathbb{P}[Y > 0] \geq \frac{\mathbb{E}[Y]^2}{\mathbb{E}[Y^2]} \geq \Omega(1) \mathbb{E} \left[\mathbf{P}_{1/2}^\eta \left[\text{Piv}_B(g_n) \mid \omega \setminus W \right]^2 \right],$$

which ends the proof. \square

Let us start the proof of Lemma 3.16. Let \square be a 1×1 square of the grid \mathbb{Z}^2 included in B' . When $|\eta \cap \square| = 1$, we let x be the only element of this set. We have:

$$\begin{aligned} \mathbb{P}[\mathcal{S}_{g_n}^{an} \cap \square \neq \emptyset = \mathcal{S} \cap W] &= \frac{1}{\mathbb{P}_{1/2}[\text{Cross}(n, n)]} \mathbb{E} \left[\widehat{\mathcal{Q}}_{g_n}^\eta [S \cap \square \neq \emptyset = S \cap W] \right] \\ &\geq 2 \mathbb{E} \left[\mathbf{1}_{|\square \cap \eta|=1} \widehat{\mathcal{Q}}_{g_n}^\eta [x \in S, S \cap W = \emptyset] \right]. \end{aligned}$$

By Lemma 2.1 of [GPS10], we have:

$$\widehat{\mathcal{Q}}_{g_n}^\eta [x \in S, S \cap W = \emptyset] = \mathbf{E}_{1/2}^\eta \left[\mathbf{E}_{1/2}^\eta \left[\chi_{\{x\}}^\eta g_n^\eta \mid \omega \setminus (W \cup \{x\}) \right]^2 \right].$$

Since g_n^η is increasing and only takes values 0 and 1, we have:

$$\mathbf{E}_{1/2}^\eta \left[\chi_{\{x\}}^\eta g_n^\eta \mid \omega \setminus \{x\} \right] = \frac{1}{2} \mathbf{1}_{\text{Piv}_x^q(g_n)}.$$

As a result:

$$\begin{aligned} \mathbf{E}_{1/2}^\eta \left[\chi_{\{x\}}^\eta g_n^\eta \mid \omega \setminus (W \cup \{x\}) \right] &= \mathbf{E}_{1/2}^\eta \left[\mathbf{E}_{1/2}^\eta \left[\chi_{\{x\}}^\eta g_n^\eta \mid \omega \setminus \{x\} \right] \mid \omega \setminus W \right] \\ &= \frac{1}{2} \mathbf{P}_{1/2}^\eta \left[\text{Piv}_x^q(g_n) \mid \omega \setminus W \right]. \end{aligned}$$

By the observation at the beginning of Subsection 5.3 of [GPS10], we have the following: Let $\omega', \omega'' \sim \mathbb{P}_{1/2}$ be two configurations that have the same underlying point process η and satisfy i) $\omega|_{\eta \setminus W} = \omega'|_{\eta \setminus W}$ and ii) conditionally on η , $\omega|_{\eta \cap W}$ is independent of $\omega'|_{\eta \cap W}$. Then:

$$\mathbf{E}_{1/2}^\eta \left[\mathbf{E}_{1/2}^\eta \left[\text{Piv}_x^q(g_n) \mid \omega \setminus W \right]^2 \right] = \mathbb{E} \left[\omega', \omega'' \in \text{Piv}_x^q(g_n) \mid \eta \right].$$

As a result:

$$\mathbb{P}[\mathcal{S}_{g_n}^{an} \cap \square \neq \emptyset = \mathcal{S} \cap W] \geq \frac{1}{2} \mathbb{E} \left[\mathbf{1}_{|\eta \cap \square|=1} \mathbb{P} \left[\omega', \omega'' \in \text{Piv}_x^q(g_n) \mid \eta \right] \right].$$

Therefore, in order to prove Lemma 3.16, it is sufficient to show that:

$$\mathbb{E} \left[\mathbf{1}_{|\eta \cap \square|=1} \mathbb{P} \left[\omega', \omega'' \in \text{Piv}_x^q(g_n) \mid \eta \right] \right] \geq \Omega(1) \alpha_4^{an}(r) \mathbb{E} \left[\mathbf{P}_{1/2}^\eta \left[\text{Piv}_B(g_n) \mid \omega \setminus W \right]^2 \right].$$

If we use the observation at the beginning of Subsection 5.3 of [GPS10] once again, we obtain that:

$$\mathbb{E} \left[\mathbf{P}_{1/2}^\eta \left[\text{Piv}_B(g_n) \mid \omega \setminus W \right]^2 \right] = \mathbb{P} \left[\omega', \omega'' \in \text{Piv}_B(g_n) \right].$$

As a result, it is enough to prove that:

$$\mathbb{E} \left[\mathbf{1}_{|\eta \cap \square|=1} \mathbb{P} \left[\omega', \omega'' \in \text{Piv}_x^q(g_n) \mid \eta \right] \right] \geq \Omega(1) \alpha_4^{an}(r) \mathbb{P} \left[\omega', \omega'' \in \text{Piv}_B(g_n) \right], \quad (3.4)$$

which is a quasi-multiplicativity type estimate. The proof of (3.4) is written in Subsection 3.3 by relying on quasi-multiplicativity arguments from [GPS10] and Chapter 5.

Step 3. The last step in [GPS10] is the proof of the following general large deviation result:

Proposition 3.17 (Proposition 6.1 of [GPS10]). *Let $n \in \mathbb{N}^*$ and let x, y be two random variables with values in $\{0, 1\}^n$ such that $x_i \geq y_i$ for every $i \in \{1, \dots, n\}$. Write $X = \sum_{i=1}^n x_i$ and $Y = \sum_{i=1}^n y_i$. Assume that there exists $a \in]0, 1[$ such that, for every $j \in \{1, \dots, n\}$ and every $I \subseteq \{1, \dots, n\} \setminus \{j\}$, we have:*

$$\mathbb{P} \left[y_j = 1 \mid y_i = 0 \forall i \in I \right] \geq a \mathbb{P} \left[x_j = 1 \mid y_i = 0 \forall i \in I \right].$$

Then:

$$\mathbb{P} \left[Y = 0 \mid X > 0 \right] \leq \frac{1}{a} \mathbb{E} \left[\exp(-aX/e) \mid X > 0 \right].$$

Let us end this section by explaining how to combine the three steps in order to obtain Theorems 2.5, 2.7 and 2.8.

Proof of Theorems 2.5, 2.7 and 2.8. Remember that, if $S \subseteq \mathbb{R}^2$ and $r \in \mathbb{R}_+$, we write $S(r)$ for the set of all squares of the grid $r\mathbb{Z}^2$ that intersect S . If we use the results of the three steps above and if we follow Section 7 of [GPS10] and Subsection 5.2.2 of Chapter 4 (where analogues of Theorems 2.5, 2.7 and 2.8 are proved) we obtain that:

$$\mathbb{P} \left[0 < |\mathcal{S}_{g_n}^{an}(1)| < r^2 \alpha_4^{an}(r), \mathcal{S}_{g_n}^{an} \subseteq [0, n]^2 \right] \leq O(1) \left(\frac{n}{r} \alpha_4^{an}(r, n) \right)^2;$$

$$\mathbb{P} \left[0 < |\mathcal{S}_{f_R}^{an}(1)| < r^2 \alpha_4^{an}(r), \mathcal{S}_{f_R}^{an} \subseteq [-R, R]^2 \right] \leq O(1) \alpha_1^{an}(r, R);$$

and:

$$\begin{aligned} \mathbb{P} \left[0 < |\mathcal{S}_{f_R}^{an}(1) \setminus [-r_0, r_0]^2| < r^2 \alpha_4^{an}(r), \mathcal{S}_{f_R}^{an} \subseteq [-R, R]^2 \right] \\ \leq O(1) \alpha_1^{an}(r_0, R) \left(\frac{r_0}{r} \right)^{1-\varepsilon_1} \alpha_4^{an}(r, r_0). \end{aligned}$$

Note that (for any h) $|\mathcal{S}_h^{an}| \geq |\mathcal{S}_h^{an}(1)|$, so these three results also hold with $|\mathcal{S}_h^{an}|$ instead of $|\mathcal{S}_h^{an}(1)|$. As a result, it only remains to deal with the events $\{\mathcal{S}_{g_n}^{an} \not\subseteq [0, n]^2\}$ and $\{\mathcal{S}_{f_R}^{an} \not\subseteq [-R, R]^2\}$. Lemma 3.6 implies that:

$$\mathbb{P} \left[\mathcal{S}_{g_n}^{an} \not\subseteq [0, n]^2 \right] \leq O(1) / n,$$

which ends the proof of Theorem 2.5 (i.e. the result concerning g_n). Concerning the function f_R , Lemma 3.6 implies that:

$$\mathbb{P} \left[\mathcal{S}_{f_R}^{an} \not\subseteq [-R, R]^2 \right] \leq O(1) \frac{1}{R}.$$

Therefore, in order to prove Theorems 2.7 and 2.8 it only remains to prove that $1/R$ is

- i) less than $O(1) \alpha_1(r, R)$;
- ii) less than $O(1) \alpha_1^{an}(r_0, R) \left(\frac{r_0}{r} \right)^{1-\varepsilon_1} \alpha_4^{an}(r, r_0)$.

Item i) comes for instance from the fact that the probability of the 1-arm event is greater than the probability of the 2-arm event in the half-plane which has exponent 1 (see Proposition 1.14). Let us prove Item ii). By Proposition 1.12, there exists $\varepsilon > 0$ such that:

$$\alpha_4^{an}(r, r_0) \geq \varepsilon \left(\frac{r}{r_0} \right)^{2-\varepsilon} \frac{1}{\alpha_1^{an}(r, r_0)}.$$

We assume without loss of generality that $\varepsilon_1 \leq \varepsilon$. We obtain that:

$$\alpha_1^{an}(r_0, R) \left(\frac{r_0}{r}\right)^{1-\varepsilon_1} \alpha_4^{an}(r, r_0) \geq \varepsilon \frac{\alpha_1^{an}(r_0, R)}{\alpha_1^{an}(r, r_0)} \cdot \frac{r}{r_0},$$

which is larger than or equal to:

$$\Omega(1)\alpha_1^{an}(r_0, R) \cdot \frac{r}{r_0} \geq \Omega(1)\frac{r_0}{R} \cdot \frac{r}{r_0} \geq \Omega(1)\frac{1}{R}.$$

This ends the proof of Item ii). □

3.3 Quasi-multiplicativity properties for the annealed spectral sample

In this subsection, we prove (3.4), which implies Lemma 3.15. We refer to Step 2 of Subsection 3.2 for the notations used in the present subsection. The proof of (3.4) relies on quasi-multiplicativity estimates. **In this section, we assume that the reader has read Section 5 of [GPS10]** (where the authors prove the analogue of (3.4) for Bernoulli percolation) **and Section 7 of Chapter 5** (where the quasi-multiplicativity property is proved for Voronoi percolation). Let us first define some events introduced in Chapter 5. The idea is that, if one wants to prove a quasi-multiplicativity type property, one can first try to prove that, conditionally on a j -arm event between scales r and R , the events defined in the three definitions below are typically satisfied at scales r and R .

Definition 3.18. If $\delta \in]0, 1[$ and D is a bounded Borel subset of the plane, we write $\text{Dense}_\delta(D)$ for the event that, for every $u \in D$, there exists $x \in \eta \cap D$ such that $\|x - u\|_2 \leq \delta \cdot \text{diam}(D)$.

Definition 3.19. In this definition, we introduce the event $\text{QBC}_\delta(D)$. This event is roughly the event that the quenched crossing probabilities of all the quads included in D whose “dimensions” are larger than $\delta \cdot \text{diam}(D)$ are non-degenerate.

- A **quad** is a topological rectangle, i.e. a subset of the plane homeomorphic to a closed disc with two disjoint non empty segments on its boundary. If Q is a quad, the event $\text{Cross}(Q)$ is the event that there is a black path included in Q that joins one segment to the other.
- Let D be a subset of the plane and let $\delta \in]0, 1[$. We denote by $\mathcal{Q}'_\delta(D)$ the set of all quads $Q \subseteq D$ which are drawn on the grid $(\delta \text{diam}(D)) \cdot \mathbb{Z}^2$ (i.e. whose sides are included in the edges of $(\delta \text{diam}(D)) \cdot \mathbb{Z}^2$ and whose corners are vertices of $(\delta \text{diam}(D)) \cdot \mathbb{Z}^2$). Also, we denote by $\mathcal{Q}_\delta(D)$ the set of all quads $Q \subseteq D$ such that there exists a quad $Q' \in \mathcal{Q}'_\delta(D)$ satisfying $\text{Cross}(Q') \subseteq \text{Cross}(Q)$.
- By Chapter 5 (Proposition 2.13), there exists a constant $C < +\infty$ such that the following holds: For every $\delta \in]0, 1[$ and every $\gamma \in]0, +\infty[$ there exists $c = c(\delta, \gamma) \in]0, 1[$ such that, for every D Borel subset of the plane that satisfies $\text{diam}(D) \geq \delta^{-2}/100$, we have:

$$\mathbb{P} \left[\forall Q \in \mathcal{Q}_\delta(D), \mathbf{P}_{1/2}^\eta [\text{Cross}(Q)] \geq c \right] \geq 1 - C \text{diam}(D)^{-\gamma}.$$

We write:

$$\text{QBC}_\delta^\gamma(D) = \{ \forall Q \in \mathcal{Q}_\delta(D), \mathbf{P}_{1/2}^\eta [\text{Cross}(Q)] \geq c(\delta, \gamma) \}.$$

(for “Quenched Box Crossings”).

The events from Definition 3.20 are the events that the interfaces at scale r or R are well separated.

Definition 3.20. Let $\delta \in]0, 1/100[$ and $1 \leq r \leq R < +\infty$. Also, let β_1, \dots, β_k denote the interfaces from $\partial[-r, r]^2$ to $\partial[-R, R]^2$ (which are drawn on the edges of the Voronoi cells) and let z_i^{ext} (respectively z_i^{int}) denote the end point of $\partial\beta_i$ on $\partial[-R, R]^2$ (respectively on $\partial[-r, r]^2$). We write $s^{ext}(r, R)$ for the infimum of $\|z_i^{ext} - z_j^{ext}\|_2$ (for $i \neq j$) and $s^{int}(r, R)$ for the infimum of $\|z_i^{int} - z_j^{int}\|_2$. We define the two following events (where GI means Good Interfaces''):

$$\text{GI}_\delta^{ext}(R) = \{s^{ext}(3R/4, R) \geq 10\delta R\}$$

and:

$$\text{GI}_\delta^{int}(r) = \{s^{ext}(3r/2) \geq 10\delta r\}.$$

(In Chapter 5, these events are denoted by $\widetilde{\text{GI}}_\delta^{ext}(R)$ and $\widetilde{\text{GI}}_\delta^{int}(r)$.)

We need several lemmas to prove (3.4). In these lemmas, we use the following notations:

- (a) W is a Borel subset of the plane,
- (b) $\omega', \omega'' \sim \mathbb{P}_{1/2}$ are two configurations that have the same underlying point process η and satisfy i) $\omega|_{\eta \setminus W} = \omega'|_{\eta \setminus W}$ and ii) conditionally on η , $\omega|_{\eta \cap W}$ is independent of $\omega'|_{\eta \cap W}$.

Moreover, for any $1 \leq r \leq R < +\infty$, we write:

$$\beta_4^{an,W}(r, R) = \mathbb{P}[\omega', \omega'' \in \mathbf{A}_4(r, R)],$$

and:

$$\widehat{\beta}_4^{an,W}(r, R) = \mathbb{P}[\omega', \omega'' \in \widehat{\mathbf{A}}_4(r, R)].$$

where the events $\widehat{\mathbf{A}}_4(r, R)$ are the events from Definition 1.16. We also define the following events analogous to $\widehat{\mathbf{A}}_4(r, R)$:

$$\widehat{\mathbf{A}}_4^{ext}(r, R) = \left\{ \mathbb{P}_{1/2} \left[\mathbf{A}_4(r, R) \mid \omega \cap B(0, R) \right] > 0 \right\},$$

$$\widehat{\mathbf{A}}_4^{int}(r, R) = \left\{ \mathbb{P}_{1/2} \left[\mathbf{A}_4(r, R) \mid \omega \setminus B(0, r) \right] > 0 \right\}$$

and we let:

$$\widehat{\beta}_4^{an,ext,W}(r, R) = \mathbb{P}[\omega', \omega'' \in \widehat{\mathbf{A}}_4^{ext}(r, R)], \quad \widehat{\beta}_4^{an,int,W}(r, R) = \mathbb{P}[\omega', \omega'' \in \widehat{\mathbf{A}}_4^{int}(r, R)].$$

Note that we clearly have:

$$\beta_4^{an,W}(r, R) \leq \beta_4^{an,ext,W}(r, R), \quad \beta_4^{an,int,W}(r, R) \leq \beta_4^{an,W}(r, R).$$

We will prove that actually all these inequalities are equalities up to constants. The following lemma is the analogue of Lemma 5.7 of [GPS10].

Lemma 3.21. *For any $\varepsilon > 0$, there exists $\bar{r} = \bar{r}(\varepsilon) < +\infty$, $c = c(\varepsilon) > 0$ and an absolute constant $d \in]0, +\infty[$ (\bar{r} , c and d are independent of W) such that the following holds:*

- For any $r_0 \geq 1$ and $r \geq r_0 \vee \bar{r}$ that satisfy

$$\widehat{\beta}_4^{an,ext,W}(r_0, 2r) \geq \varepsilon \widehat{\beta}_4^{an,ext,W}(r_0, r), \tag{3.5}$$

we have:

$$\forall r' \geq r, \quad \beta_4^{an,W}(r_0, r') \geq c \widehat{\beta}_4^{an,ext,W}(r_0, r) \left(\frac{r}{r'} \right)^d. \tag{3.6}$$

- For any $r_0 \geq \bar{r}$ and any $r \in [\bar{r}, r_0]$ that satisfy:

$$\widehat{\beta}_4^{an,int,W}(r/2, r_0) \geq \varepsilon \widehat{\beta}_4^{an,int,W}(r, r_0), \quad (3.7)$$

we have:

$$\forall r' \in [\bar{r}, r], \beta_4^{an,W}(r', r_0) \geq c \widehat{\beta}_4^{an,int,W}(r, r_0) \left(\frac{r'}{r}\right)^d. \quad (3.8)$$

Proof. We only prove the first item since the proof of the second one is the same. Let:

$$X' = \mathbb{P} \left[\omega' \in \widehat{\mathbf{A}}_4^{ext}(r_0, 2r) \mid \omega' \cap B(0, r) \right]$$

and:

$$X'' = \mathbb{P} \left[\omega'' \in \widehat{\mathbf{A}}_4^{ext}(r_0, 2r) \mid \omega'' \cap B(0, r) \right].$$

We have:

$$\begin{aligned} & \mathbb{P} \left[\omega', \omega'' \in \widehat{\mathbf{A}}_4^{ext}(r_0, 2r) \mid \omega' \cap B(0, r), \omega'' \cap B(0, r) \right] \\ & \leq \mathbb{P} \left[\omega' \in \widehat{\mathbf{A}}_4^{ext}(r_0, 2r) \mid \omega' \cap B(0, r), \omega'' \cap B(0, r) \right] \\ & \quad \wedge \mathbb{P} \left[\omega'' \in \widehat{\mathbf{A}}_4^{ext}(r_0, 2r) \mid \omega' \cap B(0, r), \omega'' \cap B(0, r) \right] \\ & = X' \wedge X'' =: \widetilde{X}. \quad (3.9) \end{aligned}$$

As a result:

$$\mathbb{E} \left[\widetilde{X} \right] \geq \widehat{\beta}_4^{an,ext,W}(r_0, 2r) \geq \varepsilon \widehat{\beta}_4^{an,ext,W}(r_0, r) \quad (\text{by (3.5)}).$$

Now, note that⁵ $\{\widetilde{X} > 0\} \subseteq \{\omega', \omega'' \in \widehat{\mathbf{A}}_4^{ext}(r_0, r)\}$. As a result:

$$\mathbb{E} \left[\widetilde{X} \mid \omega', \omega'' \in \widehat{\mathbf{A}}_4^{ext}(r_0, r) \right] \geq \varepsilon. \quad (3.10)$$

Now, as in Section 7.1 of Chapter 5, we define the following event that will help us to extend the arms to a larger scale (see Definitions 3.18, 3.19 and 3.20 for the notations; remember that given $1 \leq \rho_1 \leq \rho_2$, we write $A(\rho_1, \rho_2) = [-\rho_2, \rho_2]^2 \setminus]-\rho_1, \rho_1[^2$):

$$\begin{aligned} G_\delta^{ext}(\rho) &= \text{GI}_\delta^{ext}(\rho) \cap \text{Dense}_\delta(A(\rho/2, 2\rho)) \cap \text{QBC}_\delta^1(A(3\rho/4, 3\rho/2)) \\ & \cap \left\{ \mathbb{P} \left[\text{QBC}_{1/100}^1(A(\rho, 4\rho)) \cap \text{Dense}_{1/100}(A(\rho, 4\rho)) \mid \eta \cap A(\rho/2, 2\rho) \right] \geq 3/4 \right\} \quad (3.11) \end{aligned}$$

(the last event is defined this way so that the event $G_\delta^{ext}(\rho)$ is measurable with respect to $\omega \cap A(\rho/2, 2\rho)$). For some technical reasons we will also need the following event where we rather control the interfaces at scale $9\rho/10$:

$$\begin{aligned} \widetilde{G}_\delta^{ext}(\rho) &= \text{GI}_\delta^{ext}(9\rho/10) \cap \text{Dense}_\delta(A(\rho/2, 2\rho)) \cap \text{QBC}_\delta^1(A(3\rho/4, 3\rho/2)) \\ & \cap \left\{ \mathbb{P} \left[\text{QBC}_{1/100}^1(A(\rho, 4\rho)) \cap \text{Dense}_{1/100}(A(\rho, 4\rho)) \mid \eta \cap A(\rho/2, 2\rho) \right] \geq 3/4 \right\}. \end{aligned}$$

By Lemma 7.4 of Chapter 5, there exists $a > 0$ such that, for every $\delta \in]0, 1/1000[$ and every $\rho \in [\delta^{-2}, +\infty)$ we have:

$$\mathbb{P}_{1/2} \left[G_\delta^{ext}(\rho) \right] \geq 1 - \frac{1}{\varepsilon} \delta^a,$$

⁵Here, it is important to consider the event $\widehat{\mathbf{A}}_4^{ext}(r_0, 2r)$ and not the event $\mathbf{A}_4(r_0, 2r)$.

and similarly for $\tilde{G}_\delta^{ext}(\rho)$. In particular, if $\delta = \delta(\varepsilon) \in]0, 1/1000[$ is sufficiently small and if ρ is sufficiently large ($\rho \geq \delta^{-2}$), then:

$$\mathbb{P}_{1/2} \left[\tilde{G}_\delta^{ext}(\rho) \right] \leq \frac{\varepsilon}{4}. \quad (3.12)$$

Fix such a $\delta > 0$. By the proof of Lemma 7.6 of Chapter 5, if δ_0 is sufficiently small then there exists a constant $c' = c'(\delta) > 0$ such that:

$$\mathbb{P}_{1/2} \left[\mathbf{A}_4(r_0, 8r), G_{\delta_0}^{ext}(8r) \mid \mathbf{A}_4(r_0, 2r), G_\delta^{ext}(2r), \omega \cap B(0, r) \right] \geq c'.$$

Fix such a constant $\delta_0 > 0$. Now, note that $\text{Dense}_\delta(A(r, 4r)) \supseteq G_\delta^{ext}(2r)$ gives us spatial independence properties which imply for instance that $\hat{\mathbf{A}}_4^{ext}(r_0, 2r) \cap \text{Dense}_\delta(A(r, 4r)) \subseteq \mathbf{A}_4(r_0, 9r/5)$. As a result, with exactly the same proof we can obtain that:

$$\mathbb{P}_{1/2} \left[\mathbf{A}_4(r_0, 8r), G_{\delta_0}^{ext}(8r) \mid \hat{\mathbf{A}}_4^{ext}(r_0, 2r), \tilde{G}_\delta^{ext}(2r), \omega \cap B(0, r) \right] \geq c'. \quad (3.13)$$

As in [GPS10], we now let $\tilde{\omega}'$ and $\tilde{\omega}''$ be two configurations of distribution $\mathbb{P}_{1/2}$, that have the same underlying point process η as ω' and ω'' and that satisfy i) $\tilde{\omega}'|_{B(0,r)} = \omega'|_{B(0,r)}$ and $\tilde{\omega}''|_{B(0,r)} = \omega''|_{B(0,r)}$ and ii) conditionally on η , $\tilde{\omega}'|_{B(0,r)^c}$ is independent of $\tilde{\omega}''|_{B(0,r)^c}$. By independence, (3.13) implies that:

$$\mathbb{P} \left[\tilde{\omega}', \tilde{\omega}'' \in \mathbf{A}_4(r_0, 8r) \cap G_{\delta_0}^{ext}(8r) \mid \tilde{\omega}', \tilde{\omega}'' \in \hat{\mathbf{A}}_4^{ext}(r_0, 2r) \cap \tilde{G}_\delta^{ext}(2r), \right. \\ \left. \omega' \cap B(0, r), \omega'' \cap B(0, r) \right] \geq (c')^2. \quad (3.14)$$

Note that (3.14) implies that:

$$\mathbb{P} \left[\tilde{\omega}', \tilde{\omega}'' \in \mathbf{A}_4(r_0, 8r) \cap G_{\delta_0}^{ext}(8r) \mid \tilde{\omega}', \tilde{\omega}'' \in \hat{\mathbf{A}}_4^{ext}(r_0, 2r) \cap \tilde{G}_\delta^{ext}(2r) \right] \geq (c')^2. \quad (3.15)$$

Now, note that $\{\tilde{\omega}', \tilde{\omega}'' \in \tilde{G}_\delta^{ext}(2r)\}$ is independent of $\tilde{\omega}' \cap B(0, r) = \omega' \cap B(0, r)$ and $\tilde{\omega}'' \cap B(0, r) = \omega'' \cap B(0, r)$. Note furthermore that $X' = \mathbb{P} \left[\tilde{\omega}' \in \hat{\mathbf{A}}_4^{ext}(r_0, 2r) \mid \omega' \cap B(0, r) \right]$ and $X'' = \mathbb{P} \left[\tilde{\omega}'' \in \hat{\mathbf{A}}_4^{ext}(r_0, 2r) \mid \omega'' \cap B(0, r) \right]$ and that, as in (3.9), we have:

$$\tilde{X} \geq \mathbb{P} \left[\tilde{\omega}', \tilde{\omega}'' \in \hat{\mathbf{A}}_4^{ext}(r_0, 2r) \mid \omega' \cap B(0, r), \omega'' \cap B(0, r) \right].$$

As a result:

$$\mathbb{P} \left[\tilde{\omega}', \tilde{\omega}'' \in \tilde{G}_\delta^{ext}(2r) \cap \hat{\mathbf{A}}_4^{ext}(r_0, 2r) \mid \omega' \cap B(0, r), \omega'' \cap B(0, r) \right] \\ \geq \mathbb{P} \left[\tilde{\omega}', \tilde{\omega}'' \in \hat{\mathbf{A}}_4^{ext}(r_0, 2r) \mid \omega' \cap B(0, r), \omega'' \cap B(0, r) \right] \\ - \mathbb{P} \left[\tilde{\omega}' \notin \tilde{G}_\delta^{ext}(2r) \cup \tilde{\omega}'' \notin \tilde{G}_\delta^{ext}(2r) \mid \omega' \cap B(0, r), \omega'' \cap B(0, r) \right] \\ \geq \tilde{X} - \frac{\varepsilon}{2} \text{ (by (3.12))}.$$

Thus, by (3.14):

$$\mathbb{P} \left[\tilde{\omega}', \tilde{\omega}'' \in \mathbf{A}_4(r_0, 8r) \cap G_{\delta_0}^{ext}(8r) \mid \omega' \cap B(0, r), \omega'' \cap B(0, r) \right] \geq (c')^2 \left(\tilde{X} - \frac{\varepsilon}{2} \right)_+.$$

This implies that:

$$\begin{aligned}
& \mathbb{P} [\tilde{\omega}', \tilde{\omega}'' \in \mathbf{A}_4(r_0, 8r) \cap G_{\delta_0}^{ext}(8r)] \\
&= \mathbb{E} \left[\tilde{\omega}', \tilde{\omega}'' \in \mathbf{A}_4(r_0, 8r) \cap G_{\delta_0}^{ext}(8r), \omega', \omega'' \in \hat{\mathbf{A}}_4^{ext}(r_0, r) \right] \\
&\geq \mathbb{E} \left[\mathbb{1}_{\omega', \omega'' \in \hat{\mathbf{A}}_4^{ext}(r_0, r)} (c')^2 \left(\tilde{X} - \frac{\varepsilon}{2} \right)_+ \right] \\
&\geq \mathbb{P} \left[\omega', \omega'' \in \hat{\mathbf{A}}_4^{ext}(r_0, r) \right] \frac{(c')^2 \varepsilon}{2} \text{ (by (3.10) and Jensen's inequality).} \tag{3.16}
\end{aligned}$$

By (3.15) (or rather an analogue whose proof is the same), there exists $c'' = c''(\delta_0)$ such that, for any $r_1 \geq 2r$:

$$\mathbb{P} [\tilde{\omega}', \tilde{\omega}'' \in \mathbf{A}_4(r_0, 4r_1) \cap G_{\delta_0}^{ext}(4r_1)] \geq c'' \mathbb{P} [\tilde{\omega}', \tilde{\omega}'' \in \mathbf{A}_4(r_0, r_1) \cap G_{\delta_0}^{ext}(r_1)] ,$$

so:

$$\mathbb{P} [\tilde{\omega}', \tilde{\omega}'' \in \mathbf{A}_4(r_0, r')] \geq \frac{(c')^2 \varepsilon}{2} (c'')^{\log_4(r'/8r)} \mathbb{P} [\omega', \omega'' \in \hat{\mathbf{A}}_4^{ext}(r_0, r)] ,$$

which ends the proof since:

$$\begin{aligned}
\mathbb{P} [\tilde{\omega}', \tilde{\omega}'' \in \mathbf{A}_4(r_0, r')] &= \mathbb{E} \left[\mathbf{P}_{1/2}^\eta \left[\mathbf{A}_4(r_0, r') \mid \omega \setminus (W \cup B(0, r)) \right] \right] \\
&\leq \mathbb{E} \left[\mathbf{P}_{1/2}^\eta \left[\mathbf{A}_4(r_0, r') \mid \omega \setminus W \right] \right] \\
&= \beta_4^{an}(r_0, r') .
\end{aligned}$$

□

Lemma 3.22. *There exist two absolute constants $\varepsilon_2 > 0$ and $\bar{R} < +\infty$ such that:*

- For every $r_0 \geq \bar{R}$ and every $\rho \geq r_0$, we have:

$$\hat{\beta}_4^{an, ext, W}(r_0, 2\rho) \geq \varepsilon_2 \hat{\beta}_4^{an, ext, W}(r_0, \rho) . \tag{3.17}$$

- For every $r_0 \geq \bar{R}$ and every $\rho \in [\bar{R}, r_0]$, we have:

$$\hat{\beta}_4^{an, int, W}(\rho/2, r_0) \geq \varepsilon_2 \hat{\beta}_4^{an, int, W}(\rho, r_0) , \tag{3.18}$$

Proof. We only prove the first item since the proof of the second one is the same. First note that by Lemma 3.21 we have the following for any $\varepsilon > 0$: If $r_0 \geq 1$, $r \geq r_0 \vee \bar{r}$ (where $\bar{r} = \bar{r}(\varepsilon)$ is the constant from Lemma 3.21) and if

$$\hat{\beta}_4^{an, ext, W}(r_0, 2r) \geq \varepsilon \hat{\beta}_4^{an, ext, W}(r_0, r) \tag{3.19}$$

then for any $r' \geq r$ we have:

$$\hat{\beta}_4^{an, ext, W}(r_0, r') \geq \beta_4^{an, W}(r_0, r') \geq c \left(\frac{r}{r'} \right)^d \hat{\beta}_4^{an, ext, W}(r_0, r)$$

(where $c = c(\varepsilon)$ and d are the constants from Lemma 3.21). As explained in the proof of Lemma 5.8 of [GPS10], one can deduce from this inequality that there exists $\bar{\varepsilon} > 0$ such that, if (3.19) holds for some $\varepsilon \in]0, \bar{\varepsilon}[$, some $r_0 \geq 1$ and some $r \geq r_0 \vee \bar{r}(\varepsilon)$, then

$$\hat{\beta}_4^{an, ext, W}(r_0, 2\rho) \geq \varepsilon_2 \hat{\beta}_4^{an, ext, W}(r_0, \rho)$$

holds for some $\varepsilon_2 = \varepsilon_2(\varepsilon)$ and for every $\rho \geq r$. As a result, it is sufficient to prove that there exists $\varepsilon > 0$ such that for every $r_0 \geq 1$ there exists $r \geq r_0$ satisfying both (3.17) for any $\rho \in [r_0, r]$ and (3.19). This is actually a direct consequence of the fact that (by (1.2)) there exists an absolute constant $c \in]0, 1[$ such that, for any $r_0 \geq 1$ and any $r_1 \in [r_0, 2r_0]$:

$$c \leq \alpha_4^{an}(r_0, r_1)^2 \leq \hat{\beta}_4^{an, ext, W}(r_0, r_1) \leq 1 .$$

This ends the proof. □

Lemma 3.23. *There exist two absolute constants $\varepsilon_3 > 0$ and $\bar{R} < +\infty$ such that, for every $r \geq \bar{R}$ and every $R \geq r$, we have:*

$$\widehat{\beta}_4^{an,W}(r, R) \leq \varepsilon_3 \widehat{\beta}_4^{an,W}(r/2, 2R).$$

Proof. Note that the event $\widehat{\mathbf{A}}_4(r, R) \cap \text{Dense}_{1/00}(A(R/2, 2R))$ is included in $\widehat{\mathbf{A}}_4^{int}(r, R/2)$ where the event $\text{Dense}_{1/00}(A(R/2, 2R))$ is the event from Definition 3.18. As a result:

$$\widehat{\beta}_4^{an,W}(r, R) \leq \mathbb{P}[\neg \text{Dense}_{1/00}(A(R/2, 2R))] + \widehat{\beta}_4^{an,int,W}(r, R/2). \quad (3.20)$$

Moreover, $\widehat{\beta}_4^{an,int,W}(r, R/2) \geq \alpha_4^{an}(r, R)^2$, so $\widehat{\beta}_4^{an,int,W}(r, R/2)$ is greater than some polynomial of r/R . Since the probability of $\neg \text{Dense}_{1/00}(A(R/2, 2R))$ decays to 0 super-polynomially fast, (3.20) implies that $\widehat{\beta}_4^{an,W}(r, R) \leq \frac{1}{2} \widehat{\beta}_4^{an,int,W}(r, R/2)$ if R is sufficiently large.

Now, note that, by Lemmas 3.21 and 3.22, for any $r_0 \geq \rho$ sufficiently large, the quantities $\widehat{\beta}_4^{an,ext,W}(r_0, \rho)$ and $\beta_4^{an,W}(r_0, 2\rho)$ are of the same order and for any $\rho \geq r_0$ sufficiently large, the quantities $\widehat{\beta}_4^{an,int,W}(\rho/2, r_0)$ and $\beta_4^{an,W}(\rho, r_0)$ are of the same order. As a result, if $R \geq r$ are sufficiently large, then:

$$\begin{aligned} \widehat{\beta}_4^{an,W}(r, R) &\leq \frac{1}{2} \widehat{\beta}_4^{an,int,W}(r, R/2) \\ &\leq O(1) \beta_4^{an,W}(r/2, R/2) \\ &\leq O(1) \widehat{\beta}_4^{an,ext,W}(r/2, R/2) \\ &\leq O(1) \beta_4^{an,W}(r/2, 2R) \\ &\leq O(1) \widehat{\beta}_4^{an,W}(r/2, 2R), \end{aligned}$$

which ends the proof. \square

Lemma 3.24. *There exist two absolute constants $C \in]0, +\infty[$ and $\bar{R} < +\infty$ such that, if $r \geq \bar{R}$, if $R \geq r$ and if G is an event measurable with respect to $\omega \setminus A(r, R)$ of probability greater than $1 - \frac{1}{C}$, then:*

$$\widehat{\beta}_4^{an,W}(r, R) \leq C \mathbb{P}[\tilde{\omega}', \tilde{\omega}'' \in \mathbf{A}_4(r/8, 8R) \cap G],$$

where $\tilde{\omega}'$ and $\tilde{\omega}''$ are two configurations of distribution $\mathbb{P}_{1/2}$ that have the same underlying process η , that are (conditionally) independent on $\eta \cap (W \cup B(0, r) \cup B(0, R)^c)$ and that coincide on the other points of η . Moreover, for any $r' \in [\bar{R}, r]$ and $R' \geq R$ we have:

$$\beta_4^{an,W}(r', R') \geq \frac{1}{C} \widehat{\beta}_4^{an,W}(r, R) \left(\frac{r'R}{rR'} \right)^C.$$

Proof. If one uses the result of Lemma 3.23 (which gives an “inwards and outwards” analogue of the hypotheses (3.5) and (3.7) of Lemma 3.21) and if one follows the proof of Lemma 3.21 (by studying $X' = \mathbb{P}[\tilde{\omega}' \in \widehat{\mathbf{A}}_4(r/2, 2R) \mid \tilde{\omega}' \cap A(r, R)]$ and the analogous variable X'' and by extending the arms inwards and outwards at the same time) then one obtains the two desired results. \square

We are now in shape to prove (3.4):

Proof of Lemma 3.16. Let r, n, B, B' and \square be as in Lemma 3.16. Remember that it is sufficient to prove (3.4) i.e. that the following holds if r is sufficiently large:

$$\mathbb{E} \left[\mathbf{1}_{|\eta \cap \square|=1} \mathbb{P} \left[\omega', \omega'' \in \text{Piv}_x^q(g_n) \mid \eta \right] \right] \geq \Omega(1) \alpha_4^{an}(r) \mathbb{P}[\omega', \omega'' \in \text{Piv}_B(g_n)],$$

where x is the (random) point such that $\eta \cap \square = \{x\}$ when $|\eta \cap \square| = 1$. We use the following notations: i) y is the center of B , ii) d_0 is the distance between y and the closest side of $[0, n]^2$, iii) y_0 is the projection of y on this side, iv) d_1 is the distance between y and the closest corner of $[0, n]^2$, v) y_1 is this closest corner. We assume that $r \leq d_0/100$, $d_0 \leq d_1/100$ and $d_1 \leq n/100$. The other cases are treated similarly. Without loss of generality, we also assume that y_0 lies on the bottom side and that y_1 is the left-bottom corner. The result is a consequence of the two following claims. In these claims, we use the notations $\widehat{\beta}_3^{an,+W}(\cdot, \cdot)$ and $\widehat{\beta}_2^{an,++W}(\cdot, \cdot)$. They correspond to the quantities analogous to $\widehat{\beta}_4^{an,W}(\cdot, \cdot)$ for the 3-arm event in the half-plane and the 2-arm event in the quarter plane. Lemmas 3.21, 3.22 3.23 and 3.24 are also true for these quantities (and the proofs are exactly the same). We also use the notation $\mathbf{A}_4(z; \rho_1, \rho_2)$ (respectively $\widehat{\mathbf{A}}_4(z; \rho_1, \rho_2)$) to denote the event $\mathbf{A}_4(\rho_1, \rho_2)$ (respectively $\widehat{\mathbf{A}}_4(\rho_1, \rho_2)$) translated by some $z \in \mathbb{R}^2$. We use the analogous notations for the other arm events.

Claim 3.25. *We have:*

$$\mathbb{P}[\omega', \omega'' \in \text{Piv}_B(g_n)] \leq O(1) \widehat{\beta}_4^{an,W}(r, d_0) \widehat{\beta}_3^{an,+W}(d_0, d_1) \widehat{\beta}_2^{an,++W}(d_1, n).$$

Claim 3.26. *We have:*

$$\begin{aligned} \alpha_4^{an}(r) \widehat{\beta}_4^{an,W}(r, d_0) \widehat{\beta}_3^{an,+W}(d_0, d_1) \widehat{\beta}_2^{an,++W}(d_1, n) \\ \leq O(1) \mathbb{E} \left[\mathbf{1}_{|\eta \cap \square|=1} \mathbb{P} \left[\omega', \omega'' \in \text{Piv}_x^q(g_n) \mid \eta \right] \right] \end{aligned}$$

Proof of Claim 3.25. To prove this claim, we use the following notations: if $\rho \in [r, d_0]$ then:

$$\widehat{\beta}^{an,W}(\rho, n) := \widehat{\beta}_4^{an,W}(\rho, d_0) \widehat{\beta}_3^{an,+W}(d_0, d_1) \widehat{\beta}_2^{an,++W}(d_1, n),$$

if $\rho \in [d_0, d_1]$ then:

$$\widehat{\beta}^{an,W}(\rho, n) := \widehat{\beta}_3^{an,+W}(\rho, d_1) \widehat{\beta}_2^{an,++W}(d_1, n),$$

and if $\rho \in [d_1, n]$ then:

$$\widehat{\beta}^{an,W}(\rho, n) := \widehat{\beta}_2^{an,++W}(\rho, n).$$

Moreover, for any $\rho \in [r, n]$ we let $\text{Dense}(\rho, n) = \text{Dense}_{1/100}(A(\rho/2, 2\rho) \cup A(n/2, 2n))$. We also use the notation of pivotal events from Definition 3.11.

Note that, if $\rho \in [r, d_0/2]$, if $\eta \in \text{Dense}(\rho, n)$ and if $\omega', \omega'' \in \text{Piv}_{B(y,\rho)}^{A(y;\rho,n/2)}(g_n)$, then the three following events hold in ω' and ω'' : $\widehat{\mathbf{A}}_4(y; 2\rho, d_0)$, $\widehat{\mathbf{A}}_3^+(y_0; d_0, d_1)$ and $\widehat{\mathbf{A}}_2^{++}(y_1; d_0, n/4)$. As a result (and by spatial independence):

$$\begin{aligned} \mathbb{P} \left[\eta \in \text{Dense}(\rho, n), \omega', \omega'' \in \text{Piv}_{B(y,\rho)}^{A(y;\rho,n/2)}(g_n) \right] \\ \leq \widehat{\beta}_4^{an,W}(2\rho, d_0) \widehat{\beta}_3^{an,+W}(d_0, d_1) \widehat{\beta}_3^{an,++W}(d_1, n/4) \\ \leq O(1) \beta_4^{an,W}(\rho, d_0) \beta_3^{an,+W}(d_0, d_1) \beta_3^{an,++W}(d_1, n) \text{ (by the second part of Lemma 3.24)} \\ \leq O(1) \widehat{\beta}^{an,W}(\rho, n). \end{aligned}$$

An analogous proof implies that if $\rho \in [d_0/2, n]$ we also have:

$$\mathbb{P} \left[\eta \in \text{Dense}(\rho, n), \omega', \omega'' \in \text{Piv}_{B(y,\rho)}^{A(y;\rho,n/2)}(g_n) \right] \leq O(1) \widehat{\beta}^{an,W}(\rho, n).$$

Next, note that, for any $\rho \in [r, n]$, we have: i) $\text{Dense}(\rho, n)$ is independent of $\text{Piv}_{B(y,2\rho)}^{A(y;2\rho,n/2)}(g_n)$, ii) $\text{Piv}_B(g_n) \subseteq \text{Piv}_{B(y,\rho)}^{A(y;\rho,n/2)}(g_n) \subseteq \text{Piv}_{B(y,2\rho)}^{A(y;2\rho,n/2)}(g_n)$ and iii) $\mathbb{P}[\text{Dense}(\rho, n)] \leq O(1) \exp(-\Omega(1)\rho^2)$. As a result:

$$\mathbb{P}[\omega', \omega'' \in \text{Piv}_B(g_n)] \leq \widehat{\beta}^{an,W}(r, n) + \sum_{k=0}^{\log_2(n/r)} \exp\left(-\Omega(1)(2^k r)^2\right) \widehat{\beta}^{an,W}(2^k r, n) + \exp(-\Omega(1)n^2).$$

The second part of Lemma 3.24 now implies the desired result. \square

Proof of Claim 3.26. Let $\widehat{\omega}'$ and $\widehat{\omega}''$ be two configurations of law $\mathbb{P}_{1/2}$ that have the same underlying point process η , that are (conditionally) independent on:

$$\eta \cap \left(W \cup A(y; d_0/6, 6d_0) \cup A(y_0; d_1/6, 6d_1) \cup B(y_1, n/6)^c \right),$$

and that coincide on the other points of η . Remember that B is the box of radius r centered at y and that $W \cap B = \emptyset$. We also use the following notation: $G_\delta^{ext}(\rho)$ is the event defined in (3.11) and $G_\delta^{int}(\rho)$ is the analogous ‘‘interior’’ event:

$$\begin{aligned} G_\delta^{int}(\rho) &= \text{GI}_\delta^{int}(\rho) \cap \text{Dense}_\delta(A(\rho/2, 2\rho)) \cap \text{QBC}_\delta^1(A(3\rho/4, 3\rho/2)) \\ &\cap \left\{ \mathbb{P} \left[\text{QBC}_{1/100}^1(A(\rho/4, \rho)) \cap \text{Dense}_{1/100}(A(\rho/4, \rho)) \mid \eta \cap A(\rho/2, 2\rho) \right] \geq 3/4 \right\}. \end{aligned}$$

Moreover, we let $G_\delta^{ext}(z; \rho)$ and $G_\delta^{int}(z; \rho)$ denote these events translated by z . By Lemma 7.4 of Chapter 5, the probability of these events goes to 0 as δ goes to 0, uniformly on $\rho \in [\delta^{-2}, +\infty[$. Together, with the first part of Lemma 3.24, we have the following as soon as δ is sufficiently small and r is sufficiently large:⁶

$$\begin{aligned} &\widehat{\beta}_4^{an,W}(r, d_0) \widehat{\beta}_3^{an,+ ,W}(d_0, d_1) \widehat{\beta}_2^{an,++ ,W}(d_1, n) \\ &\leq O(1) \mathbb{P} \left[\widehat{\omega}', \widehat{\omega}'' \in \mathbf{A}_4(y; r/2, d_0/3) \cap G(y; r) \cap G_\delta^{int}(y; r/2) \cap G_\delta^{ext}(y; d_0/3) \right] \\ &\quad \cdot \mathbb{P} \left[\widehat{\omega}', \widehat{\omega}'' \in \mathbf{A}_3^+(y_0; 3d_0, d_1/3) \cap G_\delta^{int}(y_0; 3d_0) \cap G_\delta^{ext}(y_0; d_1/3) \right] \\ &\quad \cdot \mathbb{P} \left[\widehat{\omega}', \widehat{\omega}'' \in \mathbf{A}_4(y_1; 3d_1, n/3) \cap G_\delta^{int}(y_1; 3d_1) \cap G_\delta^{ext}(y_1; n/3) \right], \quad (3.21) \end{aligned}$$

where $G(y; r)$ is an event measurable with respect to $\omega \cap B(y, r) = \omega \cap B$ of probability sufficiently close to 1 to be chosen later. We fix such a δ for the rest of the proof. Let us now prove that the quantity of the right-hand-side of (3.21) is less than or equal to:

$$O(1) \frac{\mathbb{E} \left[\mathbb{1}_{|\eta \cap \square|=1} \mathbb{P} \left[\widehat{\omega}', \widehat{\omega}'' \in \text{Piv}_x^q(g_n) \mid \eta \right] \right]}{\alpha_4^{an}(r)}. \quad (3.22)$$

The proof will then be over since

$$\mathbb{E} \left[\mathbb{1}_{|\eta \cap \square|=1} \mathbb{P} \left[\widehat{\omega}', \widehat{\omega}'' \in \text{Piv}_x^q(g_n) \mid \eta \right] \right] \leq \mathbb{E} \left[\mathbb{1}_{|\eta \cap \square|=1} \mathbb{P} \left[\omega', \omega'' \in \text{Piv}_x^q(g_n) \mid \eta \right] \right].$$

The proof of (3.22) follows four steps, where we let $E_{r,d_0} = E_{r,d_0}(\delta)$, $E_{d_0,d_1} = E_{d_0,d_1}(\delta)$ and $E_{d_1,n} = E_{d_1,n}(\delta)$ the three events from the right-hand side of (3.21). So (3.21) is:

$$\widehat{\beta}_4^{an,W}(r, d_0) \widehat{\beta}_3^{an,+ ,W}(d_0, d_1) \widehat{\beta}_2^{an,++ ,W}(d_1, n) \leq O(1) \mathbb{P} [E_{r,d_0}] \mathbb{P} [E_{d_0,d_1}] \mathbb{P} [E_{d_1,n}].$$

- 1) Let $F_{d_1,n}$ denote the event that, in both $\widehat{\omega}'$ and $\widehat{\omega}''$, there exist one white arm and one black arm from $\partial B(y_1; 3d_1) \cap [0, n]^2$ to the top and right sides of $[0, n]^2$ respectively (remember that we have assumed that y_1 is the left-bottom corner and that y_0 belongs to the bottom side). With exactly the same proof as (3.15), one can show that $\mathbb{P} \left[F_{d_1,n} \mid E_{d_1,n} \right] \geq \Omega(1)$ (where the constants in $\Omega(1)$ may depend on δ).
- 2) Let $F_{d_0,n} \subseteq F_{d_1,n}$ be the event that, in both $\widehat{\omega}'$ and $\widehat{\omega}''$, there exist one black arm, one white arm and one black arm from $\partial B(y_0; 3d_0, n) \cap [0, n]^2$ to the left, top and right sides of $[0, n]^2$ respectively. In this step, we prove that:

$$\mathbb{P} [F_{d_0,n} \cap E_{d_0,d_1} \cap E_{d_1,n}] \geq \Omega(1) \mathbb{P} [E_{d_0,d_1}] \mathbb{P} [F_{d_1,n} \cap E_{d_1,n}], \quad (3.23)$$

⁶Here we use that, if we let $\widetilde{\omega}'$ and $\widetilde{\omega}''$ be as in Lemma 3.24 and if we decrease W , then for any event A the quantity $\mathbb{P} [\widetilde{\omega}', \widetilde{\omega}'' \in A] = \mathbb{E} \left[\mathbf{P}_{1/2}^\eta [A \mid \omega \setminus W]^2 \right]$ increases.

where the constant in $O(1)$ may depend on δ . This estimate is a little harder than the estimate of Step 1) above because of the interactions between E_{d_0, d_1} and $F_{d_1, n} \cap E_{d_1, n}$ at scale d_1 . In Chapter 5 (see Lemma D.6 and just below this lemma), we have proved that if r_1 is sufficiently large, if $r_2 \geq 6r_1$ and if $r_3 \geq 6r_2$, then:

$$\begin{aligned} & \mathbb{E} \left[\mathbf{P}_{1/2}^\eta \left[\mathbf{A}_4(r_1, r_2/3) \cap G_\delta^{ext}(r_2/3) \right]^2 \right] \cdot \mathbb{E} \left[\mathbf{P}_{1/2}^\eta \left[\mathbf{A}_4(3r_2, r_3) \cap G_\delta^{int}(3r_2) \right]^2 \right] \\ & \geq \Omega(1) \mathbb{E}_{1/2} \left[\mathbf{P}_{1/2}^\eta \left[\mathbf{A}_4(r_1, r_3) \cap G_\delta^{ext}(r_2/3) \cap G_\delta^{int}(3r_2) \right]^2 \right]. \end{aligned} \quad (3.24)$$

(Where $\Omega(1)$ depends on δ .) Note that, for any event A , $\mathbb{E} \left[\mathbf{P}_{1/2}^\eta [A]^2 \right]$ is the event that A is satisfied in two configurations $\bar{\omega}', \bar{\omega}'' \sim \mathbb{P}_{1/2}$ that have the same underlying point process η but are independent conditionally on η . As a result, (3.24) can be rewritten as follows:

$$\begin{aligned} & \mathbb{P} \left[\bar{\omega}', \bar{\omega}'' \in \mathbf{A}_4(r_1, r_2/3) \cap G_\delta^{ext}(r_2/3) \right] \cdot \mathbb{P} \left[\bar{\omega}', \bar{\omega}'' \in \mathbf{A}_4(3r_2, r_3) \cap G_\delta^{int}(3r_2) \right] \\ & \geq \Omega(1) \mathbb{P} \left[\bar{\omega}', \bar{\omega}'' \in \mathbf{A}_4(r_1, r_3) \cap G_\delta^{ext}(r_2/3) \cap G_\delta^{int}(3r_2) \right]. \end{aligned}$$

The proof of the above (in Chapter 5) adapts readily to our case since $\hat{\omega}'$ and $\hat{\omega}''$ are conditionally independent on $\eta \cap A(y_0; d_1/6, 6d_1)$, so we leave the details of the proof of (3.23) to the reader and refer to Chapter 5 (Lemma D.6 and just below this lemma).

3) The third step consists in proving that:

$$\mathbb{P} [F_{r, n} \cap E_{r, d_0} \cap E_{d_0, d_1} \cap E_{d_1, n}] \geq \Omega(1) \mathbb{P} [E_{r, d_0}] \mathbb{P} [F_{d_0, n} \cap E_{d_0, d_1} \cap E_{d_1, n}],$$

where $F_{r, n} \subseteq F_{d_0, n}$ is the event that, in both $\hat{\omega}'$ and $\hat{\omega}''$, there are two black arms from $\partial B(y; r/2)$ to the left and right sides of $[0, n]^2$ and two white arms from $\partial B(y; r/2)$ to the top and bottom sides of $[0, n]^2$. The proof is exactly the same as in Step 2.

4) Let us now prove that if r is sufficiently large then we can find an event $G(y; r)$ of probability as close to 1 as we want such that:

$$\alpha_4^{an}(r) \mathbb{P} [F_{r, n} \cap E_{r, d_0} \cap E_{d_0, d_1} \cap E_{d_1, n}] \leq \Omega(1) \mathbb{E} \left[\mathbb{1}_{|\eta \cap \square|=1} \mathbb{P} \left[\omega', \omega'' \in \text{Piv}_x^q(g_n) \mid \eta \right] \right].$$

To this purpose, first note that the configurations $\hat{\omega}'$ and $\hat{\omega}''$ coincide in $B = B(y, r)$. So in order to prove this estimate we only have to find an event $G(y; r)$ measurable with respect to $\omega \cap B(y, r)$ of probability sufficiently close to 1 such that the following holds: If we work under the probability measure $\mathbb{P}_{1/2}$ conditioned on $G(y; r) \cap G_\delta^{int}(y; r/2)$, on the event that there are two black arms and two white arms from $\partial B(y, r)$ to the left, right, top and bottom sides respectively, and on $\omega \cap B(y, r)^c$, then with non-negligible probability there is only one point in $\eta \cap \square$ and we can extend the four arms until the cell of this point. This is actually exactly what we have done in Lemma 4.6 of Chapter 5, so we refer to this lemma and leave once again the details to the reader.

The four steps imply (3.22), which ends the proof of the claim. \square

This also ends the proof of Lemma 3.16. \square

A Simple properties of the μ -dynamical processes

A metric on Ω . As explained in Appendix A.2.6 of [DVJ03], we can equip the set $\mathcal{M}_{\mathbb{R}^2 \times \{-1, 1\}}^B$ of all locally finite Borel measures on $\mathbb{R}^2 \times \{-1, 1\}$ with a metric d such that i) $(\mathcal{M}_{\mathbb{R}^2 \times \{-1, 1\}}^B, d)$

is a Polish space, ii) the restriction⁷ of d to Ω generates the (classical) σ -algebra we have defined in Subsection 1.1 and iii) the restriction of d to Ω is given by the following, where $\bar{\omega}_1, \bar{\omega}_2 \in \Omega$ and where $\bar{\eta}_1$ and $\bar{\eta}_2$ are such that $\bar{\omega}_1 \in \{-1, 1\}^{\bar{\eta}_1}$ and $\bar{\omega}_2 \in \{-1, 1\}^{\bar{\eta}_2}$:

$$d(\bar{\omega}_1, \bar{\omega}_2) = \int_0^{+\infty} e^{-r} \frac{d'_r(\bar{\omega}_1, \bar{\omega}_2)}{1 + d'_r(\bar{\omega}_1, \bar{\omega}_2)} dr. \quad (\text{A.1})$$

The quantity $d'_r(\bar{\omega}_1, \bar{\omega}_2)$ of (A.1) is defined by:

$$d'_r(\bar{\omega}_1, \bar{\omega}_2) = \inf_{\phi} \sup_x \|x - \phi(x)\|_2,$$

where the infimum above is over every bijection ϕ between $\bar{\eta}_1 \cap [-r, r]^2$ and $\bar{\eta}_2 \cap [-r, r]^2$ such that:

$$\forall x \in \bar{\eta}_1 \cap [-r, r]^2, \bar{\omega}_1(x) = 1 \Leftrightarrow \bar{\omega}_2(\phi(x)) = 1,$$

and the supremum is over every $x \in \bar{\eta}_1 \cap [-r, r]^2$. When such a bijection does not exist, we let $d'_r(\bar{\omega}_1, \bar{\omega}_2) = 1$.

With this definition, it is clear that the frozen dynamical Voronoi percolation process is a càdlàg process with values in $(\Omega, d|_{\Omega})$. Now, let μ be the law of a Lévy process in the plane starting from 0, let $\omega^\mu(0) \sim \mathbb{P}_{1/2}$ and let each point of the underlying configuration $\eta^\mu(0)$ evolve conditionally independently according to a process of law μ . For each t , let $\omega^\mu(t)$ the set of points we thus obtain. Then, Palm formula implies that for each fixed t , the law of $\omega^\mu(t)$ is $\mathbb{P}_{1/2}$. In particular, for each fixed t , a.s. the set of points in $\omega^\mu(t)$ is locally finite i.e. $\omega^\mu(t) \in \Omega$. By using the Markov property of Lévy processes, it is not difficult to deduce from this that a.s. for each $T < +\infty$ and each $M < +\infty$ there are finitely many points that belong to $[-M, M]^2$ at some time $t \in [0, T]$. In particular, a.s. for every t we have $\omega^\mu(t) \in \Omega$. Note furthermore that classical potential theory results on Lévy processes (see [Ber98]) imply that a.s. there is no collusion of points. By using that the time reversal process of a Lévy process is a càglàd Lévy process, we even have that, for each $T < +\infty$ and each $M < +\infty$, the infimum on $t \in [0, T]$ and on $x \neq y \in \eta^\mu(t) \cap [-M, M]^2$ of $\|x - y\|_2$ is positive. All these properties imply that the process $(\omega^\mu(t))_{t \in \mathbb{R}_+}$ is a well-defined càdlàg process with values in $(\Omega, d|_{\Omega})$.

Let us end this small section with a remark concerning giant cells.

Remark A.1. In this remark we note that a.s. there is no time with an unbounded Voronoi cell. For the frozen dynamical process this is obvious since the point process η does not evolve in time. Concerning the μ -dynamical processes, one can do the following reasoning: First, fix some $T < +\infty$ and for each box B of the grid \mathbb{Z}^2 let Z_B be the random variable that equals 1 if there exists $x \in \eta^\mu(0) \cap B$ that stays in B at least until time T . Note that $(Z_B)_B$ is a family of i.i.d. Bernoulli variables of some parameter $p(T) \in]0, 1[$. It is sufficient to prove the following claim:

Claim A.2. *A.s., if $\bar{\eta}$ is a configuration that has at least one point in each box B such that $Z_B = 1$, then the Voronoi tiling of $\bar{\eta}$ has no unbounded cell.*

Proof. If $k \in \mathbb{N}$, we let $\text{Dense}(k)$ denote the event that, for any $\bar{\eta}$ like in the claim and for any $u \in A(2^k, 2^{k+1}) = [-2^{k+1}, 2^{k+1}]^2 \setminus]-2^k, 2^k[$, there is a point $x \in \bar{\eta} \cap A(2^k, 2^{k+1})$ such that $\|x - u\|_2 \leq 2^k/100$. Note that if this event holds then for any $\bar{\eta}$ in the claim, there cannot be a Voronoi cell of $\bar{\eta}$ that intersects both $]2^k, 2^{k+1}]^2$ and $]2^{k+1}, 2^{k+1}]^2$, so it is sufficient to prove that a.s. infinitely many events $\text{Dense}(k)$ hold. Note that the events $\text{Dense}(k)$ are independent and that:

$$\mathbb{P}[\text{Dense}(k)] \geq 1 - O(1) \exp\left(-\Omega(1)p(T)2^{2k}\right).$$

This implies the desired result. □

⁷The set Ω is included in $\mathcal{M}_{\mathbb{R}^2 \times \{-1, 1\}}^B$ if we see an element of Ω as the sum of the corresponding Dirac measures.

B The 2^{nd} moment method

In this appendix, we prove Lemma 2.10. To this purpose, we follow the proof of the analogous result from [HPS97]. Recall that f_R is the 1-arm event and that:

$$X_R = \int_0^1 f_R(\omega(t)) dt.$$

Assume that there exists a constant C as in Lemma 2.10 and consider the (random) following set:

$$T_R = \left\{ t \in [0, 1] : 0 \overset{\omega(t)}{\longleftrightarrow} R \right\}.$$

By using the fact that $(X_R)_{R>0}$ is decreasing and by the Cauchy-Schwarz inequality, we have:

$$\begin{aligned} \mathbb{P}[\forall R > 0, T_R \neq \emptyset] &\geq \mathbb{P}[\forall R > 0, X_R \neq 0] \\ &= \lim_{R \rightarrow +\infty} \mathbb{P}[X_R > 0] \\ &\geq \liminf_{R \rightarrow +\infty} \frac{\mathbb{E}[X_R]^2}{\mathbb{E}[X_R^2]} \\ &\geq 1/C > 0. \end{aligned}$$

By Kolmogorov 0-1 law, we can show that either a.s. there are exceptional times or a.s. there is no exceptional time. As a result, it is sufficient to prove the following lemma.

Lemma B.1. *We have the following a.s.: if for every $R > 0$ the set T_R is non-empty, then there exists a time $t \in [0, 1]$ at which there is an unbounded black component.*

Proof. If the sets T_R were a.s. closed (hence compact), the result would have been obvious. The first step of the proof consists in modifying a little the processes so that, for each $t \in \cap_{R>0} \overline{T_R} \subseteq [0, 1]$, there is an unbounded black component at time t (where $\overline{T_R}$ is the closure of T_R). In the case of frozen dynamical Voronoi percolation, the proof is exactly the same as in the case of Bernoulli percolation, see Section 5 of [SS10] (where the authors rely on Lemma 3.2 of [HPS97]).

Therefore, it is sufficient to consider the case of the μ -dynamical Voronoi percolation process. If $y(0) \in \eta(0)$, we write $y(t)$ for the corresponding point of $\eta(t)$. For every $t \geq 0$, we define two graphs $G(t)$ and $\overline{G}(t)$ as follows:

1. The vertex set of both $G(t)$ and $\overline{G}(t)$ is $\eta(t)$.
2. Two points of $\eta(t)$ are adjacent in $G(t)$ if their Voronoi cells are adjacent (i.e. if the intersection of the two Voronoi cells is non-empty; remember that with our definition the Voronoi cells are closed sets).
3. The edge set of $\overline{G}(t)$ is defined using $(G(s))_{s \geq 0}$ as follows: two points $y(t), z(t) \in \eta(t)$ are adjacent in $\overline{G}(t)$ if there exists $t_n \rightarrow t$ such that for each n , $\{y(t_n), z(t_n)\}$ is an edge of $G(t_n)$.

Remember that in Appendix A we have seen that a.s. there is no time with an unbounded Voronoi cell. As a result, a.s. the set of times $t \in [0, 1]$ such that there is an infinite path of black vertices in $\overline{G}(t)$ contains $\cap_{R>0} \overline{T_R}$. Hence, if for every $R > 0$ we have $T_R \neq \emptyset$, then such an infinite black path exists. Note also that a.s. for every $t \in [0, 1]$ if there exists an infinite component in $G(t)$ made of black vertices then there exists an unbounded black component in $\omega(t)$. This ends the proof provided that we show the following lemma. \square

Lemma B.2. *Let μ be the distribution of a planar Lévy process and let $(\omega(t))_{t \geq 0}$ be a μ -dynamical Voronoi process. We use the same notations as in the proof of Lemma B.1. Then, a.s. for every $t \in \mathbb{R}_+$ there exists an infinite component in $G(t)$ made of black vertices if and only if there exists such a component in $\overline{G}(t)$.*

Proof. Let us first prove the following claim:

Claim B.3. *We have the following a.s.: For every $t \geq 0$, if $\overline{G}(t) \neq G(t)$, then one of the Lévy processes is not continuous at time t .*

Proof. Let us first make the following deterministic observation: Let $\overline{\eta}$ be an infinite locally finite set of points of the plane, consider the Voronoi tiling induced by $\overline{\eta}$ and let $y, z \in \overline{\eta}$. Then, the cells of y and z intersect each other if and only if y and z belong to the frontier of a disc D whose interior does not contain any point of $\overline{\eta}$.

Now, let $t \geq 0$ such that all the Lévy processes are continuous at time t . Let $y(t)$ and $z(t)$ be two points of $\eta(t)$ such that $\{y(t), z(t)\} \in \overline{G}(t)$. We want to prove that, except on a set of probability 0 that does not depend on t , $\{y(t), z(t)\} \in G(t)$. Since $\{y(t), z(t)\} \in \overline{G}(t)$, there exists $s_n \rightarrow t$ such that, for each n , $\{y(s_n), z(s_n)\} \in G(s_n)$. By the deterministic observation above, we deduce that there exist discs D_n (with centers a_n and radii r_n , say) such that $y(s_n)$ and $z(s_n)$ belong to the frontier of D_n and $\eta(t_n)$ does not intersect the interior of D_n . By using the arguments from Remark A.1, one can easily show that, except on a set of probability 0 that does not depend on t , $(r_n)_n$ and $(a_n)_n$ are bounded (indeed, otherwise there would exist an open half-plane H such that there is no point of $y(0) \in \eta(0) \cap H$ that stays in H at least until time 1). Therefore (by considering a subsequence), we can assume that $(r_n)_n$ converges to some $r \in \mathbb{R}_+$ and $(a_n)_n$ converges to some $a \in \mathbb{R}^2$. By continuity of the Lévy processes at time t we have the two following properties: (a) $y(t)$ and $z(t)$ belong to the frontier of the disc centered at x of radius r and: (b) this disc does not contain any point of $\eta(t)$ in its interior. We can now conclude by using once again the above deterministic observation. \square

We are now ready to prove Lemma B.2. Let $y(0) \in \eta(0)$ and, for every $\varepsilon > 0$, let $0 \leq t_1 = t_1(\varepsilon) \leq t_2 = t_2(\varepsilon) \leq \dots$ be the times at which the Lévy process attached to $y(0)$ is discontinuous with a jump of size at least ε . Thanks to the claim and by σ -additivity, it is sufficient to prove that, for every $k \in \mathbb{N}_+$, a.s. there is no infinite black component in $\overline{G}(t_k)$. Fix such $k \in \mathbb{N}_+$ and consider the process $(\omega'(t))_{t \geq 0}$ which is defined using $(\omega(t))_{t \geq 0}$ as follows: (a) $\omega'(0) = \omega(0)$, (b) every point of $\eta(0) \setminus \{y(0)\}$ evolve in $(\omega'(t))_{t \geq 0}$ exactly like in $(\omega(t))_{t \geq 0}$ and: (c) the point $y(0)$ evolves according to a Lévy process of distribution μ independent of everything else. Note that $\omega'(t_k) \sim \mathbb{P}_{1/2}$. In particular, a.s. there is no unbounded black component in $\omega'(t_k)$. As a result, a.s. there is no infinite component made of black vertices in $G'(t_k)$ (where $G'(t_k)$ is the obvious analogue of $G(t_k)$). Moreover, $\overline{G}(t_k)$ and $G'(t_k)$ only differ by finitely many edges, which cannot affect the existence of an infinite component. Hence, a.s. there is no infinite black component in $\overline{G}(t_k)$. This ends the proof. \square

C Absence of noise sensitivity for t_n sufficiently small

In this section, we prove Theorem 1.4 in the case where $t_n n^2 \alpha_4^{an}(n) \xrightarrow{n \rightarrow +\infty} 0$. First note that it is sufficient to prove that:

$$\mathbb{E} \left[h_n(\omega^{froz}(0)) h_n(\omega^{froz}(t_n)) \right] \xrightarrow{n \rightarrow +\infty} 1,$$

where h_n is the ± 1 indicator function of $\text{Cross}(n, n)$.

Consider the annealed pivotal event $\text{Piv}_D(g_n)$ (where D is a bounded Borel subset of the plane) and the quenched pivotal event $\text{Piv}_x^q(g_n)$ from Definition 3.2. Note that $\text{Piv}_D(g_n)$ is independent of $\eta \cap D$ and that $\text{Piv}_D^q(g_n) \subseteq \text{Piv}_D(g_n)$. As a result:

$$\begin{aligned} \mathbb{E}_{1/2} [\text{Card}\{x \in \eta : \text{Piv}_x^q(g_n) \text{ holds}\}] &\leq \sum_{B \text{ box of } \mathbb{Z}^2} \mathbb{E}_{1/2} [|\eta \cap B| \mathbb{1}_{\text{Piv}_B(q_n)}] \\ &= \sum_{B \text{ box of } \mathbb{Z}^2} \mathbb{P}_{1/2} [\text{Piv}_B(q_n)] . \end{aligned} \quad (\text{C.1})$$

In Chapter 5 (Proposition 4.1), we have proved that:

$$\sum_{B \text{ box of } \mathbb{Z}^2} \mathbb{P}_{1/2} [\text{Piv}_B(q_n)] \asymp n^2 \alpha_4^{an}(n) .$$

Now, note that:

$$\begin{aligned} \mathbb{E} \left[h_n(\omega^{froz}(0)) h_n(\omega^{froz}(t_n)) \right] &= \mathbb{E} \left[\mathbb{E} \left[h_n(\omega^{froz}(0)) h_n(\omega^{froz}(t_n)) \mid \eta \right] \right] \\ &= \mathbb{E} \left[\sum_{S \subseteq_f \eta} \widehat{h}_n^\eta(S)^2 e^{-t_n |S|} \right] \\ &\geq \mathbb{E} \left[\exp \left(-t_n \sum_{x \in \eta} \mathbf{P}_{1/2}^\eta [\text{Piv}_x^q(g_n)] \right) \right] , \end{aligned}$$

where the last inequality is (6.10) of [GS14]. The result now follows from the fact that by above $\sum_{x \in \eta} \mathbf{P}_{1/2}^\eta [\text{Piv}_x^q(g_n)] \ll t_n^{-1}$ with high probability.

D The probability of a 4-arm event conditioned on the configuration in a half-plane

In this section, we prove the following estimate on the 4-arm event conditioned on the configuration in a half-plane:

Lemma D.1. *Let H be the lower half-plane $\{(x_1, x_2) \in \mathbb{R}^2 : x_2 \leq 0\}$. There exists $\varepsilon_1 > 0$ such that, for every $1 \leq r \leq R < +\infty$:*

$$\mathbb{E} \left[\mathbf{P}_{1/2}^\eta \left[\mathbf{A}_4(r, R) \mid \omega \cap H \right]^2 \right] \leq \frac{1}{\varepsilon_1} \left(\frac{r}{R} \right)^{\varepsilon_1} \alpha_4^{an}(r, R) .$$

Proof. Let us prove the following stronger result, where $\widehat{\mathbf{A}}_4(r, R) \supseteq \mathbf{A}_4(r, R)$ is the event from Definition 1.16:

$$\mathbb{E} \left[\mathbf{P}_{1/2}^\eta \left[\widehat{\mathbf{A}}_4(r, R) \mid \omega \cap H \right]^2 \right] \leq \frac{1}{\varepsilon_1} \left(\frac{r}{R} \right)^{\varepsilon_1} \alpha_4^{an}(r, R) . \quad (\text{D.1})$$

To this purpose, we follow the proof of Lemma C.1 of Chapter 4 which is the analogous result for Bernoulli percolation on \mathbb{Z}^2 . Let $\omega', \omega'' \sim \mathbb{P}_{1/2}$ be two configurations that have the same underlying point process η , that coincide on $\eta \cap H$ and that are conditionally independent on $\eta \setminus H$. By the observations at the beginning of Subsection 5.3 of [GPS10], we have:

$$\mathbf{E}_{1/2}^\eta \left[\mathbf{P}_{1/2}^\eta \left[\widehat{\mathbf{A}}_4(r, R) \mid \omega \cap H \right]^2 \right] = \mathbb{P} \left[\omega', \omega'' \in \widehat{\mathbf{A}}_4(r, R) \mid \eta \right] . \quad (\text{D.2})$$

The general idea of the proof is that, if we condition on $\{\omega'' \in \mathbf{A}_4(r, R)\}$, then with high probability there are $\Omega(1) \log(R/r)$ scales at which the following holds in ω' : There are so many

black connexions in H^c that, if $\mathbf{A}_4(r, R)$ holds, then there must be a 3-arm event in H . Since (by the results of Subsection 1.3), the probability of the 3-arm event in the half-plane is much less than the probability of the 4-arm event, this implies the desired result. The technical difficulty is that (for some reasons that will become clear below), it seems hard to make this reasoning work at the annealed level so we have to work at the quenched level.

We start the proof by introducing events that will enable us to use box-crossing properties, spatial independence properties and quasi-multiplicativity properties at the quenched level. Fix some $M \in [100, +\infty[$ to be chosen later and let $\rho \in [100M^2, +\infty[$. Also, for any $i, k \in \mathbb{N}$ let:

$$\rho_k^i = \rho^i M^k.$$

A. The box-crossing and spatial independence properties. We will use the following events, where the ‘‘Dense’’ events and the ‘‘QBC’’ events are those from Definitions 3.18 and 3.19.

$$\widetilde{\text{GP}}^i(\rho, M) := \bigcap_{k=0}^{+\infty} \text{Dense}_{1/(100M)}(A(\rho_k^i, \rho_{k+1}^i)) \cap \text{QBC}_{1/(100M)}^2(A(\rho_k^i, \rho_{k+1}^i))$$

(where GP means ‘‘Good Point process’’). The events $\text{QBC}_{1/(100M)}^2(A(\rho_k^i, \rho_{k+1}^i))$ provide box-crossing properties for all the rectangles that are included in $A(\rho_k^i, \rho_{k+1}^i)$ and are drawn on the grid $a\mathbb{Z}^2$ for some a of the order of $\rho_{k+1}^i/(100M) = \rho_k^i/100$. However, the box-crossing constant depends on M (see Definition 3.19). The events $\text{Dense}_{1/(100M)}(A(\rho_k^i, \rho_{k+1}^i))$ provide spatial independence properties. Below, we will use obvious independence properties without mentioning them explicitly when we work under the probability measure $\mathbf{P}_{1/2}^\eta$ for some $\eta \in \widetilde{\text{GP}}^i(\rho, M)$.

It is easy to see that for each $k \in \mathbb{N}$ and each $i \in \mathbb{N}^*$:

$$\mathbb{P}[\text{Dense}_{1/(100M)}(A(\rho_k^i, \rho_{k+1}^i))] \geq 1 - \exp(-\Omega(1)(\rho_{k+1}^i/M)^2) \geq 1 - \exp(-\Omega(1)\rho^2).$$

Moreover, Definition 3.19 implies that for each $k \in \mathbb{N}$ and each $i \in \mathbb{N}^*$:

$$\mathbb{P}[\text{QBC}_{1/(100M)}^2(A(\rho_k^i, \rho_{k+1}^i))] \geq 1 - O(1) \frac{1}{(\rho_{k+1}^i)^2} \geq 1 - O(1) \frac{1}{\rho^2}.$$

As a result:

$$\mathbb{P}[\widetilde{\text{GP}}^i(\rho, M)] \geq 1 - O(1) \frac{1}{\rho^2}. \quad (\text{D.3})$$

B. The quasi-multiplicativity properties. We will use the following result which is a direct consequence of Proposition 3.16 of Chapter 6.

Proposition D.2. *There exists $C \in [1, +\infty[$ such that for every $\rho' \geq 1$ the following holds with probability larger than $1 - C(\rho')^{-2}$: For every $r_1, r_2, r_3 \in [\rho', +\infty[$ that satisfy $r_1 \leq r_2 \leq r_3$, we have:*

$$\frac{1}{C} \mathbf{P}_{1/2}^\eta[\mathbf{A}_4(r_1, r_3)] \leq \mathbf{P}_{1/2}^\eta[\mathbf{A}_4(r_1, r_2)] \mathbf{P}_{1/2}^\eta[\mathbf{A}_4(r_2, r_3)] \leq C \mathbf{P}_{1/2}^\eta[\mathbf{A}_4(r_1, r_3)].$$

Let $i \in \mathbb{N}^*$ and assume that η belongs to the event:

$$\overline{\text{GP}}^i(\rho) := \bigcap_{k=1}^{+\infty} \text{Dense}_{1/100}(A(2^k \rho^i, 2^{k+2} \rho^i)) \cap \text{QBC}_{1/100}^2(A(2^k \rho^i, 2^{k+2} \rho^i)).$$

Then, η satisfies sufficiently many box-crossing properties so that for any $r_1 \geq \rho^i$ we have:

$$\mathbf{P}_{1/2}^\eta[\mathbf{A}_4(r_1, 2r_1)] \geq \Omega(1)$$

Moreover, η satisfies sufficiently many spatial independence properties so that:

$$\widehat{\mathbf{A}}_4(r_1, r_2) \subseteq \mathbf{A}_4(2r_1, r_2/2)$$

for any $r_1, r_2 \in [\rho^i, +\infty[$ such that $r_1 \leq r_2/4$. As a result, if the event of Proposition D.2 holds for $\rho' = \rho^i$ and if $\eta \in \overline{\mathbf{GP}}^i(\rho)$ then the quasi-multiplicativity property is also true for the quantities $\mathbf{P}_{1/2}^\eta \left[\widehat{\mathbf{A}}_4(r, R) \right]$ i.e. there exists a constant $C' \in [1, +\infty[$ such that, for every $r_1, r_2, r_3 \in [\rho^i, +\infty[$ that satisfy $r_1 \leq r_2 \leq r_3$, we have:

$$\frac{1}{C'} \mathbf{P}_{1/2}^\eta \left[\widehat{\mathbf{A}}_4(r_1, r_3) \right] \leq \mathbf{P}_{1/2}^\eta \left[\widehat{\mathbf{A}}_4(r_1, r_2) \right] \mathbf{P}_{1/2}^\eta \left[\widehat{\mathbf{A}}_4(r_2, r_3) \right] \leq C' \mathbf{P}_{1/2}^\eta \left[\widehat{\mathbf{A}}_4(r_1, r_3) \right]. \quad (\text{D.4})$$

Let us write $\text{QQM}^i(\rho)$ (for Quenched Quasi-Multiplicativity) for the event that the above holds. By the same calculations as in Paragraph A above, $\overline{\mathbf{GP}}^i(\rho)$ holds with probability larger than $1 - O(1) \frac{1}{\rho^2}$. Together with Proposition D.2, this implies that:

$$\mathbb{P} [\text{QQM}^i(\rho)] \geq 1 - O(1) \frac{1}{\rho^2}. \quad (\text{D.5})$$

C. The quenched probabilities of the 3-arm event in the half-plane and of the 4-arm event. In this paragraph, we consider the annuli $A_k^i = A(\rho_k^i + 3\rho_k^i/10, \rho_{k+1}^i - 3\rho_k^i/10)$ and the half-annuli $A_k^{i,-} = \{(x_1, x_2) \in A_k^i : x_2 \leq 2\rho_k^i/10\}$. We write $\mathbf{A}_3(A_k^{i,-})$ for the 3-arm event in $A_k^{i,-}$ and we let:

$$\widehat{\mathbf{A}}_3(A_k^{i,-}) = \left\{ \mathbb{P}_{1/2} \left[\widehat{\mathbf{A}}_3(A_k^{i,-}) \mid \omega \cap A_k^i \right] > 0 \right\}.$$

We first prove the following claim:

Claim D.3. *There exists an absolute constant $c > 0$ such that the following holds. For every $\delta \in]0, 1[$ there exists a constant $M_0 = M_0(\delta) < +\infty$ such that, if $M \geq M_0$ then for every $k, i \in \mathbb{N}$ we have:*

$$\mathbb{P} \left[\mathbf{P}_{1/2}^\eta \left[\widehat{\mathbf{A}}_3(A_k^{i,-}) \right] \leq \delta \mathbf{P}_{1/2}^\eta \left[\widehat{\mathbf{A}}_4(\rho_k^i, \rho_{k+1}^i) \right] \right] \geq c.$$

Proof. If M is sufficiently large then, by Propositions 1.12, 1.14 and 1.17:

$$\mathbb{P}_{1/2} \left[\widehat{\mathbf{A}}_3(A_k^{i,-}) \right] \leq \frac{\delta}{2} \mathbb{P}_{1/2} \left[\widehat{\mathbf{A}}_4(\rho_k^i, \rho_{k+1}^i) \right].$$

Moreover, by Proposition 1.17, there exists a constant $C'' \in [1, +\infty[$ such that

$$\sqrt{\mathbb{E} \left[\mathbf{P}_{1/2}^\eta \left[\widehat{\mathbf{A}}_4(\rho_k^i, \rho_{k+1}^i) \right]^2 \right]} \leq C'' \mathbb{P}_{1/2} \left[\widehat{\mathbf{A}}_4(\rho_k^i, \rho_{k+1}^i) \right].$$

As a result (by applying the Cauchy-Schwarz inequality at the third line):

$$\begin{aligned} & \mathbb{P}_{1/2} \left[\widehat{\mathbf{A}}_4(\rho_k^i, \rho_{k+1}^i) \right] \\ & \leq \frac{1}{\delta} \mathbb{P}_{1/2} \left[\widehat{\mathbf{A}}_3(A_k^{i,-}) \right] + \mathbb{E} \left[\mathbf{P}_{1/2}^\eta \left[\widehat{\mathbf{A}}_4(\rho_k^i, \rho_{k+1}^i) \right] \mathbf{1}_{\mathbf{P}_{1/2}^\eta \left[\widehat{\mathbf{A}}_3(A_k^{i,-}) \right] \leq \delta \mathbf{P}_{1/2}^\eta \left[\widehat{\mathbf{A}}_4(\rho_k^i, \rho_{k+1}^i) \right]} \right] \\ & \leq \frac{\delta}{2\delta} \mathbb{P}_{1/2} \left[\widehat{\mathbf{A}}_4(\rho_k^i, \rho_{k+1}^i) \right] \\ & \quad + \sqrt{\mathbb{E} \left[\mathbf{P}_{1/2}^\eta \left[\widehat{\mathbf{A}}_4(\rho_k^i, \rho_{k+1}^i) \right]^2 \right]} \sqrt{\mathbb{P} \left[\mathbf{P}_{1/2}^\eta \left[\widehat{\mathbf{A}}_3(A_k^{i,-}) \right] \leq \delta \mathbf{P}_{1/2}^\eta \left[\widehat{\mathbf{A}}_4(\rho_k^i, \rho_{k+1}^i) \right] \right]} \\ & \leq \frac{1}{2} \mathbb{P}_{1/2} \left[\widehat{\mathbf{A}}_4(\rho_k^i, \rho_{k+1}^i) \right] \\ & \quad + C'' \mathbb{P}_{1/2} \left[\widehat{\mathbf{A}}_4(\rho_k^i, \rho_{k+1}^i) \right] \sqrt{\mathbb{P} \left[\mathbf{P}_{1/2}^\eta \left[\widehat{\mathbf{A}}_3(A_k^{i,-}) \right] \leq \delta \mathbf{P}_{1/2}^\eta \left[\widehat{\mathbf{A}}_4(\rho_k^i, \rho_{k+1}^i) \right] \right]}. \end{aligned}$$

This implies the result with $c = 1/(2C'')^2$. \square

D. The quenched level. Remember that the configurations ω' and ω'' have the same underlying point process η . In this paragraph, we restrict ourselves to the cases where there exist $i \in \mathbb{N}^*$ and $\rho \in [100M^2, +\infty[$ such that $r = \rho^i$ and $R = \rho r = \rho^{i+1}$ and we use the events from Paragraphs A, B and C to study the quantity

$$\mathbb{P} \left[\omega', \omega'' \in \widehat{\mathbf{A}}_4(r, R) \mid \eta \right].$$

To simplify the calculations below, we assume that $\log_M(\rho) = \log_M(R/r)$ is an integer (the proof in the general case is the same).

Fix some $\delta \in]0, 1[$ to be chosen later and assume that $M \geq M_0$ where $M_0 = M_0(\delta)$ is the constant from Claim D.3. We let $N_i = |\mathcal{N}_i|$ where \mathcal{N}_i is the set of all the integers $k \in \{0, \dots, \log_M(\rho) - 1\}$ such that:

$$\mathbf{P}_{1/2}^\eta \left[\widehat{\mathbf{A}}_3(A_k^{i,-}) \right] \leq \delta \mathbf{P}_{1/2}^\eta \left[\mathbf{A}_4(\rho_k^i, \rho_{k+1}^i) \right].$$

Note that N_i dominates stochastically a binomial random variable of parameters $\log_M(\rho)$ and c where c is the constant from Claim D.3. As a result, there exists an absolute constant $a \in]0, 1[$ such that:

$$\mathbb{P} [N_i \geq a \log_M(\rho)] \leq \frac{1}{a} e^{-a \log_M(\rho)}. \quad (\text{D.6})$$

We consider the following event:

$$\text{GP}^i(\rho, M) = \widetilde{\text{GP}}^i(\rho, M) \cap \text{QQM}^i(\rho) \cap \{N_i \geq a \log_M(\rho)\}.$$

We now prove the following claim:

Claim D.4. *Assume that there exist $i \in \mathbb{N}$ and $\rho \in [100M^2, +\infty[$ such that $r = \rho^i$ and $R = \rho r$. If M is sufficiently large, then there exists a constant $d = d(M) > 0$ (that do not depend on i and ρ) such that for every $\eta \in \text{GP}^i(\rho, M)$ we have:*

$$\mathbb{P} \left[\omega', \omega'' \in \widehat{\mathbf{A}}_4(r, R) \mid \eta \right] \leq \rho^{-d} \mathbf{P}_{1/2}^\eta \left[\mathbf{A}_4(r, R) \right].$$

Proof. Let i and ρ as in the statement of the claim and let $\eta \in \text{GP}^i(\rho, M)$. For each $k \in \{0, \dots, \log_M(\rho) - 1\}$ let $E(k) = E^i(k)$ denote the event that there are black paths as in Figure D.1. Since $\eta \in \widetilde{\text{GP}}^i(\rho, M)$, there exists $c' = c'(M) > 0$ such that, for each k , $\mathbf{P}_{1/2}^\eta [E(k)] \geq c'(M)$. Let $\tilde{N}_i \leq N_i$ be the number of integers $k \in \mathcal{N}_i$ such that $E(k)$ holds. Let $k_1 < \dots < k_{\tilde{N}_i}$ be these integers and let $l_1 < \dots < l_m$ be a possible occurrence of these. By spatial independence we have:

$$\begin{aligned} \mathbb{P} \left[\omega', \omega'' \in \widehat{\mathbf{A}}_4(r, R) \mid \eta, \tilde{N}_i = m, k_1 = l_1, \dots, k_m = l_m \right] &\leq \mathbb{P} \left[\omega'' \in \widehat{\mathbf{A}}_4(r, \rho_{l_1}^i) \mid \eta \right] \\ &\times \prod_{q=1}^{m-1} \left(\mathbb{P} \left[\omega' \in \widehat{\mathbf{A}}_4(\rho_{l_q}^i, \rho_{l_{q+1}}^i) \mid \eta, \omega' \in E(l_q) \right] \mathbb{P} \left[\omega'' \in \widehat{\mathbf{A}}_4(\rho_{l_{q+1}}^i, \rho_{l_{q+1}}^i) \mid \eta \right] \right) \\ &\times \mathbb{P} \left[\omega' \in \widehat{\mathbf{A}}_4(\rho_{l_m}^i, \rho_{l_{m+1}}^i) \mid \eta, \omega' \in E(l_m) \right] \mathbb{P} \left[\omega'' \in \widehat{\mathbf{A}}_4(\rho_{l_{m+1}}^i, R) \mid \eta \right]. \end{aligned} \quad (\text{D.7})$$

Let us study the quantities $\mathbb{P} \left[\omega' \in \widehat{\mathbf{A}}_4(\rho_{l_q}^i, \rho_{l_{q+1}}^i) \mid \eta, \omega' \in E(l_q) \right]$ for $q \in \{1, \dots, m\}$. To this purpose, note that we have (see Figure D.2):

$$\mathbf{P}_{1/2}^\eta \left[\mathbf{A}_4(\rho_k^i + 3\rho_k^i/10, \rho_{k+1}^i - 3\rho_k^i/10) \mid E(k) \right] \leq \mathbf{P}_{1/2}^\eta \left[\mathbf{A}_3(A_k^{i,-}) \right].$$

Actually, in order to obtain this estimate, we have to condition on the upper paths that cross the rectangles $[\rho_k^i + 2\rho_k^i/10, \rho_{k+1}^i - 2\rho_k^i/10] \times [\rho_k^i/10, 2\rho_k^i/10]$ and $[-(\rho_k^i + 2\rho_k^i/10), -(\rho_{k+1}^i -$

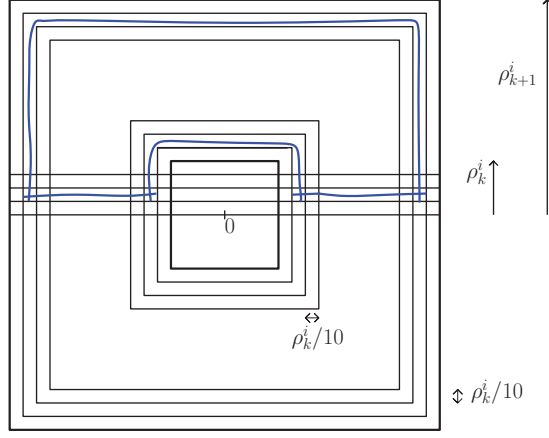

Figure D.1 – A realization of the event $E(k) = E^i(k)$.

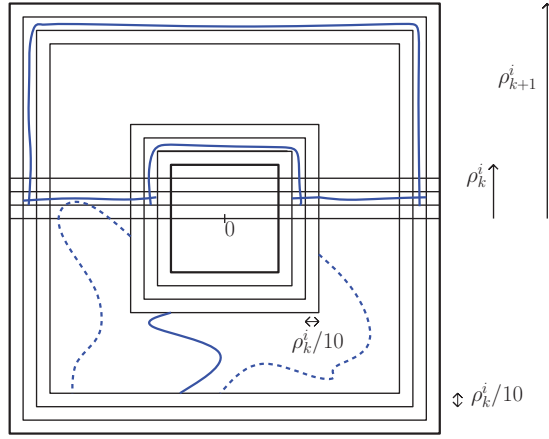

Figure D.2 – A realization of the event $E(k)$ and of the 4-arm event implies the realization of a 3-arm event in a half-plane.

$2\rho_k^i/10] \times [\rho_k^i/10, 2\rho_k^i/10]$ and observe that (since we work under the quenched measure) this conditioning does not affect the configuration below these paths. **This argument would not have applied if we were working at the annealed level.**

Since $\eta \in \widetilde{\text{GP}}^i(\rho, M)$ we have enough spatial independence properties so that $\widehat{\mathbf{A}}_4(\rho_k^i, \rho_{k+1}^i) \subseteq \mathbf{A}_4(\rho_k^i + 3\rho_k^i/10, \rho_{k+1}^i - 3\rho_k^i/10)$ for each $k \in \mathbb{N}$. As a result for each $k \in \{0, \dots, \log_M(\rho) - 1\}$ we have

$$\mathbf{P}_{1/2}^\eta \left[\widehat{\mathbf{A}}_4(\rho_k^i, \rho_{k+1}^i) \mid E(k) \right] \leq \mathbf{P}_{1/2}^\eta \left[\mathbf{A}_3(A_k^{i,-}) \right] \leq \mathbf{P}_{1/2}^\eta \left[\widehat{\mathbf{A}}_3(A_k^{i,-}) \right].$$

Since $k_1, \dots, k_{\tilde{N}_i} \in \mathcal{N}_i$, (D.7) and the above imply that:

$$\begin{aligned} \mathbb{P} \left[\omega', \omega'' \in \widehat{\mathbf{A}}_4(r, R) \mid \eta, \tilde{N}_i = m, k_1 = l_1, \dots, k_m = l_m \right] &\leq \delta^m \times \mathbb{P} \left[\omega'' \in \widehat{\mathbf{A}}_4(r, \rho_{l_1}^i) \mid \eta \right] \\ &\times \prod_{q=1}^{m-1} \left(\mathbb{P} \left[\omega' \in \widehat{\mathbf{A}}_4(\rho_{l_q}^i, \rho_{l_{q+1}}^i) \mid \eta \right] \mathbb{P} \left[\omega'' \in \widehat{\mathbf{A}}_4(\rho_{l_{q+1}}^i, \rho_{l_{q+1}}^i) \mid \eta \right] \right) \\ &\times \mathbb{P} \left[\omega' \in \widehat{\mathbf{A}}_4(\rho_{l_m}^i, \rho_{l_{m+1}}^i) \mid \eta \right] \mathbb{P} \left[\omega'' \in \widehat{\mathbf{A}}_4(\rho_{l_{m+1}}^i, R) \mid \eta \right]. \end{aligned}$$

Next, the quenched quasi-multiplicativity property (D.4) implies that the above is at most:

$$\delta^m (C')^{2m} \mathbf{P}_{1/2}^\eta \left[\widehat{\mathbf{A}}_4(r, R) \right].$$

Since $\eta \in \text{GP}^i(\rho, M)$, we have $N_i \geq a \log_M(\rho)$. Moreover, since (conditionally on η) \tilde{N}_i dominates stochastically a binomial random variable of parameters N_i and $c'(M)$, there exists $b = b(M) > 0$ such that

$$\mathbb{P} \left[\tilde{N}_i \leq b \log_M(\rho) \mid \eta \right] \leq \frac{1}{b} \exp(-b \log_M(\rho)).$$

Note furthermore that, conditionally on η , \tilde{N}_i is independent of ω'' . We finally obtain that:

$$\mathbb{P} \left[\omega', \omega'' \in \hat{\mathbf{A}}_4(r, R) \mid \eta \right] \leq \left(\frac{1}{b} \exp(-b \log_M(\rho)) + (\delta(C')^2)^{b \log_M(\rho)} \right) \mathbf{P}_{1/2}^\eta \left[\hat{\mathbf{A}}_4(r, R) \right].$$

This ends the proof (if we choose for instance $\delta = 1/(2(C')^2)$). \square

E. Integretion on η . Let us conclude the proof of (D.1). By Claim D.4, we have the following if M is sufficiently large and if there exist $i \in \mathbb{N}^*$ and $\rho \in [100M^2, +\infty[$ such that $r = \rho^i$ and $R = \rho r$:

$$\mathbb{P} \left[\omega', \omega'' \in \hat{\mathbf{A}}_4(r, R) \right] \leq \mathbb{P} \left[\eta \notin \text{GP}^i(\rho, M), \omega', \omega'' \in \hat{\mathbf{A}}_4(r, R) \right] + \rho^{-d} \mathbb{P}_{1/2} \left[\hat{\mathbf{A}}_4(r, R) \right].$$

By Proposition 1.17, the above is less than or equal to:

$$\mathbb{P} \left[\eta \notin \text{GP}^i(\rho, M), \omega', \omega'' \in \hat{\mathbf{A}}_4(r, R) \right] + O(1) \rho^{-d} \alpha_4^{an}(r, R).$$

If we combine the above with (D.3) and (D.5), we obtain that:

$$\begin{aligned} \mathbb{P} \left[\omega', \omega'' \in \hat{\mathbf{A}}_4(r, R) \right] &\leq O(1) \frac{1}{\rho^2} \\ &\quad + \mathbb{P} \left[N_i \leq a \log_M(\rho), \omega', \omega'' \in \hat{\mathbf{A}}_4(r, R) \right] + O(1) \rho^{-d} \alpha_4^{an}(r, R). \end{aligned}$$

By the Cauchy-Schwarz inequality, we have:

$$\begin{aligned} \mathbb{P} \left[N_i \leq a \log_M(\rho), \omega', \omega'' \in \hat{\mathbf{A}}_4(r, R) \right] &= \mathbb{E} \left[\mathbf{1}_{N_i \leq a \log_M(\rho)} \mathbb{P} \left[\omega', \omega'' \in \hat{\mathbf{A}}_4(r, R) \mid \eta \right] \right] \\ &\leq \sqrt{\mathbb{P} \left[N_i \leq a \log_M(\rho) \right]} \sqrt{\mathbb{E} \left[\mathbb{P} \left[\omega', \omega'' \in \hat{\mathbf{A}}_4(r, R) \mid \eta \right]^2 \right]} \\ &\leq \sqrt{\mathbb{P} \left[N_i \leq a \log_M(\rho) \right]} \sqrt{\mathbb{E} \left[\mathbf{P}_{1/2}^\eta \left[\hat{\mathbf{A}}_4(r, R) \right]^2 \right]}. \end{aligned}$$

Proposition 1.17 implies that $\sqrt{\mathbb{E} \left[\mathbf{P}_{1/2}^\eta \left[\hat{\mathbf{A}}_4(r, R) \right]^2 \right]} \leq O(1) \alpha_4^{an}(r, R)$. Hence, if we combine this with (D.6), the above is less than or equal to:

$$O(1) \sqrt{\frac{1}{a} (1-a)^{a \log_M(\rho)} \alpha_4^{an}(r, R)}.$$

As a result:

$$\begin{aligned} \mathbb{E} \left[\mathbf{P}_{1/2}^\eta \left[\hat{\mathbf{A}}_4(r, R) \mid \omega \cap H \right]^2 \right] &= \mathbb{P} \left[\omega', \omega'' \in \hat{\mathbf{A}}_4(r, R) \right] \\ &\leq O(1) \left(\frac{1}{\rho^2} + \sqrt{\frac{1}{a} (1-a)^{a \log_M(\rho)} \alpha_4^{an}(r, R)} + \rho^{-d} \alpha_4^{an}(r, R) \right). \end{aligned}$$

By Proposition 1.12, there exists $d' > 0$ such that $\frac{1}{\rho^2} \leq O(1) \rho^{-d'} \alpha_4^{an}(r, R)$. As a result (still if M is sufficiently large), there exists $d'' = d''(M) > 0$ such that the above is at most

$$\rho^{-d''} \alpha_4^{an}(r, R) = \left(\frac{r}{R}\right)^{d''} \alpha_4^{an}(r, R).$$

Fix a constant M sufficiently large so that the above holds. Finally, we have obtained the desired result (i.e. (D.1)) for any r, R satisfying $r = \rho^i$ and $R = \rho r$ for some $i \in \mathbb{N}^*$ and some $\rho \in [100M^2, +\infty[$. Fix some $\rho \in [100M^2, +\infty[$ to be chosen later. Let us conclude that (D.1) holds in general. To this purpose, first note that, by the quasi-multiplicativity property for the quantities $\alpha_4^{an}(\cdot, \cdot)$, it is enough to prove the result in the cases where there exist $i < j \in \mathbb{N}^*$ such that $r = \rho^i$ and $R = \rho^j$. Therefore, let $i < j \in \mathbb{N}^*$, let $r = \rho^i$ and $R = \rho^j$, and let us study the quantity $\mathbb{P}[\omega', \omega'' \in \widehat{\mathbf{A}}_4(r, R)]$. By spatial independence and by using the result in the cases already proved we have:

$$\mathbb{P}[\omega', \omega'' \in \widehat{\mathbf{A}}_4(r, R)] \leq \prod_{l=i}^{j-1} \mathbb{P}[\omega', \omega'' \in \widehat{\mathbf{A}}_4(\rho^l, \rho^{l+1})] \leq \prod_{l=i}^{j-1} \rho^{-d''} \alpha_4^{an}(\rho^l, \rho^{l+1}),$$

By the quasi-multiplicativity property of the quantities $\alpha_4^{an}(\cdot, \cdot)$, there exists an absolute constant $C''' \in [1, +\infty[$ such that the above is less than or equal to

$$(C''' \rho^{-d''/2})^{j-i} \rho^{-d''(j-i)/2} \alpha_4^{an}(r, R) = (C''' \rho^{-d''/2})^{j-i} \left(\frac{r}{R}\right)^{d''/2} \alpha_4^{an}(r, R).$$

This ends the proof (if we choose ρ such that $C''' \rho^{-d''/2} \leq 1$). \square

In Subsection 3.2, we need the following consequence of Lemma D.1. Remember that f_R is the 1-arm event.

Lemma D.5. *Let $R \in [1, +\infty[$ and $1 \leq \rho_1 < \rho_2 < +\infty$. Also, let A be an annulus included in $[-R, R]^2$ of the form $A(x; \rho_1, \rho_2) = x + [-\rho_2, \rho_2]^2 \setminus]-\rho_1, \rho_1[^2$ and let B be its inner square. Assume that A is at distance at least ρ_2 from 0 (in particular, neither A nor B contains 0). Let H be a half-plane whose boundary contains the center of A and is parallel to the x or y axis. Then, there exists an absolute constant $\varepsilon_1 > 0$ such that the following holds:*

$$\mathbb{E} \left[\mathbf{P}_{1/2}^\eta \left[\text{Piv}_B^A(f_R) \mid \omega \cap H \right]^2 \right] \leq O(1) (\rho_1/\rho_2)^{\varepsilon_1} \alpha_4^{an}(\rho_1, \rho_2),$$

where $\text{Piv}_B^A(f_R)$ is the pivotal event from Definition 3.11.

Proof. We first write the proof in the case where $\rho_2 \leq \rho_1^2$. Let

$$\text{Dense}(\rho_1, \rho_2) = \text{Dense}_{1/100}(A(\rho_1, 2\rho_1)) \cap \text{Dense}_{1/100}(A(\rho_2/2, \rho_2)),$$

where the events ‘‘Dense’’ are the events from Definition 3.18. Note that, if $\omega \in \text{Dense}(\rho_1, \rho_2) \cap \text{Piv}_B^A(f_R)$, then the 4-arm event in $A(x; 2\rho_1, \rho_2/2)$ holds. As a result:

$$\begin{aligned} & \mathbb{E} \left[\mathbf{P}_{1/2}^\eta \left[\text{Piv}_B^A(f_R) \mid \omega \cap H \right]^2 \right] \\ & \leq \mathbb{E} \left[\mathbf{P}_{1/2}^\eta \left[\text{4-arm event in } A(x; 2\rho_1, \rho_2/2) \mid \omega \cap H \right]^2 \right] + \mathbb{P}[\neg \text{Dense}(\rho_1, \rho_2)]. \end{aligned}$$

By using that $\mathbb{P}[\neg \text{Dense}(\rho_1, \rho_2)]$ decays to 0 super-polynomially fast in ρ_1 and Lemma D.1, we obtain that:

$$\mathbb{E} \left[\mathbf{P}_{1/2}^\eta \left[\text{Piv}_B^A(f_R) \mid \omega \cap H \right]^2 \right] \leq O(1) (\rho_1/\rho_2)^{\varepsilon_1} \alpha_4^{an}(2\rho_1, \rho_2/2) \leq O(1) (\rho_1/\rho_2)^{\varepsilon_1} \alpha_4^{an}(\rho_1, \rho_2),$$

where the last inequality comes from the quasi-multiplicativity property (and (1.2)).

Let us now prove the result in the general case. To this purpose, let M be sufficiently large to be chosen later. Also, let $A_k = A(x; \rho_1 M^k, \rho_1 M^{k+1})$ and let B_k be the inner square of A_k . The events $\text{Piv}_{B_k}^{A_k}(f_R)$, $k = 0, \dots, \log_M(\rho_2/\rho_1) - 1$, are independent and for every $k \in \{0, \dots, \log_M(\rho_2/\rho_1) - 1\}$, $\text{Piv}_{B_k}^{A_k}(f_R)$ contains $\text{Piv}_B^A(f_R)$. Therefore, the result in the case $\rho_2 \leq \rho_1^2$ and the quasi-multiplicativity for the quantities $\alpha_4^{an}(\cdot, \cdot)$ imply that in the general case:

$$\mathbb{E} \left[\mathbf{P}_{1/2}^\eta \left[\text{Piv}_B^A(f_R) \mid \omega \cap H \right]^2 \right] \leq O(1)^{\log_M(\rho_2/\rho_1)} (\rho_1/\rho_2)^{\varepsilon_1} \alpha_4^{an}(\rho_1, \rho_2).$$

Choosing M such that $\log(O(1))/\log(M) \leq \varepsilon_1$ ends the proof. □

Bibliographie présentée pour cette thèse

- [V1] Alejandro Rivera et Hugo Vanneuille. Quasi-independence for nodal lines. arXiv preprint arXiv : 1711.05009, 2017, à paraître aux *Annales de l'Institut Henri Poincaré*.
- [V2] Alejandro Rivera et Hugo Vanneuille. The critical threshold for Bargmann-Fock. arXiv preprint arXiv : 1711.05012, 2017.
- [V3] Stephen Muirhead et Hugo Vanneuille. The sharp phase transition for level set percolation of smooth planar Gaussian fields. arXiv preprint arXiv : 1806.11545, 2018.
- [V4] Christophe Garban et Hugo Vanneuille. Exceptional times for percolation under exclusion dynamics. arXiv preprint arXiv : 1605.04766, 2016, à paraître aux *Annales scientifiques de l'École Normale Supérieure*.
- [V5] Hugo Vanneuille. Annealed scaling relations for Voronoi percolation. arXiv preprint arXiv : 1806.08452, 2018.
- [V6] Hugo Vanneuille. Quantitative quenched Voronoi percolation and applications. arXiv preprint arXiv : 1806.08448, 2018.
- [V7] Hugo Vanneuille. The annealed spectral sample of Voronoi percolation. En préparation, 2018+.

-
- [AB87] Michael Aizenman and David J Barsky. Sharpness of the phase transition in percolation models. *Communications in Mathematical Physics*, 108(3):489–526, 1987.
- [AB17] Daniel Ahlberg and Rangel Baldasso. Noise sensitivity and Voronoi percolation. *arXiv preprint arXiv:1708.03054*, 2017.
- [ABGM14] Daniel Ahlberg, Erik Broman, Simon Griffiths, and Robert Morris. Noise sensitivity in continuum percolation. *Israel J. Math.*, 201(2):847–899, 2014.
- [AGMT16] Daniel Ahlberg, Simon Griffiths, Robert Morris, and Vincent Tassion. Quenched Voronoi percolation. *Advances in Mathematics*, 286:889–911, 2016.
- [Ale96a] Kenneth S. Alexander. Boundedness of level lines for two-dimensional random fields. *The Annals of Probability*, 24(4):1653–1674, 1996.
- [Ale96b] Kenneth S. Alexander. The RSW theorem for continuum percolation and the CLT for Euclidean minimal spanning trees. *The Annals of Applied Probability*, 6(2):466–494, 1996.
- [Ana15] Nalini Anantharaman. Topologie des hypersurfaces nodales de fonctions aléatoires gaussiennes. *Séminaire Bourbaki*, 68(1116):2015–2016, 2015.
- [AT07] Robert J. Adler and Jonathan E. Taylor. *Random fields and geometry*. Springer, 2007.
- [ATT16] Daniel Ahlberg, Vincent Tassion, and Augusto Teixeira. Sharpness of the phase transition for continuum percolation in \mathbb{R}^2 . *arXiv preprint arXiv:1605.05926*, 2016.
- [AW09] Jean-Marc Azaïs and Mario Wschebor. *Level sets and extrema of random processes and fields*. John Wiley & Sons, Inc., Hoboken, NJ, 2009.
- [BDC12] Vincent Beffara and Hugo Duminil-Copin. The self-dual point of the two-dimensional random-cluster model is critical for $q \geq 1$. *Probability Theory and Related Fields*, 153(3):511–542, 2012.
- [BDS07] E. Bogomolny, R. Dubertrand, and C. Schmit. SLE description of the nodal lines of random wavefunctions. *J. Phys. A: Math. Theor.*, 40:381–395, 2007.
- [Bef08] Vincent Beffara. Is critical 2d percolation universal? *In and Out of Equilibrium 2*, pages 31–58, 2008.
- [BEL17] E. Di Bernardino, A. Estrade, and J.R. León. A test of Gaussianity based on the Euler characteristic of excursion sets. *Electron. J. Statist.*, 11(1):843–890, 2017.
- [Ber98] Jean Bertoin. *Lévy processes*, volume 121. Cambridge university press, 1998.
- [BG16] Vincent Beffara and Damien Gayet. Percolation of random nodal lines. *arXiv preprint arXiv:1605.08605*, to appear in *Inst. Hautes Etudes Sci. Publ. Math.*, 2016.
- [BG17] Vincent Beffara and Damien Gayet. Percolation without FKG. *arXiv preprint arXiv:1710.10644*, 2017.

- [BGS13] Erik I Broman, Christophe Garban, and Jeffrey E Steif. Exclusion sensitivity of Boolean functions. *Probability theory and related fields*, 155(3-4):621–663, 2013.
- [BH57] Simon R. Broadbent and John M. Hammersley. Percolation processes. In *Mathematical Proceedings of the Cambridge Philosophical Society*, volume 53, pages 629–641. Cambridge Univ Press, 1957.
- [BKK⁺92] Jean Bourgain, Jeff Kahn, Gil Kalai, Yitzhak Katznelson, and Nathan Linial. The influence of variables in product spaces. *Israel Journal of Mathematics*, 77(1-2):55–64, 1992.
- [BKS99] Itai Benjamini, Gil Kalai, and Oded Schramm. Noise sensitivity of Boolean functions and applications to percolation. *Inst. Hautes Études Sci. Publ. Math.*, (90):5–43 (2001), 1999.
- [BLM13] Stéphane Boucheron, Gábor Lugosi, and Pascal Massart. *Concentration inequalities: A nonasymptotic theory of independence*. Oxford university press, 2013.
- [BM18] Dmitry Beliaev and Stephen Muirhead. Discretisation schemes for level sets of planar gaussian fields. *Communications in Mathematical Physics*, 359(3):869–913, 2018.
- [BMW97] Jacob van den Berg, Ronald Meester, and Damien G. White. Dynamic boolean models. *Stochastic Processes and their Applications*, 69(2):247–257, 1997.
- [BMW17] D. Beliaev, S. Muirhead, and I. Wigman. Russo-Seymour-Welsh estimates for the Kostlan ensemble of random polynomials. *arXiv preprint arXiv:1709.08961*, 2017.
- [BOL89] Michael Ben-Or and Nathan Linial. Collective coin flipping. *Advances in Computing Research*, 5:91–115, 1989.
- [BR06a] Béla Bollobás and Oliver Riordan. The critical probability for random Voronoi percolation in the plane is $1/2$. *Probability theory and related fields*, 136(3):417–468, 2006.
- [BR06b] Béla Bollobás and Oliver Riordan. *Percolation*. Cambridge University Press, 2006.
- [BR06c] Béla Bollobás and Oliver Riordan. Sharp thresholds and percolation in the plane. *Random Structures & Algorithms*, 29(4):524–548, 2006.
- [BR06d] Béla Bollobás and Oliver Riordan. A short proof of the Harris–Kesten theorem. *Bulletin of the London Mathematical Society*, 38(3):470–484, 2006.
- [BS98] I. Benjamini and O. Schramm. Conformal invariance of Voronoi percolation. *Commun. Math. Phys.*, 197(1):75–107, 1998.
- [BS02] Eugene Bogomolny and Charles Schmit. Percolation model for nodal domains of chaotic wave functions. *Physical Review Letters*, 88(11):114102, 2002.
- [BS07] Eugene Bogomolny and Charles Schmit. Random wavefunctions and percolation. *Journal of Physics A: Mathematical and Theoretical*, 40(47):14033, 2007.
- [BS17] Deepan Basu and Artem Sapozhnikov. Crossing probabilities for critical Bernoulli percolation on slabs. 53(4):1921–1933, 2017.
- [BTA04] A. Berlinet and C. Thomas-Agnan. *Reproducing Kernel Hilbert Spaces in Probability and Statistics*. Springer, 2004.
- [BZ88] Yurii D. Burago and Viktor A. Zalgaller. *Geometric inequalities*. Grundlehren der mathematischen Wissenschaften, Vol. 285 v. 285. Springer, 1988.
- [Car92] John L. Cardy. Critical percolation in finite geometries. *Journal of Physics A: Mathematical and General*, 25(4):L201, 1992.
- [CEL12] Dario Cordero-Erausquin and Michel Ledoux. Hypercontractive measures, talagrand’s inequality, and influences. In *Geometric aspects of functional analysis*, pages 169–189. Springer, 2012.
- [CL09] Elliott Ward Cheney and William Allan Light. *A course in approximation theory*, volume 101. American Mathematical Soc., 2009.
- [CN06] Federico Camia and Charles M. Newman. Two-dimensional critical percolation: the full scaling limit. *Communications in Mathematical Physics*, 268(1):1–38, 2006.

- [CN07] Federico Camia and Charles M. Newman. Critical percolation exploration path and sle 6: a proof of convergence. *Probability theory and related fields*, 139(3-4):473–519, 2007.
- [Cuz76] J. Cuzick. A central limit theorem for the number of zeros of a stationary Gaussian process. *Ann. Probab.*, 4(4):547–556, 1976.
- [DCHN11] Hugo Duminil-Copin, Clément Hongler, and Pierre Nolin. Connection probabilities and RSW-type bounds for the two-dimensional FK Ising model. *Communications on Pure and Applied Mathematics*, 64(9):1165–1198, 2011.
- [DCRT16] Hugo Duminil-Copin, Aran Raoufi, and Vincent Tassion. A new computation of the critical point for the planar random cluster model with $q \geq 1$. *arXiv preprint arXiv:1604.03702*, 2016.
- [DCRT17a] Hugo Duminil-Copin, Aran Raoufi, and Vincent Tassion. Exponential decay of connection probabilities for subcritical Voronoi percolation in \mathbb{R}^d . *Probability Theory and Related Fields*, pages 1–12, 2017.
- [DCRT17b] Hugo Duminil-Copin, Aran Raoufi, and Vincent Tassion. Sharp phase transition for the random-cluster and Potts models via decision trees. *arXiv preprint arXiv:1705.03104*, 2017.
- [DCRT18] H. Duminil-Copin, A. Raoufi, and V. Tassion. Subcritical phase of d -dimensional Poisson-Boolean percolation and its vacant set. *arXiv preprint arXiv:1805.00695*, 2018.
- [DCT15] Hugo Duminil-Copin and Vincent Tassion. A new proof of the sharpness of the phase transition for bernoulli percolation on \mathbb{Z}^d . *arXiv preprint arXiv:1502.03051*, 2015.
- [DCTT16] Hugo Duminil-Copin, Vincent Tassion, and Augusto Teixeira. The box-crossing property for critical two-dimensional oriented percolation. *arXiv preprint arXiv:1610.10018*, 2016.
- [DVJ03] Daryl J. Daley and David Vere-Jones. *An introduction to the theory of point processes: Volume I: Elementary Theory and Methods*. Springer Science & Business Media, 2003.
- [Fed69] Herbert Federer. *Geometric measure theory*. Die Grundlehren der mathematischen Wissenschaften, Band 153. Springer-Verlag New York Inc., New York, 1969.
- [FK96] Ehud Friedgut and Gil Kalai. Every monotone graph property has a sharp threshold. *Proceedings of the American mathematical Society*, 124(10):2993–3002, 1996.
- [For15] Malin Palö Forsström. A noise sensitivity theorem for Schreier graphs. *arXiv preprint arXiv:1501.01828*, 2015.
- [For16] Malin Palö Forsström. Monotonicity properties of exclusion sensitivity. *Electronic Journal of Probability*, 21, 2016.
- [FvdH15] Robert Fitzner and Remco van der Hofstad. Nearest-neighbor percolation function is continuous for $d > 10$. *arXiv*, 2015.
- [GG06] Benjamin T. Graham and Geoffrey R. Grimmett. Influence and sharp-threshold theorems for monotonic measures. *The Annals of Probability*, pages 1726–1745, 2006.
- [GG11] Benjamin T. Graham and Geoffrey R. Grimmett. Sharp thresholds for the random-cluster and Ising models. *The Annals of Applied Probability*, pages 240–265, 2011.
- [GPS10] Christophe Garban, Gábor Pete, and Oded Schramm. The fourier spectrum of critical percolation. *Acta Mathematica*, 205(1):19–104, 2010.
- [GPS13a] Christophe Garban, Gábor Pete, and Oded Schramm. Pivotal, cluster, and interface measures for critical planar percolation. *Journal of the American Mathematical Society*, 26(4):939–1024, 2013.
- [GPS13b] Christophe Garban, Gábor Pete, and Oded Schramm. The scaling limits of near-critical and dynamical percolation. *arXiv preprint arXiv:1305.5526*, to appear in *Journal of Eur. Math. Soc.*, 2013.
- [Gra09] Loukas Grafakos. *Classical Fourier analysis*. Graduate Texts in Mathematics 249. Springer, 2nd edition, 2009.
- [Gri99] Geoffrey R. Grimmett. *Percolation (Grundlehren der mathematischen Wissenschaften)*. Springer: Berlin, Germany, 1999.

- [Gri10] Geoffrey Grimmett. Probability on graphs. *Lecture Notes on Stochastic Processes on Graphs and Lattices. Statistical Laboratory, University of Cambridge*, 2010.
- [GS14] Christophe Garban and Jeffrey Steif. *Noise sensitivity of Boolean functions and percolation*. Cambridge University Press, 2014.
- [GW11] Damien Gayet and Jean-Yves Welschinger. Exponential rarefaction of real curves with many components. *Inst. Hautes Études Sci. Publ. Math.*, 113:69–96, 2011.
- [Har60] Theodore E. Harris. A lower bound for the critical probability in a certain percolation process. In *Mathematical Proceedings of the Cambridge Philosophical Society*, volume 56, pages 13–20. Cambridge Univ Press, 1960.
- [Har78] Theodore E Harris. Additive set-valued markov processes and graphical methods. *The Annals of Probability*, pages 355–378, 1978.
- [Hig02] D. Higdon. Space and space-time modeling using process convolutions. In C.W. Anderson, V. Barnett, P.C. Chatwin, and A.H. El-Shaarawi, editors, *Quantitative Methods for Current Environmental Issues*. Springer, London, 2002.
- [HPS97] Olle Häggström, Yuval Peres, and Jeffrey E. Steif. Dynamical percolation. *Ann. Inst. H. Poincaré Probab. Statist.*, 33(4):497–528, 1997.
- [HPS⁺15] Alan Hammond, Gábor Pete, Oded Schramm, et al. Local time on the exceptional set of dynamical percolation and the incipient infinite cluster. *The Annals of Probability*, 43(6):2949–3005, 2015.
- [HS94] Takashi Hara and Gordon Slade. Mean-field behaviour and the lace expansion. In *Probability and phase transition (Cambridge, 1993)*, volume 420 of *NATO Adv. Sci. Inst. Ser. C Math. Phys. Sci.*, pages 87–122. Kluwer Acad. Publ., Dordrecht, 1994.
- [Jan97] S. Janson. *Gaussian Hilbert spaces*. Cambridge University Press, 1997.
- [Joo12] Matthijs Joosten. *Random fractals and scaling limits in percolation*. PhD thesis, Vrije Universiteit Amsterdam, 2012.
- [Kes80] Harry Kesten. The critical probability of bond percolation on the square lattice equals $1/2$. *Comm. Math. Phys.* 74, no. 1, 1980.
- [Kes82] Harry Kesten. *Percolation theory for mathematicians*, volume 423. Springer, 1982.
- [Kes87] Harry Kesten. Scaling relations for 2d-percolation. *Communications in Mathematical Physics*, 109(1):109–156, 1987.
- [KKL88] Jeff Kahn, Gil Kalai, and Nathan Linial. The influence of variables on Boolean functions. In *Foundations of Computer Science, 1988., 29th Annual Symposium on*, pages 68–80. IEEE, 1988.
- [KMS12] Nathan Keller, Elchanan Mossel, and Arnab Sen. Geometric influences. *The Annals of Probability*, pages 1135–1166, 2012.
- [KMS14] Nathan Keller, Elchanan Mossel, and Arnab Sen. Geometric influences ii: Correlation inequalities and noise sensitivity. In *Annales de l’Institut Henri Poincaré, Probabilités et Statistiques*, volume 50, pages 1121–1139. Institut Henri Poincaré, 2014.
- [KW70] G.S. Kimeldorf and G. Wahba. A correspondence between Bayesian estimation on stochastic processes and smoothing by splines. *Ann. Math. Statist.*, 41(2):495–502, 1970.
- [KZ87] Harry Kesten and Yu Zhang. Strict inequalities for some critical exponents in two-dimensional percolation. *Journal of statistical physics*, 46(5-6):1031–1055, 1987.
- [Law08] Gregory F Lawler. *Conformally invariant processes in the plane*. Number 114. American Mathematical Soc., 2008.
- [Let18] Thomas Letendre. Variance of the volume of random real algebraic submanifolds. *Transactions of the American Mathematical Society*, 2018.
- [Lig05] Thomas M. Liggett. *Interacting particle systems*. Classics in Mathematics. Springer-Verlag, Berlin, 2005. Reprint of the 1985 original.

- [LPPSA92] Robert Langlands, Claude Pichet, Philippe Pouliot, and Yvan Saint-Aubin. On the universality of crossing probabilities in two-dimensional percolation. *Journal of statistical physics*, 67(3-4):553–574, 1992.
- [LPSA94] Robert Langlands, Philippe Pouliot, and Yvan Saint-Aubin. Conformal invariance in two-dimensional percolation. *Bull. Amer. Math. Soc.*, 1994.
- [LSW02] Gregory F. Lawler, Oded Schramm, and Wendelin Werner. One-arm exponent for critical 2D percolation. *Electron. J. Probab.*, 7:no. 2, 13 pp. (electronic), 2002.
- [Mal69] T.L. Malevich. Asymptotic normality of the number of crossing of level zero by a Gaussian process. *Theory Probab. Appl.*, 14(2):287–295, 1969.
- [Man12] Ioan Manolescu. *Universality for planar percolation*. PhD thesis, University of Cambridge, 2012.
- [Men86] Mikhail V Menshikov. Coincidence of critical-points in the percolation problems. *Doklady akademii nauk sssr*, 288(6):1308–1311, 1986.
- [Mon12] Arnaud Moncet. Real versus complex volumes on real algebraic surfaces. *Int. Math. Res. Not.*, 2012(16):3723–3762, 2012.
- [MR96] Ronald Meester and Rahul Roy. *Continuum percolation*, volume 119. Cambridge University Press, 1996.
- [MS83a] Stanislav A. Molchanov and A.K. Stepanov. Percolation in random fields. i. *Theoretical and Mathematical Physics*, 55(2):478–484, 1983.
- [MS83b] Stanislav A. Molchanov and A.K. Stepanov. Percolation in random fields. ii. *Theoretical and Mathematical Physics*, 55(3):592–599, 1983.
- [MS86] Stanislav A. Molchanov and A.K. Stepanov. Percolation in random fields. iii. *Theoretical and Mathematical Physics*, 67(2):434–439, 1986.
- [Nol08] Pierre Nolin. Near-critical percolation in two dimensions. *Electron. J. Probab*, 13(55):1562–1623, 2008.
- [NS09] Fedor Nazarov and Mikhail Sodin. On the number of nodal domains of random spherical harmonics. *Amer. J. Math.*, 131(5):1337–1357, 2009.
- [NS11] Fedor Nazarov and Mikhail Sodin. Fluctuations in random complex zeroes: asymptotic normality revisited. *Int. Math. Res. Not. IMRN*, (24):720–5759, 2011.
- [NS16] Fedor Nazarov and Mikhail Sodin. Asymptotic laws for the spatial distribution and the number of connected components of zero sets of Gaussian random functions. *Zh. Mat. Fiz. Anal. Geom.*, 12(3):205–278, 2016.
- [NSV07] Fedor Nazarov, Mikhail Sodin, and Alexander Volberg. Transportation to random zeroes by the gradient flow. *Geometric and functional analysis*, 17(3):887–935, 2007.
- [NSV08] Fedor Nazarov, Mikhail Sodin, and Alexander Volberg. The Jancovici–Lebowitz–Manificat law for large fluctuations of random complex zeroes. *Communications in mathematical physics*, 284(3):833–865, 2008.
- [NTW17] Charles Newman, Vincent Tassion, and Wei Wu. Critical percolation and the minimal spanning tree in slabs. *Communications on Pure and Applied Mathematics*, 70(11):2084–2120, 2017.
- [OSSS05] R. O’Donnell, M. Saks, O. Schramm, and R.A. Servedio. Every decision tree has an influential variable. In *46th Annual IEEE Symposium on Foundations of Computer Science (FOCS’05)*, pages 31–39, 2005.
- [Pit82] Loren D. Pitt. Positively correlated normal variables are associated. *The Annals of Probability*, pages 496–499, 1982.
- [Pit96] V.I. Piterbarg. *Asymptotic methods in the theory of Gaussian processes and fields. Transl. from the Russian by V. V. Piterbarg. Transl. ed. by Simeon Ivanov*. Providence, RI: AMS, 1996.

- [Poi05] Henri Poincaré. *La valeur de la science* (Flammarion, Paris). 1905.
- [Pou99] A.D. Poularikas. *The Handbook of Formulas and Tables for Signal Processing*. CRC Press, 1999.
- [PS98] Yuval Peres and Jeffrey E Steif. The number of infinite clusters in dynamical percolation. *Probability theory and related fields*, 111(1):141–165, 1998.
- [Rei00] David Reimer. Proof of the van den Berg-Kesten conjecture. *Combin. Probab. Comput.*, 9(1):27–32, 2000.
- [Rod15] Pierre-François Rodriguez. A 0-1 law for the massive Gaussian free field. *Probability Theory and Related Fields*, pages 1–30, 2015.
- [RS16] Matthew I. Roberts and Bati Sengul. Exceptional times of the critical dynamical Erdős Rényi graph. *arXiv preprint arXiv:1610.06000*, 2016.
- [Rud62] Walter Rudin. *Fourier analysis on groups*. Interscience Tracts in Pure and Applied Mathematics. 12., 1962.
- [Rus78] Lucio Russo. A note on percolation. *Probability Theory and Related Fields*, 43(1):39–48, 1978.
- [Rus81] Lucio Russo. On the critical percolation probabilities. *Zeitschrift für Wahrscheinlichkeitstheorie und verwandte Gebiete*, 56(2):229–237, 1981.
- [Rus82] Lucio Russo. An approximate zero-one law. *Probability Theory and Related Fields*, 61(1):129–139, 1982.
- [RW06] C.E. Rasmussen and C.K.I. Williams. *Gaussian processes for machine learning*. MIT Press, 2006.
- [Sch00] Oded Schramm. Scaling limits of loop-erased random walks and uniform spanning trees. *Israel Journal of Mathematics*, 118(1):221–288, 2000.
- [She07] Scott Sheffield. Gaussian free fields for mathematicians. *Probab. Theory Related Fields*, 139(3-4):521–541, 2007.
- [She09] Scott Sheffield. Exploration trees and conformal loop ensembles. *Duke Math. J.*, 147(1):79–129, 2009.
- [Sle62] David Slepian. The one-sided barrier problem for Gaussian noise. *Bell Labs Technical Journal*, 41(2):463–501, 1962.
- [Smi01] Stanislav Smirnov. Critical percolation in the plane: Conformal invariance, cardy’s formula, scaling limits. *Comptes Rendus de l’Académie des Sciences-Series I-Mathematics*, 333(3):239–244, 2001.
- [Smi07] Stanislav Smirnov. Towards conformal invariance of 2d lattice models. *Proceedings of the International Congress of Mathematicians (ICM)*, 2007.
- [SS99] O. Schramm and S. Sheffield. Contour lines of the two-dimensional discrete Gaussian free field. *Acta Math.*, 202(1):21–137, 1999.
- [SS10] Oded Schramm and Jeffrey E. Steif. Quantitative noise sensitivity and exceptional times for percolation. *Ann. of Math. (2)*, 171(2):619–672, 2010.
- [SS11] Oded Schramm and Stanislav Smirnov. On the scaling limits of planar percolation. In *Selected Works of Oded Schramm*, pages 1193–1247, with an appendix by Christophe Garban. Springer, 2011.
- [SW78] Paul D. Seymour and Dominic J.A. Welsh. Percolation probabilities on the square lattice. *Annals of Discrete Mathematics*, 3:227–245, 1978.
- [SW01] Stanislav Smirnov and Wendelin Werner. Critical exponents for two-dimensional percolation. *Math. Res. Lett.*, 8(5-6):729–744, 2001.
- [Tal94] Michel Talagrand. On Russo’s approximate zero-one law. *The Annals of Probability*, 22(3):1576–1587, 1994.

- [Tas14] Vincent Tassion. *Planarité et localité en percolation*. PhD thesis, Lyon, École normale supérieure, 2014.
- [Tas16] Vincent Tassion. Crossing probabilities for Voronoi percolation. *The Annals of Probability*, 44(5):3385–3398, 2016.
- [Wei82] A. Weinrib. Percolation threshold of a two-dimensional continuum system. *Phys. Rev. B*, 26(3):1352–1361, 1982.
- [Wei84] A. Weinrib. Long-range correlated percolation. *Phys. Rev. B*, 29(1):387, 1984.
- [Wen05] H. Wendland. *Scattered Data Approximation*. Cambridge Monographs on Applied and Computational Mathematics. Cambridge University Press, 2005.
- [Wer04] Wendelin Werner. Random planar curves and Schramm-Loewner Evolutions. In *Lectures on probability theory and statistics*, pages 107–195. Springer, 2004.
- [Wer07] Wendelin Werner. Lectures on two-dimensional critical percolation. *IAS Park City Graduate Summer School*, 2007.
- [Zva96] Artem Zvavitch. The critical probability for Voronoi percolation. *MSc. thesis, Weizmann Inst. of Science*, 1996.

Percolation dans le plan : dynamiques, pavages aléatoires et lignes nodales

Résumé. Dans cette thèse, nous étudions trois modèles de percolation planaire : la percolation de Bernoulli, la percolation de Voronoi, et la percolation de lignes nodales. Un modèle de percolation planaire est un modèle de coloriage aléatoire du plan en deux couleurs dont on étudie les propriétés de connexions monochromatiques. Deux axes de recherche ont motivé nos travaux.

Le premier axe porte sur des aspects de la conjecture d'universalité en percolation planaire qui prédit que ces modèles convergent vers une même limite d'échelle. Il s'agit ici de montrer des similarités fortes entre ces modèles. Plus précisément, dans le cas de la percolation de lignes nodales, nous calculons le point critique, étudions la transition de phase, et prouvons des propriétés de quasi-indépendance. Dans le cas de la percolation de Voronoi, nous montrons des relations d'échelle, prouvons des bornes sur l'exposant de la fonction de percolation, et étudions l'influence de l'environnement sur des événements de percolation.

Le deuxième axe de recherche est l'étude de dynamiques sur ces modèles au point critique, avec une attention particulière portée sur les dynamiques dites conservatives. La principale question est celle de l'existence de "temps exceptionnels" où une composante connexe infinie apparaît. En ce qui concerne la percolation de Bernoulli, nous montrons qu'il existe des temps exceptionnels pour des dynamiques conservatives à longue portée en étudiant des propriétés de localisation de l'échantillon spectral de certains événements de percolation. Dans le cas de la percolation de Voronoi, nous introduisons une version continue de l'échantillon spectral et déduisons de l'étude de cet objet qu'il existe des temps exceptionnels pour plusieurs dynamiques naturelles.

Mots-clés : percolation, sensibilité au bruit, fonctions booléennes, percolation de Voronoi, relations d'échelle, lignes nodales, transition de phase, quasi-indépendance.

Percolation in the plane: dynamics, random tilings and nodal lines

Abstract. In this thesis, we study three models of planar percolation: Bernoulli percolation, Voronoi percolation and nodal lines percolation. A model of planar percolation is a model of random colouring of the plane with two colours in which one studies connection properties. We follow two main threads.

First, we study some aspects of the conjecture of universality for planar percolation, which states that these three models converge to the same scaling limit. More precisely, the goal is to prove some strong similarities for these models. In the case of nodal lines percolation, we compute the critical point, study the phase transition and prove quasi-independence properties. In the case of Voronoi percolation, we show some scaling relations, prove inequalities for the percolation function exponent and study the influence of the environment on some percolation events.

Second, we study dynamics on these models at the critical point, particularly so-called conservative dynamics. The main question is the existence of exceptional times which are times where an infinite component appears. In the case of Bernoulli percolation, we show that there exist exceptional times for some long range conservative dynamics via the study of locality properties of the spectral sample of some percolation events. Concerning Voronoi percolation, we introduce a continuum analog of the spectral sample and we deduce from the study of this object that there exist exceptional times for several natural dynamics.

Keywords: percolation, noise sensitivity, Boolean functions, Voronoi percolation, scaling relations, nodal lines, phase transitions, quasi-independence.

Image de couverture : La composante connexe du bord gauche d'un carré pour trois modèles au point critique : la percolation de Bernoulli, la percolation de Voronoi et la percolation de lignes nodales.



ED 512

INFO MATHS

Ecole doctorale

