



**HAL**  
open science

# Cocycle dynamics and problems of ergodicity

Martin Leguil

► **To cite this version:**

Martin Leguil. Cocycle dynamics and problems of ergodicity. General Mathematics [math.GM]. Université Sorbonne Paris Cité, 2017. English. NNT : 2017USPCC159 . tel-02076287

**HAL Id: tel-02076287**

**<https://theses.hal.science/tel-02076287>**

Submitted on 22 Mar 2019

**HAL** is a multi-disciplinary open access archive for the deposit and dissemination of scientific research documents, whether they are published or not. The documents may come from teaching and research institutions in France or abroad, or from public or private research centers.

L'archive ouverte pluridisciplinaire **HAL**, est destinée au dépôt et à la diffusion de documents scientifiques de niveau recherche, publiés ou non, émanant des établissements d'enseignement et de recherche français ou étrangers, des laboratoires publics ou privés.

**Université Paris Diderot (Paris 7)  
Sorbonne Paris Cité  
UFR de Mathématiques**

**École doctorale de Sciences Mathématiques de Paris Centre (ED 386)  
Institut de Mathématiques de Jussieu - Paris Rive Gauche (UMR 7586)**

**Thèse**

pour obtenir le titre de

**Docteur de l'Université Paris Diderot (Paris 7)  
Sorbonne Paris Cité**

Spécialité Mathématique

présentée par

**Martin Leguil**

---

**Dynamique de cocycles et problèmes d'ergodicité**

---

Directeurs de thèse : **Artur Avila, Julie Déserti**

Soutenue publiquement le *4 avril 2017* devant le jury composé de :

M.	<b>Artur</b>	<b>Avila</b>	Directeur
M.	<b>Sylvain</b>	<b>Crovisier</b>	Examinateur
Mme	<b>Julie</b>	<b>Déserti</b>	Directrice
M.	<b>Charles</b>	<b>Favre</b>	Examinateur
M.	<b>Pascal</b>	<b>Hubert</b>	Examinateur (Président du jury)
M.	<b>Raphaël</b>	<b>Krikorian</b>	Rapporteur



## Résumé<sup>1</sup>

Le travail qui suit comporte quatre chapitres : le premier est centré autour de la propriété de mélange faible pour les échanges d’intervalles et flots de translation. On y présente des résultats obtenus avec Artur Avila qui renforcent des résultats précédents dus à Artur Avila et Giovanni Forni. Le deuxième chapitre est consacré à un travail en commun avec Zhiyuan Zhang et concerne les propriétés d’ergodicité et d’accessibilité stables pour des systèmes partiellement hyperboliques de dimension centrale au moins égale à deux. On montre que sous des hypothèses de cohérence dynamique, center bunching et pincement fort, la propriété d’accessibilité stable est dense en topologie  $C^r$ ,  $r \geq 1$ , et même prévalente au sens de Kolmogorov. Dans le troisième chapitre, on expose les résultats d’un travail réalisé en collaboration avec Julie Déserti, consacré à l’étude d’une famille à un paramètre d’automorphismes polynomiaux de  $\mathbb{C}^3$ ; on montre que de nouveaux phénomènes apparaissent par rapport à ce qui était connu dans le cas de la dimension deux. En particulier, on étudie les vitesses d’échappement à l’infini, en montrant qu’une transition s’opère pour une certaine valeur du paramètre. Le dernier chapitre est issu d’un travail en collaboration avec Jiangong You, Zhiyan Zhao et Qi Zhou; on s’intéresse à des estimées asymptotiques sur la taille des trous spectraux des opérateurs de Schrödinger quasi-périodiques dans le cadre analytique. On obtient des bornes supérieures exponentielles dans le régime sous-critique, ce qui renforce un résultat précédent de Sana Ben Hadj Amor. Dans le cas particulier des opérateurs presque Mathieu, on montre également des bornes inférieures exponentielles, qui donnent des estimées quantitatives en lien avec le problème dit “des dix Martinis”. Comme conséquences de nos résultats, on présente des applications à l’homogénéité du spectre de tels opérateurs ainsi qu’à la conjecture de Deift.

The following work contains four chapters: the first one is centered around the weak mixing property for interval exchange transformations and translation flows. It is based on the results obtained together with Artur Avila which strengthen previous results due to Artur Avila and Giovanni Forni. The second chapter is dedicated to a joint work with Zhiyuan Zhang, in which we study the properties of stable ergodicity and accessibility for partially hyperbolic systems with center dimension at least two. We show that for dynamically coherent partially hyperbolic diffeomorphisms and under certain assumptions of center bunching and strong pinching, the property of stable accessibility is dense in  $C^r$ -topology,  $r \geq 1$ , and even prevalent in the sense of Kolmogorov. In the third chapter, we explain the results obtained together with Julie Déserti on the properties of a one-parameter family of polynomial automorphisms of  $\mathbb{C}^3$ ; we show that new behaviours can be observed in comparison with the two-dimensional case. In particular, we study the escape speed of points to infinity and show that a transition exists for a certain value of the parameter. The last chapter is based on a joint work with Jiangong You, Zhiyan Zhao and Qi Zhou; we get asymptotic estimates on the size of spectral gaps for quasi-periodic Schrödinger operators in the analytic case. We obtain exponential upper bounds in the subcritical regime, which strengthens a previous result due to Sana Ben Hadj Amor. In the particular case of almost Mathieu operators, we also show exponential lower bounds, which provides quantitative estimates in connection with the so-called “Dry ten Martinis problem”. As consequences of our results, we show applications to the homogeneity of the spectrum of such operators, and to Deift’s conjecture.

---

1. *Mots-clés* : Systèmes dynamiques, échanges d’intervalles, flots de translation, propriété de mélange faible, systèmes dynamiques partiellement hyperboliques, ergodicité stable, automorphismes polynomiaux, opérateurs de Schrödinger quasi-périodiques, physique mathématique, théorie spectrale.

*Keywords*: Dynamical systems, interval exchange transformations, translation flows, weak mixing property, partially hyperbolic dynamical systems, stable ergodicity, polynomial automorphisms, quasiperiodic Schrödinger operators, mathematical physics, spectral theory.



# Contents

Remerciements	vii
Introduction	1
1. Cocycles	1
2. Mélange faible pour les échanges d’intervalles et flots de translation	1
3. Accessibilité pour les systèmes dynamiques partiellement hyperboliques	9
4. Étude d’une famille d’automorphismes polynomiaux de $\mathbb{C}^3$	16
5. Théorie spectrale des opérateurs de Schrödinger quasi-périodiques unidimensionnels	19
Bibliographie	29
Chapter 1. Weak mixing for interval exchange transformations and translation flows	31
Introduction	31
1. Outline	33
2. Background	34
3. Interval exchange transformations and renormalization algorithms	36
4. General weak mixing for interval exchange transformations & translation flows	42
5. Study of the weak-stable lamination	47
6. End of the proof of weak mixing	51
Bibliography	57
Chapter 2. $C^r$ -prevalence of stable ergodicity for a class of partially hyperbolic systems	59
1. Introduction	59
2. Preliminaries	65
3. Random perturbations	70
4. Submersion from parameter space to phase space	79
5. Finding spanning $c$ -families with slow recurrence	82
6. A stable criterion for stable values	84
7. Holonomy maps associated to a family of loops	86
8. Constructing charts and vector fields	90
9. On the prevalence of the accessibility property	94
Appendix A	101
Appendix B	102
Appendix C	102
Bibliography	105
Chapter 3. Dynamics of a family of polynomial automorphisms of $\mathbb{C}^3$ , a phase transition	107
1. Preliminaries	107
2. Introduction to the results	118
3. Degree growths & invariant fibrations	120
4. Centralizers	122
5. Dynamics on the invariant hypersurface $z_2 = 0$	124

6. Points with bounded forward orbit, description of the stable manifold $\mathcal{W}_{\Psi_\alpha}^s(0_{\mathbb{C}^3})$	124
7. Birational conjugacy	127
8. Definition of a Green function for $\Psi_\alpha$	129
9. Analysis of the dynamics of the automorphism $\Psi_\alpha$	130
Bibliography	143
Chapter 4. Asymptotics of spectral gaps for quasi-periodic Schrödinger operators	145
1. Introduction and main results	145
2. Preliminaries	153
3. Quantitative almost reducibility	159
4. Almost localization and duality argument	169
5. Global to local reduction	175
6. Moser-Pöschel argument and the gap estimates	179
7. The monotonicity argument	186
8. Homogeneous spectrum	191
Bibliography	195

## Remerciements

Je remercie chaleureusement Artur Avila et Julie Déserti d'avoir accepté d'être mes directeurs de thèse, et pour leur encadrement au cours de ces années. Je leur suis très reconnaissant d'avoir cherché à me faire découvrir différents aspects des systèmes dynamiques, et de m'avoir permis de travailler sur des questions stimulantes. Il est parfois difficile en tant que débutant de trouver son chemin dans le vaste domaine que sont les systèmes dynamiques, et je tiens à leur exprimer ma gratitude pour avoir su m'orienter lorsque j'en avais besoin, tout en me laissant également beaucoup de liberté. Je les remercie pour leurs nombreux conseils, leur confiance et leur présence, en particulier lors de moments de découragement, et de m'avoir toujours soutenu, notamment pour l'obtention d'un 1/2 ATER cette année à l'Université Paris Diderot, mais aussi pour la préparation des dossiers de post-doc pour l'année à venir.

Je suis très reconnaissant aux rapporteurs de cette thèse, Raphaël Krikorian et Federico Rodriguez Hertz, d'avoir accepté de relire ce manuscrit un peu hétéroclite, et ce malgré les délais assez serrés que cela impliquait, et je les remercie pour leurs encouragements. Je suis aussi reconnaissant à Raphaël Krikorian pour son soutien au cours de ces années de thèse, en particulier pour les nombreuses conversations qui m'ont permis d'avancer lorsque je travaillais sur les opérateurs de Schrödinger. Merci à Sylvain Crovisier, Charles Favre et Pascal Hubert de me faire l'honneur de faire partie du jury de cette thèse. Je remercie Sylvain Crovisier pour le temps qu'il m'a consacré au cours de multiples conversations, en particulier autour des systèmes partiellement hyperboliques. Charles Favre était responsable des projets scientifiques collectifs en mathématiques à l'École polytechnique, et je lui suis reconnaissant pour sa bienveillance tout au long de ma thèse. Je remercie également Pascal Hubert de m'avoir invité à venir parler à Marseille, et pour son soutien à l'occasion des candidatures aux post-docs.

Merci à mes professeurs du lycée Fabert pour la qualité de leur enseignement, notamment à Christiane Vincent, Pierre Daniou, Jean-Denis Eiden et Denis Prévot. Après deux années passées en classes préparatoires, je suis arrivé à l'École polytechnique avec le souhait de continuer à faire des sciences. Merci aux personnes qui ont guidé ma découverte du monde de la recherche à cette époque, en particulier Romain Dujardin, qui m'a initié à la dynamique (holomorphe) à travers un projet autour de la méthode de Newton, Jérôme Buzzi, pour un cours stimulant sur les systèmes dynamiques qui m'a donné envie de continuer dans cette voie, et Frank Pacard, à qui j'étais venu demander conseil au sujet des stages de recherche, et qui m'avait alors permis de partir au Brésil. Je suis très reconnaissant à Harold Rosenberg de m'avoir encadré durant ce premier séjour à Rio, de m'avoir fait découvrir le monde des surfaces minimales, et pour la bienveillance dont il a fait preuve par la suite ; son enthousiasme pour les mathématiques sont pour moi un modèle. Je remercie également Laurent Hauswirth, Éric Toubiana ainsi que mes professeurs de master, notamment Frédéric le Roux, Patrice le Calvez et Anton Zorich, d'avoir renforcé mon intérêt pour les systèmes dynamiques par la qualité de leur enseignement.

Je tiens aussi à exprimer ma gratitude à Bassam Fayad pour avoir toujours trouvé le temps lorsque j'en avais besoin afin de discuter de diverses questions sur lesquelles je travaillais pendant ma thèse. J'ai rencontré Jacopo de Simoi lors d'un exposé qu'il donnait à Orsay ; je le remercie sincèrement de m'avoir incité à postuler à un post-doc au Canada, et je me réjouis de le retrouver à Toronto à partir de cet été. Merci à Pierre Berger pour de multiples discussions, à Rio et Paris, et pour ses encouragements. Je suis reconnaissant également à Sébastien Gouëzel et Carlos Matheus pour leur patiente relecture



et pour leur aide lors de la finalisation de l'article sur le mélange faible. Je remercie les nombreux chercheurs qui m'ont donné de leur temps lors de différentes conversations, notamment Christian Bonatti, Jon Chaika, Giovanni Forni, Svetlana Jitomirskaya, Vadim Kaloshin, Andres Koropecki, Meysam Nassiri, Rafael Potrie, Enrique Pujals, Christian Sadel, Marcelo Viana, ainsi que Michael Goldstein pour ses encouragements quant à mon travail, et Thierry Bousch, pour m'avoir invité à venir parler au groupe de travail sur les systèmes dynamiques et la théorie ergodique à l'Université d'Orsay.

Merci à l'équipe de l'IMJ et aux personnes de l'administration travaillant à Sophie Germain, elles m'ont aidé à de nombreuses reprises durant ma thèse : Élodie Destrebecq, Maÿlis Fournaiseau, Claire Lavollay (qui m'a bien aidé pour rattraper une étourderie administrative!), Christine Le Sueur, Mylène Merciris, Pascal Chiettini, Vincent Loiseau, Sébastien Ramesh... Je remercie également Élise Delos d'avoir fait en sorte que la procédure de dépôt du manuscrit et l'organisation de la soutenance se fassent dans les meilleures conditions possibles. Je tiens aussi à remercier l'IMPA pour son hospitalité durant mes différents séjours à Rio de Janeiro, et je suis reconnaissant à l'École polytechnique et au réseau franco-brésilien de recherche en mathématiques de m'avoir financé à l'occasion de ces derniers.

Je remercie Disheng Xu pour de nombreuses conversations, mathématiques ou non, et pour sa gentillesse, Qi Zhou, pour ses conseils lorsque j'ai commencé à travailler sur les opérateurs de Schrödinger, puis pour notre collaboration, et ses encouragements, Xiaochuan Liu, pour de nombreuses discussions mathématiques à Rio, et pour avoir pris régulièrement des nouvelles ces derniers mois, Zhiyan Zhao, pour son amitié, sa gentillesse, et pour m'avoir invité à Nice pour travailler ensemble sur l'article sur les trous spectraux (et un dîner à base de canard mémorable là-bas!), et Zhiyuan Zhang, pour de nombreuses discussions mathématiques, et pour notre collaboration autour de la densité de la propriété d'accessibilité. Merci beaucoup à Nikolaos de m'avoir expliqué son travail et pour son invitation à venir parler à Londres, et à Christophe pour ses explications sur la théorie KAM lorsque je commençais à travailler sur ce sujet.

Merci à mes amis dynamiciens rencontrés au cours de conférences / écoles auxquelles j'ai eu la chance de participer, et durant mes différents séjours à l'IMPA : Bruno, Diego (à qui j'espère avoir l'occasion de rendre visite un jour au Brésil), Karina, Javier, Adriana, Bruno (que j'ai été heureux de revoir à l'occasion de son post-doc à Dijon), Luis Pedro, Rambo (guitariste infatigable des nuits triestines), Pierre-Antoine, Raquel (hôte prévenante à Rio), Freddy, Jennyffer, Michele, Matteo, Cezary, Ricardo, Mauricio, Davi, Fernando, Juan David, Davi, Eduardo, Olga, Jessica (camarade barcelo-engelbergo-londonienne de conférences), Alexandre, Thibaut, Stefano... Je les remercie pour leurs encouragements, les souvenirs partagés, et pour ce qu'ils m'ont appris lors de conversations sur les questions auxquelles ils réfléchissaient.

Merci au F (Florent), voisin débonnaire, pour sa doctrine de l'amour universel et pour avoir lancé une chaîne de mails à laquelle j'ai bien malgré moi participé et qui a bien amusé la petite communauté des thésards des sixième et septième étages (sans oublier la découverte de la machine à café *Handpresso* qui a été d'un grand secours cette dernière année), au A (Antoine) pour la bonne humeur qu'il met dans notre bureau depuis son arrivée, pour son altruisme, et pour m'avoir fait redécouvrir l'escalade. Merci à Frank, camarade dynamicien, pour son amitié infaillible, les conversations mathématiques, et tous les bons moments que nous avons eu l'occasion de partager depuis son arrivée à Paris. Merci à Charles, ami du master, que j'ai eu le plaisir de retrouver pour la thèse, et qui est toujours aussi enthousiaste pour discuter de maths. Merci à Juan-Pablo pour sa curiosité insatiable, et d'avoir souvent cherché à me changer les idées en me proposant d'aller écouter tel ou tel concert. Merci aux membres du bureau "latino" : Pooneh, Jorge, Leonardo, Rodolfo, Stéphane... Merci à mes nouveaux voisins : Rahman, qui me fait découvrir la culture iranienne, Andreas, Paula, et Théophile, camarade lorrain. Merci à Chunhui, qui m'initie aux saveurs du thé chinois, à Takfarinas, Rémi (futur voisin au Canada), Ruben, Grégoire, Ana, Marco, Kevin, à tous les membres de la CROUS Crew : Alexandre, Jean-Michel, Réda, Véronique, Vinicius, ainsi qu'aux amis du sixième

étage, qui tous ensemble font de Sophie Germain un endroit où il est agréable de venir travailler : Baptiste (que je crois avoir un peu effrayé la semaine précédant la remise de mon manuscrit), David, Kévin, Victoria, Élie, Léa, Omar, Marco, Aurélien, Charlotte, Assia... Merci aussi aux amis en thèse dans d'autres facs parisiennes : Annalaura, Florian, Juliette, Mattia, Maylis, Olivier, Selim... Merci aux camarades qui m'ont accueilli et accompagné au début de ma thèse : Alexandre, Amaury, Fathi, Hoël, Jeremy, Julie, Mario (et toute sa famille), Martin, Nicolas, Sari...

Merci à tous mes amis sur Paris, pour tous les bons moments passés ensemble depuis 2009, et pour leur soutien durant ma thèse : Thomas (et tous les bons souvenirs de Navale et de Corse), Sophie, Hervé (pour un séjour normand très opportun), Alison, Lionel (pour les répliques de *Calmos* après des repas souvent généreux), Zélia, Ludovic (pour les bons moments au ski autour d'une fondue et d'une bouteille de génépi), Stéphanie, Aurélie (pour les souvenirs cogistes et les sandwiches autour de la BNF), Elliott, Patrick, Stefan (Tixbar), Emmanuelle, Christian, Gatien (le Bon candidat), Laure, Timothée, Bertrand, Catherine, Gabriel...

Merci à mes amis qui ont eux aussi entrepris des thèses en mathématiques, et tous mes encouragements à ceux qui n'ont pas encore soutenu : Cécilia, Frédéric, Guillaume, Thibault, Thomas (et sa famille), Xiaohua... Je remercie en particulier Francisco, clarinetiste talentueux, et Gautier, compagnon carioca lors de mon premier séjour à l'IMPA.

Merci à la bande des Messins (et Messins d'adoption) : Anne, Arthur, Aurélien, Cécile, Claire, Geoffroy (pour tous les souvenirs d'enfance, et les conversations sur la politique autour d'un verre place Saint Louis), Hélène (organisatrice persévérante des retrouvailles messines), JB, Jean-Eudes, Jean-François (pour les soirées chez Marlusse), Michel, Paul-Édouard (pour son amitié depuis l'école primaire, mais aussi pour m'avoir fait découvrir la fameuse crêperie Josselin!), Quentin, Yannick... que j'ai toujours autant de plaisir à retrouver à Paris ou à Metz. Merci à tous pour vos encouragements ! Je regrette d'avoir été moins présent ces derniers temps alors que je rédigeais ma thèse.

Un grand merci à ma famille, pour son soutien indéfectible. Merci à mes parents, qui m'ont toujours encouragé à poursuivre dans la voie que j'avais choisie, et sans qui je ne serais jamais arrivé jusqu'ici. Merci à eux pour leur patience, leur confiance, leur amour, tout ce qu'ils m'ont transmis (des leçons de piano entre midi et deux quand nous étions petits à la curiosité pour l'architecture, la peinture, les sciences, le goût des voyages...), de m'avoir permis de grandir dans un environnement privilégié, et plus concrètement, de toujours être à l'écoute. Merci à mon frère, sur qui j'ai toujours pu compter (je confesse avec un peu de honte en avoir assez largement abusé ces derniers temps...), et qui m'a beaucoup manqué pendant son séjour en Chine l'an passé ; après avoir longtemps suivi des trajectoires parallèles, nous avons finalement choisi des voies différentes. Je crois ne pas beaucoup me tromper en disant ne pas être le seul à avoir de l'admiration pour ses nombreuses qualités. Merci à mes grands-parents maternels et paternels pour leur amour, pour tout le temps qu'ils m'ont consacré, et l'intérêt constant qu'ils ont eu pour ce que j'entreprenais. Des promenades en forêt aux séances de cinéma, en passant par les repas chez eux et les après-midis où ils m'ont accompagné à Saint Joseph pour répéter à l'orgue, je les remercie du fond du cœur d'avoir toujours été présents.

Je remercie également Pierre, Claire, Jean-Marie, Danièle, Pascal, Nathalie, Olivier, Anne-Marie, Catherine (à qui je promets de répondre dès après la soutenance), Dominique, Yves, Martine, ainsi que Pierre-Jean (qui m'a permis de découvrir Paris pendant les étés de mes années au lycée), Yves (et les passages rue Broca, en rougissant de l'effroi que j'ai dû causer à ses amis une nuit sur le chemin de Brest), Philippe (pour ses nombreux conseils bienveillants) et Denise pour leurs encouragements tout au long de ces années. Merci aussi à mon cousin Marc (et Diane bien sûr), pour sa bienveillance et l'intérêt qu'il a toujours manifesté pour mon frère et moi (et en souvenir de ces week-ends de voile au large de Brest pendant mon passage en Bretagne).



# Introduction

## 1. Cocycles

Dans les différents chapitres, on rencontrera les objets suivants à plusieurs reprises. Étant donné un ensemble  $M$  et un groupe  $H$  (groupe topologique, groupe de Lie...) dont on note  $e$  l'élément neutre, un *cocycle* est une paire  $(f, \phi)$ , où  $f: M \rightarrow M$  est une transformation définie sur  $M$ , et  $\phi: M \rightarrow H$  une fonction (continue, lisse...) qui à tout point de  $M$  associe un élément de  $H$ . Pour tout  $x \in M$ , on peut composer  $\phi$  de manière naturelle le long de l'orbite de  $x$  sous  $f$ , par la formule

$$\phi_n(x) := \begin{cases} \phi(f^{n-1}(x)) \cdots \phi(f(x)) \cdot \phi(x), & \text{si } n > 0, \\ e, & \text{si } n = 0. \end{cases}$$

Lorsque  $f$  est inversible, on note également

$$\phi_n(x) := \phi^{-1}(f^{-n}(x)) \cdots \phi^{-1}(f^{-2}(x)) \cdot \phi^{-1}(f^{-1}(x)), \quad \text{si } n < 0.$$

On a alors la relation suivante :

$$\phi_{m+n}(x) = \phi_m(f^n(x)) \cdot \phi_n(x), \quad \forall n, m \in \mathbb{Z}, x \in M. \quad (1.1)$$

Dans (1.1), on voit qu'on a une action de  $\mathbb{Z}$ , à travers  $(n, x) \mapsto \phi_n(x)$ , où  $(n, x) \in \mathbb{Z} \times M$ , mais on peut généraliser cette définition également aux actions d'autres groupes.

Un exemple naturel de cocycle est donné par la différentielle d'une fonction  $f: M \rightarrow M$  lisse définie sur une variété  $M$ , en lien avec la formule de la chaîne :

$$D(f^n)(x) = Df(f^{n-1}(x)) \cdots Df(f(x))Df(x), \quad \forall n \geq 0, x \in M.$$

Avec les notations précédentes, s'il existe une collection de fibres  $\{N_x, x \in M\}$  au-dessus des points de  $M$ , et si pour tout  $x \in M$ ,  $\phi(x)$  envoie  $N_x$  sur  $N_{f(x)}$  (c'est le cas par exemple pour le cocycle différentiel  $Df(x): T_x M \rightarrow T_{f(x)} M$  à travers l'action sur les sous-espaces tangents), on peut voir le cocycle comme un système dynamique *fibré* sur  $\{x\} \times N_x, x \in M$ , où la dynamique de base est donnée par celle de  $f$ , et l'action dans les fibres est celle associée à  $\phi$ .

La plupart des cocycles qui interviendront dans la suite sont des *cocycles linéaires* : étant donné un espace  $\Delta$  muni d'une mesure de probabilité  $\mu$ , il s'agit d'une paire  $(T, A)$  d'applications mesurables, où  $T: \Delta \rightarrow \Delta$  et  $A$  est une application de  $\Delta$  dans un groupe linéaire, disons  $A: \Delta \rightarrow \text{GL}(m, \mathbb{K})$  pour un certain entier  $m \geq 0$ , et où  $\mathbb{K} = \mathbb{R}$  ou  $\mathbb{C}$ . On a alors une action naturelle

$$(T, A): \begin{cases} \Delta \times \mathbb{K}^m & \rightarrow \Delta \times \mathbb{K}^m, \\ (x, v) & \mapsto (T(x), A(x) \cdot v). \end{cases}$$

## 2. Mélange faible pour les échanges d'intervalles et flots de translation

Le chapitre consacré aux échanges d'intervalles et flots de translation est tiré d'un article co-écrit avec Artur Avila.

**2.1. Échanges d'intervalles et flots de translation.** Soit  $I \subset \mathbb{R}$  un intervalle fermé à gauche et ouvert à droite. Un *échange d'intervalles* sur  $I$  est une bijection de  $I$  telle que pour une certaine partition  $\{I_\alpha\}_{\alpha \in \mathcal{A}}$  de  $I$  en sous-intervalles, et pour tout  $\alpha \in \mathcal{A}$ , la restriction  $f|_{I_\alpha}$  de  $f$  à  $I_\alpha$  est une translation. Ici et dans ce qui suit, on suppose que les intervalles sont indexés par les éléments d'un alphabet  $\mathcal{A} = \{\alpha_1, \dots, \alpha_d\}$  sur  $d > 1$  symboles. Une telle application peut-être complètement décrite à l'aide de deux données : une *donnée de longueur*, c'est-à-dire un vecteur  $\lambda \in \mathbb{R}_+^{\mathcal{A}} \simeq \mathbb{R}_+^d$  dont les

coordonnées  $\lambda_\alpha := |I_\alpha|$  correspondent à la taille des différents sous-intervalles, et une *donnée combinatoire*  $\pi = (\pi_t, \pi_b)$ , où les bijections  $\pi_t, \pi_b: \mathcal{A} \rightarrow \{1, \dots, d\}$ , indiquent dans quel ordre les différents sous-intervalles sont réordonnés après application de  $f$ ; par un léger abus de langage,  $\pi$  est également appelée une *permutation*. Plus précisément, en allant de gauche à droite, l'ordre selon lequel les intervalles sont rangés avant et après application de  $f$  est donné respectivement par  $(\pi_t^{-1}(1), \pi_t^{-1}(2), \dots, \pi_t^{-1}(d))$  et  $(\pi_b^{-1}(1), \pi_b^{-1}(2), \dots, \pi_b^{-1}(d))$ . On note  $f(\lambda, \pi)$  l'échange d'intervalles associé. On définit aussi  $|\lambda| := \sum_\alpha \lambda_\alpha$ , et alors  $I = I^\lambda := [0, |\lambda|)$ . L'action de  $f$  est donnée par un *vecteur de translation*  $w \in \mathbb{R}^A$ , dont les composantes  $w_\alpha := \sum_{\pi_b(\beta) < \pi_b(\alpha)} \lambda_\beta - \sum_{\pi_t(\beta) < \pi_t(\alpha)} \lambda_\beta$  correspondent au déplacement induit par  $f|_{I_\alpha}$ . On remarque que  $w = \Omega_\pi(\lambda)$  pour une certaine application linéaire  $\Omega_\pi$ . Dans ce qui suit, on se restreint au cas d'une donnée combinatoire *irréductible*, c'est-à-dire telle que pour tout entier  $k$  entre 0 et  $d-1$ , les  $k$  premiers éléments des deux listes précédentes forment deux ensembles distincts (si ce n'est pas le cas, l'échange d'intervalles  $f(\lambda, \pi)$  se décompose en deux sous-échanges d'intervalles plus simples n'interagissant pas). Deux échanges d'intervalles dont les données de longueur sont homothétiques ont même comportement dynamique : on peut donc projectiviser  $\lambda$  en  $[\lambda] \in \mathbb{P}_+^A \simeq \mathbb{P}_+^{d-1}$  et considérer la classe d'applications  $f([\lambda], \pi)$ .

Les échanges d'intervalles sont des systèmes discrets, et possèdent un analogue en temps continu, correspondant au flot sur certaines surfaces, appelées *surfaces de translation*. Une telle surface est une surface de Riemann compacte  $S$  munie d'une *différentielle abélienne*  $\omega$  non-nulle. La 1-forme holomorphe  $\omega$  possède un nombre fini de zéros, appelés des *singularités*; on note  $\Sigma \subset S$  l'ensemble de ces zéros, et  $\kappa_p$  l'ordre du zéro  $p \in \Sigma$ . Autour d'un point *régulier*, on peut définir une carte dans laquelle  $\omega$  est juste  $dz$ ; la famille de ces cartes fournit un atlas de  $S \setminus \Sigma$  dont les fonctions de transition sont données par des translations. Par ailleurs, au voisinage d'une singularité  $p$ , il existe une carte dans laquelle  $\omega$  devient  $z^{\kappa_p} dz$ , avec  $\kappa_p > 0$ . L'aire de  $S$  est alors donnée par la formule  $\int |\omega|^2 < +\infty$ .

On peut également voir une surface de translation comme une surface compacte munie d'un atlas de translation et possédant un nombre fini de *singularités coniques*  $p \in \Sigma$  telles que pour un certain voisinage  $U_p \ni \{p\}$ , l'ensemble  $U_p \setminus \{p\}$  est isomorphe à un  $(\kappa_p + 1)$ -revêtement d'un voisinage épointé de 0 dans  $\mathbb{R}^2$ . Les surfaces de translation sont des exemples de *surfaces plates* : toute la courbure (négative) est concentrée dans les singularités de  $S$ , et en notant  $g \geq 1$  le *genre* de  $S$ , la formule de Gauss-Bonnet s'écrit alors  $\sum_{p \in \Sigma} \kappa_p = 2g - 2$ . Toute surface de translation peut être représentée comme un polygone possédant un nombre pair de côtés, regroupés par paires de côtés parallèles et de même longueur, et dont l'ensemble des sommets est partitionné en cycles associés aux singularités.

Lorsque le genre  $g$  est fixé, on note  $\mathcal{M}_g$  l'espace des modules des différentielles abéliennes sur les surfaces de Riemann compactes de genre  $g$ , et  $\mathcal{M}_g^1$  l'hypersurface de  $\mathcal{M}_g$  associée à celles d'aire égale à un. L'ensemble  $\mathcal{M}_g$  est organisé en *strates*  $\mathcal{M}_g(\kappa_1, \dots, \kappa_m)$  regroupant les différentielles possédant  $m$  zéros de multiplicités respectives  $\kappa_1, \dots, \kappa_m$ .

Le *flot de Teichmüller*  $(\mathcal{T}^t)_{t \in \mathbb{R}}$  agit par matrices diagonales sur  $\omega \in \mathcal{M}_g$  de la manière suivante, après composition par des cartes locales adaptées :

$$\mathcal{T}^t(\omega)_z := \begin{pmatrix} e^t & 0 \\ 0 & e^{-t} \end{pmatrix} \cdot \omega_z \equiv [e^t \Re(\omega_z)] + i[e^{-t} \Im(\omega_z)].$$

En particulier, ce flot préserve les composantes connexes des strates, ainsi que la forme d'aire. *A priori*, le flot de Teichmüller semble juste dilater la coordonnée horizontale et contracter la coordonnée verticale mais comme on a le droit de découper et recoller certains morceaux de la surface associée (puisque ces opérations préservent la structure de translation), on observe des phénomènes de récurrence : pour certains temps bien choisis, on retrouve une structure proche de la structure initiale. Pour toute composante connexe  $\mathcal{C}$  d'une strate de  $\mathcal{M}_g^1$ , il existe une probabilité  $\mu_{\mathcal{C}}$  dans la classe de la mesure de Lebesgue. Le résultat fondamental suivant a été obtenu par Masur et Veech, et montre que la dynamique associée est effectivement riche.

**Théorème 0.1** (Masur-Veech [25, 32]). *Pour toute composante connexe  $\mathcal{C}$  comme ci-dessus, la restriction du flot de Teichmüller à  $\mathcal{C}$  est ergodique par rapport à la mesure  $\mu_{\mathcal{C}}$ , et même mélangeante.*

Soit  $f$  un échange d'intervalles associé aux données  $(\lambda, \pi)$ . On peut lui associer un *flot de translation* de la manière suivante. Pour la donnée combinatoire  $\pi$ , on définit un cône convexe de  $\mathbb{R}^A$  par :

$$T^+(\pi) := \left\{ \tau \mid \sum_{\pi_t(\beta) \leq k} \tau_\beta > 0 \text{ et } \sum_{\pi_b(\beta) \leq k} \tau_\beta < 0, \forall 1 \leq k \leq d-1 \right\},$$

et on introduit l'ensemble  $H^+(\pi) := -\Omega_\pi(T^+(\pi)) \subset \mathbb{R}_+^A$ . Les éléments  $h \in H^+(\pi)$  s'interprètent comme des données de suspension selon la construction suivante introduite par Veech : pour tout  $\alpha \in \mathcal{A}$ , on vient "coller" un rectangle de hauteur  $h_\alpha$  au-dessus, respectivement en-dessous, du sous-intervalle associé à  $\alpha$  avant, respectivement après application de  $f$ . On peut définir une surface de suspension, obtenue comme un certain quotient de la réunion de ces rectangles : on identifie les intérieurs des deux rectangles associés à une même lettre, et on opère certains recollements le long des bords des rectangles selon une combinatoire liée à celle de  $\pi$ . Pour l'alphabet  $\{A, B, C, D\}$  et la combinatoire  $\pi_t = (A, B, C, D)$ ,  $\pi_b = (D, C, B, A)$ , on obtient par exemple

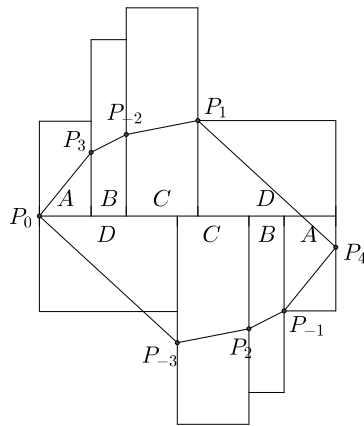

Notons  $S = S(\lambda, \pi, h)$  la surface de translation obtenue par la construction décrite ci-dessus. Le flot vertical sur  $S$  correspond alors au flot spécial au-dessus de l'échange d'intervalles  $f(\lambda, \pi)$ .

Les singularités de  $S$  ne dépendent que de  $\pi$  et sont notées  $\Sigma(\pi)$  ; de même, le genre  $g = g(\pi)$  de  $S$  dépend seulement de  $\pi$ , et on a la relation  $2g = d + 1 - \#\Sigma(\pi)$ . On définit également  $H(\pi) := \Omega_\pi(\mathbb{R}^A) \supset H^+(\pi)$ . Pour toute singularité  $s \in \Sigma(\pi)$ , on considère le vecteur  $b^s \in \mathbb{R}^d$  de coordonnées  $b_i^s := \chi_s(i-1) - \chi_s(i)$ ,  $1 \leq i \leq d$  ; on a alors  $h \in H(\pi)$  si et seulement si  $h \cdot b^s = 0$  pour tout  $s \in \Sigma(\pi)$ . De plus, l'espace  $H(\pi)$  est de dimension paire, égale à  $2g$ , et peut être identifié à l'homologie de la surface  $S$ .

**2.2. Procédures d'induction et de renormalisation.** La notion de *renormalisation* est fondamentale en systèmes dynamiques. Étant donné une application  $f: X \rightarrow X$  définie sur un ensemble  $X$ , et un sous-ensemble  $Y$  de  $X$ , on considère l'application *induite* par  $f$  sur  $Y$  ; pour l'ensemble des points  $y \in Y$  dont l'orbite future revient dans  $Y$ , il s'agit de l'application de premier retour  $y \mapsto f^{n(y)}(y)$ , où  $n(y) \in \mathbb{N} \setminus \{0\}$  correspond au temps de premier retour de  $y$ .

Il existe certaines classes d'applications  $f$  pour lesquelles on peut définir une procédure d'*induction* à partir de la construction décrite ci-dessus, lorsque l'application induite par  $f$  appartient à cette même classe. Dans ce cas, l'opération d'induction peut être itérée, en considérant des régions de l'espace de plus en plus petites. On peut alors

également introduire une procédure de *renormalisation*, où après chaque étape d'induction on effectue un changement d'échelle, de sorte que les applications qu'on obtient par ce procédé agissent sur un espace de taille fixée.

Les exemples de systèmes pour lesquels cette approche est fructueuse sont généralement de basse dimension, en raison de possibles difficultés de nature conforme en dimension supérieure, et ces systèmes ne peuvent pas être chaotiques; cela est notamment lié à l'*exposant de Lyapunov*, qui mesure le taux de croissance exponentielle des itérés d'un système dynamique. En effet, si cet exposant est positif pour l'application  $f$  initiale, il devient de plus en plus grand pour les itérés de  $f$  par la procédure de renormalisation.

Dans le cas des échanges d'intervalles, des procédures d'induction et de renormalisation ont été introduites par Rauzy et Veech. Soit  $f = f(\lambda, \pi)$  un échange d'intervalle défini sur un intervalle  $I$ . On suppose que  $\pi$  est irréductible, et que les coordonnées de  $\lambda$  sont rationnellement indépendantes. Notons  $\alpha(t) := \pi_t^{-1}(d)$ , resp.  $\alpha(b) := \pi_b^{-1}(d)$ , le symbole du sous-intervalle situé au bord droit de  $I$  avant, resp. après application de  $f$ . En particulier, nos hypothèses entraînent alors que  $\lambda_{\alpha(t)} \neq \lambda_{\alpha(b)}$ , et on a donc deux cas :

- si  $\lambda_{\alpha(t)} > \lambda_{\alpha(b)}$ , on définit le sous-intervalle  $J := I \setminus I_{\alpha(b)}$ , et on pose  $\gamma(\lambda, \pi) := t$ ;
- si  $\lambda_{\alpha(t)} < \lambda_{\alpha(b)}$ , on définit le sous-intervalle  $J := I \setminus I_{\alpha(t)}$ , et on pose  $\gamma(\lambda, \pi) := b$ .

On vérifie que  $\gamma(\lambda, \pi) = \gamma(\lambda', \pi)$  si  $\lambda$  et  $\lambda'$  sont homothétiques, et on peut donc définir  $\gamma([\lambda], \pi)$ . Considérons l'application de premier retour de  $f$  sur le sous-intervalle  $J$ ; il s'agit toujours d'un échange d'intervalles, noté  $f(\lambda^{(1)}, \pi^{(1)})$ , pour certaines données  $(\lambda^{(1)}, \pi^{(1)})$ . Dans le premier cas, on obtient par exemple :

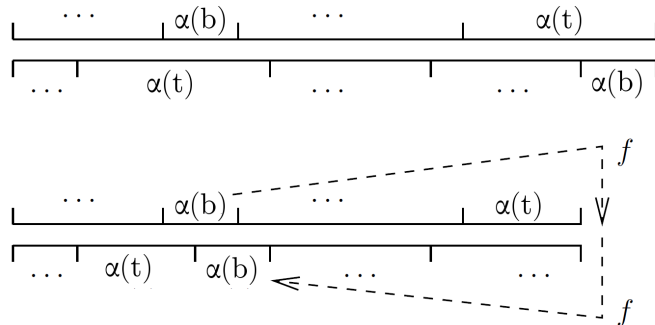

On voit que la donnée  $\pi^{(1)}$  est obtenue à partir de  $\pi$  en appliquant la transformation  $\underline{\gamma}(\lambda, \pi)$ , où  $\underline{t}$  est définie de la manière suivante (on l'appelle *transformation top*) :

$$\begin{pmatrix} \alpha_1^t & \dots & \alpha_{k-1}^t & \alpha_k^t & \alpha_{k+1}^t & \dots & \dots & \alpha(t) \\ \alpha_1^b & \dots & \alpha_{k-1}^b & \alpha(t) & \alpha_{k+1}^b & \dots & \alpha_{d-1}^b & \alpha(b) \end{pmatrix}$$

$\downarrow \underline{t}$

$$\begin{pmatrix} \alpha_1^t & \dots & \alpha_{k-1}^t & \alpha_k^t & \alpha_{k+1}^t & \dots & \dots & \alpha(t) \\ \alpha_1^b & \dots & \alpha_{k-1}^b & \alpha(t) & \alpha(b) & \alpha_{k+1}^b & \dots & \alpha_{d-1}^b \end{pmatrix},$$

où l'on a noté  $\alpha_i^* := \pi_*^{-1}(i)$ ,  $1 \leq i \leq d$ ,  $*$  =  $t, b$ . La transformation  $\underline{b}$  est appelée *transformation bottom* et est définie de manière analogue. Le plus petit ensemble de permutations contenant  $\pi$  et invariant par les transformations top et bottom est appelé la *classe de Rauzy* de  $\pi$ . On peut considérer le *diagramme de Rauzy* associé, dont les sommets sont indexés par les éléments de la classe de Rauzy, et les arêtes (orientées) relient deux permutations obtenues l'une à partir de l'autre par  $\underline{t}$  ou  $\underline{b}$ ; on notera  $\gamma$  les chemins dans ce diagramme obtenus en concaténant des arêtes.

Pour ce qui est des données de longueur, en notant  $B_{t,\pi} := \text{Id} + E_{\alpha(b)\alpha(t)}$  et  $B_{b,\pi} := \text{Id} + E_{\alpha(t)\alpha(b)}$  les matrices associées aux arêtes partant de  $\pi$ , on a la relation  $\lambda = B_{\gamma(\lambda,\pi),\pi}^* \cdot \lambda^{(1)}$ . On pose également  $B^R(\lambda, \pi) = B^R([\lambda], \pi) := B_{\gamma([\lambda],\pi),\pi}$ , et pour un chemin  $\gamma$  dans le diagramme de Rauzy, on notera  $B_\gamma$  la matrice obtenue en faisant le produit des matrices associées aux arêtes qui composent  $\gamma$ .

Il est facile de voir que les données  $(\lambda^{(1)}, \pi^{(1)})$  vérifient les mêmes hypothèses que  $(\lambda, \pi)$ ; on peut donc itérer la construction précédente, ce qui permet de définir une procédure d'induction, appelée *induction de Rauzy-Veech*. En particulier, on obtient ainsi une dynamique dans l'espace des paramètres des échanges d'intervalles, qui correspond à une application  $\mathcal{Q}_R: (\lambda, \pi) \mapsto (\lambda^{(1)}, \pi^{(1)})$ . On introduit également une procédure de renormalisation, ce qui peut se voir en considérant la donnée projectivée  $[\lambda] \in \mathbb{P}_+^A$ , et la dynamique associée est notée  $\mathcal{R}_R: ([\lambda], \pi) \mapsto ([\lambda^{(1)}], \pi^{(1)})$ . L'itéré  $n$ -ème de  $(\lambda, \pi)$  par  $\mathcal{Q}_R$  est noté  $(\lambda^{(n)}, \pi^{(n)})$ , et de même pour  $\mathcal{R}_R$ . En particulier, on obtient pour  $\mathcal{R}_R$  (et similairement pour  $\mathcal{Q}_R$ ) :

$$\lambda = B_n([\lambda], \pi)^* \cdot \lambda^{(n)}, \quad B_n^R([\lambda], \pi) := B^R(\mathcal{R}_R^{n-1}([\lambda], \pi)) \dots B^R([\lambda], \pi).$$

Après  $n$  étapes d'induction, l'intervalle obtenu correspond à  $I^{\lambda^{(n)}}$  avec les notations introduites précédemment, et on note  $J^n := I^{\lambda^{(n)}}$ . Par définition de  $B(\lambda, \pi)$  et par les propriétés des produits de matrices, les coefficients de  $B_n^R([\lambda], \pi)$  s'interprètent aussi comme le nombre de visites des différents sous-intervalles initiaux lorsqu'on considère le segment de l'orbite sous  $f$  des points de  $J^n$  avant qu'ils ne reviennent dans  $J^n$ .

L'induction de Rauzy-Veech peut également se voir dans l'espace des rectangles de suspension. En effet, on supprime les morceaux de rectangles adjacents au sous-intervalle retiré à  $I$  dans la construction précédente, et on vient coller ces derniers au-dessus et en-dessous d'autres rectangles par le jeu des identifications qu'on a définies.

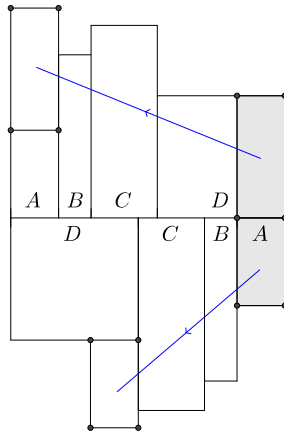

On obtient une nouvelle surface, de même aire, et cette construction préserve la structure de translation. Notons  $h^{(0)} \in H^+(\pi)$  la donnée de suspension décrivant la hauteur des rectangles. Dans la figure précédente, on voit que les hauteurs des nouveaux rectangles sont données par le vecteur  $h^{(1)} := B^R(\lambda, \pi) \cdot h^{(0)}$ . De plus, les matrices  $B^R$  préservent l'homologie : si  $\mathcal{Q}_R(\lambda, \pi) = (\lambda^{(1)}, \pi^{(1)})$ , alors on a  $B^R(\lambda, \pi) \cdot H(\pi) = H(\pi^{(1)})$ . On obtient par conséquent un cocycle de manière naturelle, défini au-dessus de la dynamique de  $\mathcal{Q}_R$  :

$$\hat{\mathcal{Q}}_R: (\lambda, \pi, h) \mapsto (\mathcal{Q}_R(\lambda, \pi), B^R(\lambda, \pi) \cdot h), \quad h \in H(\pi),$$



appelé le *cocycle de Rauzy* ; de même, on définit un cocycle au-dessus de  $\mathcal{R}_R$ , aussi appelé *cocycle de Rauzy* et noté  $\hat{\mathcal{R}}_R$ . On voit que l'application de l'induction a pour effet d'allonger la taille des rectangles. Par conséquent, le flot de translation vertical au-dessus des points de la transversale associée à l'intervalle  $J^n$  met de plus en plus de temps avant de revenir sur cette transversale, et induit des éléments de plus en plus longs dans l'homologie (construits en fermant la trajectoire correspondante par un petit segment) ; c'est ce genre d'observations qui rend ces procédures si intéressantes pour décrire les phénomènes asymptotiques liés à la dynamique.

**2.3. Le critère de Veech.** Le résultat suivant est dû à Veech et fournit une illustration des applications possibles des procédures d'induction-renormalisation. On considère un échange d'intervalles  $f = f(\lambda, \pi)$  associé à une donnée  $\pi$  irréductible, et on suppose que  $f = f(\lambda, \pi)$  est ergodique.

**Théorème 0.2** (Veech, [32]). *Si pour un certain  $h \in \mathbb{R}^A$  et  $t \in \mathbb{R}$ , l'équation suivante admet une solution mesurable  $\phi$  non-triviale :*

$$\phi(f(x)) = e^{2\pi i t h_\alpha} \phi(x), \quad \forall x \in I_\alpha, \alpha \in A, \quad (2.1)$$

alors il existe un ensemble infini  $E$  d'entiers naturels tel que

$$\lim_{E \ni n \rightarrow \infty} \|B_n^R(\lambda, \pi) \cdot th\|_{\mathbb{R}^d/\mathbb{Z}^d} = 0.$$

L'argument de Veech repose sur des idées liées à la renormalisation. Supposons que l'équation (2.1) est satisfaite pour une certaine fonction  $\phi$  mesurable non-triviale. En passant au module dans (2.1), on voit que la fonction  $|\phi|$  est invariante sous l'action de  $f$ , donc constante presque partout par ergodicité de  $f$  ; on peut donc se restreindre au cas où  $|\phi| = 1$ . En revanche, la fonction  $\phi$  est *a priori* seulement mesurable, donc on sait juste (par le théorème de Lusin) que pour tout  $\varepsilon > 0$ , il existe un compact  $K_\varepsilon \subset I$  tel que  $\phi|_{K_\varepsilon}$  est continue et la mesure de  $I \setminus K_\varepsilon$  est plus petite que  $\varepsilon$ .

Appliquons l'induction de Rauzy-Veech ; au temps  $n \geq 1$ , on obtient l'échange d'intervalles  $f_{(n)} = f(\lambda^{(n)}, \pi^{(n)}) = f(\mathcal{Q}_R^n(\lambda, \pi))$  défini sur l'intervalle  $J^n = I^{\lambda^{(n)}}$ . Pour l'application induite l'équation (2.1) donne alors

$$\phi(f_{(n)}(x)) = e^{2\pi i t (h^{(n)})_\alpha} \phi(x), \quad \forall x \in J_\alpha^n, \alpha \in A,$$

avec  $(h^{(n)})_\alpha = \sum_\beta \tau_{\alpha,\beta}^{(n)} h_\beta$ , où  $\tau_{\alpha,\beta}^{(n)}$  est le nombre de fois que l'orbite des points de  $J_\alpha^n$  visite l'intervalle  $I_\beta$  avant de revenir dans  $J^n$  ; on a également  $(f_{(n)})|_{J_\alpha^n} \equiv f^{b_\alpha^{(n)}}$ , où  $b_\alpha^{(n)} = \sum_\beta \tau_{\alpha,\beta}^{(n)}$  est le temps de premier retour des points de  $J_\alpha^n$  dans  $J^n$  sous l'action de  $f$ . Par l'interprétation de  $B$  en termes de matrices de temps de retour, l'équation précédente peut se réécrire :

$$\phi(f_{(n)}(x)) = e^{2\pi i (B_n^R([\lambda], \pi) \cdot th)_\alpha} \phi(x), \quad \forall x \in J_\alpha^n, \alpha \in A. \quad (2.2)$$

En d'autres termes, s'il existe une solution  $\phi$  à (2.1) associée à un vecteur  $th \in \mathbb{R}^A$  pour un échange d'intervalles  $f(\lambda, \pi)$ , alors par la procédure d'induction, on voit que  $\phi$  satisfait une équation similaire à (2.1) pour le vecteur  $B_n^R([\lambda], \pi) \cdot th$  et l'échange d'intervalles  $f(\lambda^{(n)}, \pi^{(n)})$ . Le gain est que l'induction agit comme une sorte de "microscope" puisque l'intervalle  $J^n$  est bien plus petit, et permet donc d'obtenir des propriétés locales sur  $\phi$ , qui est seulement mesurable. Veech montre qu'il existe un ensemble  $E \subset \mathbb{N}$  de temps tels que pour tout  $\delta > 0$ , pour  $n \in E$  suffisamment grand, il existe  $w = w(J^n)$  tel que

$$\int_{J^n} |\phi(x) - w| dx < \delta |J^n|.$$

Par l'inégalité de Markov, on déduit alors que  $\phi$  est de plus en plus proche d'une constante sur l'intervalle  $J^n$  à mesure que  $n \in E$  devient grand : l'ensemble  $X_{\delta, J^n} := \{x \in J^n \mid |\phi(x) - w| \geq \sqrt{\delta}\}$  est de mesure au plus égale à  $\sqrt{\delta} |J^n|$ . En considérant les temps de retour de l'application de renormalisation  $\mathcal{R}_R$  sur un simplexe  $\Delta \in \mathbb{P}_+^A$ , il montre également qu'on peut supposer que pour tout  $n$  dans  $E$ , les sous-intervalles de  $J^n$  sont commensurables : il existe  $\epsilon > 0$  tel que pour tout  $n \in E$ , le quotient de la longueur

du plus petit et du plus grand sous-intervalle de  $J^n$  est supérieur à  $\epsilon$ . En combinant ces arguments, on voit que pour tout  $\delta > 0$ , il existe  $n \in E$  tel que pour tout  $\alpha \in \mathcal{A}$ , il existe  $w = w(J^n)$  et  $x \in J_\alpha^n$  satisfaisant

$$|\phi(x) - w| \leq \sqrt{\delta} \quad \text{et} \quad |\phi(f_n(x)) - w| \leq \sqrt{\delta}.$$

Comme  $\phi$  est de module un, on déduit de (2.2) que

$$|e^{2\pi i(B_n^R([\lambda], \pi) \cdot th)_\alpha} - 1| \leq 2\sqrt{\delta}, \quad \forall \alpha \in \mathcal{A},$$

ce qui conclut.  $\square$

**2.4. La propriété de décroissance rapide.** Pour une classe de Rauzy  $\mathfrak{R}$ , on définit  $\hat{\Delta}_{\mathfrak{R}} := \cup_{\pi \in \mathfrak{R}} \mathbb{R}_+^A \times \{\pi\} \times T^+(\pi)$ . Cet ensemble est formé de triplets  $(\lambda, \pi, \tau)$ , et dans ces coordonnées, le flot de Teichmüller peut se lire de la manière suivante :

$$\mathcal{T}^t : (\lambda, \pi, \tau) \mapsto (e^t \lambda, \pi, e^{-t} \tau), \quad t \in \mathbb{R}.$$

Le cocycle de Rauzy devient alors :

$$\tilde{\mathcal{Q}}_R : (\lambda, \pi, \tau) \mapsto ((B^R(\lambda, \pi)^{-1})^* \cdot \lambda, \pi^{(1)}, (B^R(\lambda, \pi)^{-1})^* \cdot \tau).$$

En identifiant  $\mathbb{P}_+^A \simeq \{\lambda \in \mathbb{R}_+^A, |\lambda| = 1\}$ , l'application de renormalisation de Rauzy  $\mathcal{R}_R : ([\lambda], \pi) \mapsto (|(B^R(\lambda, \pi)^*)^{-1} \cdot \lambda|, \pi^{(1)})$  se réécrit également

$$\mathcal{R}_R(\lambda, \pi) = \left( \frac{(B^R(\lambda, \pi)^*)^{-1} \cdot \lambda}{|(B^R(\lambda, \pi)^*)^{-1} \cdot \lambda|}, \pi^{(1)} \right).$$

Soit  $|\lambda| = 1$ ; on définit  $t_R(\lambda, \pi) := -\log(|(B^R(\lambda, \pi)^{-1})^* \cdot \lambda|)$ , et on remarque que l'application  $\tilde{\mathcal{R}}_R : (\lambda, \pi, \tau) \mapsto \tilde{\mathcal{Q}}_R \circ \mathcal{T}^{t_R(\lambda, \pi)}(\lambda, \pi, \tau)$  est un produit croisé au-dessus de  $\mathcal{R}_R$ . Notons  $\phi(\lambda, \pi, \tau) := |\lambda|$ ;  $\mathcal{U}_{\mathfrak{R}}$  est défini comme l'ensemble des  $x \in \hat{\Delta}_{\mathfrak{R}}$  tels que

- $\tilde{\mathcal{Q}}_R(x)$  est défini et  $\phi(\tilde{\mathcal{Q}}_R(x)) < 1 \leq \phi(x)$ ;
- $\tilde{\mathcal{Q}}_R(x)$  n'est pas défini et  $\phi(x) \geq 1$ ;
- $\tilde{\mathcal{Q}}_R^{-1}(x)$  n'est pas défini et  $\phi(x) < 1$ .

L'ensemble  $\mathcal{U}_{\mathfrak{R}}$  est un domaine fondamental pour l'action de  $\tilde{\mathcal{Q}}_R$ , et le flot de Veech  $(\mathcal{V}^t)_{t \in \mathbb{R}}$  est défini comme le flot induit par  $\mathcal{T}^t$  sur  $\mathcal{U}_{\mathfrak{R}}$ . L'application de premier retour sur la transversale  $\phi^{-1}(1)$  est donnée par  $\tilde{\mathcal{R}}_R$ ; réciproquement, on peut voir  $(\mathcal{V}^t)_{t \in \mathbb{R}}$  comme le flot spécial au-dessus de  $\tilde{\mathcal{R}}_R$  pour la fonction "toit"  $t_R$ . Par conséquent, la dynamique de  $(\mathcal{V}^t)_t$  est intimement liée à celle de l'application de renormalisation de Rauzy. Avila-Gouëzel-Yoccoz [6] ont étudié l'application de premier retour de  $(\mathcal{V}^t)_{t \in \mathbb{R}}$  sur une section précompacte et montré que le temps de premier retour a des *queues exponentielles*.

Soit  $\pi$  une permutation irréductible, et  $\lambda$  une donnée de longueur rationnellement indépendante. Par les travaux de Marmi-Moussa-Yoccoz [24], on sait qu'il existe un entier  $n \geq 1$  tel que la matrice  $B_n([\lambda], \pi)$  a tous ses coefficients strictement positifs. On définit le simplexe  $\Delta := B_n([\lambda], \pi)^* \cdot \mathbb{P}_+^A$ . En particulier, il est compactement contenu dans  $\mathbb{P}_+^A$ . En considérant l'application  $T$  induite par  $\mathcal{R}_R$  sur le simplexe  $\Delta$ , on a alors une partition de Markov

$$\Delta = \bigcup_{\gamma} \Delta_{\gamma}, \quad \Delta_{\gamma} := B_{\gamma}^* \Delta,$$

où  $\lambda \in \Delta_{\gamma}$  si et seulement si la trajectoire de  $(\lambda, \pi)$  selon  $\mathcal{R}_R$  revient pour la première fois dans  $\Delta \times \{\pi\}$  par un chemin  $\gamma$  du diagramme de Rauzy. On note  $r_{\Delta}(\lambda) := -\log|(B_{\gamma}^*)^{-1} \cdot \lambda|$  le temps de premier retour pour  $\lambda \in \Delta_{\gamma}$ . De plus,  $T$  préserve une mesure de probabilité  $\mu$ , et possède la propriété de *distortion bornée*, i.e., les mesures  $\mu_{\gamma} := \frac{1}{\mu(\Delta_{\gamma})} T_{*}^{\gamma}(\mu|_{\Delta_{\gamma}})$  sont comparables à  $\mu$ . Le cocycle induit par le cocycle de Rauzy est alors  $(T, B)$ , où  $B|_{\Delta_{\gamma}} := B_{\gamma}$ . Par les résultats d'Avila-Gouëzel-Yoccoz, on obtient entre autres que l'application  $r_{\Delta}$  a des queues exponentielles. En notant  $\|A\|_0 := \max\{\|A\|, \|A^{-1}\|\}$  pour  $A \in \text{GL}(d, \mathbb{R})$ , on peut alors en déduire :

**Proposition 0.3** (Avila-L.). *L'application  $T$  est à décroissance rapide : il existe  $C_1 > 0$  et  $\alpha_1 > 0$  tels que*

$$\sum_{\mu(\Delta_\gamma) \leq \epsilon} \mu(\Delta_\gamma) \leq C_1 \epsilon^{\alpha_1}, \quad \forall 0 < \epsilon < 1.$$

*De même,  $B$  est à décroissance rapide : il existe  $C_2 > 0$  et  $\alpha_2 > 0$  tels que*

$$\sum_{\|B_\gamma\|_0 \geq n} \mu(\Delta_\gamma) \leq C_2 n^{-\alpha_2}, \quad \forall n \geq 1.$$

### 2.5. Mélange faible pour les échanges d'intervalles et flots de translation.

On se donne une permutation  $\pi$  irréductible ; pour que la propriété de mélange puisse être satisfaite pour  $f = f(\lambda, \pi)$ , il est nécessaire que  $\pi$  ne soit pas une rotation ; on suppose dans ce qui suit que cette condition est vérifiée.

Nous avons obtenu les résultats suivants concernant le mélange pour les échanges d'intervalles et flots de translation ; ils renforcent des théorèmes analogues obtenus par Avila-Forni [5] en termes de mesure.

**Théorème 0.4** (Avila-L.). *Soit  $d > 1$  et  $\pi$  une permutation qui n'est pas une rotation ; alors l'ensemble des  $[\lambda] \in \mathbb{P}_+^A$  tels que  $f([\lambda], \pi)$  n'est pas faiblement mélangeant est de dimension de Hausdorff strictement plus petite que  $d - 1$ .*

Dans le cadre des flots de translation, ils peuvent se paramétrer à l'aide de la donnée de suspension  $h \in H(\pi)$  comme on a vu plus haut. L'énoncé est alors :

**Théorème 0.5** (Avila-L.). *Soit  $\pi$  comme ci-dessus. L'ensemble des  $([\lambda], h) \in \mathbb{P}_+^A \times H(\pi)$  tels que le flot de translation associé n'est pas faiblement mélangeant est de dimension de Hausdorff strictement plus petite que  $2g + d - 1$ .*

Pour l'échange d'intervalles  $f$ , la propriété de *mélange faible* équivaut au fait que pour tout  $t \in \mathbb{R}$ , il n'existe pas de fonction  $\phi : I \rightarrow \mathbb{C}$  non constante satisfaisant

$$\phi(f(x)) = e^{2\pi it} \phi(x), \quad \forall x \in I.$$

Cela peut également se reformuler en :

- (1)  $f$  est ergodique (on prend  $t$  entier dans l'équation précédente) ;
- (2) pour tout  $t \in \mathbb{R} \setminus \mathbb{Z}$ , il n'existe pas de fonction  $\phi : I \rightarrow \mathbb{C}$  non-nulle telle que

$$\phi(f(x)) = e^{2\pi it} \phi(x), \quad \forall x \in I.$$

Considérons d'abord la propriété d'ergodicité. Veech [31] a montré que l'ensemble  $\mathcal{M}_f := \{\mu, f_*\mu = \mu\}$  des mesures invariantes par  $f$  est isomorphe au cône

$$\bigcap_{n=1}^{\infty} B_n^R([\lambda], \pi)^* \cdot \mathbb{R}_+^A.$$

Grâce à ce fait, on voit que  $f$  est uniquement ergodique dès que les conditions suivantes sont satisfaites :

- il existe  $n \geq 1$  tel que les coefficients de  $B_n^R([\lambda], \pi)$  sont strictement positifs ;
- pour une infinité d'entiers  $k \geq 0$ ,  $B_n^R(\mathcal{R}_R^k([\lambda], \pi)) = B_n^R([\lambda], \pi)$ .

Soit  $\lambda$  une donnée de longueur rationnellement indépendante. On sait qu'il existe  $n \geq 1$  tel que la matrice  $B_n([\lambda], \pi)$  a tous ses coefficients strictement positifs, et en considérant l'application induite par  $\mathcal{R}_R$  sur le simplexe associé, on peut voir que les points qui ne reviennent pas une infinité de fois dans ce simplexe ont une dimension de Hausdorff non-maximale (cela découle d'un résultat d'Avila-Delecroix, par la propriété de décroissance rapide montrée plus haut). On déduit que l'ensemble des paramètres pour lesquels on n'a pas unique ergodicité n'est pas de dimension de Hausdorff maximale.

Pour le point (2) ci-dessus, on veut montrer que l'ensemble des paramètres  $\lambda$  tels qu'il existe  $t \notin \mathbb{Z}$  et une fonction  $\phi$  non nulle vérifiant

$$\phi(f(x)) = e^{2\pi it} \phi(x), \quad \forall x \in I$$

a une dimension de Hausdorff non-maximale. Le cas du genre un, i.e.,  $g = g(\pi) = 1$ , est facile, et on se restreint donc au cas où  $g > 1$ . En considérant l'application  $T$  induite par  $\mathcal{R}_R$  sur un simplexe compact  $\Delta$  adapté (on a un contrôle sur les points qui s'échappent), on peut se ramener au cas d'un cocycle  $(T, B)$  pour lequel on a des propriétés de décroissance rapide, et par le Théorème 0.2, on a alors pour tout "mauvais paramètre"  $[\lambda] \in \Delta$  :

$$(t, t, \dots, t) \in (\mathbb{R}^d \setminus \mathbb{Z}^d) \cap W^s([\lambda]) \neq \emptyset,$$

où l'on a noté

$$W^s([\lambda]) := \{w \in \mathbb{R}^d, \lim_{n \rightarrow +\infty} \|B_n([\lambda]) \cdot w\|_{\mathbb{R}^d/\mathbb{Z}^d} = 0\}.$$

Le résultat qu'on veut montrer se ramène donc à étudier la *lamination faiblement stable* pour la dynamique du cocycle  $(T, B)$  dans l'espace des paramètres.

La géométrie de  $W^s$  est compliquée et a été abordée dans les travaux d'Avila-Forni. Un argument important est le résultat d'*exclusion de l'espace central-stable*, qui entraîne qu'une ligne ne passant pas par l'origine est chassée de l'origine par l'itération du cocycle. Cependant, de possibles transitions vers d'autres points à coordonnées entières rendent l'analyse délicate, et Avila-Forni ont introduit pour tenir compte de cela un argument probabiliste. On utilise leurs estimées en cherchant à obtenir un résultat de grandes déviations. Pour un réel positif  $\delta > 0$  petit et une ligne  $J$  fixée ne passant pas par l'origine, au temps  $n$ , les mauvais paramètres associés se trouvent dans un certain ensemble

$$\Gamma_\delta^n(J) := \{[\lambda] \in \Delta, J \cap W_{\delta, n}^s([\lambda]) \neq \emptyset\}.$$

On montre l'estimée suivante :

$$\mu(\Gamma_\delta^n(J)) \leq C e^{-\kappa n} \|J\|^{-\rho},$$

pour des réels  $\kappa, \rho > 0$ . Grâce à la propriété de décroissance rapide, on peut alors conclure sur la dimension de Hausdorff des paramètres non faiblement mélangeants.

Le cas des flots de translations se traite à l'aide des données de suspension ; dans ce contexte, on doit estimer l'ensemble des paires  $([\lambda], h)$  pour lesquelles la propriété de mélange faible n'est pas satisfaite. Comme pour les échanges d'intervalles, on commence par fixer  $h$ , et pour tout temps  $n$ , on construit un recouvrement de l'ensemble des mauvais paramètres  $[\lambda]$ . Par le critère de Veech, pour un point dont les itérés croissent en accord avec le taux attendu (donné par l'exposant de Lyapunov), ce même recouvrement marche pour des paramètres  $h'$  exponentiellement proches de  $h$  (relativement à l'entier  $n$ ), ce qui permet de construire un bon recouvrement de l'espace des mauvaises paires  $([\lambda], h)$  au temps  $n$ . Le cas des points dont la croissance des itérés est anormalement grande est géré à l'aide d'un argument de grandes déviations, ce qui est permis par la propriété de distorsion bornée.

### 3. Accessibilité pour les systèmes dynamiques partiellement hyperboliques

La partie consacrée à la propriété d'accessibilité pour les systèmes dynamiques partiellement hyperboliques est issue d'un article en cours de rédaction en collaboration avec Zhiyuan Zhang, et dont nous donnons une version provisoire dans cette thèse.

#### 3.1. Rappels rapides de dynamique (partiellement) hyperbolique.

**Définition 0.6** (Ensemble hyperbolique). *Soit  $f$  un difféomorphisme d'une variété riemannienne compacte  $M$ . Un ensemble hyperbolique pour  $f$  est un sous-ensemble  $K \subset M$  compact,  $f$ -invariant, tel que la restriction à  $K$  du fibré tangent admet une décomposition en somme d'un fibré instable  $E^s$  et d'un fibré stable  $E^u$ ,*

$$T_x M = E^s(x) \oplus E^u(x), \quad \forall x \in K,$$

qui vérifie les propriétés suivantes :

- les sous-fibrés  $E^s$  et  $E^u$  sont invariants, i.e.,  $Df(E^*(x)) = E^*(f(x))$ ,  $* = s, u$ ,  $\forall x \in K$  ;
- $E^s$  est uniformément contracté, tandis que  $E^u$  est uniformément dilaté : il existe des constantes  $\bar{\chi}^s, \bar{\chi}^u > 0$  et  $c > 0$  telles que pour tout  $x \in K$ ,

$$\begin{aligned} \|Df^n(v)\| &< ce^{-\bar{\chi}^s}, & \forall v \in E^s(x), n \geq 0, \\ \|Df^{-n}(v)\| &< ce^{-\bar{\chi}^u}, & \forall v \in E^u(x), n \geq 0. \end{aligned}$$

En général, l'étude des systèmes dynamiques se concentre sur les points qui possèdent une certaine forme de récurrence. Pour une application  $f: M \rightarrow M$  d'un espace topologique  $M$ , la notion la plus forte de récurrence est associée aux points fixes et périodiques; de manière plus générale, on peut définir l'ensemble *non-errant*  $\Omega(f)$  comme l'ensemble des points  $x \in M$  tels que pour tout voisinage  $U$  de  $x$ , il existe un entier  $n \geq 1$  satisfaisant  $f^n(U) \cap U \neq \emptyset$ . Dans le cas où  $M$  est une variété riemannienne compacte et où  $f$  est un difféomorphisme de  $M$ , on dit que  $f$  est *Axiome A* si  $\Omega(f)$  est un ensemble hyperbolique pour  $f$ ; on peut encore assouplir davantage ces conditions à l'aide de la notion d'*ensemble récurrent par chaînes*. À l'inverse, lorsque la variété  $M$  elle-même est un ensemble hyperbolique pour  $f$ , on dit que  $f$  est un *difféomorphisme d'Anosov*. Les difféomorphismes hyperboliques vérifient de nombreuses propriétés : par le *lemme de pistage*, ils sont *structurellement stables*, le nombre de classes de récurrence par chaînes est fini, et chacune d'entre elles est transitive. . .

On peut assouplir l'hypothèse d'hyperbolicité comme suit. De manière informelle, un difféomorphisme  $f: M \rightarrow M$  d'une variété compacte riemannienne  $M$  est dit *partiellement hyperbolique* s'il existe une décomposition

$$T_x M = E^s(x) \oplus E^c(x) \oplus E^u(x), \quad \forall x \in M,$$

du fibré tangent en somme de trois sous-fibrés invariants par la différentielle  $Df$ , tels qu'en restriction au sous-espace *stable*  $E^s$  (resp. sous-espace *instable*  $E^u$ ),  $Df$  agit comme une contraction (resp. dilatation) avec un taux uniforme, et en restriction au sous-espace *central*  $E^c$ , les taux de contraction et d'expansion de  $Df$  sont dominés respectivement par ceux de  $Df|_{E^s}$  et  $Df|_{E^u}$ . Dans la suite, on notera souvent  $d_s := \dim(E^s)$ ,  $d_u := \dim(E^u)$  et  $c := \dim(E^c)$ . Par des arguments de transformation de graphe, les fibrés stable et instable s'intègrent en des feuilletages invariants par la dynamique de  $f$  :

**Théorème 0.7** (Hirsch-Pugh-Shub, [19]). *Supposons que  $f$  est de classe  $C^r$ . On a entre autres :*

- pour  $* = s, u$ , il existe un feuilletage  $\mathcal{W}_f^*$  tel que pour tout  $x \in M$ , la feuille  $\mathcal{W}_f^*(x)$  est une variété immergée de classe  $C^r$  tangente à  $E^*$  ;
- pour tout  $x \in M$ ,  $\mathcal{W}_f^s(x)$  est formée des points dont l'orbite future converge vers celle de  $y$  plus vite que les contractions de  $Df^n|_{E^c(x)}$ , et  $\mathcal{W}_f^u$  vérifie une propriété symétrique.
- la régularité transverse des feuilletages  $\mathcal{W}_f^s$  et  $\mathcal{W}_f^u$  est Hölder.

Le fibré central n'est en revanche pas forcément uniquement intégrable, et même lorsque c'est le cas, il peut avoir des propriétés pathologiques.

On dit qu'un difféomorphisme partiellement hyperbolique  $f$  est *dynamiquement cohérent* lorsque les fibrés  $E^c \oplus E^u$  et  $E^c \oplus E^s$  s'intègrent respectivement en des feuilletages  $\mathcal{W}_f^{cu}$  et  $\mathcal{W}_f^{cs}$ ; on obtient alors un feuilletage central  $\mathcal{W}_f^c$  en intersectant les feuilles de ces derniers. De plus sous une hypothèse additionnelle, dite *d'expansivité le long des plaques*, le feuilletage central présente une forme de stabilité structurelle.

### 3.2. Accessibilité.

**Définition 0.8** (Accessibilité, classes d'accessibilité). *Un difféomorphisme partiellement hyperbolique  $f: M \rightarrow M$  est dit accessible si pour toute paire de points  $x, y \in M$ , il existe*

un chemin  $\gamma: [0, 1] \rightarrow M$  reliant  $x$  à  $y$  obtenu en concaténant des chemins  $\gamma_i: [0, 1] \rightarrow M$ ,  $i = 1, \dots, n$ , dont l'image est entièrement contenue dans une feuille stable ou instable de  $f$ ; en d'autres termes,  $\text{Im}(\gamma_i) \subset \mathcal{W}_f^*(\gamma(0))$  pour  $* = s$  ou  $u$ . De tels chemins  $\gamma$  sont appelés des chemins d'accessibilité (*su-paths* en anglais), et les images des chemins  $\gamma_i$  ci-dessus sont appelés des arcs de  $\gamma$ .

Pour tout point  $x \in M$ , on définit également la classe d'accessibilité de  $x$  pour  $f$  comme l'ensemble des points  $y$  qui peuvent être atteints à partir de  $x$  en suivant un chemin d'accessibilité. On note  $\text{Acc}_f(x)$  la classe d'accessibilité de  $x$ . L'ensemble des classes d'accessibilité forme une partition de  $M$ . En particulier, le difféomorphisme  $f$  est accessible si et seulement cette partition est réduite à une seule classe, i.e.,  $M$  tout entier.

**3.3. Accessibilité et ergodicité.** Dans les années 30, Hopf [20] a prouvé l'ergodicité du flot géodésique sur une surface compacte de courbure strictement négative. Pour cela il a introduit un argument lié à l'étude des moyennes de Birkhoff le long des feuilletages stables et instables. Cette idée a depuis été appliquée dans de nombreux contextes et est aujourd'hui connue sous le nom d'*argument de Hopf*.

Soit  $f: M \rightarrow M$  un difféomorphisme partiellement hyperbolique conservatif d'une variété compacte connexe riemannienne  $M$  de dimension  $d$ . Étant donnée une fonction intégrable  $\phi: M \rightarrow \mathbb{R}$ , on note  $\bar{\phi}^+$  la limite supérieure des moyennes de Birkhoff de  $\phi$  selon  $f$ :

$$\bar{\phi}^+ := \limsup_{n \rightarrow +\infty} \frac{1}{n} \sum_{k=1}^n \phi \circ f^k.$$

Lorsque  $\phi$  est continue, on voit que pour tout  $x \in M$ ,  $y \in \mathcal{W}_f^s(x)$ ,  $\lim_{n \rightarrow +\infty} |\phi(f^n(x)) - \phi(f^n(y))| = 0$ , d'où  $\bar{\phi}^+(x) = \bar{\phi}^+(y)$ . En particulier si la limite  $\lim_{n \rightarrow +\infty} \frac{1}{n} \sum_{k=1}^n \phi \circ f^k$  existe en  $x$ , alors elle existe sur toute la feuille  $\mathcal{W}_f^s(x)$  et y est constante. On peut définir de manière analogue une fonction  $\bar{\phi}^-$  en considérant les itérés de  $f$  dans le passé; dans ce cas, la fonction  $\bar{\phi}^-$  est constante sur les feuilles instables pour  $f$ .

Par ailleurs, pour une fonction  $\phi: M \rightarrow \mathbb{R}$  dans  $L^2$ , le théorème ergodique de Birkhoff implique que  $\bar{\phi}^+$  coïncide (modulo 0) avec la projection de  $\phi$  sur le sous-espace de  $L^2$  des fonctions  $f$ -invariantes. Pour montrer que le difféomorphisme  $f$  est ergodique, il suffit donc de voir que pour toute fonction continue  $\phi: M \rightarrow \mathbb{R}$ , la fonction  $\bar{\phi}^+$  est constante presque partout. Par la discussion précédente, et comme l'ensemble des fonctions  $f$ -invariantes est égal à l'ensemble des fonctions  $f^{-1}$ -invariantes, on sait que  $\bar{\phi}^+ = \bar{\phi}^-$  presque partout. De plus,  $\bar{\phi}^+$  est constante le long des feuilles stables, tandis que  $\bar{\phi}^-$  est constante le long des feuilles instables.

L'argument précédent a permis à Hopf de montrer l'ergodicité des difféomorphismes d'Anosov dans le cas où les feuilletages stable et instable sont lisses; en effet en raisonnant localement à l'aide de cartes, on obtient une paire de feuilletages transverses du cube  $[-1, 1]^d$ , et le théorème de Fubini nous dit qu'une fonction mesurable constante le long de deux feuilletages transverses est constante presque partout. Cela conclut, par connexité de  $M$ .

Cependant, il n'est pas vrai que pour un difféomorphisme d'Anosov général, les feuilletages stable et instable sont de classe  $C^1$ . En revanche, lorsque le difféomorphisme est de classe  $C^2$ , ces feuilletages possèdent la propriété d'*absolue continuité*; rappelons que pour un feuilletage  $\mathcal{F}$ , cette propriété a pour conséquences :

- (1) pour tout ensemble mesurable  $A \subset M$ ,  $\text{Vol}(A) = 0$  si et seulement si  $\text{Vol}_{\mathcal{F}(x)}(A) = 0$  pour presque tout  $x \in M$ , où  $\text{Vol}_{\mathcal{F}(x)}$  est le volume riemannien induit sur la feuille de  $\mathcal{F}$  passant par  $x$ ;
- (2) pour tout disque local  $\mathcal{D}$  transverse à  $\mathcal{F}$ , si  $\mathcal{D}_0 \subset \mathcal{D}$  est de volume nul dans  $\mathcal{D}$ , alors la réunion des feuilles de  $\mathcal{F}$  passant par les points de  $\mathcal{D}_0$  est de volume nul dans  $M$ .



Pour un difféomorphisme d'Anosov  $f$  de classe  $C^2$ , la preuve de l'ergodicité procède alors de la manière suivante. On considère une fonction continue  $\phi: M \rightarrow \mathbb{R}$ . Avec les notations précédentes, on sait que  $\bar{\phi}^+ = \bar{\phi}^-$  sur un ensemble  $M' \subset M$  de mesure totale, et on veut montrer que  $\bar{\phi}^+$  est constante presque partout. Grâce à l'absolue continuité, on sait par la propriété (1) ci-dessus que pour presque tout  $x \in M$ ,  $\mathcal{W}_f^s(x) \cap M'$  est de mesure totale dans  $\mathcal{W}_f^s(x)$ . Pour un tel  $x$ , et pour tout  $y \in \mathcal{W}_f^s(x) \cap M'$ , on a  $\bar{\phi}^-(y) = \bar{\phi}^+(y) = \bar{\phi}^+(x)$ . Alors, en posant  $M'' := \bigcup_{y \in \mathcal{W}_f^s(x) \cap M'} \mathcal{W}_f^u(y)$ , on obtient que  $\bar{\phi}^+$  est constante sur  $M' \cap M''$ , égale à  $\bar{\phi}^+(x)$ ; par la conséquence (2) ci-dessus de l'absolue continuité, on sait aussi que  $M''$  est de mesure totale dans un voisinage de  $x$ ; la fonction  $\bar{\phi}^+$  est donc constante presque partout sur un voisinage de  $x$ , ce qui conclut, par connexité de  $M$ .

**Théorème 0.9** (Grayson-Pugh-Shub, [17]). *Soit  $S$  une surface hyperbolique, et soit  $\{\Phi^t\}_t$  le flot géodésique sur le fibré unitaire tangent  $T^1S$ . Alors  $\Phi^1$ , l'application temps-un du flot, est stablement ergodique : il existe un voisinage  $\mathcal{U}$  de  $\Phi^1$  dans  $\text{Diff}^2(T^1S, \text{Vol})$  tel que toute fonction  $f \in \mathcal{U}$  est ergodique.*

Ce résultat est le premier exemple de système dynamique partiellement hyperbolique mais non hyperbolique stablement ergodique. Peu de temps après, Pugh et Shub ont formulé la conjecture suivante :

**Conjecture 0.10** (Pugh-Shub [27]). *Sur toute variété compacte, la propriété d'ergodicité est satisfaite pour un ouvert dense de difféomorphismes de classe  $C^2$  partiellement hyperboliques préservant le volume.*

Dans le cas partiellement hyperbolique, on n'a plus transversalité des feuilletages stable et instable comme pour un difféomorphisme d'Anosov, et la propriété d'accessibilité (ou pour le moins, une condition qui s'en rapproche) est ce dont on a besoin pour espérer faire fonctionner un argument du type de celui introduit par Hopf. À l'aide de la notion d'accessibilité, cette conjecture se divise en deux parties de la manière suivante :

**Conjecture 0.11** (Pugh-Shub [27]). *La propriété d'accessibilité est satisfaite pour un ouvert dense de difféomorphismes de classe  $C^2$  partiellement hyperboliques, préservant ou non le volume.*

**Conjecture 0.12** (Pugh-Shub [27]). *Un difféomorphisme partiellement hyperbolique de classe  $C^2$  préservant le volume et possédant la propriété d'accessibilité essentielle est ergodique.*

Ici, la notion d'*accessibilité essentielle* est une version faible au sens mesuré de l'accessibilité, qui dit que pour deux ensembles quelconques  $A$  et  $B$  de volume strictement positif, il existe un chemin d'accessibilité reliant un point de  $A$  à un point de  $B$ .

L'hypothèse de *center-bunching* est classique en dynamique partiellement hyperbolique. De manière informelle, pour un système dynamique partiellement hyperbolique  $f: M \rightarrow M$  elle signifie que le défaut de conformalité de  $Df|_{E^c}$  est dominé par l'hyperbolicité de  $Df|_{E^s}$  et  $Df|_{E^u}$ . En particulier, elle est toujours vraie lorsque la dimension centrale est égale à un.

Sous l'hypothèse de center-bunching, Burns-Wilkinson [14] ont vérifié que la propriété d'accessibilité essentielle entraîne l'ergodicité.

**3.4. Stabilité de l'accessibilité.** Étant donné une variété riemannienne compacte  $M$  et un difféomorphisme  $f: M \rightarrow M$  partiellement hyperbolique, on dit que  $f$  est *stablement accessible* s'il existe un voisinage  $\mathcal{U}$  de  $f$  en topologie  $C^1$  dont tous les éléments sont (partiellement hyperboliques et) accessibles.

Plus généralement, étant donné un point  $x \in M$ , on dit que la classe d'accessibilité  $\text{Acc}_f(x)$  est *stable*, si pour tout compact  $K \subset \text{Acc}_f(x)$ , il existe un voisinage  $\mathcal{U}_K$  de  $f$

en topologie  $C^1$  tel que pour tout  $g \in \mathcal{U}$ , on a  $K \subset \text{Acc}_g(x)$ . Il découle de la définition que les classes d'accessibilité stables sont nécessairement ouvertes.

Différents résultats ont été obtenus pour un fibré central de basse dimension (c'est-à-dire pour  $c = \dim(E^c)$  petit) relativement à la stabilité de l'accessibilité.

Lorsque  $c = 1$ , l'accessibilité est une propriété stable, par un résultat de Didier [15].

Pour le cas de la dimension deux, Avila-Viana ont montré le résultat suivant, qui est la réciproque à la propriété énoncée ci-dessus.

**Théorème 0.13** (Avila-Viana, [11]). *Supposons  $c = 2$ . Alors toute classe d'accessibilité ouverte est stable.*

En particulier, cela leur a permis de vérifier la conjecture de stabilité dans le cas d'un fibré central de dimension deux.

**Théorème 0.14** (Avila-Viana, [11]). *La propriété d'accessibilité est stable pour les systèmes partiellement hyperboliques dont le fibré central est de dimension deux.*

Leur stratégie repose sur l'utilisation de certaines paramétrisations (non injectives) des classes d'accessibilité.

**Théorème 0.15** (Avila-Viana, [11]). *Pour tout difféomorphisme partiellement hyperbolique  $f: M \rightarrow M$ , il existe un entier  $k \geq 1$ , un voisinage  $\mathcal{U}$  de  $f$  et une suite  $P_\ell: \mathcal{U} \times M \times \mathbb{R}^{k(d_u+d_s)\ell} \rightarrow M$  d'applications continues, tels que pour tous  $\ell, m \geq 1$ ,  $(g, z, v) \in \mathcal{U} \times M \times \mathbb{R}^{k(d_u+d_s)\ell}$  :*

- (1)  $P_m(g, P_\ell(g, z, v), w) = P_{\ell+m}(g, z, (v, w))$  pour tout  $w \in \mathbb{R}^{k(d_u+d_s)m}$  ;
- (2)  $M \ni \zeta \mapsto P_\ell(g, \zeta, v) \in M$  est un homéomorphisme et  $P_\ell(g, \cdot, 0) = \text{Id}$  ;
- (3)  $\text{Acc}_g(z) = \cup_{n \geq 1} P_n(\{(g, z)\} \times \mathbb{R}^{k(d_u+d_s)n})$ .

L'entier  $\ell$  ci-dessus est lié au nombre d'arcs dont sont formés les chemins d'accessibilité. Grâce à ces paramétrisations, les auteurs construisent des *chemins de déformation* de la manière suivante. Pour un difféomorphisme  $f$  et un point  $z \in M$ , un chemin de déformation basé en  $(f, z)$  est un chemin  $\gamma: [0, 1] \rightarrow M$  tel que pour un certain entier  $\ell \geq 1$ , il existe une application bornée  $\Gamma: [0, 1] \rightarrow \mathbb{R}^{k(d_u+d_s)\ell}$  telle que  $\gamma = P_\ell(f, z, \Gamma)$ . Ces chemins possèdent des continuations naturelles : pour  $(g, w)$  proches de  $(f, z)$ , le chemin  $P_\ell(g, w, \Gamma)$  est proche de  $P_\ell(f, z, \Gamma)$ . De plus, en présence d'une classe d'accessibilité ouverte, ces chemins de déformation permettent d'approcher n'importe quel autre chemin, selon le résultat suivant :

**Théorème 0.16** (Avila-Viana, [11]). *Si  $f: M \rightarrow M$  est un difféomorphisme partiellement hyperbolique, et s'il existe  $x \in M$  dont la classe d'accessibilité  $\text{Acc}_f(x)$  est ouverte, alors l'ensemble des chemins de déformation basés en  $(f, x)$  est dense dans  $C^0([0, 1], \text{Acc}_f(x))$ .*

La preuve du théorème repose sur l'argument suivant. Soient  $f$  et  $x$  tels que  $\text{Acc}_f(x)$  soit ouverte, et soient  $z, y \in \text{Acc}_f(x)$  ; les auteurs montrent qu'il existe un voisinage  $\mathcal{U}$  de  $f$  et un voisinage  $\mathcal{V}$  de  $x$  tels que pour tous  $(g, w) \in \mathcal{U} \times \mathcal{V}$ ,  $\text{Acc}_g(z) = \text{Acc}_g(w)$ . Pour cela, ils considèrent un disque  $\mathcal{D} \subset \text{Acc}_f(x)$  de dimension deux passant par  $z$  et transverse à  $E^s \oplus E^u$ , et deux chemins  $\eta_s$  et  $\eta_u$  dans  $\mathcal{D}$  s'intersectant transversalement en un unique point. Par le Théorème 0.16, ces chemins peuvent être approchés uniformément par des chemins de déformation  $\gamma_s$  et  $\gamma_u$  basés respectivement en  $(f, z)$  et  $(f, y)$ , de nombre d'intersection égal à un (par conservation du nombre d'intersection par homotopie). Pour  $(g, w) \in \mathcal{U} \times \mathcal{V}$ , ces chemins peuvent être déformés en des chemins de déformation  $\tilde{\gamma}_s$  et  $\tilde{\gamma}_u$  basés respectivement en  $(g, z)$  et  $(g, w)$  ; de plus, il existe  $x_s \in \text{Im}(\tilde{\gamma}_s)$  et  $x_u \in \text{Im}(\tilde{\gamma}_u)$  tels que  $\mathcal{W}_g^s(x_s) \cap \mathcal{W}_g^u(x_u) \neq \emptyset$ , et alors, les points  $z$  et  $w$  sont bien dans la même classe d'accessibilité pour  $g$ , ce qui conclut.



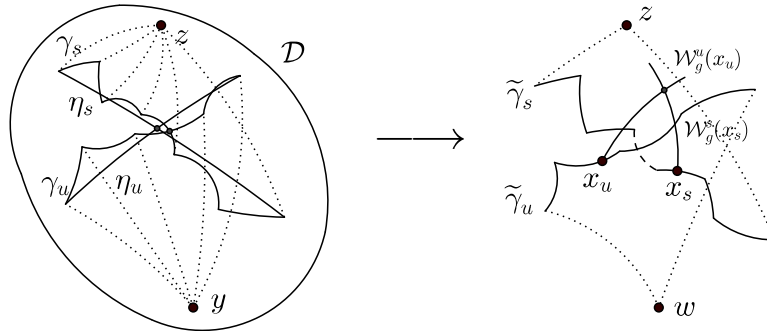

FIGURE 1. Les chemins initiaux et leurs images après déformation.

**3.5. Densité de l'accessibilité.** La densité de la propriété d'accessibilité a été montrée par Dolgopyat-Wilkinson dans [16] en topologie  $C^1$ ; dans leur preuve, ils obtiennent l'accessibilité en combinant une propriété d'accessibilité globale, modulo une famille de disques transverses aux feuilles stables et instables, et une propriété d'accessibilité locale pour ces disques, qui peut être vérifiée après perturbation  $C^1$  dans le cas où on a un contrôle suffisant des temps de retour.

En topologie  $C^r$ ,  $r \geq 2$ , différents résultats ont été obtenus dans le cas où la dimension centrale  $c$  est petite.

Dans le cas où  $c = 1$ , la densité de l'accessibilité en topologie  $C^r$ ,  $r \in \mathbb{N}_{\geq 1} \cup \{\infty\}$ , a été montrée par F. Rodriguez-Hertz, M.A. Rodriguez-Hertz et R. Ures dans [30]. Soit  $f: M \rightarrow M$  une application partiellement hyperbolique sur une variété riemannienne compacte  $M$ . Dans ce contexte, l'ensemble  $\Gamma(f)$  des classes d'accessibilité non-ouvertes possède une structure de lamination, en lien avec la propriété d'intégrabilité jointe des fibrés stable et instable. En particulier, si  $\Gamma(f) = \emptyset$ , alors toute classe d'accessibilité est ouverte, et donc  $f$  est accessible. L'argument utilisé par les auteurs pour prouver la densité de l'accessibilité repose sur le fait que si  $\Gamma(f) \neq \emptyset$ ,  $M$ , alors  $\Gamma(f)$  possède nécessairement un point périodique, et ils montrent également que pour tout point périodique  $x$  de  $f$ , on peut perturber  $f$  en une application  $g$  en topologie  $C^r$  telle que la classe d'accessibilité de  $x$  pour  $g$  soit ouverte.

Considérons à présent le cas où  $c = 2$ . Dans un article récent [21], Horita-Sambarino ont vérifié la densité de la propriété d'accessibilité en topologie  $C^r$  pour une certaine classe de systèmes, possédant entre autres un feuilletage central compact. Leur argument utilise notamment le fait que la classe d'accessibilité d'un point fixe est invariante par la dynamique; en analysant la dynamique en restriction à la feuille centrale passant par un tel point, et grâce aux résultats additionnels sur la structure des classes d'accessibilité en basse dimension, cela leur permet de montrer que de manière typique, la classe d'accessibilité intersecte une telle feuille en suffisamment de points, et est donc nécessairement ouverte. Par ailleurs, Avila-Viana ont également obtenu un résultat de densité en topologie  $C^r$  par des arguments différents.

Dans notre travail, on s'intéresse à la densité en topologie  $C^r$  des propriétés d'accessibilité et d'ergodicité pour une classe de systèmes de dimension centrale au moins égale à deux. En termes informels, on montre que pour un système partiellement hyperbolique  $f$  dynamiquement cohérent, possédant la propriété de center bunching,

dont les holonomies stables et instables ont des estimées de régularité Hölder suffisante, et si le feuilletage central est uniformément compact, ou si les fibrés centre-stable et centre-instable sont de classe  $C^1$ , alors pour tout entier  $J \geq 0$  assez grand, la propriété d'accessibilité stable (et donc d'ergodicité stable) est  $C^r - J$ -prévalente au sens de Kolmogorov dans un voisinage de  $f$  (petit par rapport à la norme  $C^1$ ). Cette notion, nettement plus forte que la densité, a été introduite afin de pallier l'absence de mesure sur l'espace des difféomorphismes : on considère un cube de dimension  $J$  dans cet ensemble, et on travaille alors par rapport à la mesure image héritée de la mesure de Lebesgue.

La difficulté pour obtenir ce genre de résultats vient du fait qu'il est difficile d'obtenir des perturbations qui produisent des déplacements suffisants des chemins d'accessibilité pour générer de l'accessibilité localement lorsqu'on veut garder un contrôle sur la norme  $C^2$  de ces perturbations.

Pour voir cela, considérons une variété  $M$  de dimension  $n \geq 1$  et un difféomorphisme  $f: M \rightarrow M$  de classe  $C^r$ ,  $r \geq 1$ . Étant donné  $x_0 \in M$  et un point  $y$  "proche" de  $f(x_0)$ , on cherche à approcher  $f$  en topologie  $C^r$  par un difféomorphisme  $g \in \text{Diff}^r(M)$  tel que  $g(x_0) = y$ . De plus on suppose que la perturbation est  $\varepsilon_0$ -localisée, c'est-à-dire  $f|_{B(x_0, \varepsilon_0)^c} \equiv g|_{B(x_0, \varepsilon_0)^c}$ . Quitte à considérer des cartes locales, et en posant  $\phi := g \circ f^{-1}$ ,  $x := f(x_0)$ , le problème se ramène donc à chercher un difféomorphisme  $\phi$  de  $\mathbb{R}^n$  de classe  $C^r$  tel que

- (1)  $\|\phi - \text{Id}\|_{C^r} \leq \delta$  pour un certain  $\delta > 0$ , où l'on a posé  $\|\phi - \text{Id}\|_{C^r} := \sup_{\xi \in \mathbb{R}^n} \max_{0 \leq i \leq r} \|\partial_\xi^i(\phi - \text{Id})\|$ ;
- (2)  $\phi(x) = y$ ;
- (3)  $\phi|_{B(x, \varepsilon)^c} \equiv \text{Id}|_{B(x, \varepsilon)^c}$  pour un certain  $\varepsilon > 0$ .

Soit  $z \in \mathbb{R}^n$  satisfaisant  $\varepsilon < \|x - z\| < 2\varepsilon$ . On a par la formule de Taylor (où  $\alpha$  désigne un multi-indice) :

$$y - x = (\phi - \text{Id})(x) = \sum_{|\alpha|=0}^{r-1} \frac{1}{\alpha!} \frac{\partial^\alpha(\phi - \text{Id})(z)}{\partial x^\alpha} (x - z)^\alpha + \sum_{|\alpha|=r} R_\alpha(z)(x - z)^\alpha$$

où la première somme s'annule (car  $\phi$  coïncide avec  $\text{Id}$  sur un voisinage de  $z$ ), et où

$$\left\| \sum_{|\alpha|=r} R_\alpha(z)(x - z)^\alpha \right\| \lesssim \sup_{\xi \in \mathbb{R}^n} \|\partial_\xi^r(\phi - \text{Id})\|_{C^r} \|x - z\|^r \leq \delta \|x - z\|^r.$$

On obtient alors

$$\|y - x\| \lesssim \delta \|x - z\|^r \lesssim \delta \varepsilon^r, \quad \text{et donc} \quad \varepsilon \gtrsim (\delta^{-1} \|y - x\|)^{1/r}.$$

En particulier, on peut voir que le déplacement des holonomies induit par une perturbation  $\delta$ -petite en topologie  $C^r$  et  $\varepsilon$ -localisée est au plus de l'ordre de  $\delta \varepsilon^r$ ; dès lors que  $r \geq 2$ , il est difficile par des perturbations suffisamment localisées (ce qui est important notamment pour garantir un bon contrôle des holonomies) d'obtenir un déplacement suffisant pour créer des classes d'accessibilité ouvertes.

Pour pallier ce problème, notre argument s'appuie sur un résultat topologique obtenu par Bonk-Kleiner qui énonce une propriété suffisante pour que l'image d'une application continue soit d'intérieur non-vide, qu'on peut voir comme une forme faible d'injectivité. On cherche alors à vérifier les hypothèses de leur résultat pour une certaine application qui encode la structure des classes d'accessibilité, afin de produire de l'accessibilité locale. On montre qu'il est en effet possible de vérifier ces hypothèses après certaines perturbations infinitésimales; la preuve repose sur un argument d'exclusion de paramètres, puisqu'on peut estimer le volume des mauvais paramètres pour lesquels une certaine situation pathologique apparaît. Cependant, l'application qu'on utilise pour décrire la classe d'accessibilité doit être Hölder pour un exposant suffisamment proche de 1; en effet, si ce n'est pas le cas, il se pourrait que la classe d'accessibilité soit de dimension

de Hausdorff totale sans être ouverte, et alors, il devient difficile de vérifier qu'on peut par perturbation détruire les situations pathologiques où les hypothèses du lemme topologique ne seraient pas vérifiées. On combine ces arguments permettant d'obtenir des propriétés d'accessibilité locale avec des arguments globaux pour obtenir la propriété d'accessibilité totale.

#### 4. Étude d'une famille d'automorphismes polynomiaux de $\mathbb{C}^3$

Le chapitre consacré aux automorphismes polynomiaux de  $\mathbb{C}^3$  est tiré d'un article co-écrit avec Julie Déserti, accepté pour publication dans le journal *The Journal of Geometric Analysis*.

Hénon s'est intéressé aux propriétés d'une famille d'*automorphismes polynomiaux* de  $\mathbb{R}^2$  qui porte aujourd'hui son nom ; il s'agit des applications

$$g_{a,b} : (z_0, z_1) \mapsto (a - z_0^2 - bz_1, z_0), \quad a \in \mathbb{R}, \quad b = \text{Jac}(g_{a,b}) \neq 0.$$

La dynamique de telles applications a fait l'objet de nombreux travaux. Selon les valeurs choisies pour les paramètres, on peut observer différents types de phénomènes : un comportement de type *fer à cheval de Smale*, ou un comportement non hyperbolique. Benedicks-Carleson [12] ont notamment établi pour certaines valeurs des paramètres (par exemple pour  $a = -1, 4$  et  $b = 0, 3$ ) la présence d'un "attracteur étrange" vers lequel les orbites convergent sous l'action de  $g_{a,b}$ . Il est également intéressant de considérer les automorphismes obtenus en prenant  $a, b$  complexes dans la définition ci-dessus ; dans le plan projectif complexe  $\mathbb{P}_{\mathbb{C}}^2$ , ils induisent les *applications birationnelles* suivantes, obtenues en homogénéisant les polynômes précédents (on conserve la même notation) :

$$g_{a,b} : (z_0 : z_1 : z_2) \dashrightarrow (az_2^2 - z_0^2 - bz_1z_2 : z_0z_2 : z_2^2).$$

Pour une application birationnelle  $f$ , le *lieu d'indétermination*  $\text{Ind}(f)$  est défini comme l'ensemble des points où l'application  $f$  n'est pas définie, c'est-à-dire ceux pour lesquels les trois coordonnées s'annulent. On obtient ici  $\text{Ind}(g_{a,b}) = (0 : 1 : 0)$  ; en regardant ce qui se passe pour l'inverse, on trouve cette fois  $\text{Ind}(g_{a,b}^{-1}) = (1 : 0 : 0)$ . En particulier,  $\text{Ind}(g_{a,b}) \cap \text{Ind}(g_{a,b}^{-1}) = \emptyset$  ; de plus,  $\text{Ind}(g_{a,b}^{-1})$  est attractif pour  $g_{a,b}$ , tandis que  $\text{Ind}(g_{a,b})$  est attractif pour  $g_{a,b}^{-1}$ . Les applications de Hénon peuvent être généralisées en considérant des polynômes en  $z_0$  de degré supérieur au lieu des polynômes quadratiques du type  $a - z_0^2$ , et les lieux d'indétermination de telles applications possèdent les mêmes propriétés.

Les applications de Hénon sont un cas particulier d'applications *algébriquement stables* (cette notion sera définie au chapitre 3). Pour une application  $f$  de ce type, on peut définir une *fonction de Green*

$$G : z \mapsto \lim_{n \rightarrow +\infty} \frac{\log^+ \|f^n(z)\|}{d^n},$$

où l'on note  $d$  le degré de  $f$ . En général, la fonction  $G$  n'est pas continue. Elle satisfait la relation

$$G \circ f = d \cdot G,$$

donc pour les points où  $G$  est non-nulle, on a une mesure précise de la vitesse avec laquelle ces derniers s'échappent à l'infini : par l'équation précédente, l'ensemble de niveau  $\{p \mid G(p) = c\}$  est envoyé par  $f$  sur l'ensemble de niveau  $\{p \mid G(p) = dc\}$ .

Le groupe des automorphismes polynomiaux de  $\mathbb{C}^2$  a une structure de produit amalgamé ; ce fait a permis à Friedland et Milnor de montrer que dans le cas de la dimension deux, tout automorphisme polynomial possédant une dynamique "riche" est *de type Hénon*. Plus précisément, un automorphisme polynomial de  $\mathbb{C}^2$  est soit conjugué à un automorphisme *élémentaire* (au sens où il préserve une certaine fibration rationnelle), soit conjugué à un produit d'*applications de Hénon généralisées*. Par exemple, pour l'automorphisme élémentaire  $e : (z_0, z_1) \mapsto (\alpha z_0 + z_1^2, \beta z_1 + \gamma)$ ,  $\alpha\beta \neq 0$ , on obtient

$$e : (z_0 : z_1 : z_2) \dashrightarrow (\alpha z_0 z_2 + z_1^2 : \beta z_1 z_2 + \gamma z_2^2 : z_2^2),$$

et on voit que  $\text{Ind}(e) = \text{Ind}(e^{-1}) = (1 : 0 : 0)$  à l'inverse de ce qu'on a observé plus haut.

En fait, cette dichotomie peut même être enrichie :

- les automorphismes élémentaires préservent une fibration rationnelle, ont un centralisateur non-dénombrable, et sont d'entropie nulle ;
- d'un autre côté, les automorphismes de type Hénon ne préservent aucune *courbe rationnelle* selon un résultat dû à Brunella [13], ont un centralisateur dénombrable, par un résultat dû à Lamy [23], préservent un *courant* dont le support est la fermeture des points d'orbite bornée, et coïncide également avec la fermeture des variétés stables de points hyperboliques (par les travaux de Bedford, Fornæss, Lyubich, Sibony, Smillie etc.).

Il est donc naturel de se demander si de tels phénomènes peuvent être observés pour des automorphismes polynomiaux de  $\mathbb{C}^n$ , pour  $n$  supérieur ou égal à trois. Dans le cas où  $n = 3$ , il n'y a pas de structure amalgamée, ni d'analogue au résultat de classification de Friedland et Milnor.

Nous avons étudié le cas de la famille à un paramètre d'automorphismes polynomiaux de  $\mathbb{C}^3$  composée des éléments de la forme

$$\Psi_\alpha : (z_0, z_1, z_2) \mapsto (z_0 + z_1 + z_0^q z_2^d, z_0, \alpha z_2),$$

où  $\alpha$  est un nombre complexe non-nul de module plus petit que un,  $q$  est un entier supérieur ou égal à deux, et  $d$  un entier plus grand que 1. On remarque que ce sont des produits-croisés au-dessus de l'application linéaire  $z \mapsto \alpha z$ , et la dynamique dans les fibres est donnée par des automorphismes de type Hénon.

Nous avons montré que le comportement dynamique des éléments de cette famille est assez différent de ce qu'on observe dans le cas de la dimension deux ; en particulier, les propriétés de cette famille empruntent à la fois aux automorphismes élémentaires et aux automorphismes de type Hénon. Par exemple, il existe une unique fibration rationnelle invariante et les degrés des itérés croissent de manière exponentielle tandis que le centralisateur est dénombrable. On exhibe notamment une application birationnelle qui fournit une semi-conjugaison de cet automorphisme avec une application

$$\Phi_\alpha : (z_0, z_1, z_2) \mapsto (\phi_\alpha(z_0, z_1), \alpha z_2),$$

qui est le produit direct de l'application linéaire  $z \mapsto \alpha z$  et d'un certain automorphisme  $\phi_\alpha$  de type Hénon, ce qui explique le comportement intermédiaire des éléments de la famille.

On remarque que le feuilletage  $\{z_2 = \text{const}\}$  est préservé par  $\Psi_\alpha$  ; de plus, l'hyperplan  $\{z_2 = 0\}$  est fixe, et attire l'orbite future de tout point lorsque  $|\alpha| < 1$ . En restriction à cet hyperplan, la dynamique est donnée par une application linéaire, et on a deux comportements possibles : ou bien les points s'échappent à l'infini avec une vitesse exponentielle donnée par les termes de la suite de Fibonacci (le nombre d'or  $\varphi$  est valeur propre), ou bien ils convergent vers  $\{0\}$  avec vitesse exponentielle. Dans le premier cas, on dit que la *vitesse d'échappement est de type Fibonacci*.

Supposons que  $|\alpha| < 1$ . Comme  $\{z_2 = 0\}$  est attractif, on peut se demander si ce genre de dynamique persiste pour des points suffisamment proches de cet hyperplan. On montre que c'est effectivement le cas, lorsque  $|\alpha|$  est suffisamment petit, c'est-à-dire quand on converge suffisamment vite vers  $\{z_2 = 0\}$ . On montre en fait la transition suivante :

**Théorème 0.17** (Déserti-L.).

- Supposons  $0 < |\alpha| < \varphi^{(1-q)/d}$ . Alors pour les points dans un certain voisinage de  $\{z_2 = 0\}$  on a deux comportements possibles : ou bien ils s'échappent à l'infini avec vitesse Fibonacci, ou bien ils appartiennent à la variété stable de l'origine et convergent vers cette dernière exponentiellement vite ; en d'autres termes, dans ce voisinage, le comportement est semblable à ce qu'on observe sur  $\{z_2 = 0\}$ .
- Supposons  $\varphi^{(1-q)/d} < |\alpha| < 1$ . En dehors de  $\{z_2 = 0\}$ , la vitesse d'échappement Fibonacci est impossible ; plus précisément, pour les points dans  $\{z_2 \neq 0\}$ , ou

bien ceux-ci appartiennent à la variété stable de l'origine, ou bien ils partent à l'infini avec vitesse maximale.

La transition précédente peut s'expliquer par exemple à l'aide d'un "cocycle"

$$A(z_0, z_1, z_2) := \begin{pmatrix} 1 + z_0^{q-1} z_2^d & 1 \\ 1 & 0 \end{pmatrix}$$

associé à la dynamique; en effet, on voit que les deux premières coordonnées de  $\Psi_\alpha$  s'expriment à partir de ce dernier :  $(z_0 + z_1 + z_0^q z_2^d, z_0) = A(p) \cdot (z_0, z_1)$ . Partant d'un point  $p$ , on note  $P_\alpha^{(n)}(p)$  la première coordonnée de l'itéré  $n$ -ème  $\Psi_\alpha^n(p)$ ; on obtient alors

$$A(\Psi_\alpha^n(p)) = \begin{pmatrix} 1 + (P_\alpha^{(n)}(p))^{q-1} \alpha^{nd} p_2^d & 1 \\ 1 & 0 \end{pmatrix}.$$

À l'aide de ces matrices, on voit donc une compétition s'installer entre le troisième terme, qui converge exponentiellement vite vers 0 avec vitesse  $\alpha$ , et la croissance du premier terme, qui est gouvernée précisément par la matrice  $A(\Psi_\alpha^n(p))$ . On déduit de l'observation précédente la dichotomie :

- si la vitesse d'échappement des premiers termes est trop faible par rapport à  $|\alpha|$ , les matrices précédentes convergent vers  $\begin{pmatrix} 1 & 1 \\ 1 & 0 \end{pmatrix}$ , qui a pour valeurs propres  $\varphi$  et  $-\varphi^{-1}$ . En particulier, sauf si les points appartiennent à la variété stable de l'origine, ils s'échappent à l'infini avec vitesse Fibonacci;
- sinon les matrices explosent, donc les premières coordonnées grandissent très vite, et s'échappent à l'infini avec une vitesse bien supérieure à la vitesse Fibonacci.

Le *degré dynamique* de l'application  $\Psi_\alpha$  est égal à  $q \geq 2$ . Bien que  $\Psi_\alpha$  ne soit pas algébriquement stable, on montre qu'il est quand même possible de définir une fonction de Green pour  $\Psi_\alpha$ , en normalisant par  $q$ ; cette fonction nous permet de déduire des informations sur les vitesses d'échappement de  $\Psi_\alpha$  à l'infini. Par la semi-conjugaison, on montre également qu'il est possible de relier la fonction obtenue à la fonction de Green de l'application  $\phi_\alpha$  introduite précédemment, et qui possède de bonnes propriétés. On obtient le résultat :

**Théorème 0.18** (Déserti-L.). *Soit  $0 < |\alpha| \leq 1$ . Pour tout point  $p \in \mathbb{C}^3$ , la limite suivante existe*

$$\lim_{n \rightarrow +\infty} \frac{\log^+ \|\Psi_\alpha^n(p)\|}{q^n}.$$

La fonction  $G_{\Psi_\alpha}^+$  associée est plurisousharmonique, Hölder et satisfait  $G_{\Psi_\alpha}^+ \circ \Psi_\alpha = q \cdot G_{\Psi_\alpha}^+$ . De plus, on obtient l'encadrement

$$1 \leq \limsup_{\|p\| \rightarrow +\infty} \frac{G_{\Psi_\alpha}^+(p)}{\log \|p\|} \leq \ell,$$

pour un certain  $\ell \geq 1$ . L'ensemble  $\{p \in \mathbb{C}^3 \mid G_{\Psi_\alpha}^+(p) > 0\}$  des points s'échappant avec une vitesse maximale est ouvert, connexe et est de mesure infinie.

Dans le cas où  $|\alpha| = 1$ , l'hyperplan  $\{z_2 = 0\}$  n'est plus attractif; on montre alors que la dynamique est similaire à celle d'un automorphisme de type Hénon en restriction à une feuille  $\{|z_2| = c\}$ ,  $c \neq 0$  :

- soit l'orbite de  $p$  est bornée;
- soit l'orbite s'échappe à l'infini avec vitesse maximale.

De plus, il est possible de construire des mesures intéressantes à partir des courants de Green. Il est facile de voir que  $\Psi_\alpha$  laisse invariants certains ensembles, et pour ces derniers, on déduit de propriétés de mélange associées aux automorphismes de Hénon un résultat d'ergodicité par rapport aux mesures qu'on a obtenues.

### 5. Théorie spectrale des opérateurs de Schrödinger quasi-périodiques unidimensionnels

Le chapitre consacré aux opérateurs de Schrödinger est basé sur un article co-écrit avec Jiangong You, Zhiyan Zhao et Qi Zhou.

**5.1. Rappels de théorie spectrale.** En physique quantique, la probabilité de trouver une particule dans une certaine région de l'espace est associée à une certaine *fonction d'onde*. L'équation de Schrödinger donne la loi d'évolution d'une fonction d'onde au cours du temps; étant donnés une fonction d'onde initiale  $\psi_0$  et un opérateur de Schrödinger  $\mathcal{H}_v = -\Delta + v$ , pour un certain potentiel  $v$ , et où l'on note  $\Delta$  le laplacien, cette équation a la forme suivante :

$$i\partial_t\psi = \mathcal{H}_v\psi, \quad \psi(\cdot, 0) = \psi_0.$$

Une solution formelle de l'équation précédente peut alors s'écrire :

$$\psi(\cdot, t) = e^{-it\mathcal{H}_v}\psi_0. \quad (5.1)$$

Pour décrire le mouvement, on est donc amené à "diagonaliser" l'opérateur  $\mathcal{H}_v$ , c'est-à-dire à étudier le *spectre* de ce dernier, dont la définition est rappelée dans ce qui suit.

Dans la suite, on considère le cas d'une particule astreinte à se déplacer sur un espace unidimensionnel, discrétisé; en d'autres termes, la fonction d'onde vit dans l'espace de Hilbert des fonctions  $\ell^2(\mathbb{Z})$  :

$$\ell^2(\mathbb{Z}) := \left\{ \psi: \mathbb{Z} \rightarrow \mathbb{C} \mid \sum_{n \in \mathbb{Z}} |\psi(n)|^2 < \infty \right\}, \quad \langle \varphi, \psi \rangle := \sum_{n \in \mathbb{Z}} \overline{\varphi(n)}\psi(n).$$

**Définition 0.19** (Opérateurs de Schrödinger avec potentiel dynamiquement défini). Soit  $f: (M, \nu) \rightarrow (M, \nu)$  une transformation inversible ergodique d'un espace  $M$  muni d'une mesure  $\nu$ , et soit  $V: M \rightarrow \mathbb{R}$  une fonction mesurable et bornée. Pour  $\theta \in M$ , l'opérateur de Schrödinger  $H_{V,f,\theta}: \ell^2(\mathbb{Z}) \rightarrow \ell^2(\mathbb{Z})$  est défini par la formule :

$$(H_{V,f,\theta}(\psi))(n) := \psi(n+1) + \psi(n-1) + V(f^n(\theta))\psi(n), \quad \forall n \in \mathbb{Z}.$$

Cette définition est consistante avec celle donnée ci-dessus : on a  $H_{V,f,\theta} = \mathcal{H}_v$  où le laplacien est le laplacien discret, et le potentiel au point  $n \in \mathbb{Z}$  est donné par  $v(n) := V(f^n(\theta))$ .

**Remarque 0.20.** Dans le chapitre consacré aux opérateurs de Schrödinger, on considère exclusivement des opérateurs de Schrödinger quasi-périodiques sur  $\ell^2(\mathbb{Z})$ , ce qui correspond au cas où  $M$  est égal au tore  $d$ -dimensionnel dans la définition précédente, i.e.,  $\mathbb{T}^d := \mathbb{R}^d/\mathbb{Z}^d$ ,  $d \geq 1$ , et où le potentiel est défini par la dynamique d'une certaine translation  $R_\alpha: x \mapsto x + \alpha$  de vecteur de rotation  $\alpha \in \mathbb{T}^d$  aux coordonnées rationnellement indépendantes. On note alors  $H = H_{V,\alpha,\theta} := H_{V,R_\alpha,\theta}$ .

Soit  $H$  un opérateur auto-adjoint sur  $\ell^2(\mathbb{Z})$ , c'est-à-dire,  $\langle H\varphi, \psi \rangle = \langle \varphi, H\psi \rangle$ . L'ensemble résolvant de  $H$  correspond à l'ensemble des valeurs  $E \in \mathbb{C}$  pour lesquelles l'opérateur  $(H - E \cdot \text{Id})^{-1}$  existe et est borné, et le *spectre*  $\Sigma = \Sigma(H)$  est défini comme le complémentaire de l'ensemble résolvant. Comme  $H$  est auto-adjoint, le spectre est un sous-ensemble compact non-vide de  $\mathbb{R}$ , et l'on a

$$\Sigma = \{E \in \mathbb{R} \mid (H - E \cdot \text{Id})^{-1} \text{ n'est pas défini}\}.$$

Le calcul fonctionnel permet d'appliquer des fonctions à l'opérateur  $H$ , et en particulier, de donner un sens à (5.1). Étant donné  $\psi \in \ell^2(\mathbb{Z})$ , on a pour toute fonction mesurable localement bornée  $g: \mathbb{R} \rightarrow \mathbb{C}$  :

$$\langle \psi, g(H)\psi \rangle = \int g(E) d\mu_\psi(E), \quad \forall E \in \mathbb{C} \setminus \Sigma,$$

où  $\mu_\psi = \mu_\psi(H)$  est la *mesure spectrale* associée à  $\psi$ .

**Remarque 0.21.** Dans le cas d'un opérateur de Schrödinger  $H_\theta = H_{V,f,\theta}$ ,  $\theta \in M$ , défini comme dans la Définition 0.19, on introduit la mesure spectrale canonique  $\mu_\theta$  :

$$\mu_\theta := \mu_{\delta_0}(H_\theta) + \mu_{\delta_1}(H_\theta),$$

et on peut voir que toute mesure spectrale  $\mu_\psi(H_\theta)$  est absolument continue par rapport à  $\mu_\theta$ . On définit également la densité intégrée d'états

$$N_\theta(E) = \int_M \mu_\theta((-\infty, E]) d\nu.$$

Pour  $\psi \in \ell^2(\mathbb{Z})$ , la mesure spectrale se décompose de manière unique comme somme d'une partie absolument continue, d'une partie singulière continue et d'une partie purement ponctuelle :

$$\mu_\psi = \mu_{\psi,ac} + \mu_{\psi,sc} + \mu_{\psi,pp},$$

où  $\mu_{\psi,ac}$  est absolument continue par rapport à la mesure de Lebesgue,  $\mu_{\psi,sc}$  est supportée par un ensemble de mesure de Lebesgue nulle et ne charge pas les points, et  $\mu_{\psi,pp}$  a pour support un ensemble dénombrable de points. Par rapport à cette décomposition, on définit alors les sous-espaces :

$$\ell^2(\mathbb{Z})_* := \{\psi \in \ell^2(\mathbb{Z}) \mid \mu_\psi = \mu_{\psi,*}\}, \quad \text{où } * = ac, sc, pp,$$

et on a  $\ell^2(\mathbb{Z}) = \ell^2(\mathbb{Z})_{ac} \oplus \ell^2(\mathbb{Z})_{sc} \oplus \ell^2(\mathbb{Z})_{pp}$ . Le spectre de  $H|_{\ell^2(\mathbb{Z})_{ac}}$  est noté  $\Sigma_{ac} = \Sigma_{ac}(H)$  et est appelé le *spectre absolument continu* de  $H$ , et on définit de manière analogue  $\Sigma_{sc}$  et  $\Sigma_{pp}$ . On dit également que  $H$  a un spectre *purement absolument continu* si  $\ell^2(\mathbb{Z})_{ac} = \ell^2(\mathbb{Z})$ , et de même pour *sc* et *pp*. En particulier, si  $H$  a un spectre purement absolument continu, alors  $\Sigma_{ac} = \Sigma$ , mais la réciproque n'est pas toujours vraie.

Le théorème suivant décrit le comportement des solutions (5.1) par rapport aux propriétés de la fonction d'onde initiale  $\psi_0$ .

**Théorème 0.22** (Théorème RAGE).

(1)  $\psi_0 \in \ell^2(\mathbb{Z})_{pp}$  si et seulement si pour tout  $\epsilon > 0$ , il existe  $n \in \mathbb{N}$  tel que

$$\sum_{|m| \geq n} |\langle \delta_m, e^{-itH} \psi_0 \rangle|^2 < \epsilon, \quad \forall t \in \mathbb{R}.$$

(2)  $\psi_0 \in \ell^2(\mathbb{Z})_{ac} \oplus \ell^2(\mathbb{Z})_{sc}$  si et seulement si pour tout  $n \in \mathbb{N}$ , on a

$$\lim_{T \rightarrow \infty} \frac{1}{2T} \int_{-T}^T \sum_{|m| \leq n} |\langle \delta_m, e^{-itH} \psi_0 \rangle|^2 dt = 0.$$

(3) Si  $\psi_0 \in \ell^2(\mathbb{Z})_{ac}$ , alors pour tout  $n \in \mathbb{N}$ , on a

$$\lim_{|t| \rightarrow \infty} \sum_{|m| \leq n} |\langle \delta_m, e^{-itH} \psi_0 \rangle|^2 = 0.$$

**Remarque 0.23.** En d'autres termes, si la mesure spectrale de la fonction d'onde initiale est purement ponctuelle, alors le mouvement de la particule est essentiellement confiné à une région bornée de l'espace. Au contraire, si la mesure spectrale initiale est continue, alors les moyennes de l'évolution de la particule au cours du temps quittent toute région bornée, et si elle est absolument continue, le même résultat est vrai sans avoir à passer à la moyenne.

On voit en particulier que le spectre purement ponctuel est lié au caractère isolant d'un matériau, tandis que le spectre purement absolument continu est associé à des propriétés de conduction du matériau.

**Théorème 0.24.** Avec les notations de la Définition 0.19, supposons que  $M$  est un espace métrique compact, que  $f$  est un homéomorphisme de  $M$ , et que  $V: M \rightarrow \mathbb{R}$  est continu. On considère les opérateurs  $H_{V,f,\theta}$ ,  $\theta \in M$ . Si  $f$  est minimal, c'est-à-dire lorsque toutes ses orbites sont denses, alors le spectre  $\Sigma(H_{V,f,\theta})$ , respectivement le spectre absolument continu  $\Sigma_{ac}(H_{V,f,\theta})$ , est indépendant de  $\theta \in M$  ; en particulier, on

note  $\Sigma_{V,f} = \Sigma(H_{V,f,\theta})$ . Notons que la partie concernant le spectre absolument continu est bien plus délicate; il s'agit d'un résultat dû à Last et Simon.

**5.2. Motivations au problème de la réductibilité.** Dans le cas continu, on rappelle le théorème de Floquet :

**Théorème 0.25** (Floquet). *Étant donnés  $n \geq 1$ ,  $T \geq 0$ , soit  $f \in C^\infty(\mathbb{R}, \mathfrak{gl}(n, \mathbb{K}))$  un champ de vecteurs  $T$ -périodique, où  $\mathbb{K} = \mathbb{R}$  ou  $\mathbb{C}$ . On considère l'équation différentielle*

$$X'(x) = f(x) \cdot X(x), \quad X(0) = \text{Id}.$$

*Alors toute solution de l'équation différentielle précédente s'écrit sous la forme  $X(x) = b(x)e^{u_0 x}$ , où  $u_0$  est une constante et*

- (1)  *$b$  est une fonction  $T$ -périodique si  $\mathbb{K} = \mathbb{C}$ ;*
- (2)  *$b$  est une fonction  $2T$ -périodique si  $\mathbb{K} = \mathbb{R}$ .*

Maintenant, étant donné un entier  $d \geq 1$ , on se donne un vecteur de fréquences  $\alpha = (\alpha_1, \dots, \alpha_d) \in \mathbb{R}^d$  rationnellement indépendant. Soit  $\mathbb{K} = \mathbb{R}$  ou  $\mathbb{C}$ , et  $n \geq 1$ . On se restreint au cadre analytique dans ce qui suit, et on se donne une fonction  $f: \mathbb{R} \rightarrow \mathfrak{gl}(n, \mathbb{K})$  telle que  $f: x \mapsto F(\alpha x) := F(\alpha_1 x, \dots, \alpha_d x)$  pour une certaine fonction analytique  $F: \mathbb{T}^d \rightarrow \mathfrak{gl}(n, \mathbb{K})$ . On considère alors l'équation différentielle

$$X'(x) = f(x) \cdot X(x).$$

Un des buts de la théorie quasi-périodique est de voir dans quelle mesure le résultat de Floquet se généralise dans ce cadre, c'est-à-dire lorsque  $f$  est quasi-périodique comme ci-dessus.

En prenant  $\alpha \in \mathbb{R}^d$  comme précédemment, considérons à présent un opérateur de Schrödinger quasi-périodique  $\mathcal{H}_v$  où  $v(x) = V(\alpha x)$  pour une certaine fonction analytique  $V: \mathbb{T}^d \rightarrow \mathbb{R}$ . On définit le *module des fréquences*  $\mathcal{M} := \{\langle j, \alpha \rangle \mid j \in \mathbb{Z}^d\}$ .

L'équation aux valeurs propres  $\mathcal{H}_v \psi = E \psi$  peut alors se réécrire sous la forme précédente. En effet, en posant  $X(x) := \begin{pmatrix} \psi(x) \\ \psi'(x) \end{pmatrix}$ , on obtient :

$$X'(x) = f(x) \cdot X(x), \quad f(x) := \begin{pmatrix} 0 & 1 \\ v(x) - E & 0 \end{pmatrix}, \quad (5.2)$$

et on a  $f: \mathbb{R} \rightarrow \mathfrak{gl}(2, \mathbb{R})$ . On dit alors que l'équation  $\mathcal{H}_v \psi = E \psi$  possède une *représentation de Floquet* si elle possède deux solutions linéairement indépendantes de la forme

$$b_1(x)e^{w_0 x}, \quad b_2(x)e^{-w_0 x}, \quad \text{si } 2iw_0 \notin \mathcal{M},$$

ou bien

$$(b_1(x) + \varepsilon x b_2(x))e^{w_0 x}, \quad b_2(x)e^{w_0 x} = b_3(x)e^{-w_0 x}, \quad \text{si } 2iw_0 \in \mathcal{M},$$

où  $\varepsilon = 0, 1$ , et  $b_i = B_i(\alpha \cdot)$  pour une fonction analytique  $B_i: \mathbb{T}^d \rightarrow \mathbb{R}$ ,  $i = 1, 2, 3$ .

**Remarque 0.26.** *Une condition suffisante pour que l'équation  $\mathcal{H}_v \psi = E \psi$  admette une représentation de Floquet est que le système (5.2) puisse être transformé en un système analogue à coefficients constants, c'est-à-dire qu'il existe une matrice  $C \in \mathfrak{gl}(2, \mathbb{R})$  et pour tout  $x$ , un changement de coordonnées  $T(E, x) \in \text{GL}(2, \mathbb{R})$  de sorte qu'en posant  $X(x) =: T(E, x)Y(x)$ , on obtienne*

$$Y'(x) = CY(x).$$

*En d'autres termes, le système (5.2) est réductible à un système à coefficients constants.*

Comme on l'a dit, les résultats présentés dans le chapitre consacré aux opérateurs de Schrödinger sont énoncés dans le cadre discret. Comme dans la remarque 0.20, on se donne un opérateur de Schrödinger quasi-périodique  $H = H_{V,\alpha,\theta}$ ; on se restreint ici au cas où la fréquence  $\alpha \in \mathbb{R} \setminus \mathbb{Q}$  est irrationnelle et où  $V: \mathbb{T} \rightarrow \mathbb{R}$  est analytique. La rotation  $x \mapsto x + \alpha$  est minimale, donc le spectre  $\Sigma(H_{V,\alpha,\theta})$  est indépendant de  $\theta$ , et on le note  $\Sigma_{V,\alpha}$ . Pour une énergie  $E$  dans  $\Sigma_{V,\alpha}$ , il n'est pas toujours possible de résoudre l'équation



aux valeurs propres  $H_{V,\alpha,\theta}\psi = E\psi$  avec  $\psi \in \ell^2(\mathbb{Z})$ . Cependant on peut trouver des solutions à croissance modérée :

**Théorème 0.27** (Théorème de Berezanskii). *Pour tout  $\varphi \in \ell^2(\mathbb{Z})$ , et pour  $\mu_\varphi(H_{V,\alpha,\theta})$ -presque tout  $E$ , il existe une solution non-nulle à  $H_{V,\alpha,\theta}\psi = E\psi$  vérifiant  $|\psi(n)| \leq 1 + |n|$ , pour tout  $n \in \mathbb{Z}$ .*

Pour  $E \in \mathbb{R}$ , une solution formelle à l'équation  $H_{V,\alpha,\theta}\psi = E\psi$  satisfait la relation :

$$\begin{pmatrix} \psi(n+1) \\ \psi(n) \end{pmatrix} = A(\theta + n\alpha) \cdot \begin{pmatrix} \psi(n) \\ \psi(n-1) \end{pmatrix}, \quad \forall n \in \mathbb{Z}.$$

où  $(\alpha, A) = (\alpha, S_E^V)$  est le *cocycle de Schrödinger* défini par

$$S_E^V(x) := \begin{pmatrix} E - V(x) & -1 \\ 1 & 0 \end{pmatrix}, \quad \forall x \in \mathbb{T}.$$

Comme dans le cadre continu détaillé ci-dessus, on se demande s'il existe une représentation de Floquet. Par la remarque 0.26, cela nous amène naturellement à introduire la notion de *réductibilité* pour le cocycle  $(\alpha, A)$ . La définition qui suit est donnée dans le cadre *analytique*, qui est celui qui nous intéresse ici.

**Définition 0.28** (Réductibilité). *On dit qu'un cocycle analytique  $(\alpha, A)$ ,  $A: \mathbb{T} \rightarrow \text{SL}(2, \mathbb{R})$ , (pas nécessairement de type Schrödinger) est réductible s'il existe une matrice constante  $B \in \text{PSL}(2, \mathbb{R})$  et une transformation analytique  $Z: \mathbb{T} \rightarrow \text{PSL}(2, \mathbb{R})$  qui conjugue le cocycle  $(\alpha, A)$  au cocycle constant  $(\alpha, B)$  :*

$$Z(x + \alpha)^{-1} A(x) Z(x) = B, \quad \forall x \in \mathbb{T}.$$

En notant  $\mathcal{A}_n(x) := A(x + (n-1)\alpha) \cdots A(x)$ ,  $n \geq 0$ , les itérés du cocycle, on voit alors que la croissance de ces derniers est donnée par celle des puissances de la matrice  $B$  modulo la conjugaison  $Z$  :

$$\mathcal{A}_n(x) = Z(x + n\alpha) B^n Z(x)^{-1}, \quad \forall x \in \mathbb{T}.$$

Une approche importante au problème de la réductibilité est liée à la théorie KAM. Dans ce cas, on commence avec un cocycle constant  $(\alpha, A)$  auquel on ajoute une petite perturbation  $F$ , et on se demande si le cocycle  $(\alpha, A + F)$  est réductible. La méthode générale repose sur un procédé itératif : si au temps  $n$ , on a un cocycle  $(\alpha, A^{(n)} + F^{(n)})$ ,  $A^{(n)}$  constant et  $|F^{(n)}| \ll 1$ , on cherche à construire une conjugaison qui transforme le cocycle  $(\alpha, A^{(n)} + F^{(n)})$  en  $(\alpha, A^{(n+1)} + F^{(n+1)})$ , où  $A^{(n+1)}$  est constant et  $|F^{(n+1)}| \ll |F^{(n)}|$ . Les conjugaisons sont obtenues en résolvant une équation linéarisée, appelée *équation cohomologique*. En répétant la construction, et si le produit des conjugaisons converge, on peut alors réduire le cocycle à un cocycle constant. Une difficulté liée à ces outils est le problème des *petits diviseurs*, qui peuvent poser problème pour la résolution de l'équation cohomologique, et pour s'en débarrasser, on est souvent amené à exclure un certain ensemble de paramètres.

La notion de réductibilité peut également être affaiblie en celle de *presque réductibilité*, introduite par Avila et Krikorian : dans ce cas, le cocycle ne peut pas forcément être conjugué à un cocycle constant, mais on peut trouver des conjugaisons qui transforment  $(\alpha, A)$  en un cocycle dont la partie non-constante est aussi petite qu'on souhaite. Ce concept généralise de fait le champ d'application de la théorie KAM : pour un cocycle presque réductible, quitte à conjuguer, on peut se ramener à un cocycle dont la partie non-constante est très petite, et espérer alors appliquer les méthodes de la théorie KAM.

**5.3. Dualité d'Aubry pour les opérateurs de Schrödinger quasi-périodiques avec un potentiel analytique.** Soit  $\alpha \in \mathbb{R} \setminus \mathbb{Q}$ ,  $\theta \in \mathbb{R}$ , et  $V: \mathbb{T} \rightarrow \mathbb{R}$  un potentiel analytique dont on note  $(\hat{v}_k)_{k \in \mathbb{Z}}$  les coefficients de Fourier. On étudie l'opérateur de Schrödinger  $H = H_{V,\alpha,\theta}$ . On définit également un *opérateur de Schrödinger*

dual  $\hat{H} = \hat{H}_{V,\alpha,\theta}$  par la formule suivante : pour tout  $n \in \mathbb{Z}$ ,

$$(\hat{H}\hat{\psi})(n) := \sum_{k \in \mathbb{Z}} \lambda \hat{v}_k \hat{\psi}(n-k) + 2 \cos(2\pi(\theta + n\alpha)) \hat{\psi}(n), \quad \forall \hat{\psi} \in \ell^2(\mathbb{Z}).$$

Par exemple, pour les opérateurs *presque Mathieu*, qui correspondent au cas particulier où l'on choisit  $V := 2\lambda \cos(2\pi \cdot)$  pour une certaine *constante de couplage*  $\lambda \in \mathbb{R}$ , on a la relation

$$\hat{H}_{2\lambda \cos(2\pi \cdot), \alpha, \theta} = \lambda H_{2\lambda^{-1} \cos(2\pi \cdot), \alpha, \theta}, \quad (5.3)$$

qui reflète une propriété de symétrie importante connue sous le nom de *dualité d'Aubry* ; dans ce cas, on observe également que l'opérateur dual est encore un opérateur de Schrödinger, ce qui n'est pas vrai en général.

De manière informelle, la dualité d'Aubry met en correspondance certaines propriétés des opérateurs  $H$  et  $\hat{H}$ . Pour un potentiel analytique général  $V$ , elle a notamment pour conséquence que le spectre  $\Sigma(\hat{H}_{V,\alpha,\theta})$  de  $\hat{H}_{V,\alpha,\theta}$  coïncide avec le spectre  $\Sigma_{V,\alpha}$  de  $H_{V,\alpha,\theta}$ .

Revenons au cas presque Mathieu. Pour toute énergie  $E \in \Sigma_{2\lambda \cos(2\pi \cdot), \alpha}$ , le cocycle associé  $(\alpha, A) = (\alpha, S_E^{2\lambda \cos(2\pi \cdot)})$  vérifie :

$$L(\alpha, A) = \max\{0, \ln |\lambda|\},$$

où  $L(\alpha, A)$  est l'*exposant de Lyapunov*

$$L(\alpha, A) = \limsup_{n \rightarrow \infty} \frac{1}{n} \ln |\mathcal{A}_n(x)|.$$

Par conséquent, pour  $0 < |\lambda| < 1$ , la relation (5.3) nous dit que les cocycles associés à l'opérateur  $\hat{H}_{2\lambda \cos(2\pi \cdot), \alpha, \theta}$  ont un exposant de Lyapunov strictement positif, tandis que ceux associés à  $H_{2\lambda \cos(2\pi \cdot), \alpha, \theta}$  ont un exposant nul, et inversement si l'on considère  $\lambda^{-1}$  à la place de  $\lambda$ . En particulier, une transition s'opère pour  $|\lambda| = 1$ . Le résultat suivant, dû à Jitomirskaya, précise cette transition :

**Théorème 0.29** (Jitomirskaya [22]). *Pour presque tous  $\alpha, \theta \in \mathbb{R}$ , l'opérateur presque Mathieu  $H = H_{2\lambda \cos(2\pi \cdot), \alpha, \theta}$  satisfait :*

- (1) lorsque  $|\lambda| < 1$ ,  $H$  a un spectre purement absolument continu ;
- (2) lorsque  $|\lambda| = 1$ ,  $H$  a un spectre purement singulier continu ;
- (3) lorsque  $|\lambda| > 1$ ,  $H$  a seulement un spectre purement ponctuel, avec des fonctions propres à décroissance exponentielle.

**Remarque 0.30.** *Par le théorème RAGE dont l'énoncé est rappelé plus haut, les deux premiers cas sont plutôt associés à un comportement métallique, ou conducteur, tandis que le troisième est relié à un comportement isolant. Dans le troisième cas, la conclusion se réexprime en disant qu'on a de la localisation pour  $H_{2\lambda \cos(2\pi \cdot), \alpha, \theta}$  ; en particulier, pour  $|\lambda| < 1$ , on voit par (5.3) et par le résultat précédent qu'on a de la localisation pour l'opérateur dual  $\hat{H}_{2\lambda \cos(2\pi \cdot), \alpha, \theta}$ .*

Pour des potentiels analytiques  $V$  plus généraux, la dualité d'Aubry met à profit de telles propriétés de localisation pour l'opérateur dual afin d'obtenir des résultats de réductibilité pour les cocycles associés à  $H_{V,\alpha,\theta}$ . Avila et Jitomirskaya ont généralisé ce genre d'idées en montrant que lorsque le potentiel  $V$  est "petit", alors les opérateurs  $\hat{H}_{V,\alpha,\theta}$  sont *presque localisés* (la définition précise sera introduite dans le chapitre relatif à ces questions), et cela implique des résultats de *presque réductibilité* pour les cocycles associés à  $H_{V,\alpha,\theta}$ .

**5.4. Estimées exponentielles sur la taille des trous spectraux pour des opérateurs de Schrödinger quasi-périodiques unidimensionnels et homogénéité du spectre.** Rappelons un résultat dû à Herman.

**Théorème 0.31** (Nombre de rotation fibré). *Soit  $F : X \times \mathbb{T} \rightarrow X \times \mathbb{T}$  (où  $X$  est un espace topologique) un homéomorphisme homotope à l'identité et préservant l'orientation, de la forme  $F(x, y) = (f(x), g_x(y))$ , et supposons que  $f$  soit uniquement ergodique sur  $X$ . Notons  $\tilde{F}$  un relèvement de  $F$  à  $X \times \mathbb{R}$ . Alors, pour tout  $(x, t)$ , et pour  $p_2 : (x, t) \mapsto t$ , la limite suivante :*

$$\lim_{n \rightarrow \infty} \frac{1}{n} (p_2 \circ \tilde{F}^n(x, t) - t)$$

*existe et est indépendante du choix de  $(x, t)$ . On l'appelle le nombre de rotation fibré de  $F$  et on le note  $\rho(F)$ . Pour toute mesure de probabilité  $\nu$  invariante par  $F$ ,  $\rho(F)$  est aussi égal à la moyenne*

$$\int_{X \times \mathbb{T}} (p_2 \circ \tilde{F}(x, t) - t) d\nu(x, t).$$

Soit  $\alpha \in \mathbb{R} \setminus \mathbb{Q}$ ,  $\theta \in \mathbb{R}$ ,  $V : \mathbb{T} \rightarrow \mathbb{R}$  analytique, et  $H = H_{V, \alpha, \theta}$  l'opérateur de Schrödinger associé. Étant donné  $E \in \mathbb{R}$ , on pose  $A := S_E^V$ ; le cocycle  $(\alpha, A)$  est homotope à l'identité. Pour tout  $x \in \mathbb{T}$ , la matrice  $A(x)$  est dans  $\text{SL}(2, \mathbb{R})$  et agit sur les points du cercle selon la formule :

$$A(x) \cdot \begin{pmatrix} \cos(2\pi y) \\ \sin(2\pi y) \end{pmatrix} = u(x, y) \begin{pmatrix} \cos(2\pi(y + \psi_x(y))) \\ \sin(2\pi(y + \psi_x(y))) \end{pmatrix}, \quad \forall x, y \in \mathbb{T},$$

pour une certaine fonction  $\psi : \mathbb{T} \times \mathbb{T} \rightarrow \mathbb{R}$ , et on définit  $F : (x, y) \mapsto (x + \alpha, y + \psi_x(y))$ . On appellera la quantité  $\psi$  la “dérive” du cocycle. Comme  $F$  est homotope à l'identité et que  $x \mapsto x + \alpha$ , le résultat précédent nous permet de définir le *nombre de rotation fibré* du cocycle  $(\alpha, A)$  comme

$$\rho(\alpha, A) := \rho(F).$$

Dans ce cas on note également  $\rho(E)$  une détermination dans  $[0, 1/2]$  du nombre de rotation fibré  $\rho(\alpha, S_E^V)$ ; il s'agit d'une fonction continue par rapport à  $E$ .

Rappelons que les *trous spectraux* pour l'opérateur  $H = H_{V, \alpha, \theta}$  sont définis comme les composantes connexes du complémentaire réel du spectre  $\Sigma_{V, \alpha}$ . Le *théorème d'étiqetage* nous dit que ceux-ci sont indexés par des entiers  $k \in \mathbb{Z}$ ; pour  $k \in \mathbb{Z}$ , le trou spectral associé est noté  $G(k) = (E_k^-, E_k^+)$ , avec  $E_k^- \leq E_k^+ \in \mathbb{R}$ , et en restriction à  $G(k)$ , le nombre de rotation fibré est constant; de plus,  $2\rho$  appartient au *module des fréquences* introduit plus haut :

$$2\rho(E) \equiv k\alpha \pmod{\mathbb{Z}}, \quad \forall E_k^- \leq E \leq E_k^+.$$

En effet, sur un trou spectral, on a des propriétés d'hyperbolicité uniforme, et donc des directions stable et instable. Par les propriétés d'invariance par rapport à la dynamique, on peut utiliser ces directions pour conjuguer le cocycle à un cocycle diagonal, puis en résolvant des équations cohomologiques, on peut se ramener au cas d'une matrice constante hyperbolique. En particulier, comme celle-ci fixe deux directions, le nombre de rotation fibré est nul, et la formule ci-dessus provient juste de la variation du nombre de rotation sous l'effet des conjugaisons.

En collaboration avec Jiangong You, Zhiyan Zhao et Qi Zhou, nous nous sommes intéressés au problème consistant à estimer la taille des trous spectraux. Pour  $\alpha \in \mathbb{R}$ , on note  $\left(\frac{p_j}{q_j}\right)_j$  les meilleures approximations rationnelles de  $\alpha$ . On définit aussi la quantité

$$\beta(\alpha) := \limsup_{j \rightarrow \infty} \frac{\ln q_{j+1}}{q_j},$$

qui mesure la qualité de l'approximation de  $\alpha$  par des rationnels. Lorsque  $\alpha$  satisfait une condition diophantienne, c'est-à-dire est mal approché par les rationnels, on a notamment  $\beta(\alpha) = 0$ . On dit que l'opérateur quasi-périodique  $H_{V, \alpha, \theta}$  se trouve dans le *régime sous-critique global* si pour toute énergie  $E$  dans le spectre, le cocycle  $(\alpha, S_E^V)$  est *sous-critique*, i.e., la croissance de ses itérés est uniformément sous-exponentielle dans une bande analytique  $\{|\Im z| < \delta\}$ ,  $\delta > 0$ . Nous avons obtenu le résultat suivant.

**Théorème 0.32** (L.-You-Zhao-Zhou). *On considère un opérateur de Schrödinger quasi-périodique  $H_{V,\alpha,\theta}$ , où  $V: \mathbb{T} \rightarrow \mathbb{R}$  est analytique, et où la fréquence  $\alpha \in \mathbb{R} \setminus \mathbb{Q}$  satisfait  $\beta(\alpha) = 0$ . Comme précédemment, notons  $\{G(k)\}_{k \in \mathbb{Z}}$  les trous spectraux. Alors dans le régime sous-critique global, le trou d'étiquette  $k \neq 0$  est exponentiellement petit par rapport à  $|k|$  :*

$$|G(k)| \leq C e^{-\gamma|k|}, \quad \forall k \in \mathbb{Z} \setminus \{0\}$$

pour des constantes  $C, \gamma > 0$  indépendantes de  $k$ .

Nous montrons en fait un résultat plus général ; pour un potentiel analytique “typique”, Avila [4] a montré que le spectre présente un nombre fini de transitions entre valeurs d'énergies *super-critiques*, pour lesquelles l'exposant de Lyapunov est strictement positif, et valeurs d'énergies *sous-critiques*, pour lesquelles  $(\alpha, S_E^V)$  est sous-critique, et aucune énergie n'est *critique*. Dans ce cas, on montre que les estimées exponentielles précédentes restent vraies pour les trous spectraux associés à des valeurs d'énergies sous-critiques.

Ce résultat généralise notamment un résultat précédent dû à Hadj Amor [18] dans le cas d'une fréquence  $\alpha$  satisfaisant une condition diophantienne, où elle montrait des bornes supérieures *sous-exponentielles* sur la taille des trous spectraux d'un opérateur de Schrödinger quasi-périodique associé à un petit potentiel (pour plus de détails sur son travail, on consultera le chapitre 4).

Notre résultat généralise le sien au cas où  $\beta(\alpha) = 0$ , et on obtient de plus des estimées *exponentielles*. En outre, nous montrons le résultat dans le cas sous-critique, ce qui généralise le cas des petits potentiels. En fait, le résultat dans le cas sous-critique est une conséquence de la preuve par Avila de la fameuse “Conjecture de la presque réductibilité” [3] selon laquelle, pour un cocycle  $(\alpha, A)$  quasi-périodique avec  $A: \mathbb{T} \rightarrow \text{SL}(2, \mathbb{R})$  analytique, si le cocycle  $(\alpha, A)$  est sous-critique, alors il est presque réductible. Grâce à la preuve de cette conjecture, on se ramène au cas des petits potentiels de la manière suivante :

- si le cocycle  $(\alpha, S_E^V)$  est sous-critique, alors on peut le conjuguer à un cocycle proche d'une constante ;
- le cocycle auquel on conjugue peut également être choisi de type Schrödinger, par des arguments dus à Avila-Jitomirskaya-Krikorian [8] : en particulier, on se ramène *pour l'énergie  $E$*  au cas d'un cocycle  $(\alpha, S_{\tilde{E}}^{\tilde{V}})$ , où  $\tilde{V}$  est un petit potentiel et  $\tilde{E} \in \mathbb{R}$  ;
- pour des valeurs de l'énergie  $E'$  voisines de  $E$ , on peut également se ramener à un cocycle  $(\alpha, S_{\tilde{E}'}^{\tilde{V}'})$  où  $\tilde{E}'$  est la *même* énergie que précédemment, et  $\tilde{V}'$  est lui aussi petit ; de plus la conjugaison utilisée pour l'énergie  $E'$  est proche de celle utilisée pour  $E$  ;
- on conclut à l'aide d'un argument de compacité.

Le résultat précédent peut donc se ramener au résultat analogue dans le cas d'un petit potentiel :

**Théorème 0.33** (L.-You-Zhao-Zhou). *On considère un opérateur de Schrödinger quasi-périodique  $H_{V,\alpha,\theta}$ , où  $V: \mathbb{T} \rightarrow \mathbb{R}$  est analytique, et où  $\beta(\alpha) = 0$ . Il existe des constantes absolues  $c_0, k_0 > 0$  telles que si  $V$  vérifie  $0 < \sup_{|z| < \epsilon} |V(z)| < c_0 \epsilon^{k_0}$  pour un certain  $0 < \epsilon < 1$ , alors on a*

$$|G(k)| \leq C e^{-\gamma|k|}, \quad \forall k \in \mathbb{Z} \setminus \{0\}$$

pour des constantes  $C, \gamma > 0$  indépendantes de  $k$ .

La preuve du résultat précédent s'effectue en deux étapes principales :

- on montre d'abord un résultat de réductibilité pour les énergies  $E$  sous-critiques au bord des trous spectraux. Plus précisément, on montre que les cocycles associés sont réductibles à des cocycles paraboliques, et on obtient des estimées précises à la fois sur le coefficient hors-diagonale (il est exponentiellement petit

par rapport à l'étiquette) et sur les conjugaisons  $Z = Z(E)$  (elles sont sous-exponentielles sur le tore, et on a un contrôle sur leur croissance sur une bande analytique) ;

- dans un deuxième temps, grâce au résultat de réductibilité, et en raisonnant selon un argument introduit par Moser-Pöschel [26], on déduit un contrôle précis sur les cocycles associés à des énergies  $E - \delta$  voisines de  $E$ ,  $\delta > 0$ , en considérant  $Z(\cdot + \alpha)^{-1} S_{E-\delta}^V Z$ , où  $Z = Z(E)$  est la conjugaison construite ci-dessus ; selon un argument de *moyenne*, on peut faire diminuer la partie non-constante du cocycle obtenu. En analysant la nouvelle partie constante (qui se trouve toujours dans  $\text{SL}(2, \mathbb{R})$ ), on voit une transition s'opérer pour cette dernière entre matrices hyperboliques et matrices elliptiques et ce, pour une valeur  $\delta = \delta_k > 0$  exponentiellement petite par rapport à l'étiquette  $k$  du trou spectral. On conclut la preuve en montrant que le terme non-constant est suffisamment petit par rapport à la variation  $\varepsilon_{\delta'_k}$ ,  $\delta'_k \simeq \delta_k$ , du nombre de rotation qu'on observe pour la partie constante, de sorte que  $\varepsilon_{\delta'_k}$  est assez grand pour induire une variation de celle du cocycle complet, c'est-à-dire,  $\rho(E - \delta) \neq \rho(E)$  ; on déduit que la taille du trou spectral associé est au plus  $\delta'_k$ .

**Remarque 0.34.** *On donne une preuve alternative du second point ci-dessus, à l'aide d'arguments reposant sur la notion de monotonie pour les cocycles à valeurs dans  $\text{SL}(2, \mathbb{R})$  (on renvoie à l'article d'Avila-Krikorian [10] pour une présentation détaillée de ces concepts). En effet, initialement le coefficient hors-diagonale de la matrice parabolique ci-dessus est exponentiellement petit, et l'action de la matrice sur le cercle induit une "dérive" (voir ci-dessus) exponentiellement petite aussi. Par monotonie des cocycles de Schrödinger, on sait que l'itéré second de la dérive est strictement monotone, et en valeur absolue, a une dérivée uniformément minorée. Comme les conjugaisons qu'on construit sont sous-exponentiellement grandes sur le tore, la dérivée de l'itéré second de la dérive après conjugaison est sous-exponentiellement petite ; par comparaison avec la dérive initiale, on voit donc que pour les cocycles associés à une perturbation  $\delta > 0$  comme précédemment, la dérive change de signe pour une valeur  $\delta = \tilde{\delta}_k > 0$  toujours exponentiellement petite, ce qui conclut.*

Expliquons pourquoi on peut se ramener à un cocycle parabolique pour des valeurs d'énergie au bord d'un trou spectral. Rappelons le résultat suivant d'Avila-Jitomirskaya [7], qui est une conséquence du théorème de Berezanskii :

**Théorème 0.35.** *Avec les notations précédentes, si  $E \in \Sigma_{V, \alpha}$  alors il existe  $\theta = \theta(E) \in \mathbb{R}$  et une solution bornée  $\hat{\psi}$  à l'équation aux valeurs propres  $\hat{H}_{V, \alpha, \theta} \hat{\psi} = E \hat{\psi}$  satisfaisant  $\hat{\psi}(0) = 1$  et  $|\hat{\psi}(n)| \leq 1$ ,  $\forall n \in \mathbb{Z}$ .*

Sous les hypothèses du théorème 0.33, considérons une énergie  $E = E_k^+$  située au bord droit du trou spectral  $G(k)$ ,  $k \neq 0$ . L'énergie est située dans le spectre donc par le résultat précédent il existe une phase  $\theta(E)$  et une solution bornée  $\hat{\psi}$  à  $\hat{H}_{V, \alpha, \theta} \hat{\psi} = E \hat{\psi}$ . Par l'hypothèse  $0 < \sup_{|\Im z| < \epsilon} |V(z)| < c_0 \epsilon^{k_0}$ ,  $0 < \epsilon < 1$ , on sait d'après les résultats d'Avila-Jitomirskaya [7] que les opérateurs de Schrödinger duaux sont *presque localisés* ; en fait, dans notre cas, on peut voir que  $2\theta(E) \equiv n\alpha \pmod{\mathbb{Z}}$  pour un certain entier  $n \in \mathbb{Z}$ . En particulier, cela implique qu'on a de la *localisation* ; par conséquent les coefficients de  $\hat{\psi}$  ont une décroissance exponentielle, donc peuvent être vus comme les coefficients de Fourier d'une fonction analytique  $\psi$  sur une bande. On définit l'*onde de Bloch*  $\tilde{U} : x \mapsto e^{\pi i n x} \begin{pmatrix} e^{2\pi i \theta} \psi(x) \\ \psi(x - \alpha) \end{pmatrix}$  associée. On peut vérifier qu'elle satisfait la relation suivante lorsqu'on applique la matrice  $A := S_E^V$  :

$$A(x) \cdot \tilde{U}(x) = \tilde{U}(x + \alpha), \quad \forall x \in \mathbb{T}.$$

Il est facile de voir que  $\tilde{U}$  ne s'annule jamais ; posons  $Z(x) := \begin{pmatrix} \tilde{U}(x) & \frac{1}{|\tilde{U}(x)|^2} R_{1/4} \tilde{U}(x) \end{pmatrix}$ , où  $R_{1/4}$  est la rotation d'angle  $\pi/4$ . On obtient une conjugaison complexe à valeurs dans

$\mathrm{SL}(2, \mathbb{C})$  et on a alors pour un certain  $\zeta \in \mathbb{R}$  :

$$Z(x + \alpha)^{-1} A(x) Z(x) = \begin{pmatrix} 1 & \zeta \\ 0 & 1 \end{pmatrix}, \quad \forall x \in \mathbb{T}.$$

Le résultat précédent fournit seulement une conjugaison *complexe*, et ne donne *a priori* pas d'information sur la taille de  $Z$  et  $\zeta$ . Pour obtenir des conjugaisons *réelles* maintenant, on peut considérer les parties réelles et imaginaires de  $\tilde{U}$ . Selon des arguments introduits par Avila-Jitomirskaya [7], [1], en analysant les troncations de  $\tilde{U}$  obtenues en gardant seulement les modes associés à des petits entiers, en utilisant l'analyticité, et par des estimées sur la croissance des itérés du cocycle  $(\alpha, A)$ , on montre que  $\tilde{U}$  n'est jamais "trop petite"; les estimées se font dans un premier temps par rapport à la phase  $\theta(E)$ , donc à l'entier  $n$  qui lui correspond, et on montre dans un second temps comment relier  $n$  à l'étiquette  $k$  du trou spectral.

**Remarque 0.36.** *Dans la discussion précédente on analyse ce qui se passe pour un trou spectral fixé; cependant, il est crucial que les constantes qu'on obtient soient indépendantes du trou considéré. Cela découle en fait de l'uniformité par rapport à l'énergie des résultats de presque localisation qui sont utilisés dans la construction.*

Dans le cas réel, sous les hypothèses et avec les notations précédentes, on obtient entre autres le résultat de réductibilité suivant dans le cas réel :

**Proposition 0.37** (L.-You-Zhao-Zhou). *Rappelons que  $2\theta(E) \equiv n\alpha$  pour un entier  $n$ . Alors il existe une application  $U: \mathbb{T} \rightarrow \mathrm{PSL}(2, \mathbb{R})$  analytique et un nombre réel  $\varphi \in \mathbb{R}$  tels que*

$$U(x + \alpha)^{-1} S_E^V(x) U(x) = \begin{pmatrix} 1 & \varphi \\ 0 & 1 \end{pmatrix}, \quad \forall x \in \mathbb{T}, \quad (5.4)$$

où  $|\varphi| \leq C e^{-c|n|}$ ,  $|U|_{\mathbb{T}} \leq e^{o(|n|)}$ , pour certaines constantes  $c, C > 0$  indépendantes de  $E$ . De plus, on obtient

$$|\mathrm{deg}(U)| = |k| \leq C'|n|$$

pour une constante  $C' > 0$  indépendante de  $E$ .

Ce n'est qu'une partie du résultat; pour un énoncé plus précis, on renvoie au chapitre afférent.

On montre également que dans le cas sous-critique global, le nombre de rotation est  $1/2$ -Hölder. Cela découle d'un résultat d'Avila-Jitomirskaya [7] prouvant la régularité Hölder du nombre de rotation dans le cas des petits potentiels. En combinant ce fait avec les bornes supérieures sur la taille des trous spectraux, on déduit sous la condition  $\beta(\alpha) = 0$  que le spectre de l'opérateur presque Mathieu pour une constante de couplage  $|\lambda| \neq 1$  est homogène. L'idée générale est que la condition  $\beta(\alpha) = 0$  associée à la continuité Hölder entraîne une certaine répulsion des trous spectraux et ceux-ci ne peuvent pas s'accumuler trop dans un intervalle donné, et on conclut à l'aide des bornes supérieures exponentielles.

Dans notre travail, on s'intéresse aussi dans le cas presque Mathieu à des bornes inférieures sur la taille des trous spectraux. Le fameux problème dit "des dix Martinis", résolu par Avila-Jitomirskaya [9], énonce que ceux-ci ne sont pas dégénérés. On montre qu'il est en fait possible d'obtenir des estimées asymptotiques exponentielles par rapport à l'étiquette du trou spectral. L'argument repose ici entre autres sur un résultat de Avila-You-Zhou. De plus, on utilise un lemme de réductibilité à un cocycle parabolique ici aussi, mais pour les bornes inférieures, le résultat non-perturbatif obtenu à l'aide de la dualité d'Aubry, qui fait intervenir les résonances d'une phase auxiliaire, est insuffisant pour conclure. On le remplace donc par des arguments perturbatifs qui permettent d'obtenir des estimées quantitatives directement en termes de l'étiquette du trou qu'on considère.



## Bibliographie

- [1] Avila, A. ; *The absolutely continuous spectrum of the almost Mathieu operator*, preprint.
- [2] Avila, A. ; *Chaoticity of the Teichmüller flow*, Homogeneous Flows, Moduli Spaces and Arithmetic, **321**, (2007).
- [3] Avila, A. ; *Almost reducibility and absolute continuity I*, preprint.
- [4] Avila, A. ; *Global theory of one-frequency Schrödinger operators*, Acta Math. **215**, pp. 1–54 (2015).
- [5] Avila A., Forni G. ; *Weak mixing for interval exchange transformations and translation flows*, Ann. of Math. **165**, pp. 637–664 (2007).
- [6] Avila A., Gouëzel S., Yoccoz J.-C. ; *Exponential mixing for the Teichmüller flow*, Publications mathématiques de l’IHÉS **104**, pp. 143–211.
- [7] Avila, A., Jitomirskaya, S. ; *Almost localization and almost reducibility*, J. Eur. Math. Soc. **12**, pp. 93–131 (2010).
- [8] Avila, A., Jitomirskaya, S. ; *Hölder continuity of absolutely continuous spectral measures for one-frequency Schrödinger operators*, Commun. Math. Phys. **301**, pp. 563–581 (2011).
- [9] Avila, A., Jitomirskaya, S. ; *The Ten Martini Problem*, Ann. of Math. **170**, pp. 303–342 (2009).
- [10] Avila, A., Krikorian, R. ; *Monotonic cocycles*, Inven. math. **202(1)**, pp. 271–331 (2015).
- [11] Avila A., Viana M. ; *Stable accessibility with 2–dimensional center*, preprint.
- [12] Benedicks, M., Carleson, L. ; *The dynamics of the Hénon map*, Ann. of Math. (2), **133** (1), pp. 73–169 (1991).
- [13] Brunella, M. ; *Minimal models of foliated algebraic surfaces*, Bull. Soc. Math. France, **127** (2), pp. 289–305 (1999).
- [14] Burns K., Wilkinson A. ; *On the ergodicity of partially hyperbolic systems*, Ann. of Math. **171**, pp. 451–489 (2010).
- [15] Didier P. ; *Stability of accessibility*, Ergodic Theory and Dynamical Systems. **23** (6), pp. 1717–1731.
- [16] Dolgopyat D., Wilkinson A. ; *Stable accessibility is  $C^1$ –dense*, Geometric methods in dynamics, **II**, Astérisque **287**, pp. 33–60 (2003).
- [17] Grayson M., Pugh C., Shub M. ; *Stably ergodic diffeomorphisms*, Ann. of Math. **140** (2), no. 2, pp. 295–329 (1994).
- [18] Hadj Amor, S. ; *Hölder continuity of the rotation number for quasi-periodic cocycles in  $SL(2, \mathbb{R})$* , Commun. Math. Phys. **287(2)**, pp. 565–588 (2009).
- [19] Hirsch M., Pugh C., and Shub M. ; *Invariant manifolds*, Lect. Notes in Math., Vol. **583**, Springer Verlag (1977).
- [20] Hopf E. ; *Fuchsian groups and ergodic theory*, Trans. A.M.S. **39**, pp. 299–314 (1936).
- [21] Horita V., Sambarino M. ; *Stable Ergodicity and Accessibility for certain Partially Hyperbolic Diffeomorphisms with Bidimensional Center Leaves*, arXiv, 1603.00053.
- [22] Jitomirskaya, S. Y. ; *Metal-insulator transition for the almost Mathieu operator*, Annals of Mathematics, **150** (3), pp. 1159–1175 (1999).
- [23] Lamy, S. ; *L’alternative de Tits pour  $Aut[\mathbb{C}^2]$* , J. Algebra, **239**, pp. 413–437 (2001).
- [24] Marmi S., Moussa P., Yoccoz J.-C. ; *The cohomological equation for Roth type interval exchange maps*, Jour. Amer. Math. Soc. **18**, pp. 823–872 (2005).
- [25] Masur H. ; *Interval exchange transformations and measured foliations*, Ann. of Math. (2) **115**, no. 1, pp. 169–200 (1982).
- [26] Moser, J., Poschel, J. ; *An extension of a result by Dinaburg and Sinai on quasi-periodic potentials*, Commun. Math. Helv. **59(1)**, pp. 39–85 (1984).
- [27] Pugh C., Shub M. ; *Stably ergodic dynamical systems and partial hyperbolicity*, J. Complexity **13** no. 1, pp. 125–179 (1997).
- [28] Puig, J. ; *A nonperturbative Eliasson’s reducibility theorem*, Nonlinearity **19**, pp. 355–376 (2006).



- [29] Rodriguez-Hertz F. ; *Stable ergodicity of certain linear automorphisms of the torus*, Annals of Mathematics **162**, pp. 65–107 (2005).
- [30] Rodriguez Hertz F., Rodriguez Hertz M. A., and Ures R. ; *Accessibility and stable ergodicity for partially hyperbolic diffeomorphisms with 1D-center bundle*, Invent. Math. **172**, pp. 353–381 (2008).
- [31] Veech W. A. ; *Projective swiss cheeses and uniquely ergodic interval exchange transformations*, Erg. Th. Dyn. Syst. I, Proc. Special Year, Maryland 1979-1980, A. Katok ed., Birkhäuser, pp. 113–195 (1981).
- [32] Veech W. A. ; *The metric theory of interval exchange transformations. I. Generic spectral properties*, Amer. J. Math. **106**, no. 6, pp. 1331–1359 (1984).

## Weak mixing for interval exchange transformations and translation flows

This chapter is based on a joint work with Artur Avila.<sup>1</sup>

Let  $d > 1$ . In this chapter we show that for an irreducible permutation  $\pi$  which is not a rotation, the set of  $[\lambda] \in \mathbb{P}_+^{d-1}$  such that the interval exchange transformation  $f([\lambda], \pi)$  is not weakly mixing does not have full Hausdorff dimension. We also obtain an analogous statement for translation flows. In particular, it strengthens the result of almost sure weak mixing proved by A. Avila and G. Forni in [AF]. We adapt here the probabilistic argument developed in their paper in order to get some large deviation results. We then show how the latter can be converted into estimates on the Hausdorff dimension of the set of “bad” parameters in the context of *fast decaying* cocycles, following the strategy of [AD].

### Introduction

An *interval exchange transformation*, or i.e.t., is a piecewise order-preserving bijection  $f$  of an interval  $I$  on the real axis. More precisely,  $I$  splits into a finite number of subintervals  $(I_i)_{i=1, \dots, d}$ ,  $d > 1$ , such that the restriction of  $f$  to each of them is a translation. The map  $f$  is completely described by a pair  $(\lambda, \pi) \in \mathbb{R}_+^d \times \mathfrak{S}_d$ :  $\lambda$  is a vector whose coordinates  $\lambda_i := |I_i|$  correspond to the lengths of the subintervals, and  $\pi$  a combinatorial data which prescribes in which way the different subintervals are reordered after application of  $f$ . We will write  $f = f(\lambda, \pi)$ . In the following, we will mostly consider *irreducible* permutations  $\pi$ , which we denote by  $\pi \in \mathfrak{S}_d^0$ ; this somehow expresses that the dynamics is “indecomposable”. Since dilations on  $\lambda$  do not change the dynamics of the i.e.t., we will also sometimes use the notation  $f([\lambda], \pi)$ , with  $[\lambda] \in \mathbb{P}_+^{d-1}$ . For more details on interval exchange transformations we refer to Section 3.

A *translation surface* is a pair  $(S, \omega)$  where  $S$  is a surface and  $\omega$  some nonzero Abelian differential defined on it. Denote by  $\Sigma \subset S$  the set of zeros of  $\omega$ ; its complement  $S \setminus \Sigma$  admits an atlas such that transition maps between two charts are just translations (see Subsection 3.2 for more details on translation surfaces). Interval exchange transformations can be seen as a discrete version of the geodesic flow on some translation surface, also called a *translation flow*. The introduction of these objects was motivated by the study of the billiard flow on rational polygons, i.e., whose angles are commensurate to  $\pi$ ; the relation between these problems is given by a construction called *unfolding*, which associates a translation surface to such a polygon (see for instance [Z2]) and makes the billiard flow into some translation flow.

In this chapter, we are interested in the ergodic properties of interval exchange transformations on  $d > 1$  subintervals. It is clear that such transformations preserve the Lebesgue measure. In fact this is often the unique invariant measure: Masur in [Mal] and Veech in [V2] have shown that if the permutation  $\pi$  is irreducible, then for Lebesgue-almost every  $[\lambda] \in \mathbb{P}_+^{d-1}$ , the i.e.t.  $f([\lambda], \pi)$  is uniquely ergodic. As a by-product of our

---

1. Institut de Mathématiques de Jussieu - Paris Rive Gauche, CNRS UMR 7586, Université Paris Diderot, Sorbonne Paris Cité Sorbonnes Universités, UPMC Université Paris 06, F-75013, Paris, France & IMPA, Estrada Dona Castorina 110, 22460-320, Rio de Janeiro, Brazil.

methods, we will see here that in fact, the set of  $[\lambda]$  such that  $f([\lambda], \pi)$  is not uniquely ergodic does not have full Hausdorff dimension.<sup>2</sup>

In another direction, Katok has proved that i.e.t.'s and suspension flows over i.e.t.'s with roof function of bounded variation are never mixing with respect to Lebesgue measure, see [Ka]. Basically, what mixing expresses is that the position of a point at time  $n$  is almost independent of its initial position when  $n \geq 0$  is large. Let us recall that a measure-preserving transformation  $f$  of a probability space  $(X, m)$  is said to be *weakly mixing* if for every pair of measurable sets  $A, B \in X$ , there exists a subset  $J(A, B) \subset \mathbb{N}$  of density zero such that

$$\lim_{J(A,B) \not\ni n \rightarrow +\infty} m(f^{-n}(A) \cap B) = m(A)m(B). \quad (0.1)$$

It follows from this definition that every mixing transformation is weakly mixing, and every weakly mixing transformation is ergodic.<sup>3</sup>

From the previous discussion, it is therefore natural to ask whether a typical i.e.t. is weakly mixing or not; this point is more delicate except in the case where the permutation  $\pi$  associated to the i.e.t.  $f(\lambda, \pi)$  is a *rotation* of  $\{1, \dots, d\}$ , i.e.,  $\pi(i+1) \equiv \pi(i)+1 \pmod{d}$ , for all  $i \in \{1, \dots, d\}$ . Indeed, in this case, the i.e.t.  $f(\lambda, \pi)$  is conjugate to a rotation of the circle, hence it is not weakly mixing, for every  $\lambda \in \mathbb{R}_+^d$ .

It is a classical fact that any invertible measure-preserving transformation  $f$  is weakly mixing if and only if it has *continuous spectrum*, that is, the only eigenvalue of  $f$  is 1 and the only eigenfunctions are constants. To prove weak mixing we thus rule out the existence of non-constant measurable eigenfunctions.

Let us recall some previous advances in the problem of the prevalence of weak mixing among interval exchange transformations. Partial results in this direction had been obtained by Katok and Stepin [KS], who proved weak mixing for almost all i.e.t.'s on 3 intervals. In [V4], Veech has shown that weak mixing holds for infinitely many irreducible permutations.

The question of almost sure weak mixing for i.e.t.'s was first fully answered by Avila and Forni in [AF], where the following result is proved:

**Theorem 1.1** (Theorem A, Avila-Forni [AF]). *Let  $\pi$  be an irreducible permutation of  $\{1, \dots, d\}$  which is not a rotation. For Lebesgue almost every  $\lambda \in \mathbb{R}_+^d$ , the i.e.t.  $f(\lambda, \pi)$  is weakly mixing.*

They also obtain an analogous statement for translation flows.

**Theorem 1.2** (Theorem B, Avila-Forni [AF]). *For almost every translation surface  $(S, \omega)$  in a given stratum of the moduli space of translation surfaces of genus  $g > 1$ , the translation flow on  $(S, \omega)$  is weakly mixing in almost every direction.*

Although translation flows can be seen as suspension flows over i.e.t.'s, the second result is not a direct consequence of the first one since the property of weak mixing is not invariant under suspensions and time changes.

Note that the previous results tell nothing about zero measure subsets of the moduli space of translation surfaces; in particular, the question of weak mixing was still open for translation flows on Veech surfaces, which are exceptionally symmetric translation surfaces associated to the dynamics of rational polygonal billiards. This problem was solved in [AD] by Avila and Delecroix:

2. It was pointed out to us by J. Athreya and J. Chaika that more is true actually: the results of Masur [Ma2] imply that the Hausdorff codimension of  $[\lambda] \in \mathbb{P}_+^{d-1}$  such that  $f([\lambda], \pi)$  is not uniquely ergodic is at least  $1/2$ .

3. Indeed, mixing holds when we can take  $J(A, B) = \emptyset$  in (0.1). For ergodicity, if the set  $A$  is  $f$ -invariant, the choice  $B = A$  in (0.1) yields that  $A$  has either full or zero measure.

**Theorem 1.3** (Theorem 2, Avila-Delecroix [AD]). *The geodesic flow in a non-arithmetic Veech surface is weakly mixing in almost every direction. Indeed, the set of exceptional directions has Hausdorff dimension less than one.*

The proof of almost sure weak mixing in [AF] is based on some parameter exclusion; however this reasoning is not adapted to the particular case of translation flows on Veech surfaces. In [AD], the authors have developed another strategy to deal with the problem of prevalent weak mixing, based on considerations on Hausdorff dimension and its link to some property that we refer to as *fast decay* in what follows (see Subsection 2.4 for the definition).

In the present chapter, we improve the “almost sure” statement obtained in [AF]; the proof we give owes much to the ideas developed in [AF] and [AD]. Our main result is the following.

**Theorem A** (Avila-L.). *Let  $d > 1$  and let  $\pi \in \mathfrak{S}_d^0$  be an irreducible permutation which is not a rotation; then the set of  $[\lambda] \in \mathbb{P}_+^{d-1}$  such that  $f([\lambda], \pi)$  is not weakly mixing has Hausdorff dimension strictly less than  $d - 1$ .*

We also get a similar statement for translation flows. Let  $d > 1$ , and  $\pi \in \mathfrak{S}_d^0$  which is not a rotation; we consider the translation flows which are parametrized by a pair  $(h, [\lambda]) \in H(\pi) \times \mathbb{P}_+^{d-1}$ , where  $\dim(H(\pi)) = 2g$  (we refer to Subsection 3.3 for a definition). By [AF] we know that the set of  $(h, [\lambda]) \in H(\pi) \times \mathbb{P}_+^{d-1}$  such that the associate flow is weakly mixing has full measure. Here we obtain

**Theorem B** (Avila-L.). *The set of  $(h, [\lambda]) \in H(\pi) \times \mathbb{P}_+^{d-1}$  such that the associate translation flow is not weakly mixing has Hausdorff dimension strictly less than  $2g + d - 1$ .*

## 1. Outline

The property of weak mixing we are interested in concerns the dynamics of some i.e.t.  $f$  on the interval  $I$ , or in other terms, *phase space*. But  $f$  is parametrized by  $([\lambda], \pi) \in \mathbb{P}_+^{d-1} \times \mathfrak{S}_d^0$  and we will see that it is possible to define a dynamics on the *space of parameters* as well. The so-called *Veech criterion* gives a link between the property of weak mixing for phase space and the dynamics of some cocycle in parameter space.

Indeed, “bad” parameters, i.e. corresponding to i.e.t.’s which are not weakly mixing, can be detected through a cocycle  $(T, A)$  derived from the Rauzy cocycle. For a parameter  $[\lambda]$ , the weak-stable lamination  $W^s([\lambda])$  is defined to be the set of vectors  $h$  whose iterates under the cocycle get closer and closer to the lattice  $\mathbb{Z}^d$ . Veech criterion tells us that the weak-stable lamination  $W^s([\lambda])$  associated to some “bad” parameter  $[\lambda]$  contains the element  $(t, \dots, t)$  for some  $t \in \mathbb{R} \setminus \mathbb{Z}$ . Prevalent weak mixing can thus be obtained by ruling out intersections between  $\text{Span}(1, \dots, 1) \setminus \mathbb{Z}^d$  and  $W^s([\lambda])$  for typical  $[\lambda]$ . In [AF], typical meant “almost everywhere”; following the strategy developed by Avila and Delecroix in [AD], we show here that this holds actually for every  $[\lambda]$  but for a set whose Hausdorff dimension is not maximal, which is stronger.

The study of the weak-stable lamination of  $(T, A)$  was done in [AF]. To achieve this, and given  $\delta > 0$ ,  $m \in \mathbb{N}$ , the authors introduce the set  $W_{\delta, m}([\lambda])$  of vectors  $h$  with norm less than  $\delta$  and such that the iterates  $A_k([\lambda]) \cdot h$  remain small for the pseudo-norm  $\|\cdot\|_{\mathbb{R}^d/\mathbb{Z}^d}$  up to time  $m$ .

The analysis is based on the following process: given a little segment  $J$  near the origin, its image by the cocycle may again contain a point near some element  $c \in \mathbb{Z}^d$ . When  $c = 0$ , the corresponding line is called a *trivial child* of  $J$ . Else, we translate the image of  $J$  by  $-c$  to bring it back to the origin, and we call this new segment a *non-trivial child* of  $J$ . Note that there may be several non-trivial children. The goal of the study is to show that for most  $[\lambda]$ , this process has finite life expectancy, that is, the family generated by a line is finite.

A key ingredient in the “local” analysis near the origin is the existence of two positive Lyapunov exponents for surfaces of genus at least 2. For a fixed segment not passing through the origin, the biggest Lyapunov exponent is responsible for the growth of the length of its iterates by the cocycle, while the second biggest generates a drift that tends to kick them further away from the origin.

The second part of the argument corresponds to a “global” analysis which handles the fact that points near the origin may become close to another integer element under cocycle iteration. To address this point, Avila and Forni have developed a probabilistic argument. Choose a finite set  $S$  of matrices such that for a typical parameter  $[\lambda]$ , the proportion of integers  $k \geq 0$  such that  $A(T^k([\lambda])) \in S$  is big. Since the set  $S$  is finite, it is possible to ensure that when the matrix we apply belongs to  $S$ , the only potential child is trivial, and moreover, such an element kicks each line further from the origin by at least a given factor. It follows that for a typical  $[\lambda]$  and for every line  $J$ , the process has finite life expectancy: for every  $\delta > 0$  and every line  $J$ , there exists some integer  $m \geq 0$  such that  $J \cap W_{\delta, m}^s([\lambda]) = \emptyset$ .

In the present chapter, we adapt the estimates obtained in [AF] to show that for every line  $J$ , the measure of the set of  $[\lambda]$  such that the process survives up to time  $m$  goes to zero exponentially fast with respect to  $m$ : if  $\Gamma_\delta^m(J)$  denotes the set of  $[\lambda]$  such that  $J \cap W_{\delta, m}^s([\lambda]) \neq \emptyset$ , we get that  $\mu(\Gamma_\delta^m(J)) \leq Ce^{-\kappa m} \|J\|^{-\rho}$  for some constants  $C, \kappa, \rho > 0$ . We give here a proof of this fact using a general large deviations result obtained in [AD].

But by [AD], we know that the decay of the volumes  $\mu(\Gamma_\delta^m(J))$  can be converted into a bound on the Hausdorff dimension of  $\cap_m \Gamma_\delta^m(J)$ . Since these sets are intimately related to the weak-stable lamination, we thus get a control of the Hausdorff dimension of “bad” parameters  $[\lambda]$ , which concludes.

For the case of translation flows, we use the parametrization  $(h, [\lambda])$  that comes from Veech’s zippered rectangle construction. For a fixed parameter  $h$  and any integer  $m \geq 0$ , as for interval exchange transformations, we can estimate the measure of the set of “bad” parameters  $[\lambda]$  at time  $m$ ; this allows us to construct a cover of this set of parameters. Then, if we consider some  $h'$  exponentially close to  $h$ , then for any “bad” parameter  $[\lambda']$ , we have two cases: either the iterates of the cocycle grow very fast (by some large deviations result, this happens very rarely), or  $[\lambda']$  belongs to some piece of the cover constructed for  $h$ ; in other terms, the previous cover can be taken locally constant with respect to  $h$ . Thus for each integer  $m \geq 0$ , we obtain a cover of “bad” parameters  $(h, [\lambda])$  at time  $m$ , and we can then estimate the Hausdorff dimension of non weakly mixing parameters.

## 2. Background

As we have explained, the property of weak mixing for i.e.t.’s is related to the dynamics of a cocycle  $(T, A)$  defined in parameter space. An important fact is that the map  $T$  we consider has a property called *bounded distortion*; indeed it is crucial for the probabilistic argument that we outlined, in particular to get some large deviations result. In this section, we will see that under some assumptions, it can be checked when the map  $T$  is obtained by restriction to a simplex compactly contained in the projective space. Another important point is that the cocycle  $(T, A)$  is *fast decaying*; we will recall this notion and see how it can be used to give a bound on the Hausdorff dimension of certain sets.

**2.1. Strongly expanding maps.** Let  $(\Delta, \mu)$  be a probability space and  $T: \Delta \rightarrow \Delta$  a measurable transformation preserving the measure class of  $\mu$ . We say  $T$  is *weakly expanding* if there exists a partition (modulo 0)  $\{\Delta^{(l)}, l \in \mathbb{Z}\}$  of  $\Delta$  into sets of positive measure, such that for all  $l \in \mathbb{Z}$ ,  $T$  maps  $\Delta^{(l)}$  onto  $\Delta$ ,  $T^{(l)} := T|_{\Delta^{(l)}}$  is invertible and the pull-back  $(T^{(l)})^* \mu$  is equivalent to  $\mu|_{\Delta^{(l)}}$ .

Let  $\Omega$  be the set of all finite words with integer entries. Given  $\underline{l} = l_0 \dots l_{n-1} \in \Omega$ , we denote by  $|\underline{l}| := n$  its length; we also define  $\Delta^{\underline{l}} := \bigcap_{k=0}^{n-1} T^{-k} \Delta^{(l_k)}$  and  $T^{\underline{l}} := T^n|_{\Delta^{\underline{l}}}$ . In particular  $\mu(\Delta^{\underline{l}}) > 0$  by weak expansiveness.

If  $\underline{l} \in \Omega$ , we denote  $\mu^{\underline{l}} := \frac{1}{\mu(\Delta^{\underline{l}})} T_*^{\underline{l}}(\mu|_{\Delta^{\underline{l}}})$ . We say that  $T$  is *strongly expanding* if for some  $K > 0$ ,

$$K^{-1} \leq \frac{d\mu^{\underline{l}}}{d\mu} \leq K, \quad \underline{l} \in \Omega. \quad (2.1)$$

**Lemma 1.4.** *Let  $T$  be strongly expanding and  $Y \subset \Delta$  with  $\mu(Y) > 0$ ; the following bounded distortion property holds:*

$$K^{-2} \mu(Y) \leq \frac{T_*^{\underline{l}}(\mu^{\underline{l}'}|_{\Delta^{\underline{l}}})(Y)}{\mu(\Delta^{\underline{l}})} \leq K^2 \mu(Y), \quad \underline{l}, \underline{l}' \in \Omega. \quad (2.2)$$

**2.2. Projective transformations.** We let  $\mathbb{P}_+^{d-1} \subset \mathbb{P}^{d-1}$  be the projectivization of  $\mathbb{R}_+^d$ . A *projective contraction* is the projectivization of some matrix  $B \in \text{GL}(d, \mathbb{R})$  with non-negative entries; in particular, the associate transformation takes  $\mathbb{P}_+^{d-1}$  into itself. The image of  $\mathbb{P}_+^{d-1}$  by a projective contraction is called a *simplex*.

**Lemma 1.5** (Lemma 2.1, Avila-Forni [AF]). *Let  $\Delta$  be a simplex compactly contained in  $\mathbb{P}_+^{d-1}$  and  $\{\Delta^{(l)}\}_{l \in \mathbb{Z}}$  a partition of  $\Delta$  into sets of positive Lebesgue measure. Let  $T: \Delta \rightarrow \Delta$  be a measurable transformation such that, for all  $l \in \mathbb{Z}$ ,  $T$  maps  $\Delta^{(l)}$  onto  $\Delta$ ,  $T^{(l)} := T|_{\Delta^{(l)}}$  is invertible and its inverse is the restriction of a projective contraction. Then  $T$  preserves a probability measure  $\mu$  which is absolutely continuous with respect to Lebesgue measure and has a density which is continuous and positive in  $\bar{\Delta}$ . Moreover,  $T$  is strongly expanding with respect to  $\mu$ .*

**2.3. Cocycles.** Let  $(\Delta, \mu)$  be a probability space. A *cocycle* is a pair  $(T, A)$ , where  $T: \Delta \rightarrow \Delta$  and  $A: \Delta \rightarrow \text{GL}(d, \mathbb{R})$  are measurable maps; it can be viewed as a linear skew-product  $(x, w) \mapsto (T(x), A(x) \cdot w)$  on  $\Delta \times \mathbb{R}^d$ . If  $n \geq 0$  we have  $(T, A)^n = (T^n, A_n)$ , where

$$A_n(x) := A(T^{n-1}(x)) \cdots A(x).$$

We say that  $(T, A)$  is *integral* if  $A(x) \in \text{GL}(d, \mathbb{Z})$  for  $\mu$ -almost every  $x \in \Delta$ .

Assume that  $T: \Delta \rightarrow \Delta$  is strongly expanding with respect to a partition  $\{\Delta^{(l)}\}_{l \in \mathbb{Z}}$  of  $\Delta$ , and that the  $\sigma$ -algebra of  $\mu$ -measurable sets is generated (mod 0) by the  $\Delta^{(l)}$ 's. For  $n \geq 0$ , we define  $\mu_n := \frac{1}{n} \sum_{k=0}^{n-1} T_*^k \mu$  and take  $\nu$  a weak-star limit of  $(\mu_n)$ . Then  $\nu$  is an ergodic probability measure which is invariant by  $T$ .

Given  $B \in \text{GL}(d, \mathbb{R})$ , we define  $\|B\|_0 := \max\{\|B\|, \|B^{-1}\|\}$ . The cocycle  $(T, A)$  is *log-integrable* if

$$\int_{\Delta} \ln \|A(x)\|_0 d\nu(x) < \infty. \quad (2.3)$$

We say that  $(T, A)$  is *locally constant* if for all  $l \in \mathbb{Z}$ ,  $A|_{\Delta^{(l)}}$  is a constant  $A^{(l)}$ . In this case, for all  $\underline{l} \in \Omega$ ,  $\lambda = l_1 \dots l_n$ , we set

$$A^{\underline{l}} := A^{(l_n)} \cdots A^{(l_1)}.$$

**2.4. Fast decay.** Let  $(\Delta, \mu)$  be a probability space. Assume that  $T$  is weakly expanding with respect to a partition  $\{\Delta^{(l)}\}_{l \in \mathbb{Z}}$  of  $\Delta$  and that the cocycle  $(T, A)$  is locally constant. As in [AD],  $T$  is *fast decaying* if there exist  $C_1 > 0$ ,  $\alpha_1 > 0$  such that

$$\sum_{\mu(\Delta^{(l)}) \leq \varepsilon} \mu(\Delta^{(l)}) \leq C_1 \varepsilon^{\alpha_1}, \quad 0 < \varepsilon < 1, \quad (2.4)$$

and we say that  $A$  is *fast decaying* if there exist  $C_2 > 0$ ,  $\alpha_2 > 0$  such that

$$\sum_{\|A^{(l)}\|_0 \geq n} \mu(\Delta^{(l)}) \leq C_2 n^{-\alpha_2}. \quad (2.5)$$

In particular, fast decay of  $A$  implies that the cocycle  $(T, A)$  is log-integrable. If both  $T$  and  $A$  are fast decaying we say that the cocycle  $(T, A)$  is fast decaying.

**2.5. Hausdorff dimension.** Let  $X$  be a subset of a metric space  $M$ . Given  $d \in \mathbb{R}_+$ , its  $d$ -dimensional Hausdorff measure is defined as follows:

$$\mu_d(X) = \lim_{\varepsilon \rightarrow 0} \inf_{\{U_i^\varepsilon\}} \sum_i \text{diam}(U_i)^\varepsilon, \quad (2.6)$$

where the infimum is taken over all countable covers  $\{U_i^\varepsilon\}$  of  $X$  such that  $\text{diam}(U_i^\varepsilon) < \varepsilon$  for all  $i$ .

**Definition 1.6.** The Hausdorff dimension of  $X$  is the unique value  $d =: \text{HD}(X) \in \mathbb{R}_+ \cup \{\infty\}$  such that  $\mu_{d'}(X) = 0$  if  $d' > d$  and  $\mu_{d'}(X) = \infty$  if  $d' < d$ .

**2.6. Fast decay & Hausdorff dimension.** Let  $\Delta \in \mathbb{P}_+^{d-1}$  be a simplex, and assume that  $T: \Delta \rightarrow \Delta$  satisfies the hypotheses of Lemma 1.5.

**Theorem 1.7** (Theorem 27, Avila-Delecroix [AD]). Assume that  $T$  is fast decaying and take  $\alpha_1 > 0$  as in (2.4). For  $n \geq 1$ , let  $X_n \subset \Delta$  be a union of  $\Delta^l$  with  $|l| = n$ , and define  $X := \liminf_{n \rightarrow \infty} X_n$ . If

$$\delta := \limsup_{n \rightarrow \infty} -\frac{1}{n} \ln \mu(X_n) > 0,$$

then

$$\text{HD}(X) \leq d - 1 - \min(\delta, \alpha_1) < d - 1.$$

### 3. Interval exchange transformations and renormalization algorithms

Following the notations of [MMY] and [AGY], we recall some classical notions of the theory of interval exchange transformations (see also [Via], [V4]). In particular, we give the definition of Rauzy induction and renormalization procedures. The rough idea is the following: given an i.e.t.  $f$ , we look at the first-return map induced by  $f$  on some subintervals that are chosen smaller and smaller. This allows us to accelerate the dynamics in phase space in order to capture asymptotic behaviors such as weak mixing. But each return map is itself an i.e.t., and the corresponding changes of parameters define a dynamics in parameter space. We also recall some classical notions on translation surfaces and translation flows, which are a continuous counterpart to i.e.t.'s. By Veech's "zippered rectangles" construction, it is possible to suspend any i.e.t. to a flow on a translation surface, which is obtained by gluing rectangles on each subinterval and performing certain identifications between them. In the space of "zippered rectangles", the extension of Rauzy induction can be seen as a cocycle, called the Rauzy cocycle. Similarly it is possible to define a cocycle over Rauzy renormalization map, and we will see that by considering first-return maps to a simplex compactly contained in  $\mathbb{P}_+^{d-1}$ , it induces a cocycle  $(T, A)$  with better properties: indeed,  $T$  has bounded distortion and  $(T, A)$  is fast decaying.

**3.1. Interval exchange transformations.** Let  $\mathcal{A}$  be an alphabet on  $d > 1$  letters, and let  $I \subset \mathbb{R}$  be an interval having 0 as left endpoint. We choose a partition  $\{I_\alpha\}_{\alpha \in \mathcal{A}}$  of  $I$  into subintervals which we assume to be closed on the left and open on the right. In the following, we denote  $\mathbb{R}_+^{\mathcal{A}} \sim \mathbb{R}_+^d$  and  $\mathbb{P}_+^{\mathcal{A}} := \mathbb{P}(\mathbb{R}_+^{\mathcal{A}}) \sim \mathbb{P}_+^{d-1}$ . An interval exchange transformation, or i.e.t., is a bijection of  $I$  defined by two data:

- (1) A vector  $\lambda = (\lambda_\alpha)_{\alpha \in \mathcal{A}} \in \mathbb{R}_+^{\mathcal{A}}$  whose coordinates correspond to the lengths of the subintervals: for every  $\alpha \in \mathcal{A}$ ,  $\lambda_\alpha := |I_\alpha|$ . We also define  $|\lambda| := \sum_{\alpha \in \mathcal{A}} \lambda_\alpha$ , so that  $I = I^\lambda := [0, |\lambda|)$ .
- (2) A pair  $\pi = \begin{pmatrix} \pi_t \\ \pi_b \end{pmatrix}$  of bijections  $\pi_*: \mathcal{A} \rightarrow \{1, \dots, d\}$ ,  $*$  =  $t, b$ , prescribing in which way the subintervals  $I_\alpha$  are ordered before and after the application of



the map. The bijections  $\pi_*$  can be viewed as one top and one bottom rows, where the elements of  $\mathcal{A}$  are displayed in the order  $(\pi_*^{-1}(1), \dots, \pi_*^{-1}(d))$ :

$$\pi = \begin{pmatrix} \alpha_1^t & \alpha_2^t & \dots & \alpha_d^t \\ \alpha_1^b & \alpha_2^b & \dots & \alpha_d^b \end{pmatrix}.$$

We sometimes identify  $\pi$  with its *monodromy invariant*  $\tilde{\pi} := \pi_b \circ \pi_t^{-1}$  and call it a *permutation*. We denote by  $\mathfrak{S}(\mathcal{A})$  the set of all such permutations, and by  $\mathfrak{S}^0(\mathcal{A})$  the subset of *irreducible* ones, that is  $\pi \in \mathfrak{S}^0(\mathcal{A})$  if and only if for every  $1 \leq k < d$ , the set of the first  $k$  elements in the top and in the bottom rows do not coincide.

Given a permutation  $\pi \in \mathfrak{S}^0(\mathcal{A})$ , and for  $* = t, b$ , we define linear maps  $\Omega_\pi^* : \mathbb{R}^{\mathcal{A}} \rightarrow \mathbb{R}^{\mathcal{A}}$  by

$$(\Omega_\pi^*(\lambda))_\alpha := \sum_{\pi_*(\beta) < \pi_*(\alpha)} \lambda_\beta, \quad \lambda \in \mathbb{R}^{\mathcal{A}}, \quad \alpha \in \mathcal{A}. \quad (3.1)$$

Set  $\Omega_\pi := \Omega_\pi^b - \Omega_\pi^t$ . For any  $\lambda \in \mathbb{R}_+^{\mathcal{A}}$ , the interval exchange transformation  $f = f(\lambda, \pi)$  is the map associated with the translation vector  $w := \Omega_\pi(\lambda)$ ; in other terms,

$$f(x) := x + w_\alpha, \quad x \in I_\alpha.$$

Two i.e.t.'s obtained one from another by a dilation on the length parameter  $\lambda$  have the same dynamical behavior; therefore, one can projectivize  $\lambda$  to  $[\lambda] \in \mathbb{P}_+^{\mathcal{A}}$  and consider  $f([\lambda], \pi)$ .

**3.2. Translation surfaces.** A *translation surface* is a compact Riemann surface  $S$  endowed with some nonzero Abelian differential  $\omega$ . Let  $\Sigma \subset S$  be the set of zeros, or *singularities* of  $\omega$ . For each  $s \in \Sigma$ , denote by  $\kappa_s$  the order of  $s$  as a zero. For any  $p \in S \setminus \Sigma$ , there exists a chart defined in the neighborhood of  $p$  such that in these coordinates,  $\omega$  simply writes down as  $dz$ . The family of such charts on  $S \setminus \Sigma$  forms an atlas for which transition maps correspond to translations in  $\mathbb{R}^2$ . Moreover, every singularity  $s$  has a punctured neighborhood isomorphic via a holomorphic map to a finite cover of a punctured disk in  $\mathbb{R}^2$ , and such that in this chart  $\omega$  becomes  $z^{\kappa_s} dz$ .

The form  $|\omega|$  defines a flat metric on  $S$  with conical singularities at  $\Sigma$ . The total angle around a singularity  $s$  is  $2\pi(\kappa_s + 1)$ . The total area of the surface is given by  $\int |\omega|^2 < \infty$ . *Normalized* translation surfaces are those for which  $\int |\omega|^2 = 1$ .

For each  $\theta \in \mathbb{R}/2\pi\mathbb{Z}$ , the *directional flow* in the direction  $\theta$  is the flow  $\phi_t^{S, \theta} : S \rightarrow S$  obtained by integration of the unique vector field  $X_\theta$  such that  $\omega(X_\theta) = e^{i\theta}$ . In local charts,  $\omega = dz$  and we have  $\phi_t^{S, \theta}(z) = z + te^{i\theta}$  for small  $t$ , so directional flows are also called *translation flows*. The (*vertical*) flow of  $(S, \omega)$  is the flow  $\phi^{S, \pi/2}$ . Translation flows are not defined at the zeros of  $\omega$  and hence not defined for all positive times on backward orbits of the singularities. The flows  $\phi_t^{S, \theta}$  preserve the volume form  $\frac{i}{2}\omega \wedge \bar{\omega}$  and the ergodic properties of translation flows we will discuss are with respect to this measure.

Let us recall some results which hold for an arbitrary translation surface: the directional flow is minimal except for a countable set of directions [Ke], the translation flow is uniquely ergodic except for a set of directions of Hausdorff dimension at most  $1/2$  [KMS], [Ma2], and the translation flow is not mixing in any direction [Ka].

It is known that for a genus one translation surface, translation flows are never weakly mixing. The same property holds for the branched coverings of genus one translation surfaces, which form a *dense* subset of translation surfaces. However, Avila and Forni [AF] have proved that for *almost every* translation surface of genus at least two, the translation flow is weakly mixing in almost every direction.

Considering translation surfaces of genus  $g$  modulo isomorphism, one gets the *moduli space* of Abelian differentials, denoted by  $\mathcal{M}_g$ . It is possible to define a flow  $(g_t)_{t \in \mathbb{R}}$  on this space, called the *Teichmüller flow*: its action on an Abelian differential  $\omega = \Re(\omega) + i\Im(\omega)$  is given by  $g_t \cdot \omega := e^t \Re(\omega) + ie^{-t} \Im(\omega)$ . By fixing the order of zeros as an unordered list  $\kappa$  of positive integers, one defines *strata*  $\mathcal{M}_{g, \kappa} \subset \mathcal{M}_g$ . We also denote by  $\mathcal{M}_{g, \kappa}^1 \subset \mathcal{M}_{g, \kappa}$  the hypersurface corresponding to normalized surfaces. Each stratum



is an orbifold of finite dimension. For each connected component  $\mathcal{C}$  of some  $\mathcal{M}_{g,\kappa}^1$ , there is a well-defined probability measure  $\mu_{\mathcal{C}}$  in the Lebesgue measure class which is invariant by the Teichmüller flow; it is called the *Masur-Veech measure*. The implicit measure-theoretical notions above refer to this measure.

Given a translation surface  $(S, \omega)$ , a *separatrix* is a geodesic line for the metric  $|\omega|$  starting from a singularity in  $\Sigma$ ; it is called a *saddle connection* when the separatrix connects two singularities and has its interior disjoint from  $\Sigma$ . The first-return map to some separatrix for the vertical flow is an interval exchange transformation. Conversely, it is possible to suspend any interval exchange transformation to a translation flow by a construction we now briefly recall.

**3.3. Veech's "zippered rectangles" construction.** Let  $\mathcal{A}$  be an alphabet on  $d > 1$  letters. Given  $(\lambda, \pi) \in \mathbb{R}_+^{\mathcal{A}} \times \mathfrak{S}^0(\mathcal{A})$ , Veech's construction allows to suspend the i.e.t.  $f(\lambda, \pi)$  to a suspension flow on a translation surface  $S$ . We consider the convex cone  $T^+(\pi) := \left\{ \tau \in \mathbb{R}^{\mathcal{A}} \mid \sum_{\pi_t(\beta) \leq k} \tau_\beta > 0 \text{ and } \sum_{\pi_b(\beta) \leq k} \tau_\beta < 0, 1 \leq k \leq d-1 \right\}$ . Let  $\Omega_\pi$  be the map defined in Subsection 3.1, and set  $H^+(\pi) := -\Omega_\pi(T^+(\pi)) \subset \mathbb{R}_+^{\mathcal{A}}$ . For any  $h \in H^+(\pi)$  and  $\alpha \in \mathcal{A}$ , we define rectangles above (resp. below) top (resp. bottom) subintervals by:

$$R_\alpha^t := (w_\alpha^t, w_\alpha^t + \lambda_\alpha) \times [0, h_\alpha] \quad \text{and} \quad R_\alpha^b := (w_\alpha^b, w_\alpha^b + \lambda_\alpha) \times [-h_\alpha, 0],$$

where  $w^* := \Omega_\pi^*(\lambda)$ ,  $*$  =  $t, b$ . The surface  $S$  is obtained by performing appropriate gluing operations on the union of those rectangles. The initial i.e.t.  $f$  corresponds to the first-return map to the transversal  $I$  of the vertical flow in  $S$ .

Denote by  $\tilde{\pi}$  the monodromy invariant, and let  $\sigma_\pi$  be the permutation on  $\{0, \dots, d\}$  defined by

$$\sigma_\pi(i) := \begin{cases} \tilde{\pi}^{-1}(1) - 1, & i = 0, \\ d, & i = \tilde{\pi}^{-1}(d), \\ \tilde{\pi}^{-1}(\tilde{\pi}(i) + 1) - 1, & i \neq 0, \tilde{\pi}^{-1}(d). \end{cases}$$

For  $i, j \in \{0, \dots, d\}$ , we denote  $i \sim j$  if  $i$  and  $j$  belong to the same orbit under  $\sigma_\pi$ . Then the quotient space  $\Sigma(\pi) := \{0, \dots, d\} / \sim$  is in one-to-one correspondence with the set of singularities of  $S$ . Moreover, for every  $s \in \Sigma(\pi)$ , let  $b^s \in \mathbb{R}^d$  be the vector defined by

$$b_i^s := \chi_s(i-1) - \chi_s(i), \quad 1 \leq i \leq d,$$

where  $\chi_s$  denotes the characteristic function of  $s$ . We define  $\Upsilon(\pi) := \{b^s, s \in \Sigma(\pi)\}$ . Let us recall the following result.

**Lemma 1.8** (Veech, [V4], §5). *Let  $\pi \in \mathfrak{S}^0(\mathcal{A})$ . For each  $s \in \Sigma(\pi)$ , one has*

$$(1, \dots, 1) \cdot b^s = \begin{cases} 1, & 0 \in s, d \notin s, \\ -1, & 0 \notin s, d \in s, \\ 0, & \text{otherwise.} \end{cases}$$

We define  $H(\pi) := \Omega_\pi(\mathbb{R}^{\mathcal{A}}) = \ker(\Omega_\pi)^\perp$ .

**Proposition 1.9.**  *$H(\pi)$  coincides with the annihilator of the subspace of  $\mathbb{R}^{\mathcal{A}}$  spanned by  $\Upsilon(\pi)$ :*

$$h \in H(\pi) \iff h \cdot b^s = 0, \quad s \in \Sigma(\pi).$$

Moreover,  $\dim(H(\pi)) = d+1 - \#\Sigma(\pi) = 2g(\pi)$ , where  $g(\pi)$  is the genus of the suspension surface  $S$ , and  $H(\pi)$  can be identified with the absolute homology  $H_1(S, \mathbb{R})$  of  $S$ .

**3.4. Rauzy classes.** Let  $\pi \in \mathfrak{S}^0(\mathcal{A})$ . We denote by  $\alpha(t)$  (resp.  $\alpha(b)$ ) the last element of the top (resp. bottom) row. We define two bijections of  $\mathfrak{S}^0(\mathcal{A})$  as follows; the

reason why we consider these transformations will become clear in the next subsection. The *top* operation  $\underline{t}$  maps  $\pi$  to the permutation

$$\underline{t}(\pi) = \begin{pmatrix} \alpha_1^t & \cdots & \alpha_{k-1}^t & \alpha_k^t & \alpha_{k+1}^t & \cdots & \cdots & \alpha(t) \\ \alpha_1^b & \cdots & \alpha_{k-1}^b & \alpha(t) & \alpha(b) & \alpha_{k+1}^b & \cdots & \alpha_{d-1}^b \end{pmatrix},$$

while the *bottom* operation  $\underline{b}$  maps  $\pi$  to

$$\underline{b}(\pi) = \begin{pmatrix} \alpha_1^t & \cdots & \alpha_{k-1}^t & \alpha(b) & \alpha(t) & \alpha_{k+1}^t & \cdots & \alpha_{d-1}^t \\ \alpha_1^b & \cdots & \alpha_{k-1}^b & \alpha_k^b & \alpha_{k+1}^b & \cdots & \cdots & \alpha(b) \end{pmatrix}.$$

We define a *Rauzy class* to be a minimal non-empty subset of  $\mathfrak{S}^0(\mathcal{A})$  which is invariant under  $\underline{t}$  and  $\underline{b}$ . Given a Rauzy class  $\mathfrak{R}$ , the corresponding *Rauzy diagram* has its vertices in  $\mathfrak{R}$  and is formed by arrows mapping  $\pi \in \mathfrak{R}$  to  $\underline{t}(\pi)$  or  $\underline{b}(\pi)$ . The set of all paths in this diagram is denoted by  $\Pi(\mathfrak{R})$ .

**3.5. Rauzy induction and renormalization procedures.** We now recall the definition of two procedures first introduced by Rauzy in [R] (see also Veech [V1]). Let  $\mathfrak{R} \subset \mathfrak{S}^0(\mathcal{A})$  be some Rauzy class, and let  $(\lambda, \pi) \in \mathbb{R}_+^{\mathcal{A}} \times \mathfrak{R}$ . We denote by  $\alpha(t)$  (resp.  $\alpha(b)$ ) the last element of the top (resp. bottom) row of  $\pi$ . Assume that  $\lambda_{\alpha(t)} \neq \lambda_{\alpha(b)}$  and set  $\ell := |\lambda| - \min(|\lambda_{\alpha(t)}|, |\lambda_{\alpha(b)}|)$ . The first-return map of  $f(\lambda, \pi)$  to the subinterval  $[0, \ell] \subset I^\lambda$  is again an i.e.t.; it is the map  $f(\lambda^{(1)}, \pi^{(1)})$ , where the parameters  $(\lambda^{(1)}, \pi^{(1)}) \in \mathbb{R}_+^{\mathcal{A}} \times \mathfrak{R}$  are defined as follows:

- (1) If  $\lambda_{\alpha(t)} > \lambda_{\alpha(b)}$  (resp.  $\lambda_{\alpha(b)} > \lambda_{\alpha(t)}$ ), we let  $\gamma(\lambda, \pi)$  be the top (resp. bottom) arrow starting at  $\pi$ , and we set  $\alpha := \alpha(t)$  (resp.  $\alpha := \alpha(b)$ ).
- (2) Let  $\lambda_\xi^{(1)} := \lambda_\xi$  if  $\xi \neq \alpha$ ; else, let  $\lambda_\xi^{(1)} := |\lambda_{\alpha(t)} - \lambda_{\alpha(b)}|$ .
- (3)  $\pi^{(1)}$  is the end of the arrow  $\gamma(\lambda, \pi)$ .

This motivates *a posteriori* the introduction of the top and bottom operations. The map  $\mathcal{Q}_R: (\lambda, \pi) \mapsto (\lambda^{(1)}, \pi^{(1)})$  defines a dynamical system in parameter space, and is called the *Rauzy induction map*.

Since  $\mathcal{Q}_R$  commutes with dilations on  $\lambda$ , it projectivizes to a map  $\mathcal{R}_R: \mathbb{P}_+^{\mathcal{A}} \times \mathfrak{R} \rightarrow \mathbb{P}_+^{\mathcal{A}} \times \mathfrak{R}$ , called the *Rauzy renormalization map*. For  $n \geq 1$ , the connected components of the domain of definition of  $\mathcal{R}_R^n$  are naturally labeled by paths in  $\Pi(\mathfrak{R})$  of length  $n$ . Moreover, if  $\gamma$  is a path of length  $n$  which ends at  $\pi^{(n)} \in \mathfrak{R}$ , and  $D_\gamma$  denotes the associate connected component, then  $\mathcal{R}_R^n|_{D_\gamma}$  follows the path  $\gamma$  in the Rauzy diagram and maps  $D_\gamma$  homeomorphically to  $\mathbb{P}_+^{\mathcal{A}} \times \{\pi^{(n)}\}$ . A sufficient condition for  $([\lambda], \pi)$  to belong to the domain of  $\mathcal{R}_R^n$  for every  $n \geq 1$  is for the coordinates of  $[\lambda]$  to be independent over  $\mathbb{Q}$ . We will always assume it implicitly in the following. Since the set of rationally dependent  $[\lambda] \subset \mathbb{P}_+^{\mathcal{A}}$  has dimension  $d - 2$ , it is not a limitation for our estimates.

**Theorem 1.10** (Masur [Ma1], Veech [V2]). *Let  $\mathfrak{R} \subset \mathfrak{S}^0(\mathcal{A})$  be a Rauzy class. Then  $\mathcal{R}_R|_{\mathbb{P}_+^{\mathcal{A}} \times \mathfrak{R}}$  admits an ergodic conservative infinite absolutely continuous invariant measure  $\mu$ , unique in its measure class up to a scalar multiple. Its density is a positive rational function.*

**3.6. The Rauzy cocycle.** We denote by  $E_{\alpha\beta}$  the elementary matrix  $(\delta_{i\alpha}\delta_{j\beta})_{1 \leq i, j \leq d}$ . Let  $\mathfrak{R} \subset \mathfrak{S}^0(\mathcal{A})$  be a Rauzy class. We associate with any path  $\gamma \in \Pi(\mathfrak{R})$  a matrix  $B_\gamma \in \text{SL}(\mathcal{A}, \mathbb{Z})$ . The definition is by induction:

- If  $\gamma$  is a vertex, we set  $B_\gamma := \mathbf{1}_d$ .
- If  $\gamma$  is an arrow labeled by  $\underline{t}$ , we define  $B_\gamma := \mathbf{1}_d + E_{\alpha(b)\alpha(t)}$ .
- If  $\gamma$  is an arrow labeled by  $\underline{b}$ , we define  $B_\gamma := \mathbf{1}_d + E_{\alpha(t)\alpha(b)}$ .
- If  $\gamma$  is obtained by concatenation of the arrows  $\gamma_1, \dots, \gamma_m$ , then set  $B_\gamma := B_{\gamma_m} \cdots B_{\gamma_1}$ .

Let us stress the following useful fact. Assume that  $(\lambda, \pi) \in \mathbb{R}_+^A \times \mathfrak{R}$  belongs to the domain of  $\mathcal{Q}_R^n$ ,  $n \geq 1$ , and that the application of  $\mathcal{Q}_R^n$  follows the path  $\gamma$ . Set  $\mathcal{Q}_R^n(\lambda, \pi) := (\lambda^{(n)}, \pi^{(n)})$ ; then

$$\lambda^{(n)} = (B_\gamma^*)^{-1} \cdot \lambda. \quad (3.2)$$

In particular, if  $\gamma$  starts at  $\pi$ , then we have  $D_\gamma = (B_\gamma^* \cdot \mathbb{P}_+^A) \times \{\pi\}$ .

With the notations of Subsection 3.5, we define  $B^R(\lambda, \pi) := B_{\gamma(\lambda, \pi)}$ . Recall that  $H^+(\pi) := -\Omega_\pi(T_\pi^+)$ . Given  $(\lambda, \pi) \in \mathbb{R}_+^A \times \mathfrak{R}$  and  $h \in H^+(\pi)$ , the map  $\mathcal{Q}_R$  extends in the following way:

$$\hat{\mathcal{Q}}_R(\lambda, \pi, h) := (\mathcal{Q}_R(\lambda, \pi), B^R(\lambda, \pi) \cdot h). \quad (3.3)$$

It describes the way “zippered rectangles” are reordered after application of Rauzy induction; in particular, it leaves the translation structure unchanged. Recall that  $H(\pi) := \Omega_\pi(\mathbb{R}^A)$ . It is possible to show that if  $\mathcal{Q}_R(\lambda, \pi) = (\lambda^{(1)}, \pi^{(1)})$ , then

$$B^R(\lambda, \pi) \cdot H(\pi) = H(\pi^{(1)}).$$

We thus obtain an integral cocycle  $B^R(\lambda, \pi)|_{H(\pi)}$  over Rauzy induction, called the *Rauzy cocycle*.

It is easy to see that if  $[\lambda'] = [\lambda]$ , then  $\gamma(\lambda', \pi) = \gamma(\lambda, \pi)$ , hence the application  $([\lambda], \pi) \mapsto B^R([\lambda], \pi)$  is well defined. If  $([\lambda], \pi) \in \mathbb{P}_+^A \times \mathfrak{R}$ , then analogously, the restriction  $B^R([\lambda], \pi)|_{H(\pi)}$  defines a cocycle over  $\mathcal{R}_R|_{\mathbb{P}_+^A \times \mathfrak{R}}$ , which we will also call the Rauzy cocycle.

**3.7. Recurrence for  $\mathcal{R}_R$ , bounded distortion and fast decay.** We choose here  $\mathcal{A} = \{1, \dots, d\}$  for some integer  $d > 1$ , and denote  $\mathfrak{S}_d^0 := \mathfrak{S}^0(\{1, \dots, d\})$ . Let  $\mathfrak{R} \subset \mathfrak{S}_d^0$  be a Rauzy class and choose  $\pi \in \mathfrak{R}$ . Assume that for some path  $\gamma_0 \in \Pi(\mathfrak{R})$  which starts and ends at  $\pi$ , the coefficients of the matrix  $B_{\gamma_0}$  are all positive. We let  $\Delta := B_{\gamma_0}^* \cdot \mathbb{P}_+^{d-1}$ ; it is a simplex compactly contained in  $\mathbb{P}_+^{d-1}$ , that we identify here with  $\{\lambda \in \mathbb{R}_+^d, |\lambda| := \sum_i \lambda_i = 1\}$ . By projection on the first coordinate, the first-return map of  $\mathcal{R}_R$  to  $\Delta \times \{\pi\}$  induces a map  $T: \Delta \rightarrow \Delta$ , whose domain of definition we denote by  $\Delta^1$ . By Poincaré recurrence theorem, we know that  $\Delta^1$  has full measure inside  $\Delta$ .

Let us denote by  $\Pi(\mathfrak{R})_\pi$  the subset of paths in  $\Pi(\mathfrak{R})$  that start and end at  $\pi$ , and which are *primitive* in the sense that all intermediate vertices differ from  $\pi$ . Then  $\Delta^1$  admits a countable partition  $(\Delta_\gamma)_{\gamma \in \Pi(\mathfrak{R})_\pi}$ , where the subset  $\Delta_\gamma := B_\gamma^* \cdot \Delta$  corresponds to those  $\lambda \in \Delta^1$  for which  $(\lambda, \pi) \in D_\gamma$  first returns to  $\Delta \times \{\pi\}$  under  $\mathcal{R}_R$  after having followed the path  $\gamma$  in the Rauzy diagram. In particular  $T|_{\Delta_\gamma}: \lambda \mapsto \frac{(B_\gamma^*)^{-1} \cdot \lambda}{|(B_\gamma^*)^{-1} \cdot \lambda|}$ . In the following we will denote  $h_\gamma := (T|_{\Delta_\gamma})^{-1}$ .

**Lemma 1.11.** *The map  $T$  preserves a probability measure  $\mu$  with respect to which it is strongly expanding, hence has bounded distortion.*

PROOF. We have seen that  $\Delta \Subset \mathbb{P}_+^{d-1}$  admits a countable partition (modulo 0)  $\{\Delta_\gamma\}_{\gamma \in \Pi(\mathfrak{R})_\pi}$  into subsets  $\Delta_\gamma = B_\gamma^* \cdot \Delta$  of positive Lebesgue measure. For each such  $\gamma$ ,  $T|_{\Delta_\gamma}$  maps  $\Delta_\gamma$  bijectively onto  $\Delta$ , and its inverse  $h_\gamma$  is the restriction of the projective contraction  $B_\gamma^*$ . Since  $\Delta \Subset \mathbb{P}_+^{d-1}$ , Lemma 1.5 tells us that the map  $T$  preserves a probability measure  $\mu$  which is absolutely continuous with respect to Lebesgue measure. Moreover,  $T$  is strongly expanding with respect to  $\mu$ , and it also has bounded distortion by Lemma 1.4.  $\square$

In the following we consider the probability measure  $\mu$  given by Lemma 1.11

**Lemma 1.12.** *The map  $T$  is fast decaying.*

Before giving the proof, we need to recall a fact from [AGY]. In this paper, Avila, Gouëzel and Yoccoz investigate the properties of a flow defined as a suspension over  $\mathcal{R}_R$ . The set  $\Delta \times \{\pi\}$  can be seen as a transverse section for the flow; moreover, the

first-return time function  $r_\Delta: \Delta \rightarrow \mathbb{R}_+ \cup \{\infty\}$  of this flow to  $\Delta \times \{\pi\}$  satisfies: for any  $\gamma \in \Pi(\mathfrak{R})_\pi$ ,

$$r_\Delta \circ h_\gamma: \lambda \mapsto \log |B_\gamma^* \cdot \lambda|. \quad (3.4)$$

Their analysis implies the following result.

**Theorem 1.13** (Theorem 4.7, Avila-Gouëzel-Yoccoz [AGY]). *The map  $r_\Delta$  has exponential tails, i.e., there exists  $\sigma_0 > 0$  such that*

$$A := \int_\Delta e^{\sigma_0 r_\Delta(\lambda)} d\mu(\lambda) < \infty.$$

By Markov inequality, it follows that for any  $r \geq 0$ ,

$$\mu(\lambda \in \Delta, r_\Delta(\lambda) \geq r) \leq Ae^{-\sigma_0 r}. \quad (3.5)$$

They also obtain the following distortion estimate.

**Lemma 1.14** (Lemma 4.6, Avila-Gouëzel-Yoccoz [AGY]). *There exists a constant  $C > 0$  such that for any path  $\gamma \in \Pi(\mathfrak{R})_\pi$ ,*

$$\|D(r_\Delta \circ h_\gamma)\|_{C^0} \leq C. \quad (3.6)$$

*Proof of Lemma 1.12.* Let  $\gamma \in \Pi(\mathfrak{R})_\pi$ . The Jacobian of  $h_\gamma$  at the point  $\lambda \in \Delta$  is given by  $|\det Dh_\gamma(\lambda)| = \frac{1}{|B_\gamma^* \cdot \lambda|^d}$ . We deduce

$$\mu(\Delta_\gamma) = \mu(B_\gamma^* \cdot \Delta) = \int_\Delta |B_\gamma^* \cdot \lambda|^{-d} d\mu(\lambda) = \int_\Delta e^{-dr_\Delta \circ h_\gamma(\lambda)} d\mu(\lambda). \quad (3.7)$$

Let  $\varepsilon > 0$  and assume that  $\mu(\Delta_\gamma) \leq \varepsilon$ . If  $\lambda_0 \in \Delta$  is chosen such that  $r_\Delta \circ h_\gamma$  is maximal in  $\lambda_0$ , then from (3.7), we see that

$$r_\Delta \circ h_\gamma(\lambda_0) \geq -\frac{\ln(\varepsilon)}{d} + C(\Delta),$$

where we have set  $C(\Delta) := \frac{\ln(\mu(\Delta))}{d}$ . By (3.6), we obtain a constant  $C'(\Delta)$  such that for any  $\lambda \in \Delta$ ,

$$r_\Delta \circ h_\gamma(\lambda) \geq -\frac{\ln(\varepsilon)}{d} + C'(\Delta).$$

If we choose  $r := -\frac{\ln(\varepsilon)}{d} + C'(\Delta)$  in (3.5), we thus get

$$\begin{aligned} \sum_{\mu(\Delta_\gamma) \leq \varepsilon} \mu(\Delta_\gamma) &\leq \mu(\lambda \in \Delta, r_\Delta(\lambda) \geq r) \\ &\leq C_1 \varepsilon^{\alpha_1} \end{aligned}$$

with  $C_1 := Ae^{-\sigma_0 C'(\Delta)} > 0$  and  $\alpha_1 := \sigma_0/d > 0$ .  $\square$

Furthermore, the Rauzy cocycle induces the locally constant cocycle  $(T, A)$  where  $A|_{\Delta_\gamma} := B_\gamma$ .

**Lemma 1.15.** *The cocycle  $(T, A)$  is fast decaying.*

**PROOF.** It remains to show that  $A$  is fast decaying. For any  $\gamma \in \Pi(\mathfrak{R})_\pi$ ,  $B_\gamma \in \text{SL}(d, \mathbb{Z})$ ; it follows that if  $\|B_\gamma\|_\infty \leq M$ , then we also have  $\|B_\gamma^{-1}\|_\infty \leq (d-1)!M^{d-1}$ . In particular, for any  $n \geq 0$ ,  $\max(\|B_\gamma\|_\infty, \|B_\gamma^{-1}\|_\infty) \geq n$  implies that  $\min(\|B_\gamma^*\|_\infty, \|(B_\gamma^*)^{-1}\|_\infty) \geq \left(\frac{n}{(d-1)!}\right)^{\frac{1}{d-1}}$ . Therefore, by (3.7), and by equivalence of the norms, there exists a constant  $\tilde{C}_0 > 0$  depending only on  $d, \mu$  and  $\Delta$  such that if  $\|B_\gamma\|_0 \geq n$  for some  $n \geq 0$ , then  $\mu(\Delta_\gamma) = \int_\Delta |B_\gamma^* \cdot \lambda|^{-d} d\mu(\lambda) \leq \tilde{C}_0 n^{-\frac{d}{d-1}} \leq \tilde{C}_0 n^{-1}$ . We deduce from what precedes that

$$\begin{aligned} \sum_{\|B_\gamma\|_0 \geq n} \mu(\Delta_\gamma) &\leq \sum_{\mu(\Delta_\gamma) \leq \tilde{C}_0 n^{-1}} \mu(\Delta_\gamma) \\ &\leq C_2 n^{-\alpha_2}, \end{aligned}$$

where we have set  $C_2 := C_1 \tilde{C}_0^{\alpha_1} > 0$  and  $\alpha_2 := \alpha_1 > 0$ , which concludes.  $\square$

We have seen that for the transformation  $T$  to be well defined, we have to restrict ourselves to the (full-measure) subset  $\Delta^1 \subset \Delta$ . Similarly, for every  $n \geq 1$ , let  $\Delta^n$  be the domain of  $T^n$  and denote by  $\Delta^\infty := \bigcap_{n \in \mathbb{N}} \Delta^n$  the subset of points in  $\Delta$  which come back to  $\Delta$  infinitely many times. To conclude this part, we will explain why it is not a limitation to consider only points in  $\Delta^\infty$ , since it will not affect the result on Hausdorff dimension we aim to show. It follows in fact from a result of Avila and Delecroix that we now recall, and which tells us that the set of escaping points has small Hausdorff dimension.

**Proposition 1.16** (Theorem 29, Avila-Delecroix [AD]). *Let  $\Delta$  be a simplex in  $\mathbb{P}_+^{d-1}$  admitting a partition  $\{\Delta^{(l)}\}_{l \in \mathbb{Z}}$ , and let  $T: \Delta \rightarrow \Delta$  be a map with bounded distortion and such that for every  $l \in \mathbb{Z}$ ,  $T|_{\Delta^{(l)}}$  is a projective transformation. Assume that  $T$  is fast decaying with fast decay constant  $\alpha_1 > 0$ . Then*

$$\text{HD}(\Delta \setminus \Delta^\infty) \leq d - 1 - \frac{\alpha_1}{1 + \alpha_1} < d - 1.$$

#### 4. General weak mixing for interval exchange transformations & translation flows

**4.1. Weak mixing for interval exchange transformations.** Let  $d > 1$  be an integer and recall that  $\mathfrak{S}_d^0 := \mathfrak{S}^0(\{1, \dots, d\})$ . Our main result is the following.

**Theorem 1.17.** *Let  $\pi \in \mathfrak{S}_d^0$  be an irreducible permutation which is not a rotation; then the set of  $[\lambda] \in \mathbb{P}^{d-1}$  such that  $f([\lambda], \pi)$  is not weakly mixing has Hausdorff dimension strictly less than  $d - 1$ .*

As recalled in the introduction, weak mixing for the interval exchange transformation  $f$  is equivalent to the non-existence of non-constant measurable solutions  $\phi: I \rightarrow \mathbb{C}$  to the following equation:

$$\phi(f(x)) = e^{2\pi i t} \phi(x), \quad x \in I, \quad (4.1)$$

for any  $t \in \mathbb{R}$ . This is equivalent to the following two conditions:

- $f$  is ergodic;
- for any  $t \in \mathbb{R} \setminus \mathbb{Z}$ , there is no nonzero measurable solution  $\phi: I \rightarrow \mathbb{C}$  to the equation

$$\phi(f(x)) = e^{2\pi i t} \phi(x), \quad x \in I. \quad (4.2)$$

Let  $\pi$  satisfying the assumptions of Theorem 1.17. The proof follows three steps:

- (1) Using fast decay and results of [Mal] and [V2], we show that the set of  $[\lambda]$  such that  $f([\lambda], \pi)$  is not ergodic does not have full Hausdorff dimension.
- (2) We then adapt a theorem of Veech [V4] to deal with the case where  $(1, \dots, 1) \notin H(\pi)$  (the genus-one case is a particular instance of it).
- (3) The case where  $g > 1$  and  $(1, \dots, 1) \in H(\pi)$  is addressed by adapting the probabilistic argument contained in [AF] to get some estimate on the Hausdorff dimension of “bad” parameters.

**4.1.1. Unique ergodicity of interval exchange transformations.** Let  $\mathfrak{R} \subset \mathfrak{S}_d^0$  be a Rauzy class, let  $\pi \in \mathfrak{R}$ . Given  $\lambda \in \mathbb{R}_+^d$  with rationally independent coordinates, we consider  $f = f(\lambda, \pi): I \rightarrow I$ . Let us denote by  $\mathcal{M}_f := \{\mu, f_*\mu = \mu\}$  the set of invariant measures; recall that the map  $\mu \mapsto (\mu(I_i))_{i=1, \dots, d}$  is a linear isomorphism between  $\mathcal{M}_f$  and the set

$$\bigcap_{n \geq 1} B_n^R(\lambda, \pi)^* \cdot \mathbb{R}_+^d.$$

From this fact, Veech (see Proposition 2.13, [V1]) deduces that  $f([\lambda], \pi)$  is uniquely ergodic as soon as there exists  $n \geq 1$  such that all the coefficients of  $B_n^R([\lambda], \pi)$  are positive, and for infinitely many  $k \geq 0$ ,  $B_n^R(\mathcal{R}_R^k([\lambda], \pi)) = B_n^R([\lambda], \pi)$ .

The first point is handled in [MMY], §1.2.3-1.2.4. In this work the authors show that for an i.e.t. which satisfies *Keane's condition*, there exists an integer  $n \geq 1$  such that all the coefficients of  $B_n^R([\lambda], \pi)$  are positive. We won't detail the definition of Keane's condition; just recall that it is implied by our assumption on the coordinates of  $[\lambda]$  to be rationally independent. Moreover, a result due to Keane states that any i.e.t. satisfying this condition is topologically minimal, that is, the orbit of any point is dense.

Take  $n \geq 1$  such that all the coefficients of  $B_n^R([\lambda], \pi)$  are positive, and let  $\gamma_0 \in \Pi(\mathfrak{R})$ ,  $|\gamma_0| = n$ , be the corresponding path in the Rauzy diagram. We also assume that  $\gamma_0$  ends at  $\pi$ . Let  $\Delta = \Delta_{\gamma_0} := B_{\gamma_0}^* \cdot \mathbb{P}_+^{d-1}$  be the associate simplex; in particular, it is compactly contained in  $\mathbb{P}_+^{d-1}$  since all the coefficients of  $B_{\gamma_0}$  are positive. By expansiveness of Rauzy renormalization (indeed  $\mathcal{R}_R^n(\Delta \times \{\pi\}) = \mathbb{P}_+^{d-1} \times \{\pi\}$ ), every point in  $\mathbb{P}_+^{d-1} \times \{\pi\}$  is in the forward orbit of a point in  $\Delta \times \{\pi\}$ , so it is enough to estimate the dimension of parameters which belong to  $\Delta \times \{\pi\}$  and that do not come back infinitely many times to it. As in Subsection 3.7, we consider the map  $T: \Delta \rightarrow \Delta$  induced by  $\mathcal{R}_R$  on  $\Delta$ ; we have seen that it has bounded distortion and that it is fast decaying for some constant  $\alpha_1 > 0$  (see (2.4) for the definition). From Proposition 1.16, we know that the set  $\Delta \setminus \Delta^\infty$  of  $[\lambda] \in \Delta$  whose iterates do not come back to  $\Delta$  infinitely many times has Hausdorff dimension less than  $d - 1 - \frac{\alpha_1}{1 + \alpha_1}$ . Therefore, we deduce from the above criterion that the set of  $[\lambda] \in \Delta$  such that the i.e.t.  $f([\lambda], \pi)$  is not uniquely ergodic has Hausdorff dimension less than  $d - 1 - \frac{\alpha_1}{1 + \alpha_1}$ . By the previous remark on expansiveness, we have thus obtained:

**Theorem 1.18.** *Let  $d > 1$  and let  $\pi \in \mathfrak{S}_d^0$ ; the set of  $[\lambda] \in \mathbb{P}_+^{d-1}$  such that  $f([\lambda], \pi)$  is not uniquely ergodic has Hausdorff dimension strictly less than  $d - 1$ .*

4.1.2. *Veech criterion for weak mixing.* An important ingredient to handle the case where  $t \notin \mathbb{Z}$  in the second and the third steps detailed above is provided by the so-called *Veech criterion* for weak mixing, whose statement we now recall.

**Theorem 1.19** (Veech, [V4], §7). *For any Rauzy class  $\mathfrak{R} \subset \mathfrak{S}_d^0$  there exists an open set  $U_{\mathfrak{R}} \subset \mathbb{P}_+^{d-1} \times \mathfrak{R}$  with the following property. Assume that the orbit of  $([\lambda], \pi) \in \mathbb{P}_+^{d-1} \times \mathfrak{R}$  under the Rauzy induction map  $\mathcal{R}_R$  visits  $U_{\mathfrak{R}}$  infinitely many times. If there exists a non-constant measurable solution  $\phi: I \rightarrow \mathbb{C}$  to the equation*

$$\phi(f(x)) = e^{2\pi i t h_j} \phi(x), \quad x \in I_j^\lambda, \quad (4.3)$$

with  $t \in \mathbb{R}$ ,  $h \in \mathbb{R}^d$ , then

$$\lim_{\substack{n \rightarrow \infty \\ \mathcal{R}_R^n([\lambda], \pi) \in U_{\mathfrak{R}}}} \|B_n^R([\lambda], \pi) \cdot th\|_{\mathbb{R}^d / \mathbb{Z}^d} = 0.$$

In the context of weak mixing of i.e.t.'s, it is especially interesting to apply Veech criterion in the particular case where  $h = (1, \dots, 1)$  (see Equation (4.1)).

4.1.3. *Analysis of the case where  $(1, \dots, 1) \notin H(\pi)$ .* Let us recall a theorem due to Veech and which states almost sure weak mixing in the case where  $(1, \dots, 1) \notin H(\pi)$ .

**Theorem 1.20** (Veech, [V4], §1-6). *Let  $\pi \in \mathfrak{S}_d^0$  and suppose that  $(1, \dots, 1) \notin H(\pi)$ . Then for almost every  $\lambda \in \mathbb{R}_+^d$ ,  $f(\lambda, \pi)$  is weakly mixing.*

We want to improve this result in the following way.

**Theorem 1.21.** *Let  $\pi \in \mathfrak{S}_d^0$  and assume that  $(1, \dots, 1) \notin H(\pi)$ . Then the set of  $[\lambda] \in \mathbb{P}_+^{d-1}$  such that  $f([\lambda], \pi)$  is not weakly mixing has Hausdorff dimension strictly less than  $d - 1$ .*

The proof follows [V4]. Fix a Rauzy class  $\mathfrak{R} \subset \mathfrak{S}_d^0$ , let  $\pi \in \mathfrak{R}$  and let  $[\lambda] \in \mathbb{P}_+^{d-1}$ .

**Proposition 1.22** (Proposition 6.5, Veech [V4]). *With notations and assumptions as above, suppose that  $h \in \mathbb{R}^d$  is such that there exists an infinite set  $E$  of natural numbers satisfying*

$$\lim_{\substack{n \rightarrow \infty \\ n \in E}} e^{2\pi i (B_n^R([\lambda], \pi) \cdot h)_j} = 1, \quad 1 \leq j \leq d. \quad (4.4)$$

Then  $h \cdot b^s \in \mathbb{Z}$  for all  $s \in \Sigma(\pi)$ , where  $b^s$  is defined as in Subsection 3.3.

Let  $U_{\mathfrak{R}} \subset \mathbb{P}_+^{d-1} \times \mathfrak{R}$  be the open set involved in the statement of Veech criterion (Theorem 1.19). Reasoning as in Subsection 4.1.1, we get that for  $n \geq 0$  sufficiently large, there exists a connected component  $\Delta \times \{\pi\} \subset U_{\mathfrak{R}}$  of the domain of definition of  $\mathcal{R}_R^n$  which is labeled by a path  $\gamma_0 \in \Pi(\mathfrak{R})$  of length  $n$  starting and ending at  $\pi$  and such that the matrix  $B_{\gamma_0}$  has all its entries positive. In particular, the corresponding simplex  $\Delta = B_{\gamma_0}^* \cdot \mathbb{P}_+^{d-1}$  is compactly contained in  $\mathbb{P}_+^{d-1}$ . By expansiveness of Rauzy renormalization we know that it is sufficient to estimate the dimension of non-recurrent parameters which belong to  $\Delta$ . As in Subsection 3.7, let  $T: \Delta \rightarrow \Delta$  be the map induced by  $\mathcal{R}_R$  on  $\Delta$ ; we have seen that it has bounded distortion and fast decay. By Proposition 1.16, we deduce that the set  $\Delta \setminus \Delta^\infty$  of  $[\lambda] \in \Delta$  such that the orbit of  $([\lambda], \pi)$  under  $\mathcal{R}_R$  visits  $\Delta \times \{\pi\}$  finitely many times has Hausdorff dimension strictly less than  $d-1$ . Veech criterion together with Proposition 1.22 thus imply:

**Theorem 1.23.** *Let  $\pi \in \mathfrak{S}_d^0$ ; for every  $[\lambda]$  in a set whose complement in  $\mathbb{P}_+^{d-1}$  has Hausdorff dimension strictly less than  $d-1$ , and for all  $h \in \mathbb{R}^d$ , if  $f = f([\lambda], \pi)$  satisfies*

$$\phi(f(x)) = e^{2\pi i h_j} \phi(x), \quad x \in I_j^\lambda, \quad (4.5)$$

for some non-constant measurable function  $\phi: I \rightarrow \mathbb{C}$ , then  $h \cdot b^s \in \mathbb{Z}$  for all  $s \in \Sigma(\pi)$ .

The analogous statement was a key ingredient in the proof by Veech of Theorem 1.20.

*Proof of Theorem 1.21.* Take  $\pi \in \mathfrak{S}_d^0$ , and assume that it satisfies  $(1, \dots, 1) \notin H(\pi)$ . By definition,  $H(\pi) = \text{Span}(\Upsilon(\pi))^\perp$ , hence for some  $s \in \Sigma(\pi)$ , we have  $(1, \dots, 1) \cdot b^s \in \mathbb{Z} \setminus \{0\}$  (recall that  $b^s$  has integral coordinates). Then, Lemma 1.8 tells us that in fact,  $(1, \dots, 1) \cdot b^s = \pm 1$ .

Let  $[\lambda]$  belong to the subset of  $\mathbb{P}_+^{d-1}$  for which the conclusion of Theorem 1.23 holds. We know that its complement does not have full Hausdorff dimension. If  $f = f([\lambda], \pi)$  is not weakly mixing, then either  $f$  is not ergodic or else there exists some nonintegral  $t \in \mathbb{R}$  and a nontrivial measurable solution to Equation (4.5) for  $f$  and  $h := (t, \dots, t)$ . The first case was handled in Subsection 4.1.1. Assume now that we are in the second case. By choosing  $s$  as previously, Theorem 1.23 implies that  $t(1, \dots, 1) \cdot b^s = h \cdot b^s \in \mathbb{Z}$ . But we also have  $(1, \dots, 1) \cdot b^s = \pm 1$ , and by definition,  $t \in \mathbb{R} \setminus \mathbb{Z}$ , a contradiction.  $\square$

The case where  $g = 1$  is contained in the preceding theorem. Indeed, it is easy to see that under the hypothesis that  $\pi$  is not a rotation, our study amounts to considering the case where  $\pi$  is as follows:

$$\pi(1) = 3, \quad \pi(2) = 2, \quad \pi(3) = 1,$$

that is  $\pi = \pi_3$ , where  $\pi_d(j) := d + 1 - j$ ,  $1 \leq j \leq d$ . But for  $d$  odd, we check that  $(1, \dots, 1) \notin H(\pi_d)$ .

Theorem 1.21 enables us to improve a previous result due to Katok and Stepin in [KS]. Here is the new statement.

**Theorem 1.24.** *If  $g = 1$  and  $\pi$  is an irreducible permutation which is not a rotation, then  $f([\lambda], \pi)$  is weakly mixing except for a set of  $[\lambda]$  of Hausdorff dimension strictly less than  $d-1$ .*

4.1.4. *Analysis of the case where  $g > 1$  and  $(1, \dots, 1) \in H(\pi)$ .* To prove Theorem 1.17, it remains to deal with the case where  $g > 1$  and  $(1, \dots, 1) \in H(\pi)$ . The reason why we wanted to get rid of the genus one case is the following: the restriction of the



Rauzy cocycle to  $H(\pi)$  has  $g$  positive Lyapunov exponents; in particular we have at least two positive exponents when  $g > 1$ . As explained in the outline, this fact is central in the argument developed in [AF] and that we are going to adapt in what follows. By Veech criterion, the result we want to prove is implied by the following theorem:

**Theorem 1.25.** *Let  $\mathfrak{R} \subset \mathfrak{S}_d^0$  be a Rauzy class with  $g > 1$ , let  $\pi \in \mathfrak{R}$  and let  $h \in H(\pi)$ . Let  $U \subset \mathbb{P}_+^{d-1} \times \mathfrak{R}$  be any open set. Then the set of  $[\lambda] \in \mathbb{P}_+^{d-1}$  satisfying*

$$\limsup_{\substack{n \rightarrow \infty \\ \mathcal{R}_R^n([\lambda], \pi) \in U}} \|B_n^R([\lambda], \pi) \cdot th\|_{\mathbb{R}^d/\mathbb{Z}^d} = 0 \quad (4.6)$$

for some  $t \in \mathbb{R}$  such that  $th \notin \mathbb{Z}^d$  has Hausdorff dimension strictly less than  $d - 1$ .

For the problem of weak mixing of i.e.t.'s, and as we have already said, we are especially interested in applying this result to  $h = (1, \dots, 1)$ . Moreover, the above statement deals with  $th \notin \mathbb{Z}^d$ ; indeed, the case where  $(t, \dots, t) \in \mathbb{Z}^d$  is related to Equation (4.1) with  $t$  an integer, and this part of the study was carried out in Subsection 4.1.1.

PROOF. Fix  $\pi \in \mathfrak{R}$  and  $h \in H(\pi)$ . Let  $U \subset \mathbb{P}_+^{d-1} \times \mathfrak{R}$  be any open set and assume that  $[\lambda] \in \mathbb{P}_+^{d-1}$  satisfies (4.6) for some  $t \in \mathbb{R}$  such that  $th \notin \mathbb{Z}^d$ . We will reduce the statement to an analogous one, but for a cocycle with better properties.

We may assume that  $U$  intersects  $\mathbb{P}_+^{d-1} \times \{\pi\}$ . As in Subsection 4.1.3, we take a connected component  $\Delta \times \{\pi\} \subset U$  of the domain of  $\mathcal{R}_R^n$ ,  $n \gg 1$ , such that  $\Delta \Subset \mathbb{P}_+^{d-1}$ . We have seen that the set of points whose orbit under  $\mathcal{R}_R$  does not visit  $\Delta \times \{\pi\}$  infinitely many times does not have full Hausdorff dimension so that we can restrict ourselves to points in the complement of this set. Let  $T: \Delta \rightarrow \Delta$  be the map induced by  $\mathcal{R}_R$  on  $\Delta$ . From Lemma 1.11 we know that  $T$  has bounded distortion, which will be crucial for the following.

Let  $\Delta^\infty$  denote the subset of  $[\lambda] \in \Delta$  to which we can apply  $T$  infinitely many times.<sup>4</sup> For every  $[\lambda] \in \Delta^\infty$ , let

$$A([\lambda]) := B_{r([\lambda])}^R([\lambda], \pi)|_{H(\pi)},$$

where  $r([\lambda])$  denotes the first-return time of  $([\lambda], \pi)$  to  $\Delta \times \{\pi\}$  under  $\mathcal{R}_R$ . Lemma 1.15 tells us that the cocycle  $(T, A)$  is fast decaying. Moreover,  $(T, A)$  is locally constant, integral and log-integrable (the last point follows from fast decay of  $A$  as was remarked in Subsection 2.4). We also see that  $\Theta := \overline{\mathbb{P}_+^{d-1}}$  is adapted to  $(T, A)$ , that is  $A^{(l)} \cdot \Theta \subset \Theta$  for all  $l$  and for every  $[\lambda]$ , we have

$$\|A([\lambda]) \cdot w\| \geq \|w\|, \quad (4.7)$$

and

$$\|A_n([\lambda]) \cdot w\| \rightarrow \infty \quad (4.8)$$

whenever  $w \in \mathbb{R}_+^d \setminus \{0\}$  projectivizes to an element of  $\Theta$ . Indeed,  $w \in \mathbb{R}_+^d \setminus \{0\}$ , and the coefficients of the matrices  $(A_n([\lambda]))_n$  are positive and go to infinity (see [MMY], §1.2.3-1.2.4).

In terms of the cocycle  $(T, A)$ , Equation (4.6) can be rewritten:

$$\lim_{n \rightarrow \infty} \|A_n([\lambda]) \cdot th\|_{\mathbb{R}^d/\mathbb{Z}^d} = 0, \quad \text{for some } t \in \mathbb{R} \text{ such that } th \notin \mathbb{Z}^d. \quad (4.9)$$

Let us denote by  $J_h$  the line spanned by  $h$ . In particular, for each ‘‘bad’’ parameter  $[\lambda]$  we have  $J_h \cap (W^s([\lambda]) \setminus \mathbb{Z}^d) \neq \emptyset$ , where

$$W^s([\lambda]) := \{w \in \mathbb{R}^d, \|A_n([\lambda]) \cdot w\|_{\mathbb{R}^d/\mathbb{Z}^d} \rightarrow 0\}$$

denotes the weak-stable space for  $\{A_n([\lambda])\}_{n \geq 0}$ . Let then

$$\mathcal{E}_{t,h} := \{[\lambda] \in \Delta, th \in W^s([\lambda])\}.$$

4. Its complement does not have full Hausdorff dimension by Proposition 1.16.



In Section 6.1 we exhibit a set  $\mathcal{E}_h$  depending only on  $h$  (in fact on the line  $J_h$ ) and such that  $\bigcup_{t \in \mathbb{R}, th \notin \mathbb{Z}^d} \mathcal{E}_{t,h} \subset \mathcal{E}_h$ . Theorem 1.25 follows from the next result, whose proof is deferred to Subsection 6.1.

**Theorem 1.26.** *We have  $\text{HD}(\mathcal{E}_h) < d - 1$ .*

□

**4.2. Proof of Theorem 1.17.** Using the previous results, we give here the proof of Theorem 1.17. Let  $\mathfrak{R} \subset \mathfrak{S}_d^0$  and take  $\pi \in \mathfrak{R}$  an irreducible permutation which is not a rotation. Assume  $[\lambda] \in \mathbb{P}_+^{d-1}$  is such that  $f = f([\lambda], \pi)$  is not weakly mixing. If  $(1, \dots, 1) \notin H(\pi)$ , then Theorem 1.21 gives the result. Let us then consider the case where  $g > 1$  and  $(1, \dots, 1) \in H(\pi)$ . As we have said, the fact that  $f$  is not weakly mixing means that either it is not ergodic or that for some  $t \in \mathbb{R} \setminus \mathbb{Z}$ , there is a nonzero measurable solution  $\phi: I \rightarrow \mathbb{C}$  to

$$\phi \circ f = e^{2\pi it} \phi. \quad (4.10)$$

By Theorem 1.18, we know that  $f([\lambda], \pi)$  is uniquely ergodic, hence ergodic, but for a set of  $[\lambda]$  with non-full Hausdorff dimension. It thus remain to deal with Equation (4.10) for  $t \notin \mathbb{Z}$ .

Assume (4.10) holds for some nonzero  $\phi$  and  $t \notin \mathbb{Z}$ . Let  $U_{\mathfrak{R}}$  be the open set given by Veech criterion (Theorem 1.19), that we apply here with this choice of  $t$  and  $h = (1, \dots, 1) \in H(\pi)$ . We take a connected component  $\Delta \times \{\pi\} \subset U_{\mathfrak{R}}$  of the domain of  $\mathcal{R}_{\mathbb{R}}^n$ ,  $n \gg 1$ , such that  $\Delta \Subset \mathbb{P}_+^{d-1}$ , and we consider the cocycle  $(T, A)$  where  $T: \Delta \rightarrow \Delta$  is the map induced by Rauzy renormalization, and  $A$  is induced by the Rauzy cocycle  $B^R|_{H(\pi)}$ . We know from Theorem 1.16 that we can restrict ourselves to the set  $\Delta^\infty$  of  $[\lambda]$  to which we can apply  $T$  infinitely many times since the set of escaping points does not have full Hausdorff dimension. By Veech criterion, (4.10) implies that

$$\lim_{n \rightarrow \infty} \|A_n([\lambda]) \cdot th\|_{\mathbb{R}^d / \mathbb{Z}^d} = 0,$$

hence  $[\lambda] \in \mathcal{E}_{t,h}$  with our previous notations. We deduce that  $[\lambda] \in \mathcal{E}_h = \mathcal{E}_{(1, \dots, 1)}$ , but by Theorem 1.26, the latter does not have full Hausdorff dimension, which concludes.

### 4.3. Weak mixing for flows.

**4.3.1. Special flows.** Any translation flow on a translation surface can be regarded, by considering its return map to a transverse interval, as a *special flow* (suspension flow) over some interval exchange transformation with a roof function constant on each subinterval.

Let  $F = F(h, \lambda, \pi)$  be the special flow over the i.e.t.  $f = f(\lambda, \pi)$  with roof function specified by the vector  $h \in \mathbb{R}_+^d$ , that is, the roof function is constant equal to  $h_i$  on the subinterval  $I_i = I_i^\lambda$ , for all  $i \in \{1, \dots, d\}$ . It is possible to see that if  $F$  is a translation flow then necessarily  $h \in H(\pi)$ . As for interval exchange transformations, we can projectivize the length data  $\lambda$ .

As explained earlier, the phase space of  $F$  is the union of disjoint rectangles  $D := \bigcup_i I_i \times [0, h_i)$ , and the flow  $F$  is completely determined by the conditions  $F_s(x, 0) = (x, s)$ ,  $x \in I_i$ ,  $s < h_i$ ,  $F_{h_i}(x, 0) = (f(x), 0)$ , for all  $i \in \{1, \dots, d\}$ . Weak mixing for the flow  $F$  is equivalent to the non-existence of non-constant measurable solutions  $\phi: D \rightarrow \mathbb{C}$  to

$$\phi(F_s(x)) = e^{2\pi its} \phi(x),$$

for any  $t \in \mathbb{R}$ , or, in terms of the i.e.t.  $f$ ,

- (1)  $f$  is ergodic;
- (2) for any  $t \neq 0$  there are no nonzero measurable solutions  $\phi: I \rightarrow \mathbb{C}$  to Equation (4.3).

**Theorem 1.27.** *Let  $\pi \in \mathfrak{S}_d^0$  with  $g > 1$ . For every  $h \in (H(\pi) \cap \mathbb{R}_+^d)$  and every  $[\lambda] \in \mathbb{P}_+^{d-1}$  except for a subset of Hausdorff dimension strictly less than  $d - 1$ , the special flow  $F(h, \lambda, \pi)$  is weakly mixing.*

The proof is an immediate consequence of Veech criterion and of Theorem 1.25.

4.3.2. *Weak mixing for translation flows.* Let  $\mathfrak{R} \subset \mathfrak{S}_d^0$  be a Rauzy class with  $d > 1$ , and let  $\pi \in \mathfrak{R}$ . We have seen that the associate space of translation flows is parametrized by  $(h, [\lambda]) \in H(\pi) \times \mathbb{P}_+^{d-1}$ , where  $H(\pi)$  has dimension  $2g$ . As for i.e.t.'s, we want to prove that the set of  $(h, [\lambda]) \in H(\pi) \times \mathbb{P}_+^{d-1}$  such that the corresponding flow is not weakly mixing has Hausdorff dimension strictly less than  $2g + d - 1$ . If we look at Theorem 1.27, the point is that the Hausdorff dimension of a product is not necessarily less than the sum of the Hausdorff dimension of the two factors.<sup>5</sup> Considering the return map to a transverse interval, and by Veech criterion, it is enough to show the following.

**Theorem 1.28.** *Let  $U \subset \mathbb{P}_+^{d-1} \times \mathfrak{R}$  be any open set. The set of  $(h, [\lambda]) \in (H(\pi) \setminus \mathbb{Z}^d) \times \mathbb{P}_+^{d-1}$  satisfying*

$$\limsup_{\substack{n \rightarrow \infty \\ \mathcal{R}_R^n([\lambda], \pi) \in U}} \|B_n^R([\lambda], \pi) \cdot h\|_{\mathbb{R}^d / \mathbb{Z}^d} = 0$$

*has Hausdorff dimension strictly less than  $2g + d - 1$ .*

Again we restrict ourselves to a simplex  $\Delta \Subset \mathbb{P}_+^{d-1}$ , and we define a cocycle  $(T, A)$ , where  $T: \Delta \rightarrow \Delta$  is the map induced by Rauzy renormalization. We let

$$\mathcal{F} := \{(h, [\lambda]) \in H(\pi) \times \Delta, h \in W^s([\lambda]) \setminus \mathbb{Z}^d\}.$$

It is then sufficient to show the following result, which is proved in Subsection 6.2.

**Theorem 1.29.** *We have  $\text{HD}(\mathcal{F}) < 2g + d - 1$ .*

## 5. Study of the weak-stable lamination

**5.1. The probabilistic argument of Avila and Forni [AF].** As in [AF], we consider here an abstract locally constant integral cocycle  $(T, A)$ . We also assume that  $T$  has bounded distortion<sup>6</sup>, and that  $(T, A)$  is fast decaying; as we have already seen, this implies that  $(T, A)$  is log-integrable. Let  $\Theta \subset \mathbb{P}_+^{d-1}$  be a compact set adapted to  $(T, A)$  (see (4.7) and (4.8) for the definition). We define  $\mathcal{J} = \mathcal{J}(\Theta)$  to be the set of lines in  $\mathbb{R}^d$ , parallel to some element of  $\Theta$  and not passing through 0.

Recall the definition of the *weak-stable lamination* associated to the cocycle  $(T, A)$  at some point  $x \in \Delta$ :

$$W^s(x) := \{w \in \mathbb{R}^d, \|A_n(x) \cdot w\|_{\mathbb{R}^d / \mathbb{Z}^d} \rightarrow 0\},$$

where  $\|\cdot\|_{\mathbb{R}^d / \mathbb{Z}^d}$  is the euclidean distance from  $\mathbb{Z}^d$ . For  $0 < \delta < 1/10$  and  $n \geq 0$ , we define

$$W_{\delta, n}^s(x) := \{w \in B_\delta(0), \forall k \leq n, \|A_k(x) \cdot w\|_{\mathbb{R}^d / \mathbb{Z}^d} < \delta\}$$

and we let

$$W_\delta^s(x) := \bigcap_{n \geq 0} W_{\delta, n}^s(x).$$

For every such  $\delta$  and for all  $w \in W^s(x)$ , we see that there exists  $n_0 \geq 0$  such that for every  $n \geq n_0$ , there exists  $c_n(w) \in \mathbb{Z}^d$  with  $A_n(x) \cdot w - c_n(w) \in W_\delta^s(T^n(x))$ .

Recall that  $\Omega$  denotes the set of all finite words with integer entries. For any  $0 < \delta < 1/10$  and  $\underline{l} \in \Omega$ , let  $\phi_\delta(\underline{l}, J)$  be the number of connected components of the set  $A^{\underline{l}}(J \cap B_\delta(0)) \cap B_\delta(\mathbb{Z}^d \setminus \{0\})$ . If  $J \in \mathcal{J}$ , we let  $\|J\|$  denote the distance between  $J$  and 0. Given  $J$  with  $\|J\| < \delta$  and  $\underline{l} \in \Omega$ , let  $J_{\underline{l}, 1}, \dots, J_{\underline{l}, \phi_\delta(\underline{l}, J)}$  be all the lines of the form  $A^{\underline{l}} \cdot J - c$  where  $A^{\underline{l}} \cdot (J \cap B_\delta(0)) \cap B_\delta(c) \neq \emptyset$  with  $c \in \mathbb{Z}^d \setminus \{0\}$ : such lines are called

5. For instance, it is possible to find  $X$  and  $Y$ ,  $\text{HD}(X) = \text{HD}(Y) = 0$ , but  $\text{HD}(X \times Y) = 1$ .

6. with respect to a measure  $\mu$ .

non-trivial children of  $J$ . We also define  $J_{\underline{l},0} := A^{\underline{l}} \cdot J$ . If  $\|A^{\underline{l}} \cdot J\| < \delta$ , then  $J_{\underline{l},0}$  is called a *trivial child* of  $J$ .

**Remark 1.30.** We define  $\phi_\delta(\underline{l}) := \sup_{J \in \mathcal{J}} \phi_\delta(\underline{l}, J)$ . It is clear that by making  $\delta \rightarrow 0$ , non-trivial children become rarer, which means that for any (fixed)  $\underline{l} \in \Omega$ , the function  $\delta \mapsto \phi_\delta(\underline{l})$  is non-decreasing. We see that there exists some  $\delta_{\underline{l}} > 0$  such that for  $\delta < \delta_{\underline{l}}$ , we have  $\phi_\delta(\underline{l}) = 0$ .

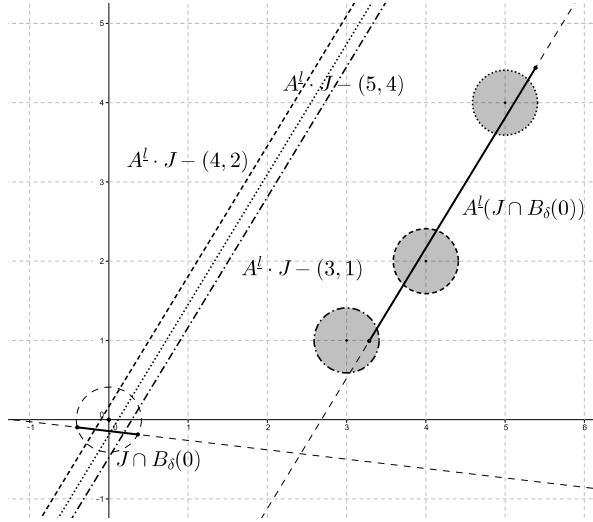

FIGURE 1. A line and its first-generation children

Fix  $N \in \mathbb{N} \setminus \{0\}$ , and let  $\Omega^N$  be the set of all words of length  $N$ . The set  $\Delta$  admits a countable partition  $\bigcup_{\underline{l} \in \mathcal{Z}} \Delta^{(\underline{l})}$ , and since  $A$  is locally constant, it is possible to associate to each  $x \in \Delta$  a word  $l_0(x)l_1(x)l_2(x) \dots$ , where  $l_m(x) \in \Omega^N$  is such that  $T^{mN}(x) \in \Delta^{l_m(x)}$ . We call such a  $l_m(x)$  a “slice” of  $x$ . To each slice  $l_m(x)$  of  $x$  corresponds the matrix  $A^{l_m(x)} = A_N(T^{mN}(x))$ . The integer  $N$  enables us to accelerate the process so as to “see” the Lyapunov exponents.

In order to study the weak-stable lamination, Avila and Forni introduced the following process. Given  $x \in \Delta$ ,  $\delta > 0$  and a line  $J$  with  $\|J\| < \delta$ , we apply successively the matrices  $(A^{l_m(x)})_m$  to  $J$  and estimate the number of children at each step. *A priori* this number might grow exponentially fast; in fact the probability that this process survives up to time  $m$  goes to zero exponentially fast with  $m$  as we will see.

Given  $0 < \eta < 1/10$ , select a finite set  $Z \subset \Omega^N$  of big measure:

$$\mu \left( \bigcup_{\underline{l} \in Z} \Delta^{\underline{l}} \right) > 1 - \eta. \quad (5.1)$$

Since the cocycle is locally constant and log-integrable, there exists  $0 < \eta_0 < 1/10$  such that for  $0 < \eta < \eta_0$ ,

$$\sum_{\underline{l} \in \Omega^N \setminus Z} \ln \|A^{\underline{l}}\|_0 \mu(\Delta^{\underline{l}}) < \frac{1}{2}, \quad (5.2)$$

which will ensure that in average, matrices with label in  $Z$  overcome the others.

Moreover, since  $Z$  is finite, it is possible by Remark 1.30 to ensure that for each  $J \in \mathcal{J}$ , when the matrix we apply to  $J$  is labeled by a word in  $Z$ , then the only potential child is trivial. But the existence of at least two positive Lyapunov exponents generates a

drift that makes each child further from the origin than the original line was. Therefore, if we can do so that a typical  $x \in \Delta$  has enough slices in  $Z$ , then the previous process has good chances to have finite life expectancy.

For every  $m \geq 0$ , we define

$$\Gamma_\delta^m(J) := \{x \in \Delta, J \cap W_{\delta, mN}^s(x) \neq \emptyset\}.$$

It is the set of points for which the above process will last a minimum of  $m$  steps. The main result of this section is the following.

**Proposition 1.31.** *There exists  $N_0 \in \mathbb{N} \setminus \{0\}$  such that for  $N > N_0$ , we may find constants  $C > 0$ ,  $\kappa > 0$  and  $\rho > 0$  such that for every  $J \in \mathcal{J}$ ,*

$$\mu(\Gamma_\delta^m(J)) \leq Ce^{-\kappa m} \|J\|^{-\rho}.$$

Note that the dependence in  $J$  in the previous expression is quite reasonable: the process will survive longer if the initial line  $J$  is chosen close to the origin, that is, when  $\|J\|$  is small.

To prove Proposition 1.31, we condition the probabilities according to whether we are in  $Z$  or not: given measurable sets  $X, Y \subset \Delta$  such that  $\mu(Y) > 0$ , and with the notations of Section 2, let

$$P_\nu(X|Y) := \frac{\nu(X \cap Y)}{\nu(Y)}, \quad \nu \in \mathcal{M} := \{\mu^{\underline{l}}, \underline{l} \in \Omega^N\}, \quad (5.3)$$

$$P(X|Y) := \sup_{\nu \in \mathcal{M}} P_\nu(X|Y). \quad (5.4)$$

We introduce functions  $\psi, \Psi$  to encode whether slices belong to  $Z$  or not. More precisely, let  $\psi: \Omega^N \rightarrow \mathbb{Z}$  be such that  $\psi(\underline{l}) = 0$  if  $\underline{l} \in Z$ , and  $\psi(\underline{l}) \neq \psi(\underline{l}')$  whenever  $\underline{l} \neq \underline{l}'$  and  $\underline{l}, \underline{l}' \notin Z$ . We denote by  $\hat{\Omega}^N$  the set of all words whose length is a multiple of  $N$ . Let then  $\Psi: \hat{\Omega}^N \rightarrow \Omega$  be given by  $\Psi(\underline{l}^1 \dots \underline{l}^m) = \psi(\underline{l}^1) \dots \psi(\underline{l}^m)$ , where  $\underline{l}^i \in \Omega^N$ ,  $i = 1, \dots, m$ . For any  $\underline{d} \in \Omega$ , define

$$\hat{\Delta}^{\underline{d}} := \bigcup_{\underline{l} \in \Psi^{-1}(\underline{d})} \Delta^{\underline{l}}.$$

Let  $\rho > 0$ . For each  $\underline{d} \in \Omega$ ,  $|\underline{d}| = m$ , we define  $C(\underline{d}) \geq 0$  as the smallest number such that

$$P(\Gamma_\delta^m(J)|\hat{\Delta}^{\underline{d}}) := \sup_{\nu \in \mathcal{M}} P_\nu(\Gamma_\delta^m(J)|\hat{\Delta}^{\underline{d}}) \leq C(\underline{d}) \|J\|^{-\rho}, \quad J \in \mathcal{J}. \quad (5.5)$$

Note that  $C(\underline{d}) \leq 1$  for all  $\underline{d}$ ; indeed, if  $\|J\| > \delta$ , then  $\Gamma_\delta^m(J) = \emptyset$ , else  $P(\Gamma_\delta^m(J)|\hat{\Delta}^{\underline{d}}) \|J\|^\rho \leq \delta^\rho \leq 1$ . The following technical estimate is the key step in the proof of Proposition 1.31.

**Lemma 1.32** (Claim 3.7, Avila-Forni [AF]). *There exists  $N_0 \in \mathbb{N} \setminus \{0\}$  such that for  $N > N_0$ , if  $Z \subset \Omega^N$  and  $0 < \eta < \eta_0$  are taken such that (5.1) and (5.2) hold, then there exists  $\rho_0(Z) > 0$  such that for  $0 < \rho < \rho_0(Z)$ , and for  $0 < \delta < 1/10$  sufficiently small, we have for any  $\underline{d} = (d_1 \dots d_m) \in \Omega$ :*

$$C(\underline{d}) \leq \prod_{d_i=0} (1 - \rho) \prod_{d_i \neq 0, \psi(\underline{l}^i)=d_i} \|A^{\underline{l}^i}\|_0^\rho (1 + \|A^{\underline{l}^i}\|_0 (2\delta)^\rho). \quad (5.6)$$

This means that at each occurrence of a slice in  $Z$ , the previous quantity decreases by at least a given factor. Therefore, if the behavior of matrices with label in  $Z$  is prevalent, it follows that for a typical infinite word  $\underline{d} = d_1 d_2 d_3 \dots$ , the probability  $P(\Gamma_\delta^m(J)|\hat{\Delta}^{\underline{d}^m})$  goes to zero exponentially fast with respect to  $m$ , where we have set  $\underline{d}^m := d_1 d_2 \dots d_m$ .

**5.2. Large deviations: proof of Proposition 1.31.** At this point we fix  $N > N_0$ ,  $Z \subset \Omega^N$ ,  $0 < \eta < \eta_0$ ,  $0 < \rho < \rho_0(Z)$  and  $0 < \delta < 1/10$  in such a way that the assumptions of Lemma 1.32 are satisfied; we also assume that  $\delta$  is small enough such that <sup>7</sup>

$$\sum_{\underline{l} \in \Omega^N \setminus Z} (\rho \ln \|A^{\underline{l}}\|_0 + \ln(1 + \|A^{\underline{l}}\|_0(2\delta)^\rho)) \mu(\Delta^{\underline{l}}) - \rho \mu \left( \bigcup_{\underline{l} \in Z} \Delta^{\underline{l}} \right) = \alpha < 0. \quad (5.7)$$

This ensures that on average, the behavior of words in  $Z$  prevails. For any  $x \in \Delta$ , we let

$$\gamma(x) := \begin{cases} -\rho & \text{if } x \in \bigcup_{\underline{l} \in Z} \Delta^{\underline{l}}, \\ \rho \ln \|A^{\underline{l}}\|_0 + \ln(1 + \|A^{\underline{l}}\|_0(2\delta)^\rho) & \text{if } x \in \Delta^{\underline{l}}, \underline{l} \in \Omega^N \setminus Z. \end{cases}$$

For each  $k \in \mathbb{N}$ , we define the random variable

$$X_k: \begin{cases} \Delta & \longrightarrow \mathbb{R} \\ x & \longmapsto \gamma(T^{kN}(x)), \end{cases}$$

and we set  $S_m := \sum_{k=0}^{m-1} X_k$ . From (5.7) and the  $T$ -invariance of  $\mu$ , we get: for every  $k \geq 0$ ,

$$\mathbb{E}(X_k) := \int_{\Delta} \gamma(T^{kN}(x)) d\mu(x) = \alpha < 0.$$

For  $x \in \hat{\Delta}^{\underline{d}}$ ,  $|\underline{d}| = m$ , let  $C_m(x) := C(\underline{d})$ . Then by (5.6),

$$\ln C_m(x) \leq S_m(x).$$

Since  $T$  is ergodic, Birkhoff's ergodic theorem implies that for almost every  $x \in \Delta$ ,

$$\limsup_{m \rightarrow \infty} \frac{\ln C_m(x)}{m} \leq \limsup_{m \rightarrow \infty} \frac{S_m(x)}{m} = \alpha < 0.$$

It follows that for almost every  $x \in \Delta$ , there exists  $m_0$  such that for  $m \geq m_0$  we have  $C_m(x) < e^{\frac{m\alpha}{2}}$ . Define

$$E_m := \{x \in \Delta, C_m(x) \geq e^{\frac{m\alpha}{2}}\}.$$

We show the following large deviations result for  $C_m$ :

**Lemma 1.33.** *There exist  $\beta < 1$  and  $\tilde{C} > 0$  such that  $\mu(E_m) \leq \tilde{C}\beta^m$ .*

To prove this result, we will use a general estimate obtained in [AD] and that we now recall. Let  $U: \Delta \rightarrow \Delta$  be a transformation with bounded distortion with respect to the reference measure  $\mu$ , let  $\nu$  be the invariant measure, and  $(U, B)$  a locally constant cocycle over  $U$ . The *expansion constant* of  $(U, B)$  is the maximal  $c \in \mathbb{R}$  such that for all  $v \neq 0$  and almost every  $x \in \Delta$ , <sup>8</sup>

$$\lim_{n \rightarrow \infty} \frac{1}{n} \ln \|B_n(x) \cdot v\| \geq c.$$

The following theorem tells us that the measure of points which exhibit anomalous Lyapunov behavior at time  $n$  decays exponentially fast with  $n$ .

**Theorem 1.34** (Theorem 25, Avila-Delecroix [AD]). *Assume that  $B$  is fast decaying. For every  $c' < c$ , there exist  $C_3 > 0$ ,  $\alpha_3 > 0$  such that for every unit vector  $v$ ,*

$$\mu\{x, \|B_n(x) \cdot v\| \leq e^{c'n}\} \leq C_3 e^{-\alpha_3 n}.$$

*Proof of Lemma 1.33.* With the notations introduced before, we define the cocycle  $(U, B)$ , where  $U := T^N$  and  $B(x) := e^{-\gamma(x)} \in \text{GL}(1, \mathbb{R})$ . When  $x \in \Delta^{\underline{l}}$ ,  $|\underline{l}| = N$ , we denote  $B^{(\underline{l})} := B(x)$ . Note that the map  $U$  has bounded distortion.

7. By (5.1) and (5.2), the left hand side is less than  $\frac{1}{2}\rho(\eta - \frac{1}{2}) < 0$  when  $\delta \rightarrow 0$ .

8. The limit exists by Oseledets theorem applied to  $\nu$ .

Since  $Z$  is finite, for  $n$  big enough,  $|B^{(\underline{l})}|_0 \geq n$  implies that  $\underline{l} \in \Omega^N \setminus Z$ , and it follows from the definition of  $\gamma$  that

$$|B^{(\underline{l})}|_0 = \|A^{\underline{l}}\|_0^\rho (1 + \|A^{\underline{l}}\|_0 (2\delta)^\rho) \geq \|A^{\underline{l}}\|_0^\rho,$$

and then  $B$  is fast decaying since  $A$  is.

We deduce from (5.7) the value of the expansion constant of the cocycle  $(U, B)$ : we have  $c = -\alpha > 0$ . Indeed,  $B_m(x) = e^{-S_m(x)}$ , so by Birkhoff's ergodic theorem, for  $|v| = 1$  and almost every  $x \in \Delta$ ,

$$\lim_{n \rightarrow \infty} \frac{1}{m} \ln |B_m(x) \cdot v| = \lim_{m \rightarrow \infty} -\frac{S_m(x)}{m} \stackrel{(5.7)}{=} -\alpha.$$

We apply Theorem 1.34 with  $c' := -\alpha/2 < c$  to get  $C_3 > 0$ ,  $\alpha_3 > 0$  such that

$$\mu\{x \in \Delta, B_m(x) \leq e^{c'm}\} \leq C_3 e^{-\alpha_3 m}.$$

Since  $e^{S_m(x)} = (B_m(x))^{-1}$ , the last inequality gives

$$\mu\left(\left\{x \in \Delta, \frac{S_m(x)}{m} \geq \frac{\alpha}{2}\right\}\right) \leq C_3 e^{-\alpha_3 m}.$$

By definition,  $\ln C_m(x) \leq S_m(x)$ , hence

$$\begin{aligned} \mu(E_m) &= \mu\{x \in \Delta, C_m(x) \geq e^{\frac{m\alpha}{2}}\} \\ &\leq \mu\left(\left\{x \in \Delta, \frac{S_m(x)}{m} \geq \frac{\alpha}{2}\right\}\right) \leq C_3 e^{-\alpha_3 m}, \end{aligned}$$

which concludes.  $\square$

Using Lemma 1.33 and the fact that  $C_m(x) \leq 1$ , we therefore obtain

$$\begin{aligned} \int_{\Delta} C_m(x) d\mu(x) &= \int_{E_m} C_m(x) d\mu(x) + \int_{\Delta \setminus E_m} C_m(x) d\mu(x) \\ &\leq \mu(E_m) + \int e^{m\alpha/2} d\mu(x) \\ &\leq \tilde{C} \beta^m + e^{m\alpha/2} \\ &\leq C e^{-\kappa m}, \end{aligned}$$

with  $\kappa := \min(-\ln \beta, -\alpha/2) > 0$  and  $C := 1 + \tilde{C} > 0$ .

From (5.5) and the formula of total probability, we thus get

$$\begin{aligned} \mu(\Gamma_\delta^m(J)) &\leq \sum_{\underline{d} \in \hat{\Omega}, |\underline{d}|=m} \mu(\hat{\Delta}^{\underline{d}}) P_\mu(\Gamma_\delta^m(J) | \hat{\Delta}^{\underline{d}}) \\ &\leq \int_{\Delta} C_m(x) \|J\|^{-\rho} d\mu(x) \leq C e^{-\kappa m} \|J\|^{-\rho}, \end{aligned}$$

which concludes the proof of Proposition 1.31.  $\square$

## 6. End of the proof of weak mixing

**6.1. Weak mixing for i.e.t.'s: proof of Theorem 1.26.** We conclude here the proof of Theorem 1.26. We consider the cocycle  $(T, A)$  defined in Subsection 4.1.4. Note that it meets all the assumptions made in Section 5. Since  $T$  is fast decaying, it is also legitimate to use the results of Subsection 2.6 to convert Proposition 1.31 into an estimate on Hausdorff dimension. With the notations introduced in Subsection 5.1, let  $\Theta := \overline{\mathbb{P}_+^{d-1}}$  and  $\mathcal{J} = \mathcal{J}(\Theta)$ , and choose some integer  $N \geq 0$  sufficiently big so that the assumptions of Lemma 1.32 are satisfied.

Let  $J$  be a line in  $\mathcal{J}$ . For every  $m \geq 0$ , we denote

$$\Gamma_\delta^m(J) := \{[\lambda] \in \Delta, J \cap W_{\delta, mN}^s([\lambda]) \neq \emptyset\}. \quad (6.1)$$

With our previous notations, it is clear that  $\Gamma_\delta^m(J)$  is a union of  $\hat{\Delta}^d$ , with  $|d| = m$ . Now, Proposition 1.31 implies that there exist constants  $C, \kappa, \rho > 0$  such that  $\mu(\Gamma_\delta^m(J)) \leq C e^{-\kappa m} \|J\|^{-\rho}$ , which yields

$$\limsup_{m \rightarrow \infty} -\frac{1}{m} \ln \mu(\Gamma_\delta^m(J)) \geq \kappa > 0.$$

Recall that  $T$  is fast decaying for some fast decay constant  $\alpha_1 > 0$ . By Theorem 1.7, we get<sup>9</sup>

$$\text{HD} \left( \bigcap_{m \geq 0} \Gamma_\delta^m(J) \right) \leq d - 1 - \min(\kappa, \alpha_1). \quad (6.2)$$

For every  $n \geq 0$ , the same reasoning remains true for  $T^{-n} \left( \bigcap_{m \geq 0} \Gamma_\delta^m(J) \right)$ . Indeed, since  $T$  leaves  $\mu$  invariant, we get as before

$$\limsup_{m \rightarrow \infty} -\frac{1}{m} \ln \mu(T^{-n}(\Gamma_\delta^m(J))) \geq \kappa,$$

and therefore,

$$\text{HD} \left( \bigcap_{m \geq 0} T^{-n}(\Gamma_\delta^m(J)) \right) \leq d - 1 - \min(\kappa, \alpha_1). \quad (6.3)$$

As in Subsection 4.1.4, we consider  $h \in H(\pi)$  and  $t \in \mathbb{R}$  satisfying  $th \notin \mathbb{Z}^d$ . Let  $x = [\lambda] \in \Delta$  be such that  $th \in W^s(x)$ , i.e.,  $x \in \mathcal{E}_{t,h}$ . We fix some small  $\delta > 0$ . By definition,  $th \in W^s(x)$  means that there is  $n_0 = n_0(x) \geq 0$  such that for every  $n \geq n_0$ , there exists  $c_n(x) \in \mathbb{Z}^d$  satisfying

$$A_n(x) \cdot th - c_n(x) \in W_\delta^s(T^n(x)). \quad (6.4)$$

Let us denote by  $J_h$  the line generated by  $h$ , and set  $J_{n,h}(x) := A_n(x) \cdot J_h - c_n(x)$ .

**Lemma 1.35.** *For any  $n_1 \geq n_0$ , there exists  $n \geq n_1$  such that  $J_{n,h}(x)$  does not pass through 0, i.e.,  $J_{n,h}(x) \in \mathcal{J}$ .*

PROOF. Fix  $n_1 \geq n_0$ . Assume by contradiction that  $J_{n,h}(x)$  passes through 0 for all  $n \geq n_1$ . Since from (4.7) and (4.8), the matrices  $A_n(x)$  expand  $\Theta = \overline{\mathbb{P}_+^{d-1}}$ , and because  $J_{n,h}(x) \in \Theta$  with  $\|J_{n,h}(x)\| < \delta$ , we obtain

$$\lim_{n \rightarrow \infty} \|A_{n-n_1}(T^{n_1}(x))^{-1}(A_n(x) \cdot th - c_n(x))\| = 0. \quad (6.5)$$

But

$$\begin{aligned} & A_{n-n_1}(T^{n_1}(x))^{-1}(A_n(x) \cdot th - c_n(x)) \\ &= A_{n_1}(x) \cdot th - A_{n-n_1}(T^{n_1}(x))^{-1} \cdot c_n(x) \\ &= \underbrace{A_{n_1}(x) \cdot th - c_{n_1}(x)}_{\|\cdot\| < \delta, \text{ constant w.r.t. } n} + \underbrace{c_{n_1}(x) + A_{n-n_1}(T^{n_1}(x))^{-1} \cdot c_n(x)}_{\in \mathbb{Z}^d} \end{aligned}$$

so from (6.5),  $c_{n_1}(x) + A_{n-n_1}(T^{n_1}(x))^{-1} \cdot c_n(x) = 0$  and  $A_{n_1}(x) \cdot th - c_{n_1}(x) = 0$ , whence  $th = (A_{n_1}(x))^{-1} \cdot c_{n_1}(x) \in \mathbb{Z}^d$  (since  $A_{n_1}(x) \in \text{SL}(d, \mathbb{Z})$ ), a contradiction.  $\square$

Let  $x = [\lambda] \in \mathcal{E}_{t,h}$ . By the previous lemma, there are infinitely many  $n \geq n_0(x)$  such that  $J_{n,h}(x) \in \mathcal{J}$ . Let us choose such an  $n$ . By (6.4), we also know that  $J_{n,h}(x) \cap W_\delta^s(T^n(x)) \neq \emptyset$ . From the definition introduced in (6.1), we get  $T^n(x) \in \Gamma_\delta^m(J_{n,h}(x))$ , for any  $m \geq 0$ , that is,

$$x \in \bigcap_{m \geq 0} T^{-n}(\Gamma_\delta^m(J_{n,h}(x))).$$

9. The sequence  $(\Gamma_\delta^m(J))_m$  is decreasing, so that  $\liminf_{m \rightarrow \infty} \Gamma_\delta^m(J) = \bigcap_{m \geq 0} \Gamma_\delta^m(J)$ .

Let us define  $\mathcal{J}_h := \{M \cdot J_h - c \mid (M, c) \in \text{SL}(d, \mathbb{Z}) \times \mathbb{Z}^d\} \cap \mathcal{J}$ . By definition, we have that for every  $n \geq 0$ ,  $J_{n,h}(x)$  belongs to the countable set  $\mathcal{J}_h$ . We have thus obtained

$$\bigcup_{t \in \mathbb{R}, th \notin \mathbb{Z}^d} \mathcal{E}_{t,h} \subset \mathcal{E}_h := \bigcup_{n \geq 0, J \in \mathcal{J}_h} \bigcap_{m \geq 0} T^{-n}(\Gamma_\delta^m(J)).$$

Moreover, we deduce from estimate (6.3) that

$$\text{HD}(\mathcal{E}_h) \leq d - 1 - \min(\kappa, \alpha_1) < d - 1. \quad \square$$

**6.2. Weak mixing for flows: proof of Theorem 1.29.** We consider the cocycle  $(T, A)$  introduced in Subsection 4.3.2. Recall that by Subsection 3.7, we know that there exists a probability measure  $\mu$  for which  $T$  has the property of bounded distortion; we denote by  $\{\Delta^{(l)}\}_{l \in \mathbb{Z}}$  the associate partition. Moreover, the cocycle  $(T, A)$  is fast decaying. Let  $L > 0$  be the maximal Lyapunov exponent, i.e.,  $L := \lim_{n \rightarrow +\infty} \frac{1}{n} \int_{\Delta} \ln \|A_n(x)\| d\mu(x)$ . In the next proposition, we estimate the measure of the set of points with anomalous Lyapunov behavior, that is, those for which the iterates of the cocycle  $(T, A)$  grow too fast. This large deviations result follows from fast decay of the cocycle and almost independence, which itself is implied by bounded distortion.

**Proposition 1.36.** *For any  $\tilde{L} > L$ , there exist  $\tilde{C}, \xi > 0$  such that for every  $n \geq 0$ ,*

$$\mu(\{x \in \Delta \mid \|A_n(x)\| \geq e^{\tilde{L}n}\}) \leq \tilde{C}e^{-\xi n}.$$

**PROOF.** For any  $(x, n) \in \Delta \times \mathbb{N}$ , we set  $I(x, n) := \frac{1}{n} \ln \|A_n(x)\|$ ; similarly, for any word  $\underline{l} \in \Omega$  of length  $n$ , we set  $I(\underline{l}) := \frac{1}{n} \ln \|A^{\underline{l}}\|$ . By definition of  $L$  and  $\tilde{L}$ , and by bounded distortion (see Subsection 2.1 for the definition), there exist  $n_0 \geq 0$  and  $\theta > 0$  such that for any  $\underline{l} \in \Omega$ , any  $n \geq n_0$ , we have  $\int_{\Delta} (I(x, n) - \tilde{L}) d\mu^{\underline{l}}(x) \leq -\theta$ . Given an integer  $n \geq 0$  and a word  $\underline{l} \in \Omega$ , let us consider the function  $\mathcal{F}_{n,\underline{l}}: t \mapsto \int_{\Delta} e^{tn(I(x,n) - \tilde{L})} d\mu^{\underline{l}}(x)$  (we just write  $\mathcal{F}_n$  when  $\underline{l} = \emptyset$ ); it is well defined by fast decay of  $A$ . Moreover, we have  $\mathcal{F}_{n_0,\underline{l}}(0) = 1$  and  $\mathcal{F}'_{n_0,\underline{l}}(0) \leq -n_0\theta < 0$ . Therefore there exist  $\delta_0, \xi_0 > 0$  such that for any  $\underline{l} \in \Omega$ , we have  $\mathcal{F}_{n_0,\underline{l}}(\delta_0) \leq e^{-\xi_0 n_0}$  and for any  $0 \leq n < n_0$ ,  $\mathcal{F}_{n,\underline{l}}(\delta_0) \leq 2e^{-\xi_0 n}$ . By definition, for any two words  $\underline{l}, \underline{l}'$ , we have  $\mu(\Delta^{\underline{l}\underline{l}'}) = T_*^{\underline{l}}(\mu|_{\Delta^{\underline{l}}})(\Delta^{\underline{l}'}) = \mu(\Delta^{\underline{l}})\mu^{\underline{l}}(\Delta^{\underline{l}'})$ . Besides, for any  $x \in \Delta$  and integers  $n, n' \geq 0$ , we have  $(n + n')I(x, n + n') \leq nI(x, n) + n'I(T^n(x), n')$ . Let  $n \geq 0$  be any integer. We deduce that

$$\begin{aligned} \mathcal{F}_{n+n_0}(\delta_0) &= \sum_{|\underline{l}|=n, |\underline{l}'|=n_0} e^{\delta_0(n+n_0)(I(\underline{l}\underline{l}') - \tilde{L})} d\mu(\Delta^{\underline{l}\underline{l}'}) \\ &\leq \sum_{|\underline{l}'|=n_0} e^{\delta_0 n_0 (I(\underline{l}') - \tilde{L})} d\mu^{\underline{l}'}(\Delta^{\underline{l}'}) \sum_{|\underline{l}|=n} e^{\delta_0 n (I(\underline{l}) - \tilde{L})} d\mu(\Delta^{\underline{l}}) \\ &\leq \sup_{|\underline{l}|=n} \mathcal{F}_{n_0,\underline{l}}(\delta_0) \cdot \mathcal{F}_n(\delta_0) \leq e^{-\xi_0 n_0} \mathcal{F}_n(\delta_0). \end{aligned}$$

Therefore, for any  $n \geq 0$ , considering the euclidean division  $n = kn_0 + r$  of  $n$  by  $n_0$ , with  $k \geq 0$  and  $0 \leq r < n_0$ , we obtain  $\mathcal{F}_n(\delta) \leq e^{-k\xi_0 n_0} \cdot 2e^{-\xi_0 r} \leq 2e^{-\xi_0 n}$ . We conclude by noting that  $\mu\{x \in \Delta \mid \|A_n(x)\| \geq e^{\tilde{L}n}\} \leq \mathcal{F}_n(\delta_0) \leq 2e^{-\xi_0 n}$ .  $\square$

We now come to the proof of Theorem 1.29. Fix  $0 < \delta < 1/10$  sufficiently small. With the notations introduced in Subsection 4.3.2, let  $(h, [\lambda]) \in \mathcal{F}$ ; we denote  $J_h := \text{Span}(h)$ , and  $\mathcal{J}_h := \{M \cdot J_h - c \mid (M, c) \in \text{SL}(d, \mathbb{Z}) \times \mathbb{Z}^d\} \cap \mathcal{J}$ . As previously, we have

$$[\lambda] \in \bigcup_{n \geq 0, J \in \mathcal{J}_h} \bigcap_{m \geq 0} T^{-n}(\Gamma_{\delta/2}^m(J)). \quad (6.6)$$

Fix  $n \geq 0$ , and take  $(M, c) \in \text{SL}(d, \mathbb{Z}) \times \mathbb{Z}^d$  such that  $J = J_{M,c}(h) := M \cdot J_h - c \in \mathcal{J}_h$ . We know from Proposition 1.31 that there exist constants  $C, \kappa, \rho > 0$  such that for any  $m \geq 0$ ,  $\mu(T^{-n}(\Gamma_\delta^m(J))) \leq Ce^{-\kappa m} \|J\|^{-\rho}$ . Recall that we denote by  $L$  the maximal



Lyapunov exponent of  $(T, A)$ . Given  $L' > NL$ , let  $X_m := \{x \in \Delta \mid \|A_{mN}(x)\| \geq e^{L'm}\}$ ; by Proposition 1.36, we know that  $\mu(T^{-n}(X_m)) \leq \tilde{C}e^{-\xi m}$  for certain constants  $\tilde{C}, \xi > 0$ . Then the proof of Theorem 1.7 given in [AD] provides us with constants  $C', \delta', K > 0$  together with a cover  $\{B_k^{m,n,M,c,h}\}_{k \geq 0}$  of  $T^{-n}(\Gamma_\delta^m(J) \cup X_m)$  by balls of diameter at most  $e^{-C'm}$ , satisfying

$$\sum_{k \geq 0} \text{diam}(B_k^{m,n,M,c,h})^{d-1-\delta'} \leq K. \quad (6.7)$$

Recall that  $\Gamma_\delta^m(J) := \{x \in \Delta, J \cap W_{\delta, mN}^s(x) \neq \emptyset\}$  is the set of points  $x \in \Delta$  for which the process introduced earlier lasts for at least  $m$  steps. By definition,  $x \in T^{-n}(\Gamma_\delta^m(J))$  if and only if there exists  $w \in J \cap B_\delta(0)$  such that

$$\|A_k(T^n(x)) \cdot w\|_{\mathbb{R}^d/\mathbb{Z}^d} < \delta, \quad \forall k \leq mN.$$

If instead of  $J$ , we start the process with a line  $J'$  close to  $J$ , we see that the first iterates of  $J' \cap B_{\delta/2}(0)$  under the cocycle remain close to those of  $J \cap B_{\delta/2}(0)$ . More precisely, given  $0 < \varepsilon < \delta/2 \cdot e^{-L'm}$ , assume that the line  $J'$  is  $\varepsilon$ -close to  $J$  in the sense that for any  $w' \in J' \cap B_{\delta/2}(0)$ ,  $\|\pi_{J'}(w') - w'\| < \varepsilon$ , where  $\pi_{J'}$  denotes the orthogonal projection on  $J'$ . Let  $x' \in T^{-n}(\Gamma_{\delta/2}^m(J'))$ ; then there exists  $w' \in J' \cap B_{\delta/2}(0)$  such that  $\|A_k(T^n(x')) \cdot w'\|_{\mathbb{R}^d/\mathbb{Z}^d} < \delta/2$ , for any  $k \leq mN$ . Set  $w := \pi_J(w') \in J \cap B_\delta(0)$ . Since  $k \mapsto \|A_k(T^n(x'))\|$  is increasing, we deduce that either  $x' \in T^{-n}(X_m)$ , or for any  $0 \leq k \leq mN$ ,

$$\|A_k(T^n(x')) \cdot w\|_{\mathbb{R}^d/\mathbb{Z}^d} < \delta/2 + \|A_k(T^n(x'))\| \varepsilon < \delta/2(1 + \|A_k(T^n(x'))\|) e^{-L'm} < \delta,$$

hence  $x' \in T^{-n}(\Gamma_\delta^m(J))$ . Therefore, there exists  $C'' > 0$  depending only on  $\delta, L'$  such that for each  $h' \in H(\pi)$  with  $d(h, h') < e^{-C''m}$ , and if  $J' := J_{M,c}(h')$  denotes the corresponding line, then the same cover will work for the “bad” parameters associated with  $J'$ , that is,

$$T^{-n}(\Gamma_{\delta/2}^m(J')) \subset \bigcup_k B_k^{m,n,M,c,h},$$

and  $[\lambda] \in T^{-n}(\Gamma_{\delta/2}^m(J'))$  whenever  $(h', [\lambda]) \in \mathcal{F}$ .

Let us choose a cover  $\{U_j\}_{j \geq 0}$  of  $H(\pi) \sim \mathbb{R}^{2g}$  by open balls of diameter less than 1. For any  $j, m \geq 0$ , we take a countable collection  $\{h_{m,p}^j\}_{p \geq 0} \subset U_j$  such that  $U_j \subset \cup_p B(h_{m,p}^j, \delta_{m,p}^j)$ , where  $0 < \delta_{m,p}^j \leq e^{-C''m}$  for all  $p \geq 0$ , and such that for some  $0 < K' < +\infty$ , we have

$$\sum_{p \geq 0} (\delta_{m,p}^j)^{2g} \leq K'. \quad (6.8)$$

From the previous discussion, we may also assume that there exists a constant  $0 < K < +\infty$  such that for any integers  $j, m, p, n \geq 0$ , any  $M \in \text{SL}(d, \mathbb{Z})$ ,  $c \in \mathbb{Z}^d$ , there exists an open cover  $\{B_k^{m,n,M,c,h_{m,p}^j}\}_{k \geq 0}$  of the set  $T^{-n}(\Gamma_\delta^m(J_{M,c}(h_{m,p}^j)) \cup X_m)$  by balls of diameter at most  $e^{-C'm}$ , which satisfies

$$\sum_{k \geq 0} \text{diam}(B_k^{m,n,M,c,h_{m,p}^j})^{d-1-\delta'} \leq K, \quad (6.9)$$

and such that for any  $(h, [\lambda]) \in \mathcal{F}$ , we have:

- $h \in U_j$  for some  $j \geq 0$ , and for any  $m \geq 0$ , there exists  $p \geq 0$  such that  $h \in B(h_{m,p}^j, \delta_{m,p}^j)$ .
- There exist  $n \geq 0$ ,  $M \in \text{SL}(d, \mathbb{Z})$ ,  $c \in \mathbb{Z}^d$  such that  $J_{M,c}(h) \in \mathcal{J}_h$  and for any  $m \geq 0$ ,  $[\lambda] \in T^{-n}(\Gamma_{\delta/2}^m(J_{M,c}(h))) \subset \cup_k B_k^{m,n,M,c,h_{m,p}^j}$ .

For each  $j, m, n, M, c, p, k$  as above, set  $r_k^{j,m,n,M,c,p} := \text{diam}(B_k^{m,n,M,c,h_{m,p}^j})$ , and take a cover  $\{\mathcal{B}_l^{j,m,n,M,c,p,k}\}_l$  of  $B(h_{m,p}^j, \delta_{m,p}^j)$  by  $O\left(\left(\frac{\delta_{m,p}^j}{r_k^{j,m,n,M,c,p}}\right)^{2g}\right)$  many balls of diameter

$r_k^{j,m,n,M,c,p}$ . We get

$$\mathcal{F} \subset \bigcup_{j,n,M,c} \bigcap_{m \geq 0} \left( \bigcup_{p,k,l} \mathcal{B}_l^{j,m,n,M,c,p,k} \times B_k^{m,n,M,c,h_{m,p}^j} \right). \quad (6.10)$$

For any  $j, n, M, c$ , and for every integer  $m \geq 0$ , let us denote  $Y_m^{j,n,M,c} := \bigcup_{p,k,l} \mathcal{B}_l^{j,m,n,M,c,p,k} \times B_k^{m,n,M,c,h_{m,p}^j}$ . We deduce from (6.8) and (6.9) that

$$\begin{aligned} & \sum_{p,k,l} \text{diam}(\mathcal{B}_l^{j,m,n,M,c,p,k} \times B_k^{m,n,M,c,h_{m,p}^j})^{2g+d-1-\delta'} \\ & \lesssim \sum_{p,k} \left( \frac{\delta_{m,p}^j}{r_k^{j,m,n,M,c,p}} \right)^{2g} (r_k^{j,m,n,M,c,p})^{2g+d-1-\delta'} \\ & = \sum_p (\delta_{m,p}^j)^{2g} \times \sum_k (r_k^{j,m,n,M,c,p})^{d-1-\delta'} \\ & \leq KK'. \end{aligned}$$

We deduce that  $\text{HD} \left( \bigcap_{m \geq 0} Y_m^{j,n,M,c} \right) \leq 2g + d - 1 - \delta'$ . But from (6.10), we know that  $\mathcal{F}$  is contained in a countable union of such sets, so that  $\text{HD}(\mathcal{F}) < 2g + d - 1$ , which ends the proof.  $\square$



## Bibliography

- [AD] Avila A., Delecroix V.; *Weak mixing directions in non-arithmetic Veech surfaces*, Journal of the American Mathematical Society **29** (2016), pp. 1167–1208.
- [AF] Avila A., Forni G.; *Weak mixing for interval exchange transformations and translation flows*, Ann. of Math. **165** (2007), pp. 637–664.
- [AGY] Avila A., Gouëzel S., Yoccoz J.-C.; *Exponential mixing for the Teichmüller flow*, Publications mathématiques de l’IHÉS **104**, 143–211.
- [F1] Forni G.; *Solutions of the cohomological equation for area-preserving flows on higher genus surfaces*, Ann. of Math. (2) **146** (1997), 295–344.
- [F2] Forni G.; *Deviation of ergodic averages for area-preserving flows on surfaces of higher genus*, Ann. of Math. (2) **155** (2002), no. 1, 1–103.
- [GK] Gutkin E., Katok A. B.; *Weakly mixing billiards, Holomorphic dynamics (Mexico, 1986)*, 163–176. Lecture Notes in Math., **1345**, Springer, Berlin, 1988.
- [Ka] Katok A. B.; *Interval exchange transformations and some special flows are not mixing*, Israel J. Math. **35** (1980) no. 4, 301–310.
- [KS] Katok A. B., Stepin A. M.; *Approximations in ergodic theory*, Uspehi Mat. Nauk **22** 1967 no. 5 (137), 81–106.
- [Ke] Keane M. S.; *Interval exchange transformations*, Math. Z. **141** (1975), 25–31.
- [KMS] Kerckhoff S., Masur H., Smillie J.; *Ergodicity of billiard flows and quadratic differentials*, Ann. of Math. (2) **124** (1986), 293–311.
- [Ko] Kontsevich M.; *Lyapunov exponents and Hodge theory*, in *The mathematical beauty of physics* (5-7 juin 1996, Saclay), J.M. Drouffe and J.B. Zuber (Eds.), 318–332, Adv. Ser. Math. Phys. **24**, World Sci. Publishing, River Edge, NJ, 1997.
- [L] Lucien I.; *Mélange faible topologique des flots sur les surfaces*, Ergodic Theory Dynam. Systems **18** (1998), no. 4, 963–984.
- [MMY] Marmi S., Moussa P., Yoccoz J.-C.; *The cohomological equation for Roth type interval exchange maps*, Jour. Amer. Math. Soc. **18** (2005), 823–872.
- [Ma1] Masur H.; *Interval exchange transformations and measured foliations*, Ann. of Math. (2) **115** (1982), no. 1, 169–200.
- [Ma2] Masur H.; *Hausdorff dimension of the set of nonergodic foliations of a quadratic differential*, Duke Math. J. **66** (1992), no. 3, 387–442.
- [NR] Nogueira A., Rudolph D.; *Topological weak-mixing of interval exchange maps*, Erg. Th. Dyn. Syst. **17** (1997), no. 5, 1183–1209.
- [R] Rauzy G.; *Échanges d’intervalles et transformations induites*, Acta Arith. **34** (1979), 315–328.
- [V1] Veech W. A.; *Projective swiss cheeses and uniquely ergodic interval exchange transformations*, Erg. Th. Dyn. Syst. I, Proc. Special Year, Maryland 1979-1980, A. Katok ed., 113–195, Birkhäuser, 1981.
- [V2] Veech W. A.; *Gauss measures for transformations on the space of interval exchange maps*, Ann. of Math. (2) **115** (1982), no. 1, 201–242.
- [V3] Veech W. A.; *The Teichmüller geodesic flow*, Ann. of Math. (2) **124** (1986), no. 3, 441–530.
- [V4] Veech W. A.; *The metric theory of interval exchange transformations. I. Generic spectral properties*, Amer. J. Math. **106** (1984), no. 6, 1331–1359.
- [V5] Veech W. A.; *Moduli spaces of quadratic differentials*, Journal d’Analyse Math. **55** (1990), 117–171.
- [Via] Viana M.; *Ergodic Theory of Interval Exchange Maps*, Revista Matemática Complutense **19** Num. 1, 2006.
- [Z1] Zorich A.; *How do the leaves of a closed 1-form wind around a surface?*, Pseudoperiodic Topology, 135–178, Amer. Math. Soc. Transl. Ser. 2, **197**, Amer. Math. Soc., Providence, RI, 1999.
- [Z2] Zorich A.; *Flat surfaces*, in collection “Frontiers in Number Theory, Physics and Geometry, Vol. 1 : On random matrices, zeta functions and dynamical systems”, Springer Verlag, Berlin, 2006, 439–586.



## $C^r$ –prevalence of stable ergodicity for a class of partially hyperbolic systems

This chapter is based on a joint work with Zhiyuan Zhang.<sup>1</sup> The version presented here is provisional, a final version will follow thereafter.

In this chapter, we prove that for  $r \in \mathbb{N}_{\geq 2} \cup \{\infty\}$ , for any dynamically coherent, center bunched and strongly pinched volume-preserving  $C^r$  partially hyperbolic diffeomorphism  $f: X \rightarrow X$ , if either (1) its center foliation is uniformly compact, or (2) its center-stable and center-unstable foliations are of class  $C^1$ , then there exists a  $C^1$ –open neighbourhood of  $f$  in  $\text{Diff}^r(X, \text{Vol})$ , in which  $C^1$ –stable ergodicity is  $C^r$ –prevalent in Kolmogorov’s sense. In particular, this result verifies Pugh-Shub’s stable ergodicity conjecture in this region. As applications, we partially answer an open question of Pugh-Shub [23], and a generic version of an open question of Hirsch-Pugh-Shub [17].

### 1. Introduction

Smooth ergodic theory, that is, the study of statistical and geometric properties of measures invariant under a smooth transformation or flow, is a much studied subject in the modern dynamical systems. It has its root in Boltzmann’s Ergodic Hypothesis in the study of gas particles back in the 19<sup>th</sup> century. Ever since Birkhoff’s proof of his ergodic theorem, there has been a constant interest in understanding the genericity of ergodic systems. The pioneering work of Kolmogorov in the 1950’s provided the first obstruction to the genericity of ergodicity for Hamiltonian systems. His idea was later developed into what is now known as the Kolmogorov-Arnold-Moser (KAM) theory. On the other hand, the work of Hopf and Anosov-Sinai provided open sets of ergodic systems, known as Anosov systems, or uniformly hyperbolic systems.

**Definition 2.1** (Anosov diffeomorphisms). *Given a compact Riemannian manifold  $X$ , a diffeomorphism  $f \in \text{Diff}^1(X)$  is called uniformly hyperbolic or Anosov if there exists a continuous splitting  $TX = E^s \oplus E^u$  of the tangent bundle into  $Df$ –invariant subbundles and constants  $\bar{\chi}^u, \bar{\chi}^s > 0$  such that for any  $x \in X$ , we have*

$$\|Df(v_1)\| < e^{-\bar{\chi}^s} \|v_1\|, \quad \forall v_1 \in E^s(x) \setminus \{0\}, \quad (1.1)$$

$$\|Df(v_2)\| > e^{\bar{\chi}^u} \|v_2\|, \quad \forall v_2 \in E^u(x) \setminus \{0\}. \quad (1.2)$$

For the next nearly thirty years after Anosov-Sinai’s work, uniformly hyperbolic systems remained the only examples where ergodicity was known to appear robustly. A breakthrough came when Grayson, Pugh, Shub [14] gave the first non-hyperbolic example of a stably ergodic system, i.e., the time-one map of the geodesic flow on the unit tangent bundle of a surface of constant negative curvature. Such systems are special cases of partially hyperbolic systems, which are defined as follows.

**Definition 2.2** (Partially hyperbolic diffeomorphisms). *Given a smooth Riemannian manifold  $X$  with compact closure, a  $C^1$  diffeomorphism  $f: X \rightarrow X$  is called partially hyperbolic if its  $C^1$  norm is uniformly bounded and there exist a nontrivial continuous*

---

1. Université Paris Diderot, Sorbonne Paris Cité, Institut de Mathématiques de Jussieu-Paris Rive Gauche, UMR 7586, CNRS, Sorbonne Universités, UPMC Univ Paris 06, F-75013 Paris, France.

splitting of the tangent bundle into  $Df$ -invariant subbundles,  $TX = E^s \oplus E^c \oplus E^u$ , and constants  $\bar{\chi}^u, \bar{\chi}^s > 0$  and  $\bar{\chi}^c, \hat{\chi}^c \in \mathbb{R}$  such that

$$-\bar{\chi}^s < \bar{\chi}^c \leq \hat{\chi}^c < \bar{\chi}^u, \quad (1.3)$$

and for any  $x \in X$ , any  $v_1 \in E^s(x) \setminus \{0\}$ ,  $v_2 \in E^c(x) \setminus \{0\}$ ,  $v_3 \in E^u(x) \setminus \{0\}$ , we have

$$\|Df(v_1)\| < e^{-\bar{\chi}^s} \|v_1\|, \quad (1.4)$$

$$e^{\bar{\chi}^c} \|v_2\| < \|Df(v_2)\| < e^{\hat{\chi}^c} \|v_2\|, \quad (1.5)$$

$$e^{\bar{\chi}^u} \|v_3\| < \|Df(v_3)\|. \quad (1.6)$$

We set  $E^{c*} := E^c \oplus E^*$ ,  $* = s, u$ . Throughout this chapter we always assume that

$$\bar{\chi}^c \leq 0 \leq \hat{\chi}^c.$$

Let  $\text{Vol}$  be the volume form induced by the Riemannian metric. For any integer  $r \in \mathbb{N}_{\geq 1} \cup \{\infty\}$ , we denote by  $\mathcal{PH}^r(X)$  (resp.  $\mathcal{PH}^r(X, \text{Vol})$ ) the set of all  $C^r$  (resp.  $C^r$  volume-preserving) partially hyperbolic systems on  $X$ .

Let  $f \in \mathcal{PH}^1(X)$ . It is well-known (see [17]) that  $E^s$  and  $E^u$  are uniquely integrable to continuous foliations  $\mathcal{W}_f^s$  and  $\mathcal{W}_f^u$  respectively, called the *stable* and *unstable* foliations. For any  $x \in X$  and  $* = s, u$ , we denote by  $\mathcal{W}_f^*(x)$  the leaf of  $\mathcal{W}_f^*$  through  $x$ ; then  $\mathcal{W}_f^*(x)$  is an immersed  $C^r$ -manifold. Besides, the stable and unstable foliations are invariant under the dynamics:

$$f(\mathcal{W}_f^*(x)) = \mathcal{W}_f^*(f(x)), \quad \forall x \in X, \quad * = s, u.$$

If  $f \in \mathcal{PH}^2(X)$ , the transverse regularity of  $\mathcal{W}_f^s$  and  $\mathcal{W}_f^u$  is Hölder (see [25]).

Based on [14] and other results, Pugh-Shub formulated the following conjecture.

**Conjecture 2.3** (Pugh-Shub's Stable Ergodicity Conjecture, [23]). *Stable ergodicity is  $C^r$ -dense among the set of  $C^r$  volume-preserving partially hyperbolic diffeomorphisms on a compact connected manifold, for any integer  $r \in \mathbb{N}_{\geq 2} \cup \{\infty\}$ .*

Since its introduction, this conjecture and related questions on stable ergodicity have been extensively studied, for instance in the following series of works [24, 9, 13, 30, 29, 28, 8, 1, 2]. We will later elaborate on the connections between them.

Conjecture 2.3 has its origin in several concrete models. Given an integer  $n \geq 1$ , let us recall that the linear automorphism of  $\mathbb{T}^n := \mathbb{R}^n/\mathbb{Z}^n$  associated to a matrix  $A \in \text{SL}(n, \mathbb{Z})$  is defined as the unique diffeomorphism  $f_A: \mathbb{T}^n \rightarrow \mathbb{T}^n$  such that the following diagram commutes,

$$\begin{array}{ccc} \mathbb{R}^n & \xrightarrow{A} & \mathbb{R}^n \\ \pi \downarrow & & \downarrow \pi \\ \mathbb{T}^n & \xrightarrow{f_A} & \mathbb{T}^n \end{array}$$

where  $\pi: \mathbb{R}^n \rightarrow \mathbb{T}^n$  denotes the natural projection. Back in the 1970's, Hirsch-Pugh-Shub [17] already asked the following question.

**Question A.** *Is any ergodic linear automorphism of  $\mathbb{T}^n$  stably ergodic, for  $n \geq 2$ ?*

A special case of the above question was asked again in [14] for an explicit  $4 \times 4$  matrix. The latter question was solved by F. Rodriguez-Hertz in [30]. In [23], the author said that the validity of Conjecture 2.3 would imply a positive answer to the following Question A' (see the remark below Conjecture 1 in [23]):

**Question A'.** *Given integers  $n, r \geq 2$ , is the  $C^r$ -generic volume-preserving perturbation of any ergodic automorphism of  $\mathbb{T}^n$  ergodic?*

Question A' has a positive answer when  $f: \mathbb{T}^n \rightarrow \mathbb{T}^n$  is an ergodic automorphism satisfying one of the following assertions:

- (1)  $f$  has no eigenvalue of modulus 1;

- (2)  $f$  has 1 eigenvalue of modulus 1, by [29];
- (3)  $f$  is pseudo-Anosov with 2 eigenvalues of modulus 1, by [30].

Another open question is the following. The version we give here is stronger than that initially stated in [23].

**Question B.** *Let  $M, N$  be two compact Riemannian manifolds, and assume that  $M$  supports a  $C^r$  volume-preserving Anosov diffeomorphism  $g: M \rightarrow M$ ,  $r \in \mathbb{N}_{\geq 2} \cup \{\infty\}$ . Is the  $C^r$ -generic volume-preserving perturbation of  $g \times \text{Id}: M \times N \rightarrow M \times N$  ergodic?*

The answer is yes when  $\dim(N) = 1$ , by [29]. A recent result of Avila-Viana [3] also gives an affirmative answer to Question B when  $\dim(N) = 2$ . To the best of our knowledge, Question B is open for any  $N$  of dimension at least 3.

In this chapter, we will give a partial answer to both Question A' and Question B. Before stating our results, we introduce the following notion.

**Definition 2.4** (Pinching). *An Anosov diffeomorphism  $f$  with constants  $\bar{\chi}^s, \bar{\chi}^u$  as in (1.1), (1.2) is called  $\theta$ -pinched for some  $\theta \in (0, 1)$  if there exist  $\hat{\chi}^u, \hat{\chi}^s > 0$  such that*

$$\begin{aligned} e^{-\hat{\chi}^s} &< \|Df^{-1}\|^{-1} \leq \|Df\| < e^{\hat{\chi}^u}, \\ -\bar{\chi}^s + \theta\hat{\chi}^u &< 0, \quad \bar{\chi}^u - \theta\hat{\chi}^s > 0. \end{aligned}$$

*A partially hyperbolic system  $f$  with constants  $\bar{\chi}^s, \bar{\chi}^u, \bar{\chi}^c, \hat{\chi}^c$  as in (1.3)–(1.6) is said to be  $\theta$ -pinched for some  $\theta \in (0, 1)$  if there exist  $\hat{\chi}^u, \hat{\chi}^s > 0$  such that*

$$\begin{aligned} e^{-\hat{\chi}^s} &< \|Df^{-1}\|^{-1} \leq \|Df\| < e^{\hat{\chi}^u}, \\ -\bar{\chi}^s + \theta\hat{\chi}^u &< \bar{\chi}^c, \quad \bar{\chi}^u - \theta\hat{\chi}^s > \hat{\chi}^c. \end{aligned}$$

By definition, given any Anosov or partially hyperbolic diffeomorphism  $f$ , there exists  $\theta \in (0, 1)$  such that  $f$  is  $\theta$ -pinched. We will answer Question A' and Question B for those with pinching exponents close to 1.

**Theorem C** (L.-Zhang). *Let  $n \geq 2$  be some integer. For any  $r \in \mathbb{N}_{\geq 2} \cup \{\infty\}$ , any linear partially hyperbolic automorphism  $f_A: \mathbb{T}^n \rightarrow \mathbb{T}^n$ , ergodic or not, that is  $(\frac{c-1}{c})^{\frac{1}{4}}$ -pinched, where  $c$  is the number of eigenvalues of  $A \in \text{SL}(n, \mathbb{Z})$  of modulus 1, there exists  $\mathcal{U}$ , a  $C^1$ -open neighbourhood of  $f_A$  in  $\mathcal{PH}^r(\mathbb{T}^n, \text{Vol})$ , such that for some  $C^r$ -dense subset  $\mathcal{U}'$  of  $\mathcal{U}$ , any map in  $\mathcal{U}'$  is a  $C^1$ -stably ergodic diffeomorphism. In particular, we give an affirmative answer to Question A', for any  $(\frac{c-1}{c})^{\frac{1}{4}}$ -pinched  $f_A$ .*

Note that even for linear automorphisms with two-dimensional center, we give a partial generalisation of the result present in [30], in the following sense:

- (1) we removed the pseudo-Anosov condition;
- (2) our result also applies to non-ergodic maps;
- (3) we weaken the regularity condition (for the perturbations) from  $C^5$  to  $C^1$ .

**Theorem D** (L.-Zhang). *The answer to Question B is yes, for any  $(\frac{n-1}{n})^{\frac{1}{7}}$ -pinched  $C^r$  volume-preserving Anosov diffeomorphism  $g: M \rightarrow M$ ,  $n \geq 2$  being the dimension of  $N$ .*

Theorems C, D are easy consequences of a more general result we proved, which is stated in the next section. As we will see, when  $\dim(E^c) \geq 2$ , we actually obtained prevalence in Kolmogorov's sense, a notion which is much stronger than density.

**1.1. Stable ergodicity and accessibility.** In [24], the authors proposed a route to prove the Stable Ergodicity Conjecture. They divided the conjecture into two parts, using the following geometric notion, originating in an argument due to Hopf [16].

**Definition 2.5** (Accessibility). *Given any partially hyperbolic diffeomorphism  $f: X \rightarrow X$ , an  $su$ -path is a path obtained by concatenating finitely many subpaths – called arcs,*



or legs – each of which lies entirely in a single leaf of the stable foliation  $\mathcal{W}_f^s$  or of the unstable foliation  $\mathcal{W}_f^u$ . The diffeomorphism  $f$  is said to be *accessible* if any two points in  $X$  can be connected by some  $su$ -path. We say that  $f$  is  $(C^1-)$ stably accessible if there exists  $\mathcal{U}$ , a  $C^1$ -open neighbourhood of  $f$ , such that any  $g \in \mathcal{U}$  is accessible.

**Conjecture 2.6** (Accessibility implies ergodicity). *Essential accessibility implies ergodicity among  $C^2$  volume-preserving partially hyperbolic diffeomorphisms.*

Recall that *essential accessibility* is a weakening of the notion of accessibility in the measured sense. It means that for any two measurable sets  $A, B$  of positive volume, there exist  $a \in A$  and  $b \in B$  which can be connected by some  $su$ -path.

**Conjecture 2.7** (Density of accessibility). *For any integer  $r \in \mathbb{N}_{\geq 2} \cup \{\infty\}$ , stable accessibility is open and dense among  $C^r$  partially hyperbolic diffeomorphisms, volume-preserving or not.*

The state-of-the-art on Conjecture 2.6 was obtained by Burns and Wilkinson in [8]. They proved Conjecture 2.6 under one mild technical condition called *center bunching*, which asserts, in loose terms, that the hyperbolic part dominates nonconformality of the center. Their result improved earlier work of Pugh-Shub in [24], which required two technical conditions: *dynamical coherence* and a stronger form of center bunching. In the work of Burns-Wilkinson, the assumption of dynamical coherence was made unnecessary thanks to the introduction of the so-called *fake foliations*. Here, dynamical coherence is a very commonly used notion in the study of partially hyperbolic systems. It asserts certain joint integrability of the invariant subspaces  $E^c, E^s, E^u$ . We will give the formal definitions of most of the above notions in Section 2.2.

In comparison, there is a paucity of progress towards Conjecture 2.7. When the center dimension is one, that is,  $\dim(E^c) = 1$ , it was proved by F. Rodriguez-Hertz, M.A. Rodriguez-Hertz and R. Ures in [29]. It is still open for any dimension larger than 1. To describe the current state of Conjecture 2.7, we mention several related results, which were obtained among certain classes of systems.

- Burns-Wilkinson [9] proved a version of Conjecture 2.7 for compact group extensions over Anosov systems.
- In a recent paper [18], Horita-Sambarino obtained some  $C^r$ -density result for a class of partially hyperbolic diffeomorphisms with  $\dim(E^c) = 2$  and *uniformly compact* center foliations (see Definition 2.22).
- Another  $C^r$ -density result for partially hyperbolic systems with  $\dim(E^c) = 2$  was obtained recently by Avila-Viana [3] using a very different method.
- Zhang [33] recently proved  $C^r$ -density of  $C^2$ -stable ergodicity for a class of skew products over Anosov maps, satisfying pinching, bunching conditions with certain type of dominated splitting in the center subspace. This is the first  $C^r$ -density result for systems with arbitrary center dimension.

The difficulty of Conjecture 2.7 is mainly due to the  $C^2$ -smallness of the perturbation. In fact, the  $C^1$ -density of stable accessibility was already proved by Dolgopyat-Wilkinson [13] in 2003. There was a line of research focused on the  $C^1$  version of Conjecture 2.3. In the case where  $\dim(E^c) = 1, 2$ , this was proved in [6] and [28]. Recently, the  $C^1$ -version of Conjecture 2.3 was completely solved by Avila-Croviser-Wilkinson [2].

As the main result of this chapter, we will verify  $C^r$ -density of stable ergodicity in  $C^1$ -neighbourhoods of two classes of partially hyperbolic systems, defined by some technical conditions; they are general enough to include those in Questions A, B. Compared to previous work, our result has two main novelties:

- (1) This is the first time that  $C^r$ -density of stable ergodicity is proved for fully nonlinear systems with arbitrary center dimension, for  $r \geq 2$ . The compact group extensions considered in [9] also have higher center dimension, but they

are simpler as the action on the fiber is by group translation, hence is characterised by finitely many parameters.

(2) We prove the prevalence of stable ergodicity in a measure-theoretical sense.

To provide motivations for (2), let us mention that in dynamical systems, there are two ways to approach the question of genericity: topological and metric. These notions are sometimes conflicting. For instance, a topological generic orientation-preserving circle diffeomorphism has rational rotation number, while in many one-parameter families of circle diffeomorphisms, the set of parameters with irrational rotation number has positive Lebesgue measure. For detailed exposition and more examples on the differences between these two notions of genericity, we refer the reader to [19] and [4]. There are different ways to define measure-theoretical prevalence, see [19, 21]. In the following we use the notion of *typical dynamical system in the Kolmogorov sense*. In loose terms, a property for diffeomorphisms is said to be prevalent in the  $C^r$ - $J$ -Kolmogorov sense if it holds for a full measure set in a  $C^r$ -generic  $J$ -parameter family. The formal definition is given in Definition 2.10.

Our main theorem in this chapter is the following.

**Theorem E** (L.-Zhang). *Let  $X$  be a compact Riemannian manifold. Let  $r \in \mathbb{N}_{\geq 2} \cup \{\infty\}$ , and assume that  $f \in \text{Diff}^r(X)$  is a volume-preserving dynamically coherent partially hyperbolic system, with  $c := \dim(E^c) > 1$ . If  $f$  is center bunched and satisfies at least one of the following assertions:*

- $f$  is  $(\frac{c-1}{c})^{\frac{1}{5}}$ -pinched and has uniformly compact center foliation,
- $f$  is  $(\frac{c-1}{c})^{\frac{1}{7}}$ -pinched and the maps  $x \mapsto E^{cs}(x), E^{cu}(x)$  are of class  $C^1$ ,

*then there exists a  $C^1$ -open neighbourhood of  $f$  in  $\text{Diff}^r(X)$ , denoted by  $\mathcal{U}$ , such that  $C^1$ -stable accessibility is prevalent in the  $C^r$ - $J$ -Kolmogorov sense in  $\mathcal{U}$ , for any  $J \geq J_0$ . Here  $J_0$  is an integer depending only on  $\dim(X)$ .*

*Moreover, let  $\text{Vol}$  be the volume form on  $X$  given by the metric, and assume that  $f \in \text{Diff}^r(X, \text{Vol})$  satisfies one of the previous conditions. Then the above conclusion is true for  $\mathcal{U}_0$ , a  $C^1$ -open neighbourhood of  $f$  in  $\text{Diff}^r(X, \text{Vol})$ , in place of  $\mathcal{U}$ . In particular,  $C^1$ -stable ergodicity is  $C^r$ -dense in  $\mathcal{U}_0$ .*

## 1.2. Idea of the proof.<sup>2</sup>

As in the aforementioned paper [13] of Dolgopyat-Wilkinson on  $C^1$ -density of stable accessibility, the proof is split into two parts: accessibility is obtained by combining a global argument, referred to as *accessibility modulo a family of center disks*, with a local one.

For a partially hyperbolic diffeomorphism  $f$  that admits a center foliation integrating the center subspace, accessibility modulo a family of center disks is a weakening of the notion of accessibility; it holds if for a finite collection of disks in some center leaves, any two points in the whole manifold can be joined by a path formed by arcs in stable or unstable leaves of  $f$  and arcs in the center disks of the family we consider. In other words, it is a kind of *su*-path for which jumps within the center disks in the family are also allowed. Moreover, when the center foliation also has some form of structural stability, such a family of center disks also exists for nearby diffeomorphisms. In order to make perturbations, it is important that the family of center disks we work with has *slow recurrence*. This part of the argument follows the same line as in the paper of Dolgopyat-Wilkinson, since the property of being accessible modulo a family of center disks with good properties can be checked after a  $C^r$ -small perturbation,  $r \geq 1$  (to build such a family, we require that the fixed points of  $f^k$  be isolated, for  $k \geq 1$ ), and in fact, it is *prevalent* in a sense that will be made precise. Additional difficulties come from the fact that we consider families of diffeomorphisms instead of a single one. While for nearby maps, the natural continuation of the initial family of disks works, for others, we show that it is possible to define a new family, whose elements as well as their first

<sup>2</sup> We refer the reader to the next section for the definitions of the notions appearing in the discussion that follows.

iterates under the dynamics do not intersect elements of the initial family. This is crucial for the second part of the argument.

The second part consists in getting some *local accessibility* property: after a typical perturbation, we show that it is possible to make each center disk in the previous collection accessible. Contrary to the first point, the proof given for the  $C^1$ -case cannot be carried out in  $C^r$  topology. Indeed, in [13], the authors consider a finite collection of accessible sequences based on some center disk, and perform perturbations to show that every sequence can be used to move in a certain direction. Therefore, by composing such sequences, it is possible to reach any point in a small ball contained in the center disk. But if we consider the  $C^2$  norm of the perturbation, it is impossible to induce a sufficiently big  $C^0$  displacement of holonomies to make this strategy work.

In our work, we thus replace their topological argument by another one, derived from a result due to Bonk-Kleiner [5], which ensures that the image of a certain map has nonempty interior; this map encodes the structure of some accessibility class, and is obtained by concatenating holonomy maps along certain 4-legged *su*-paths which come back to a common center disk that we want to make accessible. Besides, under some mild *center bunching* assumption, this map is differentiable. Then, to check the hypotheses of our topological lemma, we show that it is enough to consider infinitesimal displacements instead of  $C^0$  displacements as above, which thus allows to deal with  $C^r$ -small perturbations, for any  $r \geq 1$ . An important step consists in investigating the changes induced by a family of perturbations on the differentials of holonomy maps along certain *su*-paths. A classical fact is that we can get a good control provided that the local center disks through the corners of the *su*-path have some slow recurrence to the support of the perturbations we consider. This can be verified in connection with the definition of the collection of center disks considered above. From this, we deduce that a certain map from some parameter space of perturbations to phase space – here, some center disk – is a submersion.

It follows from this fact that we can make some parameter exclusion and show that for a typical  $C^r$  perturbation, the hypotheses of the previous topological lemma are satisfied. Since the map we consider takes values in a given accessible class, we thus get some local accessibility. Indeed, “bad” situations, for which the assumptions of the lemma are not satisfied, correspond to unlikely coincidences that we may expect to be destroyed by a generic perturbation (basically, the bad case is when the images of a very big number of pairwise disjoint “spheres” by our map all cross a common point). One of the restrictions comes from the fact that the holonomies need to be sufficiently Hölder for this approach to be carried out; indeed, we use some interpolation argument, by considering only a finite set of points, and showing that the control we have for them can be propagated to nearby points, provided that we require some suitable *pinching* condition.

By applying this strategy to all the points in some center disk of a family as considered above, we show that for a generic perturbation, any point within these disks belongs to some open accessible class. Therefore, connectedness of these disks implies that in fact, each of them is accessible. Combining this with the property of the map of being accessible modulo this collection of center disks, we can then get full accessibility.

In the definition of the map describing the structure of a certain accessibility class, we ask for some property called *dynamical coherence*, which, *a priori*, could fail to hold even for maps close to the initial one. Yet, a standard notion, referred to as *plaque expansiveness* in the literature, ensures that the center foliation has some form of structural stability. Under this assumption, it is possible to define a natural continuation of the previous map for nearby partially hyperbolic systems. Moreover, once the hypotheses of the topological lemma we use are satisfied for the map associated to a given partially hyperbolic diffeomorphism, they are still satisfied for the related map corresponding to  $C^1$ -close diffeomorphisms, by a continuity argument; then, the “room” generated by the perturbations applied to the initial diffeomorphism can be used to verify that for  $C^1$ -close maps, the property of local accessibility also holds. Yet, a subtlety comes from the fact that our methods require some control on the Hölder exponent of certain

holonomy maps; then we need a quantitative version of the notion of structural stability. For this we borrow results coming from [27], where the authors show that this can be indeed verified in two settings, when the center foliation is *uniformly compact*, or the center-stable and center-unstable bundles are  $C^1$ . Moreover, by varying the radius of the elements in the family of center disks we consider, the property of being accessible modulo a finite collection of center disks is  $C^1$ -open as well. In particular, the accessibility property we generate by the method outlined above is  $C^1$ -stable.

**Convention.** *In the course of the chapter, we will often use constants depending on a diffeomorphism  $f$  (and that may or may not depend on other things). We say that a constant  $C$  depending on a  $C^r$  diffeomorphism  $f$  is  $C^r$ -uniform if it works for all diffeomorphisms in a  $C^r$ -open neighbourhood of  $f$ . We introduce several constants related to a diffeomorphism in Notations 1, 3, 5.*

Given  $l \geq 0$  and diffeomorphisms  $f_1, f_2, \dots, f_l$ , we use the notation  $\prod_{i=1}^l f_i$  to denote  $f_l \circ \dots \circ f_1$ , where by convention  $\prod_{i=j+1}^j f_i := \text{Id}$  for any  $j = 1, \dots, l-1$ .

## 2. Preliminaries

### 2.1. Prevalence.

**Definition 2.8** ( $C^r$  topology). *Let  $r \geq 1$  be an integer. Given integers  $m, n \geq 1$ , the  $C^r$  topology on  $C^r(\mathbb{R}^m, \mathbb{R}^n)$  is the topology induced by the norm  $\|\cdot\|_{C^r}$ , where*

$$\|f\|_{C^r} := \sup_{0 \leq i \leq r, x \in \mathbb{R}^m} \|\partial_x^i f\|, \quad \forall f \in C^r(\mathbb{R}^m, \mathbb{R}^n). \quad (2.1)$$

The  $C^\infty$  topology on  $C^\infty(\mathbb{R}^m, \mathbb{R}^n)$  is the topology induced by the metric  $d_{C^\infty}$ , where

$$d_{C^\infty}(f, g) := \sum_{k=0}^{\infty} 2^{-k} \frac{\|f - g\|_{C^k}}{\|f - g\|_{C^k} + 1}, \quad \forall f, g \in C^\infty(\mathbb{R}^m, \mathbb{R}^n). \quad (2.2)$$

If  $M$  and  $N$  are two smooth Riemannian manifolds, we define accordingly the  $C^r$  topology on  $C^r(M, N)$  for  $r \in \mathbb{N} \cup \{\infty\}$ .

**Definition 2.9** (Parameter family). *Given integers  $r, m, n, J \geq 1$ , we define the space  $C^r([0, 1]^J, C^r(\mathbb{R}^m, \mathbb{R}^n))$  as the set of families  $\{f_\omega\}_\omega$  of maps  $f_\omega \in C^r(\mathbb{R}^m, \mathbb{R}^n)$  such that the derivatives  $\partial_\omega^i \partial_x^j f_\omega(x)$  are well-defined for every  $0 \leq i, j \leq r$  and depend continuously on  $(\omega, x) \in [0, 1]^J \times \mathbb{R}^m$ . For  $\{f_\omega\}_\omega \in C^r([0, 1]^J, C^r(\mathbb{R}^m, \mathbb{R}^n))$ , we set*

$$\|\{f_\omega\}_\omega\|_{C^r} := \sup_{0 \leq i, j \leq r, x \in M} \|\partial_\omega^i \partial_x^j f_\omega(x)\|. \quad (2.3)$$

The  $C^r$  topology on  $C^r([0, 1]^J, C^r(\mathbb{R}^m, \mathbb{R}^n))$  is the topology induced by  $\|\cdot\|_{C^r}$ . Endowed with this norm, the space  $C^r([0, 1]^J, C^r(\mathbb{R}^m, \mathbb{R}^n))$  is complete. The  $C^\infty$  topology on  $C^\infty([0, 1]^J, C^\infty(\mathbb{R}^m, \mathbb{R}^n))$  is defined by analogy.

Let  $r \in \mathbb{N} \cup \{\infty\}$ . Given smooth Riemannian manifolds  $M, N$  and  $\mathcal{U} \subset C^r(M, N)$ , a  $C^r - J$ -family in  $\mathcal{U}$  is an element  $\{f_\omega\}_\omega \in C^r([0, 1]^J, \mathcal{U})$ . We define the  $C^r$  topology on  $C^r([0, 1]^J, \mathcal{U})$  analogously and denote by  $d_{C^r}$  the associate metric.

Throughout this chapter, for any integer  $J \geq 1$ , we will use the notation

$$CB_J := [0, 1]^J.$$

**Definition 2.10** (Prevalence). *Let  $M$  be a smooth Riemannian manifold, and let  $\mathcal{U}$  be a  $C^r$ -open set in  $C^r(M, M)$ ,  $r \in \mathbb{N} \cup \{\infty\}$ . A property  $\mathcal{P}$  for maps in  $C^r(M, M)$  is said to be prevalent in the  $C^r - J$ -Kolmogorov sense in  $\mathcal{U}$ , if for a  $C^r$ -generic  $C^r - J$ -family  $\{f_\omega\}_\omega$  in  $\mathcal{U}$  and for Lebesgue-almost every parameter  $\omega \in CB_J$ ,  $f_\omega$  satisfies  $\mathcal{P}$ .*

We introduce the following notion for technical reasons.

**Definition 2.11** (Good family). *Let  $M$  be a smooth Riemannian manifold and let  $r \in \mathbb{N} \cup \{\infty\}$ . Given an integer  $J \geq 1$ , a family of diffeomorphisms  $\{f_\omega\}_\omega \in$*

$C^r(CB_J, \text{Diff}^r(M))$  is said to be good if the fixed points of  $f_\omega^k$  are isolated for all integer  $k \geq 1$  and Lebesgue-almost every  $\omega \in CB_J$ .

**Proposition 2.12.** *Let  $M$  be a smooth compact Riemannian manifold with volume form  $\text{Vol}$ . There exists  $J_0 = J_0(\dim(M)) \geq 1$  such that the following is true. Given integers  $r \in \mathbb{N}_{\geq 2} \cup \{\infty\}$  and  $J > J_0$ , let  $\{f_\omega\}_{\omega \in CB_J}$  be a  $C^r$ - $J$ -family in  $\text{Diff}^r(M)$  (resp. in  $\text{Diff}^r(M, \text{Vol})$ ). Then for any  $\varepsilon > 0$ , there exists  $\{g_\omega\}_{\omega \in CB_J}$ , a good  $C^r$ - $J$ -family in  $\text{Diff}^r(M)$  (resp. in  $\text{Diff}^r(M, \text{Vol})$ ), such that  $d_{C^r}(\{f_\omega\}, \{g_\omega\}) < \varepsilon$ .*

PROOF. It is essentially contained in the proof of Theorem 2.2 in [20]. In [20], the author investigates prevalence of Kupka-Smale diffeomorphisms in  $\text{Diff}^r(M)$ . Here we also need a volume-preserving version of such a result when  $\dim(M) \geq 3$ . In contrast to the Kupka-Smale property, our notion of good family is only a transversality condition on the level of 0-jets. The following lemma suffices for our purpose.

**Lemma 2.13.** *For any integers  $p, q \geq 3, r \geq 2$ , for any  $C^r$  map  $f: (-1, 1)^p \rightarrow \mathbb{R}^q$ , there exists an integer  $L \geq 1$ , and  $C^\infty$  divergence-free vector fields  $V_1, \dots, V_L$  on  $\mathbb{R}^q$ , supported in  $(-1, 1)^q$ , such that the following is true. Let us denote by  $\mathcal{F}_{V_i}^{b_i}: \mathbb{R}^q \rightarrow \mathbb{R}^q$  the time- $b_i$  map of the flow generated by  $V_i$ , and let  $F: (-1, 1)^{p+L} \rightarrow \mathbb{R}^q$  be defined by*

$$F(x, b) := \mathcal{F}_{V_L}^{b_L} \circ \dots \circ \mathcal{F}_{V_1}^{b_1}(f(x)), \quad \forall x \in (-1, 1)^p, \quad b = (b_1, \dots, b_L) \in (-1, 1)^L.$$

Then the map

$$\mathcal{G}: \begin{cases} (-1, 1)^{p+L} & \rightarrow \mathbb{R}^p \times \mathbb{R}^q \\ (x, b) & \mapsto (x, F(x, b)) \end{cases}$$

is a submersion for any  $(x, b)$  such that  $F(x, b) \in (-1, 1)^q$ .

Lemma 2.13 is proved by a direct construction. Using this lemma in place of Lemma 1.5 in [20], the proof of Proposition 2.12 proceeds as that of Theorem 2.2 in [20].  $\square$

**2.2. Partially hyperbolic diffeomorphisms.** Fix an integer  $d \geq 1$ . We let  $X$  be a smooth  $d$ -dimensional Riemannian manifold with volume form  $\text{Vol}$ .

Let  $f: X \rightarrow X$  be any  $C^1$  partially hyperbolic diffeomorphism or Anosov map. For  $* = u, s$ , we denote by  $d_{\mathcal{W}_f^*}$  the distance restricted to some leaf of  $\mathcal{W}_f^*$ , and for any  $x \in X$ , any  $\sigma > 0$ , we set  $\mathcal{W}_f^*(x, \sigma) := \{y \in \mathcal{W}_f^*(x) \mid d_{\mathcal{W}_f^*}(x, y) < \sigma\}$ .

**Definition 2.14** (Accessible class). *Let  $f: X \rightarrow X$  be a  $C^1$  partially hyperbolic diffeomorphism. For any  $x \in X$ , any  $\ell > 0$  and any integer  $k \geq 1$ , we define  $\text{Acc}_f(x, \ell, k)$  to be the set of all points  $y \in X$  that can be attained from  $x$  through some  $k$ -legged accessible sequence  $x = z_0, z_1, \dots, z_k = y$ , where for each  $0 \leq i \leq k-1$ ,  $z_{i+1} \in \mathcal{W}_f^s(z_i, \ell) \cup \mathcal{W}_f^u(z_i, \ell)$ . We set*

$$\text{Acc}_f(x) := \bigcup_{\ell > 0, k \geq 1} \text{Acc}_f(x, \ell, k),$$

and say  $\text{Acc}_f(x)$  is the accessible class of  $f$  at  $x$ .

For any  $f \in \mathcal{PH}^1(X)$ , accessible classes of  $f$  form a partition of  $X$ , and by Definition 2.5,  $f$  is accessible if and only this partition consists of a single class.

**Definition 2.15** (Dynamical coherence). *A partially hyperbolic diffeomorphism  $f: X \rightarrow X$  is dynamically coherent if  $E^{cs}, E^{cu}$  are integrable to foliations  $\mathcal{W}_f^{cs}, \mathcal{W}_f^{cu}$ , called the center stable foliation, resp. the center unstable foliation, where  $\mathcal{W}_f^s$  subfoliates  $\mathcal{W}_f^{cs}$ , while  $\mathcal{W}_f^u$  subfoliates  $\mathcal{W}_f^{cu}$ . In this case, we set  $\mathcal{W}_f^c(x) := \mathcal{W}_f^{cs}(x) \cap \mathcal{W}_f^{cu}(x)$  for any  $x \in X$ ; the collection of all such leaves forms a foliation  $\mathcal{W}_f^c$ , called the center foliation, which integrates  $E^c$ , and subfoliates both  $\mathcal{W}_f^{cs}$  and  $\mathcal{W}_f^{cu}$  (see [10]). We denote by  $d_{\mathcal{W}_f^c}, d_{\mathcal{W}_f^{cs}}, d_{\mathcal{W}_f^{cu}}$  the associate leafwise distances. For any  $x \in X$ ,  $\sigma > 0$ , and  $* = c, cs, cu$ , we set  $\mathcal{W}_f^*(x, \sigma) := \{y \in \mathcal{W}_f^*(x) \mid d_{\mathcal{W}_f^*}(x, y) < \sigma\}$ .*

It is an open question whether dynamical coherence is a  $C^1$ -open condition. A closely related property is *plaque expansiveness*, which is another commonly-used notion in the study of partially hyperbolic systems. Here, the terminology “plaque” refers to some local center manifold.

**Definition 2.16** (Plaque expansiveness). *Let  $f \in \mathcal{PH}^1(X)$  be dynamically coherent. Given  $\varepsilon > 0$ , a sequence  $(x_n)_{n \in \mathbb{Z}} \in X^{\mathbb{Z}}$  is said to be an  $\varepsilon$ -pseudo orbit with respect to  $\mathcal{W}_f^c$  if for any  $n \in \mathbb{Z}$ ,  $f(x_n) \in \mathcal{W}_f^c(x_{n+1}, \varepsilon)$ . We say that  $f$  is plaque expansive if there exists  $\varepsilon > 0$  such that if  $(p_n)_{n \in \mathbb{Z}}, (q_n)_{n \in \mathbb{Z}}$  are  $\varepsilon$ -pseudo orbits with respect to  $\mathcal{W}_f^c$  satisfying  $d(p_n, q_n) < \varepsilon$  for all  $n \in \mathbb{Z}$ , then  $q_n \in \mathcal{W}_f^c(p_n)$  for all  $n \in \mathbb{Z}$ .*

In other terms, either plaque orbits spread apart to distance bounded away from 0 or the plaques overlap. The following result is due to Hirsch-Pugh-Shub.

**Proposition 2.17** (Theorem 7.1, [17]). *If  $f \in \mathcal{PH}^1(X)$  is dynamically coherent and plaque expansive, then any  $g \in \mathcal{PH}^1(X)$  which is sufficiently  $C^1$ -close to  $f$  is also dynamically coherent. Moreover, there exists a homeomorphism  $\mathfrak{h} = \mathfrak{h}_g: X \rightarrow X$ , called a leaf conjugacy, such that for any  $x, y \in X$  in the same  $f$ -center leaf,  $\mathfrak{h}(x), \mathfrak{h}(y)$  also belong to the same  $g$ -center leaf. Besides, for any  $f$ -center leaf  $\mathcal{C}$ , we have*

$$\mathfrak{h}(f(\mathcal{C})) = g(\mathfrak{h}(\mathcal{C})).$$

**Definition 2.18** (Holonomies). *Let  $f \in \mathcal{PH}^1(X)$  be a dynamically coherent partially hyperbolic diffeomorphism. For  $* = u, s$ , let  $\mathcal{C}_1$  and  $\mathcal{C}_2$  be two local center leaves which are contained in the same  $c *$ -leaf of  $f$ . If  $\mathcal{C}_1$  and  $\mathcal{C}_2$  are sufficiently close, then by transversality, there is a subset  $\tilde{\mathcal{C}}_1 \subset \mathcal{C}_1$  such that for any  $x \in \tilde{\mathcal{C}}_1$ , the local  $*$ -leaf through  $x$  intersects  $\mathcal{C}_2$  at a unique point, denoted by  $H_{f, \mathcal{C}_1, \mathcal{C}_2}^*(x) \in \mathcal{W}_f^*(x, 1) \cap \mathcal{C}_2$ . We thus get a well-defined local homeomorphism*

$$H_{f, \mathcal{C}_1, \mathcal{C}_2}^*: \tilde{\mathcal{C}}_1 \rightarrow \mathcal{C}_2, \quad (2.4)$$

called the (local) (un)stable holonomy map between  $\mathcal{C}_1$  and  $\mathcal{C}_2$ . For any  $x_1 \in X$  and any  $x_2 \in \mathcal{W}_f^{c*}(x_1)$  sufficiently close to  $x_1$ , we define  $H_{f, x_1, x_2}^* := H_{f, \mathcal{W}_f^c(x_1, 1), \mathcal{W}_f^c(x_2, 1)}$ . In this case, there exists  $\sigma > 0$  such that the map  $H_{f, x_1, x_2}^*$  is well defined on  $\mathcal{W}_f^c(x_1, \sigma)$  and maps  $x \in \mathcal{W}_f^c(x_1, \sigma)$  to  $H_{f, x_1, x_2}^*(x) \in \mathcal{W}_f^*(x, 1) \cap \mathcal{W}_f^c(x_2, 1)$ .

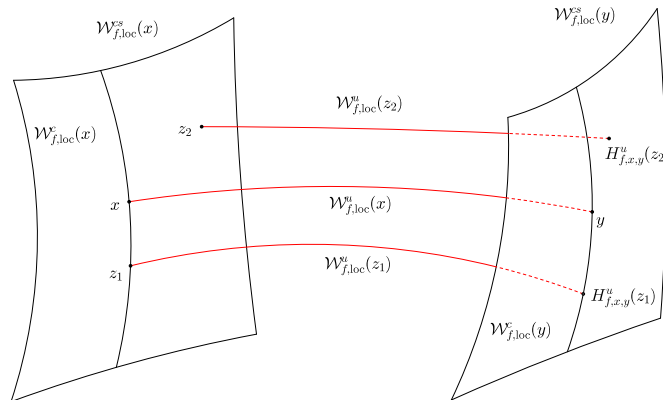

Similarly, if  $\{*, \dagger\} = \{u, s\}$  and  $\mathcal{W}_1, \mathcal{W}_2$  are sufficiently close local  $c \dagger$ -leaves, then for some subset  $\tilde{\mathcal{W}}_1 \subset \mathcal{W}_1$ , there is a well-defined local homeomorphism

$$H_{f, \mathcal{W}_1, \mathcal{W}_2}^*: \tilde{\mathcal{W}}_1 \rightarrow \mathcal{W}_2,$$



also called the (un)stable holonomy map. If  $x_1, x_2 \in X$  are sufficiently close, we set  $H_{f, x_1, x_2}^* := H_{f, \mathcal{W}_f^{c\dagger}(x_1, 1), \mathcal{W}_f^{c\dagger}(x_2, 1)}^*$ . There is no risk of confusion, since when  $x_1$  and  $x_2$  belong to the same  $\mathcal{W}_f^{c*}$ -leaf, then for any  $x \in \mathcal{W}_f^c(x_1, 1)$ , whenever defined, the images  $H_{f, \mathcal{W}_f^c(x_1, 1), \mathcal{W}_f^c(x_2, 1)}^*(x)$  and  $H_{f, \mathcal{W}_f^{c\dagger}(x_1, 1), \mathcal{W}_f^{c\dagger}(x_2, 1)}^*(x)$  coincide.

Now, let  $* = u, s$ , and let  $x_1 \in X$ . If  $x_2 \in \mathcal{W}_f^c(x_1, 1)$  is sufficiently close to  $x_1$ , then there exists  $\sigma > 0$  such that the (local) center holonomy map

$$H_{f, x_1, x_2}^c : \mathcal{W}_f^*(x_1, \sigma) \rightarrow \mathcal{W}_f^*(x_2)$$

along local leaves in  $\mathcal{W}_f^c$  is a well-defined local homeomorphism.

The following result of Pugh-Shub-Wilkinson in [25] relates the pinching condition in Definition 2.4 with the regularity of  $u, s$ -holonomy maps.

**Proposition 2.19.** *If  $f \in \mathcal{PH}^1(X)$  is  $\theta$ -pinched for some  $\theta \in (0, 1)$ , then the local unstable and stable holonomy maps are uniformly  $\theta$ -Hölder.*

In the same vein, under some condition saying that the hyperbolic behaviour of the map dominates the lack of conformality in the center, unstable, resp. stable holonomies are at least of class  $C^1$  when we consider their restriction to some center-unstable, resp. center-stable leaf. The precise definition is as follows.

**Definition 2.20** (Center bunching). *A partially hyperbolic system  $f : X \rightarrow X$  is called center bunched if the following two conditions hold:*

$$-\bar{\chi}^s - \bar{\chi}^c + \hat{\chi}^c < 0, \quad -\bar{\chi}^u + \hat{\chi}^c - \bar{\chi}^c < 0.$$

Here, we take the constants  $\bar{\chi}^s, \bar{\chi}^u, \bar{\chi}^c, \hat{\chi}^c$  as in (1.3)–(1.6).

The following result relates the condition of center bunching to the regularity of  $u, s$ -holonomies; it is contained in the proof of the main theorem in [25] and will be used in several places.

**Proposition 2.21.** *If  $f \in \mathcal{PH}^2(X)$  is dynamically coherent and center bunched, then local unstable, resp. stable holonomy maps between center leaves are  $C^1$  when restricted to some center unstable, resp. center stable leaf, and have uniformly continuous derivatives.*

In the previous statement, uniformity of the continuity is a simple consequence of the invariant section theorem and of the compactness of  $X$ .

### 2.3. On leaf conjugacy.

**Definition 2.22.** *A foliation is said to be uniformly compact if all the leaves are compact, and the leaf volume of the leaves is uniformly bounded.*

In the rest of the chapter, we will focus on dynamically coherent systems satisfying one of the following properties:

- (a)  $\mathcal{W}_f^c$  is a uniformly compact foliation;
- (b) the maps  $x \mapsto E^{cs}(x), E^{cu}(x)$  are of class  $C^1$ .

**Proposition 2.23.** *A dynamically coherent partially hyperbolic diffeomorphism  $f$  satisfying (a) or (b) is plaque expansive.*

PROOF. It is proved in [11], under (a), respectively in [17], under (b).  $\square$

These properties ensure that the leaf conjugacy  $\mathfrak{h}$  appearing in Theorem 2.17 has additional regularity properties. We will use the following result of Pugh-Shub-Wilkinson [27].

**Proposition 2.24** (Theorems A-B, [27]). *Let  $f \in \mathcal{PH}^1(X)$  be dynamically coherent, satisfying (a) (resp. (b)), and let  $\theta$  be a constant such that*

$$0 < \theta < \min \left( \frac{\bar{\chi}^s}{\hat{\chi}^s}, \frac{\bar{\chi}^u}{\hat{\chi}^u} \right) \leq 1. \quad (2.5)$$

*Then for some  $C^1$ -open neighbourhood  $\mathcal{U}_0 = \mathcal{U}_0(f, \theta)$  of  $f$ , for any  $g \in \mathcal{U}_0$ , the leaf conjugacy  $\mathfrak{h}_g$  in Theorem 2.17 exists and can be made  $\theta$ -Hölder, and local center holonomies between sufficiently close leaves are uniformly  $\theta$ -Hölder (resp.  $\theta^2$ -Hölder).*

In the following, we use Propositions 2.19, 2.21, 2.23 and 2.24 while keeping track of the uniformity of various quantities. We summarise these statements as follows.

**Notation 1.** *Given an integer  $d \geq 3$  and a  $d$ -dimensional compact Riemannian manifold  $X$  with metric  $d(\cdot, \cdot)$ , let  $f \in \mathcal{PH}^1(X)$  be dynamically coherent and plaque expansive. Then there exist  $C^1$ -uniform constants  $h_f > 0$ ,  $\sigma_f \in (0, h_f)$ ,  $C_f > 1$  satisfying*

- (1) *For  $* = c, s, u, cs, cu$ , for any  $x \in X$ ,  $y \in \mathcal{W}_f^*(x, \sigma_f)$ , we have*

$$d(x, y) \leq d_{\mathcal{W}_f^*}(x, y) \leq C_f d(x, y).$$

- (2) *(Local product structure) For  $\{*, \dagger\} = \{u, s\}$ , for any  $x \in X$ , any  $y \in B(x, \sigma_f)$ ,  $\mathcal{W}_f^*(x, h_f)$  transversally intersects  $\mathcal{W}_f^{\dagger}(y, h_f)$  at a unique point  $z$ , and  $d_{\mathcal{W}_f^*}(x, z), d_{\mathcal{W}_f^{\dagger}}(z, y) < C_f d(x, y)$ . If in addition,  $y \in \mathcal{W}^{c*}(x, \sigma_f)$ , then  $d_{\mathcal{W}_f^c}(z, y) < C_f d_{\mathcal{W}_f^{c*}}(x, y)$ .*

*Still assuming that  $f$  is dynamically coherent and plaque expansive, then by Propositions 2.19, 2.21, 2.23 and 2.24, there exist  $C^1$ -uniform constants  $\bar{\Lambda}_f > 1$ ,  $\varepsilon_f > 0$ ,  $\theta'_f, \theta''_f \in (0, 1)$ , and a  $C^2$ -uniform constant  $\Lambda_f > 0$ , such that*

- (3) *(Center bunching) If  $f \in \mathcal{PH}^2(X)$  is center bunched, then for  $* = u, s$ , for any  $x \in X$  and  $y \in \mathcal{W}_f^{c*}(x, \frac{\sigma_f}{2})$ , the holonomy map  $H_{f,x,y}^*: \mathcal{W}_f^c(x, \frac{\sigma_f}{2}) \rightarrow \mathcal{W}_f^c(y, C_f \sigma_f)$  is well-defined. Moreover,  $DH_{f,x,y}^*$  is uniformly continuous with respect to the variables<sup>3</sup>  $(f, x, y)$  and has norm bounded by  $\Lambda_f$ .*
- (4) *(Pinching)  $f$  is  $\theta'_f$ -pinched. Besides, if  $f \in \mathcal{PH}^2(X)$ , then for  $\{*, \dagger\} = \{u, s\}$ , for any  $x \in X$ ,  $y \in \mathcal{W}_f^{\dagger}(x, \frac{\sigma_f}{2})$ , the holonomy map  $H_{f,x,y}^{\dagger}: \mathcal{W}_f^{c*}(x, \frac{\sigma_f}{2}) \rightarrow \mathcal{W}_f^{c*}(y, 1)$  is well-defined and has  $\theta'_f$ -Hölder norm bounded by  $\Lambda_f$ .*
- (5) *(Hölderness of the leaf conjugacy and of local center holonomy maps) If  $f$  satisfies (a), resp. (b), then  $\theta'_f$  satisfies (2.5) in place of  $\theta$ , and for any  $g \in \mathcal{PH}^1(X)$  such that  $d_{C^1}(f, g) < \varepsilon_f$ , there exists a leaf conjugacy  $\mathfrak{h} = \mathfrak{h}_g$  as in Proposition 2.17 and whose  $\theta''_f$ -Hölder norm is bounded by  $\bar{\Lambda}_f$ . Moreover, for any  $x \in X$ , any  $y \in \mathcal{W}_g^c(x, \frac{\sigma_f}{2})$ , the holonomy map  $H_{g,x,y}^c$  is defined everywhere on  $\mathcal{W}_g^*(x, \frac{\sigma_f}{2})$ ,  $* = u, s$ , and its  $\theta''_f$ -Hölder norm, resp. its  $(\theta''_f)^2$ -Hölder norm, is bounded by  $\bar{\Lambda}_f$ .*

*Let  $f \in \mathcal{PH}^2(X)$  be dynamically coherent, center bunched, with  $c := \dim(E_f^c) \geq 2$ . For  $* = a, b$ , we say that  $f$  satisfies  $(*)$  if  $f$  satisfies condition  $(*)$  above, and*

$$\theta'_f (\theta''_f)^{\alpha(*)} > \frac{c-1}{c}, \quad (*e)$$

*where  $\alpha(a) := 2$ ,  $\alpha(b) := 3$ . Moreover, if  $f$  satisfies  $(*)$  and*

$$\beta(f, *) := \min \left( \frac{\bar{\chi}^s + \bar{\chi}^c}{\hat{\chi}^u}, \frac{\bar{\chi}^u - \hat{\chi}^c}{\hat{\chi}^s} \right) \min \left( \frac{\bar{\chi}^s}{\hat{\chi}^s}, \frac{\bar{\chi}^u}{\hat{\chi}^u} \right)^{\alpha(*)} > \frac{c-1}{c},$$

*then by Definition 2.4, Propositions 2.19, 2.24, we can choose  $\theta'_f, \theta''_f$  such that  $(*)e$  holds.*

Let us state the most general version of our result, which contains Theorem E.

3. i.e., for  $g \in \mathcal{PH}^1(X)$   $C^1$ -close to  $f$  and  $x' \in X$ , resp.  $y' \in \mathcal{W}_g^*(x')$  close to  $x$ , resp.  $y$ .



**Theorem F** (L.-Zhang). *Let  $r \in \mathbb{N}_{\geq 2} \cup \{\infty\}$  and  $f \in \mathcal{PH}^r(X)$ , with  $c := \dim(E_f^c) > 1$ . If  $f$  is dynamically coherent, center bunched, and satisfies one of the following conditions:*

- (1) *the center foliation of  $f$  is uniformly compact, and  $\beta(f, a) > (c - 1)/c$ ,*
- (2) *the maps  $x \mapsto E^{cs}(x), E^{cu}(x)$  are of class  $C^1$ , and  $\beta(f, b) > (c - 1)/c$ ,*

*then there exist  $\mathcal{U}$ , a  $C^1$ -open neighbourhood of  $f$  in  $\text{Diff}^r(X)$ , and an integer  $J_0$  only depending on  $\dim(X)$ , such that for any  $J \geq J_0$ ,  $C^1$ -stable accessibility, hence also  $C^1$ -stable ergodicity, is prevalent in  $\mathcal{U}$  in the  $C^r - J$ -Kolmogorov sense.*

*Moreover, let  $f \in \text{Diff}^r(X, \text{Vol})$  satisfy the above condition. Then the above conclusion is true for  $\mathcal{U}_0$ , a  $C^1$ -open neighbourhood of  $f$  in  $\text{Diff}^r(X, \text{Vol})$ , in place of  $\mathcal{U}$ . In particular,  $C^1$ -stable ergodicity is  $C^r$ -dense in  $\mathcal{U}_0$ .*

Indeed, if  $f$  is  $\theta$ -pinched for some  $\theta \in (0, 1)$ , then we can see that  $\beta(f, *) > \theta^{1+2\alpha(*)}$ ,  $* = a, b$ . Then, it is direct to see that Theorem F implies Theorem E.

### 3. Random perturbations

**3.1. Basic notions and constructions.** In this section, we will establish some estimates for certain perturbations of the holonomy maps of a dynamically coherent plaque expansive partially hyperbolic system. We start by considering the following more general situation.

Let  $X$  be a compact Riemannian manifold with volume form  $\text{Vol}$  induced by the metric. Given  $f \in \text{Diff}^1(X)$ , we will repeatedly use the following suspension construction.

**Definition 2.25** ( $C^r$  deformation). *Let  $r \in \mathbb{N}_{\geq 1} \cup \{\infty\}$ ,  $f \in \text{Diff}^r(X)$ , and take  $a \in \mathbb{R}^I$  for some integer  $I \geq 1$ . Let  $U$  be an open neighbourhood of  $a$  in  $\mathbb{R}^I$ . Any  $C^r$  map  $\hat{f}: U \times X \rightarrow X$  which satisfies  $\hat{f}(a, \cdot) = f$  is called a  $C^r$  deformation at  $(a, f)$  with  $I$ -parameters. We associate with  $\hat{f}$  the suspension map  $T(\hat{f})$  defined by*

$$T = T(\hat{f}): \begin{cases} U \times X & \rightarrow U \times X, \\ (b, x) & \mapsto (b, \hat{f}(b, x)). \end{cases} \quad (3.1)$$

*If in addition  $\hat{f}(b, \cdot) \in \text{Diff}^r(X, \text{Vol})$  for all  $b \in U$ , then we say that  $\hat{f}$  is a volume-preserving  $C^r$  deformation.*

*In the following,  $U$  will be taken sufficiently small so that various conditions are satisfied. We will use the notation  $U = U(\{c_i\}_i)$  to express that  $U$  satisfies the conditions associated to the collection of parameters  $\{c_i\}_i$ , and can be chosen to only depend on  $\{c_i\}_i$ ; when the conditions associated to the parameters  $\{c'_j\}_j$  are more restrictive than those associated to  $\{c_i\}_i$ , we also denote  $U(\{c'_j\}_j) \subset U(\{c_i\}_i)$  to represent that  $U(\{c'_j\}_j)$  is chosen as a subset of  $U(\{c_i\}_i)$  depending on  $\{c'_j\}_j$ .*

**Definition 2.26** (Infinitesimal  $C^r$  deformation). *Given integers  $I, r \geq 1$ , a  $C^r$  map  $V: \mathbb{R}^I \times X \rightarrow TX$  is called an infinitesimal  $C^r$  deformation with  $I$ -parameters if*

- (1) *for each  $B \in \mathbb{R}^I$ ,  $V(B, \cdot)$  is a  $C^r$  vector field on  $X$ ,*
- (2) *for each  $x \in X$ ,  $B \mapsto V(B, x)$  is a linear map from  $\mathbb{R}^I$  to  $T_x X$ .*

*Given  $a \in \mathbb{R}^I$ ,  $f \in \text{Diff}^r(X)$ , and  $V$ , an infinitesimal  $C^r$  deformation with  $I$ -parameters, then for any sufficiently small  $\epsilon > 0$ , we associate with  $V$  a  $C^r$  deformation at  $(a, f)$  with  $I$ -parameters, denoted by  $\hat{f}$ , and which is defined by the following formula:*

$$\hat{f}: \begin{cases} U \times X & \rightarrow X \\ (b, x) & \mapsto \mathcal{F}_{V(b-a, \cdot)}(1, f(x)), \end{cases}$$

*where  $U = B(a, \epsilon) \subset \mathbb{R}^I$  and for any  $B \in \mathbb{R}^I$ ,  $\mathcal{F}_{V(B, \cdot)}: \mathbb{R} \times X \rightarrow X$  denotes the flow generated by the vector field  $V(B, \cdot)$ . In this case, we say that  $\hat{f}$  is generated by  $V$ . Besides, if for each  $B \in \mathbb{R}^I$ ,  $V(B, \cdot)$  is divergence-free, then  $\mathcal{F}_{V(B, \cdot)}$  is a volume-preserving flow, and we say that  $V$  is a volume-preserving infinitesimal  $C^r$  deformation.*

The following lemma will be used to estimate the derivatives of holonomy maps in Proposition 2.36 when  $f$  is a dynamically coherent, plaque expansive partially hyperbolic diffeomorphism. We defer its proof to Appendix A.

**Lemma 2.27.** *Let  $r \in \mathbb{N}_{\geq 2} \cup \{\infty\}$ ,  $I \in \mathbb{N}_{\geq 1}$  and  $f \in \text{Diff}^r(X)$ . Let  $\hat{f}: U \times X \rightarrow X$  be a  $C^r$  deformation at  $(0, f)$  generated by some infinitesimal  $C^r$  deformation with  $I$ -parameters  $V$ , and take  $T = T(\hat{f})$  as in Definition 2.25. For each  $v \in T(U \times X)$ , we denote by  $\pi_X(v)$  the component of  $v$  in  $TX$ . Then there exists a  $C^2$ -uniform constant  $C_0 = C_0(f) > 0$ , such that by possibly taking  $U$  smaller, the following is true:*

- (1)  $\|DT\| < C_0(1 + \|\partial_b V\|_X)$  and  $\|D^2T\| < C_0(1 + \|\partial_b \partial_x V\|_X)(1 + \|\partial_b V\|_X)$ ;
- (2)  $\|\pi_X DT((0, x), B) - V(B, f(x))\| \leq \text{diam}(U) \|\partial_b V\|_X \|\partial_b \partial_x V\|_X \|B\|$  for any  $(x, B) \in X \times T_0U$ .

PROOF. See Appendix A. □

Some of the estimates will depend on the support of a deformation or of an infinitesimal deformation, which we now define.

**Definition 2.28.** *For an infinitesimal  $C^r$  deformation with  $I$ -parameters  $V: \mathbb{R}^I \times X \rightarrow TX$ , we define*

$$\text{supp}_X(V) := \{x \in X \mid \exists B \in \mathbb{R}^I \text{ such that } V(B, x) \neq 0\}.$$

Given an open neighbourhood  $U$  of the origin in  $\mathbb{R}^I$ , and a  $C^r$  deformation at  $(a, f)$  with  $I$ -parameters  $\hat{f}: U \times X \rightarrow X$ , we define

$$\text{supp}_X(\hat{f}) := \{x \in X \mid \exists b \in U \text{ such that } \hat{f}(b, x) \neq f(a, x)\}.$$

It is clear from Definitions 2.26 and 2.28 that for any infinitesimal  $C^r$  deformation  $V$ , if  $\hat{f}$  is the  $C^r$  deformation of  $f$  generated by  $V$ , then we have

$$\text{supp}_X(\hat{f}) \subset f^{-1}(\text{supp}_X(V)). \quad (3.2)$$

We introduce the following definitions, motivated by the need to control return times of a map to the support of a deformation. Indeed, it will be crucial later on to estimate the changes induced by perturbations on the stable and unstable holonomies.

**Definition 2.29.** *Let  $f \in \text{Diff}^1(X)$ . For any subsets  $A, B \subset X$ , we define*

$$\begin{aligned} R(f, A, B) &:= \inf\{n \geq 0 \mid f^n(A) \cap B \neq \emptyset \text{ or } f^{-n}(A) \cap B \neq \emptyset\}; \\ R_{\geq 0}(f, A, B) &:= \inf\{n \geq 0 \mid f^n(A) \cap B \neq \emptyset\}; \\ R_{\pm}(f, A, B) &:= \inf\{n \geq 1 \mid f^{\pm n}(A) \cap B \neq \emptyset\}. \end{aligned}$$

For any subset  $A \subset X$ , we use the abbreviation  $R_{\pm}(f, A) := R_{\pm}(f, A, A)$ .

Let  $\hat{f}: U \times X \rightarrow X$  be a  $C^1$  deformation of  $f$ . Given  $A, B \subset X$ , we set

$$R_{\pm}(\hat{f}, A, B) := \inf\{n \geq 1 \mid \exists b \in U \text{ such that } \hat{f}(b, \cdot)^{\pm n}(A) \cap B \neq \emptyset\}.$$

We define  $R(\hat{f}, A, B)$ ,  $R_{\geq 0}(\hat{f}, A, B)$ ,  $R_{\pm}(\hat{f}, A)$  in an analogous way. Moreover, it is clear that  $R(\hat{f}, A, B) = \min(R_{\geq 0}(\hat{f}, A, B), R_{\leq 0}(\hat{f}, A, B))$ .

### 3.2. $c$ -disk and $c$ -family.

**Definition 2.30** ( $c$ -disk). *Let  $f: X \rightarrow X$  be a dynamically coherent partially hyperbolic diffeomorphism. For each  $x \in X$  and  $\sigma > 0$ , we call  $\mathcal{C} = \mathcal{W}_f^c(x, \sigma)$  the center disk of  $f$  (or  $c$ -disk of  $f$  for short) centered at  $x$  with radius  $\sigma$ , and we set  $\varrho(\mathcal{C}) := \sigma$ . For any  $\theta \in (0, 1]$ , we also define  $\theta\mathcal{C} := \mathcal{W}_f^c(x, \theta\sigma)$ .*

**Definition 2.31.** *Let  $f \in \mathcal{PH}^1(X)$  be a dynamically coherent partially hyperbolic diffeomorphism. A collection of disjoint center disks  $\mathcal{D} = \{\mathcal{C}_1, \dots, \mathcal{C}_K\}$  is called a family of center disks for  $f$ , or  $c$ -family for  $f$ . We set*

- $\underline{r}(\mathcal{D}) := \inf_{\mathcal{C} \in \mathcal{D}} \{\varrho(\mathcal{C})\}$ ,
- $\bar{r}(\mathcal{D}) := \sup_{\mathcal{C} \in \mathcal{D}} \{\varrho(\mathcal{C})\}$ ,
- $n(\mathcal{D}) := K$ .

Given  $\theta \in (0, 1)$  and  $k \in \mathbb{N}_{\geq 1}$ , we say that  $\mathcal{D}$  is a  $(\theta, k)$ -spanning  $c$ -family for  $f$  if

$$X = \cup_{\mathcal{C} \in \mathcal{D}} \cup_{x \in \theta \mathcal{C}} \text{Acc}_f(x, 1, k).$$

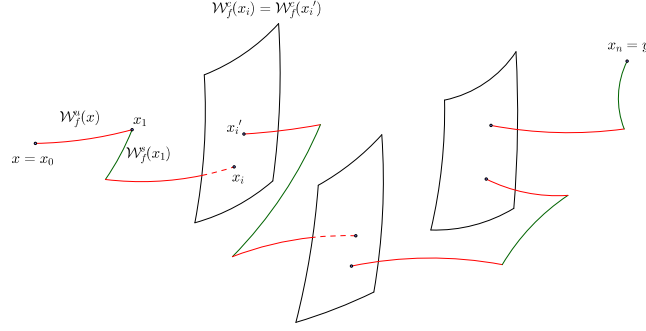

Given a collection  $\mathcal{D} = \{\mathcal{C}_1, \dots, \mathcal{C}_K\}$  of subsets of  $X$  and  $\sigma \geq 0$ , we define:

$$\begin{aligned} (\mathcal{C}_i, \sigma) &:= \{x \in X \mid d(x, \mathcal{C}_i) \leq \sigma\}, \quad \forall i \in \{1, \dots, K\}, \\ (\mathcal{D}, \sigma) &:= \cup_{i=1}^K (\mathcal{C}_i, \sigma). \end{aligned}$$

A collection  $\mathcal{D}$  of subsets of  $X$  is called  $\sigma$ -sparse if for any two distinct  $\mathcal{C}, \mathcal{C}' \in \mathcal{D}$ ,  $(\mathcal{C}, \sigma), (\mathcal{C}', \sigma)$  are disjoint. Any  $c$ -family for  $f$  is  $\sigma$ -sparse for some  $\sigma > 0$ .

The following lemma is a consequence of the continuity of the invariant foliations with respect to the dynamics, and will be used in several places. It says, among other things, that the property of having a spanning  $c$ -family is open in  $C^1$  topology.

**Lemma 2.32.** *Let  $f \in \mathcal{PH}^1(X)$  be dynamically coherent and plaque expansive. For any  $k, K \in \mathbb{N}_{\geq 1}$ ,  $\theta \in (0, 1)$ ,  $\theta' \in (0, 1]$ ,  $\rho_M > 0$ ,  $\rho_m \in (0, \frac{1}{2}\rho_M)$ ,  $\tilde{\sigma} > 0$ , and any  $\sigma \in (0, \tilde{\sigma})$ , there exist real numbers  $\varkappa = \varkappa(\rho_m, \sigma) > 0$ ,  $\lambda = \lambda(f, \theta, \theta', \rho_m, \sigma) > 0$ , and a  $C^1$ -open neighbourhood  $\mathcal{U} = \mathcal{U}(f, k, \theta, \theta', \rho_m, \rho_M, \sigma)$  of  $f$  in  $\mathcal{PH}^1(X)$  such that given any  $\tilde{\sigma}$ -sparse  $(\theta, k)$ -spanning  $c$ -family  $\mathcal{D} = \{\mathcal{C}^i\}_{i=1, \dots, K}$  for  $f$  satisfying  $[\underline{r}(\mathcal{D}), \bar{r}(\mathcal{D})] \subset (\varrho_m, \frac{1}{2}\varrho_M)$ , then for all  $g \in \mathcal{U}$ , the following is true: any family  $\mathcal{D}_g = \{\mathcal{C}_g^i = \mathcal{W}_g^c(x'_i, \varrho'_i)\}_{i=1, \dots, K}$  satisfying  $x'_i \in B(x_i, \lambda)$  and  $\varrho'_i \in (\varrho_i + \varkappa/2, \varrho_i + \varkappa)$  for all  $i \in \{1, \dots, K\}$  is a  $(\theta, k+2)$ -spanning  $c$ -family for  $g$ . Besides,  $[\underline{r}(\mathcal{D}_g), \bar{r}(\mathcal{D}_g)] \subset (\varrho_m, \varrho_M)$ , and for each  $i \in \{1, \dots, K\}$ ,  $\mathcal{C}_g^i \subset (\mathcal{C}^i, \sigma)$ ,  $\theta' \mathcal{C}_g^i \subset (\theta' \mathcal{C}^i, \sigma)$ .*

**PROOF.** Fix  $\mathcal{D}$  as in the above statement and set  $\varkappa := \min(\rho_m, \sigma/2)$ . For any  $i \in \{1, \dots, K\}$ , we have  $\mathcal{C}^i = \mathcal{W}_f^c(x_i, \varrho_i)$  for some  $x_i \in X$  and  $\varrho_i > \rho_m$ . Fix any  $\varrho'_i \in (\varrho_i + \varkappa/2, \varrho_i + \varkappa)$ . In particular,  $\varrho'_i \in (\rho_m, \rho_M)$ ,  $\mathcal{W}_f^c(x_i, \varrho'_i) \subset (\mathcal{C}^i, \sigma/2)$  and  $\mathcal{W}_f^c(x_i, \theta' \varrho'_i) \subset (\theta' \mathcal{C}^i, \sigma/2)$ . Let  $\varsigma = \varsigma(f, \theta, \rho_m, \sigma) > 0$  be such that  $(\mathcal{W}_f^c(x_i, \theta \varrho_i), 2\varsigma) \subset \bigcup_{y \in \mathcal{W}_f^c(x_i, \theta \varrho'_i)} \text{Acc}_f(y, 1, 2)$  for all  $i \in \{1, \dots, K\}$ . By Proposition 2.17,  $\mathcal{W}_g^c, \mathcal{W}_g^{cs}$  (resp.  $\mathcal{W}_g^s, \mathcal{W}_g^{cu}$ ) exist and are uniformly transverse for all  $g$  sufficiently close to  $f$  in  $\mathcal{PH}^1(X)$ . Thus, there exists  $\lambda = \lambda(f, \theta, \theta', \rho_m, \sigma) > 0$  such that for any  $g \in \mathcal{PH}^1(X)$  with  $d_{C^1}(f, g) < \lambda$ , for each  $i \in \{1, \dots, K\}$ , if  $x'_i \in B(x_i, \lambda)$ , then  $\mathcal{W}_g^c(x'_i, \varrho'_i) \subset (\mathcal{C}^i, \sigma)$ ,  $\mathcal{W}_g^c(x'_i, \theta' \varrho'_i) \subset (\theta' \mathcal{C}^i, \sigma)$  and  $(\mathcal{W}_f^c(x_i, \theta \varrho_i), \varsigma) \subset \bigcup_{y \in \mathcal{W}_g^c(x'_i, \theta \varrho'_i)} \text{Acc}_g(y, 1, 2)$ . Now, since  $\mathcal{D}$  is  $(\theta, k)$ -spanning for  $f$ , by continuous dependence of the invariant foliations with respect to the dynamics, there exists  $\lambda' = \lambda'(f, k, \theta, \theta', \rho_m, \sigma) \in (0, \lambda)$  such that for

any  $g \in \mathcal{PH}^1(X)$  with  $d_{C^1}(f, g) < \lambda'$ , any  $x \in X$ , there exists an accessible sequence for  $g$  with  $k$  legs of length at most 1 from  $x$  to a point  $y \in (\mathcal{W}_f^c(x_i, \theta_{\varrho_i}), \varsigma)$  for some  $i \in \{1, \dots, K\}$ . Combined with the earlier discussion, this concludes.  $\square$

**3.3. Extended map and center subspaces.** Given  $f \in \mathcal{PH}^1(X)$ , let  $\bar{\chi}^c, \hat{\chi}^c, \bar{\chi}^s, \bar{\chi}^u$  be as in Definition 2.2 so that (1.3) to (1.6) are satisfied. Let

$$\xi := \min(\bar{\chi}^c + \bar{\chi}^s, \bar{\chi}^u - \hat{\chi}^c). \quad (3.3)$$

Since  $-\bar{\chi}^s < \bar{\chi}^c \leq \hat{\chi}^c < \bar{\chi}^u$  and  $\bar{\chi}^c \leq 0 \leq \hat{\chi}^c$ , we have  $0 < \xi \leq \min(\bar{\chi}^s, \bar{\chi}^u)$ .

**Lemma 2.33.** *Let  $r \in \mathbb{N}_{\geq 1} \cup \{\infty\}$  and let  $f \in \mathcal{PH}^r(X)$  be dynamically coherent and plaque expansive. Given  $a \in \mathbb{R}^I$  and a neighbourhood  $U \subset \mathbb{R}^I$  of  $a$ , let  $\hat{f}: U \times X \rightarrow X$  be a  $C^r$  deformation at  $(a, f)$  with  $I$ -parameters. If  $U$  is chosen sufficiently small, the map  $T = T(\hat{f})$  is a  $C^r$  dynamically coherent partially hyperbolic system for some  $T$ -invariant splitting*

$$T_b U \oplus T_x X = E_T^s(b, x) \oplus E_T^c(b, x) \oplus E_T^u(b, x), \quad \forall (b, x) \in U \times X.$$

We denote such  $U$  by  $U(DC)$ . Moreover, for any  $(b, x) \in U \times X$ ,  $* = u, s$ ,

$$E_T^*(b, x) = \{0\} \oplus E_{\hat{f}(b, \cdot)}^*(x), \quad \mathcal{W}_T^*(b, x) = \{b\} \times \mathcal{W}_{\hat{f}(b, \cdot)}^*(x), \quad (3.4)$$

and there exists a unique linear map  $\nu_b(x, \cdot): T_b U \rightarrow E_{\hat{f}(b, \cdot)}^{su}(x) := E_{\hat{f}(b, \cdot)}^s(x) \oplus E_{\hat{f}(b, \cdot)}^u(x)$  such that

$$E_T^c(b, x) = \text{Graph}(\nu_b(x, \cdot)) \oplus E_{\hat{f}(b, \cdot)}^c(x). \quad (3.5)$$

If in addition  $r \geq 2$  and  $f$  is center bunched, then, after replacing  $U$  by  $U(CB) \subset U(DC)$ ,  $u, s$ -holonomy maps between center leaves of  $T$  (within distance 1) are  $C^1$  when restricted to some  $cu, cs$ -leaf, with uniformly continuous, uniformly bounded derivatives.

**PROOF.** In the following, we let  $* = u$  or  $s$ . For all  $b \in U$ ,  $E_{\hat{f}(b, \cdot)}^*$  is close to  $E_f^*$ , and the expansion/contraction rate of  $\hat{f}(b, \cdot)$  along  $E_{\hat{f}(b, \cdot)}^{u/s}$  is close to that of  $f$  along  $E_f^{u/s}$ . Thus, by choosing  $U$  small enough, the map  $T$  can be made arbitrarily  $C^1$ -close to  $\mathcal{T}_0: (b, x) \mapsto (b, f(x))$ , which is a dynamically coherent partially hyperbolic system ( $\mathcal{W}_{\mathcal{T}_0}^* = U \times \mathcal{W}_f^*$ ). By  $C^1$ -openness of partial hyperbolicity, and since  $f$  is assumed to be plaque expansive, we deduce that  $T$  itself is partially hyperbolic and dynamically coherent. Besides, for any  $(b, x) \in U \times X$ , any  $B + v \in T_b U \oplus T_x X$ ,

$$DT((b, x), B + v) = B + [\partial_b \hat{f}((b, x), B) + \partial_x \hat{f}((b, x), v)]. \quad (3.6)$$

Then  $DT(b, x)$  maps  $\{0\} \oplus E_{\hat{f}(b, \cdot)}^*(x)$  to  $\{0\} \oplus E_{\hat{f}(b, \cdot)}^*(\hat{f}(b, x))$ , which gives  $E_T^*(b, x) = \{0\} \oplus E_{\hat{f}(b, \cdot)}^*(x)$ . Given  $(b, x) \in U \times X$ , it is direct to check that  $\mathcal{W}_T^*(b, x) \subset \{b\} \times X$ .

Moreover, for any  $(b, x') \in \mathcal{W}_T^*(b, x)$ , we have  $T_{(b, x')}(\mathcal{W}_T^*(b, x)) = E_T^*(b, x') = \{0\} \oplus E_{\hat{f}(b, \cdot)}^*(x')$ , hence  $\mathcal{W}_T^*(b, x) \subset \{b\} \times \mathcal{W}_{\hat{f}(b, \cdot)}^*(x)$ . The other inclusion is shown in an analogous way.

Now, if  $r \geq 2$  and  $f$  is center bunched, by  $C^1$ -openness of center bunching, for sufficiently small  $U$ , we can verify that  $T^n$  is also center bunched for some  $n \in \mathbb{N}$ . The smoothness of  $s, u$ -holonomy maps of  $T$  follows from Proposition 2.21.  $\square$

Let  $f, U, \hat{f}$  and  $T$  be as in Lemma 2.33. In the following, for any  $(b, x) \in U \times X$ , we will tacitly use the inclusions  $E_{\hat{f}(b, \cdot)}^*(x) \rightarrow \{0\} \oplus E_{\hat{f}(b, \cdot)}^*(x) \subset T_b U \oplus T_x X$  for  $* = s, u, c$ , and the inclusion  $\mathbb{R}^I \simeq T_b U \oplus \{0\} \subset T_b U \oplus T_x X$ .

For any  $(b, x) \in U \times X$  and  $v \in T_b U \oplus T_x X$ , we denote by  $\pi_X(v)$  the component of  $v$  in  $T_x X$ , and we let  $\pi_*(v)$  be the component of  $v$  in  $E_{\hat{f}(b, \cdot)}^*$  for  $* = u, s, c$ . For any vector  $w \in E_T^c(b, x)$ , we also set  $\pi_b(w) := w - \pi_c(w)$ . By a slight abuse of notation, we define  $\pi_X(b, x) := x$  for any  $(b, x) \in U \times X$ .

The following lemmata collect some basic properties of the center bundle  $E_T^c$ .

**Lemma 2.34.** *There exists a  $C^1$ -uniform constant  $C_1 = C_1(f) > 0$ , such that, after possibly reducing the size of  $U$ , we have*

$$\sup_{x \in X} \|\nu_0(x, \cdot)\| \leq C_1 \|T\|_{C^1}.$$

PROOF. For any  $(x, B) \in X \times T_0U$ , and for all  $m \geq 0$ , we have by (3.6):

$$\begin{aligned} \pi_u \nu_0(x, B) &= Df^{-m}(f^m(x), \pi_u DT^m((0, x), B + \pi_u \nu_0(x, B))) \\ &\quad - \sum_{n=1}^m Df^{-n}(f^n(x), \pi_u \partial_b \hat{f}((0, f^{n-1}(x)), B)). \end{aligned}$$

Since  $B + \pi_u \nu_0(x, B) = (B + \nu_0(x, B)) - \pi_s \nu_0(x, B) \in E_T^{cs}(0, x)$ , for  $U$  sufficiently small, the first term above goes to zero (like  $(\|DT|_{E_T^{cs}}\| \|DT^{-1}|_{E_T^u}\|)^m$ ), while the series in the second term converges, hence

$$\pi_u \nu_0(x, B) = - \sum_{n=1}^{+\infty} Df^{-n}(f^n(x), \pi_u \partial_b \hat{f}((0, f^{n-1}(x)), B)).$$

Therefore, we see that  $\sup_{x \in X} \|\pi_u \nu_0(x, \cdot)\| \leq c_1 \|T\|_{C^1}$  for some  $C^1$ -uniform constant  $c_1 = c_1(f) > 0$ . We argue similarly for the stable component of  $\nu_0$ .  $\square$

**Lemma 2.35.** *After possibly reducing the size of  $U$ , the following is true:*

(1) *For any  $x \in X \setminus \text{supp}_X(\hat{f})$ , any  $B \in T_0U$ , we have*

$$DT(B + \nu_0(x, B)) = B + \nu_0(f(x), B).$$

*Equivalently,  $Df(x, \nu_0(x, \cdot)) = \nu_0(f(x), \cdot)$ .*

(2) *There is a  $C^1$ -uniform constant  $C_2 = C_2(f) > 0$  such that  $\forall (x, B) \in X \times T_0U$ ,*

$$\|\nu_0(x, B)\| \leq C_2 \|T\|_{C^1} \max(e^{-R_-(\hat{f}, x, \text{supp}_X(\hat{f}))\bar{\chi}^s}, e^{-R_{\geq 0}(\hat{f}, x, \text{supp}_X(\hat{f}))\bar{\chi}^u}) \|B\|.$$

PROOF. Proof of (1): For any  $x \in X \setminus \text{supp}_X(\hat{f})$ , any  $B \in T_0U$ , (3.6) implies that  $DT((0, x), B) = B$ . We have  $DT(\nu_0(x, B)) \in E_T^{su}(0, f(x))$  and, by (3.5),  $DT(B + \nu_0(x, B)) \in \text{Graph}(\nu_0(f(x), \cdot)) + E_f^c(f(x))$ . Thus

$$DT(B + \nu_0(x, B)) \in (B + E_T^{su}(0, f(x))) \cap (\text{Graph}(\nu_0(f(x), \cdot)) + E_f^c(f(x))),$$

while the right hand side contains only  $B + \nu_0(f(x), B)$ .

Proof of (2): By (1), for any  $x \in X$  and  $0 \leq n < R_-(\hat{f}, \{x\}, \text{supp}_X(\hat{f}))$ , we have

$$\pi_s \nu_0(x, B) = Df^n(\pi_s \nu_0(f^{-n}(x), B)), \quad \forall B \in T_0U.$$

After possibly reducing the size of  $U$ , by Lemma 2.34 we have for some  $C^1$ -uniform constant  $C_1 = C_1(f) > 0$ ,

$$\|\pi_s \nu_0(x, \cdot)\| \leq C_1 \|T\|_{C^1} e^{-R_-(\hat{f}, x, \text{supp}_X(\hat{f}))\bar{\chi}^s}.$$

Similarly, we have  $\|\pi_u \nu_0(x, \cdot)\| \leq C_1 \|T\|_{C^1} e^{-R_{\geq 0}(\hat{f}, x, \text{supp}_X(\hat{f}))\bar{\chi}^u}$ .  $\square$

**3.4. Holonomy maps.** We introduce the following notation.

**Notation 2.** *Let  $f \in \mathcal{PH}^2(X)$  be dynamically coherent, plaque expansive and center bunched. Given  $I \in \mathbb{N}_{\geq 1}$ ,  $a \in \mathbb{R}^I$ , and a  $C^2$  deformation  $\hat{f}: U \times X \rightarrow X$  at  $(a, f)$ , we will always assume that  $U$  satisfies the conclusion of Lemma 2.33, i.e.,  $U = U(CB)$ . When the exponents  $-\bar{\chi}^s < \bar{\chi}^c \leq \hat{\chi}^c < \bar{\chi}^u$  for  $f$  are given (see Definitions 2.2, 2.4), we also assume that  $U$  is chosen small enough such that the same exponents and the same constants  $h_f, \sigma_f, C_f, \bar{\Lambda}_f, \varepsilon_f, \theta'_f, \theta''_f, \Lambda_f$  (as in Notation 1) work for the perturbed map  $\hat{f}(b, \cdot)$ , for all  $b \in U$ . We denote in this case  $U = U(\chi) \subset U(CB)$ .*

In the following, we fix an integer  $I > 0$  and a map  $f \in \mathcal{PH}^2(X)$  as in Notation 2, we let  $\hat{f}: U \times X \rightarrow X$  be a  $C^2$  deformation at  $(0, f)$  with  $I$ -parameters, and we set  $T = T(\hat{f})$ .

The following proposition gives bounds for the derivatives of holonomy maps with respect to parameters.

**Proposition 2.36** (*A priori estimates*). *There exists a  $C^2$ -uniform constant  $C_3 = C_3(f) > 0$ , such that the following is true. Take any  $x \in X$ ,  $y \in \mathcal{W}_f^{cu}(x, \sigma_f)$ , and set  $z := H_{f,x,y}^u(x)$ . Let  $U = U(\chi)$ . Then for any  $B \in T_0U$ , we have*

$$\begin{aligned} & \left\| \pi_c D H_{T,(0,x),(0,y)}^u(B + \nu_0(x, B)) \right\| \\ & \leq C_3 (\|\nu_0(x, \cdot)\| + \|\nu_0(z, \cdot)\| + \|D^2 T\| d_{\mathcal{W}_f^u}(x, z)) \|B\|. \end{aligned} \quad (3.7)$$

We have an analogous statement for any  $x, y$  in a local center stable leaf.

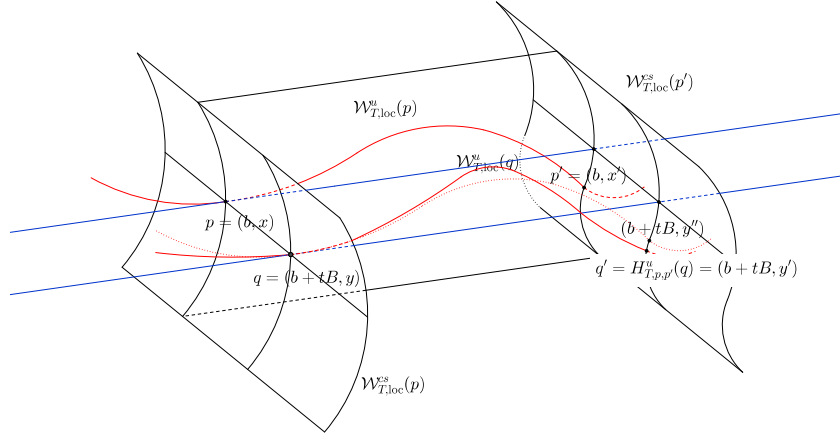

**PROOF.** This is essentially proved in [25]. We sketch the main ideas and refer to [25] for the details. Let  $\tilde{E}_T^u$  (resp.  $\tilde{E}_T^{cs}$ ) be a smooth bundle that closely approximates  $E_T^u$  (resp.  $E_T^{cs}$ ) and let  $\delta = \delta(f) > 0$  be a small  $C^1$ -uniform constant such that the following is true. We trivialize  $\tilde{E}_T^u, \tilde{E}_T^{cs}$  by choosing  $C^\infty$  embeddings  $\iota_1: \tilde{E}_T^u \rightarrow U \times X \times \mathbb{R}^{m_1}$  and  $\iota_2: \tilde{E}_T^{cs} \rightarrow U \times X \times \mathbb{R}^{m_2}$ , where for  $i = 1, 2$ ,  $m_i \in \mathbb{N}$ , and  $\mathbb{R}^{m_i}$  is equipped with a metric  $\|\cdot\|_i$  such that the Lipschitz constant of  $\iota_i$  is uniformly bounded by some  $C^1$ -uniform constant  $c_0 = c_0(f) > 0$ . Following [25], we can construct a family of Lipschitz functions  $\{\gamma_p: B(0_{\mathbb{R}^{m_1}}, 2\delta) \rightarrow \mathbb{R}^{m_2}\}_{p \in U \times X}$  parametrizing local unstable manifolds: for any  $p = (b, x) \in U \times X$ , we have

$$\mathcal{W}_T^u(p, \delta/2) \subset \exp_x(\text{Graph}(\iota_2^{-1} \gamma_p \iota_1|_{\tilde{E}_T^u(p, \delta)})) \subset \mathcal{W}_T^u(p, 2\delta).$$

Moreover, there exists a  $C^2$ -uniform constant  $c_1 = c_1(f) > 0$  such that for any sufficiently close  $p, q \in U \times X$  in the same center unstable manifold of  $T$ ,

$$\|\gamma_p(z) - \gamma_q(z)\|_2 < c_1 \|D^2 T\| d(p, q) \|z\|_1, \quad \forall z \in B(0, 2\delta) \subset \mathbb{R}^{m_1}. \quad (3.8)$$

Let  $b \in U$ ,  $x \in X$  and  $p = (b, x)$ . In a small neighbourhood of  $x$ , we can define a coordinate chart  $\tau_p: (-1, 1)^d \rightarrow X$  with the following properties:

- (1) we have  $\tau_p(0) = x$ , thus we can (and do) assume that  $x = 0$  and  $p = (b, 0)$ ;
- (2)  $D\tau_p(0, \cdot)$  maps  $\mathbb{R}^{d_u} \times \{0\}$  (resp.  $\{0\} \times \mathbb{R}^{c+d_s}$ ) to  $E_{\hat{f}(b, \cdot)}^u(x)$  (resp.  $E_{\hat{f}(b, \cdot)}^{cs}(x)$ );
- (3)  $\tilde{E}_{\hat{f}(b, \cdot)}^u$  is close to the tangent space of  $\tau_p((-1, 1)^{d_u} \times \{z_{cs}\})$ ,  $z_{cs} \in (-1, 1)^{c+d_s}$ ;
- (4)  $\tilde{E}_{\hat{f}(b, \cdot)}^{cs}$  is close to the tangent space of  $\tau_p(\{z_u\} \times (-1, 1)^{c+d_s})$ ,  $z_u \in (-1, 1)^{d_u}$ .

Such a chart is obtained by choosing a chart that satisfies the first two conditions, and then by considering its restriction to a sufficiently small neighbourhood of the origin. We can also choose  $\tau_p$  to depend continuously on  $p$ .



In the following, we fix  $p = (b, 0)$  and  $\tau = \tau_p$ . We will not distinguish a point in  $\tau((-1, 1)^d)$  and its coordinate under  $\tau^{-1}$ . Besides, we identify any tangent vector  $v \in T_x X$  with its preimage  $D\tau^{-1}(v)$ , whenever it is defined. Without loss of generality, we assume that  $\delta$  is small compared to the size of  $\tau((-1, 1)^d)$ .

Let  $p' = (b, x') \in \mathcal{W}_T^u(p)$  be a point sufficiently close to  $p$  such that there exists  $w_0 \in \iota_1(\tilde{E}_T^u(p, \delta/2)) \subset \mathbb{R}^{m_1}$  satisfying

$$x' = \exp_0(\iota_1^{-1}(w_0) + \iota_2^{-1}\gamma_p(w_0)). \quad (3.9)$$

Let  $B \in T_b U$ , and let  $t > 0$  be any sufficiently small constant. Set

$$y = y(t) := t\nu_b(x, B), \quad q = q(t) := p + t(B, \nu_b(x, B)) = (b + tB, y). \quad (3.10)$$

We define

$$y'' := \exp_y(\iota_1^{-1}(w_0) + \iota_2^{-1}\gamma_q(w_0)).$$

Then by (3.8), (3.10), and since  $\iota_1, \iota_2$  have Lipschitz constants uniformly bounded by  $c_0$ , we deduce that

$$\begin{aligned} \|x' - y''\| &< c_2(\|y\| + \|\gamma_p(w_0) - \gamma_q(w_0)\|_2) \\ &< c_3(t\|\nu_b(x, B)\| + t\|D^2T\|(\|B\| + \|\nu_b(x, B)\|)\|w_0\|_1), \end{aligned} \quad (3.11)$$

for two  $C^2$ -uniform constants  $c_2 = c_2(f), c_3 = c_3(f) > 0$ .

Let  $q' := H_{T,p,p'}^u(q)$ . By the definition of holonomies,  $\{q'\} = \mathcal{W}_T^{cs}(p') \cap \mathcal{W}_T^u(q)$ . By (3.4),  $\mathcal{W}_T^u(q) = \{b + tB\} \times \mathcal{W}_{\hat{f}(b+tB, \cdot)}^u(y)$ , hence  $q' = (b + tB, y')$  for some  $y' \in \mathcal{W}_{\hat{f}(b+tB, \cdot)}^u(y)$ . On  $U \times \tau((-1, 1)^d)$ ,  $\mathcal{W}_T^{cs}(p')$  is closely approximated by  $E_T^{cs}(p') = \text{Graph}(\nu_b(x', \cdot)) \oplus E_{\hat{f}(b, \cdot)}^{cs}(x')$ . We deduce that for some  $v^{cs}(t) \in E_{\hat{f}(b, \cdot)}^{cs}(x')$ ,

$$y' = x' + t\nu_b(x', B) + v^{cs}(t) + o(t),$$

hence

$$(y' - y'') - v^{cs}(t) = t\nu_b(x', B) + x' - y'' + o(t). \quad (3.12)$$

Since  $y', y'' \in \mathcal{W}_{\hat{f}(b+tB, \cdot)}^u(y)$ , we also know that  $y' - y''$  is close to  $E_{\hat{f}(b+tB, \cdot)}^u(y'')$ , while  $v^{cs}(t) \in E_{\hat{f}(b, \cdot)}^{cs}(x')$ . For any  $b_1, b_2 \in U$ , and  $y_1, y_2$  sufficiently close to  $x$ , the angle between  $E_{\hat{f}(b_1, \cdot)}^u(y_1)$  and  $E_{\hat{f}(b_2, \cdot)}^{cs}(y_2)$  is uniformly bounded from below. Hence, by projection on the centre-stable part, it follows from (3.12) that  $\|v^{cs}(t)\| \leq c_4(t\|\nu_b(x', B)\| + \|x' - y''\|)$ , for some  $C^2$ -uniform constant  $c_4 = c_4(f) > 0$ , and

$$\|y' - y''\| \leq (1 + c_4)(t\|\nu_b(x', B)\| + \|x' - y''\|). \quad (3.13)$$

Combining estimates (3.11) and (3.13), and since  $\|\pi_X p' - \pi_X q'\| \leq \|x' - y''\| + \|y' - y''\|$ , we deduce that for some  $C^2$ -uniform constant  $c_5 = c_5(f) > 0$ ,

$$\|\pi_X p' - \pi_X q'\| \leq c_5(\|\nu_b(x, \cdot)\| + \|\nu_b(x', \cdot)\| + \|D^2T\|d_{\mathcal{W}_{\hat{f}(b, \cdot)}^u}(x, x'))t\|B\|.$$

We conclude that for any  $p = (b, x), p' = (b, x') \in \mathcal{W}_T^u(p)$ , and  $B \in T_b U$ ,

$$\begin{aligned} \|\pi_c DH_{T,p,p'}^u(B + \nu_b(x, B))\| &= \lim_{t \rightarrow 0} \frac{\|\pi_X p' - \pi_X H_{T,p,p'}^u(t(B + \nu_b(x, B)))\|}{t} \\ &\leq c_5(\|\nu_b(x, \cdot)\| + \|\nu_b(x', \cdot)\| + \|D^2T\|d_{\mathcal{W}_{\hat{f}(b, \cdot)}^u}(x, x'))\|B\|, \end{aligned}$$

as desired.  $\square$

**Lemma 2.37.** *Let  $* = u, s$ . Take  $x \in X, y \in \mathcal{W}_f^{c*}(x, \sigma_f)$  and set  $z := H_{f,x,y}^*(x)$ . We define  $m_{\geq 0} := R_{\geq 0}(\hat{f}, \{x, z\}, \text{supp}_X(\hat{f}))$  and  $m_- := R_-(\hat{f}, \{x, z\}, \text{supp}_X(\hat{f}))$ .*

(1) *For any  $B \in T_0 U$ , we have*

$$\pi_b DH_{T,(0,x),(0,y)}^*(B + \nu_0(x, B)) = B + \nu_0(z, B).$$

(2) *There exists a  $C^2$ -uniform constant  $C_4 = C_4(f) > 0$  such that for any  $B \in T_0 U$ ,*

$$\left\| \pi_c DH_{T,(0,x),(0,y)}^*(B + \nu_0(x, B)) \right\| \leq C_4(e^{-\min(m_{\geq 0}\bar{\chi}^u, m_-\bar{\chi}^s)} \|DT\| + \|D^2T\|d_{\mathcal{W}_f^*}(x, z))\|B\|.$$

PROOF. We consider the case where  $*$  =  $u$ . The other one is handled similarly.

Proof of (1): for any  $(b, x) \in U \times X$ , we know by (3.4) that  $\mathcal{W}_T^u(b, x) \subset \{b\} \times X$ , hence the image of  $H_{T, (0, x), (0, y)}^u$  is contained in  $\{b\} \times X$ . Then for any  $B \in T_0U$ , we have  $DH_{T, (0, x), (0, y)}^u(B + \nu_0(x, B)) \in B + T_zX$ , while  $\pi_b(B + T_zX) = B + \nu_0(z, B)$ .

Proof of (2): by Proposition 2.36 and Lemma 2.35 (2), there exist  $C^2$ , resp.  $C^1$ -uniform constants  $c_2 = c_2(f) > 0$ , resp.  $c_1 = c_1(f) > 0$ , such that

$$\begin{aligned} & \left\| \pi_c DH_{T, (0, x), (0, y)}^u(B + \nu_0(x, B)) \right\| \\ & \leq c_2 (\|\nu_0(x, \cdot)\| + \|\nu_0(z, \cdot)\|) + \|D^2T\| d_{\mathcal{W}_f^u}(x, z) \|B\| \\ & \leq c_2 c_1 (e^{-\min(m \geq 0 \bar{\chi}^u, m - \bar{\chi}^s)} \|T\|_{C^1} + \|D^2T\| d_{\mathcal{W}_f^u}(x, z)) \|B\|. \end{aligned}$$

□

**Proposition 2.38.** *There exists a  $C^2$ -uniform constant  $C_5 = C_5(f) > 0$ , such that the following is true. Fix any  $C, R_0 > 0, \sigma \in (0, \sigma_f)$ . Assume that  $\hat{f}$  is generated by  $V$ , an infinitesimal  $C^2$  deformation such that  $\sigma \|\partial_b \partial_x V\|_X + \|\partial_b V\|_X < C$ . Let  $\xi > 0$  be given by (3.3), and set*

$$\xi' := \frac{\min(\bar{\chi}^s, \bar{\chi}^u) \xi}{2(\bar{\chi}^s + \bar{\chi}^u)} > 0. \quad (3.14)$$

Then there exists an open neighbourhood  $U = U(R_0, \sigma) \subset U(\chi)$  of the origin such that the following properties hold:

- (1) Let  $y \in \mathcal{W}_f^{cu}(x, \sigma)$  and  $z := H_{f, x, y}^u(x)$ . Assume that  $x \notin \text{supp}_X(V)$  and  $R_-(\hat{f}, \{x, z\}, \text{supp}_X(V)) > R_0$ . Then for any  $B \in T_0U$ ,

$$\left\| \pi_c DH_{T, (0, x), (0, y)}^u(B + \nu_0(x, B)) - \pi_c V(B, z) \right\| \leq C_5 C^2 e^{-R_0 \xi'} \|B\|.$$

- (2) Let  $y \in \mathcal{W}_f^{cs}(x, \sigma)$  and  $z := H_{f, x, y}^s(x)$ . Assume that  $R_+(\hat{f}, \{x, z\}, \text{supp}_X(V)) > R_0$ . Then for any  $B \in T_0U$ ,

$$\left\| \pi_c DH_{T, (0, x), (0, y)}^s(B + \nu_0(x, B)) \right\| \leq C_5 C^2 e^{-R_0 \xi'} \|B\|.$$

In particular, we note that the terms on the right hand side of the above inequalities are independent of  $\sigma$ , which will later allow us to choose the infinitesimal deformation  $V$  very localized.

PROOF. We first prove (1). Without loss of generality, we assume that

$$R_0 > \frac{20(\bar{\chi}^s + \bar{\chi}^u)}{\min(\bar{\chi}^s, \bar{\chi}^u)}.$$

By Lemma 2.37 (1), for any  $B \in T_0U$ , we have

$$\pi_b DH_{T, (0, x), (0, y)}^u(B + \nu_0(x, B)) = B + \nu_0(z, B). \quad (3.15)$$

For any  $2 \leq m \leq R_0$ ,  $B \in T_0U$ , successive application of Lemma 2.35 (1) gives

$$DT^{-m}(B + \nu_0(w, B)) = B + \nu_0(f^{-m}(w), B), \quad w = x \text{ or } z. \quad (3.16)$$

Moreover,  $x \notin \text{supp}_X(V)$ , hence  $f^{-1}(x) \notin \text{supp}_X(\hat{f})$  and we get

$$DT^{-1}(B + \nu_0(x, B)) = B + \nu_0(f^{-1}(x), B).$$

Let  $1 \leq n \leq R_0 - 1$ . The invariance of the foliations under the dynamics yields

$$\begin{aligned} & \pi_c DH_{T, (0, x), (0, y)}^u(B + \nu_0(x, B)) = \pi_c DH_{T, (0, x), (0, z)}^u(B + \nu_0(x, B)) \\ & = \pi_c DT^n((\pi_b + \pi_c) DH_{T, T^{-n}(0, x), T^{-n}(0, z)}^u DT^{-n}(B + \nu_0(x, B))) \\ & = \pi_c DT^n((\pi_b + \pi_c) DH_{T, T^{-n}(0, x), T^{-n}(0, z)}^u(B + \nu_0(f^{-n}(x), B))), \end{aligned} \quad (3.17)$$

where we have used that  $DH_{T, T^{-n}(0, x), T^{-n}(0, z)}^u(B + \nu_0(f^{-n}(x), B)) \in E_T^c(T^{-n}(0, z))$ .



**Claim.** *There exists a  $C^2$ -uniform constant  $c_1 = c_1(f) > 0$  such that*

$$\left\| \pi_c DH_{T, T^{-n}(0,x), T^{-n}(0,z)}^u (B + \nu_0(f^{-n}(x), B)) \right\| \leq c_1 C^2 (e^{-\min(n\bar{\chi}^u, (R_0-n)\bar{\chi}^s)} + e^{-n\bar{\chi}^u}) \|B\|.$$

PROOF. By  $y \in \mathcal{W}_f^{cu}(x, \sigma)$ , for some  $C^1$ -uniform constant  $c_2 = c_2(f) > 0$ , we obtain

$$d_{\mathcal{W}_f^u}(T^{-n}(0, x), T^{-n}(0, z)) < e^{-n\bar{\chi}^u} d_{\mathcal{W}_f^u}(x, z) < c_2 e^{-n\bar{\chi}^u} \sigma.$$

By Lemma 2.27, there also exist  $C^2$ -uniform constants  $c_i = c_i(f) > 0$ ,  $i = 3, 4, 5$ ,

$$\|DT\| < c_3 C, \quad \|D^2T\| < c_4(1 + \|\partial_b \partial_x V\|_X)(1 + \|\partial_b V\|_X) < c_5 C^2 \sigma^{-1}.$$

Recall that  $R_-(\hat{f}, \{x, z\}, \text{supp}_X(V)) > R_0 > n$  by assumption, thus by (3.2),

$$\begin{aligned} R_{\geq 0}(\hat{f}, \{f^{-n}(x), f^{-n}(z)\}, \text{supp}_X(\hat{f})) &\geq n - 1, \\ R_-(\hat{f}, \{f^{-n}(x), f^{-n}(z)\}, \text{supp}_X(\hat{f})) &\geq R_0 - n. \end{aligned}$$

Then the claim follows from Lemma 2.37 (2).  $\square$

Fix an integer  $n \in (\frac{\bar{\chi}^s}{2(\bar{\chi}^s + \bar{\chi}^u)} R_0, \frac{\bar{\chi}^s}{\bar{\chi}^s + \bar{\chi}^u} R_0)$ . By the above claim, we get

$$\left\| \pi_c DH_{T, T^{-n}(0,x), T^{-n}(0,y)}^u (B + \nu_0(f^{-n}(x), B)) \right\| \leq 2c_1 C^2 e^{-n\bar{\chi}^u} \|B\|. \quad (3.18)$$

By Lemma 2.37 (1), we have

$$\pi_b DH_{T, T^{-n}(0,x), T^{-n}(0,z)}^u (B + \nu_0(f^{-n}(x), B)) = B + \nu_0(f^{-n}(z), B). \quad (3.19)$$

By (3.16), (3.17), (3.18), (3.19) and the fact that  $\|DT^n|_{E_T^c}\| < c_6 e^{n\bar{\chi}^c}$  for some  $C^1$ -uniform constant  $c_6 = c_6(f) > 0$ , we deduce that for some  $C^2$ -uniform constant  $c_7 = c_7(f) > 0$ ,

$$\begin{aligned} &\left\| \pi_c DH_{T, (0,x), (0,y)}^u (B + \nu_0(x, B)) - \pi_c DT(B + \nu_0(f^{-1}(z), B)) \right\| \\ &\leq c_7 C^2 e^{n(\bar{\chi}^c - \bar{\chi}^u)} \|B\| \leq c_7 C^2 e^{-R_0 \xi'} \|B\|. \end{aligned}$$

By Lemma 2.27, we have that for some  $C^2$ -uniform constant  $c_8 = c_8(f) > 0$ ,<sup>4</sup>

$$\begin{aligned} &\left\| \pi_c DT(B + \nu_0(f^{-1}(z), B)) - \pi_c V(B, z) \right\| \\ &= \left\| \pi_c DT((0, f^{-1}(z)), B) - \pi_c V(B, z) \right\| \leq c_8 \text{diam}(U) C^2 \sigma^{-1} \|B\|. \end{aligned}$$

By choosing  $U$  sufficiently small such that  $\text{diam}(U) < \sigma e^{-R_0 \xi'}$ , we thus get (1).

Under condition (2), a similar argument (by choosing  $\frac{\bar{\chi}^u}{2(\bar{\chi}^s + \bar{\chi}^u)} R_0 < n < \frac{\bar{\chi}^u}{\bar{\chi}^s + \bar{\chi}^u} R_0$ ) shows that for some  $C^2$ -uniform constant  $c_9 = c_9(f) > 0$ , we have

$$\left\| \pi_c DH_{T, (0,x), (0,y)}^s (B + \nu_0(x, B)) \right\| \leq c_9 C^2 e^{-n(\bar{\chi}^c + \bar{\chi}^s)} \|B\| \leq c_9 C^2 e^{-R_0 \xi'} \|B\|.$$

$\square$

**Remark 2.39.** *Let  $f \in \mathcal{PH}^2(X)$  be as in Notation 2. Set  $\pm(u) := -, \pm(s) := +$ . In the following, given any infinitesimal  $C^2$  deformation  $V$  as above,  $* = u, s$ ,  $R_0 > 0$ ,  $\sigma \in (0, \sigma_f)$ ,  $x \in X$ ,  $y \in \mathcal{W}_f^{c*}(x, \sigma)$  such that  $R_{\pm(*)}(f, \{x, H_{f,x,y}^*(x)\}, \text{supp}_X(V)) > R_0$ , we let  $U = U(R_0, \sigma) \subset U(\chi) \subset U(CB) \subset U(DC)$  (see Lemma 2.33 and Notation 2) be such that*

- $\text{diam}(U) < \sigma e^{-R_0 \xi'}$ ,
- $R_{\pm(*)}(\hat{f}, \{x, H_{f,x,y}^*(x)\}, \text{supp}_X(V)) > R_0$ ,

where  $\hat{f}: U \times X \rightarrow X$  is the  $C^2$  deformation generated by  $V$ .

4. By (3.6),  $DT(B + \nu_0(f^{-1}(z), B)) - DT((0, f^{-1}(z)), B) = Df(\nu_0(f^{-1}(z), B)) \in E_f^{su}(z)$ .

#### 4. Submersion from parameter space to phase space

In this section, we will estimate the measure of parameters in a  $C^r$  deformation corresponding to certain “unlikely coincidences”. First, we need to estimate the derivatives (with respect to parameters) of holonomy maps along certain  $su$ -paths.

Throughout this section, we fix a map  $f \in \mathcal{PH}^2(X)$  which is dynamically coherent, plaque expansive and center bunched.

**Definition 2.40.** Given  $x \in X$ , a triplet  $\gamma = (x_1, x_2, x_3) \in X^3$  is called a  $f$ -loop at  $x$  if the following holds:

$$x_1 \in \mathcal{W}_f^u(x), \quad x_2 \in \mathcal{W}_f^s(x_1), \quad x_3 \in \mathcal{W}_f^u(x_2), \quad x \in \mathcal{W}_f^{cs}(x_3).$$

The length of  $\gamma$  is defined as

$$\ell(\gamma) := d_{\mathcal{W}_f^u}(x, x_1) + d_{\mathcal{W}_f^s}(x_1, x_2) + d_{\mathcal{W}_f^u}(x_2, x_3) + d_{\mathcal{W}_f^{cs}}(x_3, x).$$

By points (1)–(3) in Notation 1, for each  $f$ -loop  $\gamma$  such that  $\ell(\gamma) =: \sigma < \frac{\sigma_f}{2}$ , we have a well-defined map  $H_{f,\gamma}: \mathcal{W}_f^c(x, \Lambda_f^{-4}\sigma) \rightarrow \mathcal{W}_f^c(x, (1 + C_f)\sigma)$ :

$$H_{f,\gamma} := H_{f,x_3,x}^s H_{f,x_2,x_3}^u H_{f,x_1,x_2}^s H_{f,x,x_1}^u.$$

Let  $\hat{f}: U \times X \rightarrow X$  be a  $C^1$  deformation at  $(0, f)$ , and let  $T = T(\hat{f})$ . For any  $f$ -loop  $\gamma = (x_1, x_2, x_3)$  at  $x$ , we define the lift of  $\gamma$  for  $T$  as  $\hat{\gamma} := ((0, x_1), (0, x_2), (0, x_3))$ .

**Notation 3.** Recall that  $c = \dim E_f^c$ , and let

$$K_f := cC_f\Lambda_f^{4c}. \quad (4.1)$$

We fix a  $C^2$ -uniform constant  $\bar{\sigma}_f \in (0, \frac{\sigma_f}{100C_fK_f})$  such that for any  $x \in X$ , any collection  $\{\gamma_j = (x_{j,1}, x_{j,2}, x_{j,3})\}_{j=1,\dots,c}$  of  $f$ -loops at  $x$  such that  $\ell(\gamma_j) < \bar{\sigma}_f, \forall 1 \leq j \leq c$ , the map  $\prod_{j=1}^c H_{f,\gamma_j}$  is defined on  $\mathcal{W}_f^c(x, \bar{\sigma}_f)$ . In this case, for any  $1 \leq k \leq c+1$  we set  $y_k := \prod_{l=1}^{k-1} H_{f,\gamma_l}(x)$ , and for  $1 \leq j \leq c$  we define

$$y_{j,1} := H_{f,x,x_{j,1}}^u(y_j), \quad y_{j,2} := H_{f,x_{j,1},x_{j,2}}^s(y_{j,1}), \quad y_{j,3} := H_{f,x_{j,2},x_{j,3}}^u(y_{j,2}).$$

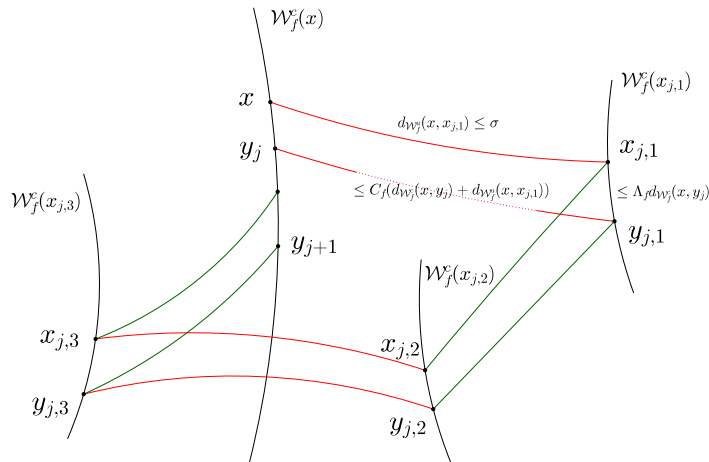

The following lemma follows from Notations 1, 3 by straightforward computations.

**Lemma 2.41.** *Let  $f, x, \gamma_j, y_j, y_{j,k}$  be given as in Notation 3. Assume that for some  $\sigma \in (0, \bar{\sigma}_f)$ , we have  $\ell(\gamma_j) < \sigma$ ,  $\forall j = 1, \dots, c$ . Then for any  $j = 1, \dots, c$ ,  $d_{\mathcal{W}_f^c}(x, y_{j+1}) \leq C_f \sigma + \Lambda_f^4 d_{\mathcal{W}_f^c}(x, y_j)$ , hence letting  $y_{j,0} := y_j$  and  $y_{j,4} := y_{j+1}$ , we have*

$$\begin{aligned} d_{\mathcal{W}_f^c}(x, y_j), d_{\mathcal{W}_f^c}(x_{j,k}, y_{j,k}) &< K_f \sigma < \frac{\sigma_f}{10}, & \forall k = 1, 2, 3, \\ d_{\mathcal{W}_f^c}(y_{j,k-1}, y_{j,k}), d_{\mathcal{W}_f^c}(y_{j,k}, y_{j,k+1}) &< 3C_f K_f \sigma < \frac{\sigma_f}{10}, & \forall k = 1, 3. \end{aligned}$$

In the following, we let  $I > 0$  be an integer, let  $V$  be an infinitesimal  $C^2$  deformation with  $I$ -parameters, and let  $\hat{f} : U \times X \rightarrow X$  be the  $C^2$  deformation at  $(0, f)$  generated by  $V$ . Set  $T = T(\hat{f})$ .

**Lemma 2.42.** *There exists a  $C^2$ -uniform constant  $C_6 = C_6(f) > 0$  such that the following is true. Let  $\sigma \in (0, \bar{\sigma}_f)$ ,  $x \in X$  and let  $\gamma = (x_1, x_2, x_3)$  be a  $f$ -loop at  $x$  with  $\ell(\gamma) < \sigma$ . Assume that  $C, R_0 > 0$  satisfy*

- (1)  $\sigma \|\partial_b \partial_x V\|_X + \|\partial_b V\|_X < C$ ;
- (2)  $R(f, \{x, x_2, x_3\}, \text{supp}_X(V)) > R_0$ ;
- (3)  $R_{\pm}(f, \{x_1\}, \text{supp}_X(V)) > R_0$ .

Let  $\xi'$  be defined as in (3.14), and take  $U = U(R_0, \sigma)$  as in Proposition 2.38. Let  $\hat{\gamma}$  be the lift of  $\gamma$  for  $T$ . Then, the holonomy map  $H_{T, \hat{\gamma}}$  is  $C^1$  in an open neighbourhood of  $x$  in  $\mathcal{W}_f^c(x)$ , and for any  $B \in T_0 U$ , we have

$$\|\pi_c DH_{T, \hat{\gamma}}(B + \nu_0(x, B)) - D(H_{f, x_3, x}^s H_{f, x_2, x_3}^u H_{f, x_1, x_2}^s)(\pi_c V(B, x_1))\| \leq C_6 C^2 e^{-R_0 \xi'} \|B\|.$$

PROOF. Let  $x = x_0 \in X$ . By definition, we have

$$H_{T, \hat{\gamma}} = H_{T, (0, x_3), (0, x)}^s H_{T, (0, x_2), (0, x_3)}^u H_{T, (0, x_1), (0, x_2)}^s H_{T, (0, x), (0, x_1)}^u.$$

Since  $f$  is center bunched and  $U \subset U(CB)$ , Lemma 2.33 implies that  $H_{T, (0, x), (0, x_1)}^u$ ,  $H_{T, (0, x_1), (0, x_2)}^s$ ,  $H_{T, (0, x_2), (0, x_3)}^u$  and  $H_{T, (0, x_3), (0, x)}^s$  are  $C^1$  when restricted to  $c^*$ -leaves,  $* = u, s$ . Given any  $B \in T_0 U$ , let us calculate  $DH_{T, \hat{\gamma}}(B + \nu_0(x, B))$ . Set  $x_4 := H_{f, \gamma}(x)$ ,  $I_0(B) := B + \nu_0(x, B) \in E_T^c(0, x)$ . For  $i = 1, \dots, 4$ , we define

$$I_i(B) := DH_{T, (0, x_{i-1}), (0, x_i)}^{*i}(I_{i-1}(B)) \in E_T^c(0, x_i), \quad (4.2)$$

where  $*_i = u$  if  $i = 1, 3$  and  $*_i = s$  if  $i = 2, 4$ . In particular, we have  $DH_{T, \hat{\gamma}}(B + \nu_0(x, B)) = I_4(B)$ . Then by Lemma 2.37 (1) and simple induction we see that

$$I_i(B) = I_i^c(B) + (B + \nu_0(x_i, B)), \quad \forall i = 1, \dots, 4, \quad (4.3)$$

with  $I_i^c(B) := \pi_c(I_i(B))$ . By (4.2), we thus obtain

$$I_i^c(B) = DH_{f, x_{i-1}, x_i}^{*i}(I_{i-1}^c(B)) + \pi_c DH_{T, (0, x_{i-1}), (0, x_i)}^{*i}(B + \nu_0(x_{i-1}, B)). \quad (4.4)$$

By the hypothesis we made on  $V$ , we see that  $x_0, x_2, x_3, x_4 \notin \text{supp}_X(V)$  and  $R_{\pm}(f, x_i, \text{supp}_X(V)) > R_0$  for  $0 \leq i \leq 4$ . Since  $U = U(R_0, \sigma)$ , we can apply Proposition 2.38 to obtain

$$\begin{aligned} \left\| \pi_c DH_{T, (0, x), (0, x_1)}^u(B + \nu_0(x, B)) - \pi_c V(x_1, B) \right\| &\leq C_5 C^2 e^{-R_0 \xi'} \|B\|, \\ \left\| \pi_c DH_{T, (0, x_{i-1}), (0, x_i)}^s(B + \nu_0(x_{i-1}, B)) \right\| &\leq C_5 C^2 e^{-R_0 \xi'} \|B\|, \quad i = 2, 4, \\ \left\| \pi_c DH_{T, (0, x_2), (0, x_3)}^u(B + \nu_0(x_2, B)) \right\| &\leq C_5 C^2 e^{-R_0 \xi'} \|B\|. \end{aligned}$$

Combining this with (4.3) and (4.4), we see that there exists a  $C^2$ -uniform constant  $C_6 = C_6(f) > 0$  such that

$$\left\| I_4^c(B) - \pi_c D(H_{f, x_3, x}^s H_{f, x_2, x_3}^u H_{f, x_1, x_2}^s)(\pi_c V(B, x_1)) \right\| \leq C_6 C^2 e^{-R_0 \xi'} \|B\|.$$

□

The following definition is motivated by Lemma 2.41 and Lemma 2.42.

**Definition 2.43.** Given any  $\sigma \in (0, (12C_f K_f)^{-1} \bar{\sigma}_f)$ ,  $C, R_0 > 0$ , let  $\gamma = (x_1, x_2, x_3)$  be a  $f$ -loop at a point  $x \in X$ . We say that  $V$  is adapted to  $(\gamma, \sigma, C, R_0)$  if the following holds:

- (1)  $\ell(\gamma) < \sigma$  and  $\sigma \|\partial_b \partial_x V\|_X + \|\partial_b V\|_X < C$ ;
- (2)  $R(f, \mathcal{W}_f^c(z, K_f \sigma), \text{supp}_X(V)) > R_0$  for  $z = x, x_2, x_3$ ;
- (3)  $R_{\pm}(f, \mathcal{W}_f^c(x_1, K_f \sigma), \text{supp}_X(V)) > R_0$ .

**Proposition 2.44.** For any integer  $L > 0$ , real numbers  $C, \kappa > 0$ , there exist  $C^2$ -uniform constants  $R_0 = R_0(f, L, c, C, \kappa) > 0$  and  $\kappa_0 = \kappa_0(f, L, c, C, \kappa) > 0$  such that the following is true.

Let  $x \in X$ ,  $\sigma \in (0, (12C_f K_f)^{-1} \bar{\sigma}_f)$ . For each  $1 \leq i \leq L$ ,  $1 \leq j \leq c$ , let  $\gamma_{i,j} = (x_{i,j,1}, x_{i,j,2}, x_{i,j,3})$  be a  $f$ -loop at  $x$  of length at most  $\sigma$  such that  $V$  is adapted to  $(\gamma_{i,j}, \sigma, C, R_0)$ . Let  $U = U(R_0, 12C_f K_f \sigma)$ . Denote by  $B = (B_{\alpha})_{1 \leq \alpha \leq I}$  a generic element of  $T_0 U = \mathbb{R}^I$  and assume that for each integer  $1 \leq j_0 \leq c$ , there exist indices  $\{\alpha_{i,j}\}_{1 \leq i \leq L, 1 \leq j \leq c} \subset \{1, \dots, I\}$  such that for any  $1 \leq i, k \leq L$  and  $1 \leq j \leq c$ , if  $i \neq k$  or  $j \neq j_0$ , then for all  $z \in \mathcal{W}_f^c(x_{i,j,1}, K_f \sigma)$ , we have

$$D_{B_{\alpha_{k,1}}, \dots, B_{\alpha_{k,c}}}(\pi_c V(B, z)) = 0, \quad (4.5)$$

while for any  $z \in \mathcal{W}_f^c(x_{i,j_0,1}, K_f \sigma)$ , we have

$$|\det(B \mapsto D_{B_{\alpha_{i,1}}, \dots, B_{\alpha_{i,c}}}(\pi_c V(B, z)))| > 2\kappa. \quad (4.6)$$

Let  $\hat{\gamma}_{i,j}$  be the lift of  $\gamma_{i,j}$  for  $T$ , and set  $z_i := \prod_{j=1}^c H_{f, \gamma_{i,j}}(x)$ . Then there exists a linear subspace  $H \subset T_0 U = \mathbb{R}^I$  of dimension  $Lc$  such that

$$\det(\Xi|_H) \geq \kappa_0,$$

$$\text{where we have set } \Xi: \begin{cases} T_0 U & \rightarrow \prod_{i=1}^L E_f^c(z_i), \\ B & \mapsto \left( \pi_c D \left( \prod_{j=1}^c H_{T, \hat{\gamma}_{i,j}} \right) (B + \nu_0(x, B)) \right)_{i=1, \dots, L}. \end{cases}$$

PROOF. For each  $1 \leq i \leq L$  and  $1 \leq j \leq c$ , we define

$$\begin{aligned} y_{i,j} &:= \prod_{l=1}^{j-1} H_{f, \gamma_{i,l}}(x), & y_{i,j,1} &:= H_{f, x, x_{i,j,1}}^u(y_{i,j}), \\ y_{i,j,2} &:= H_{f, x_{i,j,1}, x_{i,j,2}}^s(y_{i,j,1}), & y_{i,j,3} &:= H_{f, x_{i,j,2}, x_{i,j,3}}^u(y_{i,j,2}). \end{aligned}$$

By the choice of  $\bar{\sigma}_f$  in Notation 3, Lemma 2.41 yields

$$y_{i,j} \in \mathcal{W}_f^c(x, K_f \sigma), \quad y_{i,j,k} \in \mathcal{W}_f^c(x_{i,j,k}, K_f \sigma), \quad \forall k = 1, 2, 3. \quad (4.7)$$

Denote by  $\gamma'_{i,j} = (y_{i,j,1}, y_{i,j,2}, y_{i,j,3})$  the associated  $f$ -loop at  $y_{i,j}$ .

By assumption, for any  $1 \leq i \leq L$ ,  $1 \leq j \leq c$ , we have  $\ell(\gamma_{i,j}) < \sigma$ , thus by Lemma 2.41,  $\ell(\gamma'_{i,j}) \leq 12C_f K_f \sigma < \bar{\sigma}_f$ . Since  $V$  is  $(\gamma_{i,j}, \sigma, C, R_0)$ -adapted, we get

$$R(f, \{y_{i,j}, y_{i,j,2}, y_{i,j,3}\}, \text{supp}_X(V)) > R_0, \quad R_{\pm}(f, \{y_{i,j,1}\}, \text{supp}_X(V)) > R_0.$$

Let  $H := \bigoplus_{i=1}^L \bigoplus_{j=1}^c \mathbb{R} \partial_{B_{\alpha_{i,j}}}$ . Define  $\Xi_H: H \rightarrow \prod_{i=1}^L E_f^c(z_i)$  by

$$\Xi_H(B) := \left( \pi_c D \left( \prod_{j=1}^c H_{T, \hat{\gamma}_{i,j}} \right) (B + \nu_0(x, B)) \right)_{i=1, \dots, L}.$$

By Lemma 2.37, we have for any  $1 \leq i, k \leq L$ :

$$D_{B_{\alpha_{k,1}}, \dots, B_{\alpha_{k,c}}} \left( \pi_c D \left( \prod_{j=1}^c H_{T, \hat{\gamma}_{i,j}} \right) (B + \nu_0(x, B)) \right) = \sum_{l=1}^c I_{i,k,l}(B),$$

where for each  $1 \leq l \leq c$  we set

$$I_{i,k,l}(B) := D_{B_{\alpha_{k,1}}, \dots, B_{\alpha_{k,c}}} \left( \pi_c D \left( \prod_{j=l+1}^c H_{T, \hat{\gamma}_{i,j}} \right) (\pi_c D H_{T, \hat{\gamma}'_{i,l}} (B + \nu_0(y_{i,l}, B))) \right).$$

It is clear that for all  $1 \leq i \leq L$ ,  $1 \leq l \leq c$ ,

$$\pi_c D H_{T, \hat{\gamma}'_{i,l}} (B + \nu_0(y_{i,l}, B)) = \pi_c D H_{T, \hat{\gamma}'_{i,l}} (B + \nu_0(y_{i,l}, B)),$$

where we denotes by  $\hat{\gamma}'_{i,l}$  the lift of  $\gamma'_{i,l}$  for  $T$ . Since  $\gamma'_{i,l}$  and  $V$  satisfy the assumptions of Lemma 2.42 with  $(\sigma, C)$  replaced by  $(12C_f K_f \sigma, 12C_f K_f C)$ , and by  $U = U(R_0, 12C_f K_f \sigma)$ , we deduce that there exists a  $C^2$ -uniform constant  $c_1 = c_1(f) > 0$  (we incorporate the term  $12C_f K_f$  in  $c_1$ ), such that

$$\begin{aligned} |I_{i,k,l}(B) - D_{B_{\alpha_{k,1}}, \dots, B_{\alpha_{k,c}}} (D(\prod_{j=l+1}^c H_{f, \gamma_{i,j}} \cdot H_{f, x_{i,l,3}, x}^s H_{f, x_{i,l,2}, x_{i,l,3}}^u H_{f, x_{i,l,1}, x_{i,l,2}}^s) \\ \cdot (\pi_c V(B, y_{i,l,1})))| \leq c_1 C^2 e^{-R_0 \xi'} \|B\|. \end{aligned}$$

Given any  $1 \leq i, k \leq L$  and  $1 \leq j \leq c$ , if  $i \neq k$  or  $j \neq j_0$ , then by (4.7),  $z = y_{i,j,1}$  satisfies (4.5), hence

$$\|I_{i,k,j}\| < c_2 C^2 e^{-R_0 \xi'},$$

while by (4.7),  $z = y_{i,j_0,1}$  satisfies (4.6), hence

$$|\det(I_{i,i,j_0})| > c_3 \kappa - c_4 C^2 e^{-R_0 \xi'}.$$

Here  $c_2, c_3, c_4 > 0$  are  $C^2$ -uniform constants depending only on  $f, c$ .

Thus for some  $C^2$ -uniform constant  $c_5 > 0$  depending only on  $f, L, c, C$ , for any  $R_0$  sufficiently large depending only on  $f, L, c, C, \kappa$ , we have  $\det(\Xi_H) > c_5 \kappa^L$ . Moreover, it is easy to see that  $R_0$  is  $C^2$ -uniform with respect to  $f$ . Let  $\kappa_0 := c_5 \kappa^L$ . Then  $\kappa_0$  is  $C^2$ -uniformly depending on  $f, L, c, C, \kappa$ . This concludes the proof.  $\square$

## 5. Finding spanning $c$ -families with slow recurrence

Since we will be working with a parametrised family of diffeomorphisms, we need a bit more work to find suitable  $c$ -families. Let us start by recalling a result present in [13]. We use here the notations introduced in Subsection 3.2.

**Lemma 2.45** (Accessibility modulo central disks). *Let  $f \in \mathcal{PH}^1(X)$  be dynamically coherent. Assume that the fixed points of  $f^k$  are isolated, for all  $k \geq 1$ . Then for every integer  $\bar{R} > 0$  there exists a  $c$ -family for  $f$ , denoted by  $\mathcal{D} = \mathcal{D}(f, \bar{R})$ , such that*

- (1)  $\bar{r}(\mathcal{D}) < \bar{R}^{-1}$ ,
- (2)  $R(f, \mathcal{D}) > \bar{R}$ ,
- (3)  $\mathcal{D}$  is  $(\frac{1}{80}, 2)$ -spanning.

For the convenience of the choice of some constants, we replaced the constant  $\frac{1}{2}$  in [13] by  $\frac{1}{80}$ . This does not introduce any new difficulty into the proof. The following is an immediate consequence of the above lemma.

**Corollary 2.46.** *Assume that  $f \in \mathcal{PH}^1(X)$  is dynamically coherent, plaque expansive, and the fixed points of  $f^k$  are isolated for all  $k \geq 1$ . Then for every  $\bar{R} > 0$ , there exist  $C^1$ -uniform constants  $N = N(f, \bar{R}) > 0$ ,  $\rho = \rho(f, \bar{R}) \in (0, \bar{R}^{-1})$  and  $\sigma = \sigma(f, \bar{R}) > 0$  such that the following is true. For all  $g$  sufficiently  $C^1$ -close to  $f$ , there exists  $\mathcal{D}_g$ , a  $(\frac{1}{40}, 4)$ -spanning  $c$ -family for  $g$  such that (1), (2) in Lemma 2.45 are satisfied for  $(\mathcal{D}_g, g)$  in place of  $(\mathcal{D}, f)$ . Moreover, we have*

- (1)  $\underline{r}(\mathcal{D}_g) > \rho$ ,
- (2)  $n(\mathcal{D}_g) < N$ ,
- (3)  $\mathcal{D}_g$  is  $\sigma$ -sparse,
- (4)  $R(g, (\mathcal{D}_g, \sigma)) > \bar{R}$ .

**PROOF.** Let  $\mathcal{D} = \mathcal{D}(f, 2\bar{R})$  be a  $c$ -family for  $f$  given by Lemma 2.45. Set  $N := n(\mathcal{D}) + 1$ . Take  $\rho \in (0, (2\bar{R})^{-1})$  such that  $\underline{r}(\mathcal{D}) > \rho$ , and choose  $\sigma > 0$  so that (3), (4) above are true for  $(\mathcal{D}, f, 4\sigma)$  in place of  $(\mathcal{D}_g, g, \sigma)$ . Let  $\mathcal{U} = \mathcal{U}(f, 2, \frac{1}{80}, \frac{1}{40}, \rho, \bar{R}^{-1}, \sigma)$  be a  $C^1$ -open neighbourhood of  $f$  as given by Lemma 2.32. Then there exists  $\mathcal{U}' \subset \mathcal{U}$  such that for  $g \in \mathcal{U}'$ , (4) is satisfied by any  $c$ -family for  $g$ , denoted by  $\mathcal{D}_g$ , as in Lemma 2.32. Therefore, the above conclusion holds for any  $g \in \mathcal{U}'$ .  $\square$

While working with a family of diffeomorphisms, we will need to consider several  $c$ -families. The following proposition will serve as a key step in the inductive construction in Proposition 2.70.

**Proposition 2.47.** *Let  $r \in \mathbb{N}_{\geq 2} \cup \{\infty\}$ ,  $J \geq 1$ , and let  $\{f_\omega\}_{\omega \in CB_J}$  be a good (see Definition 2.11)  $C^r - J$ -family of diffeomorphisms in the space of dynamically coherent, plaque expansive  $C^r$  partially hyperbolic diffeomorphisms. Then for any integers  $K, R_0 \geq 1$ , any real numbers  $\vartheta > 0$ ,  $h_0 > 0$ , there exists a compact set  $\Omega_1 \Subset CB_J$  with  $\text{Leb}(CB_J \setminus \Omega_1) < \vartheta$ , an integer  $N_0 > 1$ , and real numbers  $\rho_0 \in (0, h_0)$ ,  $\rho_1 \in (0, \rho_0)$ ,  $\sigma_0, \lambda_0 > 0$  such that the following is true.*

Take any  $\omega \in \Omega_1$ , and any integer  $0 \leq l \leq K - 1$ . For any collection of points  $\{\omega_i\}_{i=1}^l \subset B(\omega, \lambda_0) \cap CB_J$ , any  $1 \leq i \leq l$ , let  $\mathcal{D}_i$  be a  $c$ -family for  $f_{\omega_i}$  such that

- (1)  $[\underline{r}(\mathcal{D}_i), \bar{r}(\mathcal{D}_i)] \subset (\rho_1, \rho_0)$ ,
- (2)  $n(\mathcal{D}_i) < N_0$ .

Then there exists a  $(\frac{1}{20}, 6)$ -spanning  $c$ -family for  $f_\omega$ , denoted by  $\mathcal{D}_{l+1}$ , such that (1), (2) above are satisfied for  $i = l + 1$ , and moreover,

- (1)  $\mathcal{D}_{l+1}$  is  $\sigma_0$ -sparse, and  $(\mathcal{D}_{l+1}, \sigma_0)$  is disjoint from  $(\{\mathcal{D}_i\}_{i=1}^l, \sigma_0)$ ;
- (2) for any  $\omega' \in B(\omega, \lambda_0) \cap CB_J$ , we have
  - $R(f_{\omega'}, (\mathcal{D}_{l+1}, \sigma_0), (\{\mathcal{D}_i\}_{i=1}^l, \sigma_0)) > R_0$ ,
  - $R_\pm(f_{\omega'}, (\mathcal{D}_{l+1}, \sigma_0)) > R_0$ .

PROOF. We choose  $\Omega_1$  to be any compact set contained in  $CB_J$  such that  $\text{Leb}(CB_J \setminus \Omega_1) < \vartheta$ , and for any  $\omega \in \Omega_1$ , the fixed points of  $f_\omega^k$  are isolated for any integer  $k \geq 1$ . The existence of  $\Omega_1$  is guaranteed by our hypothesis that  $\{f_\omega\}_{\omega \in CB_J}$  is a good family.

By the compactness of  $CB_J$ , there exists  $\rho_2 \in (0, h_0)$  such that for any  $\omega \in CB_J$ ,  $x \in X$ , the tangent space of  $\mathcal{W}_{f_\omega}^c(x, 4\rho_2)$  is sufficiently close to  $E_{f_\omega}^c(x)$  such that for any  $y \in B(x, \rho_2)$ ,  $\mathcal{W}_{f_\omega}^c(y, 4\rho_2)$  intersects  $B(x, \rho_2)$  in a single local center manifold.

Let  $\rho_0 \in (0, \frac{\rho_2}{2})$  be small enough so that for any  $\omega \in CB_J$ , any  $x \in X$ , we have

$$f_\omega^p(\mathcal{W}_{f_\omega}^c(x, \rho_0)) \subset \mathcal{W}_{f_\omega}^c(f_\omega^p(x), \rho_2), \quad \forall -R_0 \leq p \leq R_0. \quad (5.1)$$

By Corollary 2.46 applied to  $\bar{R} > \max(\rho_0^{-1}, R_0)$ , and by the compactness of  $\Omega_1$ , there exist  $N_0 > 0$ ,  $\rho_1 \in (0, \rho_0)$ ,  $\sigma_1 \in (0, \rho_2)$  such that for all  $\omega \in \Omega_1$  there exists a  $(\frac{1}{40}, 4)$ -spanning  $c$ -family for  $f_\omega$ , denoted by  $\tilde{\mathcal{D}}(\omega)$ , such that  $[\underline{r}(\tilde{\mathcal{D}}(\omega)), \bar{r}(\tilde{\mathcal{D}}(\omega))] \subset (\rho_1, \rho_0)$ ,  $n(\tilde{\mathcal{D}}(\omega)) < N_0$ ,  $\tilde{\mathcal{D}}(\omega)$  is  $\sigma_1$ -sparse, and  $R(f_\omega, (\tilde{\mathcal{D}}(\omega), \sigma_1)) > R_0$ .

Take  $\sigma_3 > 0$  sufficiently small such that for any  $\omega \in CB_J$ ,  $x \in X$ ,  $y \in B(x, \sigma_3)$ , and any  $\rho \in (\rho_1, \rho_0)$ , we have  $\mathcal{W}_{f_\omega}^c(y, \rho) \subset (\mathcal{W}_{f_\omega}^c(x, \rho), \sigma_1/2)$  and<sup>5</sup>

$$\mathcal{W}_{f_\omega}^c(x, \frac{1}{40}\rho) \subset \bigcup_{z \in \mathcal{W}_{f_\omega}^c(y, \frac{1}{20}\rho)} \text{Acc}_{f_\omega}(z, 1, 2). \quad (5.2)$$

Take  $\sigma_2 > 0$  such that for any  $\omega \in CB_J$ , any  $x \in X$ , any collection of  $2R_0N_0K$  points  $\{x_i\}_{i=1}^{2R_0N_0K} \subset X$ , there exists  $y \in B(x, \sigma_3)$  such that for all  $1 \leq i \leq 2R_0N_0K$ , we have  $d(\mathcal{W}_{f_\omega}^c(y, \rho_2), \mathcal{W}_{f_\omega}^c(x_i, \rho_2)) > 3\sigma_2$ .

Take a small constant  $\lambda_0 > 0$  such that for any  $\omega \in CB_J$ ,  $\omega' \in B(\omega, \lambda_0) \cap CB_J$ ,  $x \in X$ , and any  $-R_0 \leq p \leq R_0$ , we have

$$f_\omega^p(\mathcal{W}_{f_{\omega'}}^c(x, \rho_0)) \subset (f_\omega^p(\mathcal{W}_{f_\omega}^c(x, \rho_0)), \sigma_2). \quad (5.3)$$

Fix any  $\omega \in \Omega_1$ . Let  $\tilde{\mathcal{D}} := \tilde{\mathcal{D}}(\omega)$  be given by the above discussion: we denote  $\tilde{\mathcal{D}} = \{\tilde{\mathcal{C}}_1, \dots, \tilde{\mathcal{C}}_{N_1}\}$  for some  $N_1 < N_0$ . We take  $l, \{\omega_i\}_{i=1}^l$  and  $\{\mathcal{D}_i\}_{i=1}^l$  as in the proposition. We will modify  $\tilde{\mathcal{D}}$  to obtain  $\mathcal{D}_{l+1}$  that satisfies the conclusion of the proposition.

We will define  $\mathcal{C}_{l+1,1}, \dots, \mathcal{C}_{l+1,N_1}$  by induction so that  $\mathcal{D}_{l+1} = \{\mathcal{C}_{l+1,1}, \dots, \mathcal{C}_{l+1,N_1}\}$  is a  $(\frac{1}{20}, 6)$ -spanning  $c$ -family for  $f_\omega$ . Let  $0 \leq j \leq N_1 - 1$  be an integer such that for

5. Again, (5.2) follows from uniform transversality of  $\mathcal{W}_{f_\omega}^{cs}$  and  $\mathcal{W}_{f_\omega}^u$ , resp.  $\mathcal{W}_{f_\omega}^{cu}$  and  $\mathcal{W}_{f_\omega}^s$ .

all  $1 \leq k \leq j$ ,  $\mathcal{C}_{l+1,k}$  is defined and satisfies  $\varrho(\mathcal{C}_{l+1,k}) \in (\rho_1, \rho_0)$ ,

$$\frac{1}{40}\tilde{\mathcal{C}}_k \subset \bigcup_{x \in \frac{1}{20}\mathcal{C}_{l+1,k}} \text{Acc}_{f_\omega}(x, 1, 2), \quad (5.4)$$

and

$$(\mathcal{C}_{l+1,k}, \sigma_2) \cap (\mathcal{C}', \sigma_2) = \emptyset, \quad \forall \mathcal{C}' \in \mathcal{M}_k, \quad (5.5)$$

where

$$\mathcal{M}_k := \bigcup_{\substack{1 \leq i \leq l, \mathcal{C} \in \mathcal{D}_i, \\ -R_0 \leq p \leq R_0}} f_\omega^p(\mathcal{C}) \cup \bigcup_{\substack{1 \leq m \leq k-1, \\ -R_0 \leq p \leq R_0}} f_\omega^p(\mathcal{C}_{l+1,m}) \cup \bigcup_{-R_0 \leq p \neq 0 \leq R_0} f_\omega^p(\mathcal{C}_{l+1,k}). \quad (5.6)$$

The above is true for  $j = 0$ . By the choices of  $\rho_0$  and  $\lambda_0$ , by (5.1) and (5.3), for any  $1 \leq i \leq l$ ,  $\mathcal{C} \in \mathcal{D}_i$ , and  $-R_0 \leq p \leq R_0$ , there exists  $x \in X$  such that  $f_\omega^p(\mathcal{C}) \subset (f_\omega^p(\mathcal{W}_{f_\omega}^c(x, \rho_0)), \sigma_2) \subset (\mathcal{W}_{f_\omega}^c(f_\omega^p(x), \rho_2), \sigma_2)$ . Similarly, for each  $1 \leq m \leq j$ ,  $-R_0 \leq p \leq R_0$ , there exists  $x \in X$  such that  $f_\omega^p(\mathcal{C}_{l+1,m}) \subset \mathcal{W}_{f_\omega}^c(x, \rho_2)$ . Clearly,  $|\mathcal{M}_{j+1}| < 2R_0N_0K$ . Let  $\tilde{x} \in X$  and  $\tilde{\rho} \in (\rho_1, \rho_0)$  be such that  $\tilde{\mathcal{C}}_{j+1} = \mathcal{W}_{f_\omega}^c(\tilde{x}, \tilde{\rho})$ . By (5.1), (5.2), and by the choice of  $\sigma_2, \sigma_3$  above, there exists  $y \in B(\tilde{x}, \sigma_3)$  such that the center disk  $\mathcal{C}_{l+1,j+1} := \mathcal{W}_{f_\omega}^c(y, \tilde{\rho})$  satisfies (5.4) and (5.5) for  $k = j+1$ , and  $\mathcal{C}_{l+1,j+1} \subset (\tilde{\mathcal{C}}_{j+1}, \sigma_1/2)$ . We complete the construction of  $\mathcal{D}_{l+1}$  by induction.

Since  $\tilde{\mathcal{D}}$  is  $(\frac{1}{40}, 4)$ -spanning, by (5.4),  $\mathcal{D}_{l+1}$  is  $(\frac{1}{20}, 6)$ -spanning. By taking  $\sigma_0 > 0$  sufficiently small, depending only on  $\{f_\omega\}, R_0, \sigma_2$ , we can ensure that for any  $-R_0 \leq p \leq R_0$ , any  $\mathcal{C} \in \bigcup_{1 \leq i \leq l+1} \mathcal{D}_i$ , we have  $f_\omega^p(\mathcal{C}, 2\sigma_0) \subset (f_\omega^p(\mathcal{C}), \sigma_2/4)$ .

By further requiring that  $\sigma_0 < \sigma_2/10$ , (5.5) implies that  $\mathcal{D}_{l+1}$  is  $2\sigma_0$ -sparse, and

$$\bullet R(f_\omega, (\mathcal{D}_{l+1}, 2\sigma_0), (\{\mathcal{D}_i\}_{i=1}^l, 2\sigma_0)) > R_0, \quad \bullet R_\pm(f_\omega, (\mathcal{D}_{l+1}, 2\sigma_0)) > R_0.$$

By continuity, and after possibly taking  $\lambda_0$  to be even smaller, but depending only on  $\{f_\omega\}, \rho_0, \rho_1, R_0, N_0, K, \sigma_0$ , we can ensure that for all  $\omega' \in B(\omega, \lambda_0) \cap CB_J$ ,

$$\bullet R(f_{\omega'}, (\mathcal{D}_{l+1}, \sigma_0), (\{\mathcal{D}_i\}_{i=1}^l, \sigma_0)) > R_0, \quad \bullet R_\pm(f_{\omega'}, (\mathcal{D}_{l+1}, \sigma_0)) > R_0. \quad \square$$

## 6. A stable criterion for stable values

**6.1. A criterion for stable values.** In this section we state a topological lemma that is at the core of our construction of open accessible classes. First we borrow a few definitions from [5].

**Definition 2.48.** *If  $f: X \rightarrow Y$  is a continuous map between metric spaces  $X$  and  $Y$ , then  $y \in Y$  is a stable value of  $f$  if there is  $\epsilon > 0$  such that  $y \in \text{Im}(g)$  for every continuous map  $g: X \rightarrow Y$  such that  $d_{C^0}(f, g) < \epsilon$ .*

**Definition 2.49.** *A continuous map  $f: X \rightarrow Y$  between metric spaces  $X$  and  $Y$  is called light if all point inverses  $f^{-1}(y)$ ,  $y \in Y$ , are totally disconnected.*

We will use the following quantified version of Definition 2.49.

**Definition 2.50.** *Given a constant  $\epsilon > 0$ , a continuous map  $f: X \rightarrow Y$  between metric spaces  $X$  and  $Y$  is called  $\epsilon$ -light if for every  $y \in Y$ , every connected component of  $f^{-1}(y)$  has diameter strictly smaller than  $\epsilon$ .*

Now we state the main topological result we will be using in this section.

**Theorem 2.51.** *For any  $n \in \mathbb{N}$ , there exists a constant  $\epsilon = \epsilon(n) > 0$  such that any  $\epsilon$ -light continuous map  $f: [0, 1]^n \rightarrow \mathbb{R}^n$  has a stable value.*

PROOF. In Appendix B. □



**Remark 2.52.** Theorem 2.51 is a direct adaptation of a result due to Bonk-Kleiner: in [5], Proposition 3.2, the authors proved that any light continuous map from a compact metric space of topological dimension at least  $n$  to  $\mathbb{R}^n$  has stable values.

**Corollary 2.53.** For any integer  $c \geq 1$ , let  $\{\mathcal{U}_\alpha\}_{\alpha \in \mathcal{A}}$  be an open cover of  $[0, 1]^c$  such that  $\text{diam}(\mathcal{U}_\alpha) < \epsilon(c)$  for all  $\alpha \in \mathcal{A}$ , where  $\epsilon(c)$  is given by Theorem 2.51. Let  $f: [0, 1]^c \rightarrow \mathbb{R}^c$  be a continuous map such that for any  $x \in [0, 1]^c$ , there exists  $\mathcal{I} \subset \mathcal{A}$  satisfying

- (1)  $\bigcap_{\alpha \in \mathcal{I}} f(\partial \mathcal{U}_\alpha) = \emptyset$ ;
- (2)  $x \in \mathcal{U}_\alpha$  for all  $\alpha \in \mathcal{I}$ .

Then  $f$  has a stable value.

PROOF. By Theorem 2.51, it suffices to check that  $f$  is  $\epsilon(c)$ -light. Given any  $x \in [0, 1]^c$ , take  $\mathcal{I} \subset \mathcal{A}$  satisfying (1), (2). In particular, there exists  $\alpha \in \mathcal{I}$  such that  $f(x) \notin f(\partial \mathcal{U}_\alpha)$ . We denote by  $P_x$  the connected component of  $f^{-1}(f(x))$  containing  $x$ . We claim that  $P_x$  is contained in  $\mathcal{U}_\alpha$ . Indeed, by the continuity of  $f$ ,  $f^{-1}(f(x))$  has no accumulating point in  $\partial \mathcal{U}_\alpha$ . If  $P_x \cap (\mathcal{U}_\alpha)^c \neq \emptyset$ , then we can find two disjoint open sets  $U, V$  such that  $P_x \subset U \cup V$  and  $P_x \cap U, P_x \cap V$  are both nonempty. This contradicts the connectedness of  $P_x$ , hence the claim is true. In particular, the diameter of  $P_x$  is not larger than the diameter of  $\mathcal{U}_\alpha$  which by hypothesis is strictly smaller than  $\epsilon(c)$ . Since  $x$  is an arbitrary point in  $[0, 1]^c$ , we deduce that  $f$  is  $\epsilon(c)$ -light.  $\square$

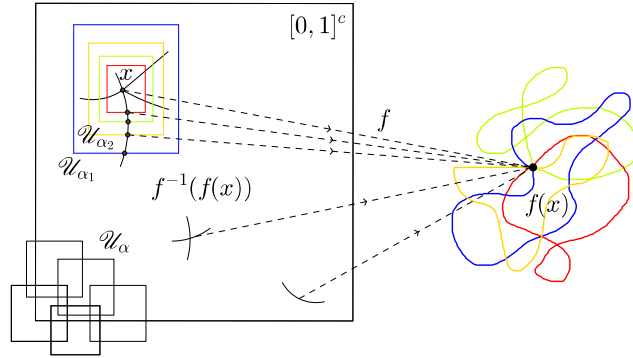

**6.2. Choosing a cover by disjoint squares.** In this section, we define a cover of  $[0, 1]^c$  by open cubes, which will later be used when we apply Corollary 2.53 to show the existence of open accessible classes.

Given an integer  $c \geq 2$ , a positive constant  $\theta \in (\frac{c-1}{c}, 1)$ , we set

$$K_0(c, \theta) := \lceil \frac{3c+1}{c-(c-1)\theta-1} \rceil + 1, \quad K_1(c, \theta) := cK_0(c, \theta). \quad (6.1)$$

In the following, we will fix  $c, \theta$  and abbreviate  $K_i(c, \theta)$  as  $K_i$ ,  $i = 0, 1$ .

By direct construction, we can fix a cover  $\{\mathcal{U}_\alpha\}_{\alpha \in \mathcal{A}}$  of  $[0, 1]^c$  by open sets in  $\mathbb{R}^c$ , which satisfies:

- (1)  $\mathcal{A}$  is a finite set and for all  $\alpha \in \mathcal{A}$ , there exist constants  $\{p_{\alpha,i}, q_{\alpha,i}\}_{i=1,\dots,c} \subset [-1, 2]$  such that  $\mathcal{U}_\alpha = (p_{\alpha,1}, q_{\alpha,1}) \times \cdots \times (p_{\alpha,c}, q_{\alpha,c})$ ;
- (2) for any  $\alpha \in \mathcal{A}$ ,  $\text{diam}(\mathcal{U}_\alpha) < \epsilon(c)$ , where  $\epsilon(c)$  is given by Theorem 2.51;
- (3) for each  $x \in [0, 1]^c$ , there exists a subset  $\mathcal{I} \subset \mathcal{A}$  with more than  $K_1$  elements satisfying that  $x \in \mathcal{U}_\alpha$  for all  $\alpha \in \mathcal{I}$ , and  $\{\partial \mathcal{U}_\alpha\}_{\alpha \in \mathcal{I}}$  are mutually disjoint;
- (4) for each  $i \in \{1, \dots, c\}$ , the points  $\{p_{\alpha,i}, q_{\alpha,i}\}_{\alpha \in \mathcal{A}}$  are mutually distinct.



For each integer  $i \in \{1, \dots, c\}$ , we let  $\mathcal{B}_i := \{p_{\alpha,i}, q_{\alpha,i}\}_{\alpha \in \mathcal{A}}$ , and for each  $\alpha \in \mathcal{A}$ , we denote  $\partial^i \mathcal{U}_\alpha := (p_{\alpha,1}, q_{\alpha,1}) \times \dots \times (p_{\alpha,i-1}, q_{\alpha,i-1}) \times \{p_{\alpha,i}, q_{\alpha,i}\} \times (p_{\alpha,i-1}, q_{\alpha,i-1}) \times \dots \times (p_{\alpha,c}, q_{\alpha,c})$ . Given any  $s \in [-1, 2]$ , we introduce the normalized coordinate

$$\varphi(i, s) := \frac{6i - 2 + s}{6c} \in (0, 1]. \quad (6.2)$$

Note that for any  $i < i'$  and any  $s, s' \in [-1, 2]$ ,  $\varphi(i, s) < \varphi(i', s')$ . We also set

$$0 < C_{\min} := 100 \left( \min_{\substack{1 \leq i \leq c \\ t \neq t' \in \mathcal{B}_i}} |\varphi(i, t) - \varphi(i, t')| \right)^{-1} < +\infty. \quad (6.3)$$

**Definition 2.54.** We define the set

$$\Gamma := \{(i, \mathcal{B}, \{s_t = (s_{t,1}, \dots, s_{t,c})\}_{t \in \mathcal{B}}) \mid i \in \{1, \dots, c\}, \mathcal{B} \subset \mathcal{B}_i, |\mathcal{B}| = K_0, \quad (6.4)$$

$$\text{and } s_t \in [-1, 2]^{i-1} \times \{t\} \times [-1, 2]^{c-i}, \forall t \in \mathcal{B}\}.$$

## 7. Holonomy maps associated to a family of loops

### 7.1. Continuous and regular family of loops.

**Definition 2.55.** Given  $f \in \mathcal{PH}^1(X)$  and  $x \in X$ , a one-parameter family  $\{\gamma(s) = (x_1(s), x_2(s), x_3(s))\}_{s \in [0,1]}$  of  $f$ -loops at  $x$  is said to be *continuous* if for any  $i = 1, 2, 3$ , the map  $s \mapsto x_i(s)$  is continuous. We define

$$\ell(\gamma) := \sup_{s \in [0,1]} \ell(\gamma(s)).$$

**Lemma 2.56** (Continuation of  $f$ -loops). *Let  $f \in \mathcal{PH}^1(X)$ , and let  $\gamma$  be a continuous family of  $f$ -loops at  $x \in X$  satisfying  $\ell(\gamma) < \frac{\sigma_f}{2}$ . Then there exist  $\mathcal{U}$ , a  $C^1$ -open neighbourhood of  $f$ , depending only on  $f$ , as well as  $\varsigma_{f,\gamma} > 0$  such that for any  $g \in \mathcal{U}$  and  $y \in B(x, \varsigma_{f,\gamma})$ , we can define  $\gamma_{g,y}$ , a continuous family of  $g$ -loops at  $y$ , such that  $\gamma_{f,x} = \gamma$  and each coordinate of  $\gamma_{g,y}(s)$  depends continuously on  $(g, y, s)$ .*

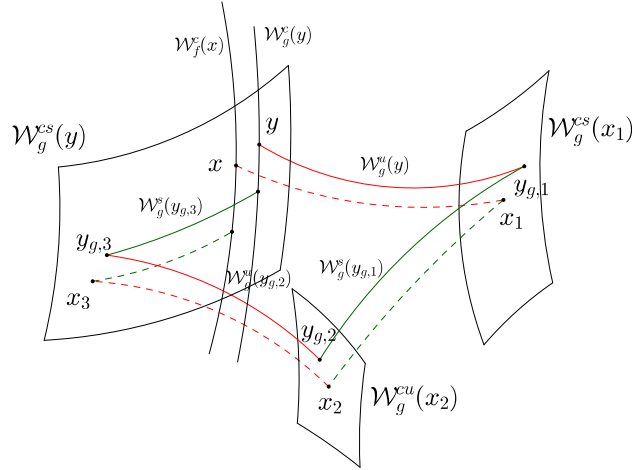

**PROOF.** Let  $\gamma = (x_1, x_2, x_3)$ . If  $(g, y)$  is chosen sufficiently close to  $(f, x)$ , then for any  $s \in [0, 1]$ , the following leaves intersect at a unique point, and we define

- (1)  $\{y_{g,1}(s)\} := \mathcal{W}_g^u(y, h_f) \cap \mathcal{W}_g^{cs}(x_1(s), h_f)$ ;
- (2)  $\{y_{g,2}(s)\} := \mathcal{W}_g^s(y_{g,1}(s), h_f) \cap \mathcal{W}_g^{cu}(x_2(s), h_f)$ ;
- (3)  $\{y_{g,3}(s)\} := \mathcal{W}_g^u(y_{g,2}(s), h_f) \cap \mathcal{W}_g^{cs}(y, h_f)$ .

Then the family  $\gamma_{g,y} := (y_{g,1}, y_{g,2}, y_{g,3})$  has the desired properties.  $\square$

**7.2. A criterion for stable accessibility.** In all this subsection, we consider a partially hyperbolic diffeomorphism  $f \in \mathcal{PH}^1(X)$  that is dynamically coherent and plaque expansive. Given  $x \in X$ , and  $\gamma = \{\gamma(s)\}_{s \in [0,1]}$ , a continuous family of  $f$ -loops at  $x$ , satisfying  $\ell(\gamma) < \bar{\sigma}_f$  (defined in Notation 3), we introduce

$$\psi = \psi(f, x, \gamma): \begin{cases} [-1, 2]^c & \rightarrow \mathcal{W}_f^c(x), \\ s = (s_1, \dots, s_c) & \mapsto \left( \prod_{j=1}^c H_{f, \gamma(\varphi(j, s_j))} \right)(x). \end{cases} \quad (7.1)$$

By Notation 3,  $\psi$  is well-defined. Besides, it is clear that  $\text{Im}(\psi) \subset \text{Acc}_f(x)$ .

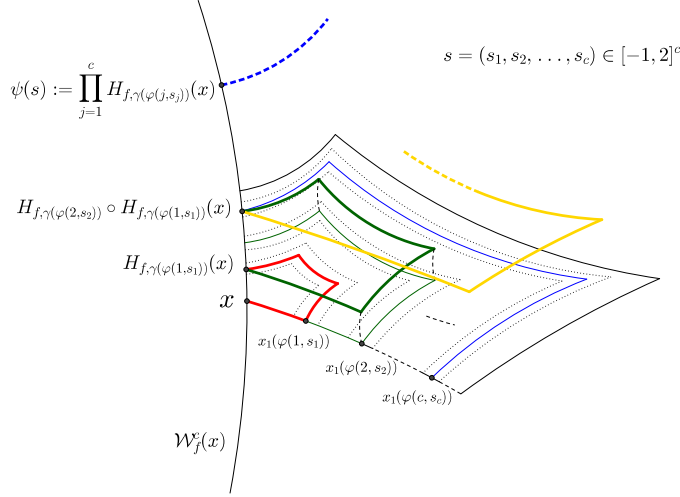

**Definition 2.57** (Property  $(\mathcal{P})$ ). We say that  $f$  satisfies property  $(\mathcal{P})$  if there exist  $0 < \theta < \theta' < 1$ ,  $k \geq 1$ , and  $\mathcal{D}$ , a  $(\theta, k)$ -spanning  $c$ -family for  $f$ , such that for any  $\mathcal{C} \in \mathcal{D}$ , any  $x \in \theta'\mathcal{C}$ , there exists a continuous family of  $f$ -loops at  $x$ , denoted by  $\{\gamma_x(s) = (x_1(s), x_2(s), x_3(s))\}_s$ , with  $\ell(\gamma_x) < \bar{\sigma}_f$ , such that the following is true: for any  $\mathcal{C} \in \mathcal{D}$ ,  $x \in \theta\mathcal{C}$ , if  $\psi_x := \psi(f, x, \gamma_x)$  is taken as in (7.1), then for any  $(i, \mathcal{B}, \{s_t\}_{t \in \mathcal{B}}) \in \Gamma$  (defined in (6.4)), there exist  $t, t' \in \mathcal{B}$  such that  $\psi_x(s_t) \neq \psi_x(s_{t'})$ .

**Lemma 2.58.** If  $f$  satisfies property  $(\mathcal{P})$ , then  $f$  is accessible.

**PROOF.** Assume that  $f$  satisfies  $(\mathcal{P})$  for  $0 < \theta < \theta' < 1$ ,  $k \geq 1$ , some  $(\theta, k)$ -spanning  $c$ -family for  $f$ , denoted by  $\mathcal{D}$ , and families of  $f$ -loops  $\{\gamma_x\}_{x \in \theta'\mathcal{C}, \mathcal{C} \in \mathcal{D}}$ . Take  $\mathcal{C} \in \mathcal{D}$ ,  $x \in \theta\mathcal{C}$ , and set  $\psi_x := \psi_x(f, x, \gamma_x)$ . We claim that  $\text{Acc}_f(x)$  is open.

To see this, take  $s \in [0, 1]^c$ . By the definition of the open cover introduced in Subsection 6.2, there exists a subset  $\mathcal{I} \subset \mathcal{A}$  with  $|\mathcal{I}| \geq K_1$ , such that  $s \in \mathcal{U}_\alpha$  for all  $\alpha \in \mathcal{I}$ , and  $\{\partial \mathcal{U}_\alpha\}_{\alpha \in \mathcal{I}}$  are mutually disjoint. Let us show that  $\cap_{\alpha \in \mathcal{I}} \psi_x(\partial \mathcal{U}_\alpha) = \emptyset$ . Assume it is not true; by (6.1) and the pigeonhole principle, we may choose  $i \in \{1, \dots, c\}$  and  $\mathcal{I}' \subset \mathcal{I}$  with  $|\mathcal{I}'| = K_0$ , such that  $\cap_{\alpha \in \mathcal{I}'} \psi_x(\partial^i \mathcal{U}_\alpha) \neq \emptyset$ . By definition,  $\partial^i \mathcal{U}_\alpha \subset [-1, 2]^{i-1} \times \mathcal{B}_i \times [-1, 2]^{c-i}$ , hence there exists  $(i, \mathcal{B}, \{s_t\}_t) \in \Gamma$  such that

$$\psi_x(s_t) = \psi_x(s_{t'}), \quad \forall t, t' \in \mathcal{B},$$

which contradicts  $(\mathcal{P})$ . Therefore,  $\cap_{\alpha \in \mathcal{I}} \psi_x(\partial \mathcal{U}_\alpha) = \emptyset$ . Since  $s$  can be taken arbitrary in  $[0, 1]^c$ , Corollary 2.53 implies that  $\psi_x$  has a stable value  $y$ , and thus,  $\text{Im}(\psi_x)$  contains an open neighbourhood of  $\{y\}$  in  $\mathcal{W}_f^c(x)$ . But  $\psi_x$  takes values in  $\mathcal{W}_f^c(x) \cap \text{Acc}_f(x)$ , hence the latter has non-empty interior; saturating by local stable and unstable leaves, we deduce that  $\text{Acc}_f(x)$  has non-empty interior too. Then, it is clear that the accessibility class  $\text{Acc}_f(x)$  is open, and the claim is proved.

Now, since  $\mathcal{D}$  is  $(\theta, k)$ -spanning, the previous claim implies that for any  $x \in X$ , the accessible class  $\text{Acc}_f(x)$  is open. By the compactness of  $X$ , there exists a finite set

$\{x_1, \dots, x_k\} \subset X$  such that  $X = \cup_{i=1}^k \text{Acc}_f(x_i)$ . Since  $X$  is connected, we thus conclude that  $f$  is accessible.  $\square$

**Corollary 2.59.** *Under the assumptions of Lemma 2.58,  $f$  is  $C^1$ -stably accessible.*

PROOF. By Lemma 2.58, it suffices to show that the set of  $f \in \mathcal{PH}^1(X)$  satisfying  $(\mathcal{P})$  is a  $C^1$ -open set. Assume that  $f$  satisfies  $(\mathcal{P})$  for  $0 < \theta < \theta' < 1$ ,  $k \geq 1$ , and  $\mathcal{D}$ , a  $(\theta, k)$ -spanning  $c$ -family for  $f$ . Let  $\varsigma_{f,\gamma}$  be as in Lemma 2.56 and let  $\sigma \in (0, \varsigma_{f,\gamma})$  be a sufficiently small constant to be determined. By Lemma 2.32, there exists  $\mathcal{U}$ , an open neighbourhood of  $f$  in  $\mathcal{PH}^1(X)$ , depending only on  $f, k, \theta, \theta', \sigma$ , such that for any  $g \in \mathcal{U}$ , there exists  $\mathcal{D}_g$ , a  $(\theta, k+2)$ -spanning  $c$ -family for  $g$ , such that for each  $\mathcal{C}_g \in \mathcal{D}_g$ ,  $\theta'\mathcal{C}_g \in (\theta'\mathcal{C}, \sigma)$ . For each  $y \in \theta'\mathcal{C}_g$ , take  $x \in \theta'\mathcal{C}$  with  $y \in B(x, \sigma) \subset B(x, \varsigma_{f,\gamma})$ ; applying Lemma 2.56 to  $\gamma_x$ , we obtain  $\gamma_{g,y}$ , a continuous family of  $g$ -loops at  $y$  which is close to  $\gamma_x$ . By choosing  $\sigma$  sufficiently small, we can ensure that for any  $g$  sufficiently close to  $f$ , any  $\mathcal{C}_g \in \mathcal{D}_g$ ,  $y \in \theta'\mathcal{C}_g$ , any  $(i, \mathcal{B}, \{s_t\}_{t \in \mathcal{B}}) \in \Gamma$ , letting  $\psi_y^g := \psi(g, y, \gamma_{g,y})$ , then there exists  $t, t' \in \mathcal{B}$  such that  $\psi_y^g(s_t) \neq \psi_y^g(s_{t'})$ . Thus any map  $g$  sufficiently close to  $f$  in the  $C^1$  topology satisfies  $(\mathcal{P})$ , which concludes.  $\square$

**7.3. Parametrising an accessible set using a family of loops.** To optimize the pinching exponents in our theorems, we will mainly consider the class of continuous families of loops as follows.

**Definition 2.60** (Regular family). *Given a diffeomorphism  $f \in \mathcal{PH}^1(X)$ ,  $x \in X$  and constants  $\sigma \in (0, \frac{\sigma_f}{2})$ ,  $C > 0$ , a continuous family  $\{\gamma(s) = (x_1(s), x_2(s), x_3(s))\}_s$  of  $f$ -loops at  $x$  is said to be a  $(\sigma, C)$ -regular family of  $f$ -loops at  $x$  if it satisfies:*

- (1)  $x_1(s) \in \mathcal{W}_f^u(x, \frac{1}{8}C_f^{-2}\sigma)$  for all  $s \in [0, 1]$ , and  $\ell(\gamma) < \sigma$ ;
- (2) the map  $s \mapsto x_1(s)$  is injective and  $C$ -Lipschitz (with respect to  $d_{\mathcal{W}_f^u}$ );
- (3) there exists  $x' \in \mathcal{W}_f^{cs}(x, \frac{1}{8}C_f^{-2}\sigma)$  such that  $x_2(s) \in \mathcal{W}_f^{cu}(x', \sigma)$  for all  $s \in [0, 1]$ .

In this case, we say that  $\gamma$  is determined by  $x'$  and  $(x_1(s))_{s \in [0,1]}$ . Indeed, for any  $s \in [0, 1]$ ,  $x_2(s)$  is the unique intersection of  $\mathcal{W}_f^s(x_1(s), h_f)$  and  $\mathcal{W}_f^{cu}(x', h_f)$ , and  $x_3(s)$  is the unique intersection of  $\mathcal{W}_f^u(x_2(s), h_f)$  and  $\mathcal{W}_f^{cs}(x, h_f)$ .<sup>6</sup>

Let  $f \in \mathcal{PH}^2(X)$  be dynamically coherent and plaque expansive, let  $x \in X$ ,  $C > 0$ ,  $\sigma \in (0, \frac{\sigma_f}{2})$ , and take  $\{\gamma(s) = (x_1(s), x_2(s), x_3(s))\}_{s \in [0,1]}$ , a  $(\sigma, C)$ -regular family of  $f$ -loops at  $x$ , determined by  $x' \in \mathcal{W}_f^{cs}(x, \frac{1}{8}C_f^{-2}\sigma)$  and  $(x_1(s))_{s \in [0,1]}$ . Let  $\hat{f}: U \times X \rightarrow X$  be a  $C^1$  deformation at  $(a, f)$ , with  $U = U(\chi)$  as in Notation 2, and set  $T = T(\hat{f})$ . We now define continuations of a regular family of  $f$ -loops.

**Definition 2.61.** *We define a lift of  $\{\gamma(s)\}_s$  as*

$$\hat{\gamma}(s) = ((a, x_1(s)), (a, x_2(s)), (a, x_3(s))), \quad \forall s \in [0, 1]. \quad (7.2)$$

Then by continuity, there exists a  $C^2$ -uniform constant  $\delta_{a,T} = \delta_{a,T}(T) > 0$  such that  $B(a, \delta_{a,T}) \subset U$ , and for any  $(b, y) \in \mathcal{W}_T^c((a, x), \delta_{a,T})$ , any  $s \in [0, 1]$ , each of the following intersections exists and is unique:

- (1)  $\{(b, \hat{x}_1(b, y, s))\} := \mathcal{W}_T^u((b, y), h_f) \cap \mathcal{W}_T^{cs}((a, x_1(s)), h_f)$ ;
- (2)  $\{(b, \hat{x}_2(b, y, s))\} := \mathcal{W}_T^s((b, \hat{x}_1(b, y, s)), h_f) \cap \mathcal{W}_T^{cu}((a, x'), h_f)$ ;
- (3)  $\{(b, \hat{x}_3(b, y, s))\} := \mathcal{W}_T^u((b, \hat{x}_2(b, y, s)), h_f) \cap \mathcal{W}_T^{cs}((a, x), h_f)$ .

We thus get a continuous family of  $\hat{f}(b, \cdot)$ -loops at  $y$ , denoted by  $\{\gamma_{b,y}(s)\}_s$ , where

$$\gamma_{b,y}(s) = (\hat{x}_1(b, y, s), \hat{x}_2(b, y, s), \hat{x}_3(b, y, s)), \quad \forall s \in [0, 1].$$

Note that in general,  $\gamma_{b,y}$  is different from  $\gamma_{f(b, \cdot), y}$  as defined in Lemma 2.56.

6. Indeed, set  $\sigma' := \frac{1}{8}C_f^{-2}\sigma$ . Then  $d(x', x_1(s)) < 2\sigma' < \sigma_f$ , hence by Notation 1,  $x_2(s)$  is well defined, and  $d_{\mathcal{W}^s}(x_1(s), x_2(s)), d_{\mathcal{W}^{cu}}(x_2(s), x') < 2C_f\sigma' < \sigma_f$ . Then  $x_3(s)$  is well defined, and  $d_{\mathcal{W}^u}(x_2(s), x_3(s)), d_{\mathcal{W}^c}(x_3(s), x') < 2C_f^2\sigma'$ . Then,  $\ell(\gamma(s)) < \sigma' + 2C_f\sigma' + 4C_f^2\sigma' + \sigma' < \sigma$ .

There exists a  $C^2$ -uniform constant  $\bar{\delta}_{a,T} = \bar{\delta}_{a,T}(T, \sigma) \in (0, \delta_{a,T})$ , such that for any  $(b, y) \in \mathcal{W}_T^c((a, x), \bar{\delta}_{a,T})$ , we have  $\ell(\gamma_{b,y}) < 2\sigma < \bar{\sigma}_{\hat{f}(b, \cdot)}$ . By Notation 3, the following map is well-defined:

$$\hat{\psi} = \hat{\psi}(T): \begin{cases} \mathcal{W}_T^c((a, x), \bar{\delta}_{a,T}) \times [-1, 2]^c & \rightarrow \mathcal{W}_T^c(a, x), \\ (b, y, s) & \mapsto (\prod_{j=1}^c H_{T, \hat{\gamma}(\varphi(j, s_j))})(b, y). \end{cases} \quad (7.3)$$

Moreover, by Lemma 2.41, for any  $(b, y, s) \in \mathcal{W}_T^c((a, x), \bar{\delta}_{a,T}) \times [-1, 2]^c$ , we have

$$\pi_X \hat{\psi}(b, y, s) = \psi(\hat{f}(b, \cdot), y, \gamma_{b,y})(s) \in \mathcal{W}_{\hat{f}(b, \cdot)}^c(y, 2K_f \sigma) \subset B(y, 2C_f K_f \sigma). \quad (7.4)$$

**Notation 4.** Assume that  $f_0 \in \mathcal{PH}^2(X)$  is dynamically coherent, center bunched and satisfies (ae) (resp. (be)). Then we define a  $C^1$ -open neighbourhood of  $f_0$ , denoted by  $\mathbb{U}(f_0)$ , satisfying the following properties:

- (1)  $\mathbb{U}(f_0) \subset \mathcal{U}_0(f_0, \theta''_{f_0})$ , where the latter is given by Proposition 2.24,
- (2)  $\mathbb{U}(f_0)$  is small enough so that any  $f \in \mathbb{U}(f_0)$  is uniformly  $\theta'_{f_0}$ -pinched, uniformly center bunched, and dynamically coherent. Moreover, the constants  $h_{f_0}, \sigma_{f_0}, C_{f_0}, \bar{\Lambda}_{f_0}, \varepsilon_{f_0}$  in Notation 1 work for any  $f \in \mathbb{U}(f_0)$ .

By points (1), (2), (4), (5) in Notation 1, such  $\mathbb{U}(f_0)$  exists. We stress that we do not require  $\Lambda_f$  to be uniformly bounded for  $f \in \mathbb{U}(f_0)$ .

The following lemma is important, and is the place where several technical conditions introduced earlier come into use.

**Lemma 2.62.** Let  $f_0 \in \mathcal{PH}^2(X)$  be as in Notation 4. Then for any  $f \in \mathbb{U}(f_0)$ , for a  $C^2$  deformation at  $(a, f)$  with  $I$ -parameters  $\hat{f}: U \times X \rightarrow X$  in  $\mathbb{U}(f_0)$  with  $U = U(\chi)$ , for any  $C > 0$ ,  $\sigma \in (0, (100C_f K_f)^{-1} \bar{\sigma}_f)$ , any  $x \in X$ , any  $(\sigma, C)$ -regular family of  $f$ -loops at  $x$ , denoted by  $\gamma$ , there exists a  $C^1$ -uniform constant  $\hat{C}_{f_0} = \hat{C}_{f_0}(f_0) > 0$  such that the following is true. Let  $T = T(\hat{f})$  and let  $\hat{\psi}$  be defined as in (7.3). Then for all  $(b, y) \in \mathcal{W}_T^c((a, x), \bar{\delta}_{a,T})$ , any  $s, s' \in [-1, 2]^c$ , we have

$$d(\hat{\psi}(b, y, s), \hat{\psi}(b, y, s')) \leq cC^{\theta_0} \hat{C}_{f_0} \Lambda_f^{4c+3} |s - s'|^{\theta_0},$$

where  $\theta_0 := \theta'_{f_0} (\theta''_{f_0})^2$ , (resp.  $\theta_0 := \theta'_{f_0} (\theta''_{f_0})^3$ ) and by (ae) (resp. (be)),

$$\theta_0 = \theta'_{f_0} (\theta''_{f_0})^2 > \frac{c-1}{c} \quad (\text{resp. } \theta_0 = \theta'_{f_0} (\theta''_{f_0})^3 > \frac{c-1}{c}). \quad (7.5)$$

**PROOF.** Given  $s = (s_k), s' = (s'_k) \in [-1, 2]^c$ , and for any  $j \in \{1, \dots, c\}$ , set  $t_j := \varphi(j, s_j) \in [0, 1]$  and  $t'_j := \varphi(j, s'_j) \in [0, 1]$  (see (6.2)). For each  $0 \leq i \leq c$ , we let

$$v_i := \prod_{j=1}^i H_{T, \hat{\gamma}(t_j)}(b, y), \quad w_i := \prod_{j=i+1}^c H_{T, \hat{\gamma}(t'_j)}(v_i).$$

Arguing as in (7.4), for each  $0 \leq i \leq c$ , we see that  $\pi_X(v_i) \in \mathcal{W}_{\hat{f}(b, \cdot)}^c(y, 2K_f \sigma)$ . Moreover, we have  $w_0 = \hat{\psi}(b, y, s')$ ,  $w_c = \hat{\psi}(b, y, s)$ . Thus it is enough to estimate  $d(w_0, w_c)$ . For any  $0 \leq i \leq c-1$ , we observe that

$$w_i = \prod_{j=i+2}^c H_{T, \hat{\gamma}(t'_j)}(H_{T, \hat{\gamma}(t'_{i+1})}(v_i)), \quad w_{i+1} = \prod_{j=i+2}^c H_{T, \hat{\gamma}(t'_j)}(H_{T, \hat{\gamma}(t_{i+1})}(v_i)).$$

The maps  $\{H_{T, \hat{\gamma}(t'_j)}\}_{j=1, \dots, c}$  are obtained by composing holonomy maps. Since  $f$ , thus  $T$ , are  $C^2$  and center bunched, Notation 1 (3) and Notation 2 yield

$$d(w_i, w_{i+1}) \leq \Lambda_f^{4c} d(H_{T, \hat{\gamma}(t'_{i+1})}(v_i), H_{T, \hat{\gamma}(t_{i+1})}(v_i)).$$

Therefore, it suffices to prove that for any  $Z = (b, z)$  where  $b \in B(a, \bar{\delta}_{a,T})$  and  $z \in \mathcal{W}_{\hat{f}(b, \cdot)}^c(y, 2K_f \sigma)$ , any  $p, q \in [0, 1]$ ,

$$d_{\mathcal{W}_{\hat{f}(b, \cdot)}^c}(\pi_X(H_{T, \hat{\gamma}(p)}(Z)), \pi_X(H_{T, \hat{\gamma}(q)}(Z))) \leq C^{\theta_0} c_1 \Lambda_f^3 |p - q|^{\theta_0}$$

for some  $C^1$ -uniform constant  $c_1 = c_1(f_0) > 0$ . To see this, we set

$$\begin{aligned} Z_1 &:= H_{T,(a,x),(a,x_1(p))}^u(Z), & Z'_1 &:= H_{T,(a,x),(a,x_1(q))}^u(Z), \\ Z_2 &:= H_{T,(a,x_1(p)),(a,x_2(p))}^s(Z_1), & Z'_2 &:= H_{T,(a,x_1(q)),(a,x_2(q))}^s(Z'_1), \\ Z_3 &:= H_{T,(a,x_2(p)),(a,x_3(p))}^u(Z_2), & Z'_3 &:= H_{T,(a,x_2(q)),(a,x_3(q))}^u(Z'_2). \end{aligned}$$

Clearly,  $Z_i, Z'_i \in \{b\} \times X$  for  $i \in \{1, 2, 3\}$ , thus we set  $z_i := \pi_X(Z_i)$ ,  $z'_i := \pi_X(Z'_i)$ .

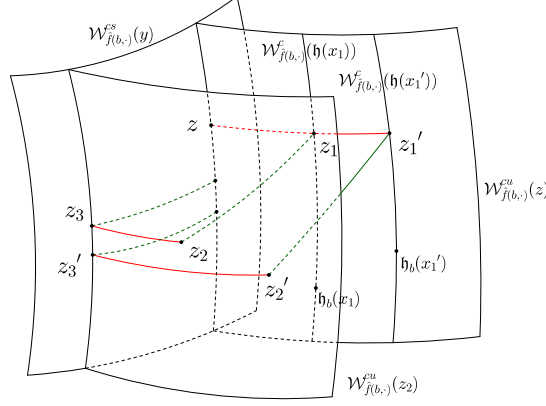

**Claim.** We have  $d_{\mathcal{W}_{\hat{f}(b, \cdot)}^u}(z_1, z'_1) \leq \bar{\Lambda}_{f_0}^2 C_{f_0} d_{\mathcal{W}_f^u}(x_1(p), x_1(q))^{\theta_1}$ . Here  $\theta_1 = (\theta''_{f_0})^2$  if (a) is satisfied, otherwise  $\theta_1 = (\theta''_{f_0})^3$ , when (b) is satisfied.

**PROOF.** We abbreviate  $x_1(p)$  (resp.  $x_1(q)$ ) as  $x_1$  (resp.  $x'_1$ ). By Notation 1 (5), we see that there exists a leaf conjugacy between  $\mathcal{W}_f^c$  and  $\mathcal{W}_{\hat{f}(b, \cdot)}^c$ , denoted by  $\mathfrak{h}_b$ , such that  $d(\mathfrak{h}_b(x_1), \mathfrak{h}_b(x'_1)) < \bar{\Lambda}_{f_0} d_{\mathcal{W}_f^u}(x_1, x'_1)^{\theta''_{f_0}}$ . Moreover, by construction, we have  $(b, \mathfrak{h}_b(x_1)) \in \mathcal{W}_T^c(a, x_1)$  and  $(b, \mathfrak{h}_b(x'_1)) \in \mathcal{W}_T^c(a, x'_1)$ . But we also have  $(b, z_1) \in \mathcal{W}_T^c(a, x_1)$  and  $(b, z'_1) \in \mathcal{W}_T^c(a, x'_1)$ . This implies that  $z_1 \in \mathcal{W}_{\hat{f}(b, \cdot)}^c(\mathfrak{h}_b(x_1))$  and  $z'_1 \in \mathcal{W}_{\hat{f}(b, \cdot)}^c(\mathfrak{h}_b(x'_1))$ . By Notation 1 (5), we can see that

$$d_{\mathcal{W}_{\hat{f}(b, \cdot)}^u}(z_1, z'_1) \leq \bar{\Lambda}_{f_0} C_{f_0} d(\mathfrak{h}_b(x_1), \mathfrak{h}_b(x'_1))^{\theta_2},$$

where  $\theta_2 = \theta''_{f_0}$  if (a) is satisfied, otherwise  $\theta_2 = (\theta''_{f_0})^2$ , since in this case (b) is satisfied. Hence  $d_{\mathcal{W}_{\hat{f}(b, \cdot)}^u}(z_1, z'_1) \leq \bar{\Lambda}_{f_0}^2 C_{f_0} d_{\mathcal{W}_f^u}(x_1, x'_1)^{\theta_1}$ , since  $\theta_1 = \theta''_{f_0} \theta_2$ .  $\square$

By Notation 1 (4) and  $\theta'_{f_0}$ -pinching of  $\hat{f}(b, \cdot)$ , we obtain  $d_{\mathcal{W}_{\hat{f}(b, \cdot)}^{cu}}(z_2, z'_2) \leq \Lambda_f d_{\mathcal{W}_{\hat{f}(b, \cdot)}^{cu}}(z_1, z'_1)^{\theta'_{f_0}}$ . By Notation 1 (3) and center bunching of  $\hat{f}(b, \cdot)$ , we get

$$\begin{aligned} & d_{\mathcal{W}_{\hat{f}(b, \cdot)}^c}(\pi_X(H_{T, \hat{\gamma}(p)}(Z)), \pi_X(H_{T, \hat{\gamma}(q)}(Z))) \leq \Lambda_f d_{\mathcal{W}_{\hat{f}(b, \cdot)}^c}(z_3, z'_3) \\ & \leq C_{f_0} \Lambda_f^2 d_{\mathcal{W}_{\hat{f}(b, \cdot)}^{cu}}(z_2, z'_2) \leq C_{f_0} \Lambda_f^3 d_{\mathcal{W}_{\hat{f}(b, \cdot)}^u}(z_1, z'_1)^{\theta'_{f_0}} \\ & \leq \bar{\Lambda}_{f_0}^2 C_{f_0}^2 \Lambda_f^3 d_{\mathcal{W}_f^u}(x_1(p), x_1(q))^{\theta'_{f_0} \theta_1}. \end{aligned}$$

Since  $\gamma$  is  $(\sigma, C)$ -regular, we have  $d_{\mathcal{W}_f^u}(x_1(p), x_1(q)) \leq C|p - q|$ . We conclude the proof by noting that  $\theta_0 = \theta'_{f_0} \theta_1$ .  $\square$

## 8. Constructing charts and vector fields

In order to construct an infinitesimal deformation, we will first introduce coordinates in a neighbourhood of each  $c$ -disk. Throughout this section, we fix  $r \in \mathbb{N}_{\geq 2} \cup \{\infty\}$ , and a map  $f \in \mathcal{PH}^r(X)$  with  $c := \dim(E_f^c) \geq 2$ , which is dynamically coherent and plaque expansive.

**Notation 5.** Recall that we denote  $d := \dim(X)$ ,  $d_s := \dim(E_f^s)$ ,  $d_u := \dim(E_f^u)$ . There exist  $C^r$ -uniform constants  $\bar{h}_f \in (0, h_f)$ ,  $\bar{C}_f > 1$  such that the following is true. For any  $c$ -disk of  $f$ , denoted by  $\mathcal{C} = \mathcal{W}_f^c(x, h)$ , with  $x \in X$  and  $h \in (0, \bar{h}_f)$ , there exists a  $C^r$  volume-preserving map  $\phi = \phi(\mathcal{C}): (-h, h)^d \rightarrow X$  such that  $\phi(0) = x$  and

- (1)  $\frac{1}{5}\mathcal{C} \subset \phi((-h/4, h/4)^c \times \{0\}^{d_u+d_s}) \subset \phi((-2h/3, 2h/3)^c \times \{0\}^{d_u+d_s}) \subset \mathcal{C}$ ;
- (2)  $\|\phi\|_{C^2} < \bar{C}_f$ ;
- (3)  $D\phi(0, \mathbb{R}^c \times \{0\}^{d_u+d_s})$ ,  $D\phi(0, \{0\}^c \times \mathbb{R}^{d_u} \times \{0\}^{d_s})$ ,  $D\phi(0, \{0\}^{c+d_u} \times \mathbb{R}^{d_s})$  are respectively equal to  $E_f^c(x)$ ,  $E_f^u(x)$ ,  $E_f^s(x)$ ;
- (4) for any  $y \in \phi((-h, h)^d)$ ,  $\Pi_c D\phi_y^{-1}: E_f^c(y) \rightarrow \mathbb{R}^c$  has determinant bounded from below (resp. above) by  $\bar{C}_f^{-1}$  (resp.  $\bar{C}_f$ ), where  $\Pi_c: \mathbb{R}^d \simeq \mathbb{R}^c \times \mathbb{R}^{d_u} \times \mathbb{R}^{d_s} \rightarrow \mathbb{R}^c$  denotes the canonical projection.

For  $*$  =  $u, s$ , set  $e_* := (1, 0, \dots, 0) \in \mathbb{R}^{d_*}$ . For any  $\lambda \in (0, h)$ , we define

$$\begin{aligned} \mathcal{W}^{cs}(\lambda) &:= \phi((-h, h)^c \times \{\lambda e_u\} \times (-h, h)^{d_s}), \\ \mathcal{W}^{cu}(\lambda) &:= \phi((-h, h)^c \times (-h, h)^{d_u} \times \{\lambda e_s\}). \end{aligned}$$

Moreover, for any  $\zeta > 0$ , there exists a  $C^1$ -uniform constant  $\bar{h}_{f,\zeta} \in (0, \bar{h}_f)$  so that for any  $c$ -disk  $\mathcal{C}$  of  $f$  with radius  $h \in (0, \bar{h}_{f,\zeta})$ , taking  $\phi = \phi(\mathcal{C})$  as above, then for any  $y \in \phi((-h, h)^d)$ ,  $\Pi_c D\phi_y^{-1}: E_f^u(y) \oplus E_f^s(y) \rightarrow \mathbb{R}^c$  has norm bounded by  $\zeta$ .

Using the chart  $\phi$  defined in Notation 5, we will construct regular families of loops for  $f$  and nearby diffeomorphisms.

**Lemma 2.63.** There exist  $C^2$ -uniform constants  $\tilde{h}_f \in (0, \bar{h}_f)$ ,  $\tilde{C}_f > 2\tilde{h}_f\bar{\sigma}_f^{-1}$  such that the following is true. For any  $\rho \in (0, \tilde{h}_f)$ , any  $\sigma \in (0, \tilde{C}_f^{-1}\rho)$ , there exist constants  $\hat{\epsilon}_0 = \hat{\epsilon}_0(f, \rho, \sigma) > 0$ ,  $\hat{\sigma}_0 = \hat{\sigma}_0(f, \rho, \sigma) \in (0, \sigma)$ , such that for any  $c$ -disk  $\mathcal{C}$  of  $f$  with radius  $h \in (\rho, \tilde{h}_f)$ , any  $g \in \mathcal{PH}^1(X)$  such that  $d_{C^1}(f, g) < \hat{\epsilon}_0$ , any  $x \in (\frac{1}{5}\mathcal{C}, \hat{\sigma}_0)$ , there exists  $\{\gamma(s) = (x_1(s), x_2(s), x_3(s))\}_{s \in [0,1]}$ , a  $(\sigma, \tilde{C}_f)$ -regular family of  $g$ -loops at  $x$  with the following properties: letting  $\sigma' := \tilde{C}_f^{-\frac{1}{2}}\sigma$ , we have

- (i) for any  $s \in [0, 1]$ , any  $i = 2, 3$ ,  $\mathcal{W}_g^c(x_i(s), K_f\sigma)$  is disjoint from the image  $\phi((-h, h)^{c+d_u} \times (-\frac{\sigma'}{2}, \frac{\sigma'}{2})^{d_s})$ ;
- (ii) take  $C_{\min}$  as in (6.3). For any  $s \in [0, 1]$ , we have

$$\mathcal{W}_g^c(x_1(s), K_f\sigma) \subset \phi((-h/2, h/2)^c \times (s\sigma' e_u + (-C_{\min}^{-1}\sigma', C_{\min}^{-1}\sigma')^{d_u}) \times (-\frac{\sigma'}{5}, \frac{\sigma'}{5})^{d_s}).$$

PROOF. Set  $\{x'\} := \mathcal{W}_g^s(x, h_f) \cap \mathcal{W}^{cu}(\sigma')$ . By Notation 1, Notation 5 (2), (3), and by taking  $\tilde{h}_f, \hat{\epsilon}_0, \hat{\sigma}_0$  sufficiently small,  $\tilde{C}_f$  sufficiently large, we have the following.

- (1) For each  $s \in [0, 1]$ , each of the following intersections exists and is unique:
  - (a)  $\{x_1(s)\} := \mathcal{W}_g^u(x, h_f) \cap \mathcal{W}^{cs}(s\sigma')$ ;
  - (b)  $\{x_2(s)\} := \mathcal{W}_g^s(x_1(s), h_f) \cap \mathcal{W}_g^{cu}(x', h_f)$ ;
  - (c)  $\{x_3(s)\} := \mathcal{W}_g^u(x_2(s), h_f) \cap \mathcal{W}_g^{cs}(x, h_f)$ .
- (2) For each  $s \in [0, 1]$ , set  $\gamma(s) := (x_1(s), x_2(s), x_3(s))$ . Then  $\gamma := \{\gamma(s)\}_{s \in [0,1]}$  is a  $(\sigma, \tilde{C}_f)$ -regular family of  $g$ -loops at  $x$  (see Definition 2.60).

By Notation 1, Notation 3, Notation 5 (2), (3),  $\tilde{C}_f\sigma < h < \tilde{h}_f$ , and (i), (ii) follow from straightforward computations, by letting  $\tilde{h}_f$ , resp.  $\tilde{C}_f$ , be sufficiently small, resp. sufficiently large.  $\square$

**Remark 2.64.** By point (ii), for any  $s, s' \in [0, 1]$  with  $|s - s'| > 5C_{\min}^{-1}$ , we have

$$\mathcal{W}_g^c(x_1(s), K_f\sigma) \cap \mathcal{W}_g^c(x_1(s'), K_f\sigma) = \emptyset.$$

**Definition 2.65.** For any  $c$ -disk  $\mathcal{C}$  such that  $\varrho(\mathcal{C}) =: h \in (0, \bar{h}_f)$ , with  $\bar{h}_f$  as in Notation 5, we define a collection of vector fields as follows. We let  $\phi = \phi(\mathcal{C}): (-h, h)^d \rightarrow X$  be given by Notation 5, and let  $\sigma \in (0, h)$ . We let  $\rho^{s,\sigma}: (-h, h)^{d_s} \rightarrow \mathbb{R}_{\geq 0}$  be a  $C^\infty$  function such that

- (1)  $\text{supp}(\rho^{s,\sigma}) \subset (-\sigma/3, \sigma/3)^{d_s}$  and  $\rho^{s,\sigma}|_{(-\sigma/5, \sigma/5)^{d_s}} \equiv 1$ ;
- (2)  $\|\rho^{s,\sigma}\|_{C^1} < 10^4 \sigma^{-1}$ .

We easily verify that such  $\rho^{s,\sigma}$  exists by explicit construction (see Appendix C).

Similarly, for each  $i \in \{1, \dots, c\}$ , each  $t \in \mathcal{B}_i$ , we let  $\rho_{\mathcal{C},i,t}^{u,\sigma}: (-h, h)^{d_u} \rightarrow \mathbb{R}_{\geq 0}$  be a  $C^\infty$  function such that

- (1)  $\text{supp}(\rho_{\mathcal{C},i,t}^{u,\sigma}) \subset (-2C_{\min}^{-1}\sigma, 2C_{\min}^{-1}\sigma)^{d_u} + \varphi(i, t)\sigma e_u$ , where  $\varphi, C_{\min}$  are taken as in (6.2), (6.3), and  $\rho_{\mathcal{C},i,t}^{u,\sigma}|_{(-C_{\min}^{-1}\sigma, C_{\min}^{-1}\sigma)^{d_u} + \varphi(i, t)\sigma e_u} \equiv 1$ ;
- (2)  $\|\rho_{\mathcal{C},i,t}^{u,\sigma}\|_{C^1} < 10^4 C_{\min} \sigma^{-1}$ .

For each  $1 \leq j \leq c$ , let  $U_j: (-h, h)^c \rightarrow \mathbb{R}^c$  be a  $C^\infty$  divergence-free vector field such that

- (1)  $U_j$  restricted to  $(-h/2, h/2)^c$  is equal to the constant vector, denoted by  $e_j$ , that has 1 at  $j$ -th coordinate and 0 at the others;
- (2)  $U_j$  vanishes outside  $(-2h/3, 2h/3)^c$ .

Since  $c \geq 2$ , such  $U_j$  always exists. Moreover, we can assume that  $U_j$  satisfies  $\|U_j\|_{C^1} < C_* h^{-1}$  for all  $j \in \{1, \dots, c\}$  for some constant  $C_* = C_*(c) > 0$ . Now, for each  $i, j \in \{1, \dots, c\}$ ,  $t \in \mathcal{B}_i$ , we let  $U_{\mathcal{C},i,t,j}^\sigma: (-h, h)^d \rightarrow \mathbb{R}^d$  be the vector field

$$U_{\mathcal{C},i,t,j}^\sigma(z) := \rho_{\mathcal{C},i,t}^{u,\sigma}(z_u) \rho^{s,\sigma}(z_s) U_j(z_c), \quad \forall z = (z_c, z_u, z_s) \in (-h, h)^d,$$

and we set

$$V_{\mathcal{C},i,t,j}^\sigma := D\phi(U_{\mathcal{C},i,t,j}^\sigma). \quad (8.1)$$

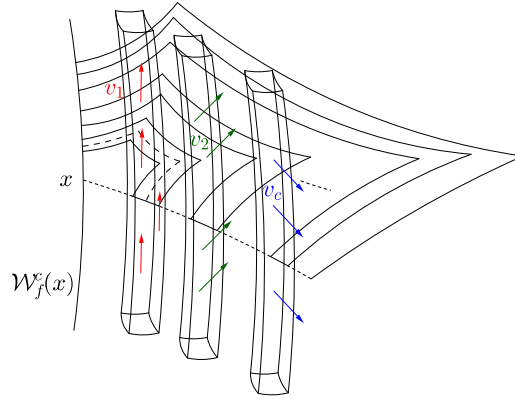

**Remark 2.66.** By construction, it is clear that

$$\text{supp}_X(V_{\mathcal{C},i,t,j}^\sigma) \subset \phi((-2h/3, 2h/3)^c \times (-2\sigma, 2\sigma)^{d_u+d_s}).$$

Thus for any  $\sigma_0 > 0$ , there exists  $\sigma > 0$  such that for any  $\mathcal{C}, i, j, t$  in Definition 2.65,

$$\text{supp}_X(V_{\mathcal{C},i,t,j}^\sigma) \subset (\mathcal{C}, \sigma_0).$$

**Lemma 2.67.** There exists a constant  $C_f^\sharp > 0$  such that for any  $h \in (0, \bar{h}_f)$ ,  $\sigma \in (0, h)$ , any  $c$ -disk  $\mathcal{C}$  for  $f$ , with radius  $\varrho(\mathcal{C}) = h$ , the vector fields  $\{V_{\mathcal{C},i,t,j}^\sigma\}_{i,j \in \{1, \dots, c\}, t \in \mathcal{B}_i}$  are well-defined, divergence-free and satisfy:

$$\sigma \|\partial_x V_{\mathcal{C},i,t,j}^\sigma\|_X + \|V_{\mathcal{C},i,t,j}^\sigma\|_X < C_f^\sharp. \quad (8.2)$$



PROOF. For each  $h, \sigma, \mathcal{C}, i, j, t$  as in the lemma, the vector field  $U_{\mathcal{C}, i, t, j}^\sigma$  is divergence-free. By Notation 5,  $\phi = \phi(\mathcal{C})$  is volume-preserving, hence by (8.1),  $V_{\mathcal{C}, i, j, r}^\sigma$  is also divergence-free. By  $\|\phi\|_{C^2} < \bar{C}_f$  and the  $C^1$ -bounds on  $\rho^{s, \sigma}, \rho_{\mathcal{C}, i, t, j}^{u, \sigma}, U_j$  in Definition 2.65, we can choose  $C_f^\sharp > 0$  to be sufficiently large so that (8.2) holds.  $\square$

The following lemma describes the values taken by  $V_{\mathcal{C}, i, t, j}^\sigma$  at the corners of loops that we will construct in Section 9.

**Lemma 2.68.** *There exists a constant  $\kappa_f > 0$  such that for any  $\rho_1 \in (0, \frac{1}{2}\tilde{h}_f)$ ,  $\tilde{\sigma} \in (0, \tilde{C}_f^{-1}\rho_1)$ ,  $\sigma \in (0, \tilde{\sigma})$  there exists a constant  $\lambda_1 = \lambda_1(f, \rho_1, \sigma) > 0$  such that for any  $\tilde{\sigma}$ -sparse  $(\frac{1}{20}, 6)$ -spanning  $c$ -family for  $f$ , denoted by  $\mathcal{D}$ , satisfying  $[\underline{r}(\mathcal{D}), \bar{r}(\mathcal{D})] \subset (\rho_1, \frac{1}{2}\tilde{h})$ , for any  $g \in \mathcal{PH}^r(X)$  such that  $d_{C^1}(f, g) < \lambda_1$ , there exists  $\mathcal{D}_g$ , a  $(\frac{1}{20}, 8)$ -spanning  $c$ -family for  $g$  with  $[\underline{r}(\mathcal{D}_g), \bar{r}(\mathcal{D}_g)] \subset (\rho_1, \tilde{h}_f)$  such that the following is true.*

For any  $\mathcal{C}_g \in \mathcal{D}_g$ , we have  $\mathcal{C}_g \subset (\mathcal{C}, \sigma)$  and  $\frac{1}{10}\mathcal{C}_g \subset (\frac{1}{10}\mathcal{C}, \sigma)$  for some  $\mathcal{C} \in \mathcal{D}$ , and for each  $x \in \frac{1}{10}\mathcal{C}_g$ , there exists a  $(\sigma, \tilde{C}_f)$ -regular continuous family of  $g$ -loops at  $x$ , denoted by  $\{\gamma(s) = (x_1(s), x_2(s), x_3(s))\}_{s \in [0, 1]}$ , such that for any  $i \in \{1, \dots, c\}$ ,  $s \in [0, 1]$ ,  $t \in \mathcal{B}_i$ , any  $y \in \mathcal{W}_g^c(x, K_f\sigma) \cup \mathcal{W}_g^c(x_2(s), K_f\sigma) \cup \mathcal{W}_g^c(x_3(s), K_f\sigma)$ , and any  $z \in \mathcal{W}_g^c(x_1(\varphi(i, t)), K_f\sigma)$ , letting  $\sigma' := \tilde{C}_f^{-\frac{1}{2}}\sigma$ , we have

$$V_{\mathcal{C}, i, t, j}^{\sigma'}(y) = 0, \quad \forall 1 \leq j \leq c, \quad \det((\pi_c V_{\mathcal{C}, i, t, j}^{\sigma'}(z))_{j=1, \dots, c}) > \kappa_f. \quad (8.3)$$

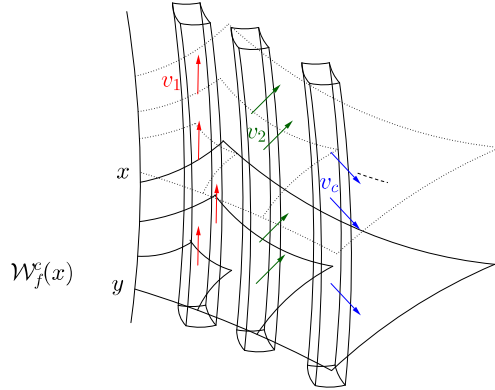

PROOF. Let  $\rho, \tilde{\sigma}, \sigma, \mathcal{D}$  be as in the lemma and let  $\sigma_1 := \hat{\sigma}_0(f, \rho_1, \sigma) > 0$  be as in Lemma 2.63. By Lemma 2.32 applied to  $(k, \theta, \theta', \rho_m, \rho_M, \sigma) := (6, \frac{1}{20}, \frac{1}{10}, \rho_1, \frac{1}{2}\tilde{h}_f, \sigma_1)$ , there exists  $\mu > 0$  depending only on  $f, \rho_1, \sigma$  such that for any  $g \in \mathcal{PH}^r(X)$  with  $d_{C^1}(f, g) < \mu$ , there exists  $\mathcal{D}_g$ , a  $(\frac{1}{20}, 8)$ -spanning  $c$ -family for  $g$ , with  $[\underline{r}(\mathcal{D}_g), \bar{r}(\mathcal{D}_g)] \subset (\rho_1, \tilde{h}_f)$ , such that for each  $\mathcal{C}_g \in \mathcal{D}_g$ , we have  $\mathcal{C}_g \subset (\mathcal{C}, \sigma_1) \subset (\mathcal{C}, \sigma)$  and  $\frac{1}{10}\mathcal{C}_g \subset (\frac{1}{10}\mathcal{C}, \sigma_1) \subset (\frac{1}{10}\mathcal{C}, \sigma)$  for some  $\mathcal{C} \in \mathcal{D}$ .

Let  $\lambda_1 := \min(\mu, \hat{\varepsilon}_0(f, \rho_1, \sigma)) > 0$ . Then for any  $g \in \mathcal{PH}^r(X)$  such that  $d_{C^1}(f, g) < \lambda_1$ , we can apply Lemma 2.63 to any  $c$ -disk  $\mathcal{C} \in \mathcal{D}$  of  $f$ , since it has radius in  $(\rho_1, \frac{1}{2}\tilde{h}_f)$ , and any  $x \in \frac{1}{10}\mathcal{C}_g \subset (\frac{1}{10}\mathcal{C}, \sigma_1)$ , to construct  $\{\gamma(s)\}_{s \in [0, 1]}$ , a  $(\sigma, \tilde{C}_f)$ -regular continuous family of  $g$ -loops at  $x$  such that the following is true. Let  $i, j, s, t, \sigma'$  be as in the lemma. Then

- (1)  $\mathcal{W}_g^c(x_i(s), K_f\sigma)$ ,  $i = 2, 3$ , are disjoint from  $\phi((-h, h)^{c+d_u} \times (-\frac{\sigma'}{2}, \frac{\sigma'}{2})^{d_s})$ ;
- (2)  $\mathcal{W}_g^c(x, K_f\sigma) \subset \phi((-h/2, h/2)^c \times (-C_{\min}^{-1}\sigma', C_{\min}^{-1}\sigma')^{d_u} \times (-\frac{\sigma'}{5}, \frac{\sigma'}{5})^{d_s})$ ;



- (3) we have  $\mathcal{W}_g^c(x_1(\varphi(i, t)), K_f \sigma) \subset \phi((-h/2, h/2)^c \times (\varphi(i, t)\sigma' e_u + (-C_{\min}^{-1}\sigma', C_{\min}^{-1}\sigma')^{d_u}) \times (-\frac{\sigma'}{5}, \frac{\sigma'}{5})^{d_s})$ .

Then, by the properties in Definition 2.65 and by Notation 5 (4), (8.3) holds for some  $\kappa_f > 0$  depending only on  $\overline{C}_f$ .  $\square$

### 9. On the prevalence of the accessibility property

In this section, we fix two integers  $r \in \mathbb{N}_{\geq 2} \cup \{\infty\}$  and  $J \geq 1$ .

**9.1. Constructing perturbations for a family of diffeomorphisms.** Let  $\{f_a\}_a$  be a  $C^r - J$ -family in the space of dynamically coherent, plaque expansive, center bunched  $C^r$  partially hyperbolic diffeomorphisms on  $X$  with center dimension at least 2.

Let  $\Omega_0$  be an open set satisfying  $\overline{\Omega_0} \Subset CB_J$ , let  $U_1$  be an open neighbourhood of the origin in  $\mathbb{R}^I$  for some integer  $I \geq 1$ , and let  $\hat{f}: \Omega_0 \times U_1 \times X \rightarrow X$  be a  $C^r$  map such that  $\hat{f}(a, 0, x) = f_a(x)$  for all  $(a, x) \in \Omega_0 \times X$ . In particular, for any  $a \in \Omega_0$ , the map  $\hat{f}(a, \cdot): U_1 \times X \rightarrow X$  is a  $C^r$  deformation of  $f_a$ . We set  $T_a := T(\hat{f}(a, \cdot))$ . Moreover, by applying Lemma 2.34 to  $\hat{f}(a, \cdot)$  in place of  $\hat{f}$ , for any  $(b, x) \in U_1 \times X$ , we denote by  $\nu_b^a(x, \cdot): \mathbb{R}^I \rightarrow E_{\hat{f}(a, b, \cdot)}^{su}(x)$  the unique linear map such that

$$E_{T_a}^c(b, x) = \text{Graph}(\nu_b^a(x, \cdot)) \oplus E_{\hat{f}(a, b, \cdot)}^c(x). \quad (9.1)$$

**Definition 2.69** (Removability). *Let  $\hat{f}$  be as above. Given  $\rho_m, \rho_M, \sigma, C, \kappa > 0$ ,  $a \in \Omega_0$ , we say that  $\hat{f}$  is  $(\rho_m, \rho_M, \sigma, C, \kappa)$ -Removable at  $a$  if the following is true. There exists  $\mathcal{D}$ , a  $(\frac{1}{20}, 8)$ -spanning  $c$ -family for  $f_a$  with  $[\underline{r}(\mathcal{D}), \overline{r}(\mathcal{D})] \subset (\rho_m, \rho_M)$ , such that for each  $\mathcal{C} \in \mathcal{D}$ , for each  $x \in \frac{1}{10}\mathcal{C}$ , there exists a  $(\sigma, C)$ -regular continuous family  $\gamma$  of  $f_a$ - loops at  $x$  with the following properties. Let  $K_0, \Gamma$  be taken as in Subsection 6.2. For any  $(i, \mathcal{B}, \{s_t\}_{t \in \mathcal{B}}) \in \Gamma$  and  $(t, j) \in \mathcal{B} \times \{1, \dots, c\}$ , we set  $\gamma_{t,j} := \gamma(\varphi(j, s_{t,j}))$ ,  $\hat{\gamma}_{t,j} := \hat{\gamma}(\varphi(j, s_{t,j}))$ ,  $z_t := (\prod_{j=1}^c H_{f_a, \gamma_{t,j}})(x)$ , and we define*

$$\Xi_{a,x}: \begin{cases} T_0 U_1 & \rightarrow \prod_{t \in \mathcal{B}} E_{\hat{f}_a}^c(z_t) \simeq \mathbb{R}^{K_0 c}, \\ B & \mapsto \left( \pi_c \left( D \left( \prod_{j=1}^c H_{T_a, \hat{\gamma}_{t,j}} \right) \cdot (B + \nu_0^a(x, B)) \right) \right)_{t \in \mathcal{B}}. \end{cases} \quad (9.2)$$

Then there exists a linear subspace  $H \subset \mathbb{R}^I$  of dimension  $K_0 c$  such that

$$|\det(\Xi_{a,x}|_H)| > \kappa.$$

In the remaining of Subsection 9.1, we consider a good  $C^r - J$ -family  $\{f_a\}_{a \in CB_J}$ . With the notations of Lemmata 2.67, 2.68 and Notation 3, and by compactness, we can choose  $C_1^\sharp, \tilde{C}_2, \tilde{K} < +\infty$  sufficiently large, resp.  $\tilde{h}, \kappa > 0$  sufficiently small, such that  $C_1^\sharp > C_{f_a}^\sharp$ ,  $\tilde{C}_2 > \tilde{C}_{f_a}$ , and  $\tilde{K} > K_{f_a} + 4$ , resp.  $\tilde{h} < \tilde{h}_{f_a}$  and  $\kappa < \kappa_{f_a}$ , for all  $a \in CB_J$ . The main goal of this subsection is the following.

**Proposition 2.70.** *There exist constants  $Q, \kappa_1 > 0$ ,  $\rho_1 \in (0, \frac{1}{2}\tilde{h})$  such that for any  $\vartheta > 0$ , any sufficiently small  $\sigma > 0$ , there exist*

- an open set  $\Omega_0$  satisfying  $\overline{\Omega_0} \Subset CB_J$  and  $\text{Leb}(CB_J \setminus \Omega_0) < \vartheta$ ;
- an integer  $I > 0$ ;
- an open neighbourhood of the origin in  $\mathbb{R}^I$ , denoted by  $U_1 = U_1(\{f_a\}, \sigma, K_0, c, C_1^\sharp, \kappa)$ ;
- a  $C^r$  map  $\hat{f}: CB_J \times U_1 \times X \rightarrow X$

such that the following is true:

- $\hat{f}(a, 0, x) = f_a(x)$ , for all  $(a, x) \in CB_J \times X$ ;
- $\|\hat{f}\|_{C^1} < Q$ ;
- $\hat{f}$  is  $(\rho_1, \tilde{h}, \sigma, \tilde{C}_2, \kappa_1)$ -Removable at  $a$ , for all  $a \in \Omega_0$ .

To prepare for the proof of Proposition 2.70, we first show the following lemma.

**Lemma 2.71.** *There exist constants  $R_1, \kappa_1 > 0$  such that the following is true. For any  $\rho_1 \in (0, \frac{1}{2}\tilde{h})$ , any sufficiently small  $\sigma > 0$ , there exists a constant  $\lambda_2 = \lambda_2(\rho_1, \sigma) > 0$  such that for any  $a \in CB_J$ , if  $\mathcal{D}$  is a  $3\widehat{K}\sigma$ -sparse  $(\frac{1}{20}, 6)$ -spanning  $c$ -family for  $f_a$  with  $[\underline{x}(\mathcal{D}), \bar{r}(\mathcal{D})] \subset (\rho_1, \frac{1}{2}\tilde{h})$ , and if  $V$  is an infinitesimal  $C^r$  deformation satisfying*

- (1)  $\sigma \|\partial_b \partial_x V\|_X + \|\partial_b V\|_X < C_1^\sharp$  and  $R_\pm(f_a, (\mathcal{D}, 3\widehat{K}\sigma), \text{supp}_X(V)) > R_1$ ;
- (2) for  $B = (B_{\mathcal{C}, i, t, j})_{\mathcal{C} \in \mathcal{D}, i, j \in \{1, \dots, c\}, t \in \mathcal{B}_i} \in \mathbb{R}^{2n(\mathcal{D})c^2|\mathcal{A}|}$  and  $\sigma'_a := \widetilde{C}_{f_a}^{-\frac{1}{2}} \sigma$ ,

$$V(B, \cdot)|_{(\mathcal{D}, 2\widehat{K}\sigma)} = \sum_{\mathcal{C} \in \mathcal{D}, i, j \in \{1, \dots, c\}, t \in \mathcal{B}_i} B_{\mathcal{C}, i, t, j} V_{\mathcal{C}, i, t, j}^{\sigma'_a};$$

then there exists a neighbourhood of the origin  $U_1 = U_1(\{f_a\}, \sigma, K_0, c, C_1^\sharp, \kappa) \subset \mathbb{R}^{2n(\mathcal{D})c^2|\mathcal{A}|}$  such that the  $C^r$  deformation  $\hat{f}: CB_J \times U_1 \times X \rightarrow X$  generated by  $V$  is  $(\rho_1, \tilde{h}, \sigma, \widetilde{C}_2, \kappa_1)$ -Removable at  $a'$ , for any  $a' \in B(a, \lambda_2) \cap CB_J$ .

**PROOF.** By compactness, we can choose  $R_1 > 0, \kappa_1 > 0$  so that for any  $a \in CB_J$ ,  $R_1 > R_0(f_a, K_0, c, C_1^\sharp, \frac{\kappa}{2})$ ,  $\kappa_1 < \kappa_0(f_a, K_0, c, C_1^\sharp, \frac{\kappa}{2})$  as in Proposition 2.44. Let  $\lambda_1 = \lambda_1(\rho_1, \sigma)$  be given by Lemma 2.68. By (1), we can choose  $\lambda_2 \in (0, \lambda_1)$  such that for any  $a, \mathcal{D}$  as in the statement of the lemma, for any  $a' \in B(a, \lambda_2) \cap CB_J$ , we have  $R_\pm(f_{a'}, (\mathcal{D}, 2\widehat{K}\sigma), \text{supp}_X(V)) > R_1$ . Then we apply Lemma 2.68 to  $a, \mathcal{D}$  to obtain  $\mathcal{D}'$ , a  $(\frac{1}{20}, 8)$ -spanning  $c$ -family for  $f_{a'}$  with  $[\underline{x}(\mathcal{D}'), \bar{r}(\mathcal{D}')] \subset (\rho_1, \tilde{h})$  such that the conclusion of Lemma 2.68 holds.

For any  $\mathcal{C}' \in \mathcal{D}'$ , any  $x \in \frac{1}{10}\mathcal{C}'$ , let  $\gamma$  be a  $(\sigma, \widetilde{C}_2)$ -regular continuous family of  $f_{a'}$ -loops at  $x$  satisfying the conclusion of Lemma 2.68. We claim that for any  $s \in [0, 1]$ , the vector field  $V$  in the lemma is adapted to  $(\gamma(s), \sigma, C_1^\sharp, R_1)$ . Indeed, by  $\widehat{K} \geq K_{f_{a'}} + 4$  and  $\mathcal{C}' \subset (\mathcal{D}, \sigma)$ , we have  $W_{f_{a'}}^c(z, K_{f_{a'}}\sigma) \subset (\mathcal{D}, 2\widehat{K}\sigma)$  for any  $z \in \{x, x_1(s), x_2(s), x_3(s)\}$ . Then by the choice of  $\lambda_2$ , we verify (2), (3) in Definition 2.43 for  $\gamma(s)$  in place of  $\gamma$ . We verify (1) in Definition 2.43 by the fact that  $\gamma(s)$  is  $(\sigma, \widetilde{C}_2)$ -regular and the hypothesis on  $V$ . Thus the claim is true.

For any  $(i, \mathcal{B}, \{s_t\}_{t \in \mathcal{B}}) \in \Gamma$ , any  $(t, j) \in \mathcal{B} \times \{1, \dots, c\}$ , we take  $\gamma_{t, j}$  as in Definition 2.69. Let  $C < +\infty$  be large enough such that  $C > C_{f_a}$  for any  $a \in CB_J$ , and take  $U_1 := U(R_1, 12C\widehat{K}\sigma)$  as in Proposition 2.44. Since (4.5), (4.6) are satisfied by (8.3), for small enough  $\sigma > 0$ , we can apply Proposition 2.44 to  $(f_a, K_0, C_1^\sharp, \frac{\kappa}{2}, V, \{\gamma_{t, j}\}_{t \in \mathcal{B}})$  in place of  $(f, L, C, \kappa, V, \{\gamma_{i, j}\}_{i=1}^L)$ , which concludes.  $\square$

**PROOF OF PROPOSITION 2.70:** Let  $R_1, \kappa_1 > 0$  be given by Lemma 2.71. Take any  $\vartheta > 0$ . We set  $K := 50^J$ . Then by applying Proposition 2.47 to  $r, J, \{f_a\}_a, K, \vartheta$  and to  $(R_1, \frac{1}{2}\tilde{h})$  in place of  $(R_0, h_0)$ , we obtain a compact set  $\Omega_1 \Subset CB_J$  and constants  $N_0 \in \mathbb{N}_{\geq 1}, \rho_0 \in (0, \frac{1}{2}\tilde{h}), \rho_1 \in (0, \rho_0), \sigma_0, \lambda_0 > 0$  satisfying the conclusion of Proposition 2.47. For sufficiently small  $\sigma > 0$ , we let  $\lambda_2 = \lambda_2(\rho_1, \sigma)$  be taken as in Lemma 2.71.

Let  $T > 0$  be some large integer such that  $\lambda := \frac{100}{T} < \min(\lambda_0, \lambda_2)$ , and set  $W_0 := (-\frac{1}{2T}, \frac{1}{2T})^J$ . We choose points  $\{a_1, \dots, a_{M_0}\} \subset \Omega_1$ ,  $M_0 \leq T^J$ , such that the collection  $\{W_i := a_i + 2W_0\}_{1 \leq i \leq M_0}$  forms an open cover of  $\Omega_1$ , and the cover multiplicity of  $\{a_i + 10W_0\}_{1 \leq i \leq M_0}$  is bounded by  $K$ .

Let  $\Theta: \mathbb{R}^J \rightarrow [0, 1]$  be a smooth function such that  $\Theta|_{2W_0} \equiv 1$  and  $\text{supp}(\Theta) \subset 3W_0$ . Let  $\Theta_i := \Theta(\cdot - a_i)$  for all  $1 \leq i \leq M_0$ , so that  $\text{supp}(\Theta_i) \subset a_i + 3W_0$ .

For each  $1 \leq i \leq M_0$ , we will inductively define a  $(\frac{1}{20}, 6)$ -spanning  $c$ -family for  $f_{a_i}$ , denoted by  $\mathcal{D}_i$ , in the following way. Assume that for some  $k \in \{1, \dots, M_0\}$ , and for all  $1 \leq i \leq k-1$ , we have defined  $\mathcal{D}_i$  satisfying

- (1)  $\mathcal{D}_i$  is a  $\sigma_0$ -sparse  $(\frac{1}{20}, 6)$ -spanning  $c$ -family for  $f_{a_i}$ ;
- (2)  $[\underline{x}(\mathcal{D}_i), \bar{r}(\mathcal{D}_i)] \subset (\rho_1, \rho_0)$ ;
- (3)  $n(\mathcal{D}_i) < N_0$ .

Note that it is always true for  $k = 1$ .

Let  $\{i_1, \dots, i_l\}$  be the set of all indices  $p \in \{1, \dots, k-1\}$  such that  $(a_p + 3W_0) \cap (a_k + 3W_0) \neq \emptyset$ . In particular,  $a_k \in (a_p + 10W_0)$ , hence  $l < K$ . Then we can apply Proposition 2.47 to obtain a spanning  $c$ -family for  $f_{a_k}$ , denoted by  $\mathcal{D}_k$ , such that (1), (2), (3) above are true for  $i = k$ . Moreover, for any  $1 \leq j \leq l$ ,  $(\mathcal{D}_{i_j}, \sigma_0)$  is disjoint from  $(\mathcal{D}_k, \sigma_0)$ , and for all  $a \in W_k \subset B(a_k, \lambda_0)$ , we have

$$\bullet R(f_a, (\mathcal{D}_k, \sigma_0), (\{\mathcal{D}_{i_j}\}_{j=1}^l, \sigma_0)) > R_1, \quad \bullet R_{\pm}(f_a, (\mathcal{D}_k, \sigma_0)) > R_1.$$

Having constructed  $\{\mathcal{D}_i\}_{1 \leq i \leq M_0}$ , we set  $I_k := n(\mathcal{D}_k)c \sum_{i=1}^c |\mathcal{B}_i|$  for each  $1 \leq k \leq M_0$ . Let  $\sigma'_{a_k} := \tilde{C}_{f_{a_k}}^{-\frac{1}{2}} \sigma$ , and let  $V^{(k)}: \mathbb{R}^{I_k} \times X \rightarrow TX$  be the infinitesimal  $C^r$  deformation defined as follows:

$$V^{(k)}(B, \cdot) := \sum_{C \in \mathcal{D}_k, i, j \in \{1, \dots, c\}, t \in \mathcal{B}_i} B_{C, i, t, j} V_{C, i, t, j}^{\sigma'_{a_k}}, \quad \forall B = (B_{C, i, t, j}) \in \mathbb{R}^{I_k}. \quad (9.3)$$

By Remark 2.66, for all sufficiently small  $\sigma > 0$ , we have  $\text{supp}_X(V^{(k)}) \subset (\mathcal{D}_k, \sigma_0)$ . Let  $I := \sum_{k=1}^{M_0} I_k$ . For any  $B = (B_k)_{k=1}^{M_0} \in \mathbb{R}^I$ , where  $B_k \in \mathbb{R}^{I_k}$  for each  $1 \leq k \leq M_0$ , we define a  $C^r$  map  $V: CB_J \times \mathbb{R}^I \times X \rightarrow TX$ :

$$V(a, B, \cdot) := \sum_{k=1}^{M_0} \Theta_k(a) V^{(k)}(B_k, \cdot). \quad (9.4)$$

By definition, the map  $V$  is linear in  $B$ . Given any  $a \in CB_J$ , let  $\{i_1, \dots, i_l\}$  be the set of indices  $p$  such that  $\Theta_p(a) \neq 0$ . Note that  $l \leq K$ . Moreover, by construction, we see that the sets  $(\mathcal{D}_{i_j}, \sigma_0)$  are mutually disjoint for  $j \in \{1, \dots, l\}$ , and

$$\text{supp}_X(V(a, B, \cdot)) \subset \bigsqcup_{j=1}^l (\mathcal{D}_{i_j}, \sigma_0). \quad (9.5)$$

By (9.4), for each  $B = (B_k)_{1 \leq k \leq M_0} \in \mathbb{R}^I$ , for any  $j \in \{1, \dots, l\}$ , we have

$$V(a, B, \cdot)|_{(\mathcal{D}_{i_j}, \sigma_0)} = \Theta_{i_j}(a) V^{(i_j)}(B_{i_j}, \cdot)|_{(\mathcal{D}_{i_j}, \sigma_0)}, \quad (9.6)$$

hence by (9.3), (9.5), and by Lemma 2.67, we deduce that

$$\sigma \|\partial_b \partial_x V\|_X + \|\partial_b V\|_X < \hat{C}_1. \quad (9.7)$$

Again, by the above construction, we see that

$$R_{\pm}(f_a, (\{\mathcal{D}_{i_j}\}_{j=1}^l, \sigma_0)) > R_1. \quad (9.8)$$

Let  $U_0$  be a small neighbourhood of the origin in  $\mathbb{R}^I$ , and for any  $(a, b) \in CB_J \times U_0$ , let  $\mathcal{F}_{V(a, b, \cdot)}: \mathbb{R} \times X \rightarrow X$  be the flow generated by  $V(a, b, \cdot)$ . We define

$$\hat{f}: \begin{cases} CB_J \times U_0 \times X & \rightarrow X, \\ (a, b, x) & \mapsto \mathcal{F}_{V(a, b, \cdot)}(1, f_a(x)). \end{cases} \quad (9.9)$$

It is clear that  $\hat{f}$  is  $C^r$ , and for each  $a \in CB_J$ ,  $\hat{f}(a, \cdot): U_0 \times X \rightarrow X$  is the  $C^r$  deformation of  $f_a$  generated by  $V(a, \cdot)$ . By (9.7), (9.9), and Lemma 2.27 (1), we obtain  $\|\hat{f}\|_{C^1} < Q$  for some  $Q > 0$  depending only on  $\{f_a\}_a$  and  $C_1^{\sharp}$ , after possibly reducing the size of  $U_0$ .

For each  $1 \leq k \leq M_0$ ,  $\mathcal{D}_k$  is a  $\sigma_0$ -sparse  $(\frac{1}{20}, 6)$ -spanning  $c$ -family for  $f_{a_k}$ , and by (9.6), for each  $B = (B_l)_{1 \leq l \leq M_0} \in \mathbb{R}^I$ , we see that  $V(a_k, B, \cdot)|_{(\mathcal{D}_k, \sigma_0)} = V^{(k)}(B_k, \cdot)|_{(\mathcal{D}_k, \sigma_0)}$ . Thus, by (9.3), (9.5), (9.7), (9.8), for all sufficiently small  $\sigma > 0$ , the assumptions of Lemma 2.71 are satisfied, hence the  $C^r$  deformation  $\hat{f}: CB_J \times U_1 \times X \rightarrow X$  is  $(\rho_1, \tilde{h}, \sigma, \tilde{C}_2, \kappa_1)$ -Removable at  $a$ , for any  $a \in W_k \subset B(a_k, \lambda_2)$ , where  $U_1 = U_1(\{f_a\}, \sigma, K_0, c, C_1^{\sharp}, \kappa) \subset U_0$ . Let  $\Omega_0 := \bigcup_{k=1}^{M_0} W_k$ . Then  $\hat{f}$  is  $(\rho_1, \tilde{h}, \sigma, \tilde{C}_2, \kappa_1)$ -Removable at  $a$  for all  $a \in \Omega_0$ . By our choices of  $\{a_i\}$ , we also have  $\Omega_1 \subset \Omega_0$ , which implies  $\text{Leb}(CB_J \setminus \Omega_0) < \vartheta$ . This concludes the proof.  $\square$

**9.2. Getting accessibility by perturbation.** In the rest of this section, we fix a map  $f_0 \in \mathcal{PH}^r(X, \text{Vol})$  with  $c := \dim(E_{f_0}^c) \geq 2$ , which is dynamically coherent, center bunched and satisfies (ae) or (be).

Let  $f \in \mathbb{U}(f_0) \cap \text{Diff}^r(X, \text{Vol})$  ( $\mathbb{U}(f_0)$  is defined in Notation 4), and let  $\mathcal{C}$  be a  $c$ -disk of  $f$  with radius  $h$  in  $(0, \bar{h}_f)$ . We let  $\phi = \phi(\mathcal{C})$  be the chart given by Notation 5. Let  $\hat{f}: U \times X \rightarrow X$  be a  $C^r$  deformation at  $(a, f)$ , and set  $T = T(\hat{f})$ . Then for  $C > 0$ ,  $\sigma \in (0, \frac{\bar{\sigma}_f}{2})$ ,  $x \in \mathcal{C}$ , and  $\gamma$ , a  $(\sigma, C)$ -regular continuous family of  $f$ -loops at  $x$ , let  $\hat{\gamma}$  be given by (7.2), and let  $\hat{\psi}$  be given by (7.3). Moreover, for all sufficiently small  $\sigma > 0$ , we have  $\pi_X \hat{\psi}(b, y, s) \in \phi((-h, h)^d)$  for all  $(b, y, s) \in \mathcal{W}_T^c((a, x), \bar{\delta}_{a,T}) \times [-1, 2]^c$ , thus we can define

$$\Phi: \begin{cases} \mathcal{W}_T^c((a, x), \bar{\delta}_{a,T}) \times [-1, 2]^c & \rightarrow \mathbb{R}^c, \\ (b, y, s) & \mapsto \Pi_c \phi^{-1} \pi_X \hat{\psi}(b, y, s), \end{cases} \quad (9.10)$$

where we denote by  $\Pi_c: \mathbb{R}^d \simeq \mathbb{R}^c \times \mathbb{R}^{d_u} \times \mathbb{R}^{d_s} \rightarrow \mathbb{R}^c$  the canonical projection.

**Lemma 2.72.** *Let  $f, \hat{f}, \mathcal{C}, \gamma, \hat{\psi}$  be as above. Then there exist  $C^2$ -uniform constants  $\widehat{C}_0 = \widehat{C}_0(f) > 0$ ,  $\theta_0 = \theta_0(f_0) \in (\frac{c-1}{c}, 1)$  such that, after possibly reducing the size of  $U$ , the following is true:*

- (1)  $\forall s \in [-1, 2]^c$ , the map  $(b, y) \mapsto \Phi(b, y, s)$  is  $C^1$ , and  $D\Phi(b, y, s)$  is uniformly continuous, uniformly bounded by  $\widehat{C}_0$ ;
- (2)  $\forall (b, y) \in \mathcal{W}_T^c((0, x), \bar{\delta}_{a,T})$ ,  $s \mapsto \Phi(b, y, s)$  has  $\theta_0$ -Hölder norm less than  $\widehat{C}_0$ .

PROOF. Point (1) follows from the fact that  $f$  is  $C^2$ , center bunched, and Lemma 2.33. Point (2) follows from Lemma 2.62.  $\square$

The main technical result of this section is the following. It provides estimates on the volume of “bad” parameters under some removability condition.

**Proposition 2.73.** *Let  $\{f_a\}_{a \in CB_J}$  be a good  $C^r - J$ -family in  $\mathbb{U}(f_0) \cap \text{Diff}^r(X, \text{Vol})$ . For any  $Q, C, \kappa_1 > 0$ , any sufficiently small  $h > 0$ ,  $\rho_1 \in (0, h)$ , and for all sufficiently small  $\sigma > 0$ , the following is true: assume that there exist*

- an open set  $\Omega_0$  satisfying  $\overline{\Omega_0} \Subset CB_J$ ;
- and integer  $I > 0$ ;
- an open neighbourhood  $U_1$  of the origin in  $\mathbb{R}^I$ ;
- a  $C^r$  map  $\hat{f}: CB_J \times U_1 \times X \rightarrow X$

such that

- $\hat{f}(a, 0, \cdot) = f_a$ , for all  $a \in CB_J$ ;
- $\|\hat{f}\|_{C^1} < Q$ ;
- $\hat{f}$  is  $(\rho, h, \sigma, C, \kappa_1)$ -Removable at  $a$ , for all  $a \in \Omega_0$ .

Then for any sufficiently small  $\epsilon > 0$ , any sufficiently small  $\delta > 0$ , there exists a subset  $\mathcal{E} = \mathcal{E}(\epsilon, \delta) \subset \Omega_0 \times U_1$  of “bad” elements in the parameter space such that

- (1)  $\text{Leb}(\mathcal{E}) < \delta$ ;
- (2) for any  $(a, b) \in (\Omega_0 \times (U_1 \cap B(0, \epsilon))) \setminus \mathcal{E}$ ,  $\hat{f}(a, b, \cdot)$  is  $C^1$ -stably accessible.

PROOF. In the following, we take  $\theta = \theta_0(f_0)$  as in Lemma 2.72, and set  $K_0 := K_0(c, \theta)$  as in (6.1). By Lemma 2.72,  $\theta > \frac{c-1}{c}$  and thus  $K_0 \geq 2$ .

Let  $\hat{f}, Q, C, \kappa_1, h, \rho_1, \sigma$  be as in the proposition. Let  $T: CB_J \times U_1 \times X \rightarrow CB_J \times U_1 \times X$  be the  $C^r$  map  $T: (a, b, x) \mapsto (a, b, \hat{f}(a, b, x))$ .

For any  $a \in \Omega_0$ ,  $\hat{f}$  can be regarded as a  $C^r$  deformation at  $((a, 0), f_a)$  with  $J + I$  parameters. Let  $\nu_{a,0}(x, \cdot): \mathbb{R}^{J+I} \rightarrow E_{f_a}^{su}(x)$  be the (unique) linear map given by Lemma 2.34. On the other hand,  $\hat{f}(a, \cdot)$  can be regarded as a  $C^r$  deformation at  $(0, f_a)$  with  $I$  parameters. Set  $T_a := T(\hat{f}(a, \cdot))$  and let  $\nu_a^I(x, \cdot): \mathbb{R}^I \rightarrow E_{f_a}^{su}(x)$  be the unique linear

map satisfying (9.1) for  $b = 0$ . It is direct to see that  $\nu_0^a(x, B) = \nu_{a,0}(x, \{0\}^J \times B)$  for all  $x \in X, B \in \mathbb{R}^I$ . In the following we tacitly use the inclusion  $\mathbb{R}^I \subset \{0\}^J \times \mathbb{R}^I$  and for any  $B \in \mathbb{R}^I$ , we abbreviate  $\nu_{a,0}(x, \{0\}^J \times B)$  as  $\nu_{a,0}(x, B)$ .

Let  $a \in \Omega_0$  be fixed. By the hypothesis of  $(\rho_1, h, \sigma, C, \kappa_1)$ -Removability, we can choose  $\mathcal{D} = \mathcal{D}(a)$ , a  $(\frac{1}{20}, 8)$ -spanning  $c$ -family for  $f_a$ , and for any  $\mathcal{C} \in \mathcal{D}$ , any  $x \in \frac{1}{10}\mathcal{C}$ , we let  $\gamma = \gamma(a, x)$  be a  $(\sigma, C)$ -regular continuous family of  $f_a$ -loops at  $x$ . By compactness, we can fix a small constant  $\bar{\delta} > 0$  such that  $\bar{\delta} < \min(\bar{\delta}_{(a',0),T}, \bar{\delta}_{0,T_{a'}})$  for all  $a' \in \Omega_0$ , where  $\bar{\delta}_{(a',0),T}, \bar{\delta}_{0,T_{a'}}$  are given by Definition 2.61. Let  $\hat{\gamma}$  be the lift of  $\gamma$  for  $T$ , and let  $\Phi: \mathcal{W}_T^c((a, 0, x), \bar{\delta}) \times [-1, 2]^c \rightarrow \mathbb{R}^c$  be the map associated to  $\hat{\gamma}$  and  $T$  as in (9.10). For each  $(i, \mathcal{B}, \{s_t\}_{t \in \mathcal{B}}) \in \Gamma$ , set

$$\Psi = \Psi_{a, \mathcal{C}, x, i, \mathcal{B}, \{s_t\}}: \begin{cases} \mathcal{W}_T^c((a, 0, x), \bar{\delta}) & \rightarrow \mathbb{R}^{K_0 c}, \\ (a', b', y) & \mapsto (\Phi(a', b', y, s_t))_{t \in \mathcal{B}}. \end{cases} \quad (9.11)$$

Differentiating  $\Psi$  at  $(a, 0, x)$ , we obtain for each  $B \in \mathbb{R}^I$ :

$$\begin{aligned} D\Psi((a, 0, x), B + \nu_{a,0}(x, B)) &= (D\Phi((a, 0, x, s_t), B + \nu_{a,0}(x, B)))_{t \in \mathcal{B}} \\ &= (\Pi_c D\phi^{-1} \pi_X D(\prod_{j=1}^c H_{T, \hat{\gamma}_{t,j}})(B + \nu_{a,0}(x, B)))_{t \in \mathcal{B}}. \end{aligned}$$

Let  $\tilde{\gamma}_{t,j}$  be the lift of  $\gamma_{t,j}$  for  $T_a$ . Then by definition and by Lemma 2.37, we obtain

$$\pi_X D(\prod_{j=1}^c H_{T, \hat{\gamma}_{t,j}})(B + \nu_{a,0}(x, B)) = \pi_c D(\prod_{j=1}^c H_{T_a, \tilde{\gamma}_{t,j}})(B + \nu_0^a(x, B)) + \nu_0^a(z, B),$$

where we have set  $z := \prod_{j=1}^c H_{f_a, \gamma_{t,j}}(x)$ .

Let  $\zeta > 0$  be a small constant to be determined. Let  $h > 0$  be sufficiently small such that for any  $a' \in CB_J$ , we have  $h < \bar{h}_{f_{a'}, \zeta}$  (as in Notation 5). Then by Lemma 2.34, there exists a constant  $D_1 > 0$  depending only on  $\{f_{a'}\}_{a'}$  such that for any  $B \in \mathbb{R}^I$ ,

$$\|\Pi_c D\phi^{-1} \nu_0^a(z, B)\| \leq D_1 \zeta Q \|B\|. \quad (9.12)$$

By  $(\rho_1, h, \sigma, C, \kappa_1)$ -Removability at  $a$ , there exists a linear subspace  $H \subset \mathbb{R}^I$  of dimension  $K_0 c$  such that

$$|\det(H \ni B \mapsto \pi_c D(\prod_{j=1}^c H_{T_a, \tilde{\gamma}_{t,j}})(B + \nu_0^a(x, B)))_{t \in \mathcal{B}}| > \kappa_1. \quad (9.13)$$

Then by (9.12), we can choose  $\zeta > 0$  to be sufficient small, depending only on  $(Q, \kappa_1, \{f_{a'}\}_{a' \in CB_J})$ , such that for some constant  $D_2 > 0$  depending only on  $\{f_{a'}\}_{a' \in CB_J}$ ,

$$|\det(H \ni B \mapsto D\Psi((a, 0, x), B + \nu_{a,0}(x, B)) \in \mathbb{R}^{K_0 c})| > D_2^{-1} \kappa_1.$$

Now, by Lemma 2.72 and the pre-compactness of  $\Omega_0$ ,  $D\Psi$  is uniformly continuous, with norms uniformly bounded for all choices of  $a, \mathcal{C}, x, i, \mathcal{B}, \{s_t\}$ . Then, by possibly reducing the size of  $\bar{\delta}$  independently of the choices of  $a, \mathcal{C}, x, i, \mathcal{B}, \{s_t\}$ , we can assume that for any  $(a', b', y) \in \mathcal{W}_T^c((a, 0, x), \bar{\delta})$ , there exists a subspace  $H' \subset T_{a', b'}(\Omega_0 \times U_1)$  of dimension  $K_0 c$  such that

$$|\det(D\Psi(a', b', y)|_{H'})| > \frac{1}{2} D_2^{-1} \kappa_1. \quad (9.14)$$

By compactness, for any  $\mathcal{C} \in \mathcal{D}$ , we can choose a finite set  $\mathcal{A}(a, \mathcal{C}) \subset \frac{1}{10}\mathcal{C}$  such that

$$\mathcal{V}(a, \mathcal{C}) := \bigcup_{x \in \mathcal{A}(a, \mathcal{C})} \mathcal{W}_T^c((a, 0, x), \bar{\delta}) \quad (9.15)$$

is an open neighbourhood of  $\{a\} \times \{0\} \times \mathcal{C}$  in  $\mathcal{W}_T^c$ . By Lemma 2.32 and by compactness, there exists a constant  $\delta_0 > 0$  (independent of the choices of  $a, \mathcal{C}, x, i, \mathcal{B}, \{s_t\}$ ) such that for any  $(a', b') \in B(a, \delta_0) \times (U_1 \cap B(0, \delta_0))$ , there exists  $\mathcal{D}'$ , a  $(\frac{1}{15}, 10)$ -spanning  $c$ -family for  $\hat{f}(a', b', \cdot)$ , such that for any  $\mathcal{C}' \in \mathcal{D}'$ ,  $\{a'\} \times \{b'\} \times \frac{1}{10}\mathcal{C}' \subset \mathcal{V}(a, \mathcal{C})$  for some  $\mathcal{C} \in \mathcal{D}$ . Without loss of generality, we assume that  $U_1 \subset B(0, \delta_0)$  and we set  $\mathcal{U}(a) := B(a, \delta_0) \times U_1$ .

Now, by the pre-compactness of  $\Omega_0$ , we can find a finite set  $\mathcal{K} \subset \Omega_0$  such that

$$\Omega_0 \times U_1 \subset \cup_{a \in \mathcal{K}} \mathcal{U}(a). \quad (9.16)$$

By (6.1) we have  $\frac{\theta(cK_0 - 2c - 1)}{(c-1)K_0} > 1$ . Let  $\beta \in (0, \min(\frac{\theta(cK_0 - 2c - 1)}{(c-1)K_0} - 1, 1))$ , so that  $-(c-1)K_0 \frac{1+\beta}{\theta} + cK_0 - 2c > 1$ . Then, choose  $\eta > 0$  small enough such that

$$v := -K_0 \frac{1+\beta}{\theta} (c-1) + K_0 c - 2c - (K_0 + 1)\eta - 1 > 0. \quad (9.17)$$

For any sufficiently small  $\delta > 0$ , for each  $i \in \{1, \dots, c\}$ , for any  $t \in \mathcal{B}_i$ , let  $\mathcal{N}_{t,i}$  be a  $\delta^{\frac{1+\beta}{\theta}}$ -net in  $[-1, 2]^{i-1} \times \{t\} \times [-1, 2]^{c-i}$  such that  $|\mathcal{N}_{t,i}| < \delta^{-\frac{1+\beta}{\theta}(c-1) - \eta}$ .

We denote by  $\Sigma$  the diagonal of  $(\mathbb{R}^c)^{K_0} \simeq \mathbb{R}^{K_0 c}$ , that is,

$$\Sigma := \{(y, \dots, y) \in \mathbb{R}^{K_0 c} \mid y \in \mathbb{R}^c\}, \quad (9.18)$$

and for any  $\delta > 0$ , we let  $\Sigma_\delta$  be the  $\delta$ -neighbourhood of  $\Sigma$  defined by

$$\Sigma_\delta := \{(y_i)_{1 \leq i \leq K_0} \in (\mathbb{R}^c)^{K_0} \mid \exists y \in \mathbb{R}^c, |y_i - y| < \delta, \forall 1 \leq i \leq K_0\}.$$

Given any  $a \in \mathcal{K}$ ,  $\mathcal{C} \in \mathcal{D}$ ,  $x \in \mathcal{A}(a, \mathcal{C})$  and  $(i, \mathcal{B}, \{s_t\}_{t \in \mathcal{B}}) \in \Gamma$ , let  $\mathcal{D} = \mathcal{D}(a)$  be the  $(\frac{1}{10}, 8)$ -spanning  $c$ -family for  $f_a$  given above and set  $\Psi := \Psi_{a, \mathcal{C}, x, i, \mathcal{B}, \{s_t\}}$ . By (9.14), the map  $D\Psi$  is a submersion from  $\mathcal{W}_T^c((a, 0, x), \bar{\delta})$  to its image, and is uniformly transverse to  $\Sigma$ , i.e., whenever  $w = (a', b', y) \in \mathcal{W}_T^c((a, 0, x), \bar{\delta}) \cap \Psi^{-1}(\Sigma)$ ,

$$T_{\Psi(w)}\Sigma + D\Psi(T_w \mathcal{W}_T^c((a, 0, x), \bar{\delta})) \simeq \mathbb{R}^{K_0 c}.$$

Therefore,  $\Psi_{a, \mathcal{C}, x, i, \mathcal{B}, \{s_t\}}^{-1}(\Sigma)$  is a submanifold of  $\mathcal{W}_T^c((a, 0, x), \bar{\delta})$  of dimension <sup>7</sup>  $J + I + 2c - K_0 c$ . Besides, by uniform transversality, there exists  $\delta_1 > 0$  independent of the choice of  $a, \mathcal{C}, x, i, \mathcal{B}, \{s_t\}$  such that for any  $0 < \delta < \delta_1$ , we have

$$\mathcal{N}(\Psi_{a, \mathcal{C}, x, i, \mathcal{B}, \{s_t\}}^{-1}(\Sigma_\delta), \delta) < \delta^{K_0 c - 2c - I - J - \eta}, \quad (9.19)$$

where we denote by  $\mathcal{N}(\mathcal{S}, \delta)$  the minimal number of  $\delta$ -balls required to cover a set  $\mathcal{S}$ .

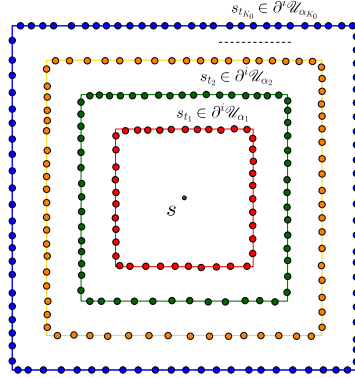

For any  $0 < \delta < \delta_1$ , let  $\mathcal{E} = \mathcal{E}(\delta)$  be the subset of “bad” parameters in the space  $CB_J \times U_1$ :

$$\mathcal{E} := \bigcup_{\substack{a \in \mathcal{K}, \mathcal{C} \in \mathcal{D}, \\ x \in \mathcal{A}(a, \mathcal{C}), \\ (i, \mathcal{B}, \{s_t\}_{t \in \mathcal{B}}) \in \Gamma \text{ s.t. } \forall t \in \mathcal{B}, s_t \in \mathcal{N}_{t,i}}} \pi_{CB_J \times U_1}(\Psi_{a, \mathcal{C}, x, i, \mathcal{B}, \{s_t\}}^{-1}(\Sigma_\delta)). \quad (9.20)$$

7. See Theorem 3.3 of [15]; by transversality,  $\Psi^{-1}(\Sigma) \subset \mathcal{W}_T^c((a, 0, x), \bar{\delta})$  has same codimension as  $\Sigma$  in  $\mathbb{R}^{K_0 c}$ . Here, transversality is w.r.t. the parameter  $b'$ , and by (9.14), it is uniform in variables  $a, x$ , which gives a uniform bound in (9.19) on the number of balls needed to cover  $\Psi^{-1}(\Sigma_\delta)$ .



Since in the above collection, only the last item,  $\mathcal{N}_{t,i}$ , depends on  $\delta$ , there exists a constant  $D_3 > 0$  such that for any  $0 < \delta < \delta_1$ ,

$$\mathcal{N}(\mathcal{E}, \delta) < D_3 \delta^{-K_0 \frac{1+\beta}{\theta} (c-1) - K_0 \eta} \delta^{K_0 c - 2c - I - J - \eta} = (D_3 \delta^v) \delta^{-I - J + 1}.$$

By (9.17), there exists  $0 < \delta_2 < \delta_1$  such that  $D_3 \delta_2^v < 1$ . We deduce that  $\text{Leb}(\mathcal{E}) \leq \delta^{J+I} \mathcal{N}(\mathcal{E}, \delta) < \delta$  for all  $0 < \delta < \delta_2$ , which concludes the proof of (1).

Now we claim that for all sufficiently small  $\epsilon > 0$ , all sufficiently small  $\delta > 0$ ,  $\mathcal{E} = \mathcal{E}(\epsilon, \delta)$ , and any  $(a, b) \in (\Omega_0 \times (U_1 \cap B(0, \epsilon))) \setminus \mathcal{E}$ ,  $\hat{f}(a, b, \cdot)$  is  $C^1$ -stably accessible.

Indeed, by (9.16), for any  $(a, b) \in (\Omega_0 \times (U_1 \cap B(0, \epsilon))) \setminus \mathcal{E}$ , there exists  $a_0 \in \mathcal{K}$  such that  $(a, b) \in \mathcal{U}(a_0)$ . Let  $\mathcal{D}_0 = \mathcal{D}(a_0)$ . Then by the definition of  $\mathcal{U}(a_0)$ , there exists a  $(\frac{1}{15}, 10)$ -spanning  $c$ -family for  $\hat{f}(a, b, \cdot)$ , denoted by  $\mathcal{D}$ , such that for each  $\mathcal{C} \in \mathcal{D}$ , there exists  $\mathcal{C}_0 \in \mathcal{D}_0$  such that  $\{a\} \times \{b\} \times \frac{1}{10}\mathcal{C} \subset \mathcal{V}(a_0, \mathcal{C}_0)$ . Then for each  $x \in \frac{1}{10}\mathcal{C}$ , by (9.15), there exists  $x_0 \in \mathcal{A}(a_0, \mathcal{C}_0)$ , such that  $(a, b, x) \in \mathcal{W}_T^c((a_0, 0, x_0), \bar{\delta})$ .

**Claim.** For any  $(i, \mathcal{B}, \{s_t\}_{t \in \mathcal{B}}) \in \Gamma$ , take  $\Psi := \Psi_{a_0, \mathcal{C}_0, x_0, i, \mathcal{B}, \{s_t\}}$  as in (9.11). Then,  $\Psi(a, b, x) \notin \Sigma$ , where  $\Sigma$  denotes the diagonal as in (9.18).

PROOF. Indeed, for any  $(i, \mathcal{B}, \{s_t\}_{t \in \mathcal{B}}) \in \Gamma$ , there exists  $\{w_t\}_{t \in \mathcal{B}}$  such that  $w_t \in \mathcal{N}_{t,i}$  and  $|s_t - w_t| < \delta^{\frac{1+\beta}{\theta}}$  for all  $t \in \mathcal{B}$ . Since  $(a, b) \notin \mathcal{E}$ , and by (9.20), there exist  $t, t' \in \mathcal{B}$  such that  $|\Phi(a, b, x, w_t) - \Phi(a, b, x, w_{t'})| > \delta$ , where  $\Phi$  is defined as in (9.10) for  $((a_0, 0), x_0)$  in place of  $(a, x)$ . By Lemma 2.72, we get

$$|\Phi(a, b, x, w_t) - \Phi(a, b, x, s_t)| < D_4 \delta^{1+\beta}, \quad |\Phi(a, b, x, w_{t'}) - \Phi(a, b, x, s_{t'})| < D_4 \delta^{1+\beta}$$

for some constant  $D_4 > 0$  independent of  $\delta$ . The claim follows, since for sufficiently small  $\delta > 0$ , we then have

$$|\Phi(a, b, x, s_t) - \Phi(a, b, x, s_{t'})| > \delta - 2D_4 \delta^{1+\beta} > 0.$$

□

Let  $\gamma_0$  be the  $(\sigma, C)$ -regular continuous  $f_{a_0}$ -loops at  $x_0$  associated to  $(a_0, x_0)$ . Since  $\bar{\delta} < \bar{\delta}_{(a_0, 0), T} < \delta_{(a_0, 0), T}$  and  $(a, b, x) \in \mathcal{W}_T^c((a_0, 0, x_0), \bar{\delta})$ , let  $\gamma_{a, b, x}$  be the continuous family of  $\hat{f}(a, b, \cdot)$ -loops at  $x$  associated to  $\gamma_0$  according to Definition 2.61. By (7.3), (7.4), (9.10), we see that  $\hat{f}(a, b, \cdot)$  satisfies  $(\mathcal{P})$  for  $\mathcal{D}$ ,  $\{\gamma_{a, b, x}\}_{x \in \frac{1}{10}\mathcal{C}, \mathcal{C} \in \mathcal{D}}$  and  $\psi = \psi(\hat{f}(a, b, \cdot), x, \gamma_{a, b, x})$  as in (7.1). Thus, (2) follows from Corollary 2.59. □

Combining Propositions 2.70 and 2.73, we are ready to prove Theorem F.

PROOF OF THEOREM F. We only detail the volume-preserving case, for the proof of the other one follows the same line, replacing  $\text{Diff}^r(X, \text{Vol})$  by  $\text{Diff}^r(X)$ .

By Notation 1, for any map  $f$  in Theorem F,  $f$  is dynamically coherent, center bunched, with  $c := \dim(E_f^c) \geq 2$ , and satisfies  $(ae)$  or  $(be)$ . Set  $\mathcal{U} := \mathbb{U}(f) \cap \text{Diff}^r(X, \text{Vol})$ , and let  $\{f_a\}_{a \in [0, 1]^J}$  be a good  $C^r - J$ -family of diffeomorphisms in  $\mathcal{U}$ . Without loss of generality, we can assume that  $\{f_a\}_{a \in [0, 1]^J}$   $C^r$ -extends to an open neighbourhood of  $[0, 1]^J$ . Then, by Proposition 2.70 and Proposition 2.73, for any  $\vartheta > 0$ , there exist an open set  $\Omega_0 \subset [0, 1]^J$  with  $\text{Leb}([0, 1]^J \setminus \Omega_0) < \vartheta$ , an open neighbourhood of the origin in  $\mathbb{R}^I$ , denoted by  $U_1$ , and a  $C^r$  map  $\hat{f}: [0, 1]^J \times U_1 \times X \rightarrow X$  s.t. for all sufficiently small  $\epsilon > 0$  and for all sufficiently small  $\delta > 0$ , there exists  $\mathcal{E} \subset \Omega_0 \times U_1$  such that  $\text{Leb}(\mathcal{E}) < \delta$  and  $\hat{f}(a, b, \cdot)$  is  $C^1$ -stably accessible for all  $(a, b) \in (\Omega_0 \times (U_1 \cap B(0, \epsilon))) \setminus \mathcal{E}$ . Given  $\epsilon > 0$  arbitrarily small, let  $\delta \in (0, \epsilon^I \vartheta)$  and  $\mathcal{E} = \mathcal{E}(\epsilon, \delta)$  be as above, and for all  $b \in U_1$ , set  $\mathcal{E}^b := \mathcal{E} \cap (\Omega_0 \times \{b\})$ . Then, by Fubini's theorem, there exists  $b \in U_1 \cap B(0, \epsilon)$  such that

$$\text{Leb}(\left([0, 1]^J \setminus \Omega_0\right) \times \{b\} \cup \mathcal{E}^b) \lesssim \text{Leb}([0, 1]^J \setminus \Omega_0) + \epsilon^{-I} \text{Leb}(\mathcal{E}) \lesssim 2\vartheta. \quad (9.21)$$

For any integer  $n \geq 1$ , we consider the following collection of  $C^r - J$ -families in  $\mathcal{U}$ :

$$\mathcal{F}_n := \left\{ \{f_a\}_{a \in [0, 1]^J} \in C^r([0, 1]^J, \mathcal{U}) \mid \text{the set of } a \in [0, 1]^J \text{ such that } f_a \text{ is not } C^1\text{-stably accessible has measure less than } \frac{1}{n} \right\}.$$

It follows from Proposition 2.12 and (9.21) above that for any  $n \geq 1$ , the set  $\bigcup_{m \geq n} \mathcal{F}_m$  is  $C^1$ -open and  $C^r$ -dense in the space  $C^r([0, 1]^J, \mathcal{U})$ . In particular,

$$\mathcal{G} := \bigcap_{n \geq 1} \bigcup_{m \geq n} \mathcal{F}_m$$

is residual, and by definition, for any  $\{f_a\}_{a \in [0, 1]^J} \in \mathcal{G}$ , the set of  $a \in [0, 1]^J$  such that  $f_a$  is not  $C^1$ -stably accessible has measure zero. This concludes the proof.  $\square$

### Appendix A

PROOF OF LEMMA 2.27. Let  $V: \mathbb{R}^I \times X \rightarrow TX$  be a  $C^r$  vector field as in Definition 2.26, and let  $U \subset \mathbb{R}^I$  be a small neighbourhood of the origin. We let  $\mathcal{F}: \mathbb{R} \times U \times X \rightarrow X$  be the associate flow; it is defined by the following equation:

$$\partial_t \mathcal{F}(t, b, x) = V(b, \mathcal{F}(t, b, x)), \quad (9.22)$$

with initial condition  $\mathcal{F}(0, b, x) = f(x)$ . For any  $(s, b, x) \in \mathbb{R} \times U \times X$ , we have

$$\begin{aligned} \bullet \partial_b \mathcal{F}(0, b, x) &= 0, & \bullet \partial_b^2 \mathcal{F}(0, b, x) &= \partial_b \partial_x \mathcal{F}(0, b, x) = 0, \\ \bullet \partial_x \mathcal{F}(0, b, x) &= \partial_x f(x), & \bullet \partial_x^2 \mathcal{F}(0, b, x) &= \partial_x^2 f(x), \\ \bullet \hat{f}(b, x) &= \mathcal{F}(1, b, x), & \bullet f(x) &= \mathcal{F}(s, 0, x). \end{aligned}$$

By differentiating (9.22), we obtain the following equations:

$$\begin{aligned} \partial_t \partial_x \mathcal{F} &= \partial_x V \partial_x \mathcal{F}, & \partial_t \partial_b \mathcal{F} &= \partial_b V + \partial_x V \partial_b \mathcal{F}, \\ \partial_t \partial_x^2 \mathcal{F} &= \partial_x^2 V (\partial_x \mathcal{F}, \partial_x \mathcal{F}) + \partial_x V \partial_x^2 \mathcal{F}, \\ \partial_t \partial_b \partial_x \mathcal{F} &= \partial_b \partial_x V (\partial_b, \partial_x \mathcal{F}) + \partial_x^2 V (\partial_x \mathcal{F}, \partial_b \mathcal{F}) + \partial_x V \partial_b \partial_x \mathcal{F}, \\ \partial_t \partial_b^2 \mathcal{F} &= \partial_b^2 V + 2 \partial_b \partial_x V (\partial_b, \partial_b \mathcal{F}) + \partial_x^2 V (\partial_b \mathcal{F}, \partial_b \mathcal{F}) + \partial_x V \partial_b^2 \mathcal{F}. \end{aligned}$$

By a slight abuse of notations, we use  $\|\cdot\|$  to denote the uniform norm for:

- derivatives of  $f$ ,  $\partial_b V$  and  $\partial_b \partial_x V$  as functions defined on  $X$ ;
- derivatives of  $\hat{f}$  and  $V$  as functions defined on  $U \times X$ ;
- derivatives of  $\mathcal{F}$  as functions defined on  $[0, 1] \times U \times X$ .

To prove (1), we need to bound the norms of  $\partial_x^2 \mathcal{F}(1, b, x)$ ,  $\partial_b \partial_x \mathcal{F}(1, b, x)$ ,  $\partial_b^2 \mathcal{F}(1, b, x)$  for  $b \in U, x \in X$ . It is clear that by reducing the size of  $U$ , we can assume that  $\|\partial_x V\| < \frac{1}{10}$ . Then by Grönwall's inequality and possibly reducing the size of  $U$ , there exists an absolute constant  $c_0 > 0$  such that

$$\|\partial_x \mathcal{F}\| < c_0 \max(1, \|\partial_x f\|), \quad \|\partial_b \mathcal{F}\| < c_0 \|\partial_b V\|_X.$$

Since  $B \mapsto V(B, \cdot)$  is linear,  $\partial_b^2 V \equiv 0$ , hence by Grönwall's inequality, there exists an absolute constant  $c_1 > 0$  such that

$$\begin{aligned} \|\partial_x^2 \mathcal{F}\| &\leq \|\partial_x^2 f\| + c_0 \|\partial_x^2 V\| \|\partial_x \mathcal{F}\|^2 \\ &\leq \|\partial_x^2 f\| + c_1 \|\partial_x^2 V\| \max(1, \|\partial_x f\|^2). \\ \|\partial_b \partial_x \mathcal{F}\| &\leq c_0 (\|\partial_b \partial_x V\| \|\partial_x \mathcal{F}\| + \|\partial_x^2 V\| \|\partial_x \mathcal{F}\| \|\partial_b \mathcal{F}\|_{[0, 1] \times U \times X}) \\ &\leq c_1 (\|\partial_b \partial_x V\| + \|\partial_x^2 V\| \|\partial_b V\|_X) \max(1, \|\partial_x f\|). \\ \|\partial_b^2 \mathcal{F}\| &\leq c_0 (\|\partial_b \partial_x V\| \|\partial_b \mathcal{F}\| + \|\partial_x^2 V\| \|\partial_b \mathcal{F}\|^2) \\ &\leq c_1 (\|\partial_b \partial_x V\| \|\partial_b V\| + \|\partial_x^2 V\| \|\partial_b V\|^2). \end{aligned}$$

Note that by possibly reducing the size of  $U$  (depending only on  $\|\partial_x^2 V(0, \cdot)\|$ ,  $\|f\|_{C^1}$ ,  $\|\partial_b V\|$ ), we can ensure that  $\|\partial_x^2 V\| < \min(\max(1, \|\partial_x f\|^2)^{-1}, \|\partial_b V\|^{-2})$ . Thus there exists an absolute constant  $c_2 > 0$  such that

$$\|\hat{f}\|_{C^2} \leq \|\mathcal{F}(1, \cdot)\|_{C^2} < c_2 (1 + \|\partial_b \partial_x V\|) (1 + \|f\|_{C^2} + \|\partial_b V\|).$$

We conclude the proof of (1) by noticing that  $\|D^2 T\| \lesssim \|\hat{f}\|_{C^2(U \times X)}$ .



To prove (2), we remark that

$$\pi_X DT((0, x), B) = \partial_b \hat{f}((0, x), B) = \partial_b \mathcal{F}((1, 0, x), B) = \int_0^1 \partial_t \partial_b \mathcal{F}((s, 0, x), B) ds.$$

Then we conclude

$$\begin{aligned} \|\partial_b \mathcal{F}((1, 0, x), B) - V(B, f(x))\| &= \left\| \int_0^1 \partial_t \partial_b \mathcal{F}((s, 0, x), B) - \partial_b V(B, \mathcal{F}(s, 0, x)) ds \right\| \\ &\leq \|\partial_x V\| \|\partial_b V\| \|B\| \leq \text{diam}(U) \|\partial_b \partial_x V\| \|\partial_b V\| \|B\|. \end{aligned}$$

□

## Appendix B

**PROOF OF THEOREM 2.51.** Recall that the order of a cover  $\mathcal{O} = \{O_k\}_{k \in K}$  is the supremum of all numbers  $\#K'$  such that  $\cap_{k \in K'} O_k \neq \emptyset$ . Let then  $\mathcal{V}_0$  be a cover of  $X := [0, 1]^n$  such that  $\mathcal{V}_0$  does not admit an open refinement of order less than or equal to  $n$ . Take  $\delta > 0$  a Lebesgue number of the cover  $\mathcal{V}_0$  and define  $\epsilon := \delta/2$ .

Assume that  $f: X \rightarrow Y$  is  $\epsilon$ -light. Let  $T$  be some triangulation of  $Y$  and denote by  $\mathcal{U} = \{U_i\}_{i \in I}$  its open star cover. For every  $i \in I$ ,  $f^{-1}(U_i)$  can be written as a disjoint union of connected open sets; their collection is an open cover of  $X$ , denoted by  $\mathcal{V} = \{V_j\}_{j \in J}$ . For each  $j \in J$ , we let  $\alpha(j) \in I$  be such that  $V_j \subset f^{-1}(U_{\alpha(j)})$ . By assumption,  $f$  is  $\epsilon$ -light, hence we can choose  $T$  fine enough such that each  $V_j$  has diameter smaller than  $2\epsilon = \delta$ . Therefore  $\mathcal{V}$  is an open refinement of  $\mathcal{V}_0$ ; in particular, any open refinement of  $\mathcal{V}$  has order at least  $n + 1$ .

We define  $\text{Ner}(\mathcal{U})$  as the collection of subsets  $I' \subset I$  such that  $\cap_{i \in I'} U_i \neq \emptyset$ . We define  $\text{Ner}(\mathcal{V})$  in a similar way. Both  $\text{Ner}(\mathcal{U})$  and  $\text{Ner}(\mathcal{V})$  are simplicial  $n$ -complexes, and we identify them with their geometric realization.

Given a partition of unity  $\{\rho_i\}$  subordinate to  $\mathcal{U}$ , we get a homeomorphism  $\rho: Y \rightarrow \text{Ner}(\mathcal{U})$  which maps a point  $y \in U_{i_1} \cap \dots \cap U_{i_l}$  to the point  $\rho(y)$  of the simplex  $(i_1, \dots, i_l)$ , and whose barycentric coordinates are given by  $(\rho_{i_1}(y), \dots, \rho_{i_l}(y))$ .

In [5], the authors show that  $\alpha$  induces a local homeomorphism  $\phi: \text{Ner}(\mathcal{V}) \rightarrow \text{Ner}(\mathcal{U})$ . Moreover, given  $j \in J$ , we define  $\nu_j := \chi_{V_j} \cdot (\rho_{\alpha(j)} \circ \phi)$ . Those functions define a partition of unity subordinate to  $\mathcal{V}$ . We let  $\nu: X \rightarrow \text{Ner}(\mathcal{V})$  be the associate map, where  $\nu$  takes  $x \in X$  to the point of  $\text{Ner}(\mathcal{V})$  with barycentric coordinates given by  $(\nu_j(x))_j$ . By construction, the following diagram commutes:

$$\begin{array}{ccc} X & \xrightarrow{f} & Y \\ \nu \downarrow & & \downarrow \rho \\ \text{Ner}(\mathcal{V}) & \xrightarrow{\phi} & \text{Ner}(\mathcal{U}) \end{array}$$

Let us see that some  $n$ -simplex  $\sigma$  of  $\text{Ner}(\mathcal{V})$  has an interior point  $\xi$  which is a stable value of  $\nu: X \rightarrow \text{Ner}(\mathcal{V})$ . In particular,  $\rho^{-1}(\phi(\xi))$  is a stable value of  $f$ , which concludes. Assume it is not the case. Then we may form a set  $\mathcal{S}$  by choosing one interior point from each  $n$ -simplex of  $\text{Ner}(\mathcal{V})$  and perturb  $\nu$  on a small neighbourhood of  $\nu^{-1}(\mathcal{S})$  to get  $\nu': X \rightarrow \text{Ner}(\mathcal{V}) \setminus \mathcal{S}$ . Let us denote by  $p: \text{Ner}(\mathcal{V}) \setminus \mathcal{S} \rightarrow [\text{Ner}(\mathcal{V})]_{n-1}$  the radial projection to the  $(n-1)$ -skeleton of  $\text{Ner}(\mathcal{V})$ . Note that the barycentric coordinates of  $\nu'' := p \circ \nu': X \rightarrow [\text{Ner}(\mathcal{V})]_{n-1}$  are subordinate to  $\mathcal{V}$ . Pulling back the open star cover of  $\text{Ner}(\mathcal{V})$  by  $\nu''$ , we get a refinement of  $\mathcal{V}$  of order at most  $n$ , a contradiction. □

## Appendix C

In this appendix, we recall how to obtain smooth bump functions with support of size  $\sigma$  and whose  $C^1$  norm is of order  $O(\sigma^{-1})$ .

**Lemma 2.74.** *Let  $n \geq 0$ . Given  $\alpha > \beta > 0$ , there exists a constant  $C = C(\alpha, \beta) > 0$  such that for any  $x \in \mathbb{R}^n$  and any  $\sigma > 0$ , there exists a smooth function  $\rho = \rho_\sigma: \mathbb{R}^n \rightarrow [0, 1]$  which meets the following requirements:*

- (1)  $\text{supp}(\rho) \subset \overline{B(x, \alpha\sigma)}$ ,
- (2)  $\rho|_{\overline{B(x, \beta\sigma)}} \equiv 1$ ,
- (3)  $\|\rho\|_{C^1} \leq C\sigma^{-1}$ .

PROOF. We start by considering the one-dimensional case. Fix  $\alpha > \beta > 0$ , and let  $x \in \mathbb{R}$ . We define  $F: \mathbb{R} \rightarrow \mathbb{R}$ , where  $F(t) := e^{-\frac{1}{t(1-t)}}$  if  $t \in (0, 1)$ , and  $F(t) := 0$  else. For any  $t \in \mathbb{R}$ , we set  $G(t) := \frac{\int_{-\infty}^t F(u)du}{\int_{-\infty}^{\infty} F(u)du}$  and  $H(t) := \int_{-\infty}^t G(u)du$ . For any  $\epsilon > 0$ , we also define  $H_\epsilon(t) := \epsilon H(t/\epsilon)$ . Now, given  $\sigma > 0$ , we set  $\delta(\sigma) := (\alpha - \beta)\sigma/2$  and we take  $\theta(\sigma)$  such that  $\theta(\sigma)H_{\sigma^2}(\delta(\sigma)) = 1/2$ . It is easy to see that  $\theta(\sigma) \sim \delta(\sigma)^{-1}/2 = (\alpha - \beta)^{-1}\sigma^{-1}$ . We introduce the function

$$J_\sigma: t \mapsto \begin{cases} \theta(\sigma)H_{\sigma^2}(t) & \text{if } t \in (-\infty, \delta(\sigma)], \\ 1 - \theta(\sigma)H_{\sigma^2}(2\delta(\sigma) - t) & \text{if } t \in [\delta(\sigma), +\infty), \end{cases}$$

and finally, we define  $\rho_\sigma: t \mapsto J_\sigma(t - x + \alpha\sigma)J_\sigma(x - t + \alpha\sigma)$ . It is easy to check that  $\rho_\sigma: \mathbb{R} \rightarrow [0, 1]$  is smooth, and that it satisfies  $\rho_\sigma|_{[x-\beta\sigma, x+\beta\sigma]} \equiv 1$  and  $\rho_\sigma|_{(x-\alpha\sigma, x+\alpha\sigma)^c} \equiv 0$ . Hence, we are left with estimating its  $C^1$  norm. Note that  $\|\rho'_\sigma\|_\infty \leq \theta(\sigma)\|H'_{\sigma^2}\|_\infty$ . We deduce from what precedes that

$$\|\rho'_\sigma\|_\infty \leq \theta(\sigma)\|H'\|_\infty = \theta(\sigma) \leq C\sigma^{-1}$$

for some constant  $C > 0$  that only depends on  $\alpha, \beta$ .

If  $x \in \mathbb{R}^n$ , then for any  $t \in \mathbb{R}^n$ , we just replace the previous function by  $\rho_\sigma: t \mapsto J_\sigma(\|t - x\| + \alpha\sigma)J_\sigma(-\|t - x\| + \alpha\sigma)$ .  $\square$



## Bibliography

- [1] A. Avila, J. Bochi, Amie Wilkinson; *Nonuniform center bunching and the genericity of ergodicity among  $C^1$  partially hyperbolic symplectomorphisms*; Annales Scientifiques de l'École Normale Supérieure **42** (2009), pp. 931–979.
- [2] A. Avila, S. Crovisier, A. Wilkinson; *Diffeomorphisms with positive metric entropy*; to appear in Publications Mathématiques de l'IHÉS.
- [3] A. Avila, M. Viana; *Stable accessibility with 2–dimensional center*; preprint.
- [4] P. Berger; *Generic family with robustly infinitely many sinks*; Inventiones mathematicae, Volume **205**, Issue 1 (July 2016), pp. 121–172.
- [5] M. Bonk, B. Kleiner; *Rigidity for quasi-Möbius group actions*; J. Diff. Geom. **61** (2002), pp. 81–106.
- [6] C. Bonatti, C. Matheus, M. Viana, A. Wilkinson; *Abundance of stable ergodicity*; Comment. Math. Helv. **79** (2004), no. 4, pp. 753–757.
- [7] M. Brin, Y. Pesin; *Partially hyperbolic dynamical systems*; Math. USSR Izvestija **8** (1974), pp. 177–218.
- [8] K. Burns, A. Wilkinson; *On the ergodicity of partially hyperbolic systems*; Ann. of Math. **171** (2010), pp. 451–489.
- [9] K. Burns, A. Wilkinson; *Stable ergodicity of skew products*; Ann. Sci. de l'Ecole Norm. Sup. **32** (1999), pp. 859–889.
- [10] K. Burns, A. Wilkinson; *Dynamical coherence and center bunching*; Discrete and Continuous Dynamical Systems. (Pesin birthday issue) **22** (2008), pp. 89–100.
- [11] P. Carrasco; *Compact Dynamical Foliations*; PhD Thesis (2010), University of Toronto (Canada).
- [12] D. Dolgopyat; *On mixing properties of compact group extensions of hyperbolic systems*; Israel J. Math. **130** (2002), pp. 157–205.
- [13] D. Dolgopyat, A. Wilkinson; *Stable accessibility is  $C^1$ –dense*; Geometric methods in dynamics, **II**, Astérisque **287** (2003), pp. 33–60.
- [14] M. Grayson, C. Pugh, Charles, M. Shub; *Stably ergodic diffeomorphisms*; Ann. of Math. **140** (2) (1994), no. 2, pp. 295–329.
- [15] M. W. Hirsch; *Differential topology (Vol. 33)*; Springer Science & Business Media, 2012.
- [16] E. Hopf; *Fuchsian groups and ergodic theory*; Trans. A.M.S. **39** (1936), pp. 299–314.
- [17] M. Hirsch, C. Pugh, and M. Shub; *Invariant manifolds*; Lect. Notes in Math., Vol. **583**, Springer Verlag, 1977.
- [18] V. Horita, M. Sambarino; *Stable Ergodicity and Accessibility for certain Partially Hyperbolic Diffeomorphisms with Bidimensional Center Leaves*; arXiv, 1603.00053.
- [19] B. Hunt, V. Kaloshin; *Handbook of Dynamical Systems*; 3:43,45 (2010).
- [20] V. Kaloshin; *Some prevalent properties of smooth dynamical systems*; Proceedings of the Steklov Institute of Mathematics **213** (1997), pp. 123–151.
- [21] W. Ott, J. Yorke; *Prevalence*; Bull. Amer. Math. Soc. **42** (2005), 263–290.
- [22] Ya. Pesin; *Families of invariant manifolds corresponding to nonzero characteristic exponents*; Math. USSR-Izv. **40** (1976), no. 6, pp. 1261–1305.
- [23] C. Pugh, M. Shub; *Stably ergodic dynamical systems and partial hyperbolicity*; J. Complexity **13** no. 1 (1997), pp. 125–179.
- [24] C. Pugh, M. Shub, M; *Stable ergodicity and julienne quasi-conformality*; Journal of the European Mathematical Society **2** (1) (2000), pp. 1–52.
- [25] C. Pugh, M. Shub, and A. Wilkinson; *Hölder foliations*; Duke Math. J. **86** No.3 (1997), pp. 517–546.
- [26] C. Pugh, M. Shub, and A. Wilkinson; *Partial differentiability of invariant splittings*; J. Stat. Phys. **144** (2004), pp. 891–921.
- [27] C. Pugh, M. Shub, and A. Wilkinson; *Hölder foliations, revisited*; Journal of Modern Dynamics **6** (2012), pp. 835–908.

- [28] F. Rodriguez-Hertz, M.A. Rodriguez-Hertz, A. Tahzibi, R. Ures; *New criteria for ergodicity and nonuniform hyperbolicity*; Duke Math. J. **160** (2011), no. 3, pp. 599–629.
- [29] F. Rodriguez Hertz, M. A. Rodriguez Hertz, and R. Ures; *Accessibility and stable ergodicity for partially hyperbolic diffeomorphisms with 1D-center bundle*; Invent. Math. **172** (2008), pp. 353–381.
- [30] F. Rodriguez-Hertz; *Stable ergodicity of certain linear automorphisms of the torus*; Annals of Mathematics **162** (2005), pp. 65–107.
- [31] M. Shub, A. Wilkinson; *Pathological foliations and removable zero exponents*; Invent. Math. **139** (2000), pp. 495–508.
- [32] A. Wilkinson; *Conservative partially hyperbolic dynamics*; Proceedings of the International Congress of Mathematicians., Volume III (2010), pp. 1816–1836.
- [33] Z. Zhang;  *$C^r$  density of stable ergodicity for a class of partially hyperbolic systems*; arXiv, 1507.03556.

# Dynamics of a family of polynomial automorphisms of $\mathbb{C}^3$ , a phase transition

This chapter is based on a joint work with Julie Déserti.<sup>1</sup>

The polynomial automorphisms of the affine plane have been studied a lot: if  $f$  is such an automorphism, then either  $f$  preserves a rational fibration, has an uncountable centralizer and its first dynamical degree equals 1, or  $f$  preserves no rational curves, has a countable centralizer and its first dynamical degree is  $> 1$ . In higher dimensions there is no such description. In this article we study a family  $(\Psi_\alpha)_\alpha$  of polynomial automorphisms of  $\mathbb{C}^3$ . We show that the first dynamical degree of  $\Psi_\alpha$  is  $> 1$ , that  $\Psi_\alpha$  preserves a unique rational fibration and has an uncountable centralizer. We then describe the dynamics of the family  $(\Psi_\alpha)_\alpha$ , in particular the speed of points escaping to infinity. We also observe different behaviors according to the value of the parameter  $\alpha$ .

## 1. Preliminaries

### 1.1. On the structure of $\text{Aut}(\mathbb{C}^2)$ .

**Definition 3.1** ( $\text{Aut}(\mathbb{C}^2)$ ,  $\text{Bir}(\mathbb{P}_{\mathbb{C}}^2)$ ). *One defines  $\text{Aut}(\mathbb{C}^2)$  as the set of bijections  $f$  of  $\mathbb{C}^2$  such that for some polynomials  $P_0, P_1, P_2, P_3 \in \mathbb{C}[z_0, z_1]$ , one has*

$$f: (z_0, z_1) \mapsto (P_0(z_0, z_1), P_1(z_0, z_1)), \quad f^{-1}: (z_0, z_1) \mapsto (P_2(z_0, z_1), P_3(z_0, z_1)).$$

*In other terms,  $f$  is invertible and the coordinate functions of  $f$  and  $f^{-1}$  are given by polynomials. The algebraic degree of  $f$ , denoted by  $\deg(f)$ , is defined as follows:  $\deg(f) := \max(\deg(P_0), \deg(P_1))$ .*

*We denote by  $\mathbb{P}_{\mathbb{C}}^2$  the complex projective plane, endowed with homogeneous coordinates. A rational map of  $\mathbb{P}_{\mathbb{C}}^2$  of degree  $d \geq 1$  is a map of the form  $g = (P_0 : P_1 : P_2)$  for some homogeneous polynomials  $\{P_i\}_{i=0,\dots,2}$  of degree  $d$  without common factors. Such a map  $g$  is birational if there exists a rational map  $h$  such that  $h \circ g = g \circ h = \text{Id}$ . One denotes by  $\text{Bir}(\mathbb{P}_{\mathbb{C}}^2)$  the group of all birational self maps of  $\mathbb{P}_{\mathbb{C}}^2$ .*

If  $g = (P_0 : P_1 : P_2) \in \text{Bir}(\mathbb{P}_{\mathbb{C}}^2)$ , we define the *indeterminacy set*  $\text{Ind}(g)$  of  $g$  to be the set where  $g$  is not defined, that is the set of all points at which the three components of  $g$  vanish simultaneously:

$$\text{Ind}(g) := \{p \in \mathbb{P}_{\mathbb{C}}^2 \mid P_0(p) = P_1(p) = P_2(p) = 0\}.$$

**Definition 3.2** (Affine, elementary automorphisms).

— *The set of all maps of the form*

$$a: \begin{cases} \mathbb{C}^2 & \rightarrow \mathbb{C}^2, \\ (z_0, z_1) & \mapsto (a_1 z_0 + b_1 z_1 + c_1, a_2 z_0 + b_2 z_1 + c_2), \end{cases}$$

*with  $a_i, b_i, c_i \in \mathbb{C}$ ,  $i = 1, 2$ , and  $a_1 b_2 - a_2 b_1 \neq 0$ , is a subgroup  $A \subset \text{Aut}(\mathbb{C}^2)$ , called the group of affine automorphisms.*

---

1. Université Paris Diderot, Sorbonne Paris Cité, Institut de Mathématiques de Jussieu-Paris Rive Gauche, UMR 7586, CNRS, Sorbonne Universités, UPMC Univ Paris 06, F-75013 Paris, France.

— The set of all maps of the form

$$e: \begin{cases} \mathbb{C}^2 & \rightarrow \mathbb{C}^2, \\ (z_0, z_1) & \mapsto (\alpha z_0 + P(z_1), \beta z_1 + \gamma), \end{cases}$$

where  $\alpha, \beta, \gamma \in \mathbb{C}$ ,  $\alpha\beta \neq 0$ , and  $P \in \mathbb{C}[z_1]$ , is a subgroup  $E \subset \text{Aut}(\mathbb{C}^2)$  called the group of elementary automorphisms. In particular, note that any element  $e \in E$  preserves the rational fibration  $\{z_1 = \text{cst}\}$ .

— We also define the subgroup  $S \subset \text{Aut}(\mathbb{C}^2)$ :

$$S := A \cap E = \{(z_0, z_1) \mapsto (a_1 z_0 + b_1 z_1 + c_1, b_2 z_1 + c_2) \mid a_i, b_i, c_i \in \mathbb{C}, a_1 b_2 \neq 0\}.$$

To any polynomial automorphism  $f = (P_0, P_1)$  of  $\mathbb{C}^2$  of degree  $d$  one can associate a map in  $\text{Bir}(\mathbb{P}_{\mathbb{C}}^2)$  as follows:

$$(z_0 : z_1 : z_2) \dashrightarrow \left( z_2^d P_0 \left( \frac{z_0}{z_2}, \frac{z_1}{z_2} \right) : z_2^d P_1 \left( \frac{z_0}{z_2}, \frac{z_1}{z_2} \right) : z_2^d \right).$$

For example, let us consider the elementary automorphism  $e_d: (z_0, z_1) \mapsto (\alpha z_0 + z_1^d, \beta z_1 + \gamma)$ , with  $\alpha, \beta, \gamma \in \mathbb{C}$ ,  $\alpha\beta \neq 0$ ,  $d \geq 2$ . It corresponds to the birational map

$$e_d: (z_0 : z_1 : z_2) \dashrightarrow (\alpha z_0 z_2^{d-1} + z_1^d : \beta z_1 z_2^{d-1} + \gamma z_2^d : z_2^d),$$

and in this case, we see that  $\text{Ind}(e_d) = (1 : 0 : 0)$ .

The following result is due to Jung.

**Theorem 3.3** (Jung's Theorem, [20]). *The group  $\text{Aut}(\mathbb{C}^2)$  is the amalgamated product of  $A$  and  $E$  along  $S$ , i.e.,*

$$\text{Aut}(\mathbb{C}^2) = A *_S E.$$

This means that each element  $f \in \text{Aut}(\mathbb{C}^2)$  can be written as a product

$$f = (a_1) e_1 a_2 \dots a_n (e_n), \quad a_i \in A \setminus E, \quad e_i \in E \setminus A,$$

and this decomposition is unique modulo the relations

$$a_i e_i = (a_i s)(s^{-1} e_i), \quad e_i a_i = (e_i s')(s'^{-1} a_i), \quad \forall s, s' \in S.$$

There are many proofs of Jung's Theorem. Let us give a flavour of that given by Lamy in [22]: for any  $f \in \text{Aut}(\mathbb{C}^2)$ , he exhibits a map  $\varphi \in \text{Bir}(\mathbb{P}_{\mathbb{C}}^2)$  induced by an elementary automorphism of  $\mathbb{C}^2$  such that  $\#\text{Ind}(f\varphi^{-1}) < \#\text{Ind}(f)$ . Recursively, he thus obtains a map  $g = f\varphi_1^{-1}\varphi_2^{-1} \dots \varphi_k^{-1}$  with  $\#\text{Ind}(g) = 0$  and  $\varphi_i \in \text{Bir}(\mathbb{P}_{\mathbb{C}}^2)$ ,  $i = 1, \dots, k$ , induced by elementary automorphisms. But  $\#\text{Ind}(g) = 0$  means that  $g$  comes from an affine automorphism, hence  $f$  can be written as a product of elementary and affine automorphisms.

From a dynamical point of view, both affine and elementary automorphisms are simple. Yet there are elements of  $\text{Aut}(\mathbb{C}^2)$  with a much more interesting behaviour. In particular, Hénon introduced families of quadratic automorphisms of the plane with very complicated dynamics ([17, 18, 5, 11]), defined as follows:

$$g_{a,b}: (z_0, z_1) \mapsto (a - z_0^2 - b z_1, z_0), \quad a \in \mathbb{C}, \quad b = \text{Jac}(g_{a,b}) \in \mathbb{C}^*.$$

Numerical experiments have shown that for some values of the parameters  $a, b$ , the orbits of  $g_{a,b}$  converge to some "strange attractor", while for some other values, a hyperbolic behaviour reminiscent of Smale's horseshoe appears [11]. Let us introduce the following generalization of the families considered by Hénon.

**Definition 3.4** (Hénon automorphisms). *A map  $h \in \text{Aut}(\mathbb{C}^2)$  is a Hénon automorphism if there exist  $\delta \in \mathbb{C}^*$  and  $P \in \mathbb{C}[z_0]$ , with  $\deg P \geq 2$ , such that*

$$h: (z_0, z_1) \mapsto (P(z_0) - \delta z_1, z_0).$$

Note that  $h = ea$ , where  $a: (z_0, z_1) \mapsto (z_1, z_0) \in A \setminus E$ , and  $e: (z_0, z_1) \mapsto (-\delta z_0 + P(z_1), z_1) \in E \setminus A$ .

One way to measure the complexity of a dynamical system is through the notion of *topological entropy*. Indeed, positive entropy is usually associated with chaotic behaviours. In dimension 1, the topological entropy of a rational fraction coincides with the logarithm of its *degree*. Yet, the algebraic degree of a polynomial automorphism of  $\mathbb{C}^2$  is not invariant under conjugacy, thus [24, 13] introduced the *first dynamical degree*, which is defined for a polynomial automorphism of  $f \in \text{Aut}(\mathbb{C}^2)$  as

$$\lambda(f) := \lim_{n \rightarrow +\infty} (\deg f^n)^{1/n}.$$

It is invariant under conjugacy, and it satisfies the following inequalities:  $1 \leq \lambda(f) \leq \deg f$ . It was proved in [28, 4] that the topological entropy is equal to the logarithm of the first dynamical degree.

Let us denote by  $\mathcal{H}$  the semigroup generated by Hénon automorphisms. In other terms, any  $f \in \mathcal{H}$  is of the form

$$f = h_1 h_2 \dots h_k, \quad h_j: (z_0, z_1) \mapsto (P_j(z_0) - \delta_j z_1, z_0),$$

where  $\delta_j \in \mathbb{C}^*$ ,  $P_j \in \mathbb{C}[z_0]$ ,  $\deg P_j \geq 2$ .

If  $f \in \mathcal{H}$ , then  $\deg(f^n) = (\deg(f))^n$ , and thus, the first dynamical degree of  $f$  coincides with its algebraic degree. In particular, for any automorphism  $f \in \text{Aut}(\mathbb{C}^2)$  of Hénon type, the first dynamical degree of  $f$  satisfies  $\lambda(f) \geq 2$ . On the other hand, if  $f$  is conjugate to an elementary automorphism, then we have  $\deg(f^n) = \deg(f)$  for every  $n \geq 1$ , and in this case, the first dynamical degree is  $\lambda(f) = 1$ .

Based on Jung's Theorem, Friedland and Milnor have shown that in fact, any two-dimensional polynomial automorphism  $f$  with a rich dynamical behaviour (in the sense that  $\lambda(f) > 1$ ) can be described in terms of Hénon maps.

**Theorem 3.5** (Friedland-Milnor, [14]). *For any  $f \in \text{Aut}(\mathbb{C}^2)$ , one has the following alternative:*

- either  $f$  is conjugate to an elementary automorphism, i.e., there exists  $\varphi \in \text{Aut}(\mathbb{C}^2)$  such that  $\varphi f \varphi^{-1} \in E$ . In particular,  $f$  preserves a rational fibration;
- or  $f$  is conjugate to a product of Hénon automorphisms, i.e., there exists  $\varphi \in \text{Aut}(\mathbb{C}^2)$  such that  $\varphi f \varphi^{-1} \in \mathcal{H}$ . In this case, we say that  $f$  is an automorphism of Hénon type. By a result due to Brunella, any such  $f$  does not preserve any rational curve ([9]).

Equivalently, for a map  $f \in \text{Aut}(\mathbb{C}^2)$ , we have:

- $\lambda(f) = 1$  if and only if  $f$  is conjugate to an element in  $E$ ;
- $\lambda(f) > 1$  if and only if  $f$  is conjugate to an element in  $\mathcal{H}$ .

**Remark 3.6.** As soon as  $k \geq 3$ , the growth of degrees of iterates of a polynomial automorphism of  $\mathbb{C}^k$  can be much more varied. For instance, in [7], Bonifant-Fornaess study sequences of degrees of iterates for polynomial automorphisms of  $\mathbb{C}^3$  of degree 2, and show that there are only a finite number of them. Given a polynomial automorphism  $f$  and  $n \geq 1$ , we denote  $d_n = d_n(f) := \deg(f^n)$ . Recall that the Fibonacci sequence is the sequence  $(F_n)_n$  defined by:  $F_0 = 0$ ,  $F_1 = 1$  and for all  $n \geq 2$ ,

$$F_n := F_{n-1} + F_{n-2}.$$

Then, the authors give examples of polynomial automorphisms  $f \in \text{Aut}(\mathbb{C}^3)$  of degree at most 2 for which we observe the following behaviours:

- $d_n = 2$ , for every  $n \geq 1$ ;
- $d_n = 2^n$ , for every  $n \geq 1$ ;
- $d_{2n} = 2^{n+1}$ ,  $d_{2n+1} = 2^{n+1}$ , for every  $n \geq 1$  (such maps are called *flushing*);
- $d_n = F_{n+2}$  for every  $n \geq 1$ ;
- $d_n = 2F_{n+1}$  for every  $n \geq 1$ ;



- the degree remains constant after high enough iterates (such maps are called *basic*).

As in Bass-Serre theory [25], one defines a graph  $\mathcal{T}$  as follows:

- The set of vertices of  $\mathcal{T}$  is the disjoint union of points in the quotient spaces  $\text{Aut}(\mathbb{C}^2)/A$  and  $\text{Aut}(\mathbb{C}^2)/E$ . In other terms, a vertex is a left coset of the form  $fA := \{fa \mid a \in A\}$  or of the form  $gE := \{ge \mid e \in E\}$ , for some elements  $f, g \in \text{Aut}(\mathbb{C}^2)$ .
- Edges of  $\mathcal{T}$  are labelled by elements in the quotient space  $\text{Aut}(\mathbb{C}^2)/S$ . They are left cosets of the form  $hS := \{hs \mid s \in S\}$  for some  $h \in \text{Aut}(\mathbb{C}^2)$ .

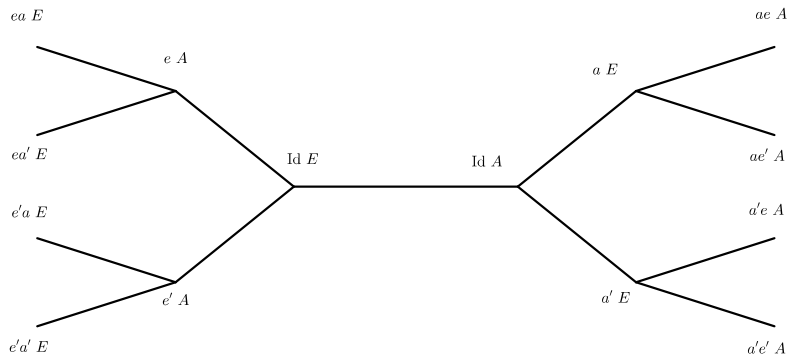

FIGURE 1. Some vertices in the tree  $\mathcal{T}$

**Remark 3.7.** Let  $h \in \text{Aut}(\mathbb{C}^2)$ . By construction, the endpoints of the edge labelled by  $hS$  are the vertices  $hA$  and  $hE$ . In other terms, given  $f, g \in \text{Aut}(\mathbb{C}^2)$ ,  $hS$  connects  $fA$  and  $gE$  if and only if  $hS \in fA \cap gE$ , and in this case,  $hA = fA$  and  $hE = gE$ .

**Remark 3.8.** The fact that  $A$  and  $E$  are amalgamated along  $S$  implies that there is no nontrivial cycle in the graph  $\mathcal{T}$ , that is,  $\mathcal{T}$  is a tree. Besides, one may define a natural action of  $\text{Aut}(\mathbb{C}^2)$  on  $\mathcal{T}$  by left translation: given  $f, g \in \text{Aut}(\mathbb{C}^2)$ , and for  $X = A, E$  or  $S$ , one sets  $f \cdot (gX) := (fg)X$ . By construction,  $E$  is the stabilizer of  $\text{Id}E$ . Therefore, for any  $f \in \text{Aut}(\mathbb{C}^2)$ ,  $fEf^{-1}$  is the stabilizer of the vertex  $fE$ , and similarly for  $A$  and  $S$ . In particular, the fundamental domain of this action is a segment, that is, an edge together with its two vertices, where  $A$  and  $E$  are the stabilizers of the vertices, and thus,  $S$  is the stabilizer of the entire segment. Moreover,  $\mathcal{T}$  is the unique tree (up to isomorphism) satisfying the above properties.

It is possible to endow the set of vertices of  $\mathcal{T}$  with a natural metric: indeed, for any two vertices  $p, q$ , we let  $d(p, q) \in \mathbb{N}$  be the number of edges in the path which connects  $p$  to  $q$ . Then, the action of  $\text{Aut}(\mathbb{C}^2)$  on  $\mathcal{T}$  by left translation induces a *faithful representation* of  $\text{Aut}(\mathbb{C}^2)$  as a subgroup of isometries of  $(\mathcal{T}, d)$ .

If the action of  $f \in \text{Aut}(\mathbb{C}^2)$  leaves two vertices  $p, q \in \mathcal{T}$  invariant, then it also fixes the edges between them, and thus, we may consider the sub-tree of  $\mathcal{T}$  (possibly reduced to the empty set) which is fixed by  $f$ ; we denote it by  $\mathcal{T}_f$ .

To any  $f \in \text{Aut}(\mathbb{C}^2)$ , one can associate a length function

$$\mathcal{T} \ni p \mapsto d(p, f(p)) \in \mathbb{R}_+.$$

By [25], the following properties hold:

- there exists a vertex in  $\mathcal{T}$  which realizes the infimum

$$\ell := \inf_{p \in \mathcal{T}} d(p, f(p));$$

- $\ell > 0$  if and only if  $\mathcal{T}_f = \emptyset$ , and then, the set of vertices that realize this infimum  $\ell$  is an infinite geodesic, denoted by  $\text{Geo}(f)$ , on which  $f$  acts by translation of length  $\ell$ .

**Remark 3.9.** *Theorem 3.5 can thus be reformulated as follows. Let  $f \in \text{Aut}(\mathbb{C}^2)$ ; one then has:*

- $\mathcal{T}_f \neq \emptyset$  if and only if  $f$  is conjugate to an elementary automorphism;
- $\mathcal{T}_f = \emptyset$  if and only if  $f$  is conjugate to an element of  $\mathcal{H}$ ; in this case, there exists a unique infinite geodesic,  $\text{Geo}(f)$ , on which  $f$  acts by translation.

The fact that  $\text{Aut}(\mathbb{C}^2)$  acts nontrivially on the tree  $\mathcal{T}$  was successfully used in different contexts. For instance, given  $f, g \in \text{Aut}(\mathbb{C}^2)$ , then by looking at their respective actions on  $\mathcal{T}$ , one can study the relations between these two maps and deal with questions such as “do  $f$  and  $g$  commute?”, or “do  $f$  and  $g$  generate a free group?”.

Besides the notion of dynamical degree recalled above, an important criterion to measure chaos is by looking at the size of the *centralizer* of an element. For an element  $f$  of a group  $G$ , one defines the centralizer  $\text{Cent}(f, G)$  of  $f$  in  $G$  as follows:

$$\text{Cent}(f, G) := \{g \in G \mid fg = gf\}.$$

Of course, the centralizer of an element  $f \in G$  always contains the group  $\{f^n \mid n \in \mathbb{Z}\}$  of its iterates. We say that the centralizer of  $f$  is trivial when it is reduced to it. In general, the more complicated the dynamics of a system is, the smaller its centralizer is expected to be.

The description of centralizers of discrete dynamical systems is an important problem in real and complex dynamics: Julia ([19]) and Ritt ([23]) showed that the centralizer of a rational function  $f$  of  $\mathbb{P}^1$  is in general the set of iterates of  $f$ , except for some very special  $f$ . Later Smale asked if the centralizer of a generic diffeomorphism of a compact manifold is trivial ([27]). Since then a lot of mathematicians have looked at this question in different contexts.

Using the action of  $\text{Aut}(\mathbb{C}^2)$  on  $\mathcal{T}$ , Lamy was able to describe the centralizer of polynomial automorphisms in two complex variables.

**Theorem 3.10** (Lamy, [21]). *Given  $f \in \text{Aut}(\mathbb{C}^2)$  of degree at least 2, the centralizer  $\text{Cent}(f, \text{Aut}(\mathbb{C}^2))$  is generated by two elements  $g, h \in \text{Aut}(\mathbb{C}^2)$  satisfying:*

- $\lambda(g) \geq 2$ , and  $\text{Geo}(f) = \text{Geo}(g)$ ;
- $h$  is conjugate to a rotation  $(z_0, z_1) \mapsto (\alpha z_0, \beta z_1)$ , where  $\alpha, \beta$  are two roots of unity of the same order;
- there exists an integer  $n$  such that  $hg = gh^n$ .

*In particular,  $\text{Cent}(f, \text{Aut}(\mathbb{C}^2))$  is isomorphic to  $\mathbb{Z} \rtimes \mathbb{Z}/p\mathbb{Z}$ , where  $p$  is the order of  $h$ .*

**Corollary 3.11.** *The centralizer  $\text{Cent}(f, \text{Aut}(\mathbb{C}^2))$  of a map  $f \in \text{Aut}(\mathbb{C}^2)$  is countable if and only if  $f$  is of Hénon type.*

Let us summarize the results recalled in the previous discussion. For two-dimensional polynomial automorphisms, one observes a clear dichotomy between the following two very different behaviours; for any  $f \in \text{Aut}(\mathbb{C}^2)$ ,

- either  $f$  preserves a rational fibration, its first dynamical degree satisfies  $\lambda(f) = 1$ , its centralizer is uncountable, and  $\mathcal{T}_f \neq \emptyset$ ;
- or  $f$  does not preserve any rational curve, its first dynamical degree satisfies  $\lambda(f) > 1$ , its centralizer is countable,  $\mathcal{T}_f = \emptyset$ , and  $f$  has infinitely many hyperbolic periodic points.

Such a global picture is not available in higher dimension. The work presented in what follows is concerned with the study of a one-parameter family of polynomial automorphisms of  $\mathbb{C}^3$ . We will see that elements in this family have features which mix properties of elementary automorphisms and of automorphisms of Hénon type.

**1.2. General notions on  $\text{Aut}(\mathbb{C}^k)$ .** Let  $k \geq 1$  be an integer. We denote by  $\mathbb{P}_{\mathbb{C}}^k$  the complex projective space of dimension  $k$ . A point  $z \in \mathbb{P}_{\mathbb{C}}^k$  can be represented by homogeneous coordinates; we write:

$$z = (z_0 : z_1 : \dots : z_{k-1} : z_k), \quad z_i \in \mathbb{C}, \quad \forall i = 0, \dots, k.$$

**Definition 3.12** (Polynomial automorphisms, rational maps).

- A polynomial map of  $\mathbb{C}^k$  is a map  $f = (f_0, f_1, \dots, f_{k-1})$  whose coordinate functions  $\{f_i\}_{i=0, \dots, k-1}$  are given by polynomials. We denote by  $\deg(f) := \max_{0 \leq i \leq k-1} \deg(f_i)$  the algebraic degree of  $f$ . In this case, we also define the first dynamical degree of  $f$  as

$$\lambda(f) := \lim_{n \rightarrow +\infty} (\deg f^n)^{1/n}.$$

- A polynomial map  $f$  is said to be dominant if it is generically of rank  $k$ . We denote by  $\text{End}(\mathbb{C}^k)$  the set of all such maps.
- A polynomial automorphism of  $\mathbb{C}^k$  is a bijection of  $\mathbb{C}^k$  such that both  $f$  and  $f^{-1}$  are polynomial maps. We denote by  $\text{Aut}(\mathbb{C}^k)$  the set of all such maps.
- A rational map of  $\mathbb{P}_{\mathbb{C}}^k$  of degree  $d \geq 1$  is a map of the form  $f = (F_0 : F_1 : \dots : F_{k-1} : F_k)$  for some homogeneous polynomials  $\{F_i\}_{i=0, \dots, k}$  of degree  $d$  without common factors. Such a map  $f$  is birational if there exists a rational map  $g$  such that  $g \circ f = f \circ g = \text{Id}$ . We denote by  $\text{Bir}(\mathbb{P}_{\mathbb{C}}^k)$  the set of all birational maps.

**Remark 3.13.** If  $f = (F_0 : F_1 : \dots : F_k)$  is a rational map of  $\mathbb{P}_{\mathbb{C}}^k$ , it is not defined everywhere. One thus introduces the indeterminacy set  $\text{Ind}(f)$  as the set of common zeros of its components, i.e.,

$$\text{Ind}(f) := \{p \in \mathbb{P}_{\mathbb{C}}^k \mid F_0(p) = F_1(p) = \dots = F_{k-1}(p) = F_k(p) = 0\}.$$

Since the  $F_i$ 's do not have common factors,  $\text{Ind}(f)$  is an analytic set of codimension at least 2.

Given a map  $f = (f_0, f_1, \dots, f_{k-1}) \in \text{End}(\mathbb{C}^k)$  of degree  $d$ , one can consider its extension to  $\mathbb{P}_{\mathbb{C}}^k$ , which is the rational map defined as follows:

$$(z_0 : z_1 : \dots : z_{k-1} : z_k) \mapsto \left( z_k^d f_0 \left( \frac{z_0}{z_k}, \frac{z_1}{z_k}, \dots, \frac{z_{k-1}}{z_k} \right) : \dots : z_k^d f_{k-1} \left( \frac{z_0}{z_k}, \frac{z_1}{z_k}, \dots, \frac{z_{k-1}}{z_k} \right) \right);$$

we still denote it by  $f$ .

Remark that if we consider a birational map of  $\mathbb{P}_{\mathbb{C}}^k$  that comes from a map  $f \in \text{End}(\mathbb{C}^k)$ , then its indeterminacy set is necessarily contained in the hyperplane at infinity,  $\{z_k = 0\}$ . In general, the behaviour under iteration of the hyperplane at infinity plays a central role in the study of  $f$ .

**Definition 3.14** (Fatou set, Julia set). Given  $f \in \text{End}(\mathbb{C}^k)$ , we define  $F(f)$  as the largest open set on which the family  $(f^n)_{n \geq 0}$  is locally equicontinuous. By definition,  $F(f)$  is open; it is called the Fatou set. Its complement, denoted by  $J(f)$ , is closed, and is called the Julia set. It is related to sensitivity to initial conditions: given a point in the Julia set, the dynamical behaviour of nearby points can be totally different.

**Definition 3.15.** Let  $f \in \text{Aut}(\mathbb{C}^k)$ . Given any hyperbolic fixed point  $p \in \mathbb{C}^k$  (that is, such that the eigenvalues of the differential of  $f$  at  $p$  have modulus different from one),

the stable, resp. unstable manifolds of  $f$  at  $p$  are defined as

$$\begin{aligned} \mathcal{W}_f^s(p) &:= \{q \in \mathbb{C}^k \mid \lim_{n \rightarrow +\infty} d(p, f^n(q)) = 0\}, \\ \text{resp. } \mathcal{W}_f^u(p) &:= \{q \in \mathbb{C}^k \mid \lim_{n \rightarrow +\infty} d(p, f^{-n}(q)) = 0\}. \end{aligned}$$

Let  $j$  be the number of eigenvalues of the differential of  $f$  at  $p$  with modulus less than one. Then  $\mathcal{W}_f^s(p)$  is biholomorphic to  $\mathbb{C}^j$ , and  $\mathcal{W}_f^u(p)$  is biholomorphic to  $\mathbb{C}^{k-j}$ .

We define the sets of points with bounded forward, resp. backward orbits:

$$\begin{aligned} K_f^+ &:= \{p \in \mathbb{C}^k \mid (f^n(p))_{n \geq 0} \text{ is bounded}\}, \\ \text{resp. } K_f^- &:= \{p \in \mathbb{C}^k \mid (f^{-n}(p))_{n \geq 0} \text{ is bounded}\}, \end{aligned}$$

and we let  $K_f := K_f^+ \cap K_f^-$  be the set of points whose entire orbit is bounded. We also define  $J_f^\pm$  as the topological boundary of  $K_f^\pm$ , i.e.,  $J_f^\pm := \partial K_f^\pm$ . Clearly, any fixed point of  $f$  is in  $K_f$ , and we can generalize the previous definitions by setting

$$\begin{aligned} \mathcal{W}_f^s(K_f) &:= \{q \in \mathbb{C}^k \mid \lim_{n \rightarrow +\infty} f^n(q) \in K_f\}; \\ \mathcal{W}_f^u(K_f) &:= \{q \in \mathbb{C}^k \mid \lim_{n \rightarrow +\infty} f^{-n}(q) \in K_f\}. \end{aligned}$$

### 1.2.1. Plurisubharmonic functions, currents.

**Definition 3.16** (Plurisubharmonic functions). Let  $\Omega$  be an open subset of  $\mathbb{C}^k$ , for some integer  $k \geq 1$ . Given an upper semicontinuous function  $u: \Omega \rightarrow [-\infty, +\infty)$  which is not identically  $-\infty$  in any component of  $\Omega$ , we say that  $u$  is plurisubharmonic in  $\Omega$  if for any  $p \in \Omega$ ,  $w \in \mathbb{C}^k$  such that  $p + w\mathbb{D} \subset \Omega$ ,

$$u(p) \leq \frac{1}{2\pi} \int_0^{2\pi} u(p + we^{i\theta}) d\theta,$$

where we denote by  $\mathbb{D}$  the unit disk  $\mathbb{D} := \{z \in \mathbb{C} \mid |z| \leq 1\}$ .

#### Example 3.17.

- Let  $\Omega \subset \mathbb{C}^k$  be an open set. If  $f$  is holomorphic in  $\Omega$  and is not identically vanishing, then  $\log \|f\|$  is plurisubharmonic in  $\Omega$ .
- A function  $v \in L_{\text{loc}}^1$  is equal almost everywhere to a plurisubharmonic function if and only if

$$\sum_{i,j} \frac{\partial^2 v}{\partial z_i \partial \bar{z}_j} p_i \bar{p}_j \geq 0,$$

for every  $p \in \mathbb{C}^k$ . In particular, the left-hand side defines a positive measure.

- Let  $\Omega_1, \Omega_2 \subset \mathbb{C}^k$  be two open sets. If  $g: \Omega_1 \rightarrow \Omega_2$  is holomorphic and  $u$  is plurisubharmonic in  $\Omega_2$ , then  $u \circ g$  is plurisubharmonic in  $\Omega_1$ , or identically  $-\infty$ . In particular, by this property, it is thus possible to use charts in order to define plurisubharmonic functions on complex manifolds.

**Definition 3.18** (Currents). Given an integer  $k \geq 1$  and an open set  $\Omega$  in  $\mathbb{C}^k$ , let us denote by  $\mathcal{D}^{p,q}(\Omega)$  the smooth differential forms  $\varphi$  with compact support of the form

$$\varphi = \sum_{|I|=p, |J|=q} \varphi_{IJ} dz_I \wedge d\bar{z}_J,$$

where  $dz_I = dz_{i_1} \wedge \cdots \wedge dz_{i_p}$  and  $d\bar{z}_J = d\bar{z}_{j_1} \wedge \cdots \wedge d\bar{z}_{j_q}$ . Given integers  $p, q \leq k$ , the space of currents of bidegree  $(k-p, k-q)$  is the dual space of  $\mathcal{D}^{p,q}(\Omega)$ . A current  $T$  of bidegree  $(k-p, k-q)$  is a differential form with distributions as coefficients:

$$T = \sum_{\substack{|I'|=k-p \\ |J'|=k-q}} T_{I',J'} dz_{I'} \wedge d\bar{z}_{J'}.$$

In this case, given any test function  $\varphi \in \mathcal{D}^{p,q}(\Omega)$ , we denote the action of  $T$  on  $\varphi$  by

$$\langle T, \varphi \rangle.$$

Given  $p \leq k$ , let  $T$  be a current of bidegree  $(k-p, k-p)$ . It is positive if  $\langle T, \varphi \rangle \geq 0$ , for all forms

$$\varphi = i\alpha_1 \wedge \bar{\alpha}_1 \wedge \cdots \wedge i\alpha_p \wedge \bar{\alpha}_p, \quad \alpha_j \in \mathcal{D}^{1,0}(\Omega).$$

In particular, a current  $T = i \sum_{i,j} T_{i,j} dz_i \wedge d\bar{z}_j$  of bidegree  $(1, 1)$  is positive if and only if for all  $(p_0, \dots, p_{k-1}) \in \mathbb{C}^k$ , the distribution

$$\sum_{i,j} T_{i,j} p_i \bar{p}_j \geq 0.$$

We denote  $dd^c = \frac{i(\bar{\partial} - \partial)}{2\pi}$ , so that  $dd^c = \frac{1}{\pi} \partial \bar{\partial}$ . Let  $\Omega \subset \mathbb{C}^k$  be an open set. We can associate with any plurisubharmonic function  $u$  in  $\Omega$  a positive current of bidegree  $(1, 1)$  as follows:

$$dd^c u = \frac{i}{\pi} \sum_{i,j} \frac{\partial^2 u}{\partial z_i \partial \bar{z}_j} dz_i \wedge d\bar{z}_j.$$

Conversely, given any closed positive current  $T$  of bidegree  $(1, 1)$ , then for every  $p \in \Omega$ , there exists a neighbourhood  $U$  of  $p$  and a plurisubharmonic function  $u$  in  $U$  such that  $T = dd^c u$  in  $U$ . We say that the function  $u$  is a *potential* of  $T$ .

**Definition 3.19** (Pull-back of a current of bidegree  $(1, 1)$ ). Given integers  $k \geq l$  and two open sets  $\Omega_1 \subset \mathbb{C}^k$ ,  $\Omega_2 \subset \mathbb{C}^l$ , let  $f: \Omega_1 \rightarrow \Omega_2$  be a holomorphic map of rank  $l$ . Let  $T$  be a closed positive current of bidegree  $(1, 1)$  on  $\Omega_2$ . We define its pull-back by  $f$ , denoted by  $f^*T$ , as follows. Given  $p \in \Omega_1$ , let  $q := f(p)$  and  $r_2 > 0$  such that  $B(q, r_2) \subset \Omega_2$ . In  $B(q, r_2)$ , we have  $T = dd^c u$  for some plurisubharmonic function  $u$ . There exists  $r_1 > 0$  such that  $f(B(p, r_1)) \subset B(q, r_2)$ . Then, we set  $f^*T|_{B(p, r_1)} := dd^c(u \circ f)$ . This definition is independent of the choice of the potential  $u$ .

### 1.2.2. Algebraically stable endomorphisms.

**Definition 3.20** (Algebraically stable endomorphism). A map  $f \in \text{End}(\mathbb{C}^k)$  is *algebraically stable* if for any hypersurface  $V$  and any integer  $n \in \mathbb{N}$ , the components of  $F^n$  do not vanish identically on  $V$ .

Let  $f$  be a polynomial automorphism of  $\mathbb{C}^k$ . By the above remark on the indeterminacy set of polynomial automorphisms,  $f$  is algebraically stable if and only if, for every  $n \in \mathbb{N}$ ,

$$f^n(\{z_k = 0\} \setminus \text{Ind}(f^n)) \not\subset \text{Ind}(f).$$

**Example 3.21.** For  $k = 2$ , a fundamental example of algebraically stable maps is given by Hénon automorphisms, introduced previously. Indeed, if  $h(z_0, z_1) = (P(z_0) - \delta z_1, z_0)$ , with  $\delta \in \mathbb{C}^*$ ,  $P \in \mathbb{C}[z_0]$ ,  $\deg(P) \geq 2$ , then  $h(\{z_2 = 0\}) = (1 : 0 : 0)$ , which is fixed.

More generally, any element in  $\mathcal{H} \subset \text{Aut}(\mathbb{C}^2)$  is algebraically stable.

Let us recall the following result.

**Proposition 3.22** (Fornaess-Sibony, [12]). The map  $f$  is algebraically stable if and only if  $\deg(f^n) = (\deg(f))^n$  for every  $n \geq 1$ .

In particular, if  $f$  is algebraically stable, then the first dynamical degree  $\lambda(f)$  coincides with  $\deg(f)$ , so there is no risk of confusion when we refer to the *degree* of such a map.

**Remark 3.23.** For  $k = 2$ , a polynomial automorphism is algebraically stable if and only if its inverse is.

Yet, for  $k \geq 3$ , there exist polynomial automorphisms of  $\mathbb{C}^k$  which are algebraically stable, but whose inverse is not. We can think of the following example, due to Guedj: given  $\lambda \in \mathbb{C}^*$  and  $a \in \mathbb{C}^*$ , we consider

$$f(z_0, z_1, z_2) = (z_0^2 + \lambda z_1 + a z_2, \lambda^{-1} z_0^2 + z_1, z_0).$$

Then  $f(\{z_3 = 0\}) = (\lambda : 1 : 0 : 0)$  is fixed, hence  $f$  is algebraically stable. On the other hand,

$$f^{-1}(z_0, z_1, z_2) = (z_2, z_1 - \lambda^{-1} z_2^2, a^{-1}(z_0 - \lambda z_1)),$$

and  $f^{-1}(\{z_3 = 0\}) = (0 : 1 : 0 : 0) \subset \text{Ind}(f^{-1})$ .

**Definition-Proposition** (Green functions, Green currents). *Let  $f \in \text{End}(\mathbb{C}^k)$  be an algebraically stable endomorphism of degree  $d \geq 2$ . We can associate with  $f$  the Green function*

$$G = G_f: z \mapsto \lim_{n \rightarrow +\infty} \frac{\log^+ \|f^n(z)\|}{d^n}.$$

In general, the function  $G$  is not continuous.

We can also assign to  $f$  the so-called Green current, defined as  $T = T_f := dd^c G_f$ , which is a closed current of bidegree  $(1, 1)$ . The current  $T$  is positive by plurisubharmonicity of  $G_f$ , and we can also see that it is non-zero. Indeed, if  $\omega$  denotes the standard Kähler form on  $\mathbb{P}_{\mathbb{C}}^k$ , then considering the extension of  $f$  to  $\mathbb{P}_{\mathbb{C}}^k$ , we see that  $\bar{T} := \lim_{n \rightarrow +\infty} \frac{(f^n)^* \omega}{d^n}$  is a well-defined positive closed current on  $\mathbb{P}_{\mathbb{C}}^k$  of mass one which gives zero mass to the hyperplane at infinity  $\{z_k = 0\}$ , hence  $T = \bar{T}|_{\mathbb{C}^k}$  has mass one in  $\mathbb{C}^k$ .

When the map  $f$  is a polynomial automorphism, we also denote  $G_f^+ := G_f$ ,  $G_f^- := G_{f^{-1}}$ ,  $T_f^+ := T_f$ , and  $T_f^- := T_{f^{-1}}$ .

Let  $f \in \text{End}(\mathbb{C}^k)$  be algebraically stable of degree  $d \geq 2$ , and let  $G = G_f$  and  $T = T_f$ . By construction,  $G$  and  $T$  transform nicely under the dynamics:

$$G \circ f = d \cdot G, \quad f^*(T) := dd^c(G \circ f) = d \cdot T. \quad (1.1)$$

The set  $\{p \in \mathbb{C}^k \mid G(p) > 0\}$  corresponds to points which escape to infinity with maximal speed. Moreover, it is a trapping region in the sense that  $f(\overline{\{p \in \mathbb{C}^k \mid G(p) > 0\}}) \subset \{p \in \mathbb{C}^k \mid G(p) > 0\}$ ; indeed, for any  $c > 0$ , it follows from (1.1) that the level set  $\{p \in \mathbb{C}^k \mid G(p) = c\}$  is mapped by  $f$  to the level set  $\{p \in \mathbb{C}^k \mid G(p) = dc\}$ .

**Theorem 3.24** (Fornaess-Sibony, [12]). *Given  $f \in \text{End}(\mathbb{C}^k)$  that is algebraically stable, let  $G = G_f$  and  $T = T_f$ . Then the support of  $T$  is contained in the set  $J_f^+$ , which is thus nonempty.*

**Proposition 3.25** (Guedj-Sibony, [15]). *Let  $f \in \text{End}(\mathbb{C}^k)$  be algebraically stable, and let  $G = G_f$ . Then*

$$\limsup_{\|p\| \rightarrow \infty} \frac{G(p)}{\log \|p\|} = 1.$$

Moreover, the set  $\{p \in \mathbb{C}^k \mid G(p) > 0\}$  is connected, and of infinite measure on any complex line where  $G$  is not identically zero.

For any  $f \in \text{End}(\mathbb{C}^k)$  which is algebraically stable, one can inductively define the analytic sets  $X_j(f)$  by

$$\begin{cases} X_1(f) = \overline{\{z_k = 0\} \setminus \text{Ind}(f)}, \\ X_{j+1}(f) = f(X_j(f) \setminus \text{Ind}(f)), \quad \forall j \geq 1. \end{cases}$$

The sequence  $(X_j(f))_j$  is decreasing,  $X_j(f)$  is non-empty since  $f$  is algebraically stable, so it is stationary. Denote by  $X(f)$  the corresponding limit set. In particular,  $X(f)$

is always contained in  $\{z_k = 0\}$ . In this case, we also introduce  $U(f)$ , the basin of attraction of  $X(f)$ :

$$U(f) := \{p \in \mathbb{C}^k \mid \lim_{n \rightarrow +\infty} f^n(p) \in X(f)\},$$

and we set  $\mathcal{K}(f) := \mathbb{C}^k \setminus U(f)$ .

**Theorem 3.26** (Guedj-Sibony, [15]). *Let  $f \in \text{End}(\mathbb{C}^k)$  be algebraically stable, and let  $G = G_f$ . Then*

$$\mathcal{K}(f) \subset \{p \in \mathbb{C}^k \mid G(p) = 0\}. \quad (1.2)$$

*In particular,  $U(f)$  is of infinite measure and has non-empty fine interior. Moreover, the basin of any attractive fixed point has complement of infinite measure which is open in the fine topology. When  $f$  is a biholomorphism, such a basin is biholomorphic to  $\mathbb{C}^k$ .*

**Remark 3.27.** *By definition, (1.2) means that points whose forward iterates are not attracted by  $X(f)$  do not escape to infinity with maximal speed. Yet, in general, the set  $\mathcal{K}(f)$  is different from the set of points with bounded forward orbit.*

### 1.2.3. Weakly regular endomorphisms.

**Definition 3.28** (Weakly regular endomorphism). *Let  $f \in \text{End}(\mathbb{C}^k)$  be algebraically stable. We say that  $f$  is weakly regular if  $X(f) \cap \text{Ind}(f) = \emptyset$ .*

Let  $f \in \text{End}(\mathbb{C}^k)$ . In this case,  $X(f)$  is an attracting set for  $f$ ; in other words there exists an open neighborhood  $\mathcal{V}$  of  $X(f)$  such that  $f(\mathcal{V}) \Subset \mathcal{V}$  and  $\bigcap_{j=1}^{+\infty} f^j(\mathcal{V}) = X(f)$ .

**Theorem 3.29** (Guedj-Sibony, [15]). *Let  $f \in \text{End}(\mathbb{C}^k)$  be weakly regular. The following assertions hold:*

- (1)  $\mathcal{K}(f) = \{p \in \mathbb{C}^k \mid G(p) = 0\}$ , and  $G$  is continuous in  $\mathbb{C}^k$ ; in particular,  $\mathcal{K}(f)$  is closed in  $\mathbb{C}^k$ ;
- (2)  $\overline{\partial\mathcal{K}(f)} \cap \{z_k = 0\} = \overline{\mathcal{K}(f)} \cap \{z_k = 0\} = \text{Ind}(f)$ ;
- (3)  $\dim(X(f)) + \dim(\text{Ind}(f)) = k - 2$ .

**Theorem 3.30** (Guedj-Sibony, [15]). *Let  $f \in \text{Aut}(\mathbb{C}^k)$ . Assume that  $f^{-1}$  is weakly regular and that  $\text{Ind}(f^{-1})$  is an attracting set for  $f$ . Then we have:*

- (1)  $K_f^- = \mathcal{K}(f^{-1}) = \{p \in \mathbb{C}^k \mid G_f^-(p) = 0\}$ , and thus,  $K_f^-$  is closed in  $\mathbb{C}^k$ ;
- (2) let  $\mathcal{B}(\text{Ind}(f^{-1}))$  denote the basin of attraction of  $\text{Ind}(f^{-1})$ ; then  $K_f^+ = \mathbb{C}^k \setminus \mathcal{B}(\text{Ind}(f^{-1}))$ , and  $K_f^+$  is closed in  $\mathbb{C}^k$ ;
- (3)  $\overline{K_f^+} \cap \{z_k = 0\} = X(f^{-1}) = \overline{J_f^+} \cap \{z_k = 0\}$ ;
- (4)  $K_f = K_f^+ \cap K_f^-$  is a compact polynomially convex subset of  $\mathbb{C}^k$  which contains the non-wandering set of  $f$ ;
- (5)  $\mathcal{W}_f^s(K_f) = K_f^+$ , and  $\mathcal{W}_f^u(K_f) = K_f^-$ .

### 1.2.4. Regular automorphisms.

**Definition 3.31** (Regular automorphism). *Let  $k \geq 1$  be an integer. A polynomial automorphism  $f \in \text{Aut}(\mathbb{C}^k)$  is regular if  $\text{Ind}(f) \cap \text{Ind}(f^{-1}) = \emptyset$ .*

It is direct to see that any regular automorphism  $f$  is weakly regular, as well as its inverse  $f^{-1}$ . It follows that both  $f$  and  $f^{-1}$  are algebraically stable.

**Example 3.32.** *Let us consider the case where  $k = 2$ . With the notations introduced previously, we can check that any element  $f \in \mathcal{H}$  is regular. In particular, regular automorphisms can be seen as a generalization of automorphisms of Hénon type to higher dimension.*

**Remark 3.33.** Observe that the notion of regular automorphism depends on the choice of coordinates, because when we conjugate a regular automorphism by a polynomial automorphism, the action on the hyperplane at infinity is not under control, and it may happen that the new automorphism is not regular.

When  $k = 3$ , Bisi was able to give a description of the centralizer of regular polynomial automorphisms of  $\mathbb{C}^3$ . In this respect, we see that the behaviour of such maps is similar to that of automorphisms of Hénon type in dimension 2.

**Theorem 3.34** (Bisi, [6]). *Let  $f \in \text{Aut}(\mathbb{C}^3)$  be a regular polynomial automorphism, and let  $g \in \text{Cent}(f, \text{Aut}(\mathbb{C}^3))$ . Then there exist two integers  $n, m \in \mathbb{Z}$  such that  $f^n = g^m$ .*

For regular automorphisms, various results obtained previously for algebraically stable and weakly regular maps can be strengthened.

**Theorem 3.35** (Guedj-Sibony, [15]). *Let  $f$  be a regular polynomial automorphism of  $\mathbb{C}^k$ . Then we have  $f(\{z_k = 0\} \setminus \text{Ind}(f)) = \text{Ind}(f^{-1})$ , so  $X(f) = \text{Ind}(f^{-1})$ , and  $X(f^{-1}) = \text{Ind}(f)$ . In particular, the set  $\text{Ind}(f)$  is attracting for  $f^{-1}$ , and  $\text{Ind}(f^{-1})$  is attracting for  $f$ .*

From this, we see that all the results appearing in Theorem 3.30 above apply in the case of regular automorphisms. Let us collect some consequences of previous results and of the works [3, 15, 4, 12, 1, 2].

**Proposition 3.36.** *Given any regular automorphism  $f$  of  $\mathbb{C}^k$  of degree at least 2, the following is true:*

- the functions  $G_f^+$  and  $G_f^-$  are continuous;
  - $K_f^+$  and  $K_f^-$  are closed in  $\mathbb{C}^k$ , and we have
- $$K_f^+ = \mathcal{K}(f) = \{p \in \mathbb{C}^k \mid G_f^+(p) = 0\}, \quad K_f^- = \mathcal{K}(f^{-1}) = \{p \in \mathbb{C}^k \mid G_f^-(p) = 0\};$$
- in other terms, any point with unbounded forward orbit escapes goes to the attractor  $X(f)$  with maximal speed, and similarly in the past;*
- the interior of  $K_f^\pm$  is contained in the Fatou set  $F(f^{\pm 1})$ ;
  - the set  $K_f$  of points with bounded orbit is a compact subset of  $\mathbb{C}^k$ ;
  - assume that  $\dim(X(f^{\pm 1})) = 0$ ; in this case,  $T_f^\pm$  is extremal in the cone of closed positive currents of bidegree  $(1, 1)$  on  $\mathbb{P}_{\mathbb{C}}^k$  whose support is contained in  $\overline{K_f^\pm} = K_f^\pm \cup X(f^{\mp 1})$  and is the unique positive closed current of bidegree  $(1, 1)$  and of mass 1 with support on  $\overline{K_f^\pm}$ ;
  - set  $\ell := \dim(\text{Ind}(f^{-1})) + 1$ . We denote by  $J_{f,\ell}^+$  the intersection with  $\mathbb{C}^k$  of the support of the current  $(T_f^+)^\ell$ , and by  $J_{f,k-\ell}^-$  the intersection with  $\mathbb{C}^k$  of the support of  $(T_f^-)^{k-\ell}$ . Then the current  $\mu_f := (T_f^+)^\ell \wedge (T_f^-)^{k-\ell}$  is invariant under  $f$  and defines a probability measure on  $J_{f,\ell}^+ \cap J_{f,k-\ell}^-$ ;
  - for any saddle fixed point  $p$  of  $f$ , we have  $\mathcal{W}_f^s(p) \subset J_f^+$ , and  $\mathcal{W}_f^u(p) \subset J_f^-$ .

**Example 3.37.** Recall that  $\mathcal{H}$  denotes the semigroup of polynomial automorphisms of  $\mathbb{C}^2$  generated by Hénon automorphisms. Let  $f \in \mathcal{H}$ , with  $d := \deg(f) \geq 2$ ;  $f$  is a regular automorphism, and the Green functions  $G_f^+$  and  $G_f^-$  are Hölder continuous. Moreover, by construction, the associate Green currents satisfy  $f^*(T_f^+) = d \cdot T_f^+$  and  $f^*(T_f^-) = \frac{1}{d} T_f^-$ . Letting  $\mu_f := T_f^+ \wedge T_f^-$ , one sees that the current  $\mu_f$  is indeed invariant by  $f$ :

$$f^*(\mu_f) = f^*(T_f^+) \wedge f^*(T_f^-) = d \cdot T_f^+ \wedge d^{-1} \cdot T_f^- = \mu_f.$$

In this case, the support of  $T_f^+$  coincides with  $J_f^+ = \partial K_f^+$ , which also equals the Julia set  $J(f)$  of  $f$ . Similarly, the support of  $T_f^-$  coincides with  $J_f^- = \partial K_f^-$ , which also equals



the Julia set  $J(f^{-1})$  of  $f^{-1}$ . Besides we have in this case that  $\dim(\text{Ind}(f^{\pm 1})) = 0$ , i.e.,  $\ell = k - \ell = 1$ . Then, it follows from the results recalled above that  $\mu_f$  is an invariant probability measure with support in the compact set  $\partial K_f$ .

**Theorem 3.38** (Bedford-Lyubich-Smillie, [1, 2, 3, 4]). *Let  $f \in \mathcal{H}$ . For any hyperbolic fixed point  $p$  of saddle type for  $f$ , that is, such that the eigenvalues  $\lambda_1, \lambda_2$  of the differential of  $f$  at  $p$  satisfy  $|\lambda_1| < 1 < |\lambda_2|$ , we have seen that  $\mathcal{W}_f^s(p) \subset J_f^+$  and  $\mathcal{W}_f^u(p) \subset J_f^-$ . In fact,  $\mathcal{W}_f^s(p)$  is dense in  $J_f^+$ , and similarly,  $\mathcal{W}_f^u(p)$  is dense in  $J_f^-$ . Equivalently, we have  $\overline{\mathcal{W}_f^s(p)} = J_f^+$  and  $\overline{\mathcal{W}_f^u(p)} = J_f^-$ .*

Moreover, the measure  $\mu_f$  maximizes entropy and is well approximated by Dirac masses at saddle points.

**Theorem 3.39** (Fornaess-Sibony, [12]). *Let  $f \in \text{Aut}(\mathbb{C}^k)$  be a regular automorphism such that  $\dim(X(f)) = 0$ , that is,  $\ell = 1$  with our previous notations. Then the measure  $\mu_f = T_f^+ \wedge (T_f^-)^{k-1}$  defined above is mixing. In other terms, for any test functions  $\varphi$  and  $\psi$ , we have*

$$\int \varphi(f^n)\psi d\mu_f \longrightarrow \left( \int \varphi d\mu_f \right) \left( \int \psi d\mu_f \right)$$

as  $n$  goes to infinity.

As a consequence, one recovers results obtained by Bedford-Smillie [3, 4] for Hénon maps.

**Corollary 3.40.** *For  $k = 2, 3$ , if  $f \in \text{Aut}(\mathbb{C}^k)$  is regular, then it is mixing for the measure  $\mu_f$  defined above. In particular, any element  $f \in \mathcal{H}$  is mixing with respect to  $\mu_f = T_f^+ \wedge T_f^-$ .*

## 2. Introduction to the results

As we detailed above, there exists a global description of the group of polynomial automorphism  $\text{Aut}(\mathbb{C}^2)$ . Contrary to the two-dimensional case, the group  $\text{Aut}(\mathbb{C}^3)$  and the dynamics of its elements are much less-known. Indeed, the algebraic structure of this group is poorly understood. In the following we study the properties of the family of polynomial automorphisms of  $\mathbb{C}^3$  given by

$$\Psi_\alpha : (z_0, z_1, z_2) \mapsto (z_0 + z_1 + z_0^q z_2^d, z_0, \alpha z_2),$$

where  $\alpha$  denotes a nonzero complex number with modulus  $\leq 1$ ,  $q$  an integer  $\geq 2$ , and  $d$  an integer  $\geq 1$ .

The automorphism  $\Psi_\alpha$  can be seen as a skew product over the map  $z_2 \mapsto \alpha z_2$ , and whose dynamics in the fibers is given by automorphisms of Hénon type. More precisely, if  $z_2 \in \mathbb{C}$ , let us denote  $\psi_{z_2} : (z_0, z_1) \mapsto (z_0 + z_1 + z_0^q z_2^d, z_0)$ ; then  $\Psi_\alpha(z_0, z_1, z_2) = (\psi_{z_2}(z_0, z_1), \alpha z_2)$ , and for every  $n \geq 1$ , we have  $\Psi_\alpha^n(z_0, z_1, z_2) = ((\psi_{z_2})_n(z_0, z_1), \alpha^n z_2)$ , where

$$(\psi_{z_2})_n = \psi_{\alpha^{n-1} z_2} \circ \cdots \circ \psi_{\alpha z_2} \circ \psi_{z_2}.$$

Let  $\Phi_\alpha$  be the polynomial automorphism of  $\mathbb{C}^3$  given by

$$\Phi_\alpha : (z_0, z_1, z_2) \mapsto (\alpha^l(z_0 + z_1 + z_0^q), \alpha^l z_0, \alpha z_2), \quad (2.1)$$

where  $l := \frac{d}{q-1}$ . It is possible to show that  $\Psi_\alpha$  is conjugate to  $\Phi_\alpha$  through the birational map of  $\mathbb{P}_{\mathbb{C}}^3$  given in the affine chart  $z_3 = 1$  by

$$\theta = (z_0 z_2^l, z_1 z_2^l, z_2),$$

that is,  $\theta \circ \Psi_\alpha = \Phi_\alpha \circ \theta$ . We introduce the homothety  $s_\alpha : (z_0, z_1) \mapsto \alpha^l(z_0, z_1)$ , and we denote by  $\phi := \psi_1$  the Hénon automorphism  $\phi : (z_0, z_1) \mapsto (z_0 + z_0^q + z_1, z_0)$ . Letting  $\phi_\alpha := s_\alpha \phi = \alpha^l \phi$ , one sees that

$$\Phi_\alpha(z_0, z_1, z_2) = (\phi_\alpha(z_0, z_1), \alpha z_2). \quad (2.2)$$

In particular,  $\Psi_\alpha$  is semi-conjugate to the automorphism of Hénon type  $\phi_\alpha$ . The advantage is that the action of  $\Phi_\alpha$  in the fibers, given by  $\phi_\alpha$ , is independent of the base point  $z_2$ . Moreover,  $\Phi_\alpha$  has better properties than  $\Psi_\alpha$ ; in particular, we will see that it is algebraically stable (see Subsection 3.1). Nevertheless  $\theta$  is birational so we might lose some information (see Section 7).

The family of automorphisms  $\{\Psi_\alpha\}_\alpha$  satisfies the following properties:

**Proposition G** (Déserti-L.). *Take  $0 < |\alpha| \leq 1$ . Then*

- *the first dynamical degree of the automorphism  $\Psi_\alpha$  (resp.  $\Psi_\alpha^{-1}$ ) is  $q \geq 2$ ;*
- *the centralizer of  $\Psi_\alpha$  is uncountable;*
- *if  $0 < |\alpha| \leq 1$ , then  $\Psi_\alpha$  preserves a unique rational fibration,  $\{z_2 = \text{cst}\}$ .*

We then focus on the dynamics of  $\Psi_\alpha$ ,  $0 < |\alpha| \leq 1$ . Let us introduce a definition. We denote by  $\varphi := \frac{1+\sqrt{5}}{2}$  the golden ratio. We say that the forward orbit of  $p$  goes to infinity with Fibonacci speed if the sequence  $(\Psi_\alpha^n(p)\varphi^{-n})_{n \geq 0}$  converges and  $\lim_{n \rightarrow +\infty} \Psi_\alpha^n(p)\varphi^{-n} = p' \neq 0_{\mathbb{C}^3}$ . In particular this implies

$$\|\Psi_\alpha^n(p)\| \sim \|p'\|\varphi^n.$$

The hypersurface  $\{z_2 = 0\}$  is fixed by  $\Psi_\alpha$ , and the induced map on it is a linear Anosov diffeomorphism. We see that for any  $p \in \{z_2 = 0\}$ , either its forward orbit goes to  $0_{\mathbb{C}^3}$  exponentially fast, or it escapes to infinity with Fibonacci speed. Concerning points escaping to infinity with maximal speed, we prove:

**Theorem H** (Déserti-L.). *Fix  $0 < |\alpha| \leq 1$ . For any point  $p \in \mathbb{C}^3$ , the limit  $\lim_{n \rightarrow +\infty} \frac{\log^+ \|\Psi_\alpha^n(p)\|}{q^n}$  exists. The function*

$$G_{\Psi_\alpha}^+(p) = \lim_{n \rightarrow +\infty} \frac{\log^+ \|\Psi_\alpha^n(p)\|}{q^n}$$

*is plurisubharmonic, Hölder continuous, and satisfies  $G_{\Psi_\alpha}^+ \circ \Psi_\alpha = q \cdot G_{\Psi_\alpha}^+$ . Set  $\ell := 2 \max\left(\frac{d}{q-1}, 1\right)$ ; then*

$$1 \leq \limsup_{\|p\| \rightarrow +\infty} \frac{G_{\Psi_\alpha}^+(p)}{\log \|p\|} \leq \ell.$$

*Moreover, the set  $\mathcal{E} := \{p \in \mathbb{C}^3 \mid G_{\Psi_\alpha}^+(p) > 0\}$  of points escaping to infinity with maximal speed is open, connected, and has infinite Lebesgue measure on any complex line where  $G_{\Psi_\alpha}^+$  is not identically zero. In particular, the set  $\{p \in \mathbb{C}^3 \mid \lim_{n \rightarrow +\infty} \|\Psi_\alpha^n(p)\| = +\infty\}$  is of infinite measure. We also exhibit an explicit open set  $\Omega \subset \mathcal{E}$ .*

**Theorem I** (Déserti-L.). *Assume  $0 < |\alpha| < 1$ . Then  $\Psi_\alpha$  has a unique periodic point at finite distance,  $0_{\mathbb{C}^3} = (0, 0, 0)$ , which is a saddle point of index 2. The fixed hypersurface  $\{z_2 = 0\}$  attracts any other point. Moreover, the set  $K_{\Psi_\alpha}^+$  of points with bounded forward orbit is exactly the stable manifold  $\mathcal{W}_{\Psi_\alpha}^s(0_{\mathbb{C}^3})$ , and the latter can be characterized analytically. The set  $J_{\Psi_\alpha}^+ := \partial K_{\Psi_\alpha}^+$  thus corresponds to  $\overline{\mathcal{W}_{\Psi_\alpha}^s(0_{\mathbb{C}^3})}$ .*

We observe a phase transition in the dynamics of the family  $\{\Psi_\alpha\}_{0 < |\alpha| \leq 1}$  for the value  $|\alpha| = \varphi^{(1-q)/d}$ :

**Theorem J** (Déserti-L.). *Assume  $0 < |\alpha| < \varphi^{(1-q)/d}$ . The set  $\mathcal{V} := \{p \in \mathbb{C}^3 \mid G_{\Psi_\alpha}^+(p) = 0\}$  is a closed neighborhood of the hyperplane  $\{z_2 = 0\}$ . It consists in the disjoint union  $\Omega'' \sqcup \mathcal{W}_{\Psi_\alpha}^s(0_{\mathbb{C}^3})$ , where  $\Omega''$  has non-empty interior and the forward orbit of any point  $p \in \Omega''$  goes to infinity with Fibonacci speed.*

Note that we also define an analytic function  $g$  whose domain of definition is equal to  $\mathcal{V}$ , and which parametrizes the stable manifold in the sense that  $\mathcal{W}_{\Psi_\alpha}^s(0_{\mathbb{C}^3})$  coincides with the zero set  $\mathcal{Z}$  of  $g$ .

**Theorem K** (Déserti-L.). *Assume now  $\varphi^{(1-q)/d} < |\alpha| < 1$ . For any  $p \in \mathbb{C}^3$ , exactly one of the following cases occurs:*

- either  $p \in \mathcal{W}_{\Psi_\alpha}^s(0_{\mathbb{C}^3})$  and its forward orbit converges to  $0_{\mathbb{C}^3}$  exponentially fast;
- or  $p \in \{z_2 = 0\} \setminus \mathcal{W}_{\Psi_\alpha}^s(0_{\mathbb{C}^3})$  and it goes to infinity with Fibonacci speed;
- or the speed explodes:  $G_{\Psi_\alpha}^+(p) > 0$ .

In particular, contrary to the previous situation where the set  $\Omega''$  has non-empty interior, we see here that Fibonacci speed does not occur outside the hypersurface  $\{z_2 = 0\}$ .

**Remark 3.41.** *We stress the fact that for any  $0 < |\alpha| < 1$ , the forward orbit of a point under  $\Psi_\alpha$  is bounded if and only if it goes to  $0_{\mathbb{C}^3}$ . Moreover, we see that in the case the orbit is unbounded, it has to escape to infinity. This rigidity phenomenon is related to the properties of the automorphism of Hénon type  $\phi_\alpha$  to which  $\Psi_\alpha$  is semi-conjugate, and which possesses an attractor at infinity such that the positive iterates of any point whose forward orbit is not bounded escape to it.*

**Theorem L** (Déserti-L.). *Assume  $|\alpha| = 1$ . We define  $K_{\Psi_\alpha}$  to be the set of points  $p \in \mathbb{C}^3$  whose orbit  $(\Psi_\alpha^n(p))_{n \in \mathbb{Z}}$  is bounded. Similarly to what we did above, we define the Green function  $G_{\Psi_\alpha}^-$ . Then for any point  $p \in \mathbb{C}^3$ , exactly one of the following assertions is satisfied:*

- either the orbit of  $p$  is bounded, i.e.  $p \in K_{\Psi_\alpha}$ ;
- or  $p \in \{z_2 = 0\} \setminus \{0_{\mathbb{C}^3}\}$  and either its forward orbit or its backward orbit escapes to infinity with Fibonacci speed;
- or  $G_{\Psi_\alpha}^+(p) > 0$  or  $G_{\Psi_\alpha}^-(p) > 0$ ; in this case, either its forward orbit or its backward orbit escapes to infinity with maximal speed.

We define the associate Green currents  $T_{\Psi_\alpha}^\pm := dd^c G_{\Psi_\alpha}^\pm$ , and we set  $\mu_{\Psi_\alpha} := T_{\Psi_\alpha}^+ \wedge T_{\Psi_\alpha}^- \wedge dz_2 \wedge d\bar{z}_2$ . The measure  $\mu_{\Psi_\alpha}$  is invariant by  $\Psi_\alpha$  and supported on the set  $\partial K_{\Psi_\alpha}$ . For any  $p_2 \neq 0$ , the set  $\mathcal{C}_{p_2} := \mathbb{C}^2 \times \{p_2 e^{ix} \mid x \in \mathbb{R}\}$  is invariant under  $\Psi_\alpha$ . Define  $\mathcal{J}_{p_2} := \partial K_{\Psi_\alpha} \cap \mathcal{C}_{p_2}$ ; it is also invariant and we show that when  $\alpha$  is not a root of unity,  $(\Psi_\alpha|_{\mathcal{J}_{p_2}}, \mu_{\Psi_\alpha})$  is ergodic.

### 3. Degree growths & invariant fibrations

#### 3.1. Degrees and degree growths.

The results in this part hold for any  $\alpha \neq 0$ . As we saw previously, the first dynamical degree is an important invariant; in this section we will thus compute  $\lambda(\Psi_\alpha^{\pm 1})$  and  $\lambda(\Phi_\alpha^{\pm 1})$ . Let us first mention a big difference between dimension 2 and higher dimensions: if  $f$  belongs to  $\text{Aut}(\mathbb{C}^2)$  then  $\deg f = \deg f^{-1}$ . This equality does not necessarily hold in higher dimension; nevertheless if  $f$  belongs to  $\text{Aut}(\mathbb{C}^n)$ , then  $\deg f \leq (\deg f^{-1})^{n-1}$  and  $\deg f^{-1} \leq (\deg f)^{n-1}$  (see [26]).

**Lemma 3.42.** *We have for any  $n \geq 0$  both*

$$\deg(\Psi_\alpha^n) = q^n + d \times \frac{q^n - 1}{q - 1}$$

and

$$\deg(\Psi_\alpha^{-n}) = \deg(\Psi_\alpha^n).$$

PROOF. Let us denote by  $(P_\alpha^{(n)})_{n \geq -1}$  the sequence of polynomials where

$$\begin{cases} P_\alpha^{(-1)}(z_0, z_1, z_2) := z_1 \\ P_\alpha^{(0)}(z_0, z_1, z_2) := z_0 \\ \forall n \geq 0 \quad P_\alpha^{(n+1)} := P_\alpha^{(n)} + P_\alpha^{(n-1)} + (P_\alpha^{(n)})^q (\alpha^n z_2)^d. \end{cases}$$

In particular, for every  $n \geq 0$ ,  $\Psi_\alpha^n(z_0, z_1, z_2) = (P_\alpha^{(n)}(z_0, z_1, z_2), P_\alpha^{(n-1)}(z_0, z_1, z_2), \alpha^n z_2)$ . Since the degree of the third component does not change, and the second component is just the first one at time  $n - 1$ , the growth of the degree is supported by the first component, that is  $\deg(\Psi_\alpha^n) = \deg(P_\alpha^{(n)})$ . Let us then show the result by induction on  $n$ . The result is true for  $n = 0$ . If it holds for  $n \geq 0$ , then we have

$$\deg(P_\alpha^{(n+1)}) = \deg\left((P_\alpha^{(n)})^q (\alpha^n z_2)^d\right) = q \left( q^n + d \times \frac{q^n - 1}{q - 1} \right) + d = q^{n+1} + d \times \frac{q^{n+1} - 1}{q - 1}.$$

□

Recall that for a polynomial automorphism  $f$  of  $\mathbb{C}^3$ , the first dynamical degree of  $f$  is defined by

$$\lambda(f) := \lim_{n \rightarrow +\infty} (\deg f^n)^{1/n}.$$

**Corollary 3.43.** *Since  $q^n \leq \deg(\Psi_\alpha^n) \leq (d+1)q^n$ , it follows that*

$$\lambda(\Psi_\alpha) = \lambda(\Psi_\alpha^{-1}) = q.$$

Following the definition of algebraic stability recalled in Subsection 1.2.2, Lemma 3.42 and Proposition 3.22 imply that  $\Psi_\alpha$  is not algebraically stable, as well as  $\Psi_\alpha^{-1}$ . It can also be seen directly from the definition. Indeed the map

$$\Psi_\alpha = ((z_0 + z_1)z_3^{q+d-1} + z_0^q z_2^d : z_0 z_3^{q+d-1} : \alpha z_2 z_3^{q+d-1} : z_3^{q+d})$$

sends  $z_3 = 0$  onto  $(1 : 0 : 0 : 0)$  and  $\text{Ind}(\Psi_\alpha) = \{z_0 = 0, z_3 = 0\} \cup \{z_2 = 0, z_3 = 0\}$ . Similarly, we see that

$$\text{Ind}(\Psi_\alpha^{-1}) = \{z_1 = 0, z_3 = 0\} \cup \{z_2 = 0, z_3 = 0\},$$

and  $\Psi_\alpha^{-1}$  sends  $z_3 = 0$  onto  $(0 : 1 : 0 : 0) \in \text{Ind}(\Psi_\alpha^{-1})$ .

Let us now consider the automorphism  $\Phi_\alpha$  introduced in (2.1). We see that  $\Phi_\alpha(\{z_0 \neq 0, z_3 = 0\}) = (1 : 0 : 0 : 0)$  does not belong to  $\text{Ind}(\Phi_\alpha)$  and  $(1 : 0 : 0 : 0)$  is a fixed point of  $\Phi_\alpha$  hence  $\Phi_\alpha^n(\{z_0 \neq 0, z_3 = 0\}) = (1 : 0 : 0 : 0)$  for any  $n \geq 1$ . In particular,  $\Phi_\alpha$  is algebraically stable. We have for every  $n \geq 0$ ,  $\deg(\Phi_\alpha^n) = q^n$ . As we have recalled, for  $n \geq 3$ , there exist examples of maps  $f \in \text{Aut}(\mathbb{C}^3)$  which are algebraically stable but whose inverse  $f^{-1}$  is not algebraically stable. Yet this is not the case for  $\Phi_\alpha$ . Indeed,

$$\Phi_\alpha^{-1}(z_0 : z_1 : z_2 : z_3) = \left( \frac{z_1 z_3^{q-1}}{\alpha^l} : -\frac{z_1 z_3^{q-1}}{\alpha^l} + \frac{z_0 z_3^{q-1}}{\alpha^l} - \frac{z_1^q}{\alpha^{lq}} : \frac{z_2 z_3^{q-1}}{\alpha} : z_3^q \right)$$

so  $\Phi_\alpha^{-1}(\{z_1 \neq 0, z_3 = 0\}) = (0 : 1 : 0 : 0)$  does not belong to  $\text{Ind}(\Phi_\alpha^{-1}) = \{z_1 = 0, z_3 = 0\}$  and is fixed by  $\Phi_\alpha^{-1}$ . Hence  $\Phi_\alpha^{-1}$  is also algebraically stable. As a result one can state:

**Proposition 3.44.** *For any integer  $n \geq 1$  the following equalities hold*

$$\deg(\Phi_\alpha^n) = \deg(\Phi_\alpha^{-n}) = q^n, \quad \lambda(\Phi_\alpha) = \lambda(\Phi_\alpha^{-1}) = q.$$

By (2.2), we have  $\Phi_\alpha(z_0, z_1, z_2) = (\alpha^l \phi(z_0, z_1), \alpha z_2)$ . Since the third component does not carry any growth, we similarly have

$$\deg(\phi_\alpha^n) = \deg(\phi_\alpha^{-n}) = q^n, \quad \lambda(\phi_\alpha) = \lambda(\phi_\alpha^{-1}) = q.$$

In particular,  $\phi_\alpha \in \text{Aut}(\mathbb{C}^2)$  satisfies  $\lambda(\phi_\alpha) \geq 2$ . We deduce from Theorem 3.5 that  $\phi_\alpha$  is an automorphism of Hénon type, i.e., it is conjugate to an element in  $\mathcal{H}$ .

**3.2. Rational invariant fibrations.** Let us come back to dimension 2 for a while. As we have recalled, if  $f$  is a polynomial automorphism of  $\mathbb{C}^2$ , the following dichotomy holds: either  $f$  is conjugate to an elementary automorphism, and then, it preserves a rational fibration, or  $f$  is of Hénon type, and in this case, it does not preserve any rational curve ([9]). Does there exist an analogous geometric criterion which could be used to distinguish polynomial automorphisms of  $\mathbb{C}^n$  for  $n \geq 3$ ? Contrary to the 2-dimensional case we will see, as soon as  $n = 3$ , that "no invariant rational curve" does not mean "first dynamical degree  $> 1$ ".

Assume that  $0 < |\alpha| \leq 1$ . Recall that

$$\Phi_\alpha = (\phi_\alpha(z_0, z_1), \alpha z_2),$$

and from what precedes, we know that  $\phi_\alpha$  is of Hénon type.

**Proposition 3.45.** *For any  $0 < |\alpha| \leq 1$ , the polynomial automorphism  $\Phi_\alpha$  preserves a unique rational fibration, the fibration given by  $\{z_2 = cst\}$ .*

**Corollary 3.46.** *For any  $0 < |\alpha| \leq 1$ , the polynomial automorphism  $\Psi_\alpha$  preserves a unique rational fibration, the fibration given by  $\{z_2 = cst\}$ .*

PROOF OF PROPOSITION 3.45. Since  $\phi_\alpha$  is of Hénon type, it does not preserve rational curves ([9]). Therefore, the only rational fibration invariant by  $\Phi_\alpha$  is  $\{z_2 = cst\}$ .  $\square$

#### 4. Centralizers

As we have recalled above, Lamy has proved that the centralizer of a polynomial automorphism of  $\mathbb{C}^2$  of Hénon type is essentially trivial ([21]), but for polynomial automorphisms of  $\mathbb{C}^k$ ,  $k \geq 3$ , unless for regular automorphisms (see [6]), few general results on centralizers are known.

Fix  $\alpha$  with  $0 < |\alpha| \leq 1$ . We would like to describe  $\text{Cent}(\Phi_\alpha, \text{Aut}(\mathbb{C}^3))$ . Of course it contains  $\{\Phi_\alpha^n \mid n \in \mathbb{Z}\}$  but also the following one-parameter family

$$\{(\eta z_0, \eta z_1, \nu z_2) \mid \nu \in \mathbb{C}^*, \eta \text{ a } (q-1)\text{-th root of unity}\}.$$

We show that the centralizer is essentially reduced to the iterates of  $\Phi_\alpha$  and such maps.

Let  $f \in \text{Cent}(\Phi_\alpha, \text{Aut}(\mathbb{C}^3))$ ; we write  $f = (f_0, f_1, f_2)$ .

**Lemma 3.47.** *We have  $\frac{\partial f_2}{\partial z_0} = 0$ ,  $\frac{\partial f_2}{\partial z_1} = 0$ . Therefore, the last component  $f_2$  only depends on  $z_2$ , and in fact it is a homothety:*

$$f_2(z_0, z_1, z_2) = f_2(z_2) = \mu z_2, \quad \mu \in \mathbb{C}^*.$$

PROOF. If we focus on the third coordinate in relation  $\Phi_\alpha \circ f = f \circ \Phi_\alpha$ , we get  $\alpha f_2 = f_2 \circ \Phi_\alpha$ , that is, for every  $(z_0, z_1, z_2) \in \mathbb{C}^3$ ,

$$\alpha f_2(z_0, z_1, z_2) = f_2(\alpha^l z_0 + \alpha^l z_1 + \alpha^l z_0^q, \alpha^l z_0, \alpha z_2).$$

Taking the derivatives in the different coordinates, we obtain:

$$\begin{cases} \alpha \frac{\partial f_2}{\partial z_0} &= \alpha^l (1 + q z_0^{q-1}) \frac{\partial f_2}{\partial z_0} \circ \Phi_\alpha + \alpha^l \frac{\partial f_2}{\partial z_1} \circ \Phi_\alpha, \\ \alpha \frac{\partial f_2}{\partial z_1} &= \alpha^l \frac{\partial f_2}{\partial z_0} \circ \Phi_\alpha, \\ \alpha \frac{\partial f_2}{\partial z_2} &= \alpha \frac{\partial f_2}{\partial z_2} \circ \Phi_\alpha. \end{cases} \quad (4.1)$$

Let us consider the first coordinate, and assume that  $\frac{\partial f_2}{\partial z_0} \neq 0$ ; we will get a contradiction by looking at highest-order terms in  $z_0$ . Since  $f_2 \in \mathbb{C}[z_1, z_2][z_0]$ , we can write  $f_2(z_0, z_1, z_2) = \sum_{k \leq k_0} R_k(z_1, z_2) z_0^k$ , where the  $R_k$  are polynomials and  $k_0$  is the degree in

$z_0$  of  $f_2$ . From our hypothesis,  $k_0 \geq 1$ . We also look at the expansion of  $R_{k_0} \neq 0$ :

$$R_{k_0}(z_1, z_2) = \sum_{m \leq m_0} Q_m(z_2) z_1^m, \quad Q_{m_0} \neq 0.$$

For the three terms, we look at the term of highest order in  $z_0$ :

$$\left\{ \begin{array}{l} \alpha \frac{\partial f_2}{\partial z_0}(z_0, z_1, z_2) = \alpha k_0 R_{k_0}(z_1, z_2) z_0^{k_0-1} + \dots \\ \alpha^l (1 + q z_0^{q-1}) \frac{\partial f_2}{\partial z_0} \circ \Phi_\alpha(z_0, z_1, z_2) = q k_0 \alpha^{l(k_0+m_0)} Q_{m_0}(\alpha z_2) z_0^{q k_0 + m_0 - 1} + \dots \\ \alpha^l \frac{\partial f_2}{\partial z_1} \circ \Phi_\alpha(z_0, z_1, z_2) = m_0 \alpha^{l(k_0+m_0)} Q_{m_0}(\alpha z_2) z_0^{q k_0 + m_0 - 1} + \dots \end{array} \right.$$

Since we assume  $k_0 \geq 1$ , and  $q > 1$ , we have  $q k_0 + m_0 - 1 > k_0 - 1$  so the coefficient of the term in  $z_0^{q k_0 + m_0 - 1}$  must vanish. But this coefficient is  $(q k_0 + m_0) \alpha^{l(k_0+m_0)} Q_{m_0}(\alpha z_2) \neq 0$ , a contradiction. Hence  $\frac{\partial f_2}{\partial z_0} = 0$ , and it follows from the second equation of (4.1) that  $\frac{\partial f_2}{\partial z_1} = 0$  as well. Therefore,  $f_2 = f_2(z_2)$ .

Now, since  $f \in \text{Aut}(\mathbb{C}^3)$ , we know that  $f_2$  is of degree at most 1. The map  $f$  commutes with  $\Phi_\alpha$ , so it must preserve its fixed point  $0_{\mathbb{C}^3}$ , and we conclude that  $f_2: z_2 \mapsto \mu z_2$  for some  $\mu \in \mathbb{C}^*$ .  $\square$

Recall that  $\phi_\alpha: (z_0, z_1) \mapsto \alpha^l(z_0 + z_0^q + z_1, z_0)$ . Let us denote  $\tilde{f} := (f_0, f_1)$ . By projecting the commutation relation on the first two coordinates, we get

$$\phi_\alpha \circ \tilde{f} = \tilde{f} \circ \Phi_\alpha. \quad (4.2)$$

**Lemma 3.48.** *The map  $\tilde{f}$  only depends on the first two coordinates.*

PROOF. We rewrite (4.2) as the following system:

$$\left\{ \begin{array}{l} \alpha^l f_0 + \alpha^l f_1 + \alpha^l f_0^q = f_0 \circ \Phi_\alpha \\ \alpha^l f_0 = f_1 \circ \Phi_\alpha. \end{array} \right. \quad (4.3)$$

We then get:

$$\alpha^l f_0 \circ \Phi_\alpha + \alpha^{2l} f_0 + \alpha^l f_0^q \circ \Phi_\alpha = f_0 \circ \Phi_\alpha^2.$$

Let  $d_0$  be the degree of  $f_0 \in \mathbb{C}[z_0, z_1][z_2]$ . Since  $\Phi_\alpha$  does not change the degree in  $z_2$ , we obtain

$$\deg(\alpha^l f_0 \circ \Phi_\alpha) = \deg(\alpha^{2l} f_0) = \deg(f_0 \circ \Phi_\alpha^2) = d_0, \quad \deg(\alpha^l f_0^q \circ \Phi_\alpha) = d_0^q,$$

but  $q > 1$ , which implies that  $d_0 = 0$ :  $f_0$  does not depend on  $z_2$ . Using the second equation of (4.3), we see that  $f_1$  does not depend on  $z_2$  either.  $\square$

Therefore, Equation (4.2) can be rewritten:

$$\phi_\alpha \circ \tilde{f} = \tilde{f} \circ \phi_\alpha.$$

But  $\phi_\alpha$  is an automorphism of Hénon type, so according to Theorem 3.10, one has that for some  $n \in \mathbb{N}$ :

**Corollary 3.49.** *The map  $\tilde{f}$  belongs to the countable set  $\text{Cent}(\phi_\alpha, \text{Aut}(\mathbb{C}^2)) \simeq \mathbb{Z} \times \mathbb{Z}_n$ .*

We have seen that for any  $f = (f_0, f_1, f_2) \in \text{Cent}(\Phi_\alpha, \text{Aut}(\mathbb{C}^3))$ ,  $(f_0, f_1)$  depends only on  $(z_0, z_1)$  and belongs to  $\text{Cent}(\phi_\alpha, \text{Aut}(\mathbb{C}^2))$ , and that  $f_2$  depends only on  $z_2$  and is a homothety. We conclude:

**Proposition 3.50.** *The centralizer of  $\Phi_\alpha$  in  $\text{Aut}(\mathbb{C}^3)$  is uncountable. More precisely*

$$\text{Cent}(\Phi_\alpha, \text{Aut}(\mathbb{C}^3)) = \text{Cent}(\phi_\alpha, \text{Aut}(\mathbb{C}^2)) \times \{z_2 \mapsto \mu z_2 \mid \mu \in \mathbb{C}^*\} \simeq (\mathbb{Z} \times \mathbb{Z}_n) \times \mathbb{C}^*, \quad n \in \mathbb{N}.$$

**Corollary 3.51.** *The centralizer of  $\Psi_\alpha$  in  $\text{Aut}(\mathbb{C}^3)$  is uncountable.*

### 5. Dynamics on the invariant hypersurface $z_2 = 0$

The following holds for any  $\alpha \neq 0$ . Let us recall that the Fibonacci sequence is the sequence  $(F_n)_n$  defined by:  $F_0 = 0$ ,  $F_1 = 1$  and for all  $n \geq 2$

$$F_n = F_{n-1} + F_{n-2}.$$

The hypersurface  $\{z_2 = 0\}$  is invariant, and when  $|\alpha| < 1$ , it attracts every point  $p \in \mathbb{C}^3$ . On restriction to this hypersurface, the growth is given by the Fibonacci numbers  $(F_n)_n$ :

$$\Psi_\alpha^n|_{z_2=0} = (F_{n+1}z_0 + F_n z_1, F_n z_0 + F_{n-1} z_1), \quad n \geq 1. \quad (5.1)$$

Similarly,

$$\Psi_\alpha^{-1}(z_0, z_1, z_2) = \left( z_1, -z_1 + z_0 - z_1^q \frac{z_2^d}{\alpha^d}, \frac{z_2}{\alpha} \right),$$

and we have

$$\Psi_\alpha^{-n}|_{z_2=0}: (z_0, z_1) \mapsto (-1)^n (F_{n-1}z_0 - F_n z_1, -F_n z_0 + F_{n+1} z_1), \quad n \geq 1. \quad (5.2)$$

Moreover, it is easy to see that any periodic point of  $\Psi_\alpha$  belongs to the hypersurface  $\{z_2 = 0\}$ . In fact,  $\Psi_\alpha$  has a unique fixed point at finite distance,  $0_{\mathbb{C}^3} = (0, 0, 0)$ , and has no periodic point of period larger than 1. Let  $\varphi := \frac{1+\sqrt{5}}{2}$  be the golden ratio and  $\varphi' := -1/\varphi$ . Since

$$F_n = \frac{\varphi^n - (\varphi')^n}{\sqrt{5}} = \frac{\varphi^n}{\sqrt{5}} + o(1),$$

we deduce from (5.1) that any point  $(\varphi'z, z, 0)$  with  $z \in \mathbb{C}$  converges to  $0_{\mathbb{C}^3}$  when we iterate  $\Psi_\alpha$ , while any other point of the form  $(\beta z, z, 0)$  with  $z \neq 0$  and  $\beta \neq \varphi'$  goes to infinity. Likewise, we see from (5.2) that any point  $(\varphi z, z, 0)$  with  $z \in \mathbb{C}$  converges to  $0_{\mathbb{C}^3}$  when we iterate  $\Psi_\alpha^{-1}$ , while any other point of the form  $(\beta z, z, 0)$  with  $z \neq 0$  and  $\beta \neq \varphi$  goes to infinity. Furthermore, in both cases, the speed of the convergence is exponential since it is in  $O(|\varphi|^{-n})$  with  $|\varphi| > 1$ . In other terms, the linear map  $\Psi_\alpha|_{z_2=0}: (z_0, z_1) \mapsto (z_0 + z_1, z_0)$  is hyperbolic, with a unique fixed point  $0_{\mathbb{C}^2} = (0, 0)$  of saddle type, and whose stable, respectively unstable manifolds correspond to the following lines:

$$\mathcal{W}_{\Psi_\alpha|_{z_2=0}}^s(0_{\mathbb{C}^2}) = \Delta_{\varphi'} := \{(\varphi'z, z) \mid z \in \mathbb{C}\}, \quad \mathcal{W}_{\Psi_\alpha|_{z_2=0}}^u(0_{\mathbb{C}^2}) = \Delta_\varphi := \{(\varphi z, z) \mid z \in \mathbb{C}\}.$$

Moreover,  $\varphi$  and  $\varphi'$  are just the eigenvalues of  $\Psi_\alpha|_{z_2=0}$ , and  $\Delta_\varphi, \Delta_{\varphi'}$  the corresponding eigenspaces.

### 6. Points with bounded forward orbit, description of the stable manifold

$$\mathcal{W}_{\Psi_\alpha}^s(0_{\mathbb{C}^3})$$

When  $0 < |\alpha| < 1$ , we remark that  $0_{\mathbb{C}^3}$  is a hyperbolic fixed point of saddle type. The tangent space at  $0_{\mathbb{C}^3}$  can be written as  $T_{0_{\mathbb{C}^3}}(\mathbb{C}^3) = E_{\Psi_\alpha}^s(0_{\mathbb{C}^3}) \oplus E_{\Psi_\alpha}^u(0_{\mathbb{C}^3})$ , where the stable, respectively unstable spaces are given by

$$E_{\Psi_\alpha}^s(0_{\mathbb{C}^3}) = \Delta_{\varphi'} \times \{0\} \oplus \{0_{\mathbb{C}^2}\} \times \mathbb{C}, \quad E_{\Psi_\alpha}^u(0_{\mathbb{C}^3}) = \Delta_\varphi \times \{0\}.$$

These spaces integrate to stable and unstable manifolds

$$\mathcal{W}_{\Psi_\alpha}^s(0_{\mathbb{C}^3}) := \{p \in \mathbb{C}^3 \mid \lim_{n \rightarrow +\infty} \Psi_\alpha^n(p) = 0_{\mathbb{C}^3}\},$$

$$\mathcal{W}_{\Psi_\alpha}^u(0_{\mathbb{C}^3}) := \{p \in \mathbb{C}^3 \mid \lim_{n \rightarrow +\infty} \Psi_\alpha^{-n}(p) = 0_{\mathbb{C}^3}\},$$

which are invariant by the dynamics; furthermore,  $\mathcal{W}_{\Psi_\alpha}^u(0_{\mathbb{C}^3}) = \Delta_\varphi \times \{0\}$ , while  $\mathcal{W}_{\Psi_\alpha}^s(0_{\mathbb{C}^3})$  is biholomorphic to  $\mathbb{C}^2$  (see [26]). Note that  $(\Delta_{\varphi'} \times \{0\}) \cup (\{0_{\mathbb{C}^2}\} \times \mathbb{C}) \subset \mathcal{W}_{\Psi_\alpha}^s(0_{\mathbb{C}^3})$ , but it is easy to see<sup>2</sup> that  $\mathcal{W}_{\Psi_\alpha}^s(0_{\mathbb{C}^3}) \neq \Delta_{\varphi'} \times \mathbb{C}$ .

2. Indeed if  $p = (p_0, p_1, p_2)$  satisfies  $p_2 \neq 0$  and  $p_1 = -\varphi p_0$ , we see that  $P_\alpha^{(0)}(p) + \varphi P_\alpha^{(1)}(p) = p_0(1 + \varphi - \varphi^2) + \varphi p_0^q p_2^d = \varphi p_0^q p_2^d \neq 0$  hence  $\Delta_{\varphi'} \times \mathbb{C}$  is not left invariant by  $\Psi_\alpha$ .

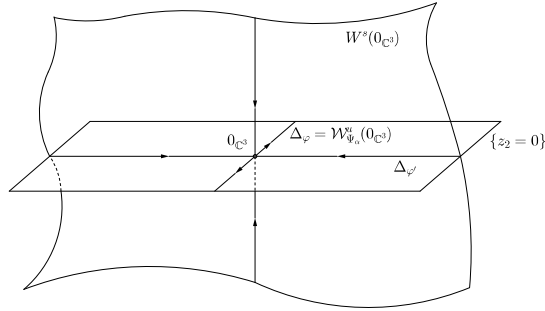

In the next statement, we introduce a series that encodes the growth of forward iterates of a point.

**Lemma 3.52.** *Let  $p = (p_0, p_1, p_2) \in \mathbb{C}^3$ . For every  $n \geq 0$  and any  $\alpha \in \mathbb{C}$ , we have*

$$P_\alpha^{(n+1)}(p) + \varphi^{-1}P_\alpha^{(n)}(p) = \varphi^n \left( \varphi p_0 + p_1 + p_2^d \sum_{j=0}^n \left( P_\alpha^{(j)}(p) \right)^q \varphi^{-j} \alpha^{jd} \right). \quad (6.1)$$

PROOF. For  $n \geq 0$  we have the following set of equalities:

$$\begin{aligned} P_\alpha^{(n+1)}(p) &= P_\alpha^{(n)}(p) + P_\alpha^{(n-1)}(p) + (P_\alpha^{(n)}(p))^q (\alpha^n p_2)^d \\ (\times \varphi) \quad P_\alpha^{(n)}(p) &= P_\alpha^{(n-1)}(p) + P_\alpha^{(n-2)}(p) + (P_\alpha^{(n-1)}(p))^q (\alpha^{n-1} p_2)^d \\ (\times \varphi^2) \quad P_\alpha^{(n-1)}(p) &= P_\alpha^{(n-2)}(p) + P_\alpha^{(n-3)}(p) + (P_\alpha^{(n-2)}(p))^q (\alpha^{n-2} p_2)^d \\ &\vdots = \quad \vdots + \quad \vdots + \quad \vdots \\ (\times \varphi^{n-1}) \quad P_\alpha^{(2)}(p) &= P_\alpha^{(1)}(p) + p_0 + (P_\alpha^{(1)}(p))^q (\alpha p_2)^d \\ (\times \varphi^n) \quad P_\alpha^{(1)}(p) &= p_0 + p_1 + (P_\alpha^{(0)}(p))^q (p_2)^d \end{aligned}$$

Summing up, and because  $\varphi^2 - \varphi - 1 = 0$ , we obtain

$$P_\alpha^{(n+1)}(p) + \varphi^{-1}P_\alpha^{(n)}(p) = \varphi^n \left( \varphi p_0 + p_1 + p_2^d \sum_{j=0}^n \left( P_\alpha^{(j)}(p) \right)^q \varphi^{-j} \alpha^{jd} \right).$$

□

For every  $n \geq -1$ , we define the polynomial  $g_n \in \mathbb{C}[z] = \mathbb{C}[z_0, z_1, z_2]$  by

$$g_n(z) := \varphi z_0 + z_1 + z_2^d \sum_{j=0}^n \left( P_\alpha^{(j)}(z) \right)^q \varphi^{-j} \alpha^{jd} = (P_\alpha^{(n+1)}(z) + \varphi^{-1}P_\alpha^{(n)}(z)) \varphi^{-n}.$$

We also introduce the power series

$$\begin{aligned} g(z) &:= \varphi z_0 + z_1 + z_2^d \sum_{j=0}^{+\infty} \left( P_\alpha^{(j)}(z) \right)^q \varphi^{-j} \alpha^{jd} \\ &= \varphi z_0 + z_1 + \sum_{j=-1}^{+\infty} \varphi^{-(j+1)} (P_\alpha^{(j+2)}(z) - P_\alpha^{(j+1)}(z) - P_\alpha^{(j)}(z)). \end{aligned}$$

Let us denote by  $\mathcal{D}$  its domain of definition, that is the set of  $p \in \mathbb{C}^3$  such that the series  $\sum_j \left( P_\alpha^{(j)}(p) \right)^q \varphi^{-j} \alpha^{jd}$  converges, and let

$$\mathcal{Z} := \{p \in \mathcal{D} \mid g(p) = 0\}$$



be the set of its zeroes. It is easy to check that both  $\mathcal{D}$  and  $\mathcal{Z}$  are invariant by the dynamics, that is  $\Psi_\alpha(\mathcal{D}) \subset \mathcal{D}$  and  $\Psi_\alpha(\mathcal{Z}) \subset \mathcal{Z}$ . Moreover, if  $p \in \mathcal{D}$ , we denote by  $r_n(p) := \sum_{j \geq n+1} \left( P_\alpha^{(j)}(p) \right)^q \varphi^{-j} \alpha^{jd}$  the tail of the corresponding series.

**Corollary 3.53.** *Suppose  $0 < |\alpha| \leq 1$ . Let  $K_{\Psi_\alpha}^+$  denote the set of points  $p = (p_0, p_1, p_2)$  whose forward orbit  $\{\Psi_\alpha^n(p), n \geq 0\}$  is bounded. This is equivalent to the fact that the sequence  $(|P_\alpha^{(n)}(p)|)_{n \geq 0}$  is bounded. If  $p \in K_{\Psi_\alpha}^+$ , then for every  $n \geq 0$ , we have*

$$|g_n(p)| = O(\varphi^{-n}). \quad (6.2)$$

In particular we deduce that

$$K_{\Psi_\alpha}^+ \subset \mathcal{Z}, \quad \text{and} \quad |r_n(p)| = O(\varphi^{-n}). \quad (6.3)$$

PROOF. It follows immediately from Lemma 3.52. Indeed under our assumptions we have:

$$|g_n(p)| \leq (|P_\alpha^{(n+1)}(p)| + \varphi^{-1}|P_\alpha^{(n)}(p)|)\varphi^{-n} = O(\varphi^{-n}).$$

This implies  $p \in \mathcal{Z}$ . Then we also have  $g_n(p) = g(p) - p_2^d r_n(p) = -p_2^d r_n(p)$  and  $|r_n(p)| = O(\varphi^{-n})$ .  $\square$

**Remark 3.54.** *We can see (6.3) as a codimension one condition that points with bounded forward orbit have to satisfy. Also, we see from (6.2) that locally, such points are close to the analytic manifold  $\mathcal{Z}_n := \{p \in \mathbb{C}^3 \mid g_n(p) = 0\}$  for  $n \geq 0$  big. If  $p = (p_0, p_1, 0)$ , we recover from (6.3) that  $p$  has bounded forward orbit if and only if it belongs to the stable manifold  $\mathcal{W}_{\Psi_\alpha}^s(0_{\mathbb{C}^3}) \cap \{z_2 = 0\} = \Delta_{\varphi'} \times \{0\}$ .*

When  $0 < |\alpha| < 1$ , we have the following analytic characterization of the stable manifold  $\mathcal{W}_{\Psi_\alpha}^s(0_{\mathbb{C}^3})$ .

**Proposition 3.55.** *Assume  $0 < |\alpha| < 1$ . The point  $p = (p_0, p_1, p_2) \in \mathbb{C}^3$  belongs to the stable manifold  $\mathcal{W}_{\Psi_\alpha}^s(0_{\mathbb{C}^3})$  if and only if the following properties hold:*

- $p \in \mathcal{Z}$ ;
- the series  $\sum_j |r_j(p)|\varphi^j$  is convergent.

Equivalently,  $p \in \mathcal{W}_{\Psi_\alpha}^s(0_{\mathbb{C}^3})$  if and only if  $\sum_j |g_j(p)|\varphi^j$  converges.

PROOF. If  $p$  belongs to the stable manifold  $\mathcal{W}_{\Psi_\alpha}^s(0_{\mathbb{C}^3})$ , then its forward orbit is bounded and Corollary 3.53 tells us that  $p \in \mathcal{Z}$ . Moreover we have

$$|r_n(p)| = O\left(\sum_{j \geq n+1} \varphi^{-j} \alpha^{jd}\right) = O(\varphi^{-n} |\alpha|^{nd}),$$

hence  $|r_n(p)|\varphi^n = O(|\alpha|^{nd})$  and the series  $\sum_j |r_j(p)|\varphi^j$  converges.

For the other implication, we get from Lemma 3.52 that for every  $j \geq 0$ ,

$$P_\alpha^{(j+1)}(p) + \varphi^{-1} P_\alpha^{(j)}(p) = -p_2^d \varphi^j r_j(p). \quad (6.4)$$

Now let  $n \geq 0$ . Write equations (6.4) for  $j = 0, \dots, n$  and combine them to obtain

$$P_\alpha^{(n+1)}(p) = \frac{(-1)^{n+1}}{\varphi^{n+1}} p_0 + p_2^d \sum_{j=0}^n (-1)^{n+j+1} r_j(p) \varphi^j \varphi^{j-n}.$$

The first term of the right hand side goes to 0 with  $n$ ; we split the sum as follows:

$$\begin{aligned} \sum_{j=0}^n (-1)^{n+j+1} r_j(p) \varphi^j \varphi^{j-n} &= \sum_{j=0}^{\lfloor n/2 \rfloor} (-1)^{n+j+1} r_j(p) \varphi^j \varphi^{j-n} \\ &+ \sum_{j=\lfloor n/2 \rfloor + 1}^n (-1)^{n+j+1} r_j(p) \varphi^j \varphi^{j-n}. \end{aligned}$$

We get

$$\left| \sum_{j=0}^{\lfloor n/2 \rfloor} (-1)^{n+j+1} r_j(p) \varphi^j \varphi^{j-n} \right| \leq \varphi^{\lfloor n/2 \rfloor - n} \sum_{j=0}^{+\infty} |r_j(p)| \varphi^j$$

hence it goes to 0 with respect to  $n$ . For the remaining term, we estimate

$$\left| \sum_{j=\lfloor n/2 \rfloor + 1}^n (-1)^{n+j+1} r_j(p) \varphi^j \varphi^{j-n} \right| \leq \sum_{j=\lfloor n/2 \rfloor + 1}^{+\infty} |r_j(p)| \varphi^j,$$

which goes to 0 as well. We conclude that  $\lim_{n \rightarrow +\infty} P_\alpha^{(n)}(p) = 0$ , hence  $p \in \mathcal{W}_{\Psi_\alpha}^s(0_{\mathbb{C}^3})$ .

The other equivalence follows from the fact that for  $p \in \mathcal{Z}$ , we have  $g_n(p) = -p_2^d r_n(p)$ .  $\square$

**Corollary 3.56.** *Assume  $0 < |\alpha| < 1$ . Then the forward orbit of a point  $p = (p_0, p_1, p_2)$  is bounded if and only if  $p$  belongs to the stable manifold  $\mathcal{W}_{\Psi_\alpha}^s(0_{\mathbb{C}^3})$ ; in other terms,  $K_{\Psi_\alpha}^+ = \mathcal{W}_{\Psi_\alpha}^s(0_{\mathbb{C}^3})$ .*

PROOF. Let  $p \in K_{\Psi_\alpha}^+$ . We have already seen in Corollary 3.53 that  $p \in \mathcal{Z}$ . Moreover, if we denote  $r_n(p) := \sum_{j \geq n+1} (P_\alpha^{(j)}(p))^q \varphi^{-j} \alpha^{jd}$ , then  $\sum_j |r_j(p)| \varphi^j$  is convergent since  $|r_j(p)| = O(\varphi^{-j} |\alpha|^{jd})$ . Then, Proposition 3.55 tells us that  $p \in \mathcal{W}_{\Psi_\alpha}^s(0_{\mathbb{C}^3})$ . The other implication is straightforward.  $\square$

**Lemma 3.57.** *Assume now  $|\alpha| = 1$ . We have seen that  $p \in K_{\Psi_\alpha}^+$  implies that  $p \in \mathcal{Z}$  and  $|r_n(p)| = O(\varphi^{-n})$ . Conversely, if  $p \in \mathcal{Z}$  and  $\sum_j |r_j(p)| \varphi^j$  is convergent, then  $p \in K_{\Psi_\alpha}^+$ .*

PROOF. Assume that  $p \in \mathcal{Z}$  and that  $\sum_j |r_j(p)| \varphi^j$  converges. As previously, we have for every  $n \geq 0$ :

$$P_\alpha^{(n)}(p) = \frac{(-1)^n}{\varphi^n} p_0 + p_2^d \sum_{j=0}^{n-1} (-1)^{n+j} r_j(p) \varphi^j \varphi^{j-(n-1)}.$$

From our assumption we deduce that  $|P_\alpha^{(n)}(p)| \leq |p_0| + |p_2|^d \sum_{j=0}^{+\infty} |r_j(p)| \varphi^j$ , hence  $|P_\alpha^{(n)}(p)| = O(1)$ .  $\square$

## 7. Birational conjugacy

Assume  $0 < |\alpha| \leq 1$ . We recall here some facts concerning the dynamics of the automorphism of Hénon type  $\phi_\alpha$ , and so on the dynamics of  $\Phi_\alpha = (\phi_\alpha, \alpha z_2)$ . Denote by  $F_{\phi_\alpha}^+ = F(\phi_\alpha)$  the largest open set on which  $(\phi_\alpha^n)_{n \geq 0}$  is locally equicontinuous, by  $K_{\phi_\alpha}^+$  the set of points  $p \in \mathbb{C}^2$  such that  $(\phi_\alpha^n(p))_{n \geq 0}$  is bounded and by  $J_{\phi_\alpha}^+$  its topological boundary. Recall that  $\phi_\alpha = \alpha^l \phi$ , where  $\phi = (z_0 + z_0^q + z_1, z_0)$  is a Hénon automorphism. In particular,  $\phi \in \mathcal{H}$ , hence it is *regular* (see Definition 3.31 and Example 3.32). It is direct to see that  $\text{Ind}(\phi_\alpha) = \text{Ind}(\phi)$ , and similarly for  $\phi_\alpha^{-1}$ . Therefore,  $\text{Ind}(\phi_\alpha) \cap \text{Ind}(\phi_\alpha^{-1}) =$

$\text{Ind}(\phi) \cap \text{Ind}(\phi^{-1}) = \emptyset$ , that is,  $\phi_\alpha$  is regular. In particular, it is algebraically stable (see Definition 3.20), hence we can define the Green function

$$G_{\phi_\alpha}^+ : (z_0, z_1) \mapsto \lim_{n \rightarrow +\infty} \frac{\log^+ \|\phi_\alpha^n(z_0, z_1)\|}{q^n}.$$

It satisfies the invariance property  $G_{\phi_\alpha}^+ \circ \phi_\alpha = q \cdot G_{\phi_\alpha}^+$ . We define the associate Green current  $T_{\phi_\alpha}^+ = \text{dd}^c G_{\phi_\alpha}^+$ . Of course there are similar objects  $F_{\phi_\alpha}^-, K_{\phi_\alpha}^-, J_{\phi_\alpha}^-, G_{\phi_\alpha}^-$  and  $T_{\phi_\alpha}^-$  associated to the inverse map  $\phi_\alpha^{-1}$ ; we also set  $K_{\phi_\alpha} := K_{\phi_\alpha}^+ \cap K_{\phi_\alpha}^-$ . One inherits a probability measure  $\mu_{\phi_\alpha} = T_{\phi_\alpha}^+ \wedge T_{\phi_\alpha}^-$  which is invariant by  $\phi_\alpha$ .

Since the automorphisms  $\phi_\alpha^{\pm 1}$  are regular, hence weakly regular, they possess attractors  $X(\phi_\alpha) = (1 : 0 : 0)$  and  $X(\phi_\alpha^{-1}) = (0 : 1 : 0)$  whose basins are biholomorphic to  $\mathbb{C}^2$ , by the result of Guedj-Sibony [15, Corollary 1.8] stated in Theorem 3.26. One denotes by  $\mathcal{K}(\phi_\alpha^\pm)$  the complement of these basins. Besides, according to the results of [8, 3, 4, 12, 1, 2] recalled previously, the following properties hold:

- the function  $G_{\phi_\alpha}^+$  is Hölder continuous;
- we have the following characterization of points with bounded orbit:
 
$$K_{\phi_\alpha}^\pm = \mathcal{K}(\phi_\alpha^\pm) = \{p \in \mathbb{C}^2 \mid G_{\phi_\alpha}^\pm(p) = 0\}; \quad (7.1)$$
 this tells us that points either have bounded forward orbit, or escape to  $X(\phi_\alpha^\pm)$  with maximal speed;
- let  $p$  be a saddle point of  $\phi_\alpha$ ; then  $J_{\phi_\alpha}^+$  is the closure of the stable manifold  $\mathcal{W}_{\phi_\alpha}^s(p)$ ;
- the support of  $T_{\phi_\alpha}^+$  coincides with the boundary of  $K_{\phi_\alpha}^+$ , i.e.,  $J_{\phi_\alpha}^+$ ;
- the current  $T_{\phi_\alpha}^+$  is extremal among positive closed currents in  $\mathbb{C}^2$  and is – up to a multiplicative constant – the unique positive closed current supported on  $K_{\phi_\alpha}^+$ ;
- the invariant measure  $\mu_{\phi_\alpha}$  has support in the compact set  $\partial K_{\phi_\alpha}$ , is mixing, maximises entropy and is well approximated by Dirac masses at saddle points.

One introduces analogous objects for the automorphism  $\Phi_\alpha$ . In particular,  $\Phi_\alpha$  is algebraically stable so we can also define the Green function

$$G_{\Phi_\alpha}^+ := \lim_{n \rightarrow +\infty} \frac{\log^+ \|\Phi_\alpha^n\|}{q^n}.$$

In fact, for any  $(z_0, z_1, z_2) \in \mathbb{C}^3$ ,  $G_{\Phi_\alpha}^+(z_0, z_1, z_2) = G_{\phi_\alpha}^+(z_0, z_1)$  because if  $z_2 \neq 0$ ,  $\lim_{n \rightarrow +\infty} \frac{\log |\alpha^n z_2|}{q^n} = 0$ . We introduce the holomorphic map

$$h: \mathbb{C}^3 \rightarrow \mathbb{C}^2, \quad h: (z_0, z_1, z_2) \mapsto (z_0 z_2^l, z_1 z_2^l).$$

It follows from the previous remark that  $G_{\Phi_\alpha}^+ \circ \theta = G_{\phi_\alpha}^+ \circ h$  where  $\theta = (z_0 z_2^l, z_1 z_2^l, z_2)$  conjugates  $\Phi_\alpha$  to  $\Psi_\alpha$  (i.e.  $\theta \Psi_\alpha = \Phi_\alpha \theta$ ). Moreover, for  $0 < |\alpha| < 1$ , one gets that

$$K_{\Phi_\alpha}^+ = K_{\phi_\alpha}^+ \times \mathbb{C}, \quad K_{\Phi_\alpha}^- = K_{\phi_\alpha}^- \times \{0\}, \quad K_{\Phi_\alpha} = K_{\phi_\alpha} \times \{0\},$$

while for  $|\alpha| = 1$ ,

$$K_{\Phi_\alpha}^+ = K_{\phi_\alpha}^+ \times \mathbb{C}, \quad K_{\Phi_\alpha}^- = K_{\phi_\alpha}^- \times \{\mathbb{C}\}, \quad K_{\Phi_\alpha} = K_{\phi_\alpha} \times \{\mathbb{C}\}.$$

Both  $\Phi_\alpha$  and  $\Phi_\alpha^{-1}$  are weakly regular (see Definition 3.28); furthermore  $X(\Phi_\alpha) = (1 : 0 : 0 : 0)$  and  $X(\Phi_\alpha^{-1}) = (0 : 1 : 0 : 0)$ . Therefore  $(1 : 0 : 0 : 0)$  (resp.  $(0 : 1 : 0 : 0)$ ) is an attracting point for  $\Phi_\alpha$  (resp.  $\Phi_\alpha^{-1}$ ). By Theorem 3.26 above, we know that the basin of attraction of  $(1 : 0 : 0 : 0)$  is biholomorphic to  $\mathbb{C}^3$ .

We do not inherit these properties for  $\Psi_\alpha$ . Indeed remark that  $K_{\Phi_\alpha}$ ,  $X(\Phi_\alpha)$  and  $X(\Phi_\alpha^{-1})$  are contained in  $\{z_2 = 0\}$ ; but  $\{z_2 = 0\}$  is contracted by  $\theta^{-1}$  (recall that  $\theta \Psi_\alpha = \Phi_\alpha \theta$ ) onto  $\{z_2 = z_3 = 0\}$  and  $\{z_2 = z_3 = 0\} = \text{Ind}(\Psi_\alpha)$ .

### 8. Definition of a Green function for $\Psi_\alpha$

In this part, we assume  $0 < |\alpha| \leq 1$ . As for  $\phi_\alpha$  and  $\Phi_\alpha$ , and despite the fact that  $\Psi_\alpha$  is not algebraically stable, we will see that it is possible to define a Green function for the automorphism  $\Psi_\alpha$  which has almost as good properties. In particular, we will see that this function carries a lot of information about the dynamics of the automorphism  $\Psi_\alpha$ . As for algebraically stable maps, we define this function as a limit, normalizing the growth of forward iterates of  $\Psi_\alpha$  by the first dynamical degree, which is equal here to  $q$ .

Let  $p = (p_0, p_1, p_2) \in \mathbb{C}^3$ , and define  $C = C(p_2) := 3 \max(1, |p_2|^d) > 0$ . We remark that for  $n \geq 0$ , we have  $|\alpha^n p_2|^d \leq C$ , hence  $\max(\|\Psi_\alpha^{n+1}(p)\|, 1) \leq C \max(\|\Psi_\alpha^n(p)\|, 1)^q$ . We deduce that for every  $n \geq 0$ ,

$$\left| \frac{\log^+ \|\Psi_\alpha^{n+1}(p)\|}{q^{n+1}} - \frac{\log^+ \|\Psi_\alpha^n(p)\|}{q^n} \right| \leq \frac{\log(C)}{q^{n+1}},$$

hence

$$\lim_{n \rightarrow +\infty} \frac{\log^+ \|\Psi_\alpha^n(p)\|}{q^n} = \lim_{n \rightarrow +\infty} \frac{\log^+ \max(|P_\alpha^{(n)}(p)|, |P_\alpha^{(n-1)}(p)|)}{q^n} =: G_{\Psi_\alpha}^+(p)$$

exists. By construction, the function  $G_{\Psi_\alpha}^+$  satisfies  $G_{\Psi_\alpha}^+ \circ \Psi_\alpha = q \cdot G_{\Psi_\alpha}^+$ . We note that on restriction to the hypersurface  $\{z_2 = 0\}$ ,

$$G_{\Psi_\alpha}^+|_{\{z_2=0\}} = 0.$$

Indeed, if  $p = (p_0, p_1, 0)$ , then  $\log^+ |P_\alpha^{(n)}(p)| = O(n)$  since we have seen that the forward iterates of  $p$  grow at most with Fibonacci speed.

For every  $n \geq 0$ , we have  $\theta \circ \Psi_\alpha^n = \Phi_\alpha^n \circ \theta$ . In particular, the following limits exist and satisfy:

$$\lim_{n \rightarrow +\infty} \frac{\log^+ \|\theta \circ \Psi_\alpha^n\|}{q^n} = \lim_{n \rightarrow +\infty} \frac{\log^+ \|\Phi_\alpha^n \circ \theta\|}{q^n} = G_{\Phi_\alpha}^+ \circ \theta. \quad (8.1)$$

Define the open set  $\mathcal{U} := \{(z_0, z_1, z_2) \in \mathbb{C}^3 \mid z_2 \neq 0\}$  and let  $p = (p_0, p_1, p_2) \in \mathcal{U}$ . For every  $n \geq 0$ , recall that

$$\theta \circ \Psi_\alpha^n(p) = \theta \left( P_\alpha^{(n)}(p), P_\alpha^{(n-1)}(p), \alpha^n p_2 \right) = \left( P_\alpha^{(n)}(p)(\alpha^n p_2)^l, P_\alpha^{(n-1)}(p)(\alpha^n p_2)^l, \alpha^n p_2 \right).$$

For  $j \in \{n-1, n\}$ , we have

$$\log^+ |P_\alpha^{(j)}(p)| - l \log^+ |\alpha^n p_2| \leq \log^+ |P_\alpha^{(j)}(p)(\alpha^n p_2)^l| \leq \log^+ |P_\alpha^{(j)}(p)| + l \log^+ |\alpha^n p_2|,$$

so that

$$\frac{\log^+ \|\theta \circ \Psi_\alpha^n(p)\|}{q^n} = \frac{\log^+ \|\Psi_\alpha^n(p)\|}{q^n} + o(1).$$

We deduce from (8.1) that

$$G_{\Psi_\alpha}^+(p) = \lim_{n \rightarrow +\infty} \frac{\log^+ \|\Psi_\alpha^n(p)\|}{q^n} = \lim_{n \rightarrow +\infty} \frac{\log^+ \|\theta \circ \Psi_\alpha^n(p)\|}{q^n} = G_{\Phi_\alpha}^+ \circ \theta(p) = G_{\Phi_\alpha}^+ \circ h(p). \quad (8.2)$$

Now if  $p = (p_0, p_1, 0)$ , then we have seen that  $G_{\Psi_\alpha}^+(p) = 0$ . Note that  $h(p) = 0_{\mathbb{C}^2}$  and  $\theta(p) = 0_{\mathbb{C}^3}$ ; therefore,  $G_{\Phi_\alpha}^+ \circ \theta(p) = G_{\Phi_\alpha}^+ \circ h(p) = 0$ . We conclude that (8.2) holds for any point  $p \in \mathbb{C}^3$ .

The function  $G_{\Psi_\alpha}^+$  is not  $\equiv -\infty$ , it is upper semicontinuous and satisfies the sub-mean value property (since  $G_{\Phi_\alpha}^+$  does and  $\theta: \mathbb{C}^3 \rightarrow \mathbb{C}^3$  is holomorphic); in other terms,  $G_{\Psi_\alpha}^+$  is plurisubharmonic. Moreover, we know that  $G_{\Phi_\alpha}^+$  is Hölder continuous, and  $h$  is holomorphic, hence  $G_{\Psi_\alpha}^+$  is Hölder continuous as well. We have shown:

**Proposition 3.58.** *For any point  $p \in \mathbb{C}^3$ , the limit*

$$\lim_{n \rightarrow +\infty} \frac{\log^+ \|\Psi_\alpha^n(p)\|}{q^n} =: G_{\Psi_\alpha}^+(p)$$

exists; the function  $G_{\Psi_\alpha}^+ = G_{\Phi_\alpha}^+ \circ \theta = G_{\phi_\alpha}^+ \circ h$  is plurisubharmonic, Hölder continuous, and satisfies  $G_{\Psi_\alpha}^+ \circ \Psi_\alpha = q \cdot G_{\Psi_\alpha}^+$ . We can then define the positive current  $T_{\Psi_\alpha}^+ := \text{dd}^c G_{\Psi_\alpha}^+$ . The maps  $\theta|_{\mathcal{U}}$  and  $h|_{\mathcal{U}}$  are submersions, and  $T_{\Psi_\alpha}^+|_{\mathcal{U}} = (\theta|_{\mathcal{U}})^*(T_{\Phi_\alpha}^+|_{\mathcal{U}}) = (h|_{\mathcal{U}})^*(T_{\phi_\alpha}^+|_{\mathcal{U}})$ . We also have  $\Psi_\alpha^*(T_{\Psi_\alpha}^+) = q \cdot T_{\Psi_\alpha}^+$ .

**Remark 3.59.** We observe that contrary to the case of  $\phi_\alpha$ , the set  $K_{\Psi_\alpha}^+$  of points whose forward orbit is bounded is strictly contained in  $\{p \in \mathbb{C}^3 \mid G_{\Psi_\alpha}^+(p) = 0\}$ ; indeed, we have seen that the latter always contains  $\{z_2 = 0\} \not\subset K_{\Psi_\alpha}^+$ .

### 9. Analysis of the dynamics of the automorphism $\Psi_\alpha$

In this section, we further analyze the dynamics of the automorphism  $\Psi_\alpha$ , distinguishing between the value of  $0 < |\alpha| \leq 1$ . In particular, we want to describe what happens outside the invariant hypersurface  $\{z_2 = 0\}$ , where we have seen that the dynamics corresponds to the one of a linear Anosov diffeomorphism.

We see that a transition occurs for  $|\alpha| = \varphi^{(1-q)/d}$ . Indeed, when  $|\alpha| < \varphi^{(1-q)/d}$ , we observe different behaviors in the escape speed outside  $\{z_2 = 0\}$  according to the choice of the starting point  $p = (p_0, p_1, p_2)$ : Fibonacci, or bigger than  $\eta^{q^n}$  for some  $\eta > 1$ . On the contrary, for  $|\alpha| > \varphi^{(1-q)/d}$ , we see that it is impossible to escape to infinity with Fibonacci speed, while the second case persists.

Let us say a few words about the critical value  $\varphi^{(1-q)/d}$  where the transition happens. We define the cocycle  $A: \mathbb{C}^3 \rightarrow \text{GL}_2(\mathbb{C})$  by:

$$A(z_0, z_1, z_2) := \begin{pmatrix} 1 + z_0^{q-1} z_2^d & 1 \\ 1 & 0 \end{pmatrix},$$

and if  $M \in \mathfrak{M}_2(\mathbb{C})$  and  $v = (v_0, v_1) \in \mathbb{C}^2$ , we set  $M \cdot v := vM^T$ . Recall that for every  $z_2 \in \mathbb{C}$ , we consider  $\psi_{z_2} = (z_0 + z_1 + z_0^q z_2^d, z_0)$ . We remark that for every  $p = (p_0, p_1, p_2) \in \mathbb{C}^3$ ,  $\psi_{p_2}(p_0, p_1) = A(p) \cdot (p_0, p_1)$ . As usual we denote  $A_0(p) := \text{Id}$  and for  $n \geq 1$ ,

$$A_n(p) := A(\Psi_\alpha^{n-1}(p)) \cdot A(\Psi_\alpha^{n-2}(p)) \dots A(\Psi_\alpha(p)) \cdot A(p).$$

In particular, for every  $n \geq 0$ ,  $\Psi_\alpha^n(p) = (A_n(p) \cdot (p_0, p_1), \alpha^n p_2)$ ; equivalently,  $(P_\alpha^{(n)}(p), P_\alpha^{(n-1)}(p)) = A_n(p) \cdot (p_0, p_1)$ . Note that

$$A(\Psi_\alpha^n(p)) = \begin{pmatrix} 1 + (P_\alpha^{(n)}(p))^{q-1} \alpha^{nd} p_2^d & 1 \\ 1 & 0 \end{pmatrix}.$$

- If  $\lim_{n \rightarrow +\infty} (P_\alpha^{(n)}(p))^{q-1} \alpha^{nd} = 0$ , then  $\lim_{n \rightarrow +\infty} A(\Psi_\alpha^n(p)) = \begin{pmatrix} 1 & 1 \\ 1 & 0 \end{pmatrix}$ , whose largest eigenvalue is  $\varphi$ . Then the growth will be exactly Fibonacci unless the initial point belongs to  $\mathcal{W}_{\Psi_\alpha}^s(0_{\mathbb{C}^3})$ . But then

$$(\varphi^{q-1} |\alpha|^d)^n = O(|P_\alpha^{(n)}(p)|^{q-1} |\alpha|^{nd}) = o(1),$$

and necessarily  $|\alpha| < \varphi^{(1-q)/d}$ .

- If  $|\alpha| > \varphi^{(1-q)/d}$ , Fibonacci growth is impossible; indeed if  $|P_\alpha^{(n)}(p)| \geq C\varphi^n$  with  $C > 0$ , then

$$|P_\alpha^{(n)}(p)|^{q-1} |\alpha|^{nd} \geq C^{q-1} (\varphi^{q-1} |\alpha|^d)^n$$

but here  $\eta := \varphi^{q-1} |\alpha|^d > 1$  so that  $|P_\alpha^{(n+1)}(p)| \gtrsim C^{q-1} \eta^n |P_\alpha^{(n)}(p)|$  and the growth is much more in fact.

We will also see that this transition reflects an analogous change in the dynamics of the automorphism of Hénon type  $\phi_\alpha$ : for  $|\alpha| < \varphi^{(1-q)/d}$ , the point  $0_{\mathbb{C}^2}$  is a sink of  $\phi_\alpha$ , while for  $|\alpha| > \varphi^{(1-q)/d}$ , the point  $0_{\mathbb{C}^2}$  becomes a saddle fixed point.

The following general lemma will be useful in the analysis that follows.

**Lemma 3.60.** *Assume that  $0 < |\alpha| \leq 1$ , and that  $p = (p_0, p_1, p_2)$  satisfies:*

$$|P_\alpha^{(n)}(p)| = O([(1 - \varepsilon)\varphi]^n).$$

*Then with our previous notations,  $p \in \mathcal{Z}$ .*

PROOF. This follows again from Lemma 3.52. Indeed for every  $n \geq 0$ ,

$$|g_n(p)| \leq (|P_\alpha^{(n+1)}(p)| + \varphi^{-1}|P_\alpha^{(n)}(p)|)\varphi^{-n} = O((1 - \varepsilon)^n)$$

hence  $g(p) = \lim_{n \rightarrow +\infty} g_n(p) = 0$ .  $\square$

**9.1. Points escaping to infinity with maximal speed.** The results of this subsection hold for any  $0 < |\alpha| \leq 1$ . We start by exhibiting an explicit non-empty open set of points escaping to infinity very fast; then we state some facts concerning the set of points going to infinity with maximal speed, and show how they can be derived from the properties of the Green function  $G_{\Psi_\alpha}^+$ .

Set  $\gamma := \frac{\ln|\alpha|}{\ln(\varphi)}$ . We choose  $M \geq 0$  sufficiently large so that  $M(q - 1) + d\gamma > 0$  (this is possible since by hypothesis,  $q - 1 > 0$ ).

**Proposition 3.61.** *We define the open set*

$$\Omega := \{p = (p_0, p_1, p_2) \in \mathbb{C}^3 \mid |p_0| > |p_1| > 0 \text{ and } |p_1|^{q-1}|p_2|^d > 2 + \varphi^M\}.$$

*Then for any point  $p \in \Omega$ , we have  $G_{\Psi_\alpha}^+(p) > 0$ ; moreover the sequence  $(|P_\alpha^{(n)}(p)|)_n$  is increasing.*

The proof splits in two lemmas that we are going to detail now.

**Lemma 3.62.** *For any point  $p$  in  $\Omega$  the escape speed is superpolynomial: for any  $n \geq -1$ ,*

$$|P_\alpha^{(n)}(p)| \geq |p_1|\varphi^{Mn}. \quad (9.1)$$

*Moreover the sequence  $(|P_\alpha^{(n)}(p)|)_n$  is increasing.*

PROOF. The proof is by induction on  $n \geq -1$ . Let  $p \in \Omega$ ; we will show that  $(|P_\alpha^{(n)}(p)|)_n$  is increasing and that (9.1) holds. It follows from our assumptions that

- $|P_\alpha^{(-1)}(p)| = |p_1| \geq |p_1|\varphi^{-M}$ .
- $|P_\alpha^{(0)}(p)| = |p_0| \geq |p_1|$ .
- Take  $n \geq 0$  and assume that  $|P_\alpha^{(n)}(p)| \geq |p_1|\varphi^{Mn}$  and  $|P_\alpha^{(n)}(p)| \geq |P_\alpha^{(n-1)}(p)|$ . We estimate:

$$\begin{aligned} |P_\alpha^{(n+1)}(p)| &\geq |P_\alpha^{(n)}(p)|(|P_\alpha^{(n)}(p)|^{q-1}|\alpha^n p_2|^d - 2) \\ &\geq |P_\alpha^{(n)}(p)|(|p_1|^{q-1}|p_2|^d \varphi^{(M(q-1)+d\gamma)n} - 2) \\ &\geq |p_1|\varphi^{Mn}(|p_1|^{q-1}|p_2|^d - 2) \\ &\geq |p_1|\varphi^{M(n+1)} \end{aligned}$$

because  $M(q - 1) + d\gamma > 0$  and  $|p_1|^{q-1}|p_2|^d - 2 > \varphi^M$ . Since  $|p_1|^{q-1}|p_2|^d - 2 \geq 1$ , the previous inequalities also show that  $|P_\alpha^{(n+1)}(p)| \geq |P_\alpha^{(n)}(p)|$ , which concludes the induction.  $\square$

**Lemma 3.63.** *Recall that  $\gamma := \frac{\ln|\alpha|}{\ln(\varphi)}$  and that  $M \geq 0$  is chosen such that  $M(q-1)+d\gamma > 0$ . Take  $p \in \mathbb{C}^3$  such that the sequence  $(|P_\alpha^{(n)}(p)|)_{n \geq 0}$  is increasing, and assume that there exists  $n_0 \geq 1$  such that for every  $n \geq n_0$ , the following inequality holds<sup>3</sup>:*

$$|P_\alpha^{(n)}(p)| \geq \varphi^{Mn}.$$

3. In particular, this is satisfied for points  $p \in \Omega$  as we have seen in Lemma 3.62.

Then the escape speed is much bigger in fact: there exist  $n_1 \geq n_0$  and  $\eta > 1$  such that for every  $n \geq n_1$ ,

$$|P_\alpha^{(n)}(p)| \geq \eta^{q^n}.$$

In terms of the Green function introduced above, we then get  $G_{\Psi_\alpha^+}^+(p) > 0$ .

PROOF. Since  $(|P_\alpha^{(n)}(p)|)_{n \geq 0}$  is increasing, we have for every  $n \geq 0$ ,

$$|P_\alpha^{(n)}(p)|^q (|\alpha|^{n^2} |p_2|)^d = |P_\alpha^{(n+1)}(p) - P_\alpha^{(n)}(p) - P_\alpha^{(n-1)}(p)| \leq 3|P_\alpha^{(n+1)}(p)|. \quad (9.2)$$

Set  $x_n := \ln |P_\alpha^{(n)}(p)|$ . From our hypotheses, we know that for every  $n \geq n_0$ ,  $x_n \geq Mn \ln \varphi$ . Since  $M(q-1) + d\gamma > 0$ , we can take  $\varepsilon > 0$  small such that we still have  $M(q-1-\varepsilon) + d\gamma > 0$ . Let  $n'_0 \geq n_0$  be chosen such that for  $n \geq n'_0$ ,  $n(M(q-1-\varepsilon) + d\gamma) \ln \varphi + d \ln |p_2| - \ln 3 \geq 0$ . Thanks to (9.2), we get: for every  $n \geq n'_0$ ,

$$\begin{aligned} x_{n+1} &\geq qx_n + nd\gamma \ln \varphi + d \ln |p_2| - \ln 3 \\ &\geq (1+\varepsilon)x_n + (n(M(q-1-\varepsilon) + d\gamma) \ln \varphi + d \ln |p_2| - \ln 3) \\ &\geq (1+\varepsilon)x_n. \end{aligned}$$

We then obtain: for every  $n \geq n'_0$ ,

$$x_n \geq (1+\varepsilon)^{n-n'_0} x_{n'_0} \geq (1+\varepsilon)^{n-n'_0} Mn'_0 \ln \varphi.$$

As a result there exists  $n_1 \geq n'_0$  such that for  $n \geq n_1$ ,

$$\frac{x_n}{n^2} \geq \frac{(q/2)^{n-n'_0} Mn'_0 \ln \varphi}{n^2} \geq -(nd\gamma \ln \varphi + d \ln |p_2| - \ln 3).$$

We can then refine the previous inequalities: for  $n \geq n_1$ ,

$$x_{n+1} \geq qx_n + nd\gamma \ln \varphi + d \ln |p_2| - \ln 3 \geq q \left(1 - \frac{1}{n^2}\right) x_n.$$

Let  $C := \prod_{n \geq n_1} \left(1 - \frac{1}{n^2}\right) x_{n_1} q^{-n_1} > 0$ ; for every  $n \geq n_1$ , we have  $x_n \geq Cq^n$ , hence  $|P_\alpha^{(n)}(p)| \geq \eta^{q^n}$ , where  $\eta := e^C > 1$ .  $\square$

**Remark 3.64.** We have seen that the automorphism  $\phi_\alpha$  possesses an attractor at infinity  $X(\phi_\alpha) = (1 : 0 : 0)$  whose basin is biholomorphic to  $\mathbb{C}^2$ . Then there exists  $C = C(\alpha) > 0$  such that the forward orbit of any point  $\tilde{p} = (p_0, p_1) \in \mathbb{C}^2$  such that  $|p_0| \gg |p_1|$  and  $\|\tilde{p}\| \geq C$  is attracted by  $X(\phi_\alpha)$ ; in particular,  $\tilde{p} \notin K_{\phi_\alpha}^+$ , and thus,  $G_{\phi_\alpha}^+(\tilde{p}) > 0$ . If  $p = (p_0, p_1, p_2) \in \mathbb{C}^3$  satisfies  $|p_0| \gg |p_1|$  and  $\|(p_0, p_1)\| \cdot |p_2|^l \geq C$ , we see that  $\|h(p)\| \geq C$ , hence  $G_{\phi_\alpha}^+(h(p)) > 0$ , and  $G_{\Psi_\alpha^+}^+(p) > 0$  as well. The definition of the set  $\Omega$  in Proposition 3.61 is coherent with this observation.

**Proposition 3.65.** Set  $\ell := 2 \max(l, 1)$ . We have

$$1 \leq \limsup_{\|p\| \rightarrow +\infty} \frac{G_{\Psi_\alpha^+}^+(p)}{\log \|p\|} \leq \ell.$$

The set  $\mathcal{E} := \{p \in \mathbb{C}^3 \mid G_{\Psi_\alpha^+}^+(p) > 0\}$  of points escaping to infinity with maximal speed is open, connected and of infinite measure on any complex line where  $G_{\Psi_\alpha^+}^+$  is not identically zero. In particular, the set

$$\{p \in \mathbb{C}^3 \mid \lim_{n \rightarrow +\infty} \|\Psi_\alpha^n(p)\| = +\infty\}$$

of points whose forward orbit goes to infinity is of infinite measure.

PROOF. The openness of  $\mathcal{E}$  follows directly from the continuity of  $G_{\Psi_\alpha^+}^+$ , shown in Proposition 3.58.

The proof of the fact that  $\mathcal{E}$  has infinite measure follows arguments given by Guedj-Sibony [15]. Since  $\phi_\alpha$  is algebraically stable, we know from Proposition 1.3 in [15] that  $\limsup_{\|\tilde{p}\| \rightarrow +\infty} \frac{G_{\phi_\alpha}^+(\tilde{p})}{\log \|\tilde{p}\|} = 1$ . Therefore

$$\begin{aligned} \limsup_{\|p\| \rightarrow +\infty} \frac{G_{\Psi_\alpha}^+(p)}{\log \|p\|} &= \limsup_{\|p=(p_0, p_1, p_2)\| \rightarrow +\infty} \frac{G_{\phi_\alpha}^+ \circ h(p)}{\log \|h(p)\|} \times \frac{l \log |p_2| + \log \|(p_0, p_1)\|}{\log \|p\|} \\ &\leq \ell \limsup_{\|\tilde{p}\| \rightarrow +\infty} \frac{G_{\phi_\alpha}^+(\tilde{p})}{\log \|\tilde{p}\|} = \ell. \end{aligned}$$

For the other inequality, we remark that

$$\begin{aligned} \limsup_{\|p\| \rightarrow +\infty} \frac{G_{\Psi_\alpha}^+(p)}{\log \|p\|} &\geq \limsup_{\|p=(p_0, p_1, 1)\| \rightarrow +\infty} \frac{G_{\phi_\alpha}^+ \circ h(p)}{\log \|h(p)\|} \times \frac{\log \|(p_0, p_1)\|}{\log \|(p_0, p_1, 1)\|} \\ &= \limsup_{\|\tilde{p}\| \rightarrow +\infty} \frac{G_{\phi_\alpha}^+(\tilde{p})}{\log \|\tilde{p}\|} = 1. \end{aligned}$$

Assume that  $p \in \mathbb{C}^3$  satisfies  $G_{\Psi_\alpha}^+(p) > 0$ , and for some  $v \neq 0_{\mathbb{C}^3}$ , consider the line  $L := \{p + tv \mid t \in \mathbb{C}\}$ . Denote by  $m(r)$  the Lebesgue measure of the set  $\{e^{ix}, x \in \mathbb{R} \mid G_{\Psi_\alpha}^+(p + re^{ix}v) > 0\}$ . From what precedes, we know that there exists  $C > 0$  such that for every  $r \geq 0$ ,

$$G_{\Psi_\alpha}^+(p + re^{ix}v) \leq \ell \log^+(r) + C.$$

By the sub-mean value property,

$$0 < G_{\Psi_\alpha}^+(p) \leq \frac{1}{2\pi} \int_0^{2\pi} G_{\Psi_\alpha}^+(p + re^{ix}v) dx \leq \frac{1}{2\pi} (\ell \log^+(r) + C) m(r).$$

Therefore,  $m(r) \geq \frac{2\pi G_{\Psi_\alpha}^+(p)}{\ell \log^+(r) + C}$ , and integrating over  $r$ , we get that the set of points  $p$  in  $L$  such that  $G_{\Psi_\alpha}^+(p) > 0$  has infinite measure. The proof of connectivity is also based on the slow growth of  $G_{\Psi_\alpha}^+$  and follows from similar arguments (see [16]).  $\square$

**9.2. General remarks when  $0 < |\alpha| < 1$ .** In this case,  $0_{\mathbb{C}^3}$  is a hyperbolic fixed point of  $\Psi_\alpha$  of saddle type, and Corollary 3.56 tells us that the set  $K_{\Psi_\alpha}^+$  of points with bounded forward orbit is exactly the stable manifold  $\mathcal{W}_{\Psi_\alpha}^s(0_{\mathbb{C}^3})$ . We thus have  $J_{\Psi_\alpha}^+ := \partial K_{\Psi_\alpha}^+ = \overline{\mathcal{W}_{\Psi_\alpha}^s(0_{\mathbb{C}^3})}$ . Let  $p = (p_0, p_1, p_2) \in \mathbb{C}^3$ . For  $n \geq 0$ ,

$$\theta \circ \Psi_\alpha^n(p) = (P_\alpha^n(p)(\alpha^n p_2)^l, P_\alpha^{(n-1)}(p)(\alpha^n p_2)^l, \alpha^n p_2) = (\phi_\alpha^n \circ h(p), \alpha^n p_2). \quad (9.3)$$

From (9.3), we get that  $h(\mathcal{W}_{\Psi_\alpha}^s(0_{\mathbb{C}^3})) = \mathcal{W}_{\phi_\alpha}^s(0_{\mathbb{C}^2}) = K_{\phi_\alpha}^+$ .<sup>4</sup> We deduce that  $J_{\phi_\alpha}^+ = \partial \mathcal{W}_{\phi_\alpha}^s(0_{\mathbb{C}^2})$ . Besides, we know that  $K_{\phi_\alpha}^+ = \{\tilde{p} \in \mathbb{C}^2 \mid G_{\phi_\alpha}^+(\tilde{p}) = 0\}$ , and this set is closed by continuity of  $G_{\phi_\alpha}^+$ . In particular,  $\mathcal{W}_{\phi_\alpha}^s(0_{\mathbb{C}^2})$  is closed. For any  $\tilde{p} \in \mathbb{C}^2$ , there are two possible behaviors: either  $p \in \mathcal{W}_{\phi_\alpha}^s(0_{\mathbb{C}^2})$  and then its forward iterates converge to  $0_{\mathbb{C}^2}$  exponentially fast, or they go to infinity with maximal speed.

**9.3. Analysis of the dynamics in the case where  $0 < |\alpha| < \varphi^{(1-q)/d}$ .** We show that under this assumption, we can construct a set of points with non-empty interior for which the escape speed is much smaller, in fact Fibonacci.

From our hypothesis on  $\alpha$ , we can take  $\varepsilon > 0$  small enough so that  $\eta := ((1 + \varepsilon)\varphi)^q |\alpha|^d < \varphi$ .

**Proposition 3.66.** *Assume  $0 < |\alpha| < \varphi^{(1-q)/d}$ . We consider the following open neighborhood of the hypersurface  $\{z_2 = 0\}$ :*

$$\Omega' := \{p = (p_0, p_1, p_2) \in \mathbb{C}^3 \mid (|p_0| + |p_1|)^{q-1} |p_2|^d < \varphi \varepsilon\}.$$

*If  $p \in \Omega'$ , there are two possible behaviors:*

4. Indeed, if  $p \in \mathcal{W}_{\Psi_\alpha}^s(0_{\mathbb{C}^3})$ , then  $h(p) \in \mathcal{W}_{\phi_\alpha}^s(0_{\mathbb{C}^2})$ ; conversely, if  $(p_0, p_1) \in K_{\phi_\alpha}^+$ , then  $(p_0, p_1) = h(p_0, p_1, 1)$  and  $(p_0, p_1, 1) \in K_{\Psi_\alpha}^+ = \mathcal{W}_{\Psi_\alpha}^s(0_{\mathbb{C}^3})$ .



- either  $p$  belongs to the stable manifold  $\mathcal{W}_{\Psi_\alpha}^s(0_{\mathbb{C}^3})$  and then its forward iterates converge to  $0_{\mathbb{C}^3}$  exponentially fast;
- or  $p$  goes to infinity with Fibonacci speed:  $(P_\alpha^{(n)}(p)\varphi^{-n})_{n \geq 0}$  converges and we have

$$\lim_{n \rightarrow +\infty} P_\alpha^{(n)}(p)\varphi^{-n} \in \mathbb{C}^*.$$

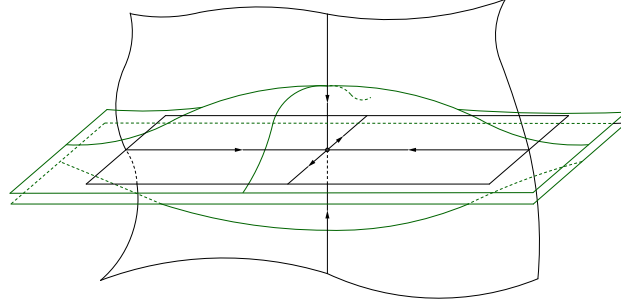

**Remark 3.67.** The last result tells us that if we start close enough to  $\{z_2 = 0\} \subset \Omega'$ , the dynamics is similar to the one we observe on restriction to this invariant hypersurface: either the starting point belongs to  $\mathcal{W}_{\Psi_\alpha}^s(0_{\mathbb{C}^3})$  and in this case its forward orbit converges to  $0_{\mathbb{C}^3}$  with exponential speed, or the iterates escape to infinity with speed exactly Fibonacci. We remark that when  $|\alpha|$  is small, we can choose  $\varepsilon > 0$  reasonably large, so that the set  $\Omega'$  becomes larger and larger. This is coherent with the fact that the smaller  $|\alpha|$  is, the faster we converge to the hypersurface  $\{z_2 = 0\}$ .

We start by showing that the speed cannot be more than Fibonacci.

**Lemma 3.68.** Any point  $p \in \Omega'$  grows at most with Fibonacci speed, that is, there exists  $C = C(p_0, p_1) > 0$  such that for any  $n \geq 0$ ,

$$|P_\alpha^{(n)}(p)| \leq C\varphi^n.$$

PROOF. Let  $\tilde{C} = \tilde{C}(p_0, p_1) := |p_0| + |p_1|$  and  $\varepsilon > 0$  be chosen as explained above. We first show that for every  $n \geq 0$ ,

$$|P_\alpha^{(n)}(p)| \leq \tilde{C}((1 + \varepsilon)\varphi)^n.$$

The result is clearly true for  $n = 0$ , and for  $n = 1$  we have

$$|P_\alpha^{(1)}(p)| \leq |p_0| + |p_1| + |p_0|^q |p_2|^d \leq \tilde{C}(1 + \tilde{C}^{q-1} |p_2|^d) \leq \tilde{C}(1 + \varepsilon)\varphi.$$

Suppose that it holds for  $n - 1$  and  $n$ , that is

$$|P_\alpha^{(n-1)}(p)| \leq \tilde{C}((1 + \varepsilon)\varphi)^{n-1}, \quad |P_\alpha^{(n)}(p)| \leq \tilde{C}((1 + \varepsilon)\varphi)^n.$$

We then have

$$\begin{aligned} |P_\alpha^{(n+1)}(p)| &\leq |P_\alpha^{(n)}(p)| + |P_\alpha^{(n-1)}(p)| + |(P_\alpha^{(n)}(p))^q (\alpha^n p_2)^d| \\ &\leq \tilde{C}((1 + \varepsilon)\varphi)^n + \tilde{C}((1 + \varepsilon)\varphi)^{n-1} + \tilde{C}^q |p_2|^d ((1 + \varepsilon)\varphi)^q |\alpha|^d)^n \\ &\leq \tilde{C}(1 + \varepsilon)^n \varphi^{n+1} + \tilde{C}\varphi\varepsilon\eta^n \\ &\leq \tilde{C}(1 + \varepsilon)^n \varphi^{n+1} + \tilde{C}\varepsilon(1 + \varepsilon)^n \varphi^{n+1} \\ &= \tilde{C}((1 + \varepsilon)\varphi)^{n+1}, \end{aligned}$$

which concludes the induction.

Using this fact, we obtain a good control on the non-linear term: for any  $n \geq 0$ ,

$$|(P_\alpha^{(n)}(p))^q (\alpha^n p_2)^d| \leq \tilde{C}^q |p_2|^d ((1+\varepsilon)\varphi|\alpha|^d)^n = C_0 \eta^n,$$

where  $C_0 = C_0(p_0, p_1) := \tilde{C} \varphi \varepsilon$ . For every  $n \geq 0$ , we have

$$\begin{aligned} |P_\alpha^{(n+1)}(p)| &\leq |P_\alpha^{(n)}(p)| + |P_\alpha^{(n-1)}(p)| + |(P_\alpha^{(n)}(p))^q (\alpha^n p_2)^d| \\ &\leq |P_\alpha^{(n)}(p)| + |P_\alpha^{(n-1)}(p)| + C_0 \eta^n. \end{aligned}$$

Thanks to the same trick as in the proof of Lemma 3.52, we obtain:

$$|P_\alpha^{(n+1)}(p)| + (\varphi - 1)|P_\alpha^{(n)}(p)| \leq \varphi^n \left( \varphi |p_0| + |p_1| + C_0 \sum_{j=0}^n \left( \frac{\eta}{\varphi} \right)^j \right).$$

Since  $\eta < \varphi$ , we can set  $C = C(p_0, p_1) := \varphi^{-1} \left( \varphi |p_0| + |p_1| + C_0 \sum_{j=0}^{+\infty} \left( \frac{\eta}{\varphi} \right)^j \right)$ . We then get: for every  $n \geq 0$ ,

$$|P_\alpha^{(n)}(p)| \leq C \varphi^n. \quad \square$$

The proof of Proposition 3.66 is the combination of Lemma 3.68 and of the next result.

**Lemma 3.69.** *Assume  $0 < |\alpha| < \varphi^{(1-q)/d}$  and take  $p \in \mathbb{C}^3 \setminus \mathcal{W}_{\Psi_\alpha}^s(0_{\mathbb{C}^3})$  with speed less than Fibonacci, i.e., there exists  $C > 0$  such that for every  $n \geq 0$ ,  $|P_\alpha^{(n)}(p)| \leq C \varphi^n$ . Then  $p$  goes to infinity with speed exactly Fibonacci:  $(P_\alpha^{(n)}(p) \varphi^{-n})_{n \geq 0}$  converges and we have*

$$\lim_{n \rightarrow +\infty} P_\alpha^{(n)}(p) \varphi^{-n} \in \mathbb{C}^*.$$

**PROOF.** Take  $p \in \mathbb{C}^3 \setminus \mathcal{W}_{\Psi_\alpha}^s(0_{\mathbb{C}^3})$  such that for every  $n \geq 0$ ,  $|P_\alpha^{(n)}(p)| \leq C \varphi^n$ ,  $C > 0$ . We first show that  $p$  goes to infinity with speed at least Fibonacci too, i.e., there exists  $C' = C'(p_0, p_1) > 0$  such that for every  $n \geq 0$ ,  $|P_\alpha^{(n)}(p)| \geq C' \varphi^n$ . Recall that if  $(z_0, z_1, z_2) \in \mathbb{C}^3$ , we denote

$$A(z_0, z_1, z_2) := \begin{pmatrix} 1 + z_0^{q-1} z_2^d & 1 \\ 1 & 0 \end{pmatrix},$$

and that for  $n \geq 0$ ,  $(P_\alpha^{(n)}(p), P_\alpha^{(n-1)}(p)) = A_n(p) \cdot (p_0, p_1)$ , where

$$A_n(p) := A(\Psi_\alpha^{n-1}(p)) \cdot A(\Psi_\alpha^{n-2}(p)) \dots A(\Psi_\alpha(p)) \cdot A(p).$$

Note that for every  $j \geq 0$ ,

$$A(\Psi_\alpha^j(p)) = \begin{pmatrix} 1 + (P_\alpha^{(j)}(p))^{q-1} \alpha^{jd} p_2^d & 1 \\ 1 & 0 \end{pmatrix}. \quad (9.4)$$

Since  $|P_\alpha^{(j)}(p)| \leq C \varphi^j$ , we see that

$$|(P_\alpha^{(j)}(p))^{q-1} \alpha^{jd} p_2^d| \leq C^{q-1} |p_2|^d (\varphi^{q-1} |\alpha|^d)^j \leq \nu \eta^j, \quad (9.5)$$

where  $\eta := \varphi^{q-1} |\alpha|^d < 1$  and  $\nu := C^{q-1} |p_2|^d \geq 0$ . Set  $M_0 := \begin{pmatrix} 1 & 1 \\ 1 & 0 \end{pmatrix}$ . If  $\varepsilon > 0$ , let us consider  $B_\varepsilon(M_0) := \{M \in \mathfrak{M}_2(\mathbb{C}) \mid \|M - M_0\|_\infty < \varepsilon\}$ . We see from (9.4) and (9.5) that for every  $j \geq 0$ ,  $A(\Psi_\alpha^j(p)) \in B_{\nu \eta^j}(M_0)$ . For  $\varepsilon > 0$  small, every matrix  $M \in B_\varepsilon(M_0)$  is hyperbolic with eigenvalues close to  $\varphi$  and  $\varphi'$ ; moreover we can choose a family of cones  $(\mathcal{C}_\varepsilon)_{\varepsilon > 0}$  around  $\Delta_\varphi$  satisfying the following: there exist  $C_0, C_1 > 0$  such that for each  $M \in B_\varepsilon(M_0)$ , every vector  $v \in \mathcal{C}_\varepsilon$  will be expanded by a factor close to  $\varphi$ :

$$(1 - C_0 \varepsilon) \varphi \|v\| \leq \|M \cdot v\| \leq (1 + C_1 \varepsilon) \varphi \|v\|.$$

Since  $p \notin \mathcal{W}_{\Psi_\alpha}^s(0_{\mathbb{C}^3})$ , the iterates of  $(p_0, p_1)$  are expanded and accumulate on the unstable space  $\Delta_\varphi = \{(\varphi z, z) \mid z \in \mathbb{C}\}$  of  $M_0$ . In fact the angle  $\angle(\Delta_\varphi, A_j(p) \cdot (p_0, p_1))$  decreases

exponentially fast, and we can assume that for some  $n_0 \geq 0$  and for every  $j \geq n_0$ ,  $A(\Psi_\alpha^j(p)) \in B_{\nu\eta^j}(M_0)$  maps  $\mathcal{C}_{\nu\eta^j}$  to  $\mathcal{C}_{\nu\eta^{j+1}}$ . We deduce that for every  $n \geq n_0$ ,

$$\begin{aligned} \prod_{j=n_0}^{n-1} (1 - C_0\nu\eta^j) \|A_{n_0}(p) \cdot (p_0, p_1)\| &\leq \frac{\|A_n(p) \cdot (p_0, p_1)\|}{\varphi^{n-n_0}} \\ &\leq \prod_{j=n_0}^{n-1} (1 + C_1\nu\eta^j) \|A_{n_0}(p) \cdot (p_0, p_1)\|. \end{aligned}$$

Let  $C' := \varphi^{n_0} \prod_{j=n_0}^{+\infty} (1 - C_0\nu\eta^j) \|A_{n_0}(p) \cdot (p_0, p_1)\| > 0$ . We have thus obtained: for every  $n \geq 0$ ,

$$\|(P_\alpha^{(n)}(p), P_\alpha^{(n-1)}(p))\| \geq C'\varphi^n.$$

Now, we note that  $p$  belongs to  $\mathcal{D}$ , the domain of definition of the series  $g$  introduced earlier. Indeed, for any  $j \geq 0$ ,  $|P_\alpha^{(j)}(p)|^q \varphi^{-j} |\alpha|^{jd} \leq C^q (\varphi^{q-1} |\alpha|^d)^j$  and  $\varphi^{q-1} |\alpha|^d < 1$ . We have shown that the sequence  $(P_\alpha^{(n)}(p), P_\alpha^{(n-1)}(p))_n$  accumulates on the unstable direction  $\{(\varphi z, z) \mid z \in \mathbb{C}\}$  of  $M_0$ ; therefore, we get

$$\lim_{n \rightarrow +\infty} \frac{P_\alpha^{(n)}(p)}{P_\alpha^{(n-1)}(p)} = \varphi. \quad (9.6)$$

Recall that for  $n \geq 0$ ,  $g_n(p) := (P_\alpha^{(n+1)}(p) + \varphi^{-1} P_\alpha^{(n)}(p)) \varphi^{-n}$ . We have seen that  $p \in \mathcal{D}$ , and then,  $(g_n(p))_n$  converges. From (9.6) we deduce that for every  $n \geq 0$ ,

$$g_n(p) = \left( \frac{P_\alpha^{(n+1)}(p)}{P_\alpha^{(n)}(p)} + \varphi^{-1} \right) P_\alpha^{(n)}(p) \varphi^{-n} \sim (\varphi + \varphi^{-1}) P_\alpha^{(n)}(p) \varphi^{-n}.$$

This implies that  $(P_\alpha^{(n)}(p) \varphi^{-n})_{n \geq 0}$  converges. But we also know from what precedes that  $\lim_{n \rightarrow +\infty} |P_\alpha^{(n)}(p) \varphi^{-n}| > 0$ , so that  $\lim_{n \rightarrow +\infty} P_\alpha^{(n)}(p) \varphi^{-n} \in \mathbb{C}^*$ , which concludes.  $\square$

Recall that we take  $\varepsilon > 0$  small enough so that  $((1 + \varepsilon)\varphi)^q |\alpha|^d < \varphi$ , and that  $\Omega' := \{(p_0, p_1, p_2) \in \mathbb{C}^3 \mid (|p_0| + |p_1|)^{q-1} |p_2|^d < \varphi\varepsilon\}$ . We deduce from Proposition 3.66 that

$$G_{\Psi_\alpha}^+ |_{\Omega'} = 0. \quad (9.7)$$

Indeed, the forward iterates of any point in  $\Omega'$  grow at most with Fibonacci speed as we have seen. In particular, the set  $\{p \in \mathbb{C}^3 \mid G_{\Psi_\alpha}^+(p) = 0\}$  has non-empty interior. Set  $\delta := (\varphi\varepsilon)^{1/(q-1)}$  and define the open ball

$$B_\delta := \{\tilde{p} = (p_0, p_1) \in \mathbb{C}^2 \mid \|\tilde{p}\|_1 = |p_0| + |p_1| < \delta\}.$$

Recall that  $l = \frac{d}{q-1}$  and that  $h: (z_0, z_1, z_2) \mapsto (z_0 z_2^l, z_1 z_2^l)$ . Remark that  $h(\Omega') \subset B_\delta$ . Indeed, if  $p = (p_0, p_1, p_2) \in \Omega'$ , then

$$\|h(p)\|_1 = |p_0 p_2^l| + |p_1 p_2^l| = ((|p_0| + |p_1|)^{q-1} |p_2|^d)^{1/(q-1)} < (\varphi\varepsilon)^{1/(q-1)} = \delta.$$

Conversely, if  $(p_0, p_1) \in B_\delta$ , then  $(p_0, p_1) = h(p_0, p_1, 1)$  with  $(p_0, p_1, 1) \in \Omega'$ , so that  $h(\Omega') = B_\delta$  in fact. Since  $G_{\Psi_\alpha}^+ = G_{\phi_\alpha}^+ \circ h$ , we deduce from (9.7) that

$$G_{\phi_\alpha}^+ |_{B_\delta} = 0.$$

But as we have seen,  $K_{\phi_\alpha}^+ = \{(p_0, p_1) \in \mathbb{C}^2 \mid G_{\phi_\alpha}^+(p_0, p_1) = 0\}$ . We conclude that for  $|\alpha| < \varphi^{(1-q)/d}$ , any point  $(p_0, p_1) \in B_\delta$  has bounded forward orbit under  $\phi_\alpha$ . Actually we can say more. Recall that  $\phi_\alpha = \alpha^l (z_0 + z_1 + z_2^q, z_0)$ . We see that  $0_{\mathbb{C}^2}$  is a sink of  $\phi_\alpha$ ; indeed, the largest eigenvalue of the Jacobian is  $\alpha^l \varphi$ , which is strictly smaller than 1 from the assumption we made on  $\alpha$ . For any  $p \in \mathbb{C}^3$  and  $n \geq 0$ ,

$$\theta \circ \Psi_\alpha^n(p) = (P_\alpha^{(n)}(p) (\alpha^n p_2)^l, P_\alpha^{(n-1)}(p) (\alpha^n p_2)^l, \alpha^n p_2) = (\phi_\alpha^n \circ h(p), \alpha^n p_2). \quad (9.8)$$

If  $p \in \Omega'$ , we know from Proposition 3.66 that there exists  $C > 0$  such that for any  $n \geq 0$ ,  $|P_\alpha^{(n)}(p)| \leq C\varphi^n$ . But then,  $|P_\alpha^{(n)}(p) (\alpha^n p_2)^l| \leq C |p_2|^l (\varphi^{q-1} |\alpha|^d)^{n/(q-1)}$ , and

$\varphi^{q-1}|\alpha|^d < 1$ , so we deduce from (9.8) and the equality  $B_\delta = h(\Omega')$  that any point in  $B_\delta$  goes to  $0_{\mathbb{C}^2}$  by forward iteration of  $\phi_\alpha$ ; equivalently, the basin of attraction  $\mathcal{W}_{\phi_\alpha}^s(0_{\mathbb{C}^2})$  of the sink  $0_{\mathbb{C}^2}$  contains the ball  $B_\delta$ . Recall also that it is a general fact that for a sink  $p$  of  $\phi_\alpha$ ,  $\mathcal{W}_{\phi_\alpha}^s(p)$  is biholomorphic to  $\mathbb{C}^2$ .

In the following, we will see how the previous results enable us to give a description of the dynamics of  $\Psi_\alpha$  in the case where  $0 < |\alpha| < \varphi^{(1-q)/d}$ . Let  $p \in \mathbb{C}^3$ . We have shown previously that  $K_{\Psi_\alpha}^+ = \mathcal{W}_{\Psi_\alpha}^s(0_{\mathbb{C}^3})$ , so assume that the forward orbit of  $p$  under  $\Psi_\alpha$  is not bounded. There are two possibilities:

- either  $G_{\Psi_\alpha}^+(p) > 0$  and the iterates of  $p$  go to infinity with maximal speed; in this case, we also have  $G_{\phi_\alpha}^+(h(p)) = G_{\Psi_\alpha}^+(p) > 0$ ;
- or  $G_{\Psi_\alpha}^+(p) = 0$  and  $G_{\phi_\alpha}^+(h(p)) = G_{\Psi_\alpha}^+(p) = 0$  too. But then we know from the general properties of  $\phi_\alpha$  that  $h(p) \in K_{\phi_\alpha}^+$ . From Subsection 9.2, we also have  $K_{\phi_\alpha}^+ = \mathcal{W}_{\phi_\alpha}^s(0_{\mathbb{C}^2})$ . It follows from (9.8) that  $\lim_{n \rightarrow +\infty} |P_\alpha^{(n)}(p)(\alpha^n p_2)^l|$  exists and vanishes. Since  $l = d/(q-1)$ , we deduce that  $\lim_{n \rightarrow +\infty} |P_\alpha^{(n)}(p)|^{q-1} |\alpha^n p_2|^d = 0$ , hence  $\lim_{n \rightarrow +\infty} A(\Psi_\alpha^n(p)) = M_0 = \begin{pmatrix} 1 & 1 \\ 1 & 0 \end{pmatrix}$  where  $A$  is the cocycle introduced earlier. Reasoning as before, and since by assumption  $p \notin \mathcal{W}_{\Psi_\alpha}^s(0_{\mathbb{C}^3})$ , we conclude accordingly that  $p$  escapes to infinity with Fibonacci speed.

We have thus shown:

**Proposition 3.70.** *When  $0 < |\alpha| < \varphi^{(1-q)/d}$ , the point  $0_{\mathbb{C}^3}$  is a saddle fixed point of  $\Psi_\alpha$  of index 2, and  $J_{\Psi_\alpha}^+ := \partial K_{\Psi_\alpha}^+ = \mathcal{W}_{\Psi_\alpha}^s(0_{\mathbb{C}^3})$ . Moreover,  $\{p \in \mathbb{C}^3 \mid G_{\Psi_\alpha}^+(p) = 0\} = h^{-1}(\mathcal{W}_{\phi_\alpha}^s(0_{\mathbb{C}^2})) = \Omega'' \sqcup \mathcal{W}_{\Psi_\alpha}^s(0_{\mathbb{C}^3})$ , where  $\Omega''$  has non-empty interior (it contains the set  $\Omega' \setminus \mathcal{W}_{\Psi_\alpha}^s(0_{\mathbb{C}^3})$ ), and the forward orbit of points that belong to it goes to infinity with Fibonacci speed. Moreover,  $\mathcal{W}_{\phi_\alpha}^s(0_{\mathbb{C}^2})$  is biholomorphic to  $\mathbb{C}^2$ , and*

$$K_{\phi_\alpha}^+ = \mathcal{W}_{\phi_\alpha}^s(0_{\mathbb{C}^2}) = \{\tilde{p} \in \mathbb{C}^2 \mid G_{\phi_\alpha}^+(\tilde{p}) = 0\}.$$

We summarize this as follows:

$$\begin{array}{rcl} & h & \\ & \{z_2 = 0\} & \rightarrow \{0_{\mathbb{C}^2}\}; \\ K_{\Psi_\alpha}^+ = \mathcal{W}_{\Psi_\alpha}^s(0_{\mathbb{C}^3}) & \rightarrow & K_{\phi_\alpha}^+ = \mathcal{W}_{\phi_\alpha}^s(0_{\mathbb{C}^2}); \\ & \Omega'' & \rightarrow \mathcal{W}_{\phi_\alpha}^s(0_{\mathbb{C}^2}); \\ \{p \in \mathbb{C}^3 \mid G_{\Psi_\alpha}^+(p) > 0\} & \rightarrow & \{\tilde{p} \in \mathbb{C}^2 \mid G_{\phi_\alpha}^+(\tilde{p}) > 0\}. \end{array} \quad (9.9)$$

Thanks to the last statement, we now give an alternative description of the stable manifold  $\mathcal{W}_{\Psi_\alpha}^s(0_{\mathbb{C}^3})$  in terms of the set  $\mathcal{Z}$  of zeros of the series  $g$  introduced previously.

**Proposition 3.71.** *Assume  $0 < |\alpha| < \varphi^{(1-q)/d}$ . Set  $\mathcal{V} := \{p \in \mathbb{C}^3 \mid G_{\Psi_\alpha}^+(p) = 0\} = \Omega'' \sqcup \mathcal{W}_{\Psi_\alpha}^s(0_{\mathbb{C}^3})$ . Then  $\mathcal{V}$  coincides with the domain of definition  $\mathcal{D}$  of the series  $g$  introduced earlier. Moreover, we have the following parametrization of the stable manifold:*

$$\mathcal{W}_{\Psi_\alpha}^s(0_{\mathbb{C}^3}) = \mathcal{Z} = \{p \in \mathcal{V} \mid g(p) = 0\} = \bigcup_{n \geq 0} \Psi_\alpha^{-n}(\Omega' \cap \mathcal{Z}).$$

PROOF. Let  $p \in \mathcal{V}$ . We know from Proposition 3.70 that there exists  $C > 0$  such that for any  $j \geq 0$ ,  $|P_\alpha^{(j)}(p)| \leq C\varphi^j$ . Then  $p$  belongs to the domain of definition of  $g$  since in this case,  $|P_\alpha^{(j)}(p)|^q \varphi^{-j} |\alpha|^{jd} \leq C^q (\varphi^{q-1} |\alpha|^d)^j$  and  $\varphi^{q-1} |\alpha|^d < 1$ . It is also clear that if  $G_{\Psi_\alpha}^+(p) > 0$ , then  $p \notin \mathcal{D}$ .

Recall that for any  $n \geq 0$ ,

$$g_n(z) = \varphi z_0 + z_1 + z_2^d \sum_{j=0}^n \left( P_\alpha^{(j)}(z) \right)^q \varphi^{-j} \alpha^{jd} = (P_\alpha^{(n+1)}(z) + \varphi^{-1} P_\alpha^{(n)}(z)) \varphi^{-n}. \quad (9.10)$$

If  $p \in \Omega'' = \mathcal{V} \setminus \mathcal{W}_{\Psi_\alpha}^s(0_{\mathbb{C}^3})$ , then as in the proof of Lemma 3.69, we see that the sequence  $(P_\alpha^{(n)}(p)\varphi^{-n})_{n \geq 0}$  converges; moreover, we get from (9.10):

$$\lim_{n \rightarrow +\infty} g_n(p) = \lim_{n \rightarrow +\infty} \left( \frac{P_\alpha^{(n+1)}(p)}{P_\alpha^{(n)}(p)} + \varphi^{-1} \right) P_\alpha^{(n)}(p)\varphi^{-n} = (\varphi + \varphi^{-1}) \lim_{n \rightarrow +\infty} P_\alpha^{(n)}(p)\varphi^{-n}.$$

But we also know that  $\lim_{n \rightarrow +\infty} |P_\alpha^{(n)}(p)\varphi^{-n}| > 0$ , so that  $g(p) = \lim_{n \rightarrow +\infty} g_n(p) \neq 0$  and  $p \notin \mathcal{Z}$ . This shows that if  $p \in \mathcal{Z}$  then  $p \in \mathcal{W}_{\Psi_\alpha}^s(0_{\mathbb{C}^3})$ ; the other implication is always true.

The last point follows from the fact that for  $\Omega' \subset \mathcal{V}$ , we have  $\Omega' \cap \mathcal{W}_{\Psi_\alpha}^s(0_{\mathbb{C}^3}) = \Omega' \cap \mathcal{Z}$ . Moreover,  $\Omega'$  contains a neighborhood of  $0_{\mathbb{C}^3}$  so the orbit of any point  $p \in \mathcal{W}_{\Psi_\alpha}^s(0_{\mathbb{C}^3})$  will eventually reach  $\Omega'$ . To conclude, we note that by invariance of the stable manifold, we have  $\mathcal{W}_{\Psi_\alpha}^s(0_{\mathbb{C}^3}) = \cup_{n \geq 0} \Psi_\alpha^{-n}(\Omega' \cap \mathcal{W}_{\Psi_\alpha}^s(0_{\mathbb{C}^3}))$ .  $\square$

**9.4. Analysis of the dynamics in the case where  $\varphi^{(1-q)/d} < |\alpha| < 1$ .** Thanks to previous results, we show the following intermediate result concerning the dynamics of  $\Psi_\alpha$  in this case.

**Proposition 3.72.** *Assume  $\varphi^{(1-q)/d} < |\alpha| < 1$ . For  $p \in \mathcal{U} = \{z_2 = 0\}^c$ , we show the following trichotomy:*

- either  $p$  belongs to the stable manifold  $\mathcal{W}_{\Psi_\alpha}^s(0_{\mathbb{C}^3})$ ; in this case, its forward iterates converge to  $0_{\mathbb{C}^3}$  with exponential speed;
- or there exist  $\varepsilon > 0$  and  $n_0 \geq 0$  such that for  $n \geq n_0$ ,

$$|P_\alpha^{(n)}(p)| \leq ((1 - \varepsilon)\varphi)^n;$$

in this case  $p \in \mathcal{Z}$ . Furthermore,

$$\limsup_{n \rightarrow +\infty} |P_\alpha^{(n)}(p)|^{q-1} |\alpha|^{nd} > 0;$$

- or the orbit of  $p$  escapes to infinity very fast:  $G_{\Psi_\alpha}^+(p) > 0$ . Moreover the sequence  $(|P_\alpha^{(n)}(p)|)_n$  is increasing after a certain time.

**PROOF.** Take  $0 < \varepsilon < 1 - \varphi^{-1}|\alpha|^{d/(1-q)}$ . Note that  $\mu := |\alpha|^d((1 - \varepsilon)\varphi)^{q-1} > 1$ . Let  $p = (p_0, p_1, p_2) \notin \mathcal{W}_{\Psi_\alpha}^s(0_{\mathbb{C}^3})$ ; according to Corollary 3.56 its forward orbit is unbounded. Suppose that there exists  $n_0 \geq 0$  such that for every  $n \geq n_0$ ,  $|P_\alpha^{(n)}(p)| \leq ((1 - \varepsilon)\varphi)^n$ . From Lemma 3.60, we know that  $p \in \mathcal{Z}$ . Moreover, if  $\limsup_{n \rightarrow +\infty} |P_\alpha^{(n)}(p)|^{q-1} |\alpha|^{nd} = 0$ ,

then with our previous notations,  $\lim_{n \rightarrow +\infty} A(\Psi_\alpha^n(p)) = \begin{pmatrix} 1 & 1 \\ 1 & 0 \end{pmatrix}$  and the growth is at least Fibonacci, which is excluded. We are then in the second case of Proposition 3.72.

Let us handle the remaining case. In particular, we can take  $n_0 \geq 0$  as big as we want such that  $|P_\alpha^{(n_0)}(p)| > ((1 - \varepsilon)\varphi)^{n_0}$ . Note that since by assumption  $|\alpha| > \varphi^{(1-q)/d}$ , and we have  $(q - 1) + d\gamma > 0$  (with the notations of Lemma 3.63). In particular,  $M = 1$  satisfies the hypotheses of this lemma. Take  $n_0 \geq 0$  sufficiently large such that  $|P_\alpha^{(n_0)}(p)| > ((1 - \varepsilon)\varphi)^{n_0}$  and  $\mu^{n_0}|p_2|^d \geq 2 + \varphi$ . We can always assume that  $|P_\alpha^{(n_0)}(p)| \geq |P_\alpha^{(n_0-1)}(p)|$ .<sup>5</sup> Since  $\left| (P_\alpha^{(n_0)}(p))^{q-1} (\alpha^{n_0})^d \right| \geq \mu^{n_0}$ , we deduce

$$\left| \frac{P_\alpha^{(n_0+1)}(p)}{P_\alpha^{(n_0)}(p)} \right| = \left| (P_\alpha^{(n_0)}(p))^{q-1} (\alpha^{n_0})^d |p_2|^d + 1 + \frac{P_\alpha^{(n_0-1)}(p)}{P_\alpha^{(n_0)}(p)} \right| \geq \mu^{n_0} |p_2|^d - 2 \geq \varphi.$$

This shows that after time at most  $n_0$ , the sequence  $(|P_\alpha^{(n)}(p)|)_n$  is increasing, moreover, there exists  $C_0 > 0$  such that for any  $n \geq 0$ ,

$$|P_\alpha^{(n)}(p)| \geq C_0 \varphi^n.$$

5. Else there exists  $n_1 < n_0$  such that  $|P_\alpha^{(n_1)}(p)| > ((1 - \varepsilon)\varphi)^{n_0}$  and  $|P_\alpha^{(n_1)}(p)| \geq |P_\alpha^{(n_1-1)}(p)|$  and we consider  $n_1$  instead of  $n_0$ .

The assumptions of Lemma 3.63 are satisfied, and we thus get the desired estimate on the speed.  $\square$

**Remark 3.73.** Denote by  $\mathcal{S}$  the set of points corresponding to the second case described in Proposition 3.72. A priori, points in  $\mathcal{S}$  might exhibit a rather complicated dynamics: their forward orbit is not bounded, still, it could happen that it does not escape to infinity. We will see that in fact this behavior does not occur:  $\mathcal{S} = \emptyset$ . This is related to the properties of the automorphism of Hénon type  $\phi_\alpha$  to which  $\Psi_\alpha$  is semi-conjugate:  $\phi_\alpha$  possesses an attractor at infinity which attracts any point whose forward orbit is not bounded.

Let us see how the previous result enables us to conclude the analysis of the dynamics of  $\Psi_\alpha$  when  $\varphi^{(1-q)/d} < |\alpha| < 1$ . Note that in this case,  $0_{\mathbb{C}^2}$  becomes a saddle point for  $\phi_\alpha$ . We have seen in Subsection 9.2 that  $\mathcal{W}_{\phi_\alpha}^s(0_{\mathbb{C}^2}) = K_{\phi_\alpha}^+$  is closed. Therefore, we recover the fact recalled above in the particular case of the saddle fixed point  $0_{\mathbb{C}^2}$ , and which asserts that  $J_{\phi_\alpha}^+ = \overline{\mathcal{W}_{\phi_\alpha}^s(0_{\mathbb{C}^2})} = \mathcal{W}_{\phi_\alpha}^s(0_{\mathbb{C}^2})$ . Let  $p = (p_0, p_1, p_2) \in \mathbb{C}^3$ . For  $n \geq 0$ ,

$$\theta \circ \Psi_\alpha^n(p) = (P_\alpha^{(n)}(p)(\alpha^n p_2)^l, P_\alpha^{(n-1)}(p)(\alpha^n p_2)^l, \alpha^n p_2) = (\phi_\alpha^n \circ h(p), \alpha^n p_2). \quad (9.11)$$

Recall that  $\mathcal{U} := \{z_2 = 0\}^c$  and that  $\mathcal{S} \subset \mathcal{U}$  denotes the set of points whose behavior is described in the second item of Proposition 3.72. From the estimate on the speed we obtained, we know that

$$\mathcal{S} \subset \{p \in \mathbb{C}^3 \mid G_{\Psi_\alpha}^+(p) = 0\}.$$

Since  $G_{\Psi_\alpha}^+ = G_{\phi_\alpha} \circ h$ , we deduce that  $h(\mathcal{S}) \subset \{\tilde{p} \in \mathbb{C}^2 \mid G_{\phi_\alpha}^+(\tilde{p}) = 0\} = \mathcal{W}_{\phi_\alpha}^s(0_{\mathbb{C}^2})$ . Assume that  $\mathcal{S}$  is non-empty and take  $p \in \mathcal{S}$ . From (9.11), and because by definition  $\mathcal{S} \subset \mathcal{U}$ , we see that  $\lim_{n \rightarrow +\infty} |P_\alpha^{(n)}(p)| \cdot |\alpha|^{nl}$  exists and vanishes. Since  $l = d/(q-1)$ , this

is in contradiction with the estimate  $\limsup_{n \rightarrow +\infty} |P_\alpha^{(n)}(p)|^{q-1} \cdot |\alpha|^{nd} > 0$  given in Proposition

3.72. Let us rephrase what we have obtained:

**Proposition 3.74.** When  $\varphi^{(1-q)/d} < |\alpha| < 1$ , the automorphism  $\Psi_\alpha$  shares a certain number of properties with the automorphism of Hénon type  $\phi_\alpha$ . The point  $0_{\mathbb{C}^3}$  is a fixed point of  $\Psi_\alpha$  of saddle type, and  $J_{\Psi_\alpha}^+ := \partial K_{\Psi_\alpha}^+ = \mathcal{W}_{\Psi_\alpha}^s(0_{\mathbb{C}^3})$ . Moreover, it follows from the previous discussion that

$$\begin{aligned} & \{z_2 = 0\} \xrightarrow{h} \{0_{\mathbb{C}^2}\}; \\ K_{\Psi_\alpha}^+ = \mathcal{W}_{\Psi_\alpha}^s(0_{\mathbb{C}^3}) & \xrightarrow{h} K_{\phi_\alpha}^+ = \mathcal{W}_{\phi_\alpha}^s(0_{\mathbb{C}^2}); \\ \{p \in \mathbb{C}^3 \mid G_{\Psi_\alpha}^+(p) > 0\} & \xrightarrow{h} \{\tilde{p} \in \mathbb{C}^2 \mid G_{\phi_\alpha}^+(\tilde{p}) > 0\}. \end{aligned} \quad (9.12)$$

In this situation, we see that the set  $\Omega''$  introduced in the case where  $0 < |\alpha| < \varphi^{(1-q)/d}$  shrinks to the hyperplane  $\{z_2 = 0\}$  which is contracted by  $h$ ; in particular, it has empty interior.

**9.5. A few words on the case where  $|\alpha| = 1$ .** Note that in this case, the point  $0_{\mathbb{C}^3}$  is still fixed by  $\Psi_\alpha$  but it is no longer hyperbolic. We show the following trichotomy:

**Proposition 3.75.** Let  $p \in \mathcal{U} = \{z_2 = 0\}^c$ . We have three possibilities:

- either  $p \in K_{\Psi_\alpha}^+$ , that is, its forward orbit is bounded;
- or  $p \in \mathcal{Z} \setminus K_{\Psi_\alpha}^+$ ; in particular,  $|P_\alpha^{(n)}(p)| = o(\varphi^{n/q})$ ;
- or  $G_{\Psi_\alpha}^+(p) > 0$ ; moreover the sequence  $(|P_\alpha^{(n)}(p)|)_n$  is increasing after a certain time.

PROOF. Assume that  $p \notin K_{\Psi_\alpha}^+$  and  $p \in \mathcal{D}$ . This implies  $|P_\alpha^{(n)}(p)| = o(\varphi^{n/q})$ . From Lemma 3.60, and since  $q > 1$ , we deduce that  $p \in \mathcal{Z}$  and we are in the second case.

Let us then assume that  $p \notin \mathcal{D}$  and fix  $\epsilon > 0$  such that  $(1 - \epsilon)\varphi > 1$ . From Lemma 3.60, we see that for every  $n_0 \geq 0$ , it is possible to find  $n \geq n_0$  such that

$|P_\alpha^{(n)}(p)| \geq ((1 - \epsilon)\varphi)^n$ . Arguing as in the proof of Proposition 3.72, we see that the assumptions of Lemma 3.63 are satisfied after a certain time, and we conclude that we are in the third case described above.  $\square$

**Remark 3.76.** Note that for any  $p \in \mathbb{C}^3$ , either its forward orbit escapes to infinity with maximal speed (this corresponds to the third case), or  $p \in \mathcal{Z}$ . We denote by  $\mathcal{S}'$  the set of points corresponding to the second case described in Proposition 3.75. We will show later that in fact  $\mathcal{S}' = \emptyset$ .

When  $\alpha^n = 1$  for some  $n \geq 1$ , we see that the dynamics of  $\Psi_\alpha$  is essentially given by the one of the Hénon automorphism  $\phi = \phi_1$ , so we assume in the following that  $\alpha$  is not a root of unity.

Reasoning as before, (9.11) tells us that  $h(K_{\Psi_\alpha}^+) = K_{\phi_\alpha}^+ = \{\tilde{p} \in \mathbb{C}^2 \mid G_{\phi_\alpha}^+(\tilde{p}) = 0\}$ , but now,  $h(\mathcal{W}_{\Psi_\alpha}^s(0_{\mathbb{C}^3})) \subsetneq \mathcal{W}_{\phi_\alpha}^s(0_{\mathbb{C}^2})$ . Again,  $K_{\Psi_\alpha}^+ \neq \{p \in \mathbb{C}^3 \mid G_{\Psi_\alpha}^+(p) = 0\}$  since there are points in  $\{z_2 = 0\}$  escaping to infinity with Fibonacci speed. The point  $0_{\mathbb{C}^2}$  is still a saddle point of  $\phi_\alpha$ , hence  $J_{\phi_\alpha}^+ := \partial K_{\phi_\alpha}^+ = \overline{\mathcal{W}_{\phi_\alpha}^s(0_{\mathbb{C}^2})}$ . The map  $\Psi_\alpha^{-1}$  is of the same form as  $\Psi_\alpha$ , and similarly, we have  $h(K_{\Psi_\alpha}^-) = K_{\phi_\alpha}^- = \{\tilde{p} \in \mathbb{C}^2 \mid G_{\phi_\alpha}^-(\tilde{p}) = 0\}$  as well as  $J_{\phi_\alpha}^- := \partial K_{\phi_\alpha}^- = \overline{\mathcal{W}_{\phi_\alpha}^u(0_{\mathbb{C}^2})}$ .

We define  $K_{\Psi_\alpha} := K_{\Psi_\alpha}^+ \cap K_{\Psi_\alpha}^-$ ; note that  $K_{\Psi_\alpha} \cap \{z_2 = 0\} = (\Delta_\varphi \times \{0\}) \cap (\Delta_{\varphi'} \times \{0\}) = \{0_{\mathbb{C}^3}\}$ , and that  $h(K_{\Psi_\alpha}) = K_{\phi_\alpha}$ . We also see that  $\theta|_{\mathcal{U}}$  maps bijectively  $K_{\Psi_\alpha} \cap \mathcal{U}$  onto  $K_{\phi_\alpha} \cap \mathcal{U} = K_{\phi_\alpha} \times \mathbb{C}^*$ . In particular,  $K_{\Psi_\alpha} = \{0_{\mathbb{C}^3}\} \cup \theta^{-1}(K_{\phi_\alpha} \times \mathbb{C}^*)$ . Since  $\theta|_{\mathcal{U}}$  is a biholomorphism, we deduce that:

$$\partial K_{\Psi_\alpha} = \partial(\{0_{\mathbb{C}^3}\} \cup \theta^{-1}(K_{\phi_\alpha} \times \mathbb{C}^*)) = \{0_{\mathbb{C}^3}\} \cup \overline{\theta^{-1}(\partial K_{\phi_\alpha} \times \mathbb{C}^*)}.$$

Now, Proposition 3.75 implies that for any  $p \in \mathcal{U}$ , either  $|P_\alpha^{(n)}(p)| = O(\varphi^{j/q})$  (this corresponds to the first and the second cases described in this proposition), or  $G_{\Psi_\alpha}^+(p) > 0$ . With the notations of Proposition 3.75, assume that  $\mathcal{S}' \neq \emptyset$  and let  $p \in \mathcal{S}' \subset (K_{\Psi_\alpha}^+)^c$ . In particular,  $G_{\Psi_\alpha}^+(p) = 0$ . But  $G_{\Psi_\alpha}^+(p) = G_{\phi_\alpha}^+(h(p))$ , so  $h(p) \in \{\tilde{p} \in \mathbb{C}^2 \mid G_{\phi_\alpha}^+(\tilde{p}) = 0\} = K_{\phi_\alpha}^+$ . Then Equation (9.11) implies that  $p \in K_{\Psi_\alpha}^+$ , a contradiction: we conclude that  $\mathcal{S}' = \emptyset$ .

We define a Green function  $G_{\Psi_\alpha}^-$  in the same way as we did before, as well as a current  $T_{\Psi_\alpha}^- := \text{dd}^c(G_{\Psi_\alpha}^-)$ . We note that  $T_{\Psi_\alpha}^\pm|_{\mathcal{U}} = (\theta|_{\mathcal{U}})^*(T_{\phi_\alpha}^\pm|_{\mathcal{U}}) = (h|_{\mathcal{U}})^*(T_{\phi_\alpha}^\pm|_{\mathcal{U}})$ , and by construction, the currents  $T_{\Psi_\alpha}^\pm$  satisfy  $\Psi_\alpha^*(T_{\Psi_\alpha}^\pm) = q^{\pm 1} \cdot T_{\Psi_\alpha}^\pm$ . The measure

$$\mu_{\Psi_\alpha} := T_{\Psi_\alpha}^+ \wedge T_{\Psi_\alpha}^- \wedge dz_2 \wedge d\bar{z}_2$$

is invariant by  $\Psi_\alpha$ . Moreover, if we denote  $\mu_{\phi_\alpha} := \mu_{\phi_\alpha} \wedge dz_2 \wedge d\bar{z}_2$ , then

$$\mu_{\Psi_\alpha}|_{\mathcal{U}} = (h|_{\mathcal{U}})^*(\mu_{\phi_\alpha}|_{\mathcal{U}}) \wedge dz_2 \wedge d\bar{z}_2 = (\theta|_{\mathcal{U}})^*(\mu_{\phi_\alpha}|_{\mathcal{U}}). \quad (9.13)$$

Since  $\mu_{\phi_\alpha}$  has support in the compact set  $\partial K_{\phi_\alpha}$ , we deduce from (9.13) that  $\mu_{\Psi_\alpha}$  is supported on  $\partial K_{\Psi_\alpha} = \{0_{\mathbb{C}^3}\} \cup \overline{\theta^{-1}(\partial K_{\phi_\alpha} \times \mathbb{C}^*)}$ .

For every  $p_2 \neq 0$ , the set  $\mathcal{C}_{p_2} := \mathbb{C}^2 \times \{p_2 e^{ix} \mid x \in \mathbb{R}\}$  is invariant both by  $\Psi_\alpha$  and  $\Phi_\alpha$ . We know that  $(\phi_\alpha, \mu_{\phi_\alpha})$  is mixing (in particular, weakly mixing), and for any  $p_2 \neq 0$ , the restriction of  $z_2 \mapsto \alpha z_2$  to  $\mathcal{C}_{p_2}$  is ergodic for  $dz_2 \wedge d\bar{z}_2$ , hence  $(\Phi_\alpha|_{\mathcal{C}_{p_2}}, \mu_{\phi_\alpha})$  is ergodic (see [10] for instance). We define  $\mathcal{J}_{p_2} := \partial K_{\Psi_\alpha} \cap \mathcal{C}_{p_2}$ ; this set is invariant, and we know that  $\mu_{\Psi_\alpha}|_{\mathcal{J}_{p_2}}$  is supported on it. By (9.13), we conclude that  $(\Psi_\alpha|_{\mathcal{J}_{p_2}}, \mu_{\Psi_\alpha})$  is ergodic too. Yet there is no hope to get mixing properties for  $\Psi_\alpha$  since by projection on the third coordinate,  $z_2 \mapsto \alpha z_2$  is a quasiperiodic factor of the dynamics. We have thus obtained:

**Proposition 3.77.** For any point  $p \in \mathbb{C}^3$ , we are in exactly one of the following cases:

- either the orbit of  $p$  is bounded, i.e.  $p \in K_{\Psi_\alpha}$ ;
- or  $p \in \{z_2 = 0\} \setminus \{0_{\mathbb{C}^3}\}$ ;
- or  $G_{\Psi_\alpha}^+(p) > 0$  or  $G_{\Psi_\alpha}^-(p) > 0$ .

The measure  $\mu_{\Psi_\alpha}$  is invariant by  $\Psi_\alpha$  and supported on the set  $\partial K_{\Psi_\alpha} = \{0_{\mathbb{C}^3}\} \cup \theta^{-1}(\partial K_{\phi_\alpha} \times \mathbb{C}^*)$ . Moreover, when  $p_2 \neq 0$  and  $\alpha$  is not a root of unity,  $(\Psi_\alpha|_{\mathcal{J}_{p_2}}, \mu_{\Psi_\alpha})$  is ergodic.





## Bibliography

- [1] Bedford, E., Lyubich, M., Smillie, J.: Distribution of periodic points of polynomial diffeomorphisms of  $\mathbf{C}^2$ . *Invent. Math.*, **114** (1), 277–288 (1993).
- [2] Bedford, E., Lyubich, M., Smillie, J.: Polynomial diffeomorphisms of  $\mathbf{C}^2$ . IV. The measure of maximal entropy and laminar currents. *Invent. Math.*, **112** (1), 77–125 (1993).
- [3] Bedford, E., Smillie, J.: Polynomial diffeomorphisms of  $\mathbf{C}^2$ . II. Stable manifolds and recurrence. *J. Amer. Math. Soc.*, **4** (4), 657–679 (1991).
- [4] Bedford, E., Smillie, J.: Polynomial diffeomorphisms of  $\mathbf{C}^2$ . III. Ergodicity, exponents and entropy of the equilibrium measure. *Math. Ann.*, **294** (3), 395–420 (1992).
- [5] Benedicks, M., Carleson, L.: The dynamics of the Hénon map. *Ann. of Math. (2)*, **133** (1), 73–169 (1991).
- [6] Bisi, C.: On commuting polynomial automorphisms of  $\mathbf{C}^k$ ,  $k \geq 3$ . *Mathematische Zeitschrift*, **258** (4), 875–891 (2008).
- [7] Bonifant, A. M., Fornæss, J. E.: Growth of degree for iterates of rational maps in several variables. *Indiana University Mathematics Journal*, **49** (2), 751–778 (2000).
- [8] Briend, J.-Y., Duval, J.: Exposants de Liapounoff et distribution des points périodiques d'un endomorphisme de  $\mathbf{CP}^k$ . *Acta mathematica*, **182** (2), 143–157 (1999).
- [9] Brunella, M.: Minimal models of foliated algebraic surfaces. *Bull. Soc. Math. France*, **127** (2), 289–305 (1999).
- [10] Bunimovich, L. A., Dani, S. G., Dobrushin, R. L., Jakobson, M. V. Kornfeld, I. P., Maslova, N. B., Pesin, Ya. B., Smillie, J., Sukhov, Yu. M., Vershik, A. M.: *Dynamical systems, ergodic theory and applications*. Springer Science & Business Media, Volume 100, (2000).
- [11] Devaney, R., Nitecki, Z.: Shift automorphisms in the Hénon mapping. *Comm. Math. Phys.*, **67** (2), 137–146 (1979).
- [12] Fornæss, J. E., Sibony, N.: Complex dynamics in higher dimensions. In *Complex potential theory (Montreal, PQ, 1993)*, volume 439 of *NATO Adv. Sci. Inst. Ser. C Math. Phys. Sci.*, 131–186. Kluwer Acad. Publ., Dordrecht, (1994). Notes partially written by Estela A. Gavosto.
- [13] Friedland, S.: Entropy of algebraic maps. In *Proceedings of the Conference in Honor of Jean-Pierre Kahane (Orsay, 1993)*, number Special Issue, 215–228 (1995).
- [14] Friedland, S., Milnor, J.: Dynamical properties of plane polynomial automorphisms. *Ergodic Theory Dynam. Systems*, **9** (1), 67–99 (1989).
- [15] Guedj, V., Sibony, N.: Dynamics of polynomial automorphisms of  $\mathbf{C}^k$ . *Ark. Mat.*, **40** (2), 207–243 (2002).
- [16] Heins, M.: On a notion of convexity connected with a method of Carleman. *Journal d'Analyse Mathématique*, **7** (1), 53–77 (1959).
- [17] Hénon, M.: Numerical study of quadratic area-preserving mappings. *Quart. Appl. Math.*, **27**, 291–312 (1969).
- [18] Hénon, M.: A two-dimensional mapping with a strange attractor. *Comm. Math. Phys.*, **50**, 69–77 (1976).
- [19] Julia, G.: Mémoire sur la permutabilité des fractions rationnelles. *Ann. Sci. École Norm. Sup. (3)*, **39**, 131–215 (1922).
- [20] Jung, H. W. E.: Über ganze birationale Transformationen der Ebene. *J. Reine Angew. Math.*, **184**, 161–174 (1942).
- [21] Lamy, S.: L'alternative de Tits pour  $\text{Aut}[\mathbf{C}^2]$ . *J. Algebra*, **239**, 413–437 (2001).
- [22] Lamy, S.: Une preuve géométrique du théorème de Jung. *Enseignement Mathématique*, **48** (3/4), 291–316 (2002).
- [23] Ritt, J. F.: Permutable rational functions. *Trans. Amer. Math. Soc.*, **25** (3), 399–448 (1923).
- [24] Russakovskii, A., Shiffman, B.: Value distribution for sequences of rational mappings and complex dynamics. *Indiana Univ. Math. J.*, **46** (3), 897–932 (1997).
- [25] Serre, J.-P.: *Arbres, amalgames,  $\text{SL}_2$* . Société Mathématique de France, Paris, 1977. Avec un sommaire anglais, rédigé avec la collaboration de Hyman Bass, Astérisque, No. 46.

- [26] Sibony, N.: Dynamique des applications rationnelles de  $\mathbf{P}^k$ . In Dynamique et géométrie complexes (Lyon, 1997), volume 8 of Panor. Synthèses, pages ix-x, xi-xii, 97–185. Soc. Math. France, Paris (1999).
- [27] Smale, S.: Differentiable dynamical systems. Bull. Amer. Math. Soc., **73**, 747–817 (1967).
- [28] Smillie, J.: The entropy of polynomial diffeomorphisms of  $\mathbf{C}^2$ . Ergodic Theory Dynam. Systems, **10** (4), 823–827 (1990).

## Asymptotics of spectral gaps for quasi-periodic Schrödinger operators

This chapter is based on a joint work with Jiangong You,<sup>1</sup> Zhiyan Zhao,<sup>2</sup> and Qi Zhou.<sup>3</sup> The version presented here is provisional, a final version will follow thereafter.

For non-critical almost Mathieu operators, and for every Diophantine frequency, we establish exponential asymptotics on the size of spectral gaps; based on these estimates, we show that the spectrum of such operators is homogeneous. We also prove that for a (measure-theoretically) typical quasi-periodic analytic potential, the spectrum is homogeneous. As an application of our results, we verify the discrete version of Deift's conjecture [26] for subcritical analytic quasi-periodic potential. These results answer a series of open problems of Damanik-Goldstein et al [14, 23, 25, 34], and Kotani [43].

### 1. Introduction and main results

In the present work, we consider one-dimensional discrete Schrödinger operators. We work in the quasi-periodic context, that is, given a *phase*  $\theta \in \mathbb{T} := \mathbb{R}/\mathbb{Z}$ , a *frequency*  $\alpha \in \mathbb{R} \setminus \mathbb{Q}$ , and some function  $V: \mathbb{T} \rightarrow \mathbb{R}$ , the potential at the point of index  $n$  is  $V(\theta + n\alpha)$ . The associate Schrödinger operator  $H = H_{V,\alpha,\theta}$  is defined by:

$$(Hu)_n = u_{n+1} + u_{n-1} + V(\theta + n\alpha)u_n, \quad \forall n \in \mathbb{Z}, \quad (1.1)$$

where  $\theta \in \mathbb{T} := \mathbb{R}/\mathbb{Z}$  is the *phase*,  $V: \mathbb{T} \rightarrow \mathbb{R}$  is the *potential*, and  $\alpha \in \mathbb{R} \setminus \mathbb{Q}$  is the *frequency*. In the following, we always assume that  $V$  is analytic. A central example is the so-called almost Mathieu operator (AMO), which corresponds to the case where  $V = 2\lambda \cos(2\pi \cdot)$  for some *coupling constant*  $\lambda \in \mathbb{R}$ . This quasi-periodic model originates from physics and has attracted constant interest there; for instance, it plays a central role in the theory by Thouless et al [51] of the integer quantum Hall effect, which partly led to the Nobel Prize that Thouless was awarded in 2016.

**1.1. Bounds on spectral gaps.** It is well known that the spectrum of  $H_{V,\alpha,\theta}$  is a closed non-empty subset of  $\mathbb{R}$ , independent of  $\theta$  if  $\alpha$  is irrational. We denote it by  $\Sigma_{V,\alpha}$ .

Given an operator  $H_{V,\alpha,\theta}$ , the integrated density of states (IDS)  $N_{V,\alpha}$  is defined as follows:

$$N_{V,\alpha}(E) := \int_{\mathbb{T}} \mu_{V,\alpha,\theta}^f(-\infty, E] d\theta, \quad \forall E \in \mathbb{R}, \quad (1.2)$$

where  $f \in \ell^2(\mathbb{Z})$  satisfies  $\|f\|_{\ell^2(\mathbb{Z})} = 1$ , and  $\mu_{V,\alpha,\theta}^f$  is the spectral measure of  $H$  corresponding to  $f$ . The Gap-Labeling Theorem [16, 39] tells us that  $N_{V,\alpha}(E) \in \alpha\mathbb{Z} \oplus \mathbb{Z}$  for any energy  $E \in \mathbb{R} \setminus \Sigma_{V,\alpha}$ . Any bounded connected component of  $\mathbb{R} \setminus \Sigma_{V,\alpha}$  is called a *spectral gap*. In particular, we may associate with each spectral gap  $G$  an integer  $k \in \mathbb{Z} \setminus \{0\}$  such that the integrated density of states restricted to  $G$  satisfies  $N_{V,\alpha} \equiv k\alpha \pmod{\mathbb{Z}}$ . We call  $k$  the *label* of the spectral gap  $G$ , and we denote  $G = G_k(V) = (E_k^-(V), E_k^+(V))$ , with  $E_k^-(V) \leq E_k^+(V) \in \mathbb{R}$ . In this chapter, we will establish exponential asymptotics for the spectral gaps of the AMO  $H_{2\lambda \cos(2\pi \cdot), \alpha, \theta}$ . From the physical side, after Von Klitzing's discovery on quantum Hall effect [40], Thouless and his coauthors [51] gave a theoretic explanation by showing that the Hall conductance at the plateaus is related

---

1. Chern Institute of Mathematics and LPMC, Nankai University, Tianjin 300071, China.  
 2. Laboratoire J.A. Dieudonné, Université de Nice-Sophia Antipolis, 06108 Cedex 02 Nice, France.  
 3. Department of Mathematics, Nanjing University, Nanjing 210093, China.

to a topological invariant known as Chern number, thus it is quantized. Our main work is to estimate the size of each plateau when the frequency  $\alpha$  is Diophantine. Recall that  $\alpha \in \mathbb{R}^d$  is called Diophantine if there exist  $K > 0$  and  $\tau > d - 1$  such that  $\alpha \in \text{DC}(K, \tau)$ , where

$$\text{DC}(K, \tau) := \left\{ \omega \in \mathbb{R}^d : \inf_{j \in \mathbb{Z}} |\langle n, \omega \rangle - j| > \frac{K}{|n|^\tau}, \quad \forall n \in \mathbb{Z}^d \setminus \{0\} \right\}. \quad (1.3)$$

We also set  $\text{DC} := \cup_{K>0, \tau>d-1} \text{DC}(K, \tau)$ . Given  $\lambda \in \mathbb{R}$ , let us denote by  $G_k(\lambda)$  the spectral gaps of the almost Mathieu operator  $H_{2\lambda \cos, \alpha, \theta}$ . We obtain the following result:

**Theorem M** (L.-You-Zhao-Zhou). *Let  $\alpha \in \mathbb{R} \setminus \mathbb{Q}$  with  $\alpha \in \text{DC}$ , and let  $|\lambda| \neq 0, 1$ . Then there exist constants  $C_\ell, C_r, \gamma_\ell, \gamma_r, > 0$  which depend on  $\lambda$  but not on  $\alpha, k$ , such that*

$$C_\ell e^{-\gamma_\ell |k|} \leq |G_k(\lambda)| \leq C_r e^{-\gamma_r |k|}, \quad \forall k \in \mathbb{Z} \setminus \{0\}.$$

In fact, the upper bound on the size of spectral gaps can be generalized to  $H_{V, \alpha, \theta}$  for any sufficiently small analytic potential  $V$  and any frequency  $\alpha \in \mathbb{R} \setminus \mathbb{Q}$  satisfying  $\beta(\alpha) = 0$ . Recall that if  $\left(\frac{p_j}{q_j}\right)_j$  is the sequence of best approximants of  $\alpha$ , we define

$$\beta(\alpha) := \limsup_{j \rightarrow \infty} \frac{\ln q_{j+1}}{q_j},$$

which measures how Liouvillean  $\alpha$  is. In particular,  $\alpha \in \text{DC}$  implies that  $\beta(\alpha) = 0$ .

**Theorem N** (L.-You-Zhao-Zhou). *We consider a one-dimensional quasi-periodic Schrödinger operator  $H_{V, \alpha, \theta}$ , where  $V \in C^\omega(\mathbb{T}, \mathbb{R})$  is analytic and  $\alpha \in \mathbb{R} \setminus \mathbb{Q}$  satisfies  $\beta(\alpha) = 0$ . As above, the spectral gaps are denoted by  $\{G_k(V)\}_{k \in \mathbb{Z}}$ . There exist absolute constants  $c_0, k_0 > 0$  such that if  $0 < \sup_{|\Im z| < \epsilon} |V(z)| < c_0 \epsilon^{k_0}$  for some  $0 < \epsilon < 1$ , then*

$$|G_k(V)| \leq C e^{-\gamma |k|}, \quad \forall k \in \mathbb{Z} \setminus \{0\}$$

for some constants  $C, \gamma > 0$  depending only on  $V$  and  $\alpha$ .

Let  $V \in C^\omega(\mathbb{T}, \mathbb{R})$  be an analytic potential. For any  $E \in \mathbb{R}$ , the *Schrödinger cocycle* is defined by  $(\alpha, S_E^V)$ , where  $S_E^V(x) := \begin{pmatrix} E - V(x) & -1 \\ 1 & 0 \end{pmatrix}$ . An energy  $E \in \Sigma_{V, \alpha}$  is called *supercritical*, resp. *subcritical*, if the associate Lyapunov exponent satisfies  $L(\alpha, S_E^V) > 0$ , resp.  $L(\alpha, S_E^V) = 0$  for  $|\Im x| < \delta$ .

**Remark 4.1.** *We will later show (see Theorem Q) that the conclusion of Theorem N is true for any analytic potential  $V$  in the “subcritical” regime.*

The proof of Theorem N relies on duality arguments. This method allows us to relax the Diophantine condition to the subexponential regime  $\beta(\alpha) = 0$ , but it cannot be carried out in the higher dimensional setting. Thus, it is interesting to ask whether it is possible to obtain exponential decay of the gaps through KAM methods, in order to deal with vectors of frequency. We obtain the following result:

**Theorem O** (L.-You-Zhao-Zhou). *Let  $\alpha \in \mathbb{R}^d$  with  $\alpha \in \text{DC}(K, \tau)$  for certain constants  $K > 0$  and  $\tau > d - 1$ , and let  $h > 0$ . Then there exist constants  $\epsilon_0, C > 0$  which depend on  $V$  (but not on  $\alpha, k$ ), and a constant  $\gamma$  which only depends on  $h$ , such that if*

$$\sup_{x \in \mathbb{T}} |V(x)| = \sup_{x \in \mathbb{R}} |V(x)| < \epsilon_0(V),$$

then the spectral gaps  $(G_k(V))_k$  of  $\Sigma_{V, \alpha}$  obey

$$|G_k(V)| \leq C e^{-\gamma |k|}, \quad \forall k \in \mathbb{Z}^d \setminus \{0\}.$$

In the following, we review some recent works in which the question of estimating the size of spectral gaps for Schrödinger operators is investigated.

In [35], Hadj Amor studies the case of discrete Schrödinger operators in the perturbative regime. By a KAM approach, she has obtained subexponential upper bounds on the size of spectral gaps.

**Theorem 4.2** (Hadj-Amor, Theorem 2, [35]). *Given an integer  $d \geq 1$ , let  $\alpha \in \mathbb{R}^d$  be a Diophantine frequency, and assume that  $V: \mathbb{T} \rightarrow \mathbb{R}$  is analytic. There exist constants  $c'_0, k'_0 > 0$  depending only on  $K, \tau$  such that if  $V$  satisfies  $\sup_{|\Im z| < \epsilon} |V^{(i)}(z)| \leq c'_0 \epsilon^{k'_0}$ ,  $i = 0, 1, 2$ , then we have*

$$|G_k(V)| \leq C e^{-\gamma|k|^\kappa}, \quad \forall k \in \mathbb{Z} \setminus \{0\},$$

where  $C, \kappa > 0$  are two numerical constants, and  $\gamma$  is a constant that only depends on  $K, \tau, \epsilon$ .

The main part of her proof consists in showing an almost reducibility result thanks to a KAM scheme of faster convergence. Hadj Amor uses it together with some transversality properties to get a lower bound on the variation of the rotation number on some intervals. But on a non-collapsed spectral gap, the rotation number is constant, and this thus gives an upper bound on the length of the gap. Although Hadj Amor [35] focuses on the case of discrete Schrödinger operators, her method applies in the continuous case as well.

Similarly to the discrete model described above, the case of continuous Schrödinger operators also draws attention. Given an integer  $d \geq 1$ , let  $\alpha = (\alpha_1, \dots, \alpha_d) \in \mathbb{R}^d$  be a rationally independent vector of frequencies. We denote by  $C^\omega(\alpha)$  the space of functions  $f: \mathbb{R} \rightarrow \mathbb{R}$  such that  $f: x \mapsto F(\alpha_1 x, \dots, \alpha_d x)$  for some analytic function  $F: \mathbb{T}^d \rightarrow \mathbb{R}$ . For any  $v \in C^\omega(\alpha)$ , the associate Schrödinger operator  $\mathcal{H} = \mathcal{H}_v$  is the unique self-adjoint extension of the operator acting on the space of  $C^2$  functions with compact support by

$$-\Delta + v: \psi \mapsto (\mathbb{R} \ni x \mapsto -\psi''(x) + v(x)\psi(x)). \quad (1.4)$$

If  $E \in \mathbb{R}$ , we define  $\rho_v(E) := \lim_{x \rightarrow \infty} \frac{1}{x} \arg(\psi'(x) + i\psi(x))$ , where  $\psi$  is any solution to  $\mathcal{H}\psi = E\psi$ . The quantity  $\rho_v$  is called the *rotation number*; it is constant precisely on spectral gaps, defined as the connected components of the real complement of the spectrum of  $\mathcal{H}$ . By the Gap-Labeling Theorem, any spectral gap can be assigned an element in  $\mathbb{Z}^d$ , where the spectral gap  $G_k(v)$  associated to  $k \in \mathbb{Z}^d$  satisfies  $\rho_v|_{G_k(v)} \equiv \frac{\langle k, \alpha \rangle}{2}$ .

The first result giving upper bounds for spectral gaps of continuous Schrödinger operators is due to Moser-Pöschel [46]. Let  $\alpha \in \mathbb{R}^d$  satisfy  $|\langle n, \alpha \rangle| \geq \Omega(|n|)^{-1}$  for any  $n \in \mathbb{Z}^d \setminus \{0\}$ , where  $\Omega$  is some not too rapidly increasing approximation function, and set

$$\mathcal{R}(\Omega) := \left\{ \frac{\langle k, \alpha \rangle}{2}, k \in \mathbb{Z}^d \mid \text{if } j \neq k \in \mathbb{Z}^d, \text{ then } \left| \frac{\langle k - j, \alpha \rangle}{2} \right| \geq \Omega(|j|)^{-1} \right\}.$$

Given  $v \in C^\omega(\alpha)$ , Moser-Pöschel consider the continuous Schrödinger operator  $\mathcal{H}_v$  defined as above. They have shown the following result, which provides Floquet representations and gives estimates on the size of the gaps.

**Theorem 4.3** (Moser-Pöschel, Theorem 1.3, [46]). *If  $|k|$  is sufficiently large and  $\frac{\langle k, \alpha \rangle}{2} \in \mathcal{R}(\Omega)$ , then  $\overline{G_k(v)}$  is either collapsed to a point  $\{E_k(v)\}$ , in which case there are two linearly independent solutions  $\mathcal{H}\psi_i = E_k(v)\psi_i$ ,  $i = 1, 2$ ,*

$$\psi_1: x \mapsto e^{\pi i \langle k, \alpha \rangle x} \chi(x), \quad \psi_2: x \mapsto e^{-\pi i \langle k, \alpha \rangle x} \overline{\chi}(x), \quad \chi \in C^\omega(\alpha),$$

or  $G_k(v) = (E_k^-(v), E_k^+(v))$  with  $E_k^-(v) < E_k^+(v)$ , and for  $E = E_k^-(v), E_k^+(v)$ , there are two linearly independent solutions  $\mathcal{H}\psi_i = E\psi_i$ ,  $i = 1, 2$ ,

$$\psi_1: x \mapsto e^{\pi i \langle k, \alpha \rangle x} (\chi_1(x) + x\chi_2(x)), \quad \psi_2: x \mapsto e^{\pi i \langle k, \alpha \rangle x} \chi_2(x), \quad \chi_1, \chi_2 \in C^\omega(\alpha).$$

Moreover, the following upper bound holds:

$$|G_k(v)| \leq C e^{-\gamma|k|}$$

for some constants  $C, \gamma > 0$  independent of  $k$ .

Moser-Pöschel's results were recently sharpened by Damanik-Goldstein in [21]. Besides showing exponential decay of the size of spectral gaps, they also obtain some inverse spectral result: if the size of the gaps decays exponentially with respect to their label, then the Fourier coefficients of the potential also have exponential decay, and thus, the potential is analytic.

**Theorem 4.4** (Damanik-Goldstein, Theorem B, [21]). *Assume that  $\alpha \in \mathbb{R}^d$  satisfies the Diophantine condition  $\alpha \in \text{DC}(K, \tau)$  for some  $0 < K < 1$  and  $d - 1 < \tau < +\infty$ . Let  $v \in C^\omega(\alpha)$ ,  $v: x \mapsto \sum_{n \in \mathbb{Z}^d} \hat{v}_n e^{2\pi i(n, \alpha)x}$ , and assume that the Fourier coefficients  $(\hat{v}_n)_{n \in \mathbb{Z}^d}$  satisfy  $|\hat{v}_n| \leq \varepsilon e^{-\gamma_0 |n|}$  for some small  $\varepsilon > 0$  and some  $\gamma_0 > 0$ . Then there exists  $\varepsilon^{(0)} = \varepsilon^{(0)}(\gamma_0, K, \tau) > 0$  such that if  $\varepsilon \leq \varepsilon^{(0)}$ , then the spectral gaps of  $\mathcal{H} = \mathcal{H}_v$  obey*

$$|G_k(v)| \leq 2\varepsilon e^{-\frac{\gamma_0}{2}|k|}, \quad \forall k \in \mathbb{Z}^d \setminus \{0\}.$$

*Conversely, there exists  $\varepsilon^{(1)} > 0$  such that if for some  $\varepsilon < \varepsilon^{(1)}$  and  $\gamma > 4\gamma_0$ , we have  $|G_k(v)| \leq \varepsilon e^{-\gamma|k|}$ ,  $\forall k \in \mathbb{Z}^d \setminus \{0\}$ , then the Fourier coefficients satisfy  $|\hat{v}_n| \leq \varepsilon^{1/2} e^{-\frac{\gamma}{2}|n|}$  for all  $n \in \mathbb{Z}^d$ .*

Let us also mention that the main target of their result was its application to the problems of isospectral potentials (see [24]) and the existence of a global solution to the KdV equation  $\partial_t \psi + \partial_x^3 \psi + \psi \partial_x \psi = 0$  with small quasi-periodic initial data (see [22] for more details).

**Remark 4.5.** *Our method to prove Theorem O still applies for continuous Schrödinger operators, which thus gives a new proof of Damanik-Goldstein's result [21]. While their result is perturbative, ours is nonperturbative, i.e. the smallness of  $V$  does not depend on the Diophantine constants  $K, \tau$ .*

As for lower bounds on the size of spectral gaps, it dates from the long-standing conjecture referred to in the literature as the ‘‘Ten Martini Problem’’, which asks whether the spectrum of the almost Mathieu operator  $H_{2\lambda \cos(2\pi \cdot), \alpha, \theta}$  is a Cantor set, in the case where  $\lambda \neq 0$  and  $\alpha$  is irrational. This problem was solved by Avila-Jitomirskaya [6].

The so-called ‘‘Dry Ten Martini Problem’’ elaborates on this question and asks, for all  $\lambda \neq 0$ , all irrational  $\alpha$ , and all integer  $k$ , if there is an open interval  $G_k(\lambda)$  such that the restriction of the IDS to  $G_k(\lambda)$  satisfies  $N_{2\lambda \cos(2\pi \cdot), \alpha} \equiv k\alpha \pmod{\mathbb{Z}}$ . In other terms, any spectral gap predicted by the Gap-Labeling theorem for  $H_{2\lambda \cos(2\pi \cdot), \alpha, \theta}$  is non-degenerate. In [13], Avila-You-Zhou have proven this fact for any non-critical coupling constant, i.e.,  $|\lambda| \neq 1$ . Note that the ‘‘Dry Ten Martini Problem’’ only concerns openness of the spectral gaps, without any quantitative estimates on their size. In Theorem M, we obtain quantitative lower bound estimates on the size of the gaps; besides, we show that the sequence  $(|G_k|)_k$  decays exponentially. This kind of exponential decay appears to be optimal even in the rational case [36, 45]. Moreover, Helffer-Kerdelhué-Sjöstrand proved that for any  $k$ , there exist  $\lambda_0 = \lambda_0(\alpha, k) > 0$  and  $C = C(\alpha, k) > 0$  such that if  $|\lambda| < \lambda_0$ , then  $|G_k(\lambda)| \geq \lambda^k / C$ .

**1.2. Homogeneous spectrum.** Another main topic in this chapter is the homogeneity of the operator  $\Sigma_{V, \alpha}$ . Recall the usual definition of this notion, introduced by Carleson [18].

**Definition 4.6.** *Given a positive number  $\mu > 0$ , a closed set  $\mathcal{S} \subset \mathbb{R}$  is called  $\mu$ -homogeneous if there exists  $\varepsilon_0 > 0$  such that for any  $E \in \mathcal{S}$  and any  $0 < \varepsilon \leq \varepsilon_0$ , we have*

$$|\mathcal{S} \cap (E - \varepsilon, E + \varepsilon)| > \mu\varepsilon. \quad (1.5)$$

The link between homogeneity of the spectrum and the inverse spectral theory of almost-periodic potentials was established in the work of Sodin-Yuditskii [49, 50], who studied the inverse spectral problem for reflectionless Jacobi matrices whose spectrum

is a given homogeneous set. Recall that  $V$  is *reflectionless* if

$$\lim_{\eta \rightarrow 0} \Re G(x, x; E + i\eta) = 0 \quad \text{for all } x \text{ and Lebesgue almost every } E \in \Sigma(V)$$

where  $G(x, y; E + i\eta) = (H_V - E - I\eta)^{-1}(x, y)$ ,  $\eta > 0$  is the Green function. Different classes of potentials, which are in fact reflectionless, were studied, prior to [20], in the basic works on ergodic potentials by Deift-Simon [27], Johnson [38], Johnson-Moser [39], Kotani [41, 42]. It was shown by Craig [20] that being reflectionless is the key feature which allows for the development of a number of fundamental objects from the periodic theory like auxiliary spectrum, trace formula, product expansions (see also the work by Gesztesy-Simon [31]). Employing the version of the trace formula from [31], Gesztesy-Yuditskii [33] found another remarkable consequence of the homogeneity property combined with being reflectionless: the spectrum is purely absolutely continuous (see also the paper by Poltoratski-Remling [47], where an even stronger result was established).

Let us recall previous results on homogeneity of the spectrum. For a continuous Schrödinger operator  $\mathcal{H}_v = -\Delta + v$  defined as in (1.4), homogeneity of the spectrum was shown by Damanik-Goldstein-Lukic [23], provided that  $v$  is small enough and that  $\alpha$  satisfies a certain Diophantine condition. Their proof is based on localization estimates and uses the exponential upper bounds obtained by Damanik-Goldstein [21]. Let us also mention that they establish a calibration between the gaps and the bands of the operator similar to that we will give later (see Theorem Q).

As for discrete quasi-periodic Schrödinger operators, Hadj Amor showed that  $\Sigma_{V,\alpha}$  is homogeneous, provided that  $\alpha$  is Diophantine and that  $V$  is sufficiently small. Indeed, it is almost a direct corollary of Corollary 3 in [35], though she didn't clarify the concept of homogeneity in her paper. For the positive Lyapunov exponent regime, Damanik-Goldstein-Schlag-Voda [25] have obtained the following result. Let  $V: \mathbb{T} \rightarrow \mathbb{R}$  be analytic, and assume that there exists  $L_0 > 0$  such that for any  $E \in \mathbb{R}$ , the Lyapunov exponent  $L(E)$  satisfies  $L(E) \geq L_0$ . Then  $\Sigma_{V,\alpha}$  is  $\mu$ -homogeneous for some  $\mu = \mu(V, K, \tau, L_0) > 0$ , provided that  $\alpha \in \mathbb{R} \setminus \mathbb{Q}$  satisfies a strong Diophantine condition. Here,  $\alpha$  being strong Diophantine means that there exist  $K, \tau > 0$  such that

$$\inf_{j \in \mathbb{Z}} |n\alpha - j| \geq \frac{K}{|n|(\log |n|)^\tau}, \quad \forall n \in \mathbb{Z} \setminus \{0\}. \quad (1.6)$$

In this case, we write  $\alpha \in \text{SDC}(K, \tau)$ . Analogously, we set  $\text{SDC} := \cup_{K, \tau > 0} \text{SDC}(K, \tau)$ . In view of these results, it is natural to investigate the global homogeneity property for general quasi-periodic potentials, as was also asked by Damanik-Goldstein-Schlag-Voda [25] (see also Remark (2) after Theorem 1 in [25]). We will show the following:

**Theorem P** (L.-You-Zhao-Zhou). *Let  $\alpha \in \text{SDC}$ . Then for a (measure-theoretically) typical analytic potential  $V: \mathbb{T} \rightarrow \mathbb{R}$ , the spectrum  $\Sigma_{V,\alpha}$  is  $\mu$ -homogeneous for some  $0 < \mu < 1$ .*

In order to precise the meaning of this result, let us recall Avila's global theory of one-frequency quasi-periodic Schrödinger operators. Avila has shown that for a (measure-theoretically) typical  $V \in C^\omega(\mathbb{T}, \mathbb{R})$ , there exist an integer  $k \geq 1$  and a collection of points  $a_1 < b_1 < \dots < a_k < b_k$  in the spectrum  $\Sigma_{V,\alpha}$  such that  $\Sigma_{V,\alpha} \subset \cup_{i=1}^k [a_i, b_i]$ , where energies alternate between supercritical and subcritical along the sequence  $(\Sigma_{V,\alpha} \cap [a_i, b_i])_i$ . Throughout this chapter, we denote by  $\{I_i\}_{1 \leq i \leq m}$  the intervals such that the energies in  $\Sigma_{V,\alpha} \cap I_i$  are subcritical, and we set  $\Sigma_{V,\alpha}^{\text{sub}} := \cup_i (\Sigma_{V,\alpha} \cap I_i)$ . While the supercritical part is considered by [25], in this work, we shall focus on the subcritical part of the spectrum. In fact, Damanik-Goldstein-Schlag-Voda [25] asked the following question (see Problem 1 of [25] and Question 3.1 of [23]): assume that the Lyapunov exponent  $L(\alpha, S_E^\lambda V)$  vanishes identically on  $\Sigma_{\lambda V, \alpha}$  for all  $0 < \lambda < \lambda_0$ ; is the spectrum  $\Sigma_{\lambda V, \alpha}$  homogeneous for any  $0 < \lambda < \lambda_0$ ? We answer their question as follows:

**Theorem Q** (L.-You-Zhao-Zhou). *Let us assume that  $\beta(\alpha) = 0$ . Then for a typical analytic potential  $V: \mathbb{T} \rightarrow \mathbb{R}$ , the following assertions hold:*



- (1) For each  $i \in \{1, \dots, m\}$ , the integrated density of states  $N_{V,\alpha}$  is  $\frac{1}{2}$ -Hölder continuous on restriction to  $I_i$ .
- (2) There exist constants  $C, \gamma > 0$  depending on  $V, \alpha$ , such that  $|G_k| \leq Ce^{-\gamma|k|}$  whenever  $k \in \mathbb{Z} \setminus \{0\}$  satisfies  $\partial G_k \cap \Sigma_{V,\alpha}^{\text{sub}} \neq \emptyset$ .
- (3) For each  $i \in \{1, \dots, m\}$ , any  $\xi > 0$ , there exists  $c > 0$  depending on  $\xi, V, \alpha$  such that for any  $k \neq k' \in \mathbb{Z}$ ,  $|k'| \geq |k|$ , satisfying  $\partial G_k \cap I_i \neq \emptyset$  and  $\partial G_{k'} \cap I_i \neq \emptyset$ , we have

$$\text{dist}([E_k^-, E_k^+], [E_{k'}^-, E_{k'}^+]) \geq ce^{-\xi|k'|}.$$

- (4) For any  $\mu \in (0, 1)$ ,  $\Sigma_{V,\alpha}^{\text{sub}}$  is  $\mu$ -homogeneous.

The first point generalizes to the subcritical regime results obtained previously by Avila-Jitomirskaya [7] and Hadj Amor [35] in the perturbative setting, while the third point is proven by combining Hölder continuity of  $N_{V,\alpha}$  together with the arithmetic condition  $\beta(\alpha) = 0$ . Let us recall that the supercritical part of the spectrum was previously studied by Goldstein-Schlag [32], where they proved Hölder continuity of the integrated density of states.

**Remark 4.7.** By Avila's global theory, we know that for a typical analytic potential, the spectrum has no critical energy; besides, we have *spectral uniformity*: there exists  $L_0 > 0$  such that  $L(E) \geq L_0$  for any  $E \in \Sigma_{V,\alpha}^{\text{sup}}$ . Thus, Theorem P is proved by combining Theorem Q together with the results of [25] concerning the supercritical regime. Let us stress that the proof of homogeneity in Theorem Q is very different from that given in [25]; for us, the main ingredients are exponential upper bounds on the spectral gaps and Hölder continuity of the integrated density of states in the subcritical regime.

**Remark 4.8.** As a consequence of Theorem P and of the work of Gesztesy-Yuditskii [33], we can give another proof of Avila's Spectral Dichotomy Conjecture, which states that for typical  $V, \alpha, \theta$ ,  $H_{V,\alpha,\theta}$  has either pure point spectrum or purely absolutely continuous spectrum.

Indeed, given  $\alpha \in \text{SDC}$ ,  $\theta \in \mathbb{T}$ , and for a (measure-theoretically) typical analytic potential  $V: \mathbb{T} \rightarrow \mathbb{R}$ , the operator  $H_{V,\alpha,\theta}$  can be written as the direct sum of  $H_{V,\alpha,\theta}^+$  and  $H_{V,\alpha,\theta}^-$  whose respective spectral types correspond to "large-like" and "small-like" operators. More precisely,  $H_{V,\alpha,\theta}^+$ , resp.  $H_{V,\alpha,\theta}^-$ , is the operator obtained by projecting  $H_{V,\alpha}$  on  $\Sigma_{V,\alpha}^{\text{sup}}$ , resp. on  $\Sigma_{V,\alpha}^{\text{sub}}$ ,  $H_{V,\alpha,\theta}^+$  satisfies Anderson localization (by the results of [15]), while  $H_{V,\alpha,\theta}^-$  has purely absolutely continuous spectrum.

Let us now consider the case of AMO, i.e.,  $H_{2\lambda \cos(\cdot), \alpha, \theta}$ , with  $\lambda \in \mathbb{R}$ ,  $\alpha \in \mathbb{R} \setminus \mathbb{Q}$ ,  $\theta \in \mathbb{T}$ . To a large extent, the homogeneity property of the spectrum of  $H_{2\lambda \cos(\cdot), \alpha, \theta}$  depends on  $\lambda, \alpha$ . Damanik-Goldstein-Lukic (Question 3.2 of [23]) asked for which values of  $\lambda$  the spectrum of AMO was homogeneous. Besides, early back to 1997, Kotani already asked if  $\lim_{j \rightarrow \infty} q_j^2/q_{j+1} = 0$ ,  $0 < \lambda < 1$ , whether the spectrum is homogeneous, where  $(p_j/q_j)_j$  is the sequence of best approximants of  $\alpha$ . We obtain the following result:

**Corollary R** (L.-You-Zhao-Zhou). Assume that  $\beta(\alpha) = 0$  and  $|\lambda| \neq 0, 1$ . Recall that the gaps in the spectrum of  $H_{2\lambda \cos(\cdot), \alpha, \theta}$  can be labelled as  $G_k = (E_k^-, E_k^+)$ , for  $k \in \mathbb{Z} \setminus \{0\}$ . We also denote  $G_0 := N_{V,\alpha}^{-1}(\{0\}) = (-\infty, \underline{E}]$ , with  $\underline{E} \in \mathbb{R}$ . Then the following conclusions hold:

- (1) The IDS  $N_{2\lambda \cos(\cdot), \alpha}$  is  $\frac{1}{2}$ -Hölder continuous.
- (2) There exist constants  $C, \gamma > 0$  depending on  $\lambda, \alpha$ , such that  $|G_k| \leq Ce^{-\gamma|k|}$ , for any  $k \in \mathbb{Z} \setminus \{0\}$ .
- (3) For any  $\xi > 0$ , there exists a constant  $c > 0$  depending on  $\xi, \lambda, \alpha$ , such that for every  $k \neq k' \in \mathbb{Z} \setminus \{0\}$  with  $|k'| \geq |k|$ , we have

$$\text{dist}([E_k^-, E_k^+], [E_{k'}^-, E_{k'}^+]) \geq ce^{-\xi|k'|}.$$

- (4) Similarly, we have  $E_k^- - \underline{E} \geq ce^{-\xi|k|}$  for any  $k \in \mathbb{Z} \setminus \{0\}$ .
- (5) For any  $\mu \in (0, 1)$ ,  $\Sigma_{2\lambda \cos, \alpha}$  is  $\mu$ -homogeneous.

If  $|\lambda| = 1$ , then by results due to Avila-Krikorian [9] and Last [44],  $|\Sigma_{2\lambda, \alpha}| = 0$  for every  $\alpha \in \mathbb{R} \setminus \mathbb{Q}$ , hence the spectrum is not homogeneous. Prior to us, Damanik-Goldstein-Schlag-Voda [25] proved that if  $\alpha \in \text{SDC}$  and  $|\lambda| \neq 0, 1$ , then  $\Sigma_{2\lambda \cos, \alpha}$  is homogeneous. Compared to their result, we generalize the condition  $\alpha \in \text{SDC}$  to  $\beta(\alpha) = 0$ , and we establish a calibration between the gaps and the bands of the operator (see estimates (1)–(3) in the above statements). Indeed, as pointed out by Damanik-Goldstein-Schlag-Voda [25]: “This feature was not known for the almost Mathieu operator even in the regime of small coupling”. In their work, they only established the following weaker estimate: there exists  $N_0(\alpha, \lambda) \geq 0$  such that if  $N \geq N_0$  and  $G_1, G_2$  are two gaps with  $|G_1|, |G_2| > e^{-N^{1-}}$  then  $\text{dist}(G_1, G_2) > e^{-(\log N)^{C_0}}$  for some  $C_0 = C_0(\lambda, \alpha) > 0$ . Also we proved that the spectrum is  $\mu$ -homogeneous for *any*  $\mu \in (0, 1)$ , while in [25] they only proved that the spectrum is  $\mu$ -homogeneous for *some*  $\mu \in (0, 1)$  which depends on  $\alpha, \lambda$ .

Notice that in our Theorem, the arithmetic property  $\beta(\alpha) = 0$  is essential, since after our work, Avila-Last-Shamis-Zhou [11] proved that if  $\beta > 0$ , then  $\Sigma_{2\lambda \cos, \alpha}$  is not homogeneous for  $e^{-\beta} < \lambda < e^\beta$ .

**1.3. Deift’s conjecture.** Deift’s conjecture asks whether for almost periodic initial data, solutions to the KdV equation are almost periodic in the time variable. Recall that calibration estimates between the gaps and the bands of Schrödinger operators similar to those obtained above play an important role in the solution of Deift’s conjecture [26] with small analytic quasi-periodic data [22, 24].

Let us make a short review of recent developments towards this conjecture. Tsugawa [52] proved local existence and uniqueness of solutions in the case of a Diophantine frequency and when the Fourier coefficients of the potential decay at a sufficiently fast polynomial rate. Damanik-Goldstein [22] proved global existence and uniqueness for a Diophantine frequency and small quasi-periodic analytic initial data. Recently, Binder-Damanik-Goldstein-Lukic [14] proved that in the same setting, solutions are in fact almost periodic in time, thus establishing Deift’s conjecture in this special case. In this chapter, we consider the discrete version of Deift’s conjecture, i.e., whether for almost periodic initial data, solutions to the Toda flow are almost periodic in the time variable.

Let us recall the definition of the Toda flow. We identify the Schrödinger operator  $H_{V, \alpha, \theta}$  with a doubly infinite Jacobi matrix  $J^0$ , where for every  $(m, n) \in \mathbb{Z}$ ,

$$J_{m,n}^0 := \begin{cases} V(\theta + n\alpha), & m = n, \\ 1, & |m - n| = 1, \\ 0 & \text{otherwise.} \end{cases}$$

In particular,  $J^0$  is self-adjoint and tridiagonal. For any Jacobi matrix  $J$  and any polynomial  $f$  with real coefficients, we define  $M_f(J) := f(J)$  and decompose the matrix  $M_f(J)$  into the sum of an upper triangular matrix  $M_f^+(J)$  and a lower triangular matrix  $M_f^-(J)$ . We also set  $\widetilde{M}_f(J) := M_f^+(J) - M_f^-(J)$ . Then, the Toda flow is defined by

$$\frac{d}{dt} J(t) = [\widetilde{M}_f(J(t)), J(t)], \quad J(0) = H_{V, \alpha, \theta}. \quad (1.7)$$

More generally, given  $f \in L^\infty(X, \mathbb{R})$  with  $\Sigma_{V, \alpha} \subset X$ , we define  $M_f(J) := f(J)$  in the sense of standard functional calculus. We consider the associated Toda flow as in (1.7), where  $\widetilde{M}_f(J)$  is defined accordingly. In fact, Binder-Damanik-Goldstein-Lukic [14] raised the open question whether one could generalize their result to Avila’s sub-critical regime, in particular, for the most important example: almost Mathieu operator, whether the result holds for  $0 < |\lambda| < 1$ . In this chapter, we give an affirmative answer to their question as follows:

**Corollary S** (L.-You-Zhao-Zhou). *Let  $\alpha \in \mathbb{R} \setminus \mathbb{Q}$  with  $\beta(\alpha) = 0$ . Given an analytic potential  $V: \mathbb{T} \rightarrow \mathbb{R}$  which is subcritical,<sup>4</sup> then for any function  $f \in L^\infty(X, \mathbb{R})$  with  $\Sigma_{V,\alpha} \subset X$  and any  $\theta \in \mathbb{T}$ , the Toda flow with initial condition  $J(0) = H_{V,\alpha,\theta}$  admits a unique solution  $J = J(t)$  defined for all  $t \in \mathbb{R}$ . Moreover, for every  $t \in \mathbb{R}$ ,  $J(t)$  is an almost-periodic Jacobi matrix with constant spectrum  $\Sigma_{V,\alpha}$ .*

*In particular, the above conclusion holds for any  $V = 2\lambda \cos(2\pi \cdot)$  with  $|\lambda| < 1$ .*

**1.4. Ideas of the proofs.** As for the upper and lower bounds of spectral gaps, we need to analyze the behavior of a Schrödinger cocycle around the edge point of some spectral gap, hence reducibility and almost reducibility properties are the central problems.

We shall review in Section 3 and Section 4 two crucial tools that are available to study the reducibility of Schrödinger cocycles in the local regime: one is based on KAM methods, while the other one relies on the almost localization argument (via Aubry duality) given by Avila-Jitomirskaya [7]. By these methods, it is possible to show that for an energy  $E_*$  on the boundary of some spectral gap, the Schrödinger cocycle  $(\alpha, S_{E_*}^V)$  can be reduced to a constant cocycle, associated with some parabolic matrix. The quantitative estimates we obtain on the size of both the off-diagonal element of the parabolic matrix and the conjugacy can be expressed in terms of the label of the spectral gap we consider. Then, we study Schrödinger cocycles associated with nearby energies, i.e.,  $E_* + \delta$  for  $|\delta|$  small; keeping the previous conjugacy, we transform  $(\alpha, S_{E_*+\delta}^V)$  into a cocycle close to constant. Moreover, as in the averaging method introduced by Moser-Pöschel [46], we can conjugate once more so that the non-constant part is now of order two in  $\delta$ ; looking at the rotation number of the leading term of the cocycle obtained after this averaging step, and by the control we have on the error term, we are able to get the desired bounds.

By Avila's proof of the Almost Reducibility Conjecture, it is in fact possible to generalize this approach to Schrödinger cocycles in the global subcritical regime. Indeed, such cocycles are almost reducible; moreover, we can assume that the constant cocycles to which they are close after conjugacy are either  $\mathrm{SO}(2, \mathbb{R})$ -cocycles (by Claim in Corollary 4.2 in [54]) or Schrödinger cocycles in the non-perturbative regime (by Lemma 2.2 in [8]). In particular, in the first case, we may still perform a KAM scheme, while in the second case, results specific to cocycles of Schrödinger type, such as those based on Aubry duality, can still be used. Moreover, by a compactness argument, we have a uniform control on the conjugacies with respect to  $E \in \Sigma_{V,\alpha}$ . As a result, we are able to transform each Schrödinger cocycle associated with a subcritical energy into another one in the local regime, and then argue as above.

Similarly to the proof of Corollary 3 in [35], homogeneity of the spectrum  $\Sigma_{V,\alpha}$  in the subcritical regime is derived from the upper bounds on the size of spectral gaps, together with Hölder continuity of the rotation number of associate Schrödinger cocycles (see Theorem 4.64 and its proof for details). Together with the previous work of Damanik-Goldstein-Schlag-Voda [25], which handles the case of supercritical regime, we can show homogeneity of the spectrum  $\Sigma_{V,\alpha}$  for a typical analytic potential  $V: \mathbb{T} \rightarrow \mathbb{R}$  and  $\alpha \in \mathrm{SDC}$ , in view of Avila's global theory of one-frequency Schrödinger operators [5].

The remaining of the chapter is organized as follows: in Section 2, we review some classical facts on the theory of quasi-periodic cocycles, in particular those of Schrödinger type, and how they can be used in the study of spectral theory of Schrödinger operators. In Section 3 and Section 4, we explain the two main techniques available to get reducibility statements in the local regime: a perturbative method of KAM type, and a non-perturbative one based on Aubry duality. In Section 5, we explain how Avila's proof of the Almost Reducibility Conjecture can be used to generalize the previous results to the global subcritical regime. Bounds on spectral gaps will be shown in Section 6, following an averaging argument due to Moser-Pöschel [46]. In Section 7, we give another proof of the upper bounds on the size of spectral gaps, using a monotonicity

4. i.e., such that for any  $E \in \Sigma_{V,\alpha}$ , the cocycle  $(\alpha, S_E^V)$  is subcritical.

argument. We conclude the chapter by Section 8, where we prove homogeneity of the spectrum for typical one-frequency quasi-periodic Schrödinger operators.

## 2. Preliminaries

**2.1. Notations.** For a bounded analytic function  $f$  defined on a strip  $\{|\Im z| < h\}$ ,  $h > 0$ , we set  $|f|_h := \sup_{|\Im z| < h} |f(z)|$ . Analogously, if  $f$  is a continuous function defined on  $\mathbb{R}$  which is 1-periodic, we can see  $f$  as a function on  $\mathbb{T}$  and we set  $|f|_{\mathbb{T}} := \sup_{x \in \mathbb{T}} |f(x)| = \sup_{x \in \mathbb{R}} |f(x)|$ . Let  $f \in C^\omega(\mathbb{T}, X)$ , where  $X$  is the range of  $f$ . In the case where  $f$  admits a bounded analytic extension to the strip  $\{|\Im z| < h\}$ ,  $h > 0$ , we denote  $f \in C_h^\omega(\mathbb{T}, X)$ .

In the following, the frequency associated to Schrödinger operators or quasi-periodic cocycles will be denoted by  $\alpha$ , with  $\alpha \in \mathbb{T}^d$ ,  $d \geq 1$ . We introduce the notation  $\langle n \rangle := \frac{\langle n, \alpha \rangle}{2}$  for any  $n \in \mathbb{Z}^d$ . When  $\theta \in \mathbb{R}$ , we also set  $\|\theta\|_{\mathbb{T}} := \inf_{j \in \mathbb{Z}} |\theta - j|$ .

In the formulations and proofs of various assertions appearing in this chapter, we shall encounter constants which may depend on several quantities. All such constants will be denoted by  $c, c_1, c_2, \dots$ , and sometimes, the same symbol might refer to different constants in case there is no ambiguity. Moreover, in some estimates, we will use the notations “ $\lesssim$ ”, “ $\gtrsim$ ”, “ $O$ ”... instead of exhibiting an explicit numerical constant.

**2.2. Continued Fraction Expansion.** Let  $\alpha \in (0, 1) \setminus \mathbb{Q}$ . We set  $a_0 := 0$  and  $\alpha_0 := \alpha$ . For  $k \geq 1$ , we define inductively

$$a_k := [\alpha_{k-1}^{-1}], \quad \alpha_k := \alpha_{k-1}^{-1} - a_k = G(\alpha_{k-1}) := \left\{ \frac{1}{\alpha_{k-1}} \right\}.$$

Let  $p_0 := 0$ ,  $p_1 := 1$ ,  $q_0 := 1$ ,  $q_1 := a_1$ , and for  $k \geq 2$ , we define inductively  $p_k := a_k p_{k-1} + p_{k-2}$ ,  $q_k := a_k q_{k-1} + q_{k-2}$ . Then  $(q_n)_n$  is the sequence of denominators of the best rational approximants of  $\alpha$ ; indeed, we have

$$\|k\alpha\|_{\mathbb{T}} \geq \|q_{n-1}\alpha\|_{\mathbb{T}}, \quad \forall 1 \leq k < q_n. \quad (2.1)$$

Besides,

$$\frac{1}{2q_{n+1}} \leq \|q_n\alpha\|_{\mathbb{T}} \leq \frac{1}{q_{n+1}}. \quad (2.2)$$

Note that  $\beta(\alpha) = \limsup_{j \rightarrow \infty} \frac{\ln q_{j+1}}{q_j} = 0$  implies that for any  $\xi > 0$ , there exists  $c_\xi > 0$  such that

$$\|k\alpha\|_{\mathbb{T}} \geq c_\xi e^{-\xi k}, \quad \forall k \geq 1. \quad (2.3)$$

**2.3. Cocycles and hyperbolicity.** Given  $d \geq 1$ ,  $A \in C^\omega(\mathbb{T}^d, \text{SL}(2, \mathbb{C}))$ , and some rationally independent  $\alpha \in \mathbb{R}^d$ , we define the quasi-periodic *cocycle*  $(\alpha, A)$ :

$$(\alpha, A): \begin{cases} \mathbb{T}^d \times \mathbb{C}^2 & \rightarrow \mathbb{T}^d \times \mathbb{C}^2, \\ (x, v) & \mapsto (x + \alpha, A(x) \cdot v). \end{cases}$$

The iterates of  $(\alpha, A)$  are of the form  $(\alpha, A)^n = (n\alpha, \mathcal{A}_n)$ , where

$$\mathcal{A}_n(x) := \begin{cases} A(x + (n-1)\alpha) \cdots A(x + \alpha)A(x), & n \geq 0, \\ A^{-1}(x + n\alpha)A^{-1}(x + (n+1)\alpha) \cdots A^{-1}(x - \alpha), & n < 0. \end{cases}$$

The *Lyapunov exponent* is given by the formula

$$L(\alpha, A) := \lim_{n \rightarrow \infty} \frac{1}{n} \int_{\mathbb{T}^d} \ln |\mathcal{A}_n(x)| dx.$$

In the case of a quasi-periodic cocycle,  $\alpha$  is rationally independent, hence  $x \mapsto x + \alpha$  is uniquely ergodic and we have

$$L(\alpha, A) = \lim_{n \rightarrow \infty} \sup_{x \in \mathbb{T}^d} \frac{1}{n} \ln |\mathcal{A}_n(x)|.$$

The cocycle  $(\alpha, A)$  is called *uniformly hyperbolic* if, for every  $x \in \mathbb{T}^d$ , there exists a continuous splitting  $\mathbb{C}^2 = E^s(x) \oplus E^u(x)$  such that for some constants  $C > 0$ ,  $c > 0$ , and for every  $n \geq 0$ ,

$$\begin{aligned} |\mathcal{A}_n(x) \cdot v| &\leq Ce^{-cn}|v|, \quad v \in E^s(x), \\ |\mathcal{A}_n(x)^{-1} \cdot v| &\leq Ce^{-cn}|v|, \quad v \in E^u(x + n\alpha). \end{aligned}$$

This splitting is invariant by the dynamics, which means that for every  $x \in \mathbb{T}^d$ ,  $A(x) \cdot E^*(x) = E^*(x + \alpha)$ , for  $*$  = “s” or “u”. In this case, we clearly have  $L(\alpha, A) > 0$ . Uniform hyperbolicity can be characterized by a cone-field criterion and is a robust property: the subset of uniformly hyperbolic cocycles, denoted by  $\mathcal{UH}$ , is open in  $\mathbb{R}^d \times C^\omega(\mathbb{T}^d, \text{SL}(2, \mathbb{C}))$ .

Moreover, a cocycle  $(\alpha, A) \in \mathbb{R}^d \times C^\omega(\mathbb{T}^d, \text{SL}(2, \mathbb{C})) \setminus \mathcal{UH}$  can be either

- *supercritical*, or *non-uniformly hyperbolic*, if  $L(\alpha, A) > 0$ ;
- *subcritical* if there exists  $c > 0$  such that  $\sup_{|\Im z| < c} \ln \|\mathcal{A}_n(z)\| = o(n)$ ,  $\forall n \geq 0$ , that is, the iterates are uniformly subexponentially bounded on a strip;
- *critical* in other cases.

**2.4. The fibered rotation number.** In this part, we restrict ourselves to the case of a real cocycle  $(\alpha, A) \in \mathbb{T}^d \times C^\omega(\mathbb{T}^d, \text{SL}(2, \mathbb{R}))$ , with  $d \geq 1$  and  $\alpha$  rationally independent. Such a cocycle acts naturally on the circle; this allows to define a notion of rotation number, which is intimately related to spectral gaps as we will see.

We introduce the projective skew-product  $F_A: \mathbb{T}^d \times \mathbb{S}^1 \rightarrow \mathbb{T}^d \times \mathbb{S}^1$ , where

$$F_A(x, w) := \left( x + \alpha, \frac{A(x) \cdot w}{|A(x) \cdot w|} \right).$$

If  $A: \mathbb{T}^d \rightarrow \text{SL}(2, \mathbb{R})$  is homotopic to the identity, then it is also the case of  $F_A$ . It is therefore possible to lift the latter to a map  $\tilde{F}_A: \mathbb{T}^d \times \mathbb{R} \rightarrow \mathbb{T}^d \times \mathbb{R}$  of the form  $\tilde{F}_A(x, y) = (x + \alpha, y + \psi_x(y))$ , where for every  $x \in \mathbb{T}^d$ ,  $\psi_x$  is  $\mathbb{Z}$ -periodic. Let us denote by  $\pi: \mathbb{T}^d \times \mathbb{R} \rightarrow \mathbb{T}^d \times \mathbb{S}^1$  the projection  $(x, y) \mapsto (x, e^{2\pi iy})$ . Then,

$$F_A \circ \pi = \pi \circ \tilde{F}_A.$$

The map  $\psi: \mathbb{T}^d \times \mathbb{T} \rightarrow \mathbb{R}$  is called a *lift* of  $A$ . Let  $\mu$  be any probability measure on  $\mathbb{T}^d \times \mathbb{R}$  which is invariant by  $\tilde{F}_A$ , and whose projection on the first coordinate is given by Lebesgue measure. The number

$$\rho(\alpha, A) := \int_{\mathbb{T}^d \times \mathbb{R}} \psi_x(y) d\mu(x, y) \pmod{\mathbb{Z}}$$

does not depend on the choices neither of the lift  $\psi$  nor of the measure  $\mu$ , and is called the *fibered rotation number* of  $(\alpha, A)$  (see [39] for more details).

The fibered rotation number is invariant under real conjugacies which are homotopic to the identity. In fact, a more general result also holds. Recall that the fundamental group of  $\text{SL}(2, \mathbb{R})$  is isomorphic to  $\mathbb{Z}$ . Let

$$R_\theta := \begin{pmatrix} \cos 2\pi\theta & -\sin 2\pi\theta \\ \sin 2\pi\theta & \cos 2\pi\theta \end{pmatrix}, \quad \theta \in \mathbb{T}.$$

Assume that  $A^{(1)}, A^{(2)}: \mathbb{T}^d \rightarrow \text{SL}(2, \mathbb{R})$  are homotopic to the identity, and that for some conjugacy  $Z: \mathbb{T}^d \rightarrow \text{PSL}(2, \mathbb{R})$ ,

$$Z(x + \alpha)^{-1} A^{(1)}(x) Z(x) = A^{(2)}(x), \quad \forall x \in \mathbb{T}^d.$$

The map  $Z: \mathbb{T}^d \rightarrow \text{PSL}(2, \mathbb{R})$  is homotopic to  $x \mapsto R_{\langle \frac{k, x}{2} \rangle}$  for some  $k \in \mathbb{Z}^d$ ; the quantity  $k$  is called the *degree* of  $A$ , and is denoted by  $\text{deg}(Z)$ . Both  $A^{(1)}$  and  $A^{(2)}$  are homotopic to the identity, hence the associate cocycles have well-defined fibered rotation numbers, and the following formula relates one to the other:

$$\rho(\alpha, A^{(1)}) = \rho(\alpha, A^{(2)}) + \langle k \rangle. \tag{2.4}$$

**2.5. Schrödinger cocycles.** Given a potential  $V \in C^\omega(\mathbb{T}, \mathbb{R})$  and a frequency  $\alpha \in \mathbb{R} \setminus \mathbb{Q}$ , a fundamental example of one-frequency quasi-periodic cocycles is the case of *Schrödinger cocycles*  $(\alpha, S_E^V)$ , where for any  $E \in \mathbb{R}$ ,

$$A(x) = S_E^V(x) := \begin{pmatrix} E - V(x) & -1 \\ 1 & 0 \end{pmatrix}, \quad \forall x \in \mathbb{T}.$$

Such cocycles were introduced because of their link with the eigenvalue equation  $H_{V,\alpha,\theta}u = Eu$ , where  $\theta \in \mathbb{T}$ ; indeed, any formal solution  $u = (u_n)_{n \in \mathbb{Z}}$  satisfies

$$\begin{pmatrix} u_{n+1} \\ u_n \end{pmatrix} = A(\theta + n\alpha) \cdot \begin{pmatrix} u_n \\ u_{n-1} \end{pmatrix}, \quad \forall n \in \mathbb{Z}.$$

Let us also recall the following well-known fact, which relates spectral properties of  $H_{V,\alpha,\theta}$  to the dynamics of Schrödinger cocycles  $(\alpha, S_E^V)$ : indeed, an energy  $E$  belongs to the spectrum  $\Sigma_{V,\alpha}$  if and only if  $(\alpha, S_E^V)$  is *not* uniformly hyperbolic.

For a Schrödinger cocycle, the Lyapunov exponent depends on the energy  $E$ , so we denote

$$L(E) = L_{V,\alpha}(E) := L(\alpha, S_E^V).$$

For any energy  $E \in \mathbb{R}$ , the map  $x \mapsto S_E^V(x)$  is homotopic to the identity, hence there is a well-defined rotation number  $\rho(\alpha, S_E^V)$ . Moreover,  $\rho(\alpha, S_E^V)$  admits a determination in  $[0, 1/2]$ , which is denoted by  $\rho(E) = \rho_{V,\alpha}(E)$ . The following formula relates the rotation number to the integrated density of states  $N = N_{V,\alpha}$  introduced in (1.2):

$$N(E) = 1 - 2\rho(E).$$

Moreover, by *Thouless formula*, we also have the following relation between the integrated density of states  $N$  and the Lyapunov exponent  $L$ :

$$L(E) = \int \ln |E - E'| dN(E').$$

**2.6. Aubry duality.** With the above notations, we now focus on the case  $d = 1$  and  $\alpha \in \mathbb{R} \setminus \mathbb{Q}$ . In this part, we recall the notion of localization for dual Schrödinger operators, and how it is linked to reducibility properties for one-frequency Schrödinger cocycles. This fact is often referred to as *Aubry duality* in the literature.

Given a frequency  $\alpha \in \mathbb{T}$ , a potential  $V \in C^\omega(\mathbb{T}, \mathbb{R})$  and a phase  $\theta \in \mathbb{T}$ , we introduce the *dual Schrödinger operator*  $\hat{H} = \hat{H}_{V,\alpha,\theta}$ , defined on  $\ell^2(\mathbb{Z})$  by the following formula:

$$(\hat{H}\hat{u})_j := \sum_{l \in \mathbb{Z}} \hat{v}_l \hat{u}_{j-l} + 2 \cos(2\pi(\theta + j\alpha)) \hat{u}_j, \quad \forall j \in \mathbb{Z}, \quad (2.5)$$

where the  $\hat{v}_l$ 's are the Fourier coefficients of  $V$ .

**Definition 4.9** (Anderson localization). *We say that the operator  $\hat{H}_{V,\alpha,\theta}$  is localized if it has pure point spectrum with exponentially decaying eigenvectors.*

**Definition 4.10** (Reducibility). *We say that a cocycle  $(\alpha, A) \in \mathbb{R} \setminus \mathbb{Q} \times C^\omega(\mathbb{T}, \text{SL}(2, \mathbb{R}))$  is reducible if it can be conjugated to a constant cocycle, i.e., there exist  $Z \in C^\omega(\mathbb{T}, \text{PSL}(2, \mathbb{R}))$  and  $B \in \text{SL}(2, \mathbb{R})$  such that*

$$Z(x + \alpha)^{-1} A(x) Z(x) = B, \quad \forall x \in \mathbb{T}.$$

Eliasson [30] has shown that when the frequency  $\alpha$  is Diophantine and  $A$  is close to a constant, the associate cocycle is typically reducible in a measure-theoretic sense.

For real cocycles, the interest of allowing the function  $Z$  to take values in  $\text{PSL}_2(\mathbb{R})$  is illustrated for instance by the following reducibility result in the uniformly hyperbolic case.

**Theorem 4.11.** *Let  $(\alpha, A)$  be a uniformly hyperbolic cocycle, with  $\alpha$  Diophantine and  $A$  analytic. Then there exists an analytic map  $Z: \mathbb{T} \rightarrow \text{PSL}_2(\mathbb{R})$  such that  $x \mapsto Z(x + \alpha)^{-1} A(x) Z(x)$  is constant.*



The version of Aubry duality stated here follows the precise formulation given in Avila-Jitomirskaya's paper [7].

**Theorem 4.12** (Classical Aubry duality). *Let  $\alpha \in \mathbb{R} \setminus \mathbb{Q}$ . Assume that  $\theta, E \in \mathbb{R}$  are such that there exists a non-zero exponentially decaying solution  $\hat{H}_{V,\alpha,\theta}\hat{u} = E\hat{u}$ . We let  $A := S_V^E$ .*

- (1) *If  $2\theta \notin \alpha\mathbb{Z} \oplus \mathbb{Z}$ , then there exists  $Z \in C^\omega(\mathbb{T}, \text{SL}_2(\mathbb{R}))$  such that for every  $x \in \mathbb{T}$ ,  $Z(x + \alpha)^{-1}A(x)Z(x) = R_{\pm\theta}$ , i.e.,  $(\alpha, A)$  is reducible to a constant rotation matrix. In particular,  $\|\mathcal{A}_n(x)\| = O(1)$ .*
- (2) *If  $2\theta \in \alpha\mathbb{Z} \oplus \mathbb{Z}$ , then there exist  $Z \in C^\omega(\mathbb{T}, \text{PSL}_2(\mathbb{R}))$  and  $\kappa \in C^\omega(\mathbb{T}, \mathbb{R})$  such that for every  $x \in \mathbb{T}$ ,  $Z(x + \alpha)^{-1}A(x)Z(x) = \begin{pmatrix} \pm 1 & \kappa(x) \\ 0 & \pm 1 \end{pmatrix}$ . In particular  $\|\mathcal{A}_n(x)\| = O(n)$ . When  $\alpha \in \text{DC}$ , we can take  $\kappa$  constant, and the cocycle  $(\alpha, A)$  is thus reducible to a constant parabolic cocycle.*

This result together with property (2.4) imply that  $\rho(E) = \pm\theta + \langle m \rangle$  for some  $m \in \mathbb{Z}$ .

The proof of this result involves an algebraic relation between the families of operators  $\{H_{V,\alpha,\theta}\}_{\theta \in \mathbb{R}}$  and  $\{\hat{H}_{V,\alpha,\theta}\}_{\theta \in \mathbb{R}}$ . Aubry duality is based on an algebraic relation between the families of operators  $\{H_{V,\alpha,\theta}\}_{\theta \in \mathbb{R}}$  and  $\{\hat{H}_{V,\alpha,\theta}\}_{\theta \in \mathbb{R}}$ . It is based on the following identity: if  $u: \mathbb{T} \rightarrow \mathbb{C}$  is an  $\ell^2(\mathbb{Z})$  function whose Fourier series  $\hat{u} = (\hat{u}_k)_{k \in \mathbb{Z}}$  satisfies  $\hat{H}_{V,\alpha,\theta}\hat{u} = E\hat{u}$ , then the Bloch wave  $\mathcal{U}: x \mapsto \begin{pmatrix} e^{2\pi i\theta}u(x) \\ u(x - \alpha) \end{pmatrix}$  satisfies

$$S_V^E(x) \cdot \mathcal{U}(x) = e^{2\pi i\theta}\mathcal{U}(x + \alpha), \quad \forall x \in \mathbb{T}. \quad (2.6)$$

**2.7. Almost localization.** Let  $\alpha \in \mathbb{R}$ ,  $\theta \in \mathbb{R}$ ,  $\epsilon_0 > 0$ . We say that  $k \in \mathbb{Z}$  is an  $\epsilon_0$ -resonance of  $\theta$  if  $\|2\theta - k\alpha\|_{\mathbb{T}} \leq e^{-\epsilon_0|k|}$  and  $\|2\theta - k\alpha\|_{\mathbb{T}} = \min_{|l| \leq |k|} \|2\theta - l\alpha\|_{\mathbb{T}}$ . Note that 0 is always a resonance. Moreover,  $\theta$  is resonant if the set of resonances is infinite. In the particular case where  $\theta = \langle n \rangle$  for some  $n \in \mathbb{Z}$ ,  $\theta$  is non-resonant; indeed,  $n$  is an especially strong resonance, and there is no resonance  $k$  with  $|k| > |n|$ .

**Definition 4.13** (Almost localization). *Let  $\alpha \in \mathbb{T}$  and  $V \in C^\omega(\mathbb{T}, \mathbb{R})$ . We say that the family  $\{\hat{H}_{V,\alpha,\theta}\}_{\theta \in \mathbb{R}}$  is almost localized if there exist  $C_0, C_1, \epsilon_0, \epsilon_1 > 0$  such that any solution  $\hat{u} = (\hat{u}_k)_{k \in \mathbb{Z}}$  to the eigenvalue problem  $\hat{H}_{V,\alpha,\theta}\hat{u} = E\hat{u}$  with  $\hat{u}_0 = 1$  and  $|\hat{u}_k| \leq 1 + |k|$  satisfies*

$$|\hat{u}_k| \leq C_1 e^{-\epsilon_1|k|}, \quad \forall C_0(1 + |n_j|) < |k| < C_0^{-1}|n_{j+1}|,$$

where  $\{n_j\}_j$  are the  $\epsilon_0$ -resonances of  $\theta$ .

Note<sup>5</sup> that almost localization implies localization for non-resonant  $\theta$ .

**Theorem 4.14** (Avila-Jitomirskaya, Theorems 3.2, 5.1 of [7]). *Let  $\alpha \in \mathbb{R}$  with  $\beta(\alpha) = 0$ . Then, given any  $C_0 > 1$  and any  $V \in C^\omega(\mathbb{T}, \mathbb{R})$ , there exists  $\lambda_0 = \lambda_0(V) > 0$  such that for any  $\lambda \in \mathbb{R}$  satisfying  $0 < |\lambda| < \lambda_0$ , there exist  $\epsilon_0 = \epsilon_0(V, \lambda) > 0$ ,  $\epsilon_1(V, \lambda, C_0) > 0$  and  $C_1 = C_1(V, \lambda, C_0) > 0$  such that  $\{\hat{H}_{\lambda V, \alpha, \theta}\}_{\theta \in \mathbb{R}}$  is almost localized with parameters  $C_0, C_1, \epsilon_0, \epsilon_1$ . More precisely, we can take any  $\lambda_0 > 0$  satisfying  $|\lambda_0 V|_\epsilon \leq c_0 \epsilon^{k_0}$  for some  $0 < \epsilon < 1$ , where  $c_0, k_0 > 0$  are absolute constants.*

*In the almost Mathieu case, i.e., when the potential has the form  $2\lambda \cos(2\pi \cdot)$  for some  $\lambda \in \mathbb{R}$ , then  $\lambda_0 = 1$ .*

Avila-Jitomirskaya [7] have generalized Aubry duality by showing that almost localization of dual Schrödinger operators also implies some weak form of reducibility of associate Schrödinger cocycles. We recall the notion of *almost reducibility* introduced by Avila-Krikorian.

5. See Remark 3.3 in [7].

**Definition 4.15** (Almost reducibility). We say that a cocycle  $(\alpha, A)$  is (analytically) almost reducible if for any  $n \geq 0$ , there exist  $h_n > 0$ , conjugacies  $Z^{(n)} \in C_{h_n}^\omega(\mathbb{T}, \mathrm{PSL}(2, \mathbb{R}))$ , and constant matrices  $B_n \in \mathrm{SL}(2, \mathbb{R})$ , such that

$$\lim_{n \rightarrow +\infty} |A^{(n)}(\cdot) - B_n|_{h_0} = 0,$$

where  $A^{(n)} := Z^{(n)}(\cdot + \alpha)^{-1}A(\cdot)Z^{(n)}(\cdot)$ . We say that the cocycle  $(\alpha, A)$  is strongly, resp. weakly almost reducible, if  $h_n \rightarrow 0$ , resp.  $h_n \rightarrow h_\infty > 0$ .

In the above formula, the cocycle  $(\alpha, A^{(n)})$  is close to the constant cocycle  $(\alpha, B_n)$  when  $n$  is large; yet, *a priori*, we don't have further information on the form of the conjugate cocycle  $(\alpha, A^{(n)})$ . For some results which are specific to Schrödinger cocycles, such as those based on Aubry duality, it is useful to know that the conjugate cocycle can be taken of Schrödinger type. It is the content of the following lemma.

**Lemma 4.16** (Avila-Jitomirskaya, Lemma 2.2 of [8]). Let  $\alpha \in \mathbb{R} \setminus \mathbb{Q}$ ,  $A \in C^\omega(\mathbb{T}, \mathrm{SL}(2, \mathbb{R}))$ , and assume that  $(\alpha, A)$  is almost reducible. Then there exists  $h_0 > 0$  such that for every  $\gamma > 0$ , there exist  $V \in C_{h_0}^\omega(\mathbb{T}, \mathbb{R})$  satisfying  $|V|_{h_0} < \gamma$ ,  $E \in \mathbb{R}$  and  $Z \in C_{h_0}^\omega(\mathbb{T}, \mathrm{PSL}(2, \mathbb{R}))$  such that

$$Z(x + \alpha)^{-1}A(x)Z(x) = S_E^V(x), \quad \forall x \in \mathbb{T}. \quad (2.7)$$

Moreover, for every  $0 < \eta \leq h_0$ , there exists  $\delta > 0$  such that whenever  $\tilde{A} \in C^\omega(\mathbb{T}, \mathrm{SL}(2, \mathbb{R}))$  satisfies  $|A - \tilde{A}|_\eta < \delta$ , then there exist  $\tilde{V} \in C^\omega(\mathbb{T}, \mathbb{R})$  with  $|\tilde{V}|_\eta < \gamma$  and  $\tilde{Z} \in C_\eta^\omega(\mathbb{T}, \mathrm{PSL}(2, \mathbb{R}))$  such that  $|Z - \tilde{Z}|_\eta < \gamma$  and  $\tilde{Z}(x + \alpha)^{-1}\tilde{A}(x)\tilde{Z}(x) = S_E^{\tilde{V}}(x)$ ,  $\forall x \in \mathbb{T}$ .

**Remark 4.17.** Let  $\alpha \in \mathbb{R} \setminus \mathbb{Q}$  satisfy  $\beta(\alpha) = 0$ . With the notations of the previous lemma, we see that if the cocycle  $(\alpha, A)$  is almost reducible, then it can be conjugated to a Schrödinger cocycle  $(\alpha, S_E^V)$  in the perturbative regime, that is, such that the potential  $V$  satisfies the assumptions of Theorem 4.14. Indeed, if  $c_0, k_0 > 0$  are the absolute constants appearing in the statement of the theorem, we choose  $0 < \epsilon < \min(h_0, 1)$  and  $\gamma < c_0\epsilon^{k_0}$ . Then, the potential  $V$  given by Lemma 4.16 satisfies  $|V|_\epsilon \leq |V|_{h_0} < c_0\epsilon^{k_0}$ , hence the dual operators  $\{\hat{H}_{V, \alpha, \theta}\}_\theta$  are almost localized for certain constants  $C_0, C_1, \epsilon_0, \epsilon_1 > 0$ . Moreover, the same holds for any cocycle  $(\alpha, \tilde{A})$  sufficiently close to  $(\alpha, A)$ , since by the previous lemma, we can conjugate  $(\alpha, \tilde{A})$  to  $(\alpha, S_E^{\tilde{V}})$  with  $|\tilde{V}|_\epsilon < c_0\epsilon^{k_0}$ .

As a consequence of Theorem 4.14, Avila-Jitomirskaya [7] have obtained almost reducibility results for Schrödinger cocycles.

**Theorem 4.18** (Theorem 1.4, [7]). Assume that the frequency  $\alpha$  satisfies  $\beta(\alpha) = 0$  and that the potential  $V: \mathbb{T} \rightarrow \mathbb{R}$  is analytic. There exists  $\lambda_0 = \lambda_0(V) > 0$  such that for  $0 < |\lambda| < \lambda_0(V)$ , the cocycles associated with  $\{H_{\lambda V, \alpha, \theta}\}_{\theta \in \mathbb{R}}$  are almost reducible.

In fact, under the same assumptions, they obtain a more precise statement.

**Theorem 4.19** (Theorem 4.1, [7]). Assume that  $0 < |\lambda| < \lambda_0(V)$ . Let  $E \in \mathbb{R}$ , and set  $A := S_{\lambda V}^E$ . Then there exists  $h = h(\lambda, V, \alpha) > 0$  with the following properties:

- (1) If  $\rho(E)$  is  $h$ -resonant, then there exists a sequence of conjugacies  $Z^{(n)} \in C^\omega(\mathbb{T}, \mathrm{SL}_2(\mathbb{R}))$  such that  $Z^{(n)}(\cdot + \alpha)^{-1}A(\cdot)Z^{(n)}(\cdot)$  converges to a constant rotation uniformly in the strip  $\{|\Im z| < h\}$ .
- (2) If  $\rho(E)$  is not  $h$ -resonant and  $2\rho(E) \notin \alpha\mathbb{Z} \oplus \mathbb{Z}$ , then there exists  $Z \in C^\omega(\mathbb{T}, \mathrm{SL}(2, \mathbb{R}))$  which can be analytically extended to  $\{|\Im z| < h\}$  and such that  $Z(\cdot + \alpha)^{-1}A(\cdot)Z(\cdot)$  is a constant rotation.
- (3) If  $2\rho(E) \in \alpha\mathbb{Z} \oplus \mathbb{Z}$ , then  $A$  is (analytically) reducible through a conjugacy  $Z \in C^\omega(\mathbb{T}, \mathrm{PSL}(2, \mathbb{R}))$ .



For a global picture on reducibility results, we refer to the paper of You and Zhou [54].

**2.8. Global theory of one-frequency Schrödinger operators & Almost Reducibility Conjecture.** Let  $\alpha \in \mathbb{R} \setminus \mathbb{Q}$ , and suppose that  $A \in C^\omega(\mathbb{T}, \text{SL}(2, \mathbb{C}))$  admits a holomorphic extension to the strip  $\{z \in \mathbb{C} : |\Im z| < h\}$ ,  $h > 0$ . Then for any  $|\epsilon| < h$  we can define  $A_\epsilon \in C^\omega(\mathbb{T}, \text{SL}(2, \mathbb{C}))$  by  $A_\epsilon(x) = A(x + i\epsilon)$ . We also introduce the following function, which is called the *acceleration* of  $(\alpha, A)$ :

$$p(\alpha, A) := \lim_{\epsilon \rightarrow 0^+} \frac{1}{2\pi\epsilon} (L(\alpha, A_\epsilon) - L(\alpha, A)).$$

The acceleration is an upper semi-continuous function in  $(\mathbb{R} \setminus \mathbb{Q}) \times C^\omega(\mathbb{T}, \text{SL}(2, \mathbb{C}))$ . Moreover, it is *quantized*, that is,  $p(\alpha, A) \in \mathbb{Z}$  (see [5]).

By quantization,  $\epsilon \mapsto L(\alpha, A_\epsilon)$  is a piecewise affine function. We say that  $(\alpha, A) \in (\mathbb{R} \setminus \mathbb{Q}) \times C^\omega(\mathbb{T}, \text{SL}(2, \mathbb{C}))$  is *regular* if  $\epsilon \mapsto L(\alpha, A_\epsilon)$  is affine for  $\epsilon$  in a neighborhood of 0. Suppose that  $L(\alpha, A) > 0$ ; then  $(\alpha, A)$  is regular if and only if  $(\alpha, A)$  is uniformly hyperbolic.

For any  $(\alpha, A) \in (\mathbb{R} \setminus \mathbb{Q}) \times C^\omega(\mathbb{T}, \text{SL}(2, \mathbb{R}))$ , regular cocycles ( $p(\alpha, A) = 0$ ) are split into two groups: those with positive Lyapunov exponent (uniformly hyperbolic cocycles), and those with zero Lyapunov exponent (subcritical cocycles). On the other hand, non-regular cocycles ( $p(\alpha, A) \neq 0$ ) are classified as follows: those with positive Lyapunov exponent (supercritical cocycles), and those with zero Lyapunov exponent (critical cocycles).

We recall the notion of *prevalence* introduced in [5] for analytic potentials. Given an arbitrary function  $\epsilon: \mathbb{Z}_+ \rightarrow \mathbb{R}_+$  with exponential decay, and any probability measure  $\mu$  on  $\Delta := \{(t_m)_{m \in \mathbb{Z}_+} \in \mathbb{C}^{\mathbb{Z}_+} \mid \forall m \in \mathbb{Z}_+, |t_m| < 1\}$  with compact support, we define a probability measure  $\mu_\epsilon$  on  $C^\omega(\mathbb{T}, \mathbb{R})$  with compact support; indeed, it is obtained by push forward of  $\mu$  under the map

$$\Delta \ni (t_m)_{m \in \mathbb{Z}_+} \mapsto \sum_{m \geq 1} \epsilon(m) 2\Re(t_m e^{2\pi i m x}).$$

Then, for any  $\alpha \in \mathbb{R} \setminus \mathbb{Q}$ , and given a starting condition  $V^0 \in C^\omega(\mathbb{T}, \mathbb{R})$ , we declare a property  $\mathcal{P}$  to be *typical* in the measure-theoretical sense if for  $\mu_\epsilon$ -almost every perturbation  $W$ , property  $\mathcal{P}$  holds for the potential  $V := V^0 + W$ . Energies  $E \in \Sigma_{\alpha, V}$  can be either subcritical, critical, or supercritical. We are now able to state the main result of Avila's global theory:

**Theorem 4.20** (Avila [5]). *Let  $\alpha \in \mathbb{R} \setminus \mathbb{Q}$ . Then for a (measure-theoretically) typical  $V \in C^\omega(\mathbb{T}, \mathbb{R})$ , the spectrum  $\Sigma_{V, \alpha}$  has no critical energy.*

Let us recall two results about Lyapunov exponents of almost Mathieu cocycles  $(\alpha, S_E^{2\lambda \cos(2\pi \cdot)})$ ,  $E \in \mathbb{R}$ .

**Theorem 4.21.** [17] *For  $\alpha \in \mathbb{R} \setminus \mathbb{Q}$ ,  $E \in \Sigma_{2\lambda \cos(2\pi \cdot), \alpha}$ , we have  $L(\alpha, S_E^{2\lambda \cos(2\pi \cdot)}) = \max\{0, \ln |\lambda|\}$ .*

**Theorem 4.22.** [5] *For  $\alpha \in \mathbb{R} \setminus \mathbb{Q}$ ,  $0 < \lambda < 1$ ,  $E \in \mathbb{R}$ , and  $\epsilon \geq 0$ ,*

$$L(\alpha, S_E^{2\lambda \cos(2\pi \cdot)}(\cdot + i\epsilon)) = \max\{L(\alpha, S_E^{2\lambda \cos(2\pi \cdot)}), \ln \lambda + 2\pi\epsilon\}.$$

In particular, for almost Mathieu cocycles with  $0 < \lambda < 1$ , all energies are subcritical.

In the case of general one-frequency quasi-periodic analytic Schrödinger operators, for energies in the spectrum, almost reducibility implies strong vanishing of the Lyapunov exponent, that is, cocycles grow subexponentially on a band; this can be seen as a “mirror” condition to positivity of Lyapunov exponent. Conversely, in [7], Avila-Jitomirskaya have formulated the so-called “Almost Reducibility Conjecture”, according

to which, for a general one-frequency quasi-periodic  $\mathrm{SL}(2, \mathbb{R})$ -cocycle, subcriticality should imply almost reducibility.

Let us illustrate this for almost Mathieu operators. In this case, Aubry duality gives

$$\hat{H}_{2\lambda \cos(2\pi \cdot), \alpha, \theta} = \lambda H_{2\lambda^{-1} \cos(2\pi \cdot), \alpha, \theta}$$

for every  $\theta \in \mathbb{R}$  and  $\lambda \neq 0$ . Besides, in the almost Mathieu case, we see from the result recalled above that for  $0 < \lambda < 1$ , all energies are subcritical, i.e., cocycles  $(\alpha, S_E^{2\lambda \cos(2\pi \cdot)})$ ,  $E \in \mathbb{R}$ , have subexponential growth on a band. By Theorem 4.14, the dual operators  $\{\hat{H}_{2\lambda \cos(2\pi \cdot), \alpha, \theta}\}_{\theta \in \mathbb{R}}$  are almost localized, and by Theorem 4.18 above, the cocycles associated with  $\{H_{2\lambda \cos(2\pi \cdot), \alpha, \theta}\}_{\theta \in \mathbb{R}}$  are almost reducible.

The ‘‘Almost Reducibility Conjecture’’ is a cornerstone of the theory; it has been recently proven by Avila:

**Theorem 4.23** (Avila [3]). *Let  $\alpha \in \mathbb{R} \setminus \mathbb{Q}$  satisfy  $\beta(\alpha) = 0$ , and let  $A \in C^\omega(\mathbb{T}, \mathrm{SL}(2, \mathbb{R}))$ . If the cocycle  $(\alpha, A)$  is subcritical, then it is almost reducible.*

### 3. Quantitative almost reducibility

In this section, we present perturbative methods which can be employed to deal with the question of reducibility of quasi-periodic cocycles. In a first part, we recall the KAM scheme used by Hadj-Amor [35]; one drawback of this approach is that it may cause a significant loss in the radius of analyticity after conjugacy. To cope with it, in a second part, we thus explain another scheme, which does not require to shrink too much the region of analyticity. Basically, the idea is to perform the conjugacy first and then deal with resonances.

**3.1. Review of the KAM scheme of Eliasson/Hadj-Amor.** Let  $a_0, \varepsilon_0, r_0 > 0$ , and let  $d \geq 1$  be some integer. Given  $A_0 \in \mathrm{SL}(2, \mathbb{R})$  with  $|A_0| \leq a_0$ ,  $F_0 \in C_{r_0}^\omega(\mathbb{T}^d, \mathfrak{gl}(2, \mathbb{R}))$  with  $|F_0|_{r_0} \leq \varepsilon_0$ , and  $\alpha \in \mathrm{DC}(K, \tau)$  for some  $K > 0$  and  $\tau > d - 1$  (see (1.3)), we consider the quasi-periodic cocycle  $(\alpha, A_0 + F_0)$ :

$$(\alpha, A_0 + F_0): \begin{cases} \mathbb{T} \times \mathbb{C}^2 & \rightarrow \mathbb{T} \times \mathbb{C}^2 \\ (x, v) & \mapsto (x + \alpha, (A_0 + F_0(x)) \cdot v). \end{cases} \quad (3.1)$$

Let  $\rho = \rho(\alpha, A_0 + F_0)$  be the rotation number of the cocycle  $(\alpha, A_0 + F_0)$ .

In this subsection, we detail the KAM scheme present in [35] (originally introduced by Eliasson [30]) and apply it to the reducibility of the above cocycle.

**Proposition 4.24.** *There exists  $\varepsilon_* = \varepsilon_*(A_0, K, \tau, r_0, d) > 0$  such that for  $0 < \varepsilon_0 < \varepsilon_*$ , the following assertions hold. Let  $k \in \mathbb{Z}^d \setminus \{0\}$  and assume that  $\rho(\alpha, A_0 + F_0) = \langle k \rangle$ .*

- 1) *There exists  $\tilde{W} \in C_r^\omega((2\mathbb{T})^d, \mathrm{SL}(2, \mathbb{R}))$  for some  $r = r(|k|) \in (0, r_0)$ , satisfying  $|\tilde{W}|_r \leq \tilde{D}e^{\tilde{\zeta}|k|}$ , where  $\tilde{D} = \tilde{D}(K, \tau, d) > 0$  and  $\tilde{\zeta} = \tilde{\zeta}(K, \tau, r_0) > 0$ , and  $B \in \mathrm{SL}(2, \mathbb{R})$  with  $\rho(0, B) = 0$ , such that*

$$\tilde{W}(x + \alpha)^{-1}(A_0 + F_0(x))\tilde{W}(x) = B, \quad \forall x \in \mathbb{T}^d.$$

- 2) *If  $\mathrm{tr}(B) = 2$ , then there exist  $W \in C_r^\omega((2\mathbb{T})^d, \mathrm{SL}(2, \mathbb{R}))$  with  $|W|_r \leq \tilde{D}e^{\tilde{\zeta}|k|}$  and  $\kappa \in \mathbb{R}$  such that*

$$W(x + \alpha)^{-1}(A_0 + F_0(x))W(x) = \begin{pmatrix} 1 & \kappa \\ 0 & 1 \end{pmatrix}, \quad \forall x \in \mathbb{T}^d. \quad (3.2)$$

Set  $\sigma := \frac{1}{200}$ . Take  $\varepsilon_0 > 0$  as above, and define the sequence  $\{\varepsilon_j\}_{j \in \mathbb{N}}$  by  $\varepsilon_{j+1} = \varepsilon_j^{1+\sigma}$ . From now on, we always assume that  $|F_0|_{r_0} = \varepsilon_0$  is small enough such that it is compatible with every simple calculation in the proof, e.g.,  $\varepsilon_0^\sigma < N_0^{2\tau}$  with  $N_0 = \frac{4\sigma}{r_0} |\ln \varepsilon_0|$ .

**PROOF OF 1).** The conjugacy  $\tilde{W}$  is given by the KAM scheme. Assume that we are at the  $(j + 1)$ <sup>th</sup> KAM step, with  $A_j \in \mathrm{SL}(2, \mathbb{R})$  and  $F_j \in C_{r_j}^\omega(\mathbb{T}^d, \mathfrak{gl}(2, \mathbb{R}))$  satisfying

$|F_j|_{r_j} \leq \varepsilon_j$  for some  $r_j \in (0, r_0)$ . As shown in [35], we can construct

$$\hat{W}_{j+1} \in C_{r_{j+1}}^\omega((2\mathbb{T})^d, \mathrm{SL}(2, \mathbb{R})), \quad A_{j+1} \in \mathrm{SL}(2, \mathbb{R}), \quad F_{j+1} \in C_{r_{j+1}}^\omega((2\mathbb{T})^d, \mathfrak{gl}(2, \mathbb{R})),$$

for some suitable  $r_{j+1} \in (0, r_j)$  such that

$$\hat{W}_{j+1}(x + \alpha)^{-1} (A_j + F_j(x)) \hat{W}_{j+1}(x) = A_{j+1} + F_{j+1}(x),$$

with  $|F_{j+1}|_{r_{j+1}} \leq \varepsilon_{j+1}$ .

Let  $e^{\pm 2\pi i \alpha_j}$  be the two eigenvalues of  $A_j$  and set  $\xi_j := \Re(\alpha_j)$ . Given  $\hat{W}_j$ , the method we use to construct  $\hat{W}_{j+1}$  follows a standard KAM procedure, which transforms the system into another one with smaller non-constant part, by a conjugation close to identity. To carry out such a standard KAM step, we need the small divisor condition

$$|\xi_j - \langle k \rangle| \geq \frac{\varepsilon_j^\sigma}{|k|^\tau}, \quad \forall 0 < |k| \leq N_j := \frac{4^{j+1} \sigma}{r_j} |\ln \varepsilon_j|. \quad (3.3)$$

According to whether this condition is fulfilled or not, we distinguish between two cases in the construction of  $\hat{W}_{j+1}$ .

- Case 1. (Resonant step) Assume that for some  $0 < |k_j| \leq N_j$ , condition (3.3) does not hold, i.e.,

$$|\xi_j - \langle k_j \rangle| < \frac{\varepsilon_j^\sigma}{|k_j|^\tau}. \quad (3.4)$$

Since  $\alpha$  satisfies a Diophantine condition, for a given  $\xi_j$ , there is at most one such  $k_j \in \mathbb{Z}^d$  with  $0 < |k_j| \leq N_j$ . It is necessary to perform a renormalization before we can make the standard KAM procedure. More precisely, let

$$H_{k_j, A_j}(x) := C_{A_j} \begin{pmatrix} e^{2\pi i \frac{\langle k_j, x \rangle}{2}} & 0 \\ 0 & e^{-2\pi i \frac{\langle k_j, x \rangle}{2}} \end{pmatrix} C_{A_j}^{-1}, \quad (3.5)$$

where  $C_{A_j}$  is a matrix of normalized eigenvectors corresponding to the eigenvalues  $e^{\pm 2\pi i \alpha_j}$ . By a direct computation, we obtain

$$\begin{aligned} A_{\langle k_j \rangle} &:= H_{k_j, A_j}(x + \alpha)^{-1} A_j H_{k_j, A_j}(x) \\ &= C_{A_j} \begin{pmatrix} e^{2\pi i(\alpha_j - \langle k_j \rangle)} & 0 \\ 0 & e^{-2\pi i(\alpha_j - \langle k_j \rangle)} \end{pmatrix} C_{A_j}^{-1}. \end{aligned}$$

After this renormalization, we have

$$|\xi_j - \langle k_j \rangle - \langle k \rangle| \geq \frac{K}{2|k|^\tau} \quad \forall 0 < |k| \leq 2N_j. \quad (3.6)$$

Indeed, we get (3.6) by noting that

$$|\langle k \rangle| \geq \frac{K}{|k|^\tau}, \quad |\xi_j - \langle k_j \rangle| \leq \frac{\varepsilon_j^\sigma}{|k_j|^\tau} \leq \frac{K}{2(2N_j)^\tau}.$$

Moreover, since  $C_{A_j}$  is a normalization of  $\begin{pmatrix} (A_j)_{12} & (A_j)_{12} \\ e^{-2\pi i \xi_j} - (A_j)_{11} & e^{2\pi i \xi_j} - (A_j)_{11} \end{pmatrix}$ , and in view of (3.4) and of the Diophantine condition satisfied by  $\alpha$ ,

$$|C_{A_j}^{-1}| \leq \frac{2(|A_j| + 1)}{|\xi_j|} \leq \frac{4(|A_j| + 1)|k_j|^\tau}{K}.$$

Letting  $F_{\langle k_j \rangle}(x) := H_{k_j, A_j}(x + \alpha)^{-1} F_j(x) H_{k_j, A_j}(x)$ , we estimate

$$|F_{\langle k_j \rangle}|_{\tilde{r}_{j+1}} \leq \frac{16(|A_j| + 1)^4 e^{|\langle k_j \rangle| \tilde{r}_{j+1}} |k_j|^{2\tau}}{K^2} \varepsilon_j, \quad \forall 0 < \tilde{r}_{j+1} < r_j.$$

According to [35], we have the following uniform bound on  $(A_j)_{j \in \mathbb{N}}$ :

$$|A_j| \leq 2a_0, \quad \forall j \in \mathbb{N}. \quad (3.7)$$

Hence, if we choose  $\tilde{r}_{j+1} = \frac{1}{N_j}$ , then  $|F_{\langle k_j \rangle}|_{\tilde{r}_{j+1}} \leq \varepsilon_j^{\frac{9}{10}}$ .

- Case 2. (Non-resonant step) If condition (3.3) holds, let  $k_j := 0$ ; then the above procedure can be done trivially since in this case,  $H_{k_j, A_j} = \text{Id}$ ,  $A_{\langle k_j \rangle} = A_j$ ,  $F_{\langle k_j \rangle} = F_j$ , and (3.3) implies (3.6).

In the two above cases, we can make a standard KAM procedure for  $A_{\langle k_j \rangle} + F_{\langle k_j \rangle}(x)$  since the small divisor condition (3.6) is always satisfied. Then, according to [35], there exist

$$\hat{W}_{j+1} \in C_{r_{j+1}}^\omega((2\mathbb{T})^d, \text{SL}(2, \mathbb{R})), \quad A_{j+1} \in \text{SL}(2, \mathbb{R}), \quad F_{j+1} \in C_{r_{j+1}}^\omega((2\mathbb{T})^d, \mathfrak{gl}(2, \mathbb{R})),$$

such that  $\hat{W}_{j+1}(x + \alpha)^{-1}(A_j + F_j(x))\hat{W}_{j+1}(x) = A_{j+1} + F_{j+1}(x)$ , with  $|F_{j+1}|_{r_{j+1}} \leq \varepsilon_{j+1}$ . Moreover,  $|\hat{W}_{j+1} - H_{k_j, A_j}|_{r_{j+1}} < \varepsilon_j^{\frac{1}{2}}$ ,  $|A_{j+1} - A_{\langle k_j \rangle}| < \varepsilon_j^{\frac{2}{3}}$ .

- If  $k_j = 0$ , we have  $H_{k_j, A_j} = \text{Id}$  and we choose  $\frac{1}{2N_{j+1}} \leq r_{j+1} \leq (1 - \frac{1}{4^{j+1}})r_j$ . Hence,

$$|\hat{W}_{j+1} - \text{Id}|_{r_{j+1}} < \varepsilon_j^{\frac{1}{2}}. \quad (3.8)$$

- If  $k_j \neq 0$ , in view of (3.5),  $|H_{k_j, A_j}|_{r_{j+1}} \leq \frac{8(|A_j|+1)^2|k_j|^\tau}{K} e^{r_{j+1}|k_j|}$ . Letting  $r_{j+1} = \frac{r_j}{30 \cdot 4^{j+1}}$ , we thus get

$$|\hat{W}_{j+1}|_{r_{j+1}} \leq \frac{8(|A_j|+1)^2|k_j|^\tau}{K} e^{r_{j+1}|k_j|} + \varepsilon_j^{\frac{1}{2}} \leq \frac{9(|A_j|+1)^2|k_j|^\tau}{K} e^{r_{j+1}|k_j|}.$$

In both cases,  $\deg(\hat{W}_{j+1}) = k_j$ , and then,  $\rho(\alpha, A_{j+1} + F_{j+1}) = \rho(\alpha, A_j + F_j) - \langle k_j \rangle$ .

Since  $\rho(\alpha, A_0 + F_0) = \langle k \rangle$ , in view of [35], we know that the cocycle  $(\alpha, A_0 + F_0)$  can be reduced to a constant cocycle  $(0, B)$  for some  $B \in \text{SL}(2, \mathbb{R})$ , with  $\rho(0, B) = 0$ . This means that the resonant case occurs only finitely many times in the sequence of conjugacies  $(\hat{W}_{l+1})_{l \in \mathbb{N}}$ , and then, choosing  $r_{j+1} := (1 - 4^{-j+1})r_j$  for  $j \geq j_s + 1$  in (3.8), we see that  $\prod_{l=0}^j \hat{W}_{l+1}$  converges to some  $\tilde{W}: (2\mathbb{T})^d \rightarrow \text{SL}(2, \mathbb{R})$  as  $j \rightarrow \infty$ , which satisfies

$$\tilde{W}(x + \alpha)^{-1}(A_0 + F_0(x))\tilde{W}(x) = B.$$

Moreover, since  $\rho(\alpha, A_0 + F_0) = \langle k \rangle$  and  $\rho(0, B) = 0$ , we have  $\deg(\tilde{W}) = k$ .

Assume that there are  $s + 1$  resonant steps,  $s \in \mathbb{N}$ , associated with integers vectors

$$k_{j_0}, \dots, k_{j_s} \in \mathbb{Z}^d, \quad \text{where } 0 < |k_{j_i}| \leq N_{j_i}, \quad i = 0, 1, \dots, s.$$

For two consecutive resonant steps, say the  $(j_i + 1)^{\text{th}}$  and  $(j_{i+1} + 1)^{\text{th}}$ , we can see that

$$|\xi_{j_{i+1}} - \langle k_{j_{i+1}} \rangle| \leq \frac{\varepsilon_{j_{i+1}}^\sigma}{|k_{j_{i+1}}|^\tau},$$

which implies that  $|\xi_{j_{i+1}}| > \frac{K}{2|k_{j_{i+1}}|^\tau}$ . On the other hand, we have  $|\xi_{j_{i+1}}| \leq \frac{2\varepsilon_{j_i}^\sigma}{|k_{j_i}|^\tau}$  because of the renormalization at the  $(j_i + 1)^{\text{th}}$  step. We thus obtain

$$|k_{j_{i+1}}| \geq \left( \frac{K}{4\varepsilon_{j_i}^\sigma} \right)^{\frac{1}{\tau}} |k_{j_i}| := \delta_{j_i} |k_{j_i}|. \quad (3.9)$$

It is possible to see that the limit map  $\tilde{W}$  obtained by the previous construction is analytic, in fact,  $\tilde{W} \in C_{r_{j_s+1}/2}^\omega((2\mathbb{T})^d, \text{SL}(2, \mathbb{R}))$ . Moreover, combining (3.9) together with the inequalities

$$|k_{j_s}| - \sum_{i=0}^{s-1} |k_{j_i}| \leq |k| \leq |k_{j_s}| + \sum_{i=0}^{s-1} |k_{j_i}|,$$

we get  $(1 - 2\delta_0)|k_{j_s}| \leq |k| \leq (1 + 2\delta_0)|k_{j_s}|$ , with  $\delta_0 = \left(\frac{K}{4\varepsilon_0^\sigma}\right)^{\frac{1}{\tau}}$ . Hence we deduce

$$\begin{aligned} |\tilde{W}|_{\frac{r_{j_s+1}}{2}} &\leq c|\tilde{W}_{j_0+1}|_{r_{j_0+1}} \cdots |\tilde{W}_{j_s+1}|_{r_{j_s+1}} \\ &\leq c \left(\frac{9(2a_0+1)^2}{K}\right)^{s+1} \prod_{i=0}^s |k_{j_i}|^\tau e^{2\pi \sum_{i=0}^s r_{j_i+1} |k_{j_i}|} \\ &\leq c \left(\frac{9(2a_0+1)^2}{K}\right)^{s+1} \prod_{i=0}^s \left(|k_{j_i}|^\tau e^{-|k_{j_i}|}\right) e^{(2\pi r_{j_0+1}+1) \sum_{i=0}^s |k_{j_i}|} \\ &\leq c \left(\frac{9(2a_0+1)^2}{K}\right)^{s+1} \prod_{i=0}^s \left(|k_{j_i}|^\tau e^{-|k_{j_i}|}\right) e^{\frac{(2\pi r_{j_0+1}+1)(1+2\delta_0)}{1-2\delta_0} |k|}. \end{aligned}$$

□

PROOF OF 2). Consider  $B = \begin{pmatrix} B_{11} & B_{12} \\ B_{21} & B_{22} \end{pmatrix}$  with  $B_{11} + B_{22} = 2$ . Besides several trivial cases, for  $\phi \in \mathbb{T}$  such that  $\tan(2\pi\phi) = \frac{B_{21}}{1-B_{22}}$  and  $\kappa = B_{12} - B_{21}$ , we have  $R_{-\phi} B R_\phi = \begin{pmatrix} 1 & \kappa \\ 0 & 1 \end{pmatrix}$ . Then, with  $W := \tilde{W} R_\phi$ , we get (3.2). □

**3.2. An improved scheme.** Given  $A_0 \in \mathfrak{sl}(2, \mathbb{R})$  with  $|A_0| \leq a_0$  for some  $a_0 > 0$ ,  $F_0 \in \mathcal{B}_{r_0} := C_{r_0}^\omega(\mathbb{T}^d, \mathfrak{sl}(2, \mathbb{R}))$  with  $|F_0|_{r_0} = \varepsilon_0$  for some  $\varepsilon_0, r_0 > 0$ , and  $\alpha \in \text{DC}(K, \tau)$  for some  $K > 0, \tau > d - 1$ , we study reducibility and almost reducibility properties of the quasi-periodic linear system  $(\alpha, A_0 + F_0)$ : 
$$\begin{cases} \dot{x} = (A_0 + F_0(\theta))x \\ \dot{\theta} = \alpha \end{cases}.$$

**Theorem 4.25.** *Given any  $r' \in (0, r_0)$ , there exists  $\varepsilon_* = \varepsilon_*(A_0, K, \tau, r_0, r', d) > 0$  such that if  $0 < \varepsilon_0 < \varepsilon_*$ , then, for any  $\varepsilon' \in (0, \varepsilon_0)$ , there exist  $W \in C_{r'}^\omega((2\mathbb{T})^d, \text{SL}(2, \mathbb{R}))$ ,  $A' \in \mathfrak{sl}(2, \mathbb{R})$  and  $F' \in \mathcal{B}_{r'}$  satisfying  $|F'|_{r'} \leq \varepsilon'$ , such that*

$$\partial_\alpha W = (A_0 + F_0)W - W(A' + F').$$

This theorem is proven by a KAM scheme, which can be seen as a strong version of almost reducibility results of Eliasson [30] and Hadj Amor [35], since in this procedure we don't need to shrink too much the region of analyticity. Moreover, we will give a quantitative estimate on the conjugation  $W$  corresponding to the ‘‘resonant site’’. A similar result was given by Chavaudret [19] in order to show strong almost reducibility for analytic and Gevrey quasi-periodic cocycles.

**3.2.1. Iterative argument.** Let us start with  $A + F$ ,  $A \in \mathfrak{sl}(2, \mathbb{R})$ , and where  $F \in \mathcal{B}_r$  satisfies  $|F|_r \leq \varepsilon$  for some  $r, \varepsilon > 0$ . Since the matrix  $A$  satisfies  $A \in \mathfrak{sl}(2, \mathbb{R})$ , it has two eigenvalues  $\pm i\xi$ , with  $\xi \in \mathbb{R} \cup i\mathbb{R}$ . The aim of the following argument is to conjugate  $A + F$  to  $A_+ + F_+$  with  $A_+ \in \mathfrak{sl}(2, \mathbb{R})$  and  $F_+ \in \mathcal{B}_{r_+}$  for any given  $r_+ \in (0, r)$  satisfying  $|F_+|_{r_+} \ll \varepsilon$ . Then, Theorem 4.25 is proved by applying this argument iteratively.

**Proposition 4.26** (Iterative argument). *Given any  $r_+ \in (0, r)$ , if  $\varepsilon$  is sufficiently small (depending only on  $A, K, \tau, r, r_+$ ), then there exist  $A_+ \in \mathfrak{sl}(2, \mathbb{R})$ ,  $W \in C_{r_+}^\omega((2\mathbb{T})^d, \text{SL}(2, \mathbb{R}))$  and  $F_+ \in \mathcal{B}_{r_+}$  with  $|F_+|_{r_+} \ll \varepsilon$ , such that*

$$\partial_\alpha W = (A + F)W - W(A_+ + F_+).$$

Moreover,

— (Non-resonant case) if for any  $n \in \mathbb{Z}^d$  with  $0 < |n| \leq N := \frac{|\ln \varepsilon|}{10(r-r_+)}$ , we have

$$|2\xi - \langle n, \alpha \rangle| \geq \varepsilon^{\frac{1}{40}}, \quad (3.10)$$

then  $|A_+ - A| \leq \varepsilon^{\frac{1}{2}}$ ,  $|W - \text{Id}|_{r_+} \leq \varepsilon^{\frac{1}{2}}$  and  $|F_+|_{r_+} \leq \varepsilon^{\frac{41}{40}}$ ;

— (Resonant case) if there exists  $n_* \in \mathbb{Z}^d$  such that

$$|2\xi - \langle n_*, \alpha \rangle| < \varepsilon^{\frac{1}{40}}, \quad 0 < |n_*| \leq N, \quad (3.11)$$

then  $|W|_{r_+} \leq \frac{2^5|A|}{K}|n_*|^\tau e^{\pi r_+|n_*|}$  and  $|F_+|_{r_+} \leq \varepsilon e^{-2\pi r_+ \varepsilon^{-\frac{1}{90\tau}}}$ .

**Remark 4.27.** In the resonant case,  $n_*$  is the only resonant site which satisfies (3.11). Indeed, if there exists  $n'_* \neq n_*$  satisfying  $|2\xi - \langle n'_*, \alpha \rangle| < \varepsilon^{\frac{1}{40}}$ , then, in view of the Diophantine property of  $\alpha \in \mathbb{R}^d$  (see (1.3)), we have

$$\frac{K}{|n'_* - n_*|^\tau} \leq |\langle n'_* - n_*, \alpha \rangle| < 2\varepsilon^{\frac{1}{40}},$$

which implies that  $|n'_*| > 2^{-\frac{1}{\tau}} K^{\frac{1}{\tau}} \varepsilon^{-\frac{1}{40\tau}} - N > N$  provided that  $\varepsilon$  is small enough such that

$$2^{\frac{2}{\tau}} K^{-\frac{1}{\tau}} \frac{|\ln \varepsilon|}{r - r_+} \leq \varepsilon^{-\frac{1}{80\tau}}. \quad (3.12)$$

**Remark 4.28.** Since  $\alpha \in \text{DC}$ , we can see that the non-resonant condition (3.10) is always satisfied if  $A$  is of hyperbolic type (i.e., when  $\xi \in i(\mathbb{R} \setminus \{0\})$ ) or of parabolic type (i.e., when  $\xi = 0$ ), since  $\varepsilon$  is small enough such that (3.12) is satisfied. In other words, the resonant case of  $A$  does not occur unless  $A$  is of elliptic type, i.e.,  $\xi \in \mathbb{R} \setminus \{0\}$ .

**Remark 4.29.** By combining (3.12) together with the Diophantine condition (1.3), (3.11) we see that  $|\xi| \geq \frac{K}{2|n_*|^\tau}$ .

For the non-resonant case, the proof follows the standard KAM scheme: we refer to Subsection 3.1 and [29, 30, 35] for details. From now on, we assume that  $\varepsilon$  is sufficiently small (depending only on  $|A|, K, \tau, r, r_+, d$ ) such that the standard KAM scheme works.

Let  $h > 0$ . Before constructing the conjugation  $W$  for the resonant case of  $A$ , let us recall the decomposition of the space  $\mathcal{B}_h$  introduced in [37]. For any given  $\eta > 0$ ,  $\alpha \in \mathbb{R}^d$  and  $A \in \text{sl}(2, \mathbb{R})$ , we decompose  $\mathcal{B}_h = \mathcal{B}_h^{(\text{nre})}(\eta) \oplus \mathcal{B}_h^{(\text{re})}(\eta)$  in such a way that for any  $Y \in \mathcal{B}_h^{(\text{nre})}(\eta)$ ,

$$\partial_\alpha Y, [A, Y] \in \mathcal{B}_h^{(\text{nre})}(\eta), \quad |\partial_\alpha Y - [A, Y]|_h \geq \eta|Y|_h. \quad (3.13)$$

Moreover, let  $\Pi_{\text{nre}}^\eta F$  and  $\Pi_{\text{re}}^\eta F$  be the standard projections from  $\mathcal{B}_h$  onto  $\mathcal{B}_h^{(\text{nre})}(\eta)$  and  $\mathcal{B}_h^{(\text{re})}(\eta)$  respectively.

The definition of the subspaces  $\mathcal{B}_h^{(\text{nre})}(\eta)$  and  $\mathcal{B}_h^{(\text{re})}(\eta)$  depends on  $A \in \text{sl}(2, \mathbb{R})$ . In particular, if  $A$  is of elliptic type, we have the following precise characterization of  $\Pi_{\text{nre}}^\eta Y$  and  $\Pi_{\text{re}}^\eta Y$  for any given  $Y(\theta) = \sum_{n \in \mathbb{Z}^d} \begin{pmatrix} \hat{Y}_{11}(n) & \hat{Y}_{12}(n) \\ \hat{Y}_{21}(n) & -\hat{Y}_{11}(n) \end{pmatrix} e^{2\pi i \langle n, \theta \rangle} \in \mathcal{B}_h$ .

**Lemma 4.30.** If  $A = \begin{pmatrix} 0 & \xi \\ -\xi & 0 \end{pmatrix}$  for some  $\xi \in \mathbb{R}$ , then

$$\begin{aligned} \Pi_{\text{nre}}^\eta Y(\theta) &= \sum_{n \in \Lambda_1(\eta)} M^{-1} \begin{pmatrix} i\hat{Y}_-(n) & 0 \\ 0 & -i\hat{Y}_-(n) \end{pmatrix} M e^{2\pi i \langle n, \theta \rangle} \\ &+ \sum_{n \in \Lambda_2(\eta)} M^{-1} \begin{pmatrix} 0 & (\hat{Y}_{11}(n) - i\hat{Y}_+(n))e^{2\pi i \langle n, \theta \rangle} \\ (\hat{Y}_{11}(-n) + i\hat{Y}_+(-n))e^{-2\pi i \langle n, \theta \rangle} & 0 \end{pmatrix} M, \\ \Pi_{\text{re}}^\eta Y(\theta) &= \sum_{n \in \mathbb{Z}^d \setminus \Lambda_1(\eta)} M^{-1} \begin{pmatrix} i\hat{Y}_-(n) & 0 \\ 0 & -i\hat{Y}_-(n) \end{pmatrix} M e^{2\pi i \langle n, \theta \rangle} \\ &+ \sum_{n \in \mathbb{Z}^d \setminus \Lambda_2(\eta)} M^{-1} \begin{pmatrix} 0 & (\hat{Y}_{11}(n) - i\hat{Y}_+(n))e^{2\pi i \langle n, \theta \rangle} \\ (\hat{Y}_{11}(-n) + i\hat{Y}_+(-n))e^{-2\pi i \langle n, \theta \rangle} & 0 \end{pmatrix} M, \end{aligned}$$

where  $\widehat{Y}_\pm(n) := \frac{1}{2}(\widehat{Y}_{12}(n) \pm \widehat{Y}_{21}(n))$ ,  $M := \frac{1}{1+i} \begin{pmatrix} 1 & -i \\ 1 & i \end{pmatrix}$  and

$$\Lambda_1(\eta) := \{n \in \mathbb{Z}^d : |\langle n, \alpha \rangle| \geq \eta\}, \quad \Lambda_2(\eta) := \{n \in \mathbb{Z}^d : |\langle n, \alpha \rangle - 2\xi| \geq \eta\}. \quad (3.14)$$

Let us now consider the resonant case of  $A$ . Recall that we focus on the elliptic type, i.e.,  $A$  has two eigenvalues  $\pm i\xi$  with  $\xi \in \mathbb{R} \setminus \{0\}$ , and there exists  $n_* \in \mathbb{Z}^d$  such that (3.11) is satisfied. By Lemma 8.1 of [37], one can find  $C_A \in \text{SL}(2, \mathbb{R})$  with

$$|C_A| \leq 2\sqrt{\frac{|A|}{|\xi|}} \leq \frac{2^{\frac{3}{2}}\sqrt{|A|}}{\sqrt{K}}|n_*|^{\frac{\tau}{2}} \quad (3.15)$$

(in view of Remark 4.29), such that  $A = C_A^{-1} \begin{pmatrix} 0 & \xi \\ -\xi & 0 \end{pmatrix} C_A$ .

Based on the decomposition  $\mathcal{B}_r = \mathcal{B}_r^{(\text{nr})}(\eta) \oplus \mathcal{B}_r^{(\text{re})}(\eta)$  with  $\eta = \varepsilon^{\frac{1}{40}}$ , we have the following lemma.

**Lemma 4.31** (Lemma 3.1 of Hou-You [37]). *Assume that  $\varepsilon \in (0, 10^{-8})$ . Then there exist  $Y \in \mathcal{B}_r$  and  $G \in \mathcal{B}_r^{(\text{re})}(\varepsilon^{\frac{1}{40}})$  such that*

$$\partial_\alpha e^Y = (A + F)e^Y - e^Y(A + G),$$

with  $|Y|_r \leq \varepsilon^{\frac{1}{2}}$ ,  $|G|_r \leq 2\varepsilon$ .

Let  $\tilde{C}_A := MC_A = \frac{1}{1+i} \begin{pmatrix} 1 & -i \\ 1 & i \end{pmatrix} C_A$ . By (3.15), we get

$$|\tilde{C}_A| \leq \frac{2^2\sqrt{|A|}}{\sqrt{K}}|n_*|^{\frac{\tau}{2}}. \quad (3.16)$$

For  $G(\theta) = \sum_{n \in \mathbb{Z}^d} \widehat{G}(n)e^{2\pi i \langle n, \theta \rangle} \in \mathcal{B}_r^{(\text{re})}(\varepsilon^{\frac{1}{40}})$  with  $\widehat{G}(n) = C_A^{-1} \begin{pmatrix} \tilde{G}_{11}(n) & \tilde{G}_{12}(n) \\ \tilde{G}_{21}(n) & -\tilde{G}_{11}(n) \end{pmatrix} C_A$ ,

the following lemma shows that it has a special form.

**Lemma 4.32.** *If  $\varepsilon$  is sufficiently small (depending only on  $|A|, K, \tau, r, r_+, d$ ), then we have  $G(\theta) = G_0 + G_1(\theta) + G_2(\theta)$ , with  $G_2 \in \mathcal{B}_{r_+}$  satisfying  $|G_2|_{r_+} \leq \varepsilon e^{-2\pi r_+ \varepsilon^{-\frac{1}{60\tau}}}$  and*

$$G_0 := \tilde{C}_A^{-1} \begin{pmatrix} G_-(0) & 0 \\ 0 & -G_-(0) \end{pmatrix} \tilde{C}_A, \quad (3.17)$$

$$G_1(\theta) := \tilde{C}_A^{-1} \begin{pmatrix} 0 & G_+(n_*)e^{2\pi i \langle n_*, \theta \rangle} \\ \overline{G_+(n_*)}e^{-2\pi i \langle n_*, \theta \rangle} & 0 \end{pmatrix} \tilde{C}_A, \quad (3.18)$$

for some  $G_-(0), G_+(n_*) \in \mathbb{C}$  satisfying

$$|G_-(0)| \leq \varepsilon^{\frac{15}{16}}, \quad |G_+(n_*)| \leq \varepsilon^{\frac{15}{16}} e^{-2\pi r |n_*|}. \quad (3.19)$$

**PROOF.** In view of Lemma 4.30, and noting that  $\tilde{C}_A = MC_A$ , we write  $G \in \mathcal{B}^{(\text{re})}(\varepsilon^{\frac{1}{40}})$  as

$$\sum_{n \in \mathbb{Z}^d \setminus \Lambda_1(\varepsilon^{1/40})} \tilde{C}_A^{-1} \begin{pmatrix} i\tilde{G}_-(n) & 0 \\ 0 & -i\tilde{G}_-(n) \end{pmatrix} \tilde{C}_A e^{2\pi i \langle n, \theta \rangle} \quad (3.20)$$

$$+ \sum_{n \in \mathbb{Z}^d \setminus \Lambda_2(\varepsilon^{1/40})} \tilde{C}_A^{-1} \begin{pmatrix} 0 & (\tilde{G}_{11}(n) - i\tilde{G}_+(n))e^{2\pi i \langle n, \theta \rangle} \\ ((\tilde{G}_{11}(-n) + i\tilde{G}_+(-n))e^{-2\pi i \langle n, \theta \rangle} & 0 \end{pmatrix} \tilde{C}_A, \quad (3.21)$$

with  $\tilde{G}_\pm(n) := \frac{1}{2}(\tilde{G}_{12}(n) \pm \tilde{G}_{21}(n))$  and for the subsets of non-resonant sites  $\Lambda_1, \Lambda_2$  defined in (3.14). For  $\varepsilon$  sufficiently small, since  $\alpha$  is Diophantine, we have

$$(\mathbb{Z}^d \setminus \Lambda_1(\varepsilon^{\frac{1}{40}})) \cap \{n \in \mathbb{Z}^d : |n| \leq K^{\frac{1}{\tau}} \varepsilon^{-\frac{1}{40\tau}}\} = \{0\}, \quad (3.22)$$

$$(\mathbb{Z}^d \setminus \Lambda_2(\varepsilon^{\frac{1}{40}})) \cap \{n \in \mathbb{Z}^d : |n| \leq 2^{-\frac{1}{\tau}} K^{\frac{1}{\tau}} \varepsilon^{-\frac{1}{40\tau}} - N\} = \{n_*\}. \quad (3.23)$$

Indeed, given any  $n \in \mathbb{Z}^d \setminus \Lambda_1(\varepsilon^{\frac{1}{40}})$  and  $n \neq 0$ , we have

$$\frac{K}{|n|^\tau} < |\langle n, \alpha \rangle| < \varepsilon^{\frac{1}{40}}.$$

So  $|n| > K^{\frac{1}{\tau}} \varepsilon^{-\frac{1}{40\tau}}$ , which implies (3.22). On the other hand, (3.23) was already shown in Remark 4.27.

In view of (3.22) and (3.23), the terms in (3.20) can be decomposed as

$$\tilde{C}_A^{-1} \begin{pmatrix} i\tilde{G}_-(0) & 0 \\ 0 & -i\tilde{G}_-(0) \end{pmatrix} \tilde{C}_A + \sum_{\substack{n \in \mathbb{Z}^d \setminus \Lambda_1(\varepsilon^{\frac{1}{40}}) \\ |n| > K^{\frac{1}{\tau}} \varepsilon^{-\frac{1}{40\tau}}} \tilde{C}_A^{-1} \begin{pmatrix} i\tilde{G}_-(n) & 0 \\ 0 & -i\tilde{G}_-(n) \end{pmatrix} \tilde{C}_A e^{2\pi i \langle n, \theta \rangle}$$

and the terms in (3.21) can be decomposed as

$$\begin{aligned} & \tilde{C}_A^{-1} \begin{pmatrix} 0 & (\tilde{G}_{11}(n_*) - i\tilde{G}_+(n_*))e^{2\pi i \langle n_*, \theta \rangle} \\ (\tilde{G}_{11}(-n_*) + i\tilde{G}_+(-n_*))e^{-2\pi i \langle n_*, \theta \rangle} & 0 \end{pmatrix} \tilde{C}_A \\ + & \sum_{\substack{n \in \mathbb{Z}^d \setminus \Lambda_2(\varepsilon^{\frac{1}{40}}) \\ |n| > \mathcal{N}}} \tilde{C}_A^{-1} \begin{pmatrix} 0 & (\tilde{G}_{11}(n) - i\tilde{G}_+(n))e^{2\pi i \langle n, \theta \rangle} \\ (\tilde{G}_{11}(-n) + i\tilde{G}_+(-n))e^{-2\pi i \langle n, \theta \rangle} & 0 \end{pmatrix} \tilde{C}_A. \end{aligned}$$

with  $\mathcal{N} := 2^{-\frac{1}{\tau}} K^{\frac{1}{\tau}} \varepsilon^{-\frac{1}{40\tau}} - N$ . Letting  $G_-(0) := i\tilde{G}_-(0)$  and  $G_+(n_*) := \tilde{G}_{11}(n_*) - i\tilde{G}_+(n_*)$ , we then get  $G_0$  and  $G_1(\theta)$  as in (3.17) and (3.18). The remaining terms are

$$\begin{aligned} & \sum_{\substack{n \in \mathbb{Z}^d \setminus \Lambda_1(\varepsilon^{\frac{1}{40}}) \\ |n| > K^{\frac{1}{\tau}} \varepsilon^{-\frac{1}{40\tau}}} \tilde{C}_A^{-1} \begin{pmatrix} i\tilde{G}_-(n) & 0 \\ 0 & -i\tilde{G}_-(n) \end{pmatrix} \tilde{C}_A e^{2\pi i \langle n, \theta \rangle} \\ + & \sum_{\substack{n \in \mathbb{Z}^d \setminus \Lambda_2(\varepsilon^{\frac{1}{40}}) \\ |n| > \mathcal{N}}} \tilde{C}_A^{-1} \begin{pmatrix} 0 & (\tilde{G}_{11}(n) - i\tilde{G}_+(n))e^{2\pi i \langle n, \theta \rangle} \\ (\tilde{G}_{11}(-n) + i\tilde{G}_+(-n))e^{-2\pi i \langle n, \theta \rangle} & 0 \end{pmatrix} \tilde{C}_A \\ = & \sum_{|n| > \mathcal{N}} \hat{G}_2(n) e^{2\pi i \langle n, \theta \rangle} \end{aligned}$$

for some  $\hat{G}_2(n) \in \text{sl}(2, \mathbb{R})$ , by noting that  $\mathcal{N} \leq K^{\frac{1}{\tau}} \varepsilon^{-\frac{1}{40\tau}}$ .

By analyticity, the Fourier coefficients of  $G \in \mathcal{B}_r$  decay exponentially, hence by (3.16), we have

$$\begin{aligned} |\tilde{G}_{ij}(n)| & \leq \frac{2^5 |A|}{K} N^\tau \varepsilon e^{-2\pi r |n|}, \quad \forall i, j = 1, 2, \quad n \in \mathbb{Z}^d, \\ |\hat{G}_2(n)| & \leq \frac{2^9 |A|^2}{K^2} N^{2\tau} \varepsilon e^{-2\pi r |n|}, \quad \forall |n| > \mathcal{N}. \end{aligned}$$

Then (3.19) follows immediately provided that  $\varepsilon$  is taken sufficiently small such that

$$2^{\frac{6}{\tau}} |A|^{\frac{1}{\tau}} K^{-\frac{1}{\tau}} \cdot \frac{|\ln \varepsilon|}{r - r_+} \leq \varepsilon^{-\frac{1}{120\tau}}. \quad (3.24)$$

By several integrations by parts (see, for example, the proof of Lemma 1 in [35]), there exists a constant  $c_d > 0$ , independent of  $r, r_+$  and  $\mathcal{N}$ , such that

$$|G_2|_{r_+} \leq c_d \frac{2^9 |A|^2}{K^2} N^{2\tau} \left( \mathcal{N} + \frac{1}{r - r_+} \right)^d \varepsilon e^{-2\pi(r-r_+)\mathcal{N}}.$$



If  $\varepsilon$  is sufficiently small such that

$$(r - r_+) \left( 2^{-\frac{1}{\tau}} K^{\frac{1}{\tau}} \varepsilon^{-\frac{1}{40\tau}} - \frac{|\ln \varepsilon|}{10(r - r_+)} \right) \geq r_+ \varepsilon^{-\frac{1}{50\tau}}, \quad (3.25)$$

$$C_d^{\frac{1}{2\tau}} \frac{2^{\frac{9}{2\tau}} |A|^{\frac{1}{\tau}} |\ln \varepsilon|}{K^{\frac{1}{\tau}} (r - r_+)} \left( 2^{-\frac{1}{\tau}} K^{\frac{1}{\tau}} \varepsilon^{-\frac{1}{40\tau}} - \frac{|\ln \varepsilon|}{10(r - r_+)} + \frac{1}{r - r_+} \right)^d \varepsilon^{-\frac{r_+}{2\tau} (\varepsilon^{-\frac{1}{50\tau}} - \varepsilon^{-\frac{1}{60\tau}})} \leq 1, \quad (3.26)$$

then we have  $|G_2|_{r_+} \leq \varepsilon e^{-2\pi r_+ \varepsilon^{-\frac{1}{60\tau}}}$ .  $\square$

**Lemma 4.33.** *If  $\varepsilon$  is sufficiently small (depending only on  $|A|$ ,  $K$ ,  $\tau$ ,  $r$ ,  $r_+$ ,  $d$ ), then there exist  $A_+ \in \mathfrak{sl}(2, \mathbb{R})$ ,  $Z \in C_{r_+}^\omega((2\mathbb{T})^d, \mathfrak{SL}(2, \mathbb{R}))$  and  $F_+ \in \mathcal{B}_{r_+}$  satisfying*

$$|A_+| \leq \varepsilon^{\frac{1}{60}}, \quad |Z|_{r_+} \leq \frac{2^4 |A|}{K} |n_*|^\tau e^{\pi r_+ |n_*|}, \quad |F_+|_{r_+} \leq \varepsilon e^{-2\pi r_+ \varepsilon^{-\frac{1}{90\tau}}} \quad (3.27)$$

such that  $\partial_\alpha Z = (A + G)Z - Z(A_+ + F_+)$ . Moreover,  $A_+$  can be written as

$$A_+ = \tilde{C}_A^{-1} \begin{pmatrix} i \left( \xi - \frac{\langle n_*, \alpha \rangle}{2} + G_-(0) \right) & G_+(n_*) \\ \overline{G_+(n_*)} & -i \left( \xi - \frac{\langle n_*, \alpha \rangle}{2} + G_-(0) \right) \end{pmatrix} \tilde{C}_A. \quad (3.28)$$

PROOF. We define

$$Z(\theta) := e^{2\pi \frac{\langle n_*, \theta \rangle}{2\xi} A} = \tilde{C}_A^{-1} \begin{pmatrix} e^{2\pi i \frac{\langle n_*, \theta \rangle}{2}} & 0 \\ 0 & e^{-2\pi i \frac{\langle n_*, \theta \rangle}{2}} \end{pmatrix} \tilde{C}_A \in C_{r_+}^\omega((2\mathbb{T})^d, \mathfrak{SL}(2, \mathbb{R})).$$

Then,  $|Z|_{r_+} \leq \frac{2^4 |A|}{K} |n_*|^\tau e^{\pi r_+ |n_*|}$ . Letting  $\tilde{A} := \left(1 - \frac{\langle n_*, \alpha \rangle}{2\xi}\right) A$ , we have

$$\partial_\alpha Z = (A + G)Z - Z(\tilde{A} + Z^{-1}GZ).$$

By a direct calculation, we can see that  $Z(\theta)^{-1}G_0Z(\theta) = G_0 \in \mathfrak{sl}(2, \mathbb{R})$  and

$$Z(\theta)^{-1}G_1(\theta)Z(\theta) = \tilde{C}_A^{-1} \begin{pmatrix} 0 & \tilde{G}_+(n_*) \\ \tilde{G}_+(n_*) & 0 \end{pmatrix} \tilde{C}_A \in \mathfrak{sl}(2, \mathbb{R}).$$

Moreover, we have

$$|Z^{-1}G_2Z|_{r_+} \leq \frac{2^8 |A|^2}{K^2} N^{2\tau} \varepsilon e^{-2\pi r_+ \varepsilon^{-\frac{1}{60\tau}}} \leq \varepsilon e^{-2\pi r_+ \varepsilon^{-\frac{1}{90\tau}}},$$

if  $\varepsilon$  is small enough such that

$$\frac{2^{\frac{4}{\tau}} |A|^{\frac{1}{\tau}} |\ln \varepsilon|}{K^{\frac{1}{\tau}} (r - r_+)} \varepsilon^{-\frac{\pi r_+}{\tau} (\varepsilon^{-\frac{1}{60\tau}} - \varepsilon^{-\frac{1}{90\tau}})} \leq 1. \quad (3.29)$$

Let  $F_+ := Z^{-1}G_2Z$  and  $A_+ := \tilde{A} + G_0 + Z^{-1}G_1Z$ . Then (3.28) can be easily verified, and

$$|A_+| \leq |A| \cdot \frac{|n_*|^\tau}{K} \varepsilon^{\frac{1}{40}} + \frac{2^4 |A|}{K} |n_*|^\tau \varepsilon^{\frac{15}{16}} (1 + e^{-2\pi r |n_*|}).$$

If  $\varepsilon$  is small enough such that (3.24) is satisfied, then we have  $|A_+| \leq \varepsilon^{\frac{1}{60}}$ . This finishes the proof of the lemma.  $\square$

To conclude the proof of the resonant case in Proposition 4.26, it remains to take  $W := e^Y Z$ .

## 3.2.2. Application to the reducibility of linear systems.

**Corollary 4.34.** *Given any  $r' \in (0, r_0)$ , there exists  $\varepsilon_* = \varepsilon_*(A_0, K, \tau, r_0, r', d) > 0$  such that if  $0 < \varepsilon_0 < \varepsilon_*$ , then the following assertions hold. Assume that  $\rho(\alpha, A_0 + F_0) = \langle k \rangle$  for some  $k \in \mathbb{Z}^d \setminus \{0\}$ .*

- 1) *There exists  $\tilde{W} \in C_{r'}^\omega((2\mathbb{T})^d, \text{SL}(2, \mathbb{R}))$  satisfying  $|\tilde{W}|_{r'} \leq \tilde{D}_1 e^{\tilde{\zeta}_1 |k|}$ , where  $\tilde{D}_1 = \tilde{D}_1(K, \tau, d) > 0$  and  $\tilde{\zeta}_1 = \tilde{\zeta}_1(\tau, r_0) > 0$ , and  $B \in \text{sl}(2, \mathbb{R})$  with  $\rho(0, B) = 0$ , such that*

$$\partial_\alpha \tilde{W} = (A_0 + F_0)\tilde{W} - \tilde{W}B.$$

- 2) *If  $\det(B) = 0$ , then there exist  $W \in C_{r'}^\omega((2\mathbb{T})^d, \text{SL}(2, \mathbb{R}))$  with  $|W|_{r'} \leq \tilde{D}_1 e^{\tilde{\zeta}_1 |k|}$  and  $\kappa \in \mathbb{R}$  with  $|\kappa| \leq \varepsilon_0^{\frac{1}{4}} e^{-\frac{2\pi r' |k|}{1+2\varepsilon_0^{\frac{1}{80\tau}}}}$  such that*

$$\partial_\alpha W = (A_0 + F_0)W - W \begin{pmatrix} 0 & \kappa \\ 0 & 0 \end{pmatrix}. \quad (3.30)$$

PROOF OF 1). The conjugacy  $\tilde{W}$  is constructed by applying Proposition 4.26 iteratively. Take  $\varepsilon_0, r_0$  and  $r'$  as above. Assume that we are at the  $(j+1)$ <sup>th</sup> KAM step, where  $A_j \in \text{sl}(2, \mathbb{R})$  has two eigenvalues  $\pm i\xi_j$  and  $F_j \in \mathcal{B}_{r_j}$  satisfies  $|F_j|_{r_j} \leq \varepsilon_j$  for some  $\varepsilon_j \ll \varepsilon_0$ . We define

$$r_j - r_{j+1} := \frac{r_0 - r'}{4^{j+1}}, \quad N_j := \frac{|\ln \varepsilon_j|}{10(r_j - r_{j+1})} = \frac{4^{j+1} |\ln \varepsilon_j|}{10(r_0 - r')}. \quad (3.31)$$

If  $\varepsilon_0$  is sufficiently small (depending only on  $|A_0|, K, \tau, r_0, r', d$ ), then the conditions (3.12), (3.24), (3.25), (3.26), (3.29) are satisfied for  $\varepsilon = \varepsilon_j, r = r_j$  and  $r_+ = r_{j+1}$ . By Proposition 4.26, we can construct

$$\hat{W}_j \in C_{r_{j+1}}^\omega((2\mathbb{T})^d, \text{SL}(2, \mathbb{R})), \quad A_{j+1} \in \text{sl}(2, \mathbb{R}), \quad F_{j+1} \in \mathcal{B}_{r_{j+1}},$$

such that  $\partial_\alpha \hat{W}_j = (A_j + F_j)\hat{W}_j - \hat{W}_j(A_{j+1} + F_{j+1})$  with  $|F_{j+1}|_{r_{j+1}} \ll \varepsilon_j$ . More precisely,

- if for any  $n \in \mathbb{Z}^d$  with  $0 < |n| \leq N_j$ , we have  $|2\xi_j - \langle n, \alpha \rangle| \geq \varepsilon_j^{\frac{1}{40}}$ , then

$$|A_{j+1} - A_j| \leq \varepsilon_j^{\frac{1}{2}}, \quad |\hat{W}_j - \text{Id}|_{r_{j+1}} \leq \varepsilon_j^{\frac{1}{2}}, \quad |F_{j+1}|_{r_{j+1}} \leq \varepsilon_{j+1} := \varepsilon_j^{\frac{41}{40}}; \quad (3.32)$$

- if there exists  $n_j \in \mathbb{Z}^d$  such that  $|2\xi_j - \langle n_j, \alpha \rangle| < \varepsilon_j^{\frac{1}{40}}, 0 < |n_j| \leq N_j$ , then

$$|A_{j+1}| \leq \varepsilon_j^{\frac{1}{60}}, \quad |\hat{W}_j|_{r_{j+1}} \leq \frac{2^5 |A_j|}{K} |n_j|^\tau e^{\pi r_{j+1} |n_j|}, \quad |F_{j+1}|_{r_{j+1}} \leq \varepsilon_{j+1} := \varepsilon_j e^{-2\pi r_{j+1} \varepsilon_j^{-\frac{1}{90\tau}}}. \quad (3.33)$$

Since  $\rho(\alpha, A_0 + F_0) = \langle k \rangle$ , by [30, 35], we know that  $(\alpha, A_0 + F_0)$  can be reduced to a constant linear system  $(0, B)$  for some  $B \in \text{sl}(2, \mathbb{R})$ , with  $\rho(0, B) = 0$ . This means that we can construct a sequence  $(\hat{W}_l)_{l \in \mathbb{N}}$  with  $\hat{W}_l \in C_{r_{l+1}}^\omega((2\mathbb{T})^d, \text{SL}(2, \mathbb{R}))$ , in which the resonant case occurs only finitely many times. Then, by recalling the estimates for the non-resonant case in (3.32) and the sequence  $(r_j)_{j \in \mathbb{N}}$  given in (3.31), we see that  $\prod_{l=0}^j \hat{W}_{l+1}$  converges to some  $\tilde{W} \in C_{r'}^\omega((2\mathbb{T})^d, \text{SL}(2, \mathbb{R}))$ , such that

$$\partial_\alpha \tilde{W} = (A_0 + F_0)\tilde{W} - \tilde{W}B.$$

Moreover,  $B$  is the limit of sequence  $(A_j)_{j \in \mathbb{N}}$ , and it is obvious that

$$|A_j| \leq 2a_0, \quad \forall j \in \mathbb{N}.$$

Assume that there are  $s+1$  resonant steps,  $s \in \mathbb{N}$ , associated with integers vectors

$$n_{j_0}, \dots, n_{j_s} \in \mathbb{Z}^d, \quad \text{where } 0 < |n_{j_i}| \leq N_{j_i}, \quad i = 0, 1, \dots, s.$$

Then  $\deg(\hat{W}_{j_i}) = n_{j_i}$ , hence  $k = n_{j_0} + \dots + n_{j_s}$ . Let us focus on two consecutive resonant steps, say the  $(j_i + 1)$ <sup>th</sup> and  $(j_{i+1} + 1)$ <sup>th</sup>. By the resonance condition at the  $j_i^{\text{th}}$ -step, we have

$$|\xi_{j_{i+1}} - \langle n_{j_{i+1}} \rangle| \leq \varepsilon_{j_{i+1}}^{\frac{1}{40}},$$

which implies that  $|\xi_{j_{i+1}}| > \frac{K}{2|n_{j_{i+1}}|^\tau}$ . On the other hand, by the renormalization at the  $(j_i + 1)^{\text{th}}$  step combined with (3.12), we get

$$|\xi_{j_{i+1}}| \leq 2\varepsilon_{j_i}^{\frac{1}{40}} \leq \frac{\varepsilon_{j_i}^{\frac{1}{80}} K}{2|n_{j_i}|^\tau}.$$

Thus we can see  $|n_{j_{i+1}}| \geq \varepsilon_{j_i}^{-\frac{1}{80\tau}} |n_{j_i}|$ . Moreover, by the inequalities

$$|n_{j_s}| - \sum_{i=0}^{s-1} |n_{j_i}| \leq |k| \leq |n_{j_s}| + \sum_{i=0}^{s-1} |n_{j_i}|,$$

we have  $(1 - 2\varepsilon_{j_0}^{\frac{1}{80\tau}})|n_{j_s}| \leq |k| \leq (1 + 2\varepsilon_{j_0}^{\frac{1}{80\tau}})|n_{j_s}|$ . Hence we deduce that

$$\begin{aligned} |\tilde{W}|_{r'} &\leq 2|\hat{W}_{j_0+1}|_{r_{j_0+1}} \cdots |\hat{W}_{j_s+1}|_{r_{j_s+1}} \\ &\leq \frac{2^{1+5(s+1)}}{K^{s+1}} \prod_{i=0}^s |A_{j_i}| |n_{j_i}|^\tau e^{\pi r_{j_{i+1}} |n_{j_i}|} \\ &\leq \left( \frac{2^{1+6(s+1)} a_0^{s+1}}{K^{s+1}} \prod_{i=0}^s (|n_{j_i}|^\tau e^{-|n_{j_i}|}) \right) e^{\pi(2+r_{j_0+1}) \sum_{i=0}^s |n_{j_i}|} \\ &\leq \tilde{D}_1 e^{\tilde{\zeta}_1 |k|} \end{aligned}$$

for some constants  $\tilde{D}_1 = \tilde{D}_1(K, \tau, a_0, d)$  and  $\tilde{\zeta}_1 = \tilde{\zeta}_1(r_0, \tau)$ .  $\square$

PROOF OF 2). Consider  $B = \begin{pmatrix} B_{11} & B_{12} \\ B_{21} & -B_{11} \end{pmatrix}$  with  $B_{11}^2 + B_{12}B_{21} = 0$ . Besides several trivial cases, for  $\phi \in \mathbb{T}$  such that  $\tan(2\pi\phi) = \frac{B_{21}}{B_{11}}$  and  $\kappa = B_{21} - B_{12}$ , we have  $R_{-\phi} B R_\phi = \begin{pmatrix} 0 & \kappa \\ 0 & 0 \end{pmatrix}$ . Then, with  $W := \tilde{W} R_\phi$ , we get (3.30).

We still need to estimate  $|k|$ . Let us focus on  $A_{j_s+1} + F_{j_s+1}$ , i.e., the system just after the last resonant step. In view of (3.28) in Lemma 4.33, we have

$$A_{j_s+1} = \tilde{C}_{A_{j_s}}^{-1} \begin{pmatrix} i \left( \xi_{j_s} - \frac{\langle n_{j_s}, \alpha \rangle}{2} + G_-^{j_s}(0) \right) & G_+^{j_s}(n_{j_s}) \\ \overline{G_+^{j_s}(n_{j_s})} & -i \left( \xi_{j_s} - \frac{\langle n_{j_s}, \alpha \rangle}{2} + G_-^{j_s}(0) \right) \end{pmatrix} \tilde{C}_{A_{j_s}},$$

where  $\tilde{C}_{A_{j_s}} \in \text{SL}(2, \mathbb{C})$  satisfies  $A_{j_s} = \tilde{C}_{A_{j_s}}^{-1} \begin{pmatrix} i\xi_{j_s} & 0 \\ 0 & -i\xi_{j_s} \end{pmatrix} \tilde{C}_{A_{j_s}}$  and

$$|\tilde{C}_{A_{j_s}}| \leq \frac{2^2 \sqrt{|A_{j_s}|}}{\sqrt{K}} |n_{j_s}|^{\frac{\tau}{2}}, \quad (3.34)$$

and  $G_-^{j_s}(0), G_+^{j_s}(n_{j_s}) \in \mathbb{C}$  satisfy

$$\left| \xi_{j_s} - \frac{\langle n_{j_s}, \alpha \rangle}{2} + G_-^{j_s}(0) \right| \leq \frac{1}{2} \varepsilon_{j_s}^{\frac{1}{40}} + \varepsilon_{j_s}^{\frac{15}{16}} \leq \varepsilon_{j_s}^{\frac{1}{40}}, \quad \left| G_+^{j_s}(n_{j_s}) \right| \leq \varepsilon_{j_s}^{\frac{15}{16}} e^{-2\pi r_{j_s} |n_{j_s}|}.$$

Note that the  $(j_s + 1)^{\text{th}}$ -step is the last resonant step, then, in view of the size of  $F_{j_s+1}$ , we have

$$|A_{j_s+1} - B| \leq 2\varepsilon_{j_s}^{\frac{1}{2}} e^{-\pi r_{j_s+1} \varepsilon_{j_s}^{-\frac{1}{90\tau}}}.$$

By (3.34),  $B$  can be written as  $B = \tilde{C}_{A_{j_s}}^{-1} \begin{pmatrix} \tilde{B}_{11} & \tilde{B}_{12} \\ \tilde{B}_{21} & -\tilde{B}_{11} \end{pmatrix} \tilde{C}_{A_{j_s}}$ , with

$$|\tilde{B}_{12}|, |\tilde{B}_{21}| \leq \varepsilon_{j_s}^{\frac{15}{16}} e^{-2\pi r_{j_s} |n_{j_s}|} + \frac{2^5 |A_{j_s}|}{K} N_{j_s}^\tau \varepsilon_{j_s}^{\frac{1}{2}} e^{-\pi r_{j_s+1} \varepsilon_{j_s}^{-\frac{1}{90\tau}}} \leq \varepsilon_{j_s}^{\frac{1}{3}} e^{-2\pi r_{j_s+1} |n_{j_s}|}.$$

Then we have  $|\tilde{B}_{11}| \leq \varepsilon_{j_s}^{\frac{1}{3}} e^{-2\pi r_{j_s+1} |n_{j_s}|}$  since  $\det(B) = 0$ . So

$$|B_{12}|, |B_{21}| \leq \frac{2^4 |A_{j_s}|}{K} |n_{j_s}|^\tau \varepsilon_{j_s}^{\frac{1}{3}} e^{-2\pi r_{j_s+1} |n_{j_s}|} \leq \frac{1}{2} \varepsilon_{j_s}^{\frac{1}{4}} e^{-2\pi r_{j_s+1} |n_{j_s}|}.$$

Since  $|k| \leq (1 + 2\varepsilon_{j_0}^{\frac{1}{80\tau}})|n_{j_s}|$ , we thus deduce

$$|\kappa| = |B_{21} - B_{12}| \leq \varepsilon_{j_s}^{\frac{1}{4}} e^{-2\pi r_{j_s+1}|n_{j_s}|} \leq \varepsilon_{j_s}^{\frac{1}{4}} e^{-\frac{2\pi r'|k|}{1+2\varepsilon_0^{1/80\tau}}}.$$

□

3.2.3. *Almost reducibility of quasi-periodic cocycles.* Correspondingly, we can also consider the reducibility and almost reducibility of the quasi-periodic  $\mathrm{SL}(2, \mathbb{R})$ -cocycle

$$\begin{pmatrix} q_{n+1} \\ q_n \end{pmatrix} = (A_0 + F_0(\theta + n\alpha)) \begin{pmatrix} q_n \\ q_{n-1} \end{pmatrix},$$

with  $A_0 \in \mathrm{SL}(2, \mathbb{R})$  satisfying  $|A_0| \leq a_0$  for some  $a_0 > 0$ ,  $F_0 \in C_{r_0}^\omega(\mathbb{T}^d, \mathrm{gl}(2, \mathbb{R}))$  with  $|F_0|_{r_0} = \varepsilon_0$  for some  $\varepsilon_0, r_0 > 0$ , and  $\alpha \in \mathrm{DC}(K, \tau)$  for some  $K > 0, \tau > d - 1$ .

Similarly to the reducibility of the quasi-periodic linear system, we have

**Corollary 4.35.** *Given any  $r' \in (0, r_0)$ , there exists  $\varepsilon_* = \varepsilon_*(A_0, K, \tau, r_0, r', d) > 0$  such that if  $0 < \varepsilon_0 < \varepsilon_*$ , then the following assertions hold. Assume that  $\rho(\alpha, A_0 + F_0) = \langle k \rangle$  for some  $k \in \mathbb{Z}^d \setminus \{0\}$ .*

- 1) *There exists  $\tilde{W} \in C_{r'}^\omega((2\mathbb{T})^d, \mathrm{SL}(2, \mathbb{R}))$  satisfying  $|\tilde{W}|_{r'} \leq \tilde{D}_1 e^{\tilde{\zeta}_1 |k|}$ , where  $\tilde{D}_1 = \tilde{D}_1(K, \tau, d) > 0$  and  $\tilde{\zeta}_1 = \tilde{\zeta}_1(\tau, r_0) > 0$ , and  $B \in \mathrm{SL}(2, \mathbb{R})$  with  $\rho(0, B) = 0$ , such that*

$$\tilde{W}(\cdot + \alpha)^{-1}(A_0 + F_0)\tilde{W}(\cdot) = B.$$

- 2) *If  $\mathrm{tr}(B) = 2$ , then there exist  $W \in C_{r'}^\omega((2\mathbb{T})^d, \mathrm{SL}(2, \mathbb{R}))$  with  $|W|_{r'} \leq \tilde{D}_1 e^{\tilde{\zeta}_1 |k|}$  and  $\kappa \in \mathbb{R}$  with  $|\kappa| \leq \varepsilon_0^{\frac{1}{4}} e^{-\frac{2\pi r'|k|}{1+2\varepsilon_0^{1/80\tau}}}$  such that*

$$W(\cdot + \alpha)^{-1}(A_0 + F_0)W(\cdot) = \begin{pmatrix} 1 & \kappa \\ 0 & 1 \end{pmatrix}. \tag{3.35}$$

**Remark 4.36.** *Let  $K, \tau > 0$  be fixed. If  $A_0$  varies in some compact subset of  $\mathrm{SL}(2, \mathbb{R})$ , then  $\varepsilon_*$  can be taken uniform with respect to  $A_0$ .*

#### 4. Almost localization and duality argument

In this part, we study the reducibility of quasi-periodic Schrödinger cocycles by non-perturbative methods, from the perspective of Aubry duality.

We will need the following results. Next theorem says that it is possible to get an upper bound on the norm of a trigonometric polynomial once we control enough points in some orbit of the rotation  $x \mapsto x + \alpha$ , up to some factor depending on the arithmetic properties of  $\alpha$  and the *essential degree*<sup>6</sup> of the polynomial.

**Theorem 4.37** (Avila-Jitomirskaya, Theorem 6.1, [7]). *Let  $(p_i/q_i)_i$  denote the sequence of best approximants of  $\alpha \in \mathbb{R}$ . Let  $1 \leq r \leq \lfloor q_{i+1}/q_i \rfloor$ . If  $p$  is a trigonometric polynomial of essential degree  $l = rq_i - 1$ , and  $x_0 \in \mathbb{T}$ , then for some absolute constant  $C_0 > 0$ , we have*

$$|p|_{\mathbb{T}} \leq C_0 q_{i+1}^{C_0 r} \sup_{0 \leq j \leq l} |p(x_0 + j\alpha)|.$$

Given a non-zero vector  $\mathcal{U}_0 \in \mathbb{C}^2$ , it is easy to construct a matrix in  $\mathrm{SL}(2, \mathbb{C})$  with first column equal to  $\mathcal{U}_0$ ; indeed, we just have to solve an equation of the type  $ad - bc = 1$ . When  $\mathcal{U}_0$  depends analytically on some parameter, it is much more difficult to build such a matrix with good estimates, and it is related to Corona Theorem of Carleson. The following result can be found in [1] and is a convenient formulation of the case  $d = 2$  of Uchiyama's Theorem for the annulus.

6. Recall that a trigonometric polynomial  $p_0: \mathbb{T} \rightarrow \mathbb{C}$  has *essential degree* at most  $\ell \geq 1$  if its Fourier coefficients outside an interval of length  $\ell$  are vanishing.

**Theorem 4.38** (see Theorem 2.6, [1]). *Let  $\mathcal{U}_0: \mathbb{T} \rightarrow \mathbb{C}^2$  be an analytic function. Assume that for some  $0 < \delta_1 \leq \delta_2^{-1}$ , we have  $\delta_1 \leq |\mathcal{U}_0(z)| \leq \delta_2^{-1}$  for  $|\Im z| < a$ . Then there exists  $\tilde{Z}: \mathbb{T} \rightarrow \text{SL}(2, \mathbb{C})$  with first column  $\mathcal{U}_0$  and such that  $|\tilde{Z}|_a \leq C\delta_1^{-2}\delta_2^{-1}(1 - \ln \delta_1\delta_2)$ .*

As a consequence of Cauchy formula, Paley-Wiener's Theorem shows that the Fourier coefficients of a function which is analytic on a strip decay exponentially fast. We give here the general statement, although we will only use it for analytic functions on  $\mathbb{T}$ .

**Theorem 4.39** (Paley-Wiener). *Let  $f \in C^\omega(\mathbb{T}^m, \mathbb{R})$  be a real analytic function on the  $m$ -torus  $\mathbb{T}^m := \mathbb{R}^m/\mathbb{Z}^m$ , with Fourier series  $f(x) = \sum_{j \in \mathbb{Z}^m} \hat{f}_j e^{2\pi i \langle j, x \rangle}$ . For  $\delta > 0$ , we denote  $\mathbb{T}^m + \delta := \{z \in \mathbb{C}^m/\mathbb{Z}^m \mid z = z_0 + z_1, z_0 \in \mathbb{T}^m, |z_1| < \delta\}$ . The function  $f$  has a holomorphic extension to a neighbourhood of  $\mathbb{T}^m$  containing  $\overline{\mathbb{T}^m + \delta}$  for some  $\delta > 0$ . Let  $M := \sup_{\overline{\mathbb{T}^m + \delta}} |f|$  be the supremum of  $|f|$  on it. Then,*

$$|\hat{f}_j| \leq M e^{-2\pi\delta|j|}, \quad \forall j \in \mathbb{Z}^m.$$

In the following, we focus on the case where the frequency  $\alpha \in \mathbb{T}$  satisfies  $\beta(\alpha) = 0$ , and we consider an analytic potential  $V \in C_{h_0}^\omega(\mathbb{T}, \mathbb{R})$  for some  $h_0 > 0$ , in the perturbative regime, that is, such that the dual Schrödinger operators are almost localized. We will later generalize these results to the global subcritical regime. Fix an energy  $E \in \Sigma_{V, \alpha}$  located on the boundary of a spectral gap; we will denote the associate matrix by

$$A(x) := S_E^V(x) = \begin{pmatrix} E - V(x) & 1 \\ 1 & 0 \end{pmatrix}.$$

For such an energy, the associate Schrödinger cocycle can be reduced to a constant parabolic cocycle. We will prove here a quantitative version of this fact; more precisely, we show that the off-diagonal coefficient of the parabolic matrix is exponentially small in terms of the label of the gap, while we also have a good control on the size of the conjugacy. These estimates follow from lower bounds on the Bloch waves intervening in the definition of the conjugacies. In particular, we will use the fact that these are not too small with respect to the label of the gap. It is important to note that the (implicit) constants that appear in the following are independent of the spectral gap we work with; it is a consequence of the uniformity of the constants obtained by almost localization.

The ideas here are based on the methods developed in [7] and [1]. In a first time, we use the parametrization by some auxiliary phase  $\theta(E)$ , and the estimates we get involve its last resonance. We then show how they can be translated in terms of the label of the spectral gap we consider. Our main statement in the following.

**Proposition 4.40.** *Let  $c_0, k_0 > 0$  be the absolute constants appearing in the statement of Theorem 4.14. If there exists  $0 < \epsilon < \min(1, h_0)$  such that  $|V|_\epsilon \leq c_0 \epsilon^{k_0}$ , or, in the almost Mathieu case, if  $V = 2\lambda \cos(2\pi \cdot)$ , with  $|\lambda| < 1$ , then for any  $E \in \Sigma_{V, \alpha}$  satisfying  $\rho(E) = \langle k \rangle$  for some  $k \in \mathbb{Z} \setminus \{0\}$ , the following assertions hold.*

- 1) *There exist  $\theta = \theta(E) = \langle n \rangle$ , for some  $n = n(k) \in \mathbb{Z}$ , and  $\hat{u} = (\hat{u}_j)_{j \in \mathbb{Z}}$ , with  $\hat{u}_0 = 1$  and  $|\hat{u}_j| \leq C_1 e^{-\epsilon_1 |j|}$  for constants  $C_1, \epsilon_1 > 0$  independent of  $E$  (hence of  $k$ ), such that  $\hat{H}_{V, \alpha, \theta} \hat{u} = E \hat{u}$ .*
- 2) *There exist a map  $U \in C^\omega(\mathbb{T}, \text{PSL}(2, \mathbb{R}))$  and a real number  $\varphi \in \mathbb{R}$  such that*

$$U(x + \alpha)^{-1} S_E^V(x) U(x) = \begin{pmatrix} 1 & \varphi \\ 0 & 1 \end{pmatrix}, \quad \forall x \in \mathbb{T}, \quad (4.1)$$

*with  $|\varphi| \leq C_2 e^{-c|n|}$ ,  $|U|_{\mathbb{T}} \leq e^{o(|n|)}$ , for some constants  $c, C_2 > 0$  independent of  $E$ . Moreover, set  $\delta_0 := \min(\frac{1}{2\pi} \epsilon_1, h_0)/4 > 0$ ; note that  $\delta_0$  is uniform in  $E$ . In the case of the almost Mathieu operator, i.e.,  $H_{2\lambda \cos(2\pi \cdot), \alpha, \theta}$ ,  $|\lambda| < 1$ , we can take  $\delta_0 := -\frac{1}{8\pi} \ln |\lambda|$ . Then,  $U$  is analytic on the strip  $\{|\Im z| < \delta_0\}$ , and for any  $0 < \delta' < \delta \leq \delta_0$ , there exists a constant  $C_3 = C_3(\delta, \delta') > 0$  independent of  $E$*

satisfying  $|U|_{\delta'} \leq C_3 e^{3\pi\delta|n|}$  and  $|\varphi|_{\delta'} \leq C_3 e^{6\pi\delta|n|}$ , where  $\varphi|_{\mathbb{T}} \equiv \varphi$ , and

$$U(z + \alpha)^{-1} S_E^V(z) U(z) = \begin{pmatrix} 1 & \varphi(z) \\ 0 & 1 \end{pmatrix}, \quad |\Im z| < \delta_0. \quad (4.2)$$

3) We have  $|\deg(U)| = |k| \leq C_4 |n|$  for some constant  $C_4 > 0$  independent of  $E$ .

PROOF OF 1). From Theorem 3.3 in [7], we know that there exist some phase  $\theta = \theta(E) \in \mathbb{R}$  and a bounded solution  $\hat{u}$  to  $\hat{H}_{V,\alpha,\theta} \hat{u} = E \hat{u}$  with  $\hat{u}_0 = 1$  and  $|\hat{u}_j| \leq 1, \forall j \in \mathbb{Z}$ .

Moreover, by Theorem 4.14, if for some  $0 < \epsilon < \min(1, h_0)$ , we have  $|V|_{\epsilon} \leq c_0 \epsilon^{k_0}$ , then the operator  $\hat{H}_{V,\alpha,\theta}$  is almost localized.

Now, let us show that  $\theta(E) = \langle n \rangle$  for some  $n \in \mathbb{Z}$ . Indeed, if  $\theta(E)$  were resonant, then by Theorem 4.2 in [7],  $\rho(\alpha, S_E^V)$  would be resonant as well. But we know that  $\rho(\alpha, S_E^V) = \langle k \rangle$  is not resonant; indeed, its last resonance is equal to  $k$ . We deduce that  $\theta(E)$  is non-resonant, hence by Remark 4.2 in [7], there exists  $l \in \mathbb{Z}$  such that  $\theta(E) = \pm \rho(\alpha, S_E^V) + \langle l \rangle = \langle \pm k + l \rangle$ , and we take  $n := \pm k + l \in \mathbb{Z}$ .

Let us fix some small  $\epsilon_0 > 0$ , and denote by  $\{n_j\}_{0 \leq j \leq J}$  the set of  $\epsilon_0$ -resonances of  $\theta$ , with  $n_J = n$ . Since  $\theta$  is non-resonant, in view of Remark 3.3 in [7], the almost localized sequence  $(\hat{u}_j)_j$  is actually localized, i.e.,

$$|\hat{u}_j| \leq C_1 e^{-\epsilon_1 |j|}, \quad \forall j \in \mathbb{Z}. \quad (4.3)$$

Moreover, as in the definition of almost reducibility, the constants  $C_1, \epsilon_1 > 0$  can be taken uniform in  $E$ ; in particular, they do not depend on the integer  $k$ .  $\square$

PROOF OF 2). We fix  $0 < h < \min(\frac{1}{2\pi} \epsilon_1, h_0)$ , where  $\epsilon_1 > 0$  is taken as in 1). For  $A := S_E^V$ , it is shown in [1] that for any  $\delta > 0$ , there exists a constant  $C = C(\delta) > 0$  independent of  $E$  such that

$$\sup_{|\Im z| < h} |\mathcal{A}_m(z)| \leq C e^{\delta |m|}, \quad \forall m \in \mathbb{Z}. \quad (4.4)$$

Moreover, by (4.3), the  $\hat{u}_j$ 's can be regarded as the Fourier coefficients of a function  $u: x \mapsto \sum_{j \in \mathbb{Z}} \hat{u}_j e^{2\pi i j x}$ , which is analytic on the strip  $\{|\Im z| < h\}$ . We also define the Bloch wave  $\mathcal{U}: x \mapsto \begin{pmatrix} e^{2\pi i \theta} u(x) \\ u(x - \alpha) \end{pmatrix}$ ; it behaves nicely under application of the cocycle:

$$A(x) \cdot \mathcal{U}(x) = e^{2\pi i \theta} \mathcal{U}(x + \alpha), \quad \forall x \in \mathbb{T}.$$

Let  $\tilde{\theta} := \theta - \langle n \rangle$ , so that  $\tilde{\theta} \in \mathbb{Z}$ , and define  $\tilde{\mathcal{U}}(x) := e^{\pi i n x} \mathcal{U}(x)$ . We thus obtain

$$A(x) \cdot \tilde{\mathcal{U}}(x) = e^{2\pi i \tilde{\theta}} \tilde{\mathcal{U}}(x + \alpha) = \tilde{\mathcal{U}}(x + \alpha), \quad \forall x \in \mathbb{T}.$$

We set  $S := \Re(\tilde{\mathcal{U}})$  and  $T := \Im(\tilde{\mathcal{U}})$ ; then for any  $x \in \mathbb{T}$ , we get

$$A(x) \cdot S(x) = S(x + \alpha), \quad A(x) \cdot T(x) = T(x + \alpha). \quad (4.5)$$

Let  $(p_i/q_i)_i$  denote the sequence of best approximants of  $\alpha$ . Let  $N \geq |n|$  be an integer, and choose  $\ell$  and  $1 \leq r \leq \lfloor q_{\ell+1}/q_{\ell} \rfloor$  such that  $r q_{\ell} - 1 = N < q_{\ell+1}$ . We denote  $I := [-\lfloor N/2 \rfloor, N - \lfloor N/2 \rfloor]$ , and we consider the function  $u^I: x \mapsto \sum_{j \in I} \hat{u}_j e^{2\pi i j x}$ ; we define  $\mathcal{U}^I, \tilde{\mathcal{U}}^I, S^I, T^I$  accordingly. Since  $\mathcal{U}^I$  is obtained from  $\mathcal{U}$  by truncating high frequency Fourier modes, we deduce from (4.3) that for  $0 \leq \delta < h$ ,

$$|\mathcal{U} - \mathcal{U}^I|_{\delta} = O(e^{-\pi(h-\delta)N}), \quad |\tilde{\mathcal{U}} - \tilde{\mathcal{U}}^I|_{\delta} = O(e^{-\pi(h-2\delta)N}). \quad (4.6)$$

Given any analytic function  $f$  defined on the strip  $\{|\Im z| < h\}$ , any  $t \in \mathbb{R}$  such that  $|t| < h$ , we let  $f_t$  be the function defined on  $\mathbb{T}$  by  $f_t: x \mapsto f(x + it)$ .

Take  $t \in \mathbb{R}$  such that  $|t| \leq h/2$ . By (4.6), we thus get

$$\left| \int_{\mathbb{T}} \mathcal{U}_t^I(x) dx \right| \geq \left| \int_{\mathbb{T}} \mathcal{U}_t(x) dx \right| - O(e^{-\pi h N/2}) \gtrsim 2/3, \quad (4.7)$$

since  $\int_{\mathbb{T}} u_t = \hat{u}_0 = 1$ . Recall that  $S_t^I + iT_t^I = e^{\pi i n(\cdot + it)} \mathcal{U}_t^I$ . Similarly, we have

$$\left| \int_{\mathbb{T}} e^{-\pi i n(x+it)} (S_t^I(x) + iT_t^I(x)) dx \right| \geq \left| \int_{\mathbb{T}} \mathcal{U}_t(x) dx \right| - O(e^{-\pi h N/2}) \gtrsim 2/3.$$

Therefore, for any  $t \in \mathbb{R}$  such that  $0 \leq \delta := |t| \leq h/2$ , we obtain

$$\max\left(\int_{\mathbb{T}} |S_t^I(x)| dx, \int_{\mathbb{T}} |T_t^I(x)| dx\right) \gtrsim e^{-\pi\delta|n|}/3 \geq e^{-\pi h|n|/2}/3. \quad (4.8)$$

Let us denote by  $(\hat{v}_j)_{j \in \mathbb{Z}}$  the Fourier coefficients of  $V$ . It is possible to see that

$$A(z) \cdot \mathcal{U}^I(z) - e^{2\pi i\theta} \mathcal{U}^I(z + \alpha) = e^{2\pi i\theta} \begin{pmatrix} g(z) \\ 0 \end{pmatrix}, \quad (4.9)$$

where the Fourier coefficients  $(\hat{g}_j)_{j \in \mathbb{Z}}$  of the function  $g: \mathbb{T} \rightarrow \mathbb{C}$  satisfy

$$\hat{g}_j = \chi_I(j) (E - 2 \cos(2\pi(\theta + j\alpha))) \hat{u}_j - \sum_{l \in \mathbb{Z}} \chi_I(j-l) \hat{u}_{j-l} \hat{v}_l.$$

Since  $\hat{H}\hat{u} = E\hat{u}$ , we then get

$$-\hat{g}_j = \chi_{\mathbb{Z} \setminus I}(j) (E - 2 \cos(2\pi(\theta + j\alpha))) \hat{u}_j - \sum_{l \in \mathbb{Z}} \chi_{\mathbb{Z} \setminus I}(j-l) \hat{u}_{j-l} \hat{v}_l. \quad (4.10)$$

Since  $\tilde{\mathcal{U}}^I(z) = e^{\pi i n z} \mathcal{U}^I(z)$ , (4.9) yields

$$A(z) \cdot \tilde{\mathcal{U}}^I(z) = \tilde{\mathcal{U}}^I(z + \alpha) + e^{2\pi i\theta} \begin{pmatrix} e^{\pi i n z} g(z) \\ 0 \end{pmatrix}. \quad (4.11)$$

By (4.3), and since the  $\hat{v}_l$ 's also decay exponentially fast by analyticity of  $V$  on the strip  $\{|\Im z| < h_0\}$ , we deduce from (4.10) that  $g$  is analytic on the strip  $\{|\Im z| < h\}$ ; moreover, for any  $0 \leq \delta \leq h/4$ , we have

$$\begin{aligned} |e^{\pi i n z} g(z)|_\delta &\lesssim e^{\pi\delta|n|} \left( \sum_{j \in \mathbb{Z}} \chi_{\mathbb{Z} \setminus I}(j) e^{-(\epsilon_1 - 2\pi\delta)|j|} + \sum_{j, l \in \mathbb{Z}} \chi_{\mathbb{Z} \setminus I}(j-l) e^{-(\epsilon_1 - 2\pi\delta)|j-l|} e^{-2\pi(h-\delta)|l|} \right) \\ &\lesssim e^{\pi\delta|n|} e^{-\pi(h-\delta)N} \left( 1 + \sum_{l \in \mathbb{Z}} e^{-2\pi(h-\delta)|l|} \right) \\ &\leq e^{-\pi h N/2} \left( 1 + \sum_{l \in \mathbb{Z}} e^{-\pi h|l|} \right). \end{aligned}$$

Combining the previous estimates with (4.11), we obtain for  $\mathcal{V}^I = S^I, T^I$ :

$$A(z) \cdot \mathcal{V}^I(z) = \mathcal{V}^I(z + \alpha) + O(e^{-\pi h N/2}), \quad |\Im z| < h/4, \quad (4.12)$$

while by (4.9), we have

$$A(z) \cdot \mathcal{U}^I(z) = e^{2\pi i\theta} \mathcal{U}^I(z + \alpha) + O(e^{-\pi h N/2}), \quad |\Im z| < h/4. \quad (4.13)$$

Let  $\tilde{\mathcal{V}}^I = \mathcal{U}^I, S^I$  or  $T^I$ . Since  $\tilde{\mathcal{V}}^I$  has essential degree at most  $N$ , by Theorem 4.37, there exists an absolute constant  $C_0 > 0$  such that for any  $x \in \mathbb{T}$  and any  $t \in \mathbb{R}$ ,  $|t| < h$ :

$$\begin{aligned} |\tilde{\mathcal{V}}_t^I|_{\mathbb{T}} &\leq C_0 q_{\ell+1}^{C_0 r} \sup_{0 \leq j \leq N} |\tilde{\mathcal{V}}_t^I(x + j\alpha)| \\ &\leq C_0 e^{o(N)} \sup_{0 \leq j \leq N} |\tilde{\mathcal{V}}_t^I(x + j\alpha)|. \end{aligned} \quad (4.14)$$

Indeed,  $\beta(\alpha) = 0$  implies that  $q_{\ell+1}^r = e^{o(rq_\ell)} = e^{o(N)}$  by the definition of  $r$  and  $\ell$ .

Using complex conjugacies, we first refine the previous estimate (4.4) on the growth of the cocycle, following the argument given by Avila in Theorem 3.4 of [1].

**Claim** (Improved estimates). *We have the following estimate:*

$$|\mathcal{A}_m|_{h/4} \leq \tilde{C} |m|^{\tilde{C}}, \quad \forall m \in \mathbb{N}, \quad (4.15)$$

for some constant  $\tilde{C} > 0$  uniform in  $E$ .

**PROOF OF THE CLAIM.** We follow [1]. Combining (4.4), (4.7), (4.13) and (4.14) for the trigonometric polynomial  $\mathcal{U}^I$ , we obtain, for some small constants  $\tilde{c} > 0$ ,  $\tilde{\delta}_1 \in (0, \pi h/100)$ :

$$\inf_{|\Im z| < h/4} |\mathcal{U}^I(z)| \geq \tilde{c} e^{-\tilde{\delta}_1 N}.$$

By (4.3), and by the definition of  $\mathcal{U}^I$ , we also know that  $\mathcal{U}^I$  is uniformly upper bounded on the strip  $\{|\Im z| < h/4\}$ . Therefore, Theorem 4.38 gives a map  $\tilde{Z}: \mathbb{T} \rightarrow \mathrm{SL}(2, \mathbb{C})$  with first column  $\mathcal{U}^I$  and with good estimates on the strip  $\{|\Im z| < h/4\}$ , such that (see (4.13))

$$\tilde{Z}(z + \alpha)^{-1} A(z) \tilde{Z}(z) = \begin{pmatrix} e^{2\pi i \theta} & 0 \\ 0 & e^{-2\pi i \theta} \end{pmatrix} + \begin{pmatrix} \beta_1(z) & b(z) \\ \beta_3(z) & \beta_4(z) \end{pmatrix}, \quad |\Im z| < h/4,$$

where  $|\tilde{Z}|_{h/4} \leq \tilde{D}_1 e^{3\tilde{\delta}_1 N}$ ,  $|b|_{h/4} \leq \tilde{D}_1 e^{5\tilde{\delta}_1 N}$  and  $|\beta_1|_{h/4}, |\beta_3|_{h/4}, |\beta_4|_{h/4} \leq \tilde{D}_1 e^{-\pi h N/2}$  for some uniform constant  $\tilde{D}_1 > 0$ . Let  $\tilde{\mathcal{D}} := \begin{pmatrix} d & 0 \\ 0 & d^{-1} \end{pmatrix}$ , with  $d^2 := e^{\pi h N/4}$ . Letting  $\tilde{\Phi} := \tilde{Z} \tilde{\mathcal{D}}$ , we obtain:

$$\tilde{\Phi}(z + \alpha)^{-1} A(z) \tilde{\Phi}(z) = \begin{pmatrix} e^{2\pi i \theta} & 0 \\ 0 & e^{-2\pi i \theta} \end{pmatrix} + \tilde{Q}(z), \quad |\Im z| < h/4,$$

where  $|\tilde{\Phi}|_{h/4} \leq \tilde{D}_1 e^{\pi h N/2}$  and  $|\tilde{Q}|_{h/4} \leq \tilde{D}_1 e^{-\pi h N/10}$ . From this, we deduce that for some constant  $\tilde{D}_2 > 0$ :

$$\sup_{0 \leq s \leq e^{\pi h N/100}} |\mathcal{A}_s|_{h/4} \leq \tilde{D}_2 e^{2\pi h N}.$$

Since  $N$  can be taken arbitrarily large, we conclude by taking  $N = \Theta(\ln m)$ .  $\square$

In the following, we focus on *real* conjugacies and we restrict ourselves to the case where  $N := |n|$ . Then, arguing as previously, but with the improved estimates on the growth of  $(\alpha, A)$  given by the claim, by combining (4.8), (4.12), (4.14) and (4.15), the following lower bound holds:

$$\max(\inf_{x \in \mathbb{T}} |S^I(x)|, \inf_{x \in \mathbb{T}} |T^I(x)|) \geq e^{-o(|n|)}, \quad (4.16)$$

where the implicit constant does not depend on  $E$ .

Now, set  $\delta_0 := h/4 > 0$ . Note that the constant  $\delta_0$  is uniform in  $E$ . Let  $0 < \delta \leq \delta_0$ . We claim that there exists a constant  $\tilde{C}_\delta > 0$  such that for any  $t \in \mathbb{R}$ ,  $|t| \leq \delta$ , we have

$$\max(\inf_{x \in \mathbb{T}} |S_t^I(x)|, \inf_{x \in \mathbb{T}} |T_t^I(x)|) \geq \tilde{C}_\delta e^{-\pi \delta |n|}. \quad (4.17)$$

Indeed, if it is not true, then for any constant  $\tilde{C}' > 0$ , there exist  $t \in \mathbb{R}$ ,  $|t| \leq \delta$ ,  $x_1, x_2 \in \mathbb{T}$  such that  $|S_t^I(x_1)|, |T_t^I(x_2)| \leq \tilde{C}' e^{-\pi \delta |n|}$ . Then, if  $\tilde{C}'$  is chosen sufficiently small, (4.12), (4.14) and (4.15) imply that

$$|S_t^I|_{\mathbb{T}}, |T_t^I|_{\mathbb{T}} \leq e^{-\pi \delta |n|}/5,$$

which contradicts (4.8). Therefore, we can choose an analytic function  $\chi: [-\delta_0, \delta_0] \rightarrow [0, 1]$  such that letting  $\mathcal{W}^I(x + it) := \chi(t)S_t^I(x) + (1 - \chi(t))T_t^I(x)$  for any  $(x, t) \in \mathbb{T} \times [-\delta_0, \delta_0]$ , then the map  $\mathcal{W}^I$  has the following properties. For any  $0 < \delta \leq \delta_0$ , there exists a constant  $\tilde{C}'_\delta > 0$  such that

$$\inf_{|\Im z| < \delta} |\mathcal{W}^I(z)| \geq \tilde{C}'_\delta e^{-\pi \delta |n|}. \quad (4.18)$$

We then define  $\mathcal{W}: x + it \mapsto \chi(t)S_t(x) + (1 - \chi(t))T_t(x)$ . From (4.6), we get

$$|\mathcal{W} - \mathcal{W}^I|_\delta = O(e^{-\pi(h-2\delta)|n|}) = O(e^{-2\pi \delta |n|}). \quad (4.19)$$

Therefore, we deduce from (4.5), (4.16) and (4.19) that the map  $\mathcal{W}$  satisfies:

$$A(z) \cdot \mathcal{W}(z) = \mathcal{W}(z + \alpha), \quad (4.20)$$

$$\inf_{x \in \mathbb{T}} |\mathcal{W}(x)| \geq e^{-o(|n|)}, \quad (4.21)$$

while, by (4.18), we also have that for some constant  $C_\delta > 0$ , uniform in  $E$ ,

$$\inf_{|\Im z| < \delta} |\mathcal{W}(z)| \geq C_\delta e^{-\pi \delta |n|}. \quad (4.22)$$

Let  $R_{1/4}$  denote the rotation  $(x, y) \mapsto (-y, x)$ . Since  $\mathcal{W}$  does not vanish, we can define  $U^{(1)} \in C_{\delta_0}^\omega(\mathbb{T}, \mathrm{PSL}(2, \mathbb{R}))$  as follows:

$$U^{(1)}(z) := \begin{pmatrix} \mathcal{W}(z) & R_{1/4} \frac{\mathcal{W}(z)}{|\mathcal{W}(z)|^2} \end{pmatrix}. \quad (4.23)$$



By (4.20), we thus obtain

$$U^{(1)}(z + \alpha)^{-1}A(z)U^{(1)}(z) = \begin{pmatrix} 1 & \varphi^{(1)}(z) \\ 0 & 1 \end{pmatrix},$$

with  $\varphi^{(1)} \in C_{\delta_0}^\omega(\mathbb{T}, \mathbb{R})$  given by  $\varphi^{(1)}(z) := \frac{\mathcal{W}(z+\alpha)^T}{|\mathcal{W}(z+\alpha)|^2}A(z)R_{1/4}\frac{\mathcal{W}(z)}{|\mathcal{W}(z)|^2}$ .

By (4.21) and by the formula giving  $\varphi^{(1)}$ , we deduce that  $|\varphi^{(1)}|_{\mathbb{T}} \leq e^{o(|n|)}$ . Besides, for any  $0 < \delta \leq \delta_0$ , it follows from (4.22) that for some uniform constant  $C'_\delta > 0$ , we have the estimate  $|\varphi^{(1)}|_\delta \leq C'_\delta e^{2\pi\delta|n|}$ . We set  $\tilde{C}_2 := C'_{\delta_0} > 0$ .

In view of (4.3), and by the formula giving  $\tilde{U}$ , we also have uniform upper bounds:  $|\mathcal{W}|_{\mathbb{T}} = O(1)$ ,  $|\mathcal{W}|_\delta = O(e^{\pi\delta|n|})$ . Combining this with (4.22) and (4.21), we deduce that for some uniform constant  $\tilde{C}_3 > 0$ ,

$$|U^{(1)}|_{\mathbb{T}} \leq e^{o(|n|)}, \quad |U^{(1)}|_{\delta_0} \leq \tilde{C}_3 e^{\pi\delta_0|n|}. \quad (4.24)$$

Now, since  $\beta(\alpha) = 0$ , we can find a solution  $\phi \in C^\omega(\mathbb{T}, \mathbb{R})$  to the cohomological equation

$$\phi(\cdot + \alpha) - \phi(\cdot) = \varphi^{(1)}(\cdot) - \int_{\mathbb{T}} \varphi^{(1)} \quad (4.25)$$

on  $\mathbb{T}$ , with  $\int_{\mathbb{T}} \phi = 0$ . Indeed, let  $0 < \delta_1 < \delta_2 < \delta_0$ . We obtain a formal solution with Fourier coefficients

$$\hat{\phi}_j = \frac{\hat{\varphi}_j^{(1)}}{e^{2\pi i j \alpha} - 1}, \quad \forall j \in \mathbb{Z} \setminus \{0\}. \quad (4.26)$$

The function  $\varphi^{(1)}$  is analytic on the strip  $\{|\Im z| < \delta_0\}$ . By Paley-Wiener's Theorem (Theorem 4.39), the Fourier coefficients of  $\varphi^{(1)}$  decay exponentially fast. Considering the strip  $\{|\Im z| < \delta_2\}$ , we get the estimate:

$$|\hat{\varphi}_j^{(1)}| \leq |\varphi^{(1)}|_{\delta_0} e^{-2\pi\delta_2|j|} \leq \tilde{C}_2 e^{2\pi\delta_0|n|} e^{-2\pi\delta_2|j|}, \quad \forall j \in \mathbb{Z}. \quad (4.27)$$

For any  $0 < \delta < \delta_0$ , arguing similarly on the strip  $\{|\Im z| < \delta/2\}$ , we also obtain:

$$|\hat{\varphi}_j^{(1)}| \leq |\varphi^{(1)}|_\delta e^{-\pi\delta|j|} \leq C'_\delta e^{2\pi\delta|n|} e^{-\pi\delta|j|}, \quad \forall j \in \mathbb{Z}. \quad (4.28)$$

Recall that  $(p_i/q_i)_i$  denotes the sequence of best approximants of  $\alpha$ . We know that

$$|q_i \alpha|_{\mathbb{T}} = \inf_{1 \leq j \leq q_{i+1} - 1} |j \alpha|_{\mathbb{T}}, \quad \text{and} \quad \frac{1}{2} \leq q_{i+1} |q_i \alpha|_{\mathbb{T}} \leq 1.$$

Since  $\beta(\alpha) = 0$ , we also have  $q_{i+1} \leq e^{o(q_i)}$ . We deduce that for any  $j \in \mathbb{Z} \setminus \{0\}$  with  $q_i \leq |j| \leq q_{i+1} - 1$ ,

$$\left| \frac{1}{e^{2\pi i j \alpha} - 1} \right| \lesssim \frac{1}{|q_i \alpha|_{\mathbb{T}}} \leq 2q_{i+1} = e^{o(|j|)}. \quad (4.29)$$

Combining (4.26), (4.27) and (4.29), we deduce that the function  $\phi: x \mapsto \sum_{j \in \mathbb{Z}} \hat{\phi}_j e^{2\pi i j x}$  is analytic on the strip  $\{|\Im z| < \delta_0\}$ . We see that  $|\phi|_{\delta_1} \leq C(\delta_1, \delta_2) |\varphi^{(1)}|_{\delta_0} \leq C(\delta_1, \delta_2) \tilde{C}_2 e^{2\pi\delta_0|n|}$ , where  $C(\delta_1, \delta_2) := \sum_j \frac{e^{-2\pi(\delta_2 - \delta_1)|j|}}{e^{2\pi i j \alpha} - 1}$ . For any  $0 < \delta < \delta_0$ , set  $\tilde{C}_\delta := C'_\delta \sum_j \frac{e^{-\pi\delta|j|}}{e^{2\pi i j \alpha} - 1}$ . By (4.28), we thus obtain  $|\phi|_{\mathbb{T}} \leq \tilde{C}_\delta e^{2\pi\delta|n|}$ . Since  $\delta$  can be chosen arbitrarily small, we deduce that  $|\phi|_{\mathbb{T}} = e^{o(|n|)}$ .

Therefore, letting  $U(z) := U^{(1)}(z) \begin{pmatrix} 1 & \phi(z) \\ 0 & 1 \end{pmatrix}$ , we finally get

$$U(z + \alpha)^{-1}A(z)U(z) = \begin{pmatrix} 1 & \varphi^{(1)}(z) + \phi(z) - \phi(z + \alpha) \\ 0 & 1 \end{pmatrix}, \quad \forall |\Im z| < \delta_0, \quad (4.30)$$

In particular, by (4.25), we obtain

$$U(x + \alpha)^{-1}A(x)U(x) = \begin{pmatrix} 1 & \varphi \\ 0 & 1 \end{pmatrix}, \quad \forall x \in \mathbb{T}, \quad (4.31)$$

with  $\varphi := \int_{\mathbb{T}} \varphi^{(1)}$ . In view of (4.24), and by the estimates on  $\phi$ , there exists a uniform constant  $\tilde{C}_4 > 0$  such that:

$$|U|_{\mathbb{T}} \leq e^{o(|n|)}, \quad |U|_{\delta_1} \leq \tilde{C}_4 e^{3\pi\delta_0|n|}.$$

Moreover, by Theorem 3.8 in [1] applied here with the choice  $n_j := n$ , so that  $n_{j+1} = +\infty$ , we have

$$\sup_{0 \leq k \leq e^{c|n|}} |\mathcal{A}_k|_{\mathbb{T}} \leq \tilde{C}_5 e^{o(|n|)} \tag{4.32}$$

for certain constants  $c, \tilde{C}_5 > 0$  independent of  $E$ . For any  $j \in \mathbb{N}$ , iterating (4.31), we obtain

$$\begin{pmatrix} 1 & j\varphi \\ 0 & 1 \end{pmatrix} = U(x + j\alpha)^{-1} \mathcal{A}_j(x) U(x), \quad x \in \mathbb{T}.$$

Take  $j := \lfloor e^{c|n|} \rfloor$ . Since  $|U|_{\mathbb{T}}, |U^{-1}|_{\mathbb{T}} \leq e^{o(|n|)}$ , and by (4.32),  $|\mathcal{A}_j|_{\mathbb{T}} \leq \tilde{C}_5 e^{o(|n|)}$ , we conclude that  $|\varphi| e^{c|n|} \leq \tilde{C}_5 e^{o(|n|)}$ , and the desired estimate on  $\varphi$  follows.  $\square$

PROOF OF 3). Let us now estimate the topological degree of the conjugacy map  $U$ . Since  $x \mapsto \begin{pmatrix} 1 & \phi(x) \\ 0 & 1 \end{pmatrix}$  is homotopic to the identity, it is enough to estimate  $\deg(U^{(1)})$ . For this, we look at the degree of its first column  $\mathcal{W}$ , seen as a map  $\mathcal{W} : \mathbb{T} \rightarrow \mathbb{R}^2 \setminus \{0\}$ . Recall that

$$\inf_{x \in \mathbb{T}} |\mathcal{W}(x)| \geq e^{-o(|n|)}. \tag{4.33}$$

Consider the Fourier expansion  $\mathcal{W}(x) = \sum_{j \in \mathbb{Z}} \hat{\mathcal{W}}_j e^{2\pi i j x}$  of  $\mathcal{W}$ , and its truncation  $\tilde{\mathcal{W}}(x) := \sum_{|j| \leq j_0} \hat{\mathcal{W}}_j e^{2\pi i j x}$  for some integer  $j_0 \in \mathbb{N}$  to be determined. By localization estimates, and from the definition of  $\mathcal{W}$ , we have  $|\hat{\mathcal{W}}_j| = O(e^{-\epsilon_1(|j| - |n|)})$ . Hence,  $|\tilde{\mathcal{W}} - \mathcal{W}|_{\mathbb{T}} \lesssim e^{-\epsilon_1(j_0 - |n|)}$ . Comparing with (4.33), for some uniform constant  $\tilde{C}_6 > 0$ , we can choose  $j_0 \leq \tilde{C}_6 |n|$  such that

$$|\tilde{\mathcal{W}}(x) - \mathcal{W}(x)| \leq |\mathcal{W}(x)|, \quad \forall x \in \mathbb{T}.$$

By Rouché’s theorem, we deduce that  $\deg(\mathcal{W}) = \deg(\tilde{\mathcal{W}})$ . Consider a coordinate of  $\tilde{\mathcal{W}}$  which is not identically vanishing. It is a trigonometric polynomial of degree less than  $\tilde{C}_6 |n|$ , so it has at most  $\tilde{C}_6 |n|$  zeros in  $\mathbb{T}$ , and we conclude that  $|\deg(\mathcal{W})| \leq \tilde{C}_6 |n|$ . Hence  $|\deg(U)| \leq \tilde{C}_6 |n|$ .

Recall that  $\rho(E) = \langle k \rangle$  and  $\theta(E) = \langle n \rangle$ . By (4.1), the upper bound on  $\deg(U)$ , and formula (2.4), we obtain a link between the parametrization by the last resonance  $n$  of  $\theta$  and the label  $k$ , i.e.,  $|k| \leq \tilde{C}_6 |n|$ .  $\square$

**4.1. Remarks on the two methods.** The first method explained in Section 3 is of perturbative type, and deals with perturbations of constant cocycles; it can be applied to general quasi-periodic cocycles taking values in  $\text{SL}(2, \mathbb{R})$ . Note that it also works for a higher dimensional base. In this KAM scheme, we encounter certain resonant steps, which are related to the rotation number of the cocycle we start with.

The second method detailed in Section 4 is non-perturbative and works only in the case of one-dimensional quasi-periodic Schrödinger cocycles. Indeed, it is based on Aubry duality, and it uses almost localization of a dual Schrödinger operator to get quantitative estimates on the conjugacy and on the parabolic cocycle obtained after reduction. As in the first method, we have to deal with resonances, but here, in terms of an auxiliary parameter  $\theta$ . But as we have seen, this phase can be related to the rotation number of the spectral gap we consider.

### 5. Global to local reduction

In this part, we extend to the subcritical regime the reducibility result which was obtained above in the case of small potentials. Let us first recall the following precise version of Theorem 4.20 stated above.

**Theorem 4.41** (Avila, [5]). *Let  $\alpha \in \mathbb{R} \setminus \mathbb{Q}$ . For a (measure-theoretically) typical  $V \in C^\omega(\mathbb{T}, \mathbb{R})$ , there exist  $k \geq 1$  and a collection of points  $a_1 < b_1 < \dots < a_k < b_k$  in the spectrum  $\Sigma_{V, \alpha}$  such that  $\Sigma_{V, \alpha} \subset \cup_{i=1}^k [a_i, b_i]$  and such that energies alternate between supercritical and subcritical along the sequence  $\{\Sigma_{V, \alpha} \cap [a_i, b_i]\}_i$ . Moreover, for each*

$i = 1, \dots, k$ ,  $\Sigma_{V,\alpha} \cap [a_i, b_i]$  is a compact set that depends continuously (in the Hausdorff topology) on  $(\alpha, V)$ .

Let  $\alpha \in \mathbb{R} \setminus \mathbb{Q}$ . Throughout this section, we consider a potential  $V \in C^\omega(\mathbb{T}, \mathbb{R})$  for which  $\Sigma_{V,\alpha}$  presents the above structure. We denote by  $\{I_i\}_{1 \leq i \leq m}$  the intervals such that the energies in  $\Sigma_{V,\alpha} \cap I_i$  are subcritical, and by  $\{J_j\}_{1 \leq j \leq m'}$  (the number  $m'$  of intervals can be  $m-1$ ,  $m$  or  $m+1$ ) the intervals such that the energies in  $\Sigma_{V,\alpha} \cap J_j$  are supercritical.

Let  $\Sigma_{V,\alpha}^{\text{sub}} := \cup_i (\Sigma_{V,\alpha} \cap I_i)$  and  $\Sigma_{V,\alpha}^{\text{sup}} := \cup_j (\Sigma_{V,\alpha} \cap J_j)$ . Following the remark in [5], we have *spectral uniformity*, i.e., there exists  $L_0 > 0$  such that for any  $E \in \Sigma_{V,\alpha}^{\text{sup}}$ ,  $L(E) \geq L_0$ . By spectral uniformity, finiteness of the number of transitions between subcritical and supercritical regimes, and continuity of the Lyapunov exponent, there exists  $\chi > 0$  such that  $\text{dist}(\Sigma^{\text{sub}}, \Sigma^{\text{sup}}) > \chi$ . Indeed, the distance between  $\Sigma^{\text{sub}}$  and  $\Sigma^{\text{sup}}$  is realized by certain spectral gaps.

From now on, we focus on the subcritical regime, i.e.,  $E \in \Sigma_{V,\alpha} \cap I_i$  for some fixed  $1 \leq i \leq m$ . Let us stress that by Theorem 4.41, the set  $\Sigma_{V,\alpha} \cap I_i$  is compact. This fact is crucial for the whole proof.

By Theorem 4.23 and the definition of almost reducibility, we have

**Proposition 4.42.** *Let  $\alpha \in \mathbb{R} \setminus \mathbb{Q}$  satisfying  $\beta(\alpha) = 0$ . There exists  $h_1 = h_1(V) > 0$ , such that for any  $\eta > 0$ , there exists  $\Gamma = \Gamma(V, \eta, h_1) > 0$  such that for every  $E \in \Sigma_{V,\alpha}^{\text{sub}}$ , one can find  $\Phi_E \in C_{h_1}^\omega(\mathbb{T}, \text{PSL}(2, \mathbb{R}))$  with  $|\Phi_E|_{h_1} < \Gamma$ ,  $R_{\phi(E)} \in \text{SO}(2, \mathbb{R})$  for some  $\phi(E) \in \mathbb{T}$ , and  $F_E \in C_{h_1}^\omega(\mathbb{T}, \mathfrak{gl}(2, \mathbb{R}))$  with  $|F_E|_{h_1} \leq \eta$ , such that*

$$\Phi_E(x + \alpha)^{-1} S_E^V(x) \Phi_E(x) = R_{\phi(E)} + F_E, \quad \forall x \in \mathbb{T}. \quad (5.1)$$

**Remark 4.43.** *The crucial fact in this result is that we can choose  $h_1$  to be independent of  $E$  and  $\eta$ , and choose  $\Gamma$  to be independent of  $E$ .*

PROOF. In view of Theorem 4.23, we deduce that for any  $E \in \Sigma_{V,\alpha} \cap I_i$ ,  $1 \leq i \leq m$ , the cocycle  $(\alpha, S_E^V)$  is almost reducible, i.e., there exists  $h = h(E, V) > 0$  such that for any  $\eta > 0$ , there exist  $\Phi_E^{(1)} \in C^\omega(\mathbb{T}, \text{PSL}(2, \mathbb{R}))$  and  $A_E \in \text{SL}(2, \mathbb{R})$  with  $|A_E| \leq 1$ , such that

$$|\Phi_E^{(1)}(\cdot + \alpha)^{-1} S_E^V(\cdot) \Phi_E^{(1)}(\cdot) - A_E|_h < \eta^2. \quad (5.2)$$

Moreover, since  $(\alpha, S_E^V)$  is subcritical and thus not uniformly hyperbolic, arguing as in the Claim appearing in Corollary 4.2 in [54], we see that it is possible to choose  $A_E = R_{\phi(E)} \in \text{SO}(2, \mathbb{R})$  for some  $\phi(E) \in \mathbb{T}$ , and  $\Phi_E^{(2)} \in C^\omega(\mathbb{T}, \text{PSL}(2, \mathbb{R}))$  satisfying

$$|\Phi_E^{(2)}(\cdot + \alpha)^{-1} S_E^V(\cdot) \Phi_E^{(2)}(\cdot) - R_{\phi(E)}|_h < \frac{\eta}{2}. \quad (5.3)$$

Note that by the construction given in [54], we can take  $\Phi_E^{(2)} := \begin{pmatrix} \eta^{\frac{1}{2}} & 0 \\ 0 & \eta^{-\frac{1}{2}} \end{pmatrix} \Phi_E^{(1)}$  if  $A_E$

is parabolic, say  $A_E = \begin{pmatrix} 1 & c \\ 0 & 1 \end{pmatrix}$  for some  $c \in \mathbb{R}$ . Otherwise we take  $\Phi_E^{(2)} := \Phi_E^{(1)}$ .

As a consequence, for any  $E' \in \mathbb{R}$  and any  $x \in \mathbb{T}$ , one has

$$|\Phi_E^{(2)}(\cdot + \alpha)^{-1} S_{E'}^V(\cdot) \Phi_E^{(2)}(\cdot) - R_{\phi(E)}|_{h(E,V)} < \frac{\eta}{2} + |E - E'| \times |\Phi_E^{(2)}|_{h(E,V)}^2. \quad (5.4)$$

It follows that with the same  $\Phi_E^{(2)}$ , we have  $|\Phi_E^{(2)}(x + \alpha)^{-1} S_{E'}^V(x) \Phi_E^{(2)}(x) - R_{\phi(E)}|_{h(E,V)} < \eta$  for any energy  $E'$  in a neighborhood  $\mathcal{U}(E)$  of  $E$ . Therefore, the same conjugacy  $\Phi_E^{(2)}$  works for any  $E' \in \mathcal{U}(E)$ .

By compactness of  $\Sigma_{V,\alpha} \cap I_i$ , we can cover it with finitely many open intervals  $\mathcal{U}(E_{i_1}^i), \dots, \mathcal{U}(E_{i_l}^i)$  as above. Then, for any  $E \in \Sigma_{V,\alpha} \cap I_i$  we choose  $1 \leq k \leq l$  such that  $E \in \mathcal{U}(E_{i_k}^i)$ , and we set  $\Phi_E := \Phi_{E_{i_k}^i}$ . We thus obtain  $h_1 = h_1(V)$  and  $\Gamma = \Gamma(V, \eta)$ , both independent of  $E$ , such that for any  $E \in \Sigma_{V,\alpha} \cap I_i$ , we have  $\Phi_E \in C_{h_1}^\omega(\mathbb{T}, \text{PSL}(2, \mathbb{R}))$ ,

$|\Phi_E|_{h_1(V)} < \Gamma$ , and

$$\Phi_E(\cdot + \alpha)^{-1} S_E^V(\cdot) \Phi_E(\cdot) = R_{\phi(E)} + F_E$$

for some  $F_E \in C_{h_1}^\omega(\mathbb{T}, \mathfrak{gl}(2, \mathbb{R}))$  satisfying  $|F_E|_{h_1(V)} \leq \eta$ .  $\square$

As a consequence of Proposition 4.42, one can easily generalize the results of Corollary 4.35 and Proposition 4.40 to the global subcritical regime for quasi-periodic Schrödinger operators.

In particular, for the almost Mathieu operator  $H_{2\lambda \cos(2\pi \cdot), \alpha, \theta}$  with  $0 < |\lambda| < 1$ , any energy in the spectrum is subcritical, hence we obtain the following corollary.

**Corollary 4.44.** *For  $\alpha \in \text{DC}(K, \tau)$  and  $0 < |\lambda| < 1$ , there exists  $0 < h < -\frac{1}{2\pi} \ln |\lambda|$  such that if  $E \in \Sigma_{2\lambda \cos(2\pi \cdot), \alpha}$  satisfies  $\rho(\alpha, S_E^{2\lambda \cos(2\pi \cdot)}) = \langle k \rangle$  for some  $k \in \mathbb{Z} \setminus \{0\}$ , then for any  $0 < h' < h$ , there exist  $\kappa = \kappa(k) \in \mathbb{R}$  and  $Z = Z(k) \in C_{h'}^\omega(\mathbb{T}, \text{PSL}(2, \mathbb{R}))$  such that*

$$Z(x + \alpha)^{-1} S_E^{2\lambda \cos(2\pi \cdot)}(x) Z(x) = \begin{pmatrix} 1 & \kappa \\ 0 & 1 \end{pmatrix}, \quad \forall x \in \mathbb{T}, \quad (5.5)$$

and for certain constants  $D = D(K, \tau, d) > 0$ ,  $D' = D'(K, \tau, d, h, h') > 0$ ,  $\tilde{\zeta} = \tilde{\zeta}(\tau, h) > 0$ ,  $\zeta' = \zeta'(K, \tau, d, h, h') > 0$ , we have the estimates:

$$|Z|_{h'} \leq D e^{\tilde{\zeta}|k|}, \quad |\kappa| \leq D' e^{-\zeta'|k|}.$$

PROOF. By Theorems 4.21 and 4.22, we know that if  $E \in \Sigma_{2\lambda \cos(2\pi \cdot), \alpha}$ , then  $(\alpha, S_E^{2\lambda \cos(2\pi \cdot)})$  is subcritical in the regime  $|\Im z| < -\frac{1}{2\pi} \ln |\lambda|$ . Therefore we can apply Proposition 4.42 and conclude that there exist  $0 < h < -\frac{1}{2\pi} \ln |\lambda|$ , a sequence of positive numbers  $(\eta_n(h))_n$  going to zero,  $\Gamma_n = \Gamma_n(\eta_n, h) > 0$  and  $\Phi_E^{(n)} \in C_h^\omega(\mathbb{T}, \text{PSL}(2, \mathbb{R}))$  with  $|\Phi_E^{(n)}|_h < \Gamma_n$ , such that

$$\Phi_E^{(n)}(x + \alpha)^{-1} S_E^{2\lambda \cos(2\pi \cdot)}(x) \Phi_E^{(n)}(x) = R_{\phi_n(E)} + F_n(x), \quad \forall x \in \mathbb{T},$$

where  $|F_n|_h < \eta_n$ . Fix  $0 < h' < h$ . Note that by Remark 4.36, the quantity  $\varepsilon_* = \varepsilon_*(A_0, K, \tau, h, h', d) > 0$  defined in Corollary 4.35 can be taken uniform with respect to  $A_0 \in \text{SO}(2, \mathbb{R})$ , thus we denote it by  $\varepsilon_*(K, \tau, h, h', d)$ .

Given any  $0 < \varepsilon_0 < \varepsilon_*(K, \tau, h, h', d)$ , one can always find  $N_*$  large enough such that

$$\eta_{N_*}(h) \leq \varepsilon_0.$$

It follows that  $|\Phi_E^{(N_*)}|_h \leq \Gamma(K, \tau)$ , hence by footnote 5 of [2], we have  $|\deg(\Phi_E^{(N_*)})| \leq C(h) \ln \Gamma$ . Since we assume  $\rho(\alpha, S_E^{2\lambda \cos(2\pi \cdot)}) = \langle k \rangle$ , then  $\rho(\alpha, R_{\phi_{N_*}(E)} + F_{N_*}) = \langle k - k_* \rangle$ , with  $k_* := \deg(\Phi_E^{(N_*)})$ .

By Corollary 4.35, there exists  $W \in C_{h'}^\omega(\mathbb{T}, \text{PSL}(2, \mathbb{R}))$  which reduces  $(\alpha, R_{\phi_{N_*}(E)} + F_{N_*})$  to the constant parabolic matrix  $\begin{pmatrix} 1 & \kappa \\ 0 & 1 \end{pmatrix}$ . Letting  $Z := \Phi_E^{(N_*)} \cdot W \in C_{h'}^\omega(\mathbb{T}, \text{PSL}(2, \mathbb{R}))$ , we have (5.5), with the estimate

$$|Z|_{h'} \leq \Gamma(K, \tau) \tilde{D}_1 e^{\tilde{\zeta}_1 |k_*|} e^{\tilde{\zeta}_1 |k|} \leq D(K, \tau, d) e^{\tilde{\zeta}_1 |k|},$$

where  $\tilde{D}_1 = \tilde{D}_1(K, \tau, d) > 0$  and  $\tilde{\zeta}_1 = \tilde{\zeta}_1(\tau, h) > 0$  are taken as in Corollary 4.35. Besides, we have

$$|\kappa| \leq \varepsilon_0^{\frac{1}{4}} e^{-\frac{2\pi h' |k - k_*|}{1 + 2\varepsilon_0^{1/80\tau}}} \leq \left( \varepsilon_0^{\frac{1}{4}} e^{\frac{2\pi h' |k_*|}{1 + 2\varepsilon_0^{1/80\tau}}} \right) e^{-\frac{2\pi h'}{1 + 2\varepsilon_0^{1/80\tau}} |k|}.$$

$\square$

On the other hand, Proposition 4.42 has the following consequence in the case of general analytic potentials. In particular, Proposition 4.40, which only deals with the perturbative regime, can be generalized as follows to the global subcritical regime for quasi-periodic Schrödinger operators.

**Corollary 4.45.** *Given a (measure-theoretically) typical  $V \in C^\omega(\mathbb{T}, \mathbb{R})$  and  $\alpha \in \mathbb{R} \setminus \mathbb{Q}$  satisfying  $\beta(\alpha) = 0$ , then for any  $E_k^+ \in I_i$ ,  $k \in \mathbb{Z} \setminus \{0\}$ ,  $1 \leq i \leq m$ , there exist  $Y \in C^\omega(\mathbb{T}, \text{PSL}(2, \mathbb{R}))$  as well as  $\varphi \in \mathbb{R}$  such that for every  $x \in \mathbb{T}$ ,*

$$Y(x + \alpha)^{-1} S_{E_k^+}^V(x) Y(x) = \begin{pmatrix} 1 & \varphi \\ 0 & 1 \end{pmatrix}. \quad (5.6)$$

Moreover, there exists  $n' = n'(k) \in \mathbb{Z}$  such that

$$|\varphi| \leq C_2 e^{-c|n'|}, \quad |Y|_{\mathbb{T}} \leq e^{o(|n'|)}, \quad |k| \leq C_5 |n'|, \quad (5.7)$$

for some constants  $c, C_5 > 0$  independent of  $k$ , and where the constant  $C_2 > 0$  is taken as in Proposition 4.40. Moreover, for any sufficiently small  $\varepsilon > 0$ , there exists  $C_\varepsilon > 0$  such that

$$|Y|_{\varepsilon/2} \leq C_\varepsilon e^{3\pi\varepsilon|n'|}. \quad (5.8)$$

Of course, a similar statement holds for  $E_k^-$  in place of  $E_k^+$ .

PROOF. For any  $E_* \in \Sigma_{V, \alpha} \cap I_i$ , the cocycle  $(\alpha, S_{E_*}^V)$  is subcritical, hence it is almost reducible. In particular, it can be conjugated to a cocycle close to constant, which we may assume to be again of Schrödinger type. Indeed, if  $c_0, k_0 > 0$  are the absolute constants given by Theorem 4.14, then by Lemma 4.16 and Remark 4.17, there are  $\tilde{h}_0 = \tilde{h}_0(V) > 0$  and  $\tilde{\Lambda} = \tilde{\Lambda}(K, \tau, \tilde{h}_0) > 0$  such that one can find  $\tilde{E} = \tilde{E}(E_*) \in \mathbb{R}$  as well as

- $\Psi_{E_*} \in C_{\tilde{h}_0}^\omega(\mathbb{T}, \text{PSL}(2, \mathbb{R}))$  with  $|\Psi_{E_*}|_{\tilde{h}_0} \leq \tilde{\Lambda} - \gamma$  for some  $\gamma > 0$ ,
- $\tilde{V}_{E_*} \in C_{\tilde{h}_0}^\omega(\mathbb{T}, \mathbb{R})$  with  $|\tilde{V}_{E_*}|_\varepsilon \leq c_0 \varepsilon^{k_0}$ , for some  $0 < \varepsilon < \min(1, \tilde{h}_0)$ ,

satisfying

$$\Psi_{E_*}(x + \alpha)^{-1} S_{E_*}^V(x) \Psi_{E_*}(x) = S_{\tilde{E}}^{\tilde{V}_{E_*}}(x), \quad \forall x \in \mathbb{T}.$$

Moreover, by Lemma 4.16 and Remark 4.17, for every  $0 < h \leq \tilde{h}_0$ , there exists  $\delta > 0$  such that for  $E \in (E_* - \delta, E_* + \delta)$ , one can find

- $\Psi_E \in C_h^\omega(\mathbb{T}, \text{PSL}(2, \mathbb{R}))$  with  $|\Psi_E - \Psi_{E_*}|_h \leq \gamma$ , so that  $|\Psi_E|_h \leq \tilde{\Lambda}$ ,
- $\tilde{V}_E \in C_h^\omega(\mathbb{T}, \mathbb{R})$  with  $|\tilde{V}_E|_\varepsilon \leq c_0 \varepsilon^{k_0}$ ,

satisfying

$$\Psi_E(x + \alpha)^{-1} S_E^V(x) \Psi_E(x) = S_{\tilde{E}}^{\tilde{V}_E}(x), \quad \forall x \in \mathbb{T}. \quad (5.9)$$

By compactness of  $\Sigma_{V, \alpha}$ , it is possible to cover it with a finite number of open intervals of the above type, hence we get a uniform upper bound on  $\Psi_E$ : there are  $h_2 = h_2(V) > 0$  and  $\Lambda = \Lambda(K, \tau, h_2) > 0$  such that for any  $E \in \Sigma_{V, \alpha}^{\text{sub}}$ , we have  $|\Psi_E|_{h_2} \leq \Lambda$  and  $|\tilde{V}_E|_\varepsilon \leq c_0 \varepsilon^{k_0}$  for some  $0 < \varepsilon < \min(1, h_2)$ . Let  $k_* = k_*(E) := \deg(\Psi_E)$ . Then by footnote 5 of [2], we deduce that the quantity  $|k_*|$  is also uniformly upper bounded on  $\Sigma_{V, \alpha}^{\text{sub}}$ , i.e., there exists  $J = J(K, \tau, h_2) > 0$  such that  $|k_*| \leq J$ .

Now, for  $E_* = E_k^+$  and  $\tilde{E} = \tilde{E}(E_k^+)$ , we have  $\rho(\alpha, S_{\tilde{E}}^{\tilde{V}_{E_*}}) = \langle k - k_*(E_*) \rangle$ . Clearly,  $\tilde{E} \in \Sigma_{\tilde{V}_{E_*}, \alpha}$  since  $(\alpha, S_{\tilde{E}}^{\tilde{V}_{E_*}})$  is not uniformly hyperbolic. Moreover, the potential  $\tilde{V}_{E_*}$  is in the perturbative regime, hence the assumptions of Proposition 4.40 are satisfied for the cocycle  $(\alpha, S_{\tilde{E}}^{\tilde{V}_{E_*}})$ . We thus get  $\varphi \in \mathbb{R}$  and  $U \in C^\omega(\mathbb{T}, \text{PSL}(2, \mathbb{R}))$  such that for any  $x \in \mathbb{T}$ ,

$$U(x + \alpha)^{-1} S_{\tilde{E}}^{\tilde{V}_{E_*}}(x) U(x) = \begin{pmatrix} 1 & \varphi \\ 0 & 1 \end{pmatrix}.$$

Moreover, there exists  $n' = n'(k) = n(k - k_*) \in \mathbb{Z}$  such that  $|\varphi| \leq C_2 e^{-c|n'|}$ ,  $|U|_{\mathbb{T}} \leq e^{o(|n'|)}$  and  $|\deg(U)| = |k - k_*| \leq C_4 |n|$  for some constants  $C_2, C_4 > 0$  independent of  $k$ . Setting  $Y := \Psi_{E_*} U$ , we get  $|Y|_{\mathbb{T}} \leq \Lambda e^{o(|n'|)}$ , and  $|\deg(Y)| = |k| \leq J + C_4 |n'| \leq C_5 |n'|$  for some uniform constant  $C_5 > 0$ . Now, (5.8) follows by choosing  $\varepsilon \leq \min(h_2, \delta_0)$ , where  $\delta_0 > 0$  is taken as in Proposition 4.40; indeed, the estimates of Proposition 4.40 give  $|U|_{\varepsilon/2} \leq C_3 e^{3\pi\varepsilon|n'|}$  for some constant  $C_3$  depending only on  $\varepsilon$ , and we also have  $|\Psi_{E_*}|_{\varepsilon/2} \leq \Lambda$ . This concludes the proof.  $\square$

**6. Moser-Pöschel argument and the gap estimates**

Given  $\alpha \in \mathbb{R} \setminus \mathbb{Q}$  satisfying  $\beta(\alpha) = 0$  and a typical  $V \in C^\omega(\mathbb{T}, \mathbb{R})$ , we consider the quasi-periodic Schrödinger operator on  $\ell^2(\mathbb{Z})$ :

$$(H_{V,\alpha,\theta}u)_n = u_{n+1} + u_{n-1} + V(n\alpha + \theta)u_n.$$

Let  $E_*$  be an edge point of some spectral gap  $G_k(V)$ , and assume that  $E_* \in I_i$ , where  $I_i$  is some interval associated with subcritical energies as we introduced in Subsection 5. In view of Corollary 4.44 and Corollary 4.45, there exist  $r > 0$  and a conjugacy  $X = \begin{pmatrix} X_{11} & X_{12} \\ X_{21} & X_{22} \end{pmatrix} \in C_r^\omega(\mathbb{T}, \text{SL}(2, \mathbb{R}))$ , such that for some  $\zeta \in \mathbb{R}$ , we have

$$X(x + \alpha)^{-1}S_{E_*}^V(x)X(x) = B = \begin{pmatrix} 1 & \zeta \\ 0 & 1 \end{pmatrix}, \quad \forall x \in \mathbb{T}. \tag{6.1}$$

**Lemma 4.46.** *The coefficients  $(X_{ij})$  satisfy the following relations: for any  $x \in \mathbb{T}$ ,*

$$\begin{cases} X_{21}(x + \alpha) = X_{11}(x), \\ X_{22}(x + \alpha) = X_{12}(x) - \zeta X_{11}(x), \end{cases} \tag{6.2}$$

and

$$X_{11}(x + \alpha)X_{12}(x) - X_{11}(x)X_{12}(x + \alpha) = 1 + \zeta X_{11}(x + \alpha)X_{11}(x). \tag{6.3}$$

For a function  $f$  defined on  $\mathbb{T}$ , we denote by  $[f]$  its average with respect to Lebesgue measure. We have the following estimate on  $[X_{11}^2]$ :

$$[X_{11}^2] = [X_{21}^2] \geq |X|_{\mathbb{T}}^{-2}/2. \tag{6.4}$$

PROOF. Equation (6.1) gives: for any  $x \in \mathbb{T}$ ,

$$\begin{aligned} & \begin{pmatrix} (E_* - V(x))X_{11}(x) - X_{21}(x) & (E_* - V(x))X_{12}(x) - X_{22}(x) \\ X_{11}(x) & X_{12}(x) \end{pmatrix} = \\ & = \begin{pmatrix} X_{11}(x + \alpha) & \zeta X_{11}(x + \alpha) + X_{12}(x + \alpha) \\ X_{21}(x + \alpha) & \zeta X_{21}(x + \alpha) + X_{22}(x + \alpha) \end{pmatrix} \end{aligned}$$

and we get the first two relations. The third one follows by taking the determinant, since  $\det(S_{E_*}^V) \equiv 1$ ,  $\det(X) \equiv 1$  and  $\det(B) = 1$ . Now, if we denote by  $C_1, C_2$  the columns of  $X$ , by  $\det(X) \equiv 1$ , we get  $[|C_1|^2][|C_2|^2] > 1$ , hence

$$[|C_1|^2] = [X_{11}^2] + [X_{21}^2] = 2[X_{11}^2] > [|C_2|^2]^{-1} \geq |X|_{\mathbb{T}}^{-2}.$$

□

Now, given  $\delta \in \mathbb{R}$ , we move the energy  $E_*$  to  $E_* + \delta$ , keeping the conjugacy  $X$ . Since  $S_{E_*+\delta}^V = S_{E_*}^V + \begin{pmatrix} \delta & 0 \\ 0 & 0 \end{pmatrix}$ , the relations obtained in (6.2) yield

$$X(x + \alpha)^{-1}S_{E_*+\delta}^V(x)X(x) = B_\delta(x) := B + \delta P(x), \tag{6.5}$$

with

$$P(x) := \begin{pmatrix} X_{11}(x)X_{12}(x) - \zeta X_{11}^2(x) & -\zeta X_{11}(x)X_{12}(x) + X_{12}^2(x) \\ -X_{11}^2(x) & -X_{11}(x)X_{12}(x) \end{pmatrix}.$$

In the following, we will use the method of averaging to estimate the size of spectral gaps. For this, we look for a conjugacy near the identity that would conjugate  $(\alpha, B + \delta P)$  to a cocycle closer to be constant. Then we examine the type of the resulting matrix in  $\text{SL}_2(\mathbb{R})$  (hyperbolic, parabolic, elliptic) to estimate the size of the gap.

The following lemma is classical. We refer to Proposition 1 in [35], where a similar statement is proved for any matrix  $A_0$  in  $\text{SL}_2(\mathbb{R})$ , but under a stronger arithmetic condition (the eigenvalues of  $A_0$  are required to satisfy some Diophantine condition relatively to the frequency  $\alpha$ ).

**Lemma 4.47.** *Let  $A_0 \in \mathrm{SL}_2(\mathbb{R})$  be a parabolic matrix, say  $A_0 = \begin{pmatrix} 1 & \mu \\ 0 & 1 \end{pmatrix}$  for some  $\mu \in \mathbb{R}$ . Assume that the frequency  $\alpha$  satisfies  $\beta(\alpha) = 0$ . Then for any  $G \in C_{\tilde{r}}^\omega(\mathbb{T}, \mathrm{sl}_2(\mathbb{R}))$ ,  $\tilde{r} > 0$ , the cohomological equation*

$$\tilde{Y}(x + \alpha)A_0 - A_0\tilde{Y}(x) = A_0(G(x) - [G]), \quad x \in \mathbb{T}, \quad (6.6)$$

*admits a unique solution  $\tilde{Y}: \mathbb{T} \rightarrow \mathrm{sl}_2(\mathbb{R})$ . Moreover, there exists a constant  $\tilde{M} = \tilde{M}(\alpha, \tilde{r}, A_0) > 0$  depending only on the arithmetic properties of  $\alpha$ , on the analytic radius  $\tilde{r}$  and on  $A_0$ , such that*

$$|\tilde{Y}|_{\tilde{r}/2} \leq \frac{|G|_{\tilde{r}}}{\tilde{M}}.$$

PROOF. Write  $G = \begin{pmatrix} d & e \\ f & -d \end{pmatrix}$  for some functions  $d, e, f \in C^\omega(\mathbb{T}, \mathbb{R})$ ; we look for a solution  $Y$  of the form  $Y = \begin{pmatrix} a & b \\ c & -a \end{pmatrix}$  for some functions  $a, b, c \in C^\omega(\mathbb{T}, \mathbb{R})$ . Finding a solution to (6.6) amounts to solving the following system:

$$\begin{aligned} a(x + \alpha) - a(x) &= \mu c(x + \alpha) + d(x) - [d], \\ b(x + \alpha) - b(x) &= e(x) - \mu d(x) - [e - \mu d] - \mu(a(x + \alpha) + a(x)) \\ c(x + \alpha) - c(x) &= f(x) - [f]. \end{aligned}$$

We denote by  $(\hat{w}_j)_{j \in \mathbb{Z}}$  the Fourier coefficients of the function  $w$ , where  $w = a, b, c, d, e, f$ . We start by solving the third equation in Fourier series:

$$\hat{c}_0 := 0, \quad \hat{c}_j := \frac{\hat{f}_j}{e^{2\pi i j \alpha} - 1}, \quad \forall j \in \mathbb{Z} \setminus \{0\}.$$

Now, since  $G$  is analytic on the strip  $\{|\Im z| < \tilde{r}\}$ , Payley-Wiener's theorem yields:

$$\hat{w}_j \leq |G|_{\tilde{r}} e^{-3\pi \tilde{r} |j|/2}, \quad w = d, e, f, \quad \forall j \in \mathbb{Z}. \quad (6.7)$$

Moreover, as in (4.29), the condition  $\beta(\alpha) = 0$  gives the estimates:

$$\left| \frac{1}{e^{2\pi i j \alpha} - 1} \right| = e^{o(|j|)}. \quad (6.8)$$

Combining this with (6.7), we deduce that the Fourier series  $c: x \mapsto \sum_{j \in \mathbb{Z}} \hat{c}_j e^{2\pi i x}$  converges on the strip  $\{|\Im z| < 3\tilde{r}/2\}$ ; moreover, we have  $|c|_{\tilde{r}/2} \leq |G|_{\tilde{r}} \sum_j \frac{e^{-3\pi \tilde{r} |j|/2}}{e^{2\pi i j \alpha} - 1}$ , where the sum depends only on the analytic radius  $\tilde{r}$  and the arithmetic properties of  $\alpha$ .

Since the function  $c$  defined above satisfies  $\int_{\mathbb{T}} c = 0$ , the first equation admits a formal solution with Fourier coefficients given by:

$$\hat{a}_0 := 0, \quad \hat{a}_j := \frac{\mu e^{2\pi i j \alpha} \hat{c}_j + \hat{d}_j}{e^{2\pi i j \alpha} - 1} = \frac{\mu e^{2\pi i j \alpha} \hat{f}_j}{(e^{2\pi i j \alpha} - 1)^2} + \frac{\hat{d}_j}{e^{2\pi i j \alpha} - 1}, \quad \forall j \in \mathbb{Z} \setminus \{0\}.$$

By (6.7) and (6.8), we see that the associate Fourier series  $a: x \mapsto \sum_{j \in \mathbb{Z}} \hat{a}_j e^{2\pi i x}$  converges on the strip  $\{|\Im z| < 3\tilde{r}/2\}$ , and that  $|a|_{\tilde{r}/2}$  is controlled by  $|G|_{\tilde{r}}$  and a term that only depends on  $A_0$  (through  $\mu$ ), on the analytic radius  $\tilde{r}$  and on the arithmetic properties of  $\alpha$ .

Similarly, we solve the second equation in Fourier series; moreover, the solution  $b: x \mapsto \sum_{j \in \mathbb{Z}} \hat{b}_j e^{2\pi i x}$  satisfies analogous estimates, which concludes the proof.  $\square$

**Proposition 4.48** (see Proposition 2, [35]). *We take a parabolic matrix  $A_0 \in \mathrm{SL}_2(\mathbb{R})$  as above. Let  $A_1 \in C_{\tilde{r}}^\omega(\mathbb{T}, \mathrm{gl}(2, \mathbb{R}))$  and  $\tilde{\epsilon}_1 > 0$  be such that  $A_0 + \epsilon A_1(x) \in \mathrm{SL}(2, \mathbb{R})$  for any  $|\epsilon| \leq \tilde{\epsilon}_1$  and  $x \in \mathbb{T}$ . We take  $\tilde{M} = \tilde{M}(\alpha, \tilde{r}, A_0)$  as previously. If  $0 < \tilde{\epsilon}_2 < \tilde{\epsilon}_1$  satisfies*

$$\tilde{\epsilon}_2 |A_1|_{\tilde{r}} < \frac{\tilde{M}}{2|A_0|}, \quad (6.9)$$

*then for every  $\epsilon$ ,  $|\epsilon| \leq \tilde{\epsilon}_2$ , there exist  $Y_\epsilon^{(1)} \in C_{\tilde{r}/2}^\omega(\mathbb{T}, \mathrm{SL}_2(\mathbb{R}))$ ,  $A'_\epsilon \in \mathrm{SL}_2(\mathbb{R})$  and  $A_2 = A_2(\epsilon): \mathbb{T} \rightarrow \mathrm{SL}_2(\mathbb{R})$  depending analytically both on  $\epsilon$  and  $x$  such that for any  $x \in \mathbb{T}$ ,*

$$Y_\epsilon^{(1)}(x + \alpha)^{-1} (A_0 + \epsilon A_1(x)) Y_\epsilon^{(1)}(x) = A'_\epsilon + \epsilon^2 A_2(x),$$



where

$$A'_\epsilon := A_0 \exp(\epsilon[G]), \quad \text{with } G: x \mapsto A_0^{-1}A_1(x) - \frac{\text{tr}(A_0^{-1}A_1(x))}{2}\text{Id}. \quad (6.10)$$

Besides, the following estimates are satisfied:

$$\begin{cases} |\tilde{Y}_\epsilon^{(1)} - \text{Id}|_{\tilde{r}/2} &\leq M|A_1|_{\tilde{r}}|\epsilon|, \\ |A'_\epsilon - A_0| &\leq M|A_1|_{\tilde{r}}|\epsilon|, \\ |A_2|_{\tilde{r}/2} &\leq M|A_1|_{\tilde{r}}^2, \end{cases}$$

for some constant  $M = M(\alpha, \tilde{r}, A_0) > 0$  depending only on the arithmetic properties of  $\alpha$ , on the analytic radius  $\tilde{r}$  and on  $A_0$ .

**Remark 4.49.** Assume that for  $|\epsilon| \leq \tilde{\epsilon}_1$ , the map  $A_0 + \epsilon A_1: \mathbb{T} \rightarrow \text{SL}(2, \mathbb{R})$  is homotopic to the identity, so that the cocycle  $(\alpha, A_0 + \epsilon A_1)$  has a well-defined rotation number. Although the conjugacy  $Y_\epsilon^{(1)}$  depends on  $\epsilon$ , it is important for our purpose that it does not change the rotation number; indeed, by the previous estimates, we may choose  $\tilde{\epsilon}_2 > 0$  to be sufficiently small such that for  $|\epsilon| \leq \tilde{\epsilon}_2$ , the map  $Y_\epsilon^{(1)}$  is homotopic to  $\text{Id}$ , and thus,  $\rho(\alpha, A_0 + \epsilon A_1) = \rho(\alpha, A'_\epsilon + \epsilon^2 A_2)$ . We will assume this tacitly in the following.

**PROOF.** We follow the proof given in [35]. Define  $G: x \mapsto A_0^{-1}A_1(x) - \frac{\text{tr}(A_0^{-1}A_1(x))}{2}\text{Id}$ , so that  $G \in C_{\tilde{r}}^\omega(\mathbb{T}, \text{sl}(2, \mathbb{R}))$ , and let  $\tilde{Y}$  be the solution to (6.6) with this choice of  $G$ . Since  $A_0 \in \text{SL}(2, \mathbb{R})$ , we have  $|A_0^{-1}| = |A_0|$ , and thus,  $|G|_{\tilde{r}} \leq |A_0||A_1|_{\tilde{r}}$ . By Lemma 4.47, we deduce that  $|\tilde{Y}|_{\tilde{r}/2} \leq \frac{|G|_{\tilde{r}}}{M} \leq \frac{|A_0|}{M}|A_1|_{\tilde{r}}$ . Take  $\tilde{\epsilon}_2 > 0$  such that  $\tilde{\epsilon}_2|A_1|_{\tilde{r}} < \frac{\tilde{M}}{2|A_0|}$ . For  $|\epsilon| \leq \tilde{\epsilon}_2$ , we then have  $|\epsilon\tilde{Y}|_{\tilde{r}/2} < 1/2$ ; we define  $Y_\epsilon^{(1)} := \exp(\epsilon\tilde{Y})$ ,  $A'_\epsilon := A_0 \exp(\epsilon[G])$ , and

$$A_2(x) := \frac{1}{\epsilon^2} \left( Y_\epsilon^{(1)}(x + \alpha)^{-1}(A_0 + \epsilon A_1(x))Y_\epsilon^{(1)}(x) - A'_\epsilon \right), \quad \forall x \in \mathbb{T}.$$

The first and second inequalities are clearly satisfied, since  $Y_\epsilon^{(1)} = \exp(\epsilon\tilde{Y})$  and  $|\epsilon\tilde{Y}|_{\tilde{r}/2} \leq \frac{|A_0|}{M}|A_1|_{\tilde{r}}|\epsilon|$ , and we also have  $A'_\epsilon = A_0 \exp(\epsilon[G])$ , with  $|\epsilon[G]| \leq |A_0||A_1|_{\tilde{r}}|\epsilon|$ . For the third one, we estimate

$$\begin{aligned} \epsilon^2|A_2|_{\tilde{r}/2} &= |Y_\epsilon^{(1)}(\cdot + \alpha)^{-1}(A_0 + \epsilon A_1)Y_\epsilon^{(1)} - A'_\epsilon|_{\tilde{r}/2} \\ &\leq |-\tilde{Y}(\cdot + \alpha)A_0 + A_0\tilde{Y} + A_0(G - [G])|_{\tilde{r}/2} \times |\epsilon| \\ &\quad + \left| \sum_{k+l \geq 2} \frac{1}{k!l!} (-\epsilon\tilde{Y}(\cdot + \alpha))^k A_0 (\epsilon\tilde{Y})^l \right|_{\tilde{r}/2} \\ &\quad + \left| \sum_{k+l \geq 1} \frac{1}{k!l!} (-\epsilon\tilde{Y}(\cdot + \alpha))^k \epsilon A_1 (\epsilon\tilde{Y})^l \right|_{\tilde{r}/2} \\ &\quad + \left| A_0 \sum_{k \geq 2} \frac{(\epsilon[G])^k}{k!} \right|. \end{aligned}$$

The first term vanishes, and in the three remaining ones, we can factor by  $\epsilon^2$ . Since  $\sum_{k+l=m} \frac{1}{k!l!} = \frac{2^m}{m!}$ , and  $2|\epsilon\tilde{Y}|_{\tilde{r}/2} \leq 1$ , the second term is smaller than  $\sum_{k=0}^{+\infty} \frac{(2|\epsilon\tilde{Y}|_{\tilde{r}/2})^k}{(k+2)!} 4|\tilde{Y}|_{\tilde{r}/2}^2 |A_0| \epsilon^2 \leq 4e|\tilde{Y}|_{\tilde{r}/2}^2 |A_0| \epsilon^2$ , and  $|\tilde{Y}|_{\tilde{r}/2}^2 |A_0| \leq \frac{|A_0|^3}{M^2} |A_1|_{\tilde{r}}^2$ . Similarly, the third one is smaller than  $\sum_{k=0}^{+\infty} \frac{(2|\epsilon\tilde{Y}|_{\tilde{r}/2})^k}{(k+1)!} |\epsilon A_1|_{\tilde{r}/2} \leq 2e|\tilde{Y}|_{\tilde{r}/2} |A_1|_{\tilde{r}/2} \epsilon^2$ , and we have  $|\tilde{Y}|_{\tilde{r}/2} |A_1|_{\tilde{r}/2} \leq \frac{|A_0|}{M} |A_1|_{\tilde{r}}^2$ . The last term is smaller than  $\sum_{k=0}^{+\infty} \frac{|\epsilon[G]|^k}{(k+2)!} |[G]|^2 |A_0| \epsilon^2$ , and  $|[G]|^2 |A_0| \leq |A_0|^3 |A_1|_{\tilde{r}}^2$ .  $\square$

Now, we apply the previous results to the cocycle  $(\alpha, B_\delta)$  defined in (6.5).



**Proposition 4.50.** *For any  $\delta \in \mathbb{R}$ , we consider the map  $B_\delta = B + \delta P \in C_r^\omega(\mathbb{T}, \text{SL}(2, \mathbb{R}))$  defined in (6.5). Let  $\tilde{M} = \tilde{M}(\alpha, r, B)$ , and as in (6.9), we choose  $\tilde{\delta}_2 > 0$  such that  $\tilde{\delta}_2 |P|_r < \frac{\tilde{M}}{2|B|}$ . For any  $\delta \in \mathbb{R}$  with  $|\delta| \leq \tilde{\delta}_2$ , there exist  $X_\delta^{(1)} \in C_{r/2}^\omega(\mathbb{T}, \text{SL}(2, \mathbb{R}))$  and  $g_2 \in C_{r/2}^\omega(\mathbb{T}, \text{sl}(2, \mathbb{R}))$  satisfying*

$$\left| X_\delta^{(1)} - \text{Id} \right|_{\frac{r}{2}} \leq c |X|_r^2 |\delta|, \quad |g_2|_{\frac{r}{2}} \leq c |X|_r^4, \tag{6.11}$$

for some constant  $c = c(\alpha, r) > 0$ , and such that for any  $x \in \mathbb{T}$ ,

$$X_\delta^{(1)}(x + \alpha)^{-1} (B + \delta P(x)) X_\delta^{(1)}(x) = \exp(b_0 + \delta b_1 + \delta^2 g_2(x)), \tag{6.12}$$

where  $b_0 := \begin{pmatrix} 0 & \zeta \\ 0 & 0 \end{pmatrix}$  and  $b_1 := \begin{pmatrix} [X_{11} X_{12}] - \frac{\zeta}{2} [X_{11}^2] & -\zeta [X_{11} X_{12}] + [X_{12}^2] \\ -[X_{11}^2] & -[X_{11} X_{12}] + \frac{\zeta}{2} [X_{11}^2] \end{pmatrix}$ .

PROOF. We have  $B = \begin{pmatrix} 1 & \zeta \\ 0 & 1 \end{pmatrix}$ , and by the estimates in (5.7) on the off-diagonal coefficient  $\zeta$ , we know that  $|B|$  is uniformly bounded for all subcritical energies on the boundary of a spectral gap. With the above notations, we thus have  $M = M(\alpha, r)$ . By a direct calculation, we see that  $B^{-1}P(x) \in \text{sl}(2, \mathbb{R})$  for any  $x \in \mathbb{T}$ , hence the formula in (6.10) gives here

$$G = B^{-1}P, \quad \text{and} \quad [G] = B^{-1}[P] = \begin{pmatrix} [X_{11} X_{12}] & [X_{12}^2] \\ -[X_{11}^2] & -[X_{11} X_{12}] \end{pmatrix}.$$

Applying Proposition 4.48 to  $B_\delta$ , we obtain  $X_\delta^{(1)} \in C_{r/2}^\omega(\mathbb{T}, \text{SL}(2, \mathbb{R}))$  and  $P_2 \in C_{r/2}^\omega(\mathbb{T}, \text{gl}(2, \mathbb{R}))$  satisfying

$$\left| X_\delta^{(1)} - \text{Id} \right|_{\frac{1}{2}r} \leq M |P|_r |\delta|, \quad |P_2|_{\frac{1}{2}r} \leq M |P|_r^2,$$

and such that

$$X_\delta^{(1)}(x + \alpha)^{-1} (B + \delta P(x)) X_\delta^{(1)}(x) = B \exp(\delta[G] + \delta^2 P_2(x)), \quad \forall x \in \mathbb{T}.$$

Then, with  $R_2 := P_2 + \sum_{j=2}^\infty \frac{\delta^{j-2}}{j!} B[G]^j$ , we get

$$B \exp(\delta[G] + \delta^2 P_2(x)) = B + \delta[P] + \delta^2 R_2(x) = \exp(b_0 + \delta b_1 + \delta^2 g_2(x))$$

for some  $g_2 \in C^\omega(\mathbb{T}, \text{sl}(2, \mathbb{R}))$  satisfying  $|g_2|_{r/2} \lesssim M |P|_r^2 + \sum_{j=2}^\infty \frac{\delta^{j-2}}{j!} |[G]^j|$ , and where the matrices  $b_0, b_1 \in \text{sl}(2, \mathbb{R})$  are taken as above. This concludes, since by the definitions of  $P$  and  $G$ , and since  $\zeta$  is uniformly bounded, we also have  $|P|_r \lesssim |X|_r^2$  and  $|[G]| \leq |X|_{\mathbb{T}}^2$ .  $\square$

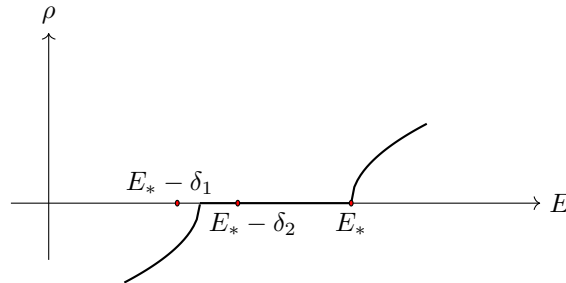

FIGURE 1. Rotation number of the cocycle  $(\alpha, X_\delta^{(2)}(\cdot + \alpha)^{-1} S_{E_* + \delta}^V(\cdot) X_\delta^{(2)}(\cdot))$

Assume now that  $E_*$  is the right edge point of the spectral gap  $G_k(V)$ , which corresponds to the case where the off-diagonal coefficient is positive, i.e.,  $\zeta > 0$ . Then

we need to focus on  $E_* + \delta$  with  $\delta < 0$ . Set  $X_\delta^{(2)} := X \cdot X_\delta^{(1)}$ . For any  $x \in \mathbb{T}$ , we have

$$X_\delta^{(2)}(x + \alpha)^{-1} S_{E_* + \delta}^V(x) X_\delta^{(2)}(x) = \exp(b_0 + \delta b_1 + \delta^2 g_2(x)).$$

By modifying the value of  $\delta$ , we can approach the left edge point of  $G_k(V)$ , and then estimate the size of  $G_k(V)$ . Indeed, we can determine the boundary of spectral gap by the change of rotation number of the cocycle  $(\alpha, \exp(b_0 + \delta b_1 + \delta^2 g_2))$ . As shown symbolically in Figure 1, when  $\delta = 0$ , the rotation number of the cocycle  $(\alpha, \exp(b_0)) = (\alpha, B)$  vanishes since  $B$  is parabolic.

- For any  $\delta_1 > 0$  such that  $E_* - \delta_1$  is beyond the left edge of  $G_k(V)$ , the rotation number of  $(\alpha, X_{-\delta_1}^{(2)}(\cdot + \alpha)^{-1} S_{E_* - \delta_1}^V X_{-\delta_1}^{(2)})$  is non-zero, thus  $|G_k(V)| < \delta_1$ .
- For any  $\delta_2 > 0$  such that  $E_* - \delta_2 \in G_k(V)$ , the cocycle  $(\alpha, X_{-\delta_2}^{(2)}(\cdot + \alpha)^{-1} S_{E_* - \delta_2}^V X_{-\delta_2}^{(2)})$  is uniformly hyperbolic, and its rotation number is still zero. Hence  $|G_k(V)| > \delta_2$ .

Let  $M_\delta := b_0 - \delta b_1$  and  $d(\delta) := \det M_\delta$ . Then  $d(\delta_1)$  is positive and bounded from below, and  $d(\delta_2)$  is negative and bounded from above.

In what precedes, we only considered an energy  $E_*$  on the right side of  $G_k(V)$ ; of course, the case where  $E_*$  is the left edge point of  $G_k(V)$  can be handled in a similar way.

**6.1. Lower bound estimates.** For the almost Mathieu operator  $H_{2\lambda \cos(2\pi \cdot), \alpha, \theta}$ , we have the following bound for each spectral gap.

**Theorem 4.51.** *Take  $\alpha$  with  $\beta(\alpha) = 0$ . We consider the spectral gaps  $\{G_k(\lambda)\}_{k \in \mathbb{Z}}$  of the almost Mathieu operator  $H_{2\lambda \cos(2\pi \cdot), \alpha, \theta}$ , with  $|\lambda| \neq 0, 1$ . Then there exist constants  $\tilde{C}, \varsigma > 0$  such that*

$$|G_k(\lambda)| \geq \tilde{C} e^{-\varsigma |k|}, \quad \forall k \in \mathbb{Z} \setminus \{0\}.$$

Before giving the proof, let us recall the following result, which plays a key role in Avila-You-Zhou’s proof of noncritical “Dry Ten Martini Problem” [13]; we just point out that while Avila-You-Zhou [13] mainly deals with Liouvillean frequencies, the following proposition really works for all irrational frequencies.

**Proposition 4.52** (Avila-You-Zhou [13]). *Let  $\alpha \in \mathbb{R} \setminus \mathbb{Q}$ ,  $0 < |\tilde{\lambda}| < 1$ ,  $E \in \Sigma_{2\tilde{\lambda} \cos, \alpha}$  and  $0 < \tilde{h} < -\frac{1}{2\pi} \ln |\tilde{\lambda}|$ . Then there exists  $T = T(\tilde{h}, \tilde{\lambda}) > 0$  such that for  $\varepsilon > 0$  sufficiently small, there is no  $Z \in C_h^\omega(\mathbb{T}, (2, \mathbb{R}))$ ,*

$$Z(\cdot + \alpha)^{-1} S_E^{2\tilde{\lambda} \cos}(\cdot) Z(\cdot) = \text{Id} + F(\cdot), \tag{6.13}$$

with  $|Z|_{\tilde{h}} \leq \varepsilon^{-1}$ ,  $|F|_{\tilde{h}} \leq \varepsilon^T$ .

**PROOF OF THEOREM 4.51.** By Aubry duality,  $\Sigma_{2\lambda \cos(2\pi \cdot), \alpha} = \Sigma_{2\lambda^{-1} \cos(2\pi \cdot), \alpha}$ , hence we only need to consider the case where  $0 < |\lambda| < 1$ . Thus by Corollary 4.44, there exists  $0 < h < -\frac{1}{2\pi} \ln |\lambda|$  such that the following holds. Let  $E$  be an edge point of the spectral gap  $G_k(\lambda)$ ; the energy  $E \in \Sigma_{2\lambda \cos, \alpha}$  satisfies  $\rho(\alpha, S_E^{2\lambda \cos}) = \langle k \rangle$ , hence there exist  $\kappa = \kappa(k) \in \mathbb{R}$  and  $Z = Z(k) \in C_{h/2}^\omega(\mathbb{T}, \text{PSL}(2, \mathbb{R}))$  such that

$$Z(x + \alpha)^{-1} S_E^{2\lambda \cos(2\pi \cdot)}(x) Z(x) = \begin{pmatrix} 1 & \kappa \\ 0 & 1 \end{pmatrix}, \quad \forall x \in \mathbb{T},$$

with the estimates:

$$|Z|_{h/2} \leq D e^{\tilde{\zeta} |k|}, \quad |\kappa| \leq D' e^{-\tilde{\zeta}' |k|},$$

for certain constants  $D = D(K, \tau, d) > 0$ ,  $D' = D'(K, \tau, d, h) > 0$ ,  $\tilde{\zeta} = \tilde{\zeta}(\tau, h) > 0$ ,  $\tilde{\zeta}' = \tilde{\zeta}'(K, \tau, d, h) > 0$ .

Then we consider (6.1) for the choices  $X := Z$  and  $\zeta := \kappa$ ,  $E_* := E$  and  $V := 2\lambda \cos(2\pi \cdot)$ . By a straightforward calculation, we have

$$d(\delta) = -\delta [Z_{11}^2] \kappa + \delta^2 ([Z_{11}^2][Z_{12}^2] - [Z_{11} Z_{12}]^2).$$

To get a lower bound on the size of the gap, one only needs to estimate the first-order term of  $d(\delta)$ ; one therefore has

$$|G_k(\lambda)| \geq c|\kappa|[Z_{11}^2] \quad (6.14)$$

for some constant  $c > 0$ . Since this fact is quite standard (see [13, 46]), we omit the details.

On the one hand, by (6.4) applied to  $X := Z$ , we have

$$|[Z_{11}^2]| \geq \frac{1}{2}|Z|_{\mathbb{T}}^{-2} \geq \frac{1}{2}|Z|_{h/2}^{-2} \geq \frac{1}{2}D^{-2}e^{-2\zeta|k|}.$$

On the other hand, by Proposition 4.52, there exists  $T = T(h/2, \lambda) > 0$  such that  $|\kappa| > D^{-T}e^{-T\zeta|k|}$ . In particular,  $T$  is independent of  $E$ . As a result, it follows from (6.14) that

$$|G_k(\lambda)| > cD^{-T}e^{-T\zeta|k|} \cdot \frac{1}{2}D^{-2}e^{-2\zeta|k|} = \tilde{C}e^{-(T+2)\zeta|k|},$$

for some constant  $\tilde{C} = \tilde{C}(K, \tau, d, h, \lambda) > 0$ . This finishes the proof of Theorem 4.51.  $\square$

**6.2. Upper bounds on the size of spectral gaps.** Let us consider (6.1) for the choices  $X := Y$  and  $\zeta := \varphi$ , where  $Y$  and  $\varphi$  are given by Corollary 4.45.

**Lemma 4.53.** *By Cauchy-Schwarz inequality, we always have  $[Y_{11}^2][Y_{12}^2] - [Y_{11}Y_{12}]^2 \geq 0$ . Moreover, the quantity  $[Y_{11}^2][Y_{12}^2] - [Y_{11}Y_{12}]^2$  vanishes if and only if  $V$  is constant.*

PROOF. By the equality case in Cauchy-Schwarz inequality,  $[Y_{11}^2][Y_{12}^2] - [Y_{11}Y_{12}]^2 = 0$  if and only if  $Y_{11}$  and  $Y_{12}$  are proportional, that is,  $Y_{12} = \mu Y_{11}$  for some  $\mu \in \mathbb{R}$ . From (6.3), we deduce that for every  $x \in \mathbb{T}$ ,  $\varphi Y_{11}(x + \alpha)Y_{11}(x) = -1$ . It follows that  $Y_{11}$  is  $2\alpha$ -periodic, hence constant since  $\alpha$  is irrational. Since  $Y_{12} = \mu Y_{11}$ , and from (6.2), this implies that the conjugacy  $Y$  itself is constant. But the parabolic matrix to which we conjugate is also constant; therefore,  $S_E^V$ , thus  $V$ , are constant too.  $\square$

**Lemma 4.54.** *Assume that the potential  $V$  is non-constant. Then, for any  $\epsilon > 0$ , there exists  $C_\epsilon > 0$  such that for every  $k \in \mathbb{Z}$ , the following inequalities hold true:*

$$0 \leq \frac{[Y_{11}^2]}{[Y_{11}^2][Y_{12}^2] - [Y_{11}Y_{12}]^2} \leq C_\epsilon e^{\epsilon|n'|} \quad \text{and} \quad [Y_{11}^2][Y_{12}^2] - [Y_{11}Y_{12}]^2 \geq C_\epsilon^{-1} e^{-\epsilon|n'|}, \quad (6.15)$$

where  $n' = n'(k) \in \mathbb{Z}$  is defined as in Corollary 4.45.

PROOF. Assume by contradiction that there exists  $\epsilon > 0$  such that for any  $C > 0$  and any  $\tilde{k}_0 \geq 0$ , there exists  $k \in \mathbb{Z}$  with  $|k| \geq \tilde{k}_0$  for which the associate integer  $n'(k)$  satisfies  $\frac{[Y_{11}^2]}{[Y_{11}^2][Y_{12}^2] - [Y_{11}Y_{12}]^2} > C e^{\epsilon|n'|}$ . Consider the polynomial

$$Q(z) := [(Y_{12} - zY_{11})^2] = [Y_{11}^2]z^2 - 2[Y_{11}Y_{12}]z + [Y_{12}^2].$$

The minimum of  $Q$  is attained when  $z = \frac{[Y_{11}Y_{12}]}{[Y_{11}^2]}$ ; it is equal to

$$Q\left(\frac{[Y_{11}Y_{12}]}{[Y_{11}^2]}\right) = \left[ \left( Y_{12} - \frac{[Y_{11}Y_{12}]}{[Y_{11}^2]} Y_{11} \right)^2 \right] = \frac{[Y_{11}^2][Y_{12}^2] - [Y_{11}Y_{12}]^2}{[Y_{11}^2]} < C^{-1} e^{-\epsilon|n'|}.$$

Hence,  $Y_{12} = \frac{[Y_{11}Y_{12}]}{[Y_{11}^2]} Y_{11} + \sigma$  for some  $\sigma : \mathbb{T} \rightarrow \mathbb{R}$  with  $[\sigma^2] \leq C^{-1} e^{-\epsilon|n'|}$ .

Moreover, in view of (6.3), we know that for every  $x \in \mathbb{T}$ ,

$$Y_{11}(x + \alpha)\sigma(x) - Y_{11}(x)\sigma(x + \alpha) = 1 + \varphi Y_{11}(x + \alpha)Y_{11}(x). \quad (6.16)$$

Since  $|Y|_{\mathbb{T}} \leq e^{\sigma(n')}$  and  $|\varphi| \leq C_2 e^{-c|n'|}$ , we have

$$|\varphi Y_{11}(\cdot + \alpha)Y_{11}(\cdot)|_{\mathbb{T}} = O(e^{-c|n'|}).$$

On the other hand, by Cauchy-Schwarz inequality,

$$[Y_{11}(\cdot + \alpha)\sigma(\cdot) - Y_{11}(\cdot)\sigma(\cdot + \alpha)] = O(e^{-\epsilon|n'|/2}).$$

Recall that there exists a uniform constant  $C_5 > 0$  such that  $|n'| \geq C_5^{-1}|k|$ . Since  $\tilde{k}_0$  can be taken arbitrarily large, the two sides of (6.16) have different sizes, which gives the contradiction.

Combining this with the fact that  $[Y_{11}^2] \geq |Y|_{\mathbb{T}}^{-2}/2 \geq e^{-o(|n'|)}$  (see (6.4)), we get the lower bound on  $[Y_{11}^2][Y_{12}^2] - [Y_{11}Y_{12}]^2$ .  $\square$

Thanks to the previous estimates, we are now able to prove Theorem N, that is, exponential decay of the size of spectral gaps in the subcritical regime. Indeed, we will deduce from what precedes that the path in  $\mathfrak{sl}_2(\mathbb{R})$  given by  $\delta \mapsto b_0 + \delta b_1$ ,  $\delta < 0$ , is as in the following picture. Then, the general idea is based on the fact that small perturbations induced by the term  $\delta^2 g_2$  preserve the transversality of this path.

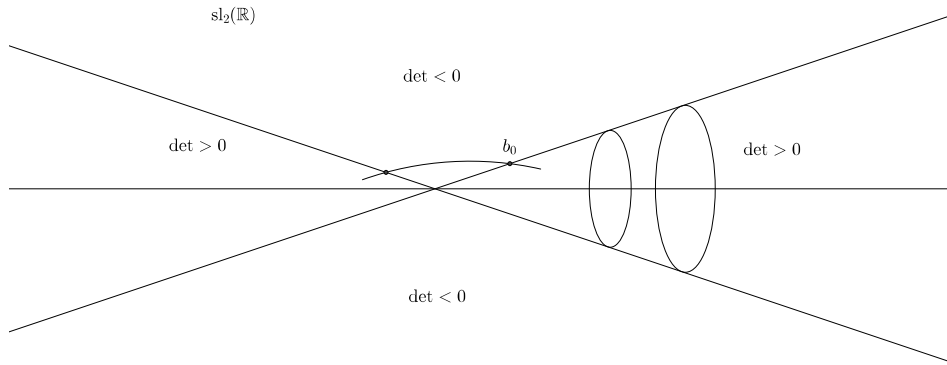

**Theorem 4.55.** Take  $c, C_5 > 0$  as in Corollary 4.45, and set  $\xi := \frac{3}{4}C_5^{-1}c$ . Then, there exists  $C > 0$  such that for any  $G_k(V)$ ,  $k \in \mathbb{Z} \setminus \{0\}$ , with  $\partial G_k(V) \cap I_i \neq \emptyset$ , we have

$$|G_k(V)| \leq C e^{-\xi|k|}.$$

By the above statement, note that it is sufficient to assume that either  $E_k^+ \in I_i$  or  $E_k^- \in I_i$ . Here we consider the case where  $E_k^+ \in I_i$  since it is the one for which we have stated the results so far, but obviously, the other one is analogous.

PROOF. Let us choose  $\epsilon := \frac{c}{4}$ , and take  $C_\epsilon > 0$  such that inequalities (6.15) are satisfied for any  $k \in \mathbb{Z}$ . We set  $C'_\epsilon := C_2 C_\epsilon > 0$ . For a given  $k$ , we consider  $\delta_1 := 2C'_\epsilon e^{-\frac{3c}{4}|n'|}$ . By the estimates on  $Y$  in Corollary 4.45 (see (5.8)), we see that for  $|k|$ , hence  $|n'|$ , large enough, we have  $\delta_1 \leq \tilde{\delta}_2$ , where  $\tilde{\delta}_2$  is taken as in Proposition 4.50. In particular, in this regime, it is legitimate to consider the cocycle  $(\alpha, \exp(b_0 + \delta b_1 + \delta^2 g_2))$  given by Proposition 4.50.

We estimate:

$$\left| \frac{[Y_{11}^2]\varphi}{[Y_{11}^2][Y_{12}^2] - [Y_{11}Y_{12}]^2} \right| \leq C'_\epsilon e^{-\frac{3c}{4}|n'|} = \frac{1}{2}\delta_1.$$

We deduce the following lower bound on the determinant  $d(\delta_1) = \det M_{\delta_1}$ :

$$\begin{aligned} d(\delta_1) &= -\delta_1 [Y_{11}^2]\varphi + \delta_1^2 ([Y_{11}^2][Y_{12}^2] - [Y_{11}Y_{12}]^2) \\ &= \delta_1 ([Y_{11}^2][Y_{12}^2] - [Y_{11}Y_{12}]^2) \left( \delta_1 - \frac{[Y_{11}^2]\varphi}{[Y_{11}^2][Y_{12}^2] - [Y_{11}Y_{12}]^2} \right) \\ &\geq 2C'_\epsilon e^{-\frac{3c}{4}|n'|} \cdot C_\epsilon^{-1} e^{-\frac{c}{4}|n'|} \cdot C'_\epsilon e^{-\frac{3c}{4}|n'|} \\ &= C''_\epsilon e^{-\frac{7c}{4}|n'|}, \end{aligned} \tag{6.17}$$

with  $C''_\epsilon := 2C_\epsilon^{-1}(C'_\epsilon)^2$ .

Let us estimate the norm of  $M_{\delta_1} := b_0 - \delta_1 b_1$ ; by (5.7),  $|Y|_{\mathbb{T}} \leq e^{o(|n'|)}$ , thus for some constant  $\tilde{C}_1 > 0$  independent of  $k$ , we have

$$|M_{\delta_1}| \leq |\varphi| + \delta_1 |Y|_{\mathbb{T}}^2 \leq \tilde{C}_1 e^{-\frac{5\epsilon}{8}|n'|}. \tag{6.18}$$

Take  $\delta \geq \delta_1$ . By Lemma 8.1 of [37], there exists  $\mathcal{P}_\delta \in \text{SL}(2, \mathbb{R})$ , with  $|\mathcal{P}_\delta| \leq 2 \left( \frac{|M_\delta|}{\sqrt{d(\delta)}} \right)^{\frac{1}{2}}$  such that

$$\mathcal{P}_\delta^{-1} M_\delta \mathcal{P}_\delta = \mathcal{D}_\delta := \begin{pmatrix} 0 & \sqrt{d(\delta)} \\ -\sqrt{d(\delta)} & 0 \end{pmatrix}.$$

Exponentiating, we get

$$\mathcal{P}_\delta^{-1} \exp(b_0 - \delta b_1) \mathcal{P}_\delta = R_{-\sqrt{d(\delta)}},$$

$$\mathcal{P}_\delta^{-1} \exp(b_0 - \delta b_1 + \delta^2 g_2) \mathcal{P}_\delta = \exp(\mathcal{D}_\delta + s_\delta),$$

with  $s_\delta = \delta^2 \mathcal{P}_\delta^{-1} g_2 \mathcal{P}_\delta$ . For  $\delta := \delta_1$ , and by (6.17) and (6.18), we obtain:

$$\frac{|M_{\delta_1}|}{\sqrt{d(\delta_1)}} \leq \frac{\tilde{C}_1}{\sqrt{C'_\epsilon}} \cdot \frac{e^{-\frac{5\epsilon}{8}|n'|}}{e^{-\frac{7\epsilon}{8}|n'|}} = ((C'_\epsilon)^{-\frac{1}{2}} \tilde{C}_1) e^{\frac{\epsilon}{4}|n'|}.$$

By (5.8), for any sufficiently small  $\varrho > 0$ , there exists a constant  $C_\varrho > 0$  such that

$$|Y|_{\varrho/2} \leq C_\varrho e^{3\pi\varrho|n'|}.$$

Choose  $0 < \varrho \leq \frac{c}{100\pi}$ . By (6.11), there exists  $c = c(\alpha, \varrho) > 0$  such that  $|g_2|_{\mathbb{T}} \leq c|Y|_{\varrho/2}^4 \leq cC_\varrho^4 e^{12\pi\varrho|n'|} \lesssim e^{\frac{\epsilon}{8}|n'|}$ ; since we also have  $|\mathcal{P}_{\delta_1}^{-1}| \cdot |\mathcal{P}_{\delta_1}| \leq 4((C'_\epsilon)^{-\frac{1}{2}} \tilde{C}_1) e^{\frac{\epsilon}{4}|n'|}$  and  $\delta_1 = 2C'_\epsilon e^{-\frac{3\epsilon}{4}|n'|}$ , we then get

$$|s_{\delta_1}|_{\mathbb{T}} \leq \delta_1^2 |\mathcal{P}_{\delta_1}^{-1}| \cdot |g_2|_{\mathbb{T}} \cdot |\mathcal{P}_{\delta_1}| \leq \tilde{C}_2 e^{-\frac{9\epsilon}{8}|n'|}$$

for some constant  $\tilde{C}_2 > 0$  independent of  $k$ . According to inequality (2.8) of [7], we deduce that there exists a numerical constant  $\tilde{C}_3 > 0$  such that

$$\left| \rho(\alpha, \exp\{M_{\delta_1} + \delta_1^2 g_2\}) + \sqrt{d(\delta_1)} \right| \leq \tilde{C}_3 |s_{\delta_1}|_{\mathbb{T}} \leq (\tilde{C}_2 \tilde{C}_3) e^{-\frac{9\epsilon}{8}|n'|}.$$

Comparing with (6.17), we see that for  $|k|$ , hence  $|n'|$ , sufficiently large, we have

$$\sqrt{d(\delta_1)} > |\rho(\alpha, \exp\{M_{\delta_1} + \delta_1^2 g_2\}) + \sqrt{d(\delta_1)}|.$$

In particular,  $\rho(\alpha, \exp\{M_{\delta_1} + \delta_1^2 g_2\}) \neq \rho(\alpha, \exp\{M(0)\}) = 0$ . For  $|k|$  large enough, we have thus proven:

$$|G_k(V)| \leq 2C'_\epsilon e^{-\frac{3\epsilon}{4}|n'|}.$$

But we know that  $|k| \leq C_5 |n'|$ , which concludes.  $\square$

**Theorem 4.56.** *Take  $c, C_5 > 0$  as in Corollary 4.45, and set  $\xi := \frac{3}{4} C_5^{-1} c$ . Then, there exists  $C > 0$  such that for any  $G_k(V)$ ,  $k \in \mathbb{Z} \setminus \{0\}$ , with  $\partial G_k(V) \cap I_i \neq \emptyset$ , we have*

$$|G_k(V)| \leq C e^{-\xi|k|}.$$

### 7. The monotonicity argument

In this part, we study the size of spectral gaps by different methods. We will give another proof of Theorem 4.55 based on monotonicity arguments; we refer to [10] for more details in this direction. Here, we deal with a (measure-theoretically) typical potential  $V \in C^\omega(\mathbb{T}, \mathbb{R})$  and a frequency  $\alpha \in \mathbb{R} \setminus \mathbb{Q}$  with  $\beta(\alpha) = 0$  satisfying the conclusions of Corollary 4.45.

Recall that the fibered rotation number is defined as the average with respect to some invariant measure  $\mu$  of a certain quantity, that we refer to as the “drift” in what follows. It is defined by the natural action of a  $\text{SL}(2, \mathbb{R})$ -cocycle on the circle.

Schrödinger cocycles depend on the energy  $E$ ; we know that the fibered rotation number is monotonic with respect to  $E$ . In particular, the derivative of the drift with respect to the energy is always nonpositive. Yet it is not strictly monotonic: indeed, we have seen that the rotation number is constant on spectral gaps. This property is linked

to the fact that the measure  $\mu$  may be supported on fixed points that are independent of the energy  $E$ . In particular we see that  $(0, 1)$  is mapped to  $(-1, 0)$  independently of  $E$ . In fact this is essentially the only obstruction to strict monotonicity. When we iterate once, we see that the derivative with respect to the energy becomes negative.

The proof proceeds as follows. We start with an energy  $E_k^+$  on the right boundary of the spectral gap labeled by  $k \in \mathbb{Z} \setminus \{0\}$ . We know that for this value of the energy, we can conjugate the cocycle to some constant parabolic cocycle. We show that the initial drift is nonpositive, but exponentially small with respect to  $k$ . Monotonicity for Schrödinger cocycles translates into monotonicity for the conjugate cocycles; in fact, the derivative of the second iterate of the drift is negative, subexponentially small in terms of the label. Then we see that after an exponentially small perturbation of the energy, we have left the spectral gap, which concludes.

Let us recall that for an energy  $E \in \mathbb{R}$  and for  $x \in \mathbb{T}$ , we denote by

$$S_E^V(x) := \begin{pmatrix} E - V(x) & -1 \\ 1 & 0 \end{pmatrix}$$

the associate matrix. The Schrödinger cocycle  $(\alpha, S_E^V)$  acts on  $\mathbb{T} \times \mathbb{S}^1$  by:

$$(x, e^{2\pi iy}) \mapsto \left( x + \alpha, \frac{S_E^V(x) \cdot e^{2\pi iy}}{|S_E^V(x) \cdot e^{2\pi iy}|} \right).$$

This map admits a lift to  $\mathbb{T} \times \mathbb{R}$ , given by  $\Phi^E: (x, y) \mapsto (x + \alpha, y + \phi_x^E(y))$ , where the “drift”  $\phi_x^E$  satisfies  $\frac{S_E^V(x) \cdot e^{2\pi iy}}{|S_E^V(x) \cdot e^{2\pi iy}|} = e^{2\pi i(y + \phi_x^E(y))}$ . We denote by  $\Phi_x^E: y \mapsto y + \phi_x^E(y)$  the map giving the change of argument, and for  $n \geq 0$ , we set  $(\Phi_x^E)^n(y) := \Phi_{x+(n-1)\alpha}^E \circ \dots \circ \Phi_x^E(y)$ ; it corresponds to the projection on the second coordinate of  $(\Phi^E)^n(x, y)$ . Recall that the rotation number  $\rho(E)$  is obtained by averaging  $(x, y) \mapsto \phi_x^E(y)$  with respect to a measure  $\mu$  invariant by  $\Phi^E$ :

$$\rho(E) = \int \phi_x^E(y) d\mu(x, y). \quad (7.1)$$

The spectrum of Schrödinger operators is compact; let  $E_0 > 0$  be such that  $\Sigma \subset [-E_0, E_0]$ . The following result corresponds to (strict) monotonicity for the quantity  $\Phi^E$  with respect to the energy.

**Lemma 4.57** (Lemma 2.3, [4]). *Let  $n \geq 2$ ; then for any  $E \in \mathbb{R}$  and  $(x, y) \in \mathbb{T} \times \mathbb{R}$ , the derivative  $\partial_E[(\Phi_x^E)^n(y)]$  is strictly negative. In particular, there exists  $\eta_0 > 0$  such that for any  $E \in [-E_0, E_0]$ , and any  $(x, y) \in \mathbb{T} \times \mathbb{R}$ , we have*

$$\partial_E[(\Phi_x^E)^2(y)] = \partial_E[\phi_x^E(y) + \phi_{x+\alpha}^E(y + \phi_x^E(y))] \leq -\eta_0 < 0. \quad (7.2)$$

**7.1. Analysis of the drift near the boundary of a spectral gap.** Given some integer  $k \in \mathbb{Z} \setminus \{0\}$ , we look at the spectral gap  $G_k(V)$ . Recall that we denote  $G_k(V) = (E_k^-(V), E_k^+(V))$ . We assume that the energy  $E_k^+ = E_k^+(V)$  on its right boundary is subcritical, i.e.,  $E_k^+ \in I_i$  for some  $1 \leq i \leq m$ . By Corollary 4.45, there exist  $Y = \begin{pmatrix} Y_{11} & Y_{12} \\ Y_{21} & Y_{22} \end{pmatrix} \in C^\omega(\mathbb{T}, \text{PSL}(2, \mathbb{R}))$  as well as  $\varphi \in \mathbb{R}$  such that for every  $x \in \mathbb{T}$ ,

$$Y(x + \alpha)^{-1} S_{E_k^+}^V(x) Y(x) = \begin{pmatrix} 1 & \varphi \\ 0 & 1 \end{pmatrix}. \quad (7.3)$$

Moreover, for some integer  $n' = n'(k) \in \mathbb{Z}$  and constants  $c, D > 0$  independent of  $k$ , we have

$$|\varphi| \leq D e^{-c|n'|}, \quad |Y|_{\mathbb{T}} \leq e^{o(|n'|)}, \quad |k| \leq D|n'|. \quad (7.4)$$

As we have seen in Section 6, (7.3) implies that for every  $\delta \in \mathbb{R}$ , and for any  $x \in \mathbb{T}$ , we have

$$S_{E_k^+ + \delta}^V(x) = Y(x + \alpha) B_\delta(x) Y(x)^{-1}, \quad (7.5)$$

where  $B_\delta(x) = B_{k,\delta}(x)$  is of the following form:

$$B_\delta(x) = \begin{pmatrix} 1 + \delta(Y_{11}(x)Y_{12}(x) - \varphi Y_{11}^2(x)) & \varphi + \delta(Y_{12}^2(x) - \varphi Y_{11}(x)Y_{12}(x)) \\ -\delta Y_{11}^2(x) & 1 - \delta Y_{11}(x)Y_{12}(x) \end{pmatrix}.$$

Let  $d_k$  be the degree of the map  $Y$ . We let  $\rho_k(\delta)$  be the fibered rotation number of the cocycle  $(\alpha, B_\delta)$ . It follows from (7.5) that

$$\rho(E_k^+ + \delta) = \rho_k(\delta) + \langle d_k \rangle. \quad (7.6)$$

We want to show that for some  $\delta < 0$  exponentially small,  $\rho(E_k^+ + \delta) \neq \rho(E_k^+)$ ; from the previous formula, we see that it is enough to show that  $\rho_k(\delta) \neq \rho_k(0)$ .

For any  $x \in \mathbb{T}$ , let us denote by  $y \mapsto \psi_x^\delta(y)$  the ‘‘drift’’ associated with the matrix  $B_\delta(x)$ . It is given by the formula:

$$\frac{B_\delta(x) \cdot e^{2\pi i y}}{|B_\delta(x) \cdot e^{2\pi i y}|} = e^{2\pi i(y + \psi_x^\delta(y))}, \quad \forall (x, y) \in \mathbb{T} \times \mathbb{R}.$$

We also denote by  $\Psi^\delta: (x, y) \mapsto (x + \alpha, \Psi_x^\delta(y))$  the lift of the action of  $(\alpha, B_\delta)$ , where  $\Psi_x^\delta(y) := y + \psi_x^\delta(y)$ . For any  $(x, y) \in \mathbb{T} \times \mathbb{R}$ , we see that

$$\psi_x^\delta(y) = -\frac{1}{2\pi} \arctan \left( \frac{P_\delta(\tan(2\pi y))}{Q_\delta(\tan(2\pi y))} \right), \quad (7.7)$$

where  $P_\delta(X)$  and  $Q_\delta(X)$  correspond to two quadratic polynomials

$$\begin{aligned} P_\delta(X) &:= (\varphi + \delta(Y_{12}^2(x) - \varphi Y_{11}(x)Y_{12}(x)))X^2 + \delta(2Y_{11}(x)Y_{12}(x) - \varphi Y_{11}^2(x))X + \delta Y_{11}^2(x), \\ Q_\delta(X) &:= (1 - \delta Y_{11}(x)Y_{12}(x))X^2 + (\varphi + \delta[(Y_{12}^2(x) - Y_{11}^2(x)) - \varphi Y_{11}(x)Y_{12}(x)])X + \\ &\quad + 1 + \delta(Y_{11}(x)Y_{12}(x) - \varphi Y_{11}^2(x)). \end{aligned}$$

We denote their respective discriminants by  $\Delta_1^\delta$  and  $\Delta_2^\delta$ . It is easy to see that

$$\Delta_1^\delta = \varphi \delta Y_{11}^2(x) (\varphi \delta Y_{11}^2(x) - 4), \quad \Delta_2^\delta = -4 + (\varphi + \delta(Y_{11}^2(x) + Y_{12}^2(x) - \varphi Y_{11}(x)Y_{12}(x)))^2.$$

Since for  $\delta = 0$ , the cocycle  $(\alpha, B_0)$  is constant, the map  $\psi_x^0 \equiv \psi^0$  does not depend on  $x$ . The parabolic matrix  $B_0$  has a unique fixed point,  $\begin{pmatrix} 1 \\ 0 \end{pmatrix}$ ; accordingly, 0 is the unique fixed point of  $y \mapsto y + \psi^0(y)$ . Any measure invariant by  $(x, y) \mapsto (x + \alpha, y + \psi^0(y))$  has support in the non-wandering set, which is here reduced to  $\mathbb{T} \times \{0\}$ . We deduce that the rotation number vanishes:  $\rho_k(0) = 0$ .

Assume that  $\delta > 0$ ,  $|\delta| \ll 1$ . Since we consider the right boundary of a spectral gap, we know that  $\varphi \geq 0$ . We assume  $\varphi > 0$ . We then see that for  $\delta > 0$  very small,  $\Delta_1^\delta < 0$  and  $\Delta_2^\delta < 0$ , so both  $P_\delta$  and  $Q_\delta$  are positive. Therefore, for any  $x \in \mathbb{T}$  and any  $y \in \mathbb{R}$ , the drift  $\psi_x^\delta(y)$  is negative; in particular, the rotation number  $\rho_k(\delta)$  becomes strictly negative: we have left the spectral gap.

The following estimate shows that the initial drift is exponentially small:

**Lemma 4.58.** *There exists a constant  $\tilde{D} > 0$  independent of  $k$  such that for any  $y \in \mathbb{R}$ ,*

$$0 \leq -\psi^0(y) \leq \tilde{D}e^{-c|n'|}. \quad (7.8)$$

PROOF. If we take  $\delta = 0$  in (7.7), we see that for every  $(x, y) \in \mathbb{T} \times \mathbb{R}$ ,

$$\psi^0(y) = -\frac{1}{2\pi} \arctan \left( \frac{\varphi \tan^2(2\pi y)}{\tan^2(2\pi y) + \varphi \tan(2\pi y) + 1} \right). \quad (7.9)$$

In particular, the previous quantity is always nonpositive; it vanishes for  $y = 0$  and attains its minimum when  $\tan(2\pi y) = -2/\varphi$ . Therefore, for any  $(x, y) \in \mathbb{T} \times \mathbb{R}$ ,

$$\psi^0(y) \geq -\frac{1}{2\pi} \arctan \left( \frac{\varphi}{1 - (\varphi/2)^2} \right).$$

Since by (7.4),  $0 \leq \varphi \leq De^{-c|n'|}$ , the result follows.  $\square$

**7.2. Estimates on the derivative of the second iterate of the drift.** We show here that the derivative of the second iterate of  $\psi^\delta$  is negative, subexponentially small; this follows from monotonicity of Schrödinger cocycles, that we detailed above, through the conjugacy  $Y$ .

Recall that for any  $x \in \mathbb{T}$ , we denote by  $\Phi_x^E: y \mapsto y + \phi_x^E(y)$  the map corresponding to the change of argument under the action of  $S_E^V(x)$ . The cocycle  $(0, Y)$  induces an action on  $\mathbb{T} \times \mathbb{S}^1$ , given by the following formula:

$$(x, e^{2\pi iy}) \mapsto \left( x, \frac{Y(x) \cdot e^{2\pi iy}}{|Y(x) \cdot e^{2\pi iy}|} \right).$$

The previous map admits a lift to  $\mathbb{T} \times \mathbb{R}$ , denoted by

$$\Theta = \Theta^k: (x, y) \mapsto (x, \Theta_x(y)).$$

In this case, the map  $(x, y) \mapsto (x, \Theta_x^{-1}(y))$  is also a lift for the action of  $(0, Y^{-1})$ . We have the following statement.

**Lemma 4.59.** *For any  $(x, y) \in \mathbb{T} \times \mathbb{R}$ ,*

$$\partial_\delta|_{\delta=0}[(\Psi_x^\delta)^2(y)] = (\Theta_{x+2\alpha}^{-1})'((\Phi_{x^k}^{E^+})^2 \circ \Theta_x(y)) \cdot \partial_E|_{E=E_k^+} [(\Phi_x^E)^2(y)] (\Theta_x(y)).$$

PROOF. The conjugacy relation (7.5) translates as follows in terms of the lifted dynamics (see [35] for instance): for any  $\delta \in \mathbb{R}$ , and any  $(x, y) \in \mathbb{T} \times \mathbb{R}$ ,

$$\Psi_x^\delta(y) = \Theta_{x+\alpha}^{-1} \circ \Phi_x^{E_k^+ + \delta} \circ \Theta_x(y).$$

Iterating once, we obtain:

$$(\Psi_x^\delta)^2(y) = \Theta_{x+2\alpha}^{-1} \circ (\Phi_x^{E_k^+ + \delta})^2 \circ \Theta_x(y),$$

and the result follows, by chain rule.  $\square$

**Lemma 4.60.** *The quantities  $\Theta'_x, (\Theta_x^{-1})'$  are always positive. Moreover,*

$$\begin{aligned} \inf_{x \in \mathbb{T}} \inf_{y \in \mathbb{R}} \Theta'_x(y) &\geq e^{-\alpha(|n'|)}, \\ \inf_{x \in \mathbb{T}} \inf_{y \in \mathbb{R}} (\Theta_x^{-1})'(y) &\geq e^{-\alpha(|n'|)}. \end{aligned} \quad (7.10)$$

We also have

$$\sup_{x \in \mathbb{T}} \sup_{y \in \mathbb{R}} \Theta'_x(y) \leq e^{\alpha(|n'|)}, \quad \sup_{x \in \mathbb{T}} \sup_{y \in \mathbb{R}} (\Theta_x^{-1})'(y) \leq e^{\alpha(|n'|)}. \quad (7.11)$$

PROOF. For any  $x \in \mathbb{T}$ , the quantity  $\Theta_x(y)$  is characterized by the following equation:

$$\tan(2\pi\Theta_x(y)) = \frac{Y_{21}(x) + Y_{22}(x) \tan(2\pi y)}{Y_{11}(x) + Y_{12}(x) \tan(2\pi y)}.$$

Set  $t = \tan(2\pi y)$ . Since  $\det(Y) = 1$ , we thus get

$$\begin{aligned} \Theta'_x(y) &= \frac{1 + \tan(2\pi y)^2}{(1 + \tan(2\pi\Theta_x(y)))^2 (Y_{11}(x) + Y_{12}(x) \tan(2\pi y))^2} \\ &= \frac{1 + t^2}{(Y_{12}^2(x) + Y_{22}^2(x))t^2 + 2(Y_{11}(x)Y_{12}(x) + Y_{21}(x)Y_{22}(x))t + (Y_{11}^2(x) + Y_{21}^2(x))}. \end{aligned}$$

The denominator is equal to  $(Y_{11}(x) + Y_{12}(x)t)^2 + (Y_{21}(x) + Y_{22}(x)t)^2$ . Set

$$\begin{cases} a &= a_k &:= Y_{12}^2(x) + Y_{22}^2(x), \\ b &= b_k &:= 2(Y_{11}(x)Y_{12}(x) + Y_{21}(x)Y_{22}(x)), \\ c &= c_k &:= Y_{11}^2(x) + Y_{21}^2(x), \end{cases}$$

so that  $\Theta'_x(y) = \frac{1+t^2}{at^2+bt+c}$ . Since  $\det(Y) = 1$ , we have  $b^2 - 4ac = -4$ . In particular, the discriminant of the denominator is equal to  $-4$ , and  $\Theta'_x(y)$  is always positive. Set



$M = M_k := \frac{2|b|}{a}$ . For any  $t \in [-M, M]$ , we obtain

$$\frac{1+t^2}{at^2+bt+c} \geq \frac{1}{aM^2+|b|M+c} \geq \frac{1}{25c}.$$

For any  $|t| \geq M$ , we have  $at^2 \geq 2|bt|$ , hence

$$\frac{1+t^2}{at^2+bt+c} \geq \frac{1+t^2}{2at^2+c} \geq \min\left(\frac{1}{c}, \frac{1}{2a}\right).$$

By (7.4), we know that  $|Y|_{\mathbb{T}} \leq e^{o(|n'|)}$ . We deduce:

$$\inf_{x \in \mathbb{T}} \inf_{y \in \mathbb{R}} \Theta'_x(y) \geq \frac{1}{100|Y|_{\mathbb{T}}^2} \geq e^{-o(|n'|)}.$$

The polynomial  $(at^2+bt+c)$  is minimal when  $t = t_k := -\frac{b}{2a}$ , and it is then equal to  $\frac{1}{a}$ ; note that  $t_k \in [-M, M]$ . For any  $t \in [-M, M]$ , we have

$$\frac{1+t^2}{at^2+bt+c} \leq a(1+M^2) \leq a+16c.$$

For any  $|t| \geq M$ , we have  $at^2 \geq 2|bt|$ , hence

$$\frac{1+t^2}{at^2+bt+c} \leq \frac{2(1+t^2)}{at^2+2c} \leq \max(2/a, 1/c).$$

Recall that  $|Y|_{\mathbb{T}} \leq e^{o(|n'|)}$ . Moreover  $a$  and  $c$  correspond to the squares of the norms of the columns of  $Y$ , hence  $\inf_{\mathbb{T}} a, \inf_{\mathbb{T}} c \geq e^{-o(|n'|)}$  and we deduce

$$\sup_{x \in \mathbb{T}} \sup_{y \in \mathbb{R}} \Theta'_x(y) \leq e^{o(|n'|)}.$$

For any  $x \in \mathbb{T}$ , the map  $y \mapsto (\Theta_x)^{-1}(y)$  is defined in the same way for the matrix  $Y(x)^{-1}$ . In particular, for any  $(x, y) \in \mathbb{T} \times \mathbb{R}$ , we have

$$\tan(2\pi(\Theta_x)^{-1}(y)) = \frac{-Y_{21}(x) + Y_{11}(x) \tan(2\pi y)}{Y_{22}(x) - Y_{12}(x) \tan(2\pi y)},$$

hence

$$(\Theta_x^{-1})'(y) = \frac{1+t^2}{(Y_{12}^2(x) + Y_{11}^2(x))t^2 - 2(Y_{22}(x)Y_{12}(x) + Y_{21}(x)Y_{11}(x))t + (Y_{22}^2(x) + Y_{21}^2(x))},$$

and the estimates are proven similarly.  $\square$

Recall that  $\psi^\delta$  denotes the drift associated with the cocycle  $(\alpha, B_\delta)$ . For any  $(x, y) \in \mathbb{T} \times \mathbb{R}$ , we estimate the derivative of its second iterate, given by  $(\Psi_x^\delta)^2(y) = y + \psi_x^\delta(y) + \psi_{x+\alpha}^\delta(y + \psi_x^\delta(y))$ . Combining Lemma 4.57, Lemma 4.59 and Lemma 4.60, we deduce the following lower bound:

**Proposition 4.61.** *We have the following uniform bounds: for any  $(x, y) \in \mathbb{T} \times \mathbb{R}$ ,*

$$-\eta_0 e^{o(|n'|)} \leq \partial_\delta|_{\delta=0} [(\Psi_x^\delta)^2(y)] \leq -\eta_0 e^{-o(|n'|)} < 0. \quad (7.12)$$

PROOF. We have seen in Lemma 4.59 that for any  $(x, y) \in \mathbb{T} \times \mathbb{R}$ ,

$$\partial_\delta|_{\delta=0} [(\Psi_x^\delta)^2(y)] = (\Theta_{x+2\alpha}^{-1})'((\Phi_x^{E_k^+})^2 \circ \Theta_x(y)) \cdot \partial_E|_{E=E_k^+} [(\Phi_x^E)^2(y)] (\Theta_x(y)). \quad (7.13)$$

Now, we know from Lemma 4.57 that for any  $(x, y) \in \mathbb{T} \times \mathbb{R}$ ,

$$\partial_E|_{E=E_k^+} [(\Phi_x^E)^2(y)] (\Theta_x(y)) \leq -\eta_0. \quad (7.14)$$

From Lemma 4.60 we also have uniform bounds:

$$e^{-o(|n'|)} \leq (\Theta_{x+2\alpha}^{-1})'((\Phi_x^{E_k^+})^2 \circ \Theta_x(y)) \leq e^{o(|n'|)}. \quad (7.15)$$

The inequalities in (7.12) then follow from (7.13), (7.14) and (7.15).  $\square$

**7.3. End of the proof of upper bounds.** Let us see how the previous results imply exponential decay of the size of spectral gaps. In particular, we obtain another proof Theorem 4.55.

Near the right edge of  $G_k(V)$ , the cocycle  $(\alpha, S_{E_k^+ + \delta}^V)$  is conjugated to  $(\alpha, B_\delta)$ , and we have the following expansion for the drift of its second iterate: there exist continuous functions  $\alpha^0 = \alpha_k^0: y \mapsto \alpha^0(y)$  and  $\alpha^1 = \alpha_k^1: (x, y) \mapsto \alpha^1(x, y)$ , such that for any  $(x, y) \in \mathbb{T} \times \mathbb{R}$ ,

$$(\Psi_x^\delta)^2(y) - y = \psi_x^\delta(y) + \psi_{x+\alpha}^\delta(y + \psi_x^\delta(y)) = \alpha^0(y) + \delta\alpha^1(x, y) + O(\delta^2).$$

From (7.8) and (7.12), we have uniform bounds on them: for any  $(x, y) \in \mathbb{T} \times \mathbb{R}$ ,

$$0 \leq -\alpha^0(y) \leq 2\tilde{D}e^{-c|n'|}, \quad \alpha^1(x, y) \leq -\eta_0 e^{-o(|n'|)} < 0.$$

By compactness, there exists  $\tilde{\delta}_k > 0$ , with

$$\tilde{\delta}_k \lesssim \frac{\sup_y |\alpha^0(y)|}{\inf_{x', y'} |\alpha^1(x', y')|} \leq 2\tilde{D}\eta_0 e^{-|n'|c + o(1)}, \quad (7.16)$$

such that for  $\delta < -\tilde{\delta}_k$ , we may find  $\omega_k^\delta > 0$  satisfying: for any  $(x, y) \in \mathbb{T} \times \mathbb{R}$ ,

$$\psi_x^\delta(y) + \psi_{x+\alpha}^\delta(y + \psi_x^\delta(y)) \geq \omega_k^\delta > 0. \quad (7.17)$$

Take  $\delta < -\tilde{\delta}_k$ , and let  $\mu$  be any measure invariant under  $\Psi^\delta: (x, y) \mapsto (x + \alpha, \Psi_x^\delta(y))$ . In particular,  $\int \psi_x^\delta(y) d\mu = \int \psi_{x+\alpha}^\delta(y + \psi_x^\delta(y)) d\mu$ , and we deduce from (7.17) that

$$\rho_k(\delta) = \int \psi_x^\delta(y) d\mu(x, y) \geq \omega_k^\delta/2 > 0 = \rho_k(0). \quad (7.18)$$

Thanks to (7.6) and the remark that follows it, we deduce that  $E_k^+ + \delta \notin G_k(V)$ ; therefore  $E_k^+ - E_k^- \leq \tilde{\delta}_k$ . From (7.16), and since  $|k| \leq D|n'|$  by (7.4), we obtain uniform constants  $\tilde{C}, \tilde{\xi} > 0$  such that

$$|G_k(V)| \leq \tilde{C} e^{-\tilde{\xi}|k|},$$

which concludes the proof.  $\square$

## 8. Homogeneous spectrum

In this section, we study homogeneity of the spectrum  $\Sigma_{V, \alpha}$  of a Schrödinger operator  $H_{V, \alpha, \theta}$  for some (measure-theoretically) typical potential  $V \in C^\omega(\mathbb{T}, \mathbb{R})$ , and when the frequency  $\alpha \in \mathbb{R} \setminus \mathbb{Q}$  satisfies a strong Diophantine condition. Homogeneity of  $\Sigma_{V, \alpha}^{\text{sup}}$  has already been handled in [25], hence we focus on  $\Sigma_{V, \alpha}^{\text{sub}} = \cup_i (\Sigma_{V, \alpha} \cap I_i)$  in the following.

**8.1. Hölder continuity of the rotation number.** At first, we consider the integrated density of states  $N = N_{V, \alpha}$  of the Schrödinger operator  $H_{V, \alpha, \theta}$ . We follow the strategy of proof of Theorem 1.6 in [7] to show the Hölder continuity of  $N$  in the global regime.

**Theorem 4.62.** *Let  $\beta(\alpha) = 0$ . For a (measure-theoretically) typical  $V \in C^\omega(\mathbb{T}, \mathbb{R})$ , the integrated density of states  $N = N_{V, \alpha}$  of  $H_{V, \alpha, \theta}$  is  $\frac{1}{2}$ -Hölder continuous on  $I_i$ ,  $1 \leq i \leq m$ .*

**PROOF.** Fix  $0 < \epsilon < 1$ ,  $i \in \{1, \dots, m\}$  and  $E \in \Sigma_{V, \alpha} \cap I_i$ . In view of (5.9), there exists a map  $\Psi_E \in C^\omega(\mathbb{T}, \text{SL}(2, \mathbb{R}))$  which conjugates the Schrödinger cocycle  $(\alpha, S_E^V)$  to a cocycle  $(\alpha, S_{\tilde{E}}^V)$  in the perturbative regime considered in [7] and [1], that is, with our choice of  $\epsilon$ , such that  $|\tilde{V}_E|_\epsilon < c_0 \epsilon^{k_0}$ , where  $c_0, k_0 > 0$  are absolute constants.

By Theorem 3.8 of [1], there exist a phase  $\theta' = \theta'(E) \in \mathbb{T}$  and constants  $C = C(\alpha, \epsilon) > 0$ ,  $c = c(\alpha, \epsilon) > 0$  and  $\epsilon_0 = \epsilon_0(\epsilon) > 0$  such that the following is true. Let us denote by  $\{n_j\}_j$  the set of  $\epsilon_0$ -resonances of  $\theta'$ , ordered in such a way that  $|n_j| \leq |n_{j+1}|$ . For any small  $\varepsilon > 0$ , take  $j$  such that  $e^{-cN} \leq \varepsilon \leq Cn^{-4C}$ , with  $n := |n_j| + 1$  and  $N := |n_{j+1}|$  if defined, else  $N := +\infty$ . By composing  $\Psi_E$  with the conjugacy

given by Theorem 3.8 of [1], and since  $\Psi_E$  is uniformly upper bounded, we get a map  $\Phi \in C_c^\omega(\mathbb{T}, \text{SL}(2, \mathbb{C}))$  such that  $|\Phi|_c \leq Cn^C$  and

$$\Phi(x + \alpha)^{-1} S_E^V(x) \Phi(x) = \begin{pmatrix} e^{2\pi i \theta'} & 0 \\ 0 & e^{-2\pi i \theta'} \end{pmatrix} + \begin{pmatrix} q_1(x) & q(x) \\ q_3(x) & q_4(x) \end{pmatrix}, \quad \forall x \in \mathbb{T},$$

where  $|q_1|_c, |q_3|_c, |q_4|_c \leq Ce^{-cN}$  and  $|q|_c \leq Ce^{-cn}$ . Let  $D := \begin{pmatrix} d^{-1} & 0 \\ 0 & d \end{pmatrix}$  with  $d := |\Phi|_c \varepsilon^{1/4}$ , and set  $W := \Phi D \in C^\omega(\mathbb{T}, \text{SL}(2, \mathbb{C}))$ . It follows from the bounds on  $\Phi$  and  $\varepsilon$  that  $|W|_c \leq C' \varepsilon^{-1/4}$  for some uniform constant  $C' > 0$ . Define  $Z_\varepsilon := W(\cdot + \alpha)^{-1} S_{E+i\varepsilon}^V W = W(\cdot + \alpha)^{-1} S_E^V W + W(\cdot + \alpha)^{-1} \begin{pmatrix} i\varepsilon & 0 \\ 0 & 0 \end{pmatrix} W$ , so that for some uniform constant  $C'' > 0$ , we get

$$|Z_\varepsilon|_c \leq 1 + C'' \varepsilon^{1/2}.$$

As a result, we obtain the following estimate on the Lyapunov exponent:

$$L(E + i\varepsilon) = L(\alpha, Z_\varepsilon) \leq \ln |Z_\varepsilon|_c \leq C'' \varepsilon^{1/2}. \quad (8.1)$$

The above conclusions are similar to Theorem 4.4 and Corollary 4.6 in [7], and we refer to them for more details.

On the other hand, by Thouless formula, we have  $L(E_1) = \int \ln |E_1 - E_2| dN(E_2)$  for any  $E_1 > 0$ . Therefore, there exists a constant  $c' > 0$  such that for any  $\varepsilon > 0$ ,

$$\begin{aligned} L(E + i\varepsilon) &= L(E + i\varepsilon) - L(E) \\ &= \frac{1}{2} \int \ln \left( 1 + \frac{\varepsilon^2}{(E - E')^2} \right) dN(E') \\ &\geq c' (N(E + \varepsilon) - N(E - \varepsilon)). \end{aligned}$$

Combining the last estimate with (8.1), we deduce that  $N(E + \varepsilon) - N(E - \varepsilon) \leq C'' c'^{-1} \varepsilon^{1/2}$  for any small  $\varepsilon > 0$ . Therefore, for any  $E \in \Sigma_{V,\alpha} \cap I_i$ , there exists  $\varepsilon^0 = \varepsilon^0(E) > 0$  such that  $N$  is uniformly  $\frac{1}{2}$ -Hölder on  $[E - \varepsilon^0, E + \varepsilon^0]$ . By the compactness of  $\Sigma_{V,\alpha} \cap I_i$ , we can cover it by a finite number of such intervals, and we conclude that the integrate density of states  $N$  is uniformly  $\frac{1}{2}$ -Hölder on  $\Sigma_{V,\alpha} \cap I_i$ .  $\square$

Recall that the rotation number  $\rho$  of  $(\alpha, S_V^E)$  is related to the integrated density of states  $N$  of  $H_{V,\alpha,\theta}$  as follows:

$$N(E) = 1 - 2\rho(E).$$

We then have the following corollary.

**Corollary 4.63.** *Let  $\beta(\alpha) = 0$ . Then the rotation number  $\rho$  of  $(\alpha, S_V^E)$  is  $\frac{1}{2}$ -Hölder continuous on  $I_i$ ,  $1 \leq i \leq m$ .*

## 8.2. End of the proofs of Theorem P and Theorem Q.

**Theorem 4.64.** *Let  $\beta(\alpha) = 0$ . Given any  $\mu_0 \in (0, 1)$ , there exists  $\epsilon_0 = \epsilon_0(\mu_0) > 0$  such that for any  $E \in \Sigma_{V,\alpha}^{\text{sub}}$ , we have*

$$|\Sigma_{V,\alpha}^{\text{sub}} \cap (E - \epsilon, E + \epsilon)| > \mu_0 \epsilon, \quad \forall 0 < \epsilon \leq \epsilon_0. \quad (8.2)$$

Set  $\mathcal{M} := \{\langle n \rangle : n \in \mathbb{Z}\}$ . We start with the following claim.

**Claim.** *Let  $\xi > 0$  be taken as in Theorem 4.55. Then there is a constant  $c > 0$  such that, for any spectral gap  $G_k = (E_k^-, E_k^+)$ ,  $k \in \mathbb{Z} \setminus \{0\}$ , with  $[E_k^-, E_k^+] \cap I_i \neq \emptyset$ , if  $\epsilon > 0$  is sufficiently small such that  $\frac{4|\ln \epsilon|}{3\xi} \geq |k|$ , then*

$$|\rho^{-1}(\mathcal{M}) \cap [E_k^+, E_k^+ + \epsilon] \cap I_i|, |\rho^{-1}(\mathcal{M}) \cap [E_k^- - \epsilon, E_k^-] \cap I_i| \leq c\epsilon^{\frac{8}{3}}.$$

PROOF OF THE CLAIM. Take  $k \in \mathbb{Z} \setminus \{0\}$  and  $\epsilon > 0$  as above. We show the above estimate for the interval  $[E_k^+, E_k^+ + \epsilon] \cap I_i$ ; the other case is handled in a similar way. Set  $E_* := E_k^+$  and assume that  $[E_*, E_* + \epsilon] \cap I_i \neq \emptyset$ , otherwise there is nothing to prove. Since we also have  $[E_k^-, E_k^+] \cap I_i \neq \emptyset$ , we deduce that  $E_* \in I_i$ .

Let  $\mathcal{N} := \{n \in \mathbb{Z} \setminus \{0\} : \rho^{-1}(\langle n \rangle) \cap [E_*, E_* + \epsilon] \cap I_i \neq \emptyset\}$ . By Corollary 4.63,  $\rho$  is  $\frac{1}{2}$ -Hölder continuous on  $I_i$ , hence there exists a constant  $c_1 > 0$  such that for any  $n \in \mathcal{N}$ ,

$$|\rho(E_*) - \rho(E)| \leq c_1 \epsilon^{\frac{1}{2}}, \quad \forall E \in \rho^{-1}(\langle n \rangle) \cap [E_*, E_* + \epsilon] \cap I_i.$$

On the other hand, take  $\xi > 0$  as in Theorem 4.55. Since  $\beta(\alpha) = 0$ , by (??), we see that there is a numerical constant  $c_\xi > 0$  such that

$$|\rho(E_*) - \rho(E)| = |\langle k - n \rangle| \geq c_\xi e^{-\frac{\xi}{8}|k-n|}.$$

By the above estimate, we get  $c_\xi e^{-\frac{\xi}{8}|k-n|} \leq c_1 \epsilon^{\frac{1}{2}}$ , and thus,  $|k-n| \geq \frac{8}{\xi}(\frac{1}{2}|\ln \epsilon| + \ln(\frac{c_\xi}{c_1}))$ . Since  $\frac{4|\ln \epsilon|}{3\xi} \geq |k|$ , it follows that  $|n| \geq |k-n| - |k| \geq \frac{8}{\xi}(\frac{1}{3}|\ln \epsilon| + \ln(\frac{c_\xi}{c_1}))$ . By the exponential upper bound obtained in Theorem 4.55, we get

$$\sum_{n \in \mathcal{N}} |\rho^{-1}(\langle n \rangle)| \leq C \int_{\frac{8}{\xi}(\frac{1}{3}|\ln \epsilon| + \ln(\frac{c_\xi}{c_1}))}^{+\infty} e^{-\xi t} dt = \frac{C e^\xi}{\xi} e^{-8(\frac{1}{3}|\ln \epsilon| + \ln(\frac{c_\xi}{c_1}))} = \frac{C e^\xi}{\xi} \left(\frac{c_1}{c_\xi}\right)^8 \epsilon^{\frac{8}{3}}.$$

□

PROOF OF THEOREM 4.64. Fix  $E \in \Sigma_{V,\alpha}^{\text{sub}}$ , i.e.,  $E \in \Sigma_{V,\alpha} \cap I_i$  for some  $1 \leq i \leq m$ . Recall that by spectral uniformity, there exists  $\chi > 0$  such that  $\text{dist}(\Sigma_{V,\alpha}^{\text{sub}}, \Sigma_{V,\alpha}^{\text{sup}}) > \chi$ . Choose  $0 < \epsilon < \chi$  such that  $(E - \epsilon, E + \epsilon) \cap I_j = \emptyset$  for  $j \neq i$ . We define

$$\mathfrak{C}(E, \epsilon) := \{m \in \mathbb{Z} \setminus \{0\} : \rho^{-1}(\langle m \rangle) \cap (E - \epsilon, E + \epsilon) \cap I_i \neq \emptyset\}.$$

Let  $m_0 = m_0(E, \epsilon) \in \mathfrak{C}(E, \epsilon)$  be such that  $|m_0| = \min_{m \in \mathfrak{C}(E, \epsilon)} |m|$ . Since  $E \in \Sigma_{V,\alpha}$ , we have  $E \notin (E_{m_0}^-, E_{m_0}^+)$ , hence  $|(E_{m_0}^-, E_{m_0}^+) \cap (E - \epsilon, E + \epsilon)| \leq \epsilon$ .

If  $|m_0| > \frac{4}{3\xi}(|\ln \epsilon| - \ln 2)$ , then  $e^{-\xi|m_0|} \leq 2^{\frac{4}{3}} \epsilon^{\frac{4}{3}}$ . We thus get

$$\sum_{m \in \mathfrak{C}(E, \epsilon) \setminus \{m_0\}} |(E_m^-, E_m^+) \cap (E - \epsilon, E + \epsilon)| \leq \frac{2^{\frac{7}{3}} \epsilon^{\frac{4}{3}}}{1 - e^{-\xi}}.$$

Otherwise,  $|m_0| \leq \frac{4}{3\xi}(|\ln \epsilon| - \ln 2) = \frac{4}{3\xi} \ln(2\epsilon)$ . In view of the above claim, we obtain

$$\begin{aligned} & \sum_{m \in \mathfrak{C}(E, \epsilon) \setminus \{m_0\}} |(E_m^-, E_m^+) \cap (E - \epsilon, E + \epsilon) \cap I_i| \\ & \leq |\rho^{-1}(\mathcal{M}) \cap [E - \epsilon, E_{m_0}^-] \cap I_i| + |\rho^{-1}(\mathcal{M}) \cap [E_{m_0}^+, E + \epsilon] \cap I_i| \\ & \leq \frac{2^{\frac{11}{3}} C e^\xi}{\xi} \left(\frac{c_1}{c_\xi}\right)^8 \epsilon^{\frac{8}{3}}, \end{aligned}$$

since the lengths of  $[E - \epsilon, E_{m_0}^-]$  and  $[E_{m_0}^+, E + \epsilon]$  are both smaller than  $2\epsilon$ . Therefore, we conclude that there exists a constant  $c_2 > 0$  such that

$$\sum_{m \in \mathfrak{C}(E, \epsilon) \setminus \{m_0\}} |(E_m^-, E_m^+) \cap (E - \epsilon, E + \epsilon) \cap I_i| \leq c_2 \epsilon^{\frac{4}{3}}.$$

Now fix  $\mu_0 \in (0, 1)$ . Choose  $\epsilon_0$  such that  $0 < \epsilon_0 < \min\{(\frac{1-\mu_0}{c_2})^3, \chi\}$  and let  $0 < \epsilon \leq \epsilon_0$ . Combining the previous inequalities, we finally get

$$\begin{aligned} |(E - \epsilon, E + \epsilon) \cap \Sigma_{V,\alpha}^{\text{sub}}| & \geq 2\epsilon - |(E_{m_0}^-, E_{m_0}^+) \cap (E - \epsilon, E + \epsilon)| \\ & \quad - \sum_{m \in \mathfrak{C}(E, \epsilon) \setminus \{m_0\}} |(E_m^-, E_m^+) \cap (E - \epsilon, E + \epsilon) \cap I_i| \\ & \geq 2\epsilon - \epsilon - c_2 \epsilon^{\frac{4}{3}} \\ & \geq \epsilon(1 - c_2 \epsilon^{\frac{1}{3}}) \\ & \geq \mu_0 \epsilon, \end{aligned}$$

as desired.  $\square$

**PROOF OF THEOREM Q.** It just remains to prove point (3) giving lower bounds on bands. Let then  $k \neq k' \in \mathbb{Z}$ ,  $|k'| \geq |k|$ , with  $\partial G_k \cap I_i \neq \emptyset$  and  $\partial G_{k'} \cap I_i \neq \emptyset$ . Without loss of generality, we can assume that  $[E_k^+, E_{k'}^-] \subset I_i$  and  $\text{dist}([E_k^-, E_k^+], [E_{k'}^-, E_{k'}^+]) = E_{k'}^- - E_k^+$ . On the one hand, since  $\beta(\alpha) = 0$ , for any  $\xi > 0$ , (2.3) implies that there exists  $c_\xi > 0$  such that

$$|\rho(E_{k'}^-) - \rho(E_k^+)| = |(k' - k)| \geq c_\xi e^{-\xi|k' - k|/4} \geq c_\xi e^{-\xi|k'|/2}.$$

On the other hand, by Corollary 4.63, for some constant  $\tilde{C} > 0$ , we have  $|\rho(E_{k'}^-) - \rho(E_k^+)| \leq \tilde{C}(E_{k'}^- - E_k^+)^{\frac{1}{2}}$ . Combining the above estimates, we conclude that

$$\text{dist}([E_k^-, E_k^+], [E_{k'}^-, E_{k'}^+]) \geq \tilde{C}^{-2} c_\xi^2 e^{-\xi|k'|}.$$

$\square$

**PROOF OF THEOREM P.** Assume that the frequency  $\alpha$  satisfies a strong Diophantine condition, i.e.,  $\alpha \in \text{SDC}$  (see (1.6) for the definition). In particular, this implies  $\beta(\alpha) = 0$ .

Take some  $\mu_0 \in (0, 1)$ . Arguing as in Theorem 4.64, we see that there exists  $\epsilon'_0 > 0$  such that for any  $E \in \Sigma_{V, \alpha}^{\text{sub}}$  and any  $0 < \epsilon \leq \epsilon'_0$ ,

$$|(E - \epsilon, E + \epsilon) \cap \Sigma_{V, \alpha}^{\text{sub}}| > \mu_0 \epsilon.$$

On the other hand, for any  $J_i = [E_b, E_*]$ , we have  $\Sigma_{V, \alpha} \cap (E_b - \chi, E_* + \chi) = \Sigma_{V, \alpha} \cap (E_b, E_*)$ . Then the results of [25] (see item (b) of Theorem H) imply that for some  $\mu_1 = \mu_1(V, K, \tau, L_0, \eta) > 0$ , there exists  $\epsilon'_1 > 0$  such that for any  $E \in \Sigma^{\text{sup}}$  and any  $0 < \epsilon \leq \epsilon'_1$ ,

$$|(E - \epsilon, E + \epsilon) \cap \Sigma_{V, \alpha}^{\text{sup}}| > \mu_1 \epsilon.$$

Take  $\mu_2 := \min\{\mu_0, \mu_1\}$  and  $\epsilon'_2 := \min\{\epsilon'_0, \epsilon'_1\}$ . Then for any  $E \in \Sigma$ , any  $0 < \epsilon \leq \epsilon'_2$ , we have

$$|(E - \epsilon, E + \epsilon) \cap \Sigma_{V, \alpha}| = |(E - \epsilon, E + \epsilon) \cap \Sigma_{V, \alpha}^{\text{sub}}| + |(E - \epsilon, E + \epsilon) \cap \Sigma_{V, \alpha}^{\text{sup}}| > \mu_2 \epsilon.$$

In other terms,  $\Sigma_{V, \alpha}$  is  $\mu_2$ -homogeneous.  $\square$

**PROOF OF THEOREM R.** Assume that  $\alpha \in \mathbb{R} \setminus \mathbb{Q}$  satisfies  $\beta(\alpha) = 0$ . In the case of the almost Mathieu operator, we have  $\hat{H}_{2\lambda \cos(2\pi \cdot), \alpha, \theta} = \lambda H_{2\lambda^{-1} \cos(2\pi \cdot), \alpha, \theta}$  for any  $\lambda \in \mathbb{C} \setminus \{0\}$ . Moreover, by Aubry duality, the spectrum of  $\hat{H}_{2\lambda \cos(2\pi \cdot), \alpha, \theta}$  coincides with that of  $H_{2\lambda \cos(2\pi \cdot), \alpha, \theta}$ . In other terms,  $\Sigma_{2\lambda \cos(2\pi \cdot), \alpha} = \Sigma_{2\lambda^{-1} \cos(2\pi \cdot), \alpha}$ . Therefore, since we restrict ourselves to  $|\lambda| \neq 1$ , we only need to consider the case where  $|\lambda| < 1$ . This corresponds to the subcritical regime, and Theorem 4.64 then implies that for any given  $\mu \in (0, 1)$ , the spectrum  $\Sigma_{2\lambda \cos(2\pi \cdot), \alpha}$  is  $\mu$ -homogeneous.  $\square$

## Bibliography

- [1] Avila, A.; *The absolutely continuous spectrum of the almost Mathieu operator*, preprint.
- [2] Avila, A.; *Almost reducibility and absolute continuity I*, preprint.
- [3] Avila, A.; *KAM, Lyapunov exponents and the spectral dichotomy for one-frequency Schrödinger operators*, in preparation.
- [4] Avila, A.; *On the spectrum and Lyapunov exponent of limit periodic Schrödinger operators*, Commun. Math. Phys. **288**, 907–918 (2009).
- [5] Avila, A.; *Global theory of one-frequency Schrödinger operators*, Acta Math. **215**, 1–54 (2015).
- [6] Avila, A., Jitomirskaya, S.; *The Ten Martini Problem*, Ann. of Math. **170**, 303–342 (2009).
- [7] Avila, A., Jitomirskaya, S.; *Almost localization and almost reducibility*, J. Eur. Math. Soc. **12**, 93–131 (2010).
- [8] Avila, A., Jitomirskaya, S.; *Hölder continuity of absolutely continuous spectral measures for one-frequency Schrödinger operators*, Commun. Math. Phys. **301**, 563–581 (2011).
- [9] Avila A. and Krikorian R.; *Reducibility or non-uniform hyperbolicity for quasi-periodic Schrödinger cocycles*, Annals of Mathematics. **164**, 911–940 (2006).
- [10] Avila, A., Krikorian, R.; *Monotonic cocycles*, Inven. math. **202(1)**, 271–331 (2015).
- [11] Avila A., Last Y., Shamis M., Zhou Q.; ; *On the abominable properties of the Almost Mathieu operator with well approximated frequencies*, in preparation.
- [12] Avila A., You J., Zhou Q.; *Sharp phase transitions for the almost Mathieu operator*, ArXiv:1512.03124
- [13] Avila, A., You, J., Zhou, Q.; *Dry ten Martini problem in the non-critical case*, preprint.
- [14] Binder, I., Damanik, D., Goldstein, M., Lukic, M.; *Almost periodicity in time of solutions of the KdV equation*, arXiv preprint arXiv:1509.07373. (2015).
- [15] Bourgain J., Goldstein M.; *On nonperturbative localization with quasi-periodic potential*, Ann. of Math. **152**, 835–879 (2000).
- [16] Bellissard, J., Lima, R., Testard, D.; *Almost periodic Schrödinger operators*, Mathematics + physics. Vol. 1, 1–64, World Sci. Publishing, Singapore (1985).
- [17] Bourgain, J., Jitomirskaya, S.; *Continuity of the Lyapunov exponent for quasi-periodic operators with analytic potential*, J. Stat. Phys. **108**, 1203–1218 (2002).
- [18] Carleson, L.; *On  $H^\infty$  in multiply connected domains*, in *Conference on harmonic analysis in honor of Antoni Zygmund, Vol. I, II (Chicago, Ill., 1981)*, Wadsworth Math. Ser., 349–372. Wadsworth, Belmont, CA, 1983.
- [19] Chavaudret, C.; *Strong almost reducibility for analytic and Gevrey quasi-periodic cocycles*. Bull. Soc. Math. Fr., **141(1)**, 47–106(2013).
- [20] Craig, W.; *The trace formula for Schrödinger operators on the line*, Comm. Math. Phys. **126(2)**, 379–407 (1989).
- [21] Damanik, D., Goldstein, M.; *On the inverse spectral problem for the quasi-periodic Schrödinger equation*, Publ. Math. Inst. Hautes Études Sci., **119**, 217–401 (2014).
- [22] Damanik, D., Goldstein, M.; *On the existence and uniqueness of global solutions for the KdV equation with quasi-periodic initial data*, J. Ame. Math. Soc. **29(3)**, 825–856 (2016).
- [23] Damanik, D., Goldstein, M., Lukic, M.; *The spectrum of a Schrödinger operator with small quasi-periodic potential is homogeneous*, to appear in J. Spec. Theory. arXiv:1408.4335.
- [24] Damanik D., Goldstein M., Lukic M.; *The Isospectral Torus of Quasi-Periodic Schrödinger Operators via Periodic Approximations*, Invent Math. Volume **207**, Issue 2, 895–980 (2017).
- [25] Damanik, D., Goldstein, M., Schlag, W., Voda, M.; *Homogeneity of the spectrum for quasi-periodic Schrödinger operators*, to appear in JEMS.
- [26] Deift, P.; *Some open problems in random matrix theory and the theory of integrable systems*. Integrable Systems and Random Matrices, 419–430, Contemp. Math. **458**, Amer. Math. Soc., Providence, RI (2008).
- [27] Deift, P., Simon, B.; *Almost periodic Schrödinger operators*, Communications in mathematical physics, **90 (3)**, 389–411 (1983).

- [28] Delyon, F., Souillard, B.; *The rotation number for finite difference operators and its properties*, Commun. Math. Phys. **89** (3), 415–426 (1983).
- [29] Dinaburg, E.I., Sinai, Y.G.: *The one-dimensional Schrödinger equation with quasi-periodic potential*. Funkt. Anal. Prilož. **9**, 8–21(1975).
- [30] Eliasson, L. H.; *Floquet solutions for the 1–dimensional quasi-periodic Schrödinger equation*, Commun. Math. Phys. **146**, 447–482 (1992).
- [31] Gesztesy, F., Simon, B.; *The xi function*, Acta Mathematica, **176** (1), 49–71 (1996).
- [32] Goldstein, M., Schlag, W.; *Hölder continuity of the integrated density of states for quasi-periodic Schrödinger equations and averages of shifts of subharmonic functions*, Ann. Math. (2) **154-1**, 155–203 (2001).
- [33] Gesztesy, F., Yuditskii, P.; *Spectral properties of a class of reflectionless Schrödinger operators*, J. Func. Anal. **241**, 486–527 (2006).
- [34] Goldstein, M. Private communication in the conference ” Almost-Periodic and Other Ergodic Problems” (2015).
- [35] Hadj Amor, S.; *Hölder continuity of the rotation number for quasi-periodic cocycles in  $SL(2, \mathbb{R})$* , Commun. Math. Phys. **287** (2), 565–588 (2009).
- [36] Helffer B., Kerdelhué P. and Sjöstrand J.; *Le papillon de Hofstadter revisité*, Mémoire de la SMF 43, supplément au bulletin de la SMF **118**, Fasc. 3 (1990).
- [37] Hou, X., You, J.; *Almost reducibility and non-perturbative reducibility of quasi-periodic linear systems*, Invent math. **190**, 209–260 (2012).
- [38] Johnson, R. A.; *The recurrent Hill’s equation*, Journal of Differential Equations, **46** (2), 165–193 (1982).
- [39] Johnson, R., Moser, J.; *The rotation number for almost periodic potentials*, Commun. Math. Phys. **84**, 403–438 (1982).
- [40] Klitzing K.V., Dorda G., Pepper M.; *New method for high-accuracy determination of the fine-structure constant based on quantized Hall resistance*, Phys. Rev. Lett. **45** (6): 494–497 (1980).
- [41] Kotani S.; *Ljapunov indices determine absolutely continuous spectra of stationary random one-dimensional Schrödinger operators*, North-Holland Mathematical Library, **32**, 225–247 (1984).
- [42] Kotani S.; *One-dimensional random Schrödinger operators and Herglotz functions*, Probabilistic Methods in Mathematical Physics, K. Ito and N. Ikeda (eds.), Academic Press, New York, 219–250 (1987).
- [43] Kotani, S.; *Generalized Floquet theory for stationary Schrödinger operators in one dimension*, Chaos, Solitons and Fractals, **8** (11), 1817–1854 (1997).
- [44] Last Y.; *Zero measure spectrum for the almost Mathieu operator*, Comm. Math. Phys **164**, no. 2, 421–432 (1994).
- [45] Van Mouche P.; *The coexistence problem for the discrete Mathieu operator*, Comm. Math. Phys. **122** , no. 1, 23–33 (1989).
- [46] Moser, J., Poschel, J.; *An extension of a result by Dinaburg and Sinai on quasi-periodic potentials*, Commun. Math. Helv. **59** (1), 39–85 (1984).
- [47] Poltoratski, A., Remling, C.; *Reflectionless Herglotz functions and Jacobi matrices*, Commun. Math. Phys. **288** (3), 1007–1021 (2009).
- [48] Puig, J.; *A nonperturbative Eliasson’s reducibility theorem*, Nonlinearity **19**, 355–376 (2006).
- [49] Sodin, M., Yuditskii, P.; *Almost periodic Sturm-Liouville operators with Cantor homogeneous spectrum*, Comment. Math. Helv. **70** (4), 639–658 (1995).
- [50] Sodin, M., Yuditskii, P.; *Almost periodic Jacobi matrices with homogeneous spectrum, infinite-dimensional Jacobi inversion, and Hardy spaces of character-automorphic functions*, J. Geom. Anal. **7** (3), 387–435 (1997).
- [51] Thouless D.J., Kohmoto M., Nightingale M.P. and den Nijs M.; *Quantised Hall conductance in a two dimensional periodic potential*, Phys. Rev. Lett. **49**, 405–408 (1982).
- [52] Tsugawa K.; *Local well-posedness of KdV equations with quasi-periodic initial data*, SIAM Journal of Mathematical Analysis, **44**, 3412–3428 (2012).
- [53] Vinnikov, V., Yuditskii, P.; *Functional models for almost periodic Jacobi matrices and the Toda hierarchy*, Matematicheskaya fizika, analiz, geometriya **9** (2), 206–219 (2002).
- [54] You, J., Zhou, Q.; *Embedding of analytic quasi-periodic cocycles into analytic quasi-periodic linear systems and its applications*, Commun. Math. Phys. **323**, 975–1005 (2013).