



HAL
open science

Phylogeny of sleep in tetrapods: analysis of evolutionary patterns, electrophysiological and behavioral studies in two squamates species and new methodological perspectives

Paul-Antoine Libourel

► **To cite this version:**

Paul-Antoine Libourel. Phylogeny of sleep in tetrapods: analysis of evolutionary patterns, electrophysiological and behavioral studies in two squamates species and new methodological perspectives. Neuroscience. Université de Lyon, 2019. English. NNT : 2019LYSE1020 . tel-02086610

HAL Id: tel-02086610

<https://theses.hal.science/tel-02086610>

Submitted on 1 Apr 2019

HAL is a multi-disciplinary open access archive for the deposit and dissemination of scientific research documents, whether they are published or not. The documents may come from teaching and research institutions in France or abroad, or from public or private research centers.

L'archive ouverte pluridisciplinaire **HAL**, est destinée au dépôt et à la diffusion de documents scientifiques de niveau recherche, publiés ou non, émanant des établissements d'enseignement et de recherche français ou étrangers, des laboratoires publics ou privés.



N°d'ordre NNT : 2019LYSE1020

THESE de DOCTORAT DE L'UNIVERSITE DE LYON

opérée au sein de
l'Université Claude Bernard Lyon 1

Ecole Doctorale 476
Neurosciences et cognition

Spécialité de doctorat : Neurosciences

Soutenue publiquement le 15/02/2019, par :
Paul-Antoine Libourel

Phylogénie du sommeil chez les tétrapodes :
Analyse de patterns évolutifs, études électrophysiologiques et
comportementales chez deux espèces de squamates et nouvelles perspectives
méthodologiques

Devant le jury composé de :

Pr Julliard Karyn, Professeure, Université Claude Bernard Lyon1, Centre de Recherche en Neurosciences de Lyon **Présidente**

Pr Arnulf Isabelle, Professeure, faculté de médecine la Sorbonne, **Rapporteur**

Dr Benchenane Karim, Chargé de recherche, CNRS, Ecole supérieure de physique et chimie industrielle, **Examineur**

Dr Herrel Anthony, Directeur de recherche CNRS, Museum National d'histoire naturelle, **Co-Directeur de thèse**

Dr Luppi Pierre-Hervé, Directeur de recherche CNRS, Centre de recherche en neurosciences de Lyon, **Directeur de thèse**

Dr Rattenborg Niels, Chercheur, Institut Max Planck d'ornithologie, Allemagne, **Examineur**

Dr Schmidt Markus, Professeur/Chercheur, hôpital universitaire de Bern, Suisse, **Rapporteur**

UNIVERSITE CLAUDE BERNARD - LYON 1

Président de l'Université	M. le Professeur Frédéric FLEURY
Président du Conseil Académique	M. le Professeur Hamda BEN HADID
Vice-président du Conseil d'Administration	M. le Professeur Didier REVEL
Vice-président du Conseil Formation et Vie Universitaire	M. le Professeur Philippe CHEVALIER
Vice-président de la Commission Recherche	M. Fabrice VALLÉE
Directrice Générale des Services	Mme Dominique MARCHAND

COMPOSANTES SANTE

Faculté de Médecine Lyon Est – Claude Bernard	Directeur : M. le Professeur G. RODE
Faculté de Médecine et de Maïeutique Lyon Sud – Charles Mérieux	Directeur : Mme la Professeure C. BURILLON
Faculté d'Odontologie	Directeur : M. le Professeur D. BOURGEOIS
Institut des Sciences Pharmaceutiques et Biologiques	Directeur : Mme la Professeure C. VINCIGUERRA
Institut des Sciences et Techniques de la Réadaptation	Directeur : M. X. PERROT
Département de formation et Centre de Recherche en Biologie Humaine	Directeur : Mme la Professeure A-M. SCHOTT

COMPOSANTES ET DEPARTEMENTS DE SCIENCES ET TECHNOLOGIE

Faculté des Sciences et Technologies	Directeur : M. F. DE MARCHI
Département Biologie	Directeur : M. le Professeur F. THEVENARD
Département Chimie Biochimie	Directeur : Mme C. FELIX
Département GEP	Directeur : M. Hassan HAMMOURI
Département Informatique	Directeur : M. le Professeur S. AKKOUCHE
Département Mathématiques	Directeur : M. le Professeur G. TOMANOV
Département Mécanique	Directeur : M. le Professeur H. BEN HADID
Département Physique	Directeur : M. le Professeur J-C PLENET
UFR Sciences et Techniques des Activités Physiques et Sportives	Directeur : M. Y. VANPOULLE
Observatoire des Sciences de l'Univers de Lyon	Directeur : M. B. GUIDERDONI
Polytech Lyon	Directeur : M. le Professeur E. PERRIN
Ecole Supérieure de Chimie Physique Electronique	Directeur : M. G. PIGNAULT
Institut Universitaire de Technologie de Lyon 1	Directeur : M. le Professeur C. VITON
Ecole Supérieure du Professorat et de l'Education	Directeur : M. le Professeur A. MOUGNIOTTE
Institut de Science Financière et d'Assurances	Directeur : M. N. LEBOISNE

PREFACE

All this work started in 2010, from an informal discussion in a Cape Verde restaurant in Paris. After having drunk just enough caipirinhas to let the craziest scientific ideas be born, a very simple question appeared in the discussion: do lizards dream? After a short night with memory consolidation and a quick bibliography, the question changed a bit, to become: do reptiles show paradoxical sleep? Followed by, which animals show paradoxical sleep? And, slow wave sleep? Is slow wave sleep and paradoxical sleep proper to warm blooded animal? Finally, other kinds of questions were raised: what is paradoxical sleep, what is slow wave sleep? How to define these states? The idea stayed in mind for a bit of time, the time to read and the time to start building the project. One idea was: if mammals and birds, species with the most complex cognitive abilities have paradoxical sleep then we should study a “clever” reptile. “Clever” and big, because proportionally to their size, reptiles have a relatively small brain. Then the argentine tegu appeared to be the perfect candidate, “clever”, big enough, and not aggressive (relatively). Yet, if we wanted to characterized sleep in a new species we should record all the parameters that allow to differentiate the two sleep states in mammals. It was a very naïve thing to think that it would be easy. Indeed, no brain atlases were available, no stereotactical frame existed for this species, no system allow us to monitor the behavior synchronized with the physiology and the brain activity. As these animals are poikilotherms (cold blooded species), their temperature follows the ambient temperature, so at which temperature should we record them? In which animal facilities? This dissertation is the fruit of 8 years of passionate work and of fixing every problem one by one in order to answer to a quite simple question “do lizards dream?”.

GLOSSARY

AW: active wake
CA1: Cornu ammonis 1
CSF: Cerebrospinal fluid
CT: Computed tomography
DVR: Dorso ventricular ridge
EEG: Electroencephalogram
ECG: Electrocardiogram
EOG: Electrooculogram
EMG: Electromyogram
HShW: High-voltage sharp wave
LFP: Local field potential
MC: Medial cortex
MRI: Magnetic resonance imaging
NS: Nucleus sphericus
PGO: Ponto-geniculo occipital
PS: Paradoxical sleep
PSD: Power spectrum density
QW: quiet wake
REM sleep: Rapid eye movement sleep
S1: Sleep 1
S2: Sleep 2
SCN: Suprachiasmatic nuclei
SLS: sleep like state
SWA: Slow wave activity
SWS: Slow-wave sleep
hSWP-R: hippocampal Sharp wave ripples complex

Phylogénie du sommeil chez les tétrapodes :

Analyse de pattern évolutifs, études électrophysiologiques et comportementales chez deux espèces de squamates et nouvelles perspectives méthodologiques

RESUME

Le sommeil constitue un comportement vital complexe, identifié chez la quasi-totalité des animaux étudiés. Sur la base d'études princeps dans les années 50 chez le chat et l'homme, le sommeil a pu être séparé clairement en deux états distincts : le sommeil lent et le sommeil paradoxal. Ces deux états ont ainsi été caractérisés sur la base de critères électroencéphalographiques, physiologiques et comportementaux. Basé sur une définition mammalienne, il a ainsi été montré que les mammifères terrestres et les oiseaux, tous deux homéothermes, possédaient ces deux états de sommeil. Cependant, l'origine évolutive de ces deux états reste inconnue et nous ne savons toujours pas s'ils ont évolué de façon indépendante ou s'ils ont été hérités d'un ancêtre commun. Les amphibiens et les reptiles, positionnés à la base des tétrapodes et des amniotes constituent par conséquent, des taxons clés dans la compréhension de l'évolution de ces deux états de sommeil. Afin de mieux comprendre la phylogénie de ces deux états, nous avons réalisé dans un premier temps une revue et méta-analyse de la littérature du sommeil chez ces espèces. Dans un second temps, et dans le but de pouvoir conduire des approches comparatives et ainsi mieux décrire la plasticité du sommeil, nous avons développé un dispositif miniature sans fil permettant d'enregistrer simultanément l'électrophysiologie, la physiologie, la température et le comportement en laboratoire et en milieu naturel. Enfin, nous avons conduit une étude électrophysiologique, physiologique, pharmacologique et comportementale chez deux espèces de squamates (*Salvator merianae* et *Pogona vitticeps*). Cette étude nous a permis de montrer que deux états électroencéphalographiques de sommeil existaient chez ces espèces. Cependant, elles ont aussi révélé des divergences phénotypiques importantes au sein même des lézards, ainsi qu'avec le sommeil des mammifères et des oiseaux, démontrant ainsi une origine commune mais complexe des deux états de sommeil.

Mot clés : sommeil, évolution, tétrapodes, squamates, sommeil lent, sommeil paradoxal, *Pogona Vitticeps*, *Salvator merianae*.

Phylogeny of sleep in tetrapods

Analysis of evolutionary patterns, electrophysiological and behavioral studies in two squamates species and new methodological perspectives

ABSTRACT

Sleep is a vital and complex behavior, identified in nearly all animals. Based on studies on cats and humans conducted in the 50's, sleep was separated into two distinct sleep states: slow wave sleep and paradoxical sleep (or REM sleep). Those two states were identified based on electroencephalographic, physiological and behavioral parameters. Based on this mammalian definition, it has been demonstrated that those two states exist in terrestrial mammals and birds, both homeotherms. However, the evolutive origin of these sleeps states remains unknown and we do not know whether they evolved independently or if they were inherited from a common ancestor. Amphibians and reptiles are respectively positioned at the base of the tetrapod and the amniote tree. Therefore, they constitute key taxa in the understanding of the origin of these states. In order to understand the phylogeny of these states, we first performed an exhaustive review and meta-analysis of the sleep literature in these groups. Next, in order to be able to conduct comparative approaches and better understand the sleep plasticity, we developed a standalone miniature device to record electrophysiology, physiology, temperature, and behavior simultaneously and this under both lab and field conditions. Finally, we conducted an electrophysiological, physiological, pharmacological and behavioral study of two squamates species (*Salvator merianae* and *Pogona vitticeps*). This study revealed that two electroencephalographical sleep states exist in these species. However, they also showed that the phenotype of these states diverged between the two lizards and between the lizards on the one hand and mammals and birds on the other hand. This would suggest a common, but complex, origin of these two sleep states;

Keywords: sleep, evolution, Tetrapoda, squamates, slow wave sleep, REM sleep, paradoxical sleep, *Pogona vitticeps*, *Salvator merianae*.

CONTENT

Preface	2
Glossary	3
Résumé	4
Abstract	5
General Introduction	10
(1) History, characterization and organization of the sleep states in mammals	10
(2) The two processes model of sleep regulation.	12
(3) Ontogeny of sleep	13
(4) Phylogeny of sleep	13
(5) The need to conduct comparative work to understand sleep	15
Part I : Sleep in amphibians and reptiles	17
Abstract	18
I. Introduction	19
(1) What is sleep?	19
(2) Who sleeps?	22
(3) Why sleep?	24
(4) The evolution of sleep	25
(5) Amphibians and non-avian reptiles, key but challenging taxa in understanding the functions and evolution of sleep	26
II. Amphibians	28
(1) Caudata	28
(2) Anura	29
III. Non-avian reptiles	31
(1) Turtles	32
(2) Crocodylians	34
(3) Squamates	36
IV. Limitations of the data	39
(1) Methodological limitations	39
(2) Limitations of mammalian-centred definitions of sleep	42
V. Discussion	43

(1) Phylogenetic analysis _____	43
(2) The evolution of sleep _____	45
VI. Conclusions _____	47
VII. Figures et tables _____	49
Part II : <i>OENIROS, a new method to record sleep</i> _____	67
Abstract _____	68
I. Introduction _____	69
II. Methods _____	72
(1) Surgery and experimental recording conditions _____	72
(2) A new device to quantify sleep _____	75
III. Results _____	84
(1) Multiple parameters recorded in baseline condition with ONEIROS (wireless version) in rat _____	84
(2) Selective paradoxical sleep deprivation in a rat using ONEIROS _____	86
(3) Multiple parameters recorded in baseline condition with ONEIROS (wireless logger) in a pigeon _____	89
IV. Discussion _____	92
(1) Recording electrophysiology, behavior and temperature using a miniature instrument _____	92
(2) Sleep deprivation with ONEIROS _____	93
(3) Evaluation of the arousal thresholds with ONEIROS _____	93
(4) Recording sleep in semi natural environment with ONEIROS _____	93
V. Conclusion _____	94
Part III : <i>Comparative analysis of sleep in two squamates</i> _____	95
Abstract _____	96
I. INTRODUCTION _____	97
(1) Behavioral sleep _____	97
(2) Two sleep states in mammals and birds _____	97
(3) Sleep in squamates (lizards and snakes) _____	98
I. MATERIALS AND METHODS _____	99
(1) Animals _____	99
(2) Ethical considerations _____	100
(3) Imaging and verification of the electrode position _____	100
(4) Perfusion _____	101
(5) Nissl staining _____	101
(6) Surgery _____	101

(7) Behavior	102
(8) Arousal threshold	102
(9) In vivo electrophysiology	103
(10) Sleep deprivation	103
(11) Pharmacology	103
(12) Preprocessing, visualization, and “shelter scoring”	103
(13) Automated vigilance states scoring	104
(14) Electrode selection	104
(15) Clustering and S2 extraction	105
(16) Physiological measurements	105
(17) Sharp Wave extraction	106
(18) Statistics	106
II. RESULTS	107
(1) Replication of the bearded dragon sleep experiments.	107
(2) Behavioral sleep in the tegu is characterized by a decrease in the number of eye movements and a higher arousal threshold.	109
(3) Multisite LFPs recordings reveal the occurrence of slower frequencies during active wake compared to quiet wake and behavioral sleep.	111
(4) Tegu sleep is composed of two states, differentiated by sharp waves, 15 Hz oscillations, and eye movements	113
(5) High amplitude sharp waves occur specifically during S1 sleep periods	115
(6) Sleep deprivation and an antidepressant suppressed high amplitude sharp waves and 15Hz oscillations.	116
III. DISCUSSION	120
(1) Sleep in the bearded dragon	120
(2) Sleep in the argentine tegu	121
IV. SUPPLEMENTARY INFORMATION	126
Part IV : General conclusions and Perspectives	135
I. Conclusions	135
(1) What are SWS and REM sleep? Limitations of the use of a mammalian definition in a comparative context.	135
(2) Necessity to develop complementary approaches	137
(3) Lizard sleep	137
V. Perspectives	138
(1) Models	139
(2) Methods	139

GENERAL INTRODUCTION

From a behavioral point of view, sleep could be considered as a “simple” rest. One can easily understand that, when there is nothing to do (absence of light for diurnal species for example) or when environmental factors are not beneficial, sleep could be an excellent way to save energy. But, interestingly, when the need arises to be active for a prolonged period of time, why can an organism not resist the irremediable pressure to sleep? Why do all animals experience this daily rest, unconscious from their environment, and often times exposed to predation? Conserved over millions of years of evolution, this would certainly mean that sleep serves a core function. But, what function? Or what functions? Is the role of sleep the same for each species? In addition, how was this universal and apparently essential behavior selected for by natural selection? One way to understand why we all sleep, is to look at the diversity of the sleep phenotypes across species with different morphologies, life styles, diets, and ancestry ... and try to make parallels, comparisons, and correlations. An evolutionary perspective through studies of the current diversity of sleep phenotypes, is key to have a better and more complete understanding of what is sleep and of why all animals sleep. But, let's start at the beginning.

(1) History, characterization and organization of the sleep states in mammals

In 1875, the British physician, Richard Caton (Caton, 1875) discovered the electrical nature of the brain, by recording with a galvanometer the electrical current generated. In 1877, Caton reported that ‘[...] a variation of the current frequently occurred when the rabbit awoke from sleep,[...]’ (Caton, 1877). This was the first report of an EEG variation related to sleep. Then in 1913, the French psychologist, Henri Piéron, in his book ‘le probleme physiologique du sommeil’ produce an extensive study defining and characterizing sleep from a behavioral and physiological point of view. He defined sleep as a period of sustained inactivity, with a species specific posture, in a specific location, associated with a high arousal threshold, and a reversibility after an intense stimulation (Piéron, 1913). A behavioral definition that is still used to identify sleep. But sleep research really emerged after the first human sleep electroencephalogram which was recorded by Hans Berger in 1929 (Berger, 1929). Then, in 1935, Alfred Lee Loomis (Loomis, Harvey, & Hobart, 1935a, 1935b) identified variations in the human EEG across sleep and proposed the first human sleep state classification. Now, the EEG is the tool of reference used to diagnose/ describe/ score sleep in human as well as animals. In the 50's, another important discovery

marked sleep research. Indeed, even if preliminary signs of its presence was reported before (for a review see Gottesmann, 2001), a new sleep state was clearly identified, in 1953. First in humans by Eugen Aserinsky and Nathaniel Kleitman (Aserinsky & Kleitman, 1953) and later in the cat in 1958 by William Dement (Dement, 1958). This state was found to be related to dream content (Aserinsky & Kleitman, 1953; Dement & Kleitman, 1957) and was named Rapid Eye Movement Sleep (REM sleep). It is characterized by the presence of active phenomena, like rapid eye movements (Aserinsky & Kleitman, 1953), an irregular heart rate (Aserinsky & Kleitman, 1953; Snyder *et al.*, 1964) and breathing rate (Aserinsky & Kleitman, 1953), motor automatisms (Gassel, Marchiafava, & Pompeiano, 1964), and an awake-like cortical brain activity (Aserinsky & Kleitman, 1953; Jouvet, Michel, & Courjon, 1959a). Moreover, in 1959 Michel Jouvet and collaborators identified that this state was moreover specifically associated with a muscular atonia and named this state Paradoxical sleep (PS). They also discovered the presence of pontine waves during PS in the cat (Jouvet, Michel, & Courjon, 1959b), and that the brainstem was sufficient to generate the state (Jouvet, Michel, & Courjon, 1960). During this state thermoregulatory processes including shivering, pilo erection, sweating are abolished (Parmeggiani, 2003). In opposition to the active nature of the PS, the rest of the sleep period is characterized by reduced physiological processes and was named non-REM sleep or Slow wave sleep (SWS). Non-REM sleep is mainly associated with high amplitude slow frequencies in the cortical EEG (Loomis, Harvey, & Hobart, 1938; Steriade, 1993). Even if most of the dream recalls seem to occur during PS, some of them have been reported after an awakening during Non-REM sleep, (Cavallero *et al.*, 1992). In humans, Non-REM sleep is subdivided into 3 sub-states N1, N2 and N3. N1 indicates the sleep onset and is characterized by the presence of theta oscillations (4–7Hz). Some slow eye movements may occur. This explains why, in 1938, Loomis characterized PS as N1 (Loomis *et al.*, 1938). N2 is light sleep and is scored when spindle oscillations (12–14Hz) and K-complex waves appear with the theta rhythm. Finally, N3, also named deep sleep, is characterized by the presence of delta slow oscillations (0.5–3Hz). N3 is mainly equivalent to the SWS scored in animals. In humans, sleep occurs in cycles of around 90 minutes and lasts 8 hours on average. The beginning of the night contains more N1, N2 and N3 stages, whereas at the end of the sleep cycle, PS become more prominent and replaces N3 progressively. In most of the species studied it appears that PS always follows a non-REM sleep period and is always followed by an arousal.

(2) The two processes model of sleep regulation.

In 1982, Alexander Borbély introduced the two process model of sleep regulation (Borbély, 1982; Borbély *et al.*, 2016). The model explains that sleep is regulated by the interaction of a homeostatic process (process S) with a circadian process (process C) (see Fig 1). The process S is represented by the pressure of sleep after a sleep deprivation or, in other words, a sustained period of wake. The amplitude of the slow waves, or the slow wave activity (SWA), is the principal marker of the process. During the recovery period following a sleep deprivation the SWA is greatly increased compared to a normal SWA without sleep deprivation. Note that PS is also homeostatically regulated (Benington & Heller, 1994). Core body temperature and hormonal release (principally melatonin) are the marker of the C process. This process is under the control of the circadian clock and driven by the suprachiasmatic nuclei (SCN). The circadian regulation as well as the homeostatic regulation are considered as a key points to identify sleep (Tobler, 1995).

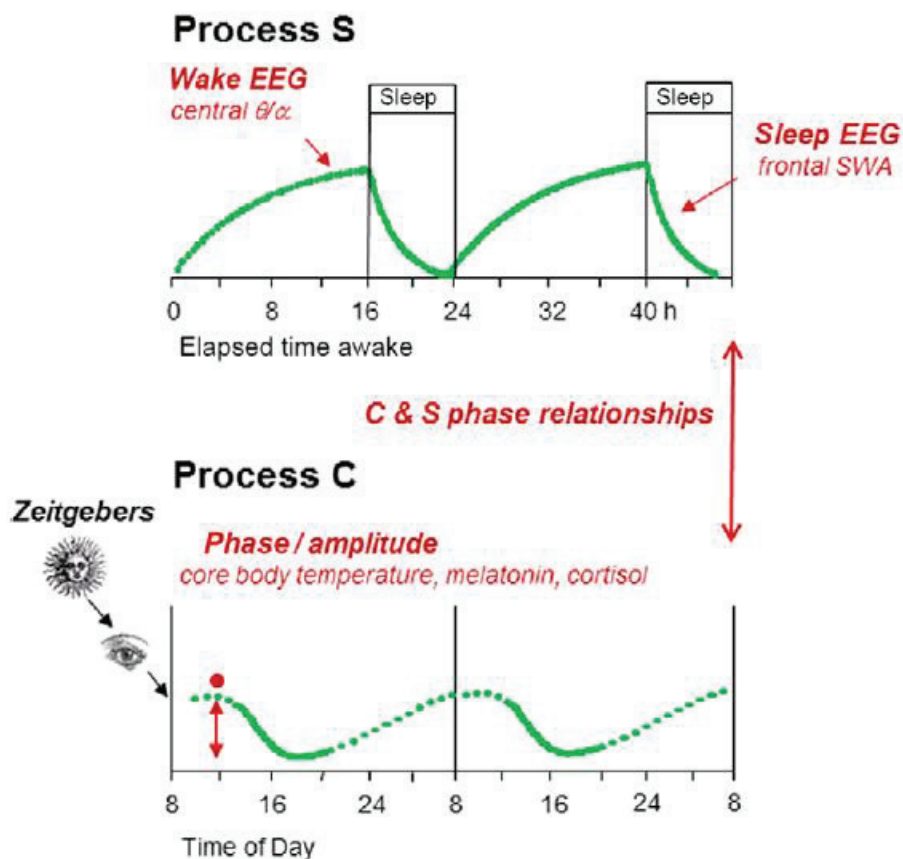

Fig 1. Schematics of the two-process model, extract from Borbély *et al.* 2016

(3) Ontogeny of sleep

It is well established that the quantities of sleep covary with the aging process. The development is accompanied by a continuous decrease in the total sleep time, PS time and an increase in the waking and Non-REM sleep percentage. Associated with the fact that precocial species show similar quantities of Non-REM sleep and PS as adults (Jouvet-Mounier, Astic, & Lacote, 1969; Ibuka, 1984; Scriba *et al.*, 2013b), and that PS is present in great quantities during the development, this lead researchers to proposed a role of sleep in development (Roffwarg, Muzio, & Dement, 1966; Blumberg, 2013).

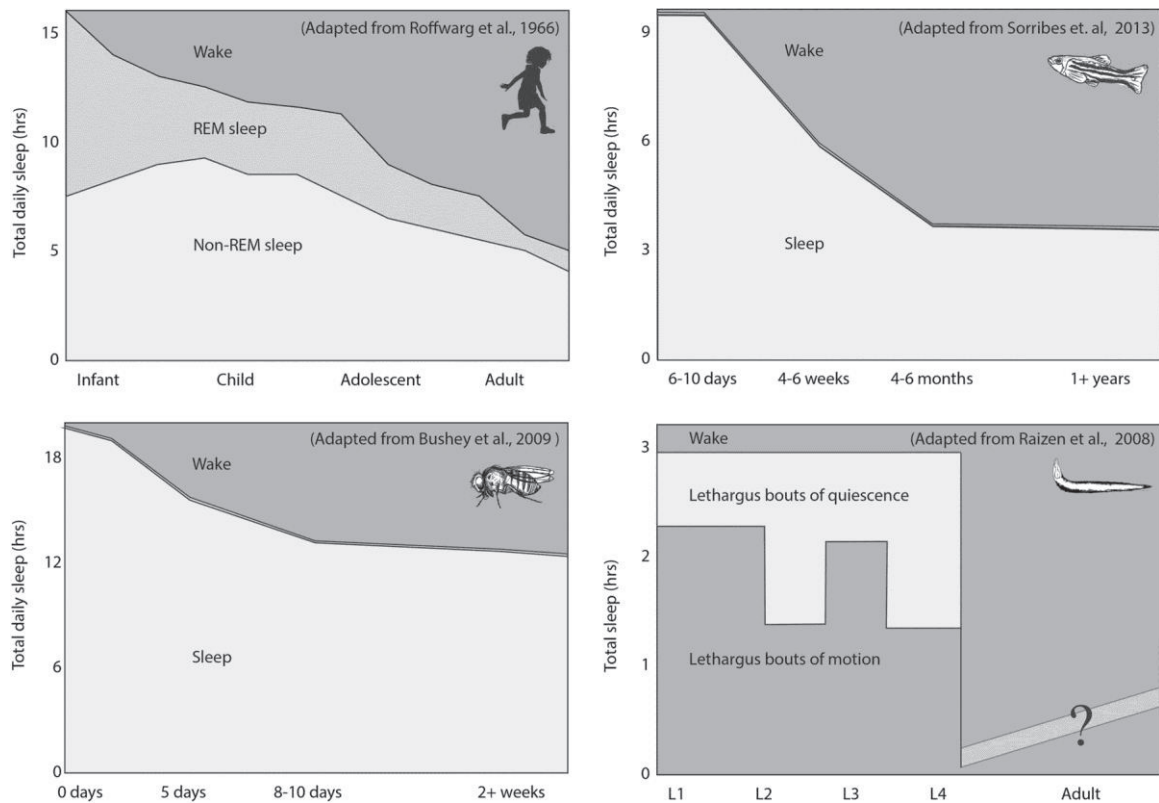

Fig 2. Sleep ontogeny across phylogeny. Flies, fish and worms all exhibits developmentally regulated changes to sleep amount in as mammals. (Extracted from Kayser & Biron, 2016)

(4) Phylogeny of sleep

From a behavioral point of view, and including the homeostatic and circadian criteria in the definition of sleep, it is commonly accepted that all animals sleep (Campbell & Tobler, 1984; Siegel, 2008; Nath *et al.*, 2017). However some studies report the absence of sleep or the absence of inactivity periods (Van Twyver, 1973; Kavanau, 1998). These reports of absence or periodic

reduction of sleep quantities can be caused by environmental conditions, that favor the fitness of the species, like parental care (Lyamin *et al.*, 2005) or mating success, for example (Lesku *et al.*, 2012). Currently, the existence of non-sleeping species remains to be demonstrated. However, these examples of periodic reduction of sleep suggests that the time allocated to sleep likely constitutes a tradeoff with the reproductive success of an individual. The unilateral sleep experienced by cetaceans (Lyamin *et al.*, 2008) and birds (Rattenborg, Lima, & Amlaner, 1999) is also an example showing how selection on both sleep and other functions resulted in the capacity of some animals to “sleep while awake”.

SWS and PS have been identify in all terrestrial mammals studied so far (Campbell & Tobler, 1984). Cetaceans constitute an exception in mammals as PS has not been clearly identified in these species (Lyamin *et al.*, 2008). These states have also been identified in birds (Rattenborg *et al.*, 1999; Roth *et al.*, 2006). In birds, as in mammals, a higher amplitude and a slower activity in the EEG characterizes SWS (Klein, Michel, & Jouvet, 1964; Amlaner & Ball, 1994). PS episodes in birds are much shorter than in mammals, and the muscle atonia is not always visible in the EMG. The EEG looks like an awake EEG, and eye movements co-occur. The homeostatic regulation of sleep with an increase in the slow wave activity is also present in birds (Rattenborg, Martinez-Gonzalez, & Lesku, 2009), as are the greater quantities of PS during development (Scriba *et al.*, 2013b). But, what about reptiles including crocodylians, chelonians and lepidosaurians, species that share a common ancestor with mammals and birds. The presence of these two states is less clear in these species. Indeed, only a few studies were conducted mainly in the 70's. Some authors identified periods with eye movements occurring during the behavioral sleep and proposed these periods to be a PS-like state (Tauber, Rojas-Ramírez, & Hernández Peón, 1968; Peyrethon & Dusan-Peyrethon, 1969; Vasilescu, 1970; Romo, Cepeda, & Velasco, 1978; Ayala Guerrero, 1987; Huntley, 1987, 1987; Ayala-Guerrero & Vargas Reyna, 1987; Ayala-Guerrero, Calderon, & Perez, 1988; Ayala-Guerrero & Mexicano, 2008b). Regarding the presence of SWS it is even less clear as only rare studies reported slow waves in the EEG during sleep (Hermann, Jouvet, & Klein, 1964; Peyrethon & Dusan-Peyrethon, 1969; Romo *et al.*, 1978; Meglasson & Huggins, 1979). However multiple authors recorded high amplitude waves in the EEG during behavioral sleep (Tauber, Roffwarg, & Weitzman, 1966; Karmanova, Belekhova, & Churnosov, 1971; Flanigan, 1973, 1974; Van Twyver, 1973; Walker & Berger, 1973; Flanigan, Wilcox, & Rechtschaffen, 1973; Flanigan *et al.*, 1974; Ayala Guerrero, 1987; Ayala-Guerrero & Vargas Reyna, 1987; Ayala-Guerrero *et al.*, 1988; Ayala-Guerrero & Huitron Resendiz, 1991; Eiland, Lyamin, & Siegel, 2001; Ayala-Guerrero & Mexicano, 2008b). As a summary, sleep in

reptiles remains poorly understood and the presence of PS and SWS remains an open question. In non-amniotes species like amphibians, fishes, or invertebrates, sleep seems to be quite homogenous and stable. Only few studies reported active processes during behavioral sleep, like color change in cuttlefishes (Frank *et al.*, 2012) or antenna twitches in bees (Klein *et al.*, 2008). As a conclusion, sleep across the phylogeny of living organisms displays a certain stability in the behavioral aspects, but regarding the electrophysiological aspects of sleep and the separation into sleep states, things becomes less clear.

(5) The need to conduct comparative work to understand sleep

Why does evolution separate sleep into two sleep states in mammals and birds? What is the respective role of these states? Why do we experiment sleep with dreams? Is this a meaningless artefact of a mechanism occurring in our brain or is it an overview of internal constructive processes? If yes, which processes? A comparative approach could help us to understand these phenomena. Indeed, if not all animals experience sleep in this manner, the differences between species could help us understand the selective pressures on sleep. This will help to understand the origin of these sleep states, as well as the morphology and physiology that has favored these sleep states. More interestingly, this would give insights into the characteristics of these states that support a core function, if there is one. The two sleep states have been clearly identified in terrestrial mammals and birds, identified, yes! But based on a mammalian definition. Then, if a phenomenon does not have the same signature in a different species, does that mean that this is not the same phenomenon? If a wing does not have any feathers, does that mean that bats do not have wings? If a foot does not have toes, does that mean that a horse's hoof does not serve the same function? Should we define a phenomenon based on its phenotype or on its function? If the phenotypes are different and if we do not know their role how can we define it? One way to deal with these issues, is to describe as broadly as possible the phenomenon, forget our initial mammalian definition, and screen as many species as possible. In the case of the evolution of sleep states, amphibians and non-avian reptiles (turtles, lizards and snakes and crocodiles) are positioned respectively at the base of the tetrapod and amniotes tree. The non-avian reptiles share a common ancestor with mammals and birds. Therefore, they become the perfect choice to start describing the phylogenetic diversity of sleep and sleep states. Interestingly, amphibians and non-avian reptiles are poikilotherms, meaning that they are not producing internal heat to maintain a constant body temperature as homeotherms (mammals and birds) do. Because of the

difference in thermoregulatory physiology, the presence or absence of the two sleep states could provide new cues to the role of SWS and PS.

The present project started by conducting an as exhaustive as possible review of the literature on sleep in amphibians and non-avian reptiles. In order to try to trace back ancestral sleep traits, we computed a preliminary analysis of the phylogeny of behavioral and electrophysiological features of sleep. In this first chapter, we also highlight the difficulties to infer homologies in species that have a different anatomy (three-layer cortex, poikilothermy, muscle anatomy, ...) and life style.

In a second chapter, we describe a new wireless methodology we developed to record sleep for comparative studies. Indeed, one of the main difficulties to infer homologies based on the existing literature on sleep in amphibians and non-avian reptiles is the limitation of the number of parameters recorded to identify sleep and sleep states. The device allows to record simultaneously most of the parameters used to characterize (identify) sleep states in mammals, like EEG, EMG, ECG. In addition, the system allows one to evaluate the arousal threshold and the sleep homeostasis thanks to an embedded miniature arousal device. We also added the possibility to record movements, and the ambient, brain and body temperature.

Finally, we choose one species of lizard, the argentine tegu (*Salvator merianae*), and conducted behavioral, electrophysiological, pharmacological and sleep homeostasis studies in order to determine whether this lizard displays one or more sleep states and whether it shares features common to mammalians sleep states. In parallel, we also replicated recently published recordings for another lizard species (*Pogona vitticeps*) allowing us to compare these two species and to describe the diversity of sleep states observed.

PART I : SLEEP IN AMPHIBIANS AND REPTILES

Sleep in amphibians and reptiles, a review and an analysis of evolutionary patterns.

2016, *Biological Reviews* 91, 833–866

Paul-Antoine Libourel^{1*} and Anthony Herrel^{2,3}

¹SLEEP - Physiopathologie des réseaux neuronaux du cycle sommeil, Centre de Recherche en Neurosciences de Lyon, Inserm U1028 - CNRS UMR5292, Faculté de Médecine Laennec, 7 rue Guillaume Paradin, 69372 LYON Cedex 08 France.

²UMR 7179 C.N.R.S/M.N.H.N., Département d'Ecologie et de Gestion de la Biodiversité, 57 rue Cuvier, Case postale 55, 75231, Paris Cedex 5, France

³Ghent University, Evolutionary Morphology of Vertebrates, K.L. Ledeganckstraat 35, B-9000, Gent, Belgium.

*Author for correspondence (E-mail: libourel@sommeil.univ-lyon1.fr).

ABSTRACT

Despite the ubiquitous nature of sleep, its functions remain a mystery. In an attempt to address this, many researchers have studied behavioural and electrophysiological phenomena associated with sleep in a diversity of animals. The great majority of vertebrates and invertebrates display a phase of immobility that could be considered as a sort of sleep. Terrestrial mammals and birds, both homeotherms, show two sleep states with distinct behavioural and electrophysiological features. However, whether these features have evolved independently in each clade or were inherited from a common ancestor remains unknown. Unfortunately, amphibians and reptiles, key taxa in understanding the evolution of sleep given their position at the base of the tetrapod and amniote tree, respectively, remain poorly studied in the context of sleep. This review presents an overview of what is known about sleep in amphibians and reptiles and uses the existing data to provide a preliminary analysis of the evolution of behavioural and electrophysiological features of sleep in amphibians and reptiles. We also discuss the problems associated with analysing existing data, as well as the difficulty in inferring homologies of sleep stages based on limited data in the context of an essentially mammalian-centric definition of sleep. Finally, we highlight the importance of developing comparative approaches to sleep research that may benefit from the great diversity of species with different ecologies and morphologies in order to understand the evolution and functions of sleep.

Key words: sleep, amphibian, reptile, REM sleep, paradoxical sleep, slow-wave sleep, active sleep, quiet sleep, evolution.

I. INTRODUCTION

In the following review, we first provide a brief overview of how sleep is defined, where it is observed in the animal kingdom, and what its possible functions may be. Excellent reviews on these topics are available (Kovalzon, 1976; Hartse, Kristyna M., 1994; Tobler, 1995; Siegel, 2005; Rattenborg *et al.*, 2007; Cirelli & Tononi, 2008; Siegel, 2008; Mignot, 2008; Lesku *et al.*, 2008; Siegel, 2009; Hartse, 2011) and, thus, we only briefly touch upon these matters here. A detailed review of the literature on sleep in amphibians and non-avian reptiles is then provided, including a discussion of the behavioural and electrophysiological indicators of sleep in these taxa. We then provide a preliminary quantitative analysis of these data in a phylogenetic framework, and discuss the evolution of sleep in reptiles and amphibians in the context of the evolution of sleep in vertebrates more generally. In doing so, we place specific emphasis on the difficulties encountered in defining sleep or sleep stages in reptiles and amphibians based on either behavioural or electrophysiological data. Finally, we discuss the need to develop comparative and developmental analyses to understand sleep in its evolutionary context and to identify its function(s). We also emphasize the need for additional studies on taxa such as reptiles and amphibians, and raise the question of the presence of a paradoxical sleep-like state in reptiles and amphibians.

(1) What is sleep?

Together with reproduction and feeding, sleep appears to be one of the fundamental requirements of all vertebrates. Most of the vertebrates studied to date display a daily period of prolonged immobility that can be considered as a sleep-like state. A behavioural definition of sleep was proposed just over a century ago and can be used to study the presence or absence of sleep in different organisms (Piéron, 1913). The behavioural features of sleep include: (1) the spontaneous use of a stereotypic or species-specific posture during periods of immobility, (2) the maintenance of behavioural immobility, (3) an elevated behavioural response threshold to arousal stimuli, and (4) a rapid behavioural state reversibility upon stimulation. After the discovery of variation in brain waves related to vigilance in animals (Caton, 1877) and in man (Berger, 1929), electrophysiological criteria were added to the definition of sleep (Loomis *et al.*, 1938).

A sleep state associated with rapid eye movements (REM sleep) was identified first in man and later in the cat (Aserinsky & Kleitman, 1953; Dement, 1958). Jouvet, Michel & Courjon (1959) showed that a muscle atonia appears during this state in the cat. They referred to this state as "paradoxical sleep" because the electroencephalogram (EEG) pattern resembles the EEG of an

awake animal. After these discoveries, electroencephalography, electromyography (EMG), and electro-oculography (EOG) were accepted as valid methods to identify sleep in mammals. These techniques subsequently allowed the identification of two distinct sleep states in birds as well (Klein *et al.*, 1964; Ookawa & Gotoh, 1964). Consequently, two main states are now recognized in both birds and mammals: slow-wave sleep, also called non-REM sleep, or quiet sleep, and paradoxical sleep, also known as REM sleep, or active sleep. The specific physiological and behavioural correlates associated with these two sleep states are detailed below. In the following review we use the terms ‘quiet sleep’ and ‘active sleep’ to avoid the confusion induced by naming sleep states based on only a single feature. This terminology is often used in ontogenetic studies when talking about sleep in newborn animals. The active sleep of newborns and embryos contains many twitches and motor automatisms and is defined as such without the electrophysiological criteria typically used for adults (Corner, 1977; Blumberg & Lucas, 1996). We use the terms ‘rest’ or ‘quiescence’ when we do not postulate a true homology with mammalian sleep. This also pertains to the term ‘quiet wakefulness’.

Adult mammalian quiet sleep is characterized by a relatively low-frequency, large-amplitude EEG signal. However, this state is composed of many specific electrophysiological patterns including hippocampal sharp waves, sleep spindles, K-complexes, and delta waves (Sirota & Buzsáki, 2005). As a consequence, human quiet sleep has been separated into as many as three different states. Hippocampal sharp waves are an important feature of quiet wakefulness and quiet sleep, and have been recorded in the CA1 region of the hippocampus. Hartse *et al.* (1979) refer to these waves in the cat as ventral hippocampal spikes. Sharp waves begin during quiet wakefulness and appear in bursts when an animal falls asleep. These hippocampal sharp waves are also associated with high-frequency (200 Hz) fusiform waves called ripples in rats and mice (Ylinen *et al.*, 1995). During quiet sleep heart rate, respiratory rate, and muscle tone are reduced compared to the waking state. Metabolism is maintained at a lower level, but thermoregulatory mechanisms such as shivering, sweating, piloerection, and vasomotion are maintained (Parmeggiani, 2003). Brain temperature, on the other hand, decreases.

Mammalian active sleep is characterized by an EEG signal with lower amplitude than during quiet sleep. A hippocampal regular oscillation at 4–9 Hz also exists in rodents and cats. EEG patterns called ponto-geniculo occipital (PGO) waves can be recorded in the pons, lateral geniculate nuclei, and in the occipital cortex of cats (Jouvet *et al.*, 1959; McCarley, Nelson, & Hobson, 1978). During active sleep the animal displays atonia of the postural muscles (Jouvet *et*

al., 1959) and eye movements (Aserinsky & Kleitman, 1953). Twitches of the limbs or the tail are often present as well, and remain the main component of active sleep in newborns (Blumberg & Lucas, 1996). Penile and clitoral erections are also characteristic of this state (Schmidt *et al.*, 1994). Finally, thermoregulation mechanisms such as vasomotion, piloerection, shivering, and sweating are not maintained, and an increase of the brain temperature has been reported in rabbits, cats, rats and mice (Parmeggiani, 2003).

One characteristic that the two sleep states have in common is their homeostatic regulation (Tobler, 2011). After a quiet sleep or active sleep deprivation, a recovery of the deprived state is observed. An increase of the power of the slow waves during quiet sleep after deprivation has also been reported and is referred to as an increase in slow-wave activity (SWA) in mammals (Franken *et al.*, 1991) and birds (Rattenborg *et al.*, 2009).

However, the electrophysiological criteria and physiological correlates of sleep are not universal, with different patterns being present in some adult mammals (Siegel, 2009), neonate mammals (Blumberg & Lucas, 1996), and some birds (Rattenborg *et al.*, 2011). An alternative EEG manifestation, associated with unihemispheric quiet sleep, has been observed in some species of birds, cetaceans, manatees, and otarid seals. This sleep state is characterized by a unilateral slow-wave activity EEG signal while the animal maintains a waking EEG pattern in the contralateral cortex. The occurrence of this type of sleep has been suggested to be related to the need to remain vigilant in areas with high predation pressure in birds (Rattenborg *et al.*, 1999), and to the need to resurface for breathing in marine mammals (Lyamin *et al.*, 2008). Additionally, cetaceans do not exhibit active sleep (Lyamin *et al.*, 2008). The arousal threshold is also not uniform across mammals, being lowest during active sleep in humans, but highest during this state in rats and most other mammals (Siegel, 2009). Brain temperature changes are also not uniform across mammals, increasing in rat, cat, sheep, rabbit, and dog during active sleep, whereas in monkeys and humans a decrease in brain temperature has been reported (Denoyer *et al.*, 1991). Interestingly, in some basal mammals and birds (i.e. the platypus; *Ornithorhynchus anatinus*, the echidna; *Tachyglossus aculeatus*, and the ostrich; *Struthio camelus*), eye movements and a reduced muscle tone appear to be associated with ‘cortical’ slow waves characteristic of quiet sleep (Siegel *et al.*, 1996; Lesku *et al.*, 2011) and sometimes also with a ‘typical’ active sleep EEG (Nicol *et al.*, 2000; Lesku *et al.*, 2011). The amount of active and quiet sleep decrease continuously across the life of nearly all species studied (Roffwarg *et al.*, 1966) and neonate mammals do not

present the EEG features typically associated with quiet and active adult mammalian sleep (Seelke & Blumberg, 2008).

Other states of prolonged immobility exist across vertebrates. They are referred to as dormancy states, often called hibernation, torpor, or aestivation. These particular states present the same behavioural characteristics as sleep, but in mammals and birds they are mainly associated with a reduction in body temperature and metabolic rate (Geiser, 1988, 2004). At an electrophysiological level, mammals in torpor cease active sleep below 25°C, yet the EEG still displays slow-wave oscillations like those observed during typical quiet sleep, even if these waves tend to decrease with temperature until a hibernation state with little EEG activity is observed (Walker *et al.*, 1977). Another interesting feature of these states is the rebound of slow-wave sleep after daily torpor (Deboer & Tobler, 2000, 2003), which suggest a distinct difference between dormancy and sleep, even if a continuum between sleep and torpor likely exists (Walker *et al.*, 1983; Berger, 1984).

(2) Who sleeps?

Even if some authors reported that some fish, frogs, turtles, and crocodiles never sleep (Hobson, 1967; Van Twyver, 1973; Kavanau, 1998), the current consensus is that virtually all animals, including insects, nematodes, scorpions, spiders, and vertebrates, show some form of sleep, or at least sleep-like states (Campbell & Tobler, 1984; Hartse, Kristyna M., 1994; Siegel, 2008). Both quiet sleep and active sleep have been clearly identified in terrestrial mammals, seals, manatees, and birds. The presence of these two states in amphibians and non-avian reptiles remains debated and is discussed later in this review (Fig. 1). Cetaceans, by contrast, do not display electrophysiological features of active sleep, but short periods of muscle jerks and eyelid movements have been reported during the resting period in some species (Lyamin *et al.*, 2008). It has also been demonstrated recently that migratory birds can fly continuously for over six months (Liechti *et al.*, 2013), raising the question of whether they sleep during this period, or not (Rattenborg, 2006b). Unihemispheric sleep could be a solution to long-term migration, even if it has never been demonstrated using EEG recordings during migrant flight. However, some laboratory studies have been performed during the migration period and show a clear reduction in the quantity of sleep and brief naps of uni- or bihemispheric sleep have been reported (Rattenborg *et al.*, 2004; Fuchs *et al.*, 2009). When considering the diversity of species studied, it becomes clear that the types of sleep observed and the characteristics of sleep at a behavioural and electrophysiological level may differ dramatically even among closely related species.

Moreover, it is important to consider sleep also in an ontogenetic context as the quantity of sleep and active sleep are greater at the beginning of life in all species studied in this context. Yet, studies examining the evolution of sleep typically focus on sleep in mature animals only.

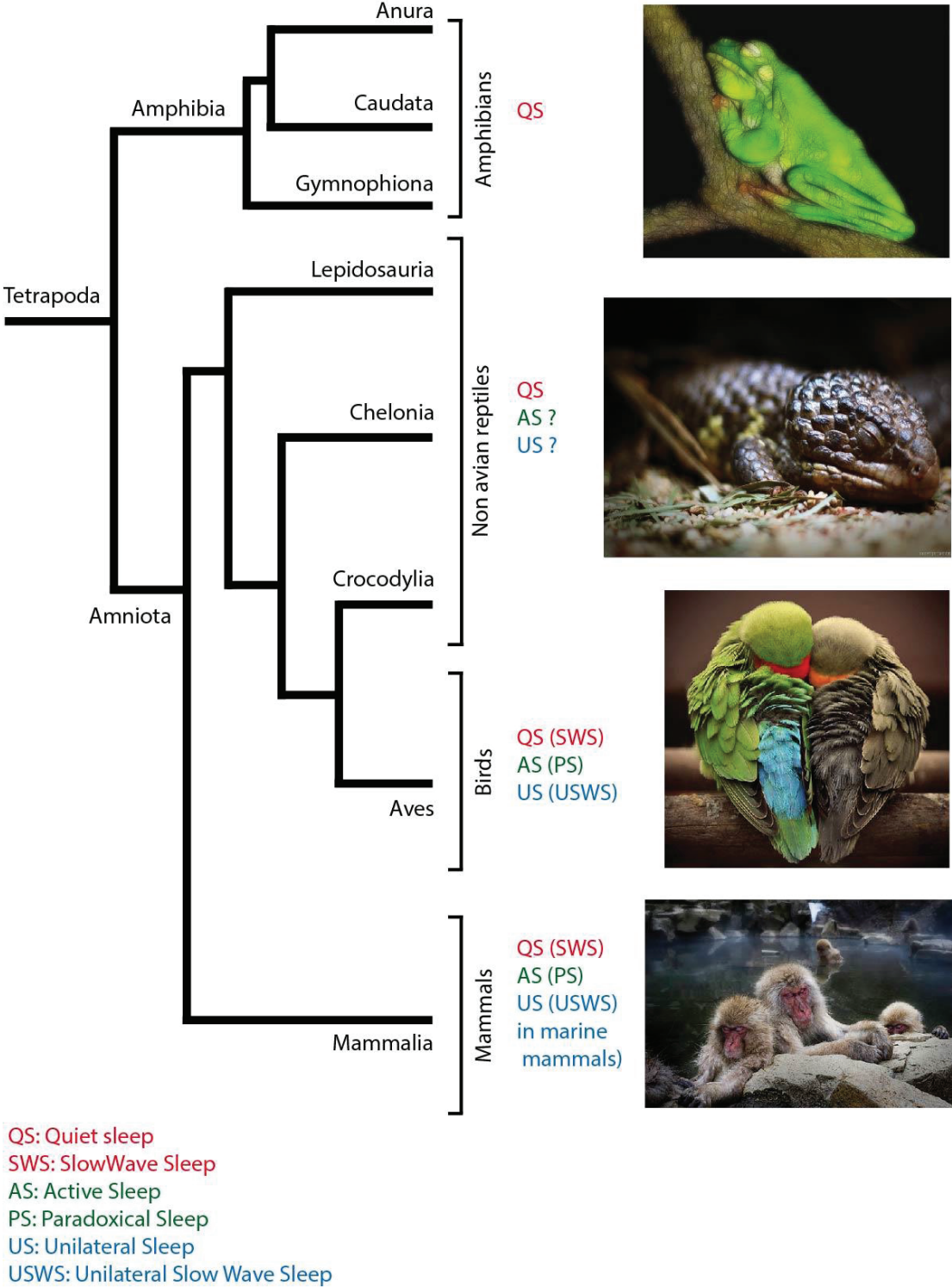

Fig. 1. Simplified cladogram illustrating the relationships among extant vertebrate groups and the sleep states currently accepted to be present. Question marks indicate that the presence of some sleep states in this group remains controversial. Sleep states AS (active sleep), QS (quiet sleep) and US (unihemispheric sleep) are based on behavioural criteria only. States in parentheses including rapid eye movement (REM)

sleep, slow-wave sleep (SWS), and unihemispheric slow-wave sleep (USWS) are defined based on electrophysiological criteria. Cladogram based on Pyron & Wiens (Pyron & Wiens, 2011) and (Chiari et al., 2012). Picture credits: tree frog (*Litoria* sp.), Helmut Hess; sleepy lizard (*Tiliqua rugosa*), Lachlan Sear; love birds (*Agapornis roseicollis*), Ansgar Trimborn; Japanese macaque (*Macaca fuscata*), Trey Ratcliff.

(3) Why sleep?

Whereas the functions of the main waking behaviours, like reproduction, locomotion, feeding, and foraging are obvious and needed to maximize the lifetime reproductive success (fitness) of all living animals, the role of being inactive, unconscious of the environment and by consequence exposed to predation, remains unclear. If sleep is not necessary for an animal, this state would likely have been eliminated by natural selection, at least in some species (Rechtschaffen, 1998; Cirelli & Tononi, 2008; Siegel, 2008). However, most animals spend a significant proportion of their life asleep. As a consequence, sleep must provide real benefits for the organism, but its functions currently remains unclear and highly debated (Rechtschaffen, 1998; Siegel, 2005; Mignot, 2008). Some authors assert that sleep is simply a way to pass time that cannot be spent performing waking-related functions (Meddis, 1975; Rial et al., 2007), however, it is generally accepted that sleep has vital and important functions. Indeed, many physiological changes occur during sleep, and sleep is also associated with changes in gene expression. Moreover, cognitive changes are observed as the result of sleep deprivation. Consequently, many theories have been proposed to explain why animals sleep. These theories can be classified based on the three main suggested functions: restorative, cognitive, and developmental.

Firstly, some sleep researchers have proposed that sleep may be beneficial for energy conservation or restoration. These hypotheses are mainly based on the fact that temperature decreases during sleep in endotherms. Berger & Phillips (1995) proposed that sleep could serve to conserve energy. Benington & Heller (1995) proposed a function for quiet sleep in the replenishment of cerebral glycogen depleted during the waking state. Still others have proposed that sleep serves a role in molecular biosynthesis or gene expression (Mignot, 2008).

Secondly, molecular, anatomical, and behavioural data suggest a role for sleep in brain function and memory. It has been proposed that during sleep, and particularly during quiet sleep, a synaptic downscaling occurs in order to reorganize synaptic connectivity (Tononi & Cirelli, 2006). Others have suggested a role of sleep in memory consolidation (Stickgold & Walker, 2005;

Stickgold, 2005) and a specific role of quiet and active sleep in contextual and emotional memory, respectively (Walker, 2010).

Lastly, based the fact that the amount of sleep, particularly active sleep, is greater during the juvenile stages of many animals (Roffwarg *et al.*, 1966; Astic & Jouvet-Mounier, 1968), and that juveniles display a greater quantity of this state during the first few days of their lives (Jouvet-Mounier *et al.*, 1969), some authors proposed a role of active sleep in brain maturation by promoting brain and neuromuscular development (Roffwarg *et al.*, 1966; Blumberg, 2010). This hypothesis is also supported by the fact that behavioural patterns of active sleep, like spontaneous motility are also present *in ovo* and *in utero* in all species studied, even if those species do not display an active sleep-like state as adults (Corner, 1977; Blumberg & Lucas, 1996).

To test some of these hypotheses, correlation analyses relating sleep duration and sleep fragmentation to body mass, metabolism, diet, brain size, etc., across different species of mammals have been performed (Zepelin & Rechtschaffen, 1974; Zepelin, 2000; Lo *et al.*, 2004; Lesku *et al.*, 2006, 2008; Capellini *et al.*, 2008). However, these correlative approaches reveal some contradictions due to the different methods employed, and no clear consensus has emerged. In 2014, Schmidt (Schmidt, 2014) proposed a unifying theory of the function of sleep based on results from comparative, ecological, metabolic, cellular, phylogenetic, and ontogenetic data. This ‘energy allocation model’ proposes that the wake/sleep cycle constitutes a trade-off of temporal utilization of energy to maximize fitness. This model proposed a specific role of mammalian active sleep to enhance energy allocation to somatic and central nervous system processes. Surprisingly, despite its ubiquitous nature and our understanding of the various processes and physiological changes associated with sleep across phylogeny and ontogeny, we still do not know exactly why we sleep.

(4) The evolution of sleep

Although many papers have discussed the evolution of sleep, relatively few have done so in a quantitative and phylogenetically informed way (Lesku *et al.*, 2006; Roth *et al.*, 2006; Capellini *et al.*, 2008). In general, it is considered that all vertebrates sleep or show sleep-like states. Quiet sleep with slow waves is thought to be present only in mammals and birds, however. As mammalian active sleep has not been demonstrated unequivocally in amphibians or reptiles, it is often considered to have evolved independently in mammals and birds. Moreover, it is thought that this convergent evolution is accompanied by the appearance of homeothermy (Kavanau,

2002). Berger (1984) raised the possibility that mammalian active sleep could be a 'vestige of a reptilian ectothermic state of inactivity' based on the loss of thermoregulation in mammals during this state (Berger, 1984, p. 320). Karmanova (1982) developed comparative studies to understand the evolution of sleep in vertebrates and postulated that amphibians and fish display a 'protosleep' or 'primary sleep'. This state is manifested by three forms of rest or sleep-like states (SLS): cataleptic (plastic muscle tone) or SLS1, catatonic (rigid muscle tone) or SLS2, and cataplectic sleep (atonia) or SLS3. The SLS1 state appears mainly during the day when the eyes are open, whereas SLS3 and SLS2 are observed during nighttime rest periods. The arousal threshold increases relative to the type of SLS, and the heart rate decreases accordingly. Karmanova's research group refers to the resting periods (SLS) of reptiles as intermediate sleep, this state containing mainly SL1 and SL3. They further suggest that SLS3 sleep is the evolutionary precursor of mammalian and bird quiet sleep, and that SLS1 and SLS2 are precursors of quiet wakefulness. They described periods of motor automatisms in amphibians and reptiles, sometimes associated with high-voltage sharp waves and with an EEG similar to that observed during the awake state. They proposed that these activation phases are an ancient form of mammalian active sleep (Karmanova & Lazarev, 1979; Karmanova, 1982). Others have proposed based on the presence of slow waves during the awake state in some reptiles that the awake state of reptiles evolved into the slow-wave sleep observed in mammals (Rial *et al.*, 2010).

(5) Amphibians and non-avian reptiles, key but challenging taxa in understanding the functions and evolution of sleep

Amphibians evolved during the Devonian some 370 million years ago. Extant amphibians are composed of three major groups (Fig. 1); Anura (frogs and toads), Caudata (salamanders and newts), and Gymnophiona (caecilians). Of these, the Anura make up 88% of all species. Amphibians live in a wide variety of habitats and range from fossorial, terrestrial, and arboreal, to entirely aquatic. Due to their pivotal placement at the transition from water to land at the base of the tetrapod tree, these animals may provide important clues to the changes that occurred during the transition to a terrestrial habitat. Non-avian reptiles are a heterogeneous group of amniotes including crocodiles, turtles, and lepidosaurians (lizards, snakes, and rhynchocephalians) (Fig. 1). Among these groups, lepidosaurians are the most diverse with 9,413 species (www.reptile-database.org). Turtles are much less numerous with 328 identified species, and extant crocodylians contain only 25 species, despite their evolutionary abundance in the fossil

record. Like amphibians, reptiles are extremely diverse and have invaded all possible niches ranging from the marine environment to species that are exclusively fossorial.

Sleep is clearly related to thermoregulation, metabolism, cognition, and development, and its description is mainly based on work using mammals as a model system. In consequence, the phylogenetic position of amphibians and non-avian reptiles, their ectothermy, and their precocial lifestyle at birth make them important taxa in understanding the function and origin of sleep. With respect to the special case of active sleep, their position becomes even more crucial as only terrestrial mammals and birds appear to display this sleep state. Moreover, if active sleep is related to maturation (Roffwarg *et al.*, 1966; Blumberg, 2010) then this state is likely only present during the developmental phase of these species and may no longer be present in the adult. This raises the importance of studying sleep throughout ontogeny when trying to infer homologies between sleep states. However, most work on amphibians and reptiles involves adults despite the fact that phasic twitches are present *in ovo* in many amphibians and reptiles (Corner, 1977). Studying sleep in amphibians and reptiles remains challenging, however. Many have relatively small brains, are often aquatic or semi-aquatic, and the literature on their neuroanatomy is sparse. Moreover, the currently accepted mammalian-centric definition of sleep which is mostly based on cortical electrophysiological patterns may impose difficulties when applied to other taxa. For example, brain waves are related to neuronal networks and are influenced by temperature. As a consequence, the poikilothermic nature and the absence of a neocortex in amphibians and non-avian reptiles constitute an important hurdle when attempting to draw parallels with sleep in mammals. These difficulties may also explain why the behavioural and electrophysiological data available for amphibians and non-avian reptiles are rather sparse.

In the context of the present review we first provide an overview of what is known about sleep in amphibians and non-avian reptiles. We present for each clade the experimental conditions in which animals have been recorded including the light cycle, temperature, and the environment in which experiments were conducted. Next, we review the behaviour patterns related to sleep including continuous immobility, arousal threshold, and the presence of eye movements, and motor automatism during sleep. We then review the electrophysiological patterns associated with sleep including what is known about EEG frequency and amplitude variations relative to the EEG during the awake state, the muscle tone, the heart and respiratory rates, and the presence of high-voltage sharp waves (HShW). Finally, we present data on sleep deprivation, where investigated, and the possible mammalian sleep-state homologies discussed

in the literature. We discuss the limitations and problems associated with these data and subsequently provide a preliminary analysis of the evolution of associated sleep traits in reptiles and amphibians and highlight the difficulties of proposing hypotheses pertaining to the evolution of sleep without simultaneously integrating behavioural, neuroanatomical, molecular, and electrophysiological aspects of sleep.

II. AMPHIBIANS

With over 7,235 described species (www.amphibiaweb.org), amphibians are probably the most poorly studied taxa among tetrapods with sleep-wake data existing for only a handful of species (0.14% of all known species). Whereas sleep data exist for only 0.15% of all species of salamanders, fewer data are available for frogs (0.14%) and caecilians (0%). Moreover, existing data for frogs are highly skewed towards derived taxa such as bufonids, hylids, and ranids, effectively leaving most of the ecological and phylogenetic diversity unexplored. Below we describe the behavioural and electrophysiological information available for the different taxa studied. Data for all amphibians are summarized in Tables 1-4.

(1) Caudata

(a) *Experimental conditions*

One species of salamanders has been studied in the context of sleep, the tiger salamander (*Ambystoma tigrinum*; Lucas & Serman, 1969). Neither the light cycle, nor the temperature and recording duration were reported.

(b) *Behavioural evidence*

The only investigation in salamanders was performed on 27 *Ambystoma tigrinum* (Lucas & Serman, 1969) and showed that they display rhythmic behavioural activity with a 4 h rest-activity cycle.

(c) *Electrophysiological evidence*

The EEG analysis in *Ambystoma tigrinum* revealed a decrease in frequency and amplitude during prolonged resting periods. The absence of clear neck atonia and distinct eye movements obviated the identification of any state analogous to mammalian active sleep.

(d) *Summary*

In the only species of salamander studied to date, arousal threshold and sleep deprivation were not evaluated. Based on this experiment we can conclude, however, that at least one species of salamander display a rest-activity cycle during which the rest phase could potentially represent sleep. *A. tigrinum* displays slower brain activity during prolonged resting *versus* the awake state.

(2) Anura

(a) *Experimental conditions*

Nine different species of anuran have been studied in the context of sleep: two species of bufonids, the western toad [*Anaxyrus (Bufo) boreas*; Huntley, Donnelly & Cohen, 1978], and the common African toad [*Amietophrynus (Bufo) regularis*; Laming, 1982], however, this last species was studied only relative to its behavioural activity. Three species of hylids were also studied: the tree frogs *Osteopilus (Hyla) septentrionalis*, *Hyla squirella*, and *Hyla cinerea* (Hobson, Goin, & Goin, 1968); and four species of ranids: the European common frog (*Rana temporaria*; Aristakesyan & Karmanova, 1998, 2007; Belich, 1984; Karmanova, 1982; Karmanova & Lazarev, 1979; Laming, 1982; Lazarev, 1978a), the American bullfrog (*Lithobates (Rana) catesbeianus*; Hobson, 1967), the marsh frog (*Pelophylax (Rana) ridibunda*; Karmanova, 1982) and the Emei music frog (*Babina daunchina*; Fang *et al.*, 2012). One third of these experiments did not report recording duration and only half reported a recording duration greater or equal to 24 h. The light cycle was specified as a natural cycle or as a 12 h:12 h light:dark cycle for half of these experiments. Ambient temperature was described as constant in most of these studies but was not reported in four cases. Hobson *et al.* (1968) were the only authors to make behavioural observations and an arousal threshold evaluation in the field as well as under laboratory conditions.

(b) *Behavioural evidence*

All anuran species studied to date, in which frequency rate and heart rate has been recorded, display a specific posture of immobility with a decrease in of those parameters (Hobson, 1967; Hobson *et al.*, 1968; Lazarev, 1978b; Karmanova, 1982; Belich, 1984). Karmanova reported that *Pelophylax (Rana) ridibunda* spends most of its time in a resting state (80-90% of a 24 h period) and was also able to identify three kinds of resting states (sleep-like states). An SLS3 with eyes closed was observed in some animals during less than 10% of the 24 h period. This state was characterized by a slowing of the heart and respiratory rate. Arousal threshold was examined in only three publications. Although *Anaxyrus boreas* showed an increased arousal threshold to gentle

handling during rest (Huntley, Donnelly, & Cohen, 1978), there was no such change in *Lithobates catesbeianus* in response to electrical stimulation between the awake and resting states (Hobson, 1967). Three species of hylid studied by Hobson *et al.* (1968) showed a higher arousal threshold to gentle handling in laboratory compared to field conditions. In laboratory conditions no differences in arousal threshold were observed between awake and resting states, indeed they stated that: 'frogs are inert and non reactive unless heavily stimulated' (p. 386). Studies by Russian authors (Karmanova & Lazarev, 1979; Karmanova, 1982) associated the three SLS categories with an increased arousal threshold. However, we could not find any specific details of the experiments performed. Rhythmic movements of the feet during sleep-like states were reported only in *Rana temporaria* (Lazarev, 1978a, 1978b; Belich, 1984).

(c) *Electrophysiological evidence*

Huntley *et al.* (1978) and Lazarev (1978a) reported a decrease in EEG frequency and amplitude for *Anaxyrus boreas* and *Rana Temporaria* in a sleep-like state compared to when awake. Hobson *et al.* (1968) and Fang *et al.* (Fang *et al.*, 2012) report decreased EEG amplitude in the three tree frogs and *Babiba daunchina*, respectively. The factorial analysis study of Fang *et al.* (2012) found a statistical link between EEG band, vigilance state, and electrode placement. A fusiform oscillation at 12–14 Hz during the resting state was also observed; this was not present in the alert state. Karmanova & Lazarev (1979) reported a polymorphic and irregular EEG with a low amplitude in passive wakefulness similar to the waking state in *Rana temporaria*, whereas during the cataplexy state (SLS3), slow-wave activity was present on the EEG (0.5–2 Hz) (Lazarev, 1978a; Karmanova & Lazarev, 1979).

(d) *Sleep deprivation*

The only sleep deprivation study on an amphibian (*Rana temporaria*) reported a decrease of wakefulness during the recovery phase (20% awake in baseline to 5% during recovery) after 6 h of sleep deprivation using a gentle handling method (Aristakesyan & Karmanova, 1998). Similar to mammals and birds, for the first 2 h after rest deprivation the EEG of the frog during the deepest sleep state showed a statistically significant increase in the low-frequency power and an inhibition of the faster frequency component as compared to the baseline signal.

(e) *Summary*

For anurans, two main trends can be inferred from the EEG recordings: (1) high-voltage slow waves are more prominent during the awake state than during rest, and (2) a slight enhancement

in slow-wave activity may occur during the deepest sleep state (Karmanova *et al.*, 1971; Aristakesyan & Karmanova, 1998). Another feature of the EEG during the resting state in amphibians is the presence of EEG fusiform activity correlated with respiration, a finding reported in all studies to date that have recorded respiratory rate. Despite conflicting results from some studies, we conclude that the amphibian species studied to date display behavioural characteristics of sleep. Moreover, high-voltage sharp waves (HShW; often referred to as sharp waves or spike waves in the reptilian sleep literature) were only reported by Lazarev (1978*a,b*) for *Rana temporaria*. These HShW were 30–50 μ V in amplitude with a duration of 80–110 ms and were recorded mostly in the optic tectum and more rarely in the medial cortex (generally accepted to be the homologue of the mammalian hippocampus). Lazarev (1978*a,b*) noted that these patterns sometimes coincided with a brief rise in electromyogram (EMG) amplitude and that the spectral EEG during these waves was almost identical to that of wakefulness. The majority of studies did not report complete atonia or eye movements during the resting state suggesting the absence of an active sleep state in amphibians. However, Karmanova & Lazarev (1979) did report an ‘activation phase’ with an EEG similar to that observed during the awake state, motor automatisms, and a phasic transitory heart rate increase associated with HShW in *R. temporaria*. It should be noted, however, that only one study recorded electro-oculographic activity and only four reported electromyographic data.

III. NON-AVIAN REPTILES

Data on sleep are available for only 0.24% of all reptiles. Whereas 12% of all crocodylian species have been examined, data are available for only 2.43% of all turtles, and a mere 0.12% of all lizards. Taxa such as crocodylians are key to our understanding of the evolution of avian sleep, however, given that extant species of birds are most closely related to crocodiles. Although the position of turtles in the amniote tree remains debated, turtles are generally considered to be the sister taxon to both crocodylians and birds based on large-scale molecular analyses (Crawford *et al.*, 2012). The most important, yet least studied, group of reptiles – given their position at the base of the reptilian tree – is clearly the Lepidosauria. Data on non-avian reptiles are critical to the evaluation of hypotheses on the origin of sleep and its potential convergence in mammals and birds (Rattenborg *et al.*, 2011). Unfortunately, data for reptilian species are scarce, but the available information is summarized in Tables 5-8.

(1) Turtles

(a) *Experimental conditions*

Nine species of turtles and tortoise were studied in the context of sleep, the yellow-footed tortoise (*Chelonoidis denticulata*; Walker & Berger, 1973), the red-footed tortoise (*Chelonoidis carbonaria*; Flanigan, 1974), *Kinosternon* sp. (Ayala Guerrero, 1987), the box turtle (*Terrapene carolina*; Eiland, Lyamin & Siegel, 2001; Flanigan *et al.*, 1974), the European pond turtle (*Emys orbicularis*; Belich, 1984; Karmanova *et al.*, 1971; Vasilescu, 1970), the bolson tortoise (*Gopherus flavomarginatus*; Ayala-Guerrero, Calderon & Perez, 1988), the marginated tortoise (*Testudo marginata*; Hermann, Jouvet, & Klein, 1964), the Russian tortoise (*Testudo horsfieldi*; Aristakesyan, 2009), and the aquatic loggerhead sea turtle (*Caretta caretta*; Susic, 1972). Half of the studies recorded animals during 24 h or more in a chamber at constant temperature. However, a third of the papers report a constant illumination during the experiment.

(b) *Behavioural evidence*

All chelonians studied to date display a state of prolonged immobility, different from basking, with the eyes closed, the plastron resting on the ground, and the head fully relaxed. All studies that recorded heart rate and/or respiratory rate noted a diminution of these parameters during sleep. Of Interest is that half of the studies report eyes movements and/or twitches during sleep-like states. Four publications report arousal thresholds in turtles (Walker & Berger, 1973; Flanigan, 1974; Flanigan *et al.*, 1974; Ayala Guerrero, 1987). Except for the study of Walker & Berger (1973) where no differences in arousal threshold were detected for *Chelonoides denticulata*, longer response latencies were found. Ayala-Guerrero (1987) evaluated arousal threshold by gentle handling; the three other studies used electric shocks. Walker & Berger (1973) administered electric shocks at different intensities every 10 min during a 6–8 h period of sleep for three to four days, whereas Flanigan (1974) and Flanigan *et al.* (1974) administered shocks at an intensity which generated arousal in 50% of cases observed, with at least one stimulation every 60 min.

(c) *Electrophysiological evidence*

Of the ten experiments reporting EEG activity, five reported no changes in EEG frequency and amplitude between wakefulness and resting or sleep-like states. These experiments involved the aquatic *Caretta caretta* (Susic, 1972) and the terrestrial *Chelonoidis denticulate*, *Ch. carbonaria* and *Terrapene carolina* (Walker & Berger, 1973; Flanigan, 1974; Flanigan *et al.*, 1974; Eiland *et*

al., 2001). Susic (1972) did not report HShW, but the four other experiments cited above noted the presence of HShW during the resting period, including quiet wake as well as sleep. Three other experiments also reported HShW during rest (Karmanova *et al.*, 1971; Ayala Guerrero, 1987; Ayala-Guerrero *et al.*, 1988). Ayala-Guerrero *et al.* (1988), Ayala-Guerrero (1987) and Karmanova *et al.* (1971) noted a diminution in EEG amplitude and a decrease in EEG frequency in *Gopherus flavomarginatus*, *Kinosternon* sp., and *Emys orbicularis* associated with reduced vigilance. By contrast, Vasilescu (1970) reported only a decrease in EEG frequency in *Emys orbicularis*. Hermann *et al.* (1964) was the only experiment to report an increase in EEG amplitude but a decrease in EEG frequency during sleep (in *Testudo marginata*), thus concluding that turtle sleep is similar to mammalian slow-wave sleep.

(d) Sleep deprivation

Only three studies investigated sleep deprivation. Flanigan *et al.* (1974) and Flanigan (1974) report an increase in the quantity of sleep during the recovery phase after 48 h of constant arousal. However, Susic (1972) found no increase in the quantity of rest following 12 h of constant arousal in the fully aquatic *Caretta caretta*. Flanigan *et al.* (1974) and Flanigan (1974) also noted an increase in the quantity of HShW during the recovery period after sleep deprivation.

(e) Sleep state homologies

Three publications describe the presence of two sleep-like states, including the presence of a mammalian active sleep-like state (Vasilescu, 1970; Ayala Guerrero, 1987; Ayala-Guerrero *et al.*, 1988). They based their conclusions on the presence of eye movements and motor twitches during sleep. Vasilescu (1970) also reported atonia during a state that he called 'paradoxical sleep'. In contrast to the above, neither Susic (1972) nor Walker & Berger (1973) reported changes in the EEG and Walker & Berger (1973) report no change in the arousal threshold response, concluding that *Caretta caretta* and *Chelonoidis denticulata* do not sleep. They consequently suggested that prolonged resting periods in reptiles should be considered as an inactive behaviour rather than true sleep. Walker & Berger (1973) was the only study included in this review to record oxygen consumption over a 4–6 h period. Oxygen consumption was related to EMG activity but the 'spike rate' (presumably meaning the sharp wave rate) was not correlated to oxygen consumption resulting in the following observation: 'The absence of negative correlations between spiking and O₂ consumption indicates that in this respect spiking is not analogous to SWS' (Walker & Berger, 1973, p. 462).

Eiland *et al.* (2001) made unit recordings in the brainstem to search for evidence of active-sleep-specific activity. Although specific pontine neurons in the mammalian locus coeruleus and dorsal raphe cease discharging during active sleep while other cholinergic neurons increase in activity during this state, Eiland *et al.* (2001) found that most recorded brainstem neurons discharged only when the animal was active and reduced their discharge rates with immobility. Thus, they were unable to identify neurons related to a specific vigilance state that could be homologous to those observed during active sleep in mammals. Of note is the presence of EMG potentials during sleep that resemble mammalian active-sleep-related twitches (Eiland *et al.*, 2001). However, these authors were unable to confirm this finding using simultaneous polygraphic and video records.

(f) *Summary*

Data on sleep in turtles are sparse but a consensus suggests that they show an immobility state associated with a reduction of heart and respiratory rates. This state may represent a sleep state as the arousal threshold was usually higher in this state when investigated. The electrophysiological results are more difficult to interpret. Five studies reported no change in EEG variables related to the diminution of vigilance, three reported a decrease in EEG amplitude and frequency, one a decrease only in frequency, and one an increase in amplitude and decrease in frequency. HShW have been reported to be more prominent during sleep in half of the studies on turtles. Three studies reported the presence of a mammalian active sleep-like state, and one the presence of mammalian quiet sleep-like state. The only study on a fully aquatic turtle species (Susic, 1972) concluded the absence of sleep in that species based on an unchanged EEG during immobility and the absence of a recovery period after continuous arousal.

(2) Crocodylians

(a) *Experimental conditions*

Three species of Crocodylia were studied, the American alligator (*Alligator mississippiensis*; Van Twyver, 1973), the spectacled caiman (*Caimans sclerops*; Flanigan, Wilcox & Rechtschaffen, 1973; Meglasson & Huggins, 1979; Parsons & Huggins, 1965a,b; Rechtschaffen, Bassan & Ledecy-Janecek, 1968; Warner & Huggins, 1978), and the broad-snouted caiman (*Caiman latirostris*; Peyrethon & Dusan-Peyrethon, 1969). Of these eight papers, two (Parsons & Huggins, 1965a, 1965b) investigated the effect of temperature on EEG variables, but outside of the context of

sleep. Of the remaining six, only three reported recordings lasting equal or longer than 24 h, and only three reported the use of a day/night light cycle. The others gave no information on the light cycle used, or used constant illumination. The ambient temperature was reported in most cases but was too low for normal behaviour in half of the studies where it was reported. Warner & Huggins (1978) were the only authors to record animals in a breeding colony. Flanigan *et al.* (1973) reported that animals took days to fall asleep under laboratory conditions, even when they were isolated in a sound-attenuated chamber. By contrast, Warner & Huggins (1978) found that sleep was easy to identify in the same species under semi-natural conditions with higher temperature. This suggests that unnatural laboratory conditions may influence the sleep-wake cycle and that provision of an environment more similar to the natural environment may be required in studies of sleep in reptiles and amphibians.

(b) Behavioural evidence

Three species of crocodiles have been studied behaviourally in relation to vigilance states. For *Caiman sclerops* (Rechtschaffen, Bassan, & Ledecy-Janecek, 1968; Flanigan *et al.*, 1973; Warner & Huggins, 1978; Meglasson & Huggins, 1979) all reports describe a prolonged resting stage involving total immobility with the eyes closed. The three studies (on *C. sclerops* and *C. latirostris*) that quantified respiratory rate and heart rate reported a decrease in both parameters during sleep (Peyrethon & Dusan-Peyrethon, 1969; Flanigan *et al.*, 1973; Warner & Huggins, 1978). Only Peyrethon *et al.* (1969) reported fast twitches of the anterior limbs, fingers and eyes movement during sleep-like state in *C. latirostris*. Three arousal threshold evaluation tests on juvenile *C. sclerops* gave variable results: whereas Rechtschaffen *et al.* (1968) found that the animal was always easily aroused, Flanigan *et al.* (1973) highlight some difficulties to evaluate correctly the arousal response because the animals adapted rapidly adapted to the stimuli, and Meglasson & Huggins (1979) reported a higher arousal threshold during sleep.

(c) Electrophysiological evidence

In contrast to other reptilian species, most studies reported a slight increase in EEG amplitude and a decrease in EEG frequency in the sleep-like state. However, Flanigan *et al.* (1973) noted a decrease in both amplitude and frequency and Van Twyver (1973) reported no change in EEG activity. The latter study concluded that *Alligator mississippiensis* do not sleep as the eyes were rarely closed during periods of immobility. Four studies investigated the relationship between HShW and vigilance. Van Twyver (1973) and Flanigan *et al.* (1973) reported a negative correlation between the number of HShW and overall activity level. Meglasson & Huggins (1979)

reported that HShW were present during all activity states (quiescence, arousal, and diving). Peyrethon & Dusan-Peyrethon (1969), by contrast, reported these features only during active wakefulness and suggested a positive relationship between HShW and attention level in *C. latirostris*. Peyrethon & Dusan-Peyrethon (1969) provide the only report of a mammalian active sleep-like state in one individual in the form of short phases lasting 50 s on average during which the animal displayed rapid eye movements with the eyelids closed. However, the nuchal muscle tone did not change compared to the other sleep stages, and the EEG was similar to that of the awake state. Fast twitches of the anterior limbs and toes were also reported.

(d) Sleep deprivation

Flanigan *et al.* (1973) performed a gentle handling sleep deprivation study on four animals over periods varying between 24 and 48 h. They reported an increase in the duration of immobility periods after sleep deprivation, and a substantial increase in the number of HShW which they referred to as a 'spike rebound'.

(e) Summary

Despite the low number of publications concerning sleep in crocodiles we can conclude that all studies report a behavioural sleep except one study on *A. mississippiensis*. The authors of this study concluded that this species does not sleep based on the fact that the animal rarely closed the eyes and that the EEG did not change throughout the day. In contrast to other reptilian species, the EEG amplitude and frequency during sleep like states in crocodiles appears to change, similar to what is observed during mammalian quiet sleep. Only one study reports eye movements and motor automatisms during behavioral sleep not associated with muscle atonia. The presence of HShW during quiescence has been reported in only two studies. Sleep deprivation studies were performed only once but showed an increase in the immobility period and the number of HShW of normal sleep during the recovery period.

(3) Squamates

(a) Experimental conditions

Most studies on squamates (lizards and snakes) report both behavioural and electrophysiological data, and most involved iguanians. Only two publications deal with more actively foraging species and include a varanid, the desert monitor (*Varanus griseus*; Karmanova *et al.*, 1971), and a glass lizard (*Ophisaurus apodus*; Aristakesyan, 2009). 45% of the experiments report recordings lasting less than 24 h, and 55% did not report the light cycle or used constant

illumination. Constant temperatures were used in most experiments, often selected to approximate natural conditions, including the provision of a higher temperature basking spot in three studies.

(b) *Behavioural evidence*

All studies reported behavioural immobility with the eyes closed; there were no reports concluding that these animals do not sleep. All studies which measured heart and respiratory rates reported a decrease in these parameters related to quiescence. Ten experiments evaluated the arousal threshold during sleep in squamates, albeit including either gentle handling or electric shocks. All report a higher arousal threshold or an increase in latency of response to stimulation during sleep (Ayala-Guerrero & Huitron-Resendiz, 1991; Ayala-Guerrero & Mexicano, 2008a; Ayala-Guerrero & Vargas Reyna, 1987; Flanigan, 1973; Huntley & Cohen, 1980; Huntley, 1987; Peyrethon & Dusan-Peyrethon, 1969; Stropes, 1975; Tauber, Rojas-Ramirez & Hernandez Peon, 1968).

(c) *Electrophysiological evidence*

Comparing the basic sleep-like state with the awake state, six experiments reported a decrease in both EEG amplitude and frequency, and seven studies reported a decrease in EEG frequency alone. Romo, Cepeda & Velasco (1978) found an increase in EEG amplitude but a decrease in EEG frequency for the regal horned lizard (*Phrynosoma solare*), concluding that there was a clear parallel with the slow-wave sleep of mammals. Peyrethon & Dusan-Peyrethon (1969) reported no change in EEG variables of the green iguana (*Iguana iguana*) during different behavioural states, and a decrease in EEG frequency in the only snake studied to date (*Python sebae*; Peyrethon & Dusan-Peyrethon, 1969). Tauber *et al.* (1968) found no correlation between the number of HShW and behaviour in the Mexican spiny-tailed iguana (*Ctenosaura pectinata*). Huntley (1987), Huntley & Cohen (1980) and Stropes (1975), however, reported a greater HShW occurrence during wake compared to sleep in the desert iguana (*Dipsosaurus dorsalis*) and the chuckawalla (*Sauromalus obesus*), respectively. Nine publications reported an increase in the number of HShW during quiescence. Peyrethon & Dusan-Peyrethon (1969) and Flanigan (1973) for *Iguana iguana*, *Python sebae* and *Ctenosaura pectinata* reported a correlation between respiratory rate and the presence of EEG fusiform oscillations. An interesting behavioural observation involved the presence of asynchronous eye closure in the western fence lizard (*Sceloporus occidentalis*; Mathews *et al.*, 2006) which the authors suggested was correlated with predation risk. Other studies have

reported unilateral eye closure in reptiles (Flanigan, 1973, 1974; Flanigan *et al.*, 1974; Peyrethon & Dusan-Peyrethon, 1969; Tauber, Roffwarg & Weitzman, 1966; Tauber *et al.*, 1968; Warner & Huggins, 1978). For a detailed review on unihemispheric sleep see Rattenborg, Amlaner & Lima (1999). The presence of unihemispheric sleep in reptiles remains, however, unclear.

(d) *Sleep deprivation*

Two studies reported the use of a 48 h sleep-deprivation study to test for a homeostatic response (Ayala-Guerrero & Mexicano, 2008a; Flanigan 1973). Both noted the presence of a recovery period (in *Iguana iguana* and *Ctenosaura pectinata*). Flanigan (1973) also reported a substantial increase in the number of HShW after deprivation, similarly to his results on sleep-deprived chelonians (Flanigan, 1974; Flanigan *et al.*, 1974) and crocodylians (Flanigan *et al.*, 1973).

(e) *Sleep state homologies*

Nine publications report electrophysiological data suggesting the presence of two sleep states in lizards. Three of these identified a sleep stage with high-amplitude slow waves and a second stage with low-amplitude fast waves (Romo *et al.*, 1978; Stropes, 1971, 1975). Other authors propose a homology of this second sleep-like state with mammalian active sleep based on the presence of nuchal muscle atonia (Huntley, Donnelly & Cohen, 1977; Huntley, 1987), eye movements (Ayala-Guerrero & Huitron-Resendiz, 1991; Ayala-Guerrero & Mexicano, 2008a; Ayala-Guerrero & Vargas Reyna, 1987; Tauber *et al.*, 1966), motor automatisms (Ayala-Guerrero & Huitron-Resendiz, 1991; Ayala-Guerrero & Mexicano, 2008a; Ayala-Guerrero & Vargas Reyna, 1987), or EEG activity (Romo *et al.*, 1978). Tauber *et al.* (1966) studied two species of chameleon (*Trioceros (Chamaeleo) jacksoni*, *Trioceros (Chamaeleo) melleri*) that demonstrate a high degree of eye mobility and visual acuity during wakefulness. They found that eye movements of chameleons during sleep are disconjugate but not associated with atonia, motor twitches, or changes in EEG pattern. They proposed homology with eye movement during sleep in humans but did not suggest homology with mammalian active sleep (Tauber *et al.*, 1966). Stropes (1971, 1975) also reported eye movements during sleep, in *Sauromalus obesus* and the finged-toed lizard (*Uma notata*), but these eye movements were present during both of the two electrophysiological sleep-like states identified.

(f) *Summary*

All studies agree on the presence of sleep-like states in squamates, but the diversity of findings prevents clear conclusions regarding the electrophysiological nature of sleep in these animals. Interestingly, however, just under half of the studies on squamates report eye movements during sleep, and three studies describe muscle atonia. Moreover, six studies report motor automatisms during sleep, and half of all studies agree on the presence of two sleep states. Finally, five studies concluded the presence of a sleep state homologous to mammalian active sleep. Unfortunately, none of the studies on squamates performed to date have examined all of the electrophysiological and physiological traits that allow the characterization of active sleep in mammals.

IV. LIMITATIONS OF THE DATA

Any review aiming to synthesize the existing literature is limited by the quality and quantity of the available data. With respect to sleep in amphibians and reptiles, these limitations are significant. Below we list the principal limitations encountered in trying to derive a broader understanding on the evolution of sleep from these data.

(1) Methodological limitations

In mammals it has been shown that sleep is strongly influenced by environmental variables such as lighting conditions and temperature (Berger & Phillips, 1995). Due to the poikilothermic nature of amphibians and reptiles, these species are strongly influenced by environmental conditions such as light and temperature. Unfortunately, only a few studies have explicitly tested the influence of temperature on the activity–rest cycle and on EEG amplitude or high-amplitude EEG wave distribution in amphibians and reptiles, and not necessarily in the context of sleep. In general, these studies report a reduction of EEG amplitude and a decrease in EEG frequency in relation to ambient temperature (De Vera, Gonzalez & Rial, 1994; Hunsaker & Lansing, 1962; Huntley, 1987; Parsons & Huggins, 1965b; Van Twyver, 1973) as has also been shown in mammals (Deboer, 1998). In sleep studies where HShW were recorded, their number appears to decrease with decreasing temperature (Flanigan *et al.*, 1973; Huntley & Cohen, 1980; Huntley, 1987; Van Twyver, 1973). The most complete study on the effect of temperature and seasonal light cycle duration on sleep was performed by Huntley (1987) on *Dipsosaurus dorsalis* who recorded EEG patterns in these lizards at 10°C, 20°C and 30°C during spring, autumn, and winter. He reported that the proportion of sleep decreased slightly with duration of the night. He also found that the occurrence of HShW diminished, and that the EEG amplitude and

frequency decreased with temperature suggesting that light cycle and temperature fluctuations have a strong impact on the sleep cycle (Huntley, 1987). However, most studies on amphibian and reptilian sleep report experiments that were performed under constant light and temperature conditions. Moreover, about half of the studies monitored animals for less than 24h or did not report this parameter, thus imposing strong limitations on the use of these data in a broader comparative context.

Another important factor that may bias sleep patterns is the age of the animal. In mammals and birds, sleep duration, and particularly active sleep duration, is known to decrease with age (Jouvet-Mounier & Astic, 1966; Scriba *et al.*, 2013). To our knowledge, there are no studies exploring the effects of age on sleep patterns in amphibians and reptiles. However, all crocodiles studied to date were juveniles, all turtles were adults, and the lizards included both juveniles and adults. If an age effect is present as in mammals and birds, then this may bias attempts at comparative analyses of sleep using these data. Similarly, although all amphibians studied were non-larval, their exact ages were not reported. If the developmental hypothesis of Roffwarg *et al.* (1966) holds for non-avian reptiles and amphibians, active sleep may be present only *in ovo* during the maturation phase of the animal and may disappear soon after hatching. Corner (1977) reviewed data on motility cycles in early life and during development in the context of sleep and reported that brief movement patterns during periods of relative inactivity were found in all species studied including arthropods, molluscs, fishes, amphibians, birds and mammals. This underlines the importance of investigating the role of development in sleep studies.

The ability of an animal to interact with its environment is also known to influence sleeping patterns. For example, Rattenborg *et al.* (2008) showed that sloths (*Bradypus variegatus*) sleep 40% less when recorded in their natural environment compared to laboratory conditions., Warner & Huggins (1978) noted that animals recorded in a semi-natural environment appear to fall asleep faster than animals recorded in isolation in laboratory conditions. This suggests the importance of factors such as social context, when working on gregarious species as has been demonstrated for mice. Febinger *et al.* (2014) reported that mice housed in a group have shorter bouts of active sleep and quiet sleep during the light phase and more active sleep during the dark phase. Moreover, a recent field study focusing on the link between predation and sleep showed that high predation risk may influence the timing of sleep, but not the amount of sleep in sloths (Voirin *et al.*, 2014). It has been shown that simulated predator encounters reduced the amount of sleep in wild rats due to a lower number of sleep episodes (Lesku *et al.*, 2008a). Further investigations

pertaining to the ecological context of sleep are required for non-avian reptiles and amphibians (Capellini *et al.*, 2008; Lima *et al.*, 2005; Revell & Hayes, 2009).

In our overview of the literature, we also observed methodological differences in the evaluation of the arousal threshold response. Flanigan *et al.* (1973) identified the problem of animals habituating to the presentation of cutaneous stimuli. In subsequent studies these workers switched to the use of electric shocks calibrated to a 50% awakening threshold, with sufficient time between shocks to avoid habituation (Flanigan, 1973). However, others did not note a difference in the arousal threshold when using shocks of varying intensity (Walker & Berger, 1973). Unfortunately, shocks in that study were administered at very short intervals (every 10 min on average), potentially rendering their results on arousal threshold questionable. The same reservations may apply to the study of Hobson (1967) on *Lithobates catesbeianus* where stimuli were administered at very short intervals. Arousal threshold has been evaluated in 22 experiments on amphibians and reptiles, of which 18 report an elevated arousal threshold when animals were in behavioural sleep. Of the four studies reported no change in arousal threshold during behavioural sleep, two used manual stimulation of which one noted probable habituation (Flanigan *et al.*, 1973; Rechtschaffen *et al.*, 1968), and the two others used electric shocks but with very short latencies (Hobson, 1967; Walker & Berger, 1973).

Another potential confounding factor in comparing data recorded using different protocols is the type of recording device. Two kinds of electrodes are typically used for recording brain waves: wires and screws. Wire electrodes, because of their smaller contact surface area, record more-local electrical fields in the brain. By contrast, EEGs recorded using screws are averaged over a larger surface area and local activity may be less detectable, resulting in different patterns. About half of the studies in reptiles and amphibians used screw electrodes while the others used wire electrodes, representing a potentially confounding difference. Another important feature of the electrode is the nature of the metal used; the conductivity and the impedance of an electrode are related both to the metal used and to the size of the electrode tip. These properties affect how brain waves are measured especially amplitude measurements, and may thus hinder comparative analyses. Moreover, brain waves are specific to the neuronal organization of the study organism, its neuroanatomy, and neuronal connectivity (Bullock, 1997; Bullock & Basar, 1988; Buzsaki, Anastassiou & Koch, 2012). The positioning of the electrodes thus may influence the measurement of brain waves, and as a consequence homology in the nature and origin of the high-amplitude EEG waves reported by different authors is questionable. As no detailed neuro-

anatomical atlas exists for reptiles and amphibians, and as electrode placements are often not verified histologically, comparisons among species and studies are rendered difficult. Electromyographic recordings may also be influenced by interspecific differences in muscle fibre-type composition. In contrast to many mammals, the dorsal nuchal musculature in many amphibians and reptiles is not postural in nature and thus may be a very poor indicator of muscle atonia in these animals. In fact, the slow-twitch muscle fibres, which are important in the maintenance of head posture, are present in reptiles, but positioned deep, adjacent to the vertebral column (Schilling, 2011). The superficial muscles such as the *m. spinalis capitis* and *m. obliquus capitis* (Herrel & De Vree, 1999), which are easily recordable, contain mostly fast-twitch fibres and typically are recruited for phasic movements such as cranial elevation during feeding (Gans, Carrier & De Vree, 1985; Herrel, Cleuren & Vree, 1996). It is thus possible that many electromyographic recordings in reptiles may be affected by the positioning of electrodes in non-postural muscles, yet this remains to be verified.

(2) Limitations of mammalian-centred definitions of sleep

Another important limitation when trying to compare sleep in different groups of vertebrates is the definition of sleep. The criteria used to define sleep and its different stages are principally based on work in mammals. At a behavioural level, parameters are more easily generalized as they involve the presence of a stereotypic posture, immobility, rapid state reversibility, an elevated arousal threshold, eye closure, and phasic motor automatisms. However, when working with physiological and electroencephalographic parameters, criteria that are used to identify sleep and its different stages cannot be generalized so easily, particularly since these parameters are linked to the lifestyle, neuroanatomy, and metabolism of a species. In consequence dormancy states have often been considered as independent from sleep states. As ectothermic animals have a body temperature that is dependent on the environment and behaviourally regulated, the classical mammalian sleep definition may be limited when working with non-homeothermic species. As a result, the establishment of homology of sleep based on these classical criteria is tenuous. Moreover, the variability of these phenomena is large in a phylogenetic and ontogenetic context, thus rendering broad-scale interpretations difficult.

Thus, evaluating the presence of mammalian active sleep, or its equivalent, in amphibians and non-avian reptiles is extremely difficult. All studies regarding the presence of an active sleep-like state in reptiles raise the question as to whether their results potentially represent an alternative state such as a short waking event rather than true mammalian active sleep. Yet,

reptiles possess pontine structures homologous to those of mammals (Ayala-Guerrero & Mexicano, 2008b; Medina *et al.*, 1993; Northcutt, 2002), and periventricular hypothalamic peptides such as orexin and melanin-concentrating hormone (Cardot, Fellmann & Bugnon, 1994; Dominguez *et al.*, 2010) involved in the regulation of active sleep in mammals (Luppi, Peyron & Fort, 2013; Saper *et al.*, 2010). Basal birds and mammals also have the largest amounts of behavioural active sleep (Lesku *et al.*, 2011; Siegel *et al.*, 1996, 1999) suggesting that this may be an ancestral trait. Phasic motility also appears to exist during the development of reptiles, raising the possibility that this type of sleep may have been present in a common ancestor, still present in early ontogenetic stages. This raises questions about the real nature, origin and functions of active sleep across species and its evolutionary and developmental origins.

Ayala-Guerrero & Mexicano (2008a) attempted to test arousal threshold during a supposed active sleep state. They were able to demonstrate an elevated arousal threshold suggesting that these animals were not awake. Whether EEG activity, muscle atonia or the presence of eye movements are better indicators of the presence of an active sleep homologue in amphibians or non-avian reptiles remains unresolved. Because of these limitations, we believe that it is essential to base comparative analyses of sleep, especially in ectothermic animals, on a combination of behavioural, physiological, electroencephalographic, neuro-anatomical, developmental, and ecological variables. Clearly, behavioural features of sleep are more easily interpreted and could be the first to be evaluated in a broad comparative context.

V. DISCUSSION

(1) Phylogenetic analysis

In an attempt to infer common sleep features at the origin of tetrapods and amniotes using data on sleep available in the literature, we reconstructed ancestral character states using maximum likelihood methods (Pagel, 1999). In doing so, we attempt to infer patterns rather than processes or function. We focused our analysis on behavioural and electrophysiological parameters given their wider availability in the literature. We could not use sleep and wake quantities as parameters because of the environmental bias.

(a) Behavioural patterns

Despite differences in environmental conditions during recording and non-continuous monitoring it appears that all amphibians and non-avian reptiles studied to date display a daily phase of immobility with stereotypic postures that involve eye closure (except in species lacking eyelids). The heart rate and respiratory rate, when measured, show a tendency to decrease when amphibians and reptiles are in a sleep-like state. The evolution of other traits is less clear, but our maximum likelihood estimates may be informative in inferring evolutionary patterns. The likelihood that an increase in the arousal threshold during quiescence (Fig. 2) is an ancestral feature of tetrapods is high (0.90). Similarly, the likelihood that an increased arousal threshold is an ancestral feature of non-avian reptiles is very high (0.99). A similar analysis of the presence of 'sleep homeostasis', i.e. the presence of a sleep-like recovery state after sleep deprivation (Fig. 3) gave a high likelihood of this being an ancestral feature for tetrapods (0.98) and non-avian reptiles (0.99). The only species that appears to have lost this physiological trait is the only fully aquatic species recorded: the loggerhead sea turtle (*C. caretta*). This exception suggests constraints imposed by an aquatic environment on the evolution of sleep, as also has been suggested for mammals (Lyamin *et al.*, 2008; Madan & Jha, 2012). Of the behavioural features typically associated with mammalian and avian active sleep, twitches and motor automatisms during sleep (Fig. 4) have a high likelihood (0.99) that they were present in the ancestor of reptiles. The presence of eye movements during periods of behavioural sleep (Fig. 5) is a feature commonly linked to mammalian active sleep. The analysis shows that the likelihood of this being a shared feature of tetrapods is low (0.31) although the likelihood of this feature being ancestral for non-avian reptiles (0.53) and present in the ancestor of archosaurs and chelonians is higher (0.80). Together, these results are consistent with the premise that behavioural sleep is present in amphibians and reptiles, but the behavioural distinction between quiet sleep and active sleep is more difficult despite the probable presence of some features of mammalian active sleep at the base of non-avian reptiles (Fig. 1).

(b) *Electrophysiological patterns*

A feature often thought to characterize active sleep in mammals is the presence of periods of complete muscle atonia. However, the presence of this feature at the base of the reptilian tree (Fig. 6) is unlikely (0.03). This feature has formed the basis of arguments over the presence of active sleep in reptiles. Due to the bias caused by the different brain regions recorded and by the different methodologies used to record brain waves, we chose to quantify the variation in frequency and amplitude during sleep relative to the awake state. EEG frequency decreases during

sleep-like states in nearly all amphibians and reptiles where it has been measured (Fig. 7). Consequently, the likelihood that this is an ancestral feature for amniotes (0.96) and lissamphibians (0.99) is high. The pattern with respect to EEG amplitude is different, however (Fig. 8). Whereas the likelihood for a decrease in EEG amplitude during sleep-like states to be ancestral for lissamphibians is high (0.90), the likelihood for decreased amplitude to be an ancestral state is much lower at the base of the amniotes (0.40). The condition of no change in EEG amplitude relative to the vigilant state is the more likely at the base of amniotes. Finally, the ancestral character state reconstruction of the presence of HShW at the base of the reptilian tree is also equivocal (0.5; see Fig. 9).

(2) The evolution of sleep

The above review suggests that although some reptilian and amphibian features of sleep are different from sleep characteristics observed in mammals and birds, there are also similarities, suggesting either a common origin or a strong convergence in the evolution of behavioural sleep. However, the origin of the separation of mammalian sleep into two distinct states remains unclear. During active sleep birds display phases of eye movements and occasional twitching (Rattenborg *et al.*, 2011b). The EEG patterns of birds during quiet sleep and active sleep are similar to those of mammals. However, some characteristics of mammalian brain activity during sleep, such as thalamocortical spindles, hippocampal sharp wave ripples, and hippocampal theta waves, have not been observed in birds (Rattenborg *et al.*, 2011b) suggesting subtle but potentially important differences. The presence of atonia in postural muscles during active sleep has been reported in birds (Dewasmes *et al.*, 1985), but it is not as clearly defined as in mammals (Amlaner & Ball, 1994; Rattenborg *et al.*, 2011b), meaning that conclusions regarding homology cannot be drawn. The same issue concerns changes in sleep during development: in newborn rats an activated EEG, rapid eye movements, muscle atonia, inhibition of the thermoregulatory response, and hippocampal theta waves are not observed during active sleep. Such considerations raise concern regarding the use of only electrophysiological features to identify sleep homologies. Moreover, although the presence of HShW during episodes of behavioural quiescence has been proposed as a marker of quiet sleep in reptiles (Hartse, 2011), HShW have been reported in amphibians only in the optic tectum of *Rana temporaria* (Lazarev, 1978a,b). In reptiles, studies on the presence of HShW are sparse. Some pharmacological experiments in turtles revealed that HShW react in the same way to a pharmacological agent as do ventral hippocampal sharp waves in mammals (Hartse & Rechtschaffen, 1982). The origin of HShW in reptiles, however, remains

unknown, despite the fact that some *in vitro* and *in vivo* local field potential recordings in brain areas like the thalamus, medial and dorsal cortex, and the optic tectum have been performed (Gaztelu, Garcia-Austt & Bullock, 1991; Lorenzo, Macadar & Velluti, 1999; Servit, Strejckova & Volanschi, 1971). Thus, additional studies are needed to understand better whether reptilian HShW are generated by structures homologous to those observed in mammals.

The integration of neuroanatomy with brain activity may provide a more comprehensive understanding on sleep-state homologies and evolution. For example, Rattenborg (2006b) postulated that the origin of the slow oscillations recorded during sleep in birds could be explained by their higher degree of cortico-cortical (i.e. pallio-pallial) connectivity. He proposed that the origin of these slow waves could be linked to convergent evolution of a higher degree of cortico-cortical connectivity in both mammals and birds. Such observations reveal the challenges of inferring homologies for species that do not possess the neocortical organization necessary for generating the slow waves characteristic of mammalian active sleep.

A high level of variation of active sleep is observed in relation to ambient temperature (Sokoloff & Blumberg, 1998). In addition, the proportion of active sleep is greatest early in development and greatest when animals are at a thermoneutral temperature (Szymusiak & Satinoff, 1981). Consequently, development, the temperature dependence of active sleep, and the mammalian-centric definition mostly based on electrophysiological patterns may prevent its identification in adult reptiles and amphibians. However, our phylogenetic analysis shows that twitches and eye movements were likely present during behavioural sleep at the stem of the reptilian tree. These behavioural patterns of active sleep coupled with the presence of phasic motility *in ovo* in non-avian reptiles, makes the presence of active sleep at the base of the amniote more than likely even if it might display an electrophysiological phenotype different from that of mammals.

What does this mean for the evolution of sleep? If mammals and birds do not show the same sleep states as their more basal reptilian ancestors, this would suggest convergent evolution of sleep in these two taxa, potentially associated with their homeothermic physiology and higher energy requirements. An alternative hypothesis is that all tetrapods share similar sleep states and neuronal sleep generators, but that the electrophysiological correlates of sleep are induced by differences in neuroanatomy and by consequence result in differences in brain activity. In that case sleep would be ancestral for tetrapods with modification of brain connectivity in mammals and birds driving the differences in brain signatures observed. Thus, all living tetrapods may share

a common ancestral type of sleep, but the features common to this ancestral sleep have not yet been identified. Irrespective of the hypothesis to be tested, data on sleep in amphibians and reptiles are crucial to be able to discriminate among them.

VI. CONCLUSIONS

Most amphibians and reptiles display behavioural criteria of sleep, including stereotypic postures, maintenance of behavioural immobility, an elevated behavioural response threshold to arousal stimuli, eye closure, and homeostatic regulation of sleep. Twitches or motor automatisms and eye movements during sleep are likely present in reptiles, but their significance and origin remain poorly understood.

The respiratory rate and heart rate appear to decrease in reptiles and amphibians during sleep-like states as is the case in mammals and birds. The decrease in EEG frequency in sleep-like states compared to the awake state is likely an ancestral feature in tetrapods. However, the amplitude of the EEG is more variable across amphibians and non-avian reptiles than in mammals during sleep. High-voltage sharp waves, considered a marker of sleep in mammals, cannot be clearly related to sleep in either amphibians or reptiles, raising the question of whether their presence is really related to sleep.

The combination of all behavioural and electrophysiological patterns typically associated with mammalian active sleep has never been reported in amphibians. However, the behavioural characteristics of mammalian active sleep are likely to have been present at the stem of reptiles. It is not possible to link these features clearly to active sleep in mammals because of the variability in electrophysiological features in reptiles.

Studying sleep in a comparative context is essential, using as many behavioural, physiological, and electrophysiological variables as possible to gain better insights into the nature and evolution of sleep in non-avian reptiles and amphibians. The poikilothermic lifestyle of these groups is associated with important differences in physiology and behaviour when compared to mammals or birds. The parameters typically used to describe sleep in mammals parameters may not apply to animals with such a different physiology, neuroanatomy, and behaviour. The diversity of mechanisms implicated in the control of sleep-wake physiology, as well as the variety of epiphenomena related to sleep observed across vertebrates, may partly explain the lack of

consensus regarding the function, evolution, and nature of sleep. Any analysis of the ontogenetic and phylogenetic features of sleep encounters the difficulty of identifying homologous features across species, which may hinder phylogenetic inferences on the evolutionary origins of sleep states (Blumberg, 2013). Despite this, comparative and developmental approaches remain essential to understanding sleep in all of its manifestations. Indeed, the time lost by sleeping rather than being invested in reproduction, parental care, or foraging suggests an essential role for sleep. Finally, the variability in duration, fragmentation, and physiological modifications of sleep across the animal kingdom reveal its adaptive nature, making it both interesting and crucial to draw parallels among species in an evolutionary context.

VII. FIGURES ET TABLES

Arrousal Threshold during sleep

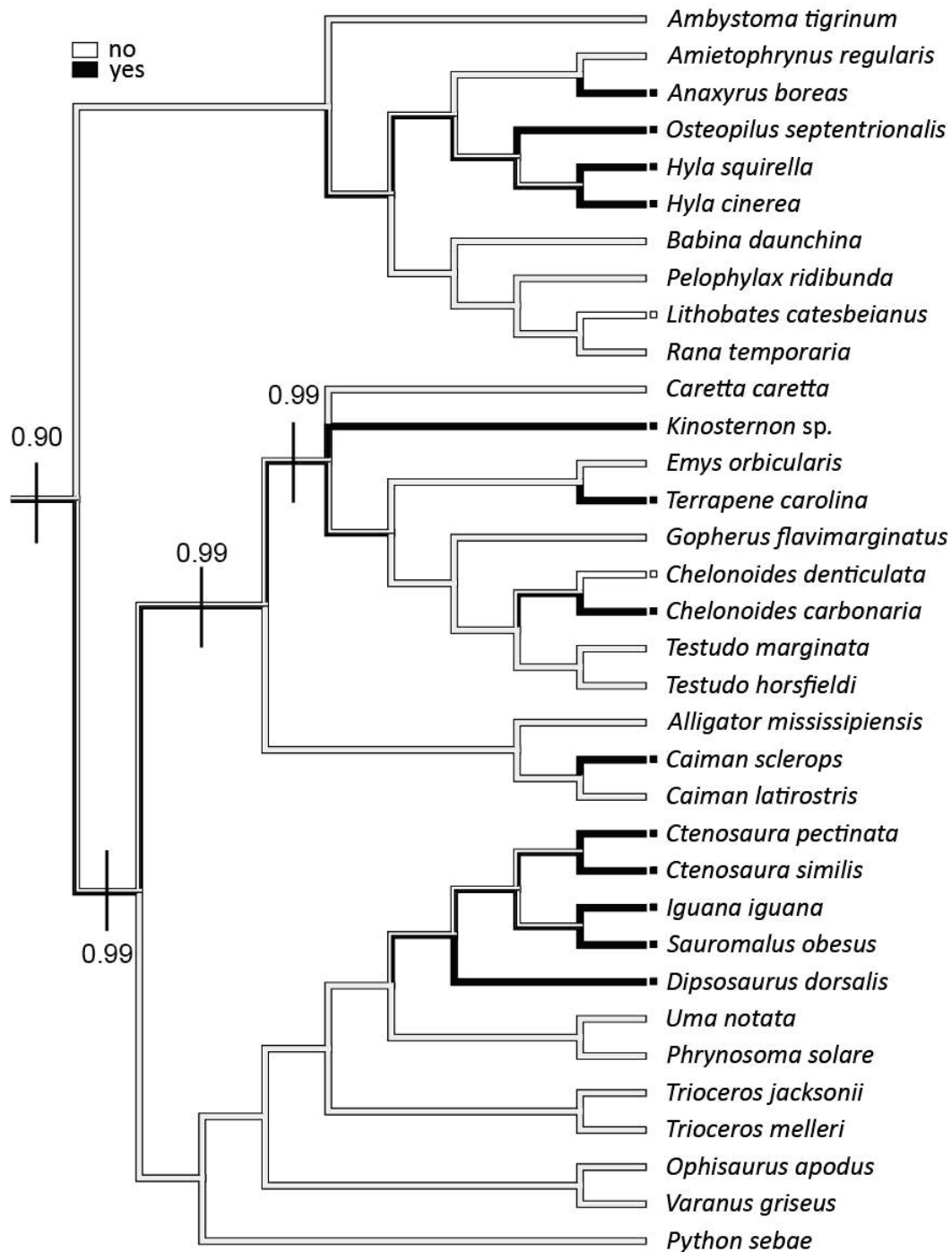

Fig. 2. Maximum-likelihood-based ancestral character state reconstruction of the presence of an elevated arousal threshold during quiescence. Black squares indicate the presence of an elevated arousal threshold in terminal taxa. Shading along the branches illustrate the reconstructed ancestral states. Numbers indicate the likelihood of the presence of the character at a given node. Phylogeny based on Pyron & Wiens (2011) for amphibians, Chiari et al. (2012) for amniotes, Pyron et al. (2013) for squamates and Guillon et al. (2012) for turtles. All branches are set to unit lengths as branch lengths were not available for all taxa.

Sleep homeostasis

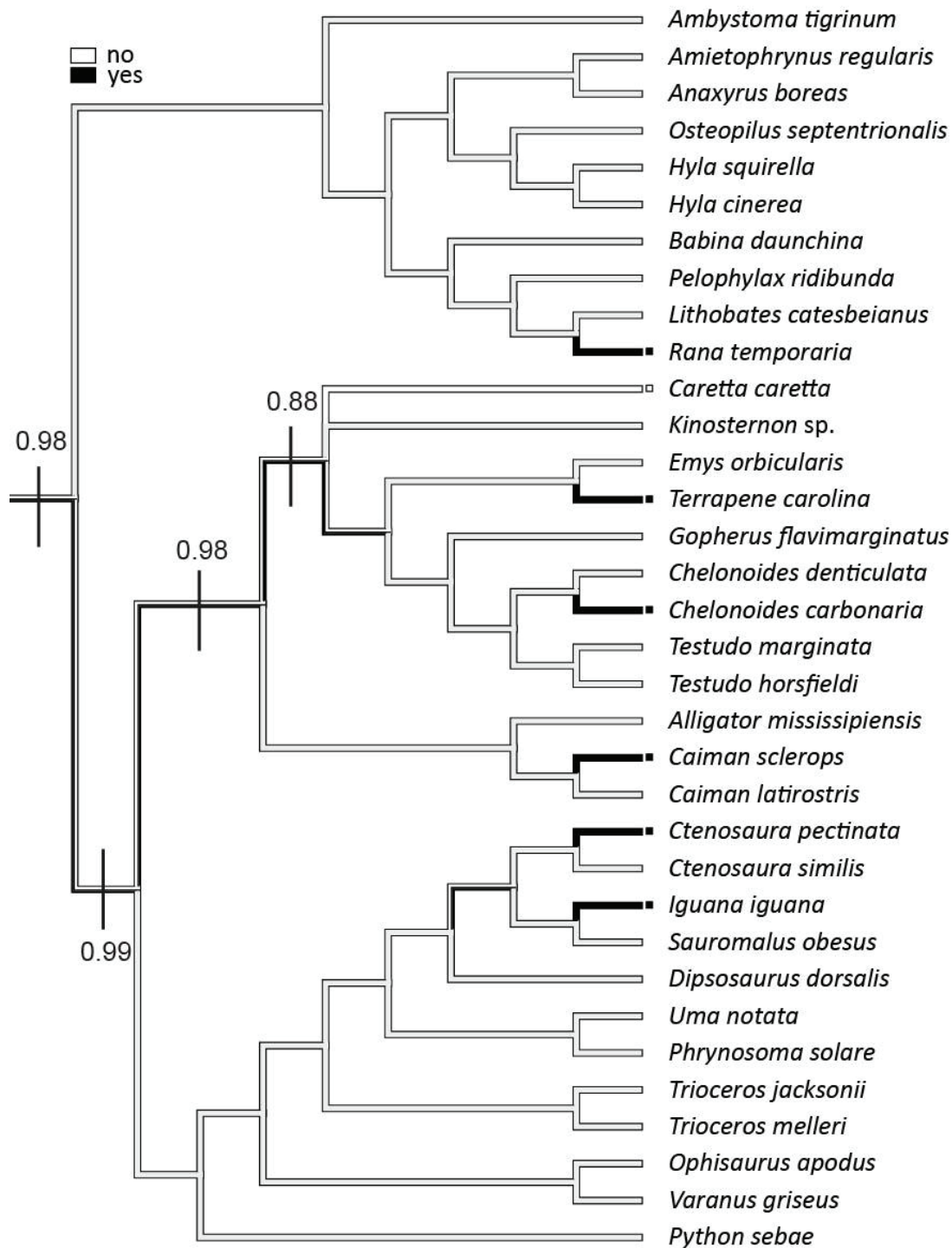

Fig. 3. Maximum-likelihood-based ancestral character state reconstruction of the presence of ‘sleep homeostasis’ (i.e. an increase in sleep-like state duration after sleep deprivation). Black squares indicate the presence of sleep homeostasis in terminal taxa. Other details are as in Fig. 2.

Twitches and motor automatisms during sleep

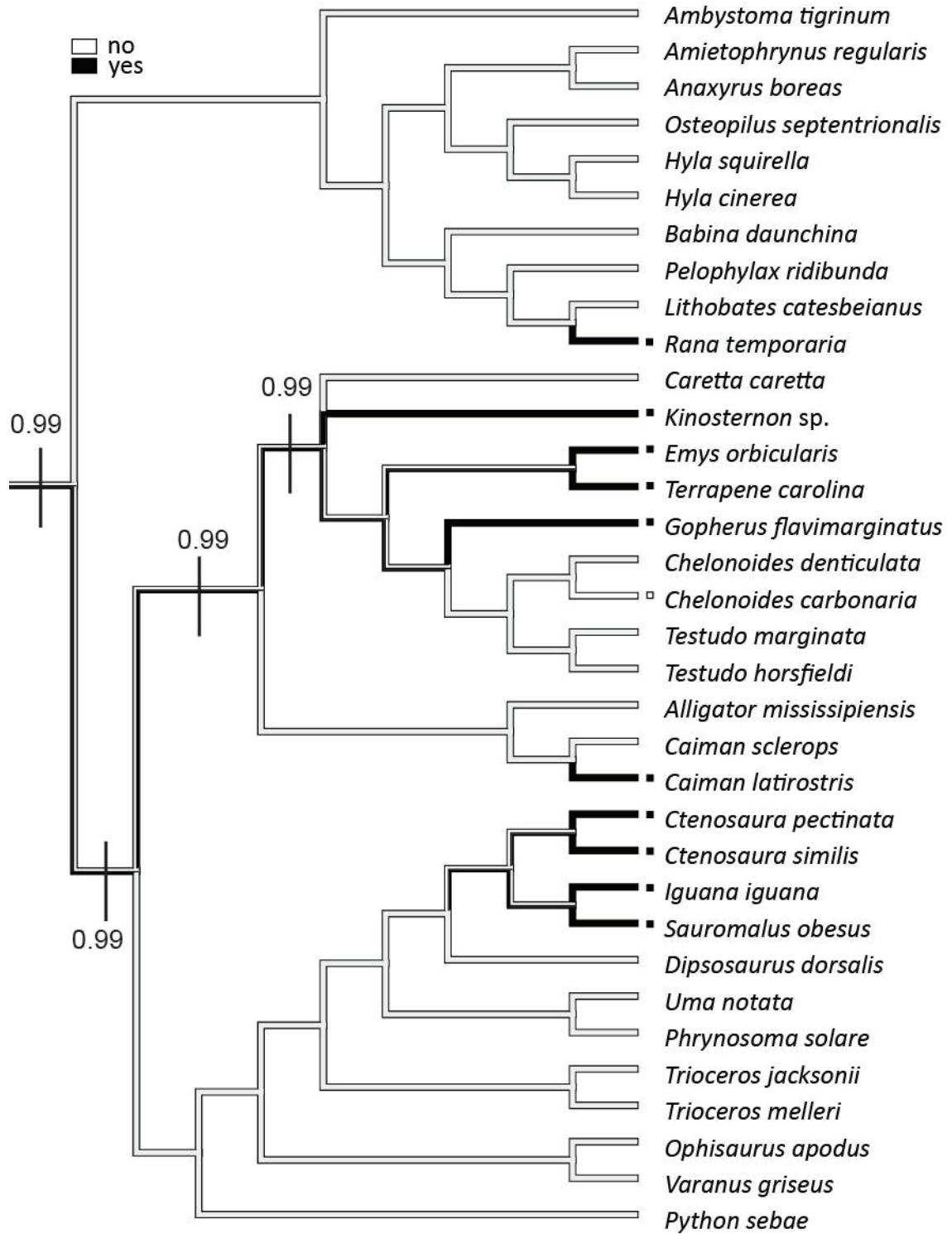

Fig. 4. Maximum-likelihood-based ancestral character state reconstruction of the presence of twitches and motor automatisms during sleep-like states. Black squares indicate the presence of twitches or motor automatisms during sleep-like states. Other details are as in Fig. 2.

Eye movements during sleep

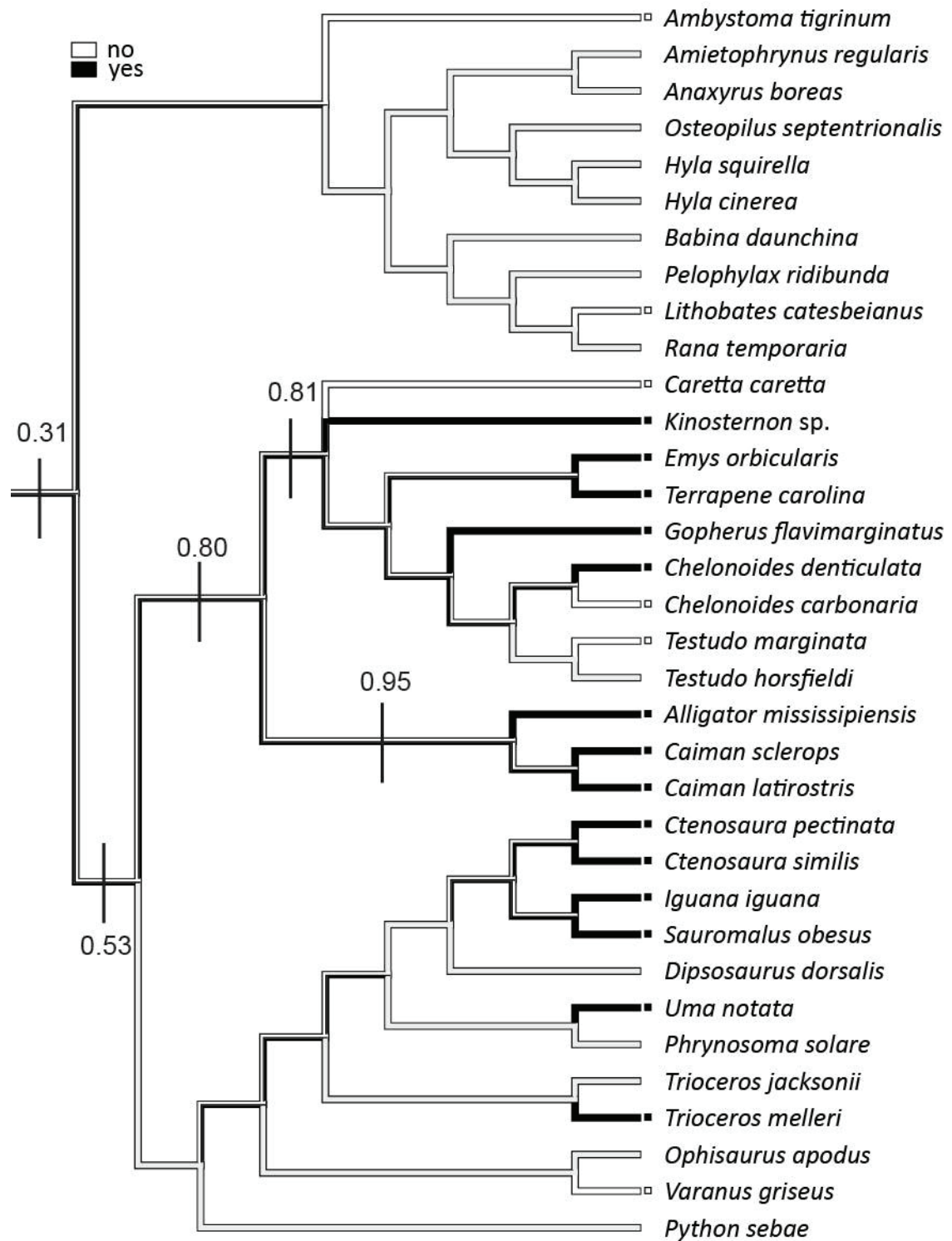

Fig. 5. Maximum-likelihood-based ancestral character state reconstruction of the presence of eye movements during sleep-like states. Black squares indicate the presence of eye movements during sleep-like states in terminal taxa. Other details are as in Fig. 2.

Muscle atonia during sleep

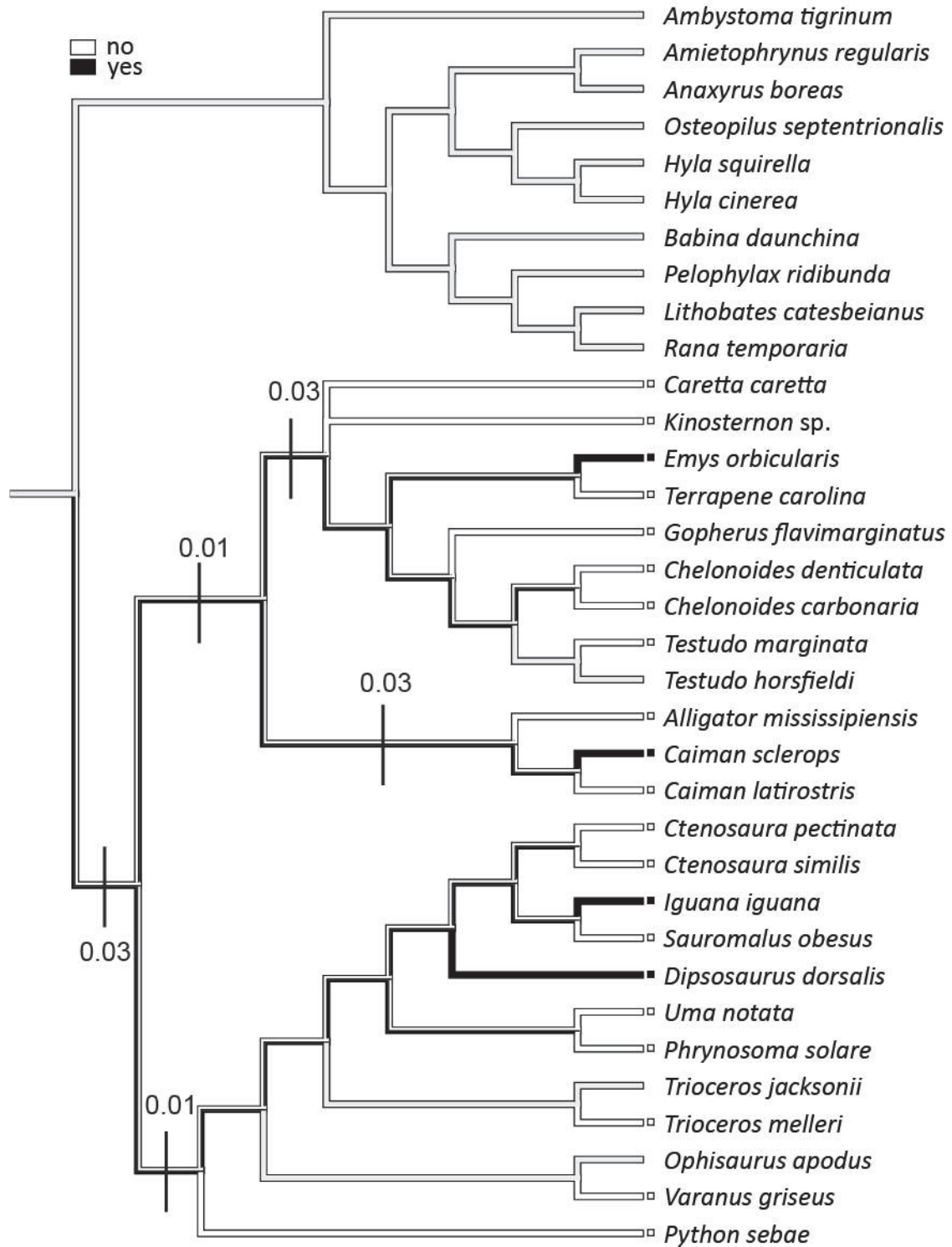

Fig. 6. Maximum-likelihood-based ancestral character state reconstruction of the presence of muscle atonia during sleep-like states. Black squares indicate the absence of muscle tone during sleep-like states in terminal taxa. Other details are as in Fig. 2.

EEG frequency decrease during sleep

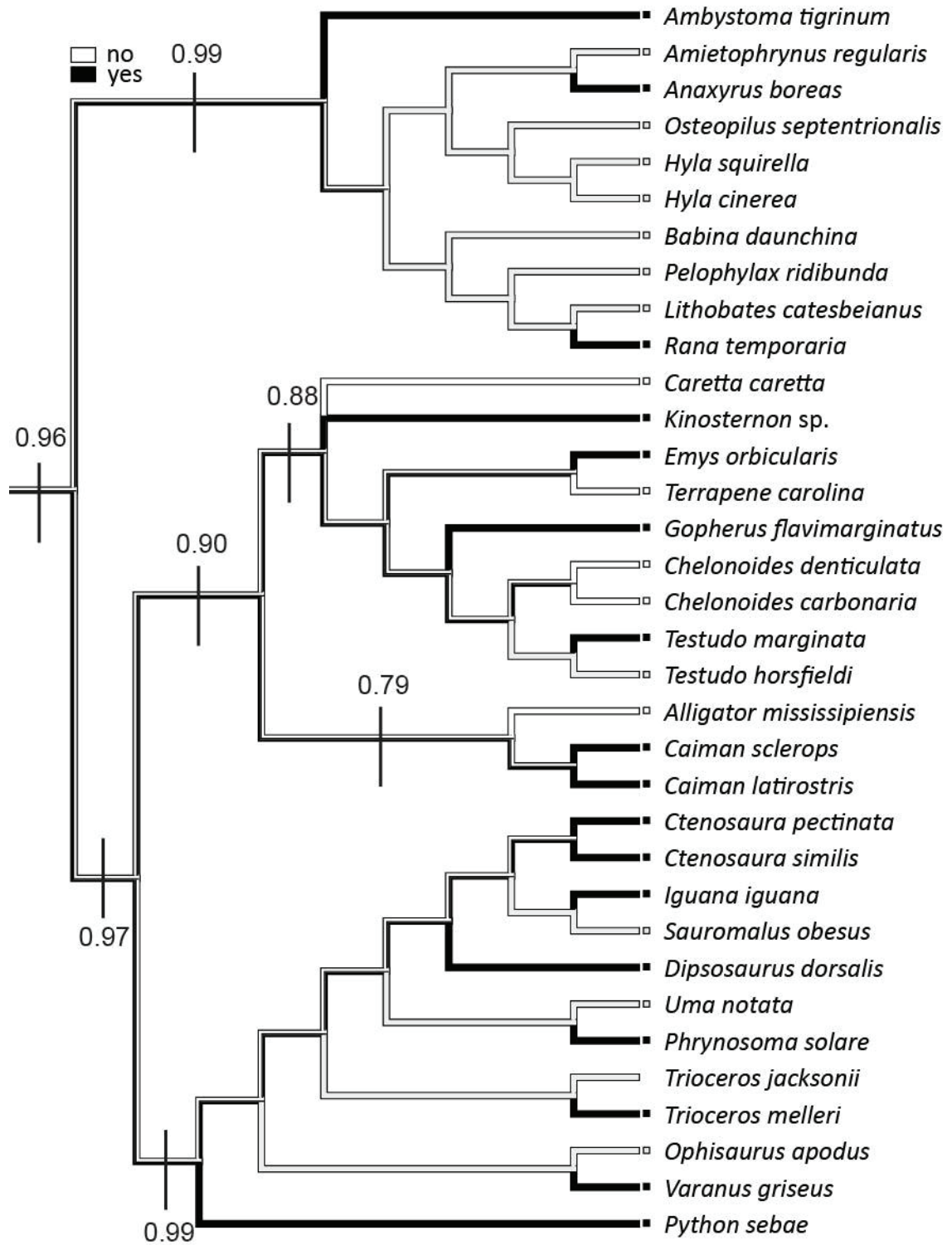

Fig. 7. Maximum-likelihood-based ancestral character state reconstruction of the presence of a decrease in EEG frequency during sleep-like states. Black squares indicate a decrease in EEG frequency in terminal taxa. Other details are as in Fig. 2.

EEG amplitude sleep vs wake

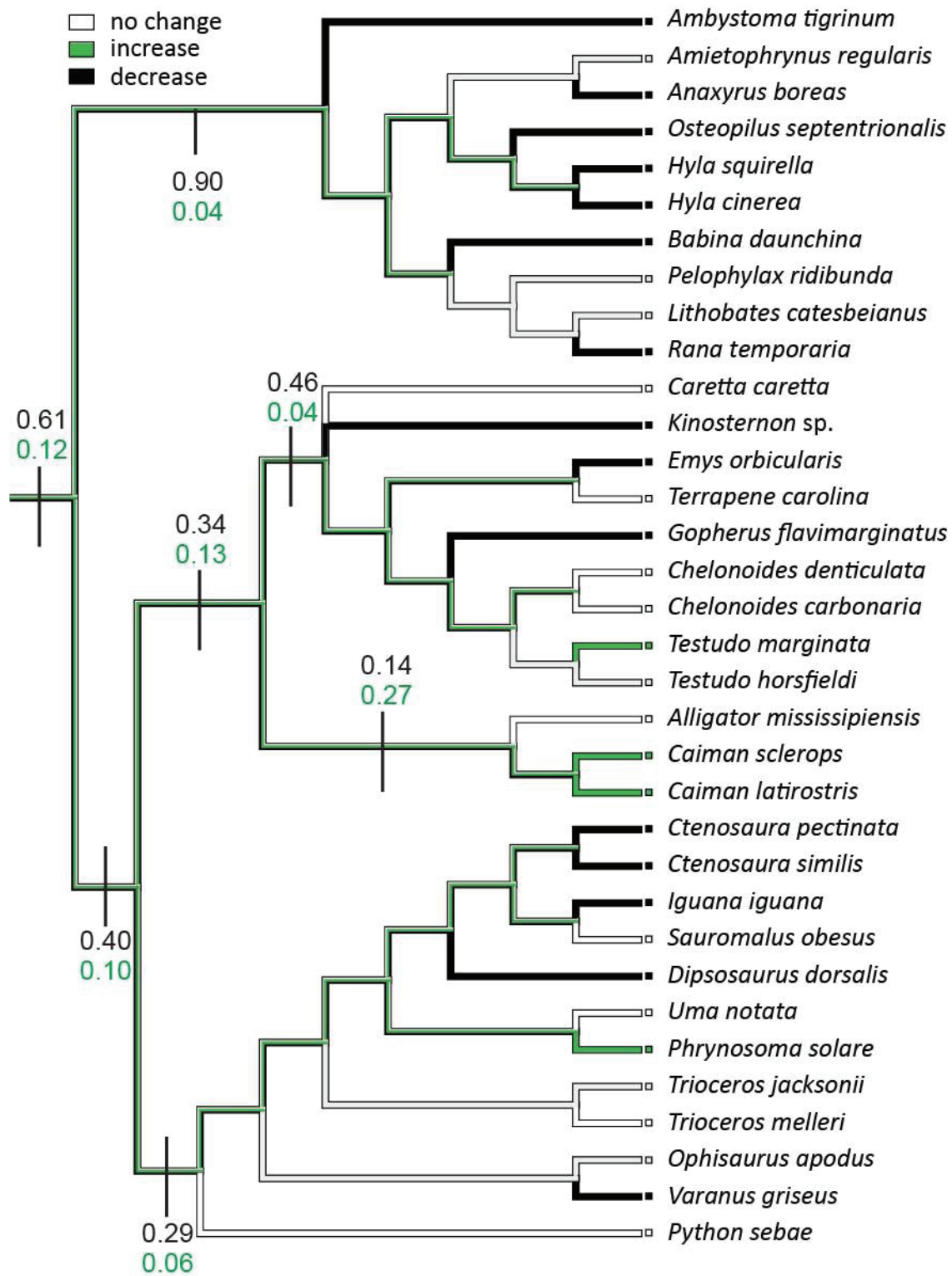

Fig. 8. Maximum-likelihood-based ancestral character state reconstruction of EEG amplitude during sleep-like states. Black squares indicate the presence of a decreased EEG amplitude; white squares indicate no change in EEG amplitude, and green squares indicate an increase in EEG amplitude in terminal taxa. The black number at each node is the likelihood of a decrease in EEG amplitude; the green one represents the likelihood of an increase in EEG amplitude. Other details are as in Fig. 2.

Presence of High Voltage Sharp Waves during sleep

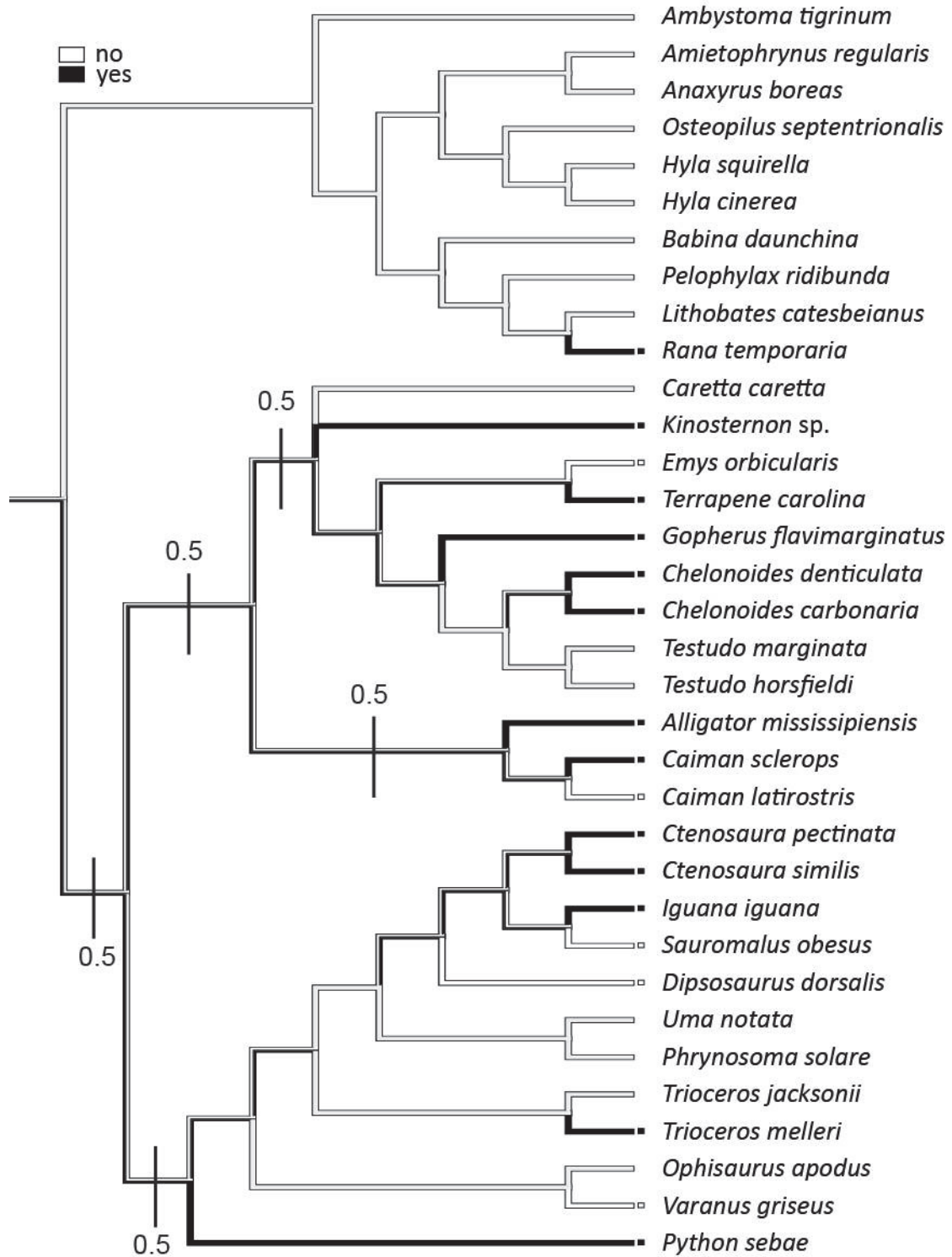

Fig. 9. Maximum-likelihood-based ancestral character state reconstruction of the presence of high-voltage sharp waves during quiescence. Black squares indicate the presence of high-voltage sharp waves during quiescence in terminal taxa. Other details are as in Fig. 2.

Table 1. Amphibian sleep: experimental parameters

Order	Family	Genus	Species	Author	No. of animals	Recording duration	Light cycle	Ambient temperature	EOG recorded	EMG recorded	Arousal threshold evaluated	SLS deprivation evaluated
Caudata	Ambystomatidae	<i>Ambystoma</i>	<i>tigrinum</i>	Lucas & Sterman (1969)	27	NR	NR	NR	Yes	Yes	NR	NR
Anura	Bufoidea	<i>Amietophrynus</i>	<i>regularis</i>	Laming (1982)	7	<24h	12:12h	24 ± 3°C	NR	NR	NR	NR
Anura	Bufoidea	<i>Anaxyrus</i>	<i>boreas</i>	Huntley <i>et al.</i> (1978)	NR	≥24h	Natural cycle	20°C	NR	Yes	Yes	NR
Anura	Hylidae	<i>Osteopilus</i>	<i>septentrionalis</i>	Hobson <i>et al.</i> (1968)	6	≥24h	Natural cycle	20–24°C	NR	NR	Yes	NR
Anura	Hylidae	<i>Hyla</i>	<i>squirella</i>	Hobson <i>et al.</i> (1968)	NR	≥24h	Natural cycle	20–24°C	NR	NR	Yes	NR
Anura	Hylidae	<i>Hyla</i>	<i>cinerea</i>	Hobson <i>et al.</i> (1968)	NR	≥24h	Natural cycle	20–24°C	NR	NR	Yes	NR
Anura	Ranidae	<i>Babina</i>	<i>daunchina</i>	Fang <i>et al.</i> (2012)	10	NR	NR	NR	NR	NR	NR	NR
Anura	Ranidae	<i>Lithobates</i>	<i>atesbeianus</i>	Hobson (1967)	20	≥24h	NR	22–24°C	Yes	Yes	Yes	NR
Anura	Ranidae	<i>Pelophylax</i>	<i>ridibunda</i>	Karmanova (1982)	6	≥24h	NR	NR	NR	NR	NR	NR
Anura	Ranidae	<i>Rana</i>	<i>temporaria</i>	Laming (1982)	6	<24h	12:12h	5 ± 1°C	NR	NR	NR	NR
Anura	Ranidae	<i>Rana</i>	<i>temporaria</i>	Aristakesyan & Karmanova (1998)	10	NR	NR	NR	NR	Yes	NR	Yes
Anura	Ranidae	<i>Rana</i>	<i>temporaria</i>	Belich (1984)	NR	≥24h	NR	15–16°C	NR	NR	NR	NR
Anura	Ranidae	<i>Rana</i>	<i>temporaria</i>	Lazarev (1978a)	8	NR	NR	20 ± 2°C	NR	Yes	NR	NR
Anura	Ranidae	<i>Rana</i>	<i>temporaria</i>	Reviews: Karmanova (1982) and Karmanova & Lazarev (1979)	NR	NR	NR	NR	NR	Yes	Yes	NR

Wake duration includes quiet wake and active wake. Wake EEG characteristics are based on quiet-wake EEGs. Quiet sleep duration in *L. atesbeianus* is based on the duration in a reclined position.

Table 2. Amphibian sleep: behavioural parameters

Genus	Species	Author	Heart rate, wakefulness versus SLS	Respiratory rate, wakefulness versus SLS	Eye movements during SLS	Period of full atonia recorded during SLS	Twitches or motor automatism during SLS	Arousal threshold during quiescence compared to the awake state	SLS recovery after deprivation
<i>Ambystoma</i>	<i>tigrinum</i>	Lucas & Sterman (1969)	NR	NR	No	NR	NR	—	—
<i>Amietophrynus</i>	<i>regularis</i>	Laming (1982)	NR	NR	NR	NR	NR	—	—
<i>Anaxyrus</i>	<i>boreas</i>	Huntley <i>et al.</i> (1978)	Decrease	Decrease	NR	NR	NR	Higher	—
<i>Osteopilus</i>	<i>septentrionalis</i>	Hobson <i>et al.</i> (1968)	Decrease	NR	NR	NR	NR	Higher	—
<i>Hyla</i>	<i>squirella</i>	Hobson <i>et al.</i> (1968)	Decrease	NR	NR	NR	NR	Higher	—
<i>Hyla</i>	<i>cinerea</i>	Hobson <i>et al.</i> (1968)	Decrease	NR	NR	NR	NR	Higher	—
<i>Babina</i>	<i>daunchina</i>	Fang <i>et al.</i> (2012)	NR	NR	NR	NR	NR	—	—
<i>Lithobates</i>	<i>catesbeianus</i>	Hobson (1967)	Decrease	Decrease	No	NR	NR	No change	—
<i>Pelophylax</i>	<i>ridibunda</i>	Karmanova (1982)	NR	Decrease	NR	NR	NR	—	—
<i>Rana</i>	<i>temporaria</i>	Laming (1982)	NR	NR	NR	NR	NR	—	—
<i>Rana</i>	<i>temporaria</i>	Aristakesyan & Karmanova (1998)	NR	NR	NR	NR	NR	—	Yes
<i>Rana</i>	<i>temporaria</i>	Belich (1984)	Decrease	NR	NR	NR	Yes	—	—
<i>Rana</i>	<i>temporaria</i>	Lazarev (1978 <i>a</i>)	Decrease	NR	NR	NR	NR	—	—
<i>Rana</i>	<i>temporaria</i>	Reviews: Karmanova (1982) and Karmanova & Lazarev (1979)	Decrease	NR	NR	NR	Yes	Higher	—

Only protosleep 3 is considered as a sleep-like state in the studies by Karmanova (1982), Lazarev (1978*a*), Belich (1984) and Aristakesyan & Karmanova (1998). In a review Karmanova (1982) mentions that the arousal threshold is higher in P3. However, we could not find any details about the actual experiments. We do not consider the P3 of Karmanova (1982) and Lazarev, 1978*a* as showing period of full atonia as no phasic decrease in muscle tone was reported during this state.

NR, not reported; SLS, sleep-like state.

Table 3. Amphibian sleep: electrophysiological parameters

Genus	Species	Author	EEG correlated with respiratory rate	Presence of HShW	EEG wake amplitude (μ V)	EEG wake frequency (Hz)	EEG SLS1 amplitude (μ V)	EEG SLS1 frequency (Hz)	EEG SLS2 amplitude (μ V)	EEG SLS2 frequency (Hz)	Main SLS EEG amplitude relative to the awake state	Main SLS EEG frequency relative to the awake state
<i>Ambystoma</i>	<i>tigrinum</i>	Lucas & Sterman (1969)	Yes	NR	—	20–40	—	1–20	—	—	Decrease	Decrease
<i>Anietophrynus</i>	<i>regularis</i>	Laming (1982)	Yes	NR	—	—	—	—	—	—	—	—
<i>Anaxyrus</i>	<i>boreas</i>	Huntley <i>et al.</i> (1978)	Yes	NR	5–10	10–14	3–7	5–7	—	—	Decrease	Decrease
<i>Osteopilus</i>	<i>septentrionalis</i>	Hobson <i>et al.</i> (1968)	Yes	NR	50–100	5–8	<50	8–30	—	—	Decrease	—
<i>Hyla</i>	<i>squirella</i>	Hobson <i>et al.</i> (1968)	Yes	NR	50–100	5–8	<50	8–30	—	—	Decrease	—
<i>Hyla</i>	<i>cinerea</i>	Hobson <i>et al.</i> (1968)	Yes	NR	50–100	5–8	<50	8–30	—	—	Decrease	—
<i>Babina</i>	<i>daunchina</i>	Fang <i>et al.</i> (2012)	NR	NR	—	—	—	—	—	—	Decrease	—
<i>Lithobates</i>	<i>catesbeianus</i>	Hobson (1967)	Yes	NR	20–30	6–15	—	—	—	—	—	—
<i>Pelophylax</i>	<i>ridibunda</i>	Karmanova (1982)	NR	NR	—	—	—	—	—	—	—	—
<i>Rana</i>	<i>temporaria</i>	Laming (1982)	Yes	NR	—	—	—	—	—	—	—	—
<i>Rana</i>	<i>temporaria</i>	Aristakesyan & Karmanova (1998)	NR	NR	—	—	—	—	—	—	—	—
<i>Rana</i>	<i>temporaria</i>	Belich (1984)	NR	NR	—	—	—	—	—	—	—	—
<i>Rana</i>	<i>temporaria</i>	Lazarev (1978a)	NR	During quiescence	—	0.5–1.5; 3–4	10–20	0.5–2.0	—	—	Decrease	Decrease
<i>Rana</i>	<i>temporaria</i>	Reviews: Karmanova (1982) and Karmanova & Lazarev (1979)	NR	During quiescence	10–40	0.5–1.5; 3–4	—	0.5–2.0	—	—	Decrease	Decrease

Only protosleep 3 is considered as a sleep-like state in the studies by Karmanova (1982), Lazarev, (1978a), Belich (1984) and Aristakesyan & Karmanova (1998). EEG, electroencephalography; HShW, high-voltage sharp waves; NR, not reported; SLS, sleep-like state.

Table 4. Amphibian sleep: vigilance state parameters

Genus	Species	Author	SLS duration (%) (AS + QS)	AS duration (%) (if described)	AS episode mean duration (s) (if described)	No. of SLS	Mammalian AS homology	Mammalian QS homology
<i>Ambystoma</i>	<i>tigrinum</i>	Lucas & Stermann (1969)	—	—	—	1	—	—
<i>Amietophrynus</i>	<i>regularis</i>	Laming (1982)	—	—	—	NR	—	—
<i>Anaxyrus</i>	<i>boreas</i>	Huntley <i>et al.</i> (1978)	53	—	—	1	—	—
<i>Osteopilus</i>	<i>septentrionalis</i>	Hobson <i>et al.</i> (1968)	—	—	—	1	—	—
<i>Hyla</i>	<i>squirella</i>	Hobson <i>et al.</i> (1968)	—	—	—	1	—	—
<i>Hyla</i>	<i>cinerea</i>	Hobson <i>et al.</i> (1968)	—	—	—	1	—	—
<i>Babina</i>	<i>daunchina</i>	Fang <i>et al.</i> (2012)	—	—	—	1	—	—
<i>Lithobates</i>	<i>catesbeianus</i>	Hobson (1967)	71	—	—	0	—	—
<i>Pelophylax</i>	<i>ridibunda</i>	Karmanova (1982)	10	—	—	NR	—	—
<i>Rana</i>	<i>temporaria</i>	Laming (1982)	—	—	—	NR	—	—
<i>Rana</i>	<i>temporaria</i>	Aristakesyan & Karmanova (1998)	11.1	—	—	1	—	—
<i>Rana</i>	<i>temporaria</i>	Belich (1984)	—	—	—	1	—	—
<i>Rana</i>	<i>temporaria</i>	Lazarev (1978a)	—	—	—	1	—	—
<i>Rana</i>	<i>temporaria</i>	Reviews: Karmanova (1982) and Karmanova & Lazarev (1979)	—	—	—	1	—	—

Only protosleep 3 is considered as a sleep-like state in the studies by Karmanova (1982), Lazarev, (1978a), Belich (1984) and Aristakesyan & Karmanova (1998). AS, active sleep; NR, not reported; QS, quiet sleep; SLS, sleep-like state.

Table 5. Reptilian sleep: experimental parameters

Order	Family	Genus	Species	Author	No. of animals	Recording duration	Light cycle	Ambient temperature	EOG recorded	EMG recorded	Arousal threshold evaluated	SLS deprivation evaluated
Chelonia	Emydidae	<i>Emys</i>	<i>orbicularis</i>	Vasilescu (1970)	33	<24 h	NR	NR	Yes	Yes	NR	NR
Chelonia	Emydidae	<i>Emys</i>	<i>orbicularis</i>	Karmanova <i>et al.</i> (1971)	10	≥24 h	Natural cycle	NR	Yes	Yes	NR	NR
Chelonia	Emydidae	<i>Emys</i>	<i>orbicularis</i>	Belich (1984)	NR	≥24 h	NR	Water at 15–16°C	No	NR	NR	NR
Chelonia	Emydidae	<i>Terrapene</i>	<i>carolina</i>	Flanigan <i>et al.</i> (1974)	10	≥48 h	Constant light	26–29°C	Yes	Yes	Yes	Yes
Chelonia	Emydidae	<i>Terrapene</i>	<i>carolina</i>	Eiland <i>et al.</i> (2001)	4	<24 h	12:12 h	23–29°C	Yes	Yes	NR	NR
Chelonia	Kinosternidae	<i>Kinosternon</i>	sp.	Ayala-Guerrero (1987)	4	≥48 h	Constant Light	23°C	Yes	Yes	Yes	NR
Chelonia	Testudinidae	<i>Chelonoidis</i>	<i>carbonaria</i>	Flanigan (1974)	6	≥48 h	Constant light	27–29°C	Yes	Yes	Yes	Yes
Chelonia	Testudinidae	<i>Chelonoidis</i>	<i>denticulata</i>	Walker & Berger (1973)	7	≥24 h	12:12 h	25°C day, 23°C night	Yes	Yes	Yes	NR
Chelonia	Testudinidae	<i>Gopherus</i>	<i>flacumarginatus</i>	Ayala-Guerrero <i>et al.</i> (1988)	4	≥24 h	Constant light	25–28°C	Yes	Yes	NR	NR
Chelonia	Testudinidae	<i>Testudo</i>	<i>horsfieldi</i>	Aristakesyan (2009)	NR	NR	NR	NR	NR	NR	NR	NR
Chelonia	Testudinidae	<i>Testudo</i>	<i>marginata</i>	Hermann <i>et al.</i> (1964)	3	<24 h	NR	NR	Yes	Yes	NR	NR
Chelonia	Cheloniidae	<i>Caretta</i>	<i>caretta</i>	Susic (1972)	3	NR	Natural cycle	Water 22–24°C	Yes	Yes	NR	Yes
Crocodylia	Alligatoridea	<i>Alligator</i>	<i>mississippiensis</i>	Van Twyver (1973)	7	NR	NR	Different temperatures 4–32°C	Yes	Yes	NR	NR
Crocodylia	Alligatoridea	<i>Caiman</i>	<i>latirostris</i>	Peyrethon & Dusan-Peyrethon (1969)	1	≥48 h	12:12 h	26°C	Yes	Yes	NR	NR
Crocodylia	Alligatoridea	<i>Caiman</i>	<i>sclerops</i>	Meglsson & Huggins (1979)	5	≥24 h	12:12 h	37 ± 1°C	No	Yes	Yes	NR
Crocodylia	Alligatoridea	<i>Caiman</i>	<i>sclerops</i>	Rechtschaffen <i>et al.</i> , 1968	4	NR	NR	NR	Yes	Yes	Yes	NR
Crocodylia	Alligatoridea	<i>Caiman</i>	<i>sclerops</i>	Flanigan <i>et al.</i> (1973)	10	≥48 h	Constant light	Water 25–28°C	Yes	Yes	Yes	Yes
Crocodylia	Alligatoridea	<i>Caiman</i>	<i>sclerops</i>	Warner & Huggins (1978)	7	<24 h	12:12 h	Constant warm water at 27–30°C	No	Yes	NR	NR
Squamata	Anguillidae	<i>Ophichthus</i>	<i>apodus</i>	Aristakesyan (2009)	NR	NR	NR	NR	NR	NR	NR	NR
Squamata	Chamaeleonidae	<i>Troceros</i>	<i>jacksonii</i>	Tauber <i>et al.</i> (1966)	2	NR	NR	NR	NR	NR	NR	NR
Squamata	Chamaeleonidae	<i>Troceros</i>	<i>melleri</i>	Tauber <i>et al.</i> (1966)	2	<24 h	NR	NR	No	Yes	NR	NR
Squamata	Iguanidae	<i>Ctenosaura</i>	<i>pectinata</i>	Ayala-Guerrero & Huitron-Rescendiz (1991)	4	24 h	Constant light	Constant + hot spot 25–29°C	Yes	Yes	Yes	NR
Squamata	Iguanidae	<i>Ctenosaura</i>	<i>pectinata</i>	Tauber <i>et al.</i> (1968)	36	<24 h	12:12 h	23–26°C	Yes	Yes	Yes	NR
Squamata	Iguanidae	<i>Ctenosaura</i>	<i>pectinata</i>	Flanigan (1973)	3	≥48 h	12:12 h	Thermal gradient + hot spot day: 34–50°C + hot spot 4 h night 27–32°C	Yes	Yes	Yes	Yes
Squamata	Iguanidae	<i>Ctenosaura</i>	<i>similis</i>	Ayala-Guerrero & Vargas Reyna (1987)	7	≥48 h	Constant light	29–32°C	No	Yes	Yes	NR
Squamata	Iguanidae	<i>Dipsosaurus</i>	<i>dorsalis</i>	Huntley <i>et al.</i> (1977)	8	<24 h	12:12 h	21°C	No	Yes	NR	NR
Squamata	Iguanidae	<i>Dipsosaurus</i>	<i>dorsalis</i>	Huntley & Cohen (1980)	10	NR	NR	10°C, 20°C, 30°C	No	Yes	Yes	NR
Squamata	Iguanidae	<i>Dipsosaurus</i>	<i>dorsalis</i>	Huntley (1987)	37	NR	Natural cycle	10°C, 20°C, 30°C	No	Yes	Yes	NR
Squamata	Iguanidae	<i>Iguana</i>	<i>iguana</i>	Peyrethon & Dusan-Peyrethon (1969)	1	≥48 h	NR	NR	Yes	Yes	Yes	NR
Squamata	Iguanidae	<i>Iguana</i>	<i>iguana</i>	Ayala-Guerrero & Mexicano (2008a)	10	≥24 h	Constant Light	25–30°C	Yes	Yes	Yes	Yes

Table 5. Continued

Order	Family	Genus	Species	Author	No. of animals	Recording duration	Light cycle	Ambient temperature	EOG recorded	EMG recorded	Arousal threshold evaluated	SLS deprivation evaluated
Squamata	Iguanidae	<i>Iguana</i>	<i>iguana</i>	Flanigan (1973)	3	≥48 h	12:12 h	Thermal gradient + hot spot day: 34–50°C + hotspot 4 h night 27–32°C	Yes	Yes	Yes	Yes
Squamata	Iguanidae	<i>Sauromalus</i>	<i>obsesus</i>	Stropes (1975)	8	NR	12:12 h	29–34°C	Yes	Yes	Yes	NR
Squamata	Phrynosomatidae	<i>Phrynosoma</i>	<i>solare</i>	Romo <i>et al.</i> (1978)	13	≥24 h	12:12 h	30 ± 0.5°C	No	Yes	NR	NR
Squamata	Phrynosomatidae	<i>Uma</i>	<i>notata</i>	Stropes (1971)	4	≥24 h	Constant light	36–38°C	Yes	Yes	NR	NR
Squamata	Pythonidae	<i>Python</i>	<i>sebae</i>	Peyrethon & Dusan-Peyrethon (1969)	1	≥48 h	NR	NR	Yes	Yes	NR	NR
Squamata	Varanidae	<i>Varanus</i>	<i>griseus</i>	Karmanova <i>et al.</i> (1971)	1	≥24 h	Natural cycle	NR	Yes	Yes	NR	NR

Wake duration includes quiet wake and active wake. Wake EEG characteristics are based on quiet-wake EEG.

We included the PTD level 3 of Meglasson & Huggins (1979) as sleep. We considered postures 3 and 4 described by Flanigan (1973, 1974) and Flanigan *et al.* (1973, 1974) as sleep. EMG, electromyography; EOG, electro-oculography; NR, not reported; SLS, sleep-like state.

Table 6. Reptilian sleep: behavioural parameters

Genus	Species	Author	Heart rate, wakefulness <i>versus</i> SLS	Respiratory rate, wakefulness <i>versus</i> SLS	Eye movements during SLS	Period of full atonia recorded during SLS	Twitches or motor automatism during SLS	Arousal threshold during quiescence compared to the awake state	
								SLS	SLS recovery after deprivation
<i>Enys</i>	<i>orbicularis</i>	Vasilescu (1970)	Decrease	NR	Yes	Yes	Yes	—	—
<i>Enys</i>	<i>orbicularis</i>	Karmanova <i>et al.</i> (1971)	NR	NR	No	No	No	—	—
<i>Enys</i>	<i>orbicularis</i>	Belich (1984)	Decrease	NR	NR	NR	Yes	—	—
<i>Terrapene</i>	<i>carolina</i>	Flanigan <i>et al.</i> (1974)	Decrease	Decrease	Yes	No	NR	Higher	Yes
<i>Terrapene</i>	<i>carolina</i>	Eiland <i>et al.</i> (2001)	NR	NR	Yes	No	Yes	—	—
<i>Kinosternon</i>	sp.	Ayala-Guerrero (1987)	Decrease	NR	Yes	No	Yes	Higher	—
<i>Chelonoidis</i>	<i>carbonaria</i>	Flanigan (1974)	Decrease	Decrease	No	No	No	Higher	Yes
<i>Chelonoidis</i>	<i>denticulata</i>	Walker & Berger (1973)	Decrease	NR	Yes	No	NR	No change	—
<i>Gopherus</i>	<i>flavomarginatus</i>	Ayala-Guerrero <i>et al.</i> (1988)	Decrease	NR	Yes	No	NR	—	—
<i>Testudo</i>	<i>horsfieldi</i>	Aristakesyan (2009)	NR	NR	NR	NR	NR	—	—
<i>Testudo</i>	<i>marginata</i>	Hermann <i>et al.</i> (1964)	Decrease	Decrease	No	No	NR	—	—
<i>Caretta</i>	<i>caretta</i>	Susic (1972)	NR	NR	No	No	NR	—	No
<i>Alligator</i>	<i>mississippiensis</i>	Van Twyver (1973)	NR	NR	No	No	NR	—	—
<i>Caiman</i>	<i>latirostris</i>	Peyrethron & Dusan-Peyrethron (1969)	Decrease	Decrease	Yes	No	Yes	Higher	—
<i>Caiman</i>	<i>sclerops</i>	Meglansson & Huggins (1979)	NR	NR	NR	No	NR	—	—
<i>Caiman</i>	<i>sclerops</i>	Rechtschaffen <i>et al.</i> (1968)	NR	NR	No	Yes	NR	No change	—
<i>Caiman</i>	<i>sclerops</i>	Flanigan <i>et al.</i> (1973)	Decrease	Decrease	No	No	NR	No change	Yes
<i>Caiman</i>	<i>sclerops</i>	Warner & Huggins (1978)	Decrease	Decrease	NR	No	NR	—	—
<i>Ophisaurus</i>	<i>apodus</i>	Aristakesyan (2009)	NR	NR	NR	NR	NR	—	—
<i>Troceros</i>	<i>jacksonii</i>	Tauber <i>et al.</i> (1966)	NR	NR	NR	NR	NR	—	—
<i>Troceros</i>	<i>melleri</i>	Tauber <i>et al.</i> (1966)	Decrease	NR	Yes	No	NR	—	—
<i>Ctenosaura</i>	<i>pectinata</i>	Ayala-Guerrero & Huitron-Resendiz (1991)	Decrease	NR	Yes	No	Yes	Higher	—
<i>Ctenosaura</i>	<i>pectinata</i>	Tauber <i>et al.</i> (1968)	Decrease	NR	Yes	No	NR	Higher	—
<i>Ctenosaura</i>	<i>pectinata</i>	Flanigan (1973)	Decrease	Decrease	No	No	NR	Higher	—
<i>Ctenosaura</i>	<i>similis</i>	Ayala-Guerrero & Vargas Reyna (1987)	Decrease	Decrease	Yes	No	Yes	Higher	Yes
<i>Dipsosaurus</i>	<i>dorsalis</i>	Huntley <i>et al.</i> (1977)	Decrease	Decrease	NR	Yes	NR	Higher	—
<i>Dipsosaurus</i>	<i>dorsalis</i>	Huntley & Cohen (1980)	NR	NR	NR	No	NR	Higher	—
<i>Dipsosaurus</i>	<i>dorsalis</i>	Huntley (1987)	Decrease	Decrease	NR	Yes	NR	Higher	—
<i>Iguana</i>	<i>iguana</i>	Peyrethron & Dusan-Peyrethron (1969)	Decrease	Decrease	No	Yes	No	Higher	—
<i>Iguana</i>	<i>iguana</i>	Ayala-Guerrero & Mexicano (2008a)	Decrease	NR	Yes	No	Yes	Higher	Yes
<i>Iguana</i>	<i>iguana</i>	Flanigan (1973)	Decrease	Decrease	No	No	Yes	Higher	Yes
<i>Sauromalus</i>	<i>obsesus</i>	Stropes (1975)	Decrease	NR	Yes	No	Yes	Higher	—
<i>Phrynosoma</i>	<i>solare</i>	Romo <i>et al.</i> (1978)	NR	NR	NR	No	NR	—	—
<i>Uma</i>	<i>notata</i>	Stropes (1971)	Decrease	NR	Yes	No	NR	—	—
<i>Python</i>	<i>sebae</i>	Peyrethron & Dusan-Peyrethron (1969)	Decrease	NR	NR	No	NR	—	—
<i>Taramus</i>	<i>griseus</i>	Karmanova <i>et al.</i> (1971)	NR	Decrease	No	No	NR	—	—

NR, not reported; SLS, sleep-like state.

Table 7. Continued

Genus	Species	Author	EEG correlated with respiratory rate	Presence of HShW	EEG wake amplitude (μ V)	EEG wake frequency (Hz)	EEG SLS1 amplitude (μ V)	EEG SLS1 frequency (Hz)	EEG SLS2 amplitude (μ V)	EEG SLS2 frequency (Hz)	Main SLS EEG amplitude relative to the awake state	Main SLS EEG frequency relative to the awake state
<i>Triaceros</i>	<i>melleri</i>	Tauber <i>et al.</i> (1966)	NR	During quiescence	35–45	7–9	35–45	6–8	—	—	No change	Decrease
<i>Ctenosaura</i>	<i>pectinata</i>	Ayala-Guerrero & Huitron-Resendiz (1991)	NR	During quiescence	—	9–10.2	—	5.4–6	—	9–10.2	Decrease	Decrease
<i>Ctenosaura</i>	<i>pectinata</i>	Tauber <i>et al.</i> (1968)	NR	During wake and quiescence	15–50	15–18	—	13–15	—	13–15	No change	Decrease
<i>Ctenosaura</i>	<i>pectinata</i>	Flanigan (1973)	Yes	During quiescence	2.9–152.3	3–8; 10–13; 15–18; 20–24	2.6–90	2–6; 8–10; 12–18; 20–23	—	—	No change	Decrease
<i>Ctenosaura</i>	<i>similis</i>	Ayala-Guerrero & Vargas Reyna (1987)	NR	During quiescence	20–160	12–25	—	—	—	—	Decrease	Decrease
<i>Dipsosaurus</i>	<i>dorsalis</i>	Huntley <i>et al.</i> (1977)	NR	NR	100	13–16	1–3	10–13	—	10–15	Decrease	Decrease
<i>Dipsosaurus</i>	<i>dorsalis</i>	Huntley & Cohen (1980)	NR	During wake	—	—	—	—	—	—	NR	NR
<i>Dipsosaurus</i>	<i>dorsalis</i>	Huntley (1987)	NR	During wake	30–50	8.7–10.4	3–5	4.2–7.5	—	7.9–14.6	Decrease	Decrease
<i>Iguana</i>	<i>iguana</i>	Peyrethron & Dusan-Peyrethron (1969)	Yes	During quiescence	50	40–42	30	30–35	—	—	No change	No change
<i>Iguana</i>	<i>iguana</i>	Ayala-Guerrero & Mexicano (2008a)	NR	During quiescence	24.2	9–11.4	9.2	5–6	19	8–9	Decrease	Decrease
<i>Iguana</i>	<i>iguana</i>	Flanigan (1973)	NR	During quiescence	2.9–152.3	3–8; 10–13; 15–18; 20–24	2.6–90	2–6; 8–10; 12–18; 20–23	—	—	No change	Decrease
<i>Sauromalus</i>	<i>obsesus</i>	Stropes (1975)	NR	During wake	35	7–16	30	1–14	10–60	3–11	No change	Decrease
<i>Phrynosoma</i>	<i>solare</i>	Romo <i>et al.</i> (1978)	NR	NR	5–10	—	—	—	—	—	Increase	Decrease
<i>Uma</i>	<i>notata</i>	Stropes (1971)	NR	NR	10–40	6–9	15–50	0–4	10–30	5–8	No change	Decrease
<i>Python</i>	<i>sebae</i>	Peyrethron & Dusan-Peyrethron (1969)	Yes	During quiescence	30	20–25	30	14–15	—	—	No change	Decrease
<i>Varanus</i>	<i>griseus</i>	Karmanova <i>et al.</i> (1971)	NR	During quiescence	—	3–4; 8–12	—	3–7	—	—	Decrease	Decrease

EEG, electroencephalography; HShW, high-voltage sharp waves; NR, not reported; SLS, sleep-like state.

Table 8. Reptilian sleep: vigilance state parameters

Genus	Species	Author	SLS duration (%) (AS+ QS)	AS duration (%) (if described)	AS episode mean duration (s) (if described)	No. of SLS	Mammalian AS homology	Mammalian QS homology
<i>Emys</i>	<i>orbicularis</i>	Vasilescu (1970)	—	—	<15	2	Yes	—
<i>Emys</i>	<i>orbicularis</i>	Karmanova <i>et al.</i> (1971)	—	—	—	1	—	—
<i>Emys</i>	<i>orbicularis</i>	Belich (1984)	—	—	—	1	—	—
<i>Terrapene</i>	<i>carolina</i>	Flanigan <i>et al.</i> (1974)	85	—	—	1	—	—
<i>Terrapene</i>	<i>carolina</i>	Eiland <i>et al.</i> (2001)	—	—	—	1	—	—
<i>Kinosternon</i>	sp.	Ayala-Guerrero (1987)	—	—	19.2	2	Yes	—
<i>Chelonoidis</i>	<i>carbonaria</i>	Flanigan (1974)	91	—	—	1	—	—
<i>Chelonoidis</i>	<i>denticulata</i>	Walker & Berger (1973)	—	—	—	0	—	—
<i>Gopherus</i>	<i>flavomarginatus</i>	Ayala-Guerrero <i>et al.</i> (1988)	72.5	—	11	2	Yes	—
<i>Testudo</i>	<i>horsfieldi</i>	Aristakesyan (2009)	—	—	—	1	—	—
<i>Testudo</i>	<i>marginata</i>	Hermann <i>et al.</i> (1964)	48	—	—	1	—	Yes
<i>Caretta</i>	<i>caretta</i>	Susic (1972)	—	—	—	0	—	—
<i>Alligator</i>	<i>mississippiensis</i>	Van Twyver (1973)	—	—	—	0	—	—
<i>Caiman</i>	<i>latirostris</i>	Peyrethron & Dusan-Peyrethron (1969)	67	0.35	50	2	Yes	Yes
<i>Caiman</i>	<i>scleroops</i>	Megllasson & Huggins (1979)	12.7	—	—	1	—	Yes
<i>Caiman</i>	<i>scleroops</i>	Rechtschaffen <i>et al.</i> (1968)	—	—	—	1	—	—
<i>Caiman</i>	<i>scleroops</i>	Flanigan <i>et al.</i> (1973)	>50	—	—	1	—	—
<i>Caiman</i>	<i>scleroops</i>	Warner & Huggins (1978)	—	—	—	1	—	—
<i>Ophisaurus</i>	<i>apodus</i>	Aristakesyan (2009)	—	—	—	1	—	—
<i>Troceros</i>	<i>jacksonii</i>	Tauber <i>et al.</i> (1966)	—	—	—	1	—	—
<i>Troceros</i>	<i>melleri</i>	Tauber <i>et al.</i> (1966)	—	—	—	1	—	—
<i>Ctenosaura</i>	<i>pectinata</i>	Ayala-Guerrero & Huitron-Resendiz (1991)	68	0.61	12.9	2	Yes	—
<i>Ctenosaura</i>	<i>pectinata</i>	Tauber <i>et al.</i> (1968)	—	—	—	2	Yes	—
<i>Ctenosaura</i>	<i>pectinata</i>	Flanigan (1973)	34–66.5	—	—	1	—	—
<i>Ctenosaura</i>	<i>similis</i>	Ayala-Guerrero & Vargas Reyna (1987)	—	1	22.4	2	Yes	—
<i>Dipsosaurus</i>	<i>dorsalis</i>	Huntley <i>et al.</i> (1977)	71	13.5	—	2	Yes	—
<i>Dipsosaurus</i>	<i>dorsalis</i>	Huntley & Cohen (1980)	—	1–5.9	—	2	Yes	—
<i>Dipsosaurus</i>	<i>dorsalis</i>	Huntley (1987)	50–62	—	—	NR	—	—
<i>Iguana</i>	<i>iguana</i>	Peyrethron & Dusan-Peyrethron (1969)	67.5	—	—	1	—	—
<i>Iguana</i>	<i>iguana</i>	Ayala-Guerrero & Mexicano (2008a)	51	0.54	22	2	Yes	—
<i>Iguana</i>	<i>iguana</i>	Flanigan (1973)	34–66.5	—	—	1	—	—
<i>Sauromalus</i>	<i>obsesus</i>	Stropes (1975)	—	—	—	2	—	—
<i>Phrynosoma</i>	<i>solare</i>	Romo <i>et al.</i> (1978)	50	—	—	2	—	—
<i>Uma</i>	<i>notata</i>	Stropes (1971)	61	—	—	2	—	Yes
<i>Python</i>	<i>sebae</i>	Peyrethron & Dusan-Peyrethron (1969)	65–85	—	—	1	—	—
<i>Varanus</i>	<i>griseus</i>	Karmanova <i>et al.</i> (1971)	—	—	—	1	—	—

AS, active sleep; NR, not reported; QS, quiet sleep; SLS, sleep-like state.

PART II : ONEIROS, A NEW METHOD TO RECORD SLEEP

**ONEIROS, a new miniature standalone device for recording sleep
electrophysiology, physiology, temperatures and behavior in the lab and field.**

2018, Journal of neurosciences methods

Bertrand Massot ^a, Sébastien Arthaud^b, Baptiste Barrillot^b, Johanna Roux^b, Gianina Ungurean ^b,
Pierre-Hervé Luppi^b, Niels C. Rattenborg^c, Paul-Antoine Libourel^{b,#}

Corresponding author (Tel: +33 4 78 77 10 03; E-mail: pa.libourel@univ-lyon1.fr).

^a INL, UMR5270 CNRS, INSA Lyon ; Université Claude Bernard Lyon 1; Villeurbanne, F-69621 ; France

^b CRNL, SLEEP Team, UMR 5292 CNRS/U1028 INSERM; Université Claude Bernard Lyon 1; Lyon, F-69372; France

^c Max Planck Institute for Ornithology, Avian Sleep Group, 82319 Seewiesen, Germany

ABSTRACT

Background: Sleep is an inactive state of reduced environmental awareness shared by all animals. When compared to wakefulness, sleep behavior is associated with changes in physiology and brain activity. The nature of these changes varies considerably across species, and therefore is a rich resource for gaining insight into the evolution and functions of sleep. A major obstacle to capitalizing on this resource is the lack of a small device capable of recording a high number of biological parameters for extended periods of time both in the laboratory and the field.

New method: ONEIROS is a new tool designed for conducting sleep research on small, freely moving animals. The miniature, standalone system is capable of recording electrophysiological signals (up to 26 electroencephalogram (EEG), electromyogram (EMG), electrooculogram (EOG), electrocardiogram (ECG)), metabolic (3 temperature channels) and behavior via a 3D accelerometer for several days. In addition, the device is equipped with a vibrating motor which can be used to assess arousal thresholds and to disrupt sleep. The system is available in a wireless or a datalogger configuration useable in the field.

Results: To demonstrate the efficacy of this tool, we simultaneously recorded for the first time, EEG, hippocampal local field potential, EMG, EOG, brain, body and ambient temperature, and 3D accelerometry. In addition, we selectively deprived rats of paradoxical sleep by triggering the vibrating motor after online recognition of the state. Finally, by successfully recording a pigeon in an 8 m³ aviary in a social context with the device in the logger configuration, we demonstrate the feasibility of using the device in the field.

Keywords: Wireless, telemetry, datalogger, electrophysiology, sleep, pigeon, sleep deprivation

I. INTRODUCTION

Sleep is a vital and complex behavioral state that competes with the time allocated to foraging, courtship, parental care, and vigilance (Rattenborg *et al.*, 1999; Lesku *et al.*, 2012; Rattenborg *et al.*, 2016). From a behavioral standpoint, sleep is traditionally defined as an inactive state with reduced responsiveness to environmental stimuli (i.e. elevated arousal threshold) that is rapidly reversible in response to sufficient stimulation. In many species, sleep occurs in a species-specific posture and at specific times of the day (Fig. 1.). The duration and intensity of sleep increases following sleep deprivation, indicating that it is homeostatically regulated (Piéron, 1913; Campbell & Tobler, 1984). Initially identified in mammals, two electrophysiological sleep states can be defined during behavioral sleep: paradoxical sleep (PS) or rapid eye movement sleep (REM sleep) and slow wave sleep (SWS) or non-REM sleep (NREM sleep) (Aserinsky & Kleitman, 1953; Jouvet *et al.*, 1959). SWS is distinguished from wakefulness and PS by the presence of high amplitude, low frequency waves in the electroencephalogram (EEG), reduced heart and respiratory rate, reduced brain and body temperature, reduced muscle tone (compared to wakefulness), and the scarcity of eye movements. Environmental awareness is lower compare to resting wakefulness (Fig. 1.). During PS, the EEG exhibits a desynchronized (low-amplitude, high-frequency) wake-like pattern. In contrast to wakefulness, PS is associated with tonic skeletal muscle atonia (Jouvet *et al.*, 1959). This atonia is phasically interrupted by rapid eye movements (Aserinsky & Kleitman, 1953) and other forms of muscular twitching, particularly in young mammals (Corner, 1977). In addition, heart and respiratory rates become irregular during PS (Snyder *et al.*, 1964). Brain temperature increases, but all thermoregulatory mechanisms (i.e. muscle tone, pilo-erection, sweating, and shivering) are abolished (Jouvet *et al.*, 1959; Parmeggiani, 2003). Finally, both SWS and PS are homeostatically regulated. Total sleep deprivation is compensated by an increase in the quantity and intensity of SWS (Borbély & Neuhaus, 1979), and selective PS deprivation is also followed by a recovery period with more PS (Dement, 1960).

	Quiet wake	Slow wave sleep	Paradoxical sleep	
Arousal threshold	-	+	+	} Behavior
Homeostasis	-	+	+	
Specific posture	-	+	+	
Cortical EEG	Desynchronized	High amplitude slow waves	Desynchronized	} Electrophysiology
Eye movements	+	-	+	
Muscle tone	-	-	--	
Muscle twitches	-	-	+	
Heart rate variability	+/-	-	+	} Metabolism
Respiratory rate variability	+/-	-	+	
Body temperature	+	-	-	
Brain temperature	+	-	+	

Fig. 1. Table illustrating the main behavioral, electrophysiological and metabolic parameters that covary with the quiet states (Quiet wake, slow wave sleep and paradoxical sleep) in mammals.

Whereas it is largely accepted that sleep is present in animals ranging from jelly fish to the more complex animals (Campbell & Tobler, 1984; Raizen *et al.*, 2008; Siegel, 2008; Omond *et al.*, 2017; Nath *et al.*, 2017), it is less clear whether all animals display two sleep states. Of the non-mammalian animals investigated, unequivocal evidence of mammalian-like SWS and PS was only found in birds (Klein *et al.*, 1964; Heller, Graf, & Rautenberg, 1983; Dewasmes *et al.*, 1985; Rattenborg *et al.*, 2009). Nonetheless, some reports of a PS like state in non-avian reptiles (Shein-Idelson *et al.*, 2016; Libourel & Herrel, 2016), or twitches during behavioral sleep in cuttlefishes (Frank *et al.*, 2012) or in bees (Klein *et al.*, 2008) suggest that two sleep states could also be present in other species.

Classically, sleep is studied in laboratory animal models (rats, mice, cats, dogs, fruitflies, and zebrafish) at various levels of analysis, including genetic, molecular, neuroanatomical, physiological, or cognitive. Several tools are available to assess these aspects of sleep; for example: optogenetic, immunohistochemical, behavioral tests, neuronal activity recordings, LFP, EEG, EMG, ECG, EOG, and temperature measurements. However, of the species in which sleep has been studied (less than 200 of the approximately 66 000 vertebrates), most of them were studied in to the lab via a tethered device that recorded EEG and EMG. A weakness of this approach is that using a tether could induce stress by reducing the animal's freedom of movement and precluding the use of sleeping shelters (Tang *et al.*, 2004). Therefore, wireless alternatives are obviously required to reduce stress and foster more natural sleep patterns. Since 2000, one logger (Vyssotski, 2005; Vyssotski *et al.*, 2009; <http://www.vyssotski.ch/neurologger.html>) and several telemetric systems with a limited transmission range (Tang & D. Sanford, 2002; Weiergräber *et al.*, 2005; Lapray *et al.*, 2008; Zayachkivsky *et al.*, 2013) have been developed to record sleep-related EEG and EMG activity in rodents. The telemetry devices could record 1 or 2 channels at

a low sampling rate (<1 kHz) for periods lasting from days to months, in the case of devices with capacitive wireless transmission (Tang & D. Sanford, 2002). Other systems can record more channels (>32) at a higher sampling rate (>10kHz) needed to record neuronal activity (Hawley *et al.*, 2002; Mohseni *et al.*, 2005; Sodagar *et al.*, 2009; Harrison *et al.*, 2011; Yin *et al.*, 2014). Nevertheless, with a battery of an acceptable size for a laboratory rodent to carry, these systems can only record for a few hours, which is insufficient for most sleep studies wherein disturbing the animals should be minimized. In general, it is essential that a sleep recording device records for at least 48 hours. Moreover, for comparative studies of species that do not exhibit sleep states readily comparable to mammalian SWS and/or PS based on EEG and EMG activity alone, it is important to record as many parameters as possible to facilitate comparison with mammals. Consequently, in the case of comparative sleep studies, behavioral, electrophysiological and metabolic parameters should be recorded in order to provide more informative features regarding how an animal sleeps. Unfortunately, none of the existing devices has enough channels to record multiple EEG, EMG, ECG and EOG channels, LFPs, and brain and body temperature for at least 48 hours. Moreover, none incorporates a means to evaluate the behavioral criteria of sleep, such as arousal threshold, reversibility, and homeostasis. Another important constraint is the weight and the size of the device. Obviously, all devices could record for a month with large batteries. However, most species are small and cannot carry heavy systems. Therefore, to increase autonomy, the power consumption of the system should be minimized.

In addition to these constraints, if the aim is to record the animal in the wild, other parameters are needed to describe sleep behavior. In the lab we often record video in conjunction with the electrophysiology, but in the wild, this cannot be done easily. An alternative is to record the animal's head movement with accelerometry along the three axes (Rattenborg *et al.*, 2017). Moreover, as the quantity of sleep and the presence of torpor/hibernation are temperature dependent, it is also important to record naturally occurring changes in ambient temperature in the wild. However, the major difference between recording in the lab and the wild is the manner in which the data is stored. In the lab, movement is usually restricted to a small space from which data can be transferred and stored on a computer via wireless transmission. However, in the field or in large enclosures (Lesku *et al.*, 2011) that exceed the transmission range of small telemetry devices, the data needs to be logged on the device (Rutz & Hays, 2009). Currently, only one device available in various versions (<http://www.vyssotski.ch/neurologger.html>), is small enough, to record EEG and EMG combined with 3D accelerometry for sleep studies (Vyssotski, 2005). This device has been used successfully to record sleep-related electrophysiology and behavior in

the field in sloths (Rattenborg *et al.*, 2008; Voirin *et al.*, 2014), sandpipers (Lesku *et al.*, 2012), barn owl chicks (Scriba *et al.*, 2013a), and even frigatebirds in flight (Rattenborg *et al.*, 2016). Although this device opened the door for the first field-based sleep studies and remains a powerful tool for many field-based sleep studies, the low number of channels (four) and the absence of a device for assessing arousal thresholds and disrupting sleep limits the scope of the questions that can be addressed with this device.

In summary, sleep is a universal and complex state, characterized by behavioral, electrophysiological and metabolic changes from wakefulness. Currently, multiple tools can assess some features of its phenotype in lab or more rarely in the wild, but none of them can measure the behavioral, electrophysiological, and metabolic features of sleep at the same time, in small species, for long periods. A device with these capabilities is needed for comparative and ecological experiments aimed at understanding the evolution and functions of sleep. Therefore, we developed ONEIROS (ONE Instrument for Recording Our Sleep), a wireless/datalogger system designed for sleep studies. This system is small enough to be worn by rats. The device can record 26 referential channels of electrophysiology (EEG, EMG, ECG, EOG or LFP), three temperature channels, and 3-axial accelerometry. Moreover, to evaluate the arousal threshold of to enforce sleep deprivation, the system includes a lightweight, vibrating motor. ONEIROS weighs less than 10g, when configured with a battery capable of recording for more than 48 hours. To validate the system, we simultaneously recorded for the first time the EEG, EMG, EOG, 6 LFPs in the hippocampus, the brain and body temperature, and 3D head acceleration of a rat. We also performed selective PS deprivation on a rat for 6 hours by activating the vibrating motor fixed on the device when PS was automatically detected via a custom online sleep scoring algorithm (Libourel *et al.*, 2015). We compared the effect of the deprivation with published data obtained with gentle handling and automated deprivation methods. Finally, to demonstrate the feasibility of recording in the wild, we recorded a pigeon in a large aviary with other birds.

II. METHODS

(1) Surgery and experimental recording conditions

(a) *Ethical considerations*

All experiments were conducted with the 3R principles in animal experimentation and in accordance to the European Community Council Directive for the use of research animals (86/609/EEC and 2016/63/EU).

(b) Rat baseline

Under ketamine-xylazine anaesthesia ($100\text{mg}\cdot\text{kg}^{-1}$ - $10\text{mg}\cdot\text{kg}^{-1}$ respectively, I.P.), one Sprague Dawley male adult rat (230g, Charles River Laboratories, France) was placed on a stereotaxic frame (David Kopf Instruments, USA) and implanted for with sensors for recording the EEG, EMG, and EOG, as well as body and cerebral temperatures. Following incision of the scalp and removal of the skin, holes were drilled in the skull. EEG monitoring: two stainless steel screws (Bilaney, Plastics One, Germany) were fixed in the parietal (from bregma: anterior-posterior (AP), -4mm; medial-lateral (ML), +3mm) and frontal (AP, +3mm; ML, + 1mm) parts of the skull and two above the cerebellum (AP, -12mm; ML, +3mm) served as references. In addition, a 4-electrode bundle was placed in the hippocampus for LFP recordings. It was composed by 4-tungsten wires ($35\mu\text{m}$ in diameter, Scientific Wire Company, England) with different lengths (500 μm of difference for each). The bundle was inserted with the following coordinates: AP, - 3.8mm; ML, +1.8mm, and dorsal-ventral, -4mm, to record from the lower part of the dentate gyrus (longest wire) to the CA1 region (shortest wire) of the hippocampus. The screws and bundle were fixed on the skull and electrically insulated from one another using acrylic Superbond (Sun Medical Co, Japan). EMG monitoring: two gold-coated electrodes were inserted into the neck muscles. EOG monitoring: two wires with gold-coated thin ball ends (1mm in diameter) were bilaterally placed under the eyelid, close to each eye. The wires were fixed on the skull with Superbond. Cerebral temperature monitoring: one additional hole was drilled in the occipital part of the skull and a thermistor (GA100K6MCD1, Measurement Specialties) was inserted close to the brain. The hole was filled with bone wax. Body temperature monitoring: one thermistor was inserted deeply between the neck muscles and secured with a suture. All wires were then connected to a head connector (Electronic Interface Board-36-PTB Neuralynx), which was secured to the skull using Superbond acrylic. Next, dental Paladur cement (Heraeus Kuzler) was applied around the head connector to protect all of the wires and the connector. At the end of the implantation procedure, the rat received a non-steroidal anti-inflammatory injection (carprofene, $5\text{mg}\cdot\text{kg}^{-1}$, S.C.) and was allowed to recover for 7 days, during which it was weighed and monitored daily. Then, the rat was housed in a Plexiglas barrel (30cm in diameter, Blox Usinage Plastique, France) with bedding, food and water *ad libitum* placed in a recording chamber with a 12h/12h light-dark cycle, ventilation, and a 23°C ambient temperature. ONEIROS was plugged into the animal's implant and baseline recordings started after 2 days' habituation to the device and the new environment. Signals were collected using DaqReverse, a custom Matlab (Mathworks, matlab r2016b) program, and were sampled at 256 Hz except for the temperature

and accelerometer which were sampled at 64 Hz. Vigilance states were scored using SlipAnalysis a custom Matlab program with a 5-s sliding time frame window according to the following criteria: Active wake (AW) was characterized by desynchronized and irregular low-voltage and high-frequency (5-9 Hz) EEG activity, sustained EMG neck muscle tone, and movement detected by the accelerometer. EEG activity was similar during AW and Quiet wake (QW), but QW was differentiated from AW by the absence of movement. Slow-wave sleep (SWS) was characterized by high-voltage slow-waves (1.5-4 Hz) combined with low muscle tone similar to QW. Paradoxical sleep (PS) was characterized by a very regular theta rhythm (5-9 Hz) associated with muscle atonia (absence of muscle tone and accelerometer activity).

(c) *Rat Paradoxical Sleep deprivation*

One Sprague Dawley adult rat (male, 270g) was used. The surgical procedure was the same as previously described. Briefly, four screws for EEGs were fixed on the skull bilaterally over parietal and frontal cortices and two screws over the cerebellum for references. Two EMG and two EOG electrodes, and brain and body thermistors were also implanted. At the end of the implantation procedure, the rat received a non-steroidal anti-inflammatory injection (carprofene, 5mg.kg⁻¹, S.C.) and was allowed to recover for 7 days, during which it was weighed and monitored daily. The rat was first placed in the recording chamber for baseline recording. Data were sampled at 128 Hz except for temperature and accelerometry which were sampled at 64 Hz. The baseline signals were scored and template parameters for each state were extracted from the EEG and EMG for online sleep scoring (Libourel *et al.*, 2015). To enforce PS deprivation (PSD), we used an online algorithm to detect PS (Libourel *et al.*, 2015) and a vibrating motor embedded on the ONEIROS device (Fig. 2. A) to awaken the rat when PS was detected. The vibration intensity was set to 100% and the stimulation duration was 700 ms. After a 6-h period of PSD, the rat was recorded for an additional 6-h recovery (PS recovery - PSR). The time spent in each vigilance state was quantified during baseline, PSD, and PSR.

(d) *Pigeon baseline*

One adult pigeon (one female, *Columbia livia*, 250 g) was anesthetized using *isoflurane*, then placed in stereotactic device (David Kopf Instruments, USA) and instrumented for EEG, EMG, EOG recordings. For EEG monitoring, four gold-plated, round-tipped (0.5 mm diameter) electrodes (Bürklin, Germany) were placed over the anterior and posterior hyperpallium (Wulst), a primary visual area. The electrodes were symmetrically placed, 4 mm apart along the AP axis and 2.5 mm and 3 mm from the midline for the anterior and

posterior electrodes, respectively. Two electrodes were placed above the left and right sides of the cerebellum served as references for the ipsilateral EEG electrodes. For EOG monitoring, two electrodes were placed in the porous bone cavity behind the top of the eye; the electrodes did not enter the orbit. After positioning, the EEG and EOG electrodes were secured with dental acrylic. For EMG monitoring, two wire electrodes were inserted into the nuchal neck muscles. To ensure a good adhesion between the dental acrylic and the bone, small holes were drilled through the top layer of the cranium, which allowed the acrylic to infiltrate the bone. The electrodes, cables and the connector were embedded in dental acrylic. At the end of the implantation procedure, the bird received an intramuscular injection of meloxicam (Metacam 2mg/kg) for post-operative analgesia. The pigeon was allowed to recover for 24 hours before attaching the data transmitter to the connector on its head. For the recordings, the device was equipped with a 1 Gb SD card and was attached to the connector on the bird's head. The pigeon was then placed in an all-female group aviary (2 m x 2 m x 2 m) together with another three uninstrumented birds. The aviary was equipped with an infrared camera for video monitoring (Axis M20 Network Camera Series). The EEG, EMG, EOG and 3-axis accelerometry were recorded in logger mode at 256 Hz for 24 hours. At the end of the recordings, the bird was recaptured, the device was removed and the data collected from the SD card. All animals had ad libitum access to food and water. The aviary had a 12h/12h light-dark cycle and an ambient temperature of 20°C.

(2) A new device to quantify sleep

(a) *Embedded system for data acquisition*

ONEIROS was designed to provide a flexible set of tools, fitting in a tiny device, for the analysis of sleep in small animals. It includes an integrated, low-power electrophysiology frontend to measure up to 26 biosignals, 3 temperature signals, and 3 accelerometer axes. An additional vibrating motor can be connected to the system and controlled using either real-time or predefined sequences of variable durations and intensities of vibration to assess arousal thresholds or prevent sleep. The system can be used either as a data logger, by using an embedded media storage, or as a telemetry device for real-time monitoring and analysis of the signals. The overall hardware architecture and software embedded on the system were developed to ensure that it would match the requirements (number of channels needed and bandwidth) of various possible experimental conditions and animal species. The size of the entire electronic system is 9 mm x 16 mm x 25 mm and it weighs 4 g. Together with a small 3 Volts, 150 mAh Li/MnO₂ primary battery of 1.4 g (CP251525, GMB Company Ltd.) it can be encapsulated in a 28 mm x

18 mm x 15 mm plastic enclosure (Fig. 2. B). The addition of the vibration motor requires an additional width of 2 mm on one side of the enclosure and a weight of 1 g.

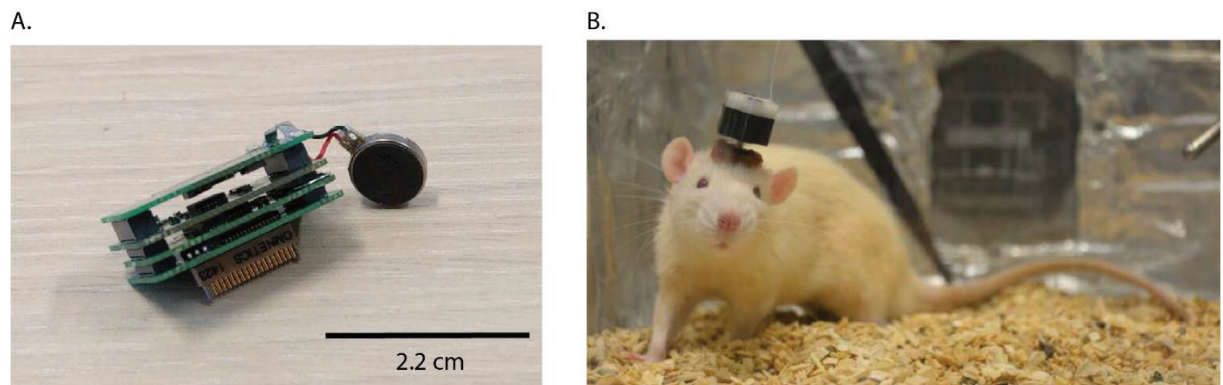

Fig. 2. A. Picture of the device showing the stack of boards with circular vibrating motor connected. B. Picture of a rat with the enclosed wireless device on its head.

(b) Hardware boards

To enable rapid changes and optimizations of the main system functions, we designed small printed circuit boards which can be stacked together to form a functional measurement system (Fig. 2. A). The boards are interchangeable allowing adaptation of the system to specific experiment conditions. This modularity also allows for future improvements of the main functions. In the current version, four boards form a fully working system: a power stage, which provides independent power from the battery for the analog and digital boards; a communication stage which consists of either an embedded memory storage board, or a wireless data transfer board; an analog stage which contains the frontend for the acquisition of biosignals; and, finally, a digital stage which controls and synchronizes data acquisition from the analog stage and transfer to the communication stage. The connection between each stage is made by stackable connectors on a single side or on both side of the board depending on the position of the board in the system (for example, the power board contains connectors only on the bottom side as it is the upper stage of the system). The global interconnection between all boards is shown on Fig. 3. Any board can be replaced by any other one of the same type, as long as the connectors' placement and pinout is retained. To minimize noise on the analog signals, the analog power supply and the serial bus to the analog frontend are placed on the first stack of connectors. The digital power supply, control lines and serial bus to the digital boards are placed on the second stack of connectors at the opposite of the circuit board. The overall functional diagram of the current version of the system is shown on Fig. 3.

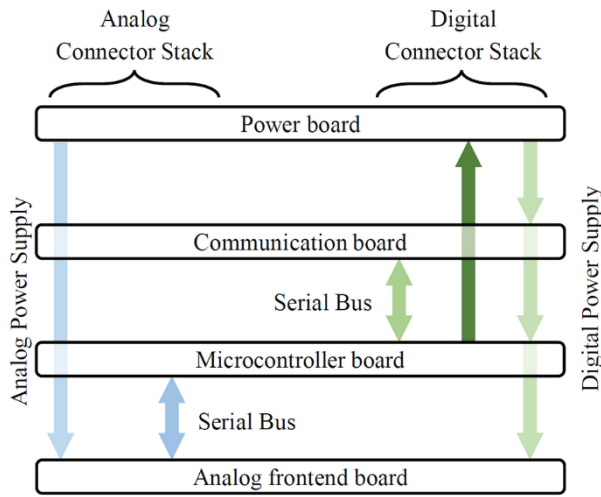

Fig. 3. Diagram of the interconnection between hardware modules

(c) Power board

The power board is placed at the top of the system stack, together with the battery. The electronic circuit is mainly composed of a dual channel boost-converter (LTC3535, Linear Technology Corporation) to provide constant voltages for analog and digital power supplies from the voltage of the battery, which can vary from 3.2 V down to 2 V at the end of the battery life. Due to the voltages required by the communication and analog frontend stages, the boost-converter is configured to output 3.3 V for the digital power supply with up to 100 mA output current (required in case of the use of a micro-SD card in the communication stage). On the other hand, the second channel of the boost-converter is configured to output 3.6 V for the analog power supply, which is subsequently fed into a 3.3 V low-noise, low-dropout regulator (LDO). The dedicated LDO (LP5907, Texas Instruments Inc.) is used to minimize the output ripple of the boost-converter on the analog power supply, as the amplifier stage of the analog frontend board can be very sensitive to power supply variations and noise. The power board also contains a light indicator (low power LED) connected to the digital connector stack and can be controlled by the microcontroller and used to indicate the state of the device. The power switch is a Hall Effect, bidirectional latch (AN48846B-NL, Panasonic Corporation) which can be opened and closed using a proximity magnet. This enables control of the power board even when the system is enclosed in a waterproof housing.

(d) Communication board

Two communication boards have been developed and can be exchanged depending on the environmental conditions of the measurement as well as the requirements of the experiment. The first board is composed of a micro-SD card interface, and enables the embedded recording of acquired data on a memory card. With this board, the system is used as an autonomous data-logger system mounted on the animal; the data is retrieved from the memory card after the experiment. The second board developed is composed of a 2.4 GHz transceiver (nRF24L01p, Nordic Semiconductors) and an associated radio-frequency (RF) circuit and ceramic chip antenna. When assembled with the RF communication board, the system is used as a wireless telemetry system and the data are collected in real-time by using a base-station receiver connected to a computer via a Universal Serial Bus (USB) cable. As described, the modularity of the system enables it to record in laboratory conditions, with real-time acquisition of the data, as well as in a natural or semi-natural environment where the animal can freely move with the device in the data-logger configuration.

(e) Analog Frontend board

The analog frontend board is intended to be placed at the lower stage of the board stack, as the connector (Omnetics, Dual Row Nano Strip series, 32 contacts) is located on the bottom side of the board for linking the electronic interface board (EIB) to the electrodes and temperature sensors on the animal. The board is based on the RHD2132 (Intan Technologies, LLC.) digital electrophysiology interface chip. This low-power, integrated circuit contains a 16-bit analog/digital converter (ADC), a 32 channels low-noise amplifier with programmable bandwidths and 3 additional auxiliary inputs. The 3 auxiliary channels are used for temperature measurements with negative-temperature coefficient thermistors of 100 kOhm at 25 °C. Due to hardware (EIB connector) and software limitations, only 26 amplified channels are used for electrophysiology measurements which make a total of 32 channels when combined with temperature (3 channels) and three accelerometer axes. Data acquisition is triggered independently for each channel, and the ADC result is retrieved using the serial communication bus connected to the micro-controller board. This enables each channel to be independently sampled at different rates as described in the software section. This flexibility allows the user to adjust the power consumption of the device through changing the sampling rate required for each biosignal, temperature, and accelerometer axis.

(f) Microcontroller board

The microcontroller board contains the microcontroller unit (MCU) and the digital accelerometer integrated chip, as well as a driver for the vibrating motor. The accelerometer is an ADXL362 (Analog devices, Inc.), a 3-axis MEMS accelerometer with a resolution of 12 bit and an average active consumption of 2 μ A. The microcontroller used in the system is a MSP430FR5969 (Texas Instrument, Inc.). This microcontroller was selected due to its very low-power consumption of 100 μ A/MHz and its flexibility in terms of power management (1 active and 3 low-power modes of operation). The software embedded on the microcontroller is described in the section (g). The microcontroller is connected to three communication serial buses using the Serial Protocol Interface (SPI) to control and transfer data from the accelerometer, the analog frontend board, and the communication board. Additionally, the microcontroller is directly connected to a universal haptic drive (DRV2603, Texas Instruments Corporation) which controls an 80 mA vibration motor that can be connected directly to the microcontroller board.

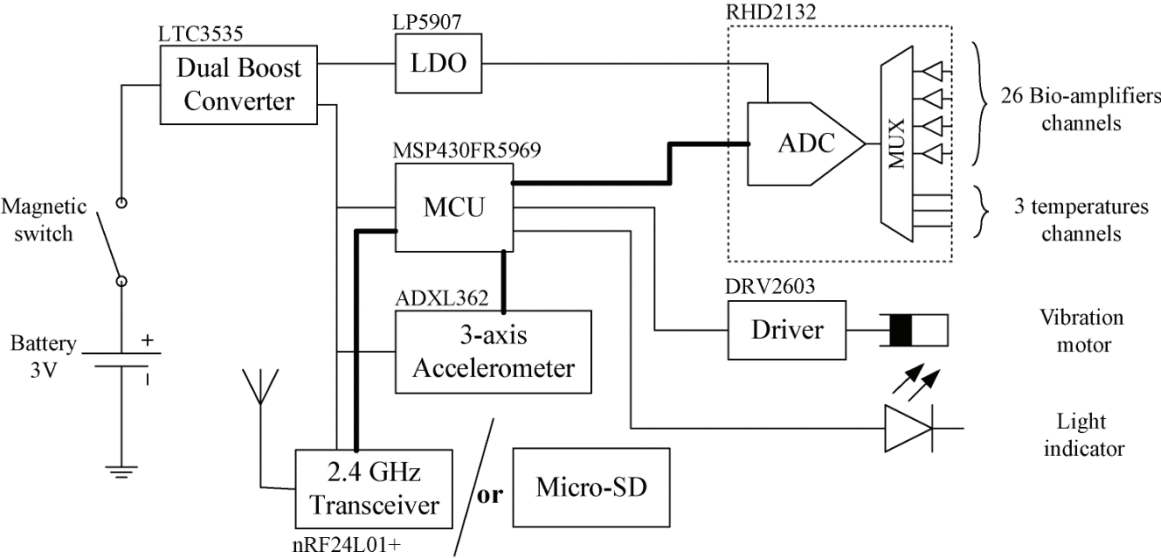

Fig. 4. Functional diagram of the complete instrumentation

(g) Software embedded on the microcontroller

The software embedded on the microcontroller was developed using the Code Composer Studio integrated development environment (Texas Instrument, Inc.). The software was written in C language, compiled using the TI compiler and transferred to the microcontroller with an EZ-FET programmer for the MSP430 microcontroller family. The role of this software is to provide flexibility and adaptability of the instrumentation to the specific needs of each experiment (i.e. the number of channels used among the 32 channels available, and a dedicated sampling frequency for each individual channel). As a result, this method of acquisition has the

advantage of minimizing the power consumption of the entire system when less channels or lower sampling rates are required, thus extending the autonomy of the device for longer experiments.

At startup, the first task of the software is to detect whether the telemetry or the logger board is used for recording data and to configure the peripherals accordingly. Then the program enters an infinite loop where three different states are executed sequentially: a) retrieving the sampling rate of each channel, b) generating an acquisition sequence based on the table of sampling frequencies, and then c) indefinitely acquiring and transferring samples (following the generated sequence) until the system is stopped by power down or configuration change. If using a telemetry configuration, where data are transmitted to a remote computer, the software is able to receive real-time orders to control the vibration motor. In that case, an algorithm executed on the remote computer can automatically use the data received from the system to, for example, classify awake or sleep states of the animal and then send back vibration commands to induce sleep deprivation or to assess arousal threshold. Fig. 5. illustrates the overall execution of the program with annotations regarding wireless or logger specific usages.

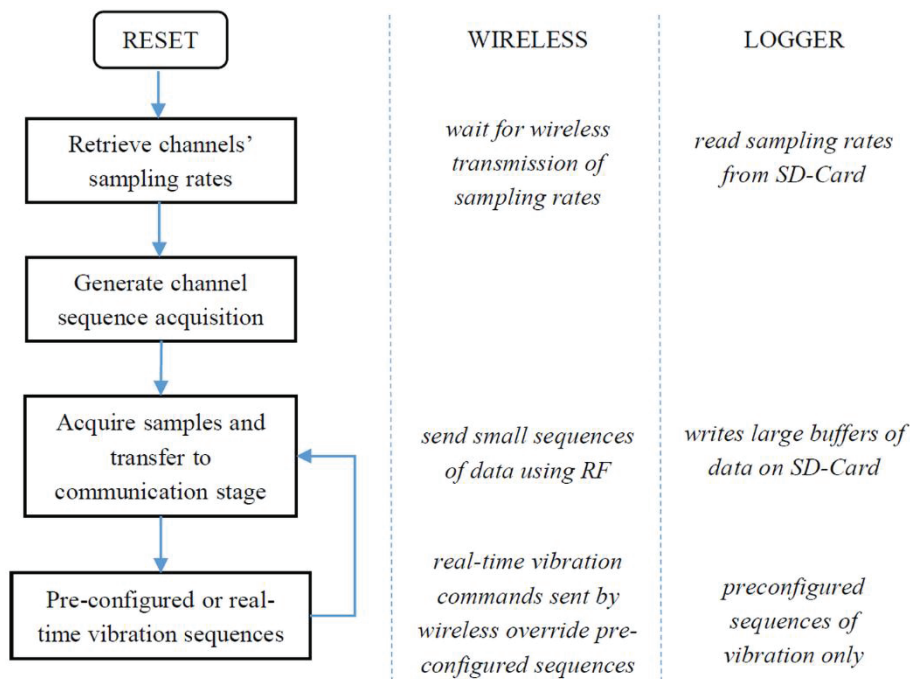

Fig. 5. Flowchart of the embedded software on the microcontroller unit

(h) Signals description and acquisition

The device enables the acquisition of 32 different channels of three different types: a) 26 channels for biosignals, including a reference channel, b) 3 channels for temperature based on negative temperature coefficient (NTC) thermistors, c) 3 channels for accelerometry based on a

3-axis digital accelerometer. Due to limited wireless bandwidth, and also to limited power consumption when using the logger configuration, the overall maximum sampling frequency is set to 8192 samples per second (sps). This maximum sampling rate can be split over the different channels via software (Fig. 6.) in any combination as long as the sum of all frequencies is equal to or lower than 8192 Hz (for example, 1 channel sampled at 8192 sps or 8 channels sampled at 1024 sps). Based on the sampling rate defined for each channel individually, the embedded software automatically generates a sequence of acquisition at a fixed clock rate with respect to every channel frequencies. For timing precision, a 32.768 kHz crystal oscillator is used with a drift of only 20 ppm or less. Then every possible sampling frequency that is an integer divisor of this clock (8192, 4096, 2048, 1024, etc.) can be set. When sent using wireless communication, data are collected using a RF remote receiver connected to a remote computer using a USB connection. The remote receiver is composed of the same transceiver chip (nRF24L01p) as the transmitter, and is associated to a PSoC 5LP (Cypress Semiconductors) microcontroller unit which transmits sampling rate configurations to the system and collects data frames which are subsequently sent to the computer through USB port. On the host computer, a dedicated driver as well as graphic user interface have been developed using Matlab (The Mathworks) to facilitate configuration, real-time visualization and control, as well as storage of the data (Fig. 6.).

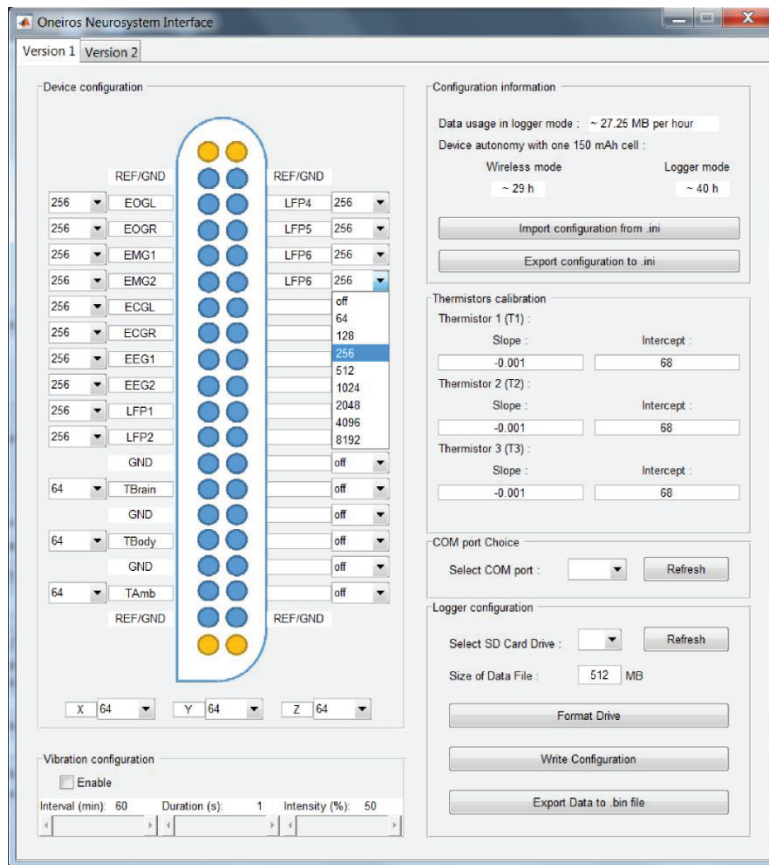

Fig. 6. Screen shot of the configuration tool design on Matlab for allocating the sampling rates to the different channels.

(i) Biosignals

The 26 unipolar channels for biosignal measurements are acquired through the analog frontend which contains one instrument amplifier (referred to a reference electrode) for each channel with a fixed gain of 192 V/V. The output of all amplifiers can be multiplexed to the input of a single 16-bit analog to digital converter. These channels are meant to measure biosignals, such as EEG, ECG, EMG, EOG and LFP. Each channel has a digital precision of $0.195 \mu\text{V}$ and total voltage range of $\pm 6.39 \text{ mV}$. Integrated and configurable analog bandpass filters prevent aliasing effects and enable DC removal.

(j) Temperatures

The analog frontend contains three auxiliary (not amplified) analog channels used to acquire temperature measured with NTC, 100kOhm thermistors. The thermistors (GA100K6MCD1, Measurement Specialties) are polarized with voltage from a voltage divider by using a 100kOhm resistor (Fig. 7.). Auxiliary inputs are sampled through the same analog to digital converter as the biosignals, but with a voltage range of 0 - 2.4V. When using the voltage divider to polarize the

thermistor, the linearity error is lower than 1% in the range 15 – 40°C, and variations lower than 0.002 °C can be measured.

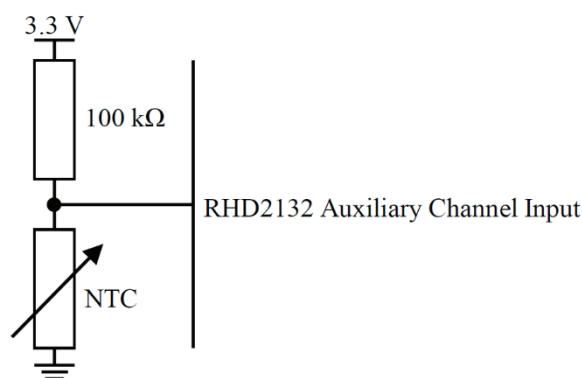

Fig. 7. Temperature measurement circuit diagram

(k) Accelerometry

A 3-axis, 12-bit digital accelerometer is used to assess movement of the animal's head. By using a range of +/- 1g, the accuracy of the measurement is 0.001g. Internal bandwidth can be configured depending on the sampling frequency to avoid aliasing. Data are directly retrieved by the microcontroller through a serial peripheral interface (SPI).

(l) Electrical characteristics

Although analog signal processing, analog to digital conversion, and digital interfaces with the microcontroller contribute to the overall power consumption of the system, for the most part, the autonomy of the system will depend on the communication board. Whether it uses RF communication or SD-Card storage, this stage has much higher power consumption when handling data. Hence, its consumption depends on the amount of data collected by the system; i.e. the total sampling rate of the configuration. In order to predict the autonomy of the system, the overall consumption has been accurately measured for different sampling frequencies (Fig. 8.).

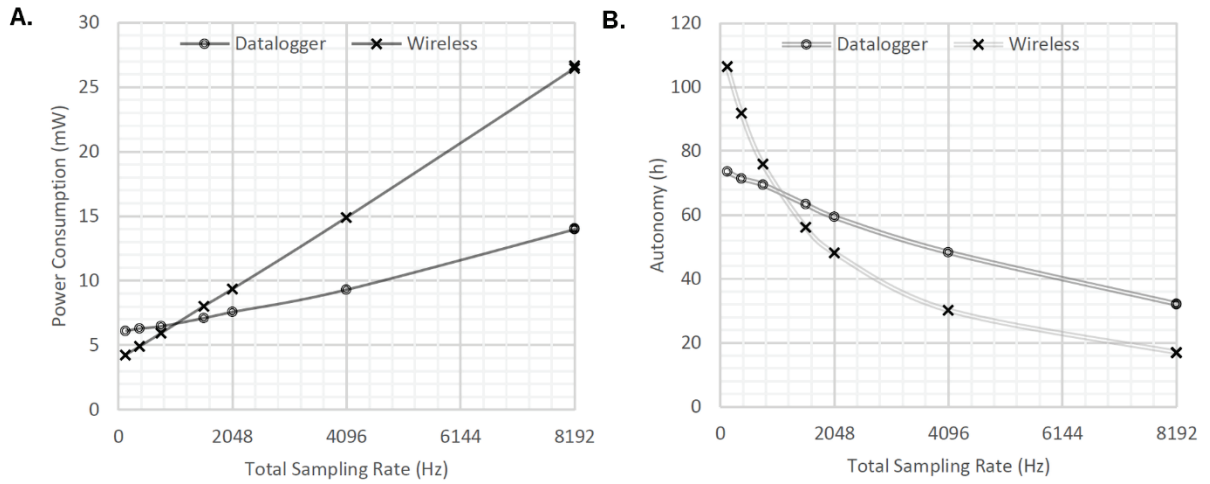

Fig. 8. Power consumption of the system with a 3V supply voltage and expected autonomy with a 150mAh primary battery.

III. RESULTS

(1) Multiple parameters recorded in baseline condition with ONEIROS (wireless version) in rat

To validate the design of our system (size, weight, signal quality, and autonomy), we first monitored a rat in standard lab conditions. Here, for the first time we were able to record at the same time most of the electrophysiological parameters that covary with the different states of vigilance. Fig. 9. A. illustrates 90s of raw signal recorded with ONEIROS and Fig. 9. B. shows 10s of each state. The characteristics and quantity of each state were consistent with previously published data (Fig. 10.). During active wake (AW: dark blue), EEG and hippocampal activity is desynchronized, with the later also showing a sustained theta frequency (around 6Hz, see time frequency plot) characteristic of periods of locomotion (see also Fig. 9. and Fig. 10. D.) (Sławińska & Kasicki, 1998). The EMG, EOG, and the accelerometer show bursts of intense activity. The brain and nuchal temperature are at high levels. During QW (light blue), the animal stops moving, as reflected in the EMG and accelerometry recordings. Eye movements become less frequent and the EEG tends to increase in amplitude and decrease in frequency when compared to AW (Fig. 10. B). During SWS (red), the EEG is dominated by large slow waves (Fig. 9. and Fig. 10. D). During SWS, the EMG remains at a low level, the accelerometry shows little variation, indicating the absence of movement, and eye movements are nearly absent. Both temperatures tend to decrease during SWS. When the animal falls into PS (green), the parietal EEG and hippocampal recording show typical activity in the theta band (Fig. 9. and Fig. 10. D), eye movements occur, the EMG becomes atonic, the brain temperature increases to wake levels, but

body (nuchal) temperature continues to decline (Fig. 9., Fig. 10. C). A small nuchal “twitch” is also visible on the accelerometer signal (Fig. 9. B). Although high voltage waves were observed when the animal knocked the device against the cage wall, the signals were usually free of artefacts, even during grooming and locomotion.

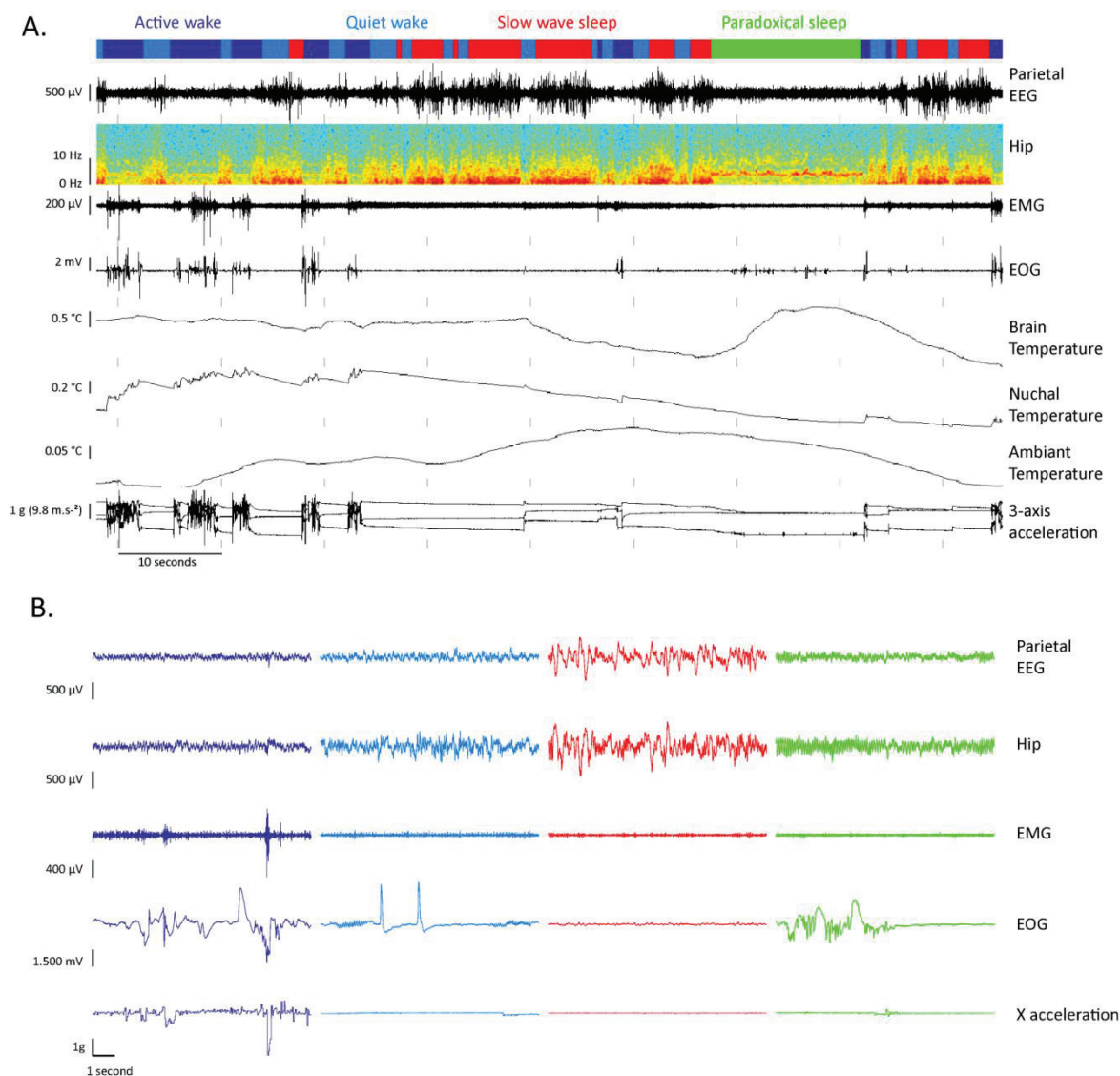

Fig. 9. Raw signals obtained with ONEIROS in wireless mode from a rat during different vigilant states. A. 90 second recording of all signals. From the top to the bottom; hypnogram illustrating the wake/sleep scoring (active wake in dark blue, quiet wake in light blue, slow wave sleep in red, and paradoxical sleep in green); parietal EEG; time frequency representation of the hippocampal local field potential (color coded from -131 dB in blue to -73 dB in red); EMG with a high pass filter (cutoff frequency 10Hz, order 2); EOG; brain temperature; nuchal temperature; ambient temperature; 3 axial accelerometry. B. Representative 10 second examples of the parietal EEG, hippocampal LFP, EMG, EOG and acceleration along x axis, occurring during the four states.

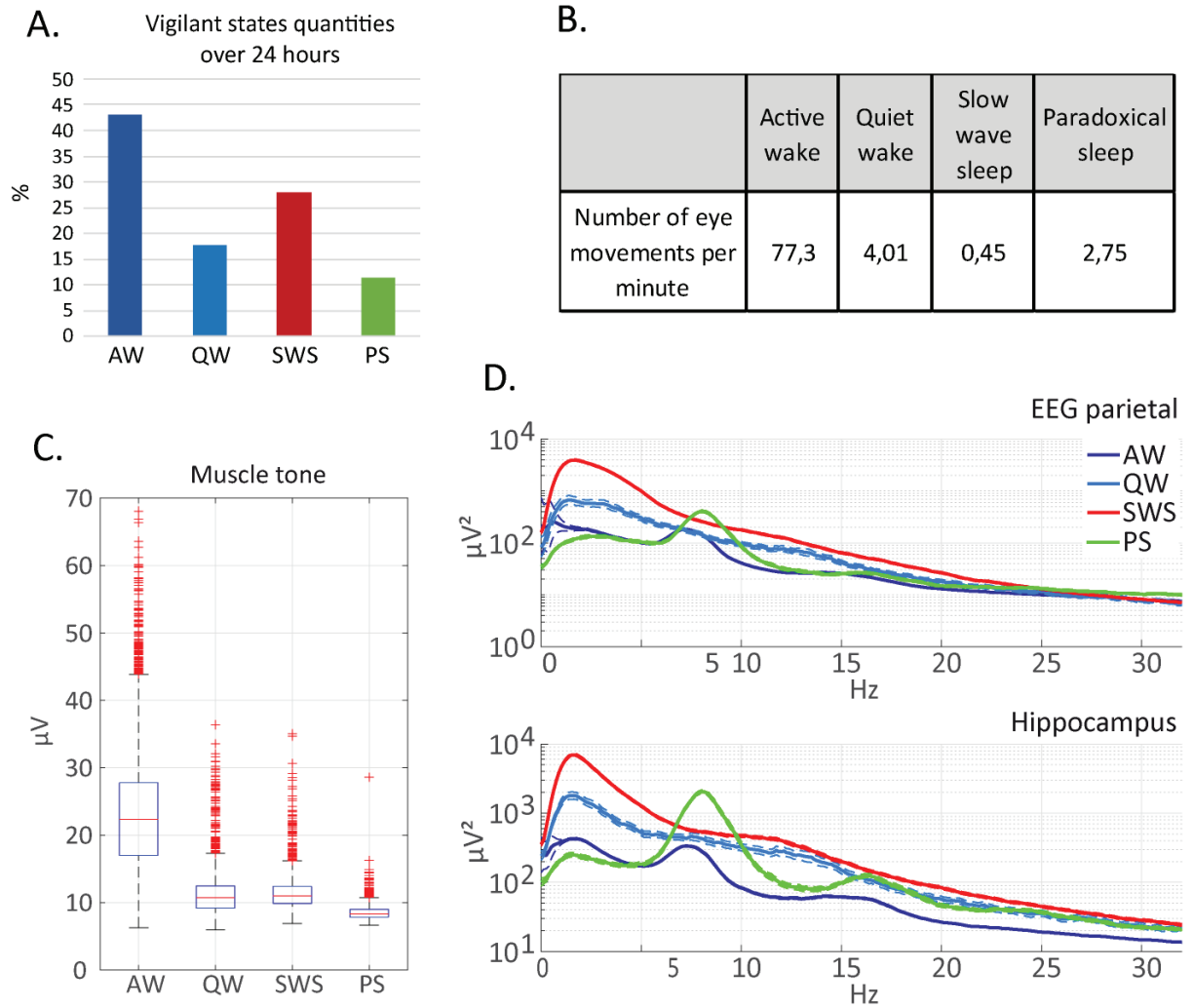

Fig. 10. Results over 24 hours obtained from wireless recordings in a rat. A. Quantification of the vigilant states over 24 hours. B. Number of eye movements per minute per state. C. Distribution of the muscle tone per epoch for each state. D. Power spectrum in each state computed for parietal EEG and hippocampal LFP.

(2) Selective paradoxical sleep deprivation in a rat using ONEIROS

The vibrating motor embedded in the ONEIROS device (Fig. 2. A.) was used to evaluate its efficacy in suppressing PS for several hours and inducing a homeostatic increase in PS during post-deprivation recovery. We performed selective PS deprivation for 6 hours by using a probabilistic online sleep scoring algorithm (Libourel *et al.*, 2015). Fig. 11. illustrates the raw signals during the PS deprivation (PSD) experiment. After a few seconds of PS (see atonia and EEG desynchronization), the algorithm sends a stimulation (white bar on the bottom bar) that immediately awakens the animal. The latency to detect PS was around 3-4 seconds. Fig. 11. B. shows the percentage of PS per hour during and after the deprivation (in green) compared to

baseline conditions (in blue). The deprivation reduced the quantity of PS for 6 hours by 60% (58% in baseline to 23% during PSD). Moreover, PSD also induced a rebound of PS (PSR) quantity during the recovery period with an increase of 85% over baseline levels (14% in baseline vs 26% during PSR, Fig. 11. D.). Compared to 4 hours of PSD via gentle handling (Ravassard *et al.*, 2016), Fig. 11. E) and unpublished data from our lab using a mechanical shaking device (Viewpoint S.A., (Libourel *et al.*, 2015), the quantity of remaining PS during PSD with ONEIROS is higher (5% with ONEIROS compared to 2.6% and 2.7% with the other methods). This is due to the presence of PS episodes during which the stimulations didn't immediately awaken the animal. However, PS quantities during the recovery were consistent with those obtained with the other methods.

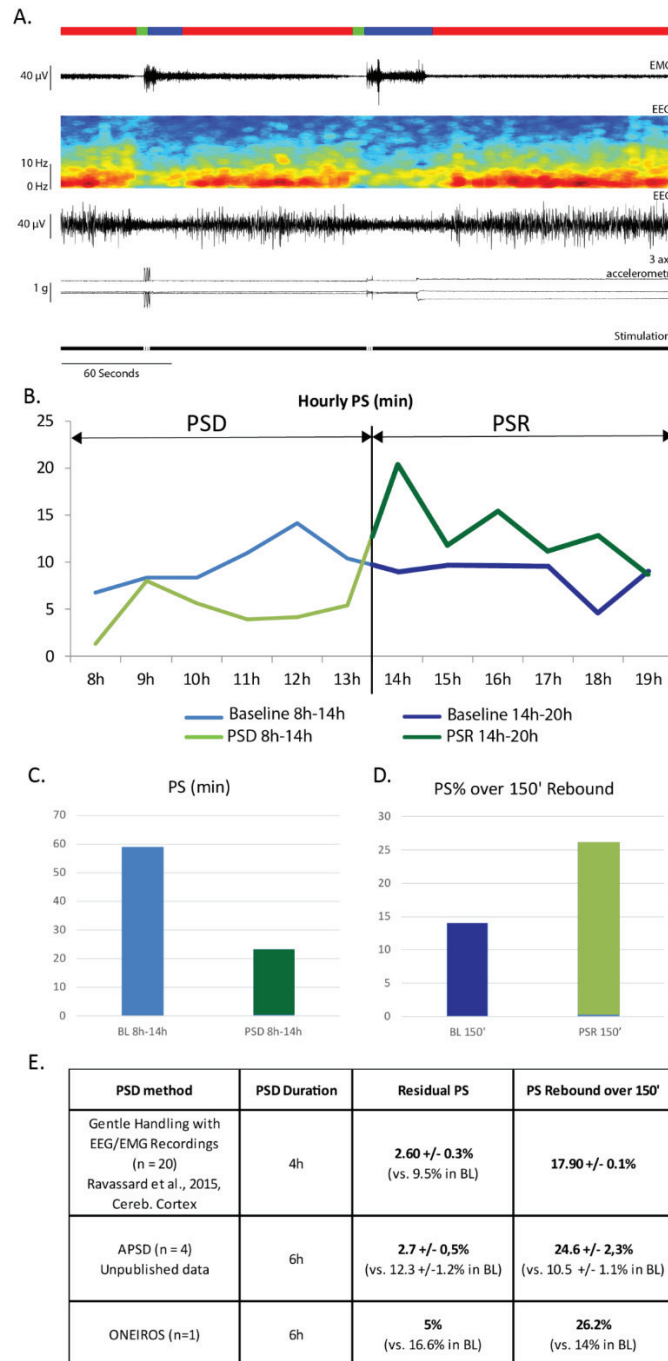

Fig. 11. Paradoxical Sleep deprivation efficiency. A. Hypnogram showing vigilance states (wake in blue, Slow wave sleep (SWS) in red, and Paradoxical Sleep (PS) in green), raw EMG signal, EEG time frequency and the associated raw EEG signal, and accelerometry. The bottom black bar shows when a stimulation was sent to awaken the animal (white bar). B. Percent time spent in PS per hour over the 12-hour baseline (in light blue 8h-14h and dark blue 14h-20h), PS deprivation period (from 8 to 14h in light green), and PS recovery period (from 14h to 20h in dark green). B. the histogram shows the mean quantity in minutes of PS during 6-hour baseline (left) compared to the remaining quantity of PS during PSD (right). C. The histogram illustrates the increase in PS after deprivation by showing the percentage of PS during 6 hours of baseline (left) compared to the 6 hours after the deprivation (right). D. the table compares the residual quantities of PS during PSD and PSR, during 4 hours of PS deprivation enforced via gentle handling (Ravassard et al., 2016), 6 hours of automated PS deprivation induced by a custom shaking device (Libourel et al., 2015), and ONEIROS PS deprivation.

(3) Multiple parameters recorded in baseline condition with ONEIROS (wireless logger) in a pigeon

The electrophysiological and behavioral aspects of sleep recorded with ONEIROS in the pigeon were similar to those recorded in birds using other methods. Oillustrates raw recordings with alternating periods of QW and AW, followed by SWS. The periods of AW were characterized by increased muscle activity and increased motion (visible on the accelerometry channels), and desynchronized EEG activity. The two peaks at 12 Hz and 24 Hz present on the power spectrum of AW (0A) resulted from head scratching. The periods of QW were characterized by low muscle activity (0B), comparatively small and infrequent changes in the accelerometry signal, generated by the birds' head movements, and desynchronized EEG activity. During SWS the EEG showed increased low frequency activity, when compared to all other states, increased Delta/Gamma ratio (0C) and the near absence of motion. Muscle tone usually remained at a level comparable to QW.

PS was characterized by EEG activation and behavioral signs of reduced muscle tone (e.g. head dropping as shown in the accelerometry recordings). As in other studies on pigeons and other avian species, the nuchal EMG rarely showed a reduction in activity, despite the behavioral signs of reduced tone. The number of eye movements increased during PS when compared to SWS. As previously described in pigeons and other birds (e.g. Dewasmes et al., 1985; Tobler and Borbély, 1988), eye movements included saccades, as well as faster oscillations (at 25-30 Hz). Unlike saccades which rarely occurred during SWS, the fast oscillations occurred during all sleep and waking states. They are thought to disperse oxygen and nutrients in the vitreous humor of the avian eye by moving a membrane (pecten) that protrudes inside the vitreous humor (Pettigrew, Wallman, & Wildsoet, 1990).

Overall, the duration and timing of sleep bouts, as well as the amount of each state was typical for pigeons (0E). During the 12-h night, the bird spent 82.9% and 9.5% of the time in SWS and PS, respectively (0D).

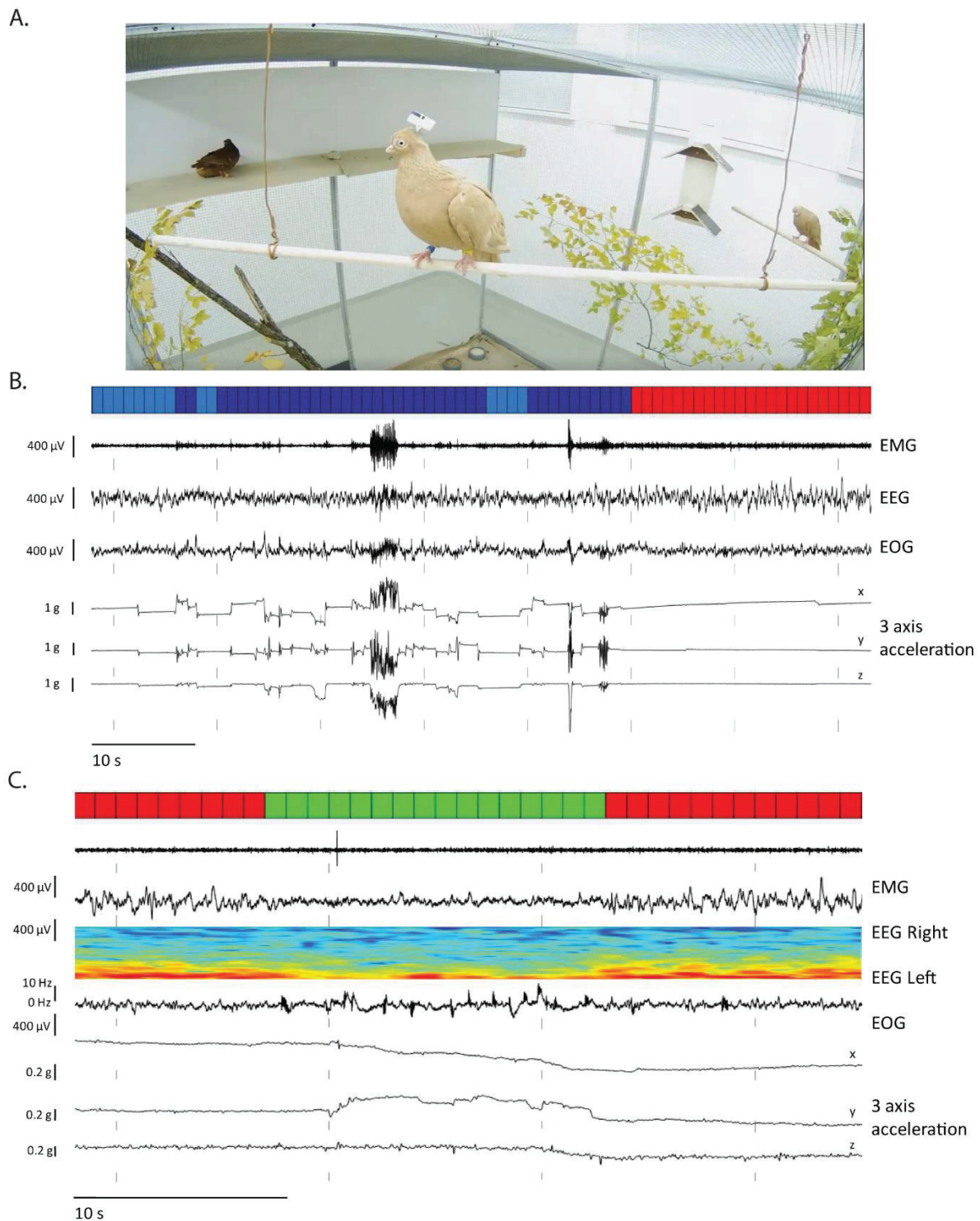

Fig. 12. Raw signals obtained with ONEIROS in logger mode from a pigeon during different vigilant states. A. Pigeon wearing ONEIROS (logger version) in the aviary during recording B. Raw signal illustrating the transition from wake to slow wave sleep (SWS). C. Raw signal illustrating one paradoxical sleep (PS) episode preceded and succeeded by SWS. From the top to the bottom; hypnogram illustrating the wake/sleep scoring (active wake in dark blue, quiet wake in light blue, SWS in red, and PS in green); EMG with a high pass filter (cutoff frequency 10Hz, order 2); right EEG; for B. only time frequency representation of the left EEG; EOG; 3-axial accelerometry.

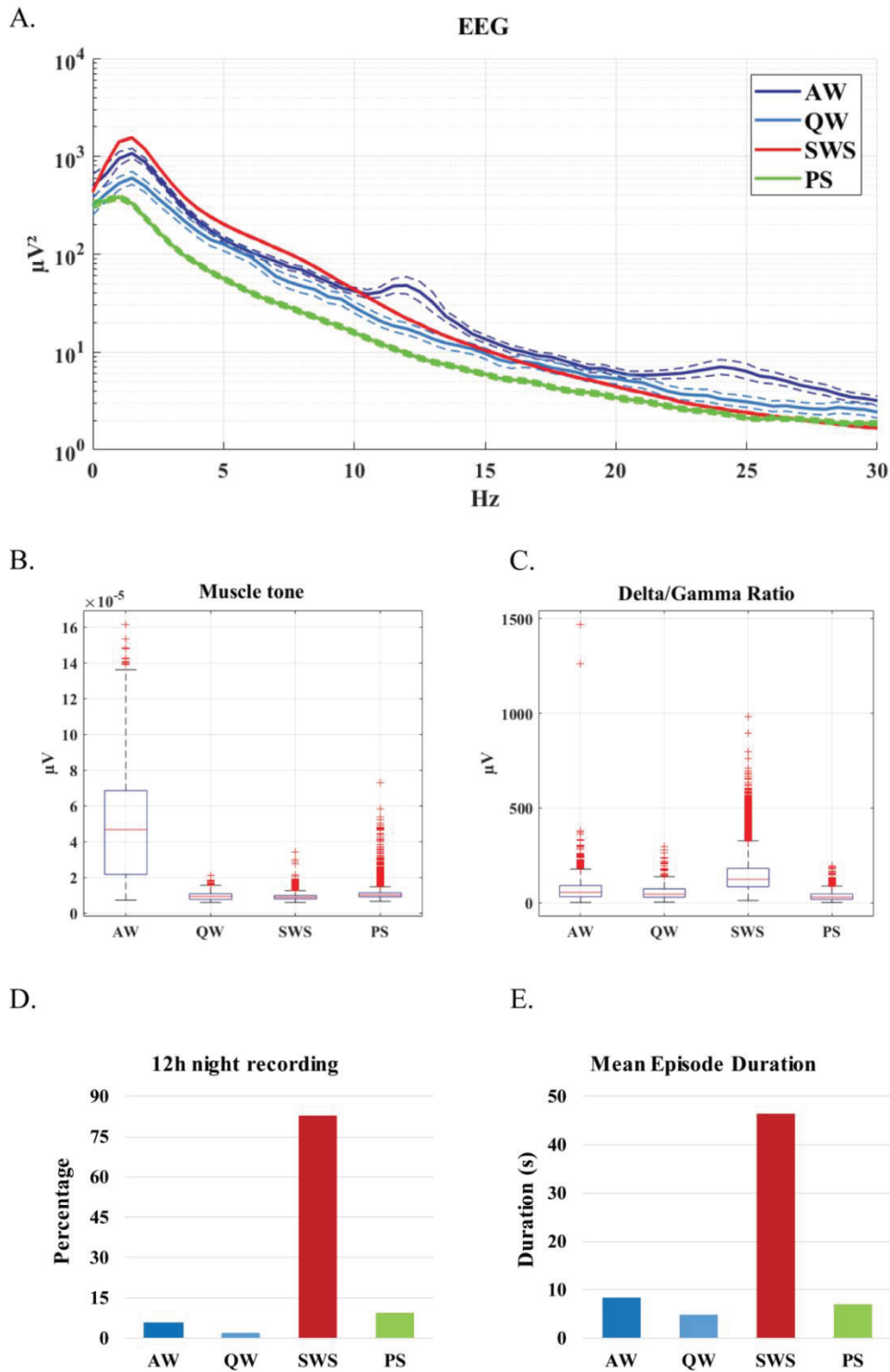

Fig. 13. Characteristics of wakefulness and sleep obtained from 12h night recordings of a pigeon with the ONEIROS logger. A. Power spectrum in each state computed for right EEG. B. Distribution of the muscle tone per epoch for each state. C. Distribution of the Delta/Gamma ratio for each state. D. Percentage of time spent in each state during 12h night recordings. E. Mean episode duration for each state. AW – active wakefulness; QW – quiet wakefulness; SWS – slow wave sleep; PS – paradoxical sleep. Accelerometry axis direction: x – forward-backwards, y – lateral, z – vertical.

IV. DISCUSSION

(1) Recording electrophysiology, behavior and temperature using a miniature instrument

One of the main reasons for developing ONEIROS was to combine in one small, light wireless device all of the electronics required to record multiple parameters related to sleep for long periods of time in small animals. Technically, the main constraints are size, weight, and autonomy. By coupling a frontend designed to record electrophysiology, an integrated digital accelerometer, a circuit to record temperature from multiple thermistors, and a low power microcontroller, we were able to build a system for studying sleep in small animals. Our recordings in baseline conditions in a rat, demonstrated that the size, weight, and autonomy of the system meet the requirements for recording sleep in the laboratory setting. Indeed, for the first time we were able to record without artefact in a freely moving animal most of the physiological and metabolic parameters that covary with sleep states (EEG, EMG, EOG, ECG, LFPs, and brain and body temperature). Moreover, we were also able to record the posture and the acceleration of the head via a 3 axis accelerometer, as well as ambient temperature. Our results and analysis demonstrate that an overall view of the classical features of sleep can be obtained with a single device. For example, the system can simultaneously record 10 electrophysiological channels at 256 Hz, three temperatures, and three acceleration channels at 64 Hz, for 35 hours with a 150 mAh battery; or 64 hours with 4 EEG, 1 temperature and 1 acceleration at 128Hz; an infinite number of other recording configurations are also possible. To our knowledge, in contrast to other commercial and/or published devices, ONEIROS is the only one that provides such flexibility in the configuration of the channels number and sampling rate, allowing users to completely customize data acquisition according to their needs.

In terms of limitation, while the system is small enough to be worn by rats, it is too large to be used on smaller animals such as mice. We estimate that the device is only suitable for animals over 100g. Future efforts should be directed toward reducing the size and weight of the device further, maybe with some compromises in term of capability and flexibility. Regarding the fields of application, although the system was designed for recording sleep, it could be used for other neuroscience applications. Behavioral tasks such as mazes, novel object recognition, and fear conditioning that require freely moving animals, might also benefit from the use of ONEIROS. Moreover, the device might be useful in studies using animal models of epilepsy wherein long-term recordings are needed to capture seizure related brain activity and behaviors.

(2) Sleep deprivation with ONEIROS

For the first time a vibration motor integrated in a wireless recording device has been used to perform automated, real-time PS deprivation. Our results indicated that the stimulation was intense enough to awaken the animal and thereby induce sleep deprivation. The system effectively reduced PS across a 6-hour period, and induced a homeostatic increase in PS following deprivation similar to that observed using other methods, such as gentle handling and shaking the floor of the animal's cage. However, the remaining quantity of PS during PSD was a bit higher compared to the other methods, likely because the stimulation was less intense compared to gentle stimulation or cage shaking. This also suggests that it might be difficult to awaken the animal with the device and settings used during longer term sleep deprivations. Possible solutions to this problem would be either to increase the duration of the stimulations (700ms in our experiments) or randomized the pattern of the stimulations. Another possibility would be to encapsulate the vibrating motor inside the dental cement, directly over the head of the animal.

(3) Evaluation of the arousal thresholds with ONEIROS

In addition to the main parameters that characterized sleep (electrophysiology, posture, temperature), including its homeostatic regulation, arousal threshold is also an important feature of sleep. With ONEIROS, the intensity, occurrence, and duration of the vibrating motor stimulation can also be specified, allowing for the systematic assessment of arousal thresholds.

(4) Recording sleep in semi natural environment with ONEIROS

By changing the wireless transmission stack to the logger stack, the device can be quickly transformed from a lab-based device to a logger suitable for recording sleep in the field. In this regard, ONEIROS does not need any additional systems to store the data (receiver, computer), as the signals are stored directly on an integrated SD card. In the logger configuration, sleep can be recorded in wild using methods previously employed with data loggers having fewer capabilities (Rattenborg *et al.*, 2016). To demonstrate the feasibility of recording sleep in the field, we implanted a pigeon and recorded its vigilance states in an aviary where other birds were also housed. The instrumented bird displayed normal behavior including short flights in the 2 x 2 x 2 m aviary. Thus the system could be used in a completely natural environment, as previously done with a logger with fewer recording capabilities (Vyssotski *et al.*, 2009; Lesku *et al.*, 2012; Rattenborg *et al.*, 2016). In comparison to this system, ONEIROS includes the capacity to record temperature, a useful parameter for evaluating the relationship between ambient temperature,

body temperature, and sleep (SWS and PS) and hibernation or torpor under natural conditions. In addition, it can record more channels, which is necessary when recording sleep in a species for the first time. ONEIROS provides more sleep parameters combined in a single miniature device than other devices used for recording into the wild. Future improvements of ONEIROS will include a recording scheduler, in order to define specific recording periods. For example, this could be used to exclude the post-operative recovery period, and thereby extend the recording duration capability of the device. Moreover, we plan to develop waterproofing and other protections necessary for recording in the wild.

V. CONCLUSION

ONEIROS was developed to record multiple aspects of sleep (behavior, electrophysiology, metabolism) from animals in the lab and the wild. The goal was to provide researchers with a tool that overcomes the limitations of existing wireless devices. The system provides high flexibility in terms of number of channels and sampling rate with low power consumption, allowing long-term recordings in small animals (from 100g). By wirelessly recording a rat under baseline conditions, performing a paradoxical sleep deprivation experiment in a rat, and logging data under semi-natural conditions in a pigeon, we demonstrated that ONEIROS is a useful tool for recording sleep under diverse conditions. For the first time EEG, EMG, EOG, ECG, LFPs, 3D acceleration, brain, body and ambient temperature recording, as well as homeostatic and arousal threshold experiments, can be conducted with the same system in the lab and in the wild on small animals. By facilitating comprehensive comparative and ecological studies of sleep, this device may lead to new perspectives regarding the evolution and functions of sleep.

PART III : COMPARATIVE ANALYSIS OF SLEEP IN TWO SQUAMATES

Partial homologies between sleep states in lizards, mammals, and birds suggest a complex evolution of sleep states in amniotes.

2018, *Plos Biology*

Paul-Antoine Libourel^{1*}, Baptiste Barrillot¹, Sébastien Arthaud¹, Bertrand Massot², Anne-Laure Morel¹, Olivier Beuf³, Anthony Herrel^{4,#}, Pierre-Hervé Luppi^{1,#}

These authors contributed equally to this work

Corresponding author: pa.libourel@univ-lyon1.fr

¹ Neuroscience Research Center of Lyon, SLEEP Team, UMR 5292 CNRS/U1028 INSERM; Université Claude Bernard Lyon 1; Lyon, F-69372; France

² Nanotechnologies Institute of Lyon, UMR5270 CNRS, INSA Lyon ; Université Claude Bernard Lyon 1 ; Villeurbanne, F-69621 ; France

³ Health Image processing and acquisition Research Center of Lyon, UMR 5220 CNRS/U1206 INSERM, INSA-Lyon, Université Claude Bernard Lyon 1, UJM-Saint Etienne, F-69616, LYON, France

⁴ MECADEV, UMR7179 CNRS, National Museum of Natural History, Paris, 75005, France

ABSTRACT

It is crucial to determine whether Rapid Eye Movement sleep (REM) and Slow Wave Sleep (SWS) (or Non-REM sleep), identified in most mammals and birds, also exist in lizards, as they share a common ancestor with these groups. Recently, a study in the bearded dragon (*Pogona vitticeps*) reported states analogous to REM and SWS alternating in a surprisingly regular 80-second period, suggesting a common origin of the two sleep states across amniotes. We first confirmed these results in the bearded dragon with deep brain recordings and EOG recordings. Then, to confirm a common origin and more finely characterize sleep in lizards, we developed a multiparametric approach in the tegu lizard, a species never recorded to date. We recorded EOG, EMG, heart rate, and local field potentials and included data on arousal thresholds, sleep deprivation, and pharmacological treatments with fluoxetine, a serotonin reuptake blocker that suppresses REM sleep in mammals. As in the bearded dragon, we demonstrate the existence of two sleep states in tegu lizards. However, no clear periodicity is apparent. The first sleep state showed high amplitude isolated sharp waves (S1 sleep) and the second sleep state (S2 sleep) displayed 15 Hz oscillations, isolated ocular movements, and a decrease in heart rate variability and muscle tone compared to S1. Fluoxetine treatment induced a significant decrease in S2 quantities and in the number of sharp waves in S1. Because S2 sleep is characterized by the presence of ocular movements and is inhibited by a serotonin reuptake inhibitor, as is REM sleep in birds and mammals, it might be analogous to this state. However, S2 displays a type of oscillation never previously reported and does not display a desynchronized EEG as is observed in the bearded dragons, mammals, and birds. This suggests that the phenotype of sleep states and possibly their role can differ, even between closely related species. Finally, our results suggest a common origin of two sleep states in amniotes. Yet, they also highlight a diversity of sleep phenotypes across lizards demonstrating that the evolution of sleep states is more complex than previously thought.

Keywords: Sleep, Lizards, Active Sleep, Quiet Sleep, Slow Wave sleep, REM sleep, evolution, reptiles

I. INTRODUCTION

(1) Behavioral sleep

Based on the 1913 behavioural definition (Piéron, 1913), sleep is characterized by sustained immobility, a species-specific sleep posture and location, and a high arousal threshold. In addition, it displays a circadian distribution and is homeostatically regulated. Based on these criteria, it has been shown that sleep occurs in all animals, from the simplest organism to the most complex ones (Campbell & Tobler, 1984; Cirelli & Tononi, 2008; Siegel, 2008; Nath *et al.*, 2017). Such ubiquity of sleep indicates that it constitutes a fundamental need for all living organisms.

(2) Two sleep states in mammals and birds

In the 50's, two distinct sleep states were described in humans and cats (Aserinsky & Kleitman, 1953; Jouvet *et al.*, 1959). The first sleep state is slow-wave sleep (SWS) also known as non-REM sleep or quiet sleep. This state is characterized in mammals by the occurrence of cortical high amplitude slow delta waves (0.5–4Hz) (Steriade, 2006), hippocampal sharp wave ripple complexes (Girardeau *et al.*, 2009; Buzsáki, 2015), and spindle oscillations (Berger, 1929; De Gennaro & Ferrara, 2003). During SWS, physiological processes are reduced, including heart rate, body temperature, eye movements, and muscle tone. In sharp contrast, the active sleep state named rapid eye movement (REM) or paradoxical sleep (Jouvet *et al.*, 1959), commonly associated with dreaming in humans, is characterized by rapid eye movements and cortical desynchronization like the awake state, but without muscle tone (Aserinsky & Kleitman, 1953; Jouvet *et al.*, 1959). REM sleep and SWS are also characterized by a high arousal threshold. During REM sleep, in contrast to SWS, thermoregulation processes including shivering, piloerection, and sweating are abolished (Parmeggiani, 2003), brain temperature increases and the heart and breathing rates become irregular (Snyder *et al.*, 1964). Finally, toe, tail, limb, and whisker movements occur phasically (muscle twitches) during REM sleep (Gassel *et al.*, 1964). SWS and REM sleep have been unequivocally identified to date only in terrestrial mammals and birds (Campbell & Tobler, 1984) (Fig 1A). Since these species are homeotherms, it has often been proposed that the two sleep states evolved together with homeothermia (Kavanau, 2002). However, the poikilothermic non-avian reptiles, including lizards and snakes, turtles, and crocodiles share a common ancestor with mammals and birds. Squamates (lizards and snakes) are

the group that shares the most ancestral features with the common ancestor of birds and non-avian reptiles (Fig 1A). Therefore, to retrace the evolution of the two sleep states studying species in this group is essential.

(3) Sleep in squamates (lizards and snakes)

Despite its importance in understanding the evolutionary origins of these sleep states, less than 40 studies, mostly from the 70's, have been devoted to the study of sleep in non-avian reptiles (Campbell & Tobler, 1984; Hartse, Kristyna M., 1994; Libourel & Herrel, 2016). Of them, 16 were dedicated to squamates with only seven articles including more than three recorded animals (Tauber *et al.*, 1968; Flanigan, 1973; Romo *et al.*, 1978; Huntley, 1987; Ayala-Guerrero & Vargas Reyna, 1987; Ayala-Guerrero & Mexicano, 2008b; Shein-Idelson *et al.*, 2016). In addition, these studies were performed in only six species, all belonging to the infra-order Iguania. They revealed that this lizard family displays behavioural sleep during the night, including a specific posture and, when examined, a high arousal threshold and a homeostatic response to sleep deprivation. The sleep period was often described as one large bout during the night. During the day, periods of activity intersected long phases of quiet wake. Sleep was also reported to be associated with a decrease of the heart and respiratory rates. Regarding the presence of one or multiple sleep states in lizards, the existence of a REM-like sleep state was already suggested in 1966 (Tauber *et al.*, 1968), mainly based on the presence of eye movements during sleep periods. However, these older studies failed to convince and no consensus was obtained because of limitations in methodology, recording conditions, and the absence of replication (Libourel & Herrel, 2016). However, in 2016 Shein-Idelson *et al.* provided convincing evidence for the existence of two electrophysiological sleep states (Shein-Idelson *et al.*, 2016) in a species never previously recorded for this purpose, the bearded dragon (*Pogona vitticeps*). The authors observed, specifically during the night when the animal was lying on the floor of the cage with its eyes closed, a very regular alternation of periods characterized by the occurrence of “slow waves” and periods characterized by LFP desynchronization, similar to those observed during the awake state, and associated with isolated eye movements. The authors concluded that both SWS and REM sleep exist in this species with a very rhythmic periodicity. However, such a periodicity, as regular as a clockwork, is quite surprising and was never before reported in neither other non-avian reptiles nor in mammals and birds. Moreover, muscle tone, motor automatism, heart rate, and arousal threshold evaluation were missing to unequivocally demonstrated that the state identified as REM sleep did

not correspond to short periods of awakening known to be also characterized by desynchronized EEG and eye movements.

Therefore, we decided to replicate the experiments of Shein Idelson and colleagues (2016) and to compare these data with data for another species of lizard from a different family to test the generality of these findings. We replicated data on one bearded dragon (*Pogona vitticeps*) (Fig 1B) and developed a mutliparametric approach to examine sleep in the argentine tegu lizard, *Salvator merianae* (Fig 1B). We chose this species as it belongs to the Lacertoidea family for which sleep has never been recorded with the exception of three papers focusing on circadian rhythms (Milsom *et al.*, 2008; Piercy *et al.*, 2015; Sanders *et al.*, 2015). Furthermore, this predatory species displays an active foraging life style, an omnivorous diet, and high cognitive abilities with one of the highest encephalization quotients across squamates (Platel, 1975). Consequently, it may have larger quantities of sleep and more specifically REM sleep than other lizards (Lesku *et al.*, 2006). Six sub-adult Argentine Tegus (*Salvator merianae*) were studied. We recorded LFPs by means of 35 μ m diameter tungsten electrodes implanted at different depths in four forebrain regions. We simultaneously recorded the nuchal EMG, EOG, and the ECG using a wireless system. All the animals were video monitored for 24 hours a day with four near infra-red cameras. As brain LFP amplitudes and frequencies covary with temperature (Deboer, 1998), we performed all the experiments at a constant temperature. Therefore, baseline conditions, the arousal threshold, and the effect of nine hours of sleep deprivation by means of gentle handling were recorded at 28°C (body temperature). Finally, systemic injections of fluoxetine, a serotonin reuptake inhibitor known to suppress REM sleep in mammals (Slater, Jones, & Moore, 1978; Gao, Duncan, & Wehr, 1992), were performed at two different concentrations

I. MATERIALS AND METHODS

(1) Animals

We report data on one bearded dragon (*Pogona vitticeps*), six Argentine Tegus (*Salvator merianae*), five males and one female (#2), with an age of two years (± 0.5), 3 \pm 0.7 kg. All tegus were bought from official breeders and were maintained individually in a 4 meters square area (2m x 2m). The bearded dragon was maintained and recorded in a smaller terrarium (90cm length, 50cm width, 40cm high). The tegus were fed with dead mice two to three times a week and the bearded dragon was fed with crickets and vegetables twice weekly. Water was provided

ad libitum. Prior to experiments, animals were maintained under a 12:12 light/dark cycle in a room maintained at 25°C with a hot spot at 45°C available between 11am and 6pm. Six infra-red (850nm) panels (Viewpoint SA) were always on. A shelter transparent to infra-red wavelengths was used to monitor the animals during the dark phase. All the experiments were conducted in a room at 25°C after at least two days of habituation. A custom floor heating regulated at 30°C was used for the tegu. The nuchal temperature was measured for one animal of each species thanks to micro thermistor implanted in the nuchal muscles. The nuchal temperature measured on one animal was around 28°C for the tegu and 25°C for the bearded dragon.

(2) Ethical considerations

All experiments were conducted with the 3R principles in animal experimentation and in accordance to the European Community Council Directive for the use of research animals (86/609/EEC; http://ec.europa.eu/food/fs/aw/aw_legislation/scientific/86-609-eeec_en.pdf and http://ec.europa.eu/environment/chemicals/lab_animals/pdf/endorsed_awb-nc.pdf); 2016/63/EU;

Protocols and procedures used were approved by the local ethics committee for animal experimentation of the university Lyon 1 (N° BH2012-43).

(3) Imaging and verification of the electrode position

Prior to the surgery two 100µm diameter holes were drilled under anesthesia (cf. surgery part) in the anterior and posterior part of the parietal bone. These holes served as references during the surgery. MRI imaging was carried out on a 3T GEHC MR750 System using a 8-channel wrist coil. The head of the lizard was placed at the center of the coil. After a three plane localizer, two 3D high spatial resolution MR imaging (HR-MRI) acquisition sequences were performed in the coronal plane. For both HR-MRI acquisitions, similar parameters were used: 59.2 mm slab thickness with 100 × 80 mm² Field Of View (FOV), 148 × 448 × 384 acquisition matrix size, 592 × 1024 × 768 reconstruction matrix leading to a slice thickness of 100µm with an in-plane pixel of 97 × 97 µm². First, a T1-weighted FSGGR sequence with 30° flip angle, 29.4 ms TR, 10.1 ms TE, +7.8kHz receiver bandwidth with 22'15" scan time. Second, a FIESTA-C sequence with 70° flip angle, 10.8 ms TR, 3.6 ms TE, +41.7kHz receiver bandwidth with 12'45" scan time. A few days later, a CT Scan was performed to image the skull. The experiments were done on a NVEON system (Siemens), with a tension of 80kV, a current of 500µA, and an exposure time of 900ms with 720 steps. The reconstruction of the final volume permits to obtain a voxel size of 55,62

μm^3 in the three dimensions. The two modalities (MRI and CT Scan) were realigned by choosing at least 10 common landmarks and using a principal component analysis method for realignment (Avizo v7.0.1). Next, landmarks were put on the MRI slices at the targeted electrode positions. A custom script (Matlab r2016b, Mathworks, USA) was used to transform the targeted landmarks into the reference frame defined by the holes drilled on the skull. The coordinates obtained were those used for the surgery. This procedure was used for all animals of both species. One week after the surgery, a second CT scan was performed in order to check the electrode positions by realigning the last CT scan to the two pre-surgical images.

(4) Perfusion

Under surgical anesthesia (cf. surgery), after an electrocoagulation lesioning (2s 0.5mA), animals were perfused transcardially (Hoops, 2015) with a 400ml-Ringer-Lactate solution (Braun Medical, France) followed by a 2000ml-4% paraformaldehyde fixative solution, with a perfusion pump (Gilson, France) set at a 55ml/min rate. Brains were removed and post-fixed for 2 days at 4°C in the same solution. Brains were included in paraffin (LEICA ASP300, Germany) and mounted (Myr EC 350-2, Spain), and 7 μm slices were cut with a microtome (Leica RM2245, Germany) for histochemistry processing. One slice every seven was kept.

(5) Nissl staining

The Nissl staining was done for the bearded dragon and tegu #2, #3, #4, #5, #6. The paraffin was removed from each slice with two 4 minute baths of methylcyclohexane, then two 4-minute baths of 100% alcohol, followed by a 4-minute bath of water. The Nissl stain was performed by putting the slices successively into the following baths: 2 minutes of water, 4 minutes of Cresyl Violet acetate (1g/L) (Sigma Aldrich, USA), 1 minute of alcohol 75%, 30 seconds of alcohol 95%, 15 minutes of alcohol 15%, 5 seconds of alcohol 100%, 5 seconds of alcohol 100%, 2 minutes of OTTIX (MM France, France). Then slices were digitalized (Zeiss Axioscan Z1, Germany) with a 5X Fluar (ON 0.25) lens.

(6) Surgery

The animals were anaesthetized with a mixture of ketamine (66 to 100 mg/Kg) and medetomidine (100 to 200 $\mu\text{g}/\text{kg}$) at 19°C injected intramuscularly and equally distributed in the four limbs (Barrillot *et al.*, 2018). After every 6 hours, re-injections of half the previous dose were performed. Reflexes and respiratory rate were checked throughout the surgery. During tegu's

surgery, two stainless steel electrodes were inserted bilaterally in the intercostal muscles for measuring heart rate, two others were also implanted in the neck muscles to assess muscle tone. For the tegu and the bearded dragon, two other electrodes, gold plated at the tip, were positioned behind each eye, under the eyelid, to record eye movements. The tegu were also implanted with three to four bundles of six 35 μ m diameter tungsten electrodes in different brain regions (dorsal ventricular ridge, nucleus sphericus, rostral medial cortex and/or caudal medial cortex). Only the DVR was implanted with this kind of bundle during the bearded dragon surgery. One screw was fixed on the skull between the two eyes for signal referencing for the tegu. The reference was inserted on the most caudal part of the parietal bone for the bearded dragon. To do so, lizards were placed in an adapted stereotactic frame. All wires were then connected to a head connector (EIB-36-PTB Neuralynx), which was secured over the skull using acrylic Superbond (Sun Medical Co.). Next, dental Paladur cement (Heraeus Kuzler) was applied around the head connector to protect all the wires and the connector.

(7) Behavior

The behavior of the animal was monitored with 4 cameras (Dragonfly2 DR2-HIBW, PointGrey) equipped with a band pass filter in the near infra-red wavelength. One camera was recording the full area, and the three others were dedicated to the animal shelter. The videos were recorded 24h a day (VPCore2, Viewpoint), and the actimetry which is the number of pixels changing more than 14 grey levels between two successive images, was evaluated online for each camera.

(8) Arousal threshold

The arousal threshold was evaluated for the argentine tegu. A micro rotor was fixed over the head of the animal for at least 4 days. The micro rotor was programmed with a custom device to rotate at the maximum power for 5 seconds every hour to avoid any habituation. When the rotor was activated a LED light was on. Using the 4 videos, any sign of awakening (like an eye opening, a leg or head movement) after a stimulation was recorded, as well as the latency thereof. The percentage of awakening after stimulation was evaluated for each hour for each animal. The mean percentage was then calculated for 5 animals (Fig 2A).

(9) In vivo electrophysiology

For the tegu, the electrophysiological signals from at least 22 tungsten electrodes into the brain, 2 ECG, 2 EMG, 2 EOG, and in some animals a screw EEG, were recorded wirelessly (TBSI W32). A custom battery (3000mAh) for recording at least four days without changing the battery was used and fixed over the back of the animal with tape. The amplification of the system was 1000 times. The digitalization was performed using a DAQ card (National Instruments USB 6363) with a custom script (Matlab r2016b, Mathworks, USA). The data were sampled first at 20 kHz, low pass filtered at 500 Hz and sub-sampled at 2 kHz online. The videos were synchronized with an output TTL to trig the start and the stop of each video. For the bearded dragon, the DVR LFP was recorded with 8 tungsten electrodes at different depth (-4 to -2 mm below the skull, at 1.28mm caudal to the anterior part of the pineal hole and 1.94 mm lateral). 2 EOG were also recorded. The signals were recorded thanks to a custom wireless recording device at 128Hz and to a custom matlab script.

(10) Sleep deprivation

The sleep deprivation was performed on the argentine tegu by gentle handling without changing the light cycle from 7 pm to 4 am. The shelter was removed from the area and when the animal displayed a sign of sleep (mostly closing the eyes), the experimenter woke up the animal by pulling a rope attached to the animal's tail. After deprivation, the animal was left for at least 24h without any human intervention. The sleep deprivation was performed on 4 animals and the recordings started during the baseline and ended at least 24h after the recovery.

(11) Pharmacology

Twelve ml of Fluoxetine (10, and 60 mg/kg - Interchim, France) or saline (vehicle) solutions were randomly injected intraperitoneally at 4 pm in the tegu. Animals were recorded during at least 48h after injections. Each injection was spaced at least 2 days apart for NaCl and 3 days after the Fluoxetine injections.

(12) Preprocessing, visualization, and “shelter scoring”

All the electrophysiological signals of the tegu were filtered with a zero phase-shift low pass filter (cut off frequency 100 Hz order 2) and sub-sampled at 250 Hz before any other treatments. Next, the electrophysiological signals, the actimetry and the video were imported into a custom software program (SlipAnalysis, developed under Matlab r2016b, Mathworks, USA). An empty

hypnogram was then created. The hypnogram was then manually filled per 5 seconds from the video with two states: animal inside the shelter or animal outside the shelter. All the analyses performed were also done with custom scripts (Matlab r2016b, Mathworks).

(13) Automated vigilance states scoring

For the argentine tegus, differential EOG calculated from the subtraction between the two EOGs was filtered with a low pass filter (F_c 10Hz, order 10). Then, the maximal value of the redressed signal was evaluated every second. Every eye movement occurrence and duration was extracted by taking any part of the signal higher than $30\mu\text{V}$. Next, every epoch of the hypnogram during which the interval between eye movements was higher than 30s was scored as sleep. The other epochs were considered as quiet wake. The episodes of sleep spaced by less than two minutes were merged, and those lasting less than two minutes were removed. A differential EMG calculated from the subtraction between two EMGs was filtered with a high pass filter (F_c 10Hz, order 10) and the absolute value of the Hilbert transform was calculated. An average filter with a 0.5 second window was applied and the mean value was evaluated for every one second bout. AW was scored when the processed EMG value was above $20\mu\text{V}$. Every episode lasting less than 5 seconds was ignored and episodes spaced by less than five seconds were merged (Fig 2D and Fig. S1). For the baseline experiments, the episodes scored as sleep in the automated hypnograms were compared with the “shelter scoring” (table S1). A mean correct rate of 0.873 was obtained on the six animals, with a mean sensitivity of 0.911 and a mean specificity of 0.874.

(14) Electrode selection

At least 22 electrodes were implanted in three to four regions in each tegu. In order to remove electrodes that were likely in the cerebrospinal fluid (CSF) we computed the mean power spectrum density (MPSD) into the 0.5–45 Hz band. For all animals, based on the imaging (MRI and post-surgery CT scan) we labeled the electrodes that were in the CSF, and those into the brain. A threshold was obtained by computing the mean plus one standard deviation from all MPSD of the CSF electrodes. Every electrode with MPSD below the threshold was removed from the analyses and considered as being into the CSF (Fig S2). In order to choose the best electrode to extract the S2 states, we computed the mean power spectrum density during the episodes scored as sleep. An interpolated spectrum was computed by removing the 10–20 Hz and keeping the value in 5–10 Hz and 20–25 Hz (Fig S3A–F). A spline interpolation was used to evaluate this interpolated spectrum. By this means, an electrode was chosen per animal by taking the electrode

with the maximal ratio between the interpolated and the real spectrum into the 10–20 Hz band. Animal two was removed from the S2 and HShW analysis because none of its electrodes had a ratio higher than 0.5%. As only the DVR was recorded, we choose the electrode with the highest amplitude for the Bearded dragon.

(15) Clustering and S2 extraction

We used the methodology of Shein Idelson et al. (Shein-Idelson *et al.*, 2016). From the baseline experiments, between 9 pm and 2 am, the signal of the chosen electrode was whitened with an autoregressive algorithm. A multi-taper power spectrum between 0.5 and 30 Hz was computed for each 3-seconds epoch scored as sleep (windows 3 seconds, bandwidth 1 Hz, 5 tapers, (Bokil *et al.*, 2010)). Each power spectrum was normalized by the mean power spectrum. A correlation matrix of these power spectra was calculated. Then, a hierarchical clustering with two clusters was realized, based on an Euclidian distance of the correlation and using a Ward linkage (Fig 1D, 4C). A mean normalized power spectrum per animal was then calculated for each cluster (Fig 1D, 4D). For the figure 1, in the bearded dragon and in the tegu we used the ratio used by Shein Idelson et al. (δ/β , [0.5–4Hz] / [11–30Hz]). But regarding our detail analysis on tegus, in order to extract the band power ratio that maximize the cluster detection, we detected the peak of each power spectrum of the state the maximum power into the 10–20 Hz band and the crossing frequency between the two normalized power spectra. Based on the means of these values, we defined the S2 detection Ratio (S2R), which is the mean power of the 10–22 Hz band divided by the sum of the 4–10 Hz and the 22–28 Hz band ($S2R = [10-22 \text{ Hz}] / ([4-10 \text{ Hz}] + [22-28 \text{ Hz}])$). This ratio was calculated for the 24h baseline of each animal on the chosen whitened electrode. A threshold was defined as the mean plus one standard deviation (Fig 3E). Every part of the signal above that threshold was considered as S2. If the S2 episodes were separated by less than two seconds, they were merged and the episodes lasting less than one second were removed. The auto correlation of the Figure 1E and 1F was computed as described in Shein-Idelson et al.

(16) Physiological measurements

The heart rate was extracted from the ECG electrode previously filtered with a high pass filter (Fc 10 Hz, order 10). A peak detection was made (threshold 100 μ V, min interval between peak 0.7 seconds). The instantaneous heart rate was then computed by measuring the interval between peaks. The muscle tone was extracted from differential EMG filtered with a high pass filter (Fc 10 Hz, order 10). The muscle tone is the absolute value of the Hilbert transform of the

signal was filtered with a mean filter (windows 0.5s). The eye movement density was calculated from the EOG channels. The signal was filtered with a low pass filter (F_c 10 Hz, order 10). Each part of the signal above $30\mu\text{V}$ was considered as an eye movement. The density of eye movements corresponds to the number of eye movements occurring per minutes per state. The figure 1F representing the phase histogram of the eye movements of the bearded dragon, was obtain by detecting the δ and β periods. The δ/β ratio was evaluated. Each δ periods were extracted when the ratio was higher than his average and β periods when the ratio was lower the average. Each cycle of δ - β periods were normalized between 0 and 2π . Then the distribution of the occurrence of the ocular movements were evaluated relatively to this cycle.

(17) Sharp Wave extraction

For the tegus, the high amplitude sharp waves (HShWs) extraction was performed on all channels that were not considered as being in the CSF. The HShWs detection algorithm was adapted from the spike detection algorithm described by Quiroga et al. (Quiroga, Nadasdy, & Ben-Shaul, 2004). The HShWs were detected without any filter applied to the data. The threshold used was 10 times the signal to noise ratio, 50ms before and after the peak of the HShW was used for the waveform averaging. The channels kept for the analysis (baseline, sleep deprivation, and pharmacology) were the channels with the cleanest mean waveforms. The HShWs density was evaluated by dividing the number of HShWs during a state by the duration of that state.

(18) Statistics

All the statistics were performed using Matlab (Mathworks, USA). Wilcoxon signed-rank tests were used for single comparisons between mean parameters per state (Fig 1B, 1C, 1D, 3I, 5B, 5C). For multiple conditions with balanced designs, an analysis of variance with two factors (ANOVA2) was used followed by post-hoc analysis using Fisher's least significant difference procedure (Fig 3F, 3H, 4D, 4E, 4F, 5E, 5F, 5G, 5H). For unbalanced designs, Kruskal-Wallis tests were performed and followed by post-hoc analysis using Fisher's least significant difference procedure. For the ANOVA2, the normality of the data was tested with a Lilliefors test. When data were not normal, a Gaussian normalization centered on 0 with a variability of 0.2 was applied before any statistical test. The homoscedasticity was verified when needed using a Bartlett's test. A difference was considered significant if the p-value was lower than 0.05 (* for a $P < 0.05$, ** for $P < 0.001$, *** for $P < 0.0001$). All data are expressed as mean \pm standard error of the mean.

II. RESULTS

(1) Replication of the bearded dragon sleep experiments.

The signals obtained from tungsten electrodes implanted in the dorso-ventricular ridge (DVR) of a bearded dragon, a forebrain structure proposed to be homologous to the mammalian isocortex, the amygdala, and/or the claustral complex (Bruce & Neary, 1995; Aboitiz, 1999; Butler, Reiner, & Karten, 2011; Tosches *et al.*, 2018) revealed different patterns across vigilance states (Fig 1C). During the dark period, the bearded dragon displays a stereotypical posture, with the head lying on the floor in a specific location of the terrarium. This posture was never seen during the light period as the animal always had its head up from the floor. During this period, two electrophysiological phases with distinct frequency content coexisted (Fig 1C, 1D). The first electrophysiological sleep state, rich in δ (0.5–4Hz) frequencies, was characterized by a signal containing 1 to 2 slow negative high amplitude sharp waves (HShW) per second, lasting around 100–200 ms with an amplitude of 500 mV. The second electrophysiological sleep state contained frequencies in the β (11–30Hz) band, an oscillatory pattern that looked like the awake one (Fig 1C). The δ/β power ratio and the autocorrelation of the signal revealed a very regular alternance between periods with δ and periods with β (Fig E). The periodicity of these cycles was around 90s. Finally, the extraction of the occurrences of the eye movements from the EOG showed that the second electrophysiological sleep state contained more ocular movements than the first one. Eye movements were mainly isolated and appeared mostly at the beginning of sleep state 2 (Fig 1F). Our results obtained for one animal confirm the results reported by Shein-Idelson and coworkers. However, the same recordings and analysis performed on the argentine tegu revealed different electrophysiological patterns (Fig 1C). Indeed, even if two electrophysiological sleep states could be detected during the night resting phase (Fig 1D), the first sleep state did not contain slow negative high amplitude sharp waves as observed in the bearded dragon, and the second sleep state differed from the awake activity as an oscillation around 15Hz dominates this phase. Finally, the autocorrelation analysis suggested no periodicity of the δ/β power ratio (Fig 1G). As the same protocol was performed on these two lizard species and as it revealed such different results we decided to characterize sleep in greater detail in the argentine tegu and developed a mutliparameter approach as described below.

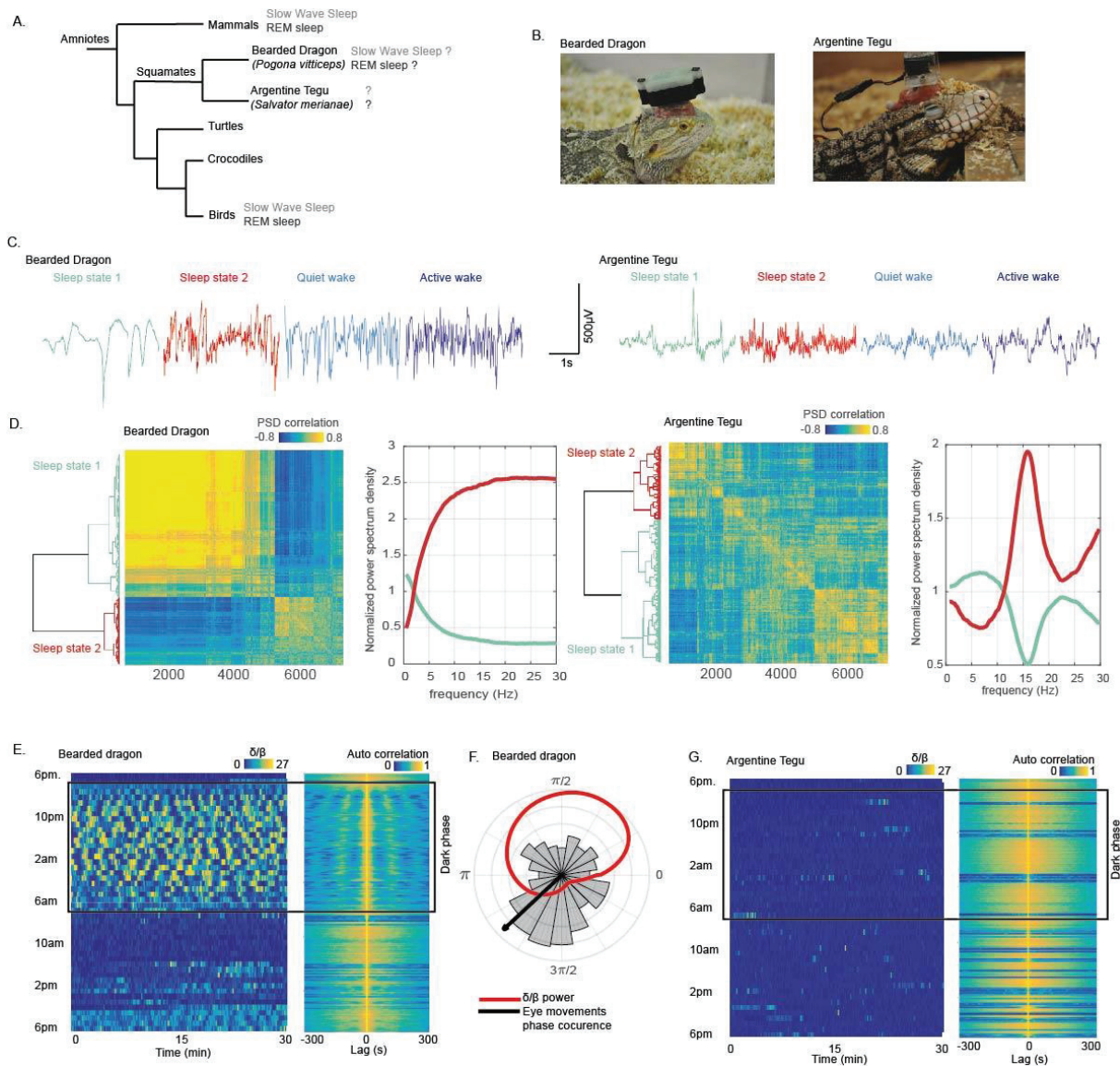

Fig. 1. *The tegu lizard does not sleep like a bearded dragon.* (A) Phylogenetic tree of amniotes representing the common origin of mammals, birds, and non-avian reptiles. The figure also illustrates that both REM sleep and SWS have been identified in mammals and birds, and more recently possibly also in a lizard, the bearded dragon (*Pogona vitticeps*). We investigated sleep in the argentine tegu (*Salvator merianae*) to determine whether the bearded dragon is the only lizard to display those two sleep states. (B) Pictures of the two species recorded. The animals were equipped with a recording device on their head. (C) Raw signal of one local field potential recorded in the dorso-ventricular ridge (DVR) with 35 μ m diameter tungsten electrode in the two species, during sleep state 1 (sharing similarities with mammalian SWS) in bluish, sleep state 2 (sharing similarities with mammalian REM sleep) in red, quiet wake in light blue, and active wake in dark blue. The raw data illustrate the difference in all states of the DVR local field potential. (D) Dendrogram (left) and correlation map (right) obtained from the hierarchical clustering of the distance between the correlation of each LFP three second-window power spectrum between 9pm and 2am in both species. On the right of each correlation map, the normalized mean power spectra of the two clusters computed for one animal in each species, representing the two distinct sleep states identified, Sleep state 1 (S1) in bluish and Sleep state 2 (S2) in red. The comparison of the normalized power spectra of each state reveals a frequency profile that is clearly different between the two species, with a desynchronized activity (composed of all the frequencies higher than 5Hz) for the

bearded dragon during S2 and a power spectrum mainly composed of 15Hz oscillations for the tegu. (E) the band power ratio ($\delta(0.5-4\text{Hz}) / \beta(11-30\text{Hz})$) computed as in Shein-Idelson et al. (Shein-Idelson et al., 2016) for the bearded dragon. Each horizontal segment represents 30min of the ratio computed with a 10 second window and a step of 0.1 s. The value of the ratio is color coded, from 0 (blue) to 27 (yellow). The figure from the top to the bottom represents the evolution of the ratio over 24 hours from 6pm. A dark rectangle indicates the dark period. On the right, the normalized autocorrelation map of the ratio is illustrated. The autocorrelation was computed within 600s windows with a step of one second. Both figures reveal a rhythmic alternance with a period of around 90s across episodes with δ frequencies (yellow) and episodes with β (blue) during the dark period, were the animal is lying on the floor with the eyes closed. (F) the distribution of the eye movements within each δ - β cycle, the mean phase is represented with a black arrow. The red line is the mean δ/β power ratio across the δ - β cycle. (G) This is the same figure as (E) for the argentine tegu. The figure reveals no clear cycle in the δ/β power ratio over 24 hours.

(2) Behavioral sleep in the tegu is characterized by a decrease in the number of eye movements and a higher arousal threshold.

During the light period, the tegus remained outside of their shelter and displayed short periods of active behavior, with head movements, locomotion, drinking, and feeding intersected by periods of immobility (Quiet Wake, QW) where animals were lying on the floor, eyes closed, head down with the four limbs spread apart. We observed that all animals entered their shelter one hour ($19\text{h}11\pm 27\text{min}$) before the onset of darkness (Fig 2A). Next, they curled up and kept their eyes closed and stayed in their shelter until 2h after light onset ($10\text{h}10\pm 23\text{min}$). During this phase, repositioning and movements of the head, limbs, toes, or whole body rarely occurred and the eyes remained mostly closed. We also observed rare tongue flicking with the head slightly up and the eyes closed.

To objectively demonstrate that the animals were sleeping we then measured for each hour the percentage of stimulations that induces an arousal and the associated number of eye movements and the heart rate. Between 6pm and 10am, the percentage of time spent in the shelter was significantly higher than between 10am and 6pm, while the number of stimuli that induced an awakening was significantly lower ($P<0.01$). In addition, the number of eye movements and the heart rate tended to decrease during the night ($P=0.0556$) (Fig 2A, 2C, 2D). In line with the behavioral definition of sleep, these results strongly suggest that the animals are awake between 10am and 6pm and are sleeping between 6pm and 10am. We then developed a custom script based on the number of eye movements (Fig 2F) and the muscle activity (Fig S1) to automatically score sleep (S), quiet wake (QW) and active wake (AW) (Fig 2E). We compared the

periods of time spent in the shelter with sleep periods scored with our algorithm and obtained 87 % of correct assignments, a sensitivity of 0.91, and a specificity of 0.87 (table S1). Using such automatic scoring, we measured the percentage of time spent in each state over 24h: $6.4 \pm 1\%$ (AW), $29 \pm 2\%$ (QW) and $64.6 \pm 2\%$ (S) with a mean bout duration of $0.5 \pm 0.1\text{min}$ (AW), $2.6 \pm 0.2\text{min}$ (QW) and $18.3 \pm 1.6\text{min}$ (S).

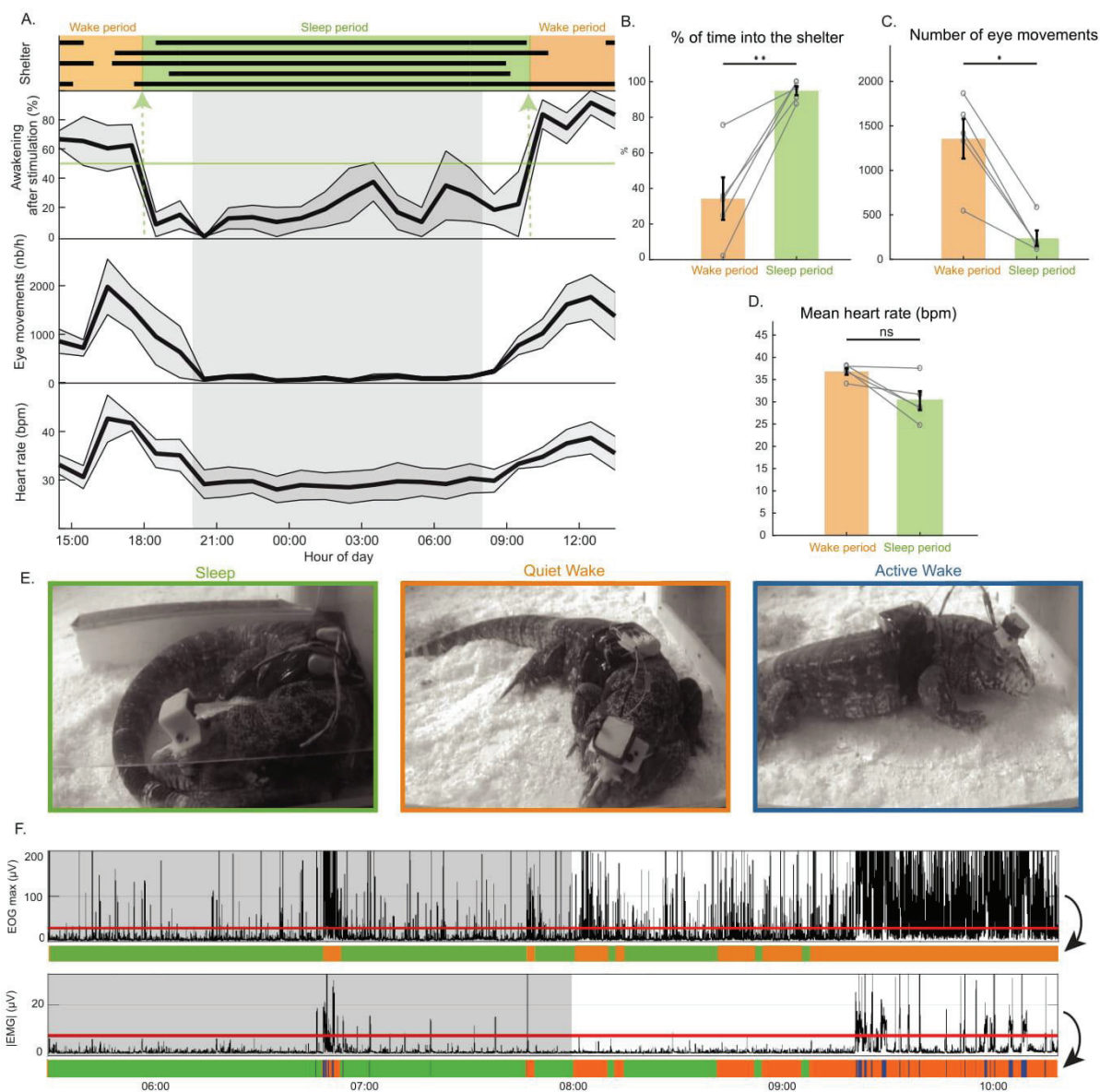

Fig. 2. Behavioral sleep and automated scoring in the Argentine Tegu (*Salvator merianae*). (A) The gray zone between 8PM and 8AM represents the dark phase. Representation over 24h of the time spent inside (black bars) the shelter for each of the five animals recorded (top); mean \pm SEM (line and gray zone) percentage of awakenings induced by a sensory stimulation made every hour ($n = 5$ animals); the mean \pm SEM number of eye movements per hour; the mean \pm SEM heart rate per hour. Choosing a threshold of 50% of awakening induced by the stimulation, we defined wake (in orange) and sleep periods (in green). (B) The sleep period significantly matched with the time passed inside the shelter ($P = 0.0079$), (C, D) A significant decrease of the number of eye movements per hour ($P = 0.0159$) and

tendency of heart rate decrease ($P=0.0556$) occurred during sleep compared to wake. (E) Positions and behavior of an animal during the three behavioral states identified: behavioral sleep (green panel), with an animal in its shelter, the body curled up and eyes closed; Quiet wake (orange panel) with an animal outside the shelter lying on the floor, eyes often closed, and active wake (blue panel) with an animal moving. (F) Graph illustrating the eye movements (maximal value of the EOG for each 1s window during 5h). The red line indicates the threshold used to differentiate sleep (green) from wake (orange). The graph below represents the average of the absolute value of the EMG for the same period. The red line indicates the threshold used to differentiate quiet (orange) and active wake (blue).

(3) Multisite LFPs recordings reveal the occurrence of slower frequencies during active wake compared to quiet wake and behavioral sleep.

Baseline recordings of local field potentials (LFPs) were made during 24h at 30°C in the dorso-ventricular ridge (DVR), the rostral (rMC) and caudal medial cortex (cMC), homologous to the mammalian hippocampus (Striedter, 2016), and the nucleus sphericus (NS) a vomeronasal region (Ulinski & Kanarek, 1973) caudal to the DVR (Fig 3D, C, E). A 3D reconstruction of the coordinates of the brain structures and of the skull was made for each animal using *in vivo* MRI and CT scans (Fig 3A) in order to accurately implant the targeted structures (Fig 3C, D). Bundles of 35µm tungsten electrodes (Fig 3B) were implanted in these structures. The electrode positions were verified using a post-implantation CT scan merged with the pre-implantation MRI and CT scans and post mortem histology (Fig 3C). The bundles consisted of four to eight electrodes covering 1500 µm dorso-ventrally (Fig S2). In addition to the LFPs, we also recorded the EMG of the deep nuchal muscles, the EOG of both eyes, and the heart rate (Fig 3E).

During AW, a significantly higher muscle tone ($P<0.001$), a higher number of eye movements ($P<0.001$) and a higher heart rate ($P<0.001$) were recorded compared to QW and S. In addition, the LFP spectral power during AW was dominated by low frequencies (around 5Hz) (Fig 3E, 3F). When comparing QW and S, no significant difference was seen in muscle tone and heart rate variability. However, the heart rate significantly decreased during S compared to QW (29.4 ± 2.6 vs. 40.32 ± 1.2 bpm, $P<0.001$). The LFPs in all regions showed a high diversity of patterns during all states, and no obvious modifications of the mean power spectrum (Fig 3E, 3F) excepting a small peak around 15 Hz during S compared to QW in the DVR and rMC electrodes (Fig 3F). A large peak around 20Hz was also clearly visible during all states, primarily in the NS (Fig 3F).

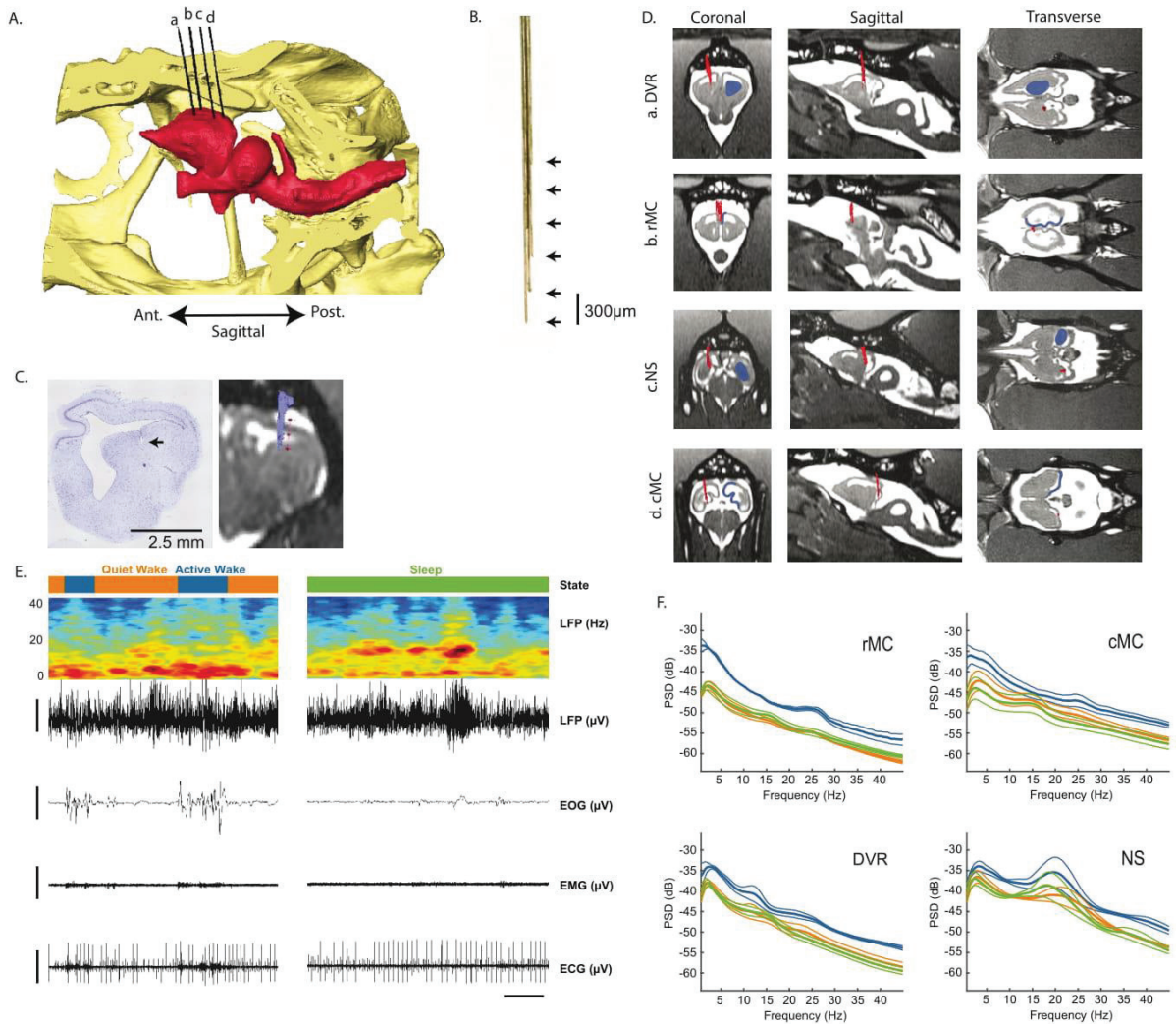

Fig. 3. Electrode placement and raw signals. (A) 3D sagittal reconstruction of a lizard skull (in yellow) and brain (in red) based on *in vivo* pre-surgical MRI and CT scans. Electrode bundles (in black) were reconstructed from post-surgery CT scans. The electrodes a-d are, respectively, in the dorso-ventricular Ridge (DVR), rostral medial cortex (rMC), nucleus sphericus (NS), and caudal medial cortex (cMC). (B) Pictures of one of the bundles composed of six tungsten wires of $35\mu\text{m}$ diameter spaced by $300\mu\text{m}$ vertically. (C) Left and middle: $7\mu\text{m}$ brain slices, labeled with a Nissl stain. Black arrow illustrates the lesions made by the electrodes implanted in the DVR. Right: corresponding electrode bundle reconstruction merged with the MRI. (D) Coronal, sagittal and transverse MRI sections of each region implanted (in blue). The positions of the bundles of electrodes reconstructed from a CT scan and merged with the presurgical MRI are shown in red. (E) Left: top to bottom: hypnogram of a period showing active (in blue) and quiet (in orange) wake states; the time frequency spectrogram representation of a DVR LFP recording (in blue the low power, in red the high power); the DVR LFP raw trace; the electrooculogram (EOG) filtered with a low pass filter at 10Hz; the electromyogram (EMG) filtered with a high pass filter at 10Hz; the electrocardiogram (ECG) filtered with a high pass filter at 10Hz. The horizontal scale bar represents 10 seconds and the vertical scale bars $200\mu\text{V}$. It shows that active wake (AW) is characterized by the predominance of low frequencies in the LFP, the presence of eye movements and an increase in muscle activity and heart rate. During quiet wake (QW) and sleep (S) states, the spectral composition is quite similar. (F) Mean \pm SEM, power spectra across animals, computed for each state (blue, active wake; orange, quiet waking; green, sleep) and each region.

(4) Tegu sleep is composed of two states, differentiated by sharp waves, 15 Hz oscillations, and eye movements

In agreement with the power spectrum analysis, we observed on the raw signal (Fig 4A) as well as on the time/frequency representation (Fig 4B) the phasic occurrence during sleep of oscillations at a frequency of 15Hz. We first selected for each animal the electrode showing the highest power of this 15Hz frequency during sleep using an unsupervised method (Fig S3, S4). We then performed a hierarchical clustering of the sleep signals based on the correlations between each three second window power spectrum for each animal. This revealed the existence of two clusters of sleep (Fig 4C). These two clusters define two electrophysiologically distinct sleep periods; S1 periods not showing any predominant oscillation and S2 periods characterized by the presence of an oscillation around 15 Hz (Fig 4D). Based on the mean power spectra of S1 and S2 computed for each animal, we extracted a power ratio (S2R) to automatically detect the periods with 15 Hz oscillations ($S2R = [10-22\text{Hz}] / ([4-10\text{ Hz}] + [22-28\text{Hz}])$) (Fig 4E). Periods displaying 15 Hz oscillations mostly occurred during sleep ($83.4 \pm 2\%$) although some were observed during QW ($16.4 \pm 2\%$). They were nearly absent during AW ($0.09 \pm 0.05\%$) (Fig 4F). The oscillations had a peak frequency of 15.3 ± 0.03 Hz, lasted on average 4.3 ± 0.1 sec (but some episodes lasted 1 to 32 ± 2.3 sec). They occurred 4.6 ± 0.1 times per minute (2229.6 ± 260 bouts over 24 hours) without a regular periodicity with an average individual variability of 3.4 oscillations per minute ranging between 0.02 and 16. Sleep periods with these oscillations (S2) constituted $17.2 \pm 2.3\%$ of the total sleep time. No change in the power and the frequency of the oscillations was detected across the night. S2 periods occur preferentially at the beginning ($18.9 \pm 0.9\%$) and at the end ($18.4 \pm 2.4\%$) rather than in the middle ($13 \pm 1.7\%$, $P=0.0139$ and $P=0.0287$, respectively) of the night (Fig 4G, 4H). Further, S2 was associated with a lower heart rate ($P=0.0079$, mean value; S1: 28.39 Bpm; S2: 29.15 Bpm, S1-S2: -0.24 Bpm), lower heart rate variability ($P=0.0079$, mean value; S1 2.2 Bpm; S2: 1.79 Bpm; S1-S2: -0.41 Bpm), a small but significant decrease in muscle tone ($P=0.0079$, mean value; S1: $3.92\mu\text{V}$; S2: $3.77\mu\text{V}$, S1-S2: $-0.15\mu\text{V}$), and an increase of the number of eye movements compared to S1 sleep periods ($P=0.0079$, mean value; S1: 9.31min^{-1} ; S2: 13.13min^{-1} ; S1-S2: 3.82min^{-1}) (Fig 4I). Finally, the mean power spectra analysis revealed that the 15 Hz oscillations occurring during S2 were present in all regions except the NS (Fig 4J).

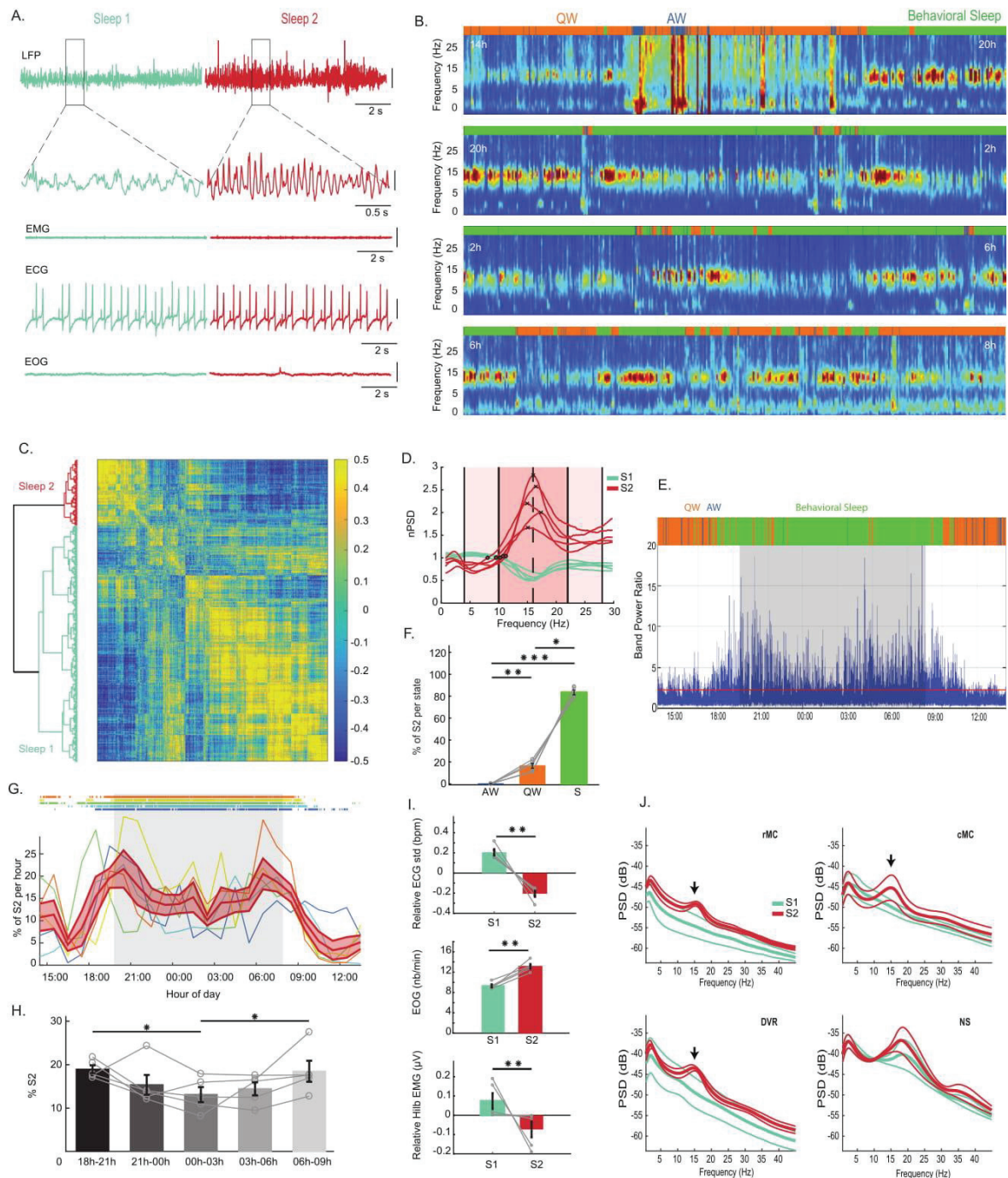

Fig. 4. *Two electrophysiological sleep states exist in the Argentine tegu.* (A) from top to bottom: the first line shows raw LFP data obtained from an electrode located in the DVR during a S1 sleep period in bluish with no preeminent oscillations and a S2 sleep period in red showing 15Hz oscillations. The lines below show an enlargement of the areas indicated by a square. The next lines show the corresponding muscle activity (EMG), heart rate (ECG) and electrooculogram (EOG). The vertical scale bars represent $100\mu\text{V}$. (B) time frequency representation of 24 hours of recording of a whitened LFP DVR split in four 6-hour periods starting at 2pm (in blue the low power, in red the high power). The color bar above each time frequency illustrates the hypnogram obtained with automated scoring (blue for active wake, orange for quiet wake, and green for sleep). The phasic occurrence, mainly during sleep, of periods with oscillations around 15 Hz is clearly visible. In addition, the increase in low frequencies is clearly visible during active wake. (C) Dendrogram (left) and correlation map (right) obtained from the

hierarchical clustering of the distance between the correlation of a LFP three second-window power spectrum, between 9pm and 2am. (D) Mean power spectra of the two clusters computed for each animal, representing the two distinct sleep states identified, Sleep 1 (S1) in bluish and Sleep 2 (S2) in red. The black crosses are the frequency peaks of the mean power spectrum during S2 and the black circles the crossing between the power spectra of S1 and S2. The mean of these values is used to extract the S2 detection ratio, $S2R = [10-22\text{Hz}] / ([4-10\text{Hz}] + [22-28\text{Hz}])$. (E) Computation of the ratio S2R defined in (D) over 24 hours in one animal. The red line is the threshold (the mean + 1 std of S2R) used to detect S2 sleep. (F) Percentage of S2 periods automatically detected during the three vigilance states showing that S2 occurs mostly during behavioral sleep (N=5, S vs. QW $P=0.0201$ S vs. AW, $P=0.0002$, AW vs. QW $P=0.0099$). The grey lines represent the individual values for each animal. (G) Percentage of S2 periods per hour for each animal and the corresponding sleep periods above. In red mean percentage of $S2 \pm \text{SEM}$, across animals per hour during 24h, showing that S2 periods tend to be more numerous at the beginning and at the end of the night than in the middle of it. (H) Histograms per 3 hours showing that S2 periods occur significantly more at the beginning and at the end of the sleep time (from left to right $P=0.0139$, $P=0.0287$, $n=5$). (I) Histograms showing from top to bottom a significant decrease of the heart rate variability ($P=0.0079$, $n=5$); an increase in the number of eye movements ($P=0.0079$, $n=5$), and a small decrease in muscle tone computed as the norm of the Hilbert transform ($P=0.0079$, $n=5$) between S2 (red) and S1 (bluish) for each episode lasting more than two seconds. The heart rate variability and the muscle tone are represented relative to the mean muscle tone between S1 and S2 for each animal. The grey lines show individual values. (J) Mean \pm SEM power spectra across animals for each region during S1 (bluish) and S2 (red) showing that the oscillation around 15 Hz characterizing S2 (arrows) is present in the DVR as well as in the rostral medial cortex (rMC) and its caudal part (cMC). In contrast, the 15 Hz oscillation is not visible in the nucleus sphericus (NS) in which a 20Hz oscillation occurs both during S1 and S2.

(5) High amplitude sharp waves occur specifically during S1 sleep periods

High amplitude sharp waves (HShWs) were observed on LFPs from all structures (Fig 5A). They were extracted automatically from LFP signals using a spike sorter algorithm (Quiroga *et al.*, 2004) (Fig 5B, 5C). The HShWs displayed a mean amplitude of $635 \pm 124 \mu\text{V}$ and lasted less than 50ms (Fig 5C). They were significantly more numerous in the middle of the night between 0am and 3am (1.1 ± 0.2) than during the first (0.5 ± 0.1) and last three hours of sleep (0.54 ± 0.1) ($p < 0.001$) (Fig 5B, 5D). They appeared mostly during S1 periods (72.8%) although some were visible during S2 (14.4%) and QW (5%) (Fig 5E, 5F).

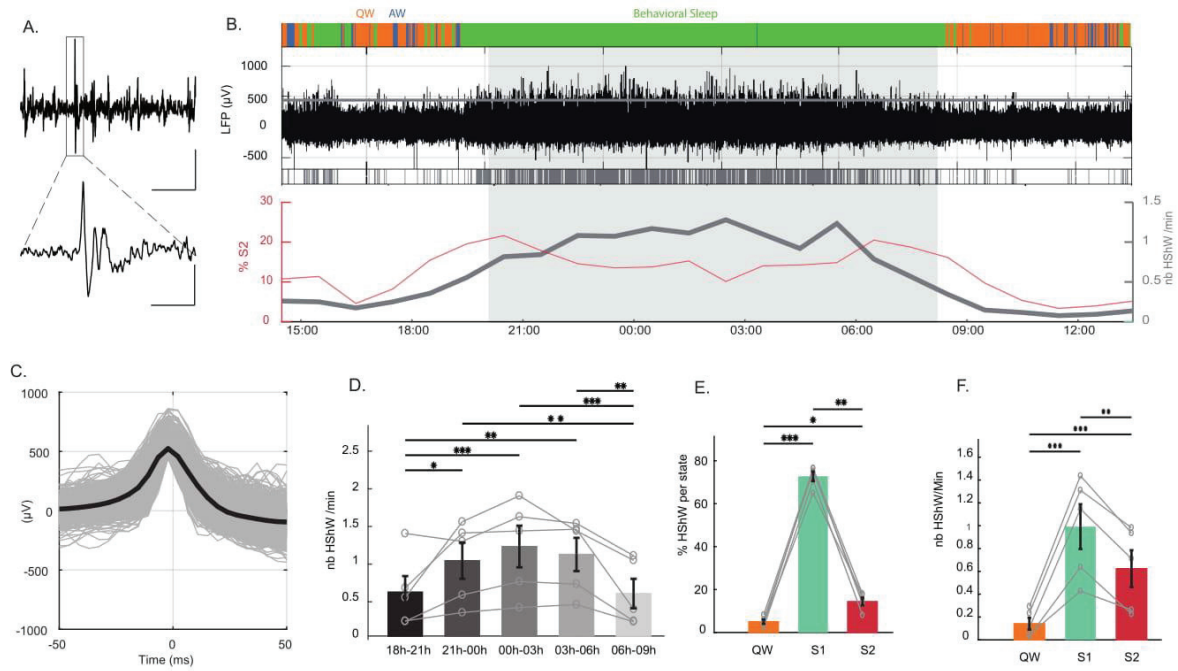

Fig. 5. Sharp waves during sleep. (A) LFP raw trace showing a high amplitude sharp wave (HShW) at low (horizontal scale bar represents 5s) and high magnification (horizontal scale bar represents 0.5s in the square area shown at the bottom) the vertical scale bar represents $400\mu\text{V}$. (B) From top to bottom, hypnogram during 24 hours, raw traces of a DVR LFP. The grey line corresponds to the threshold used to detect the HShWs. Below, a raster plot of the HShWs detected is shown in gray. The number of HShWs per minute (in gray) and the percentage of S2 (in red) are shown. They appear to occur in antiphase. (C) All and mean waveforms of the HShWs detected by the automatic detection. (D) Histograms showing that HShWs occur more in the middle than at the beginning and at the end of the night ($n=5$), from top to bottom $P=0.0026$, $P=0.0006$, $P=0.0087$, $P=0.0034$, $P=0.0007$, $P=0.0112$). The grey lines represent individual values. (E) Histograms showing that HShWs occur mainly during S1 ($n=5$, QW (in orange) vs. S1 (in bluish); $P=0.0002$, QW vs. S2 (in red) $P=0.0139$, S1 vs. S2 $P=0.0088$). (F) Density of HShWs is also higher during S1 ($n=5$, QW vs. S1 $p < 0.0001$, QW vs. S2 $P=0.0008$, S1 vs. S2 $P=0.0047$).

(6) Sleep deprivation and an antidepressant suppressed high amplitude sharp waves and 15Hz oscillations.

To determine whether sleep homeostasis is present in lizards, a 9 hour gentle handling sleep deprivation was performed between 7 pm and 4 am (Fig 6A). During this sleep deprivation the sleep quantities (S1+S2) were reduced significantly by $84.7 \pm 4.8 \%$ compared to baseline conditions (Fig 6A, 6C) ($P=0.0006$ for S1 and $P=0.0012$ for S2). During sleep deprivation, the number of HShWs significantly decreased (Fig 6D, 6E) ($P=0.0216$). After sleep deprivation, a significant increase of sleep (Fig 6B, increase of behavioral sleep: $8.96 \pm 2.18 \%$) occurred during

the following 24 hours compared to the baseline ($P=0.0302$). The recovery of sleep was only significant for S1 (Fig 6B, 6C) ($P=0.0245$). The density of HShWs during sleep, was significantly increased during the 24 hours following the sleep deprivation compared to the baseline condition (Fig 6F, 6G).

We then tested the effect of fluoxetine on the occurrence of the 15Hz oscillation periods defined as S2 and HShWs to determine whether they showed similarities with mammalian REM sleep and hippocampal sharp waves, respectively. Indeed, it has been shown that both REM sleep in mammals and birds (Slater *et al.*, 1978; Gao *et al.*, 1992; Fuchs *et al.*, 2006) and *in vitro* hippocampal sharp waves are inhibited by serotonin reuptake inhibitors (ul Haq *et al.*, 2016). We injected fluoxetine (Fuller, Wong, & Robertson, 1991; Wong, Bymaster, & Engleman, 1995) at two concentrations (10mg/kg and 60mg/kg) and a saline solution as a control (Fig 7). Control injection of saline did not induce any effect on the total percentage of sleep, the number of sleep episodes or their duration compared to baseline ($P>0.05$). The lower concentration of fluoxetine did not affect the total amount of active wake, quiet wake, and S1 (Fig 7A, 7B) ($P>0.05$). Nevertheless, sleep episodes (S1+S2) were interrupted by short awakenings compared to baseline inducing a significant decrease of their mean duration (10mg/kg and 60mg/kg $P=0.0366$ and $P=0.0255$, respectively) and a significant increase in the number of sleep episodes (10mg/kg and 60mg/kg $P=0.0106$ and $P=0.0325$, respectively). Regarding the specific effect on the 15Hz oscillations, their quantities were not significantly decreased with 10mg/Kg of fluoxetine, in contrast to 60mg/Kg strongly suggesting that the state of S2 is dramatically reduced (Fig 7A, 7B) ($P=0.0096$). Regarding the effect on the HShw density (fig 7C, 7D, 7E, 7F), both doses tended to reduced it during the 24 hours after injection but it was only significant for 60mg/kg.

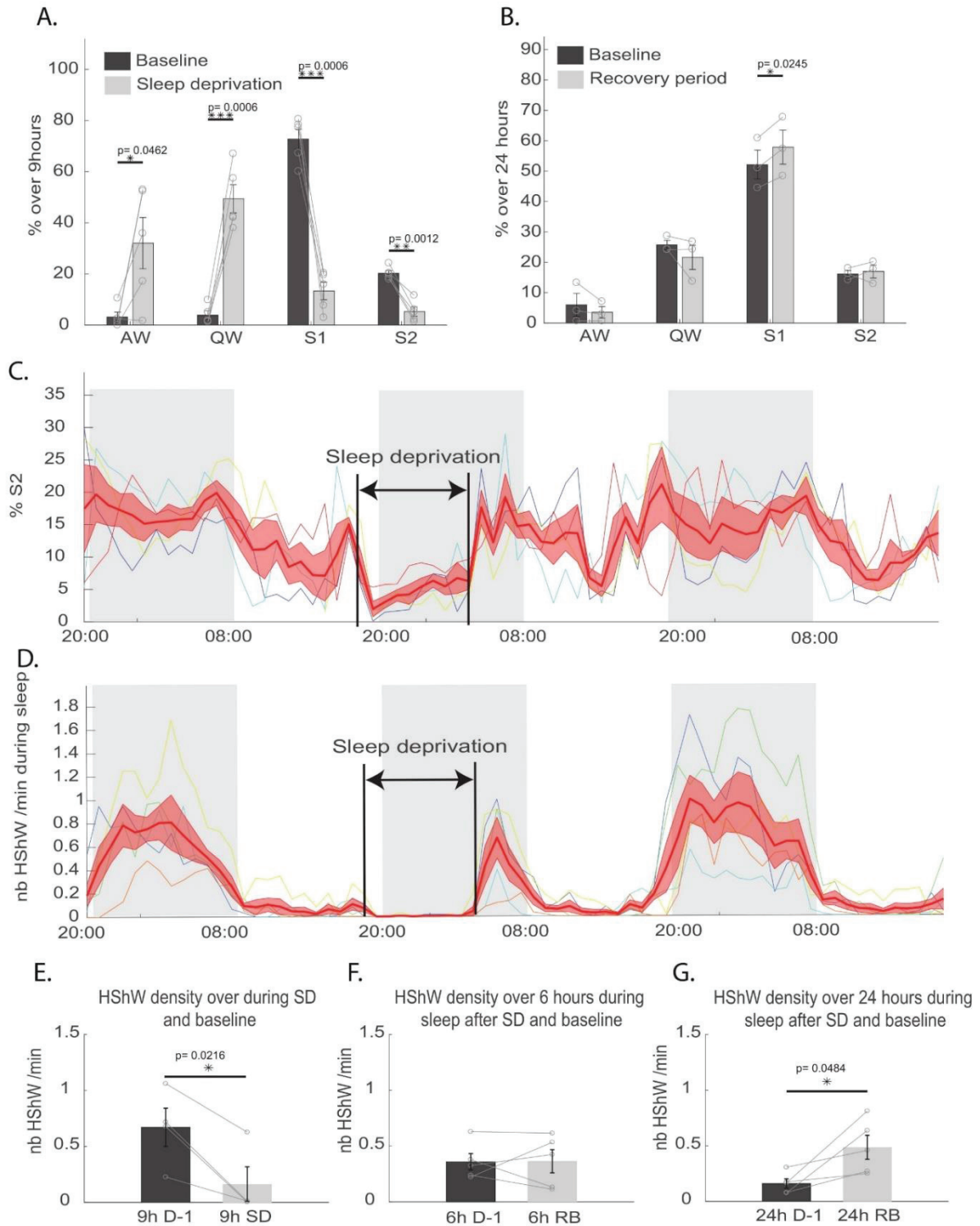

Fig. 6. **Effect of sleep deprivation.** (A) Quantification over 9 hours of baseline (dark grey) and 9 hours of sleep deprivation (light grey) of the percentage occupied by all states, including active wake (AW), quiet wake (QW), sleep state 1 (S1) and sleep state 2 (S2), showing the efficiency of the sleep deprivation. S1 was scored automatically based on the decrease of the eye movement density associated with a low muscle tone, and S2 scored based on the 15Hz oscillations. (B) Quantification over 24 hours of baseline (dark grey) and the 24 hours following the sleep deprivation (light grey) of the percentage occupied by all states, showing the recovery of S1. (C) Representation of the individual (thin colored lines) and mean

+/- sem (large red line) percentage of S2 per hour, from the day before the sleep deprivation to the day after. The thin colored lines are the individual changes in such percentage. (D) Representation of the individual (thin colored lines) and means +/- sem (large red line) of the HShw density per hour, from the day before the sleep deprivation to the day after. (E) Histograms showing a significant reduction in the number of HShWs during sleep deprivation (n=4, P=0.0216), (F) No effect on the HShw density during the 6 hours of sleep following the sleep deprivation was detected, but a significant (G) increase was observed over 24hours after sleep deprivation.

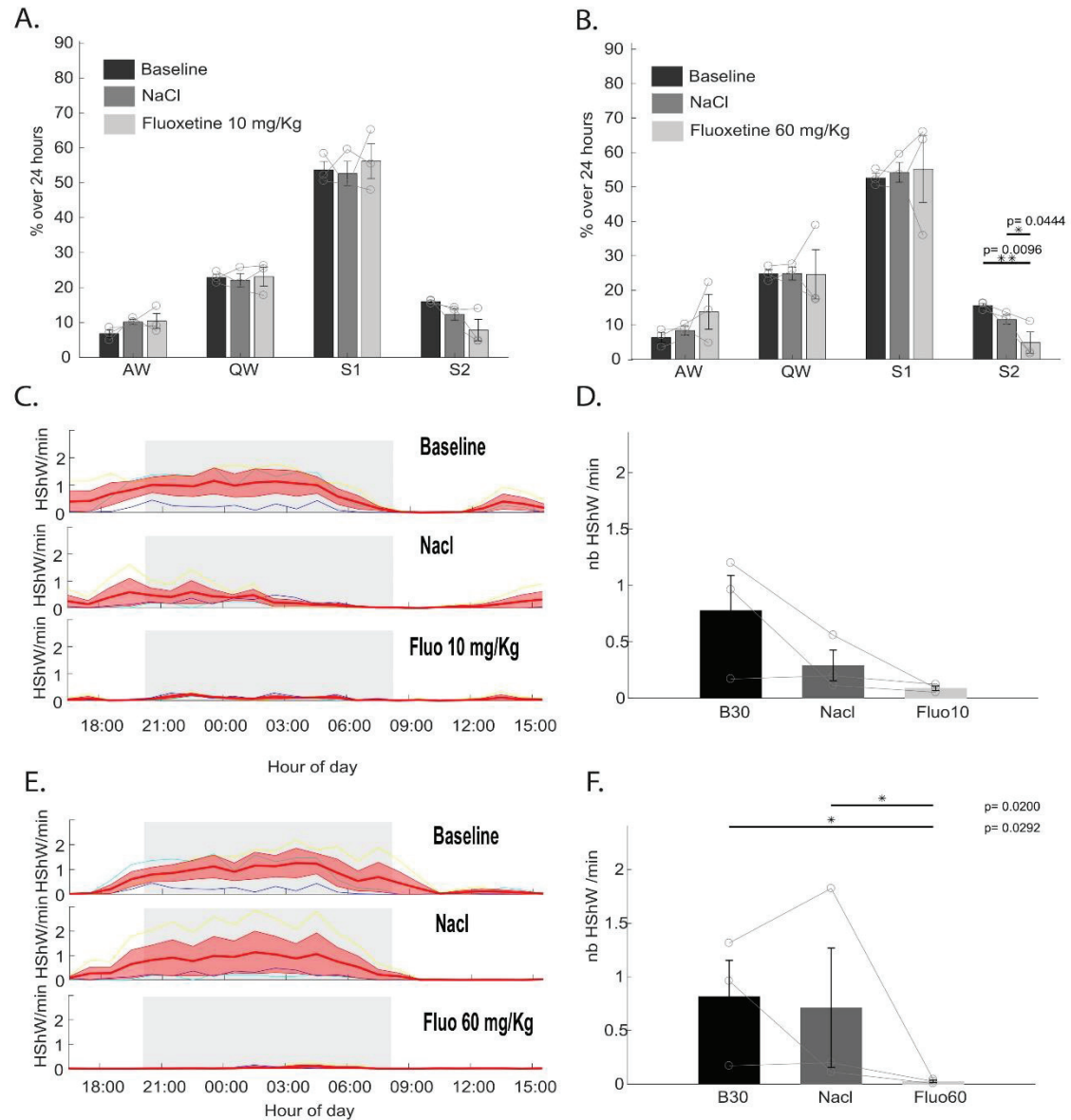

Fig. 7. *Effect of sleep of antidepressants on the tegu sleep.* (A) Quantification over 24 hours of baseline (dark grey), following saline (middle grey), and fluoxetine injections (10mg/Kg) (light grey) of the percentage occupied by all states, including active wake (AW), quiet wake (QW), sleep state 1 (S1) and sleep state 2 (S2). S1 was scored automatically based on the decrease of the eye movement density associated with a low muscle tone, and S2 scored based on the 15Hz oscillations. (B) Quantification over 24 hours of baseline (dark grey), following saline (middle grey), and fluoxetine injections (60mg/Kg)

(light grey) of the percentage occupied by all states. (C) Individual (thin colored lines) and mean \pm sem (large red line) changes of the HShw density per hour during 24 hours of baseline, following saline, and fluoxetine (10mg/Kg) injection. (D) Histograms showing that no significant change occurs between 6pm and 10am in the number of HShWs after injection of NaCl or 10mg/Kg of fluoxetine at 5pm. (E) Individual (thin colored lines) and mean \pm sem (large red line) changes of the HShw density per hour during 24 hours of baseline, following saline, and fluoxetine (60mg/Kg) injection. (F) Histograms showing a significant decrease of the number of HShw after injection of 60mg/Kg of fluoxetine compared to baseline and saline injections between 6pm and 10am.

III. DISCUSSION

In the present paper we confirm the findings of Shein-Idelson et al. on the bearded dragon (Shein-Idelson *et al.*, 2016). Moreover, by coupling multisite LFPs, videos and physiological recordings both under baseline condition and during and after sleep deprivation and fluoxetine injections we were able to demonstrate the existence of two sleep states in the argentine tegu. Further, we provide evidence of similarities between these two states in the tegu and mammalian and avian SWS and REM sleep. However, the phenotype of these two states in the tegu differs strongly to that observed in mammals, birds, and more surprisingly, the bearded dragon.

(1) Sleep in the bearded dragon

(a) Behavioral Sleep

Based on their posture and specific location, previous studies concluded that squamates display behavioral signs of sleep during the night. Yet, only four of these studies measured the arousal threshold (Tauber *et al.*, 1968; Flanigan, 1973; Huntley, 1987; Ayala-Guerrero & Mexicano, 2008b) and only two used sleep deprivation experiments (Flanigan, 1973; Ayala-Guerrero & Mexicano, 2008b). Even if arousal threshold and sleep deprivation were missing for the bearded dragon the animal displayed a stereotypical posture with the head on the floor, the eyes closed, in a specific location of the terrarium. Thus, we suggest that in accordance with Shein-Idelson et al. the animal was sleeping during this period.

(b) Electrophysiological sleep,

In this replication experiment, we confirmed that the bearded dragon displays two electrophysiological patterns corresponding to two sleep states. The first one, rich in δ frequencies, explained by the presence of slow HShWs, was proposed to be homologue of the mammalian slow wave sleep. Indeed, this state is characterized by cortical delta waves and hippocampal sharp waves in mammals. However, whether those slow HShWs are similar to delta

or sharp waves or if those waves reflect a brain mechanism specific to the bearded dragon, remains unknown. Complementary experiments, including cognitive tests, and extracellular as well as intracellular recordings should be conducted. Moreover, describing the memory network of non-avian reptiles, and specifically the implication of the DVR is necessary to understand the role of these waves and to test whether they have the same cognitive role as in mammals. Regarding the second sleep state described by Shein-Idelson et al., the DVR local field potential look like the awake state (Fig 1C) and isolated eye movements are more present during this phase. Based on these two features and the alternation with the SWS like state, Shein-Idelson et al. proposed that this state is homologous to mammalian and avian REM sleep. If the animal is indeed sleeping, then this would be the most parsimonious hypothesis. However, eye movements and a desynchronized brain activity are also present during quiet wake. An arousal threshold evaluation should be conducted to differentiate this putative REM-like sleep state from quiet wake in this species. Nevertheless, the study by Shein-Idelson et al. provides credit to the hypothesis of the existence of a REM-like sleep state in squamates. The alternation between the two sleep states reported for the bearded dragon is also observed in mammals. However, a periodicity with a regularity like the one observed in the bearded dragon was never reported in either mammals or birds, questioning the nature thereof. Moreover, recent reports of artificial cyclical states with the same periodicity under urethane (Clement *et al.*, 2008), or infra slow brain oscillations in the sigma band during mammalian slow wave sleeps suggest that other ultradian cycles could exist in mammals (Lecci *et al.*, 2017), and possibly also squamates. Nevertheless, none of these cycles is associated with an increase in eye movements. Our replication confirms that the bearded dragon has two sleep states alternating with surprising regularity. However, at this point we cannot conclude about the nature and the homology of these states and other species should be investigated to test the generality of these results.

(2) Sleep in the argentine tegu

(a) Behavioral Sleep

Thanks to the evaluation of the behavioral criteria of sleep we show for the first time that the argentine tegu, the only species of the Lacertoidae studied so far, also displays behavioral sleep at night. As the animal spent (in these conditions) more than 90% of its time with its eyes closed and lying on the floor it is difficult to differentiate sleep from quiet wake based on these features. We demonstrate here that behavioral sleep differs from QW by a higher arousal threshold, a decrease in the number of eye movements, and a lower heart rate in addition to the specific

location and posture typically observed. We also observed eye movements and occasionally small movements of the toes and the head. More often, large movements or repositioning of the animal during behavioral sleep was also observed in the tegu, as reported for other lizards (Libourel & Herrel, 2016). This would suggest that a state similar to REM sleep could be present in lizards. However the nature of REM sleep could not be strictly identified from eye and other movements as arousal also shows these features (Halasz *et al.*, 2004).

(b) Does S1 sleep correspond to SWS?

Using our unsupervised, integrative and multi-parameter approach we were able to distinguish two sleep states in the tegu during behavioral sleep. S1 was characterized electrophysiologically by the absence of 15Hz oscillations during behavioral sleep. In addition, numerous isolated high amplitude sharp waves (HShWs) occur at a rate of 1 per minute in all structures recorded. The presence in the EEG of isolated sharp waves specifically during sleep has been already reported in other lizards (Flanigan, 1973; Ayala-Guerrero & Vargas Reyna, 1987; Ayala-Guerrero & Mexicano, 2008b). Isolated sharp waves have been also recorded during sleep in turtles and crocodiles (for review see (Libourel & Herrel, 2016)). Because of their morphology and their presence during sleep it has been suggested that those waves could be similar to the mammalian hippocampal Sharp wave ripples (hSWP-R, duration between 40-100ms, amplitude that can exceed 2.5mV and a variable occurrence of 1 to 60 per minute (Buzsáki, 2015)). hSWP-Rs are generated by a burst of activity in CA3 inducing a large depolarization in CA1 stratum radiatum associated with a fast oscillation in the CA1 pyramidal layer (Buzsáki, 2015). Their role in the mammalian memory consolidation processes is well described (Girardeau *et al.*, 2009; Buzsáki, 2015). Therefore, their existence in a reptilian brain during sleep would have important consequences regarding the function of sleep in these animals. However, the shape of the HShWs is also consistent with cortical slow waves. In the tegu, as well as in the bearded dragon, HShWs were reported during behavioral sleep, just like hippocampal sharp waves and cortical slow waves in mammals. Regarding their morphology, the tegu and turtle HShWs show a similar duration, shorter than 50ms, with an amplitude between 0.2 and 1 mV and an occurrence of 1/min, similar to the mammalian hippocampal sharp waves. Interestingly, in contrast to the data reported in other lizards and non-avian reptiles, the bearded dragon showed slow HShWs occurring at a high rate of 60-120 per min (0.5-1 Hz) with a half width of 100 to 400 ms morphologically rather similar to mammalian slow waves. Moreover, the localization of the tegu HShWs also questions their true nature. Indeed, mammalian hippocampal sharp waves are recorded in the mammalian

hippocampus, subiculum, and entorhinal cortex (Buzsáki, 2015) and were not reported in birds (for review see (Rattenborg *et al.*, 2011)). In contrast, slow waves have been recorded in most cortical regions in mammals (Massimini *et al.*, 2004; Chauvette *et al.*, 2011) and birds, as well as in the avian DVR during anesthesia (Beckers *et al.*, 2014). As HShWs were observed in all recorded regions in the tegu forebrain this could suggest that reptilian HShWs could be a precursor form of avian and mammalian slow waves. This hypothesis is also supported by a recent report of HShWs in the crocodilian DVR under anesthesia (Tisdale *et al.*, 2018). In reptiles, pharmacological experiments have been also conducted. In the 70's, injections of atropine sulfate, amphetamine, nembutal, alpha-methyl-tyrosine, and parachlorophenylalanine, drugs known to modify the quantity of ventral hippocampal sharp waves in the cat, were shown to induce the same effects on turtle sharp waves (*Geochelone carbonaria*) (Hartse & Rechtschaffen, 1974, 1982). This let the authors suggest that reptilian HShWs could be similar to mammalian sharp waves. However, some of the drugs that suppress mammalian hippocampal sharp waves also suppress cortical slow-waves. In the argentine tegu we demonstrated that the HShWs tend to disappear after fluoxetine injection. However, in mammals, little is known on the effect of serotonin on hippocampal ShWs. To our knowledge only one paper reported that serotonin block, *in vitro*, rodent hippocampal Sharp waves (ul Haq *et al.*, 2016).

As a conclusion, since the precise mechanism of the generation of HSWs has not been identified, their definition relies on a rather vague description based on their shape, state of occurrence, occurrence rate, and pharmacological responsiveness. Unfortunately, these properties do not allow us to differentiate between hSWP-Rs and slow waves, or another type of waves specific to lizards. However, as both hippocampal sharp waves and cortical slow waves are present during slow wave sleep in mammals this would suggest that S1 in the tegu is likely homologous to mammalian and avian slow wave sleep. Moreover, after fluoxetine injection the HShWs disappear (Fig 7), but the automated sleep scoring algorithm (fig 7A, 7B) suggests that the animal is able to sleep without these waves. This is further suggested by the typical sleep posture taken up by the animal inside its shelter. This suggests that the HShWs are only one feature of the complex phenotype sleep in reptiles. Moreover, these waves by themselves are not sufficient to characterize this sleep state in reptiles.

(c) Does S2 sleep correspond to REM sleep?

Based on the presence of active periods during sleep, the existence of REM sleep has been suggested in six of the seven previous studies on lizards. They mostly observed limb and eye

movements associated with an EEG with an awake-like activity. In the tegu, we reported a state (S2) which shares partial similarities with mammalian and avian REM sleep. It is electrophysiologically characterized by the presence of oscillations with a 15Hz frequency present in nearly all structures recorded during behavioral sleep. To our knowledge, such a type of oscillation has never been reported before during sleep in any lizard species. We demonstrated that S2 episodes preferentially appear at the beginning and at the end of the sleep period and lasted 4.3 seconds on average. The 2229.6 ± 261 episodes constituted $17.2 \pm 2.3\%$ of the total sleep time. Because some S2 episodes lasted more than 20s, it is unlikely that the oscillations correspond to sleep spindles, an oscillation appearing during NREM sleep in mammals in the same range of frequencies (between 10 and 18 Hz) and lasting between 0.4 and 1 second (Berger, 1929; De Gennaro & Ferrara, 2003). In addition, we observed that a higher density of eye movements and a decrease in muscle tone occurred during S2 compared to S1. We also showed that the 15Hz oscillations but not behavioral sleep was suppressed after the injection of fluoxetine, a specific serotonin reuptake inhibitor (Fig 7). This suggests that S2 was suppressed after 60mg/Kg of Fluoxetine injection, although we cannot exclude that the drugs may have suppressed the oscillations but not the state. Against such hypothesis, we were not able to identify periods after fluoxetine injection displaying an increase of eye movements and a decrease of muscle tone as seen during S2. In addition, no significant changes were observed when comparing the muscle tone and the eye movement density during behavioral sleep (S1+ S2) in the different conditions (EOG density during Baseline vs. Saline vs. Fluoxetine 60mg/Kg, $P=0.6115$; muscle tone $P=0.416$). Yet, even if the serotonin distribution in the brainstem is similar in lizards compared to mammals (Wolters *et al.*, 1985) and despite the fact that some studies on lizards have suggested a similar effect of fluoxetine on aggression (Deckel, 1996), it remains unknown whether S2 state shares the same neuronal substrate with mammalian REM Sleep. Importantly, the duration and regular occurrence of REM sleep reported in the bearded dragon does not match that seen for S2 in the tegu, nor that previously reported in birds and mammals. Indeed, in the tegu, the duration and temporal distribution of S2 is quite similar to that seen for REM sleep in most birds which display a short mean duration of episodes of 5 to 10 seconds, and a percentage of around 10% of total sleep time (Roth *et al.*, 2006). Another important feature of bird and mammalian REM sleep is the presence of ocular saccades. As reported here in the tegu from EOG recordings and in the bearded dragon based on unilateral video monitoring, more eye movements also occur specifically during the postulated REM sleep episodes. However, in both cases, the eye movements were isolated (Shein-Idelson *et al.*, 2016)

and often unilateral in the tegu, in contrast to the rapid eye movements recorded in mammals which occurs in bursts (Vertes, 1984), illustrating that the phenotype of S2 is different from that of REM sleep in mammals and birds.

Altogether, our results for the tegu and those obtained for the bearded dragon suggest that two different sleep states with partial similarities to REM and NREM sleep exist in two different species of lizard, even if an arousal threshold evaluation would be necessary in both species to clearly differentiate S2 from quiet wake. Yet the short duration of the REM-like sleep state in the tegu renders this extremely difficult from a practical point of view. However, these two states display a very different temporal distribution and type of oscillations in the two species. It therefore raises the question whether one or the other is the exception among lizards. The recording of additional lizard species is required to answer this question. Further, additional experiments are necessary to determine whether the structures generating REM-like sleep episodes in the bearded dragon and the tegu are the same as those generating REM sleep in birds and mammals. Moreover, the constant temperature used does not reflect the natural temperature fluctuations experienced by these animals and therefore constitutes a limitation of this study. Finally, we observed rare small and isolated twitches, or motor automatisms in the tegu during the night but without a strict association with the S2 state. It might be that these muscle twitches occur during short periods of awakening or that in tegu twitches are not associated to a specific sleep state. Another possibility is that they occur specifically during S2 only in young animals as it has been shown that they are more numerous during this stage in mammals (Roffwarg *et al.*, 1966; Jouvet-Mounier *et al.*, 1969). In agreement with this hypothesis, more muscle twitches have been observed in juvenile lizards and even *in ovo* (Corner, 1977). To summarize, the two species of lizards recorded displayed two sleep states sharing some similarity with mammalian and avian REM and NREM, but diverged notably regarding the presence of twitches, the speed and number of the eye movements, and the absence of a wake-like EEG for the tegu compared to mammalian REM sleep.

(d) Implications for the origin of the sleep states

Our results demonstrate the existence of two different sleep states in the tegu and the bearded dragon, sharing features with mammalian and bird REM and NREM sleep. The existence of a REM-like sleep state in a lizard suggests that homeothermic animals are not the only ones to show two sleep states. However, even if some non-avian reptiles display two sleep states, the ancestral or convergent origin of these states remains unclear. In fact, too few studies

have been conducted in non-avian reptiles to fully conclude that a REM-like sleep state did not appear convergently. Moreover, around 75% of the studies on turtles and almost all of the studies on crocodiles (both groups being closely related to birds) did not report two sleep states. Whether the two sleep states originated at the base of the amniote tree or before also remains to be determined by means of new studies of sleep in other non-avian reptiles as well as amphibians and fish. Deciphering the origin of the two sleep states is complicated, and the “further” we move away from mammals, and the “classical definition” of sleep, the more difficult it will be to identify homologies. More than providing additional evidence for a reptilian REM-like sleep state, our results reveal the true diversity in sleep phenotypes, a diversity that should be explored through integrated and complementary approaches, without an underlying biased definition based on mammalian studies. Indeed, even in mammals and birds experiments on basal species show that those states could be mixed (Siegel *et al.*, 1999; Lesku *et al.*, 2011). Maybe the question should not be if non-avian reptiles show REM sleep and slow wave sleep, but how do these states appear and evolved along the different branches of the amniote tree.

IV. SUPPLEMENTARY INFORMATION

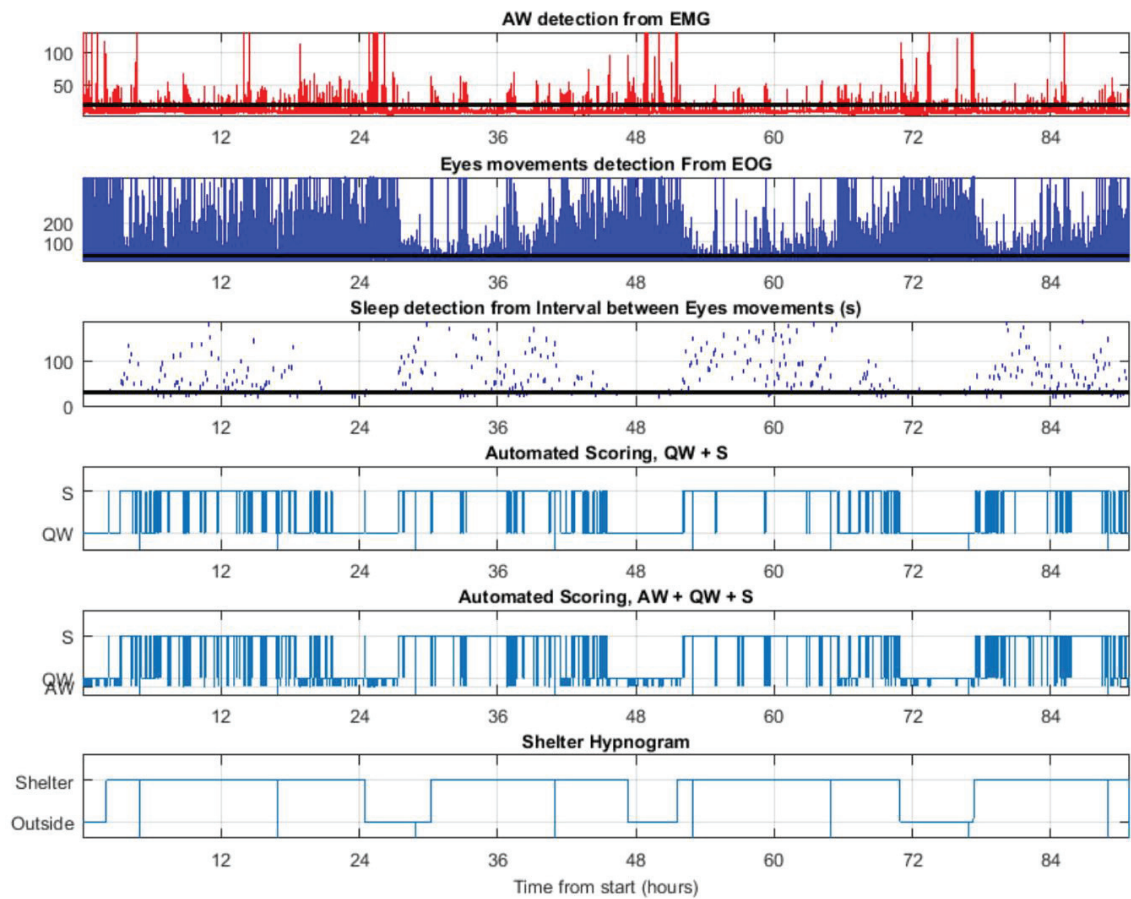
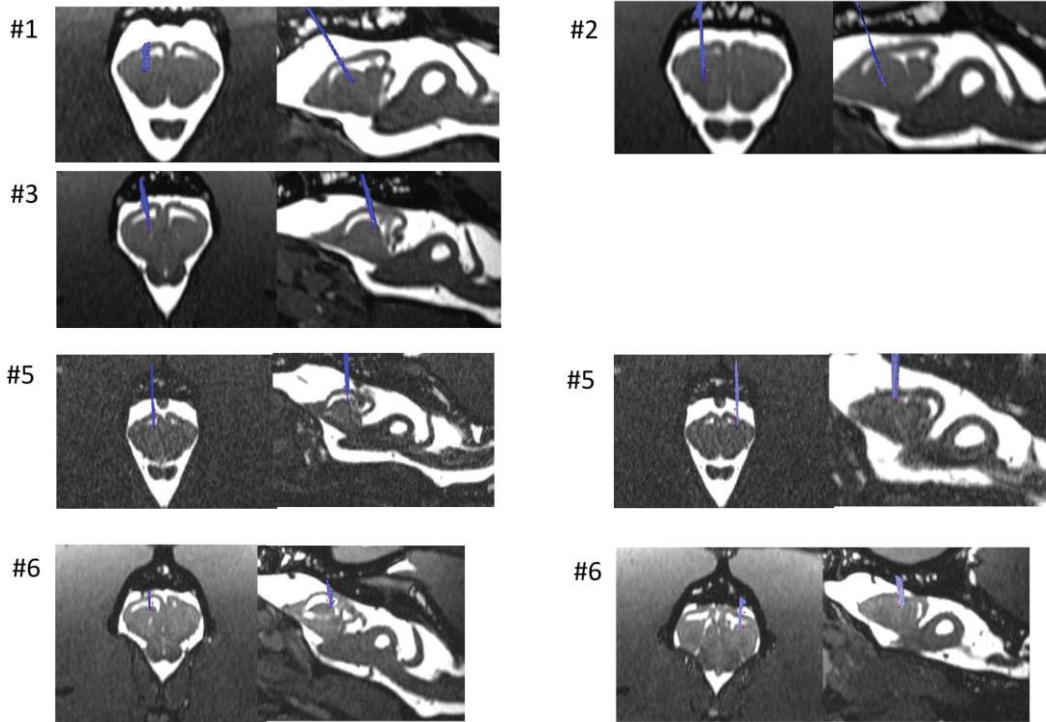
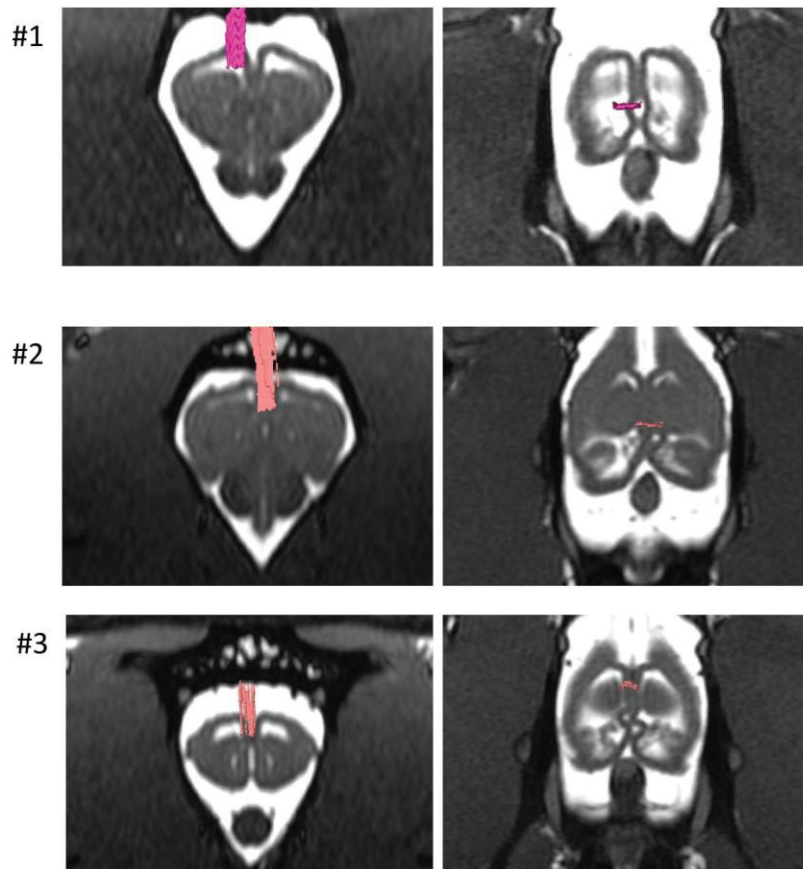

Fig S1. Automated scoring over 24h in animal #1. The figure represents 4 days of automated scoring. From top to the bottom: the absolute EMG value in red and the threshold (black line) used for detecting active wake (AW) bouts; the maximal amplitude of eye movement for a 1sec window and the threshold used (in black) for detecting eye movements; the interval between eye movement and the threshold (in black) used to score quiet wake (QW) and sleep (S) periods; the hypnogram obtained from the automated scoring with QW and S; the final automated hypnogram including the three states; a manual hypnogram representing the position of the animal, outside or inside the shelter.

Dorso Ventricular Ridge + Dorsal Cortex



Medial Cortex



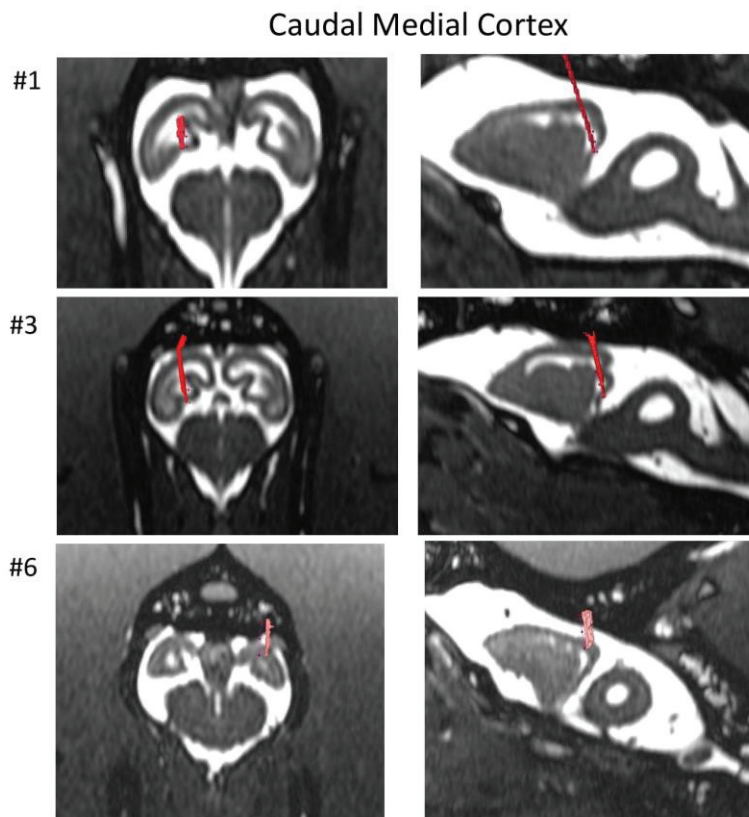
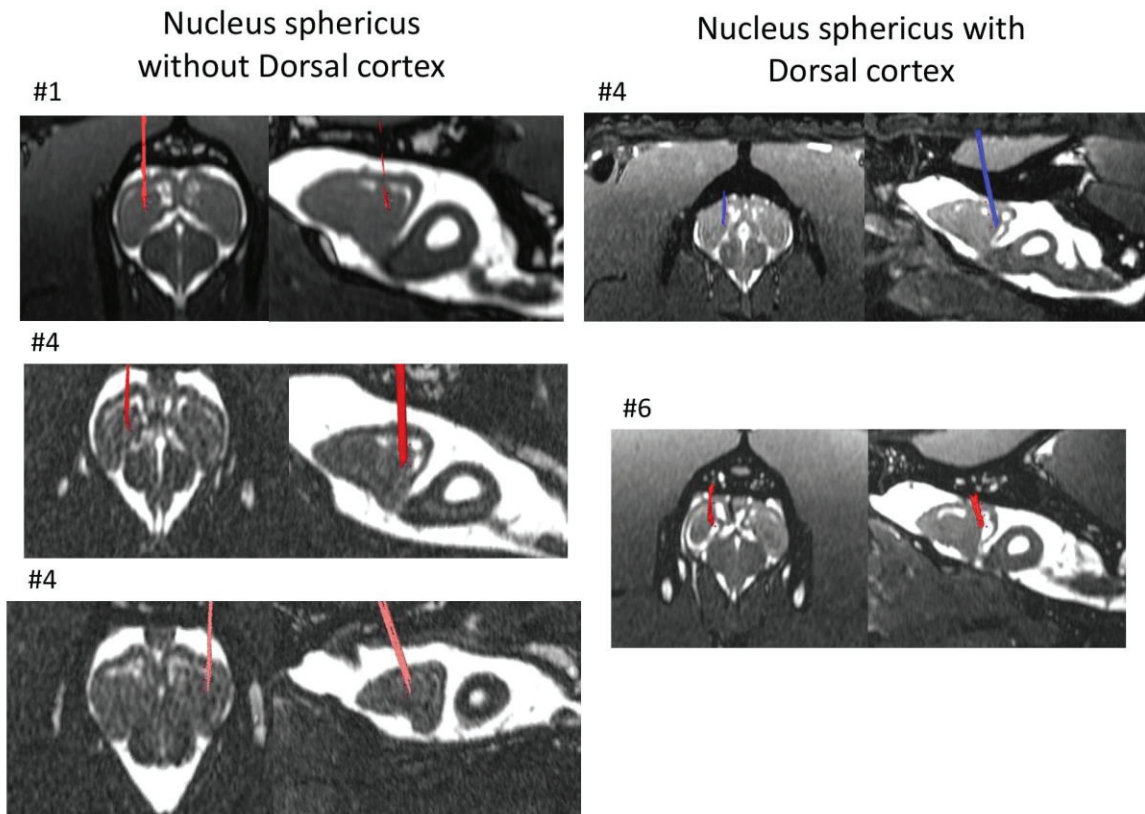

Fig S2. Electrode position from MRI and CT scan. Frontal, sagittal, and horizontal slices of pre-surgical MRI, merged with electrode segmented from a CT scan obtained after surgery for each brain region in each animal.

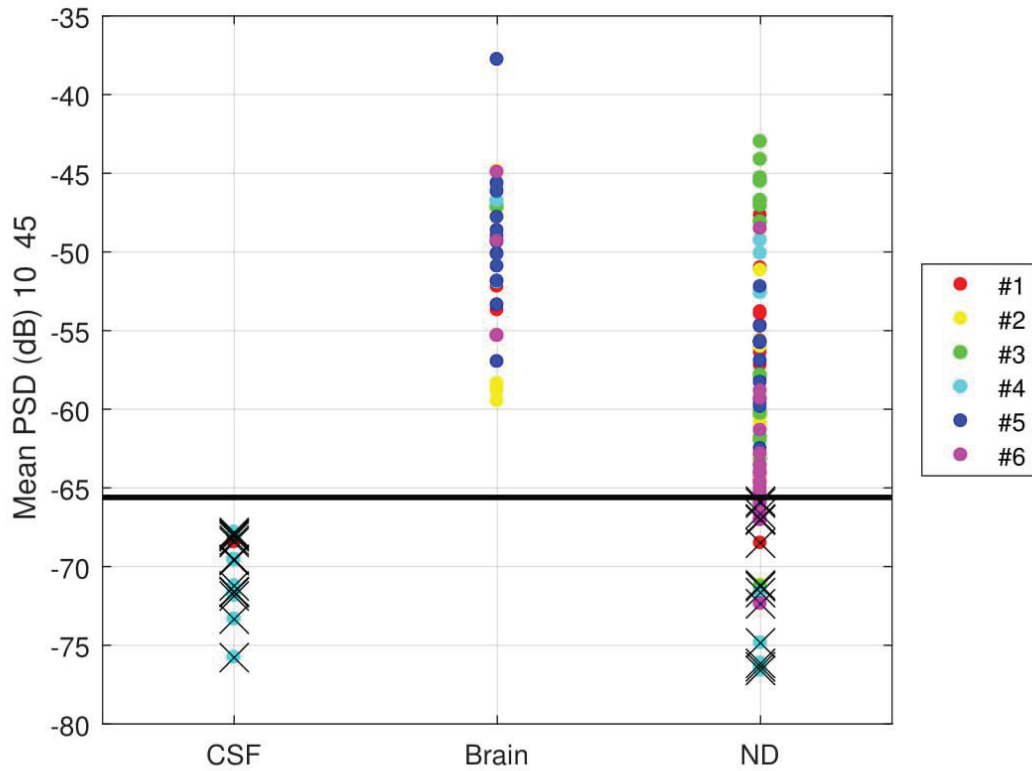
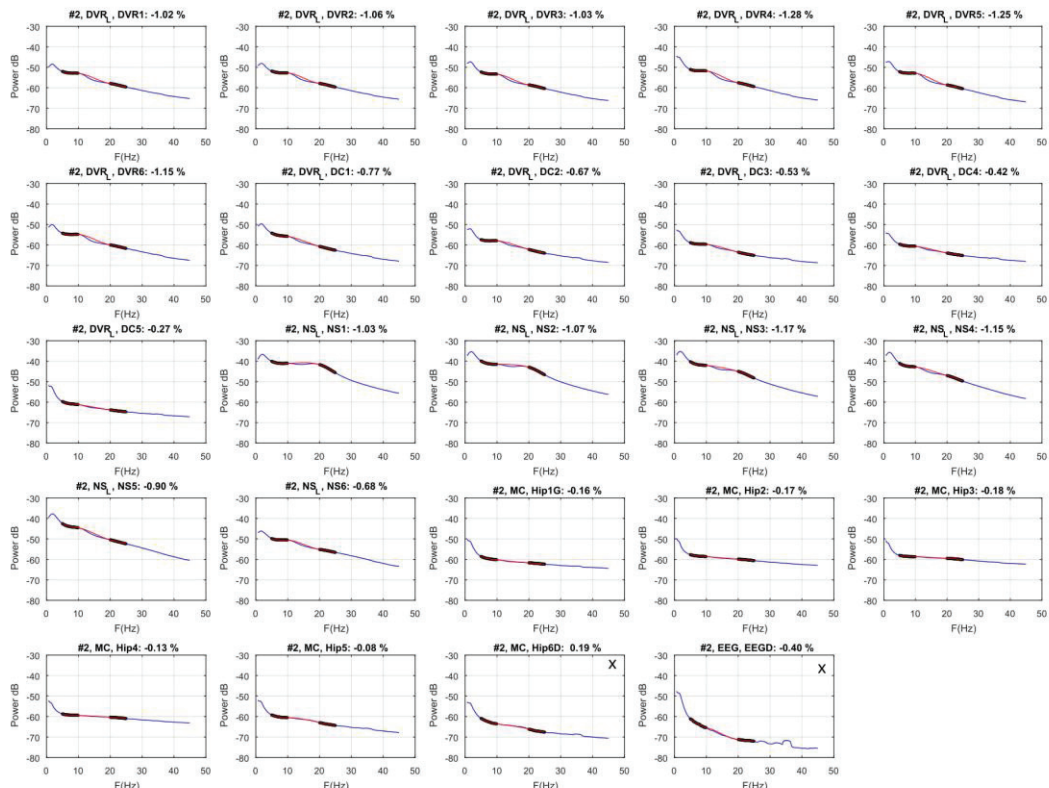
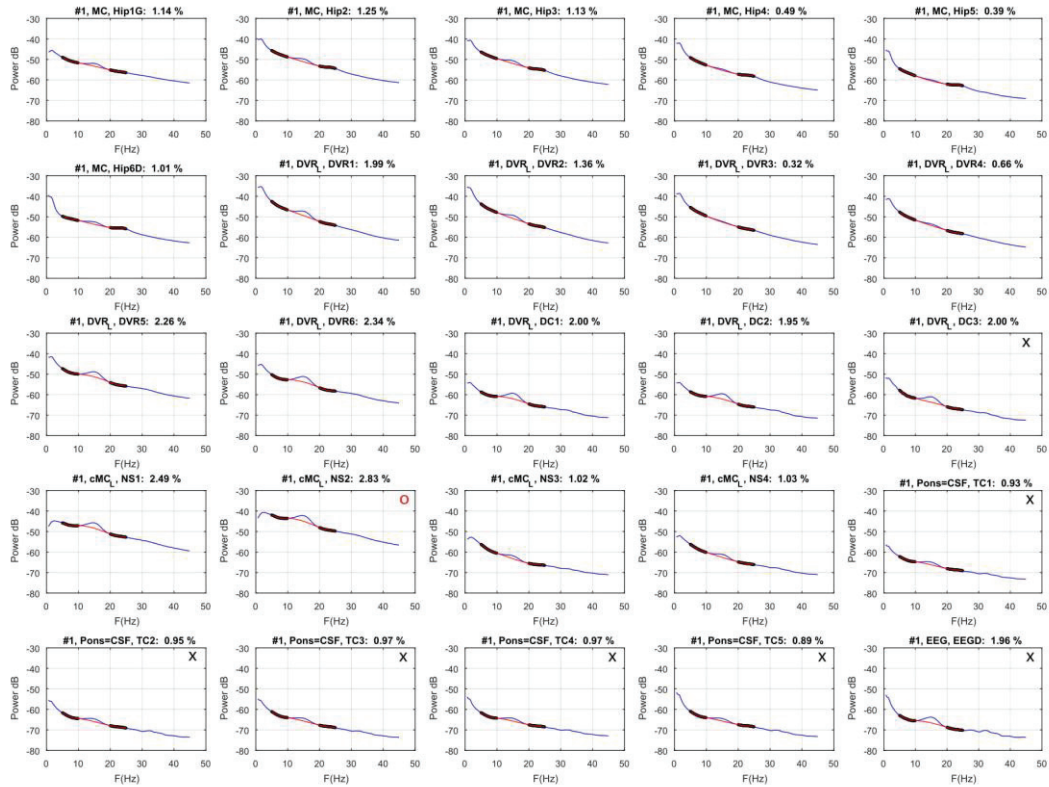
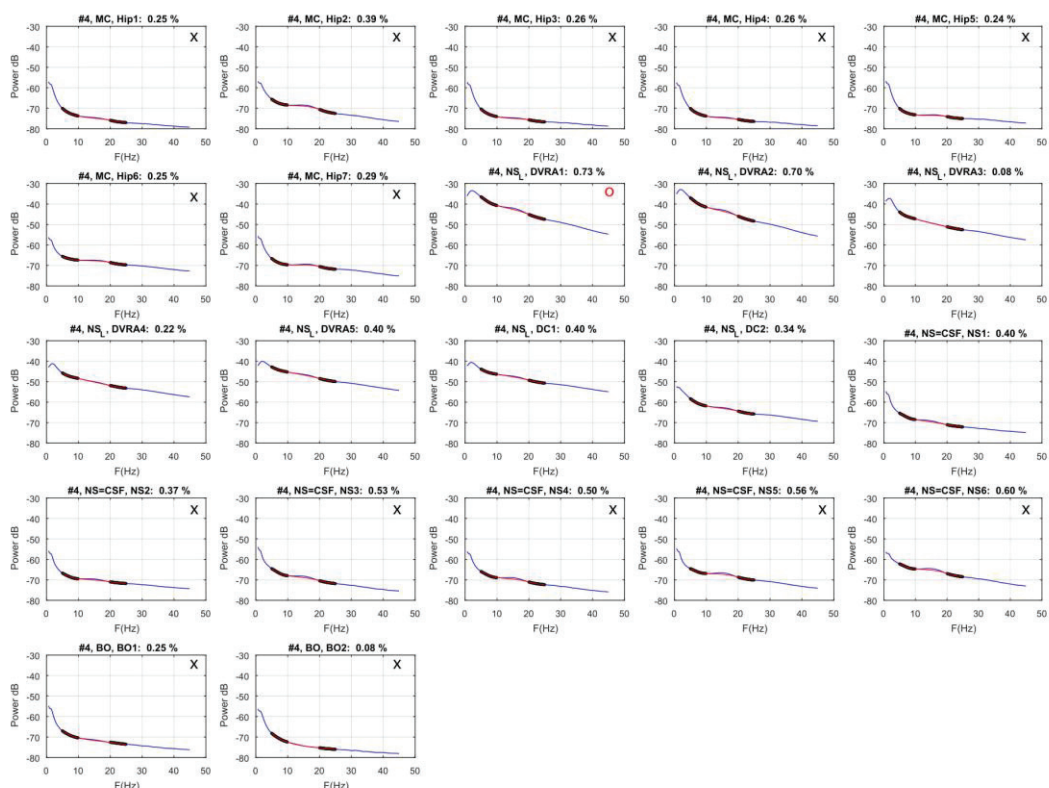
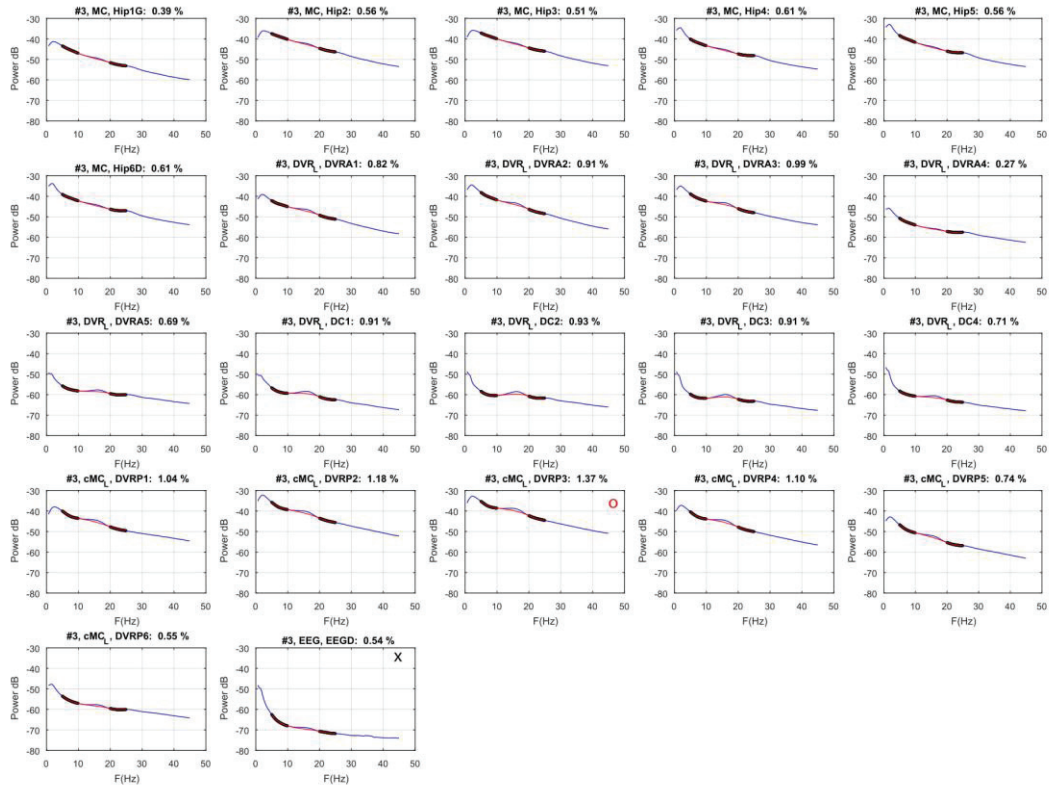

Fig S3. Electrode sorting. Representation of the mean power spectral density between 10 and 45Hz for all electrodes of all animals. On the left the electrodes that were identified from the MRI and CT scan as being into the cerebral spinal fluid (CSF). In the middle, the electrodes that are in the brain and at the right the electrodes with an undetermined position (ND). The black line represents the average plus one standard deviation of the power spectral density from the electrodes located in CSF. All electrodes with a cross are considered as not being in the brain and therefore were not considered for further processing.





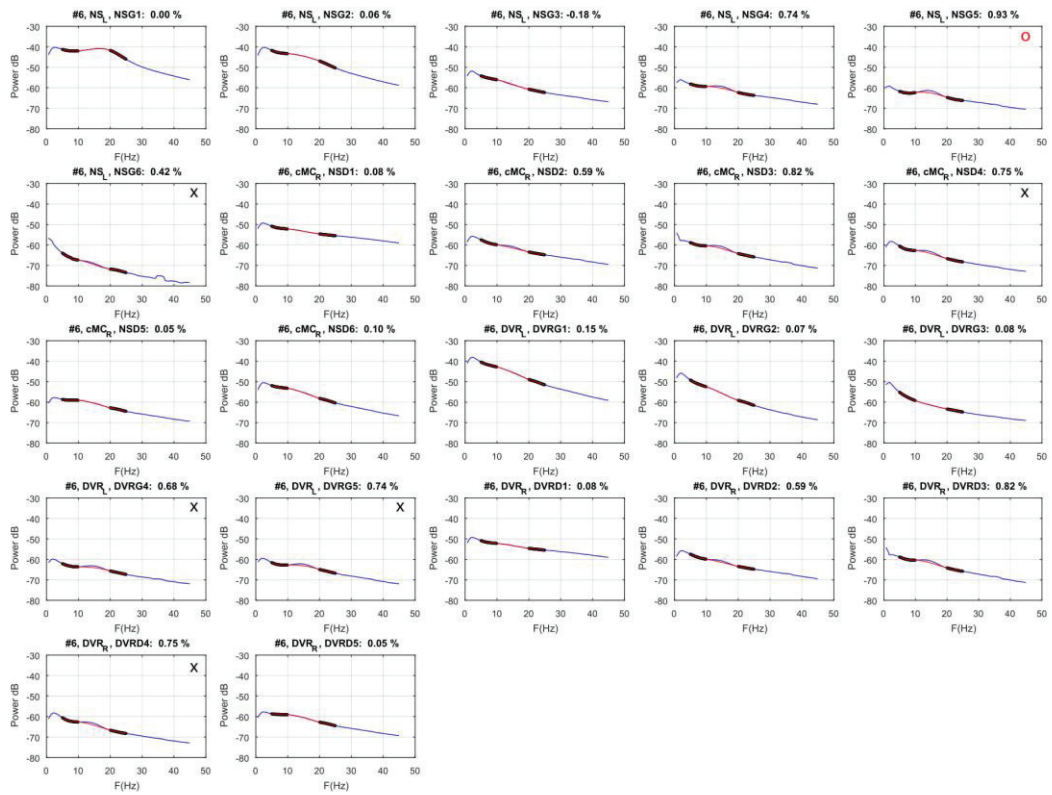
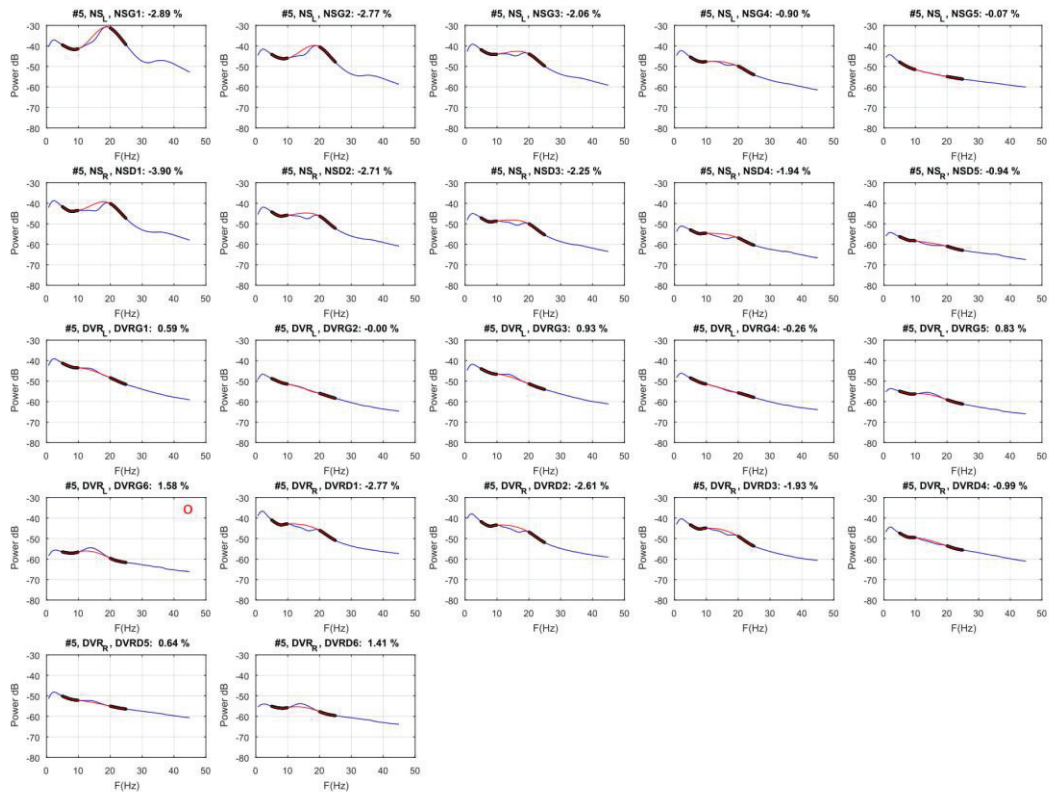

Fig S4. Electrode choice for S2 calculation. Mean power spectrum during sleep for all electrodes (in blue) for all animals. In black, the values kept for the interpolation (red). A ratio that characterized the quantity of oscillation in the 10–20Hz is calculated for each electrode. To do so, the percentage of increase of the mean power spectrum between 10–20Hz is computed compared to the interpolated curve. The title for each axis contains the animal number, the region recorded (based on the MRI and CT scan), the electrode name and the ratio obtained. All electrodes considered as into the cerebral spinal fluid are labeled at the upper right corner of the axis by a cross, whereas a red circle represent the electrodes with the higher ratio, chosen for the analysis of S2.

	Correct	Sensitivity	Specificity
#1	0.730	0.989	0.704
#2	0.911	0.777	0.965
#3	0.868	0.974	0.837
#4	0.924	0.947	0.919
#5	0.915	0.869	0.941
#6	0.890	0.911	0.883
Mean	0.873	0.911	0.875

Table S1: Efficiency of the automated scoring

The table presents the mean and individual efficiency of the automatic scoring. The correct rate, the sensitivity and the sensibility to score correctly sleep is presented. The sleep epochs of the automated hypnogram are compared with the epochs scored “shelter” of the manual hypnogram.

PART IV : GENERAL CONCLUSIONS AND PERSPECTIVES

I. CONCLUSIONS

- (1) What are SWS and REM sleep? Limitations of the use of a mammalian definition in a comparative context.

From a behavioral point of view, it is currently accepted that sleep could be defined by a reversible sustained immobility, a stereotypic posture, and a high arousal threshold. In addition to these points, sleep is also homeostatically regulated (Piéron, 1913; Campbell & Tobler, 1984). Based on that definition, it is highly probable that all animals sleep, including the most basal ones like worms and jellyfishes (Raizen *et al.*, 2008; Siegel, 2008; Nath *et al.*, 2017). Our preliminary phylogenetical analysis done on amphibians and non-avian reptiles in the first chapter, also support this hypothesis. Indeed the behavioral features of sleep analysed (arousal threshold and homeostasis after sleep deprivation), showed a high likelihood to be ancestral for all the tetrapods. However, regarding the presence of SWS and REM sleep, things become more complicated. Indeed, Slow wave sleep takes its name from the high amplitude slow waves present in the cortical EEG during this state. In mammals, these oscillations are generated by an alternance between Up (intense synaptic activity) and Down (silent) states in the cortico-thalamic network (Steriade, 1993). However, what about species with a different cortical organization, like birds with their non-laminar pallium (Rattenborg, 2006a), non-avian reptiles with their three-layer cortex or amphibians without a cortical organization (Northcutt, 1981, 2002). Should we expect to have the same EEG signature if the neuronal substrate is not the same? Birds do have slow waves, but we still do not know if these waves are generated by the same mechanisms and share the same function in birds and mammals (Rattenborg, 2006a). Then, in the first chapter we highlights multiple methodological limitations (different ambient temperatures, electrodes types, recorded brain regions ...) rendering difficult to interpret the reptilian and amphibian's literature. Nevertheless, even with these limitations, it's remain very probable that amphibians and reptiles do not show the same slow waves pattern in surface EEG during behavioral sleep than mammals and birds (see chapter1); therefore, we certainly cannot identify this state based

on this feature in these species. In mammals, the other name of this state is non-REM sleep, in opposition to REM sleep characterized by periods with rapid eye movements. In the first chapter, we showed that mainly all non-avian reptiles recorded with EOG displayed isolated eye movements during behavioral sleep. This could help us to identify two sleep states and indeed and this parameter or criterion was often used by researchers to postulate that non-avian reptiles have REM sleep. However, REM sleep is also characterized, by a wake-like cortical activity. Then, this raises the question: how to differentiate REM sleep from quiet wake? Another possibility could be to record EMG. In mammals, muscular atonia is one of the major features that helps investigators to score REM sleep. Moreover, this feature is thought by some researchers to be essential to prevent movements during the intense cortical activity observed during this state. But, muscle tone participates to the maintenance of a high body temperature in mammals and birds. In addition, the innervation as well as the muscle composition, could differ in vertebrates (Burgos Bretones *et al.*, 1987; Luna, Daikoku, & Ono, 2015). Therefore, if there is no clear atonia in non-avian reptile reported during sleep (see Chapter1), this will not demonstrate that there is no REM sleep like state. In fact, these animals could be always atonic because of their thermoregulation strategy and a different muscular anatomy. Consequently, muscle atonia would not be also a major criterion to identify a putative REM sleep in poikilotherms species. Finally, since the discovery of two sleep states in mammals, there were several attempts, mainly in the 70's, to try to identify these two states in non-avian reptiles and amphibians (see chapter 1). However, none of these studies that reported a REM sleep like state, were given enough information to differentiate the putative REM sleep to a quiet wake or short awakening. And finally, maybe the question: "do SWS and REM sleep exist in those species?" is not the right one. Maybe the question should be: "how do these animals sleep?". I strongly believe that evolution has "selected for" and conserved these two sleep states in mammals for a purpose. However, I do not know why the proposed functions in mammals (memory consolidation, synaptic plasticity, brain development, cleaning the brain, reinforcing the immune system ...) would not have been useful for at least non-avian reptiles. Therefore, if the function of sleep is shared by all the amniotes, maybe the epiphenomena related to sleep states are simply different in poikilothermic species due to their different anatomy and physiology. If so, the only way to progress would be to develop a multi-parametric approach.

(2) Necessity to develop complementary approaches

Sleep is a more complex state than a simple inactivity. Sleep has a behavioral definition that could be assessed by video monitoring, and/or accelerometry (Rattenborg *et al.*, 2017). The arousal threshold and the homeostatic regulation could be evaluated only by the use of a stimulus to either prevent sleep (Borbély & Neuhaus, 1979; Rechtschaffen *et al.*, 1989) or to evaluate the “sleep depth” (Bonnet & Johnson, 1978). In addition, the two mammalian sleep states were identified/characterized based on electrophysiological and physiological parameters, including EEG, EOG, EMG, ECG, body and brain temperature, as well as deep brain recordings. Therefore, in a comparative context most of the parameters that covary with behavioral sleep and sleep states should be recorded. However, classically, in most species studied for comparative purposes, only EEG and EMG have been recorded. This could be explained by the limited number of parameters that could be evaluated by the classical recording devices, or at least by the difficulty to record all these parameters at the same time. Moreover, animals were often recorded in lab conditions with a tethered device, limiting their movements, their space, and their access to a shelter (Aulsebrook *et al.*, 2016; Rattenborg *et al.*, 2017). In order to overcome most of these limitations, we developed ONEIROS, a miniature standalone device designed to record classical sleep parameters (see chapter 2). This system was tested for baseline recording in rats, pigeons, and lizards using both wireless recordings and dataloggers. The results show that the device could also be used into the wild. Arousal threshold as well as selective PS deprivation was also possible thanks to ONEIROS. Because of the multiple parameters recorded, this tool opens new opportunities to conduct comparative sleep studies in the lab and in the field.

(3) Lizard sleep

In the third chapter, our work on lizard sleep raises more questions than it answers. Indeed, before we started our project, it was often mentioned in the literature that non-avian reptiles do not show REM sleep (see chapter 1). However, around 40% of the papers (mainly written in the 70's) claimed the existence of eye movements as well as movements during sleep periods in non-avian reptiles (Libourel & Herrel, 2016). However, none of these papers was able to convincingly show that these movements were due to REM sleep and not due to short awakenings. The absence of clear slow waves, or a clear difference between wake and sleep EEG was also not helpful to identify the states. In our review, we raised the issues associated with the methodology and the bias induced by the mammalian definition of sleep. More recently, Shein Idelson *et al.* (2016) discovered a very curious sleep phenotype in an agama (the bearded dragon, *Pogona vitticeps*).

Using of state-of-the-art methods they observed a very stereotypic local field potential in a forebrain region supposed to be an associative structure. They reported a perfect alternance between two electroencephalographical states. One containing high amplitude Slow/Sharp waves and the other quite desynchronized, rich in high frequencies just like when the animal is awake. Moreover, this was associated with isolated eye movements under closed eye lids. In parallel, we were able to confirm these results in the same species but found a very different phenotype of sleep in another species the argentine tegu (*Salvator mearianae*). Indeed, in the third chapter, our experiments confirmed the existence of two sleep states in these two lizard species. But, the same brain regions do not have the same electrophysiological signatures. Even if we found some features similar to REM sleep in the argentine tegu like a decrease in muscle tone, eye movements, and a suppression of the sleep state with an antidepressant, we found also some divergent characteristics. The first sleep state does not show slow waves or slow frequencies, the second has slow and isolated eye movements instead of rapid ones, no clear atonia but rather a very slight decrease in the muscle tone, no strong variability in heart rate and only rare twitches. More curiously, a brain activity during the putative REM-like sleep state that does not look like the awake state. All together, these results illustrate that sleep in lizards, and potentially other non-avian reptiles, is more complex than that described for mammals. In mammals, one can easily identify REM sleep by looking at the phasic features of this state (twitches, eye movements, whisker movements, irregular breathing rate ...), whereas in a lizard (tegu but bearded dragons as well) this becomes less clear, as the active phenomena are rare and isolated. What does this mean? Due to their energy regulation strategy, do they not have the same phenotype of REM sleep? Do they possibly have a more pronounced mammalian REM sleep like state during their development *in ovo* ? Why do two lizard species do not share the same sleep phenotype? Our results suggest that the emergence of two sleep states is certainly common to the amniotes but also raise questions about the less active nature of the lizard REM-like sleep state. Our work highlights the difficulties to draw parallels between different species and the potential bias inherent in defining sleep states based on a mammalian sleep phenotype. However, our results do change the quite stereotypic view of SWS and REM sleep that is common in the literature.

V. PERSPECTIVES

Our results illustrate the complexity of sleep and the necessity to develop multiple approaches in term of models as well as methods.

(1) Models

Thanks to this work, we were able to demonstrate that at least two species of lizards display two sleep states. However, this does not mean that all non-avian reptiles show two sleep states, neither that one or the other lizard displays the generic sleep phenotype of non-avian reptiles. This does also not inform us on the origin of the two sleep states. Indeed, other non-avian reptiles including crocodiles and turtles as well as other squamates should be studied. In order to optimize the phenotypic description of sleep in non-avian reptiles and to better understand its evolution one should sample species in each of the branches of the non-avian reptile sub-orders. Moreover, amphibian species, including anurans, salamanders, and caecilians need to be recorded to provide further insights into the possible earlier origin of these states. In addition, ontogenetic studies are also missing in non-avian reptiles. These experiments would inform us on the development of the states and would give information on the possible homology between states.

(2) Methods

In the third chapter, we demonstrated changes in the local field potential of the brain, in the physiology, the behavior, and in the response to drugs in relation to sleep behavior in lizards. These methods can be used simultaneously (see chapters 2 and 3) and could reveal important differences across taxa. However, alone, they are not sufficient to reveal the full mystery of the origin of sleep states. Indeed, it is well known that the brainstem as well as hypothalamic nuclei are involved in the generation and in the maintenance of REM sleep in mammals (Jouvet & Mounier, 1960; Vertes, 1984; Steriade & McCarley, 2005; Luppi *et al.*, 2012; Luppi, Peyron, & Fort, 2013). One can ask whether the same neurons exists in non-avian reptiles and whether they share the same role (Cardot, Fellmann, & Bugnon, 1994; Ayala-Guerrero & Mexicano, 2008a). Moreover, by recording the local field potentials we only have a rather blurry picture of what happened in a specific region without any idea of the network and the role of the different regions involved in a state (Denker *et al.*, 2011; Kajikawa & Schroeder, 2011; Gaucher, Edeline, & Gourévitch, 2012). We are also limited to the covered area. Complementary methods could/should be used to fully characterized sleep in these species. First the neuroanatomy and the connectivity of the sleep network should be described. In order to trace parallels between the sleep neuronal network of lizards and mammals we should also understand the functional connectivity of the sleep and wake cycle in reptiles. The brainstem organization seems to be quite well conserved across amniotes (Newman & Cruce, 1982; ten Donkelaar *et al.*, 1987; Cruce, Stuesse, & Newman, 1988) and is known to be involved in the REM sleep regulation and

generation (Vertes, 1984; Wolters *et al.*, 1986; Steriade & McCarley, 2005; Luppi *et al.*, 2012). Consequently, this region could be the first target. With a first challenge: identifying the stereotactical location of the nuclei that discharge or stop to discharge specifically during REM sleep in mammals. The locus coeruleus, the dorsal raphe nucleus, the sublaterodorsal nucleus, the laterodorsal tegmentum, the pedunculopontine tegmentum could be the first nuclei to target. Recording their neuronal activity during vigilant states or modifying the activity of a specific neuronal population thanks to optogenetics or chemogenetics would inform us on the functional role of these nuclei and will help us to draw parallel between a reptilian REM-like sleep state and mammalian REM sleep. These methods could now be used because of the development of genome engineering tools like CRISPR CAS 9. One major feature of REM sleep is also the cortical activity (Renouard *et al.*, 2015; Jones, 2016; Koike *et al.*, 2017). Therefore, it becomes interesting to characterize the pallial activity in reptiles during sleep states (Shein-Idelson *et al.*, 2016). This could be done thanks to high-density multi-electrode recording in freely moving (Sirota & Buzsáki, 2005; Du *et al.*, 2011; Shein-Idelson *et al.*, 2016) or in restrained conditions with functional MRI (Logothetis, 2008; Duyn, 2011, 2012) with respective limitations in terms of spatial and temporal resolution.

Sleep is a complex behavior that has been modified according to selective pressures during evolution in relation to anatomical and physiological changes in animals. Therefore, to understand the whole nature of sleep we have no other choice than combining comparative studies with multimodal methods and to forget the classical mammalian view of the two sleep states. Understanding why we humans sleep is understanding why and how all animals sleep.

PART V : REFERENCES

- ABOITIZ, F. (1999) Comparative development of the mammalian isocortex and the reptilian dorsal ventricular ridge. Evolutionary considerations. *Cerebral Cortex (New York, N.Y.: 1991)* **9**, 783–791.
- AMLANER, C.J. & BALL, N.J. (1994) Avian Sleep. In *Principles and practice of sleep medicine* (eds M.H. KRYGER, T. ROTH & W. DEMENT), pp. 81–94. Saunders, Philadelphia.
- ARISTAKESYAN, E.A. (2009) Evolutionary aspects of interaction of sleep and stress: phylo- and ontogenetic approach. *Journal of Evolutionary Biochemistry and Physiology* **45**, 724–739.
- ARISTAKESYAN, E.A. & KARMANOVA, I.G. (1998) The effects of six-hour protosleep (primary sleep) deprivation in the brown frog (*Rana temporaria*). *Journal of Evolutionary Biochemistry and Physiology* **34**, 356–359.
- ASERINSKY, E. & KLEITMAN, N. (1953) Regularly occurring periods of eye motility, and concomitant phenomena, during sleep. *Science (New York, N.Y.)* **118**, 273–274.
- ASTIC, L. & JOUVET-MOUNIER, D. (1968) [Effects of weaning as a function of age on the wake-sleep cycle in guinea pigs]. *J Physiol (Paris)* **60 Suppl 2**, 389.
- AULSEBROOK, A.E., JONES, T.M., RATTENBORG, N.C., ROTH, T.C. & LESKU, J.A. (2016) Sleep Ecophysiology: Integrating Neuroscience and Ecology. *Trends in Ecology & Evolution* **31**, 590–599.
- AYALA GUERRERO, F. (1987) Sleep in *Kinosternon* sp. *Experientia* **43**, 67–82.
- AYALA-GUERRERO, F., CALDERON, A. & PEREZ, M.C. (1988) Sleep patterns in a chelonian reptile (*Gopherus flavomarginatus*). *Physiol Behav* **44**, 333–337.
- AYALA-GUERRERO, F. & HUITRON RESENDIZ, S. (1991) Behavioral and electrophysiological patterns of wakefulness-sleep states in a lizard. *Bol Estud Med Biol* **39**, 9–14.
- AYALA-GUERRERO, F. & MEXICANO, G. (2008a) Topographical distribution of the locus coeruleus and raphe nuclei in the lizard *Ctenosaura pectinata*: Functional implications on sleep. *Comparative Biochemistry and Physiology Part A: Molecular & Integrative Physiology* **149**, 137–141.
- AYALA-GUERRERO, F. & MEXICANO, G. (2008b) Sleep and wakefulness in the green iguanid lizard (*Iguana iguana*). *Comparative Biochemistry and Physiology Part A: Molecular & Integrative Physiology* **151**, 305–312.
- AYALA-GUERRERO, F. & VARGAS REYNA, L. (1987) Sleep and wakefulness in the lizard *Ctenosaura similis*. *Boletin De Estudios Medicos Y Biologicos* **35**, 25–33.
- BARRILLOT, B., ROUX, J., ARTHAUD, S., AVERTY, L., CLAIR, A., HERREL, A. & LIBOUREL, P.-A. (2018) Intramuscular administration of ketamine-medetomidine assures stable anaesthesia needed for long-term surgery in the argentine tegu *Salvator merianae*. *Journal of Zoo and Wildlife Medicine: Official Publication of the American Association of Zoo Veterinarians*.
- BECKERS, G.J., VAN DER MEIJ, J., LESKU, J.A. & RATTENBORG, N.C. (2014) Plumes of neuronal activity propagate in three dimensions through the nuclear avian brain. *BMC Biology* **12**, 16.
- BELICH, A.I. (1984) The wake-sleep cycle in poikilothermic vertebrates according to data of continuous, noncontact recording of heart rate and motor activity. *Neurosci Behav Physiol* **14**, 159–166.
- BENINGTON, J.H. & HELLER, H.C. (1994) REM-sleep timing is controlled homeostatically by accumulation of REM-sleep propensity in non-REM sleep. *The American Journal of Physiology* **266**, R1992–2000.
- BERGER, H. (1929) Über das Elektrenkephalogramm des Menschen. *Archiv für Psychiatrie und Nervenkrankheiten* **87**, 527–570.

- BERGER, R.J. (1984) Slow wave sleep, shallow torpor and hibernation: homologous states of diminished metabolism and body temperature. *Biological Psychology* **19**, 305–326.
- BLUMBERG, M. (2010) Beyond dreams: do sleep-related movements contribute to brain development? *Frontiers in Neurology*.
- BLUMBERG, M.S. (2013) Ontogeny of Sleep. In *Encyclopedia of Sleep* pp. 32–37. Elsevier.
- BLUMBERG, M.S. & LUCAS, D.E. (1996) A developmental and component analysis of active sleep. *Dev Psychobiol* **29**, 1–22.
- BOKIL, H., ANDREWS, P., KULKARNI, J.E., MEHTA, S. & MITRA, P.P. (2010) Chronux: a platform for analyzing neural signals. *Journal of Neuroscience Methods* **192**, 146–151.
- BONNET, M.H. & JOHNSON, L.C. (1978) Relationship of arousal threshold to sleep stage distribution and subjective estimates of depth and quality of sleep. *Sleep* **1**, 161–168.
- BORBÉLY, A.A. (1982) A two process model of sleep regulation. *Human Neurobiology* **1**, 195–204.
- BORBÉLY, A.A., DAAN, S., WIRZ-JUSTICE, A. & DEBOER, T. (2016) The two-process model of sleep regulation: a reappraisal. *Journal of Sleep Research* **25**, 131–143.
- BORBÉLY, A.A. & NEUHAUS, H.U. (1979) Sleep-deprivation: Effects on sleep and EEG in the rat. *Journal of comparative physiology* **133**, 71–87.
- BRUCE, L.L. & NEARY, T.J. (1995) The limbic system of tetrapods: a comparative analysis of cortical and amygdalar populations. *Brain, Behavior and Evolution* **46**, 224–234.
- BURGOS BRETONES, J.J., RAZQUIN PERALTA, B., AGUIRRE URIZAR, J. & RIVERA POMAR, J.M. (1987) Muscle fiber types in tetrapods. A comparative histochemical and morphometric study. *Histology and Histopathology* **2**, 31–38.
- BUTLER, A.B., REINER, A. & KARTEN, H.J. (2011) Evolution of the amniote pallium and the origins of mammalian neocortex. *Annals of the New York Academy of Sciences* **1225**, 14–27.
- BUZSÁKI, G. (2015) Hippocampal sharp wave-ripple: A cognitive biomarker for episodic memory and planning: HIPPOCAMPAL SHARP WAVE-RIPPLE. *Hippocampus* **25**, 1073–1188.
- CAMPBELL, S.S. & TOBLER, I. (1984) Animal sleep: a review of sleep duration across phylogeny. *Neuroscience and Biobehavioral Reviews* **8**, 269–300.
- CAPELLINI, I., BARTON, R.A., MCNAMARA, P., PRESTON, B.T. & NUNN, C.L. (2008) PHYLOGENETIC ANALYSIS OF THE ECOLOGY AND EVOLUTION OF MAMMALIAN SLEEP. *Evolution* **62**, 1764–1776.
- CARDOT, J., FELLMANN, D. & BUGNON, C. (1994) Melanin-concentrating hormone-producing neurons in reptiles. *Gen Comp Endocrinol* **94**, 23–32.
- CATON, R. (1875) Electrical Currents of the Brain. *The Journal of Nervous and Mental Disease* **2**, 610.
- CATON, R. (1877) Interim report on investigation of electric currents of the brain. *Brit Med J* **1**, supp. 62.
- CAVALLERO, C., CICOGLIA, P., NATALE, V., OCCHIONERO, M. & ZITO, A. (1992) Slow wave sleep dreaming. *Sleep* **15**, 562–566.
- CHAUVETTE, S., CROCHET, S., VOLGUSHEV, M. & TIMOFEEV, I. (2011) Properties of slow oscillation during slow-wave sleep and anesthesia in cats. *The Journal of Neuroscience: The Official Journal of the Society for Neuroscience* **31**, 14998–15008.
- CHIARI, Y., CAHAIS, V., GALTIER, N. & DELSUC, F. (2012) Phylogenomic analyses support the position of turtles as the sister group of birds and crocodiles (Archosauria). *BMC Biol* **10**, 65.

- CIRELLI, C. & TONONI, G. (2008) Is sleep essential? *PLoS biology* **6**, e216.
- CLEMENT, E.A., RICHARD, A., THWAITES, M., AILON, J., PETERS, S. & DICKSON, C.T. (2008) Cyclic and Sleep-Like Spontaneous Alternations of Brain State Under Urethane Anaesthesia. *PLoS ONE* **3**, e2004.
- CORNER, M.A. (1977) Sleep and the beginnings of behavior in the animal kingdom—Studies of ultradian motility cycles in early life. *Progress in Neurobiology* **8**, 279–295.
- CRAWFORD, N.G., FAIRCLOTH, B.C., MCCORMACK, J.E., BRUMFIELD, R.T., WINKER, K. & GLENN, T.C. (2012) More than 1000 ultraconserved elements provide evidence that turtles are the sister group of archosaurs. *Biology Letters* **8**, 783–786.
- CRUCE, W.L., STUESSE, S.L. & NEWMAN, D.B. (1988) Evolution of the reticular formation. *Acta Biologica Hungarica* **39**, 327–333.
- DE GENNARO, L. & FERRARA, M. (2003) Sleep spindles: an overview. *Sleep Medicine Reviews* **7**, 423–440.
- DEBOER, T. (1998) Brain temperature dependent changes in the electroencephalogram power spectrum of humans and animals. *Journal of Sleep Research* **7**, 254–262.
- DEBOER, T. & TOBLER, I. (2000) Slow waves in the sleep electroencephalogram after daily torpor are homeostatically regulated. *Neuroreport* **11**, 881–885.
- DEBOER, T. & TOBLER, I. (2003) Sleep regulation in the Djungarian hamster: comparison of the dynamics leading to the slow-wave activity increase after sleep deprivation and daily torpor. *Sleep* **26**, 567–572.
- DECKEL, W., A. (1996) Behavioral changes in *Anolis carolinensis* following injection with fluoxetine. *Behavioural Brain Research* **78**, 175–182.
- DEMENT, W. (1958) The occurrence of low voltage, fast, electroencephalogram patterns during behavioral sleep in the cat. *Electroencephalography and Clinical Neurophysiology* **10**, 291–296.
- DEMENT, W. (1960) The Effect of Dream Deprivation. *Science* **131**, 1705–1707.
- DEMENT, W. & KLEITMAN, N. (1957) The relation of eye movements during sleep to dream activity: an objective method for the study of dreaming. *J Exp Psychol* **53**, 339–346.
- DENKER, M., ROUX, S., LINDÉN, H., DIEMANN, M., RIEHLE, A. & GRÜN, S. (2011) The Local Field Potential Reflects Surplus Spike Synchrony. *Cerebral Cortex* **21**, 2681–2695.
- DENOYER, M., SALLANON, M., BUDA, C., DELHOMME, G., DITTMAR, A. & JOUVET, M. (1991) The posterior hypothalamus is responsible for the increase of brain temperature during paradoxical sleep. *Exp Brain Res* **84**, 326–334.
- DEWASMES, G., COHEN-ADAD, F., KOUBI, H. & LE MAHO, Y. (1985) Polygraphic and behavioral study of sleep in geese: existence of nuchal atonia during paradoxical sleep. *Physiology & Behavior* **35**, 67–73.
- TEN DONKELAAR, H.J., BANGMA, G.C., BARBAS-HENRY, H.A., DE BOER-VAN HUIZEN, R. & WOLTERS, J.G. (1987) The brain stem in a lizard, *Varanus exanthematicus*. *Adv Anat Embryol Cell Biol* **107**, 1–168.
- DU, J., BLANCHE, T.J., HARRISON, R.R., LESTER, H.A. & MASMANIDIS, S.C. (2011) Multiplexed, High Density Electrophysiology with Nanofabricated Neural Probes. *PLoS ONE* **6**, e26204.
- DUYN, J. (2011) Spontaneous fMRI activity during resting wakefulness and sleep. In *Progress in Brain Research* pp. 295–305. Elsevier.
- DUYN, J.H. (2012) EEG-fMRI Methods for the Study of Brain Networks during Sleep. *Frontiers in Neurology* **3**.
- EILAND, M.M., LYAMIN, O.I. & SIEGEL, J.M. (2001) State-related discharge of neurons in the brainstem of freely moving box turtles, *Terrapene carolina major*. *Archives Italiennes De Biologie* **139**, 23–36.

- FANG, G., CHEN, Q., CUI, J. & TANG, Y. (2012) Electroencephalogram bands modulated by vigilance states in an anuran species: a factor analytic approach. *Journal of Comparative Physiology A* **198**, 119–127.
- FLANIGAN, W.F. (1973) Sleep and wakefulness in iguanid lizards, *Ctenosaura pectinata* and *Iguana iguana*. *Brain, Behavior and Evolution* **8**, 401–436.
- FLANIGAN, W.F. (1974) Sleep and wakefulness in chelonian reptiles. II. The red-footed tortoise, *Geochelone carbonaria*. *Archives Italiennes De Biologie* **112**, 253–277.
- FLANIGAN, W.F., KNIGHT, C.P., HARTSE, K.M. & RECHTSCHAFFEN, A. (1974) Sleep and wakefulness in chelonian reptiles. I. The box turtle, *Terrapene carolina*. *Archives Italiennes De Biologie* **112**, 227–252.
- FLANIGAN, W.F., WILCOX, R.H. & RECHTSCHAFFEN, A. (1973) The EEG and behavioral continuum of the crocodilian, *Caiman sclerops*. *Electroencephalography and Clinical Neurophysiology* **34**, 521–538.
- FRANK, M.G., WALDROP, R.H., DUMOULIN, M., ATON, S. & BOAL, J.G. (2012) A Preliminary Analysis of Sleep-Like States in the Cuttlefish *Sepia officinalis*. *PLoS ONE* **7**, e38125.
- FRANKEN, P., DIJK, D.J., TOBLER, I. & BORBÉLY, A.A. (1991) Sleep deprivation in rats: effects on EEG power spectra, vigilance states, and cortical temperature. *The American Journal of Physiology* **261**, R198-208.
- FUCHS, T., MAURY, D., MOORE, F.. & BINGMAN, V.. (2009) Daytime micro-naps in a nocturnal migrant: an EEG analysis. *Biology Letters* **5**, 77–80.
- FUCHS, T., SIEGEL, J.J., BURGDORF, J. & BINGMAN, V.P. (2006) A selective serotonin reuptake inhibitor reduces REM sleep in the homing pigeon. *Physiology & Behavior* **87**, 575–581.
- FULLER, R.W., WONG, D.T. & ROBERTSON, D.W. (1991) Fluoxetine, a selective inhibitor of serotonin uptake. *Medicinal research reviews* **11**, 17–34.
- GAO, B., DUNCAN, W.C. & WEHR, T.A. (1992) Fluoxetine decreases brain temperature and REM sleep in Syrian hamsters. *Psychopharmacology* **106**, 321–329.
- GASSEL, M.M., MARCHIAFAVA, P.L. & POMPEIANO, O. (1964) Phasic changes in muscular activity during desynchronized sleep in unrestrained cats. an analysis of the pattern and organization of myoclonic twitches. *Archives Italiennes De Biologie* **102**, 449–470.
- GAUCHER, Q., EDELINE, J.-M. & GOURÉVITCH, B. (2012) How different are the local field potentials and spiking activities? Insights from multi-electrodes arrays. *Journal of Physiology-Paris* **106**, 93–103.
- GEISER, F. (1988) Reduction of metabolism during hibernation and daily torpor in mammals and birds: temperature effect or physiological inhibition? *J Comp Physiol B* **158**, 25–37.
- GEISER, F. (2004) Metabolic Rate and Body Temperature Reduction During Hibernation and Daily Torpor. *Annual Review of Physiology* **66**, 239–274.
- GIRARDEAU, G., BENCHENANE, K., WIENER, S.I., BUZSÁKI, G. & ZUGARO, M.B. (2009) Selective suppression of hippocampal ripples impairs spatial memory. *Nature Neuroscience* **12**, 1222–1223.
- GOTTESMANN, C. (2001) The golden age of rapid eye movement sleep discoveries. 1. Lucretius--1964. *Progress in Neurobiology* **65**, 211–287.
- HALASZ, P., TERZANO, M., PARRINO, L. & BODIZS, R. (2004) The nature of arousal in sleep. *Journal of Sleep Research* **13**, 1–23.
- UL HAQ, R., ANDERSON, M.L., HOLLNAGEL, J.-O., WORSCHER, F., SHERKHELI, M.A., BEHRENS, C.J. & HEINEMANN, U. (2016) Serotonin dependent masking of hippocampal sharp wave ripples. *Neuropharmacology* **101**, 188–203.

- HARRISON, R.R., FOTOWAT, H., CHAN, R., KIER, R.J., OLBERG, R., LEONARDO, A. & GABBIANI, F. (2011) Wireless Neural/EMG Telemetry Systems for Small Freely Moving Animals. *IEEE Transactions on Biomedical Circuits and Systems* **5**, 103–111.
- HARTSE, K.M. (2011) The phylogeny of sleep. In *Handbook of clinical neurology* pp. 97–109. Elsevier.
- HARTSE, K.M. & RECHTSCHAFFEN, A. (1974) Effect of atropine sulfate on the sleep-related EEG spike activity of the tortoise, *Geochelone carbonaria*. *Brain, Behavior and Evolution* **9**, 81–94.
- HARTSE, K.M. & RECHTSCHAFFEN, A. (1982) The effect of amphetamine, nembutal, alpha-methyl-tyrosine, and parachlorophenylalanine on the sleep-related spike activity of the tortoise, *Geochelone carbonaria*, and on the cat ventral hippocampus spike. *Brain, Behavior and Evolution* **21**, 199–222.
- HARTSE, KRISTYNA M. (1994) Sleep in insects and nonmammalian vertebrates. In *Principles and Practice of Sleep Medicine* pp. 95–104, 2nd edition. WB Saunders, Philadelphia.
- HAWLEY, E.S., HARGREAVES, E.L., KUBIE, J.L., RIVARD, B. & MULLER, R.U. (2002) Telemetry system for reliable recording of action potentials from freely moving rats. *Hippocampus* **12**, 505–513.
- HELLER, H.C., GRAF, R. & RAUTENBERG, W. (1983) Circadian and arousal state influences on thermoregulation in the pigeon. *The American Journal of Physiology* **245**, R321–328.
- HERMANN, H., JOUVET, M. & KLEIN, M. (1964) [Polygraphic Analysis of Sleep in the Tortoise]. *C R Hebd Seances Acad Sci* **258**, 2175–2178.
- HOBSON, J.A. (1967) Electrographic correlates of behavior in the frog with special reference to sleep. *Electroencephalogr Clin Neurophysiol* **22**, 113–121.
- HOBSON, J.A., GOIN, O.B. & GOIN, C.J. (1968) Electrographic correlates of behavior in tree frogs. *Nature* **220**, 386–387.
- HOOPS, D. (2015) A perfusion protocol for lizards, including a method for brain removal. *MethodsX* **2**, 165–173.
- HUNTLEY, A., DONNELLY, M. & COHEN, H. (1978) Sleep in the western toad *Bufo boreas*. *Sleep Res* **7**, 141.
- HUNTLEY, A.C. (1987) Electrophysiological and behavioral correlates of sleep in the desert iguana, *Dipsosaurus dorsalis* Hallowell. *Comparative Biochemistry and Physiology Part A: Physiology* **86**, 325–330.
- IBUKA, N. (1984) Ontogenesis of circadian sleep-wakefulness rhythms and developmental changes of sleep in the altricial rat and in the precocial guinea pig. *Behavioural Brain Research* **11**, 185–196.
- JONES, B.E. (2016) Neuroscience: What Are Cortical Neurons Doing during Sleep? *Current biology: CB* **26**, R1147–R1150.
- JOUVET, M., MICHEL, F. & COURJON, J. (1959a) [On a stage of rapid cerebral electrical activity in the course of physiological sleep]. *Comptes Rendus Des Seances De La Societe De Biologie Et De Ses Filiales* **153**, 1024–1028.
- JOUVET, M., MICHEL, F. & COURJON, J. (1959b) [Electric activity of the rhinencephalon during sleep in cats]. *Comptes Rendus Des Seances De La Societe De Biologie Et De Ses Filiales* **153**, 101–105.
- JOUVET, M., MICHEL, F. & COURJON, J. (1960) [EEG study of physiological sleep in the intact, decorticated and chronic mesencephalic cat]. *Revue Neurologique* **102**, 309–310.
- JOUVET, M. & MOUNIER, D. (1960) [Effect of lesions of the pontile reticular formation on sleep in the cat]. *C R Seances Soc Biol Fil* **154**, 2301–2305.
- JOUVET-MOUNIER, D., ASTIC, L. & LACOTE, D. (1969) Ontogenesis of the states of sleep in rat, cat, and guinea pig during the first postnatal month. *Developmental psychobiology* **2**, 216–239.
- KAJKAWA, Y. & SCHROEDER, C.E. (2011) How Local Is the Local Field Potential? *Neuron* **72**, 847–858.

- KARMANOVA, I.G. (1982) *Evolution of sleep: Stages of the formation of the 'wakefulness-sleep' cycle in vertebrates*. Karger, originally published in russian by Nauka publishers.
- KARMANOVA, I.G., BELEKHOVA, M.G. & CHURNOSOV, E.V. (1971) [Behavioral and electrographic expression of natural sleep and wakefulness in reptiles]. *Fiziol Zh SSSR Im I M Sechenova* **57**, 504–511.
- KARMANOVA, I.G. & LAZAREV, S.G. (1979) Stages of sleep evolution (facts and hypotheses). *Waking Sleeping* **3**, 137–147.
- KAVANAU, J.L. (1998) Vertebrates that never sleep: implications for sleep's basic function. *Brain research bulletin* **46**, 269–279.
- KAVANAU, J.L. (2002) REM and NREM sleep as natural accompaniments of the evolution of warm-bloodedness. *Neuroscience & Biobehavioral Reviews* **26**, 889–906.
- KAYSER, M.S. & BIRON, D. (2016) Sleep and Development in Genetically Tractable Model Organisms. *Genetics* **203**, 21–33.
- KLEIN, B.A., OLZSOWY, K.M., KLEIN, A., SAUNDERS, K.M. & SEELEY, T.D. (2008) Caste-dependent sleep of worker honey bees. *Journal of Experimental Biology* **211**, 3028–3040.
- KLEIN, M., MICHEL, F. & JOUVET, M. (1964) [POLYGRAPHIC STUDY OF SLEEP IN BIRDS]. *Comptes Rendus Des Seances De La Societe De Biologie Et De Ses Filiales* **158**, 99–103.
- KOIKE, B.D.V., FARIAS, K.S., BILLWILLER, F., ALMEIDA-FILHO, D., LIBOUREL, P.-A., TIRAN-CAPPELLO, A., PARMENTIER, R., BLANCO, W., RIBEIRO, S., LUPPI, P.-H. & QUEIROZ, C.M. (2017) Electrophysiological Evidence That the Retrosplenial Cortex Displays a Strong and Specific Activation Phased with Hippocampal Theta during Paradoxical (REM) Sleep. *The Journal of Neuroscience: The Official Journal of the Society for Neuroscience* **37**, 8003–8013.
- KOVALZON, V.M. (1976) Evolutionary and ecological aspects of sleep. *Usr. Sovr. Biol* **81**, 381–398.
- LAPRAY, D., BERGELER, J., DUPONT, E., THEWS, O. & LUHMANN, H.J. (2008) A novel miniature telemetric system for recording EEG activity in freely moving rats. *Journal of Neuroscience Methods* **168**, 119–126.
- LAZAREV, S.G. (1978a) [Electroencephalographic analysis of wakefulness and the primary form of sleep in the frog, *Rana temporaria*]. *Zh Evol Biokhim Fiziol* **14**, 379–384.
- LAZAREV, S.G. (1978b) [Neurophysiologic analysis of activation spontaneously developing in *Rana temporaria* frogs against a background of primary sleep]. *Zh Evol Biokhim Fiziol* **14**, 507–510.
- LECCI, S., FERNANDEZ, L.M.J., WEBER, F.D., CARDIS, R., CHATTON, J.-Y., BORN, J. & LÜTHI, A. (2017) Coordinated infraslow neural and cardiac oscillations mark fragility and offline periods in mammalian sleep. *Science Advances* **3**, e1602026.
- LESKU, J.A., MEYER, L.C.R., FULLER, A., MALONEY, S.K., DELL'OMO, G., VYSSOTSKI, A.L. & RATTENBORG, N.C. (2011) Ostriches Sleep like Platypuses. *PLoS ONE* **6**, e23203.
- LESKU, J.A., RATTENBORG, N.C., VALCU, M., VYSSOTSKI, A.L., KUHN, S., KUEMMETH, F., HEIDRICH, W. & KEMPENAERS, B. (2012) Adaptive Sleep Loss in Polygynous Pectoral Sandpipers. *Science* **337**, 1654–1658.
- LESKU, J.A., ROTH II, T.C., AMLANER, C.J. & LIMA, S.L. (2006) A phylogenetic analysis of sleep architecture in mammals: the integration of anatomy, physiology, and ecology. *The American Naturalist* **168**, 441–453.
- LESKU, J.A., ROTH, T.C., RATTENBORG, N.C., AMLANER, C.J. & LIMA, S.L. (2008) Phylogenetics and the correlates of mammalian sleep: A reappraisal. *Sleep Medicine Reviews* **12**, 229–244.
- LIBOUREL, P.-A., CORNEYLLIE, A., LUPPI, P.-H., CHOUVET, G. & GERVASONI, D. (2015) Unsupervised online classifier in sleep scoring for sleep deprivation studies. *Sleep* **38**, 815–828.

- LIBOUREL, P.-A. & HERREL, A. (2016) Sleep in amphibians and reptiles: a review and a preliminary analysis of evolutionary patterns: Sleep in amphibians and reptiles. *Biological Reviews* **91**, 833–866.
- LIECHTI, F., WITVLIET, W., WEBER, R. & BÄCHLER, E. (2013) First evidence of a 200-day non-stop flight in a bird. *Nature Communications* **4**.
- LO, C.C., CHOU, T., PENZEL, T., SCAMMELL, T.E., STRECKER, R.E., STANLEY, H.E. & IVANOV, P.C. (2004) Common scale-invariant patterns of sleep-wake transitions across mammalian species. *Proc Natl Acad Sci U S A* **101**, 17545–17548.
- LOGOTHETIS, N.K. (2008) What we can do and what we cannot do with fMRI. *Nature* **453**, 869–878.
- LOOMIS, A.L., HARVEY, E.N. & HOBART (1938) Cerebral states during sleep, as studied by human brain potential. *J Exp Psychol* **21**, 128–144.
- LOOMIS, A.L., HARVEY, E.N. & HOBART, G. (1935a) POTENTIAL RHYTHMS OF THE CEREBRAL CORTEX DURING SLEEP. *Science (New York, N.Y.)* **81**, 597–598.
- LOOMIS, A.L., HARVEY, E.N. & HOBART, G. (1935b) FURTHER OBSERVATIONS ON THE POTENTIAL RHYTHMS OF THE CEREBRAL CORTEX DURING SLEEP. *Science (New York, N.Y.)* **82**, 198–200.
- LUCAS, E.A. & STERMAN, M.B. (1969) The salamander EEG: a model of primitive sleep and wakefulness. *Psychophysiology* **6**, 230.
- LUNA, V.M., DAIKOKU, E. & ONO, F. (2015) “Slow” skeletal muscles across vertebrate species. *Cell & Bioscience* **5**.
- LUPPI, P.H., CLEMENT, O., SAPIN, E., PEYRON, C., GERVASONI, D., LEGER, L. & FORT, P. (2012) Brainstem mechanisms of paradoxical (REM) sleep generation. *Pflugers Arch* **463**, 43–52.
- LUPPI, P.H., PEYRON, C. & FORT, P. (2013) Role of MCH neurons in paradoxical (REM) sleep control. *Sleep* **36**, 1775–1776.
- LYAMIN, O., MANGER, P., RIDGWAY, S., MUKHAMEDOV, L. & SIEGEL, J. (2008) Cetacean sleep: An unusual form of mammalian sleep. *Neuroscience & Biobehavioral Reviews* **32**, 1451–1484.
- LYAMIN, O., PRYASLOVA, J., LANCE, V. & SIEGEL, J. (2005) Animal behaviour: continuous activity in cetaceans after birth. *Nature* **435**, 1177.
- MASSIMINI, M., HUBER, R., FERRARELLI, F., HILL, S. & TONONI, G. (2004) The sleep slow oscillation as a traveling wave. *The Journal of Neuroscience: The Official Journal of the Society for Neuroscience* **24**, 6862–6870.
- MCCARLEY, R.W., NELSON, J.P. & HOBSON, J.A. (1978) Ponto-geniculo-occipital (PGO) burst neurons: correlative evidence for neuronal generators of PGO waves. *Science* **201**, 269–272.
- MEDDIS, R. (1975) On the function of sleep. *Anim Behav* **23**, 676–691.
- MEGLASSON, M.D. & HUGGINS, S.E. (1979) Sleep in a crocodylian, *Caiman sclerops*. *Comp Biochem Physiol* **63A**, 561–567.
- MIGNOT, E. (2008) Why We Sleep: The Temporal Organization of Recovery. *PLoS Biology* **6**, e106.
- MILSOM, W.K., ANDRADE, D.V., BRITO, S.P., TOLEDO, L.F., WANG, T. & ABE, A.S. (2008) Seasonal Changes in Daily Metabolic Patterns of Tegu Lizards (*Tupinambis merianae*) Placed in the Cold (17°C) and Dark. *Physiological and Biochemical Zoology* **81**, 165–175.
- MOHSENI, P., NAJAFI, K., ELIADES, S.J. & WANG, X. (2005) Wireless Multichannel Biopotential Recording Using an Integrated FM Telemetry Circuit. *IEEE Transactions on Neural Systems and Rehabilitation Engineering* **13**, 263–271.

- NATH, R.D., BEDBROOK, C.N., ABRAMS, M.J., BASINGER, T., BOIS, J.S., PROBER, D.A., STERNBERG, P.W., GRADINARU, V. & GOENTORO, L. (2017) The Jellyfish *Cassiopea* Exhibits a Sleep-like State. *Current Biology* **27**, 2984-2990.e3.
- NEWMAN, D.B. & CRUCE, W.L. (1982) The organization of the reptilian formation: a comparative study using Nissl and Golgi techniques. *Journal of Morphology* **173**, 325-349.
- NICOL, S.C., ANDERSEN, N.A., PHILLIPS, N.H. & BERGER, R.J. (2000) The echidna manifests typical characteristics of rapid eye movement sleep. *Neurosci Lett* **283**, 49-52.
- NORTHCUTT, R.G. (1981) Evolution of the Telencephalon in Nonmammals. *Annual Review of Neuroscience* **4**, 301-350.
- NORTHCUTT, R.G. (2002) Understanding Vertebrate Brain Evolution. *Integrative and Comparative Biology* **42**, 743-756.
- OMOND, S., LY, L.M.T., BEATON, R., STORM, J.J., HALE, M.W. & LESKU, J.A. (2017) Inactivity Is Nycthemeral, Endogenously Generated, Homeostatically Regulated, and Melatonin Modulated in a Free-Living Platyhelminth Flatworm. *Sleep* **40**.
- OOKAWA, T. & GOTOH, J. (1964) Electroencephalographic study of chickens; Periodic recurrence of low voltage and fast waves during behavioral sleep. *PoultryScience* **43**, 1603-1604.
- PARMEGGIANI, P.L. (2003) Thermoregulation and sleep. *Frontiers in Bioscience* **8**, s557-567.
- PARSONS, L.C. & HUGGINS, S.E. (1965a) A Study of Spontaneous Electrical Activity in the Brain of Caiman Sclerops. *Proc Soc Exp Biol Med* **119**, 397-400.
- PARSONS, L.C. & HUGGINS, S.E. (1965b) Effects of temperature on electroencephalogram of the caiman. *Proc Soc Exp Biol Med* **120**, 422-426.
- PETTIGREW, J.D., WALLMAN, J. & WILDISOET, C.F. (1990) Saccadic oscillations facilitate ocular perfusion from the avian pecten. *Nature* **343**, 362-363.
- PEYRETHON, J. & DUSAN-PEYRETHON, D. (1969) [Polygraphic study of the sleep-wake cycle in 3 genres of reptiles]. *C R Seances Soc Biol Fil* **163**, 181-186.
- PIERCY, J., ROGERS, K., REICHERT, M., ANDRADE, D.V., ABE, A.S., TATTERSALL, G.J. & MILSOM, W.K. (2015) The relationship between body temperature, heart rate, breathing rate, and rate of oxygen consumption, in the tegu lizard (*Tupinambis merianae*) at various levels of activity. *Journal of Comparative Physiology B* **185**, 891-903.
- PIERON, H. (1913) *Le problème physiologique du sommeil*. Masson.
- PLATEL, P.R. (1975) Nouvelles données sur'encéphalisation des Reptiles Squamates. *Journal of Zoological Systematics and Evolutionary Research* **13**, 161-184.
- PYRON, R.A. & WIENS, J.J. (2011) A large-scale phylogeny of Amphibia including over 2800 species, and a revised classification of extant frogs, salamanders, and caecilians. *Mol Phylogenet Evol* **61**, 543-583.
- QUIROGA, R.Q., NADASDY, Z. & BEN-SHAUL, Y. (2004) Unsupervised spike detection and sorting with wavelets and superparamagnetic clustering. *Neural Computation* **16**, 1661-1687.
- RAIZEN, D.M., ZIMMERMAN, J.E., MAYCOCK, M.H., TA, U.D., YOU, Y., SUNDARAM, M.V. & PACK, A.I. (2008) Lethargus is a *Caenorhabditis elegans* sleep-like state. *Nature* **451**, 569-572.
- RATTENBORG, N.C. (2006a) Evolution of slow-wave sleep and palliopallial connectivity in mammals and birds: A hypothesis. *Brain Research Bulletin* **69**, 20-29.
- RATTENBORG, N.C. (2006b) Do birds sleep in flight? *Naturwissenschaften* **93**, 413-425.

- RATTENBORG, N.C., DE LA IGLESIA, H.O., KEMPENAERS, B., LESKU, J.A., MEERLO, P. & SCRIBA, M.F. (2017) Sleep research goes wild: new methods and approaches to investigate the ecology, evolution and functions of sleep. *Philosophical Transactions of the Royal Society B: Biological Sciences* **372**, 20160251.
- RATTENBORG, N.C., LESKU, J.A., MARTINEZ-GONZALEZ, D. & LIMA, S.L. (2007) The non-trivial functions of sleep. *Sleep Medicine Reviews* **11**, 405–409.
- RATTENBORG, N.C., LIMA, S.L. & AMLANER, C.J. (1999) Half-awake to the risk of predation. *Nature* **397**, 397–398.
- RATTENBORG, N.C., MANDT, B.H., OBERMEYER, W.H., WINSAUER, P.J., HUBER, R., WIKELSKI, M. & BENCA, R.M. (2004) Migratory Sleeplessness in the White-Crowned Sparrow (*Zonotrichia leucophrys gambelii*). *PLoS Biology* **2**, e212.
- RATTENBORG, N.C., MARTINEZ-GONZALEZ, D. & LESKU, J.A. (2009) Avian sleep homeostasis: Convergent evolution of complex brains, cognition and sleep functions in mammals and birds. *Neuroscience & Biobehavioral Reviews* **33**, 253–270.
- RATTENBORG, N.C., MARTINEZ-GONZALEZ, D., ROTH, T.C. & PRAVOSUDOV, V.V. (2011) Hippocampal memory consolidation during sleep: a comparison of mammals and birds. *Biological Reviews* **86**, 658–691.
- RATTENBORG, N.C., VOIRIN, B., CRUZ, S.M., TISDALE, R., DELL'OMO, G., LIPP, H.-P., WIKELSKI, M. & VYSSOTSKI, A.L. (2016) Evidence that birds sleep in mid-flight. *Nature Communications* **7**, 12468.
- RATTENBORG, N.C., VOIRIN, B., VYSSOTSKI, A.L., KAYS, R.W., SPOELSTRA, K., KUEMMETH, F., HEIDRICH, W. & WIKELSKI, M. (2008) Sleeping outside the box: electroencephalographic measures of sleep in sloths inhabiting a rainforest. *Biology Letters* **4**, 402–405.
- RAVASSARD, P., HAMIEH, A.M., JOSEPH, M.A., FRAIZE, N., LIBOUREL, P.-A., LEBARILLIER, L., ARTHAUD, S., MEISSIREL, C., TOURET, M., MALLERET, G. & SALIN, P.-A. (2016) REM Sleep-Dependent Bidirectional Regulation of Hippocampal-Based Emotional Memory and LTP. *Cerebral Cortex* **26**, 1488–1500.
- RECHTSCHAFFEN, A. (1998) Current perspectives on the function of sleep. *Perspectives in Biology and Medicine* **41**, 359–390.
- RECHTSCHAFFEN, A., BASSAN, M. & LEDECKY-JANECEK, S. (1968) Activity patterns in *caiman sclerops*. *Psychophysiology* **5**, 201.
- RECHTSCHAFFEN, A., BERGMANN, B.M., EVERSON, C.A., KUSHIDA, C.A. & GILLILAND, M.A. (1989) Sleep deprivation in the rat: I. Conceptual issues. *Sleep* **12**, 1–4.
- RENOUARD, L., BILLWILLER, F., OGAWA, K., CLEMENT, O., CAMARGO, N., ABDELKARIM, M., GAY, N., SCOTE-BLACHON, C., TOURE, R., LIBOUREL, P.-A., RAVASSARD, P., SALVERT, D., PEYRON, C., CLAUSTRAT, B., LEGER, L., ET AL. (2015) The supramammillary nucleus and the claustrum activate the cortex during REM sleep. *Science Advances* **1**, e1400177–e1400177.
- RIAL, R.V., AKAÂRIR, M., GAMUNDÍ, A., NICOLAU, C., GARAU, C., APARICIO, S., TEJADA, S., GENÉ, L., GONZÁLEZ, J., DE VERA, L.M., COENEN, A.M.L., BARCELÓ, P. & ESTEBAN, S. (2010) Evolution of wakefulness, sleep and hibernation: From reptiles to mammals. *Neuroscience & Biobehavioral Reviews* **34**, 1144–1160.
- RIAL, R.V., NICOLAU, M.C., GAMUNDÍ, A., AKAÂRIR, M., APARICIO, S., GARAU, C., TEJADA, S., ROCA, C., GENÉ, L., MORANTA, D. & ESTEBAN, S. (2007) The trivial function of sleep. *Sleep Medicine Reviews* **11**, 311–325.
- ROFFWARG, H.P., MUZIO, J.N. & DEMENT, W.C. (1966) Ontogenetic development of the human sleep-dream cycle. *Science (New York, N.Y.)* **152**, 604–619.
- ROMO, R., CEPEDA, C. & VELASCO, M. (1978) Behavioral and electrophysiological patterns of wakefulness-sleep states in the lizard *Phrinosoma regali*. *Boletín De Estudios Medicos Y Biologicos* **30**, 13–18.

- ROTH, T.C., LESKU, J.A., AMLANER, C.J. & LIMA, S.L. (2006) A phylogenetic analysis of the correlates of sleep in birds. *Journal of Sleep Research* **15**, 395–402.
- RUTZ, C. & HAYS, G.C. (2009) New frontiers in biologging science. *Biology Letters* **5**, 289–292.
- SANDERS, C.E., TATTERSALL, G.J., REICHERT, M., ANDRADE, D.V., ABE, A.S. & MILSOM, W.K. (2015) Daily and annual cycles in thermoregulatory behaviour and cardio-respiratory physiology of black and white tegu lizards. *Journal of Comparative Physiology B* **185**, 905–915.
- SCHMIDT, M.H. (2014) The energy allocation function of sleep: A unifying theory of sleep, torpor, and continuous wakefulness. *Neuroscience & Biobehavioral Reviews* **47**, 122–153.
- SCHMIDT, M.H., VALATX, J.L., SCHMIDT, H.S., WAUQUIER, A. & JOUVET, M. (1994) Experimental evidence of penile erections during paradoxical sleep in the rat. *Neuroreport* **5**, 561–564.
- SCRIBA, M.F., HARMENING, W.M., METTKE-HOFMANN, C., VYSSOTSKI, A.L., ROULIN, A., WAGNER, H. & RATTENBORG, N.C. (2013a) Evaluation of two minimally invasive techniques for electroencephalogram recording in wild or freely behaving animals. *Journal of Comparative Physiology A* **199**, 183–189.
- SCRIBA, M.F., ROULIN, A., HENRY, I., DUCREST, A.L., VYSSOTSKI, A.L. & RATTENBORG, N.C. (2013b) Mammalian-like rem sleep ontogeny in barn owls in the wild.
- SEELKE, A.M. & BLUMBERG, M.S. (2008) The microstructure of active and quiet sleep as cortical delta activity emerges in infant rats. *Sleep* **31**, 691–699.
- SHEIN-IDELSON, M., ONDRACEK, J.M., LIAW, H.-P., REITER, S. & LAURENT, G. (2016) Slow waves, sharp waves, ripples, and REM in sleeping dragons. *Science* **352**, 590–595.
- SIEGEL, J.M. (2005) Clues to the functions of mammalian sleep. *Nature* **437**, 1264–1271.
- SIEGEL, J.M. (2008) Do all animals sleep? *Trends in Neurosciences* **31**, 208–213.
- SIEGEL, J.M. (2009) Sleep viewed as a state of adaptive inactivity. *Nature Reviews Neuroscience* **10**, 747–753.
- SIEGEL, J.M., MANGER, P.R., NIENHUIS, R., FAHRINGER, H.M. & PETTIGREW, J.D. (1996) The echidna *Tachyglossus aculeatus* combines REM and non-REM aspects in a single sleep state: implications for the evolution of sleep. *J Neurosci* **16**, 3500–3506.
- SIEGEL, J.M., MANGER, P.R., NIENHUIS, R., FAHRINGER, H.M., SHALITA, T. & PETTIGREW, J.D. (1999) Sleep in the platypus. *Neuroscience* **91**, 391–400.
- SIROTA, A. & BUZSÁKI, G. (2005) Interaction between neocortical and hippocampal networks via slow oscillations. *Thalamus and Related Systems* **3**, 245.
- SLATER, I.H., JONES, G.T. & MOORE, R.A. (1978) Inhibition of REM sleep by fluoxetine, a specific inhibitor of serotonin uptake. *Neuropharmacology* **17**, 383–389.
- ŚLAWIŃSKA, U. & KASICKI, S. (1998) The frequency of rat's hippocampal theta rhythm is related to the speed of locomotion. *Brain Research* **796**, 327–331.
- SNYDER, F., HOBSON, J.A., MORRISON, D.F. & GOLDFRANK, F. (1964) Changes in respiration, heart rate, and systolic blood pressure in human sleep. *Journal of Applied Physiology* **19**, 417–422.
- SODAGAR, A.M., PERLIN, G.E., YAO, Y., NAJAFI, K. & WISE, K.D. (2009) An Implantable 64-Channel Wireless Microsystem for Single-Unit Neural Recording. *IEEE Journal of Solid-State Circuits* **44**, 2591–2604.
- STERIADE, M. (1993) Sleep oscillations in corticothalamic neuronal networks and their development into self-sustained paroxysmal activity. *Rom J Neurol Psychiatry* **31**, 151–161.
- STERIADE, M. (2006) Grouping of brain rhythms in corticothalamic systems. *Neuroscience* **137**, 1087–1106.

- STERIADE, M. & MCCARLEY, R.W. (2005) *Brainstem control of wakefulness and sleep* 2nd ed. Plenum Press, New York.
- STICKGOLD, R. (2005) Sleep-dependent memory consolidation. *Nature* **437**, 1272–1278.
- STICKGOLD, R. & WALKER, M.P. (2005) Memory consolidation and reconsolidation: what is the role of sleep? *Trends Neurosci* **28**, 408–415.
- STRIEDTER, G.F. (2016) Evolution of the hippocampus in reptiles and birds. *The Journal of Comparative Neurology* **524**, 496–517.
- SUSIC, V. (1972) Electrographic and behavioral correlations of the rest-activity in the sea turtle *Caretta caretta*. *J Exp Marine Biol Ecol* **10**, 81–87.
- TANG, X. & SANFORD, L. (2002) Telemetric Recording of Sleep and Home Cage Activity in Mice. *Sleep* **25**, 677–685.
- TANG, X., ORCHARD, S.M., LIU, X. & SANFORD, L.D. (2004) Effect of varying recording cable weight and flexibility on activity and sleep in mice. *Sleep* **27**, 803–810.
- TAUBER, E.S., ROFFWARG, H.P. & WEITZMAN, E.D. (1966) Eye movements and electroencephalogram activity during sleep in diurnal lizards. *Nature* **212**, 1612–1613.
- TAUBER, E.S., ROJAS-RAMÍREZ, J. & HERNÁNDEZ PEÓN, R. (1968) Electrophysiological and behavioral correlates of wakefulness and sleep in the lizard, *Ctenosaura pectinata*. *Electroencephalography and Clinical Neurophysiology* **24**, 424–433.
- TISDALE, R.K., LESKU, J.A., BECKERS, G.J.L. & RATTENBORG, N.C. (2018) Bird-like propagating brain activity in anesthetized Nile crocodiles. *Sleep* **41**.
- TOBLER, I. (1995) Is sleep fundamentally different between mammalian species? *Behavioural Brain Research* **69**, 35–41.
- TOBLER, I. (2011) Phylogeny of sleep regulation. In *Principles and Practice of Sleep Medicine* (eds M.H. KRYGER, T. ROTH & W.C. DEMENT), p. Elsevier.
- TOBLER, I. & BORBÉLY, A.A. (1988) Sleep and EEG spectra in the pigeon *Columba livia* under baseline conditions and after sleep deprivation. *Journal of Comparative Physiology A* **163**, 729–738.
- TONONI, G. & CIRELLI, C. (2006) Sleep function and synaptic homeostasis. *Sleep Medicine Reviews* **10**, 49–62.
- TOSCHES, M.A., YAMAWAKI, T.M., NAUMANN, R.K., JACOBI, A.A., TUSHEV, G. & LAURENT, G. (2018) Evolution of pallium, hippocampus, and cortical cell types revealed by single-cell transcriptomics in reptiles. *Science*, eaar4237.
- ULINSKI, P.S. & KANAREK, D.A. (1973) Cytoarchitecture of nucleus sphericus in the common boa, *Constrictor constrictor*. *The Journal of Comparative Neurology* **151**, 159–174.
- VAN TWYVER, H. (1973) Sleep and wakefulness of the american alligator. *Sleep Res* **2**, 87.
- VASILESCU, E. (1970) Sleep and wakefulness in the tortoise *Emys orbicularis*. *Rev Roum Biol Ser Zool* **15**, 177–179.
- VERTES, R.P. (1984) Brainstem control of the events of REM sleep. *Progress in neurobiology* **22**, 241–288.
- VOIRIN, B., SCRIBA, M.F., MARTINEZ-GONZALEZ, D., VYSSOTSKI, A.L., WIKELSKI, M. & RATTENBORG, N.C. (2014) Ecology and Neurophysiology of Sleep in Two Wild Sloth Species. *Sleep* **37**, 753–761.
- VYSSOTSKI, A.L. (2005) Miniature Neurologgers for Flying Pigeons: Multichannel EEG and Action and Field Potentials in Combination With GPS Recording. *Journal of Neurophysiology* **95**, 1263–1273.

- VYSSOTSKI, A.L., DELL'OMO, G., DELL'ARICCIA, G., ABRAMCHUK, A.N., SERKOV, A.N., LATANOV, A.V., LOIZZO, A., WOLFER, D.P. & LIPP, H.-P. (2009) EEG Responses to Visual Landmarks in Flying Pigeons. *Current Biology* **19**, 1159–1166.
- WALKER, J.M. & BERGER, R.J. (1973) A polygraphic study of the tortoise (*Testudo denticulata*). Absence of electrophysiological signs of sleep. *Brain Behav Evol* **8**, 453–467.
- WALKER, J.M., GLOTZBACH, S.F., BERGER, R.J. & HELLER, H.C. (1977) Sleep and hibernation in ground squirrels (*Citellus* spp): electrophysiological observations. *Am J Physiol* **233**, R213–21.
- WALKER, L.E., WALKER, J.M., PALCA, J.W. & BERGER, R.J. (1983) A continuum of sleep and shallow torpor in fasting doves. *Science (New York, N.Y.)* **221**, 194–195.
- WALKER, M.P. (2010) Sleep, memory and emotion. In *Progress in Brain Research* pp. 49–68. Elsevier.
- WARNER, B.F. & HUGGINS, S.E. (1978) An electroencephalographic study of sleep in young caimans in a colony. *Comparative Biochemistry and Physiology Part A: Physiology* **59**, 139–144.
- WEIERGRÄBER, M., HENRY, M., HESCHELER, J., SMYTH, N. & SCHNEIDER, T. (2005) Electrographic and deep intracerebral EEG recording in mice using a telemetry system. *Brain Research Protocols* **14**, 154–164.
- WOLTERS, J.G., DE BOER-VAN HUIZEN, R., TEN DONKELAAR, H.J. & LEENEN, L. (1986) Collateralization of descending pathways from the brainstem to the spinal cord in a lizard, *Varanus exanthematicus*. *J Comp Neurol* **251**, 317–333.
- WOLTERS, J.G., TEN DONKELAAR, H.J., STEINBUSCH, H.W. & VERHOFSTAD, A.A. (1985) Distribution of serotonin in the brain stem and spinal cord of the lizard *Varanus exanthematicus*: an immunohistochemical study. *Neuroscience* **14**, 169–193.
- WONG, D.T., BYMASTER, F.P. & ENGLEMAN, E.A. (1995) Prozac (fluoxetine, Lilly 110140), the first selective serotonin uptake inhibitor and an antidepressant drug: twenty years since its first publication. *Life sciences* **57**, 411–441.
- YIN, M., BORTON, D.A., KOMAR, J., AGHA, N., LU, Y., LI, H., LAURENS, J., LANG, Y., LI, Q., BULL, C., LARSON, L., ROSLER, D., BEZARD, E., COURTINE, G. & NURMIKKO, A.V. (2014) Wireless Neurosensor for Full-Spectrum Electrophysiology Recordings during Free Behavior. *Neuron* **84**, 1170–1182.
- YLINEN, A., BRAGIN, A., NADASDY, Z., JANDO, G., SZABO, I., SIK, A. & BUZSAKI, G. (1995) Sharp wave-associated high-frequency oscillation (200 Hz) in the intact hippocampus: network and intracellular mechanisms. *J Neurosci* **15**, 30–46.
- ZAYACHKIVSKY, A., LEHMKUHLE, M.J., FISHER, J.H., EKSTRAND, J.J. & DUDEK, F.E. (2013) Recording EEG in immature rats with a novel miniature telemetry system. *Journal of Neurophysiology* **109**, 900–911.
- ZEPELIN, H. (2000) Mammalian sleep. In *Principles and practice of sleep medicine* (eds M.H. KRYGER, T.C. ROTH & W.C. DEMENT), pp. 69–80, 3rd edition. Philadelphia.
- ZEPELIN, H. & RECHTSCHAFFEN, A. (1974) Mammalian sleep, longevity, and energy metabolism. *Brain Behav Evol* **10**, 425–470.