



HAL
open science

Une analyse de corpus de l'alternance causative en anglais

Laurence Romain

► **To cite this version:**

Laurence Romain. Une analyse de corpus de l'alternance causative en anglais. Linguistique. Université de Lille, 2018. Français. NNT : 2018LILUH016 . tel-02092787

HAL Id: tel-02092787

<https://theses.hal.science/tel-02092787>

Submitted on 8 Apr 2019

HAL is a multi-disciplinary open access archive for the deposit and dissemination of scientific research documents, whether they are published or not. The documents may come from teaching and research institutions in France or abroad, or from public or private research centers.

L'archive ouverte pluridisciplinaire **HAL**, est destinée au dépôt et à la diffusion de documents scientifiques de niveau recherche, publiés ou non, émanant des établissements d'enseignement et de recherche français ou étrangers, des laboratoires publics ou privés.

UNIVERSITÉ DE LILLE
ÉCOLE DOCTORALE SCIENCES DE L'HOMME ET DE LA SOCIÉTÉ
UMR STL 8163

A CORPUS-BASED STUDY OF THE CAUSATIVE ALTERNATION IN ENGLISH
UNE ANALYSE DE CORPUS DE L'ALTERNANCE CAUSATIVE EN ANGLAIS

Thèse présentée et soutenue publiquement le 5 octobre 2018 par

Laurence ROMAIN

En vue de l'obtention du grade de Docteur des universités

Discipline : SCIENCES DU LANGAGE

COMPOSITION DU JURY:

Maarten LEMMENS, Professeur, Université de Lille, France, *directeur*

Agnès CELLE, Professeure, Université Paris Diderot, France, *rapporteuse*

Guillaume DESAGULIER, Maître de Conférences HDR, Université Paris 8, France,
rapporteur

Beate HAMPE, Professeure, Universität Erfurt, Allemagne

Florent PEREK, Lecturer, University of Birmingham, Royaume-Uni

Gaëtanelle GILQUIN, Professeure, Université Catholique de Louvain

ACKNOWLEDGEMENTS

First and foremost, my deepest gratitude goes to my advisor, Maarten Lemmens, for helping me navigate the waters of PhD life. Maarten took a leap of faith when accepting to supervise my research back in 2013 and I am grateful for it. The mixture of intellectual challenges, trust, and encouragement he provided through the years were essential to the completion of this work. Not only did Maarten give me a warm welcome when I joined the STL lab, but he also proved to be extremely compassionate and understanding when life got in the way. For this, I am truly grateful.

I also want to sincerely thank Agnès Celle, Guillaume Desagulier, Gaëtanelle Gilquin, Beate Hampe, and Florent Perek for accepting to make time in their busy schedules to sit on the jury.

The work presented here would not be the same without the helpful comments of some of my colleagues at STL: Bert Cappelle, Cédric Patin, Dany Amiot, Delphine Tribout, Ilse Depraetere, Chad Langford and Chris Piñon who offered feedback at various stages of this research. I am thankful to Thomas Herbst for his comments and for sharing his work with me during his stay at our university. I would also like to extend my thanks to the staff at STL for all their help with the logistics surrounding PhD life: Edouard Neidenberger, Justin Duquesnoy, Marie-Christine Ismaïel, Nadège Sieckelinck, and Caroline Taillez.

Very special thanks go to Andrew McMichael of the University of Toulouse who first introduced me to cognitive linguistics and construction grammar, and encouraged me to go further.

I am extremely lucky to have shared an office with smart, kind and overall wonderful people who made this adventure a little easier and whom I now count as friends: Pierre Chauveau-Thoumelin, Sequoya Yiaueki, Bertille De Vlieger, Benoît Leclercq, José Duròn, and Jasper Van-gaever.

I am also indebted to Sarah, Kevin, George, Erica, and Gemma who accepted to proofread some of these chapters. To Mathilde, my best friend, and patient listener, thank you.

Finally, I would like to thank my parents for their constant support, their trust, and for believing in me even if they do not know the first thing about linguistics.

ABSTRACT

The present research takes issue with the supposed dichotomy between alternations on the one hand and surface generalisations on the other, within the framework of construction grammar. More specifically the aim of this thesis is threefold. Through the careful analysis of a large dataset, we aim to provide a thorough description of the causative alternation in English (*The fabric stretched* vs. *Joan stretched the fabric*), suggest a method that allows for a solid measure of a verb's alternation strength and of the amount of shared meaning between two constructions, and finally, show that in order to capture constraints at the level of the construction, one must pay attention to lower level generalisations such as the interaction between verb and arguments within the scope of each construction.

In an effort to add to the discussion on alternation vs. surface generalisations, we propose a detailed study of the two constructions that make up the causative alternation: the intransitive non-transitive causative construction and the transitive causative construction. Our goal is to measure the amount of meaning shared by the two constructions and also show the differences between the two. In order to do so we take three elements into account: construction, verb and theme (i.e. the entity that undergoes the event denoted by the verb). We use distributional semantics to measure the semantic similarity of the various themes found with each verb and each construction in our corpus. This grouping highlights the different verb senses used with each construction and allows us to draw generalisations as to the constraints on the theme in each construction.

Keywords: construction grammar, argument structure constructions, alternations, distributional semantics, corpus analysis, verbs, themes

RÉSUMÉ

La présente recherche s'interroge sur la présumée dichotomie entre les alternances et les généralisations de surface dans le cadre théorique de la grammaire de constructions. Plus précisément, l'objectif de cette thèse est ternaire. Par l'analyse attentive d'une grande quantité de données, nous faisons une description détaillée de l'alternance causative en anglais (*The fabric stretched* vs. *Joan stretched the fabric*), nous proposons une méthode qui permet de mesurer la force d'alternance des verbes ainsi que la quantité de sens partagée entre les deux constructions, et, enfin, nous montrons que si l'on veut rendre compte des contraintes au niveau de la construction, l'on doit alors prendre en compte les généralisations de plus bas niveau, telles que les interactions entre le verbe et ses arguments dans le cadre de chaque construction.

Afin d'ajouter au débat entre alternance et généralisations de surface, nous proposons une analyse détaillée des deux constructions qui forment l'alternance causative en anglais : la construction intransitive non-causative d'une part et la construction transitive causative de l'autre. Notre but est de mesurer la quantité de sens partagée par les deux constructions mais aussi de montrer en quoi ces deux constructions diffèrent. Dans cette optique, nous prenons en compte trois éléments: construction, verbe et thème (i.e. l'entité sujette à l'évènement dénoté par le verbe). Nous utilisons la sémantique distributionnelle pour la mesure des similarités sémantiques entre les divers thèmes employés avec chaque verbe dans chaque construction dans notre corpus. Ce groupement sémantique met en lumière les différents sens verbaux employés avec chaque construction et nous permet d'établir des généralisations quant aux contraintes qui s'appliquent au thème dans chaque construction.

Mots-clefs : grammaire de constructions, structures argumentales, alternances, sémantique distributionnelle, analyse de corpus, verbes, thèmes

RÉSUMÉ SUBSTANTIEL EN FRANÇAIS

UNE ANALYSE DE CORPUS DE L'ALTERNANCE CAUSATIVE EN ANGLAIS

Cette thèse propose, par le biais d'une analyse d'un corpus comprenant plus de 10,000 occurrences de la construction intransitive non-causative et de la construction transitive causative, d'évaluer la quantité d'information partagée entre ces deux constructions et d'ajouter au débat entre alternance et généralisations de surface dans le cadre de la grammaire de constructions.

Cette recherche peut être déroulée en trois étapes : (i) une description de l'alternance causative en anglais (*The fabric stretched vs. Joan stretched the fabric*) basée sur un corpus de 11,554 instances de 29 verbes dans ces deux constructions, (ii) une méthode d'analyse qui permet de mesurer la force d'alternance des verbes mais aussi la quantité et le type d'informations partagées par les deux constructions et (iii) une réflexion quant à l'importance des généralisations de bas niveau en complément des généralisations au niveau de la construction schématique.

Pour ce faire, ce travail est divisé en deux parties. Tout d'abord, une partie "cadre théorique" qui propose un état de l'art sur la question des structures argumentales en linguistique cognitive mais aussi une comparaison des postulats de celle-ci avec d'autres approches. Dans cette première partie, nous abordons la question de la place de la construction et de l'organisation du "constructicon" chez les locuteurs.trices de l'anglais. Ensuite, une partie dédiée à l'exposition des données collectées et utilisées pour cette recherche, de la méthode et des techniques utilisées pour mesurer les similarités et différences entre les deux constructions ainsi que des résultats préliminaires et enfin un chapitre dédié à la présentation des résultats obtenus avec la méthode développée ainsi qu'une évaluation générale de cette méthode.

Première partie: le cadre théorique

La première partie de cette thèse est divisée en quatre chapitres. Le chapitre 2 se penche sur les origines cognitives de la grammaire de construction. Le chapitre 3 propose un aperçu de la littérature sur les rôles thématiques ainsi qu'une discussion sur la validité de ces rôles. Le chapitre 4 présente la notion de sens constructionnel et décrit de façon détaillée les deux constructions

composant l'alternance causative. Le chapitre 5 explore la présumée dichotomie entre alternance et généralisations de surface.

La grammaire de construction trouve son origine dans les approches cognitives du langage. Ainsi, les notions fondatrices de cette théorie sont proches de celles qui composent la linguistique cognitive de façon plus générale. Dans le chapitre 2, nous présenterons ces quelques notions, telles que la question des prototypes et des ressemblances de famille. Nous verrons également ce qui définit une construction et comment ces constructions forment un réseau structuré chez les locuteurs et locutrices. Parmi les idées directrices de la grammaire de construction figure la notion selon laquelle les locuteurs.trices choisissent des structures grammaticales qui correspondent à la façon dont est iels conçu l'évènement. Ainsi, et sur la base d'une connaissance de concepts en relation avec une structure de connaissances plus globale, un.e locuteur.trice sait qu'un évènement de type "break" comprend nécessairement un "broken" (i.e. l'entité qui subit l'évènement dénoté par le verbe) mais peut choisir d'inclure ou non la cause de cet évènement, le "breaker." De cette façon, un choix est fait quant aux nombres d'arguments inclus dans la structure argumentale choisie. Si l'on choisit de n'inclure que l'entité qui subit l'évènement dénoté par le verbe, alors on peut employer la construction intransitive non-causative. Si l'on choisit de décrire l'évènement de telle sorte que la cause soit mentionnée, alors on choisit la constructions transitive causative, qui est prototypiquement associée à un évènement de manipulation. Bien sûr, il est possible d'avoir recours à d'autres constructions, notamment le passif, pour décrire les évènements susmentionnés. Cependant, pour ce travail nous nous concentrons sur les constructions intransitive non-causative et transitive causative. La discussion proposée dans le chapitre 2 offre une lecture de deux modèles avancés par Langacker (1991): le modèle dit "billiard ball" et le "stage model" adaptée à l'analyse de l'alternance causative.

Après avoir présenté les grandes lignes de l'état de l'art quant à la question des rôles sémantiques, le chapitre 3 introduit une approche plus constructionnelle de cette question en insistant notamment sur l'importance des généralisations locales lors de l'élucidation des types de rôles trouvés dans les constructions causative et non-causative. Dans ce chapitre nous justifions notre choix quant à l'emploi du terme "thème" pour désigner dans les deux constructions l'entité qui subit l'évènement dénoté par le verbe. Bien que la conceptualisation de l'évènement et du rôle du thème diffère selon la construction choisie, nous préférons une étiquette plus schématique sur l'ensemble et établir des contraintes au niveau de l'interaction entre verbe, construction et thème. Ainsi nous préférons un terme plus global dont les spécificités seront affinées selon le verbe et la construction avec lesquels il est employé.

Sur la base des conclusions du chapitre 3, le chapitre 4 poursuit la définition et délimitation des deux constructions de l'alternance causative : la construction intransitive non-causative et la construction transitive causative. Ainsi, ce chapitre renforce encore l'importance des généralisations locales pour les constructions de structures argumentales. Au-delà de ces considérations, nous évoquons aussi plus en détail ce qui constitue ces constructions; notamment, le type de verbes (verbes qui dénotent un "changement d'état") et le type de thèmes employés soit en position sujet dans la variante intransitive, soit en position object dans la variante transitive. Nous explicitons également les différences entre construction causative et "setting construction," où le

rôle réalisé en position sujet dans une construction transitive ne réfère pas à l'entité responsable de l'évènement.

Dans le chapitre 5, nous comparons différentes approches quant à la question des alternances et des constructions. Plus spécifiquement, nous présentons dans un premier temps les approches centrées sur le verbe, comme l'approche lexicale-projectionniste et la théorie de la valence. Dans un deuxième temps, nous présentons l'hypothèse selon laquelle il vaudrait mieux s'intéresser aux généralisations de surface plutôt qu'à la valence. Dans la discussion, nous montrons que ces deux axes ont des avantages quant à l'étude de certaines alternances. Ainsi, bien que nous défendons une approche constructionnelle des structures argumentales où chaque construction a un sens qui lui est propre, nous croyons aussi que les locuteurs.trices connaissent la valence typique d'un verbe. En prêtant attention aux spécificités de chaque construction mais aussi à ce qui les lie, nous atteignons des conclusions plus réalistes quant à l'organisation des connaissances langagières des locuteurs.trices. C'est précisément cette comparaison que nous effectuons dans la deuxième partie de la thèse.

Deuxième partie: Données, méthodes et résultats

La deuxième partie de cette thèse est divisée en deux chapitres. Tout d'abord, dans le chapitre 6, nous expliquons comment le corpus utilisé pour ce travail a été constitué ; puis, nous décrivons différentes stratégies d'analyse des alternances et fournissons quelques résultats préliminaires avant de présenter la méthode développée pour la présente recherche. Enfin, le chapitre 7 présente les résultats obtenus avec cette méthode pour chaque groupe de verbes et chaque verbe individuellement.

Comme mentionné plus haut, le corpus utilisé pour cette recherche contient 11,554 occurrences de 29 verbes dans deux constructions. Ces occurrences ont été extraites du Corpus Of Contemporary American English (COCA). Ce corpus est très volumineux (plus de 560 millions de mots) et est composé de sources variées qui vont de la retranscription d'émissions de télévision à des articles académiques. De plus, ce corpus est accessible en ligne et propose une interface facile d'utilisation. Cependant, n'étant pas annoté syntaxiquement, il est impossible d'extraire directement des constructions précises. C'est pourquoi nous avons choisi d'extraire un échantillon pour chaque verbe, et d'annoter ensuite manuellement chaque occurrence selon la construction employée. Des 32,355 occurrences extraites, 11,554 correspondaient à l'une ou l'autre construction. Dans ce chapitre sont aussi présentées deux méthodes d'analyse adaptées aux alternances. La première est l'analyse collocationnelle distinctive (Gries and Stefanowitsch 2004). Cette méthode permet de calculer dans quelle mesure un lexème (ici un verbe) est attiré ou repoussé par une construction parmi un choix de deux constructions ou plus. Ainsi, l'on mesure d'une certaine façon la similarité sémantique entre verbes et constructions. Bien que cette méthode permette de classer les verbes selon leur préférence constructionnelle, elle ne permet pas de voir dans quel mesure un verbe alterne réellement entre deux constructions. De plus, notre corpus n'étant qu'un échantillon, il n'est pas entièrement adapté à ce type de mesure. Une autre méthode, proposée par Lemmens (forthc.), consiste à mesurer la force d'alternance des verbes causatifs

en calculant le degré de chevauchement des thèmes employés avec chaque verbe entre les deux constructions. Le raisonnement est le suivant : si un verbe apparaît dans les deux constructions mais avec des thèmes majoritairement différents, alors l'on pourrait considérer que ce verbe a une alternance faible. Si, au contraire, ce verbe apparaît avec une majorité de thèmes similaires dans les deux constructions, alors ce verbe a une alternance forte. Cette méthode est particulièrement intéressante en ce qu'elle propose de prendre en compte le thème dans la description de l'alternance et l'utilise même comme instrument de mesure. Cependant, elle peut être améliorée en changeant quelques paramètres. En effet, cette méthode ne prend pas en compte les similarités sémantiques des thèmes. Imaginons que le verbe *break* apparaisse avec des thèmes tels que *arm*, *ankle*, *leg*, *nose*, *fibula* et *collarbone*. Si par hasard, dans notre corpus seuls *arm* et *leg* n'étaient employés dans la construction intransitive et que *ankle*, *nose* et *fibula* n'apparaissaient que dans la construction transitive, alors il semblerait que le seul thème commun soit *collarbone*. Cependant, on ne peut ignorer la similarité sémantique de tous ces thèmes puisqu'ils font tous référence à des os. Ainsi, en ne prenant pas en compte cette dimension, on passe "à côté" de généralisations qui se jouent dans l'interaction entre verbe et thème. Pour pallier ce manque, nous proposons de grouper les thèmes sémantiquement. Nous pourrions par exemple effectuer ces groupements sur la base de l'intuition (la nôtre ou celles d'autres locuteurs.trices). Cependant, cette méthode s'avèrerait bien trop coûteuse à la fois en termes de temps et d'objectivité. C'est pourquoi nous avons choisi d'utiliser un outil robuste pour la mesure des similarités de sens : la sémantique distributionnelle. La sémantique distributionnelle permet de mesurer la similarité de lexèmes sur la base des collocateurs qu'ils partagent.

Dans le chapitre 7, nous présentons donc en détail les résultats obtenus avec cette méthode. Ces résultats sont présentés d'abord sous forme de tableau pour chaque groupe de verbes. Ces tableaux montrent les différents sens verbaux identifiés pour chaque verbe, que ceux-ci soient employés avec les deux constructions ou seulement l'une ou l'autre de ces constructions. Puis, pour chaque verbe, nous présentons les cartes sémantiques obtenues. Celles-ci permettent de visualiser clairement les différents agglomérats de thèmes jugés similaires. Grâce à ces agglomérats, nous pouvons non seulement identifier différents sens verbaux (puisque ceux-ci sont généralement associés à des groupes de thèmes similaires) mais aussi nous apercevoir que certains sens verbaux ne sont partagés qu'avec certains groupes de thèmes. En effet, certains verbes n'ont qu'un sens (ils sont sémantiquement compacts), mais même ce sens n'est partagé qu'avec certains groupes de lexèmes.

Ces exemples montrent donc l'importance majeure des généralisations de bas niveau et plus spécifiquement du rôle capital joué par les arguments dans les constructions argumentales. De manière plus générale notre méthode permet de bien mettre en avant ce qui fait l'identité de chacune des constructions de l'alternance, mais aussi de montrer ce qu'elles ont en commun. De plus, par le biais d'une analyse aussi détaillée nous parvenons à identifier des contraintes sur le thème selon qu'il est en position sujet ou en position objet.

CONTENTS

List of Figures	12
List of Tables	15
1 Introduction	18
1.1 Research questions	19
1.1.1 A description of the causative alternation	19
1.1.2 A methodology to measure alternation strength and shared meaning	21
1.1.3 Theoretical implications	22
1.2 Structure of the thesis	23
1.2.1 Part 1: The theoretical framework	23
1.2.2 Part 2: Method, data and results	24
I Theoretical framework	26
2 The cognitive background of construction grammar	27
2.1 A brief overview of construction grammars	27
2.2 Prototypes, frames and ICMs	29
2.3 The experiential grounding of event structure	35
3 Arguments, participants and roles	38
3.1 The semantics of roles	38
3.1.1 Agent: a prototype-based category	39
3.1.2 Experiencer, Patient, Theme: semantic and syntactic constraints	43
3.2 The interaction between constructions and roles	50
3.2.1 Mapping from lexical semantics to syntax	50
3.2.2 Constructionist approaches to argument realisation	55

4	Constructional meaning	61
4.1	Lexical rules vs. constructions	61
4.2	A description of the non-causative and the causative constructions	66
5	Alternation or construction?	71
5.1	Alternation vs. surface generalizations	71
5.1.1	Verb-centric approaches	71
5.1.2	Surface generalizations	76
5.2	Inheritance links and allostructions	82
5.2.1	Allostructions	83
5.2.2	Inheritance links: the subpart link	86
II	Method, data and results	89
6	Data and method	90
6.1	Collection and annotation	90
6.1.1	The corpus	90
6.1.2	Defining the scope of each construction	95
6.2	Measuring the alternation strength of causative verbs	99
6.2.1	Distinctive collostructional analysis	99
6.2.2	Theme overlap	104
6.2.3	Semantic grouping of themes	110
7	Evaluation and results	122
7.1	BREAK verbs	124
7.1.1	<i>Break</i>	124
7.1.2	<i>Crack</i>	131
7.1.3	<i>Crush</i>	136
7.1.4	<i>Shatter</i>	139
7.1.5	<i>Snap</i>	143
7.1.6	<i>Tear</i>	147
7.2	BEND verbs	150
7.2.1	<i>Bend</i>	151
7.2.2	<i>Crease</i>	155
7.2.3	<i>Crinkle</i>	159
7.2.4	<i>Crumple</i>	162
7.2.5	<i>Fold</i>	166
7.2.6	<i>Wrinkle</i>	170
7.3	ROLL verbs	173
7.3.1	<i>Roll</i>	175
7.3.2	<i>Drop</i>	181

7.3.3	<i>Move</i>	188
7.3.4	<i>Slide</i>	190
7.3.5	<i>Turn</i>	193
7.4	GROW verbs	200
7.4.1	<i>Grow</i>	200
7.4.2	<i>Expand</i>	205
7.4.3	<i>Increase</i>	209
7.4.4	<i>Proliferate</i>	212
7.4.5	<i>Stretch</i>	216
7.4.6	<i>Thicken</i>	221
7.5	CHANGE OF TEMPERATURE verbs	227
7.5.1	<i>Burn</i>	229
7.5.2	<i>Chill</i>	234
7.5.3	<i>Cool</i>	239
7.5.4	<i>Freeze</i>	243
7.5.5	<i>Heat</i>	248
7.5.6	<i>Warm</i>	252
7.6	General evaluation	256
8	Conclusion	261
8.1	Summary	261
8.2	A corpus-based description of the causative alternation	263
8.3	A method for the analysis of alternations	263
8.4	Theoretical implications	264
8.5	Research prospects	265

LIST OF FIGURES

2.1	The symbolic structure of a construction (Croft and Cruse 2004: 258)	28
3.1	Basic thematic roles (Langacker 1991: 288)	45
3.2	Participant roles and argument roles (Goldberg 1995)	58
3.3	Mismatches of roles: <i>sneeze</i> and the caused-motion construction (Goldberg 1995: 54)	58
4.1	The transitive construction (Goldberg 1995)	66
4.2	The action chain (adapted from Langacker 1991)	67
4.3	The canonical event model (adapted from Langacker 1991)	68
4.4	Complex event conception (Lemmens 1998: 33)	70
5.1	The transitive verb-particle constructions with its two allostructions (Cappelle 2006: 18)	83
5.2	The locative constructeme and its allostructions (Perek 2015: 162)	85
5.3	Subpart link (Goldberg 1995: 78)	87
5.4	Subpart link (adapted)	87
6.1	Theme Overlap in percent	108
6.2	A semantic map of the themes that occur with <i>freeze</i> in the intransitive non- causative construction	121
6.3	A semantic map of the themes that occur with <i>freeze</i> in the transitive causative construction	121
7.1	Themes that occur with <i>break</i> in the intransitive non-causative construction . . .	127
7.2	Themes that occur with <i>break</i> in the transitive causative construction	128
7.3	Themes that occur with <i>crack</i> in the intransitive non-causative construction . . .	132
7.4	Themes that occur with <i>crack</i> in the transitive causative construction	133
7.5	Themes that occur with <i>crush</i> in the transitive causative construction	137
7.6	Themes that occur with <i>shatter</i> in the intransitive non-causative construction . .	140
7.7	Themes that occur with <i>shatter</i> in the transitive causative construction	141

7.8	Themes that occur with <i>snap</i> in the intransitive non-causative construction . . .	144
7.9	Themes that occur with <i>snap</i> in the transitive causative construction	145
7.10	Themes that occur with <i>tear</i> in the intransitive non-causative construction	148
7.11	Themes that occur with <i>tear</i> in the transitive causative construction	149
7.12	Themes that occur with <i>bend</i> in the intransitive non-causative construction . . .	153
7.13	Themes that occur with <i>bend</i> in the transitive causative construction	154
7.14	Themes that occur with <i>crease</i> in the intransitive non-causative construction . . .	157
7.15	Themes that occur with <i>crease</i> in the transitive causative construction	158
7.16	Themes that occur with <i>crinkle</i> in the intransitive non-causative construction . .	160
7.17	Themes that occur with <i>crinkle</i> in the transitive causative construction	161
7.18	Themes that occur with <i>crumple</i> in the intransitive non-causative construction . .	163
7.19	Themes that occur with <i>crumple</i> in the transitive causative construction	164
7.20	Themes that occur with <i>fold</i> in the intransitive non-causative construction	167
7.21	Themes that occur with <i>fold</i> in the transitive causative construction	168
7.22	Themes that occur with <i>wrinkle</i> in the intransitive non-causative construction . .	171
7.23	Themes that occur with <i>wrinkle</i> in the transitive causative construction	172
7.24	Themes that occur with <i>roll</i> in the intransitive non-causative construction	179
7.25	Themes that occur with <i>roll</i> in the transitive causative construction	180
7.26	Themes that occur with <i>drop</i> in the intransitive non-causative construction . . .	183
7.27	Themes that occur with <i>drop</i> in the transitive causative construction	184
7.28	Themes that occur with <i>move</i> in the intransitive non-causative construction . . .	191
7.29	Themes that occur with <i>move</i> in the transitive causative construction	192
7.30	Themes that occur with <i>slide</i> in the intransitive non-causative construction	194
7.31	Themes that occur with <i>turn</i> in the intransitive non-causative construction	198
7.32	Themes that occur with <i>turn</i> in the transitive causative construction	199
7.33	Themes that occur with <i>grow</i> in the intransitive non-causative construction . . .	203
7.34	Themes that occur with <i>grow</i> in the transitive causative construction	204
7.35	Themes that occur with <i>expand</i> in the intransitive non-causative construction . .	206
7.36	Themes that occur with <i>expand</i> in the transitive causative construction	207
7.37	Themes that occur with <i>increase</i> in the intransitive non-causative construction . .	210
7.38	Themes that occur with <i>increase</i> in the transitive causative construction	211
7.39	Themes that occur with <i>proliferate</i> in the intransitive non-causative construction .	214
7.40	Themes that occur with <i>proliferate</i> in the transitive causative construction	215
7.41	Themes that occur with <i>stretch</i> in the intransitive non-causative construction . .	217
7.42	Themes that occur with <i>stretch</i> in the transitive causative construction	218
7.43	Themes that occur with <i>thicken</i> in the intransitive non-causative construction . .	223
7.44	Themes that occur with <i>thicken</i> in the transitive causative construction	224
7.45	Themes that occur with <i>burn</i> in the intransitive non-causative construction . . .	230
7.46	Themes that occur with <i>burn</i> in the transitive causative construction	231
7.47	Themes that occur with <i>chill</i> in the intransitive non-causative construction	235
7.48	Themes that occur with <i>chill</i> in the transitive causative construction	236

7.49	Themes that occur with <i>cool</i> in the intransitive non-causative construction	240
7.50	Themes that occur with <i>cool</i> in the transitive causative construction	241
7.51	Themes that occur with <i>freeze</i> in the intransitive non-causative construction . . .	244
7.52	Themes that occur with <i>freeze</i> in the transitive causative construction	245
7.53	Themes that occur with <i>heat</i> in the intransitive non-causative construction	249
7.54	Themes that occur with <i>heat</i> in the transitive causative construction	250
7.55	Themes that occur with <i>warm</i> in the intransitive non-causative construction . . .	253
7.56	Themes that occur with <i>warm</i> in the transitive causative construction	254

LIST OF TABLES

6.1	Labels and constructions	92
6.2	Overview of data sample	93
6.3	Overview of BREAK verbs	93
6.4	Overview of BEND verbs	94
6.5	Overview of ROLL verbs	94
6.6	Overview of GROW verbs	95
6.7	Overview of CHANGE OF TEMPERATURE verbs	95
6.8	The distribution of <i>break</i> in the intransitive non-causative and the transitive causative constructions	101
6.9	Results of the distinctive collexeme analysis	102
6.10	Frequency of ROLL verbs in the motion constructions and (non-)causative constructions	103
6.11	Theme overlap	107
6.12	Paradigmatic vs. syntagmatic relations (Sahlgren 2008: 39)	115
6.13	Ten occurrences of <i>dress</i> and <i>shirt</i> extracted from COCA	117
6.14	Co-occurrence matrix for <i>dress</i> and <i>shirt</i>	118
7.1	BREAK verbs: shared and construction-specific verb senses	125
7.2	Characteristics of <i>break</i>	126
7.3	Characteristics of <i>crack</i>	131
7.4	Characteristics of <i>crush</i>	136
7.5	Characteristics of <i>shatter</i>	139
7.6	Characteristics of <i>snap</i>	143
7.7	Characteristics of <i>tear</i>	147
7.8	BEND verbs: shared and construction-specific verb senses	151
7.9	Characteristics of <i>bend</i>	152
7.10	Characteristics of <i>crease</i>	155
7.11	Characteristics of <i>crinkle</i>	159

7.12	Characteristics of <i>crumple</i>	165
7.13	Characteristics of <i>fold</i>	166
7.14	Characteristics of <i>wrinkle</i>	170
7.15	ROLL verbs: shared and construction-specific verb senses	174
7.16	Characteristics of <i>roll</i>	175
7.17	Characteristics of <i>drop</i>	182
7.18	Instances of <i>drop</i> with <i>temperature</i> and <i>price</i> in COCA	182
7.19	Characteristics of <i>move</i>	188
7.20	Characteristics of <i>slide</i>	190
7.21	Characteristics of <i>turn</i>	195
7.22	GROW verbs: shared and construction-specific verb senses	201
7.23	Characteristics of <i>grow</i>	202
7.24	Characteristics of <i>expand</i>	208
7.25	Characteristics of <i>increase</i>	209
7.26	Characteristics of <i>proliferate</i>	213
7.27	Characteristics of <i>stretch</i>	216
7.28	Characteristics of <i>thicken</i>	222
7.29	CHANGE OF TEMPERATURE verbs: shared and construction-specific verb senses	228
7.30	Characteristics of <i>burn</i>	229
7.31	Characteristics of <i>chill</i>	237
7.32	Characteristics of <i>cool</i>	239
7.33	Characteristics of <i>freeze</i>	243
7.34	Characteristics of <i>heat</i>	248
7.35	Characteristics of <i>warm</i>	252

*“Language once again successfully resists
the attempts of linguists to make it neat and clean.”*

WILLIAM CROFT

CHAPTER 1

INTRODUCTION

Recently, cognitive linguistics (and construction grammar) has taken a turn toward more usage-based approaches, thus relying on large datasets to build linguistic theories. This work on the causative alternation in English follows this general trend, with a corpus-based approach to the question of alternations and generalisations. The present research has three goals: (i) provide a thorough description of the constructions involved in the causative alternation in English, (ii) offer a method to measure a verb's alternation strength and the amount of meaning shared by two constructions and (iii) add to the discussion on constructional meaning via lower-level generalisations.

Although it focuses specifically on causative verbs (roughly, verbs that denote a “change of state”), the method suggested here can be applied to virtually any verb that alternates between two or more argument structure constructions. Notably, this research follows the steps of Lemmens (1998) who took up a lexical-paradigmatic approach to causative verbs and the constructions they are used in combination with. Close to the ideas of various (early) construction grammarians (Fillmore, Kay, and O'Connor 1988; Goldberg 1995; Kay 1984, 1988; Kay and Fillmore 1999; Lakoff 1987) and cognitive grammar (Langacker 1987, 1991), Lemmens defended a conception of grammar that took both lexical items and more schematic constructions (syntactic patterns) into account and tore down the imaginary wall between grammar and the lexicon.

While Lemmens (1998, 2006) provided much of the inspiration for this research, it was also motivated by a will to measure some of the tenets of construction grammar against relatively large amounts of corpus data. Defending a usage-based approach, where actual language in large quantities is assumed to be essential to our understanding of the mechanisms underlying the storage and production of language, this thesis aims to support and reinforce some of the claims made within the larger framework of cognitive linguistics by analysing systematically a substantial quantity of data points.

1.1 Research questions

1.1.1 A description of the causative alternation

One of the reasons why we undertook this research is an effort to add to the discussion on alternating constructions in construction grammar, where it is often posited that constructions have meaning of their own and that the alternation itself does not play as important a role as may be believed by other approaches such as generative grammar (Chomsky 1965) or lexical-projectionist approaches (Levin 1993). We believe that in order to assess the role played by argument structure alternations in the mind of speakers, it is important to look closely at the data and evaluate to what extent meaning is shared between two alternants, as was done by Cappelle (2006) and Perek (2015), for example. In order to reach this goal, we compared two argument structure constructions that share certain elements. That is, many causative verbs are known to alternate between an intransitive and a transitive construction. What is more, one of the participants of the event denoted by the verb is shared. This participant, which has been given several names in the literature but which we call “theme” is the participant that undergoes the event denoted by the verb. It is found in subject position in the intransitive non-causative construction and in object position in the transitive causative construction.

Since one of our aims was to provide a description of the causative alternation we set out to analyse instances of both the intransitive non-causative construction, illustrated with the example in (1) and the transitive causative construction, as shown in example (2).¹

- (1) [...] and return it to normal after **mixture** has *frozen*.
- (2) Cover and *freeze* **mixture** 1 hour or until frozen around the edges.

There are many verbs that can be found with these two constructions: Levin (1993) counts 355 verbs that enter the causative alternation. It is beyond the scope of this thesis to analyse 355 different verbs thoroughly. Therefore we decided to focus on 29 verbs out of the list of 355 verbs proposed by Levin. These verbs are grouped into five different sets, provided below. The first three were identified by Levin (1993) and the last two we created ourselves based on their supposed semantic similarity. The verbs that make up these two sets were put together in the category “other verbs of change of state” by Levin.

- (3) Verbs and verb groups used for this research:
 - a. BREAK verbs: *break, crack, crush, shatter, snap* and *tear*
 - b. BEND verbs: *bend, crease, crinkle, crumple, fold* and *wrinkle*
 - c. ROLL verbs: *roll, drop, move, slide* and *turn*
 - d. GROW verbs: *grow, expand, increase, proliferate, stretch* and *thicken*
 - e. CHANGE OF TEMPERATURE verbs: *burn, chill, cool, freeze, heat* and *warm*

¹Both examples come from the Corpus of Contemporary American English, also known as COCA (Davies 2008-).

We decided to put GROW verbs together because they all denote a change in the size of the undergoer. As to the last set, as its name suggests, it is made up of verbs that denote a change of temperature. While this obviously does not cover the entire scope of the causative alternation, the set of verbs analysed is quite varied: they describe fairly different types of events and are thus already a good indication of the mechanisms at play in the two constructions which compose the alternation. This set of 29 verbs served as the basis for our investigation of the causative alternation and of each construction individually. We extracted 32,355 instances of these verbs from the Corpus of Contemporary American English, which we then annotated manually for construction. In this sample, we identified 11,554 instances of the intransitive non-causative construction and the transitive causative construction combined.

As we will argue throughout this thesis, a careful look at the data is essential when one wants to provide a description of a linguistic phenomenon. The constitution of a relevant and substantial corpus is one of the first steps in this direction. It allows a description of linguistic phenomena at different levels of generalisation : by studying a wide and varied array of instances of one or more argument structure constructions, one can identify item-specific constraints, verb-class constraints and even, abstracting away from individual instances, constraints at the level of the schematic argument structure construction itself.

This research will present examples of constraints at these various levels. For example, in the instances presented in (1) and (2), one argument is shared: *mixture* and it undergoes the same change of state (denoted by the verb *freeze*) in each example; thus, it goes from “not frozen” to “frozen.” However, while going through the data we found that some themes are not shared, as exemplified in (4) and (5).

- (4) I *stretch* the **truth** a smidge, or, you know, something like that.
 (5) *The **truth** *stretches* (a smidge)

It quickly became clear that a vast majority of the verbs we chose were much more frequent in one construction or the other, thus already showing a substantial difference in their distribution between the two constructions. We also wanted to add one level of description in the behaviour of argument structure constructions. That is, in construction grammar, the analyses of argument structure constructions (and maybe more specifically of alternating argument structure constructions) usually revolve around one slot in the construction, that taken up by the verb (Croft 2003; Goldberg 1995; Gries and Stefanowitsch 2004; Perek 2014; Stefanowitsch and Gries 2003, among others). To counterbalance this, we decided to describe the kinds of themes found either in subject position in the intransitive non-causative construction and/or in object position in the transitive causative construction. This adds considerably to the description of the mechanisms underlying these two constructions but is also the basis for the method we propose to measure the alternation strength of verbs that occur in these constructions, which we describe in the next section.

1.1.2 A methodology to measure alternation strength and shared meaning

As already mentioned, among the verbs that we chose for this analysis, a majority are found with both constructions, albeit with varying frequency. Although it is possible to measure whether a verb is significantly attracted to one construction or the other (or none) via distinctive collexeme analysis (Gries and Stefanowitsch 2004) and thus also which construction selects which verbs, this measure does not provide information as to the “alternation strength” of verbs (Lemmens *forthc.*). That is, while it is interesting to see which construction recruits which verbs (thus already providing considerable insight into constructional meaning), it would also be interesting to measure to what extent a verb is shared by the two constructions. We know that all verbs selected for this research alternate, but we do not know how much and, most importantly how. Lemmens (*forthc.*) proposes a method where the theme is taken into account. The motivation behind this measure is as follows. We know that certain themes are restricted to one construction (when used in combination with a given verb), such as *truth* with *stretch*. By the same token, a theme such as *law* is restricted to the transitive construction when used in combination with *break*, as illustrated below:

- (6) I have never *broken* a **law** in my life.
- (7) *A **law** has never *broken*

Now, imagine this was true of a vast majority of themes. If there are only a minority of themes that are shared by the two constructions, then one could conclude that describing these two constructions as an alternation would not be relevant since they would then share very little meaning. On the other hand, if many themes are shared, then it makes more sense to posit the alternation. Thus, the method proposed by Lemmens (*forthc.*) is a measure of “theme overlap,” which counts the number of themes that are restricted to one construction or the other and the number of themes that are shared.

This measure is the first step towards a measure of a verb’s alternation strength and of the amount of meaning shared by the two constructions. However, since the themes are taken at face value, we may miss an aspect of the issue. For example, it may be the case that a verb appears to have a lower alternation strength, i.e. a very limited number of themes are shared by the two constructions, but this may be biased by the semantic similarity of certain themes. More specifically, in a given corpus, a verb such as *break* may have, among its themes *arm*, *ankle*, *leg*, *nose*, *fibula* and *collarbone*. If it were the case that in this particular sample corpus it turns out that *arm* and *leg* only occur with the transitive causative construction and *ankle*, *nose* and *fibula* only with the intransitive non-causative construction, then it would mean that the only shared theme is *collarbone*. However, we know that all these themes refer to bones. Therefore, it would be more relevant to pay attention to themes as members of a semantic group composed of semantically similar themes.

One common method to group themes semantically is speakers’ intuitions; however, similarity judgements based on similarity have two flaws: they are time-consuming and most importantly, they may be biased. Therefore we decided to use a more reliable method: distributional semantics,

which is an excellent tool to organise lexemes into semantically similar clusters. The grouping of themes into semantically similar clusters is an essential step in our method. Not only does it take themes into account, but it also measures their semantic similarity and thus facilitates the identification of various verb senses. As we will see, different verb senses are associated with different clusters of semantically related themes. The identification of various verb senses shows some discrepancies in the distribution of these senses between the two constructions and it also paves the way towards the identification of a proper constructional meaning for each construction in the alternation, which is a central concern in constructionist approaches to language.

1.1.3 Theoretical implications

Argument structure constructions are a central topic in construction grammar, and their meaning is usually defined by means of a schematic event which is directly related to a central, prototypical meaning inherited from the verbs that occur the most frequently with these constructions. Goldberg (1995) is a good example of such an approach. Goldberg posits that a construction has a central meaning and extensions that are related to this prototype via polysemy links (Goldberg 1995: 74-77) which she illustrates with the various senses associated with various realisations of the ditransitive construction. This particular construction, Goldberg argues, has a central sense X CAUSES Y TO RECEIVE Z of which senses such as X ENABLES Y TO RECEIVE Z and X INTENDS Y TO RECEIVE Z are extensions.

These assumptions are confirmed for a certain number of constructions by Stefanowitsch and Gries (2003) who show the link between constructional meaning and verbs' attraction to a particular construction through the analysis of two argument structure constructions, the *into*-causative (as in *They tricked her into buying their product*) and the ditransitive construction (among other more or less schematic constructions). Then, Croft (2003) argues in favour of positing verb-class and verb-based argument structure constructions in an effort to "reconcile" constructions and lexical rules. Perek (2014), using the same approach as Stefanowitsch and Gries (2003), namely collexeme analysis, also argues in favour of positing verb-class constructions for the conative construction, e.g. *She kicked at the ball* for which he identifies several semantic classes of verbs that are each represented by a prototypical verb, among which verbs of "cutting", verbs of "striking" and verbs of "pulling."

Drawing from these analyses and tools, we propose to go even further into the decomposition of constructional meaning and argument structure constructions and, using the method we developed and described in the previous section, we go below the level of the verb or verb-class and focus on the interaction between the construction, the verb and, most importantly, the themes. Taking not only themes into account, but also their semantic similarity should allow us to identify collocation-based generalisations which are either related to one verb sense or that show how constructional meaning interacts with verb senses to constrain the use of certain themes in a given construction. With this research, we reinforce the hypothesis that adding a level of granularity to the analysis of argument structure constructions is essential to the proper identification of constructional meaning. As such, this research adds both to the hypothesis of

surface generalisations proposed by Goldberg (2002) but also to the discussion on the role of the alternation in speakers' knowledge of their language by showing the amount of information that is specific to each construction and that which is shared by the two constructions.

1.2 Structure of the thesis

This thesis is divided into two main sections. The first presents our theoretical framework, including a description of its background and its current state with regard to research on argument structure constructions and alternations. The second part provides a detailed description of the data and method used for this research and a fine-grained analysis of the data together with the results obtained from our method of analysis, an evaluation of these results and some general conclusions as to the status of the causative alternation in English.

1.2.1 Part 1: The theoretical framework

The first part of this thesis is divided into four chapters: Chapter 2 presents the cognitive background of construction grammar, Chapter 3 discusses the question of arguments and thematic roles, Chapter 4 introduces the notion of constructional meaning and offers a detailed description of the two constructions analysed for this research and finally, Chapter 5 explores the supposed dichotomy between alternations and constructions.

Construction grammar is a theory that finds its roots in cognitive approaches to language. In Chapter 2 we will provide a definition of what counts as a construction and show that constructions are stored in a structured inventory sometimes called the "constructicon," where there is a continuity between syntax and the lexicon. Among the key concepts that shape today's construction grammar are prototype effects (Rosch 1973) and family resemblances (Wittgenstein 1953). We will see how these interact with argument structure constructions, and how it allows us to posit hypotheses with regard to the instantiation of the constructions of the causative alternation. For example, how certain semantically similar themes behave in the same way. As to the question of argument structure constructions, it is grounded in two different yet compatible theories: the concept of "frame semantics" developed by Fillmore (1977) and the notion that our organisation of event structure is grounded in our experience of the world.

In Chapter 3 we will briefly present two prototypical thematic roles, namely agent and patient and show how traditional thematic roles may be problematic for the description of actual language data, notably with the alternative construction. Through this chapter we will discuss the role found in both the intransitive non-causative construction and the transitive causative construction: the theme. Our notion of theme is, among other things, based on Langacker's concept of thematic relationship, which is centred around the theme participant (Langacker 1991). We will then move on to an overview of constructional approaches to the argument realisation and insist on the importance of local generalisations, following Lemmens's argument that "a unified description of the grammar of processes and events requires the inclusion of a lexical perspective" (Lemmens 1998: 47) and the basic assumption in construction grammar that any

participant role of a verb must be construable as an instance of the more general argument role of the construction (Goldberg 1995).

This interaction between elements of the construction and the construction itself will be investigated further in Chapter 4, where we will explore the supposed dichotomy between lexical rules and constructions (Croft 2003). We will then offer a detailed description of the intransitive non-causative construction and the transitive causative construction, which we will allow us to show some of the differences and common properties of these two constructions.

The differences between the two constructions will lead us to Chapter 5, where we will evaluate different approaches to the question of alternating argument structure constructions. We will first discuss approaches that are centred around the verb, namely lexical-projectionist approaches (Levin 1993) and valency approaches (Herbst and Schüller 2008). These approaches will be measured against the proposed status of surface generalisations defended by Goldberg (2002). Finally, we will compare two potential links between the two constructions: allostructions on the one hand (Cappelle 2006) and a subpart link on the other (Goldberg 1995).

1.2.2 Part 2: Method, data and results

The second part of this work revolves around the data. It is divided into two chapters. Chapter 6 provides an overview of the data, a presentation of the method and results from previously proposed methods. Chapter 7 makes up the bulk of this research and is a presentation of the results obtained from the method we developed followed by an evaluation of this method.

The first chapter of this section starts with an explanation of how the data were chosen and collected (Section 6.1). As mentioned before, our research is centred around 29 verbs of change of state, divided into five semantically related groups. As to the collection of these data, we decided to use a large corpus (the Corpus of Contemporary American English), which has the advantage of being made up of various types of documents (from transcriptions of spoken language to academic papers) and of being available online. The user-friendly interface allows precise queries. However, since this corpus is not tagged for syntax, one has to extract somewhat “raw” data. We will show in this chapter how this affects the number of data points.

Still in Chapter 6, we describe two methods that deal with alternations: first, distinctive collocation analysis (Gries and Stefanowitsch 2004), which offers a measure of attraction between lexemes and two competing constructions, in Section 6.2.1 and theme overlap (Lemmens *forthc.*), which measures the overlap of themes between uses of a verb in two constructions, in Section 6.2.2. Finally, and drawing from these methods we will present the tool that we use to implement our method: distributional semantics (Lenci 2008). Distributional semantics uses corpus data and statistical methods to measure the semantic similarity of lexemes.

Thanks to distributional semantics, and as presented in Chapter 7, we organise themes found with each verb in each construction into semantically similar clusters. These clusters give rise to different verb senses for a given verb, or, especially if the semantic scope of the verb is limited to one sense, it shows discrepancies in the distribution of themes between the two constructions, if there are any. This chapter provides a description of the results obtained for each verb group and

each verb. The chapter is structured around (i) each verb group and (ii) each individual verb. This chapter is concluded by a general evaluation of the method and the results obtained (Section 7.6).

Finally, Chapter 8 presents a summary of the present research and a broader conclusion centred around the three dimensions of this research: descriptive, methodological and theoretical. It also outlines potential further research which could improve and/or complement the present work.

PART I
THEORETICAL FRAMEWORK

CHAPTER 2

THE COGNITIVE BACKGROUND OF CONSTRUCTION GRAMMAR

This research takes a constructionist approach to language, thus adopting many of the claims made in construction grammar(s), and more broadly in cognitive linguistics. We will start this chapter with a (very) brief overview of some of the main tenets of construction grammar(s) (Section 2.1), and will then explore in more detail the cognitive background of this theory, navigating principles such as prototype theory, frame semantics, and idealised cognitive models (ICMs) (Section 2.2). Finally, we will focus on the experiential grounding of event structure (Section 2.3).

2.1 A brief overview of construction grammars

Construction grammar emerged in the late 1980's with major works such as Fillmore (1988), Fillmore, Kay, and O'Connor (1988), Kay (1984, 1988), and Lakoff (1987). Two branches of construction grammar developed in parallel: Berkeley Construction Grammar (taking its name from the corresponding university) on the one hand and Langacker's own version of cognitive grammar (Langacker 1987, 1991). Construction grammarians stood against so-called Chomskyan approaches to language and notably against the notion of a clear division of labour between the syntax on the one hand (syntactic rules) and the lexicon on the other. They instead argued that grammatical constructions, then defined as "any syntactic pattern which is assigned one or more conventional functions in a language, together with whatever is conventionalized about its contribution to the meaning or the use of structures containing it" (Fillmore 1988: 36) should be given a central place in the study of language. This approach blurred the border between syntax and the lexicon, notably by focusing on partially lexically filled idioms and syntactic structures. The definition of what counts as a construction has since then evolved and become broader.¹ One of the definitions

¹Although there are linguists who distinguish between constructions and "patterns of coining," on the grounds that the former is productive whereas the latter is not. See for example Kay (2013) for this point of view and Desagulier (2016) for a usage-based discussion.

that stood out particularly is that of Goldberg (1995): “C is a CONSTRUCTION iff_{def} C is a form-meaning pair $\langle F_i, S_i \rangle$ such that some aspect of F_i or some aspect of S_i is not strictly predictable from C’s component parts or from other previously established constructions” (Goldberg 1995: 4). This particular definition excludes expressions whose meaning can be seen as componential; however, Goldberg later changed her definition. In Goldberg (2006), the definition is extended to include patterns that are fully predictable “as long as they occur with sufficient frequency” (Goldberg 2006: 5) and thus Goldberg concluded: “it’s constructions all the way down” (Goldberg 2006: 18). Croft (2001), while agreeing with the main principles of Berkeley and “Goldbergian” construction grammars, goes even further and argues that syntactic categories only exist in relation to constructions, and not the other way around.

Overall, constructionist linguists agree that a construction is a pairing of form and meaning, similar to Saussure’s linguistic sign (Saussure 1916/1995). Therefore, a construction is a symbolic unit, as represented in Figure 2.1, borrowed from Croft and Cruse (2004: 258).

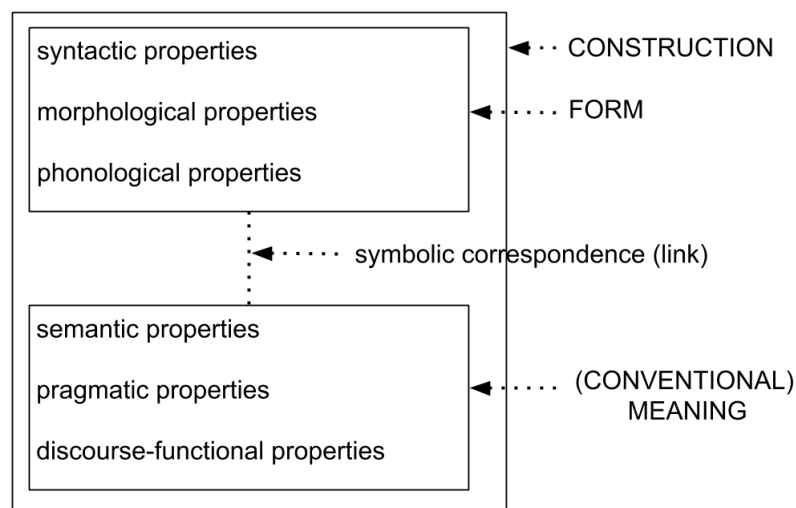

Figure 2.1: The symbolic structure of a construction (Croft and Cruse 2004: 258)

As is visible from Figure 2.1, the form (the syntactic, morphological and phonological properties) of a construction is associated to its (conventional) meaning (semantic, pragmatic and discourse-functional properties) via a symbolic correspondence link in the same way that the *signifiant* is associated with the *signifié* in Saussure (1916/1995). This definition applies to a wide variety of elements of language, from the word, e.g. *wombat*, to more schematic constructions such as [*the X-er, the Y-er*], e.g. *the older, the wiser*. All these constructions constitute what is often referred to as the “constructicon” (Jurafsky 1992), which is a structured inventory of linguistic knowledge (Langacker 1987: 73).

Following the main assumptions of cognitive linguistics, construction grammarians posit that “knowledge of language is knowledge” (Goldberg 1995: 5). Therefore, language is part of a wider array of cognitive abilities. The next two sections will focus on the cognitive mechanisms associated with language and explore the cognitive background of construction grammar.

2.2 Prototypes, frames and ICMS

While exploring constructional meaning it is essential to pay attention to the mechanisms that underlie the organisation of linguistic knowledge. Lakoff claims that “we organize our knowledge by means of structures called *idealized cognitive models*, or ICMS, and that category structures and prototype effects are by-products of that organization.” (Lakoff 1987: 68). To better understand what Lakoff means, we will start by presenting the theory known as “prototype theory” and its main claims (Rosch 1973).

It is widely agreed that categorisation is one of our most basic cognitive activities as humans: we organise our knowledge of the world into categories, for example, we know that a cat is a member of the category **ANIMAL**. Our ability to construe a cat as an instantiation of the category **ANIMAL** comes from our ability to categorise and to organise our experience of the world in kinds of things that can be grouped into a larger and more abstract category, such as **ANIMAL**. This type of mental construct is called a “conceptual category”—these categories are cognitive tools which Croft and Cruse claim have at least four different functions: learning, planning, communication and economy (Croft and Cruse 2004: 74). In what is known as the classical model of category structure, categories are based on sets of necessary and sufficient features. Members of a category need to exhibit a certain number of necessary features to be part of a category and an entity that exhibits a certain number of sufficient features will automatically be a member of a corresponding conceptual category. Although formerly widely accepted, this theory has now been discarded by many researchers, following work by Wittgenstein on “family resemblances” (Wittgenstein 1953), which then influenced the work of Rosch (1973, 1978/2004), whose prototype theory will be discussed in more detail in this section.

One of the first scholars to point out the inadequacies of the classical theory of categorisation (sets of necessary and sufficient features, clear-cut boundaries) was Wittgenstein (1953) who showed, via a description of the category **GAME**, that there actually were major flaws in the classical theory. He explains that while there are many things that we call *game*, it is extremely difficult, even impossible, to find features that are common to all of them. Rather, he argues, these various items such as chess, poker and ring-a-ring-of-roses are related by what he calls “family resemblances” in much the same way that members of a family resemble one another. That is to say, members of a family do not usually share a fixed set of common features: for example, some will have dark hair and blue eyes, while others will have blue eyes but blond hair, some will be tall and sturdy, while others will be short and sturdy. In this sense, family members share many or few of these features, but rarely all of them. Members of the category **GAME** exhibit the same kind of family resemblances. Some games are fun and not competitive, some are competitive but a large part is left to chance (such as board games with a roll of the dice), some involve physical activity such as tennis, while others mostly rely on wit, such as chess. As Lakoff puts it: “games, like family members, are similar to one another in a variety of ways. That, and not a single, well-defined collection of common properties, is what makes game a category” (Lakoff 1987: 16).

In the classical theory, there is no degree of membership, an item is either a member or a non-member of the category, and all members of the category are equal. This entails two things:

first, that no one member of a category is more of a member than any other, and second, that an item is either inside or outside the category, since the borders of the category are clear-cut. These two assumptions have been challenged multiple times. Lakoff, following Wittgenstein, shows that categories are not completely closed in that it is easy to include new members based on their family resemblance with previously approved members of the category; he gives the example of video games that were easily added to the category *GAME* when they were invented (Lakoff 1987: 16). This proves that categories do, in fact, have extendable boundaries. Furthermore, according to Wittgenstein, certain members of a category can be considered to be better examples of the category than others: “Someone says to me: ‘Show the children a game.’ I teach them gaming with dice, and the other says ‘I didn’t mean that sort of game’” (Wittgenstein 1953: 70). This shows that, at least in this specific context, dice are not a very good example of a game. A word of caution might be in order here: the fact that something is not a very good example of a category is not necessarily linked to its degree of membership in that category; we will explore this question in more detail later and continue to use the notion of centrality in the sense of goodness-of-example for now. That is to say, for Wittgenstein, certain members of a category are more central than others. Thus, since dice are not a very good example of *GAME*, it is considered a less central member of the category *GAME*.

Another interesting study in this vein is that of Berlin and Kay (1969), which focuses on colour terms. While different languages may set different borders on the colour spectrum, they found that there actually are regularities in the ways speakers organise their knowledge of colours and colour terms. They identified what they called “basic colour terms”, which are usually monomorphemic (*blue* versus *light-blue*), common, applicable to many things (*brown* versus *auburn*), and, “the color referred to by the term must not be contained within another color” (Lakoff 1987: 25), e.g. *viridescent* is contained in *green*. From these observations, Berlin and Kay draw several conclusions, such as the idea that basic colour terms actually do correspond to basic colour categories and that focal colours are considered the best examples of these categories. This does not mean that the category boundaries of focal colours are the same across languages, or even that different languages have the same number of focal colour categories but rather that, despite the discrepancy of category boundary, speakers across the world tend to pick focal colours as the best examples of their category. If we consider that goodness-of-example makes certain members of a category more central than others, then this study shows that colour categories, like many other categories, have more or less central members. To summarise, while speakers of different languages do not cut the colour spectrum into the same number of categories, or do not use the same boundaries for these categories, they all agree that focal colours are the most representative members of each category.

Another aspect of categorisation that is relevant to the development of prototype theory is the notion of basic-level categories which were first explored, albeit with a different name, by Brown (1958, 1965). In his 1958 paper, Brown explores the idea of categories on the basis of how objects are most commonly named. He uses as an example the name *dime* for a coin representing a certain amount of money: “To name a coin *dime* is to establish its equivalence, for naming purposes, with all other coins of the same denomination” (Brown 1965: 16). Therefore, by using *dime* as the most

common name for the referent, one identifies it as being equivalent to other members of the category *dime*. According to Brown, there is also another reason why *dime* is preferred to *coin*, *money* or *1952 dime*: “The most common name for each of these [items] categorizes them as they need to be categorized for the community’s nonlinguistic purposes. The most common name is at the level of *usual utility*.” (Brown 1958: 16, my emphasis). This level of usual utility is what allows speakers to differentiate between different members of a superordinate category, e.g. *coin* is more inclusive than *dime*, however, when one wishes to make a purchase, it is important to differentiate between a *dime*, a *quarter* and a *penny* since they do not represent the same amount of money. Brown also argues that this level of usual utility is subject to variation depending on the speakers and context. Children who do not need to use money (because of their young age) will probably use the more inclusive term *coin* for *dime*, *penny* and *quarter* indiscriminately. Furthermore, “People and pets function uniquely for some and in various generic ways for others. They have a corresponding variety of designations, but each name is at the utility level for the group that uses it.” (Brown 1958: 16). For Brown, the level of usual utility is thus central to the categorisation process and other names for a specific item “represent possible recategorizations useful for one or another purpose” (Brown 1958: 17). While categorisation at the level of usual utility is basic and concrete, these recategorisations are “acts of imagination” which go both from concrete to abstract, and from abstract to concrete (Brown 1958: 17-18). This is also true of verbs, where one verb is used as a superordinate for a category, e.g. *break* can be considered a basic-level verb, whereas verbs such as *shatter*, *crack* and *crush* denote various kinds of *breaking*. The verbs in this category share family resemblances but not necessary and sufficient features. While *shatter* normally implies that the undergoer is completely broken, this is not true of *crack* for which the undergoer may be construed as partially but not completely broken. As to *crush*, it implies external force, whereas *snap* and *crack* do not. As we will see in Section 7.1, the level of specificity of a verb also has an influence on its distribution.

Brown’s level of usual utility roughly corresponds to what is now known as the basic-level of categories, and is one of the most central notions of Rosch’s prototype theory. As elegantly summarised by Lakoff: “Basic-level categorization depends upon experiential aspects of human psychology: gestalt perception, mental imagery, motor activities, social functions and memory” (Lakoff 1987: 37).

In short, categorisation revolves around at least three principles: (i) members of a category do not necessarily share a certain number of necessary and sufficient features, rather, they are related via family resemblances, (ii) certain members of a category are much better examples of this category than others, (iii) there is a basic level at which humans categorise that corresponds to the more salient aspects of a category.

For the next part of this section we will turn our attention to the work of Eleanor Rosch, who, following Wittgenstein (1953) and Berlin and Kay (1969), proceeded to conduct a number of experiments with different subjects in different settings but which all led to similar conclusions: that categories contain central members which act as cognitive reference points for other members of the category and are called “prototypes”; the existence of these prototypes gives rise to “prototype effects” which appear to be extremely pervasive in language but also in var-

ied cognitive processes (Rosch 1973, 1975, 1978/2004). One of Rosch's most influential papers exploring the idea of prototypes was published in 1973 and her ambition was to show "that the domains of color and form are structured into non-arbitrary, semantic categories which develop around perceptually salient 'natural prototypes'" (Rosch 1973: 328). This research allowed her to demonstrate "the way in which perceptual-cognitive factors (the salience and memorability of certain areas of the color space) can influence the formation of linguistic categories" (Rosch 1973: 348). In another paper (Rosch 1975), Rosch set out to show that prototypes have a special position in their category: they are more central and are used as a reference in relation to which speakers organise and judge of the degree of centrality of other members of the category. She concludes that:

not all members of a category are equivalent and that [this study] adds information concerning the relation between the prototype and nonprototype category members, namely that the best examples of a category can serve as reference points in relation to which other category members are judged. (Rosch 1975: 544)

Rosch's 1978 paper summarises and clarifies two main aspects of her theoretical claims regarding prototype and basic-level effects. She notably explains these two dimensions of categorisation (vertical and horizontal) as follows: the choice of a basic level in categorisation (vertical dimension) is based on a need to access "the most inclusive (abstract) level at which the categories can mirror the structure of attributes perceived in the world." (Rosch 1978/2004: 93). This basic level stands between a superordinate level and a subordinate level. Basic levels may vary depending on the context of reference, but there are a certain number of distinguishing features for basic-level items which have been identified by various researchers (Berlin and Kay 1969; Brown 1965; Rosch 1973, 1975) and summed up by Croft and Cruse (2004). The basic level is the level at which items can be identified based on how we interact with them: *flower* can be associated with a sniffing gesture, but one could not mime *plant* or *dahlia* that way. It is also the level at which we can more easily visualise the item: one can easily form a mental picture of *chair*, but it is more difficult to form just one mental picture of *furniture*. The basic level also has to do with part-whole relations, it is the level that speakers usually choose for neutral reference: *dog* versus *spaniel*. Finally, the basic level is the level at which an item will be more rapidly categorised: if shown a picture of a cat, most people are expected to refer to it as *cat* rather than *feline* or *Maine Coon* (Croft and Cruse 2004: 83-4). Basic-level categories present several advantages; notably, they are maximally distinct categories in that "they maximize perceived similarity among category members and minimize perceived similarities across contrasting categories." (Lakoff 1987: 52).

As to the horizontal dimension of categorisation, Rosch suggests that "to increase the distinctiveness and flexibility of categories, categories tend to become defined in terms of prototypes or prototypical instances that contain the attributes most representative of items inside the category and least representative of items outside the category." (Rosch 1978/2004: 93). This also entails that the most optimal way to identify categories is not to look at their boundaries (which are often fuzzy), but rather to look at prototypical items in the category, which are therefore more central and are better examples of the category than less central members. However, a word of

caution is in order here, as is noted by Rosch in her 1978 paper: “To speak of a prototype at all is simply a convenient grammatical fiction; what is really referred to are judgments of degree of prototypicality.” (Rosch 1978/2004: 101). This means that prototypes are not absolute or universal, they are judgments made by speakers at a certain time and in a certain context. In this way, it is interesting to relate the theory of prototype effects and basic-level effects to Fillmore’s frame semantics (Fillmore 1977).

Fillmore developed the idea of frame semantics in response to the shortcomings of truth-conditional semantics. His aim was to provide, if not a model, at least a certain number of empirical observations which would account for the rich understanding between speakers, and he defended the idea that the meaning of words could not be reduced to a list of features. Per Fillmore, our concepts are “related in such a way that to understand any one of them you have to understand the whole structure in which it fits.” (Fillmore 1982/2006: 373). This structure is what is referred to as the “frame”, also known as the “base” in Langacker’s terminology; concepts can only be understood as part of a bigger structure of knowledge. Fillmore’s view is that “words represent categorizations of experience, and each of these categories is underlain by a motivating situation occurring against a background of knowledge and experience.” (Fillmore 1982/2006: 373-4). As such, a word concept is not solely defined by a concept profile, it requires knowledge and understanding of a related base. A famous example is that of the radius and the circle. The radius is understood as the straight line that goes from the centre of a circle to its circumference. In this particular example, *radius* is said to profile this line against the **CIRCLE** base or frame. In other words, one cannot understand the concept of **RADIUS** if one does not understand the concept **CIRCLE** and the concept **RADIUS** can only be understood against the frame **CIRCLE**. Another interesting example is the difference between two terms which refer to the top of a building; *roof* and *ceiling* denote approximately the same thing except that *roof* is profiled in relation to the exterior of the building while *ceiling* is profiled in relation to the interior of the building. Furthermore, it is also the case that certain words may, in different contexts, relate to different frames. *Mouth*, a well-known example of this, relates to a number of different frames depending on its contexts of use. A word such as *mouth* is usually considered polysemous because it denotes a schematic concept, roughly, an opening to a container. What is interesting about a frame semantics analysis of such a term is that it shows that each sense of *mouth* is understood in relation to a distinct frame such as **BODY**, **BOTTLE**, **CAVE**, or **RIVER** (Croft and Cruse 2004: 19). Words usually only refer to parts of a structure of knowledge or experience without necessarily denoting the entire frame; there is no reason to believe that the profiling of a concept activates the entire frame, or any other frame higher up in the hierarchy. Because it is more economical, only the relevant frame(s) will be activated in a given context: “To properly characterize a particular notion, one must invoke appropriate levels in relevant hierarchies, i.e. whichever levels make available those concepts by means of which a characterization is easily and naturally achieved” (Langacker 1987: 148).

This is also true of argument structure constructions, as we will see in Section 4.2 and Chapter 5, these constructions, in combination with the verb, profile certain arguments and participants, as shown in the examples in (8) and (9) which we invented to illustrate this point. Examples (8) and (9) profile different participants, respectively a theme (*bottle*), which undergoes the event

denoted by the verb *break* and a theme (*bottle*) and an agent (*Jane*).

- (8) The bottle fell and shattered.
- (9) Jane shattered the bottle.

As mentioned earlier, one can easily combine Fillmore's frame semantics with prototype effects. This point is made by Fillmore himself:

[...] very often the frame or background against which the meaning of a word is defined and understood is a fairly large slice of the surrounding culture, and this background understanding is best understood as a "prototype" rather than as a genuine body of assumptions about what the world is like. (Fillmore 1982/2006: 379)

Therefore, narrowing down the meaning of a word in a specific context to the relevant frame is also possible thanks to prototype effects. Fillmore describes this phenomenon with the word *breakfast*, which is prototypically construed as denoting a meal that is taken in the morning, after a period of sleep and consisting of particular food and drinks such as coffee or tea, orange juice and toast. It is also understood against a background in which people usually have three meals per day, and *breakfast* refers to the first of these three meals. The advantage of a prototype effects analysis is that it allows uses of *breakfast* in contexts in which some of the prototypical criteria do not apply e.g. a restaurant which serves breakfast all day; in this scenario, the morning criterion is left aside but the term *breakfast* is used to refer to the prototypical menu of this meal (Fillmore 1982/2006: 380-1). Lakoff (1987) argues that prototype effects and frame semantics are due to the fact that we organise our knowledge into cognitive models.

According to Lakoff, "we organize our knowledge by means of structures called *idealized cognitive models*, or ICMS, and [...] category structures and prototype effects are by-products of that organization." (Lakoff 1987: 68). He illustrates this theory with the example of the concept *weekend* which can only be understood against a frame in which time is organised in a seven-day week, five of which are work days or week days and the last two, prototypically the days when we do not work are referred to as the *weekend*. This structure of time is conventional in our culture and idealised, it is not a natural phenomenon. Therefore, the reason why we call this model idealised is that it may correspond to our reality to a varying degree (Lakoff 1987: 70). For someone who only works on Saturday and Sunday, the concept *weekend* does not apply in the same way: what is prototypically construed as being a time for rest actually corresponds to their working days. Furthermore, certain concepts may require the combination of different frames (Fillmore 1982/2006), or domains (Langacker 1987) to account for a psychologically more salient representation of the concept. Lakoff (1987) illustrates this with the concept **MOTHER** which may correspond to different models: the birth model, the genetic model, the nurturance model, the marital model, and the genealogical model. In this case, different ICMS may be activated, and thus form a cluster. Lakoff's ICM cluster (or *cluster models*) roughly corresponds to what Langacker (1987) calls an abstract domain, namely "any concept or conceptual complex that functions as a domain for the definition of a higher-order concept" (Langacker 1987: 150). That is, in order to fully capture what the concept **MOTHER** may denote, one needs to have access to

a combination of different ICMs, or different frames against which the concept **MOTHER** may be profiled. And while different people may disagree on what profile(s) corresponds to *mother*, it is clear that linguistically, *mother* may activate any and several of these various frames/ICMs. Lakoff (1987) also argues that there may still be pressure to pick one model as more elementary or more important, notably in the way dictionaries are organised: one definition is given primary status by being the first one in the list of definitions of the concept. Depending on one's construal of **MOTHER**, the corresponding prototypical definition will be picked. Lakoff also points out that when used metaphorically, the senses of *mother* are based on one of the various models that participate in the more general concept **MOTHER** (Lakoff 1987: 76). In the idiomatic phrase *Necessity is the mother of invention*, it is the birth model that is used, whereas if one feels *mothered* by someone (who is not their actual mother), the base of the metaphor is the nurturance model (Lakoff 1987: 76).

So far we have mostly focused on nouns denoting concepts and how they may give some insight as to how we organise our knowledge of language and of the world around us. One of the most central claims of (at least several theories of) construction grammar is that any pairing of form and meaning is a construction, and that constructions are stored in the "constructicon" (Goldberg 2006: 64). It thus follows that, just like the nouns mentioned before, argument structure constructions are subject to prototype effects (Taylor 1998). As we will see in the next section, argument structure constructions can be viewed as symbolic structures organised in such a way that they reflect basic human experiences, which exhibit prototype effects (Langacker 1991).

2.3 The experiential grounding of event structure

In a paper exploring the competing motivations behind the organisation of argument structure constructions, John Dubois concludes that "Grammars code best what speakers do most" (Dubois 1985: 363); that is, language follows speakers' experiences and perception of the world. In this paper, Dubois attempts to understand how speakers choose the organisation of arguments (and roles) among different options. He conducted an experiment with speakers of Sacapultec, an ergative Mayan language, in order to see which argument structure pattern speakers chose to organise their discourse. He found that "[...] preferred argument structure is itself founded on characteristic patterns of *preferred information flow* in Sacapultec narrative discourse." (Dubois 1985: 349) In other words, speakers prefer structures that most resemble their experience. While Dubois does not draw this particular conclusion, his work clearly paved the way for the exploration of the relation between what he called internal and external motivations, that is, to what extent extralinguistic information comes into play in speakers' choice of argument structure patterns. As we have mentioned before, knowledge of language is knowledge, and therefore there is no reason why there should be substantial discrepancies between our experience and conception of the world and how we use language to structure these experiences and concepts. This idea is paramount within Langacker's work:

Cognitive models fundamental to our experience and our conception of the world are claimed to underlie the prototypical values of certain grammatical constructs

pertaining to clause structure. Grammatically significant as well is the structure of events – or more precisely, the structure of our *conception* of events – in terms of conceptual autonomy and dependence. Clausal organization is in large measure shaped by the interaction of these factors (Langacker 1991: 282).

The way grammatical constructions structure information matches our experience of the world and of particular events. As we will see in Section 4.2, there is a relation between our conception of causation and the construction chosen to describe it, notably in the distribution of themes in the intransitive non-causative construction and the transitive causative construction. Argument structure constructions, just like concepts, are subject to prototype and basic-level effects. This is clear in Goldberg’s scene-encoding hypothesis: “Constructions that correspond to basic sentence types encode as their central senses, event types that are basic to human experience” (Goldberg 1995: 40). In this hypothesis, Goldberg refers to central senses and basic event types; this entails that the most prototypical occurrences of argument structure constructions encode events that are basic to our experience, which is an illustration of the intersection of Rosch’s vertical and horizontal dimensions (the interaction of prototype effects and basic-level effects, cf. Section 2.2) (Rosch 1978/2004). Furthermore, there is evidence from language acquisition studies that children learn “light” or “general purpose” verbs earlier. These verbs are usually associated with the central meaning of the construction they occur in most frequently e.g. *give* is strongly associated with the ditransitive construction, *break* and *kill* are prototypically associated with the transitive causative construction, *go* is prototypically associated with the intransitive motion construction and *make* with the resultative construction (Clark 1978; Goldberg 1998). The idea that “general purpose” verbs are learned first and strongly associated with basic argument pattern constructions echoes Brown’s study on basic-level effects and the level of usual utility (Brown 1958) (cf. Section 2.2). The argument here is that argument structure constructions (in the sense of construction grammar) have meaning even at the most schematic level, without necessarily requiring any of their slots to be filled, and the various verbs that occur in these constructions add meaning to the construction (cf. Section 4.1).

By the same token, Slobin (1985) suggests that children start by using grammatical constructions that are used to describe “prototypical scenes;” notably, the transitive construction is used to describe the “Manipulative Activity Scene,” which is one of the most basic human experiences and refers to a basic causal event in which an agent causes a change of state in a patient (which roughly corresponds to the transitive causative construction, cf. Section 4.2). Thus, the central meaning of the construction is associated with a basic humanly relevant scene that involves two roles: agent and patient (cf. Chapter 3). These two roles are prototypical in that they are the most commonly used by children, being the minimal participants in a causative construct. Langacker describes these with the help of two models: the billiard ball model and the stage model (Langacker 1991: 283-4). The billiard ball model is used to describe the energetic interaction between objects, minimally two. The stage model, on the other hand, is focused on the perceiver’s experience of a number of discrete events, and defined as follows: “the stage model idealizes a fundamental aspect of our moment-to-moment experience: the observation of external events,

each comprising the interactions of participants within a setting” (Langacker 1991: 284).

This analysis is particularly relevant: since basic grammatical constructions encode basic human experiences, it follows that these minimal and basic roles are not linguistic constructs but, rather, they are abstractions based on our everyday experiences. Children (and adults) categorise their experiences by abstracting away from a number of discrete events and roles: they thus make generalisations over instances of syntactic patterns. These roles are what Langacker calls “role archetypes” (Langacker 1991). The first two he lists are the agent and the patient, the former corresponding to a person initiating a transfer of energy resulting in a change of state in the latter. It is interesting to note that, according to Langacker, the archetype is not only animate but human, which we will see in Section 6.2.2 is not necessarily apparent in the data. Langacker argues that while “[a]n event is conceptually dependent vis-à-vis its participants, [...] a person or a physical object can be conceptualized independently of any event in which it might participate” (Langacker 1991: 286).

What comes out of these theoretical claims is that argument structure constructions, just like nouns, exhibit prototype effects: it is argued in Goldberg (1995, 1998) and Taylor (1998) that argument structure constructions have a central meaning and extensions are created from that central meaning. Taylor (1998: 177) gives an elegant definition of constructions in this regard: “A construction is a schema or template, which captures what is common to a range of expressions, and which, at the same time, sanctions the creation of new expressions of the respective type.” Abstraction from a number of instances of a syntactic pattern, associated with basic human experiences e.g. the transitive causative construction with its two roles, agent and patient/theme, allows for the attribution of a central meaning to this construction, which thus gives rise to less central instantiations of the construction. Taylor (1998) argues that since constructions exhibit prototype effects, some instances will be considered more central because they match all the specifications of the construction; however, if an instance of the construction only matches some of the specifications, it will be less central. This does not entail that the resulting construction will be less acceptable, rather that this particular sense of the construction might be less productive.²

In short, while more central instances of an argument structure construction coincide with basic prototypical human experiences, less central members of this category will denote less basic experiences.

The next chapter will focus on arguments and roles, first by paying particular attention to the semantics of the roles found in the non-causative construction and the causative construction, then by looking at the mapping from lexical semantics to syntax.

²Although over time, it is likely that the more varied uses of a construction may lead to its entrenchment at a higher level of schematicity, cf. Hilpert (2015) who posits the following upward strengthening hypothesis: “grammaticalization happens when the activation of a node in a constructional network strengthens not only that node itself, but also a node that is situated at a higher, more abstract level of that network.”

CHAPTER 3

ARGUMENTS, PARTICIPANTS AND ROLES

Central to the question of the structure of our perception of events are semantic roles. Semantic roles and their syntactic realisation have been extensively discussed in the literature (cf. Croft 1991, 1998, 2012; Cruse 1973; Davidse 1991, 1992; Dowty 1991; Halliday 1967a,b; Langacker 1991; Lemmens 1998, 2006; Levin and Rappaport Hovav 2005, *inter alia*). In the following two sections we will present some of the theories proposed by various researchers and that pertain to the roles found in the causative and the non-causative constructions. We will start by looking at how these roles and their associated semantics have been discussed in the literature in Section 3.1, and then we will discuss how these semantic roles are realised in the syntax in Section 3.2, with a more specific focus on constructional approaches to argument realisation. As we will argue, the notion of role is not necessarily relevant outside of the structure in which the roles appear. We will see that for the intransitive non-causative construction and the transitive causative construction, the role that matters most is one that is often broadly labelled “theme.” In the discussion we will show how generalisations can be drawn from the interaction between constructional and verbal meaning.

3.1 The semantics of roles

As is usually the case, there are two main broad categories of semantic roles that stand out when studying causation: agent and patient. Starting from a prototypical definition of these two roles, we will find a certain amount of variation as to the kinds of agents and patients found with the intransitive non-causative construction and the transitive causative construction. In Section 3.1.1 we will explore the broad category of agents, with examples from our corpus to illustrate the variation found with this role. We will then discuss the specificities of the patient and theme in Section 3.1.2.

3.1.1 Agent: a prototype-based category

Although there has been some disagreement among researchers as to the number and kinds of roles, there is a striking agreement as to what counts as a prototypical agent: “a volitional actor in full control of the event (from act of will to achievement of the goal) and who is thus also fully responsible for it” (Lemmens 1998: 99), (cf. also Dowty 1991). For Lakoff and Johnson, the prototypical agent is the direct manipulator since “the concept of CAUSATION is based on the prototype of DIRECT MANIPULATION” (Lakoff and Johnson 1980: 75) in which an animate agent volitionally acts upon a patient to cause a change of state.

Lemmens identifies at least four different types of agents; first, he makes a distinction between volitional and non-volitional agent and second between two types of inanimate agents: instrument and force (Lemmens 1998: 100). The most prototypical agent, the volitional agent is illustrated in (10). In both examples (10a) and (10b), the agent is human. The same goes for examples (11a) and (11b), except that in these cases, the agent is no longer volitional, they do not voluntarily crease their trousers or burn their chest. These examples are less typical than the examples in (10), they are extensions from the prototype.

- (10) Volitional agent
- a. With the chains that bound my hands, **I** broke the neck of one who came to feed me.
 - b. Sometimes **she** howled and savagely tore the wallpaper of her bedroom.
- (11) Non-volitional agent
- a. The only difficult part is making sure **I** don't crease my trousers.
 - b. **I** spilled the tea and burned my chest instead.
- (12) Inanimate agent: usually known as “instrument”
- a. [...] a fierce metal **helmet**, was lowered on her for forty minutes; it gave her a headache and burned her ears.
 - b. Meanwhile, a **cooler** upstairs is freezing the greens.
- (13) Inanimate agent: usually known as “force”
- a. The late afternoon **sun** has burnt their edges.
 - b. The **impact** crushed his left vertebral artery.

Another kind of extension from the prototypical agent is the group of inanimate agents. Inanimate agents are illustrated in (12) and (13). (12a) and (12b) are examples of instruments which are construed as agents. Although in this case the agent does not correspond to a prototypical agent or proto-agent (cf. section Section 4.2), what appears to be an instrument can easily be found in an agent role, since as Schlesinger (1989: 207) argues, cases are *cluster concepts*, i.e. a category centred around a prototype but whose members have varying degrees of centrality (cf. also Delancey 1984; Fillmore 1977; Lemmens 1998 for similar views on the category of agents). As Lemmens, following Nishimura (1993: 496), argues, the instrument in these examples corresponds to the entity that is construed to be primarily responsible for the event denoted by the verb.

Here, the helmet and the cooler are primarily responsible for the *burning* and *freezing* events respectively. An animate volitional (most likely human) agent is clearly involved in (12a), as suggested by the use of the passive construction, it is nevertheless the instrument that is coded as an agent, since it is construed as directly inflicting the burning. This shows that the notion of role is a matter of construal and focus. Here the speaker chooses to describe the event in such a way that the helmet is construed as responsible for the burning. What is interesting with (12b), is that it actually seems quite difficult to identify the human agent originally responsible for the freezing event. Is it the person who put the greens in the cooler or the person who invented coolers? This brings us to question whether an animate entity is responsible for the freezing event at all. The answer seems to be no. One could argue that this is some sort of personification of the cooler (cf. Nishimura 1993: 505); however, what matters here is that in this instance, the cooler is clearly identified as an agent, in that it is the entity directly responsible for the freezing event, albeit not a prototypical one. Note that Schlesinger (1989: 193) makes a similar observation, arguing that machines are more easily construed as agentive than non-mechanical instruments.¹

All in all, the ability of instruments to be coded as agents on certain occasions shows that the agent category should be an open one and that agentivity is context-dependent. Lemmens, for example, argues that the difference between instruments that can be placed in subject position, i.e. be considered agents, and those that cannot is due to a semantic difference, but the distinction reflects a difference in conceptualization rather than an ontological one (Lemmens 1998: 101). That is, there is not a limited list of entities that can take on agent roles, rather, any entity can be conceptualised as an agent given that they satisfy certain semantic conditions. These conditions are usually related to the semantics of the verb and, as will be argued in Section 3.2, of the construction.

In the examples in (13), the agent is inanimate and is labelled *force*. It differs slightly from the category of instruments. Among the distinctions one might be tempted to make between instruments and force is that force is not man-made and/or does not necessarily originate from an animate entity acting upon it. I would argue that the boundary between instruments and force is blurry and open to interpretation. As Nishimura (1993: 504) points out with regard to instruments: “once contextually furnished with force, any inanimate entity can be conceived to be on an equal footing as typical instances of Force.”

Other examples of ambiguous agents that are too difficult to clearly identify either as instrument or force are found in (14) and (15).

- (14) [...] which of the facial muscles operate the human smile. These **muscles** appeared to have frozen the area around Gretel Mindel’s mouth.
- (15) [...] as the **heat** of the car’s engine warmed the blanket and melted our bodies.

In (14), the muscles are clearly construed as the entity directly responsible for the freezing event, which is reinforced by the use of the verb *operate* in the previous sentence. Whether *muscles* should be labeled instrument or force is not easy to decide. Muscles are operated by the brain,

¹Cooler is used in the American sense of the term: a refrigerator/refrigerated room, not just an insulated container, as it would be somewhat more difficult, but not necessarily impossible, to think of a container as an agent.

therefore by extension by an animate entity; however, in this particular scenario, the animate entity, Gretel Mindel, did not control their muscles. This lack of control from an animate entity would thus point towards force. As to the example in (15), it is the heat caused by the car's engine that is construed as responsible for the warming event. While the engine can easily be construed as an instrument (it is man-made, and usually operated by a human), the heat it produces would rather be construed as a force since it is a consequence of the engine running rather than the primary goal of the engine.

Cruse (1973), for example, proposes four different features for agentivity: volitive (an act of will is implied), effective (exertion of a—literal or metaphorical—force), initiative (action is initiated by a command) and agentive. Both force and instrument can be seen as effective in that sense. As to the volitive feature, it is one of the prototypical features of agents, and is found both with animates and with inanimates used metonymically, as shown below.

As mentioned before, animate entities are prototypical agents; however, they are sometimes referred to via metonymy. This is shown in examples (16), (17) and (18).

- (16) [...] the **church** has frozen spending, salaries and new hires.
- (17) As its involvement in the drug war grows, the **Pentagon** outlines a plan to crush the cartels.
- (18) The **association** has expanded its sphere of influence to become the umbrella organization for American music education.

In all three sentences above, the *church*, *Pentagon* and *association* respectively refer metonymically to the people within these institutions, and thus to animate agents. While this does not pose any problem with regard to interpretation, it should be kept in mind when analysing automatically large quantities of data, as will be done in sections 6.2.2 and 6.2.3.

However, there are cases of transitive constructions where the subject position is filled by an animate and the verb is a verb of change of state but the subject is not an agent. In this particular construction the patient (realised in object position) is in some way co-referent with the role realised in subject position. In instances of this construction the role realised in subject position is not an agent but a setting, which is why this construction is often referred to as the *setting* construction. For Guerrero Medina (2014: 135), the setting construction corresponds to Davidse's pseudo-effective construction in the Medium-centred ergative system, in which "the Subject is described as a mere circumstantial setting for the process" (Davidse 1992: 128).

Talmy (2000: 517) distinguishes between the notions of agent (implies volition) and author (does not imply volition) on the one hand and undergoer on the other hand. He gives the following examples to illustrate the role of undergoer (Talmy 2000: 517):

- (19) I lost.
- (20) The hapless fellow (by misfortune) broke his arm when he fell.

These two sentences exhibit two distinct constructions : (19) is an instance of the intransitive non-causative construction and (20) is an instance of the setting construction, where the

undergoer (*the hapless fellow*) is understood as a sort of circumstantial setting for the *breaking* event. Neither construction is causative. Talmy (2000) describes the undergoer as not having “undertaken actions that culminate in th[e] event [mentioned]. Rather, the event is conceived as autonomously occurrent and as HAPPENING TO the Undergoer” (Talmy 2000: 517). This notion of something happening to an entity coincides with the tests developed by Cruse (1973) and the difference between a *do-clause* and a *happen-clause*, which we will discuss in the next section. However, Talmy (2000: 517-518) restricts the undergoer role to a sentient entity and argues that the event is generally unpleasant for the undergoer, thus affecting them negatively.

Langacker (1991: 346) calls these constructions subject-setting constructions, and provides the following examples:

- (21) a. Thursday saw yet another startling development.
b. Independence Hall has witnessed many historic events.

In Langacker’s subject-setting construction, as its name suggests, the subject is not a transitive subject but merely a setting for the event and represents a sort of *container - content* relationship between subject and object. Therefore, in this construction, the subject is not a participant as such. Langacker (1991: 347) illustrates the difference between a setting and a participant with the following examples:

- (22) a. Fellini features Olympia Dikakis in his new film.
b. Fellini’s new film features Olympia Dukakis.

In (22a), the subject, *Fellini*, is a participant, whereas in (22b), the subject, *Fellini’s new film* is a setting, which is easily demonstrated by means of passivisation:

- (23) a. Olympia Dukakis is featured by Fellini in his new film.
b. *Olympia Dukakis is featured by Fellini’s new film.

Langacker (1991) also mentions as instances of the subject-setting construction, a construction such as *The garden is swarming with bees*, describing it in the following terms: “The import of this construction is that the subject hosts a certain type of activity by the components of a mass that is essentially coextensive with it, so that instances of that activity also extend to its boundaries.” (Langacker 1991: 348).

To conclude on the setting construction, any instance of a transitive construction in which the subject is a setting for the event described is therefore not causative. As such we will not discuss this construction further since it is not part of the so-called causative alternation.

So far, we have seen that the agent role can be filled by many different kinds of entities, be they animate, volitional, non-volitional, instruments or force. This leads us to the conclusion that this particular role is a rather open category, which is not really constrained since almost anything can be an agent granted it is furnished with enough context.

As we will see in the next section, the patient role may be more constrained in certain situations, notably when it is found in subject position.

3.1.2 Experiencer, Patient, Theme: semantic and syntactic constraints

Prototypically, the patient is the participant that undergoes a change of state; it is usually not construed as having any control over the event. As such, the patient is prototypically found in Object position (cf. Section 3.2), as illustrated in the following examples:

- (24) We will expand **access** to our community colleges [...]
- (25) Stir avocado into sauce to thicken **it**.
- (26) [...] try curling your pinky inward without bending the **knuckles** of any other finger.
- (27) A slug had shattered the **bone**.
- (28) He insists on carrying along a camp stove to heat his military **dinners**.

In all of these instances, an agent acts upon a patient in such a way that the patient undergoes a change of state. All of the entities undergoing the change of state in these examples can also be found in subject position in intransitive non-causative constructions, as illustrated in examples (29-33).

- (29) **Access** continued to expand with the growth of third-party payer systems [...]
- (30) [...] **sauce** will thicken as it cools.
- (31) its fingers each have three **knuckles** [...] that bend separately [...]
- (32) **Bones** and glass shatter equally.
- (33) While his **dinner** was heating [...]

In examples (29 - 33), no agent is mentioned, thus giving more prominence to the entity undergoing the change of state which we have so far called patient. The type of events illustrated in (29 - 33) is what Talmy (2000) calls an *autonomous event*. It is close to what Langacker (1991) dubs thematic relationship which we will describe later on in this section.

As we will see in more detail in Chapter 7 it is sometimes the case that an intransitive non-causative construction is found with an adjunct in which a potential agent may be expressed, as in (34).

- (34) The corn rose over their heads, bending with the wind.

Talmy (2000: 481-488) mentions a similar, yet different type of construction which he calls a resulting-event causative. In a resulting-event causative, it is an event, not an entity, that is the cause of the change of state, as shown in (35) adapted from Talmy (2000: 481).

- (35) The vase broke from (as a result of) a ball('s) rolling into it.
 - a. * The vase's breaking resulted from a ball.
 - b. The vase's breaking resulted from a ball's rolling into it.

The wind in (34) is the entity responsible for the bending event, but is not expressed in a traditional *by*-Prepositional phrase. However, it is clear that it has the potential to be construed as an agent, as shown by the similar event described by means of a transitive causative construction in (36) in which a similar kind of entity, *the breeze*, is the agent acting upon the patient *corn*. It is also possible to imagine a description of the scene without the slightest mention of an agent, as in (37):

(36) The breeze bent the corn [...]

(37) The corn was bending.

So far we have only discussed examples, such as (24-28) and (29-33), in which the same entity can be found in Object position in the transitive causative construction and in Subject position in the intransitive non-causative construction. The fact that these entities are found with both constructions leads to believe that they share certain characteristics, at least in combination with the verbs they are used with in these constructions. However, as is visible from the examples (38-43) this is not always the case.

(38) a. You broke my dash-dot code on the first hearing.

b. * my dash-dot code broke

(39) a. [...] no one has come in and asked us to break one of the Ten Commandments.

b. * one of the Ten Commandments broke

(40) a. [...] he broke about half a dozen state and federal gun laws by simply possessing the gun.

b. * about half a dozen state and federal gun laws broke

(41) a. After supper I broke my promise.

b. * my promise broke (after supper)

(42) a. Ozzie Guillen broke one of his own rules on Saturday night.

b. * one of Ozzie Guillen's own rules broke (on Saturday night)

(43) a. [...] you'll break a bad alignment habit in no time.

b. * a bad alignment habit will break in no time

As illustrated in (38 - 43), some entities can only occur in Object position, which shows that there are indeed constraints on which patients can be expressed as the sole participant role in the description of an event denoting a change of state. To put it simply, things such as laws, rules, habits and promises can be broken but cannot break. Therefore we should also ask ourselves whether these entities belong to the same category of semantic roles as the entities which can be expressed in Subject position in the intransitive non-causative construction. And thus, what is the difference between these kinds of entities?

Langacker (1991) proposes that in an event where an entity undergoes a change of state, this entity, which he calls the theme, together with the predicate form some sort of minimal unit:

the thematic relationship. The theme can be any of the first four thematic roles illustrated in Figure 3.1:

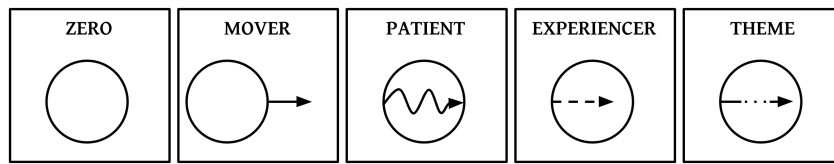

Figure 3.1: Basic thematic roles (Langacker 1991: 288)

Different types of arrows indicate the different kinds of events affecting these roles, as described by Langacker:

A participant in the zero role is represented quite naturally by an unadorned circle. Because the other roles can only be manifested with the passage of time, various kinds of arrows are employed to distinguish them notionally. As noted previously, a mover changes position with respect to its surroundings, a patient is characterized as undergoing an internal change of state (i.e. some change in its own constitution), and an experiencer is the locus of a mental process (emotion, perception, ideation, etc.). (Langacker 1991: 288)

Therefore, any of these roles can be part of the thematic relationship and they may be expressed in such a way that does not involve an external force. That is, the event can easily be construed as involving solely this participant, thus giving it special prominence. Many examples of such descriptions of events can be found:

- (44) As the water froze in the trenches [...]
- (45) The trees [...] grew prodigiously.
- (46) Her back cracked.
- (47) The same night, a tenant house in the county burned [...]

Examples (44-47) all describe events construed to involve a single participant: the theme in the thematic relationship. As Langacker (1991) argues, all these events can be conceptualised without the implication of a force-dynamic component, and thus, the energy source is factored out and the change of state is conceived as occurring autonomously. Typical instances of this are examples such as (44) and (45), which are events that occur somewhat naturally.

When it comes to this kind of events, Langacker distinguishes between two types of A/D alignment: intrinsic A/D alignment and experiential A/D alignment. In this expression, A stands for “autonomous element” and D for “dependent element.” Autonomous elements exist independently of a linguistic system whereas dependent elements are associated with linguistic considerations. That is, “any relational notion can be regarded as conceptually dependent, since it requires for its conceptualization some intrinsic reference—however schematic—to the entities that participate in the relation.” (Langacker 1987: 299-300) Therefore, the difference between the

two types of A/D alignment is whether it is in principle possible for one conceptual component to occur independently of the other (intrinsic) or, for experiential A/D alignment, whether it actually does occur independently or if it can only occur as part of a larger configuration, “that is, it takes into account the actual clusterings of event components that are encountered in experience and coalesce to form established concepts” (Langacker 1991: 289).

Let us borrow the examples from Langacker (1991) to illustrate this discrepancy:

- (48) a. My balloon {burst/broke/popped}.
 b. Jason {burst/broke/popped} my balloon.

According to Langacker, if we take an intrinsic A/D alignment standpoint, it is possible in principle to consider that the verbs in (48a) contain both the thematic relationships and the energy component responsible for the change of state event (Langacker 1991: 290). However, from an experiential A/D alignment standpoint, the events in (48a) form a minimal unit which cannot really be decomposed into conceptual components, and are as such considered thematic relationships. For the events in (48b), however, the relationship is expanded to include an instigator, or at least, an energy source responsible for the change of state.

This seems to be the case for examples (44 - 47) where the energy source responsible for the event is factored out and the events are experientially autonomous, whereas in examples (49-52), the conception of the event is expanded to include external forces.

- (49) The extreme cold froze the water in the trenches.
 (50) The arboriculturist grew beautiful trees.
 (51) She cracked her back.
 (52) The fire/A criminal burned a tenant house.

It is easy to conceptualise an event such as trees growing as occurring autonomously, since trees pretty much grow of their own accord granted certain conditions are met such as access to water and sunshine. However, the freezing of water is not necessarily perceived as occurring completely autonomously, water freezes as a result of extremely low temperatures. As to the back cracking, other elements come into play: the event described in (46) may be caused by external pressure, by a particular move and may also occur without the owner of the back willingly cracking it. What (50) and (51) have in common is a volitional agent, at least in these sentences, i.e. one could conceive of accidental events such as one involving an unqualified yet lucky arboriculturist as in *The arboriculturist accidentally grew beautiful trees* and an event in which the back cracking is an unwanted consequence of another action as in *She accidentally cracked her back when turning around to talk to me*. This being said, it seems that it is easier to conceptualise these events as occurring autonomously when the event described can be construed as the unintended result of an action instigated by an agent. This type of event is illustrated by examples (53) and (54).

- (53) The French door shattered and glass flew into the room.
 (54) Thinner nails will bend, and larger will split the wood.

It seems that one of the reasons why these events can be conceived of without the implication of an external agent is that the event they describe was not necessarily intended, as illustrated in (54). This lack of intention may be perceived to reflect some sort of tension between the patient and the supposed agent. This tension can come from a different result than was expected, a lack of volition on the part of the agent, or simply, as in (45), the absence of an agent. It may also be due to the speaker's decision to put the focus on the entity primarily responsible for the event. That is, in (54) the bending event is due to a characteristic of the nail (its being thin) and (53), the fragility of the door (because it's made almost entirely of glass) makes it likely to shatter; in (45), the trees can easily be construed as responsible for their own growing.

Nevertheless, these do not constitute a list of necessary and sufficient conditions to determine exactly what semantic role is associated with this position. There seems to be a more complicated set of conditions that allow particular entities to be expressed as themes (following Langacker's definition of *theme*) in subject position. If we go back to examples (38 - 43), we find a nuance between (39, 40, 42) on the one hand and (38, 41, 43) on the other: when broken, promises, habits and codes no longer hold whereas laws and rules are not directly affected by the breaking event. All these do not undergo the same kind of change, actually, one might even argue that a rule, law or commandment that was broken is in fact not affected at all.² Interestingly, WordNet (Princeton University 2010) does not distinguish between *breaking a promise* and *breaking a rule*. While these distinctions are interesting and important, we will save this more specific discussion for Section 7.1.1.

For now what we are interested in is the distinction between entities that can be used in subject position in an intransitive non-causative construction and those that cannot. The discussion of the mapping from semantics to syntax will be saved for Section 3.2, but we will nonetheless focus here on the semantic differences between these entities and try and determine whether they should be considered members of the same category of semantic roles. The question we ask ourselves is whether they should both be considered patients.

As mentioned in the previous section, in a discussion of the notion of agentivity which includes examples similar to our examples (44 - 47), Cruse (1973) proposes four different features for agentivity. The last feature, "agentive," is particularly relevant as it is found with objects which are regarded as "using [their] own energy in carrying out the action" (Cruse 1973: 21). This feature does not always seem present in sentences in which verbs are used intransitively. Cruse compares the following sentences, by means of a reflexivisation test:

- (55) a. John moved to avoid the falling stones.
- b. John moved himself to avoid the falling stones.
- (56) a. The machine automatically switches off at 6 p.m.
- b. The machine automatically switches itself off at 6 p.m.
- (57) a. The stone flew through the air.
- b. ?? The stone flew itself through the air.

²A point also made by Lemmens (1998: 36-37).

- (58) a. The ball rolled across the floor.
 b. The ball rolled itself across the floor.

He concludes that when the agentivity feature is not present, reflexivisation renders the sentence somewhat abnormal. He nevertheless notes a difference between (57) and (58), while he considers that (57) is questionable, he finds that (58) “is by no means impossible, but suggests that the ball contained some sort of mechanism” (Cruse 1973: 21). It seems nevertheless that the exact same comment could be made about stones and their ability to fly (themselves), if a stone contained a mechanism that allowed it to fly then (57b) would be acceptable. A more relevant test devised by Cruse may give more information as to the difference(s) between 57b and 58b. He mentions that some of these verbs can only be used transitively if the object bears the agentive feature:

- (59) a. The stone flew.
 b. ?? John flew the stone.
 (60) a. The ball rolled across the floor.
 b. John rolled the ball across the floor.

What is interesting here is that while (59b) is indeed quite questionable, i.e. such an event would require that the stone be construed as an entity carrying some characteristic such as wings and/or an engine that would allow it to co-participate in the flying event, (60b) is perfectly acceptable. Since Cruse suggests that for the ball to be used in subject position in (58b), it necessarily implies that it contains some sort of mechanism, we would expect (60b) to be questionable. I would argue that the difference between the stone and the ball in these cases comes from the fact that, because of their mere shape and natural forces such as gravity, balls prototypically roll but stones do not fly. It is much more effortful to think of an event where a stone flies without the implication of a volitional agent than it is with a ball rolling. As such it seems that the question here is not so much how agentive the entity in subject position is, but rather how likely it is to be acted upon in the manner denoted by the verb. One can roll a ball, but it does not seem likely that one can fly a stone. Actually, one would have to use a periphrastic causative construction of the type [X SEND Y *flying*] or [X MAKE Y *fly*].³

Cruse (1973: 13) also uses the test proposed by Halliday (1968) to distinguish between the subjects in (61) and (62).⁴

- (61) a. John punched Bill.
 b. What John did was punch Bill.
 c. ?? What happened to John is that he punched Bill.
 (62) a. The vase broke.
 b. ?? What the vase did was break.

³For a detailed analysis of periphrastic constructions, see Gilquin (2010).

⁴Examples taken from Cruse (1973).

c. What happened to the vase is that it broke.

Changing the structure of the clause by means of two different forms of an *identifying clause* helps perceive a difference in agentivity. According to Cruse (1973), (61a) is a *do-clause* while (62a) is a *happen-clause*.

While this test works for subjects, it is not sufficient to identify the potential agentivity of certain objects. Consider the following examples (from Halliday (1968) and Cruse (1973)):

(63) John marched the prisoners.

(64) John shot the prisoners.

If we use the same test for these sentences, they seem similar. However, as Cruse points out:

(65) *John marched the prisoners* entails *The prisoners did something*.

(66) *John shot the prisoners* does not entail *The prisoners did something*.

This already provides an element of answer. Let us see whether this applies to our other examples.

(67) As the water froze in the trenches [...]

a. What the water did was freeze.

b. What happened to the water is that it froze.

(68) The trees [...] grew prodigiously.

a. What the trees did was grow.

b. What happened to the trees is that they grew.

(69) Her back cracked.

a. What her back did was crack.

b. What happened to her back is that it cracked.

(70) The same night, a tenant house in the county burned [...]

a. What the house did was burn.

b. What happened to the house is that it burned.

Interestingly, all the themes in these examples seem to fit both descriptions. That is they seem to fit both a patient and an agent description, thus forming a sort of hybrid role. However, it still seems somewhat less acceptable with the following example:

(71) The vase broke.

a. ?? What the vase did was break.

b. What happened to the vase it that it broke.

Then again, the acceptability of these statements would have to be tested via acceptability judgements before we can draw any real satisfying conclusions. The role found in subject position in the intransitive non-causative construction and/or in object position in the transitive causative construction can sometimes be seen as a mixture between agent and patient since it undergoes the event denoted by the verb (patient) but can also be considered, as Lemmens (1998) does, that it co-participates in the event. Although we find the expression “co-participate” a bit strong, notably for entities which display no agentivity, we agree to some extent that there is something specific about the role realised in subject position in intransitive non-causative constructions that makes it different from the role realised in object position in a transitive causative construction. And as Lemmens (1998: 40) argues: “the semantic value of the non-causative construction is that it neutralizes whether the process was self-instigated or instigated by an external Instigator.”

Since we could not find any tests that are satisfying in identifying the difference between the entities realised in subject position in the intransitive non-causative construction and in object position in the transitive causative construction, we will explore these differences with large amounts of data in Chapter 7. Since we do not believe in a fully binary and clear cut division between agent and patient, we will consider that the role that is common to our two constructions is that of a theme. That is, it is simply the entity that undergoes the event denoted by the verb. In the next section, we will provide a brief overview of the literature on mapping from lexical semantics to syntax and further argue in favour of positing a theme whose characteristics may vary depending on which construction it is used with.

3.2 The interaction between constructions and roles

Now that we have explored certain instances of the more schematic agent and patient roles, we will turn our attention to the relation between semantics and syntax in the realisation of these arguments. We will start with a brief (and non exhaustive) overview of some of the literature on principles of argument realisation and the mapping from lexical semantics to syntax in Section 3.2.1. We will then present constructionist approaches to argument realisation in Section 3.2.2.

3.2.1 Mapping from lexical semantics to syntax

As mentioned in Section 3.1, participant roles can be broadly defined against a given number of categories such as agent and patient. However, although participants can occur outside of events, “an event is conceptually dependent vis-à-vis its participants” (Langacker 1991: 286). That is, except for a very small group of meteorological verbs such as *rain* or *snow*, any verb needs at least one participant role, which is realised as its subject. While this may seem rather straightforward, things become more complicated when there is more than one participant and thus the lexical semantics of the roles has to be mapped onto the argument structure of the verb. Which participant is realised in subject position, which in object position, which in an oblique?

As is usually the case with language, the answer is not quite straightforward and as Croft

(2012: 178) puts it: “the mapping from standard thematic roles to grammatical roles is many to many.” Several theories have been put forward so far, and Levin and Rappaport Hovav (2005) offer an excellent summary of the literature on the mapping from lexical semantics to syntax. Notably, they review two types of constraints on which roles are mapped onto which syntactic positions: equivalence class preservation constraints and prominence preservation constraints. In short, equivalence class constraints posit that semantic roles align with specific syntactic positions, i.e. the agent is typically found in subject position and the patient in object position. However, this does not always hold. Notably in the case of change of state verbs, many of which can have a patient⁵ role in subject position (Levin and Rappaport Hovav 2005). Therefore, semantic roles are associated with various syntactic realisations and syntactic positions can be filled by different semantic roles. There is clearly not a strict mapping from one semantic role to one syntactic position.

Prominence preservation constraints ensure that the most prominent semantic role be given the most prominent argument position, and so on for other arguments in the structure. This does not imply that the same semantic role is always realised in the same position, rather, that the prominence of certain roles is preserved. Both constraints can be considered to play a role in the relationship between semantic representation and syntactic representation; however, the predominance constraint is based on a thematic hierarchy. Several attempts have been made to find a somewhat universal thematic hierarchy, for example, Jackendoff (1990: 258) offers the following (which does not include Experiencer or Instrument):

(72) Actor > Patient/Beneficiary > Theme > Location/Source/Goal

However, a thematic hierarchy is problematic in several ways, as shown by Levin and Rappaport Hovav (2005) and Croft (2012) among others. Aside from the fact that there is no general agreement as to the number of roles and their position in the hierarchy, another issue that is often mentioned in the literature is the fact that semantic roles are derived from the events in which they are found and thus, since “semantic roles are derived constructs, then any hierarchy defined in terms of them should also be a derived construct” (Levin and Rappaport Hovav 2005: 157).

Nonetheless, Levin and Rappaport Hovav (2005) argue that context dependence is the primary motivation for thematic hierarchies. Context dependence means that the “options for the syntactic realization of a particular argument are often not determined solely by its semantic role, but also by the semantic roles borne by its coarguments” (Levin and Rappaport Hovav 2005: 158). Fillmore (1968) proposes a subject selection rule in accordance with the following thematic hierarchy principle:

(73) If there is an A, it becomes the subject; otherwise, if there is an I, it becomes the subject; otherwise the subject is the O.

⁵The term *patient* is used here to refer to a broadly defined role: the person or thing undergoing a change of state as in *The vase broke*, which we refer to as the *theme* throughout this research.

In (73), A means agent, I instrument and O stands for objective i.e. patient/theme. This hierarchy can be illustrated by the examples in (74), also from Fillmore (1968: 49).

- (74) a. The door opened.
 b. John opened the door
 c. The wind opened the door.
 d. John opened the door with a chisel.

Levin and Rappaport Hovav (2005: 159) also provide the ungrammatical equivalents in (75).

- (75) a. * The door opened with the wind.
 b. * The door opened by John
 c. * The chisel opened the door by John.

While (74c) and (75a) both contain the same roles, namely, a patient (*the door*) and an instrument (*the wind*), only (74c) is considered correct by Levin and Rappaport Hovav (2005). As opposed to (75a), (74c) respects the thematic hierarchy principle which assigns greater prominence to the instrument, a principle exemplified in (73) by Fillmore's subject selection rule and which states that the only way a patient can be put in subject position is when there is no other argument for this verb.

Nonetheless, as mentioned before, there is disagreement among researchers as to the number and kinds of roles and on their ranking in the hierarchy. This problem will not be discussed in detail here; see Dowty (1991: 553-559), Croft (2012: 176-182) and Levin and Rappaport Hovav (2005: 164-183) for a more detailed discussion. Yet, Levin and Rappaport Hovav (2005) support the view that a combination of the two approaches on constraints in the realisation and organisation of arguments (equivalence class and prominence preservation constraints) is relevant to the question of argument realisation. They also point out that thematic hierarchies, although they may appear flawed, are tools used to capture local generalisations rather than a universal construct (Levin and Rappaport Hovav 2005: 183).

Langacker proposes two different concepts to account for the choice of a description of event structure: first, the action chain (derived from the billiard-ball model) and, second, the notion that a thematic relationship is at the centre of event conception (in relation to the concept of A/D layering) (Langacker 1991: 291). This thematic relationship, he argues, can either be used on its own i.e. an event described by means of a verb with a single participant, or be at the core of a more complex description of an event, which includes external forces (e.g. in a causative transitive construction). Both concepts are described in more detail in Section 3.1.2 and Section 4.2.

As mentioned in Section 3.1.2, Langacker (1991: 287) argues that there is an asymmetry in the autonomy of certain elements involved in events. We have already established that while an event is dependent vis-à-vis its participants, the aforementioned participants are conceptually independent. Langacker also posits that some of the subevents involved in an event can be conceived independently of the event. This is what he dubs A/D asymmetry. The event he uses as an example is the bursting of a balloon. This event is decomposable into several component

subevents such as “the release of pent-up pressure, the emission of a popping sound, and a sudden, drastic change in the shape and spatial distribution of the rubber membrane comprising it” (Langacker 1991: 286). As Langacker argues, it is possible to think of a popping sound without necessarily involving a bursting balloon. As such, these two subevents, although often associated with each other, can be conceived to occur independently. Langacker also argues that it is often the case that one subevent is conceptually dependent on another subevent, notably in the conception of events involving causation. He mentions that any volitional control, or more broadly any event of causation, necessarily implies the conception of a specific subevent i.e. the activity that is carried out (Langacker 1991: 287). Such an asymmetry in the interdependence of component subevents is illustrated in (76).

- (76) a. The wind caused the tree to fall over.
 b. The tree fell over.
 c. * The wind caused.

While it is possible to conceptualize the falling subevent without the exertion of force (volitional or not), it is not possible to conceive of the causation subevent on its own without a specific activity being carried out, as in (76c). This can be extended to causative verbs, without use of the [X CAUSE Y TO Z] construction, but simply with the intransitive non-causative construction and the transitive causative construction, as in (77):

- (77) a. Merriment creased the corners of his eyes.
 b. [...] the corners of his eyes creased [...]
 c. * Merriment creased.

In this particular case, the creasing subevent can be conceptualised independently of any external force causing it, as illustrated in (77b). However, it is not possible to conceptualise causation on its own, it necessarily requires a specific subevent, and since, as Langacker argues, the notion of causation makes reference to the induced change, (77c) is impossible. If we look at this in terms of argument realisation, we see that in examples such as (77), only the participants which can be conceptualised as participants of autonomous subevents can be realised as the sole argument of the verb (and thus in subject position). A participant such as *merriment* is a participant of the causation subevent, and as such cannot be realised on its own. There are a number of exceptions to this principle. These are instances of the objectless transitive, cf. Section 4.2, Goldberg (2001) and Lemmens (2006) for a more detailed description and discussion of this phenomenon. The single participant involved in the type of subevents denoted by an intransitive non-causative construction for example is the theme, and together with its relation to the subevent, it forms the thematic relationship (Langacker 1991: 287). This, according to Langacker, forms the nucleus or innermost layer of the conception of an event. As to the mapping from lexical semantics to this single participant, the theme may be “any one of several role archetypes” (Langacker 1987: 287), that is, there is not a strict mapping from one role archetype to a syntactic position but rather, the syntactic position subject can be filled by any instance of the role archetype so long as it

follows certain constraints such as being part of an independent subevent. It is also important to note that the realisation of the different arguments involves recourse to force-dynamic relations among participants. Even though participants are conceptually independent, their realisation in the grammatical structure is based on their relation to one another.

Both the action chain and the A/D organisation of an event imply directionality, but they each go counter to the other. The action chain starts with the force or energy source that instigates the event while with the A/D organisation, it is the thematic relationship (without implication of external force) that is the starting point of the path. In other words, the action chain starts with the energy source and ends with the theme while the A/D organisation moves from the theme to the energy source. Langacker argues that there is an inherent tension between these two paths. This results in a contrast between two participants which are found at the opposite end of each path, prototypically an agent (as the energy source) and a patient (as the theme). Langacker argues that the agent and patient's prominence is directly related to fundamental aspects of the conception of an event, and as such "they represent the unmarked choices for the basic grammatical relations of clausal subject and direct object" (Langacker 1991: 293).

As to coding, which Langacker defines as "the relationship between a conceptualization one wishes to express and the linguistic structures activated for that purpose" (Langacker 1991: 294), many options are available to speakers. However, the mere properties of an event are not a good indicator of what causal structure a speaker will choose, since as Langacker (1991: 294) puts it: "conceptually, there are countless ways of construing a given event, and a particular event conception might deviate from the canon in any manner or to any degree." As a cognitivist, Langacker insists that it is crucial to recognize that speakers may construe and thus describe a situation in many alternate ways. Furthermore, speakers are aware of the different grammatical structures they can use to describe an event and of their contrasting conceptual imports. When a speaker describes a situation, they need to decide how much information they want to communicate, i.e. the scope of predication which "delimits the basic conceptual content to be conveyed, and essential aspects of this content are rendered explicit by an appropriate choice of lexical items." (Langacker 1991: 297)

Speakers make decisions that result in a particular organisation of the clause to reflect their conception of the event: "an imposition of a processual profile and a particular trajector/landmark alignment" (Langacker 1991: 297). This organisation translates into a choice as to which roles are mapped onto the subject and object positions in the clause. Since they are prominent participants, Langacker refers to the subject and object as *focal participants* (Langacker 1991: 301):

Choosing a participant to be the subject or object is very much akin to focusing a spotlight on it; by making these selections, the speaker directs attention to the focused participants (as well as the interconnections that involve them directly) and thereby imposes a particular image on the scene. Still, the choice of subject and object is non-arbitrary and shows a partial correlation with semantic roles. (Langacker 1991: 301)

According to Langacker, the subject is the relational figure, that is, the figure within the profiled thematic relationship (Langacker 1991: 312). This does not imply that all subjects are tied to a specific semantic role, rather, what they share is a particular status within the clause; and this applies both to transitive and intransitive subjects. One could argue that the subject is topical. However there is a difference between a subject and a topic, the subject is only of importance at clause-level while a topic is relevant at discourse-level.

Croft (2012) reviews approaches to argument realisation via the force-dynamics of causation. He notably mentions the work of Talmy (1974, 1976) on the different types of causation. Talmy draws a list of four types of causation: physical causation (at the heart of such models as the billiard-ball model, in which an entity acts upon another), volitional causation (with animate agents), affective causation (the mental state of the patient is affected), and inductive causation (with a mental initiator and a mentally affected patient). In all of these, Croft (1991) argues, there is a dualism involving an initiator and an endpoint; depending on the kind of causation, the initiator is either physical or mental and so is the endpoint. Different types of causation trigger different types of roles and affect their realisation as subject and/or object.

There is disagreement in the literature as to whether physical and volitional causation should be treated as distinct categories. As mentioned in Section 3.1.2, on the one hand, Cruse (1973) proposes four different types of agentivity: volitive, effective, initiative and agentive. On the other hand, Van Valin and Wilkins (1996) argue in favour of a mere pragmatic distinction between volitional and physical causation, advancing that for many verbs, volitionality is not necessary but only a minority of specific verbs require volitional agent e.g. *murder* (Van Valin and Wilkins 1996: 309). As shown by Cruse, and discussed in Section 3.1.2, however, this contrast is relevant for argument realisation.

All in all, it seems pretty clear, as Croft puts it, that “thematic roles look like a poor candidate for an explanation of which participants are encoded as Subject, Object, or various types of Oblique Prepositional Phrases in English and other languages” (Croft 2012: 178). While they play a role in argument realisation, they are only part of the answer. A solid theory of argument realisation needs to take into account a number of factors at various levels of generalisation such as the verb’s frame semantics, force-dynamic relations among participants (instead of fixed thematic role hierarchies) and interaction between the semantics of the verb and the semantics of the construction. Local generalisations are of the utmost importance when it comes to argument realisation and the mapping from lexical semantics to syntax. In the next section we will present cognitivist and constructionist approaches to argument realisation and more specifically works such as Croft (1998, 2001, 2012), Goldberg (1995, 2005, 2014), and Lemmens (1998, *forthc.*) which explore the interaction between verbs’ participant roles and argument roles contributed by argument structure constructions themselves.

3.2.2 Constructionist approaches to argument realisation

When dealing with argument structure constructions and argument realisation, constructionist approaches usually argue in favour of a distinction between elements of meaning provided by

the verb and elements of meaning provided by the construction. In a constructionist approach, while it is assumed that constructions, even the most schematic ones, have meaning, it is not the case that constructions are the only providers of meaning (Goldberg 1995: 24). Rather, meaning comes both from the construction itself and the elements that are used with it. As Lemmens argues, both syntactical and lexical aspects of meaning must be taken into account if one wants to provide an accurate description of argument structure constructions: “a unified description of the grammar of processes and events requires the inclusion of a lexical perspective” (Lemmens 1998: 47). Lemmens (forthc.) also shows the importance of taking arguments of the verb into account when describing argument structure constructions and their meaning, an argument we have taken up in Romain (2017) and will further defend in Section 6.2.2.

Goldberg, for example, argues in favour of a distinction between the roles associated with the verb and the roles associated with the construction: “Participant roles are to be distinguished from the roles associated with the construction, which will be called *argument roles*.” (Goldberg 1995: 43) The idea behind this distinction is that participant roles are associated with the specific semantic frame of the verb (cf. Section 2.2), whereas argument roles are more broadly defined agents, patients and other central roles. The participant roles of the verb reflect the verb’s specific semantics. A somewhat similar view as to the different levels of specificity is also expressed by Langacker:

An inventory of semantic roles can always be refined and articulated into more specific types on the basis of further data or a finer-grained analysis—at the extreme, every verb defines a distinct set of participant roles, that reflect its own unique semantic properties [...] Conversely, a role conception is arrived at by abstracting away from the peculiarities of individual examples. (Langacker 1991: 284)

Croft (2012), on the other hand, gets rid of semantic roles and prefers a version of argument realisation where the verb, in combination with an argument structure construction, profiles certain arguments. He argues that “[t]he causal chain as a whole is the semantic frame for the event that is profiled by the verb” (Croft 2012: 206) and that it is the verb which profiles arguments in combination with an argument structure construction. According to him,

[...] representing role designation as part of the verbal profile has several advantages over the alternatives. It places role designation in the semantic representation of verbs (or more precisely, verbs in particular argument structure constructions). [...] And above all, it places the arbitrariness of argument realization, to the extent that it is arbitrary precisely where it belongs: in the signifier-signified relationship between form (verb + argument structure) and meaning (the event semantic frame with its verbal profile). (Croft 2012: 206-207)

Croft posits four basic linking rules for argument realisation (Croft 1998: 24; Croft 2012: 207):

- (78) a. The verbal profile is delimited by Subject and Object (if any)
 b. Subject is antecedent to Object in the causal chain:
 SUBJ → OBJ

- c. An Antecedent Oblique is antecedent to the Object in the causal chain; a Subsequent Oblique is subsequent to the Object in the causal chain:

A.OBL → OBJ → S.OBL

- d. Incorporated arguments are between Subject and Object in the causal chain:

SBJ → INCORP → OBJ

Striking in these rules is the absence of semantic roles. According to Croft, “all that matters is relative position in the causal chain” (Croft 2012: 207). Also notable is the fact that both core arguments (such as Subject and Object) and Obliques are accounted for by these rules. Croft distinguishes between two types of Obliques: ANTECEDENT OBLIQUES and SUBSEQUENT OBLIQUES. An example of the former would be an Instrumental preposition phrase while the latter would be a Beneficiary phrase.

For these researchers, both the verb and the argument structure construction play a role in the realisation of arguments, albeit in somewhat different fashions.

In Goldberg’s model, participant roles capture constraints and generalizations at the level of the verb, but are still instances of the more general argument roles. It is very often the case that participant roles of the verb and argument roles of the construction coincide, that is, both verb and construction require the same number and type of participants/arguments. However, there also seem to be quite a few exceptions to this fusion of participant roles and argument roles. Indeed, a verb that typically takes a certain number of participants may see this number reduced or augmented when used in certain contexts, as will be shown in Section 4.1. As we know, verbs are very often polysemous and this polysemy entails different argument structure patterns, however it is not necessary to posit a separate verb sense for each possible combination of participants, rather, this is resolved via the frame semantics of the verb.

Goldberg posits two principles for the fusing of the participant roles and the argument roles: the semantic coherence principle and the correspondence principle. The former states that for roles to be fused, they need to be semantically compatible, that is, any participant role of a verb must be an instance of the more general argument role of the construction. As to the latter, it states that any participant role that is lexically profiled must correspond (be fused with) an argument role of the construction (Goldberg 1995: 50). Furthermore, “[...] the possibility of roles fusing is not determined by whether a single role filler can simultaneously fill both roles, but rather by whether the roles themselves are of compatible types.” (Goldberg 1995: 50)

Let us illustrate this with an example. For Goldberg, the transitive causative construction takes two argument roles: an agent and a patient (which we prefer to call theme, as explained in Section 3.1). The verb *break* typically takes two participant roles which we could call *breaker* and *broken*. In example (79) the *breaker* is *Mark* and the *broken* is *eggs*.

(79) Mark broke six eggs.

The fused structure of the verb’s participant roles and the construction’s argument roles is illustrated in Figure 3.2 with the verb *break* used with the transitive causative. Figure 3.2 shows that *breaker* and *broken* are instantiations of the more schematic roles agent and patient.

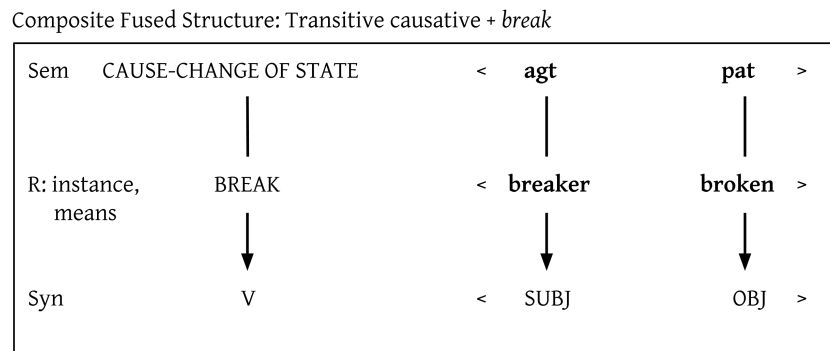

Figure 3.2: Participant roles and argument roles (Goldberg 1995)

In this particular case, both principles of semantic coherence and correspondence are respected. There are, however, cases of mismatch between roles of the verb and roles of the construction. One such example is when a construction adds a role that is not a participant role of the verb. Goldberg’s famous example with *sneeze*, illustrated in (80) shows how the caused-motion construction contributes argument roles that are not participant roles of the verb.

(80) He sneezed the napkin off the table. (Goldberg 1995)

The verb *sneeze* contributes a single participant: the *sneezer*. However, as illustrated in Figure 3.3, since the meaning of *sneeze* is compatible with the meaning of the caused-motion construction, when the two are combined the construction contributes argument roles such as a goal and a theme, which are, in this case, instantiated by *off the table* and *the napkin* respectively.

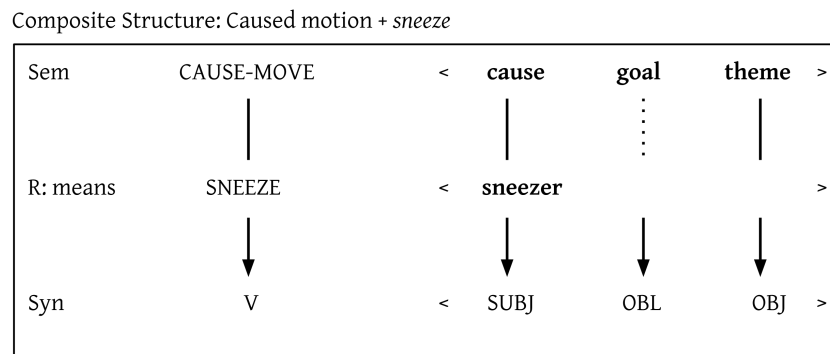

Figure 3.3: Mismatches of roles: *sneeze* and the caused-motion construction (Goldberg 1995: 54)

This phenomenon is handled by the semantic coherence principle in that as long as the argument role contributed by the construction is semantically compatible (i.e. can be construed as a potential participant role of the verb) with the semantics of the verb, the fact that the construction “adds” an argument to the verb is perfectly acceptable. As illustrated in Figure 3.3, the participant role of *sneeze* is realised as subject, while the argument roles contributed by the construction, the goal and the theme, are realised as oblique and object respectively. This will also be discussed in Section 4.1.

All the verbs studied for this research can be found with at least two constructions: an intransitive non-causative construction which profiles only one argument role, the experiencer/theme which is realized in subject position (cf. Langacker's thematic relationship discussed in Section 3.2.1); and a transitive causative construction which profiles two argument roles: an agent (actor) and a patient. This is often called the causative alternation and as such deserves a comparison of the kinds of roles profiled by each member of the alternation.

Goldberg proposes different phenomena to account for the fact that certain profiled roles may sometimes not be expressed: "shading" and "cutting," which we will describe and illustrate with examples below. If we look at the sentences in (81) and (82) for example, we see the same verb used with two different argument structure constructions, respectively the intransitive non-causative and the transitive causative constructions. The question that arises at this point is whether different verb senses should be posited for each argument structure construction.

(81) The house burned.

(82) They burned the house.

The meaning of *burn* could be represented in two different ways (the following representations are taken from Goldberg (1995)). In each case, the obligatory profiled participants are in bold. Although the number of arguments varies between the two sentences above, the meaning of the verb remains constant, in both cases it denotes a burning event through which something (the house) is destroyed/damaged by fire. The differences illustrated in 83 below are directly linked to the type of construction chosen. As we will see in Chapter 7, it is not necessary to posit different verb senses for each argument structure construction, but rather the meaning of the sentence is a result of the combination of verb meaning, constructional meaning and of the theme associated with the verb.

(83) burn <burner **burned**>
burn <**burner** **burned**>

Again we see that in (81), there is no mention of an instigator/agent. As mentioned before, the intransitive non-causative construction "neutralizes whether the process was self-instigated or instigated by an external Instigator" (Lemmens 1998: 40). Therefore, the agent, or instigator, is not an obligatory profiled participant. However, in a transitive causative construction, the agent/instigator is obligatorily realised. As we will see in more detail in Section 7.5, it is not solely the meaning of the verb that matters but the interaction with the semantics of the verb and the semantics of the different participants involved in the event: is the participant undergoing the change of state a patient or a theme?

Goldberg defines shading as "a process whereby a particular participant [...] is no longer profiled" (Goldberg 1995: 57). When *shaded*, this participant may be realised in an adjunct. She mentions the passive as an example of this phenomenon, but it could also be illustrated with the following example:

(84) The corn rose over their heads, bending **with the wind**.

In (84), it is the wind that causes the corn to bend, but since the event is a basic thematic relationship, the external force responsible for the bending is only expressed in an adjunct.

As to cutting, Goldberg proposes the following comparison: “‘cutting’ is intended to invoke the notion of a director cutting one of the participants out of the picture” (Goldberg 1995: 57). As opposed to cases of shading, the “cut” participant cannot be realised, even in an oblique. Goldberg illustrates this with an instance of the middle construction (Goldberg 1995: 58):

(85) * This bread cuts easily by Sarah.

As such, cutting does not seem to apply to members of the causative alternation, while shading does.

For this particular research we will prefer Goldberg’s approach to Croft’s as it fits the description of the two constructions at hand better. However, as we will see in Section 4.1, the interaction between elements of the construction and the construction itself remains at the heart of the study of argument structure constructions. Now that we have provided a sketch for the mapping from lexical semantics to the syntactic realisation of arguments, we will focus on constructional meaning, notbaly via the exploration of how schematic argument structure constructions combine with smaller constructions to convey particular meaning and, once again we will see how prototype and basic-level effects affect the way speakers conceptualise their description of events.

CHAPTER 4

CONSTRUCTIONAL MEANING

4.1 Lexical rules vs. constructions

In accordance with the major principles of construction grammar, we have observed that even very schematic constructions, such as argument structure constructions, have meaning. Their meanings are related to basic human experiences and are therefore organised as such, with their categorisation exhibiting prototype and basic-level effects. Basic-level effects are notably seen in the frequency of certain verbs: basic verbs are more frequent than those which denote a higher degree of specificity. That is, verbs such as *break* are more frequently used than, say, *shatter* or *crack*. It appears that *light* or *general purpose* verbs (cf. Clark (1978)) are generally more frequently used, as they exhibit properties of what Brown (1958) called the level of *usual utility*. Their frequency of use is easily confirmed via a quick corpus query: *break* occurs 105,635 times in COCA, while *shatter* and *crack* occur respectively 54,365 and 12,554 times in COCA. Prototype effects also play a role in language acquisition, and thus in the acquisition of argument structure constructions: children make generalisations over a number of instances of constructions used to describe somewhat prototypical events. This is why it is often assumed in the cognitive literature that constructions have a central meaning (arrived at by abstracting away from a number of occurrences of the argument structure pattern), and that from this central meaning, (metaphorical) extensions emerge. Closer to the more central meaning of the construction are verbs which are not only light, but which also usually share much of the semantics associated with the argument structure construction, e.g. *give* is prototypically associated with the ditransitive construction since its meaning is very close to the central meaning of the construction: 'X CAUSES Y TO RECEIVE Z'.

This leads to a question regularly addressed in the literature: that of the interaction between verbs and the constructions they occur in (Croft 2003, 2012; Goldberg 1995; Perek 2014). On this subject, Goldberg makes the following observation:

Although I have argued that constructions have meaning independently of verbs, it is clearly not the case that the grammar works entirely top-down, with constructions

simply imposing their meaning on unsuspecting verbs. In point of fact, there are reasons to think that the analysis must be both top-down and bottom-up. (Goldberg 1995: 24)

Goldberg's main argument in favour of positing two simultaneous mechanisms for the analysis of argument structure constructions comes from Fillmore's frame semantics (Fillmore 1977). The argument here is that meanings are understood against a certain background or *frame*. While it is clear that verb meaning is understood as part of a rich background of encyclopaedic knowledge, we can also say that part of the meaning of the verb is understood against the background of the construction it occurs with. Thus, constructional meaning and verb meaning interact as follows: argument structure constructions contribute meaning to the verb they occur with, and verbs profile a certain aspect of the basic event denoted by the construction (Goldberg 1995).

Furthermore, speakers generalise over a number of occurrences of the same construction used with different verbs, which is argued to contribute to the establishment of a central meaning for this construction. Therefore, it appears that the verbs used frequently in particular argument structure constructions also contribute to defining the meaning of the construction. This entails that if an event exhibits at least some of the characteristics of the central prototypical meaning of a construction, then speakers are likely to use this construction to describe their conception of the event, even with less central verbs. The combination of constructional meaning and verb meaning is what licenses creative uses of verbs in specific constructions, as shown in examples (86–89). While these instantiations of the various argument structure constructions could hardly be considered central members of their respective argument structure category, they are still perfectly valid instances of these constructions.

- (86) Sam sneezed the napkin off the table. (Goldberg 1995)
- (87) [...] when gamers could still take a joke before the politically correct crowd bitched and moaned those ads into extinction. (NOW corpus)
- (88) John Williams [...] rode up on his tallbike and told us that the town is now rolling with retrodirect bikes. (NOW corpus)
- (89) Dev Patel has totally Longbottomed. (www.buzzfeed.com)

Goldberg uses (86) to show that “richer aspects of verb meaning are required for aspects of linguistic theory other than predicting the syntactic expression of arguments.” (Goldberg 1995: 29). It is the combination of speakers' knowledge that sneezing implies expulsion of air, and of their knowledge of constructional meaning ‘X CAUSES Y TO MOVE Z’ that allows them to understand this expression and which licences the transitive use of *sneeze* (cf. Chapter 3 and Section 3.2). As to (87), it is easy to understand the relation between the crowd's ‘moaning’ and the result that ensued: the ads have become extinct. It takes both encyclopaedic knowledge and knowledge of constructional meaning to understand that it is the crowd's moaning that led to the ads being extinct (cf. Goldberg and Jackendoff (2004) for an extensive discussion of resultatives). Example (88) is an instance of the ‘swarm’ construction (e.g. *The garden is swarming with bees*), a construction for locative predication which denotes an intense activity in a specific location, in this case *the*

town. Example (89) is particularly interesting as it contains a novel verb, *Longbottom*, which is a conversion of the proper noun *Longbottom*, which itself is the name of a character from the Harry Potter series by J.K Rowling. Although the noun refers to a fictional character, the verb is used to refer to Matthew Lewis's (the actor who played Neville Longbottom in the Harry Potter films) transformation from awkward teenager to handsome man. In this case, both the verb and the construction denote a change of state, therefore it is not surprising that this particular construction should be chosen.

In short, these examples show that verbs and constructions interact to create new meaning, but it is also important that at least part of the semantics of the verb fit the semantics of the construction. If we consider the semantics of the verb *longbottom*, it seems that it fits the intransitive construction better than the causative transitive construction: *?They Longbottomed Dev Patel*. The verb *longbottom* seems to imply if not a self-instigated change, at least a naturally occurring change of state (cf. Section 4.2 for more details on the semantics of both constructions). Then again, it might be argued that the lexeme *Longbottom* used in the intransitive non-causative construction is somehow coerced into this construction. For example, Michaelis (2004: 51) proposes the following "Override Principle:"

The Override Principle: If a lexical item is semantically incompatible with its syntactic context, the meaning of the lexical item conforms to the meaning of the structure in which it is embedded. (Michaelis 2004: 51)

According to this principle, a lexical item might be "semantically incompatible" with an argument structure construction but occur with it nonetheless on the grounds that the construction somewhat imposes its meaning on that of the lexical item (an argument also adopted in Boas 2011, for example). While we agree to some extent that the use of a lexeme in a specific construction which it is not prototypically associated with may lead to this lexeme gaining meaning from the construction, we consider, however, that a lexical item cannot be semantically incompatible and occur with an argument structure construction. Some element of the meaning of the lexeme has to match some element of the meaning of the construction for them to be used together. However, since coercion is a rather debated topic and it is not directly relevant to the present research, we will not go into much more detail here.

While Goldberg (1995) acknowledges the existence of constructional polysemy, notably for the ditransitive construction, she argues that the basic sense of this construction, i.e. successful transfer, has a special role in the network of related meanings. This view comes in opposition to the necessity of having recourse to a set of lexical rules from which to derive each verb's argument structure(s) and the syntactically relevant information they may contain. The different senses of the ditransitive construction can be represented as in (90), with a [[form]/[meaning]] format, based on Langacker (1987). For this particular construction, the central sense is coded as [actual XPoss], in which XPoss stands for 'transfer of possession' (Croft 2003: 56).

- (90) a. [[SBJ VERB OBJ1 OBJ2] / [actual XPoss]]
 b. [[SBJ VERB OBJ1 OBJ2] / [conditional XPoss]]
 c. [[SBJ VERB OBJ1 OBJ2] / [negative XPoss]]

- d. [[**SBJ VERB OBJ1 OBJ2**] / [future XPoss]]
- e. [[**SBJ VERB OBJ1 OBJ2**] / [enabling XPoss]]
- f. [[**SBJ VERB OBJ1 OBJ2**] / [intended XPoss]]
- g. [[**SBJ VERB OBJ1 OBJ2**] / [depriving XPoss]]

However, the idea that argument structure constructions are organised as categories centered around a prototype or central meaning is not unchallenged.

Croft (2003) argues that it would be more plausible to describe the division of labour between verb meaning and constructional meaning at a lower level of generalisation. Even though Goldberg (1995) lists the various meanings of the ditransitive construction based on groups of verbs, she considers that all these meanings are extensions from a prototype. Croft (2003), on the other hand, argues in favour of verb-class specific or verb specific constructions, thus giving more salience to verb meaning. As their name indicates, verb-class specific constructions are constructions whose meaning is related and constrained to a given class of verbs, and verb-specific constructions are those constructions which are even more constrained and thus limited to one verb (Croft 2003: 58). The different constructions are related not to a basic or central sense but rather simply to one another via family resemblances. Croft argues that verb-specific and verb-class specific constructions are more accurate representations of a speaker's knowledge in that they include more specific meaning (Croft 2003: 56-7). In his paper, Croft explores the meanings of the ditransitive construction and suggests that these various meanings are directly related to verb-class or verb specific constructions, and thus makes the case for a lower level of generalisation, as illustrated in (91).

- (91) a. [[**SBJ GIVING.VERB OBJ1 OBJ2**] / [actual XPoss]]
 [[**SBJ BALL.MOT.VERB OBJ1 OBJ2**] / [actual XPoss via ballistic motion]]
 [[**SBJ DEIC.CAUS.VERB OBJ1 OBJ2**] / [actual XPoss via deictic caused motion]]
- b. [[**SBJ COND.GIVING.VERB OBJ1 OBJ2**] / [conditional XPoss]]
 - c. [[**SBJ REFUSE.VERB OBJ1 OBJ2**] / [negative XPoss]]
 - d. [[**SBJ FUT.GIVING.VERB OBJ1 OBJ2**] / [future XPoss]]
 - e. [[**SBJ PERMIT.VERB OBJ1 OBJ2**] / [enabling XPoss]]
 - f. [[**SBJ CREATE.VERB OBJ1 OBJ2**] / [intended XPoss after creation]]
 [[**SBJ OBTAIN.VERB OBJ1 OBJ2**] / [intended XPoss after obtaining]]
 - g. [[**SBJ COST.VERB OBJ1 OBJ2**] / [depriving XPoss via paying]]

The distinction between the two mostly comes from the inclusion of a meaningful element to the syntactic component, which should not be a problem within the frame of construction grammar since one of the theory's primary claims is that syntactic constructions have meaning.

Besides, the fact that it seems more likely that speakers generalise at the level of verb-classes does not exclude the possibility that they have stored in their construction a more schematic and

abstract representation of the construction.¹ However, a very schematic representation would fail to acknowledge speakers' knowledge of verb-class or verb-specific constraints as to which verbs can be recruited in one construction or another. Also, in this sense, the representation of verb-class specific and verb-specific constructions is not too different from that of partially lexically filled idioms, which are stored as constructions but necessarily include a pre-defined lexical component. In short, Croft argues in favour of a more usage-based approach to the representation of constructions: "Speakers are not exposed to verbs in isolation, nor are they exposed to schematic argument structure constructions without verbs in them. Actually occurring utterances are closest to verb-specific constructions." (Croft 2003: 64). This entails that the amount of meaning contributed by the verb and by the construction is not necessarily fixed; while speakers understand and use constructions productively, it is not always clear which aspect of meaning is contributed by the verb and which is contributed by the construction.

By the same token, Perek (2014) advocates a usage-based approach to the question of constructional polysemy. He explores the hypothesis formulated by Croft (2003) that constructional polysemy is better approached with family resemblances between verb-class specific constructions rather than extensions from a single central meaning, and applies this to the conative construction by means of a modulation of collexeme analysis (Stefanowitsch and Gries 2003). Collexeme analysis or collostructional analysis is a method developed to investigate the interaction between lexemes and the constructions they occur in. However, it is modelled on the assumption that all instances of an argument structure construction denote either the central meaning of the construction or an extension of this meaning. Therefore, it implies that the strongest collexemes of a construction—in this case, the verbs that are the most attracted to the construction (cf. Section 6.2.1 for a more detailed description of collostructional analysis)—are a reliable indicator of the meaning of the construction. Perek challenges this view and offers a modulation of this method based on verb-class specific constructions. For his analysis of the conative construction he applies this method to three classes of verbs: verbs of striking, verbs of cutting and verbs of pulling (Perek 2014). He thus finds that for each group of verbs, the inherent meaning of the strongest collexemes aligns with constructional meaning at this level of generalisation when they occur in this construction. He therefore concludes that "collexeme analysis profiles the constructional meaning much better at the level of each verb class than at the most general level" (Perek 2014: 82).

The question now is how do these theoretical claims apply to the intransitive and transitive constructions that we investigate here? Both are extremely schematic in that they are used with a wide variety of verbs, and may be construed as having several more or less related meanings. We will therefore explore the different aspects of causation in the next section.

¹See for example Bencini and Goldberg (2000) who show via a sorting experiment that argument structure constructions play a more important role in sentence interpretation than the verb.

4.2 A description of the non-causative and the causative constructions

This section will focus on causation and the semantics of two constructions that are frequently used with causative verbs in English, the intransitive construction and the transitive construction. The concept of causation is central in many argument structure constructions and in basic human experiences, as summed up by Lakoff: “prototypical causation is one of the most fundamental of human concepts. It is a concept that people around the world use in thought. It is used spontaneously, automatically, effortlessly, and often.” (Lakoff 1987: 55)

We will see in this section how the different concepts discussed so far in Chapter 2 and Section 4.1 apply to the categorisation of argument structure constructions. As will be discussed, the simple labels intransitive and transitive might not be sufficiently precise to encompass the dynamics at stake in the two constructions studied in this work.

We will start by looking at the construction which corresponds the most to the prototypical conception of causation: the transitive construction, cf. Figure 4.1. Goldberg (1995) offers a schematic representation of the form and semantics of the transitive construction in which the position of subject and object are respectively aligned with what Dowty (1991) calls a proto-agent and a proto-patient. According to her, this skeletal representation is prototypical and other constructions inherit from this construction (Goldberg 1995: 117).

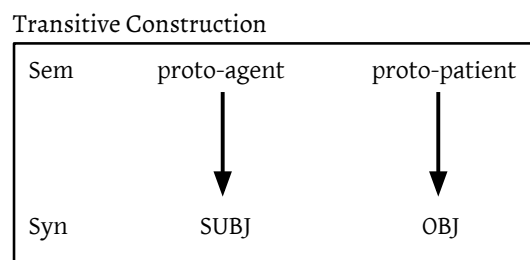

Figure 4.1: The transitive construction (Goldberg 1995)

As to the semantics of the transitive construction, Goldberg argues in favour of positing several senses related by family resemblances but with the prototypical transitive scene, in which an animate agent acts upon a usually inanimate patient as the central meaning of the construction. The form and semantics of the prototypical transitive construction, which includes some sort of causation i.e. an agent acts upon a patient, could be represented as: $[[\text{SUBJ CAUS.VERB OBJ}] / [\text{ChangeOfState by causation}]]$, using the format $[[\text{FORM}] / [\text{Meaning}]]$. Therefore, non-prototypical instances of this construction are considered extensions from this central meaning e.g. the patient is animate and/or the agent is inanimate. However she also acknowledges that there are groups of verbs that occur in what seems to be a syntactically similar pattern, but which do not appear to be instantiations of this basic central sense. She mentions verbs such as *acquire*, *get*, *have*, *own* and *inherit* which form a cluster which, when used in the transitive construction, have a meaning quite distant from the prototypical sense in which an animate agent affects

a patient e.g. *John acquired a computer*. For this particular cluster she proposes the meaning [X HAVE Y]. Unfortunately, she does not extend her analysis of the transitive construction much further but claims the following: “Additional senses of the transitive construction, related to it by polysemy links, would inherit the linking specifications of the construction they are dominated by.” (Goldberg 1995: 118)². It is clear in Goldberg’s work that what she considers the central sense of the construction has a predominant role in speakers’ construal of the construction, since even though she acknowledges the existence of clusters of different meanings, she still considers they are extensions from the central sense.

Since the transitive construction is used with many different verbs with sometimes barely related meanings, it is very difficult to posit a constructional meaning that would cover all instantiations of the construction. It would seem more cognitively plausible to adopt Croft’s view that constructional meaning is better captured at a lower level, namely verb-class specific (or sometimes even verb-specific) constructional meaning (Croft 2003). Before moving on to a more detailed analysis of instances of the transitive construction (cf. chapter 7), we will offer a more general description of the transitive construction used with causative verbs. The term causative is used here to refer to any verb that denotes a change of state. Instantiations of the transitive construction with causative verbs can therefore be more specifically designated as instances of the causative construction which is represented as follows: [[SUBJ CAUS.VERB OBJ] / [ChangeOfState by causation]]. The meanings of these verbs usually align with the prototypical meaning of the transitive construction mentioned above, but for the sake of clarity, this representation will now be used for the causative construction: Cx2.

Any event of causation is dependent on two major participants: an agent and a patient. While the characteristics of each participant may vary slightly from verb to verb, they nevertheless remain central to the concept of causation. They can be represented with Langacker’s action chain as in Figure 4.2. In this representation, the action chain is limited to two participants, which Langacker calls *head* and *tail*, which correspond respectively to an agent and a patient. The agent acts upon the patient so that the patient undergoes a change of state, which is represented by the squiggly arrow.

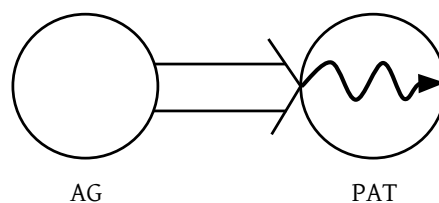

Figure 4.2: The action chain (adapted from Langacker 1991)

To this model, Langacker adds the stage model, in which the role of perceiver or viewer i.e. the person watching the action is added. This model also includes a setting, in which the

²cf. section Section 5.2 for a more extensive discussion of the various inheritance links that capture the commonalities between constructions.

participants interact (Langacker 1991: 285). The combination of the action chain and the stage model is represented in Figure 4.3.

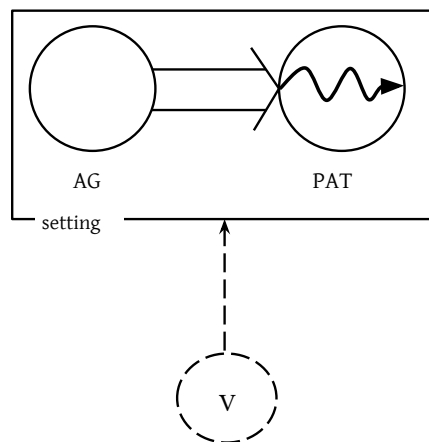

Figure 4.3: The canonical event model (adapted from Langacker 1991)

This model represents elements that exist pre-linguistically: participants interacting in an event. However, its relation to the linguistic structures used to describe the event is significant. This is what Langacker (1991) refers to as *coding* and defines as “the relationship between a conceptualization one wishes to express and the linguistic structures activated for that purpose” (Langacker 1991: 294). As mentioned in section 2.3, speakers choose linguistic structures that best correspond to their conception of events, therefore, depending on the situation some of the participants will be activated while others will be left out (cf. section 3.2). This is particularly relevant to our interests since the present research compares two constructions used with causative verbs and which do not require the same number of participants. The causative construction, Cx2, requires an agent and a patient, and instances of this construction are frequent and closely related to the representation suggested above. However, English causative verbs also occur quite frequently in the intransitive construction. Examples of causative verbs occurring in these two constructions are provided in (92) and (93).

- (92) a. The beer bottle shattered on the cement.
 b. Pia’s cheeks burned.
 c. Reduce the tension, and the cable won’t snap.
- (93) a. Bullets shatter bottles and glasses all around him.
 b. A flush burns his cheeks.
 c. Rocket Roscoe once delivered a ball so hard that it snapped a net cable at the U.S Open.

The examples in (92) are instances of the non-causative construction Cx1, and the examples in (93) are instances of the causative construction Cx2. The same verbs are found in both constructions with the same kind of participant undergoing the change of state: *bottle* in (92a) and (93a), *cheeks* in (92b) and (93b), and *cable* in (92c) and (93c).

Since causative verbs, which denote a change of state, and therefore at least an extension of a causation event, occur in both these constructions, does this imply that these two constructions are related? And, if so, in what way are these two constructions related?

The discussion as to whether this is a case of alternation or simply two different constructions related by some inheritance link as part of a network of constructions will be saved for chapter 5. For now, we will simply consider that these two constructions are used by speakers as two different ways of describing a causative event.

Langacker argues that “a linguistic structure embodies conventional imagery and thus imposes a certain construal on the situation it codes” (Langacker 1991: 294). Therefore, as the focus is usually on the subject, the more agent-like participant tends to be placed in subject position. This somewhat applies to the instantiations of Cx2 presented in (93), in which the subject of the verb is the participant acting upon the patient. However, in (92a) and (92c), this participant is an instrument, therefore not a prototypical agent, but which in these examples seems to be given a certain extent of agentivity, which is why they are placed in subject position. As to the intransitive constructions presented in (92), the participant in subject position would actually correspond to the patient, since it is the participant that undergoes the change of state.

According to Taylor (1998), the intransitive construction is a broadly defined template of the form [NP – V], which is then more narrowly divided into three types: the agentive intransitive (94), the inchoative intransitive (95) and the middle intransitive (96).

- (94) Joe is baking (in the kitchen).
- (95) The cake is baking (in the oven).
- (96) This oven doesn't bake very well.

These examples from Taylor (1998) illustrate three different kinds of subject: in (94), the entity denoted by the subject initiates the activity; in (95), the subject entity undergoes a change of state, and in (96), the entity denoted by the subject is assigned a property. However, (96) is problematic in several ways: first, Taylor considers it is an instance of what is often referred to as the middle or medio-passive construction, but I would argue that this is actually an instantiation of the objectless transitive construction (cf. Goldberg 2001; Lemmens 2006 for a more extensive discussion of objectless causatives/deprofiled object constructions). In (96), the subject cannot, as with middle constructions, be construed as a patient: it is not the entity that undergoes the change of state or that is affected by the event denoted by the verb. Rather, the ambiguity comes from the fact that the participant in subject position is the tool used by an agent to cause a change of state in a patient: to bake it. A quick comparison of (96) and (97) shows the difference between the two constructions.

- (97) This tomato peels easily.

In (96), it is not the oven that is baked but in (97), it is the tomato that is peeled. Therefore, not only is (96) not an instantiation of the middle construction, but as it has been argued in Lemmens (1998), the middle construction also differs from other instances of the intransitive construction.

The diversity in the roles taken on by the subjects in the intransitive construction suggested by Taylor seems too big to be saliently construed as a single construction with three different instantiations. It would seem more cognitively plausible to posit three different constructions, each with its own specific semantics.

For this research, the focus will be on instantiations of what Taylor refers to as the inchoative intransitive construction: that in which the entity denoted by the subject is affected by the event denoted by the verb, as in (95). The reason for this decision is that this work is centered on causative verbs, which denote a change of state. Thus, the intransitive construction, Cx1, is what Lemmens (1998) refers to as the non-causative construction and describes as follows: “non-causative constructions profile the Medium, an entity that is affected by the process, yet is at the same time also an agentive participant.” (Lemmens 1998: 40). What Lemmens calls the Medium is what is referred to in this work as the Theme, i.e. the entity affected by the event denoted by the verb, and which is in subject position in Cx1. For now, I propose the following representation of Cx1: [[SUBJ CAUS.VERB] / [Theme ChangeOfState]] (based on Langacker 1987). What is particularly relevant with Cx1 is that “The semantic value of the non-causative construction is that it neutralizes whether the process was self-instigated or instigated by an external Instigator” (Lemmens 1998: 40). This idea is represented in figure 4.4, which offers a representation of three different construals of a same event. In the first setting, the event is limited to the patient, and does not profile an agent or instrument.

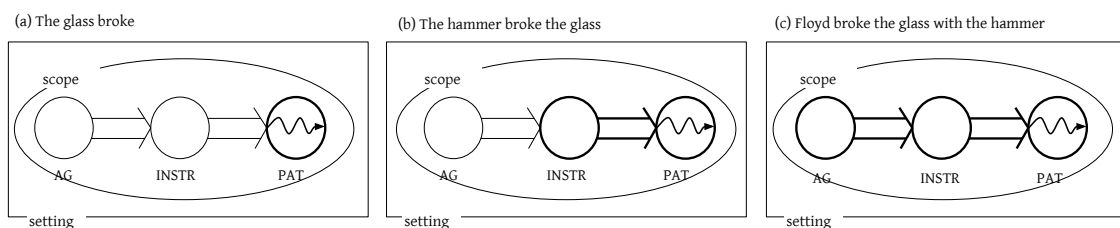

Figure 4.4: Complex event conception (Lemmens 1998: 33)

This construction might therefore not be considered as a prototypical description of a causative event, since, according to Dowty (1991) and Goldberg (1995), the prototypical agent usually aligns with the position of subject. In this particular construction, the subject position is taken by the patient *the glass*.

Now that we have briefly described the two constructions this research focuses on, and how certain principles of cognitive linguistics apply to their categorisation, we will pay attention to how these constructions differ from each other and what they have in common. The next chapter will introduce two different approaches regarding the question of alternation: (i) a lexical-projectionist approach and (ii) a constructionist approach. We will see that while lexical-projectionist approaches tend to view the alternations as part of the verbs’ meanings, constructionist approaches put the individual construction at the heart of the issue, focusing instead on individual constructional meaning. We will then further explore the constructionist approach and how construction grammar deals with the organisation of constructions in a network.

CHAPTER 5

ALTERNATION OR CONSTRUCTION?

When it comes to the various argument structure constructions (or patterns) a verb can occur in, there is quite some disagreement in the literature as to the mechanisms underlying the realisation of these structures. Some theories, such as transformational grammar, would consider that there is a deep structure in which all arguments are found, but the realisation of certain arguments will depend on which surface structure a speaker chooses (Chomsky 1965). The realisation of these arguments also depends on certain rules, which we will describe in Section 5.1.1. Others, such as Levin (1993) and Levin and Rappaport Hovav (2005) are projectionist approaches and assume that verbs come with a certain amount of information, and that this information is sufficient to determine these verbs' various valency patterns. Another approach to verb arguments structure patterns is Valency theory, which takes its name from Tesnière (1959) who borrowed the term from chemistry. We will show how this approach is also centred around the verb, but differs slightly from the projectionist approach. Yet other approaches take one step back from the verb and combine both semantics and syntax by positing constructions (Goldberg 1995, 2006). We will see in Section 5.1.2 how these approaches put more emphasis on constructions than on the verb itself and how they manage to address issues that other theories do not have the tools to deal with. Finally, in Section 5.2, we will show how these constructions interact and how they appear to be fully part of speakers' knowledge of their language.

5.1 Alternation vs. surface generalizations

5.1.1 Verb-centric approaches

Chomsky (1965) approaches argument structure from the theoretical standpoint of transformational grammar, in which certain rules govern the number of arguments a verb can take. He posits two types of rules: branching rules, on the one hand, and subcategorisation rules on the other. Within context-sensitive subcategorisational rules, he also distinguishes between *strict subcategorisation rules* and *selectional rules*. Strict subcategorisation rules are “rules which analyze

a symbol in terms of its categorial context” (Chomsky 1965: 95), while selectional rules are “rules which analyze a symbol (generally, a complex symbol) in terms of syntactic features of the frames in which it appears” (Chomsky 1965: 95). In other words, strict subcategorization rules govern the realisation of a certain number of arguments while selectional rules deal with the kinds of arguments selected (e.g. abstract, animate). According to Chomsky (1965), “[...] *every frame in which V appears, in the VP, is relevant to the strict subcategorization of V, and [...] no frame which is not part of the VP is relevant to the strict subcategorisation of V*” (Chomsky 1965: 96). Therefore, all possible realisations of a verb’s argument structures are specified by the appropriate strict subcategorisation rule. Interestingly, Chomsky adds as a note to this general statement that “Idiosyncratic syntactic features of particular lexical items, not introduced by such general rules [...] but simply listed in the lexical entries, play no role in verb subclassification” (Chomsky 1965: 216). It would thus appear that these rules apply to the vast majority of cases and that idiosyncrasies are dealt with in the lexicon. As will be discussed in section 5.1.2, this idea is not unproblematic. This first approach to verb valency focuses on rules of syntax; however, later on in the same chapter, Chomsky proposes a somewhat different approach. Instead of keeping these rules with the syntax (or grammar), he suggests to remove them from what he calls the categorial component, which corresponds to the grammar and is “determined by the universal conditions that define ‘human language’” (Chomsky 1965: 120), and to add them to the lexicon. This illustrates the view that speakers’ knowledge of language is divided into two parts: the mental grammar and the lexicon. With this second proposition, Chomsky thus suggests that lexical entries are very rich, since on top of containing the basic meaning of verbs, they also contain large amounts of information as to the number and type of arguments verbs may take. Thus, on the one hand, we have a syntactic system in charge of the organisation of elements in a sentence, and on the other, lexical items which we use with this system:

The lexicon consists of entries associated with certain substitution transformations that introduce lexical items into strings generated by the categorial component. All contextual restrictions in the base are provided by these transformational rules of the lexicon. The function of the categorial component is to define the system of grammatical relations and to determine the ordering of elements in deep structures. (Chomsky 1965: 122)

This second approach has been explored in various works, notably in Pinker (1989), who claims that “syntactic argument structures of verbs are predictable from their semantic structures, via the application of linking rules” (Pinker 1989: 62), but also in Levin (1993), G. Francis, Hunston, and Manning (1996), Hunston and G. Francis (2000) and to a somewhat lesser extent Levin and Rappaport Hovav (2005). These “verb-centric” approaches argue that verbs contain all the information necessary to use them, and that speakers are aware of the different meanings a verb may have, but also of the various argument structure constructions it may be used with. As such, lexical-projectionist approaches start and end with the verb: verbs’ argument structure patterns are closely associated with different facets of their meanings.

Levin’s work is quite representative of this approach; it is “guided by the assumption that

the behaviour of a verb, particularly with respect to the expression of its arguments, is to a large extent determined by its meaning” (Levin 1993: 1). Therefore, such an approach suggests that there is more to verbs’ meanings than mere lexical semantic information. Speakers would thus be aware not simply of the different meanings of a verb, but also what argument structure realisation each meaning entails.

In more recent work, Levin and Rappaport Hovav (2005) argue that argument realization depends mostly on two things: first, on predicate decompositions and second, on the fillers of argument positions themselves. The number of arguments and their relations would thus be determined by the meaning of the verb via predicate decomposition while the kind of arguments used with the verb also relies on the fillers. What Levin and Rappaport Hovav (2005) call predicate decomposition is “a representation of meaning formulated in terms of one or more primitive predicates chosen to represent components of meaning that recur across significant sets of verbs” (Levin and Rappaport Hovav 2005: 69). Hence, predicate decomposition allows speakers to identify which argument structure patterns are realised with each verb, based on generalisations over classes of verbs but also on idiosyncratic elements of meaning. The idiosyncratic element of meaning contained in each verb is what they call the *root*. Both the generalisation and the root play a role in argument realisation: “Predicate decompositions are constructed so that verbs belonging to the same semantic class have decompositions with common substructures, with roots of the same ontological type filling the same position in these substructures” (Levin and Rappaport Hovav 2005: 72). As such, if the roots are semantically related, then the verbs associated with these roots form a subclass with the same argument realisation patterns. Thus, Levin and Rappaport Hovav (2005) propose to combine the decomposition of event structures with idiosyncratic elements of verbal meaning. For example, they argue that verbs of change of state, while they all contain predicates that represent the notions of change and state (Levin and Rappaport Hovav 2005: 71), also refer to different kinds of state. They provide the following examples:

- (98) a. *dry*: [[X ACT] CAUSE [Y BECOME <DRY>]]
 b. *open*: [[X ACT] CAUSE [Y BECOME <OPEN>]]
 c. *shorten*: [[X ACT] CAUSE [Y BECOME <SHORTEN>]]

As illustrated in (98), according to Levin and Rappaport, the verb itself contains a causative component. They assume that verbs such as *dry*, *open* and *shorten* contain the elements [CAUSE BECOME], which may strike as a surprising assumption since this causative element is not present when these verbs are used in the intransitive non-causative, as illustrated in (99).

- (99) a. He had delivered the first canvas to the gallery before it had *dried*.
 b. The building *opened* in August 2014.
 c. The day *shortened* considerably.

Although Levin and Rappaport Hovav (2005) argue that the causative component is present in the verb in the causative use, we prefer to consider that the verb is not entirely and solely

responsible for the causative component. Rather, we embrace a constructionist approach, as shown in Chapter 4, which gives less prominence to the verb and acknowledges the role of constructional meaning as to the notion of causation.

Levin and Rappaport Hovav (2005) focus on the import of the verb and argue that, since verbs denote events, “[...] a theory of the semantic determinants of argument realizations needs to be grounded in a theory of event conceptualization” (Levin and Rappaport Hovav 2005: 75). That part of the meaning of verbs which provides the verb with its argument structure should be easily derived from the type of conceptual event it denotes. As such, the semantic properties associated with these events influence the event structure and thus the morphosyntactic realisation of arguments. The argument presented here is that verbs which denote similar events should exhibit the same argument structure patterns. Levin and Rappaport Hovav (2005) identify four broad groups of semantic factors that have an influence on argument realisation: causal notions, aspectual notions, event complexity and a fourth group which includes such notions as sentience, animacy and volitionality (Levin and Rappaport Hovav 2005: 128). All these factors interact to determine the number, positions and characteristics of arguments realised.

As mentioned in the introduction to this chapter, there is also another approach to argument structure patterns that is centered around the verb but does not follow the same principles as projectionist approaches. This approach is known as Valency theory (Tesnière 1959). Adherents of Valency theory such as Herbst (2011), Faulhaber (2011) and Hampe and Schönefeld (2006) argue in favour of a model or grammar that takes into account item specificity together with broader generalisations. Their approach works along the lines of Goldberg (2006: 63) who postulates that “[i]tem-specific knowledge exists alongside more general knowledge.” That is, they defend a theory of argument structure patterns which is also verb-centric but differs from projectionist approaches.¹

Their approach differs from projectionist approaches in that it is not meaning driven but form driven. In this vein, for example, Faulhaber (2011: 331) argues that “neither analogy nor semantic rules can sufficiently account for verb-complementation patterns” and insists on “the importance of the role of storage or memorization of valency patterns in combination with the verb as the valency carrier” (Faulhaber 2011: 331). Thus, Faulhaber (2011) questions the semantic import of verbs as to their realisation in various argument structures. She argues, for example, that “exceptions” are a sign that analogy and semantic rules are not sufficient to account for syntactic restrictions. This argument is based on the overgeneralisation errors produced by learners (be it L1 or L2) when guessing the valency of a new verb. Contrary to the proposal by Dixon (1991: 6) that “once a learner knows the meaning and grammatical behavior of most of the words in a language, then from the meaning of a new word he can infer its likely grammatical possibilities,” Faulhaber (2011) argues that the number of exceptions to this principle renders it inaccurate in its depiction of argument structure pattern realisation. While such overgeneralisations are common among learners, they do not represent the reality of native speakers of the English language. Rather, native speakers know not to overgeneralise thanks to indirect negative evidence (Goldberg 2006; Tomasello 2003), whereby speakers acquire verb-specific argument realisations through

¹cf. notably the Valency Dictionary of English (Herbst, Heath, et al. 2004) and Herbst and Schüller (2008).

the absence of evidence of a regular construction. To illustrate this concept, we can borrow an example from Tomasello (2003): speakers know that while *give*, *send*, *bequeath* and *donate* can all be used with the dative construction, e.g. *He gave his books to the library*, only *give*, *send* and *bequeath* can be used with the ditransitive construction (**He donated the library his books*). That is, although speakers would expect to find *donate* in a similar pattern (the ditransitive construction), they have been consistently exposed to *donate* in the dative construction only. The lack of evidence of the use of *donate* in the ditransitive construction provides them with indications that *donate* does not allow this argument structure pattern. This type of indirect negative evidence is item-specific, and cannot be deduced from the meaning(s) of a given verb in relation to semantically similar verbs.

In the same vein, Herbst (2011: 347) argues that “the amount of item-specificity to be observed in language must be accounted for in a theory of complementation and that generalizations concerning parallels between semantic properties of verbs and their occurrence in particular valency patterns must be treated with a certain degree of caution.” With regards to argument structure constructions, Herbst (2011: 359) claims that “as soon as there is an element of item-specificity involved, what the learner will have to know is whether — **irrespective of any general properties of item or construction** — a particular item can occur in a particular construction” (my emphasis).² That is, no part of the semantics of the verb or the construction is considered as being solely responsible for the compatibility (or lack thereof) of the item (the verb) with the (argument structure) construction. While we agree to some extent that the argument structure patterns associated with a verb are not fully predictable from this verb’s meaning(s), we take some caution as to such a bold statement. Nonetheless, Herbst (2011: 360) also argues that on top of this knowledge, a learner must know which verbs can occur in which constructions and which constructions can be used with which verbs. As a complement to the generalisation proposed by Goldberg (1995, 2006) that the semantics of the verb must match the semantics of the construction and reciprocally, Herbst (2011) posits that learners must be aware of item-specific knowledge (which is thus purely form-driven) when it comes to argument structure patterns.

Similarly, and in an effort to account for syntactic creativity, Hampe and Schönefeld (2006) study the use of a complex-transitive argument structure construction (close to a resultative construction, cf. (100, 101)) with verbs that are unusual in this construction. That is, verbs that are not significantly attracted to this construction (cf. Section 6.2.1 for a description of the family of collostructional analyses yielding this type of results). Their approach is two-headed, they start off by looking for the verbs that are most commonly found with this construction, and then move on to a verb-based account by studying uses of this construction with verbs that are not usually found with it, namely *encourage*, *fear*, *support* and *bore*.

(100) *And I shall find you empty of that fault.* (Hampe and Schönefeld 2006, from the British National Corpus)

(101) *Irish catholics were represented in the dominant culture as an inferior race, ridiculed and considered*

²cf. also Lieven and Noble (2011) for a review of the literature on acquisition of argument structure patterns and the interaction between verb valency and generalisations over schematic constructions.

incompetent and beastly. (Hampe and Schönefeld 2006, from the British National Corpus)

Based on this research, Hampe and Schönefeld (2006: 127) argue that “processes of schematisation over usage patterns plausibly also extract *item-based, mid-level schemas* which must be assumed to be central to the creation of the expressions at issue.”

As opposed to lexical-projectionist approaches, valency approaches are more compatible with a construction grammar framework, which can easily accommodate both item-specific knowledge and broad generalisations over argument structure constructions. We will further explore the constructionist view in the next section.

5.1.2 Surface generalizations

While lexical-projectionist approaches attribute elements of argument structure realisation to the verb and the verb classes, Goldberg (2002) takes a different approach in that she looks at the question of alternation from the level of the construction. Rather than assuming that verbs contain all the information necessary as to the various argument structure patterns they can be used with, she considers that there is more to be gained from looking at various instances of a same argument structure pattern, thus abstracting away from the verb and looking at argument structure from the level of the argument structure construction. This differs from Levin and Rappaport Hovav (2005) in that less prominence is given to the notion of alternation and more importance is given to the similarities between various instances of one argument structure construction. That is, rather than looking at a given verb’s valency or at a class of verbs which share valency patterns, Goldberg (2002) looks at instances of one argument structure construction used with a wide array of different verbs. The aim of this approach is to reinforce the role of the construction in speakers’ mind. Abstracting away from a verb or a class of verbs allows for a clearer and broader definition of constructional meaning. This point of view is expressed in Goldberg’s Surface Generalisation Hypothesis:

Surface generalization hypothesis

There are typically broader syntactic and semantic generalizations associated with a surface argument structure form than exist between the same surface form and a distinct form that it is hypothesized to be syntactically or semantically derived from.
(Goldberg 2002: 329)

Goldberg’s argument is that too much attention has been paid to alternations and too little to the actual syntactic and semantic generalisations associated with a specific argument structure construction. That is, rather than looking for similarities between two different argument structure patterns used with the same verb, as in (102), Goldberg proposes to look at similarities between uses of the same argument structure pattern across a broad array of verbs, as illustrated in (103).

- (102) a. His fingers were pressed so hard against the glass I thought **it might crack** [...]
b. The highly focused beam of light could heat and **crack the glass**.

- (103) a. He stood, and **his knees cracked**.
 b. In the past, **the climate has warmed** and **it has cooled**.
 c. **Cynthia's brow creased**.
 d. After a minute or two, **the paste will thicken** and coat bottom of pan [...]
 e. **His jaw** slowly **dropped**.

Goldberg's surface generalisation hypothesis seems to be a logical follow-up to the basic principles of construction grammar. In this theory, less prominence is given to the verb and it is generally agreed upon that "the verb alone often cannot be used to determine whether a given construction is acceptable" (Goldberg 1995: 21), that is, there are constraints on the realisation of certain verbs in certain constructions which do not depend solely on the verb. Goldberg illustrates this with the following example:

- (104) a. Sam carefully broke the eggs into the bowl.
 b. * Sam unintentionally broke the eggs onto the floor.

On its own, *break* does not provide enough information as to its distribution across argument structure patterns, since *Sam unintentionally broke the eggs* is perfectly acceptable. However, the lack of intention combined with *break* is not accepted with the caused-motion construction, as illustrated in (104b). The same kind of argument is proposed by Yoshimura and Taylor (2004), who suggest that at the heart of middle constructions such as *This book reads well* is a type of middle subject that is common to all middle constructions. The properties of this subject are close to the notion of "qualia structure" put forward by Pustejovsky (1995), where the qualia structure of an object comprises characteristics such as its weight, shape, creator and so on. However, as shown by Lemmens (2005), while Pustejovsky considered the qualia structure of an object to be a set of fixed characteristics, Yoshimura and Taylor (2004) argue in favour of its variability according to context. Nevertheless, while the idea of a middable subject is attractive, Lemmens (2005: 34) notes that it leads Yoshimura and Taylor (2004) to lump instances of the middle construction together with instances of the intransitive non-causative construction.

On the whole, the idea defended by constructionists such as Goldberg is that constraints such as those illustrated in (104) are due to the construction itself, rather than to the verb. A verb's valency is not the sole projection of its various meanings: as shown in (104), the unacceptability of (104b) cannot be predicted solely on the basis of the semantics of the verb. There are other elements which are taken into account, and these elements can be accounted for by the meaning of the construction. This approach is valuable in that it not only accounts for various regular instances of each construction but it also accounts for somewhat more creative uses of verbs. One of the most famous examples of this is the well-known sentence in (105), but similar examples with a resultative construction are easy to find on the web and in corpora, as illustrated by (106) and (107), both found in the COCA.

- (105) She sneezed the napkin off the table.
 (106) [...] the typical film that guilt-tripped Malaysians into loving their mother.

(107) [...] before the politically correct crowd bitched and moaned those ads into extinction.

The example in (105) is frequently used to illustrate how it is impossible to predict all potential argument structure patterns a verb may be used with. There is nothing in the meaning of *sneeze* that could predict its transitive use in a caused-motion construction. *Sneeze* is usually construed as an intransitive verb, whose only argument is an experiencer. It would seem rather far-fetched to expect a speaker to have such an argument structure pattern stored with the *sneeze* lexical entry. Explanation for the other two examples can be found in Section 4.1. Thus, in order to better understand the mechanisms underlying the realisation of argument structure constructions, Goldberg argues that we need to go beyond the level of the verb and look at the bigger picture that constructions draw. Therefore, she gives more prominence to individual constructional meaning rather than alternations.

One of the constructions she uses to illustrate her point is the ditransitive construction. Using the examples in (108) and (109), she shows that there are more similarities between (108b) and (109b) than between (108a) and (108b), and (109a) and (109b) respectively (Goldberg 2002: 330).

- (108) a. Mina bought a book for Mel.
 b. Mina bought Mel a book.
- (109) a. Mina sent a book to Mel.
 b. Mina sent Mel a book.

Among the elements shared by the two instances of the ditransitive constructions is, obviously, their surface form (Goldberg 2002: 330). Goldberg proposes a number of tests to highlight these similarities. She also argues that there are a number of semantic properties shared by various instances of this construction even across different classes of verbs, notably the notions of *giving*, *not giving* and *taking away*. The fact that *giving* and its antonym and negative form are put together in a class of related meanings is not a problem, since there is of course a strong relation between a concept and its antonym (Goldberg 2002: 333). Instead of grouping examples such as (108a) and (108b) together because of their shared verb, she finds that a surface approach provides more information as to the meaning of these constructions and the verbs they are used with. Nevertheless, Goldberg's claim is not simply that constructional meaning is solely the result of a surface form, she acknowledges the importance of the interaction between various elements: "The overall interpretation [of a clause] is arrived at by integrating the argument structure construction with the main verb and various arguments, in light of the pragmatic context in which the clause is uttered" (Goldberg 2002: 341-2).

If we apply this principle to the so-called causative alternation, we also find a lot of similarities between various instances of each construction. In order to make this claim, however, and to give a better account of the constraints of each construction (the intransitive non-causative on the one hand and the transitive causative on the other), we need to not only look at verbs that are shared between the two constructions but also at the arguments they take. This will be done respectively in Section 6.2.1 and in Section 6.2.2, where we take a closer look at the amount of meaning shared by the two constructions, but also, more specifically at the kinds of arguments each construction

recruits individually. For now, if we look at the kind of event denoted by each construction over a wide array of verbs, as illustrated in (110) for the intransitive non-causative and (111) for the transitive causative construction, we see that there are clear similarities between all instances of each construction respectively.

- (110) a. When the robot hits a stone, its body **bends** like an inchworm encountering a pebble.
 b. His arm went out to brace himself and the wrist **snapped** audibly.
 c. While his dinner was **heating**, he leaned against the sink [...]
 d. [...] and articles on food and health have **proliferated**.
 e. The knob **turned** [...]
- (111) a. The female then **bends** her abdomen.
 b. One otter **snaps** the backbone of a piranha with its powerful molars [...]
 c. The mechanic **heated** five of the prepacked meals the miners ate [...]
 d. What Aaron Barr did was pretty much **proliferate** the nonsense.
 e. But when I **turned** the handle, [...]

First and foremost, as mentioned by Goldberg for other constructions, instances of a same construction all share a surface form, which need not specify word order or grammatical categories but sometimes does (Goldberg 2002: 347). Furthermore, they share certain semantic features which are provided both at the level of the construction and that of the verb. Among these semantic features are the argument/participant roles realised in Subject and Object positions. All examples in (110) realise a particular role in subject position; that is, in all these examples, the entity in subject position undergoes a change of state which is further specified by the verb: *bend*, *snap*, *heat*, *proliferate* or *turn*, but they are not prototypical agents. Of course, this is a fundamental property of the construction that we have to take into account if we want to avoid lumping these examples with other intransitives, such as those in (112), and which denote a very different type of event.³

- (112) a. We've never **walked** together before.
 b. [...] you see visuals, but you don't see who's **talking**.
 c. I could have **danced** all night.

In all these instances of the intransitive construction, the entity in subject position does not undergo a change of state. The fact that we do not lump these with the non-causative intransitives does not take anything away from a surface generalisation approach. To the contrary, it allows us to make generalisations regarding the non-causative intransitive, which requires a specific type of subject. As such, the argument role realised in Subject position of the intransitive non-causative construction captures generalisations over the instances of this specific construction with different verbs and the participant roles associated with these verbs. This division between the examples in (112) and non-causatives is not binary, as shown by the (made up) example

³Examples from the NOW corpus: <https://corpus.byu.edu/now/>

in (113), where the subject undergoes a change of state but could also be construed as “doing something” to some extent.

(113) Stephanie died six weeks later.

In the same way, we should not lump instances of the transitive causative construction with instances of other transitive constructions such as those in (114).⁴

- (114) a. Abrams **saw** images that reminded him of the horrors of Black Sunday.
b. And he **hears** the child’s voice.

These examples differ from the causative transitive in that they do not denote a causation event but a perception event, and the role realised in subject position is very different from that of a causative transitive. The transitive causative construction takes an Agent (in the broad sense, i.e. , including instruments and forces) in Subject position whereas the general role realised in Subject position in the sentences in (114) is an Experiencer.

It would be a mistake to simply lump all instances of intransitives together and the same holds for transitives. However, generalising over a number of instances of the intransitive non-causative construction, for example, allows us to identify certain characteristics of this construction; notably the type of verbs they recruit and what kind of elements can then be recruited as arguments.

More evidence for the usefulness of a surface generalization approach comes from Goldberg (1999), who shows that children, who start by learning argument structure patterns on an item-by-item basis (Goldberg 1999: 200), then move on to generalising over instances of the same construction used with various verbs (cf. also Tomasello 2000). Since children mostly use general purpose verbs at first (cf. Chapter 2), they use these verbs as prototypes which are put at the centre of constructional meaning. They thus manage to abstract away from individual occurrences of certain verbs with certain argument structure constructions to then identify the meaning of each construction. Their ability to generalise and categorise lets them grasp a large amount of constructional meaning, which they would not reach if they only learned argument structure patterns verb-by-verb; and they acquire their knowledge of irregular patterns via indirect negative evidence (Boyd and Goldberg 2011). In the end, it would seem that the amount of meaning shared by two different constructions in a so-called alternation is actually limited to the meaning of the verb they share. If we compare examples (110b) and (111b), we see that what the two constructions have in common is a snapping event, which is provided by the verb itself. In these two examples, bones are affected by the snapping event in the same way, but there are cases in which the event denoted by the verb differs from one construction to the other even with an apparently similar theme, as shown in (115).

- (115) a. For example, on a bean plant, one leaf can freeze and the other not?
b. At the season’s end, be sure to pick and freeze any excess leaves to preserve that summery flavor for winter dishes.

⁴Examples from NOW corpus

A comparison of the meaning of *freeze* in both these examples shows a difference in meaning, even with the theme *leaf*. While (115b) implies the use of a freezer or a freezing device, the freezing event in (115b) occurs naturally as a result of low temperatures. These examples illustrate the semantic import of each construction, and once again highlight the differences between the two, even at the level of verb meaning. In both cases, there is a freezing event, but one is construed as “natural” while the other is construed as “artificial” and requires an instrument or device. The expression of an external agent is a property of the transitive causative construction which is clearly not shared by the intransitive non-causative. It seems difficult to argue that verbs such as *freeze*, *proliferate*, *bend*, *snap* and *turn* are inherently causative since they can be used in a non-causative construction. As such it seems that the only element these two constructions have in common is a broadly defined event which is denoted by the verb they share. To conclude, there are visibly more similarities between various instances of a same construction than there are between two different constructions which only share a verb, and sometimes a theme.

Nevertheless it should be kept in mind that while certain generalisations can be achieved with a surface generalisation approach, it is surely not the case that speakers are not aware of the existence of an alternation pattern to some extent. As Goldberg herself admits, “the essentially structuralist observation that the semantic interpretation of one linguistic construct tends to be affected by the existence of possible alternatives receives empirical support from a number of studies” (Goldberg 2002: 349). That is, speakers are aware of the different possibilities offered to them to describe a given event, and their awareness of these various possibilities affects which structure they choose to use to describe an event.

Applied to the causative alternation, the argument shows that speakers may choose to include, or not, an external cause in their description of the event, in the same way that they can choose to include a resultative phrase to further specify the event, as illustrated in (116).

- (116) I can only wait, and hope I will **freeze to death**. But of course, I know this won’t happen [...] I will simply **freeze**, and never greet the death that usually accompanies it.

In this example, it is clear that the author differentiates between the two constructions, one is a simple intransitive non-causative while the other is a combination of an intransitive non-causative with a resultative construction.

Yet, since speakers’ awareness of the existence of alternating patterns should not be underestimated, it is relevant to look more closely at the semantic and syntactic components shared by various instances of each construction but also compare these results with the semantic and syntactic features of the other construction. Looking at occurrences of a number of verbs in each construction may allow us to categorise at different levels of generalisation. In this way, greater accuracy can be achieved, and depending on the similarities and differences between each construction, one can decide to posit a certain type of link between these constructions, be it an alternation link or another type of link, as will be discussed in Section 5.2.

Somehow less extreme than a full-on surface generalisation approach, but still acknowledging the import of constructional meaning, Lemmens (1998) proposes a somewhat similar approach to verb valency which he calls lexico-paradigmatic. This approach is very close to constructionist

approaches in that it goes beyond the scope of the verb and includes elements of syntax at a higher level of generalisation. In his paper on objectless transitives, he argues that “the valence of a verb is the entrenchment of similar individual occurrences in a given construction. Obviously, the lexico-semantic structure of the verb itself will provide further semantic specifications for the schematic roles projected by the construction” (Lemmens 2006: 32). That is, speakers generalise over instances of verbs in a specific construction. Lemmens’s position is nevertheless more nuanced, in that he does not put the study of alternations on the back burner, as illustrated in Lemmens (forthc.) where he proposes a qualitative and quantitative analysis of the alternation by focusing on the alternation strength of causative verbs via a measure of theme overlap between the two constructions. Rather, he argues in favour of a mixed approach in which generalisations over a number of instances of the same construction and generalisations over a given verb’s use in different argument structure constructions are part of a speaker’s knowledge of their language. This approach will be described in more detail, and applied to the causative alternation in Section 6.2.2.

As a conclusion to this section, it can be argued that while projectionist approaches encounter certain limitations in that they are not sufficiently robust to account for all possible argument structure patterns a verb may be used with, they are correct in assuming that verbs do play a central role in the interpretation of a clause. This position, which puts the verb at the centre of the issue is shared to some extent by adherents of Valency theory, who argue in favour of verb-specific knowledge together with broader generalisations over argument structure constructions. Surface generalisation approaches, while attempting to compensate for the limitations of projectionist approaches may underestimate the extent to which speakers are aware of alternations and their potential status in speakers’ inventory of constructions. While certain constructionist approaches tend to discard alternations to some extent, they nevertheless posit the existence of various links between constructions. In the next section we will present two potential candidates for the link between the intransitive non-causative construction and the transitive causative construction.

5.2 Inheritance links and allostructions

In construction grammar, it is generally assumed that constructions are part of a structured network in which constructions are related via inheritance links (Goldberg 1995, 2006). These links come in many forms: polysemy links, subpart links, instance links and metaphorical extension links (Goldberg 1995). Goldberg (1995) posits that these links are also part of speakers’ knowledge of their language; that is, speakers are aware of the existence of these links between the various constructions they have stored in their constructicon. This section will present arguments in favour of positing a subpart link between the transitive causative construction and the intransitive construction. It will also present the allostruction approach proposed by Cappelle (2006), and taken up by Perek (2015) and show why it is not be adapted to the causative alternation.

5.2.1 Allostructions

Cappelle (2006) proposes an alternative to the alternation vs. construction dichotomy: the notion of allostruction. He argues that “[a]lternations [...] cannot be accommodated to any of [the] four inheritance links” (Cappelle 2006: 25) proposed by Goldberg (1995). Allostructions are, according to him, a solution to this issue and he proposes to treat allostructions as a linguistic item which is part of the inventory of linguistic items in construction grammar, the constructicon. His argument is based on the idea that speakers must be aware of the existence of alternative ways to express ideas, and that we should thus consider alternations as a linguistic item and as part of the inventory of constructions that compose the constructicon. Cappelle (2006) offers an analysis of the particle placement alternation: [V Prt NP] - [V NP Prt]. This alternation is illustrated with the idiomatic expression *make up one’s mind up* in (117a) and (117b):

- (117) a. I made up my mind 10 years ago [...]
 b. I grew up and had a sense of direction because I made my mind up early.

Cappelle offers the following argument in favour of positing allostructions as part of speakers’ inventory of their language:

The view that each such alternating idiom is stored twice (once as an instance of the continuous pattern and once as an instance of the discontinuous pattern) without there being a level of representation at which the two versions are perceived to be semantically identical lacks psychological plausibility (Cappelle 2006: 13).

This position is a response to a constructionist tendency to look for constructional meaning individually, i.e. compare instances of a same schematic construction for similarity among its various instances rather than compare different constructions found with the same central component, the verb in the case of argument structure constructions or the particle in the case of particle placement alternations, examples of which are Goldberg (2002) and Gries (2003). Cappelle therefore proposes to account for alternating variants with the help of *allostructions*: “variant structural realizations of a construction that is left partially underspecified” (Cappelle 2006: 18) and suggests the representation in Figure 5.1.

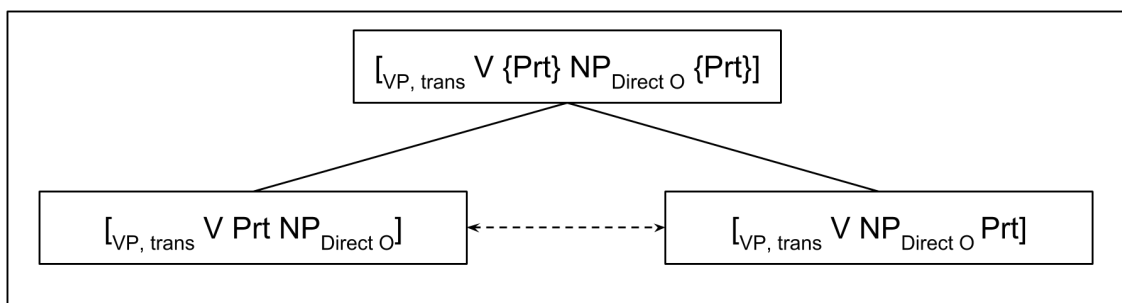

Figure 5.1: The transitive verb-particle constructions with its two allostructions (Cappelle 2006: 18)

This representation shows the existence of a construction in which the word-order (and thus the placement of the particle) is left unspecified. It also shows that there are two possible realisations of a same schematic construction which is partially unspecified; and this, Cappelle argues “is a piece of linguistic knowledge that speakers of English learn on the basis of systematic variation in the language they hear being used around them” (Cappelle 2006: 19). While the concept of allostructions accounts for the similarities in the distribution of the two allostructions, it still acknowledges the potential constraints which will lead speakers to choose one over the other.

Recognising the existence of allostructions as part of a speaker’s knowledge of their language within the framework of construction grammar is not problematic, since the *supercategory* (i.e. the underspecified construction) can be part of the constructicon together with its two allostructions. Furthermore, allostructions are similar to what Langacker (1987) calls “categorizing relations.” Cappelle notes that Langacker assumes two types of categorising relations: bidirectional and unidirectional. Both are compatible with allostructions. Bidirectional relations apply to contexts in which the allostructions can be used interchangeably, whereas unidirectional relations apply when one of the allostruction is clearly preferred to the other. Therefore, and since other types of inheritance links have been posited between construction, it would make sense to include allostructions as part of the inventory of constructions.

While Cappelle (2006) applies this concept to the question of particle placement, Perek (2015) applies it to argument structure constructions, notably the so-called dative alternation and locative alternation. Perek (2015: 153) also mentions that Cappelle calls the generalisation inherited by the allostructions the *constructeme*, a term which we will use as well. This term is particularly relevant when describing the import of the allostructions compared to that of the supercategory, as put by Perek: “the constructemes capture the level at which constructions are semantically equivalent and the allostructions specify exactly how these constructions differ” (Perek 2015: 153). Since he is dealing with argument structure constructions, Perek argues that the kind of semantic similarities and differences captured by the allostruction model are the same as those captured by the frame-semantic approach to alternating verbs (Perek 2015: 153). However, as Perek points out, while frame semantics captures similarities and differences in meaning at the level of the verb, the allostruction model does so at the level of the construction, thus including the potential variation in form in the model.

Both Cappelle (2006) and Perek (2015) argue for the inclusion of the allostruction model as part of speakers’ knowledge of their language since it serves to capture “regularities that speakers can extract from a number of analogical usage events” (Cappelle 2006: 3-4).

As we mentioned before, Cappelle uses the particle placement alternation to illustrate his allostructions model and Perek uses two sets of three-argument constructions: the dative and locative alternations. Perek proposes the representation in Figure 5.2 for the locative alternation.

The locative alternation can be illustrated with the well-known *spray/load* examples in (118) and (119):

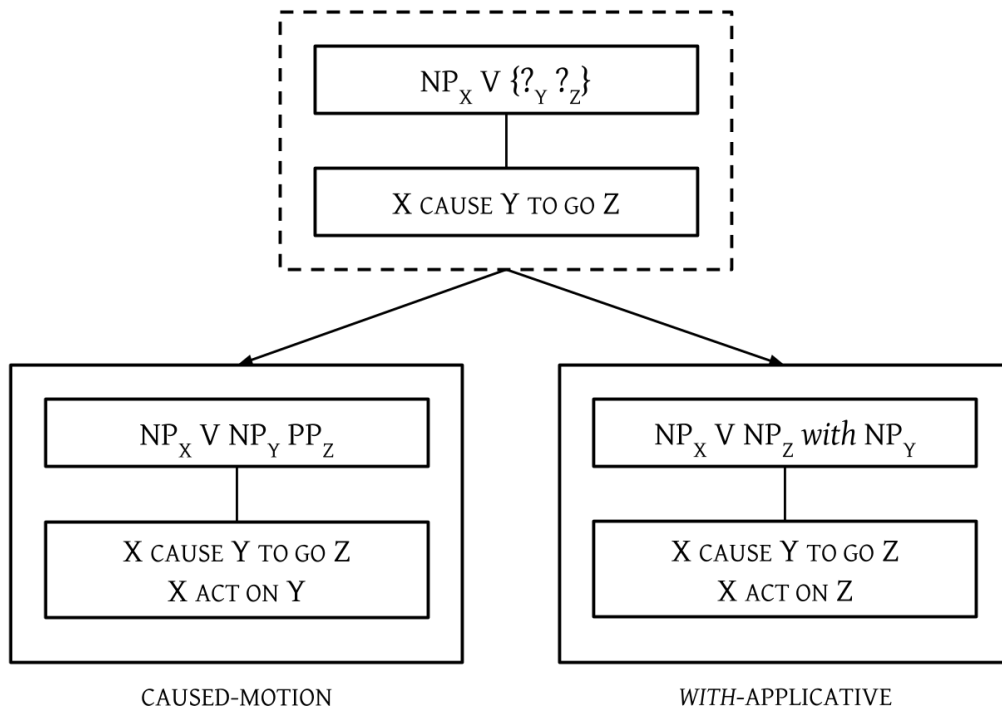

Figure 5.2: The locative constructeme and its allostructions (Perek 2015: 162)

- (118) a. John sprayed paint onto the wall.
 b. John sprayed the wall with paint.
- (119) a. John loaded the hay onto the truck.
 b. John loaded the truck with hay.

As Perek notes, “both constructions refer to an event of caused change of location, but the caused-motion construction construes the event as an action by the agent on the theme [...] whereas the *with*-applicative construction construes it as an action on the location” (Perek 2015: 160). Therefore, the two constructions are very similar and their differences are rather superficial.

The major way in which these alternations differ from the causative alternation is that in the causative alternation, the two members of the alternation do not share the same number of arguments. One depicts an event including an caused change of state while the other simply depicts a change of state.

Keeping all this in mind, could an allostruction model work for the causative alternation? The answer is no, as the two constructions differ in the way they are used to describe a speaker’s conceptualisation of an event: one is a causation event, while the other is not. The allostruction model works really well with the dative alternation and the locative alternation because, as Perek argues: “[t]he variants of two such alternations [...] have highly similar constructional meanings, in that in both cases they share the same basic event description” (Perek 2015: 162). With the so-called causative alternation, we have two constructions that do not describe the same event type, since even though both imply to some degree a change of state, one implies external

causation while the other does not. This type of difference is not superficial, and can therefore not be subsumed in an allostruction model.

5.2.2 Inheritance links: the subpart link

In the framework of construction grammar, the relations between different constructions are captured by inheritance links “which motivate many of the properties of particular constructions while at the same time allowing for subregularities and exceptions” (Goldberg 2002: 67). These links are meant to show what different constructions have in common and in what ways they differ; as such they “capture the fact that all non-conflicting information between constructions is shared” (Goldberg 1995: 74-75). Among these, the Subpart link is particularly relevant for the two constructions under study here: “A *subpart link* is posited when one construction is a *proper subpart* of another construction and exists independently” (Goldberg 1995).

Goldberg (1995: 78) proposes this type of link to describe the relation between the intransitive motion construction and the caused-motion construction, as illustrated respectively in examples (120) and (121).

(120) The ball rolled across the floor.

(121) Sarah rolled the ball across the floor.

According to Goldberg, the intransitive motion construction in (120) is a subpart of the caused-motion construction in (121). The subpart link, defined as an item describing a link between two constructions aligns neatly with Langacker’s definition of the thematic relationship (the subpart) and its extension to a transitive with the addition of an external force (the bigger construction), cf. Section 3.1 and Langacker (1991).

The relation between the two motion constructions is illustrated in Figure 5.3.

As shown by this diagram, the subpart of the caused-motion construction, the intransitive motion construction shares a certain number of properties with the caused-motion construction: a motion event, a theme and a goal. The only element that is missing is the cause.

This description of the relation between the intransitive motion construction and the caused-motion construction seems to fit the description of the relation between the intransitive non-causative construction and the transitive causative construction, as illustrated respectively in (122) and (123).

(122) [...] there were fruits and vegetables in thin, transparent plastic bags that crinkled like cellophane.

(123) Our witnesses crinkled their paper bags.

This relation is illustrated in Figure 5.4 which presents an adapted version of Goldberg’s diagram that we use to describe the relation between these two constructions.

The diagram shows the characteristics shared by the two constructions: an event denoting a change of state and an entity undergoing the change of state. The main difference between the two constructions is the presence of an external cause in the transitive causative construction. If

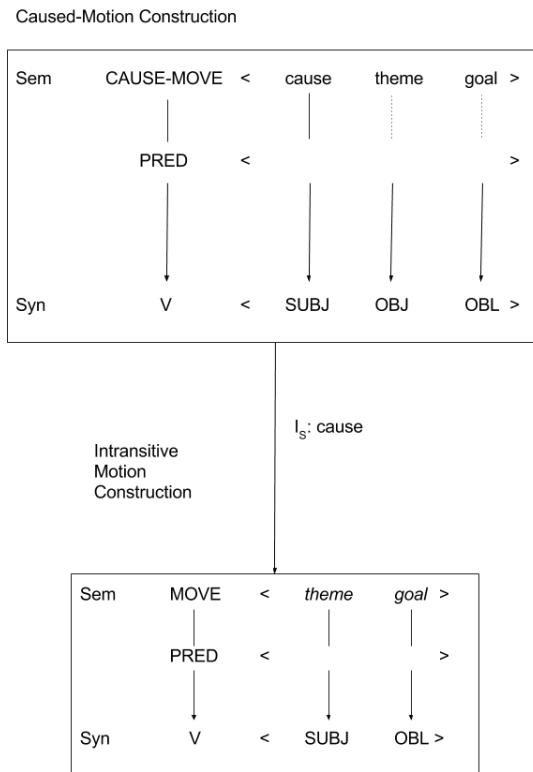

Figure 5.3: Subpart link (Goldberg 1995: 78)

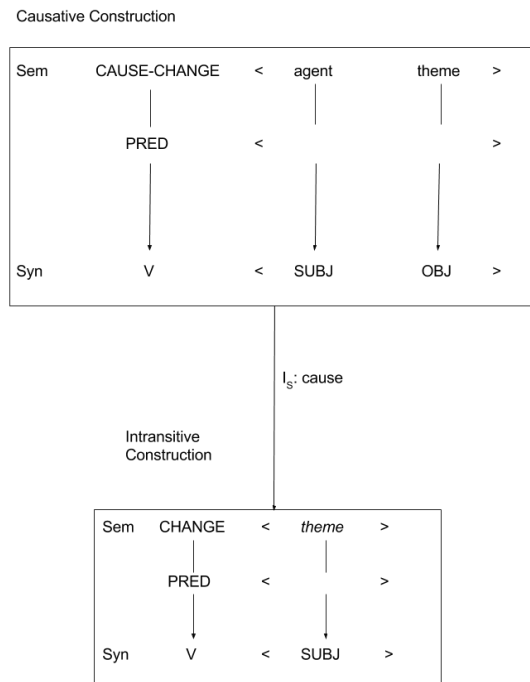

Figure 5.4: Subpart link (adapted)

we were to describe these constructions in Langackerian terms, we could say the subpart is the thematic relationship and the bigger construction is an extension of this thematic relationship which includes an external cause.

While the subpart link provides a comfortable description of the relation between the two constructions, it does not cover all the specific semantic specifications associated with the intransitive non-causative construction. Such a representation illustrates the basic syntax and semantics (form and meaning) of the construction but does not include information as to the limitations the construction and the verbs occurring in this construction impose on the kind of themes they recruit. While the idea of a subpart link is not problematic for the examples in (122) and (123), it becomes more problematic when dealing with instances of the transitive causative construction which contain a patient that cannot be construed as a theme and thus not realised as subject in the intransitive construction, as illustrated in (124):

- (124) a. After supper I broke my promise.
b. * my promise broke (after supper).

If we were to consider that the subpart of a construction simply represents a portion of a whole without the addition of information such as constraints on the elements this specific subpart recruits, then the model does not hold. However, it is not necessarily the case that the subpart is merely a portion of the whole, otherwise positing such a link would not be quite as relevant. The intransitive non-causative construction is a proper subpart of the transitive causative construction in that the event it describes is indeed a subpart of the causation event denoted by the whole. Nonetheless, it is not the case that any occurrence of the transitive causative construction will have a counterpart in the form of a subpart construction, since as we have already mentioned and will explore in detail in Chapter 7, the intransitive non-causative construction appears to have different constraints on the themes it recruits from that of its transitive causative counterpart. As such, (124b) is not a subpart of (124a); the subpart link does not hold between the two.

So far we have seen that the inheritance link proposed by Goldberg (1995) fits the description of the so-called causative alternation quite well, granted that it is made clear that while one construction is a proper subpart of another, both constructions still have properties and constraints that are proper to each. The subpart relation between the two constructions is also considered by Lemmens (1998: 64) to be a sort of metonymy relation since one construction is a part of the other. That is, the intransitive non-causative construction is a part of the transitive causative construction (the “whole”). This view is close to that of Goldberg (1995). Therefore, for the description of the similarities and differences between the two constructions, we will prefer Goldberg’s inheritance link as it captures efficiently the fact that one construction includes one extra yet major element: causation.

PART II
METHOD, DATA AND RESULTS

CHAPTER 6

DATA AND METHOD

This chapter will focus on a presentation of the method and data used for this research. The first section, Section 6.1, will present the corpus that was used for this research, which was extracted from the online version of the Corpus of Contemporary American English, and second how the data were selected. In the second section, Section 6.2.1, we will explore a collostructional method proposed by Stefanowitsch and Gries (2003, 2005) which provides a tool to measure the attraction between particular lexemes and constructions, and thus allows us to extract a certain amount of constructional meaning. We will then move on to a method proposed by Lemmens (forthc.), to measure the amount of information shared between two “alternating” constructions (Section 6.2.2). Finally, we will show how these methods can combine with distributional semantics. Distributional semantics allows an objective and systematic grouping of lexemes. This grouping provides more information as to the different elements that occur in each construction and thus gives more insight as to individual constructional meaning (Section 6.2.3).

6.1 Collection and annotation

6.1.1 The corpus

When collecting data for this research, we need to compare two constructions: an intransitive non-causative construction and a transitive causative construction. In order to start the selection process, we turn to Levin (1993) and her categories of alternating verbs. Levin lists 355 verbs that can alternate between an intransitive non-causative construction and a transitive causative construction. So as to achieve a qualitative and yet quantitative study, only a portion of verbs are chosen among the large number of verbs she lists for the causative alternation. Our aim is to work on groups of verbs which were related within their group but which would differ to some extent from those of the other groups. Therefore, we selected five groups: the first three were identified by Levin, the last two groups contain verbs that Levin (1993) put in the broad category: “other verbs of change of state.”

1. **BREAK** verbs: *break, crack, crush, shatter, snap, tear*
2. **BEND** verbs: *bend, crease, crinkle, crumple, fold, wrinkle*
3. **ROLL** verbs: *roll, drop, move, slide, turn*
4. **GROW** verbs: *grow, expand, increase, proliferate, stretch, thicken*
5. **CHANGE OF TEMPERATURE** verbs: *burn, chill, cool, freeze, heat, warm*

All of these refer to different kinds of change of state. The first group is one of the most prototypical groups of verbs of change of state, usually associated with telic, effective change: something is perceived as either broken or not broken.¹ **BEND** verbs, on the other hand, may denote a certain gradation of change: something can be slightly bent, or very wrinkled. **ROLL** verbs denote more a motion than a change of state, and thus make for a nicely contrasting group. The last two groups contain verbs that Levin (1993) put in the broad category: “other verbs of change of state.” The first set, the **CHANGE OF TEMPERATURE** verbs, were picked for this research based on one common component of meaning: a change of state associated with a change of temperature. The second, which is made up of **GROW** verbs, was constituted based on one shared component of meaning: they all denote a change of state that is progressive and strictly related to the size of the undergoer.

Instances of these verbs were extracted from the Corpus Of Contemporary American English (COCA).² This particular corpus was chosen for several reasons. First, it is one of the biggest contemporary corpora of English with 520 million words, distributed over twenty-five years (from 1990 to 2015) and with a total of 20 millions words per year. Second, it contains data from five different types of sources: academic papers, fiction, spoken language, popular magazines and newspapers. Third, it offers an online interface that is easy to use and gives precise results. Furthermore, COCA is tagged for parts of speech, which allows for precise queries. Unfortunately, it is not tagged for syntax (and syntactic functions), that is, one cannot look for a string such as [Subject Verb Object] or [Subject Intransitive Verb]. This is not a major issue since, in any case, argument structure constructions such as the transitive causative construction and the intransitive non-causative construction are not all that easy to parse automatically and a large amount of manual annotation would have been required anyway. Therefore, the collection of data went as follows. For each verb, we would type a query that would return any instance of this word used as a verb, so as to avoid things such as nouns (e.g. *a burn*) and deverbal adjectives (e.g. *a broken leg*). Of course, such a query will return many instances of these verbs used with a construction that is neither the intransitive non-causative nor the transitive causative construction. While it may be seen as noise or pollution, the presence of many other different constructions in our corpus allowed us to measure (at least approximately) to what extent each of the verbs we studied favoured one construction or another. Therefore we chose to keep these data in our corpus, to label them, but we nevertheless focused on instances of the intransitive non-causative construction and of the transitive causative construction.

¹Of course, there are many occurrences of the adjective *broken* with adverbs of degree, but prototypically, *broken* tends to denote a complete change of state.

²Davies 2008-.

Label	Construction	Example
Cx1	Intransitive non-causative construction	<i>The limb snapped [...]</i>
Cx2	Transitive causative construction	<i>[...] heat 1/2 cup of extra wild blueberries in a dry skillet.</i>
Cx3a	Intransitive resultative construction	<i>[...] and hope I will freeze to death.</i>
Cx3b	Transitive resultative construction	<i>[...] she stretched the string taut.</i>
CxN	Other constructions (e.g. passive)	<i>[...] he and Gloria were physically stretched to the limit.</i>

Table 6.1: Labels and constructions

As mentioned before, the Corpus Of Contemporary American English is made up of 520 million words. The consequence is that for each verb the query returned thousands of instances; for example, *break* occurs 105,635 times in COCA, *drop* occurs 73,999 times and *grow* occurs 147,827 times. Clearly, it was not possible to analyse all these instances individually. Therefore, we extracted between 500 and 1,950 instances of each verb loosely based on this verb's overall frequency in the corpus for a total of 32,355 instances of all 29 verbs together. Once these data were extracted, we annotated the resulting corpus of 32,355 instances of these 29 verbs for construction.

The most frequent constructions we found for these verbs were, apart from the intransitive non-causative and the transitive causative constructions, instances of the caused-motion construction and of the family of resultative constructions (cf. Goldberg and Jackendoff (2004) for an analysis and inventory of the family of resultative constructions). Since these constructions appeared very frequently with the verbs we studied, we decided to annotate them specifically. We used the labels given in Table 6.1 to identify these constructions.

As is visible from Table 6.1, the labels Cx1 and Cx2 correspond respectively to the intransitive non-causative and the transitive causative constructions. As to the family of resultative constructions, we did not differentiate between prototypical resultatives and motion constructions since we follow Goldberg and Jackendoff (2004) in believing that these are all members of the family of resultatives. In other words, instances of the intransitive motion construction and of the intransitive resultative construction were all labelled Cx3a, while instances of the caused-motion construction and of the transitive resultative constructions were labelled Cx3b. However, these constructions were not retained since they differ from the intransitive non-causative construction and transitive causative construction in that they take a resultative phrase realised in an oblique. The label CxN was used for other constructions or, when the previously mentioned constructions occurred in combination with constructions such as the passive. We chose not to analyse instances of the intransitive non-causative construction and of the transitive construction when used in combination with the passive because the passive construction may make it difficult to clearly establish a verb's transitivity. Furthermore, there might be some constructional ambiguity between an actual passive construction of the type [X BE V_{PP}] where PP is the past participle and a construction of the type [X BE Adj], as illustrated in (125) and (126). Therefore we preferred to focus on clear instances of these constructions without the passive.

GRAND TOTAL	
Instances extracted	32,355
Instances retained	11,554
Instances of Cx1	4,481
% Cx1	39.84%
Instances of Cx2	7,073
% Cx2	60.16%

Table 6.2: Overview of data sample

(125) We agree that the criminal justice system is broken.

(126) [...] said that no laws were broken.

Out of the 32,355 instances extracted from COCA, we found 11,554 instances of either the intransitive non-causative construction or of the transitive causative construction. The total number of instances extracted and retained can be found in Table 6.2. This table also displays the number of instances of the intransitive non-causative construction and of the transitive causative construction among the instances retained. Percentages have been included, in order to give an idea of the frequency of each construction in our corpus.

This table clearly shows the preponderance of transitive causative constructions which represent 60.16% of the constructions retained. It also shows that a lot of manual coding was necessary since out of the 32,355 instances of our 29 verbs extracted from COCA, only 11,554 were instances of either the intransitive non-causative construction or the transitive causative construction. Although there is a general tendency for the transitive causative construction to be more frequent than its intransitive counterpart, this is not necessarily the case for all verb groups, as we will see below.

We will also look at frequencies for each verb group in the following paragraphs, with one table per verb group giving detailed frequency counts for each individual verb. As we will see, out of five verb groups, three are more frequently used with the transitive causative construction. The two that are used slightly more frequently with the intransitive non-causative construction are ROLL verbs and GROW verbs. Instances of GROW verbs are almost equally distributed between the intransitive non-causative construction (50.50%) and the transitive causative construction (49.50%). Instances of ROLL verbs are slightly more common with the intransitive non-causative construction (51.96%) than with the transitive causative construction (48.04%).

BREAK	break	crack	crush	shatter	snap	tear	TOTAL
Instances extracted	1750	800	700	800	1100	1600	6750
Instances retained	641	377	329	499	330	92	2268
Instances of Cx1	121	150	2	173	110	22	578
% Cx1	18.88%	39.79%	0.61%	34.67%	33.33%	23.91%	25.49%
Instances of Cx2	520	227	327	326	220	70	1690
% Cx2	81.12%	60.21%	99.39%	65.33%	66.67%	76.09%	74.51%

Table 6.3: Overview of BREAK verbs

The first verb group, which consists of BREAK verbs, is usually considered to be prototypically causative and is unsurprisingly more frequently found in the transitive causative construction (74.51% of instances), as is visible in Table 6.3. Although all these verbs occur more frequently in the transitive causative construction (between 60.21% and 81.12% for most of them), *crush* is the only one that is found with this construction only (99.39% of all instances).

As to BEND verbs, Table 6.4 shows that as a group they tend to be more frequently found with the transitive causative construction as well. However, if we look at these verbs individually, we see that *crinkle* is actually more frequently found with the intransitive non-causative construction, with only 38.18% of instances occurring with the transitive causative construction. Also, *crumple* is only marginally more frequent with the transitive causative construction, with 52.56%.

BEND	bend	crease	crinkle	crumple	fold	wrinkle	TOTAL
Instances extracted	1950	850	600	1050	1400	1100	6950
Instances retained	480	359	330	390	363	701	2623
Instances of Cx1	167	112	204	185	84	215	967
% Cx1	34.79%	31.20%	61.82%	47.44%	23.14%	30.67%	36.87%
Instances of Cx2	313	247	126	205	279	486	1656
% Cx2	65.21%	68.80%	38.18%	52.56%	76.86%	69.33%	63.13%

Table 6.4: Overview of BEND verbs

As we will discuss in more detail in Section 6.2.1, ROLL verbs are not very frequent in either the intransitive non-causative construction or the transitive causative construction. However, Table 6.5 shows that out of the two constructions, they tend to be more frequently found with the intransitive non-causative construction. Out of the five ROLL verbs, three seem to prefer the intransitive non-causative construction, namely *move*, *slide* and *roll* with respectively 76.42%, 92.31% and 65.85% of their instances with this construction.

ROLL	drop	move	roll	slide	turn	TOTAL
Instances extracted	1050	1700	1300	950	1100	6100
Instances retained	355	369	236	39	123	1122
Instances of Cx1	98	282	86	36	81	583
% Cx1	27.61%	76.42%	36.44%	92.31%	65.85%	51.96%
Instances of Cx2	257	87	150	3	42	539
% Cx2	72.39%	23.58%	63.56%	7.69%	34.15%	48.04%

Table 6.5: Overview of ROLL verbs

As a group, GROW verbs are the most evenly distributed between the two constructions, with 50.50% occurrences in the intransitive non-causative construction (cf. Table 6.6). However, within the group there are discrepancies between certain verbs in their distribution across the two constructions. A striking example is *proliferate* which occurs 93.65% of the time with the intransitive non-causative construction. This is counter-balanced by verbs such as *expand* and *increase*, both of which occur much more frequently with the transitive causative construction (about 69% for both). As such the tendency of the group shows discrepancies rather than unity in the distribution of these verbs across the two constructions.

GROW	expand	grow	increase	proliferate	stretch	thicken	TOTAL
Instances extracted	1100	1100	1000	550	1105	500	5355
Instances retained	744	229	776	488	270	269	2776
Instances of Cx1	225	160	233	457	114	213	1402
% Cx1	30.24%	69.87%	30.03%	93.65%	42.22%	79.18%	50.50%
Instances of Cx2	519	69	543	31	156	56	1374
% Cx2	69.76%	30.13%	69.97%	6.35%	57.78%	20.82%	49.50%

Table 6.6: Overview of GROW verbs

Finally, Table 6.7 shows that although five out of six CHANGE OF TEMPERATURE verbs are more frequently found with the transitive causative construction, their distribution varies between the two constructions. For example, *cool* is almost evenly distributed with 51.62% of its occurrences in the transitive causative construction. On the other end of the spectrum, *heat* is almost exclusively found with the transitive causative construction with only 15 occurrences in the intransitive non-causative construction out of 334 instances retained (4.49% of intransitives).

CHANGE OF TEMPERATURE	burn	chill	cool	freeze	heat	warm	TOTAL
Instances extracted	1400	1200	1100	1400	900	1200	7200
Instances retained	639	518	308	566	334	400	2765
Instances of Cx1	281	97	149	311	15	98	951
% Cx1	43.97%	18.73%	48.38%	54.95%	4.49%	24.50%	34.51%
Instances of Cx2	358	421	159	255	319	302	1814
% Cx2	56.03%	81.27%	51.62%	45.05%	95.51%	75.50%	65.61%

Table 6.7: Overview of CHANGE OF TEMPERATURE verbs

The final corpus we worked with is constituted of 11,554 instances of the twenty-nine verbs selected used with either the intransitive non-causative construction and the transitive causative construction.

The next section will give more details regarding the selection process and the delimitation of what we consider an intransitive non-causative construction and a transitive causative construction.

6.1.2 Defining the scope of each construction

While it may at first seem easy to identify an instance of one of these two constructions, it becomes less clear when confronted with actual data. For the intransitive non-causative construction, the premise was as follows.

Intransitive non-causative construction:

Any instance of any of the twenty-nine verbs selected used with an intransitive construction in which the subject refers to the entity undergoing the event denoted by the verb counts as an intransitive non-causative construction.

This implies that the entity realised in subject position must be a theme, that is, an entity which undergoes the event denoted by the verb, and no other undergoer can be expressed in any

other position. Furthermore, if the subject position is filled by the entity undergoing the event denoted by the verb, then no agent should be expressed in other argument positions since the role realised in subject position is the primary focus in this context. As expressed by Langacker: “Our working hypothesis is that a subject is properly characterized as the *primary clausal figure*” (Langacker 1991: 330). That is, there is a reason why a speaker may choose an intransitive non-causative construction and thus to only mention the entity undergoing the event and not the cause of the event. Usually the agent (in the broad sense of the term), is unknown or irrelevant. Again, following Langacker: “It is crucial to realize that the focal status of the subject and object, as well as the basis for choosing them, pertain to the *profiled* relationship” (Langacker 1991: 330).

However, as discussed in Section 3.1.2, it is sometimes the case that an agent-like entity is expressed in a prepositional phrase which functions as an adjunct. This was shown with example (34), which we reproduce here in (127).

(127) The corn was bending *with the wind*.

Also found in *with* prepositional phrases are entities not clearly identifiable as agents, but with which a certain correlation is construed, as shown in (128).

(128) Those strands of connective tissue thicken *with age*, and our skin gets thinner, says Katie Rodan.

In this particular example, *age* is not necessarily construed as directly causing the event denoted by the verb, but rather establishes some sort of correlation with the thickening event.

There are, however, other cases in which the agent is expressed in a prepositional phrase, but not necessarily with *with*. Such instances of agents expressed in various prepositional phrases are found in (129), (130) and (131) below.

(129) Lines snapped *under the storm's force*.

(130) Within a half-hour, the French line buckled and broke *before the weight of allied numbers*—and with it, French morale.

(131) the blood vessels will tear and break *from the force*

Although an agent is expressed in all these examples, it is not realised in the prototypical subject position, but rather in an oblique. This is an instance of what Goldberg (1995: 57) calls *shading*. Shading is a “process whereby a particular participant is ‘put in the shadows’, and thus no longer profiled” (Goldberg 1995: 57). As such, in this case, the *shaded* participant is the agent and is realised in an adjunct.

Since the agent is not expressed as an argument of the verb but in an adjunct, such examples are considered as instances of the intransitive non-causative construction.

As for the transitive causative construction, the following definition was used.

Transitive causative construction:

Any instance of any of these verbs in a construction in which the entity realised in object position is the undergoer of the event denoted by the verb and the entity realised in subject position is the entity responsible for this event counts as an instance of the transitive causative construction.

This excludes all instances of these verbs used in an objectless construction, such as in (132).³

(132) Crack, crush, slam and flatten more!

(133) [...] diary notes that talk about fighting the urge to slaughter, to tear, to stab.

These examples are instances of the objectless construction which allows omission of the object with certain verbs. Considering a lot of our work focuses on the theme (i.e. the entity undergoing the event denoted by the verb), it did not make sense to use these constructions in our corpus. Furthermore, as shown in Goldberg (2001) and Lemmens (2006), this construction has specific constraints which are much more intricate than the “regular” transitive causative construction.

Another construction which highly resembles the transitive causative construction, at least syntactically, is the setting construction. Instances of the setting construction are provided in (134). In these examples, the entity realised in object position is the entity undergoing the event, however, as discussed below, these do not count as instances of the transitive causative construction.

- (134) a. When he was seventeen, he broke his leg in a sledding accident
 b. Dravecky snapped the humerus bone in his arm while pitching against Montreal.
 c. Some investors are hoping that we freeze our toes this winter.

In all sentences in (134), the role realised in subject position is not an agent, it is not the entity responsible for the action denoted by the verb. Since the entity realised in subject position is not the one that caused the event to occur, but rather a setting for the event (Davidse 1992; Guerrero Medina 2014: 128), these sentences cannot be interpreted as instances of the causative construction. In a way, in these examples, both the entities realised in subject position and in object position undergo the event denoted by the verb to some extent. The role realised in subject position here is what Talmy calls the Undergoer (Talmy 2000: 517), which he opposes to the typical Agent but also to the Author, which are respectively illustrated below in (137), (135) and (136)(Talmy 2000: 517).

(135) The masochist (deliberately) broke his arm by hitting it with a hammer. (Agent)

(136) The careless kid (accidentally) broke his arm in hitting it playfully with a hammer. (Author)

(137) The hapless fellow (by misfortune) broke his arm when he fell. (Undergoer)

³Examples from the News On the Web (NOW) Corpus (Davies 2013).

While we do not necessarily mark a contrast between the Agent and Author, we do however differentiate between these two and Talmy's Undergoer. What differentiates the first two is the notion of volition. The agent willingly acts upon the theme in order to achieve a certain result, whereas the author does not complete the action willingly but, as shown in (136), does so accidentally. The reason why we choose not to differentiate between these two is that both the Author and the Agent caused the change of state denoted by the verb, willingly or not. In opposition, the undergoer, as illustrated in (137), is not construed as causing the breaking event: "an Undergoer [...] has not agentively undertaken actions that culminate in that event. Rather, the event is conceived as autonomously occurrent and as HAPPENING TO the Undergoer" (Talmy 2000: 517). Therefore, since the role realised in subject position is in no way agentive, this construction cannot be construed as a causative.

So far we have seen that there are two constraints for a construction to be identified as a transitive causative construction. First, the object (i.e. the theme) has to be overtly realised. Second, the subject position must be filled by an agent (or author, as per Talmy 2000), that is, the entity that causes the event denoted by the verb. As discussed in Section 3.1, an instrument or a force can both be construed as causing the event denoted by the verb and, as such, be found in subject position in a true transitive causative construction.

As to the semantics associated with the event itself, as mentioned in Section 3.1.2, some of the themes realised in object position in the transitive causative construction were shown to not be quite as clearly affected by the event as others.

- (138) Advocates of proportionality claim that universities that are not "proportional" are breaking the law.
- (139) Rosemont smiled sleepily at Hector, unsure if he was breaking house rules by sitting in the atrium this late.

In both examples (138) and (139), the theme, respectively *the law* and *house rules*, is not directly affected by the event. This might be argued to justify why such themes cannot be found in subject position in intransitive non-causative constructions. However, a similar theme, *promise* is affected by a breaking event, as shown in (140).

- (140) It was a mistake to support the President, seeing how he broke his promises to us about not going to war immediately.
- (141) Because we were married, and ...she broke the contract.

Actually, *promise* is closer to *law* in this respect, since a promise, like a contract, creates a bond between at least two definite entities. If one of these entities breaks the contract or promise, then the contract or promise no longer holds. To the contrary, a law is a contract between one entity (the authority) and a number of individual entities. If one member of the second group breaks the law, the law still holds for the rest of the group. Bearing this in mind, and the fact that many other items are in fact sometimes barely affected by the event denoted by the verb, such instances were considered instances of the transitive causative construction. Even though

the law or rule itself is not directly affected, the contract between the authority and the entity that broke the law is affected in some way. This, we believe, suffices to justify identifying such constructions as instances of the transitive causative construction.

Now that we have defined more clearly what counts as an instance of the intransitive non-causative construction and as an instance of the transitive causative construction, we can start properly measuring to what extent verbs alternate between these two constructions. The measure we are looking to find is the alternation strength of these verbs, which would allow us to quantify to what extent the two constructions overlap in terms of meaning. In order to measure this overlap, we will apply several measures. We will start with a **collostructional analysis** (Section 6.2.1) to see which verbs are more attracted to which construction. Then, in Section 6.2.2, we will measure **theme overlap**, which will give us a first idea of how many themes are actually shared by the two constructions. Finally, in Section 6.2.3 we will present a method known as **distributional semantics**, which we will then use to group themes into semantically related clusters. This last measure offers more insight into the amount of meaning shared by the two constructions.

6.2 Measuring the alternation strength of causative verbs

6.2.1 Distinctive collostructional analysis

The question we ask ourselves in this section is whether certain verbs clearly favour one construction or if they are equally distributed with both constructions. In order to measure this preference we use a measure of attraction between certain lexemes and certain constructions known as collostructional analysis.

Collostructional analysis is a method developed by Stefanowitsch and Gries (2003). It is “an extension of collocational analysis that takes into account grammatical structure and is specifically geared to investigating the interaction of lexemes and the grammatical constructions associated with them” (Stefanowitsch and Gries 2003: 209). That is, it combines collocational analysis with constructional analysis. Instead of simply looking for collocations between lexemes, collostructional analysis takes as its basis a specific construction and then looks for lexemes that are “strongly attracted or repelled by a particular slot in the construction” (Stefanowitsch and Gries 2003: 214). In this specific way, it differs from more traditional collocational analyses, which do not pay attention to particular syntactic slots but focus on “raw” collocations.⁴ Stefanowitsch and Gries (2003: 214) argue that this type of approach is too imprecise since it does not reflect syntactic organisation in any way. However, it is usually assumed that since these approaches are not constrained by syntactic concerns, they can be conducted on very large amounts of data. Using large amounts of data then makes up for their imprecision since the sheer amount of data and the overall frequency of items will be high enough to discard accidental collocates and the relevant collocates (and collocations) will emerge naturally. This is an argument we will adopt in Section 6.2.3 when we discuss the advantages of distributional semantics.

⁴For more information on collostructional analysis and its predictive power, see Gries, Hampe, and Schönefeld (2005) and Gries, Hampe, and Schönefeld (2010); for this method’s ability to help “discover” constructions, see Hampe (2011).

One of the goals of collocation analysis is to provide a tool relying on precise data to draw a sketch for the identification of constructional meaning. As Stefanowitsch and Gries (2003: 224) illustrate with their analysis of the *into*-causative construction (e.g. *He tricked me into employing him*), collocation analysis measures the attraction between a construction and the lexemes that occur in a given slot of this construction. Collocation analysis thus shows which lexemes are the most attracted to the construction. The most significantly attracted collexemes are those that are the closest to the central meaning of the construction. For example, the *into*-causative is usually associated with concepts such as trickery and force, and as Stefanowitsch and Gries (2003) show, the verbs that are the most significantly attracted to the verb slot of the *into*-causative construction have a meaning that is similar to that of the construction (e.g. *trick, fool, coerce, force, mislead*).

While this approach could be used to get to the meaning of the intransitive non-causative construction and/or the transitive causative construction individually, it is actually even more relevant to our research to use a method that allows us to compare two or more constructions. The solution to this is provided by Gries and Stefanowitsch (2004) who extend collocation analysis to the question of so-called alternations. More specifically, the method they call *distinctive collocation analysis* provides a tool to compare a pair of semantically similar constructions and identify potential subtle differences in their meaning, it “identifies lexemes that exhibit a strong preference for one member of the pair as opposed to the other, and thus makes it possible to identify subtle distributional differences between the members of such a pair” (Gries and Stefanowitsch 2004: 97). Such a method should either confirm near constructional synonymy or, to the contrary, highlight differences of meaning between the two constructions. Furthermore, it should help identify specific constraints on these alternations and the constructions which make up the alternation.

The distinctive collocation analysis requires four frequencies. For the analysis of the causative alternation, the four frequencies should be as follows: the lemma frequency of a verb V1 in construction C1, the lemma frequency of verb V1 in construction C2, and the frequencies of constructions C1 and C2 with other verbs. While distinctive collocation analysis is normally meant to be used on a full corpus, we had to restrain it to the data points we had in our corpus (made up of 11,554 occurrences of the 29 verbs we studied). The reason for this is that the Corpus of Contemporary American English is too large and it is virtually impossible to identify all instances of the intransitive non-causative construction and of the transitive causative construction. For instance, there are in total 114,181 occurrences of *break* as a verb in the COCA. As such, it is impossible to analyse all instances of *break*. This is why we chose to reduce our corpus to a sample of randomly selected instances of each of the verbs we studied. From this sample corpus made up of 11,554 instances of the intransitive non-causative construction and of the transitive causative construction, we extracted the frequencies given in Table 6.8. Such a table of frequencies is all that is needed as input for a distinctive collocation analysis.

Gries and Stefanowitsch (2004) investigate alternations such as the dative alternation, the active and passive, verb-particle constructions and *will* vs. *be going to*. They conclude that for some of the alternations they studied, “there is clear evidence that each of the two members of an

	<i>break</i>	Other verbs	Row totals
INTRANSITIVE NON-CAUSATIVE Cx	121	4360	4481
TRANSITIVE CAUSATIVE Cx	520	6553	7073
Column totals	641	11013	11554

Table 6.8: The distribution of *break* in the intransitive non-causative and the transitive causative constructions

alternating pair is a construction in its own right with its own meaning.” (Gries and Stefanowitsch 2004: 124) Still, they also acknowledge that sometimes there is a certain amount of semantic overlap between two constructions but “what is primary are the constructions, and not the paraphrase relation” (Gries and Stefanowitsch 2004: 124).

Unfortunately, with a limited number of verbs, distinctive collexeme analysis can only give us an idea of which verbs are significantly attracted to one construction, the other or none. The limitations in our corpus do not allow us to draw solid conclusions about constructional meaning at this point, but we can nevertheless notice that some verb groups are more or less attracted to one construction or the other. The results of the distinctive collexeme analysis can be found in Table 6.9.

As is visible from these results, out of 29 verbs, 26 show a significant preference for one construction or the other. The only three exceptions are *roll*, *stretch* and *crack*. Also, out of these 26 verbs, more than half are significantly attracted to the transitive causative construction.

If we look at the distribution of verbs between the two constructions by groups, we find that verbs from the BREAK group tend to be significantly attracted to the transitive causative construction, thus confirming intuitions that these are prototypically causative. For example, among the top three verbs attracted to this construction are *crush* and *break*. The first is almost exclusively used in the causative construction, and the second is the most prototypical member of the group. The only exception in this group is *crack* which is attracted to the intransitive non-causative construction, but not significantly. All three other BREAK verbs (*tear*, *snap*, and *shatter*) are significantly attracted to the transitive causative construction, although to a lesser extent.

A majority of verbs from the BEND group are significantly attracted to the transitive causative construction: *fold*, *wrinkle*, *crease* and *bend*. Only two of these are significantly attracted to the intransitive non-causative construction: *crinkle* and *crumple*.

As to the GROW group, four verbs are attracted to the intransitive non-causative construction, three significantly (*proliferate*, *thicken*, *grow*) one non-significantly (*stretch*). The other two, *increase* and *expand*, are significantly attracted to the transitive causative construction.

The six verbs constituting the CHANGE OF TEMPERATURE group are equally distributed between the two constructions. Three are significantly attracted to the transitive causative construction: *heat*, *chill*, *warm*; and three are significantly attracted to the intransitive non-causative construction: *freeze*, *cool*, *burn*.

Verbs of the ROLL group are attracted to the intransitive non-causative construction but these

6.2. MEASURING THE ALTERNATION STRENGTH OF CAUSATIVE VERBS

words	Observed frequency CAUS	Observed frequency NON-CAUS	Total	Expected frequency CAUS	Expected frequency NON-CAUS	Preferred occurrence	Collostruction strength	p. value
crush	327	2	329	201.4	127.6	CAUS	67.06	p<0.001
heat	319	15	334	204.46	129.54	CAUS	49.59	p<0.001
break	520	121	641	392.4	248.6	CAUS	28.3	p<0.001
chill	421	97	518	317.1	200.9	CAUS	23.19	p<0.001
fold	279	84	363	222.22	140.78	CAUS	10.03	p<0.001
warm	302	98	400	244.87	155.13	CAUS	9.26	p<0.001
increase	543	233	776	475.04	300.96	CAUS	7.06	p<0.001
expand	519	225	744	455.45	288.55	CAUS	6.49	p<0.001
wrinkle	486	215	701	429.13	271.87	CAUS	5.61	p<0.001
drop	257	98	355	217.32	137.68	CAUS	5.32	p<0.001
crease	247	112	359	219.77	139.23	CAUS	2.84	p<0.01
tear	70	22	92	56.32	35.68	CAUS	2.75	p<0.01
snap	220	110	330	202.02	127.98	CAUS	1.66	p<0.05
shatter	326	173	499	305.47	193.53	CAUS	1.53	p<0.05
bend	313	167	480	293.84	186.16	CAUS	1.44	p<0.05
roll	150	86	236	144.47	91.53	CAUS	0.6	NS
proliferate	31	457	488	298.74	189.26	NON-CAUS	151.53	p<0.001
move	87	282	369	225.89	143.11	NON-CAUS	49.82	p<0.001
thicken	56	213	269	164.67	104.33	NON-CAUS	41.9	p<0.001
grow	69	160	229	140.19	88.81	NON-CAUS	21.17	p<0.001
crinkle	126	204	330	202.02	127.98	NON-CAUS	17.08	p<0.001
freeze	255	311	566	346.49	219.51	NON-CAUS	14.96	p<0.001
slide	3	36	39	23.87	15.13	NON-CAUS	11.5	p<0.001
turn	42	81	123	75.3	47.7	NON-CAUS	9.02	p<0.001
crumple	205	185	390	238.75	151.25	NON-CAUS	3.6	p<0.001
cool	159	149	308	188.55	119.45	NON-CAUS	3.49	p<0.001
burn	358	281	390	391.18	247.82	NON-CAUS	2.48	p<0.01
stretch	156	114	270	165.29	104.71	NON-CAUS	0.87	NS
crack	227	150	377	230.79	146.21	NON-CAUS	0.44	NS

Table 6.9: Results of the distinctive collexeme analysis

verb	Intransitive motion Cx	Transitive motion Cx	Total motion Cx	Intransitive non-causative Cx	Transitive causative Cx	Total
drop	189 27.63%	140 20.47%	329 48.10%	98 14.33%	257 37.57%	684
move	736 59.93%	123 10.02%	859 69.95%	282 22.96%	87 7.08%	1228
roll	476 46.30%	316 30.74%	792 77.04%	86 8.37%	150 14.59%	1028
slide	516 63.39%	259 31.82%	775 95.21%	36 4.42%	3 0.37%	814
turn	333 43.30%	313 40.70%	646 84.01%	81 10.53%	42 5.46%	769

Table 6.10: Frequency of ROLL verbs in the motion constructions and (non-)causative constructions

results should be taken with a grain of salt.

It might be relevant to mention at this point that while verbs of the ROLL group are used with both the intransitive non-causative construction and the transitive causative construction, they are all mostly found in other kinds of constructions, namely the intransitive motion construction and the transitive (caused-)motion construction. Actually, the majority of verbs from the ROLL group are much more frequently found with motion constructions, than with the (non-)causative constructions, as shown in Table 6.10. We did not conduct a distinctive collostructional analysis for these two constructions as this was beyond the scope of the present research, but it would be interesting to compare the results of the distinctive collostructional analysis of the motion constructions and of the (non-)causative constructions to see whether there is a certain similarity in the distribution of these verbs between the transitive and intransitive counterparts of each set of constructions.

All in all, a distinctive collexeme analysis applied to our data can only take us so far. It is interesting to see that the top four verbs that are attracted to the intransitive non-causative construction all denote events that are more easily construed as involving an undergoer subject rather than a purely agentive subject (as in an agent acting upon a patient), i.e. events that the theme is construed as being able, if not to instigate, at least to co-participate in. *Proliferate*, *move*, *thicken* and *grow* all suggest something that the subject does (or that happens to the subject) rather than something that is done to it. The verbs that are the most significantly attracted to the transitive causative construction show more variety and do not necessarily all point to an event that is prototypically construed as causative, or denoting an event where an agent acts upon a patient in such a way that it triggers a change of state. This might actually be a first sign indicating that the intransitive non-causative construction is more restrictive than its transitive causative counterpart. Several elements point in this direction: there are more verbs that are significantly attracted to the transitive causative construction, they are more varied, and their degree of attraction varies more (cf. p. value in Table 6.9). Fewer verbs are attracted to the intransitive non-causative construction, only eleven of them significantly. Out of these eleven,

ten display a p. value inferior to 0.001. All these elements point towards an analysis in which the intransitive non-causative construction is less frequent but also more restricted as to the kind of verbs that are found with this construction.

Unfortunately, this restriction cannot be proven with distinctive collexeme analysis and the limitations of our data bring limitations as to the conclusions that can be drawn. For this reason, another analysis will be conducted but with a focus on the theme, rather than just the verbs. In order to better grasp the nuances between the two constructions, we will conduct a qualitative and quantitative study of the themes that occur with each verb and in each construction. The next section, Section 6.2.2, will present a method that helps to measure the amount of information shared by the two constructions.

6.2.2 Theme overlap

The results of the distinctive collexeme analysis, although they are to be treated carefully due to the limitations in our corpus, suggest that the intransitive non-causative construction is less frequent and more selective than the transitive causative construction. That is, there are fewer occurrences of the intransitive non-causative construction in our corpus and fewer verbs are significantly attracted to this particular construction than to the transitive causative construction. Yet, almost every verb in our corpus can be found with this construction. So, why is this construction less frequent? Does it recruit different verbs entirely? Or at least, different verb senses? Also, do verbs really alternate in the two constructions or are they used quite differently, depending on which construction they occur with?

One way to measure this is to compare how the two constructions differ and what they have in common. We have already seen that all 29 verbs can be used with both constructions—although *crush* might be seen as an exception since only two occurrences of the intransitive non-causative construction were found. Therefore, since our aim is to identify the differences between the two constructions, verbs studied on their own appear as a poor indication of these differences. Since the verbs alone cannot provide sufficient insights into the mechanisms underlying the alternation, we need to go down one level and pay attention to the themes that are found in each construction, and with each verb.

Lemmens (forthc.) develops a method to measure the alternation strength of causative verbs which implies the themes that occur in these constructions. He defines the alternation strength of a verb as “an index which would indicate the degree with which a verb alternates between a one-participant construction (Cx1) and a two-participant construction (Cx2)” (Lemmens forthc.). Lemmens’s aim was to measure whether verbs alternate enough to render the alternation cognitively salient. The aim of this method is to quantify the shared meaning between the two constructions and thus to add to the discussion on alternations and surface generalisations. When it comes to alternations, as mentioned in Chapter 5, there is an opposition between defenders of an alternation approach (e.g. Levin 1993; Levin and Rappaport Hovav 2005), based on a verb’s semantics and its being sufficient to predict the number of arguments this verb can take, and defenders of surface generalisations (e.g. Goldberg 2002), who suggest that it is more relevant to

draw conclusions at the level of the construction, thus focusing on what various occurrences of one construction have in common rather than on what two different constructions occurring with the same verb have in common.

The hypothesis guiding Lemmens's approach is that "a high alternation index could be interpreted as lending support to the alternation model, since it would indicate that the alternation is frequent and productive and thus cognitively salient" (Lemmens *forthc.*). On the other hand: "a low alternation index indicates that the verb does not alternate all that frequently, which could thus be taken as indicating that each of the two constructions should be seen in its own right, lending support to the surface generalisations model" (Lemmens *forthc.*). While Lemmens acknowledges that these conclusions might not be entirely valid, he proposes to test this hypothesis by first running a distinctive collostructional analysis, as we did in the previous section but he also shows that such an analysis is insufficient to properly determine a verb's alternation strength. He uses the simplified examples in (142) and (143) to show how themes matter when it comes to measuring a verb's alternation strength.

(142) *break the law* (only occurs in the transitive causative construction)

(143) *the day broke* (only occurs in the intransitive non-causative construction)

The hypothesis here is that it is likely that a verb which has been shown to alternate between the two constructions might actually be found with completely different themes in each construction. While the example above is an exaggeration (many things can actually break or be broken), it helps prove the point. That is, the overall frequency of a construction may also be partly due to the overall frequency of the themes that occur in it. If a given verb has a tendency to be used in combination with a highly frequent theme, and that this theme is only found in object position, such as in (142), then this verb's attraction to the transitive causative construction may actually be tilted due to the frequency of themes such as *law*.

Therefore, if it were the case that a given verb only occurred in the transitive causative construction with certain themes, and in the intransitive non-causative construction with completely different themes, would it still make sense to talk of an alternation? The answer is no, of course. To quote Goldberg (2001): "Bubbles, TVs, breadsticks, and hearts break in very different ways and with very different consequences." What Goldberg means with this assertion is that in itself, the verb *break* does not provide enough information as to the event it denotes: there are many ways in which things can break, and in which you can break things. She argues that "the patient argument supplies much of the relevant information" (Goldberg 2001), which we agree with. Therefore, it is essential to pay attention to what items are found in subject position with the intransitive non-causative construction and in object position with the transitive causative construction to get to the heart of the meaning of each instance of these constructions.

Furthermore, if a verb such as *break* were to be used with a certain set of different meanings in one construction and with a different set of meanings in another construction, it would not be entirely correct to assume that this verb has a high alternation strength. That is, speakers would most likely be aware that certain aspects of the meaning of *break* fit one construction and other aspects of its meaning fit another construction. As such, it would make the idea of alternations

less plausible, since two clearly distinct meanings could be associated with the two different constructions.

In order to measure the actual alternation strength of a verb, all three elements have to be taken into account: the construction, the verb and the theme. Therefore, one solution to achieve this is to measure how much overlap there is for one verb over the two constructions. That is, how many different themes are shared between the two constructions for a given verb. This is what Lemmens (forthc.) calls *Theme overlap* and which is close to the Jaccard index (which is also known as Intersection over Union and the Jaccard similarity coefficient), but is specific to alternating constructions. The Jaccard Index is an index used in statistics to measure the similarity of sample sets. Even though both are very similar, we will prefer Lemmens's term as it is more clearly related to our research. The method to obtain overlap is a simple division: we divide the number of shared themes (themes that occur in both constructions) by the number of themes in total. The result of the theme overlap analysis subsequently provides the Shared Type Index for each verb, as presented in Table 6.11.

For example, as is visible in Table 6.11, the verb *burn* occurs with 274 different themes in our corpus. Out of these 274 themes, 103 occur only with the intransitive non-causative construction (37.59%) and 133 occur only with the transitive causative construction (48.54%). In the end, only 38 themes out of 274 are found in both constructions (13.87%). That is, *burn* has a Shared Type Index of 0.14.

Before we move on to a more thorough description and discussion of our results for Theme Overlap, we will explain more clearly what counts as a theme. While Lemmens (forthc.) measures Theme Overlap with tokens at first, we decided to skip this step altogether since, as Lemmens points out, such a measure with tokens may be skewed by the high frequency of certain themes. For example, with *burn*, the theme *calorie* occurs 46 times, all in the transitive causative construction. On the other hand, a theme such as *candle* occurs 11 times (five times in the intransitive non-causative construction, and 6 times in the transitive causative construction). When we compare these frequencies to these themes' overall frequencies in the COCA, we notice a major difference: *calorie* (as a type, that is *calorie*, *calories* and *cals*) is found 30,717 times whereas *candle* (*candle* and *candles*) is found 9,888 times. *Calorie* is three times more frequent than *candle* in the entire corpus. If we were to merely count tokens, *calorie* would skew the results due to its overall frequency in this particular corpus. Furthermore, Lemmens argues that a measure with tokens only shows the quantitative overlap, whereas a measure with types offers a more qualitative measure of overlap.

Therefore, we decided to count types rather than tokens; that is, instead of counting *calorie* 46 times and *candle* 11 times, both *calorie* and *candle* count for one.

As can be seen in Table 6.11, for our 29 verbs, the Shared Type Index ranges from zero to 0.27, which really is not very high. Out of these 29 verbs, 17 have a Shared Type Index below 0.10 (i.e. 10% or less shared themes), six of which are below 0.05. This means that 20.7% of these verbs have a Shared Type Index of 0.05 or less, and 58.6%, that is, the majority, have a Shared Type Index equal or inferior to 0.10. So, the majority of verbs we analysed have a Shared Type Index which is inferior or equal to 10%, as can be seen in Figure 6.1. The remaining verbs are divided as follows: seven verbs (24.1%) have a Shared Type Index between 0.11 and 0.15, two verbs have a

6.2. MEASURING THE ALTERNATION STRENGTH OF CAUSATIVE VERBS

Verb	Themes	NON-CAUS	NON-CAUS ONLY	CAUS	CAUS ONLY	Shared	Shared Type Index
<i>crush</i>	193	2	2	191	191	0	0.00
<i>slide</i>	25	22	22	3	3	0	0.00
<i>proliferate</i>	338	321	312	26	17	9	0.03
<i>stretch</i>	108	35	32	76	73	3	0.03
<i>grow</i>	158	120	115	43	38	5	0.03
<i>drop</i>	202	50	39	163	152	11	0.05
<i>fold</i>	145	41	32	113	104	9	0.06
<i>freeze</i>	227	84	69	158	143	15	0.07
<i>heat</i>	118	13	5	113	105	8	0.07
<i>chill</i>	201	28	13	188	173	15	0.07
<i>tear</i>	66	20	15	51	46	5	0.08
<i>crack</i>	178	89	75	103	89	14	0.08
<i>break</i>	239	68	49	190	171	19	0.08
<i>move</i>	172	126	112	60	46	14	0.08
<i>crumple</i>	151	74	61	90	77	13	0.09
<i>roll</i>	66	30	24	42	36	6	0.09
<i>snap</i>	109	62	51	58	47	11	0.10
<i>shatter</i>	247	98	72	175	149	26	0.11
<i>bend</i>	146	58	41	105	87	18	0.12
<i>cool</i>	173	100	78	95	73	22	0.13
<i>turn</i>	37	19	14	23	18	5	0.14
<i>burn</i>	274	141	103	171	133	38	0.14
<i>thicken</i>	100	82	68	32	18	14	0.14
<i>expand</i>	372	153	97	275	219	56	0.15
<i>warm</i>	154	52	27	127	102	25	0.16
<i>crease</i>	80	22	9	71	58	13	0.16
<i>increase</i>	342	148	81	261	194	67	0.20
<i>wrinkle</i>	87	55	37	50	32	18	0.21
<i>crinkle</i>	73	57	37	36	16	20	0.27

Table 6.11: Theme overlap

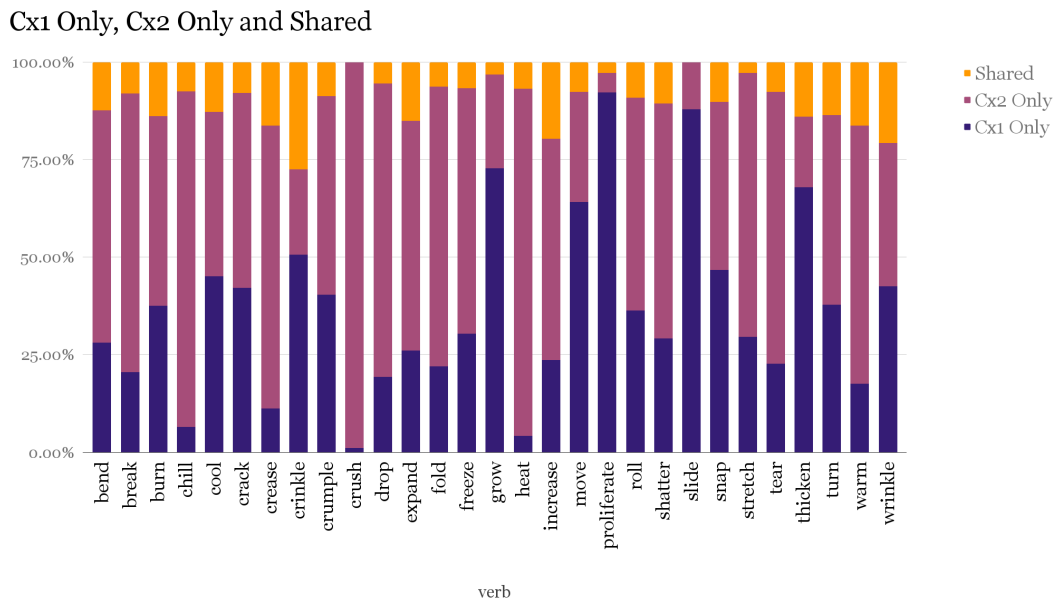

Figure 6.1: Theme Overlap in percent

Shared Type Index between 0.16 and 0.20, and three verbs have a Shared Type Index between 0.21 and 0.27. The two verbs that have the strongest alternation strength are *crinkle* and *wrinkle*. Yet, these two verbs still have only about a quarter of their themes that overlap. As noted previously, a majority of verbs have a Shared Type Index equal or inferior to 0.10, which means that with these verbs, the two constructions share maximally 10% of their themes. Therefore, a majority of these verbs have very little alternation strength. The conclusion here is that it seems, based on these results, that the intransitive non-causative construction and the transitive causative construction actually recruit different themes, or as Lemmens (forthc.) puts it for the verb *break*: “the things one breaks tend to be different from the things that break.”

These results to support a more constructional approach in the sense that the two constructions apparently recruit almost entirely different themes, which would entail that their meaning is quite different. If the things that one breaks and the things that break are completely different then how related are the two constructions? While it would be tempting to keep to the conclusion that an alternation model is rather unlikely, or not cognitively salient since the two constructions do not appear to be completely related, these results must be treated with caution. As mentioned by Lemmens, the downside of this measure is that it takes themes at face-value, but does not take semantic similarity into account. If we were to measure this similarity between the themes found with each construction, the alternation index might be higher. For example, things that break in exactly the same way could be grouped into one category such as *bone(s)* and its hyponyms, such as *collarbone*, *fibula* and *kneecap*. In point of fact, we counted 66 different themes in the 92 occurrences of *tear* we found with either an intransitive non-causative construction or a transitive causative construction, only five of which are shared by the two constructions. Yet, this calculation does not take into account semantic similarity. That is, it is likely that among these 66 themes some of

them are actually semantically related. There must be things among our 66 themes that one tears or that tear in exactly the same way. All themes occurring with *tear* in either the intransitive non-causative construction or the transitive causative construction can be found in (144).⁵

- (144) a. **List of themes found with *tear*:** *ACL, aluminium, angle, application, bag, band, button, canvas, cartilage, cartridge, clothes, cotton, crease, dress, envelope, fabric, fall, family, flag, flesh, foil, fuselage, handle, hair, hamstring, hand, heart, labrum, lacing, lettuce, map, mat, newspaper, page, painting, pants, pantyhose, paper, part, path, picture, PRON, sandwich, seal, sheet, shirt, Silly Putty, skin, slip, something, sticker, stillness, stockings, suit, tape, tent, ticket, towel, tunic, valley, velvet, vessel, vest, wallpaper, webbing, word*
- b. **List of themes found with *tear* in the intransitive non-causative construction only:** *ACL, band, canvas, cotton, crease, fall, handle, lacing, map, mat, picture, skin, tent, towel, velvet, vessel*
- c. **List of themes found with *tear* in the transitive causative construction only:** *aluminium, angle, application, button, cartilage, cartridge, clothes, dress, envelope, family, flag, flesh, foil, fuselage, hair, hamstring, hand, heart, labrum, lettuce, newspaper, painting, pants, pantyhose, paper, part, path, PRON, sandwich, seal, sheet, shirt, Silly Putty, slip, sticker, stillness, stockings, suit, tape, ticket, tunic, valley, vest, wallpaper, webbing, word*
- d. **List of themes found with *tear* that are shared by the two constructions:** *bag, fabric, page, skin, something*

Among the things that tear, we find *canvas, cotton, lacing* and *towel*, all of which refer to items made from fabric. We could add *tent* to this list too, since it is made of fabric, among other components. There are also items made from fabric that occur as themes with *tear* in the transitive causative construction: *clothes, dress, flag, sheet, shirt, stockings, suit, tunic, vest*. And, unsurprisingly, two of the five themes that are shared refer to items made from fabric: *bag* and *fabric*. Furthermore, although only *page* is found among the shared themes, there are quite a few other themes that refer to items made of paper in both constructions: *map* and *picture* with the intransitive non-causative construction and *envelope, newspaper, paper, sticker, ticket, wallpaper* with the transitive causative construction. Just as items made from fabric tear or are torn similarly, items made of paper tear or are torn similarly. In the end, even though we only found five themes that are shared between the two constructions, if we look at these themes in detail, we find a lot of them are very similar in the way they tear or are torn. As such, it seems that *tear*'s alternation index is higher than the Theme Overlap measure might suggest. For example, we could divide the themes that occur with the intransitive non-causative construction into three semantic groups: FABRIC, PAPER and FLESH. The FABRIC cluster contains *band, canvas, cotton, crease, fall, handle, lacing, mat, tent, towel* and *velvet*. The PAPER group comprises *map* and *picture*. As to the FLESH group, it is represented by *ACL, skin* and *vessel*. Although only one of these themes is shared with the

⁵A few notes about these themes: PRON stands for pronouns which were used to refer to animate entities. *Something* was kept as such since it is found in contexts where it is impossible to elicit what this *something* refers to exactly, such as: *Danny screamed "STOP" so hard he felt something tear in his throat* and *"They won't let me use a razor yet. Afraid I'll tear something."*

transitive causative construction, we find members of all three groups with this construction, for example *clothes* and *vest* for the FABRIC group; *newspaper* and *ticket* for the PAPER group and finally, *cartilage* and *hamstring* for the FLESH group. Among the themes found with the transitive causative construction are themes that refer to THIN FLAT ITEMS such as *lettuce* and *webbing*. But we also find themes that are used with a metaphorical sense of *tear*, such as *family*, *valley* and *stillness*. Then there are other objects such as *sandwich* and *Silly Putty* which do not resemble any other group. And finally, *heart* which is also a metaphorical extension of *tear*. Already we see that, rather than just five themes shared out of 66 (7.58%), we have three identifiable clusters that are shared out of approximately seven, thus bringing theme overlap to almost 50%. Furthermore, we note that only the transitive causative construction is found with abstract entities and metaphorical extensions of *tear*. A word of caution is important at this point: already, we see that the task of measuring precisely theme overlap with groups of semantically related themes is rendered difficult by the idiosyncrasy of certain themes. Therefore, rather than a method that yields a precise percentage of overlap, we will take a more qualitative approach in the description of the results. That is, although we will measure the semantic similarity of the various themes, we will not be able to provide a clear-cut percentage for theme overlap. Rather, we will show, via the clustering of themes, what aspects of meaning are shared by the two constructions and which are specific to each construction.

While a grouping into semantically related themes might seem easy with a verb such as *tear*, it is not so simple with most other verbs. The reason why we chose *tear* for our demonstration is that there are few instances of this verb in our corpus. *Tear* only occurs 92 times in either the intransitive non-causative construction or the transitive causative construction, with 66 different themes. However, a verb such as *break* occurs 641 times, with 239 different themes. The sheer number of themes makes the task of manually grouping them semantically more difficult and much more time-consuming. Not only would it take a lot of time to organise all these themes into semantically related groups for each of the 29 verbs, but it might also be problematic scientifically. How does one judge semantic similarity? One person manually coding all themes for semantic similarity would yield potentially biased, idiosyncratic results. Having different people complete this task and then comparing results could have been a solution. However, this would have required a lot of time and potentially financial compensation which we were not able to provide. These constraints, together with a remaining risk of subjectivity rendered this task hardly feasible. Therefore, what we needed was a way to measure semantic similarity automatically and systematically. We thus chose distributional semantics, which we will present in more detail in Section 6.2.3. As we will see, distributional semantics offers a method for the measure of semantic similarity that is reliable, systematic and adaptable to our research.

6.2.3 Semantic grouping of themes

As mentioned in the previous section, building semantic classes based on intuition might appear as a sound option to add to the Theme Overlap measure. Given our knowledge of, and experience with windows and mirrors, we intuitively know that these items can be considered semantically

similar as themes in a breaking event. While this is feasible up to a point, it nevertheless becomes problematic when applied to large numbers of themes, and may leave room for errors. As such, it is preferable to use a more objective measure of semantic similarity.

One possible option would be to look for the different verb senses of each verb and associate them with all the themes that fit this particular sense. Building such a relation between verb senses and themes would help elucidate whether these verb senses are shared by the two constructions, or, more specifically, which verb senses are found in combination with which construction(s). The online version of WordNet is a great resource for verb sense disambiguation.⁶ Each verb entry contains one or more subsenses which are related to other verbs via synonymy relations, when such relations can be found. This is what Fellbaum (1998) calls *synsets*, for “synonym sets.” According to Fellbaum (1998: 71), WordNet comprises more than 11,500 verb synsets.

Interestingly, some of the semantic domains identified by WordNet were created based on the verbs’ shared arguments. An example of this are “verbs of bodily care and functions” which “form a coherent semantic field by virtue of the fact that most of the verbs *wash, comb, shampoo, make up, ache, atrophy* select for the same kinds of noun arguments (kinds of body parts)” (Fellbaum 1998: 72). While this seems absolutely relevant for verbs such as *shampoo* and *comb*, it does not make quite as much sense to group verbs such as *make up* and *ache* since they clearly refer to very different types of events.

Since strict synonymy remains rather limited between verbs in English, many relations identified in synsets are near-synonymy relations rather than pure synonymy relations. Also, certain constraints applying to various verbs within a synset are not accounted for by different synsets but “the information given in parentheses (a gloss and one or more sample sentences) often spells out the specific usage restrictions associated with individual verbs” (Fellbaum 1998: 73). These usage restrictions mostly have to do with the level of formality of each verb, which means that they cannot easily substitute one another in most contexts. The level of formality of the verbs we study is not taken into account for our analysis, as we would rather focus on broader meaning differences such as the fact that a verb can be used to denote somewhat different events. For example, sometimes verbs are used both with a literal and a figurative meaning, or with concrete and abstract themes. We expect these differences in meaning to also be apparent in the distribution of these verbs between the two constructions at stake here: the intransitive non-causative construction and the transitive causative construction. Already, we noted such a difference with the themes used with *tear* in the previous section (Section 6.2.2).

WordNet also takes these distributional differences into account, following the notion that “Subtle meaning differences between apparent synonyms sometimes show up in different selectional restrictions. For example, *rise* and *fall* can select as an argument such abstract entities as *the temperature* or *prices*, but their close synonyms *ascend* and *descend* cannot” (Fellbaum 1998: 73). The selection of different themes (abstract vs. concrete) is also something that we notice as one of the main selectional constraints for numerous verbs that are usually believed to alternate between the two constructions. The fact that WordNet makes these distinctions apparent between verbs that would otherwise qualify as near-synonyms should be helpful in identifying various subsenses

⁶Princeton University 2010 <http://wordnet.princeton.edu/>

for each verb; mainly, a distinction between a causative and a non-causative meaning, which is directly relevant to the questions we raise with this research. It should be noted that WordNet also pays attention to CAUSE relations between verbs; be it between lexicalised causative pairs (*show-see*) or with selectional restrictions such as the kind of argument found in subject and object position: e.g. Fellbaum (1998: 83) mentions that verbs such as *break* can take either an animate agent or an inanimate cause whereas certain verbs such as *mold* only take an inanimate cause. She also mentions motion verbs such as *roll* and *bounce* which are found in both the intransitive non-causative construction and the transitive causative construction.

The linguists behind WordNet used resources such as the Brown Corpus (Kučera and W. N. Francis 1967) and dictionary definitions which are often based on hyperonymy and antonymy relations (notably for nouns). The advantage of using a corpus as a resource for the elucidation of various verb senses and semantic relations between verbs is clear: the definitions and semantic relations which result from this research are very likely to be representative of actual usage. On the one hand, a corpus will provide researchers with words used in various contexts; on the other hand the use of dictionaries presents a certain advantage on the sheer amount of data that can be accessed: “Unlike psycholinguistic experiments, dictionaries provide evidence for representing tens of thousands of words” (Fellbaum 1998: 76). Thanks to these two types of resources, WordNet provides verb definitions that have been measured against actual usage and are based on what Fellbaum calls *troponymy relations*: “The troponymy relation between two verbs can be expressed by the formula *To V₁ is to V₂ in some particular manner*” (Fellbaum 1998: 79). WordNet also makes room for metaphor relations between verbs, thus, an expression such as *break down* is found as a synonym for *die* (Fellbaum 1998: 73). Both the semantic and syntactic aspects of metaphor relations are accounted for in WordNet: “Metaphorical sense extensions of verbs often share not only the meaning but also the syntax of their literal synonyms, expressed in WordNet by sentence frames [...] Thus the verbs *break* and *break down* and their metaphorical synonym *die* are all unaccusatives” (Fellbaum 1998: 73).

Now that we have described how WordNet works, let us see how useful it can be for the identification of various verb senses in relation to the themes we found with each verb and each construction. Here is an example of what the entry for the verb *tear* looks like on WordNet:

(145) Definitions found for *tear* (V) on WordNet:

- a. **tear**, rupture, snap, bust (separate or cause to separate abruptly) “The rope snapped”; “tear the paper”
- b. **tear** (to separate or be separated by force) “planks were in danger of being torn from the crossbars”
- c. **tear**, shoot, shoot down, charge, buck (move quickly and violently) “The cart tore down the street”; “He came charging into my office”
- d. pluck, pull, **tear**, deplume, deplumate, displume (strip of feathers) “pull a chicken”; “pluck the capon”
- e. **tear** (fill with tears or shed tears) “Her eyes were tearing”

WordNet identifies five different verb senses for *tear*, including an entry for the unrelated verb *tear*, as shown in (145e). If we compare the different verb senses elucidated by WordNet with the themes that occur with this verb in the intransitive non-causative construction and the transitive causative construction we find the following results. Most of the themes we have identified fit the first definition (items made of paper, items made from fabric, other items in which a concrete tear occurs) and they tear in the same way, yet, some do not. That is, WordNet does not provide a definition that suits the situations in which the tear is figurative, as shown in examples (146a, 146b, 146c, 146d, 146e).

- (146) Instances of *tear* that do not fit WordNet's definitions:
- a. "I've seen how it has torn my family when you don't accept that people are going to fall in love with who they fall in love with."
 - b. He smiled a barbed smile now that tore his heart, and felt the scald of bitter tears.
 - c. ...but a cough tore the stillness.
 - d. The last Red Monkey awoke more than two hundred years ago, [...], waging a great war that tore the Rift Valley with fire and blood.
 - e. Oh hateful hands to tear such loving words...

However, we notice that in all of these examples, *tear* is used in a sense that is close to that of *break*. What is interesting to note is that these examples all contain the transitive causative construction, and they could not be found with the intransitive non-causative construction (**my family tore*, **the stillness tore*, etc.). This is relevant since all the other themes seem to be found in both constructions, albeit less frequently with the intransitive non-causative construction. Since these particular instances do not clearly fit the definitions provided by WordNet, it is not surprising that WordNet should have both the intransitive non-causative use and the transitive causative use of the verb *tear* under the same entry: "separate or cause to separate abruptly." Since WordNet does not seem to take into account a definition of *tear* that applies to non concrete or non literal tearing events, it does not take into account this particular distributional feature of the verb. The fact that themes that are torn figuratively can only be found in object position in the transitive causative construction and thus that *tear* can apparently not be used with an intransitive non-causative construction in figurative uses is illustrated by the grouping of these two verb senses under the same entry. Our analysis of this verb and the themes and constructions it occurs with (based on actual usage) allows us to elucidate aspects of the meaning of *tear* that WordNet could not. Nevertheless, this is not the case for all verbs which can be found with both constructions, for the verb *freeze*, for example, the intransitive non-causative use and the transitive causative use are found under different entries in WordNet, as illustrated in (147):

- (147) Definitions found for *freeze* (V) on WordNet:
- a. **freeze**, stop dead (stop moving or become immobilized) "When he saw the police car he froze"
 - b. **freeze** (change to ice) "The water in the bowl froze"

- c. **freeze** (be cold) “I could freeze to death in this office when the air conditioning is turned on”
- d. **freeze** (cause to freeze) “Freeze the leftover food”
- e. **freeze**, suspend (stop a process or a habit by imposing a freeze on it) “Suspend the aid to the war-torn country”
- f. **freeze** (be very cold, below the freezing point) “It is freezing in Kalamazoo”
- g. **freeze**, freeze out, freeze down (change from a liquid to a solid when cold) “Water freezes at 32 degrees Fahrenheit”
- h. **freeze**, block, immobilize, immobilise (prohibit the conversion or use of (assets)) “Blocked funds”; “Freeze the assets of this hostile government”
- i. **freeze** (anesthetize by cold)
- j. **freeze** (suddenly behave coldly and formally) “She froze when she saw her ex-husband”

Also, *freeze* has twice as many entries as *tear*, which only counts five, one of which is a completely different verb with a different pronunciation. Interestingly, WordNet distinguishes between two different types of cold: “be cold” in (147c), and “be very cold, below the freezing point” in (147f). The main difference between (147c) and (147f) seems mostly to come from the theme: in the former it is a human that is freezing whereas in the latter it is the weather (note the use of the impersonal form).

What this shows so far is that, unfortunately, WordNet is not sufficient to help resolve semantic grouping and to clearly identify the various subsenses of a verb and their distribution between the two constructions at stake here. These limitations may be due to the fact that the corpus which was used for the elaboration of different verb senses in WordNet is somewhat small and slightly dated. The Brown Corpus contains “only” a million words, which unfortunately does not make it as exhaustive as one might hope. Also, while WordNet is very useful for the identification of meaning relations between different verbs, the various subsenses of a given verb are not always effectively captured by their being grouped with other (near-)synonymous verbs. Furthermore, even though the small flaws of WordNet could easily be made up for, we still face one problem: we would have to look at each and every theme individually and find the definition that fits it best, which would take too much time and effort for not entirely satisfactory results. What we really need here is a tool that will measure semantic similarity, that will group themes automatically and systematically and that will thus help us identify each verb’s various senses.

One such measure of semantic similarity is found with distributional semantics, which measures semantic proximity by paying attention to a word’s collocates over large amounts of data. Put simply, words which share frequent collocates are likely to be semantically close or related, or, as Firth puts it: “you shall know a word by the company it keeps” (Firth 1957: 11). In essence, distributional semantics measures semantic similarity on the basis of semantic contexts, as formulated by Lenci in his *Distributional Hypothesis*: “The degree of semantic similarity between two linguistic expressions *A* and *B* is a function of the similarity of the linguistic contexts in which *A*

Paradigmatic relations Selections: “x or y or...”				
Syntagmatic relations	she	adores	green	paint
Combinations	he	likes	blue	dye
“x and y and...”	they	love	red	colour

Table 6.12: Paradigmatic vs. syntagmatic relations (Sahlgren 2008: 39)

and B can appear” (Lenci 2008: 3).

Sahlgren (2008) argues that the distributional hypothesis emanates from structuralist views on the organisation of language and the elaboration of the concept of meaning in these theories. One of the main ideas that the distributional model takes from structuralism is the notion that a word’s meaning is retrievable from the different contexts in which it is used, and that, ultimately “linguistic meaning is inherently differential, and not referential (since that would require an extra-linguistic component); it is *differences* of meaning that are mediated by *differences* of distribution” (Sahlgren 2008: 36, referring to Harris 1968, 1970). This idea can be traced back to Saussure’s *Cours de Linguistique Générale* (Saussure 1916/1995), in which it is argued that a word’s *signification* is different from its *valeur*: “[Les valeurs] sont toujours constituées : 1. par une chose *dissemblable* susceptible d’être *échangée* contre celle dont la valeur est à déterminer ; 2. par des choses *similaires* qu’on peut *comparer* avec celle dont la valeur est en cause” (Saussure 1916/1995: 159).⁷ All in all, for structuralists such as Saussure, linguistic meaning is identified via differentiation, and what follows from this are two types of relations: (i) syntagmatic relations which are based on co-occurrence and (ii) paradigmatic relations which are based on shared collocates. Put simply, syntagmatic relations deal with words that can be found together frequently whereas paradigmatic relations deal with words that can be substituted, i.e. that can be found in the same slot in given contexts.

Following these remarks on the similarities between a structural view of language as presented by Saussure (1916/1995) and the distributional model of Harris (1970), Sahlgren proposes a REFINED DISTRIBUTIONAL HYPOTHESIS according to which “a distributional model accumulated from co-occurrence information contains syntagmatic relations between words, while a distributional model accumulated from information about shared neighbors contains paradigmatic relations between words” (Sahlgren 2008: 40). The differences between these two types of relations can be more easily visualised in Table 6.12, borrowed from Sahlgren (2008), and in which paradigmatic relations are seen as “vertical” and syntagmatic relations as “horizontal.”

Distributional semantics can serve many purposes, for example, Schütze (1998) uses context-group discrimination to group occurrences of a word into clusters of similar occurrences which are then represented in a vector space, based on information extracted from second-order co-occurrence (i.e. paradigmatic relations: which words do these words co-occur with) for word sense disambiguation. Distributional semantics is also becoming more and more popular among researchers in construction grammar: Perek (2016b) uses it to measure and assess syntactic

⁷ Values are always made up of: 1. a dissimilar thing, likely to be substituted for that whose value is to be determined, 2. by similar things which can be compared to that whose value is at stake.

productivity and Hilpert and Perek (2015) use it to then create motion charts which are a precise visualisation technique to monitor constructional meaning change over time. Gries and Stefanowitsch (2010) use cluster analytic techniques to identify semantic classes of verbs occurring in given constructions in order to elucidate a construction's most prototypical senses and subsenses. In order to identify both senses and subsenses, Gries and Stefanowitsch (2010: 84) use visualisation by means of a dendrogram, which clusters lexemes into smaller groups which are then subsumed into bigger clusters e.g. they identify two different clusters of negative stimulus verbs for the *into*-causative construction (*She bullied him into accepting her terms*): (i) *embarrass, shame* and *panic* (ii) *frighten, scare, intimidate*. Another example is Levshina and Heylen (2014) who, advocating for a radically data-driven approach to construction grammar, use semantic vector space models to study near-synonym causative constructions with *laten* and *doen* in Dutch.

The model we use here is based on shared neighbours and their frequency. That is, we are more interested in paradigmatic relations than syntagmatic relations. Our aim is to measure semantic similarity by assuming that words that appear in similar immediate contexts are likely to have a closely related meaning. Many researchers who use distributional semantics note that the notion of semantic similarity that we use may be misleading (Padó and Lapata 2003; Perek 2016b; Sahlgren 2008, to name a few). Semantic similarity should not be taken to mean synonymy or near-synonymy, rather, what we refer to as semantic similarity includes antonymy or hyponymy relations. The part of words' meaning that is shared is reflected in their distribution, but the fact that they appear in similar contexts does not entail that they are synonyms or near-synonyms. To take an example of antonymy with one of the verbs we study here, namely *increase*: things that increase or that one increases also tend to decrease or be decreased. By the same token, when it comes to hyponymy relations, one freezes peas and vegetables in the same way. Interestingly, there is evidence in the literature for the psychological/cognitive validity of this notion of similarity. Miller and Charles (1991), for example, ran several experiments on a number of undergraduate students and found that speakers tend to judge semantic similarity through the similarity of the contexts in which words occur. What is particularly pertinent with this measure of semantic similarity or semantic relatedness is that it starts with the premise that words that are found in the same context or slot are expected to be semantically related. This is specifically relevant to our research since our aim is to find out which items undergo events in the same way, that is, we could expect that since windows and mirrors break in the same way, they also shatter in the same way and as such should be deemed semantically similar. Nevertheless, as we will show, the model we use here does not take syntactic structure into account and as such does not discriminate between verbs, nouns and adverbs in the environment surrounding the word. Therefore, even though semantic relatedness holds between various items, it does not necessarily reflect their use in the same syntactic positions and semantic roles. Let us note here that there have been attempts to use syntactic tagging and dependency relations within distributional semantics. Padó and Lapata (2003) are a good example; they constructed semantic spaces that take syntactic relations into account for two tasks: semantic priming and automatic discrimination of lexical relations. Padó and Lapata (2003) conducted their experiments on the BNC, having previously parsed it with MINIPAR (Lin 1998), and, following this parsing, then gave

and blasts can be heard. The government says Red he'd wear a coat and tie but bring this toothpaste and lotion, stockings, and three Czechoslovakian dressed to go home. She was wearing a shiny purple my dad's chin is bleeding across the front of his body with the fight. She was dressed in a white toe in lightweight khaki; ball cap, button-down safari into his peripheral vision, a toned matron in a sleeveless unless the Romans are scoundrels. He wore a blue Wallace. With his usual attire of tattered denims, flannel	shirt shirt shirts shirt shirt shirt shirt shirt shirt shirt	activists were creating trouble as far as 1 mile (2 kilometers along, hold it up, and tell a droll story on and a quality photo album for Anton. He would be so and a tight black skirt, and was leaning across the counter and ants crawl all over his face. There are helicopters flying and blue jeans, cowboy boots. A gold necklace. Gold and cargo pants. For some years he has been conducting field and cargo shorts marching smartly behind. The woman glanced at and dark, pointed boots, but his riveted trousers were work and dirty Stetson, and what one friend calls his good-ol
a splashy gold brooch set on her large bosom, her always try to look very good, and I changed the great-fitting jeans, a classic navy blazer, a sexy strapless hiding place. We watched as a woman wearing a white be in the lead car, decked out in a gold-colored he is Marsilio Ficino (1433-1499). (His Renaissance her and bury my face in the front of that voile says shyly, then she lifts the hem of her white too much makeup, and a vulgar nail polish. In to a doctor's appointment, cook breakfast for Papa,	dress dresses dress dress dress dress dress dress dress dress dress	a flaming pink — came slowly toward me, walking with a all the time on the performance. And people came to me and a chic trench. The way to wear denim now is and a straw hat opened the box and picked up the ring and African-motif hat. Dwayne Shipp says the parade's and cap could be vital clues. The only other example here and cry 'til I had no more tears to shed. and curtsies. p96 In the soft fading light, she looks so and department she was a studied dissonance, declining to the and feed the babies before school. We smile back at her

Table 6.13: Ten occurrences of *dress* and *shirt* extracted from COCA

different weights to different labels based on their dependency relations. Not only did the model measure semantic similarity but it also measured the importance of certain dependency relations, thus providing a sort of hierarchy of relations and thus of collocates.

Models of distributional semantics are usually implemented via vector space models, which were created by Salton and colleagues (Salton, Wong, and Yang 1975) for the SMART information retrieval system (Salton 1971). The concept underlying vector space models is the representation of words (vectors) in a semantic space. Each word is a point in this vector space and its coordinates are calculated on the basis of co-occurrence counts. In short, "Points that are close together in this space are semantically similar and points that are far apart are semantically distant" (Turney and Pantel 2010: 141).

In order to calculate the coordinates of each word vector, a count of its collocates in a given text window is necessary. For each word vector, we count the word types that occur with it and then compare these collocates to those of each and every word vector we want to compare. Vector space models require a certain amount of text in which to look for instances of each word vector. Based on these texts, a co-occurrence matrix is built. In a co-occurrence matrix, each row represents a word vector and its collocates are represented in the columns. An example of a small co-occurrence matrix is given in Table 6.14; this matrix was built from the sample corpus in Table 6.13.

This sample co-occurrence matrix contains 19 columns which represent 19 of the words that are found within a 10-word window (10 to the left and 10 to the right) of the word vectors. Even though it is not apparent from the sample corpus presented in Table 6.13, all lexical words (nouns, verbs, adjectives, certain adverbs) were lemmatised with TreeTagger (Schmid 1994) and all function words (prepositions, conjunctions, auxiliaries, pronouns) were deleted before building the co-occurrence matrix. Lexical words are lemmatised to avoid repetition within the matrix. Function words are deleted because they do not bear enough relevant meaning and would only be a source of unnecessary noise. Lemmatisation and the suppression of near semantically-empty words make the co-occurrence matrix more salient, by keeping only relevant and semantically

	across	blue	boot	bury	cap	cargo	core	denim	doctor	dress	example	face	fly	front	gold	hat	say	wear	white
dress	0	0	0	2	1	0	2	1	2	0	2	1	0	1	2	2	3	2	2
shirt	2	2	2	0	1	2	0	1	0	2	0	1	2	1	2	0	1	3	1

Table 6.14: Co-occurrence matrix for *dress* and *shirt*

rich words, we only use semantically relevant contexts. Already, we see that both *dress* and *shirt* co-occur with a certain number of lexemes referring to colours such as *gold* and *white*. They also share the verb *wear*. We also notice the presence of another garment: *cap* and of a fabric: *denim*. Clearly this sample is too small to draw conclusions on how semantically close *dress* and *shirt* are. Nevertheless, the same method applied to a much bigger corpus including thousands of collocates yields precise results and would most likely confirm the semantic similarity between *dress* and *shirt*.

While this is meant as a simple example of what a co-occurrence matrix looks like, it already brings up an important question that needs to be tackled when working with distributional semantics: how many words on each side of the target word should be taken into account?

Sahlgren (2008) discusses the different window sizes that can be used when using distributional semantics by presenting different points of view, and notes the large amount of variation within the literature (from just a couple of words to 100 words) and the different aspects taken into account, mentioning notably Schütze (1992) who uses a 1000 character window based on the assumption that longer words should be more relevant semantically than shorter words, which are usually function words with little semantic weight. While Sahlgren agrees, at least partially, that the size of the window is “just another experimentally determinable parameter” (Sahlgren 2008: 45), he also argues that a smaller context window is better suited for paradigmatic relations (as shown in Karlgren and Sahlgren (2001)). The size of the context window can also be dependent on what one decides to take into account in terms of collocates, for example, lemmatising texts and getting rid of function words so that only lexical words, which have more semantic weight, are considered. Others, such as Padó and Lapata (2003, 2007), actually use a model for which the data are parsed for syntax and thus takes dependency relations into account.

There is some validity in most of these approaches and all have their (more or less important) flaws. One of the issues with parsed data is that it is usually scarce, whereas a less detailed approach which does not take syntactic dependencies into account but focuses on lemmas will hopefully see the lack of syntactic information balanced out by the large amount of data on which the model can be built. Therefore, for this work, a non-parsed corpus was chosen. The model used here was built by Florent Perek (cf. Hilpert and Perek 2015 for an example of how this model is used), and as follows.⁸

The model we use was built from a database containing all the nouns that occur in COCA. Then two different methods were used, depending on the number of words we wanted to compare for

⁸Grateful thanks go to Florent Perek for letting me use his model and the R script used for the visualisation techniques described later in this section. His help played a pivotal role in the development of the research presented here.

dimensionality reduction: (i) Multi-Dimensional Scaling (Kruskal 1964) and (ii) t-SNE (Maaten 2008). Both methods are implemented in the R environment (R Development Core Team 2013). Multi-Dimensional Scaling (MDS) works best with a lower number of word vectors, whereas t-SNE is more suitable when one wants to compare a higher number of words. In the matrix, the collocates were reduced to the 10,000 most frequent nouns, verbs, adjectives and adverbs in COCA. These collocates were found within a two-word window around the target noun; the choice of such a small window mostly avoids unnecessary noise, and since it only takes into account lemmatised lexical words, it actually turns out to be the most efficient window size. Two additional transformations were applied to the matrix: (i) the co-occurrence counts were weighted by means of Positive Pointwise Mutual Information⁹ to give more weight to collocates that co-occur more often with one noun compared to the other nouns and, (ii) the number of columns was limited to 300 via Singular Value Decomposition, thereby saving only the most relevant collocates.¹⁰ These transformations serve to render the matrix as salient as possible and maximise the chances of representing semantic similarity. Such a measure of similarity is obtained by calculating the distance between different rows which, in our case represent the different themes. In this method, the rows are word vectors and the matrix shows the distribution of each theme in the corpus (cf. Purandare and Petersen 2004 and Turney and Pantel 2010, among others, for other applications of Vector Space Models to linguistics). The semantic distance between each row is measured via a cosine measure by means of the “cosine” function of the R package *lsa* (Wild 2007). This measure helps derive semantic (dis)similarity (Perek 2016b: 157).

This measure of distance is then used to represent themes into clusters of related meanings (semantic grouping). The shorter the distance between two word vectors as calculated from the matrix, the more semantically close they are. There are different options to visualise this semantic similarity, one of them is hierarchical clustering. This is obtained via the “*hclust*” function in the R environment which measures the distance between each vector and then groups the lexemes accordingly. One of the advantages of distributional semantics is its ability to provide greatly effective tools for visualisation techniques. Thanks to the different measures and functions applied to the co-occurrence matrix, one can easily visualise clusters of words grouped according to their semantic relatedness.

Several visualisation techniques can be used with distributional semantics, one is the construction of a dendrogram via hierarchical clustering. As explained by Perek (2016b: 164): “The hierarchical clustering algorithm uses pairwise distances between rows to recursively merge the two most similar observations or clusters of observations into a higher-level cluster, until there is only one cluster containing all objects.” The dendrogram is mostly useful when one wants to extract clear-cut groups of semantically related lexemes and identify senses and subsenses (as in Gries and Stefanowitsch 2010 for example). However, semantic groups are not always clear cut and one might wish for a visualisation technique that leaves room for blurry borders between groups. For this type of visualisation, semantic plots are the best option. Not only do they avoid

⁹Such weighting can be done with the DISSECT toolkit (Dinu, Pham, and Baroni 2013)

¹⁰Singular Value Decomposition (SVD) comes from linear algebra and corresponds to the factorisation of a matrix. In linguistics, we use reduced SVDs to reduce the number of columns in the matrix in order to make it even more semantically salient and more economical to use and store.

necessarily pairing items together, but they also allow us to clearly visualise lexemes as placed on an actual semantic map. That is, if we consider a semantic space which contains various lexemes, then it follows that these lexemes will be placed in this space depending on how semantically close or distant they are. This presents the advantage of visualising the entire space and helps identify semantic subspaces that are more or less populated i.e. clusters of lexemes will be more or less dense depending on the number of lexemes that populate this cluster in the semantic space. As we will see in Chapter 7, the varying density of a cluster may say a lot about constructional meaning.

Since we use semantic vector space models and distributional semantics to group themes that are semantically related in order to identify the different senses of a verb in context, depending on the kinds of themes this verb is used with but also to compare the semantic maps obtained for each construction, the use of semantic plots is the best option. If a verb is used with a specific meaning in one of the two constructions, and this particular combination is productive, then this should appear in a cluster on the semantic map. In order to conduct this analysis, we proceeded as follows: for each verb and each construction, each theme is entered in the R script as a word vector. Then, depending on the number of themes, we used either MDS or t-SNE to assess semantic similarity and obtain clusters of semantically related themes.

Although our results will be presented in greater detail in Chapter 7, it is relevant at this point to include an example of what a semantic map looks like. These maps are created thanks to the “plot” function in the R environment. The maps we present here contain the themes that occur with *freeze* in the intransitive non-causative construction (Figure 6.2) and in the transitive causative construction (Figure 6.3). Several clusters of semantically related themes have been circled and numbered, and semantically related groups were given the same number across the two constructions i.e. group 1 corresponds to the group of body parts both with the intransitive non-causative construction in Figure 6.2 and the transitive causative construction in Figure 6.3.

We will not go into the details of the various semantic groups here but we will briefly comment on the model’s performance for this specific case. First, one major thing that we notice is the model’s ability to group semantically similar themes. We can already see that body parts are grouped together (in group 1) and that themes which are water-based are grouped as well (group 3) on both maps (Figure 6.2 and Figure 6.3). Second, if we look at Figure 6.3, it becomes apparent that the map makes a pretty clear distinction between themes that refer to abstract concepts and themes that refer to more concrete entities. This separation is signalled by the black dotted line in Figure 6.3 (that we added manually over the semantic map). Also, group 2, which contains lexemes that refer to food items is clearly more densely populated in the semantic map for the transitive causative construction (Figure 6.3) than its counterpart in the intransitive non-causative construction (Figure 6.2).

Now that we have introduced distributional semantics and its applications, we will turn to the specific application of this methodology to the causative alternation and the measure of a verb’s alternation strength. We will see how this methodology allows us to evaluate the validity of the alternation and to what extent meaning is shared between the two constructions, based on an analysis of 29 verbs which denote a change of state.

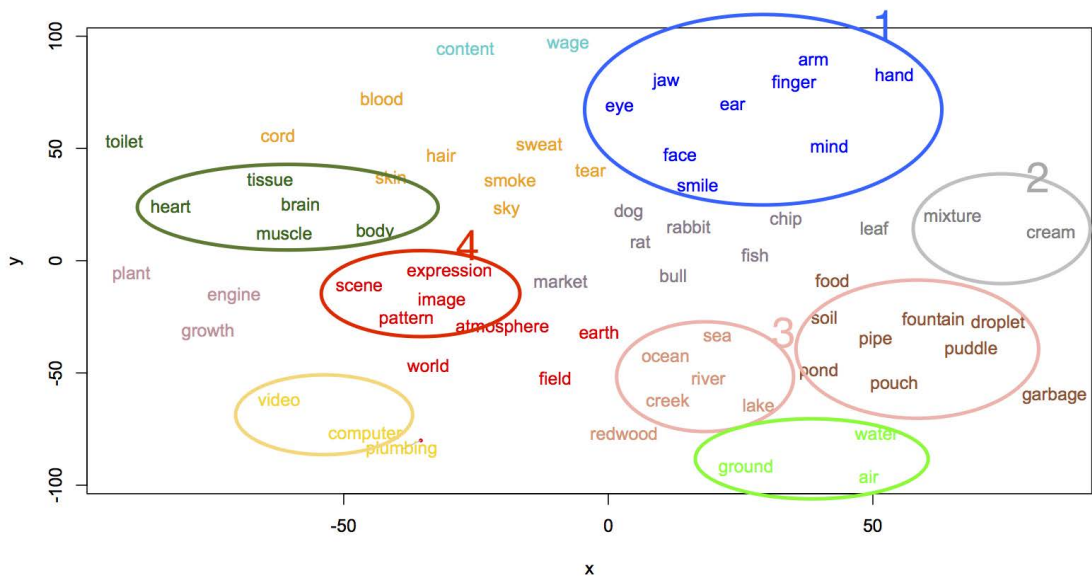

Figure 6.2: A semantic map of the themes that occur with *freeze* in the intransitive non-causative construction

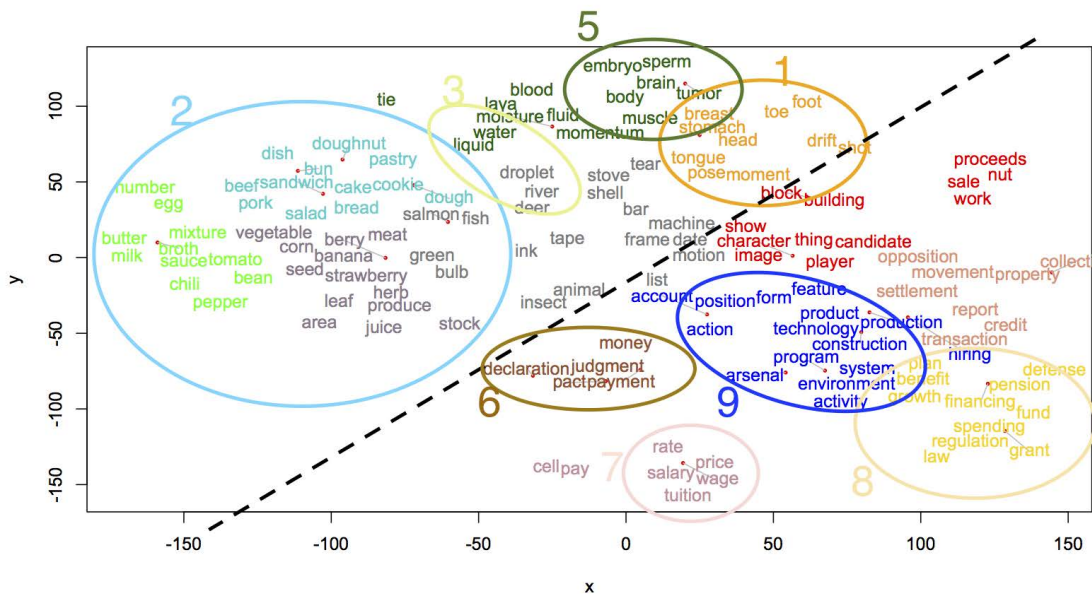

Figure 6.3: A semantic map of the themes that occur with *freeze* in the transitive causative construction

CHAPTER 7

EVALUATION AND RESULTS

This chapter will present a detailed account of the distributional semantics analysis and how it allows us to draw conclusions over the two constructions. As we will see, through the automatic grouping of themes and the visualisation techniques offered by distributional semantics, we were able to distinguish various verb senses for each of the 29 verbs selected for this research. These various senses were extracted via the grouping of themes in semantic clusters based on their similarity: the combination of a verb with a specific set of themes usually gives rise to a specific verb sense. As we will see, the amount of overlap of verb senses between the two constructions varies from one verb to the next, thus showing that an analysis based solely on the interaction between the verb and the construction is not sufficient. Accessing meaning via the interaction of the theme, the verb and the construction(s) they are used with not only provides more insight into verbal meaning but most importantly allows us to abstract away from individual instances to get a better idea of constructional meaning. Distributional semantics also shows the discrepancies between the two constructions, notably in the distribution of themes over the two constructions, highlighting the fact that certain clusters are much more populated on one map than on the other.

Even though this analysis is run verb by verb, it remains constructional in essence. As the data show, certain generalisations can be drawn from collocations between verbs and themes that apply to constructional meaning at a more schematic level. That is, instances of one construction with different verbs and different themes share characteristics that reinforce a more schematic constructional meaning, proper to each construction.

This chapter is structured as follows. It is divided into six sections; the first five correspond to verb groups and the last is a general evaluation of the method and the results it yielded. At the beginning of each section for verb groups, we provide a table that sums up the various verb senses associated with the verbs that make up the group. This table contains brief definitions for each verb sense, and, if applicable, a division into the different types of themes that are found with this verb sense (notably when the sense is shared by the two constructions but not with all themes).

The tables are divided into two columns, one for the intransitive non-causative construction and one for the transitive causative construction. All definitions that are placed in between the two columns (in the center of the table) correspond to verb senses that are shared by the two constructions. The definitions come from three different sources: the Oxford English Dictionary Online (*OED Online* 2018) (henceforth *OED online*), WordNet (Princeton University 2010), and if neither of these sources offered an appropriate definition, we have drawn one up ourselves.

When a verb sense is shared by the two constructions, the corresponding definition is often of the form “(cause to) become ADJ”. The reason for this shared definition with the causal element in brackets is justified by the idea that, as mentioned in Chapter 4, argument structure constructions contribute meaning to the verb they occur with, and verbs profile a certain aspect of the basic event denoted by the construction (Goldberg 1995). We agree that there is a certain amount of interaction between the semantics of the verb and the semantics of the construction. That is, the construction chosen to describe an event fits with the perception of the event: depending on whether an external cause is identifiable or relevant, a speaker will choose to include this cause in the construction (thus using the transitive causative construction) or not (thus choosing the intransitive non-causative construction). This also implies that the meaning of the verb in combination with the theme fits the semantics of the construction. As we will see, when a sense is not shared by the two constructions it is often because the theme, in combination with the verb sense, does not fit the semantics associated with the argument roles of the construction (cf. Goldberg 2006: 20). When a sense is shared, it is mostly the type of event denoted by the verb that is shared between the two constructions, even though they do not share the same profiled participant roles. This is often the case with the verbs studied for this research. The question remains whether the two constructions denote two different semantic frames or simply different profilings of the same semantic frame. This will be discussed in further detail in this chapter’s sections.

Within each section, there is a further division into individual verbs, each of which starts with a table containing the following elements: number of instances of the verb in both constructions, preferred construction (based on the distinctive collostructional analysis), number of themes that occur with this verb in the instances retained, number of themes that occur with each construction and percentage of theme overlap.

A word of caution is in order with regards to distributional semantics. As will be shown in this chapter, some of the nouns that are used as themes are highly polysemous, which makes them difficult to place correctly on the semantic map, since their co-text may be similar to more than one group of themes. This polysemy is either the result of processes such as metonymy and metaphor or of the existence of different facets for one theme. Facets are “distinguishable components of a global whole, but they are not capable of being subsumed under a hyperonym” (Croft and Cruse 2004: 116). For example, Croft and Cruse (2004) identify two facets for *book*: [TOME] (e.g. *a red book*) and [TEXT] (e.g. *an interesting book*). These different facets cannot always be perceived automatically by the tools of distributional semantics. However, when such is the case, a manual annotation is implemented which allows for a better grasp of the meaning conveyed by the theme in association with the verb. Also, a few words about the presentation of

the semantic maps. Most of the time, relevant clusters have been circled or put in a rectangle, the shape of the form containing this cluster is related to the shape of the cluster as represented on the semantic map. For example, the only difference between a group that is in an oval and one that is in a rectangle is that the position of the words on the map made it easier to use one or the other. As to the red “pins,” they are part of a function in R and are used when a word is originally positioned in such a way that it makes the result too difficult to read, thus placing it slightly further away from its original position, but not dramatically affecting the integrity of the cluster. When a word is placed in a position that is far away from words which we intuitively believe are actually semantically close (because they are used with the same sense of the verb), then we manually draw a line between this particular word and the cluster we believe it should have been placed with.

7.1 BREAK verbs

As mentioned in Chapter 6, BREAK verbs are often assumed to be prototypically causative. This is supported, at least to some extent, by the distinctive collocation analysis we ran in Section 6.2.1 which showed that BREAK verbs are attracted to the transitive causative construction since two of these are found within the top three verbs that are the most significantly attracted to this construction. Out of five verbs (*break, crack, crush, shatter, snap* and *tear*), only one is significantly attracted to the intransitive non-causative construction: *crack*. As we will see in the discussion, there is more to the alternation than just verb’s preferences. We will show that not only are these verbs generally more attracted to the transitive causative construction but they are also found with a wider variety of senses (and themes) with the transitive causative construction. Out of a total of 29 different verb senses identified for these six verbs, only four are exclusively found with the intransitive non-causative construction. 13 senses are shared (at least to some extent) by the two constructions and 12 are specific to the transitive causative construction. However, it is also regularly the case, as illustrated in Table 7.1, that a verb sense is shared with a certain number of themes but restricted to one construction with other themes. When this happens, the meaning of the verb itself remains constant across the two constructions, but the theme is either construed as having characteristics that make it likely to undergo the event denoted by the verb (intransitive non-causative construction), or as something that can/must be acted upon in order to undergo the event denoted by the verb (transitive causative construction).

7.1.1 Break

The verb *break* is prototypically considered as essentially causative, while also being often associated with the causative alternation (cf. notably Levin 1993). While this is true to some extent, Table 7.2 shows that although it is found with both constructions, it is much more frequently found with the transitive causative construction. Also, many instances from the sample we used had to be discarded because they were either part of the family of resultatives, or instances of the setting construction (cf. Section 6.1.2). Nonetheless, we found 641 instances of *break* used with either the

BREAK	
Intransitive non-causative construction	Transitive causative construction
<i>break</i>	
1.3 with <i>water</i>	<ol style="list-style-type: none"> 1. “(cause to) become broken” <ol style="list-style-type: none"> 1.1 with BONES 1.2 with various themes 2. with MOTIVE-POWERED DEVICES, “make or become inoperative” 3. with PEOPLE & MIND STATES, “(cause to) lose emotional control” <ol style="list-style-type: none"> 3.1 with <i>heart</i>, “(cause to) become really sad” 4. with NEWS, “(cause to) become public” 5. with DAY & ATMOSPHERIC ELEMENTS, “appear” 6. with LAW, “infringe” 7. with PROMISE, “betray” 8. with HABIT & SITUATION, “terminate, put an end to”
<i>crack</i>	
<ol style="list-style-type: none"> 2.1 with BONES 3.1 with FIREARMS 4. with <i>voice</i>, “change its pitch” 5. with PEOPLE and MIND STATES, “yield to pressure” 	<ol style="list-style-type: none"> 1. with various themes, “(cause to) break without a separation of the parts” 2. with BONES, move in a way that causes a cracking sound <ol style="list-style-type: none"> 2.2 with <i>knuckles</i> 3. “(cause to) emit a sharp sound” <ol style="list-style-type: none"> 3.2 with <i>whip</i> 6. “access” <ol style="list-style-type: none"> 6.1 with STRUCTURES, “gain access to” 6.2 with CODES, “decipher” 6.3 with PROBLEMS, “solve” 7. with <i>window</i>, “open slightly”
<i>crush</i>	
	<ol style="list-style-type: none"> 1. with various themes, “deform, pulverize, or force inwards by compressing forcefully” 2. with ENEMIES, “subdue” 3. with PEOPLE & MIND STATES, “ruin emotionally”
<i>shatter</i>	
	<ol style="list-style-type: none"> 1. with concrete items, “break into pieces” 2. with abstract themes, “(cause to) become severely damaged” 3. “disrupt, interrupt abruptly”
<i>snap</i>	
2. with PEOPLE and MIND STATES, “lose emotional control”	<ol style="list-style-type: none"> 1. with BONES, BRANCHES and various themes, “(cause to) break sharply” 3. with FABRIC and similar themes, “(cause to) emit a sound due to flapping” (mostly intransitive non-causative construction) 4. with FINGERS, “(cause to) make a snapping sound” (mostly transitive causative construction) 5. with STREAK, “put an end to” 6. with PICTURE, “take a picture with a camera”
<i>tear</i>	
	<ol style="list-style-type: none"> 1. with 1.1 FABRIC, 1.2 PAPER and 1.3 FLESH, “rip” <ol style="list-style-type: none"> 1.4 with other themes 2. “cause to break apart (figuratively)” 3. “interrupt suddenly”

Table 7.1: BREAK verbs: shared and construction-specific verb senses

intransitive non-causative construction or the transitive causative construction. Unsurprisingly, there is a wider variety of themes that occur with the transitive causative construction. The degree of theme overlap for **break** is within the average, with 7.95% of overlap between the two constructions.

<i>break</i>			
Instances retained	641	Themes	239
Instances of Cx1	121	Cx1 themes	68
Instances of Cx2	520	Cx2 themes	190
Preferred construction	Cx2	Theme overlap (in %)	7.95%

Table 7.2: Characteristics of *break*

As expected from a verb that is as frequent as *break* (111,181 occurrences as a verb in COCA), it is found with many different senses, the majority of which are not shared by the two constructions. Both Table 7.2 and the semantic maps in Figure 7.1 and Figure 7.2 show the discrepancy in the number and variety of themes found with each construction.

We will start the discussion with the most literal sense of *break*, which as we will see later, like many other literal verb senses, is shared by the two constructions. This sense corresponds to the meaning “(cause to) become broken,” and is found with a variety of themes, among which we could identify a cluster of themes referring to BONES and other clusters made up of a variety of themes that do not necessarily share specific features. The first cluster comprises various body parts such as *ankle* (148a-i) or *arm* (148b-i). The second set contains themes that refer to various objects such as *toy* (148a-ii) or *chairs* (148b-ii). A third sense is exclusively found with the intransitive non-causative construction and with the theme *water*, referring to the content of the amniotic sac, the amniotic fluid. In this case, *water* is used somewhat metonymically since it is actually the sac that breaks, as illustrated in (148a-iii).

(148) **Group 1:** with various themes, “(cause to) become broken”

- a. with the intransitive non-causative construction:
 - i. 1.1 with BONES: [...] the sledgehammer makes contact with the **ankle**. It breaks with a sharp CRACK.
 - ii. 1.2 with other themes: You bought a plastic **toy** at Christmas from Japan, and **it** broke the next day.
 - iii. 1.3 with *water*: Juanita Massie can recall her baby’s kicks inside her belly, how her **water** broke [...]
- b. with the transitive causative construction:
 - i. 1.1 with BONES: You attacked me from behind and broke my **arm** this day [...]
 - ii. 1.2 with other themes: Back then, rioters could set fires and break **chairs** and fight the SWAT teams.

The second sense identified for *break* is “(cause to) become inoperative.” This sense is specific to MOTIVE-POWERED DEVICES, it is made up of themes referring to devices that require a source

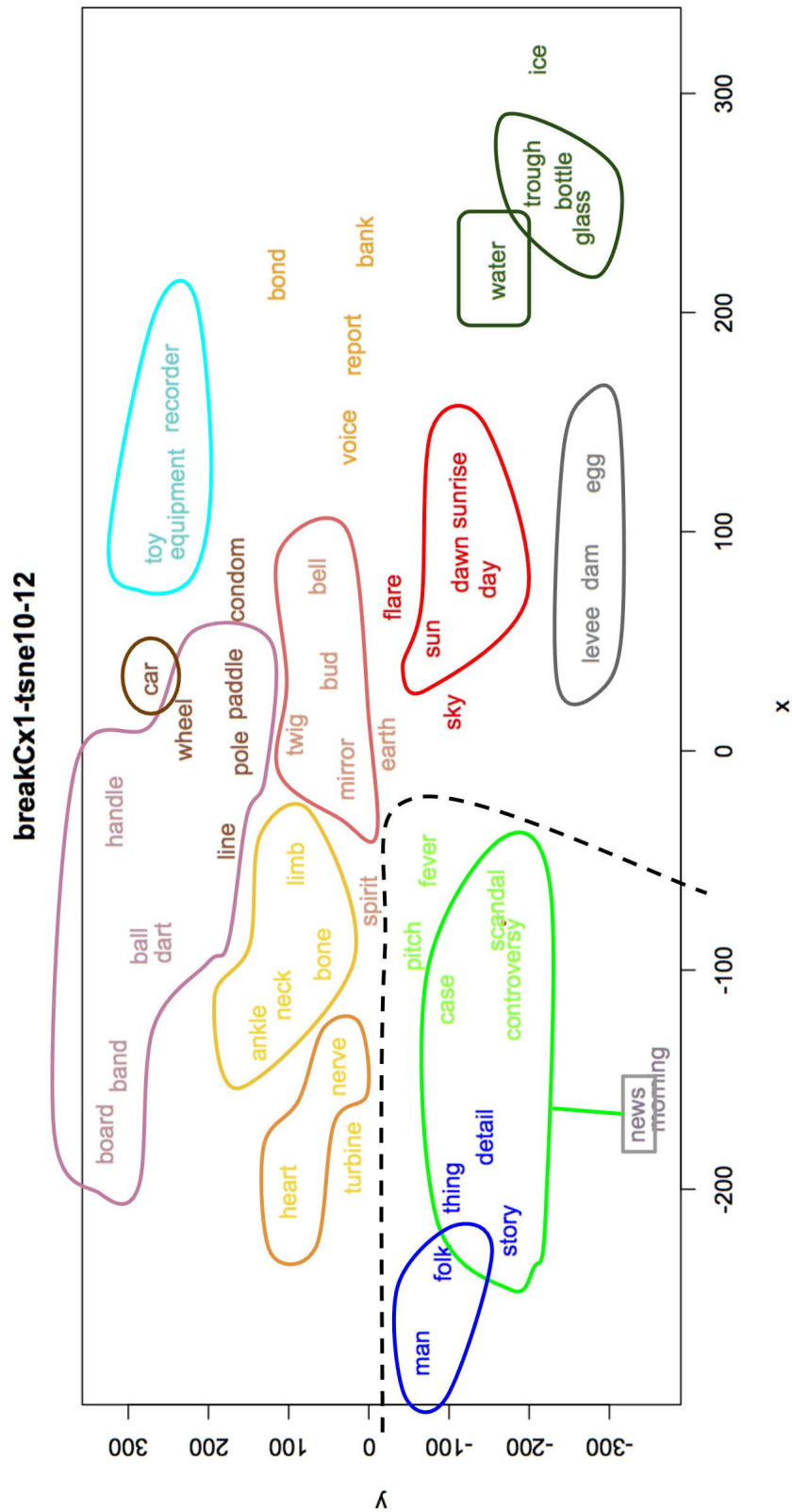

Figure 7.1: Themes that occur with *break* in the intransitive non-causative construction

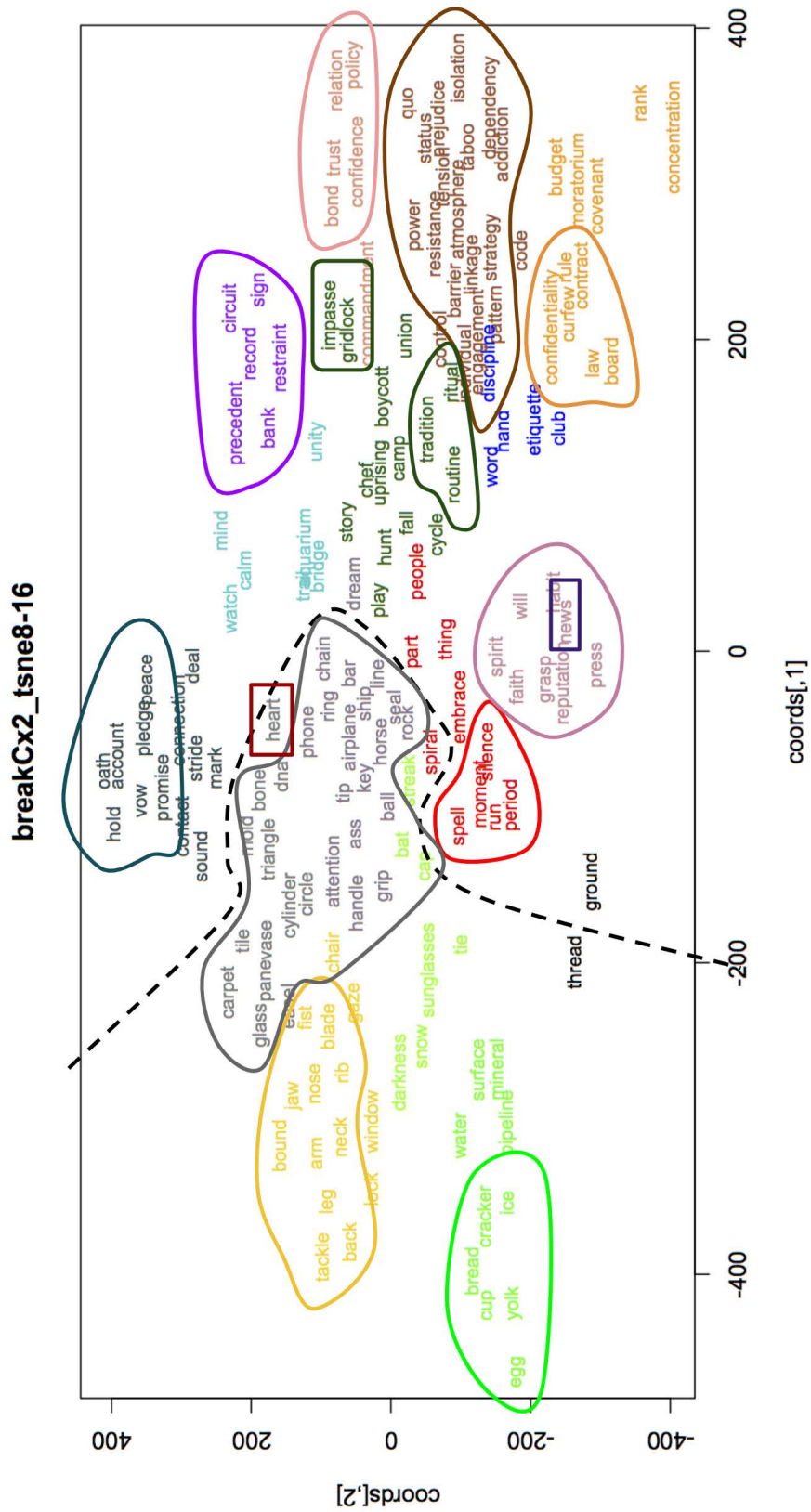

Figure 7.2: Themes that occur with *break* in the transitive causative construction

of power (electricity, gas, steam etc.), as shown in (149).¹

- (149) 2. with MOTIVE-POWERED DEVICES, “make or become inoperative” (OED online):
- a. My tape **recorder** broke, but I’m going to get it fixed tomorrow.
 - b. The intent here is for me to learn flight-testing and not break the **airplane** while I do it [...]

The third sense is a metaphorical extension of the first one, and is found with PEOPLE and MIND STATES. With this sense of *break*, the theme, referring to a person or referring to someone’s state of mind undergoes an event that we label “lose emotional control.” As is visible from the examples in (150), this sense of *break* is shared by the two constructions.

- (150) **Group 3:** with PEOPLE & MIND STATES, “(cause to) lose emotional control”
- a. with the intransitive non-causative construction:
 - i. **Folks** would fall out, freak out, break under the pressure of the “Probe” [...]
 - ii. Did police put their fists in women’s faces so the husbands’ **spirits** would break along with the women’s jaws?
 - b. with the transitive causative construction:
 - i. New York breaks a lot of **people**, but Spree seems to be thriving there.
 - ii. Poverty does that. It breaks the **spirit** a long time before the body dies.

This sense is closely related to that found with the theme *heart*, which is also shared by the two constructions and means “(cause to) become very sad.” Since these two are very similar, the second was labeled 3.1, rather than considered a different sense on its own.

- (151) **Group 3.1:** with *heart*
- a. with the intransitive non-causative construction:
 - i. Tonight my **heart** is breaking but I know this hurt won’t last [...]
 - ii. Her **heart** breaks over those who rebuff her invitation to flourish [...]
 - b. with the transitive causative construction:
 - i. You only call me after a girl breaks your **heart**.
 - ii. It breaks my **heart** because their spirits were broken here [...]

The next set of themes is found with a meaning of *break* that differs a little from the first two. This cluster, which is more easily visible in Figure 7.1 than Figure 7.2, comprises themes that generally refer to NEWS OR INFORMATION, such as *story*, *controversy*, *scandal* and *news* itself. Two examples are provided for each construction in (152) below.

¹Although this is not necessarily striking from our corpus, we have a hunch that this particular group may actually prefer the intransitive non-causative construction, since it is easier to construe an event where an engine breaks down on its own rather than someone or something truly interfering with it in a way that causes the engine to break. This could be compared to the near synonym phrasal verb *break down*, which is exclusively used intransitively. Also, it appears from the example in (149b) that this use of *break* may have more to do with the physical integrity of the airplane rather than its become inoperative. Unfortunately, we do not have the data to solidly back up this claim and will therefore leave it as such.

(152) **Group 4:** with NEWS, “(cause to) become public”

- a. with the intransitive non-causative construction:
 - i. [...] they considered Woods less of a role model since **news** of his extramarital affairs broke in November.
 - ii. After the infidelity **scandal** broke, paparazzi shadowed James every move [...]
- b. with the transitive causative construction:
 - i. [...] our White House correspondent that broke the **news** this morning about the departure of Jean Bertrand-Aristide.
 - ii. Our friend John Heilemann broke the **story** for Time magazine [...]

In all of these examples, a piece of news/information is revealed or becomes available to the public. This meaning is close to other senses of *break* which imply an opening from which something escapes, or bursts out. The Oxford English Dictionary provides the following definition for the next set of themes: *To burst out of darkness, begin to shine; as of the day, morning, daylight*. We decided to shorten this definition to the verb “appear”, as illustrated in (153). In the Oxford English Dictionary, this definition is found under the more general entry *Intransitive senses implying movement accompanied by the breaking of ties or barriers; to burst*.

(153) **Group 5:** with DAY & ATMOSPHERIC ELEMENTS, “appear”

- a. [...] as **dawn** breaks in Afghanistan [...]
- b. At that moment **sunrise** broke over the ridge [...]

Lemmens (2006) also mentions the motion aspect involved in this type of constructions and argues that although the original meaning has been almost completely lost, *dawn* (153a) and *sunrise* (153b) are not the entities that actually undergo the event denoted by the verb. In this case the subject position is filled by the “breaker” and the “breekee” is omitted. The assumption here is that the sun or dawn breaks the darkness. However, since this meaning is rather opaque, we kept *sunrise* and *dawn* as themes with the intransitive non-causative construction.

The next four groups, each of which corresponds to a different meaning of *break*, are specific to the transitive causative construction. First off, group number 6 is made up of themes such as *curfew*, *law* and *rule*. When used with these themes, *break* is a near synonym of “infringe,” as illustrated in (154a) and (154b).

(154) **Group 6:** with LAW, “infringe”

- a. [...] he broke about half a dozen state and federal gun **laws** by simply possessing the gun.
- b. He also broke another **rule** of political comedy.

Somewhat similar but still different is the meaning of *break* when associated with themes such as *oath*, *pledge* and *promise*, which are illustrated in (155). With these themes, *break* is close to “betray.”

(155) **Group 7:** with PROMISE, “betray”

- a. It was a mistake to support the President, seeing how he broke his **promises** to us about not going to war immediately [...]
- b. The problem is not that George Bush just broke his tax **pledge**.

The last group is further divided into two clusters, one that corresponds to HABIT, cf. (156a), and one that corresponds to SITUATION, cf. (156b). With both clusters the meaning of *break* is roughly “terminate, put an end to.”

(156) **Group 8:** “terminate, put an end to”

- a. 8.1 with HABIT:
 - i. [...] we’ve talked a little bit about how to break bad **habits** [...]
 - ii. [...] find the joy in breaking your **routine**, Mellan suggests.
- b. 8.2 with SITUATION
 - i. Steven’s then-fiance, Traci Greer, broke their **engagement** and married Walter Millbank.
 - ii. [...] a full scale effort to break the isolation imposed on us [...]

This meaning is less specific than the previous two senses of *break*, and is thus associated with a wider variety of themes. However, the kind of event denoted by the verb in combination with these themes is very similar across all instances.

To sum up, we have identified eight different verb senses associated with *break*, three of which are shared by the two constructions with all their themes (but not necessarily with the same frequency), one which is shared with most themes but not all, and finally, four which are specific to one construction only.

7.1.2 Crack

Crack is one of the few verbs that are not significantly attracted to a particular construction. However, the raw frequencies provided in Table 7.3 show that it occurs more frequently with the transitive causative construction, and there is a little bit more variety in the themes used with this construction than with its intransitive non-causative counterpart. With 7.87% of theme overlap, *crack* is within the average.

<i>crack</i>			
Instances retained	377	Themes	178
Instances of Cx1	150	Cx1 themes	89
Instances of Cx2	227	Cx2 themes	103
Preferred construction	NS	Theme overlap (in %)	7.87%

Table 7.3: Characteristics of *crack*

As we will see in the discussion, there is one main sense of *crack* that corresponds to “(cause to) break without a separation of the parts,” and this sense, which is literal, is shared by the two

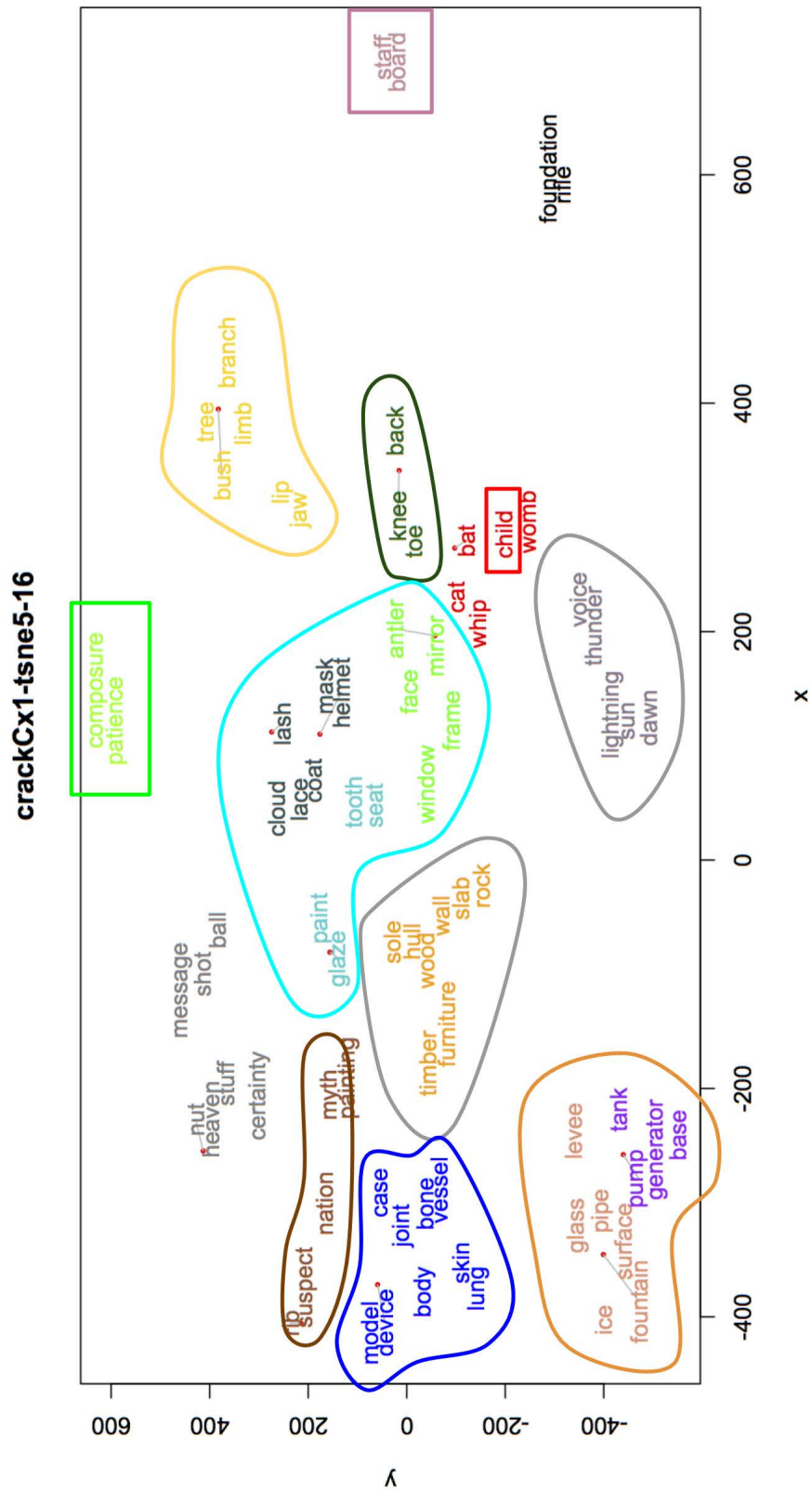

Figure 7.3: Themes that occur with *crack* in the intransitive non-causative construction

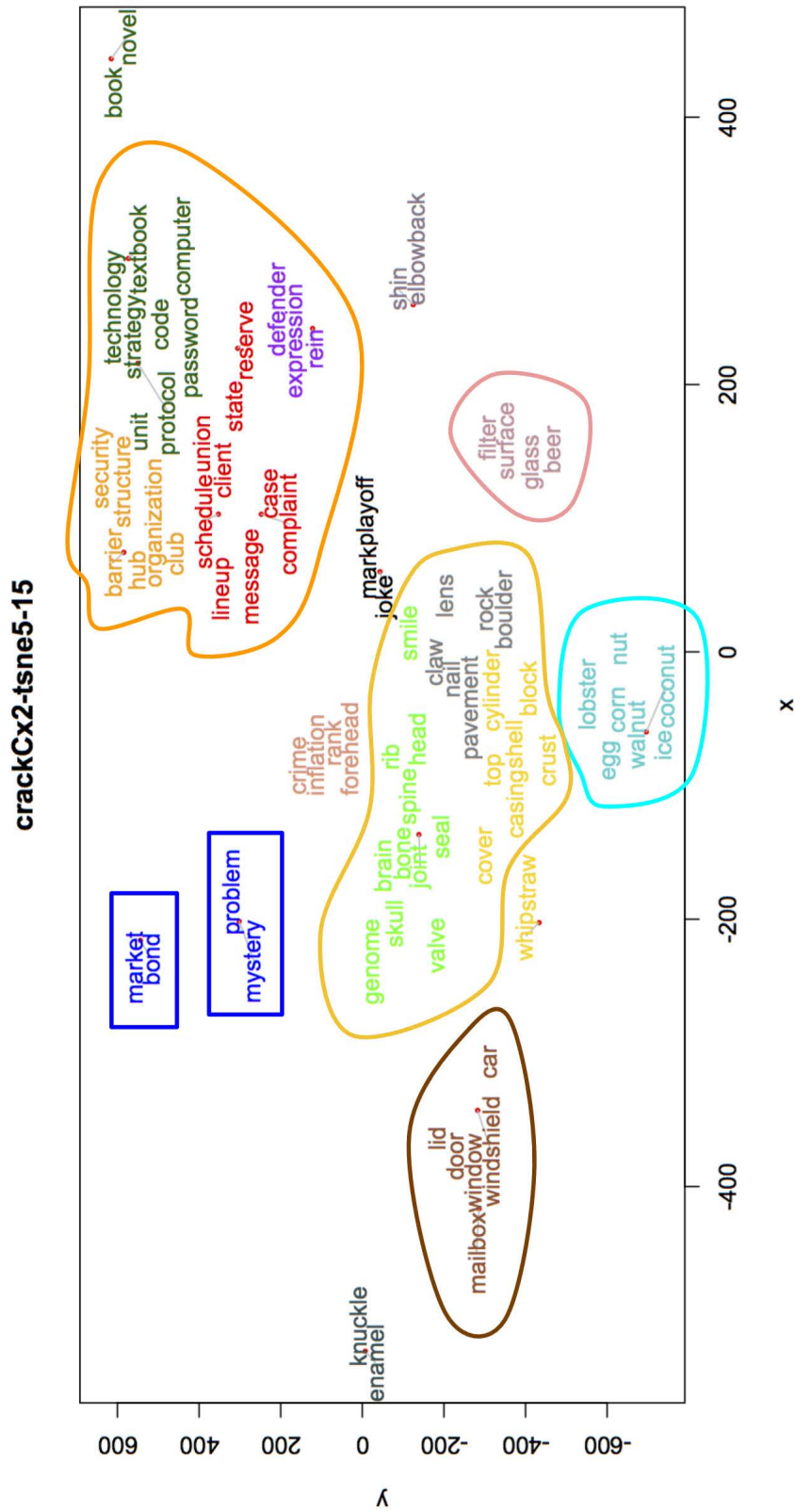

Figure 7.4: Themes that occur with *crack* in the transitive causative construction

constructions. This sense has also been extended metaphorically, but when used metaphorically, it means “access” and is limited to the transitive causative construction. A third global meaning has to do with sound and it is further divided into three different senses: “move in a way that causes a cracking sound,” “(cause to) emit a sharp sound,” and “change its pitch.” Among the most striking features of *crack* is the fact that there are many more themes referring to abstract concepts and entities with the transitive causative construction than with the intransitive non-causative construction, as is clearly visible from the corresponding semantic maps in Figure 7.3 and Figure 7.4.

We will start the discussion with group 1, which is composed of various themes that refer to concrete things and with which *crack* takes on the meaning “(cause to) break without a separation of the parts”. Although this sense is shared by the two constructions, it is found with a little more variety in the transitive causative construction. However, the meaning of the verb is constant across the two constructions, as illustrated with the examples in (157).

- (157) **Group 1:** with various themes, “(cause to) break without a separation of the parts” (definition from the OED online)
- a. With the intransitive non-causative construction:
 - i. [...] the concrete **sarcophagus** entombing the reactor is now beginning to crack [...]
 - ii. **Wood** cracked and splintered as the shower of rock smashed the cargo box [...]
 - b. With the transitive causative construction:
 - i. [...] and how efficiently its jaws could crack the **carapaces** of the insects it caught.
 - ii. Galt cracked a **walnut** in his fist?

The second group is made up themes referring to various bones, and which, when used with *crack* do not break but emit a sound due to their friction. This sense is mostly found with the intransitive non-causative construction in our corpus (158a-158b), with the exception of *knuckles*, which is exclusively found with the transitive causative construction (158c).

- (158) **Group 2:** with BONES, “move in a way that causes a cracking sound” (mostly intransitive non-causative construction, with the exception of *knuckle*)
- a. He stood, and his **knees** cracked.
 - b. Her **back** cracked a final time, and she went down [...]
 - c. They all cracked their **knuckles**.

The third group also has to do with sounds, and is mostly specifically used (at least in our corpus) with FIREARMS in the intransitive non-causative construction (159a), and with *whip* in the transitive causative construction (159b).

- (159) **Group 3:** “(cause to) emit a sharp sound”
- a. 3.1 with FIREARMS: A distant **rifle** cracked and the crows shut up.
 - b. 3.2 with *whip*: He cracked his **whip** and pulled away.

There is one more sense of *crack* that is related to the emission of sounds, but in this case, it is specific to *voice* and limited to the intransitive non-causative construction, as illustrated in (160). In this type of contexts, *crack* means “change its pitch” and is usually associated with overwhelming emotions.

- (160) **Group 4:** with *voice*, “change its pitch” (intransitive non-causative construction only)
- a. Corgin’s **voice** cracked when he tried to reply.
 - b. Sometimes my **voice** cracked with emotion [...]

The next group also implies emotions, but somewhat differently. This group, which corresponds to “yield to pressure,” is found with two types of themes which either refer to PEOPLE or MIND STATES. In these cases, the person or their mental state, such as *patience* in (161b-ii), is affected by a certain amount of pressure or intimidation put on them.

- (161) **Group 5:** “yield to pressure” (intransitive causative construction only)
- a. with PEOPLE, “yield to pressure”
 - i. It is a syndrome with bar **staff** who crack under the misconceived but persistent impression that this life is glamorous.
 - ii. [...] the Huron **nation** finally cracked under the pressure of two opposing forces.
 - iii. By 2 A.M. both **suspects** had begun to crack under Pugh’s relentless interrogation [...]
 - b. with MIND STATES, “fail under pressure”
 - i. [...] his steely **composure** may crack, as he suffers from arachnophobia.
 - ii. Diana’s **patience** cracked.

The last verb sense, illustrated by the examples in (162), corresponds to “ACCESS” and it can be further divided into three subsenses: “gain access to,” as in (162a), “decipher,” as in (162b), and “solve,” as in (162c) depending on the kind of theme *crack* is used with. As we mentioned before, this sense is a metaphorical extension of the first sense we identified (“(cause to) break without a separation of the parts”) in that in this type of scenario, something is metaphorically broken so that one can have access to what is inside, usually information.

- (162) **Group 6:** “ACCESS” (transitive causative construction only)
- a. 6.1: with STRUCTURES, “gain access to”
 - i. Among Fortune 500 companies, women have cracked the CEO **ranks** [...]
 - ii. The legendary Mile High **Club** is hard to crack nowadays [...]
 - b. 6.2: with CODES, “decipher”
 - i. No one has seemed to crack the **code** on Generation X [...]
 - ii. [...] wartime mathematicians collaborated in cracking the Nazi Enigma **code**.
 - c. 6.3: with PROBLEMS, “solve”

- i. [...] the acerbic, pill-popping doctor who is so brilliant at cracking a medical **mystery** every week.
- ii. Our goal is to crack real **problems** that really make sense [...]
- iii. In the silence the realization dawned that I'd just cracked my first **case** [...]

There is one more sense of *crack* that differs slightly from the other senses discussed so far and that is apparently specific to the theme *window*, as illustrated in the examples in (163). Although it differs slightly from the other senses of *crack*, it is nonetheless consistent with the notion of “opening” and “access.”

(163) **Group 7:** with *window*, “open slightly”

- a. It was cool enough that I only had to crack the side **windows** a little bit to get a nice cross breeze.
- b. The thought of it made him feel hot and he cracked the **window**.

This sense of *crack* corresponds to “open slightly.” It is close to certain senses of *crack* which imply that one breaks something only to a certain extent and it also resembles one of the notions conveyed by the noun *crack*: “A narrow space between two surfaces which have broken or been moved apart” (OED online).

7.1.3 *Crush*

Crush is the only verb among the 29 verbs we chose for this research that has a theme overlap of 0%. This is due to the fact that it is also the only verb for which only two occurrences of the intransitive non-causative construction were found, against 327 instances of *crush* with the transitive causative construction. We will show in the discussion how relevant this is with regards to what we consider the inherent meaning of the transitive causative construction as opposed to the intransitive non-causative construction.

<i>crush</i>			
Instances retained	329	Themes	193
Instances of Cx1	2	Cx1 themes	2
Instances of Cx2	327	Cx2 themes	191
Preferred construction	Cx2	Theme overlap (in %)	0%

Table 7.4: Characteristics of *crush*

The first group presented below is made up of various themes, all of them referring to concrete items that are crushed in the same way: “deform, pulverize, or force inwards by compressing forcefully.” This appears to be the most frequent sense of *crush*, with roughly half of its instances corresponding to this group and sense (in tokens, at least). To match with the clusters computed by t-SNE, we further divided this group into four subgroups, namely FLORA & FAUNA (164a), BODY PARTS (164b), VARIOUS OBJECTS (164c) and FOOD (164d). This sense of *crush* entails the use of force, which confirms our idea that *crush* is inherently causative and, as such, is almost exclusively found with the transitive causative construction.

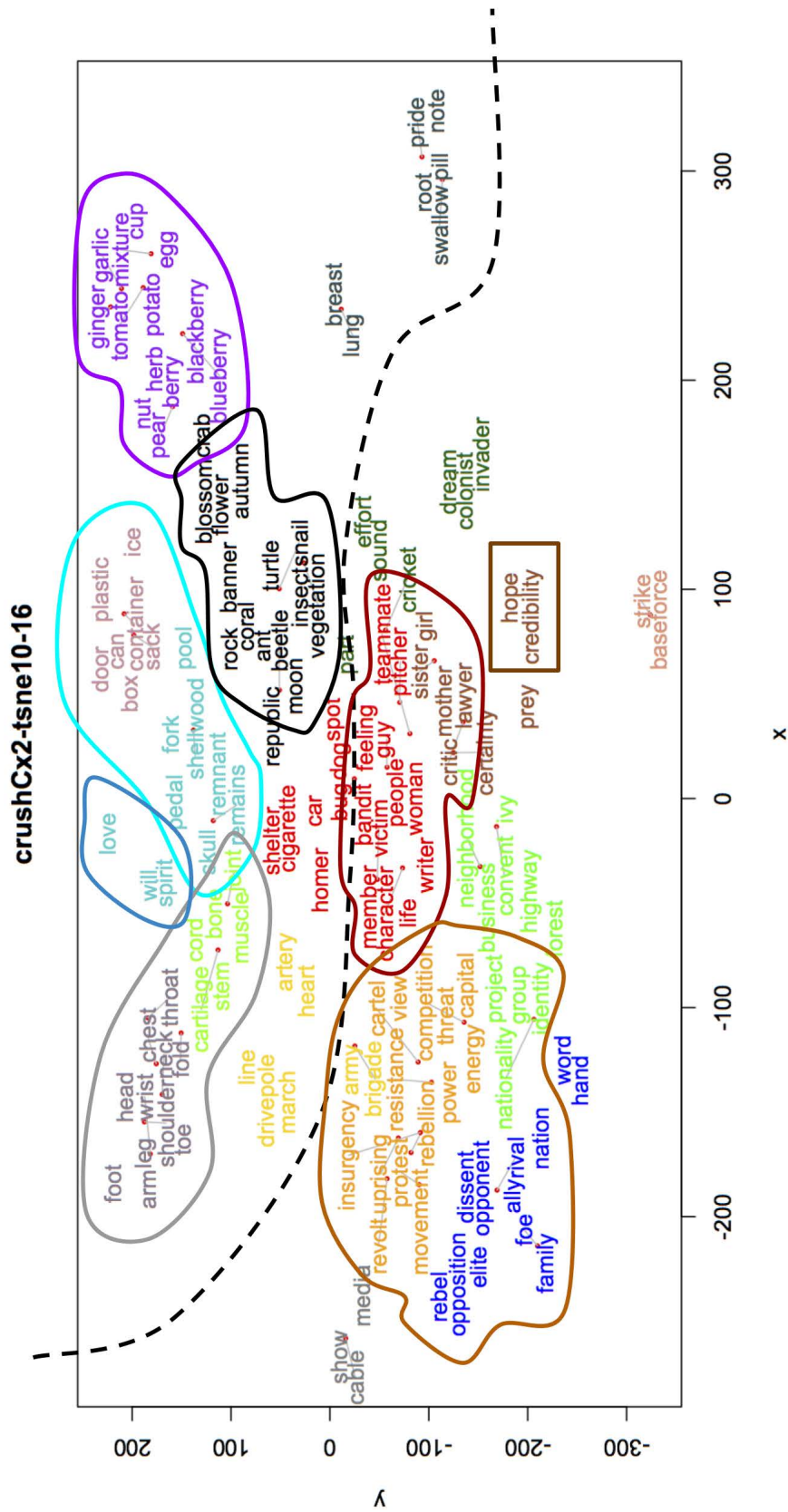

Figure 7.5: Themes that occur with *crush* in the transitive causative construction

- (164) **Group 1:** “deform, pulverize, or force inwards by compressing forcefully”²
- a. With FLORA & FAUNA:
 - i. [...] the black scorpion had crushed the **beetle** it had been after with its claws [...]
 - ii. Somehow she had clenched her fist and had crushed the little white **blossoms**.
 - b. With BODY PARTS:
 - i. [...] the woman of Thebez who threw a stone that crushed the **head** of the general Abimelech [...]
 - ii. A horse had crushed both of Porter’s **legs** in 1937 at the Piping Rock Club on Long Island [...]
 - c. With VARIOUS OBJECTS:
 - i. I can crush soda **cans** with my hand.
 - ii. The collision crushed Lewis’s rear **door**.
 - d. With FOOD:
 - i. Peel and crush the **garlic**.
 - ii. Use a spoon (or the mortar) to lightly crush **tomatoes** and **beans** [...]

The second group is made up of themes that, when used with *crush*, also imply the use of force. These themes were labelled ENEMIES, and they comprise nouns such as *insurgency*, *revolt*, *resistance*, *rebellion* and *foe*. For all of these, the sense associated with *crush* is “subdue,” as illustrated in (165).

- (165) **Group 2:** with ENEMIES, “subdue”
- a. Although the British colonial authorities brutally crushed the **rebellion** [...]
 - b. [...] how Jackson had nearly crushed the Federal **army** in a panic so complete that [...]

The third and last group, which comprises themes that either refer to PEOPLE or FEELINGS & MIND STATES, corresponds to “ruin emotionally.” For PEOPLE, as in (166a), it implies that an event or person affects the mental health of the theme. As to FEELINGS & MIND STATES, it involves that someone’s state of mind is negatively impacted, as illustrated in (166b).

- (166) **Group 3:** “ruin emotionally”
- a. with PEOPLE:
 - i. It crushed my **mother**.
 - ii. I doubt many agents set out to crush **writers** through these methods [...]
 - b. with FEELINGS and MIND STATES:
 - i. Unfortunately, teachers can sometimes crush a child’s **spirit** with negative remarks and sarcastic comments.
 - ii. Tampa Bay [...] crushed the 49ers’ will in the first half.

²Definition from the OED online.

Since we only found two examples of *crush* with the intransitive non-causative construction, it is virtually impossible to assess potential verb senses for *crush* in this construction. However, the two instances in (167) and (168) tend to point towards the meaning associated with group 1, which is the most frequent and the most literal.

- (167) The **walnuts** were chopped just so to crush *between your molars* with a small satisfying explosion
- (168) [...] feeling soft plant **things** crush *beneath her hands*.

As is the case for other verbs, *crush* seems to have its agent or instrument expressed in an oblique (the prepositional phrases italicised in the examples above) when used with the intransitive non-causative construction. This partially reinforces the idea that this verb is inherently causative. This inherent causativity also shows in the distribution of *crush*, since it hardly ever occurs with the intransitive non-causative construction.

7.1.4 *Shatter*

With regards both to BREAK verbs and to the 29 verbs we chose in total, *shatter* is within the average. As is visible in Table 7.5, it shows a preference for the transitive causative construction, more variety in the themes recruited with this construction and a theme overlap at 10.53%.

<i>shatter</i>			
Instances retained	499	Themes	247
Instances of Cx1	173	Cx1 themes	98
Instances of Cx2	326	Cx2 themes	175
Preferred construction	Cx2	Theme overlap (in %)	10.53%

Table 7.5: Characteristics of *shatter*

There are two main senses that are associated with *shatter* and are shared by the two constructions. One is literal: “break into pieces” and the other is figurative: “(cause to) become severely damaged.” The first is found with themes that refer to concrete items and the second is associated with themes that refer to concepts, feelings, ideas and people. As we will see in the discussion (and is apparent on the semantic maps in Figure 7.6 and Figure 7.7), and through examples, there is actually a slight discrepancy between the uses of these two senses depending on the construction that is chosen. A third group, which is limited to the transitive causative construction corresponds to “disrupt, interrupt abruptly.”

We will start by presenting the literal sense of *shatter*, which is found with a certain variety of themes, as illustrated in (169).

- (169) **Group 1:** with various themes, “break into pieces”
- a. With the intransitive non-causative construction:
 - i. The beer **bottle** clicked off his teeth and shattered on the cement.
 - ii. The sliding glass **doors** shatter as one of Jones’s men breaches the door.

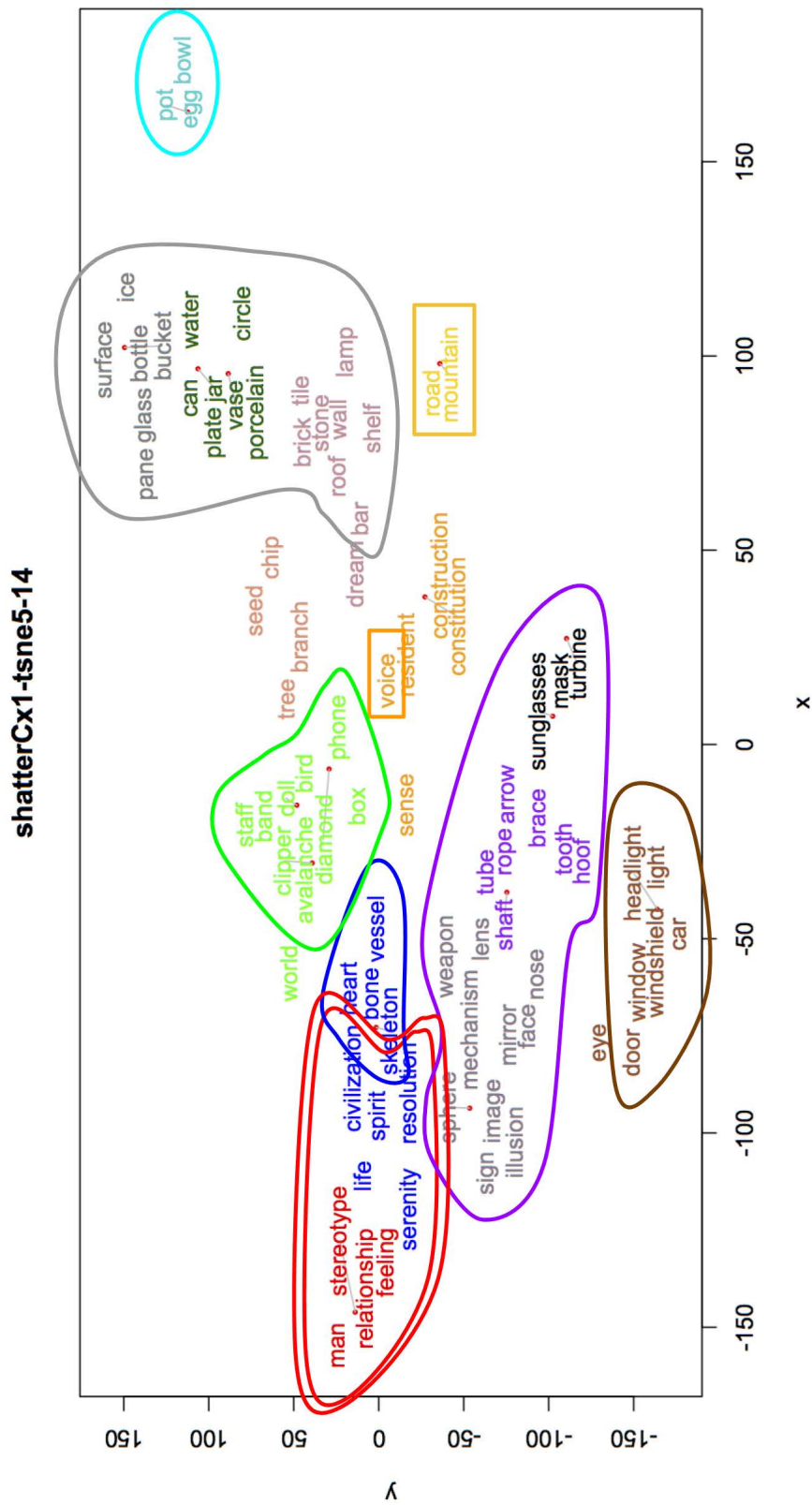
Figure 7.6: Themes that occur with *shatter* in the intransitive non-causative construction

- b. With the transitive causative construction:
 - i. The explosion took place in the lobby and shattered its stone **entrance**.
 - ii. A few minutes later, rifle fire shattered Brodie's right **arm**.

Although this sense is shared by the two constructions, and several themes are shared too, there is a little more variety in the themes found with this sense in the transitive causative construction, since most of the themes found with the intransitive non-causative construction refer to objects that are either made of glass or of another fragile material, which makes them more likely to shatter. This is clearly visible from the semantic maps in Figure 7.6 and Figure 7.7.

The next sense is a figurative use of *shatter*, which is found with PEOPLE and abstract groups of themes such as MIND STATES, IDEAS & ILLUSIONS and RELATIONS. This sense is also shared by the two constructions, as illustrated in (170a) and (170b); however, it is also much more productive in the transitive causative construction. It is clear that the cluster of themes used with this sense is much smaller on Figure 7.6, as illustrated by the double red line, than on Figure 7.7, where it takes up more than half of the semantic map and is separated from the concrete themes by a black dashed line.

(170) **Group 2:** with abstract themes, “(cause to) become severely damaged”

- a. With the intransitive non-causative construction:
 - i. [...] his **dream** of becoming a doctor shattered.
 - ii. [...] Dana's **resolution** shattered, along with her vow to stay out of her sister's life [...]
- b. With the transitive causative construction:
 - i. By deciding to court-martial the captain the Air Force implicitly shattered a fundamental **assumption** of combat [...]
 - ii. This shattered the UN's initial **consensus** in mid-July on how to respond to the Congo crisis [...]

Finally, the last sense identified is represented on Figure 7.7 by the cluster that contains the following themes: *moment*, *silence*, *stillness*, and *blackness*. It is similar to “disrupt” but implies an event that is sudden and radical, as illustrated in (171). This sense is exclusively found with the transitive causative construction since it requires the intervention of an external cause to be brought about.

(171) **Group 3:** “disrupt, interrupt abruptly” (transitive causative construction only)

- a. Its roar shattered the early morning **silence**.
- b. Gunshots, shattering the **stillness**.

Again, even though two out of the three senses identified for a verb are shared by the two constructions, there are subtle nuances that appear in the distribution of themes between the two constructions. As to the sense that is exclusively found with the transitive causative construction, it aligns well with the semantics associated with the construction since it requires the intervention of an external cause to be brought about.

7.1.5 *Snap*

Snap is one of the rare verbs that is more frequently used with the transitive causative construction but recruits more varied themes in the intransitive non-causative construction. As shown in Table 7.6, only one third of all the instances of *snap* we retained are with the intransitive non-causative construction but we identified 62 themes with this construction against only 58 with its transitive counterpart. As is visible from the semantic maps in Figure 7.8 and Figure 7.9, the two constructions are used with the same core of themes, but each also has specific groups of themes that are not shared.

<i>snap</i>			
Instances retained	330	Themes	109
Instances of Cx1	110	Cx1 themes	62
Instances of Cx2	220	Cx2 themes	58
Preferred construction	Cx2	Theme overlap (in %)	10.09%

Table 7.6: Characteristics of *snap*

The first group identified corresponds to the most frequent use of *snap*, for which the verb sense is “(cause to) break sharply.” It is illustrated in (172a) with the intransitive non-causative construction and (172b) with the transitive causative construction. It is the only sense of *snap* that is equally shared by the two constructions, that is, it is as frequent with one as it is with the other.

- (172) **Group 1:** with BONES, BRANCHES and various themes, “(cause to) break sharply”
- a. With the intransitive non-causative construction:
 - i. By the angle of his outturned foot she guesses his **ankle** or **knee** has snapped.
 - ii. His ski **pole** snapped.
 - b. With the transitive causative construction:
 - i. Certainly the weight of an adult raccoon would have been sufficient to snap the **branch**.
 - ii. If she’d had her old power, she’d have snapped my **neck**.

The second group is restricted to the intransitive non-causative construction and comprises themes that refer to PEOPLE and MIND STATES (identified by a red circle on Figure 7.8). The associated meaning of *snap* is “lose emotional control.” Two examples are provided below, one with a theme referring to a person (173a) and one with a theme referring to a mental state (173b).

- (173) **Group 2:** with PEOPLE and MIND STATES, “lose emotional control” (intransitive non-causative construction only)
- a. The normally laid-back **actor** snaps when a reporter makes fun of his costume without seeing a stitch of it.
 - b. [...] who had been subjected to such brutalities that his **reason** had snapped.

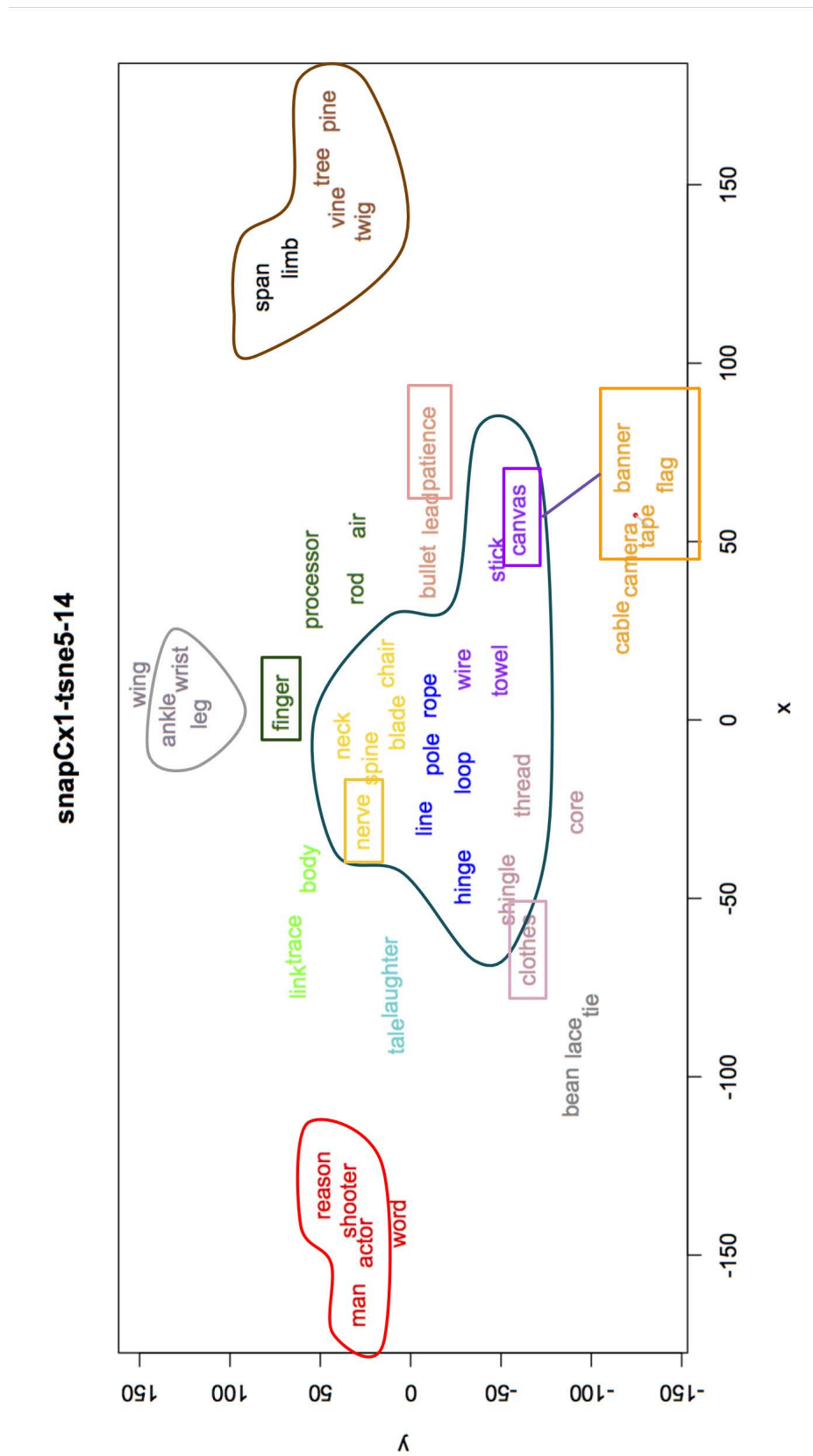
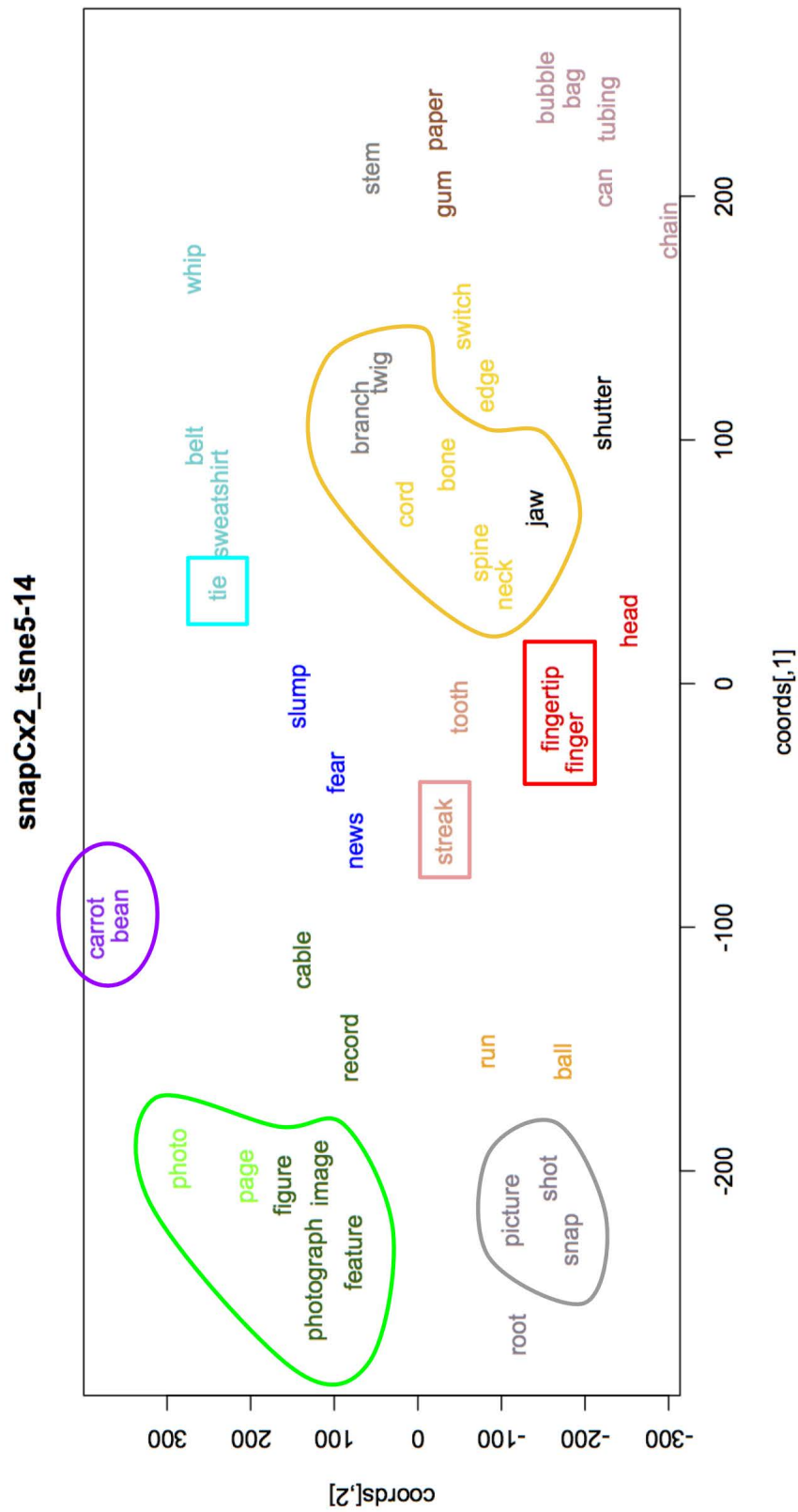

Figure 7.8: Themes that occur with *snap* in the intransitive non-causative construction

Figure 7.9: Themes that occur with *snap* in the transitive causative construction

As to the third group, while it is technically shared by the two constructions (we found one instance with the transitive causative construction), it is almost exclusively used with the intransitive non-causative construction, as shown in (174). In this case, *snap* means “(cause to) emit a sound due to flapping.”

- (174) **Group 3:** with FABRIC and similar items, “(cause to) emit a sound due to flapping” (mostly intransitive non-causative construction)
- a. Sidebar Stiff Resistance Green **flags** honoring Islam snap above tombs of historic martyrs in the Afghan city of Gardiz.
 - b. The yellow Police **tape** that still circles the yard snaps in the wind.

The fourth group is also supposedly shared by the two constructions. Yet, only one instance of this sense was found with the intransitive non-causative construction, against 61 with the transitive causative construction. This sense means “(cause to) make a snapping sound,” and it is restricted to *fingers* and *fingertips*, since it denotes a sound that is specific to a motion of the fingers. Two examples (with the transitive causative construction) are provided in (175).

- (175) **Group 4:** with FINGERS, “(cause to) make a snapping sound” (mostly transitive causative construction)
- a. He danced on the beach and snapped his **fingers**.
 - b. At the end of the song you’ll all file off the runway, snapping your **fingertips**.

The next two groups, respectively 5 and 6, are restricted to the transitive causative construction. First we found themes such as *streak* and *record* which are used with a very specific sense of *snap* that appears to be mostly used within sports commentary and corresponds to the meaning “put an end to.”

- (176) **Group 5:** with STREAK, “put an end to” (transitive causative construction only)
- a. Women’s soccer team ties North Carolina 0-0 to snap the Tar Heels’ 92-game **streak**.
 - b. Chris Haney (9-10) snapped a personal four-game losing **streak** by allowing five hits in eight innings.

The last group is made up of themes such as *photo*, *shot* or *picture*. It is a synonym of *take* as in *take a picture*, as shown in (177).

- (177) **Group 6:** with PICTURE, “take a picture with a camera”
- a. Something else flashed and I saw Mr. Paparazzi was back, snapping more **pictures**.
 - b. Travis snapped a **shot** with the camera.

Once more, the most literal sense of *snap* is shared by the two constructions, but senses that deviate slightly from this literal sense tend to be specific to one construction. Furthermore, in this case, there are two verb senses that are highly collocational: to snap one’s fingers and to snap a picture/photo. It is the combination of the verb and the theme (or a restricted set of

synonyms) that give the verb its specific meaning. This meaning also aligns with the meaning usually associated with the transitive causative construction: the theme has to be something that can be acted upon.

7.1.6 *Tear*

Tear is a verb that is mostly associated with the resultative constructions (both transitive and intransitive), which is why out of 1,600 instances extracted from COCA, only 92 were instances of either the intransitive non-causative construction or the transitive causative construction. Among these 92 instances, 70 are uses of *tear* with the transitive causative construction (cf. Table 7.7). This verb is significantly attracted to the transitive causative construction, and as we will see in the discussion (and as is visible from the semantic maps in Figure 7.10 and Figure 7.11), this construction also recruits a wider variety of themes.

<i>tear</i>			
Instances retained	92	Themes	66
Instances of Cx1	22	Cx1 themes	20
Instances of Cx2	70	Cx2 themes	51
Preferred construction	Cx2	Theme overlap (in %)	7.58%

Table 7.7: Characteristics of *tear*

The first group we identified via distributional semantics corresponds to the literal meaning of *tear*: “rip” and it can be further divided into several groups such as FABRIC, PAPER and FLESH. These are the only three groups we found with the intransitive non-causative construction, as shown in (178a) and Figure 7.10.

(178) **Group 1: “rip”**

- a. With the intransitive non-causative construction:
 - i. 1.1 with FABRIC: [...] she says she prefers these [**towels**] because they don't shred and they never tear when wet.
 - ii. 1.2 with PAPER: The **picture** tears, Bean panics - it tears even more.
 - iii. 1.3 with FLESH: [...] the cortisone my mother took made her **skin** so thin that **it** tore like tissue paper [...]
- b. With the transitive causative construction:
 - i. 1.1 with FABRIC: [...] they sit on the floor on ragged chunks of coral rock that sometimes tear their **clothes**.
 - ii. 1.2 with PAPER: Sometimes she howled and savagely tore the **wallpaper** of her bedroom and then lay on the floor.
 - iii. 1.3 with FLESH: Tall, thick branches fortified with sharp thorns snagged my clothing and tore my **flesh**.
 - iv. 1.4 with other items: She stood on her chair, making small grunting noises as she tore the **sandwich** and squeezed the bread and peanut butter into paste.

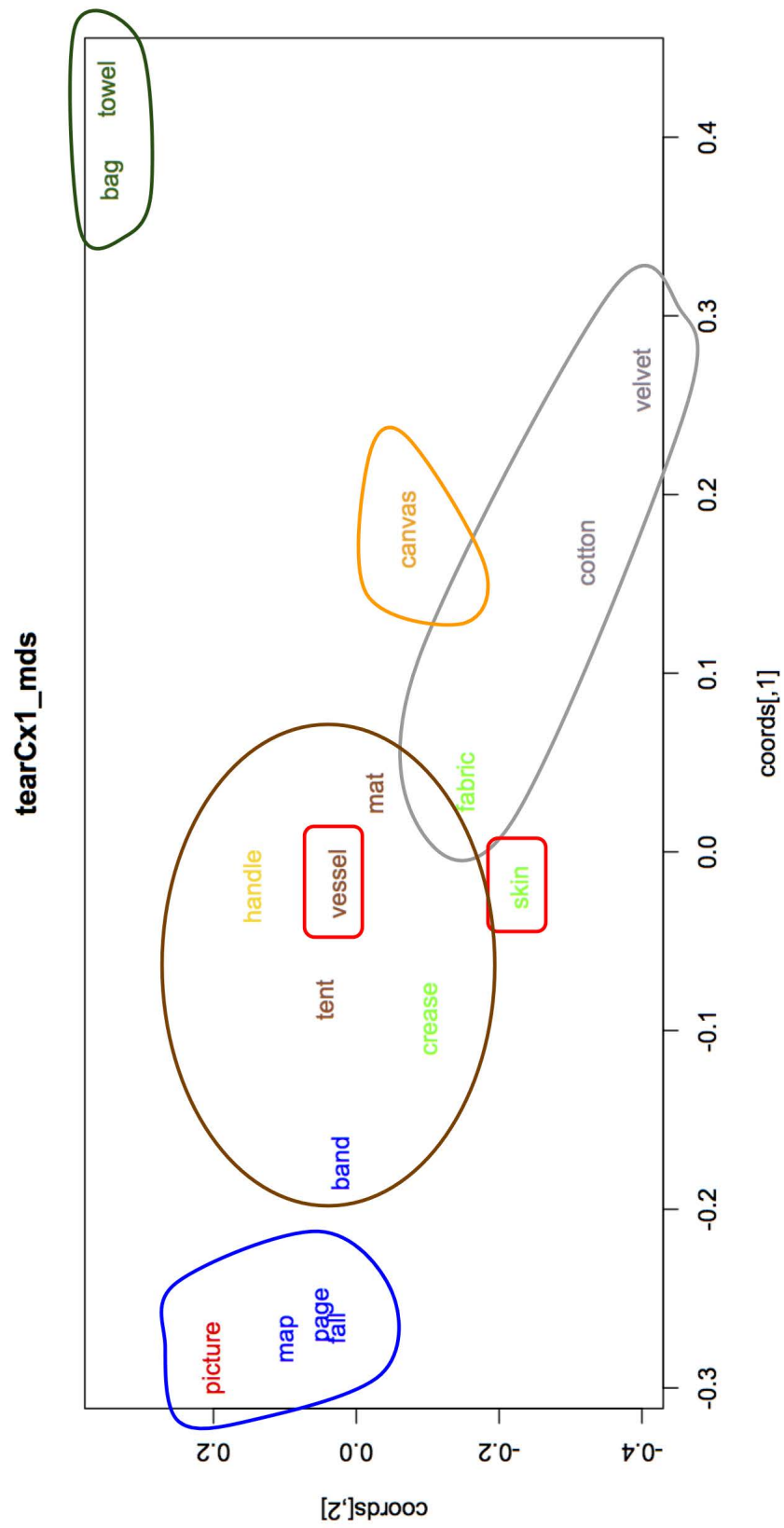
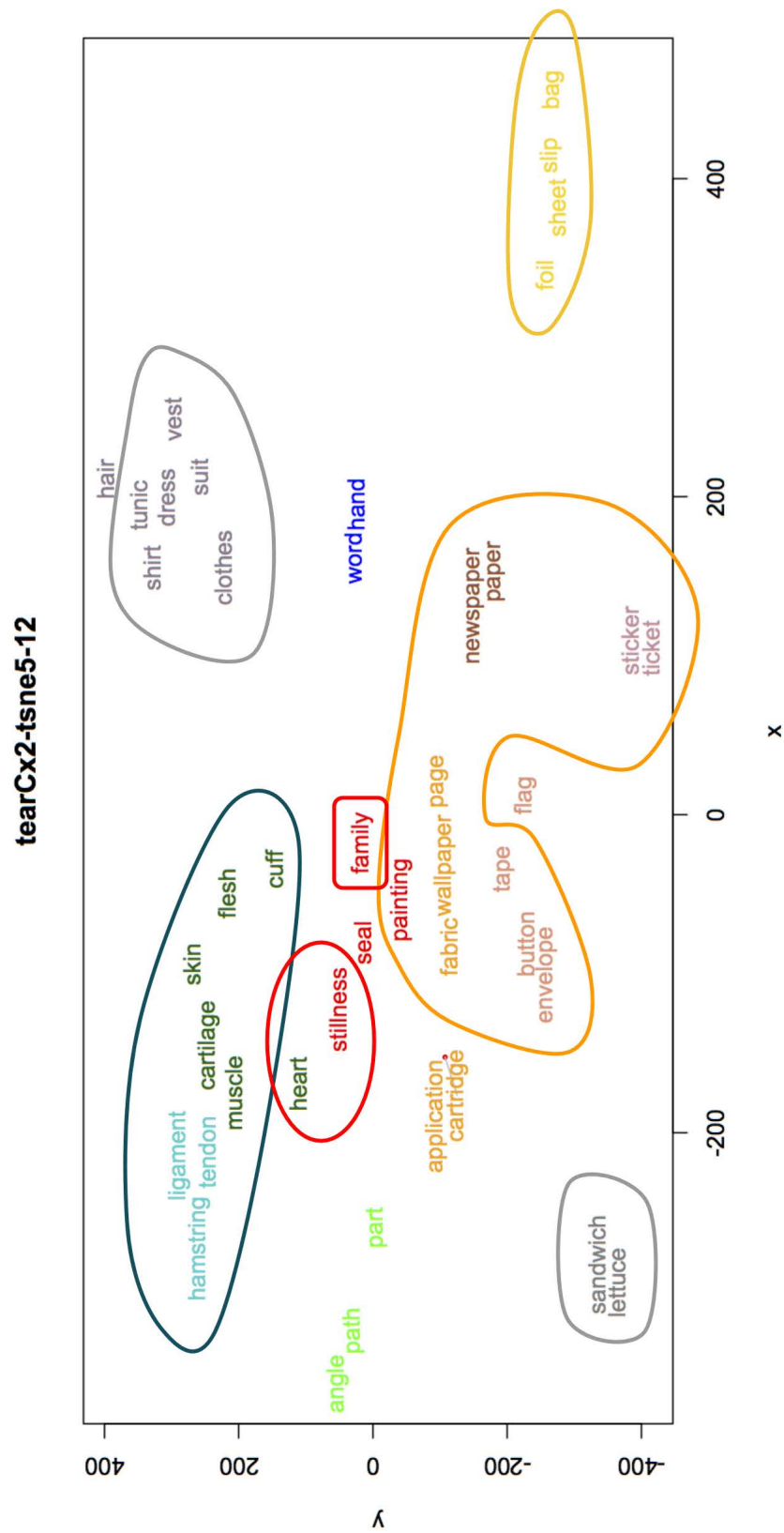

Figure 7.10: Themes that occur with *tear* in the intransitive non-causative construction

Figure 7.11: Themes that occur with *tear* in the transitive causative construction

While the intransitive non-causative construction is limited to these three types of themes, it is clear that the transitive causative construction is used with a wider variety of themes, an example of which is provided in (178b-iv). This shows that in order for a theme to be used with *tear* in the intransitive non-causative construction, it requires that this theme can be construed as being likely to tear on its own. Whereas with the transitive causative construction, the theme is not so restricted as to its “tearability” but rather, it has to be something that can be acted upon. This further explains why the transitive causative construction is also found with figurative senses, as we will see below.

Two more senses of *tear* were identified that are restricted to the transitive causative construction. The first is a figurative use of *tear*, where its sense is close to “cause to break apart (figuratively).”

(179) **Group 2:** “cause to break apart (figuratively)”

- a. I’ve seen how it has torn my **family** when you don’t accept that people are going to fall in love with who they fall in love with.

The second is close to *shatter*, in that it is used with themes such as *stillness* and means “interrupt suddenly,” cf. the example in (180).³

(180) **Group 3:** “interrupt suddenly”

- a. [...] but a cough tore the **stillness**.

Tear is also one of the verbs whose literal meaning is shared by the two constructions but figurative extensions are not. This verb’s figurative meanings align better with the transitive causative construction, which is also explained by the fact that themes found in object position with these meanings are not usually construed as having the capacity to tear naturally. This capacity is a feature shared by the themes found in subject position, however.

7.2 BEND verbs

This section deals with BEND verbs, which is a set put together by Levin (1993) and composed of six verbs: *bend*, *crease*, *crinkle*, *crumple*, *fold* and *wrinkle*. As we will see in the discussion of these six verbs, we identified 12 different verb senses associated with various groups of similar themes. Three of these verbs, *crease*, *crinkle* and *wrinkle*, have very specific meanings and are found with similar groups of themes such as FABRIC, SKIN and SURFACE (plus PAPER for *crease* and *crinkle*). Not only do they share these groups of themes, but due to their very specific semantics, they tend to be found solely with these themes. That is, with BEND verbs, the more specific the meaning, the less variety in the themes found with with these verbs. Therefore, since both verb sense and themes are specific, the polysemy of these verbs is virtually non-existent, which is why they tend to display a very high degree of theme overlap. Nonetheless, even these verbs whose polysemy is extremely limited show some discrepancies in the distribution of themes between the two

³For comparison with *shatter*, we reproduce here example (171a): *Its roar shattered the early morning silence.*

constructions, thus highlighting differences in constructional meaning. As to verbs such as *bend*, *crumple* and *fold*, they have a lower degree of theme overlap due to their polysemy which results in different themes being used with different verb senses which are not always shared. One more thing we noticed with BEND verbs in general is that they only recruit ANIMATES as themes in the intransitive non-causative construction.

BEND	
Intransitive non-causative construction	Transitive causative construction
<i>bend</i>	
1. “shape or force something straight into a curve or an angle” 2. “(cause to) move to an angled position” 3. “(of a person) incline the body downwards from the vertical”	4. “interpret or modify (a rule) to suit someone”
<i>crease</i>	
1.1 with CREAMY LIQUID PRODUCTS	1. “(cause to) become creased” with SKIN, FABRIC and PAPER 1.2 with SURFACE
<i>crinkle</i>	
	1. “(cause to) become crinkled” with SKIN, FABRIC and PAPER 1.1 with SURFACE
<i>crumple</i>	
1. “(of a person) collapse” 2. “break down” 3. “(cause to) become creased, bent or crooked”	
<i>fold</i>	
1. “(of an enterprise or organisation) cease trading or operating as a result of financial problems” 1.1 “(especially of a sports player or team) suddenly stop performing well or effectively” 1.2 “stop resisting to pressure”	2. “bend (something flexible and relatively flat) over on itself so that one part covers another”
<i>wrinkle</i>	
1.1 with PEOPLE	1. “(cause to) become wrinkled” with FABRIC, SKIN and SURFACE

Table 7.8: BEND verbs: shared and construction-specific verb senses

7.2.1 *Bend*

Like the majority of BEND verbs, *bend* is attracted to the transitive causative construction, with 257 instances of this construction out of 480 instances retained, as can be seen in Table 7.9. It is

one of the few verbs that has a theme overlap over ten percent, with 12.33%. However, as most of the verbs studied for this research, it shows more variety in the themes recruited by the transitive causative construction, with a total of 105 different themes occurring with this construction against only 58 for its intransitive counterpart.

<i>bend</i>			
Instances retained	480	Themes	146
Instances of Cx1	167	Cx1 themes	58
Instances of Cx2	257	Cx2 themes	105
Preferred construction	Cx2	Theme overlap (in %)	12.33%

Table 7.9: Characteristics of *bend*

As is visible from both semantic maps (Figure 7.12 and Figure 7.13), there is a clear division between nouns referring to concrete and abstract themes, which is identified by the black dashed line. In total, four different meanings were isolated: three of which are found with concrete nouns and the last with abstract nouns. All of these are illustrated in (181 – 185), for which the definitions have been adapted from the OED online.

(181) **Group 1:** “shape or force (something straight) into a curve or angle” (transitive causative construction)

- a. [...] Ann and the other women were able to bend the thin **sticks** and weave them together with their attached leaves [...]
- b. [...] gravity will bend a light **beam** a certain way [...]

(182) **Group 1:** “form a curve or angle” (intransitive non-causative construction)

- a. His **rod** bent and the line slashed across the pool.
- b. These **hairs** bend when the antennae move [...]

The first group is found with both constructions and the number and variety of themes used with this sense of *bend* is rather constant across the two constructions. It seems to be the most frequently used sense of *bend*, based on type frequency. This sense is truly shared by the two constructions. The same holds for the second group, illustrated in (183), which comprises themes that refer to various body parts such as *arm*, *elbow* and *knee*.

(183) **Group 2:** “(cause to) move to an angled position”

- a. [...] he sees that the old monk’s **arm** is not bending [...]
- b. Bend your **knees** and sit into a squat.

The third group, shown in (184) is made up of themes that are either pronominal, proper nouns (and thus not shown on the semantic map), or nouns that refer to people or, more generally, animates.

(184) **Group 3:** “(of a person) incline the body downwards from the vertical” (Only with the intransitive non-causative construction)

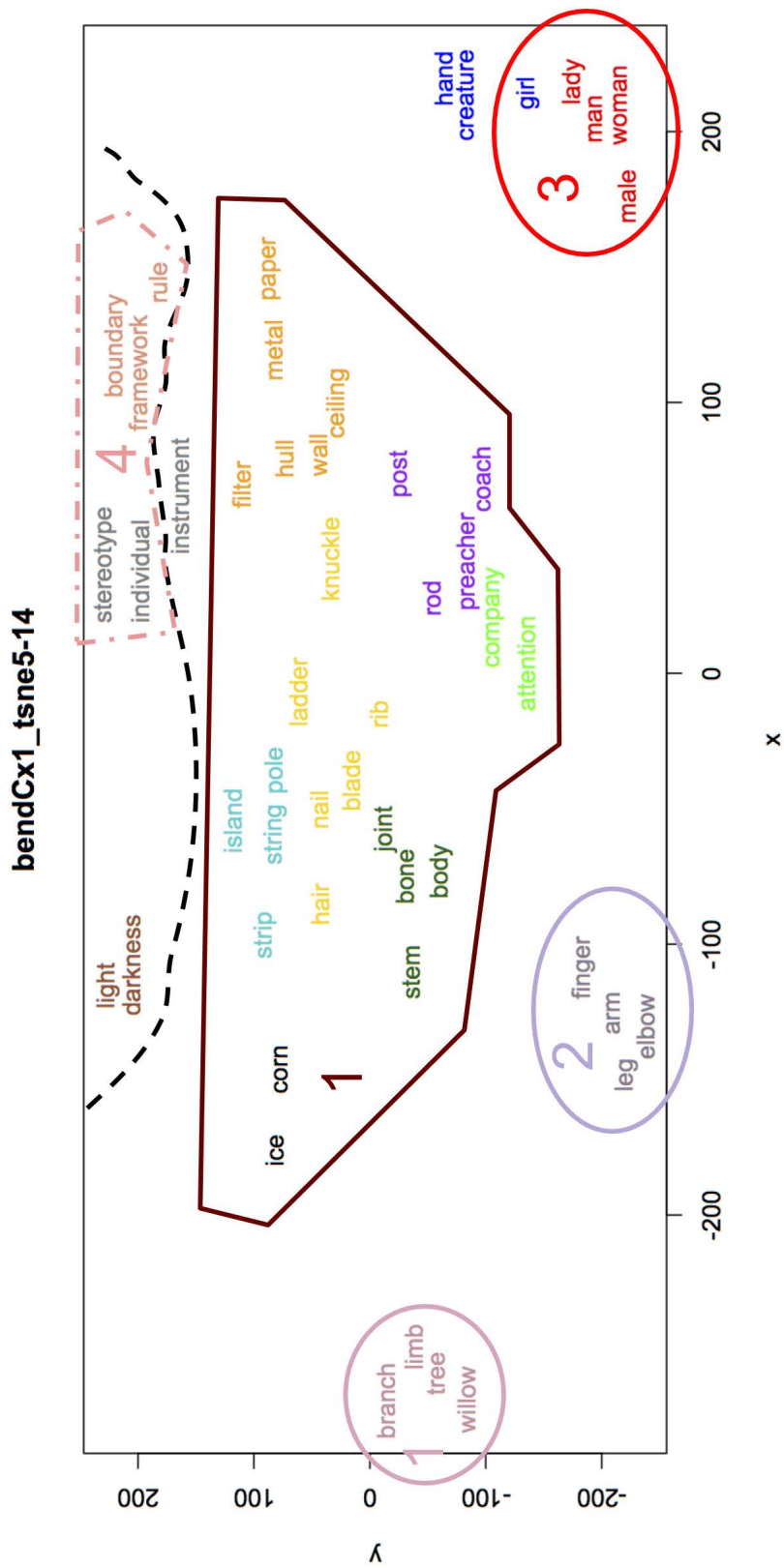
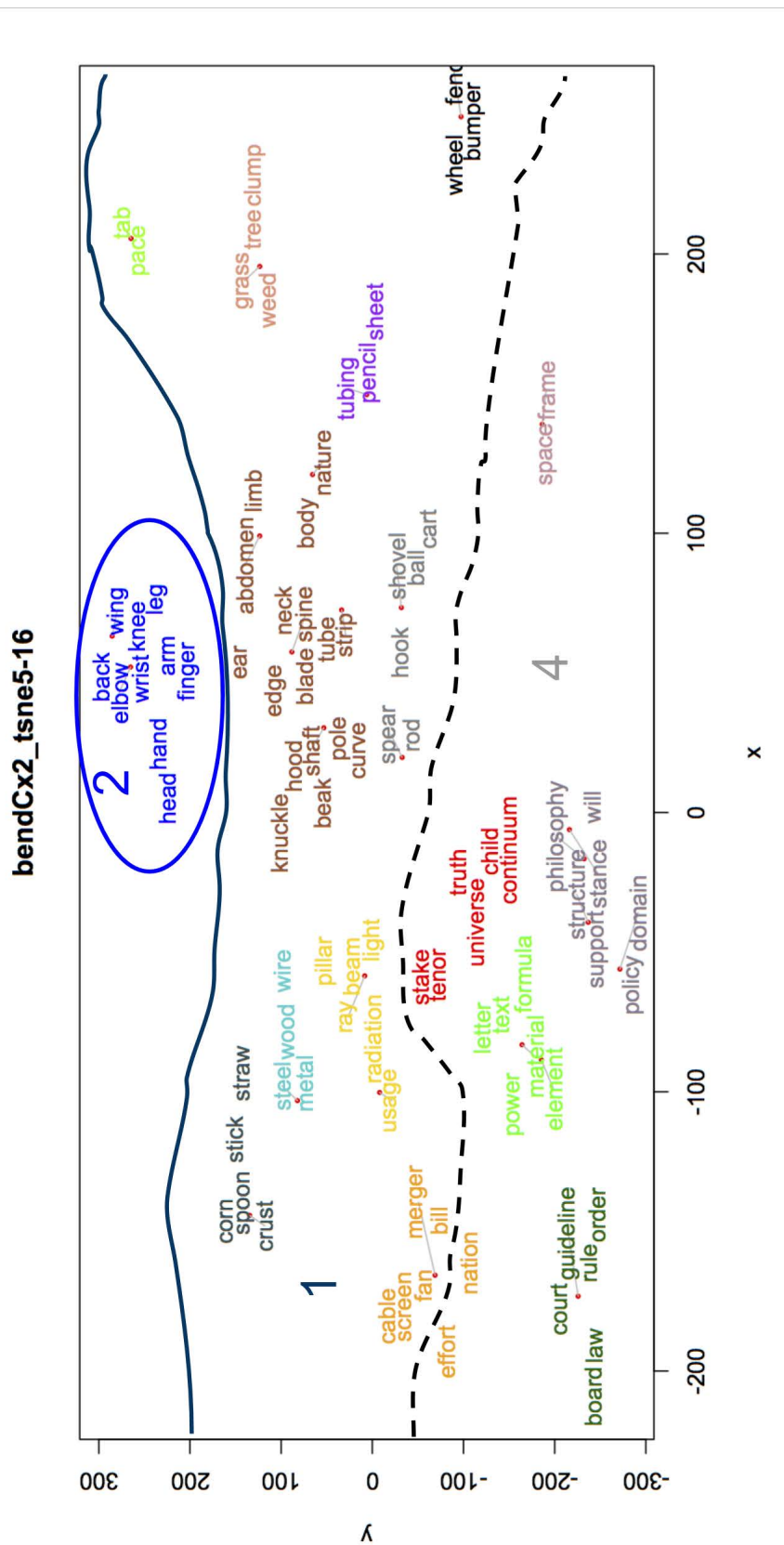

Figure 7.12: Themes that occur with *bend* in the intransitive non-causative construction

Figure 7.13: Themes that occur with *bend* in the transitive causative construction

- a. **He** bent and reached for the singed novel that had disrupted his calm life.
- b. One of the **men** bent to support the door's weight [...]

This particular sense of *bend* only occurs with the intransitive non-causative construction.

The next set of themes that was isolated by t-SNE comprises more abstract themes, which generally refer to rules, laws and such. Although it was found with both constructions, it is more frequent with the transitive causative construction.

(185) **Group 4:** “Interpret or modify (a rule) to suit someone”

- a. With the intransitive non-causative construction:
 - i. These rigid **boundaries** do not bend, even for the most stubborn of students.
- b. With the transitive causative construction:
 - i. He knew a few that would bend the uniform ethics **guidelines** of the Cop Guild [...]
 - ii. [...] three notable new laws that clearly demonstrated the willingness of the legislature to bend and twist the **text** of its statutes [...]
 - iii. Okay, so I was bending the **truth** a little, giving him the false impression that I was a fisherman [...]

To sum up, four different senses were identified for *bend*, two of which are truly shared by the two constructions. The third only occurs with the intransitive non-causative construction and seems to epitomise the meaning associated with themes occurring in the intransitive non-causative construction in general: the theme is an animate which instigates the event denoted by the verb. Finally, the fourth verb sense, although found with both constructions, is much more frequently found with the transitive causative construction.

7.2.2 Crease

Crease is another example of a BEND verb that is significantly attracted to the transitive causative construction. However, it differs from *bend* in that its meaning is more restricted. As is visible in Table 7.10, while *crease* was found 112 times with the intransitive non-causative construction and 247 times with the transitive causative construction, only 22 different themes were identified with the former and 71 with the latter. In other words, there are fewer things that *crease* or that can be *creased* than that *bend* or can be *bent*. However, *crease* is one of the five verbs that have a theme overlap above 15%.

<i>crease</i>			
Instances retained	359	Themes	80
Instances of Cx1	112	Cx1 themes	22
Instances of Cx2	247	Cx2 themes	71
Preferred construction	Cx2	Theme overlap (in %)	16.25%

Table 7.10: Characteristics of *crease*

Because of the small number of themes found with *crease* in the intransitive non-causative construction, MDS was used rather than t-SNE for the creation of the corresponding semantic map. Since the transitive causative construction recruits more themes, t-SNE was used for the creation of the semantic maps representing the themes used with the transitive causative construction.

One verb sense was identified for *crease*, which applies to specific kinds of themes. These themes were clustered into five groups, three of which are shared by the two constructions, and which correspond to various things that can crease or that can be creased such as *skin* (group 1a), *fabric* (group 1b), and *paper* (group 1c). These are shown respectively in (186), (187) and (188).

(186) **Group 1a:** SKIN

- a. Dirk's **brow** creased as he gripped the Englishman's hand.
- b. Georgo's **scalp** creased when he grinned, which made him look crazy and charming.
- c. A small frown creased her **forehead**.

(187) **Group 1b:** FABRIC

- a. His impeccable gray **suit** creased as he folded his arms across his chest and looked at her steadily.
- b. [...] I went on, neatly creasing pairs of Steve's batting **gloves** [...]
- c. It was hard to sit in the car without creasing her new **dress**.

(188) **Group 1c:** PAPER

- a. My daughter Chlo, who read each book until the **pages** creased, asked me if I'd show her the Eiffel Tower one day.
- b. Carefully, he creases the **letter** a second, then a third time.
- c. He creases the **newspaper** with origami precision [...]

A fourth group occurs with the intransitive non-causative construction only and comprises themes such as *concealer* and *(eye)shadow*, which refer to kinds of make-up and are creamy or liquid and may crease when applied on skin, as illustrated in (189).

(189) **Group 1d:** CREAMY LIQUID PRODUCTS APPLIED ON SKIN

- a. Beverly Hills Mineral Foundation, \$65, is a mineral-based liquid **formula** that won't crease or fade.
- b. Blot your face to get rid of excess oil and blend in **foundation** that has creased using a clean makeup sponge in a circular motion
- c. This creamy **shadow** won't crease or budge.

A fifth group was found solely with the transitive causative construction and comprises themes that are not made of skin, paper or fabric but refer to a sort of surface which various things can crease, as illustrated in (190). These seem to be somewhat metaphorical extensions of the prototypical meaning of *crease*.

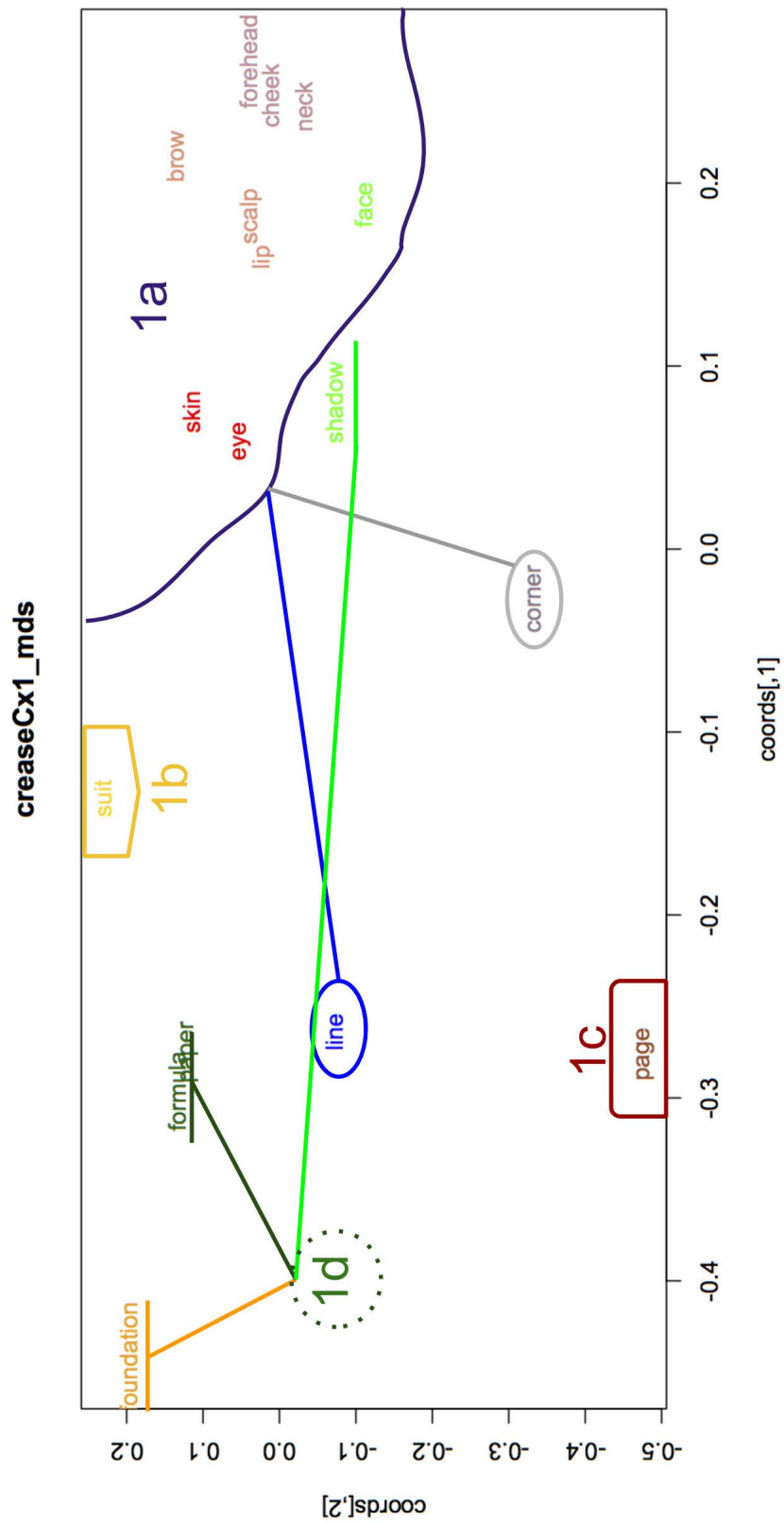
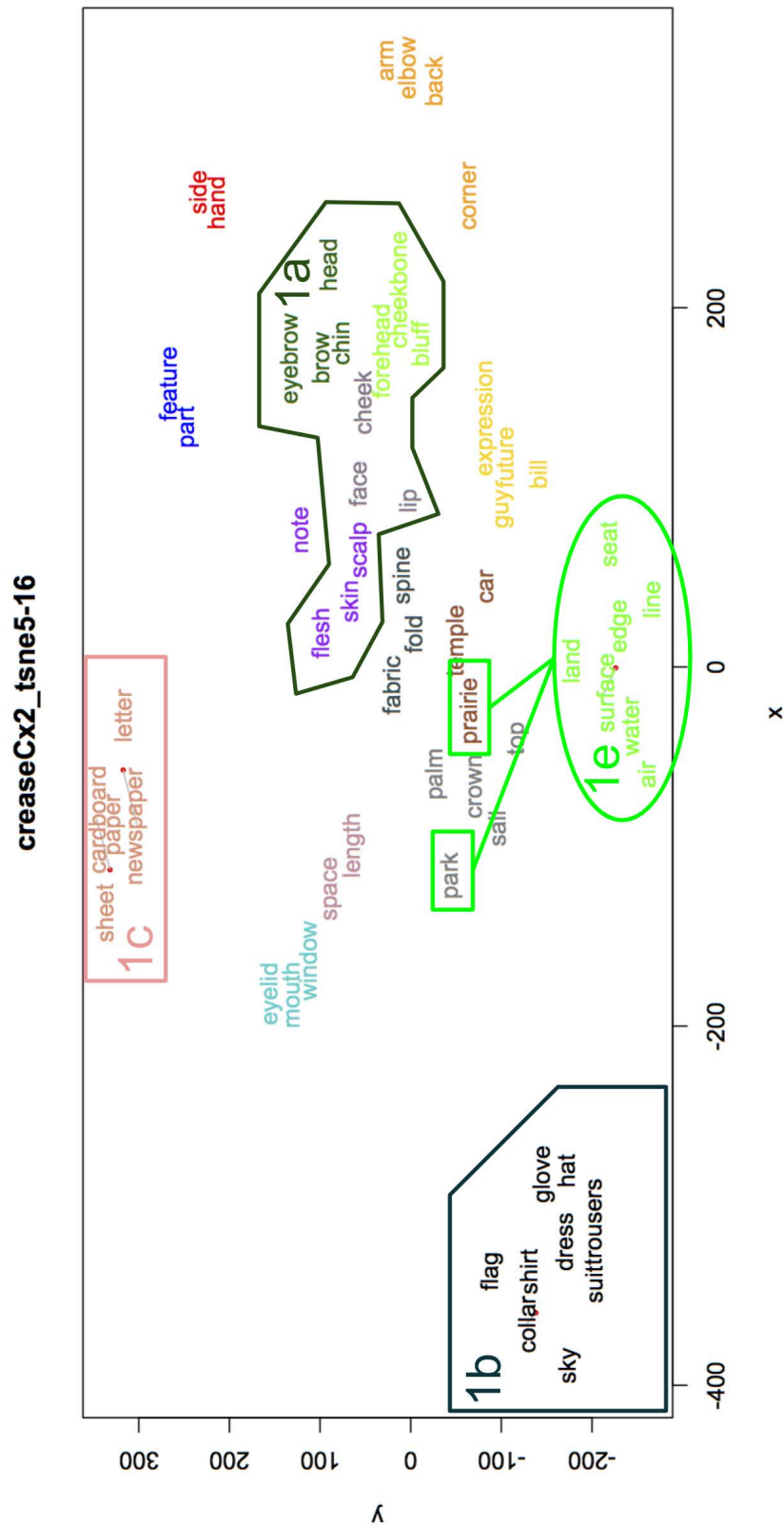

Figure 7.14: Themes that occur with *crease* in the intransitive non-causative construction

Figure 7.15: Themes that occur with *crease* in the transitive causative construction

(190) Group **1e**: SURFACE

- a. Six flashing oars creased the **surface** of the river in synchronized strokes [...]
- b. [...] the highway only barely creasing the snowed-over sagebrush **flatland**.
- c. [...] the crew gathered in the skylounge to admire the colors of the **water** that we creased with our white wake.

All in all, even though only one verb sense was identified for *crease*, roughly: “(cause to) become creased”, distributional semantics allowed us to isolate groups of themes that are semantically close and thus highlight differences between the use of *crease* with the intransitive non-causative construction and the transitive causative construction. Once again, we find that the two constructions do not recruit the exact same kind of themes. Two groups were isolated that are only used with one of the two constructions, and t-SNE also allowed us to see that there are more themes in the PAPER and FABRIC groups with the transitive causative construction than with its intransitive counterpart, as is visible from Figure 7.14 and Figure 7.15.

7.2.3 *Crinkle*

As indicated in Table 7.11, *crinkle* is the verb which shows the highest theme overlap with exactly 27.4% shared themes, and is one of the only three verbs with an overlap over 20%. It is also one of the only two BEND verbs which are significantly attracted to the intransitive non-causative construction. Just like *crease*, its meaning is quite specific and thus it is only found with a small number of different themes: 73 in total out of 330 instances of *crinkle* with either the intransitive non-causative construction (204 instances, 57 themes) or the transitive causative construction (126 instances, 36 themes).

<i>crinkle</i>			
Instances retained	330	Themes	73
Instances of Cx1	204	Cx1 themes	57
Instances of Cx2	126	Cx2 themes	36
Preferred construction	Cx1	Theme overlap (in %)	27.4%

Table 7.11: Characteristics of *crinkle*

It is very close semantically to *crease* and just like *crease*, only one verb sense was identified and this verb sense can be further divided into different clusters of themes which can be labelled SKIN, FABRIC and PAPER, as can be seen in Figure 7.16 and Figure 7.17. All of these are found with both constructions, as illustrated in (191 – 193).

(191) Group **1a**: SKIN

- a. Sabirah’s **eyes** crinkled as though she smiled.
- b. [...] a 16-year-old vegetarian whose smile crinkles her freckled **cheeks** [...]

(192) Group **1b**: FABRIC

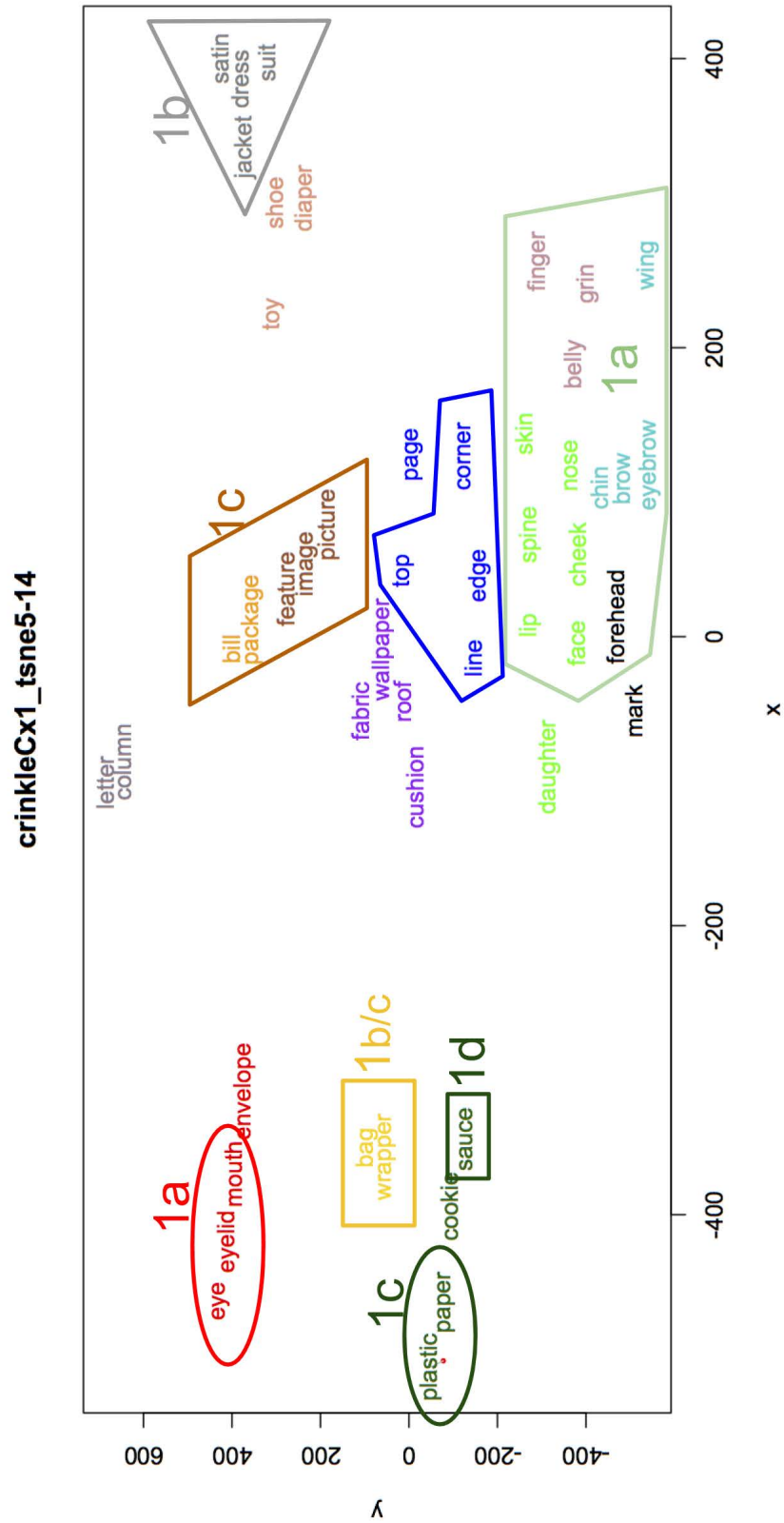

Figure 7.16: Themes that occur with *crinkle* in the intransitive non-causative construction

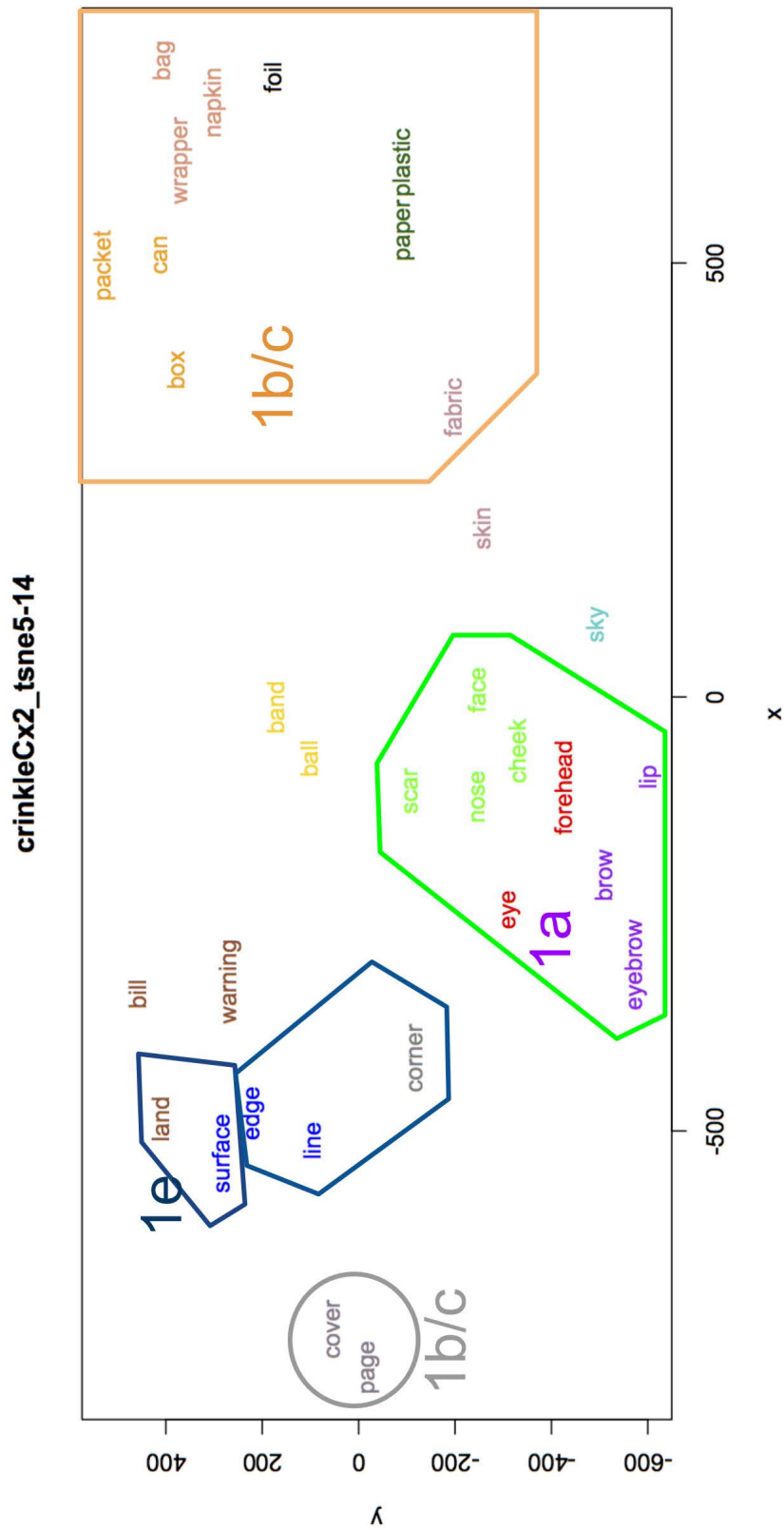

Figure 7.17: Themes that occur with *crinkle* in the transitive causative construction

- a. Her **dress** crinkles under her blaze of blond hair as her scissors eat through flashy wrapping.
- b. [...] a T-shirt with a simple design and plain-looking pants but in a different **fabric** (one with a sheen or one that made noise when you crinkled it)

(193) Group 1c: PAPER

- a. [...] but the walls had torqued so the **wallpaper** crinkled, especially in the gables.
- b. [...] which means nobody will be munching popcorn or crinkling **wrappers** during the picture.

What is interesting to note however, is that *crinkle* is not only associated with a change of shape but also the emission of sound, as is clear from the instance in (194).

(194) As she rolled over, the letter in her pocket crinkled a warning.

Again, just like *crease*, we found *crinkle* with themes referring to a sort of surface in the transitive causative construction, as shown in (195).

(195) Group 1e: SURFACE

- a. The flat **land** he crinkled and folded; the dismal swamp he made bright with burbling brook and [...]
- b. [...] a light breeze crinkled the **surface** of an otherwise smooth and moonlit sea.

To sum up, the semantic maps helped us isolate different clusters of themes associated with each construction, and (just like with *crease*) allowed us to identify which groups of themes were specific to one construction only, even though a single verb sense was identified for *crinkle*, namely: “(cause to) become crinkled”.

7.2.4 Crumple

Crumple is the other BEND verb (together with *crinkle*) that is significantly attracted to the intransitive non-causative construction. As we will see in this subsection, it also shares some of the specificities of *bend* in that only the intransitive non-causative construction recruits themes referring to animates. As indicated in Table 7.12, *crumple* shows more variety in the themes it recruits in the two constructions than *crease* and *crinkle*. Also, even though it is significantly attracted to the intransitive non-causative construction, in our corpus it occurs slightly more frequently with the transitive causative construction. The theme overlap between the two constructions for *crumple* is average with regards to the other verbs studied, with 8.61% shared themes.

As is visible from Figure 7.18, t-SNE isolated one group of smaller clusters of themes which are exclusive to the intransitive non-causative construction (as identified by means of the dashed black line) and occur with two of the three verb senses identified for *crumple*.

The first cluster comprises nouns referring to animates, mostly human beings who either crumple physically or morally, as shown in (196a) and (196b) respectively. Neither WordNet nor

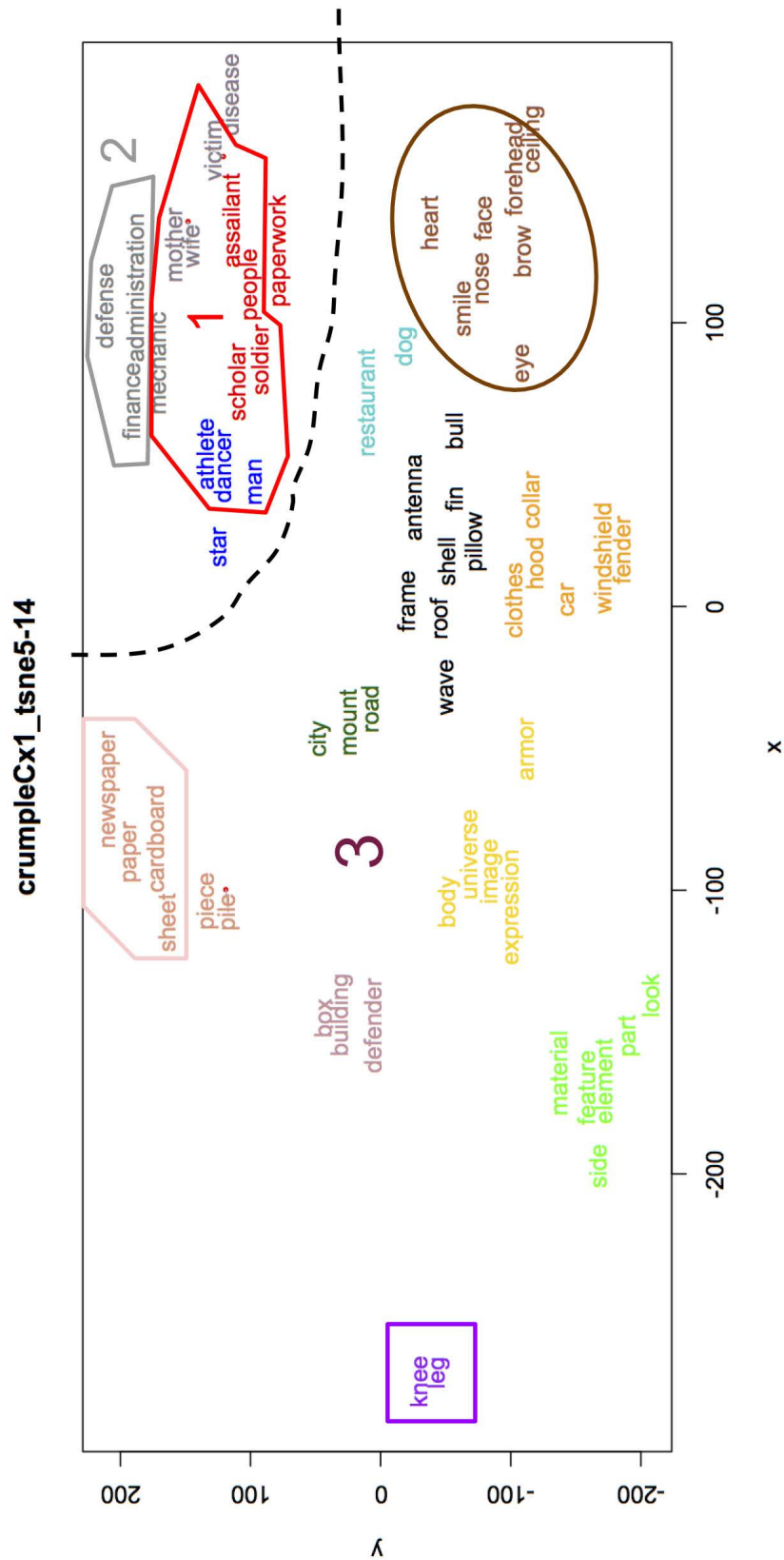
Figure 7.18: Themes that occur with *crumple* in the intransitive non-causative construction

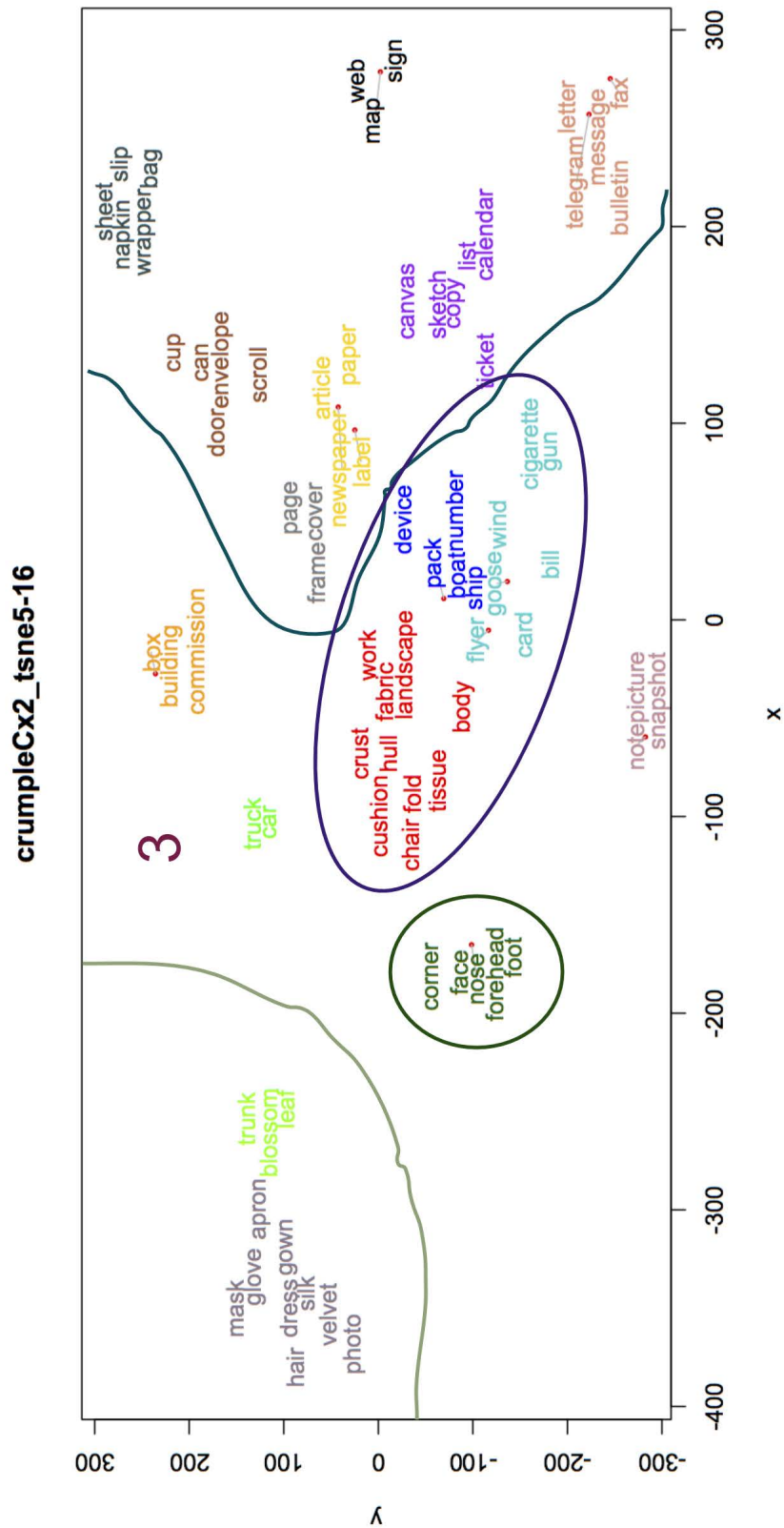
Figure 7.19: Themes that occur with *crumple* in the transitive causative construction

<i>crumple</i>			
Instances retained	390	Themes	151
Instances of Cx1	185	Cx1 themes	74
Instances of Cx2	205	Cx2 themes	90
Preferred construction	Cx1	Theme overlap (in %)	8.61%

Table 7.12: Characteristics of *crumple*

the OED online has a definition that captures this verb sense specifically, so we chose to use the near-synonym *collapse* which can also be used for physical or moral collapsing.

(196) Group 1: “(of a person) collapse”

- a. The **dancers** crumple and fall like wilting flowers.
- b. [...] the **scholar** crumples under the accumulated pain of centuries [...]

The second cluster, identified as group 2 is made up of themes associated with a sense of *crumple* that is close to the notion of breaking down, such as *defense*, *administration* and *finances*, as illustrated in (197).

(197) Group 2: “break down”

- a. Washington Post columnist George Will said the **administration** had crumpled “like a punctured balloon.”
- b. And the **defense**, an expensive collection of name-tag-wearing free agents, crumples like a losing lottery ticket.

Although these two groups were only found with the intransitive non-causative construction, a third group was identified which is shared by the two constructions. As captured by the definitions borrowed from the OED online, this third sense is found with themes which refer to items made of fabric or paper and to creases in the skin, as illustrated in (198).

(198) Group 3: “(cause to) become creased, bent or wrinkled”

- a. With the intransitive non-causative construction:
 - i. [...] a two-micron polyester **sheet** so delicate that it crumples if you breathe on it [...]
 - ii. Nick’s **face** crumpled for a moment, as if he was about to be overcome [...]
- b. With the transitive causative construction:
 - i. He stands straight and wipes off his hands, crumples the **gloves** and tosses them down on the gleaming hood.
 - ii. “I don’t think I can ever return to Bombay,” she said, crumpling her **nose** disdainfully.

As is visible on Figure 7.19, t-SNE isolated a group of themes referring to items made from fabric (on the left hand side of the map), a group of items made of paper (on the right hand side of the map) and a mixture of various themes corresponding to the same verb sense in the middle.

All in all, three verb senses were identified for *crumple*, only one of which is shared by the two constructions. Interestingly, the verb senses which are not shared are those that require an animate theme or a theme that refers to an institution (which by metonymy refers to animates), such as *administration*, thus showing that the intransitive non-causative construction recruits themes that have an ability to co-participate in the event denoted by the verb.

7.2.5 *Fold*

According to the distinctive collocation analysis conducted on our set of verbs, *fold* is significantly attracted to the transitive causative construction, and we also found that it occurs with more themes in this construction than in its intransitive counterpart, as shown in Table 7.13. As is the case for the majority of our verbs, only few themes are shared by the two constructions with *fold* (6.21% overlap).

<i>fold</i>			
Instances retained	363	Themes	145
Instances of Cx1	84	Cx1 themes	41
Instances of Cx2	279	Cx2 themes	113
Preferred construction	Cx2	Theme overlap (in %)	6.21%

Table 7.13: Characteristics of *fold*

Two main senses were found for *fold*. The first, which was labeled as group 1, is almost exclusively found with the intransitive construction, and can be divided into two subsenses. The second (group 2) is mostly found with the transitive causative construction, and similarly to *crease*, *crinkle* and *crumple*, occurs with themes referring to items made of paper or fabric.

One of the most striking things when comparing the two semantic maps is that a vast majority of the themes that occur with the intransitive non-causative construction refer to people or institutions (cf. Figure 7.20) whereas almost all the themes that occur with the transitive causative construction refer to objects (cf. Figure 7.21).

Most of the themes found with the intransitive non-causative construction refer to institutions and businesses, as illustrated in (199). All of these correspond to the first verb sense we identified for *fold*, for which we borrowed the OED online's definition.

- (199) Group 1: “(of an enterprise or organization) cease trading or operating as a result of financial problems”
- a. As South Korean banks close, **businesses** fold and unemployment lines grow [...]
 - b. The Jefferson Place **Gallery** folded under financial stress.

Then, there is a similar but slightly different meaning associated with *fold* when used with themes such as *team*, as illustrated in (200).

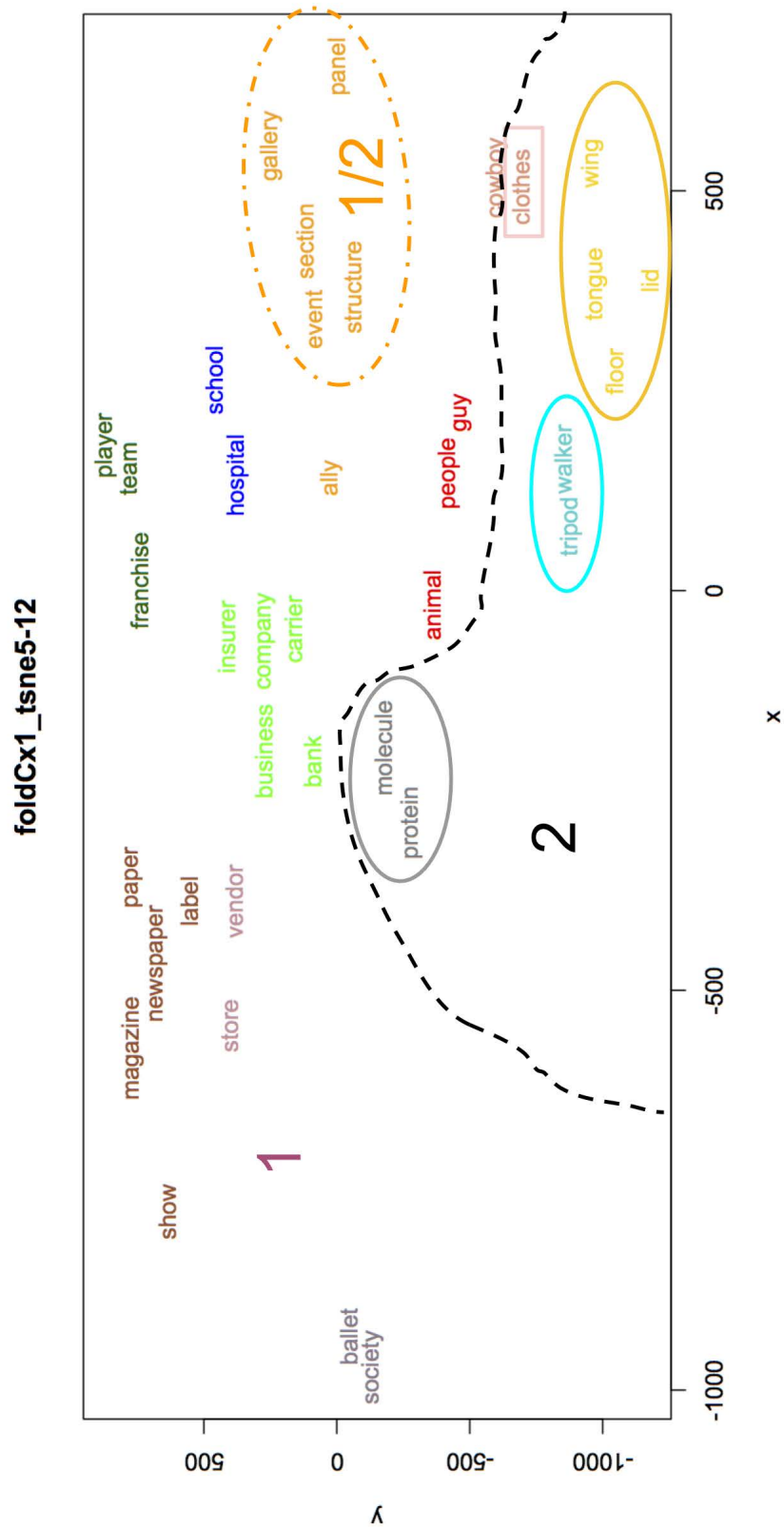
Figure 7.20: Themes that occur with *fold* in the intransitive non-causative construction

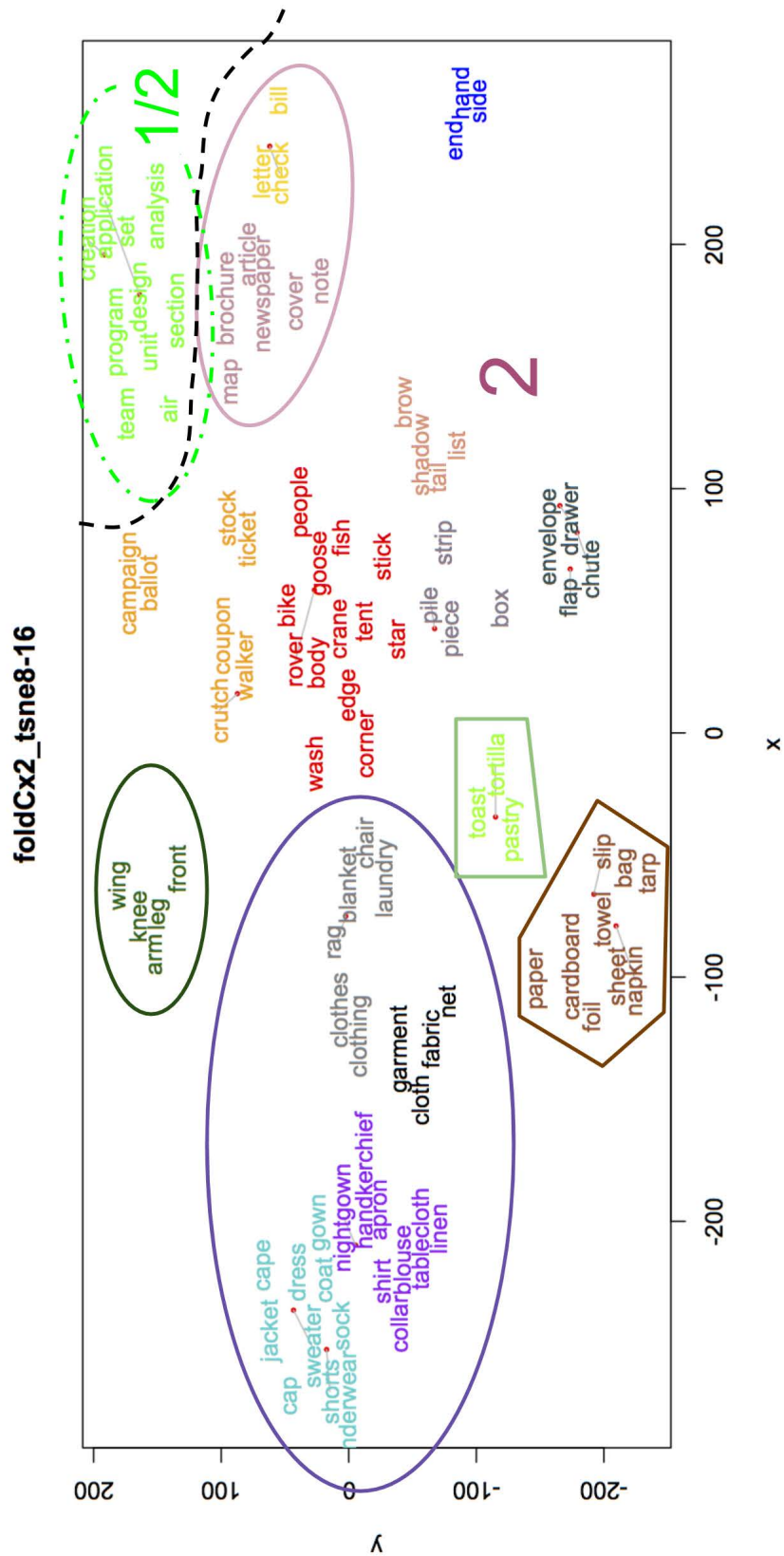
Figure 7.21: Themes that occur with *fold* in the transitive causative construction

(200) Group 1.1: “(especially of a sports player or team) suddenly stop performing well or effectively”

- a. In the weeks after D’Antoni completed his first season with the Spirits, the **team** folded.

Another subsense refers to a person’s mental state, as illustrated in (201), and means that people no longer resist to pressure, which is very close to the set in (199).

(201) Group 1b: “stop resisting to pressure”

- a. Most **people** I know would have folded a long time ago.
- b. And my guess is that in the end, Chuck Schumer and all these **people** are pretending to be agonizing, they’ll all fold.

Yet another subsense is related to the game of poker, and is used when players “drop out of a hand.”⁴

Most of the themes found with the transitive causative construction refer to concrete objects that can be folded such as clothes and other items made from fabric, paper items, body parts such as *wings* and *arms* and even food such as *pastry*, *toast* and *tortilla*. A few examples are given in (202), together with the corresponding definition found in the online version of the OED.

(202) Group 2: “Bend (something flexible and relatively flat) over on itself so that one part of it covers another.”

- a. Her son, who slept on the sofa bed these days, had neatly folded his **blanket** and put it on a chair.
- b. The Quaker folded the **map** and held it out for Saturn to take.
- c. That’s what we do. We fold the French **toast**.

Although each construction is quite clearly associated with one of the two verb senses we found for *fold*, the theme overlap analysis revealed that eight themes are shared by the two constructions. However, out of these eight themes, only four are used with the same sense of *fold* in each construction: *section*, *clothes*, *walker* and *wing*. Two examples are provided in (203).

(203) *clothes*

- a. I tried to fold [his **clothes**], but **they** were stiff, and would not fold.
- b. Lasker folded his **clothes** and left them in a neat pile.

(204) *walker*

- a. Both types of **walkers** are heavier and more cumbersome than crutches, even though **they** fold to become more compact.
- b. Harriet folded the aluminum **walker**.

⁴Definition from the OED online.

Another theme that appears to be shared by the two constructions is *paper*, but *paper* is polysemous and it is therefore not surprising that it should occur with different senses in each construction. This is illustrated in (205), where it becomes clear that different facets of *paper* are used for each construction. In (205a), which corresponds to the sense associated with group 1 (“(of an enterprise or organization) cease trading or operating as a result of financial problems”), it is the company that folds, whereas in (205b), it is the object (i.e. the newspaper) that is folded.

(205) Shared theme, different facets:

- a. Four people lost jobs when the **paper** folded.
- b. When I was done, I attempted to fold [the **paper**], but the obituary page stuck out.

In the end, *fold* seems to have a very low alternation strength since it is found with a distinct sense in each construction and very few themes are found with the two constructions and the same meaning. The conclusion we draw here is that there is very little shared meaning between the two constructions as used with *fold*.

7.2.6 *Wrinkle*

Wrinkle is the verb that ranks second as to theme overlap with 20.69% of themes shared by the two constructions, as indicated in Table 7.14. Although it is significantly attracted to the transitive causative construction, there are actually more themes found with the intransitive non-causative construction than with the transitive causative construction (55 and 50 respectively), which is all the more surprising knowing that *wrinkle* occurs with the transitive causative construction more than twice as often as with the intransitive non-causative construction.

<i>wrinkle</i>			
Instances retained	701	Themes	87
Instances of Cx1	215	Cx1 themes	55
Instances of Cx2	486	Cx2 themes	50
Preferred construction	Cx2	Theme overlap (in %)	20.69%

Table 7.14: Characteristics of *wrinkle*

Two main groups appear with *wrinkle* on each map: one group is composed of nouns referring to FABRIC items such as *blouse*, *cloth* or *uniform* and the other to SKIN such as *forehead*, *cheek* or *scar*. A third group appears on Figure 7.23 which roughly corresponds to SURFACE (as was the case for *crease* and *crinkle*) with themes such as *concrete* or *water*; as to *surface* itself, it is found with the intransitive non-causative construction, as can be seen on Figure 7.22. In all cases, the meaning associated with *wrinkle* is constant over the two constructions and corresponds to “(cause to) become wrinkled.” A few examples with themes from these groups are provided in (206 – 208).

(206) FABRIC

- a. She wore a knit **dress** she had slipped on because **it** wouldn’t wrinkle on the train
- b. Be careful! You’ll wrinkle my **blouse**!

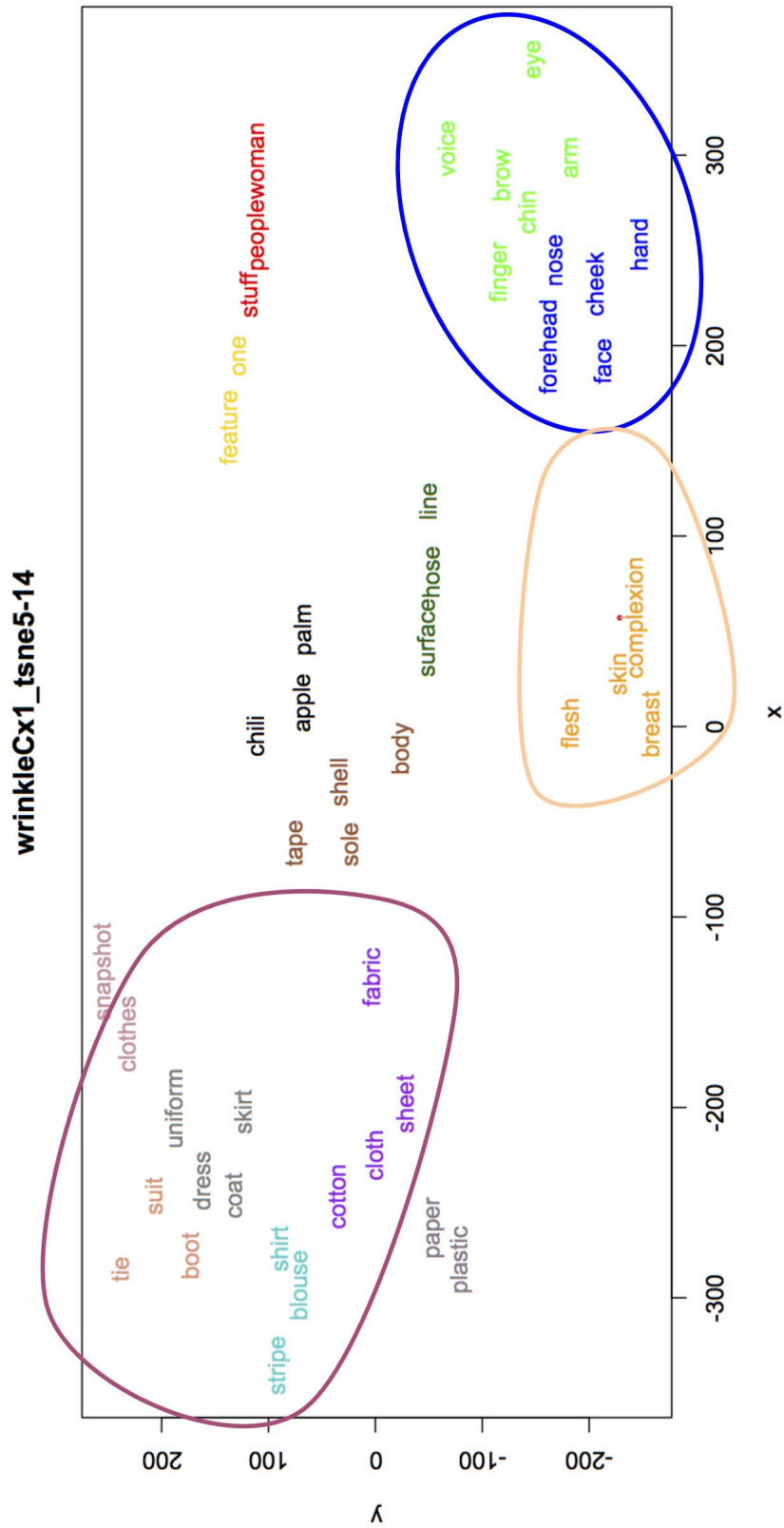
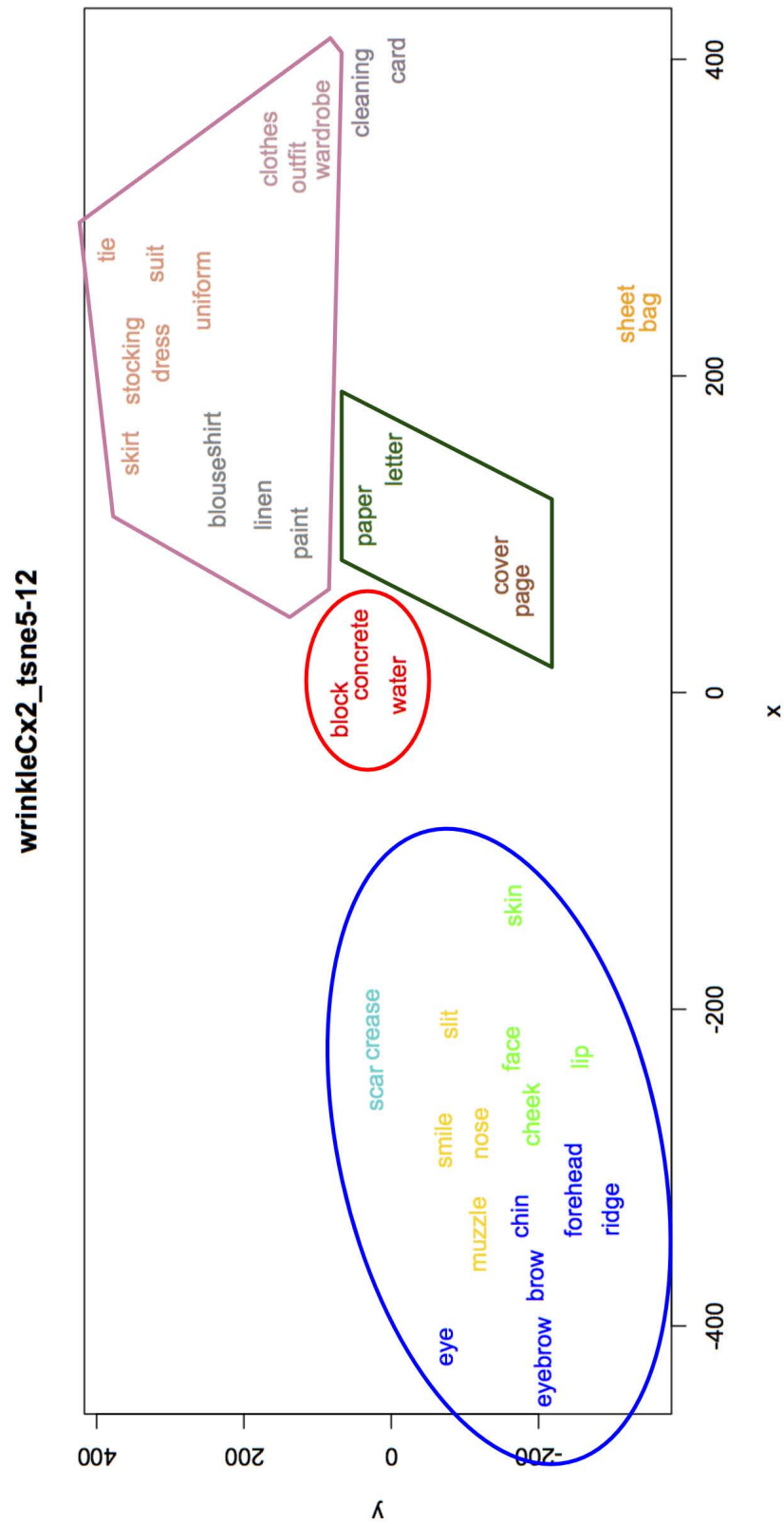

Figure 7.22: Themes that occur with *wrinkle* in the intransitive non-causative construction

Figure 7.23: Themes that occur with *wrinkle* in the transitive causative construction

- (207) SKIN
- a. [...] all of a sudden his **face** wrinkled, and he began to cry awkwardly.
 - b. Catherine sat for a while wrinkling and unwrinkling her **eyebrows**.

- (208) SURFACE
- a. I consider how the glossy **surface** has wrinkled [...]
 - b. The wind wrinkled the **water** and the sunlight glinted and flickered.

As is the case with other BEND verbs, the intransitive non-causative construction recruits themes that refer to animates, and more specifically human beings. Although the verb sense remains constant and in the end the *wrinkling* event is related to SKIN via metonymy, themes referring to people were only found with the intransitive non-causative construction, as shown in (209a) and (209b).

- (209) With PEOPLE
- a. Once **people** start to stoop and wrinkle they all look alike to me.
 - b. [...] **women** so exposed are more apt to wrinkle.

While the theme overlap analysis made it clear that a relatively high number of themes are shared by the two constructions with *wrinkle*, the use of distributional semantics shows that this overlap may actually be even higher, since the two constructions recruit themes that not only form clearly identifiable groups but are also extremely similar. In a way, it appears that almost all themes are shared, with the exception of themes referring to human beings which seem to be exclusively found with the intransitive non-causative construction.

Once more, our analysis shows that the intransitive non-causative construction is found with themes that can be construed as co-participating in events where no external causal agent is required. With this construction, the event denoted by the verb is construed as occurring somewhat naturally, and independently.

7.3 ROLL verbs

This section deals with the ROLL verbs, which have been shown to occur much more frequently with motion constructions (cf. 6.2.1). Nevertheless, they were identified by Levin (1993) as being part of the causative alternation and as such, were deemed worthy of interest. They are *roll*, *drop*, *move*, *slide* and *turn*. Some of them do display certain characteristics which align with those of other verbs from other groups; i.e. they have few senses that are shared between the two constructions. Unfortunately, their low frequency with the intransitive non-causative construction and the transitive causative construction restricts the scope of the conclusions that can be drawn with regards to the causative alternation. Nevertheless, as is visible from Table 7.15, we managed to identify a variety of verb senses that align with one or both constructions. These verb senses will be discussed in more detail in the following subsections.

ROLL	
Intransitive non-causative construction	Transitive causative construction
<i>roll</i>	
1. “(cause to) move by turning over or rotating” 2. with <i>camera</i> , “begin operating or running” 3. with AIRCRAFT & WATERCRAFT, “move, rock, or sway from side to side” 4. with WHEELED VEHICLES, “(cause to) move along” 5. with <i>thunder</i> , “emit, produce, or utter with a deep prolonged reverberating sound” 6. with PEOPLE, various meanings, cf. Section 7.3.1	7. “shape or roll into a cylinder” 8. with BODY PARTS, “cause to move by turning over”
<i>drop</i>	
1. “(cause to) go down in value” 2. “give up” 3. “(cause to) fall down/to the ground” 4. “lose weight” 5. “utter with seeming casualness” 6. “take drugs” 7. “leave someone” 8. “spend money” 9. with <i>voice</i> , “lower the pitch of”	
<i>move</i>	
1.1 with ANIMATES 2. with ANIMATES, “stationary motion” 3. with MOVIES, MUSIC, “move at a certain pace” 4. “metaphorical motion”	1. “(cause to) be in motion, with or without change of location” 5. with PRODUCTS & INFORMATION, “deal, sell, spread” 6. with PEOPLE, “have an emotional or cognitive impact”
<i>slide</i>	
1. with concrete themes, “move obliquely or sideways, usually in an uncontrolled manner” 2. with abstract themes, “metaphorical downward motion”	
<i>turn</i>	
1.1 with <i>heads</i> , “(cause to) change emotional orientation or direction” 2. “(cause to) change orientation or direction metaphorically” 3. “(cause to) move around an axis or a center” 4. with <i>path, river, road, sidewalk</i> , “make a turn (in its shape)”	1. “(cause to) change orientation or direction” 5. “(cause to) move around a center so as to show another side of” 6. with <i>stomach</i> , “make (or become) nauseated” 7. with <i>tables</i> , “reverse one’s position relative to someone else, especially by turning a position of disadvantage into one of advantage” 8. with MONEY, “get by buying or selling” 9. (idiomatic) [TURN <i>the other cheek</i>]

Table 7.15: ROLL verbs: shared and construction-specific verb senses

7.3.1 Roll

As we noted in Section 6.2.1, *roll* is one of the few verbs that shows no constructional preference, it is not significantly attracted to either of the two constructions. Furthermore, there are almost as many themes found with the intransitive non-causative construction as there are with the transitive causative construction. Nevertheless, while there is not such a large discrepancy between the number of themes found with each construction, not so many of these themes are shared: only 9%. Still, in our corpus, *roll* is not found with a large number of different themes, which may explain the little amount of overlap between the two constructions.

<i>roll</i>			
Instances retained	236	Themes	66
Instances of Cx1	86	Cx1 themes	30
Instances of Cx2	150	Cx2 themes	42
Preferred construction	NS	Theme overlap (in %)	9.09%

Table 7.16: Characteristics of *roll*

With the help of distributional semantics and WordNet, seven different verb senses were identified for *roll* in the intransitive non-causative construction. The first verb sense, labeled **1** on the semantic maps, is the most prototypical definition of *roll*: “(cause to) move by turning over or rotating.” WordNet provides the non-causative version of this definition as the first entry for *roll*. In our corpus, it applies to several themes, as illustrated in (210).

(210) **Group 1**: “move by turning over or rotating”

- a. [...] at the last moment it [= the **ball**] begins to roll and, picking up momentum, stops fifteen yards from the hole.
- b. Round **logs** want to roll and you need something to hold them securely.
- c. I parked the empty beer **can** so clumsily that it fell on its side and rolled.

This sense of *roll* also applies to *head*, but it can actually be divided into two subsenses, one is literal, the other is figurative, as illustrated in (211) and (212 – 214).

(211) The **head** bounced off a thick root and rolled. It came up near Greyjoy’s feet.

(212) Somebody’s **head** would roll for the failure to make him aware of all this.

(213) Some in Ireland want even more **heads** to roll. SINEAD-OCONNOR: I want the entire regime to go.

(214) They were also at fault... **heads** had to roll, and his was the first one to go [...]

In (211), the actual *head* rolls on the floor, after having been presumably separated from the rest of the body, whereas in (212), the head rolling is actually meant to refer to someone being fired from a job, or removed from a position of power, but not literally decapitated, although the metaphor remains rather vivid.

In examples (210a – 211), all themes share a particular feature that allows them to roll, they all have either a spheric or cylindrical shape. The same holds for the themes corresponding to this meaning of *roll* in the transitive causative construction, as illustrated in (215).

- (215) **Group 1:** “cause to move by turning over or in a circular manner or as if on an axis”
- a. When my kids were old enough, I would occasionally take them bowling. They rolled a few gutter **balls** [...]
 - b. [...] rolled some **shots** that knocked down a few pins.
 - c. One might as well, therefore, roll the **rock** of Sisyphus as try to identify the bard who [...]

Only three themes were found for this particular sense of *roll* in the transitive causative construction, two of which only occur once (*shot(s)* and *rock(s)*). *Ball* occurs three times with this construction. It should also be noted that examples (215a) and (215b) come from the same text, and the latter comes after the former in the original text.

The second sense that was identified only applies to several themes, one of which is (*camera*), and the others refer to *FILM* or a digital equivalent. Both these clusters were found with both constructions but with a wider variety of themes when used with the transitive causative construction, as shown in (216a) and (216b).

- (216) **Group 2:** “begin operating or running”
- a. With the intransitive non-causative construction:
 - i. Coop stifled a chuckle, but only because the damn **cameras** were still rolling.
 - ii. If this were a Disney movie, the **credits** would roll, and everybody would live happily ever after.
 - iii. [...] to produce tape footage he’ll need for different “**packages**” that will roll during the pregame show and live game telecast.
 - b. With the transitive causative construction:
 - i. Roll that motherfucking **camera**, Wolfie!
 - ii. Roll that **video**, will you, Donnie?
 - iii. Thrilling pictures. Roll the **videotape**.
 - iv. Hallie paused, her cue for the station to roll the **tape** Trips transmitted earlier.

The fourth sense we identified only applies to the intransitive non-causative construction, and to kinds of aircraft and watercraft, as shown in (217).

- (217) **Group 3:** “move, rock, or sway from side to side”
- a. Without the tail fin, the **airplane** would have rolled uncontrollably.
 - b. The **ship** rolled and the body of the scientist hiding there tumbled out.

With other modes of transportation, notably vehicles with wheels, *roll* takes another sense, in relation to its manner of motion, as shown in (218).

(218) **Group 4:** with WHEELED VEHICLES, “(cause to) move along”

- a. With the intransitive non-causative construction:
 - i. As the **bus** rolled and stopped, rolled and stopped, he looked at his classmates [...]
- b. With the transitive causative construction:
 - i. We took turns rolling our **cart**.

This sense is also found with the transitive causative construction with items such as *cart*, as shown in (218b).

WordNet only lists this sense as a non-causative one, but the example in (218b) suggests that it can also be found with a transitive causative construction.

It should be noted here as well that the combination of *roll* and *car* or an equivalent with the transitive causative construction differs from the example above. WordNet does not have the corresponding definition in its listings but the online version of the Oxford English Dictionary has an entry for it: “overturn (a vehicle).” This sense is illustrated by the example in (219).

(219) My mother drove a Plymouth Fury right through a 7-eleven, my father rolled a **Cadillac Seville** nine times on Christmas Eve [...]

There are two other senses of *roll* that we only found with the intransitive non-causative construction. The first, illustrated in (220), has to do with sound, and more specifically the kind of sound associated with *thunder*. This is what can be seen as a “metaphtonymy” (Goossens 1990) where the reverberating sound is perceived as similar to that of (heavy) rolling objects. Therefore we have a metonymy from the “rolling object” to the “sound made by a rolling object” and a metaphorical mapping from the sound of the rolling object to the sound emitted by thunder.

(220) **Group 5:** “emit, produce, or utter with a deep prolonged reverberating sound”

- a. Lightning flashed, **thunder** rolled, and several neighbors shouldered tools and headed for home.

The second is actually more accurately identified as a group of subsenses related to various activities but what these subsenses have in common is that the theme is a human.

(221) **Group 6:** aggregate of various subsenses with a human as the theme and with reference to an activity

- a. Fucking Quintana, that creep can roll, man [with reference to bowling]
- b. I mean, the guy is rolling. [referring to Barack Obama winning the primaries]
- c. Once you’re rolling, safety means constantly assessing the situation [as on a bike]

Among the miscellaneous senses of *roll* found in our corpus were four idiomatic expressions, which correspond to fully or partially lexically filled constructions, and are illustrated in the following examples:

- (222) [*How X ROLL*] construction:
- a. But that's not how we roll here.
 - b. "That's how I roll." First used by rapper Big Pun, this phrase has swept the nation as a meaningless explanation for any kind of bizarre behavior.
- (223) [*ready to roll*] construction:
- a. Fill the spool over and you're ready to roll.
 - b. We can't wait two weeks while we're getting ready to roll.
- (224) [*ROLL with the punches*] construction:
- a. [...] but I've learned to roll with the punches, even the sucker ones.
 - b. If she rolls with the punches and has a good time, [...]
- (225) [*ROLL with X*] construction:
- a. And he just rolls with it all. It's this mellowness that is so impressive.
 - b. Katie Couric, rolling with the oddballitude of this new correspondent, remarked that Cojocarú looked like Prince, [...]

All examples in (222, 223, 224) and (225) have a pronominal theme or a proper noun as a theme and are thus not represented on the semantic map. In examples (222) and (223), the sense of *roll* is rather unclear. Both seem to denote a general behaviour or activity, but none of these is specifically mentioned. As to the examples in (224) and (225), it could actually be considered that they are two sides of the same coin, or more accurately, of the same construction, with (224) being the original construction. As explained in Romain (2018), (225) appears to be a case of constructional re-analysis, where the complex and mostly substantive [*ROLL with the punches*] construction has been turned into the complex, mostly schematic construction [*ROLL with X*] (cf. Croft and Cruse (2004: 255) for an overview of the syntax-lexicon continuum and more or less schematic constructions).

WordNet provides two definitions of *roll* that we think are fairly similar, keeping in mind that one is used with the intransitive non-causative construction and the other with the transitive causative construction. The first is "take the shape of a roll or a cylinder", and the example they provide is *the carpet rolled out*, where *roll* is used with a particle. The second is "shape by rolling", which they illustrate with the example *roll a cigarette*. We propose to merge these two definitions into one, which we only found with the transitive causative construction: "shape into a roll or cylinder". This particular sense of *roll* is found with themes such as *cigar* and *cigarette*, but also with themes such as *mattress*, *bag*, *shorts* and *log*, *dough*, *tortilla*. This sense is illustrated by the examples in (226).

- (226) **Group 7:** "shape into a roll or cylinder"
- a. Jeff takes down the tent, packs up his bag, rolls his **mattress** [...]
 - b. Christopher rolled three pairs of hiking **shorts** and put them in the blue stuff sack [...]
 - c. Starting at short end, roll **dough**. Place on cookie sheet.

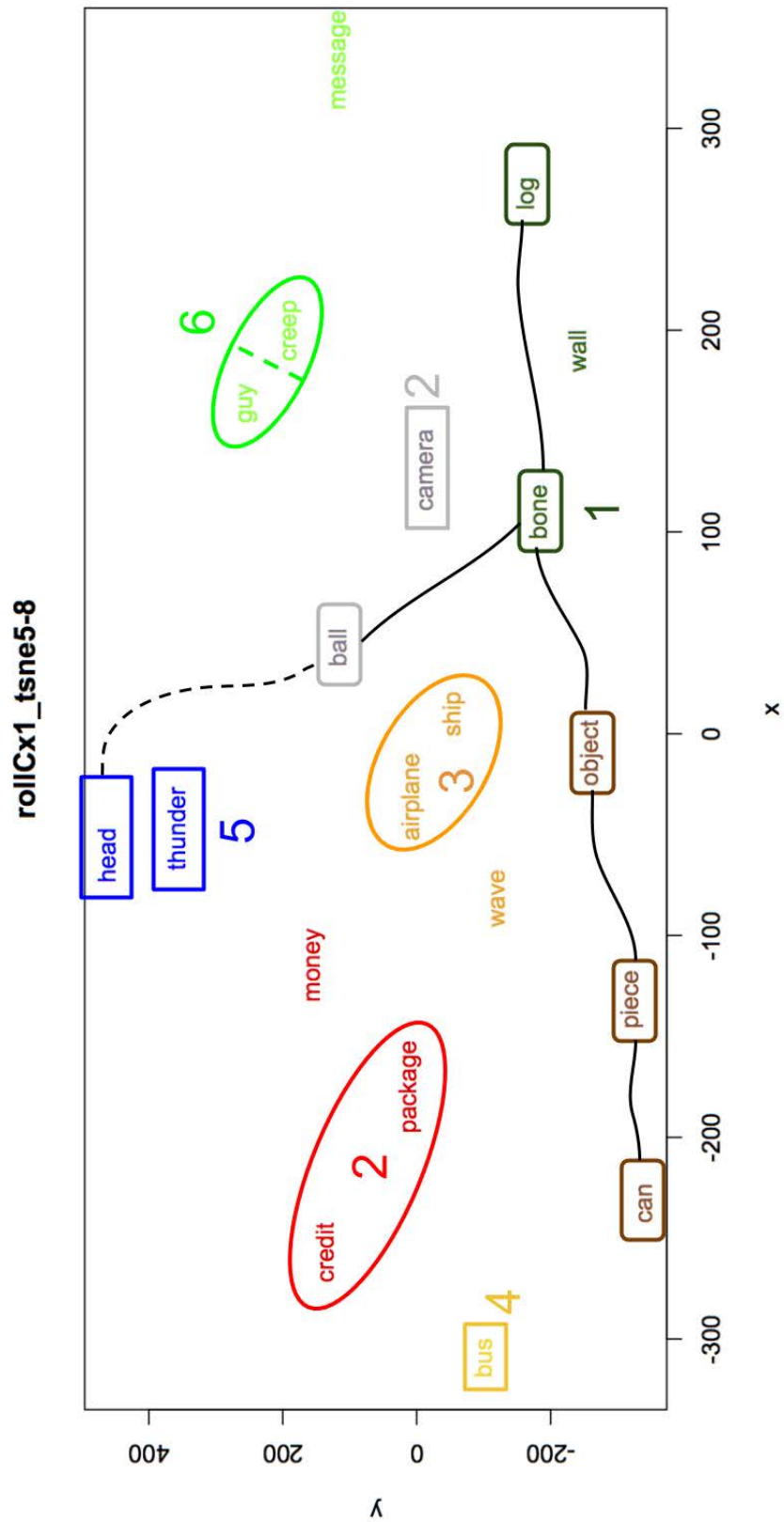
Figure 7.24: Themes that occur with *roll* in the intransitive non-causative construction

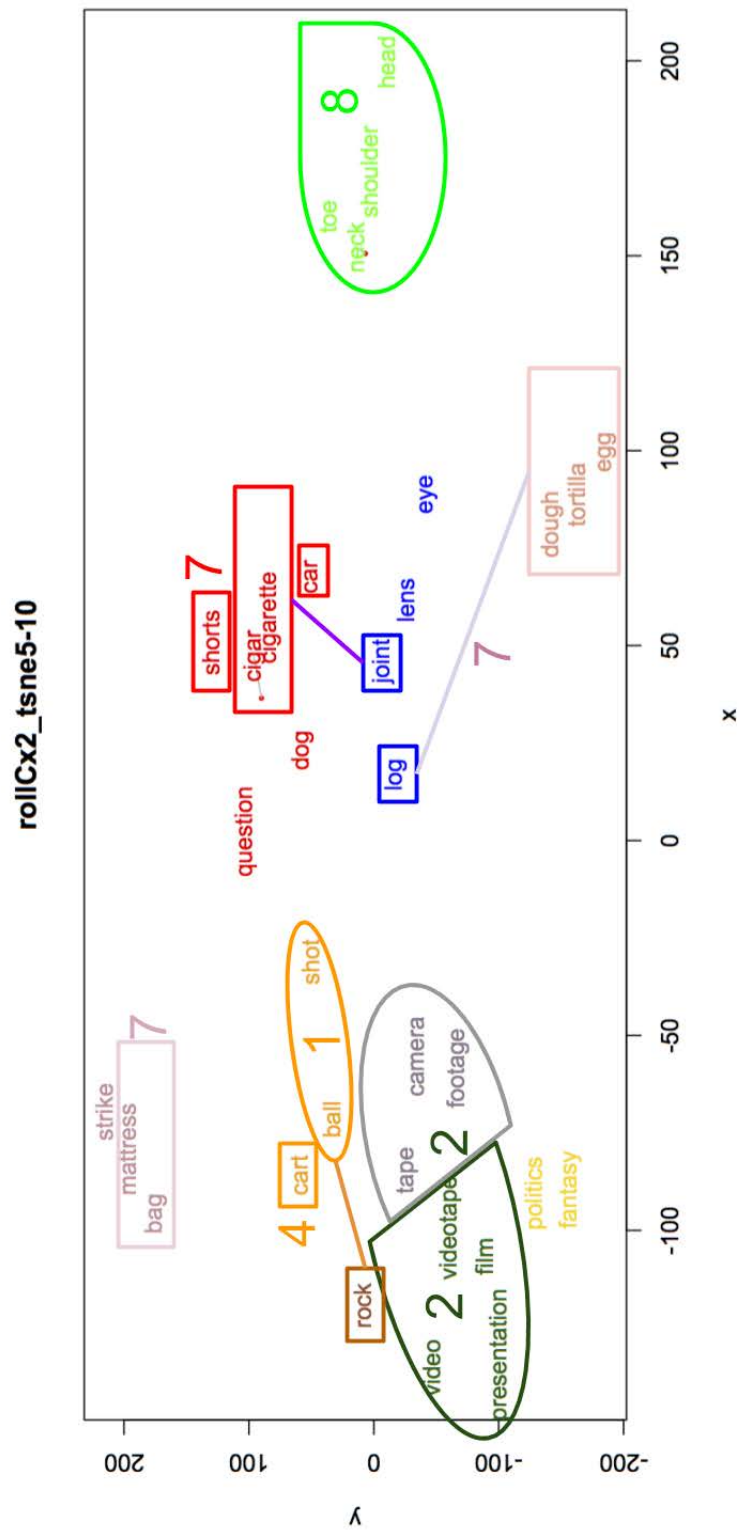
Figure 7.25: Themes that occur with *roll* in the transitive causative construction

- d. You don't have to worry about how you hold the pan or how you roll your **eggs**.
- e. If you roll the **tortilla**, it's a burrito [...]

The next cluster of themes identified by t-SNE comprises themes which refer to various body parts such as *neck, shoulder, head, toe* but also *eye*. The sense of *roll* associated with these themes is actually close to that of group 1: “cause to move by turning over or in a circular manner or as if on an axis”, except that there is no motion on a path involved here. The rolling motion is stationary.

(227) **Group 8:** “cause to move by turning over or in a circular manner or as if on an axis” (stationary motion)

- a. He takes a deep breath and rolls his **neck** and his **head**.
- b. Singing loudly to herself, she would roll her **shoulders**.
- c. a farrier will usually roll the **toe** and raise the heels off the ground with some pads and cushion.
- d. She sighed and rolled here **eyes**.

Interestingly, the theme *log* is used with a different meaning in each construction. We noted its use in the intransitive non-causative construction as one of the themes whose shape enabled it to move in a rolling motion, and thus as part of the sense identified by group 1. However, when used with the transitive causative construction in our corpus, the log is not made of wood but refers to the cake which takes its name from its resemblance to the actual wooden log.

To sum up, about eight senses of *roll* were identified with the help of t-SNE, three of which are shared by the two constructions (with or without the causative component). As to the five others, three are specific to the intransitive non-causative construction and two are specific to the transitive causative construction. Overall, it seems that the themes found with the intransitive non-causative construction tend to have an inherent feature that enables them to *roll*, whether it be their shape (e.g. *ball, film* and vehicles) or another characteristic (e.g. the sound of *thunder*). This is not necessarily the case of the themes found in the transitive causative construction which can actually be shaped into a roll or moved in a circular motion.

7.3.2 Drop

As mentioned in Section 6.2.1, *drop* is more frequently found with, and is significantly attracted to, the transitive causative construction. As is visible from Table 7.17, *drop* has a theme overlap of 5.45% which ranks it among the verbs with the lowest percentage of theme overlap. Like many other verbs here, *drop* exhibits more variety in the themes it recruits when used with the transitive causative construction than with the intransitive non-causative construction.

Unsurprisingly, and based on the assumption that *drop* is more frequently used in the transitive causative construction and with a more varied array of themes, more verb senses were identified with the transitive causative construction than with the intransitive non-causative construction. This is also visible in the number of clusters and the density of these clusters on each map:

<i>drop</i>			
Instances retained	355	Themes	202
Instances of Cx1	98	Cx1 themes	50
Instances of Cx2	257	Cx2 themes	163
Preferred construction	Cx2	Theme overlap (in %)	5.45%

Table 7.17: Characteristics of *drop*

cf. Figure 7.26 for the themes used with *drop* in the intransitive non-causative construction and Figure 7.27 for the transitive causative construction.

On the semantic map representing the themes that occur with *drop* in the intransitive non-causative construction, two verb senses were identified which correspond almost perfectly to two clearly divided areas on the map. Up to eight different verb senses were identified on the semantic map representing the themes that occur with *drop* in the transitive causative construction.

For the intransitive non-causative construction, the two verb senses that were identified are (i) “go down in value” and (ii) “fall vertically” which are related via the UP IS MORE metaphor; to these we add a third sense that is found with both constructions but only concerns one theme (*voice*): (iii) “lower the pitch of.” Groups 1 (for the transitive causative construction) and 1a-i (for the intransitive non-causative construction) correspond to the sense “go down in value” as defined by WordNet. There are more themes corresponding to this verb sense with the intransitive non-causative construction than with the transitive causative construction. Furthermore, a quick query on COCA confirms that this sense is much more frequent with the intransitive non-causative construction, notably for the only two nouns from this group that are shared by the two constructions: *price* and *temperature*. A query searching for the verb *drop* used with *temperature* or *price* in a two-word window before the verb (i.e. in assumed subject position) or after the verb (i.e. in assumed object position) returned the results presented in Table 7.18.⁵

	<i>temperature</i>	<i>price</i>
hits for N in “subject” position i.e. * * DROP_v*	612	553
hits for N in “object” position i.e. DROP_v* * *	57	191

Table 7.18: Instances of *drop* with *temperature* and *price* in COCA

In our corpus, *temperature* and *price* only occur once with the transitive causative construction; these uses are reported in (228) and (229).

(228) ...you know fans, they use less electricity, they can drop the **temperature**...

(229) Studios felt they could do a lot more in volume if they dropped the **prices**.

However, *price* and *temperature* occur respectively seven times and eight times with the intransitive non-causative construction. Although these are relatively small numbers, they are still

⁵This query is only meant to give a rough idea of the distribution of these two nouns with the verb *drop*, since COCA is not tagged for syntax and syntactic roles. Although it is slightly imprecise, the substantial difference in numbers should be confirmation enough that these two nouns are more frequently used in subject position (i.e. before the verb) than in object position (i.e. after the verb).

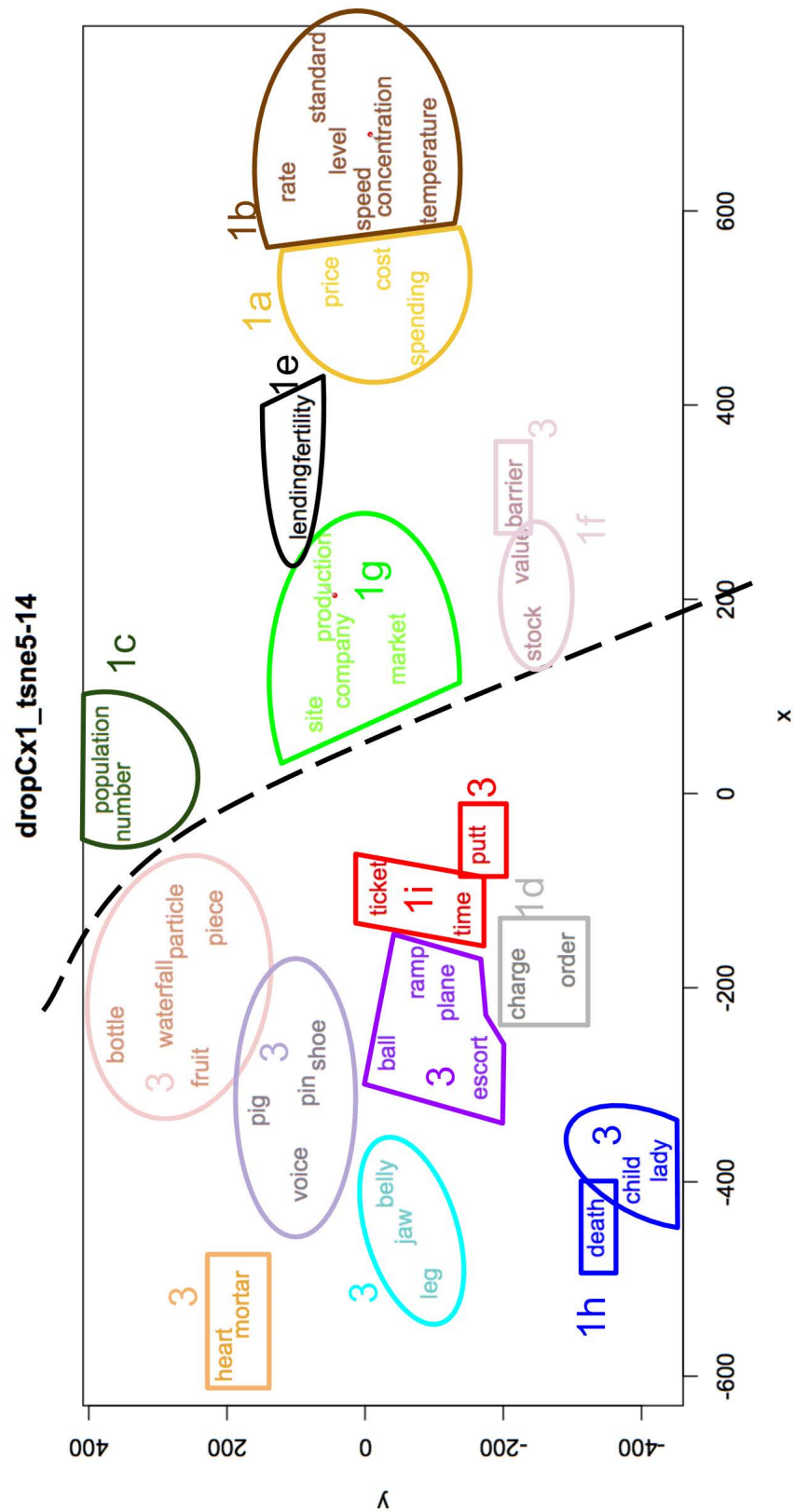
Figure 7.26: Themes that occur with *drop* in the intransitive non-causative construction

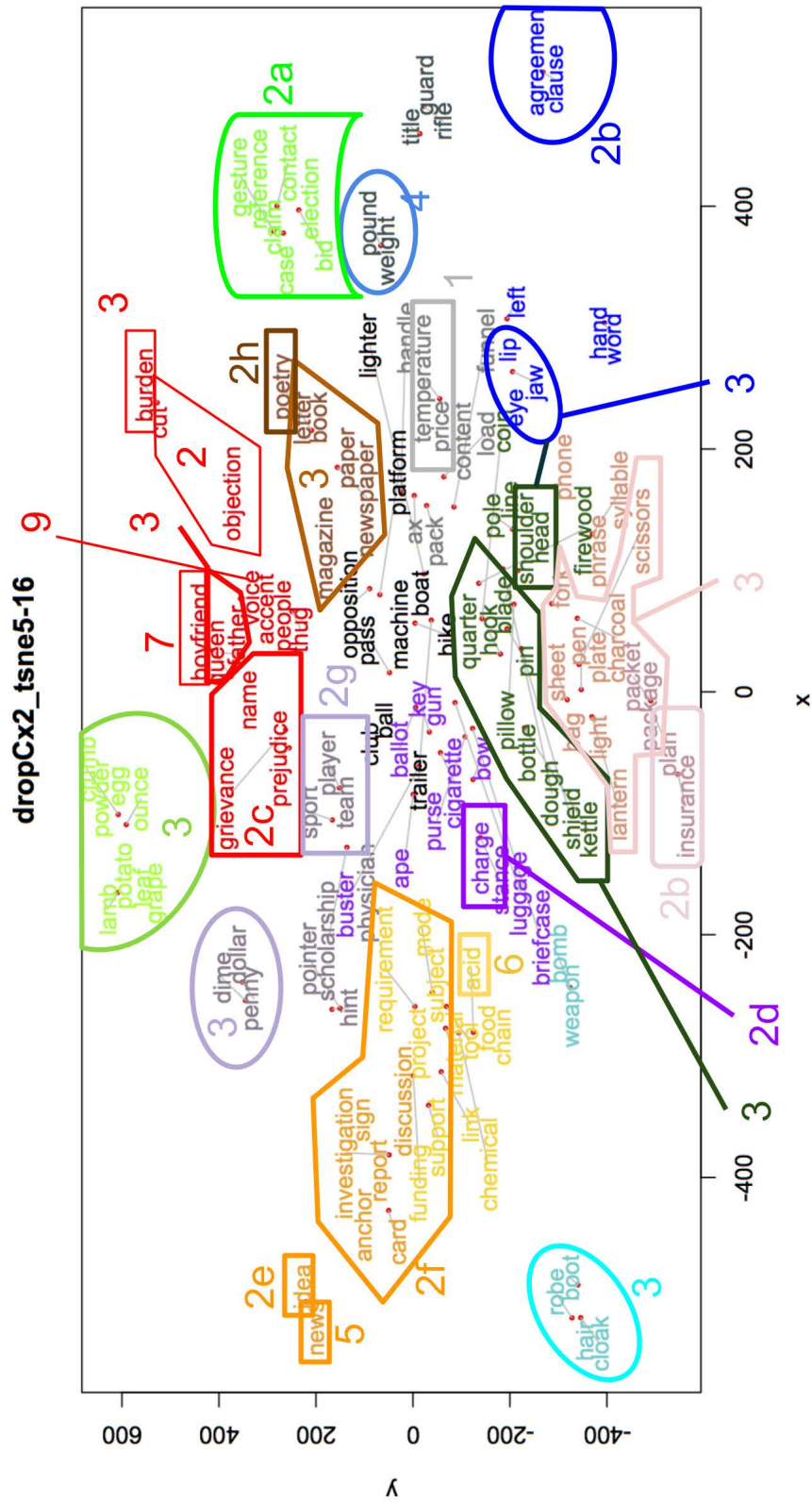

Figure 7.27: Themes that occur with *drop* in the transitive causative construction

quite representative of the discrepancy of use between the two constructions. Also, we note that, based on the numbers presented in Table 7.18, *price* appears to be more frequently found in the transitive causative construction than *temperature*; this can easily be explained by the fact that we generally have more power over *prices* than we do over the *temperature*, at least outdoors.

Groups labeled **3** on both maps correspond to the meaning “fall vertically” for the intransitive non-causative construction and “let fall to the ground” for the transitive causative construction. This group is composed of a large variety of themes, most of which refer to people, animals or inanimate objects, e.g. *child*, *pig* and *book*. Although it appears that few themes are shared by the two constructions in this group, e.g. *bottle*, *jaw* and *pin*, if we look at the bigger picture, we find similarities within the themes used with this sense of *drop*: *child*, *lady* and *escort* in the intransitive non-causative construction all refer to people, and the same is true of *queen* and *father* in the transitive causative construction. Nevertheless, it is indisputable that there are more things that one can drop than that drop on their own, even though it is not always easy to identify exactly what can be construed as dropping as if of its own accord and what cannot. The general impression we get here, due to the larger number of themes found with the transitive causative construction for this sense of *drop*, is that the intransitive non-causative construction is somewhat more constrained than its causative counterpart, at least with *drop*.

While t-SNE performed really well with the placing of the themes used in the intransitive non-causative construction with regards to the senses of *drop* found with this construction, a few exceptions to the division between “fall” and “lower in value” were found, which can be explained. These “wrongly” placed themes and their corresponding instances are found in (230).

(230) Examples of themes found with Cx1 that were “wrongly” placed by t-SNE

- a. Unlike **deaths** from stroke and heart disease in general that have dropped during the past three decades [...]
- b. when lodging and package prices plunge (one-day lift **tickets** drop in April and again in May, with limited lift service anticipated into June)
- c. precipitating Saturday’s trade of LW Ted Donato, whose ice **time** had dropped, to the Islanders.
- d. Many economists had expected November **orders** to drop. Durable goods are big ticket items like computers, cars, and refrigerators.
- e. As hospitals sent patients home sooner, **charges** dropped for employers and insurance companies.

All of these correspond to the meaning “lower in value” and are therefore labeled **1**, even though they appear on the side of the map that is mostly filled by themes that correspond to group **3**, that is, the “fall” meaning. Their being misplaced is most likely due to their polysemy. As we can see, in (230a), it is actually the number of deaths that dropped and not just death itself. As for (230b) and (230e), both *ticket* and *charges* actually refer to an amount of money i.e. the price of a ticket and the equivalent of *taxes* for *charges*. As to (230c) and (230d), they refer respectively to an amount of time and a number of orders. To sum up, all of these indirectly refer either to an

amount or a number of something.

There is one theme, briefly mentioned above, which corresponds to neither of these two meanings: *voice*. This theme occurs with both constructions, and the meaning of *drop* is constant over the two constructions; it denotes a lowering of the pitch or volume.

(231) With *voice*, “lower the pitch of”

- a. Lily’s **voice** dropped.
- b. “Then,” he said, dropping his **voice**, “I, too, search. I go with you.”

WordNet only has it listed in its transitive use, but our corpus shows its use with the intransitive construction. While this sense of *drop* is shared by the two constructions, we only found it with one theme.

There is another noun that appears to be shared by the two constructions: *charge(s)*, as illustrated in (232). The meaning of *charge(s)* is not the same across the two constructions and, thus, the meaning of *drop* is not the same either. This happens regularly with polysemous nouns.

(232) Different use of *charges* with each construction:

- a. As hospitals sent patients home sooner, **charges** dropped for employers and insurance companies.
- b. All he wants is his land back and his family. If you could just drop the **charges** before it’s too late, and all just go away?

As mentioned before, the meaning of *charges* in the intransitive non-causative construction has to do with an amount of money, whereas in the transitive causative construction its meaning corresponds to *accusations*. Therefore, *charge(s)* is actually not shared by the two constructions since *charge(s)* as meaning *accusations* cannot be found in the intransitive non-causative construction. This particular meaning of *drop*, as it is found with *charge(s)*, does not occur with the intransitive non-causative construction and will be dealt with in the next paragraph.

All in all, three verb senses were identified for the intransitive non-causative construction. Six more were found with the transitive causative construction, the most represented of which broadly corresponds to *give up*, *abandon*, as shown in (233):

(233) Examples of *drop* with the sense “give up”

- a. [...] Nichols would [...] accept his federal life prison sentence if the state dropped its **case**.
- b. UC dropped its damage **claims** in exchange for an injunction which UC may use at any time.
- c. He could apply for disability from the school system if he dropped his **grievances**.
- d. When Glaxo and Burroughs Wellcome merged, for instance, they each had to drop a handful of **projects** in development that would have competed against their new partners.

- e. The Soviet Union fell apart, and dropped its **support** of Syria, which was protecting the captors in Lebanon.

The themes that correspond to this sense of *drop* were identified as part of group 2, with various subgroups corresponding to various clusters on the semantic map. There is no specific hierarchy associated with the letters that are used for group 2, they were mostly used to highlight the number of different clusters that correspond to this meaning of *drop*.

The density of the semantic map for themes that are found with *drop* in the transitive causative construction allowed us to identify nine groups. Four of these have already been discussed and the other five are presented in (234 - 237).

- (234) **Group 4:** “lose weight:” You must have dropped ten **pounds** since you left Dennis.
- (235) **Group 5:** “utter with seeming casualness:”⁶ Or perhaps, is it Simon Cowell for dropping the bombshell **news** that he’s quitting “American Idol”
- (236) **Group 6:** “take drugs:” I ask why all the furniture is missing and my Dad reminisces about dropping **acid** and watching Neil Armstrong walk on the moon.
- (237) **Group 7:** “leave someone” (close to group 2): the world seemed emptied of the people that Penelope had known – the **boyfriends** she had dropped and the ones who had dropped her.
- (238) **Group 8,** not labeled on map, “spend money:” They all drop at least \$4,000 to fly to a Third World country

As mentioned in Section 6.2.3, this method measures semantic similarity on the basis of paradigmatic relations, and as such, when a noun has several senses (or even subsenses), these senses may not always be easy to differentiate. This becomes apparent with the example of *dollar* in the transitive causative construction, which is placed with semantically related nouns: *dime* and *penny*. However, *dime* and *penny* refer to the actual coin, whereas *dollar* refers to an amount of money and means “spending”, as illustrated in (238). Although in our corpus, *dollar* occurs with *drop* with the sense “spend money,” it can also be found with the meaning “let fall,” as illustrated in (239), taken from COCA.

- (239) She got up, dropped a **dollar** on the table.

As such, it could be argued that t-SNE is not wrong in placing *dollar* with *penny* and *dime*. However, it failed to grasp the different *facets* of the meaning of *dollar*, for which two facets can be identified: [MONEY] (e.g. an Australian dollar) and [BILL] or [COIN] (e.g. a silver dollar). Example (238) refers to the [MONEY] facet, whereas (239) refers to the [COIN] facet of *dollar*. These two facets of *dollar* are difficult to differentiate automatically and as Croft and Cruse argue: “It should be borne in mind that facets as such are not meanings, but pre-meanings, and are both the result of construal processes and at the same time the subject of further construal” (Croft and Cruse 2004: 117). Furthermore, models of distributional semantics such as the one we use here do not

⁶This definition comes from WordNet.

place the same object twice and as such, *dollar* was placed with semantically related nouns that are similar to only one facet of *dollar*.

To sum up, nine different verb senses have been identified for *drop*, six of which are only found with the transitive causative construction. The other three are as follows: two are shared by the two constructions but with a (very) limited number of themes (e.g. the sense “lower the pitch of” with *voice* as its only represented theme), and the last (“(let) fall”), although constant over the two constructions remains more frequent and is used with a more varied array of themes in the transitive causative construction than in the intransitive non-causative construction, thus showing that at least with the verb *drop*, the intransitive non-causative construction is more constrained than its causative counterpart.

7.3.3 Move

Although we found that *move* is most frequently used in the intransitive motion construction (736 instances out of 1228 or 59.93%, cf. Table 7.19), it is nevertheless more frequently found with the intransitive causative construction (282 instances, 22.96%) than with the caused-motion construction (123 instances, 10.02%) or the transitive causative construction (87 instances, 7.08%). According to the results of the distinctive collostructional analysis, given the choice between the intransitive non-causative construction and the transitive causative construction, *move* is significantly attracted to the former. A total of 369 instances of *move* with either of these two constructions were retained, amounting to a total of 172 different themes. Out of these 172 themes, 126 occur with the intransitive non-causative construction and 60 with the transitive causative construction, for a total of 8.14% overlap. *Move* is apparently constant in that it is attracted to the intransitive non-causative construction but also shows more diversity in the themes recruited with this construction.

<i>move</i>			
Instances retained	369	Themes	172
Instances of Cx1	282	Cx1 themes	126
Instances of Cx2	87	Cx2 themes	60
Preferred construction	Cx1	Theme overlap (in %)	8.14%

Table 7.19: Characteristics of *move*

It seems that only one verb sense is shared by the two constructions. This sense is labeled as group 1. It is somewhat easier to isolate on the semantic map for the transitive causative construction (Figure 7.29) than on that of the intransitive non-causative construction (Figure 7.28). This sense corresponds to the most basic and concrete meaning of *move*, which denotes motion, with or without a change of location.

(240) **Group 1:** “(cause to) be in motion, with or without a change of location”

- a. With the intransitive non-causative construction:
 - i. His **lips** were silently moving.
 - ii. Mike hops off his **bike** before **it** stops moving.

- b. With the transitive causative construction:
- i. I couldn't breathe, I couldn't move my **arms** when I got out.
 - ii. The piston rod usually connected to a crosshead beam, which moved a connecting **pin** [...]

This sense is shared by the two constructions with inanimate themes, but only animate themes are found with the intransitive non-causative construction with this meaning. Then again, although t-SNE placed many nouns referring to people together on the semantic map, as seen in group 2, there are various verb senses that are found with animate themes in the intransitive non-causative construction. The problem with themes referring to people, notably when these themes do not necessarily refer to a specific status (e.g. *dancer* or *policymaker*) is that they are used with different senses of *move*, people move houses (241c), move from one point to another (241a), gesture (241b), etc. Therefore, even though these themes are grouped on the semantic map they do not necessarily reflect one verb sense. In other words, there is only so much distributional semantics can do.

(241) **Group 2:** animate themes (intransitive non-causative construction only)

- a. I took two shots at him, but that **baby** was moving fast!
- b. My **parents** moved in synchronicity in the kitchen.
- c. He moved because his best **friend** in all the world moved.

A third group was isolated by t-SNE which comprises themes referring to people but which all have a specific status such as *dancers* or *actors*. These move in particular manners, and no change of location is necessarily involved.

(242) **Group 3:** “stationary motion, no change of location necessary”

- a. like one of those scenes in a movie where only two of the **actors** move and all the rest are completely still.
- b. The **characters** move well, the game play is smooth [...]
- c. the **dancers** were not defying gravity so much as teasing it. **Some** moved suspended in the air for seconds at a time [...]

Two more groups and thus verb senses were identified for *move* with the intransitive non-causative construction: groups 4 and 5. The first comprises themes which refer to movies or music, and the verb denotes a certain pace.

(243) **Group 4:** “move at a certain pace”

- a. This one [= **drama**] has a stellar cast [...] and despite moving a bit slow in the pilot [...]
- b. In the beginning of “Rocky Mountain,” the **music** moves in thirds and rises like the mountains being described.
- c. This unconventionally structured **thriller** moves at an energetic pace [...]

The second is made up of themes referring to entities such as *administration* or *government* which move in the sense that they take a new metaphorical direction, or make efforts to change their course of action.

(244) **Group 5:** “metaphorical motion”

- a. That summer, President Clinton announced that the **Administration** would move aggressively to deter fraud in the asylum system.
- b. [...] newly elected **legislatures** moved to transform old legal regimes [...]
- c. The **government** is trying to ease popular discontent by moving quickly to restore services knocked out by the war [...]

As to the senses associated with the transitive causative construction, only two were identified that are not shared with the intransitive non-causative construction. The first, represented as group 6 denotes an event of dealing or spreading (cf. 245), and is found with themes such as *product* and *information*. The second corresponds to the cluster of themes labeled as group 7 and which all refer to people. This sense of move is defined by WordNet as “have an emotional or cognitive impact”, as shown in (246).

(245) **Group 6:** Unlike Amazon, the site feels more like a record shop that wants to move **product** than the den of a friend with great taste in music.

(246) **Group 7:** I know it moved my **brother** deeply.

All in all, there are more senses of *move* that are associated with the intransitive non-causative construction, but the most striking aspect of *move* is that only one sense was identified that is fully shared by the two constructions.

7.3.4 *Slide*

Unfortunately, *slide* does not bring much to the discussion on the similarities and differences between the intransitive non-causative construction and the transitive causative construction since it hardly ever occurs with these constructions, preferring the motion constructions. As reported in Table 7.20, we only found 39 instances of these constructions out of the 950 instances of *slide* extracted from COCA.

<i>slide</i>			
Instances retained	39	Themes	25
Instances of Cx1	36	Cx1 themes	22
Instances of Cx2	3	Cx2 themes	3
Preferred construction	Cx1	Theme overlap (in %)	0%

Table 7.20: Characteristics of *slide*

Only three instances of the transitive causative construction were found, all three have themes that refer to objects that can slide and that one can slide such as *bolt* and *shaft*, as illustrated in (247) and (248).

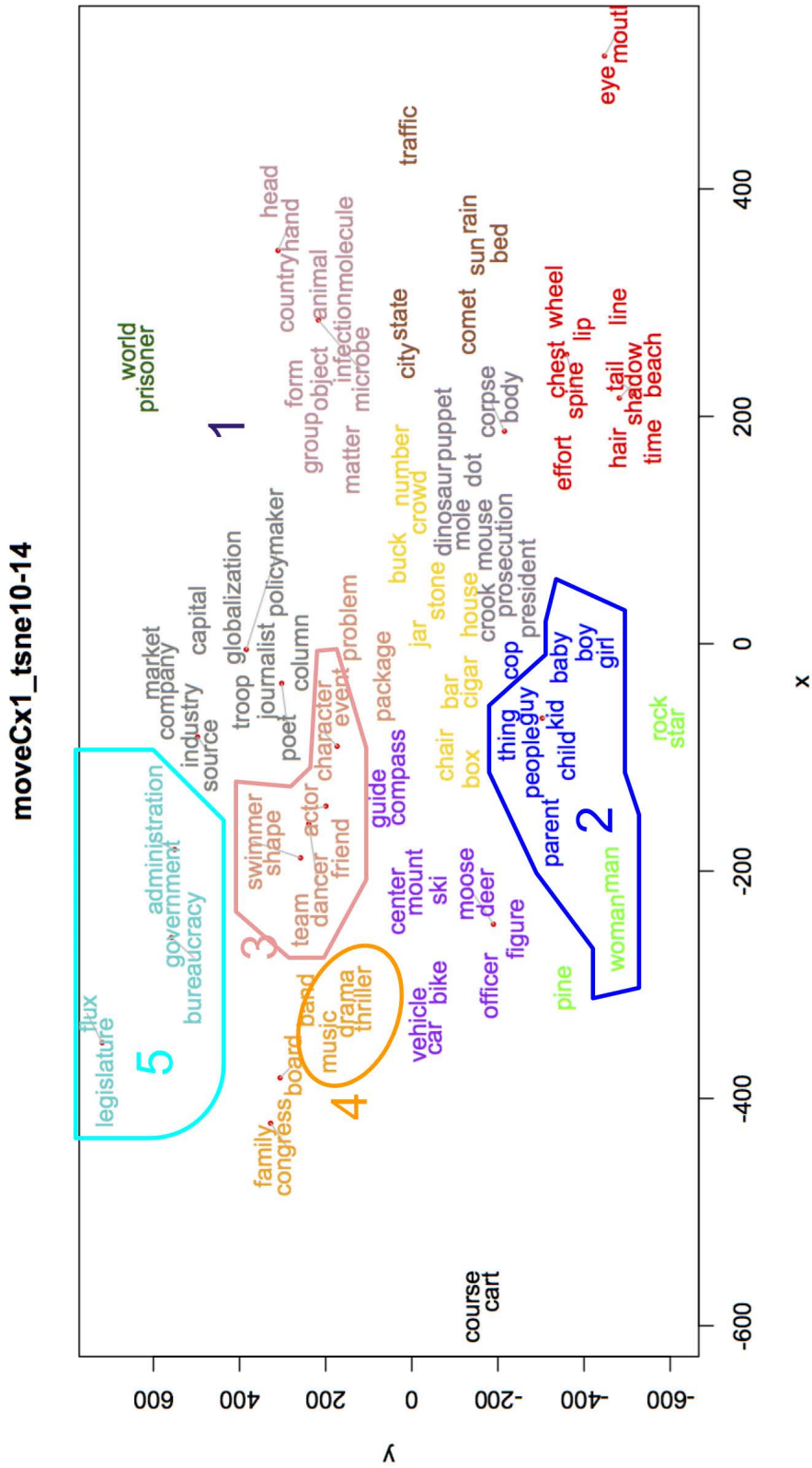
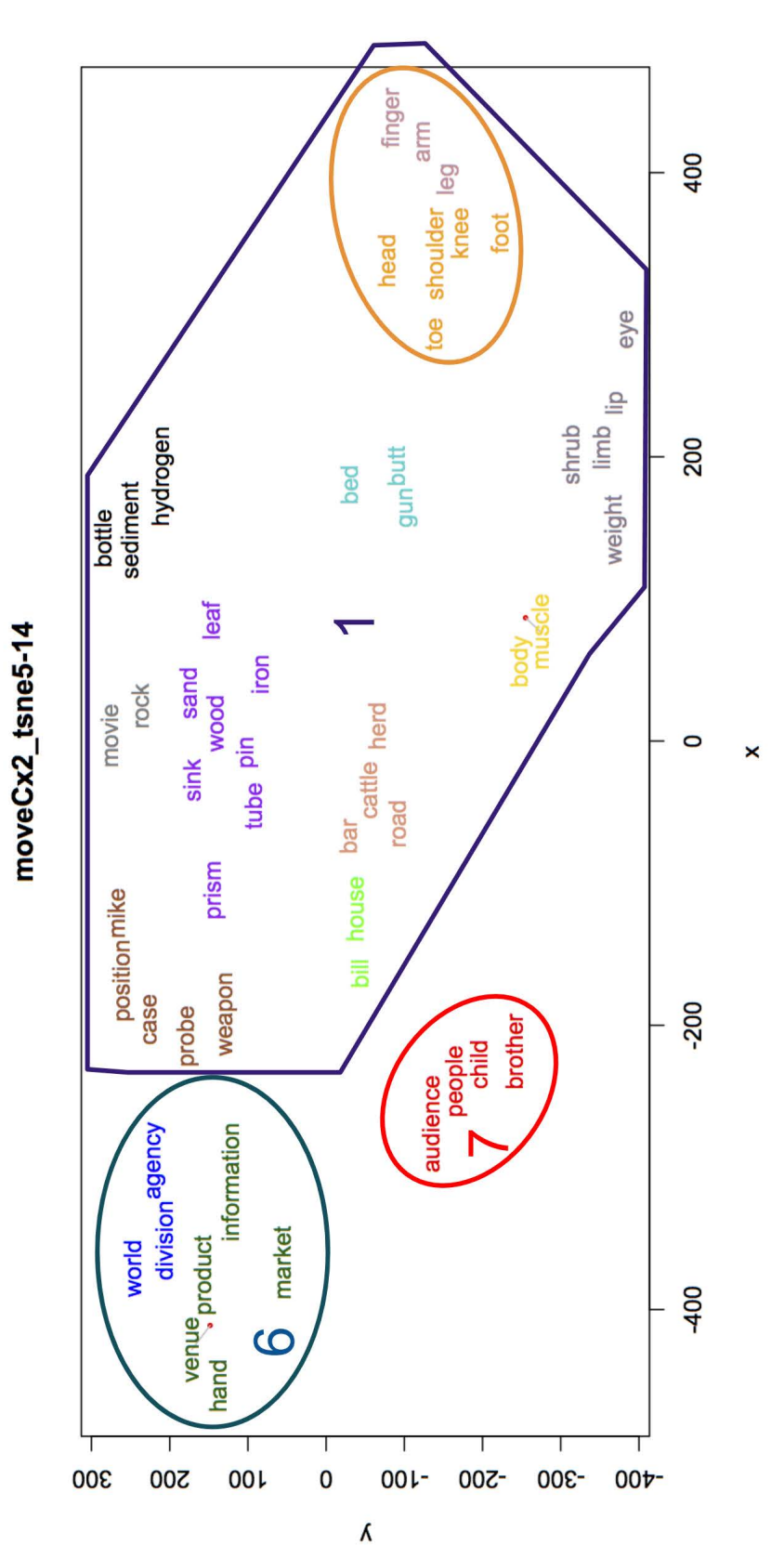

Figure 7.28: Themes that occur with *move* in the intransitive non-causative construction

Figure 7.29: Themes that occur with *move* in the transitive causative construction

(247) T. had shut the doors with a crash and slid the iron **bolt** that locked them.

(248) Push a button, slide the lower **shaft**, and lock the pole into place.

As to the intransitive non-causative construction, it was found with 36 different themes, which can easily be divided into two categories: those that are concrete and thus used with the sense “move obliquely or sideways, usually in an uncontrolled manner”, shown in (249), and those that are abstract and are used with a sense that we define as “metaphorical downward motion”, shown in (250).

(249) **Group 1:** concrete themes; “move obliquely or sideways, usually in an uncontrolled manner”

- a. [...] you shouldn’t automatically brake when your **car** starts to slide on a snow-covered road.
- b. The **strap** slid a tiny bit.
- c. The **doors** began to slide.

(250) **Group 2:** abstract themes; metaphorical downward motion

- a. Unfortunately the religious left began to fade just when the **economy** began to slide
- b. As interest **rates** began to slide, employers and investment advisers pressed home the notion that stocks were the top-performing investment

With so few examples, it is difficult to assess whether there are shared verb senses between the two constructions. Nevertheless it seems that the metaphorical use of *slide* is only possible with the intransitive non-causative construction. Also, the only themes that we found with the transitive causative construction are very similar and slide in a specific way.

7.3.5 Turn

As is visible from Table 7.21, *turn* is one of the few verbs that have a theme overlap higher than ten percent, with a total of five shared themes out of 37. *Turn* is also significantly attracted to the intransitive non-causative construction, although as discussed in Section 6.2.1 and shown in Table 6.10, like most ROLL verbs it is more frequently found with either the intransitive motion construction or the caused-motion construction than with the intransitive non-causative and transitive causative constructions. The low frequency of *turn* in the last two constructions lead to our corpus comprising only 123 instances of *turn* in either of these two constructions, which explains the small number of themes found with *turn*.

Since there were so few themes occurring with *turn* in the intransitive non-causative construction and the transitive causative construction, we used MDS rather than t-SNE. As mentioned in Section 6.2.3, MDS gives better results than t-SNE when there are few items to place on the semantic map.

The biggest and most densely populated cluster on the semantic map representing the themes used with the intransitive non-causative construction corresponds to verb sense number 1. This verb sense corresponds to part of the first entry for *turn* in WordNet: “change orientation or

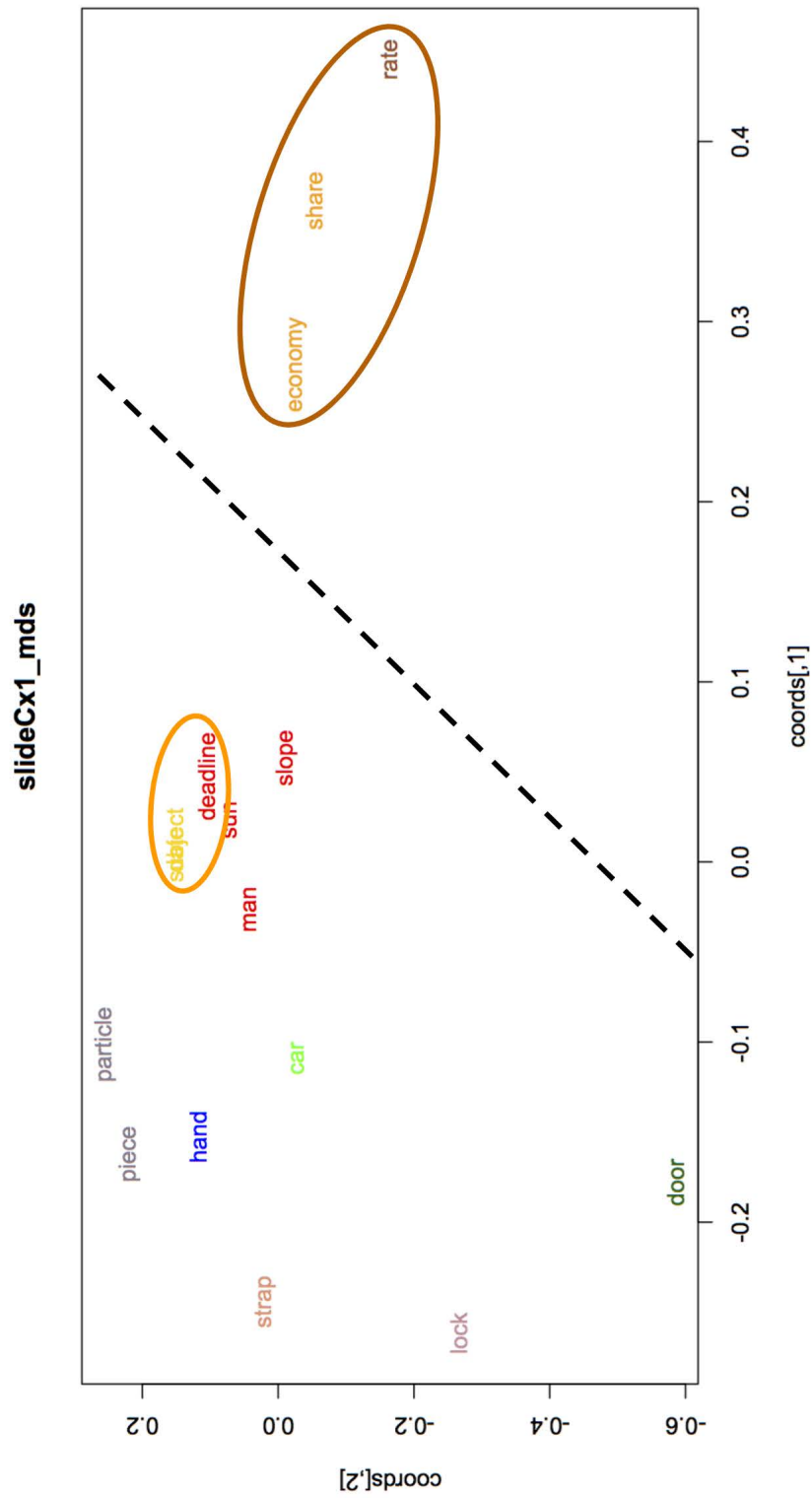

Figure 7.30: Themes that occur with *slide* in the intransitive non-causative construction

<i>turn</i>			
Instances retained	123	Themes	37
Instances of Cx1	81	Cx1 themes	19
Instances of Cx2	42	Cx2 themes	23
Preferred construction	Cx1	Theme overlap (in %)	13.51%

Table 7.21: Characteristics of *turn*

direction, also in the abstract sense.” We decided to divide this definition into two senses, one concrete, the other abstract, because themes matching these definitions are separated on the semantic map (at least for the intransitive non-causative construction). Therefore, group 1 corresponds to the concrete sense of changing orientation or direction for the intransitive non-causative construction (251a) and “cause to change orientation or direction” for the transitive causative construction, as illustrated in (251b).

(251) **Group 1:** “(cause to) change orientation or direction”

- a. With the intransitive non-causative construction:
 - i. Then it [= a **bird**] turned again and headed seaward once more.
 - ii. He’d probably be careful not to stare too hard, for fear it [= the **dummy**] would turn and look at him again.
 - iii. [...] and all three **men** turned and looked like she might as well have been the mailman.
 - iv. On the ground, a spry **raccoon** hurries him along, turning to look at him as if to say “keep up.”
- b. With the transitive causative construction:
 - i. I paint the warm gesso in one direction, then turn the **board** and go in the opposite direction.
 - ii. I turned my **head** and raised my voice.

Somewhere in between the concrete and abstract sense of “changing orientation or direction” are examples such as (252a) and (252b), which both draw their meaning from the concrete motion of the *head*, but which actually denote a more abstract concept, that of paying or drawing attention to someone or oneself. The former is found with the intransitive non-causative construction and the latter with the transitive causative construction. Both are specific to the theme *head* in its plural form. These subsenses of *turn* are illustrated in (252), and given with a little context to help clarify their actual meaning.

(252) **Group 1bis:**

- a. Eddie’s camera kept clicking while she stood strap-hanging on the uptown local. No **heads** turned.
- b. She had well over a dozen young men who fawned over her [...] Lydia had become [...] bored with the effortlessness with which she could turn **heads**.

In both these examples, there is a literal and figurative movement at stake. Heads are expected to turn both literally and figuratively. *No heads turned* means that no one looked at Marilyn Monroe (=she in (252a)), and thus no one paid attention to her. In (252b), men turn their heads to look at Lydia and become enthralled by her. The causative use of this expression is found with or without a sentimental aspect, you can turn heads in the sense that people fall in love with you or in the sense that people simply pay attention to you. Also, the agent need not be an animate, as is visible in this example from COCA: *Election Day this year may not turn heads*.

Since we divided the first entry from WordNet into two subsenses, we labeled the second subsense group 2, and the meaning associated with these themes as used in combination with *turn* is “to change orientation or direction in the abstract sense”, it is rather close to another of WordNet’s definitions: “change to the contrary”, which they illustrate with the example *the tides turned against him*. Three themes fit this sense of *turn* in the intransitive non-causative construction, although they are not clustered close to one another on the semantic map. These themes are *market*, *tide* and *war*, an example is provided in (253).

(253) **Group 2:** “(cause to) to change orientation or direction in the abstract sense”

- a. With the intransitive non-causative construction:
 - i. James Peters [...] is creating a “smaller but stronger company” that will “weather the storm and ensure our viability” when the wholesale energy **market** turns.
 - ii. The next winter at Stalingrad [...] the **war** turned.
- b. With the transitive causative construction:
 - i. that induced the opposition to overreach and ended up turning the **tide**

This sense is found with both constructions, as illustrated in (253b), but we only found one occurrence with the transitive causative construction in our corpus.

A third cluster was identified which corresponds to WordNet’s definition “to move around an axis or a center”, and is illustrated in (254). Again, this sense is shared by the two constructions.

(254) **Group 3:** “to move around an axis or a center”

- a. With the intransitive non-causative construction:
 - i. The reel **handle** turned quicker now
 - ii. The **knob** turned, the door opened, I fell inside.
- b. With the transitive causative construction:
 - i. She tried to turn the knurled **knob** of the window lock
 - ii. They move down center and turn unseen squeaky **faucets**.

The last remaining theme on the intransitive non-causative construction map is *sidewalk*, which in the way it is used in our corpus with *turn* seems to have a meaning close to that of group 1, as shown in (255). The main difference with this group is that *sidewalk* is not an animate, and it denotes fictive motion (also known as “abstract motion” in Lakoff (1987: 168-177), “virtual motion” in Talmy (1983); see also Talmy (2000: 99-172), for a thorough description of fictive

motion). As Matlock (2004, 2006, 2010) shows, there is a clear connection between actual motion and fictive motion in the way they are construed by speakers, notably, as mentioned by Matlock (2010: 256): it “appear[s] to involve dynamic conceptualization, specifically, simulated motion along the trajector or linear extension of the trajector”.

Other themes that were not found in our corpus but which would be used with the same sense of *turn* include *road*, *path* and *river* for example. These are only found with the intransitive non-causative construction, which also shows a major difference with the themes that correspond to group 1.

(255) **Group 4:** *river, path, sidewalk, road*

- a. [...] the **sidewalk** turned and ran beside the lot.
- b. When he reached the place where the **river** turned, he adjusted the rifle strapped to his back [...] (not found in our corpus)
- c. The **path** turned, then opened up to a semicircle of teak benches. (not found in our corpus)

Group 5 on the semantic map for the transitive causative construction actually comprises four themes which are somewhat wide apart on the map. Even though they are not clustered together, they are used with the same sense of *turn*, which is a near synonym of *flip*, or, as defined in WordNet: “cause to move around a center so as to show another side of”. Examples for this group are provided in (256).

(256) **Group 5:** “cause to move around a center so as to show another side of”

- a. But Dot’s hand was reaching into the book, turning **pages**, thick chunks of pages, until she reached the back cover.
- b. And you say turn it [= **steak**] several times, right?

There are no instances of this sense of *turn* with the intransitive non-causative construction in our corpus, but it sometimes occurs with this construction, albeit less frequently than with the transitive causative construction.

The next two senses are actually rather idiomatic. The sixth sense identified for *turn* with the transitive causative construction in our corpus is used with *stomach*, and has the specific meaning “make or become nauseated.”⁷

(257) **Group 6:** “make (or become) nauseated”

- a. [...] the thought that the roots of murder might reach back to those horrible prep school days turned my **stomach**.

Group 7 is only used with *tables* and is an idiomatic expression which means “reverse one’s position relative to someone else, especially by turning a position of disadvantage into one of advantage”.⁸

⁷Definition from the OED online.

⁸Definition from the OED online.

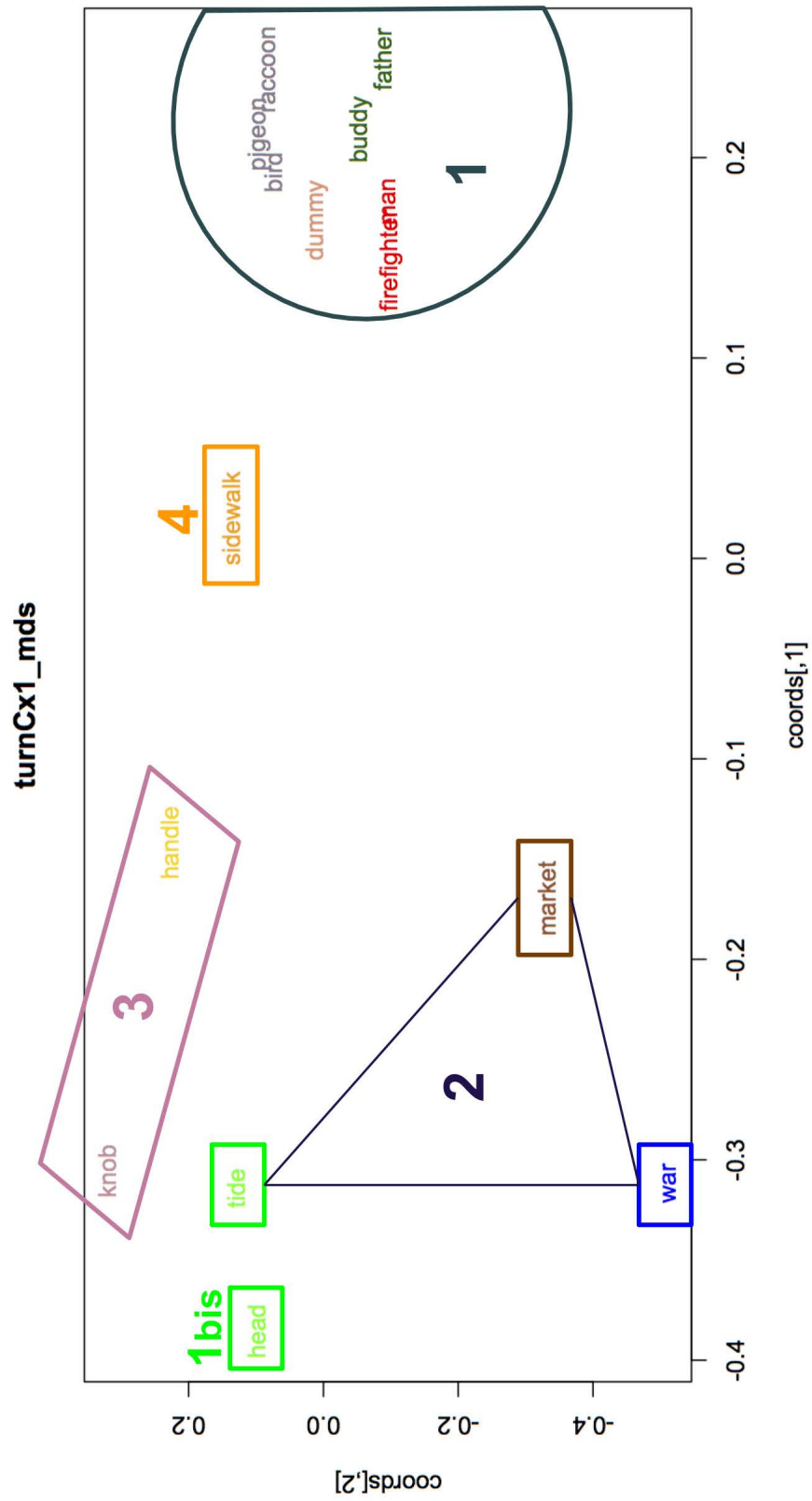
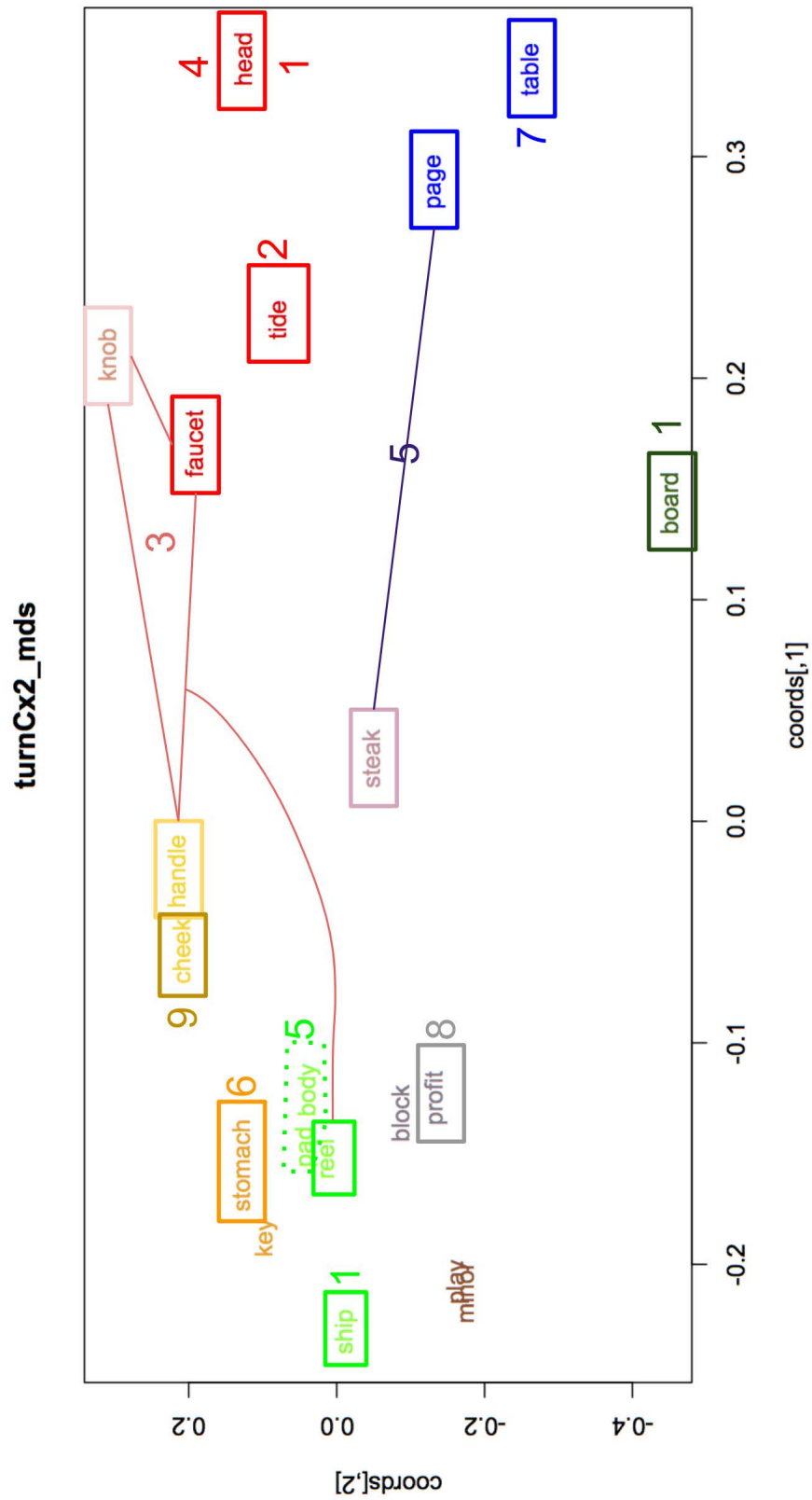

Figure 7.31: Themes that occur with *turn* in the intransitive non-causative construction

Figure 7.32: Themes that occur with *turn* in the transitive causative construction

(258) **Group 7:** “reverse one’s position relative to someone else, especially by turning a position of disadvantage into one of advantage”

- a. But instead of becoming Carrie, Bullock turned the **tables**.

The next sense of *turn* isolated by MDS is found with themes such as *profit* and match WordNet’s definition: “get by buying or selling”, as illustrated in (259).

(259) **Group 8:** “get by buying or selling”

- a. Liquor is reportedly turning a handsome **profit** now.

Finally, another theme that frequently occurs with *turn* in the transitive causative construction is *cheek*, which is found in the idiomatic expression [TURN *the other cheek*]. This is labeled **9** on the semantic map.

To sum up, although *turn* had a theme overlap above ten percent, in the end we only found three shared senses in our corpus, out of nine different senses found across the two constructions. However, a note of caution is important here since, as we mentioned at the beginning of this section, we only had 123 instances of *turn* in our corpus, due to this verb being most frequently used with either the intransitive motion construction or the caused-motion construction.

7.4 GROW verbs

GROW verbs (*grow*, *expand*, *increase*, *proliferate*, *stretch* and *thicken*) are for the most part attracted to the intransitive construction, according to the distinctive collostructional analysis. However, if we look at their raw distribution between the two constructions, we find that they are rather evenly distributed (about 50%) of instances for each construction. When going through the data more thoroughly, we see that some of these verbs are inherently intransitive, that is, their use in context fits much better with the meaning associated with the intransitive non-causative construction (e.g. self-instigation or co-participation of the theme in the event denoted by the verb), such as *grow*. Others, such as *increase* and *expand* only have one sense, which is broadly defined, and thus is shared by the two constructions, because it is not really constrained. On the other hand, verbs such as *stretch* and *thicken* are found respectively with nine and seven different senses, many of which are specific to one construction or the other. For example, as is visible in Table 7.22, only one of the seven meanings associated with *stretch* is shared by the two constructions. And this sense can be further divided into two subsenses, or at least found with two different sets of themes, depending on which construction is used.

7.4.1 Grow

Grow is one of three verbs that has a theme overlap around 3%, which is extremely low. According to the distinctive collostructional analysis, it is significantly attracted to the intransitive non-causative construction. This preference is also visible in the number of themes recruited by the intransitive construction: 120 different themes against only 43 for the transitive causative construction, as shown in Table 7.23.

GROW	
Intransitive non-causative construction	Transitive causative construction
<i>grow</i>	
1. “increase in size”	
1.1 with PRODUCE	
1.2 with HAIR	
2. with PEOPLE: “become older”	
3. with EMOTIONS: “increase (in intensity)”	
4. with BUSINESS: “increase in size”	
<i>expand</i>	
1. with all themes: “become or make larger or more extensive”	
<i>increase</i>	
1. with abstract themes: “become or make greater in size, amount or degree”	
1.1 with concrete themes and an oblique	1.2 with concrete themes
<i>proliferate</i>	
1. “reproduce”	
2. “multiply”	
2.1 with all themes	2.2 with all themes but animates
3. with WRITTEN OR SPOKEN WORD “spread”	
<i>stretch</i>	
1. “extend one’s body or body part to its full length”	
1.1 with PEOPLE	1.2 with BODY PARTS
2. with PEOPLE: “make great demands on someone’s abilities”	
3. with BODY PARTS and LONG OBJECTS: “become longer or wider without breaking”	
4. with FINANCES OR RESOURCES: “be sufficient or adequate for a certain purpose”	5. with FINANCES OR RESOURCES: “make great demands on the capacity or resources of”
6. “extend over a period of time”	7. “extend the scope of”
	8. with <i>story, truth</i> : “modify to some extent”
	9. with CAPACITIES: “refine”
<i>thicken</i>	
1. with LIQUID OR CREAMY FOOD/PRODUCTS: “become or make less liquid”	
2. with various themes: “become or make larger”	
3. with <i>plot</i> : “become (or make) more complex”	
4. with GAS OR VAPOR-LIKE ELEMENTS: “become more dense”	
5. with <i>air</i> and <i>atmosphere</i> : “become (or make) denser with different particles”	
6. with GROUPS: “become more populated”	
7. with SOUNDS: “change its quality”	

Table 7.22: GROW verbs: shared and construction-specific verb senses

<i>grow</i>			
Instances retained	229	Themes	158
Instances of Cx1	160	Cx1 themes	120
Instances of Cx2	69	Cx2 themes	43
Preferred construction	Cx1	Theme overlap (in %)	3.16%

Table 7.23: Characteristics of *grow*

For the most part, *grow* occurs with completely different themes in the intransitive non-causative construction and the transitive causative construction. Out of 158 different themes found with *grow*, only five are shared by the two constructions: *flower*, *garden*, *plant*, *tree* and *business*. On the whole, the transitive causative construction mostly recruits themes that refer to PRODUCE, with two exceptions, visible on the semantic map in Figure 7.34: a small cluster composed of *beard* and *hair*, and another small cluster which contains *portfolio* and *business*. As to the intransitive non-causative construction, it recruits a wider variety of themes, but a majority of these themes are abstract nouns, as the semantic map in Figure 7.33 shows. We identified four main clusters corresponding to different types of growth, and which can be roughly labeled (1) PRODUCE & HAIR, (2) PEOPLE, (3) EMOTIONS and (4) BUSINESS.

The first group identified, which is actually shared by the two constructions is the group that contains themes referring to PRODUCE & HAIR, as illustrated in (260).

(260) **Group 1:** “increase in size”

- a. PRODUCE
 - i. **Lemons and tiny sour oranges** grew in the window.
 - ii. Gallo bought land in three fine-wine regions to grow **grapes** with various characteristics.
- b. HAIR
 - i. She could grow a **beard**, scraggly yes, but a beard nonetheless.

Although we found an example of HAIR with the transitive causative construction (260b-i), there were none with the intransitive non-causative construction in our corpus, but themes corresponding to HAIR can be found with this construction as well.

The second group, for which an example is provided in (261), was only found with the intransitive non-causative construction and contains themes referring to PEOPLE. With this group, the meaning of *grow* implies becoming older. Of course, *grow*, in this sense, also implies that the theme increases in size, as in group 1. However, we decided to keep the two groups separated since in group 2, the theme is an animate.

(261) **Group 2:** “become older”

- a. [...] but as the weeks passed and both **infants** started to grow, the parents watched in amazement [...]

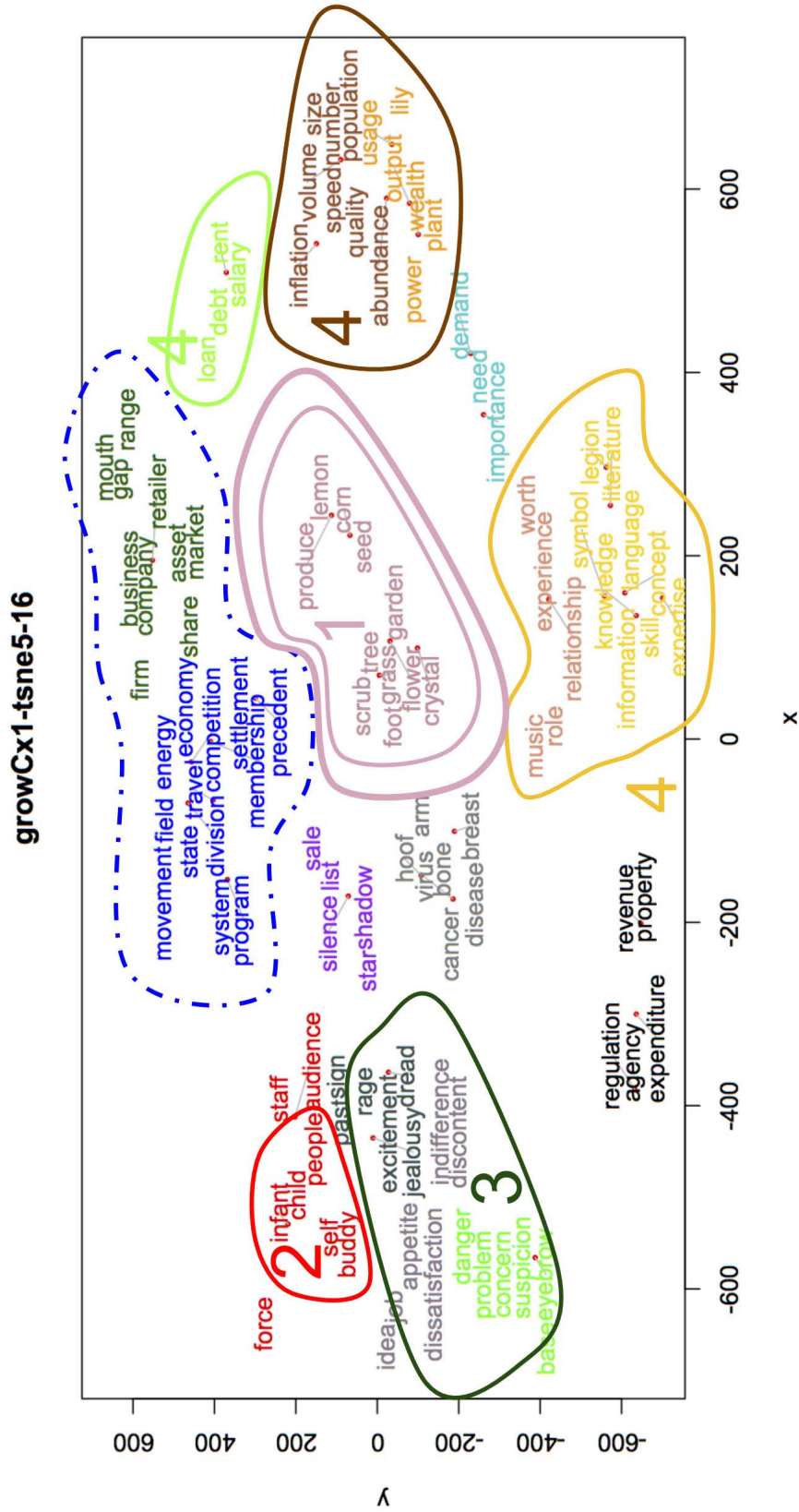

Figure 7.33: Themes that occur with *grow* in the intransitive non-causative construction

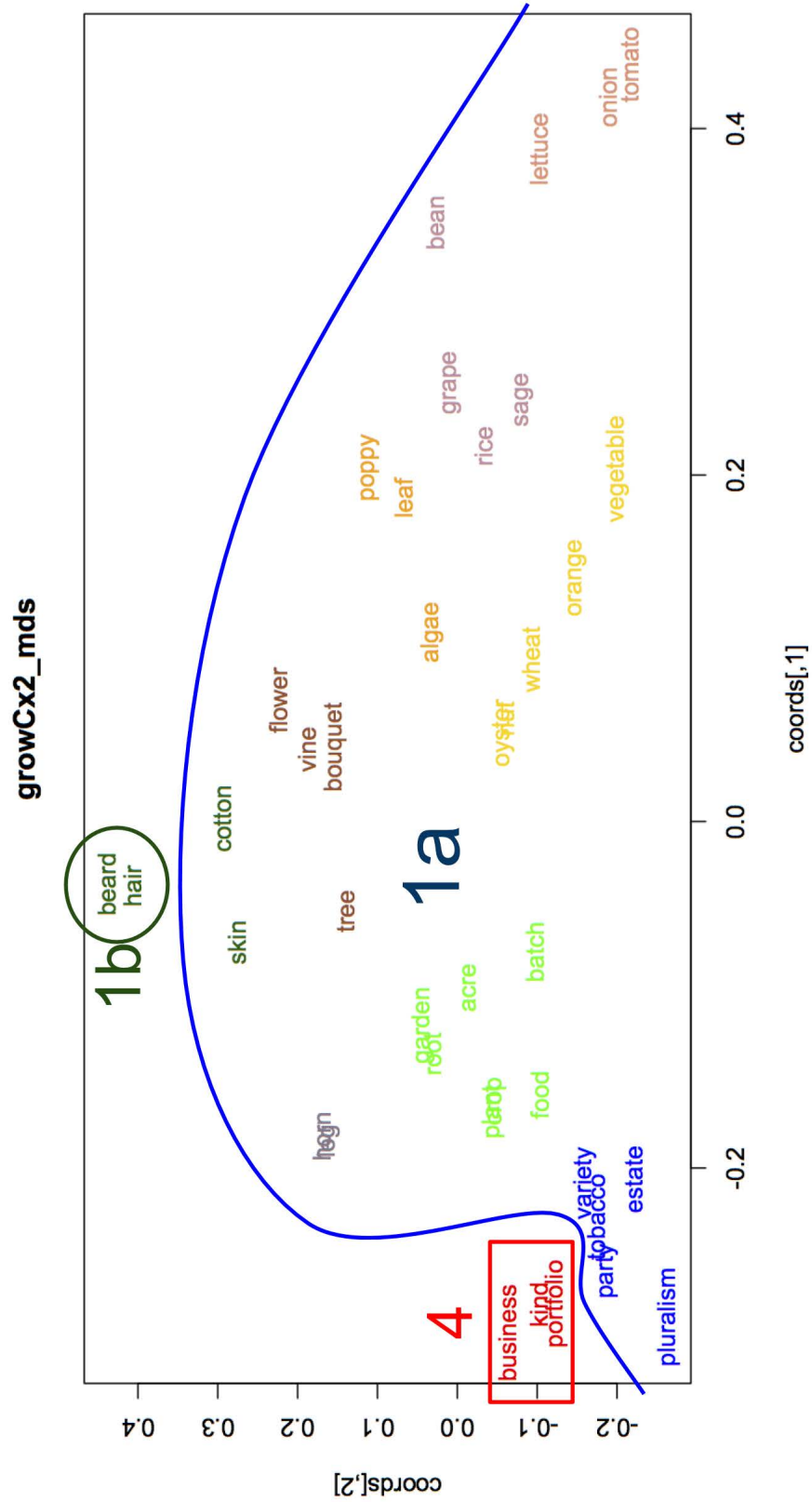

Figure 7.34: Themes that occur with *grow* in the transitive causative construction

A third group comprises themes referring to EMOTIONS, as shown in (262). This sense of *grow* is exclusively found with the intransitive non-causative construction.

(262) **Group 3:** “increase (in intensity)”

- a. Clint’s **rage** grew, clawing to be freed, [...]
- b. His **jealousy** grew.

A fourth group was found that is almost exclusively used with the intransitive non-causative construction, it corresponds to the sense “growing in size” but applies to more abstract things such as *economy*, *experience* and *business*. A few examples are provided in (263a-i) and (263a-ii) for the intransitive non-causative construction and in (263b-i) for its transitive counterpart.

(263) **Group 4:** “increase in size” with abstract themes

- a. With the intransitive non-causative construction:
 - i. According to the most recent figures, Japan’s long-suffering **economy** is growing for the first time in years.
 - ii. As local technical **expertise** grows, more and more planning efforts are stressing the need for integrated assessments [...]
- b. With the transitive causative construction:
 - i. We can expand our business by lowering fares and any additional profitability means we can grow our **business**.

On the whole it seems that there is a tendency for things to grow somewhat naturally, i.e. the meaning of the verb *grow* aligns better with the meaning associated with the intransitive non-causative construction. *Grow* has a meaning which implies self-instigation at least to some extent, and therefore fits better with a non-causative construction. Two of the four groups of themes are shared by the two constructions but they display more variety with the intransitive non-causative construction. Many of the themes that are found in the intransitive non-causative construction refer to things that can be perceived as growing of their own accord. As to the few themes that are found with the transitive causative construction, they are things over which people have at least a little control, and for which they can be perceived to take active part in the growing process.

7.4.2 *Expand*

Expand, together with *increase*, is one of the few verbs that have a theme overlap over 15%, as is visible from Table 7.24. It is also the verb that has the highest number of occurrences with the intransitive non-causative construction and the transitive causative construction: out of 1100 instances extracted from COCA, 744 are either the former or the latter construction which amounts to a little above 67%. Not only does *expand* have a high theme overlap, it also seems to be prototypically used with either of the two (non-)causative constructions. What is more, it shows a certain amount of diversity among the themes recruited in either construction.

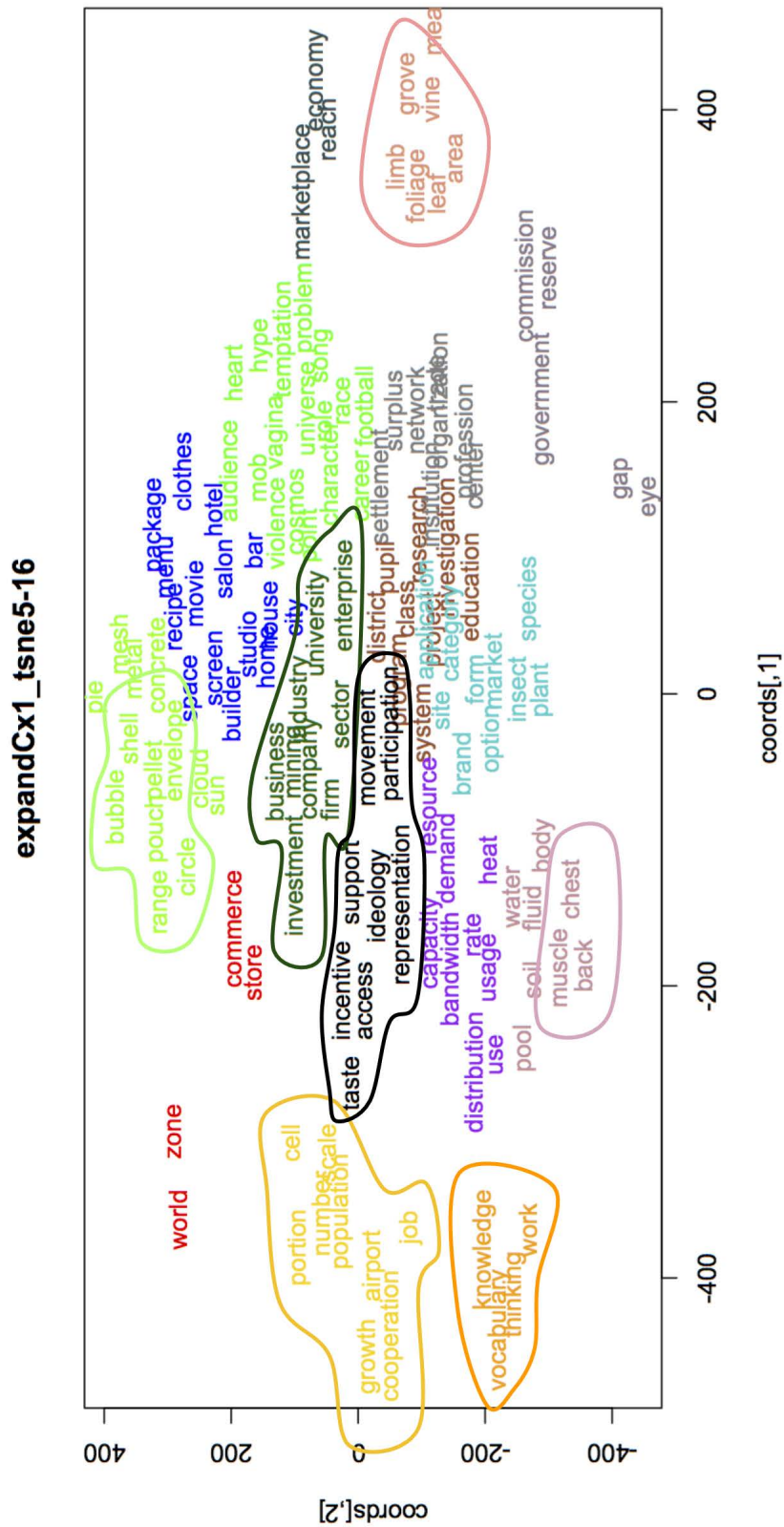
Figure 7.35: Themes that occur with *expand* in the intransitive non-causative construction

expandCx2_tsne30-16

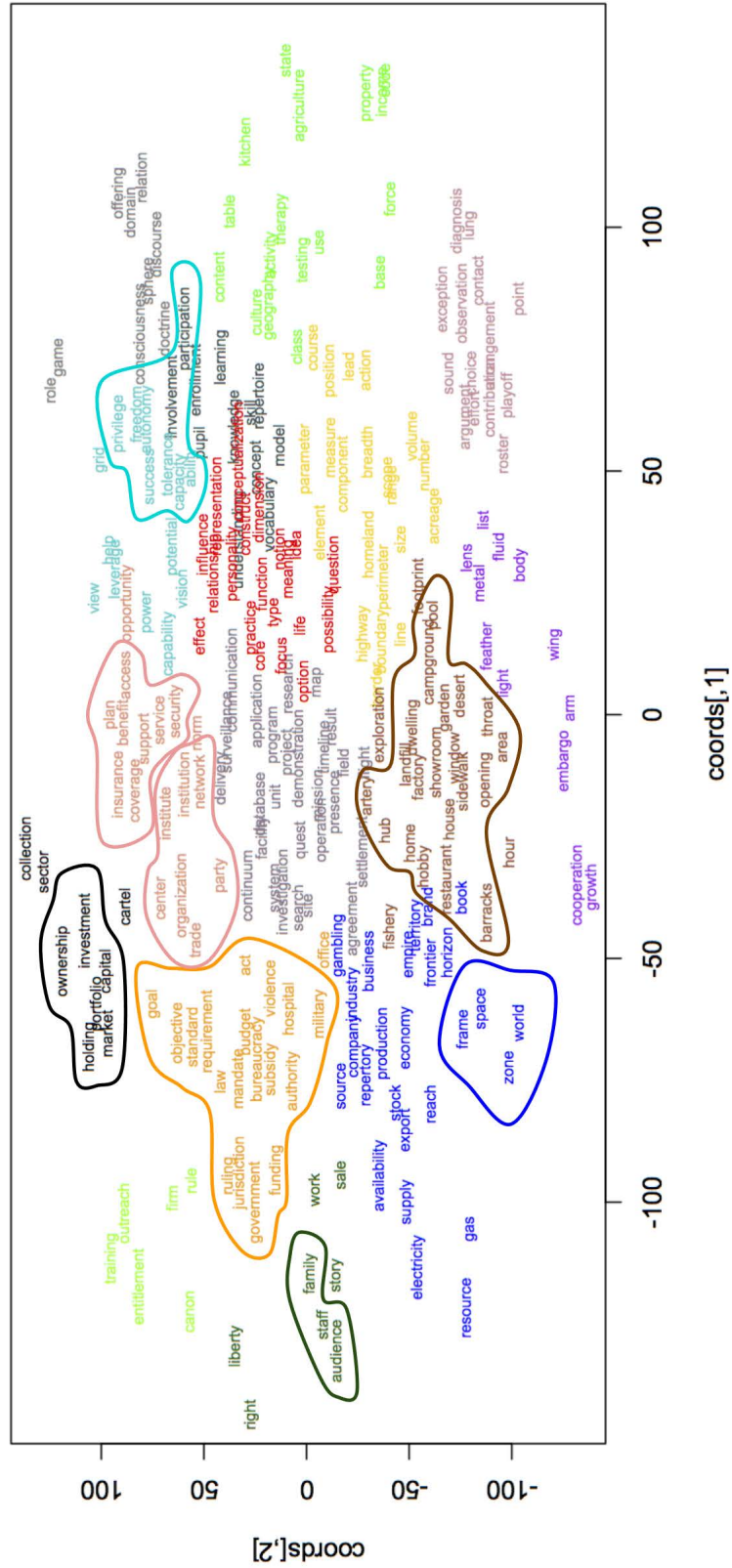

Figure 7.36: Themes that occur with *expand* in the transitive causative construction

<i>expand</i>			
Instances retained	744	Themes	372
Instances of Cx1	225	Cx1 themes	153
Instances of Cx2	519	Cx2 themes	275
Preferred construction	Cx2	Theme overlap (in %)	15.05%

Table 7.24: Characteristics of *expand*

What comes out of the data is that this verb does not seem to require a particular type of theme. The general impression, supported by the semantic maps (Figure 7.35, Figure 7.36), is that pretty much anything can expand or be expanded by an external cause.

Something that is not necessarily visible from the semantic maps, is that *expand* recruits a lot of complex noun phrases composed of a noun and a prepositional phrase introduced by *of*, and which take the form “N of N” such as *sphere of influence*, *body of knowledge*, *number of N*, *circle of gangster acquaintances*, *portion of the cavern*, *rate of travel facilities*, *pool of available volunteer coaches* and quite a few others. For these, the first noun was considered the theme, because sometimes the second noun cannot be used as a theme on its own, as shown in (264) and (265).

(264) [...] their participation greatly expands **the pool of available volunteer coaches**

(265) [...] ?their participation greatly expands **available volunteer coaches**

All in all, most themes seem to correspond to a rather broad but satisfying definition of *expand*, as found in the OED online: “become or make larger or more extensive.” A few examples are provided in (266) and (267), which were taken from various clusters identified by t-SNE.

(266) With the intransitive non-causative construction

- a. New **leaves** of both deciduous and evergreen trees in the central Himalaya expand late in the dry season.
- b. Your child’s **vocabulary** will expand dramatically and he’ll begin to use the rules of grammar.
- c. Even as his **business** expands nationally, Landino takes time off to campaign in his conservative district.

(267) With the transitive causative construction

- a. By 1906, Ford began high-volume automobile manufacturing, expanding his Detroit **factory** and bringing in machinists and technical experts [...]
- b. [...] and rock critic Ken Tucker says its ambition and accessibility should expand OutKast’s **audience**.
- c. the most serious of which is to greatly expand the federal Food and Drug Administration’s **authority** to regulate the nicotine content of cigarettes.

As such, *expand* is one of the rare verbs whose meaning is clearly shared by the two constructions, with the causal element being added by the transitive causative construction.

7.4.3 Increase

As was the case for *expand*, *increase* is one of the verbs that is the most commonly found with either the intransitive non-causative construction or the transitive causative construction, with 776 instances of these two constructions retained from the 1000 instances of *increase* extracted from COCA (these data can be found in Table 6.2). *Increase* is also one of the rare verbs to come close to a theme overlap of 20%; a more detailed overview of this verb's distribution is provided in Table 7.25.

<i>increase</i>			
Instances retained	776	Themes	342
Instances of Cx1	233	Cx1 themes	148
Instances of Cx2	543	Cx2 themes	261
Preferred construction	Cx2	Theme overlap (in %)	19.59%

Table 7.25: Characteristics of *increase*

Increase is very similar to *expand* in several aspects: first, it really fits with the meaning of both the intransitive non-causative and the transitive causative constructions; second, it has a high degree of overlap and third, its meaning is rather constant across the two constructions: “(cause to) become greater in size, amount or degree.” However, it also differs from *expand* in one way: a vast majority of the themes found with *increase* denote non-concrete items. Among the various clusters formed by t-SNE are nouns referring to various activities such as *production*, *export*, *recycling*, cognitive processes such as *perception*, *appreciation*, nouns referring to measures or numbers such as *voltage*, *percentage*, *density* or acts such as *rape*, *murder*, *violence*.

These clusters are found both with the intransitive non-causative construction and the transitive causative construction. A few examples are provided in (268 – 270).

(268) ACTIVITY

- a. In one year rice **production** increased by 1 million metric tons.
- b. [...] the Saudis will increase their September oil **production** [...]

(269) COGNITIVE PROCESS

- a. [...] as the child's readiness to communicate increases, parental **knowledge** would also increase.
- b. We have to take good drugs and market them conservatively and increase our **knowledge** of the settings where the risk-benefit ratio is best.

(270) MEASURE & NUMBER

- a. [...] fishing efficiency increased as the **proportion** of Class II vessels in the fleet increased [...]
- b. What strategies did Private departments use to increase the **proportion** of female undergraduates?

Although most of the themes found with *increase* are non-concrete nouns, a few exceptions were found. Among these exceptions are *crop*, *muscle* or *truck*, but they are used somewhat

increaseCx1_tsne5-16

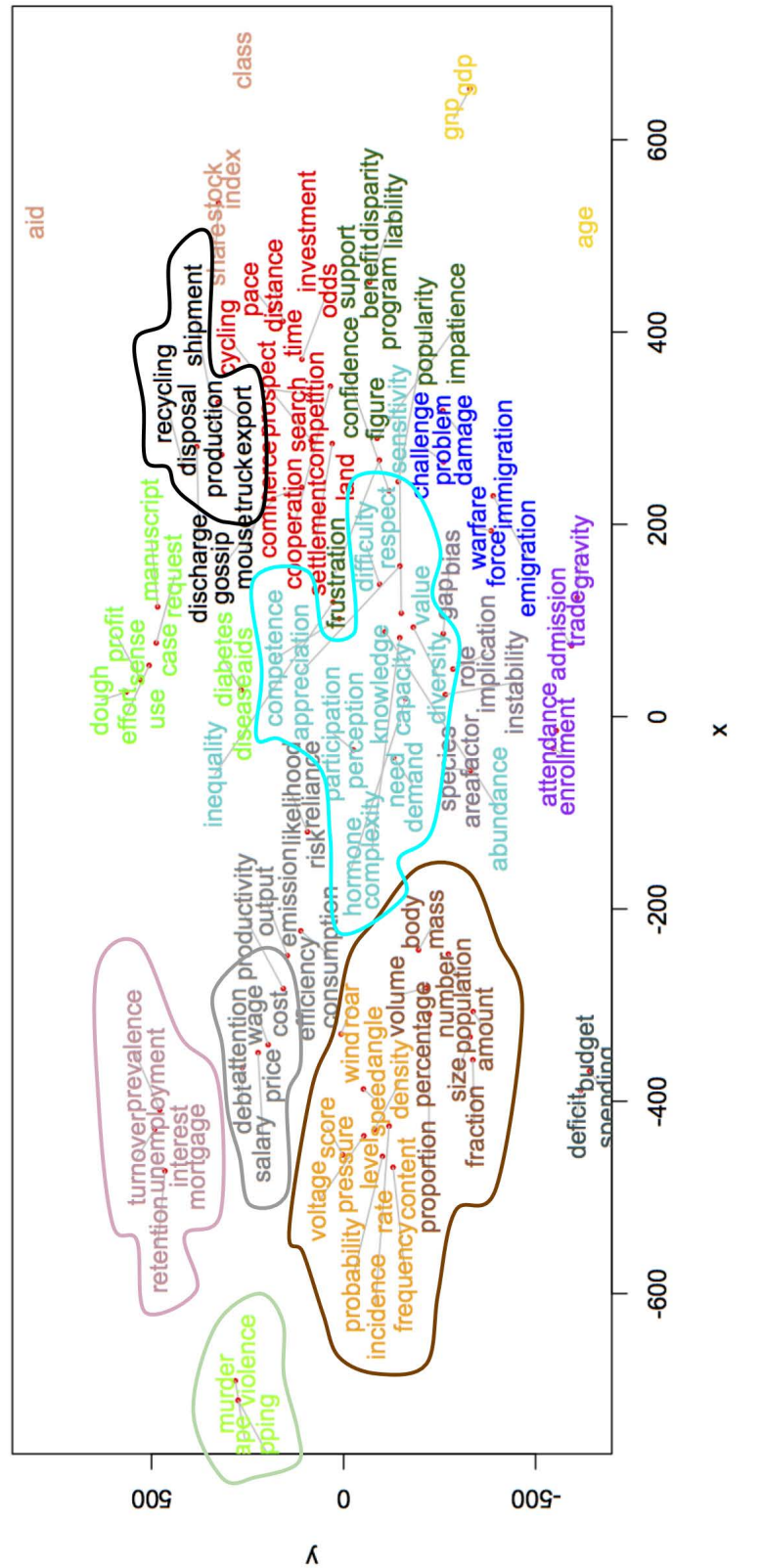

Figure 7.37: Themes that occur with *increase* in the intransitive non-causative construction

increaseCx2_tsne30-16

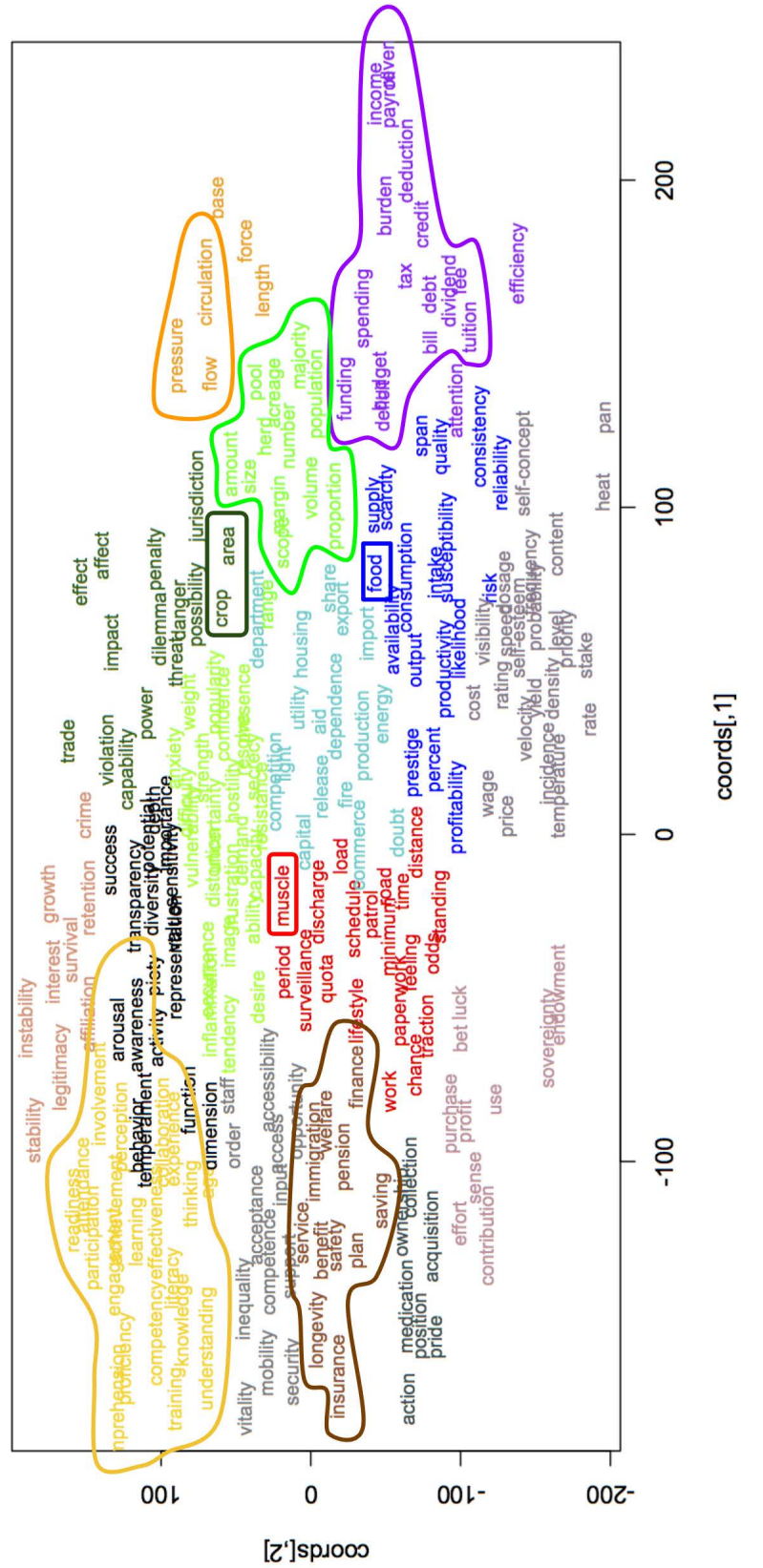

Figure 7.38: Themes that occur with *increase* in the transitive causative construction

differently with the two constructions. Three examples of *increase* used with concrete themes in the transitive causative construction are provided in (271–273).

- (271) Roughing up the bonding surfaces and increasing the mounting **area** might help to improve their strength.
- (272) The first step was to increase **crops**, starting with corn.
- (273) [...] it is likely that increasing **muscle**-any amount-would have a favorable effect on the calorie-burning capacity of women [...]

These three examples are rather standard and do not differ much from the use of *increase* with non-concrete themes. However, this is not necessarily the case for the concrete themes used with *increase* in the intransitive non-causative construction, for which a few examples are given in (274–276).

- (274) [...] until the **dough** increases *in size* [...]
- (275) [...] his **land** would probably have increased *in value*
- (276) There's no question that food **trucks** are increasing *in number and popularity* around the city.

These instances differ slightly from other uses of *increase* with the intransitive non-causative construction due to the presence of a prepositional phrase introduced by *in* in each of them. One wonders whether *dough*, *land* and *truck* are truly themes as such, since what appears to increase is not necessarily the dough, land or trucks per se but respectively their size, value and number and popularity. This suggests the existence of a lower-level construction of the type [X INCREASE *in* {size/amount/value/degree}].

To sum up, there seems to be one broad satisfying sense of *increase* which applies rather nicely to all the themes identified which corresponds to the OED online's definition: "become or make greater in size, amount or degree." However, concrete themes do not seem to work so well with the intransitive non-causative construction since they are always (at least in our corpus) complemented by a prepositional phrase introduced by *in* and in which the noun actually appears as a better candidate for the actual theme.

7.4.4 Proliferate

Just like *increase* and *expand*, *proliferate* is one of the verbs that occur very frequently with either the intransitive non-causative or the transitive causative constructions. Out of 550 instances extracted from COCA, 488 were retained as either instances of the intransitive non-causative construction or its transitive causative counterpart. However, as opposed to *expand* and *increase*, it is actually much more frequently found with the intransitive non-causative construction than with the transitive causative construction. As is visible in Table 7.26, almost 94% of all instances retained are instances of the intransitive non-causative construction. Also in opposition to *expand* and *increase*, it has very little theme overlap, which may be partly due to its largely unequal distribution

between the two constructions, and the very small number of instances of the transitive causative construction.

<i>proliferate</i>			
Instances retained	488	Themes	338
Instances of Cx1	457	Cx1 themes	321
Instances of Cx2	31	Cx2 themes	26
Preferred construction	Cx1	Theme overlap (in %)	2.66%

Table 7.26: Characteristics of *proliferate*

There are many groups of themes that can be identified with the intransitive non-causative construction. The corresponding semantic map in Figure 7.39 is actually very dense, which makes it hard to find appropriate clusters for all themes, but a few were found nonetheless. These clusters range from themes referring to animates such as ANIMALS and LIVING ORGANISMS to inanimates such as a broadly defined group corresponding to HUMAN INVENTIONS.

As is clearly visible on the semantic map for themes that occur with the transitive causative construction (Figure 7.40), there are no themes referring to living organisms with the transitive causative construction. The theme *girl*, which appears on the semantic map actually refers to characters in stories:

- (277) With writers like those, the paranormal YA explosion has been great at proliferating kick-ass **girls**; even Twilight author Stephenie Meyer calls her character Bella a feminist.

The idea of reproduction is only found with the intransitive non-causative construction, and the transitive causative construction only corresponds to the multiplication aspect of *proliferate*, as illustrated by the examples in (278–279b).

- (278) **Group 1:** “reproduce” (intransitive non-causative construction only)
- a. In that oil-rich environment, **bacteria** proliferate, causing inflammation that shows up in the form of pimples.
 - b. The **elk** in turn have proliferated because their chief predator, the gray wolf, has been exterminated.
- (279) **Group 2:** “multiply”
- a. With the intransitive non-causative construction:
 - i. Physician-owned **hospitals**, which proliferated in the 1990s, have sparked intense battles within the hospital industry for years.
 - ii. [...] as **disasters**, both human and natural, continue to proliferate.
 - b. With the transitive causative construction:
 - i. while he feeds his army and pursues weapons of mass destruction and proliferates ballistic missile **technology** around the world
 - ii. But it is a good example of how the system proliferates **titles** and **appointments** in its steady process of multiplying and rearranging tasks.

proliferateCx1_tsne60-16

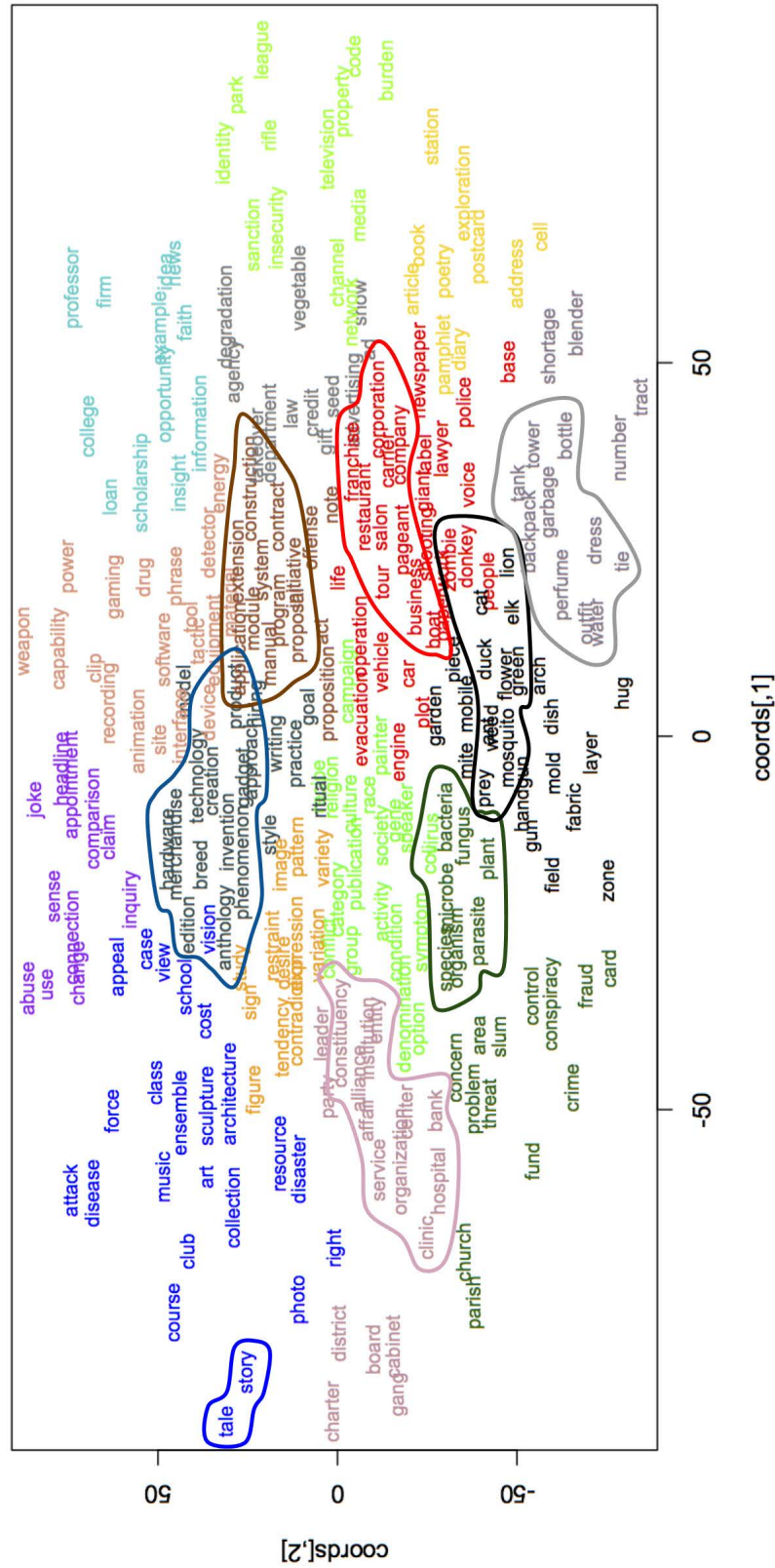

Figure 7.39: Themes that occur with *proliferate* in the intransitive non-causative construction

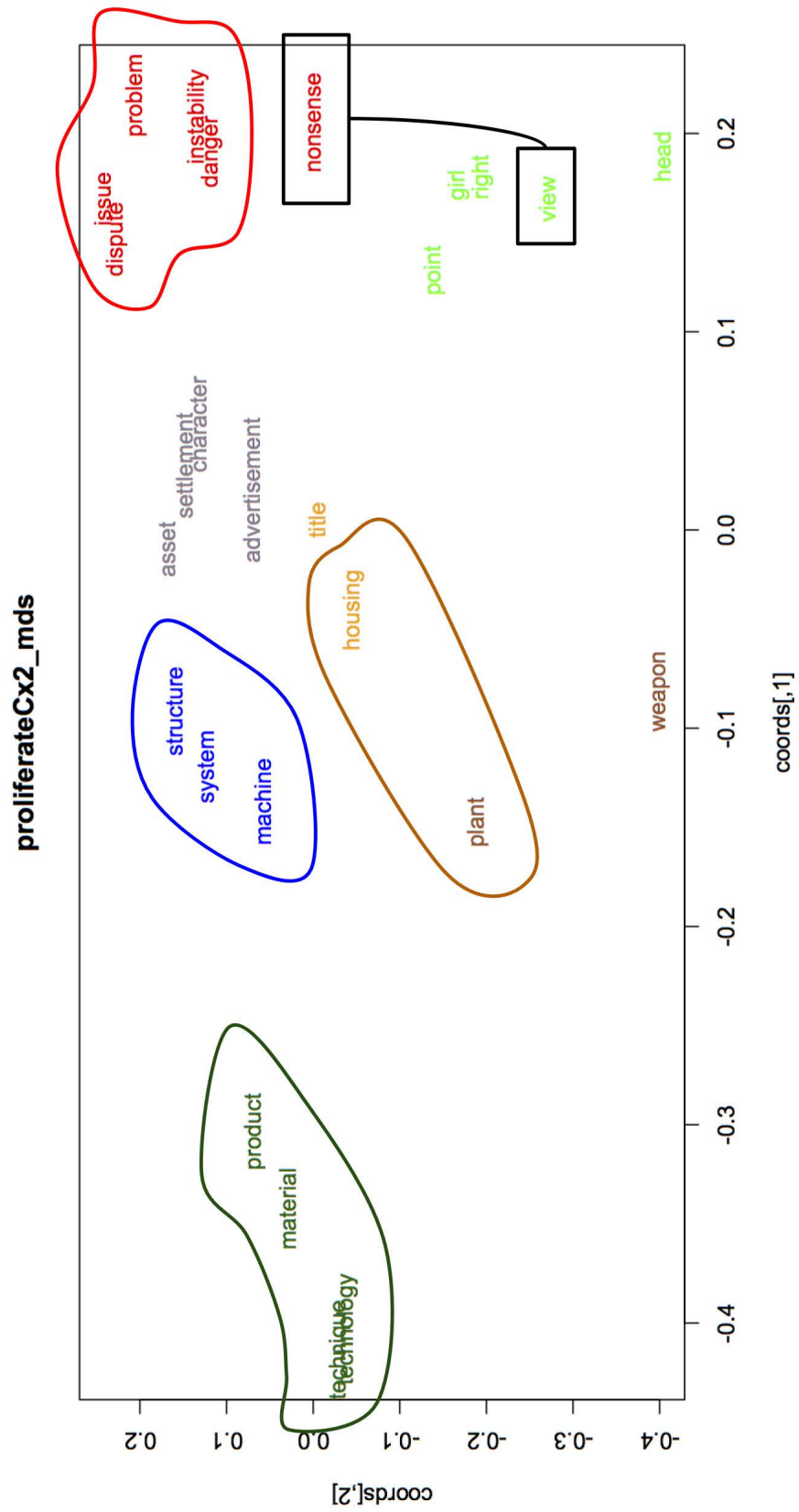

Figure 7.40: Themes that occur with *proliferate* in the transitive causative construction

There is another sense that appears to be shared by the constructions. We found occurrences of *proliferate* with themes that refer broadly to WRITTEN OR SPOKEN WORD in both constructions, and with these themes, the meaning of *proliferate* is actually very close to *spread*, as can be seen in (280).

(280) **Group 3: “spread”**

- a. With the intransitive non-causative construction:
 - i. A few years ago [...] **stories** proliferated in the popular culture about the yearning for motherhood among career women.
 - ii. As the long-awaited “Y 12” date nears, **tales** of what will happen are proliferating on the Internet, in print, and in movies.
- b. With the transitive causative construction:
 - i. Hansen plans to proliferate his “white Aryan **views**” via public access cable in Salt Lake City.
 - ii. What Aaron Barr did was pretty much proliferate the **nonsense**.

To sum up, three senses were identified for *proliferate*: “reproduce”, which is only found with the intransitive non-causative construction, “multiply” and “spread” which are shared by the two constructions.

7.4.5 *Stretch*

As is visible from the numbers given in Table 7.27, *stretch* is one of the verbs that shows no constructional preference, being attracted to neither of the two constructions. It also has a very low degree of theme overlap, which may or may not be due to the relatively small number of themes found with each construction. From the results that came out of our data, *stretch* is only slightly more frequently used with the transitive causative construction, but it shows a lot more variety in the number of different themes recruited in this construction than it does in the intransitive non-causative construction.

<i>stretch</i>			
Instances retained	270	Themes	108
Instances of Cx1	114	Cx1 themes	35
Instances of Cx2	156	Cx2 themes	76
Preferred construction	NS	Theme overlap (in %)	2.78%

Table 7.27: Characteristics of *stretch*

We will start off the discussion of *stretch* by mentioning themes that do not appear on either semantic map because they are not nouns, but pronouns used to refer to people. Pronouns referring to people are found with both constructions but with different meanings. In the intransitive non-causative construction, the stretching event is purely physical, and actually implies that someone stretches their body or a body part, as shown in (281). In the transitive causative

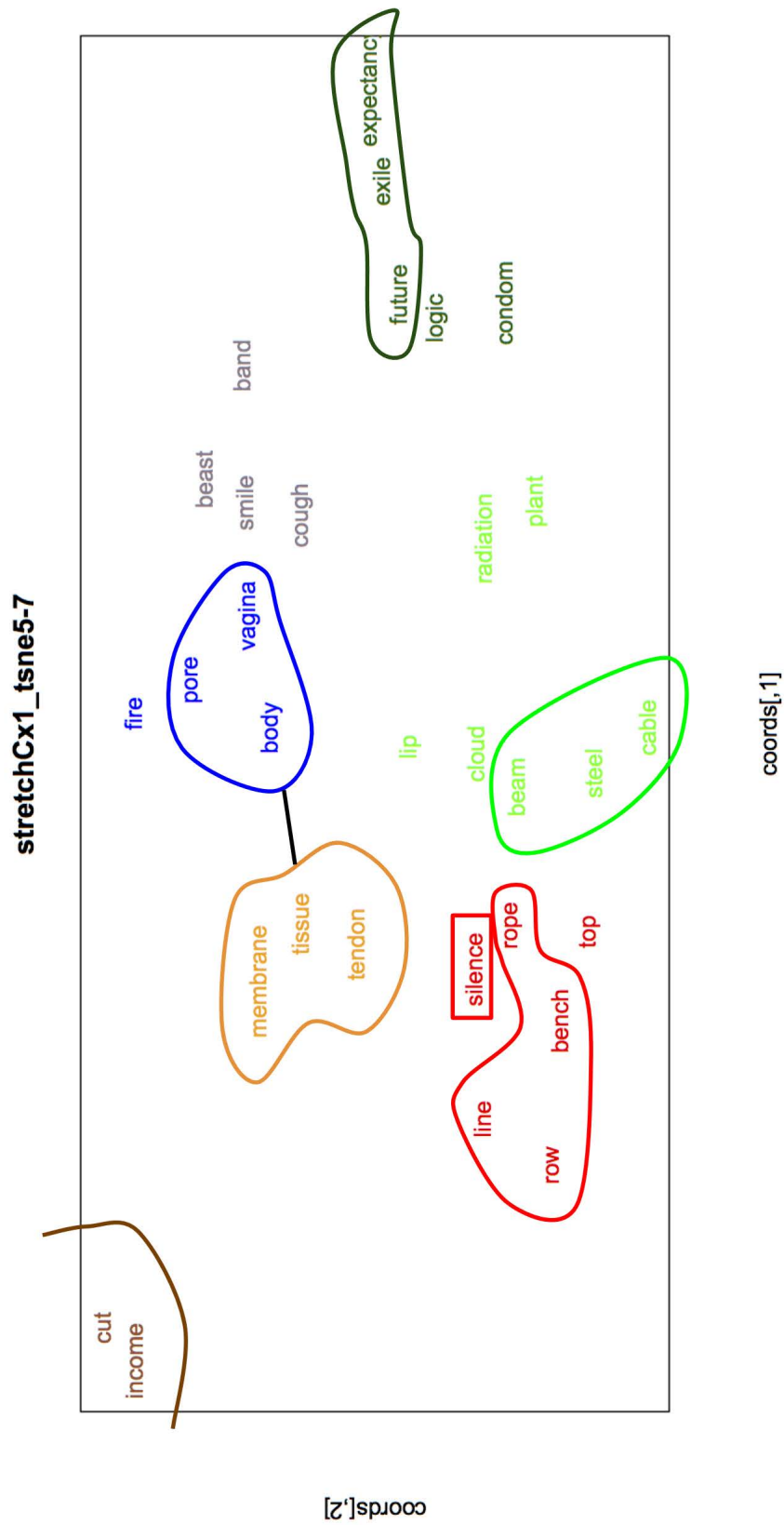
Figure 7.41: Themes that occur with *stretch* in the intransitive non-causative construction

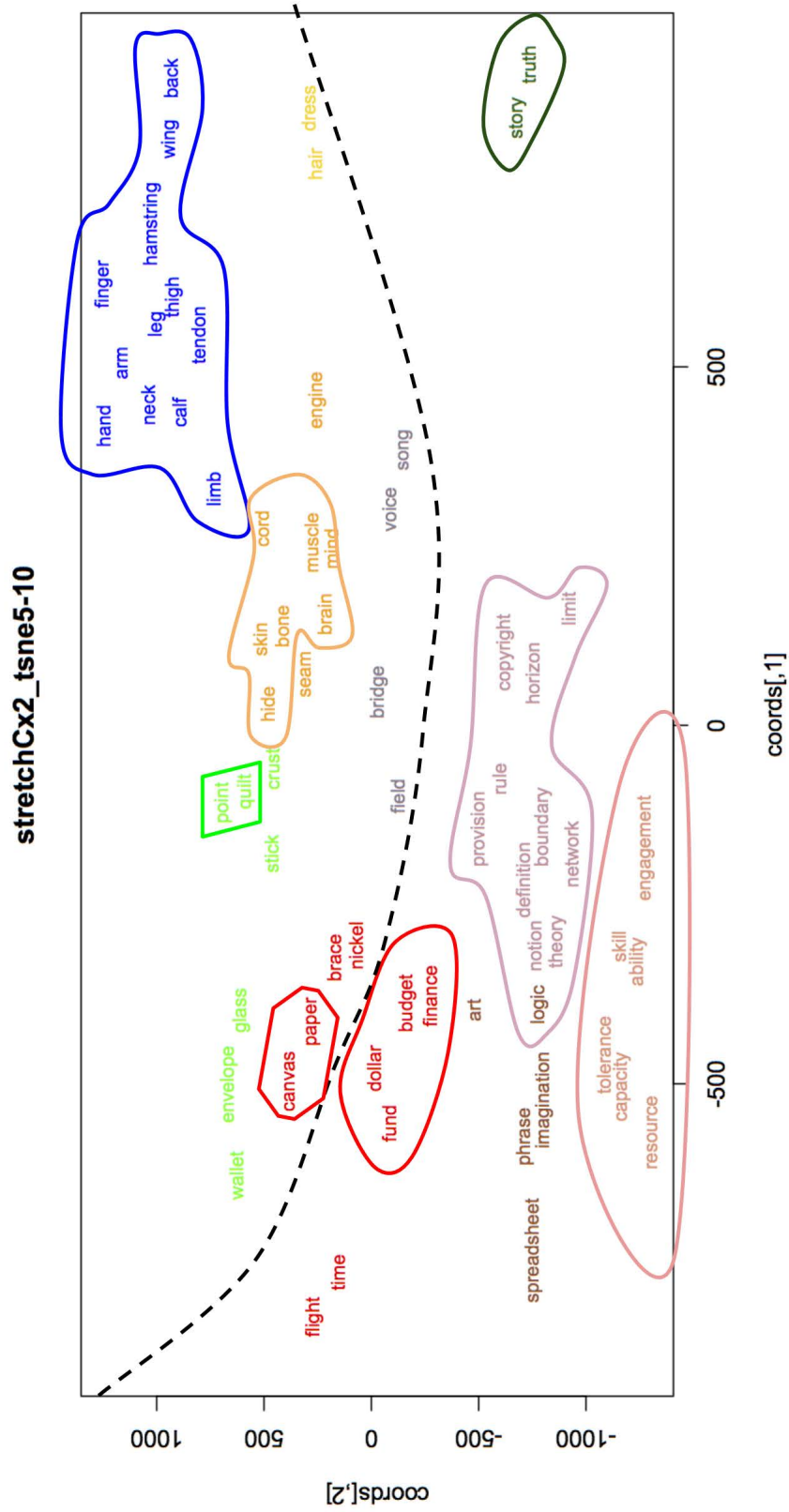

Figure 7.42: Themes that occur with *stretch* in the transitive causative construction

construction, on the other hand, people are stretched morally and/or psychologically, as shown in (282). The definitions used here are adapted from those of the OED online.

(281) **Group 1:** “extend one’s body or body part to its full length”

a. With the intransitive non-causative construction:

- i. Sharing a bed was just a way of life, but as **she** stretched luxuriously without bumping into anyone she thought how nice this was.

(282) **Group 2:** “make great demands on someone’s abilities”

a. With the transitive causative construction:

- i. And so they cajoled us, and stretched **us** and guilt-tripped us into being better people [...]

As to body parts, they can be found both with the intransitive non-causative construction and the transitive causative construction, but as is clearly visible from the semantic maps in Figure 7.41 and Figure 7.42, they are completely different body parts, with the exception of *tendon*, which is shared by the two constructions. Body parts that are used with the intransitive non-causative construction are more related to skin or tendons than to the body as a whole, e.g. *tissue*, *pore* or *vagina*, as shown in the example in (283). As to the transitive causative construction, it is found with limbs and muscles such as *arm*, *leg* or *hamstring*, as shown in example (284). The definitions used here are adapted from that of the OED online.

(283) **Group 3:** “become longer or wider without breaking”

a. With the intransitive non-causative construction:

- i. But for the most part, [the **vagina**]’s designed to stretch then return to its shape.

(284) **Group 1:** “extend one’s body or body part to its full length”

a. With the transitive causative construction:

- i. He recommends stretching your **calves**, **hamstrings**, lower **back**, **hips** and **shoulders**.

Therefore, with the intransitive non-causative construction we find parts of the body that stretch naturally, whereas the transitive causative construction recruits themes that refer to body parts that people stretch willingly, thus suggesting a subtle difference in the meaning of *stretch* with these groups of themes depending on the construction it is used with.

Another group of themes that seems to be shared by the two constructions is made up of themes that are related to MONEY. However, only one such theme can be seen on Figure 7.41: *income*, whereas there is an actual cluster of MONEY themes on Figure 7.42 with themes such as *fund*, *budget* and *finance*. Again, there seems to be a slight nuance in the meaning of *stretch* with these themes depending on the construction it is used with, which is actually clearly captured by the definitions given in the online version of the OED, as shown in examples (285) and (286).

- (285) **Group 4:** “(of finances or resources) be sufficient or adequate for a certain purpose”
- a. With the intransitive non-causative construction:
 - i. No way could Annie’s **income** from waitressing stretch to cover a fulltime nurse while she was away.
- (286) **Group 5:** “make great demands on the capacity or resources of”
- a. With the transitive causative construction:
 - i. Club projects stretched municipal operating **budgets** and kept migrants connected to their places of origin.

All the other clusters created by t-SNE are specific to either one construction or the other. First off, with the intransitive non-causative construction, we find a group of themes which refer to things that actually stretch over time, such as *future*, *exile* or *expectancy*, plus *silence*, which, even though it is not placed in the same location on the map also stretches over time. A couple of examples are provided in (287).

- (287) **Group 6:** “extend over a period of time”
- a. With the intransitive non-causative construction:
 - i. As that **exile** stretched in time, [...]
 - ii. **Silence** stretched between them.

Secondly, a number of themes found with the transitive causative construction refer to limitations such as *rule*, *boundary*, and *definition* (cf. Figure 7.42). These are found in the light magenta cluster in Figure 7.42. We provide a couple of examples in (288) below to help illustrate the meaning taken on by *stretch* when used with these themes, which we defined as “extend the scope of.”

- (288) **Group 7:** “extend the scope of”
- a. With the transitive causative construction:
 - i. Cole is only one of thousands who are stretching the **definition** of mechanical engineering.
 - ii. [...] a dirty daydream can help stretch your sexual **boundaries** and let you explore hidden desires without consequences.
 - iii. Olbermann’s popularity and evolving image as an ideologue has led NBC News to stretch traditional **notions** of journalistic objectivity.

A third (small) cluster contains the themes *truth* and *story*, which are both used with *stretch* in the transitive causative construction with the meaning “modify to some extent,” as shown in the examples in 289 below.

- (289) **Group 8:** “modify to some extent”
- a. With the transitive causative construction:

- i. I was torturing the **story**, stretching **it** to accommodate ever more of those things-in-the-world that impinge on the enterprise of fiction.
- ii. “Do you ever lie?” [...] “Yes. Yes. I stretch the **truth** a smidge or, you know, something like that.”

Another cluster was identified by t-SNE which contains themes such as *tolerance*, *capacity*, *resource*, *skill*, *ability* and *engagement*. Although they seem rather related at first glance, and their polysemy leads them to be clustered together, they are not necessarily used with the same meaning of *stretch*. However, at least two of them are used with the same meaning which is close to “refine” in these contexts, as illustrated in the examples in (290).

(290) **Group 9:** “(of capacities) refine”

- a. With the transitive causative construction:
 - i. [...] as you push binoculars to their limit and stretch their **ability** to discern detail.
 - ii. I’m putting in a lot of time, stretching my **skills**, and trying the unfamiliar – even if it makes me uneasy.

Going back to the intransitive non-causative construction, we find two clusters of themes such as *line*, *rope*, *beam*, and *cable* which all refer to long objects which stretch in size, as in (291a).

(291) **Group 3:** “become longer or wider without breaking”

- a. With the intransitive non-causative construction:
 - i. The **rope** had stretched.
 - ii. **Cables** stretch, derailleurs stop shifting crisply, spoke tension changes, and bearings loosen.

While it is probably not impossible to find instances of these themes with *stretch* in the transitive causative construction, they are nevertheless not found in our corpus. This may reinforce the idea that such nouns refer to objects that have an inherent ability to stretch due to their shape and size.

The last group may actually be the only group (with the exception of *tendon* for body parts) with which the meaning of *stretch* is constant over the two constructions. Otherwise, we either find groups of themes that seem to be shared by the two constructions but which are actually used with different meanings of *stretch*, depending on which construction they occur in (such as BODY PART or MONEY) or groups that are specific to one construction only, and give *stretch* a specific meaning such as “extend over a period of time” for things such as *silence* or “modify the scope of” for *definition* and *boundary*.

7.4.6 *Thicken*

Thicken is significantly attracted to the intransitive non-causative construction, and also displays more variety in the themes recruited in this construction than its transitive counterpart, as reported in Table 7.28. Although we found approximately the same number of different themes

with *thicken* as with *stretch*, *thicken* has a much higher degree of overlap, namely 14% (against 2.78% for *stretch*). As such, we should expect more shared meaning between the two constructions.

<i>thicken</i>			
Instances retained	269	Themes	100
Instances of Cx1	213	Cx1 themes	82
Instances of Cx2	56	Cx2 themes	32
Preferred construction	Cx1	Theme overlap (in %)	14%

Table 7.28: Characteristics of *thicken*

One of the first things we notice both from Figure 7.43 and Figure 7.44 is the clear demarcation between nouns referring to food and all the other nouns. This separation is highlighted by the black dashed line on both semantic maps. More specifically, these nouns refer to LIQUID OR CREAMY FOOD, and quite a few of these themes are shared by the two constructions: *curry*, *gravy*, *milk*, *mixture*, *sauce* and *soup* are found with both constructions. Admittedly, the LIQUID OR CREAMY FOOD cluster is slightly more populated on the semantic map that corresponds to the intransitive non-causative construction, but as mentioned before, *thicken* occurs more frequently with the intransitive non-causative construction than with its transitive counterpart, which may explain the slight difference in the number of LIQUID OR CREAMY FOOD themes on each map. A few examples of this group are provided below.

(292) **Group 1:** with LIQUID OR CREAMY FOOD/PRODUCTS, “become or make less liquid”

- a. With the intransitive non-causative construction:
 - i. Add milk and continue to cook until **gravy** thickens, still stirring constantly, about 7 minutes.
 - ii. The bubbles become small and heavy as the **syrup** thickens.
- b. With the transitive causative construction:
 - i. Thicken **gravy** with soft, fresh, extra-fine bread crumbs [...]
 - ii. We’re using old bread to actually thicken this **soup**.

As becomes apparent from these examples, the sense of *thicken* here is “to make or become less liquid.” This sense is obviously specific to liquid and or creamy things but in our corpus it also appears to be restricted to food items.

This meaning of *thicken* is part of a sub-group of meanings associated with this verb i.e. to thicken in terms of density as opposed to its meaning with other themes for which the thickening event implies a change in the general size. For example, things such as *hair*, *blanket*, *layer*, or *body* become larger as a result of the thickening process, as illustrated in the examples in (293) below.

(293) **Group 2:** with various themes, “become or make larger”

- a. With the intransitive non-causative construction:
 - i. Her **body** was beginning to change, to thicken.
 - ii. [...] the coyote grew and its **neck** thickened, causing the wire to cut into its flesh.

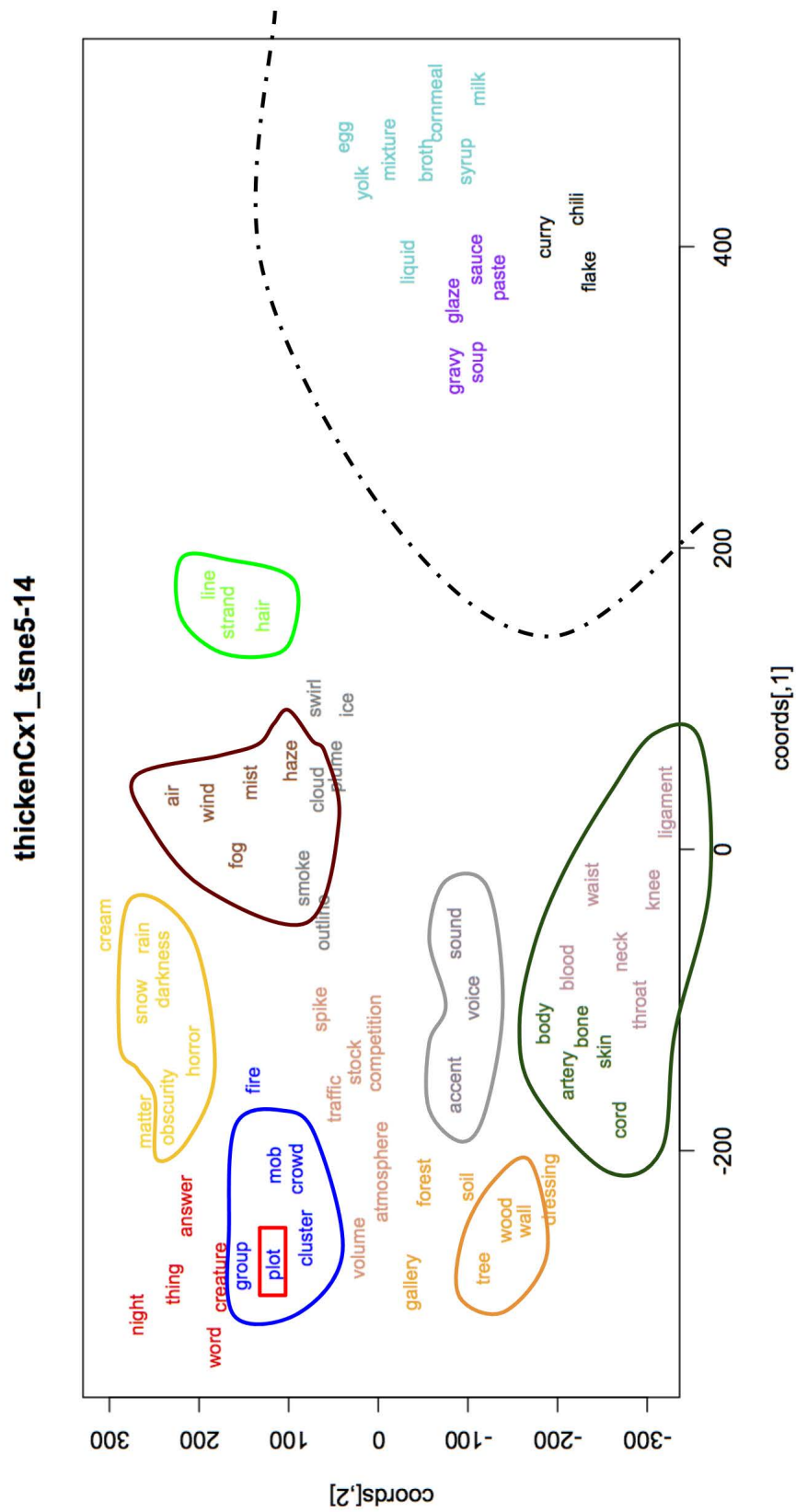
Figure 7.43: Themes that occur with *thicken* in the intransitive non-causative construction

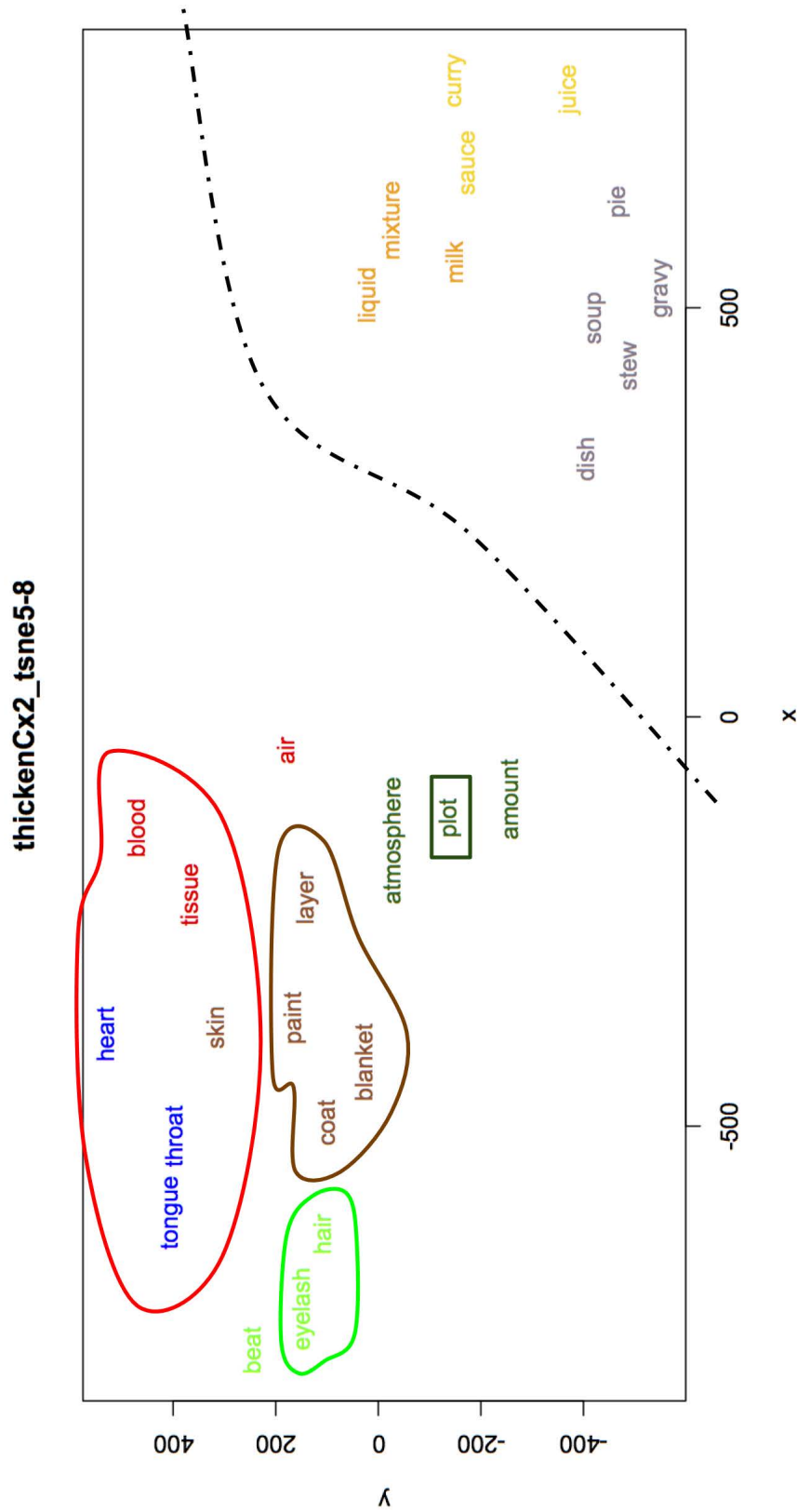

Figure 7.44: Themes that occur with *thicken* in the transitive causative construction

- iii. Those strands of connective **tissue** thicken with age [...]
- b. With the transitive causative construction:
 - i. A new kind of cell layer, called the endocardium, would have lined the **heart**, thickening **it** and making it more powerful.
 - ii. [Cornstarch] just thickens the **coat**, fluffs it up [...]
 - iii. He applied a final layer of transparent color [...] to thicken the **paint** [...]

In all these examples, it may be the case that the theme undergoes a change in its density, but most importantly it undergoes a change in size. When the coyote's neck thickens in (293a-ii), it actually becomes larger or wider. The same applies to all the examples above. This sense of *thicken* is shared by the two constructions, and works with different clusters of nouns, as they were identified by t-SNE, such as BODY PARTS, HAIR or LAYER (as in example (293b-iii), for instance).

There is one more sense of *thicken* that is shared by the two constructions although only one instance was found with the transitive causative construction, and it is the idiomatic expression “the plot thickens,” as shown in examples (294a) and (294b) below.

(294) **Group 3:** with *plot*, “become (or make) more complex”

- a. With the intransitive non-causative construction:
 - i. What is crucial in such entertainment is that things happen, **plots** thicken.
- b. With the transitive causative construction:
 - i. Plenty of **plots** to thicken here.

In these cases, the meaning of *thicken* is somewhat more difficult to parse but it is equivalent to “become (or make) more complex,” and it is exclusive to the theme *plot* since the combination of this verb and this theme is considered an idiomatic expression. It is interesting to note that the expression is usually listed as an intransitive non-causative construction, but here it seems to have been extended to the transitive causative construction. A quick query on both COCA and the Corpus of Historical American English, which contains over 400 million words from texts dating from 1810 to 2000 (Davies 2000), shows that there are attestations of the intransitive non-causative construction [*the plot* THICKEN] back in 1820 but for the transitive causative construction [SUBJ. THICKEN *the plot*], we only found one instance in 1950 and 11 instances between 1990 and 2017, whereas there are at least 94 instances of the intransitive non-causative construction in COCA, that spread from 1990 to 2017. It is difficult to draw solid conclusions as to what this may mean with regards to the causative alternation and the shared meaning between the two constructions. However, since a plot is mostly a human creation, it is not difficult to conceive of it as being potentially controlled by an exterior force that could “thicken” it easily.

A group appears on Figure 7.43 that contains things such as *mist*, *fog*, *haze*, *cloud* and *smoke*. These themes correspond to the subsense of *thicken* that implies an increase in density. That is, with these themes, the thickening event implies a bigger concentration of the particles that make up the mist, fog or smoke, but the mist, fog or smoke do not necessarily spread out or increase their size. A few examples of the use of *thicken* with these themes are provided in (295) below.

(295) **Group 4:** with GAS OR VAPOR-LIKE ELEMENTS, “become more dense”

- a. With the intransitive non-causative construction:
 - i. The jade burns for hours, the **smoke** thickens and spreads.
 - ii. The **haze** had thickened and I inhaled the sharp dry smell of autumn.

We see in (295a-i) that the thickening and spreading events are distinctly mentioned, although they appear to co-occur, one does not necessarily correlate with the other. The smoke could spread without thickening and thicken without spreading.

There are two nouns that are similar to these and which are shared by the two constructions: *air* and *atmosphere*, as illustrated in (296a) and (296b).

(296) **Group 5:** with *air* and *atmosphere*, “become denser with different particles”

- a. With the intransitive non-causative construction:
 - i. After the pummeling subsided about 4 billion years ago, the **atmosphere** thickened, oceans formed, and the first life emerged.
 - ii. Feels as if the air is thickening somehow, becoming more difficult to breathe.
- b. With the transitive causative construction:
 - i. [...] plumes of blue smoke rise upward to thicken the already hazy **atmosphere** [...]
 - ii. This daily parade of combustion engines clogs the city streets and thickens the **air** [...]

Air and *atmosphere* are the only two members of the GAS OR VAPOR-LIKE ELEMENTS group that are used as themes in the transitive causative construction. In point of fact, they differ slightly from the other elements in the group in that they do not necessarily thicken in the same way. As a matter of fact, when elements such as *fog* or *smoke* thicken, it simply requires that the density of the particles that make up the fog or smoke increase. However, it seems that in order for the air or the atmosphere to thicken, it requires the intervention of particles that are not construed as normal elements constituting the air or atmosphere. This is most visible in the following examples (297-298) where the element that participates in the thickening event is expressed in an oblique in the shape of a *with*-prepositional phrase.

(297) The very **air** was thickening *with smoke from the burning citadel*.

(298) The **air** thickened *with the will of his temperamental genius*.

(299) [...] the **air** thickened *with the odor of three-day-old garbage* [...]

In this respect, *air* and *atmosphere* differ from other similar nouns such as *fog*, *mist* and *smoke*.

The next group is composed of themes such as *group*, *mob*, *cluster* and *crowd* which all refer to groups of things or people. These themes, which we label GROUP thicken by becoming more populated, the size of the group or cluster does not necessarily change but the number of its constituting members increases. Again, this group is only found with the intransitive non-causative construction as it is difficult to conceive of such entities as being acted upon in a

thickening event. A couple of examples are provided in (300) to illustrate this particular meaning of *thicken*.

(300) **Group 6:** with GROUPS, “become more populated”

- a. With the intransitive non-causative construction:
 - i. I looked at the **mob**, saw **it** was thickening.
 - ii. [...] as the **crowd** thickened, their electrical contact with one another allowed the jolts to spread through the entire throng [...]

The last group, which is also exclusively found with the intransitive non-causative construction, is composed of *accent*, *voice* and *sound*. This group is labelled SOUNDS, and although the instances found in our corpus do not allow a very specific sense of *thicken* to emerge, it seems to denote a change in the quality of the sound due to an emotional charge. For example, an accent becomes more pronounced when it thickens, and a voice becomes more loaded with emotions.

(301) **Group 7:** with SOUNDS, “change its quality”

- a. With the intransitive non-causative construction:
 - i. Whenever he gets on a coffee rant, his **accent** thickens [...]
 - ii. She heard her **voice** thicken and swallowed hard.

Overall, seven groups of themes have been identified which correspond to various senses of *thicken*. Out of these seven senses, four are shared by the two constructions. All the themes that are shared by the two constructions exhibit a quality that allows them to be acted upon by an exterior cause in a thickening event. As to the three other groups, there is something in their meaning (in combination with *thicken*) which displays one or two of the following characteristics: (i) they can be construed as co-participating in the thickening event and (ii) they cannot be construed as being acted upon by an exterior cause in a thickening event.

7.5 CHANGE OF TEMPERATURE verbs

The six verbs that form the CHANGE OF TEMPERATURE verbs were selected from Levin’s list of alternating verbs (Levin 1993) and are *burn*, *chill*, *cool*, *freeze*, *heat* and *warm*. The only reason why they were grouped together for this research is that they share one element of meaning which implies a change of temperature in the theme, the entity that undergoes the change of state denoted by the verb. Although Levin did not group them, we find that they share several characteristics. Notably, most of them tend to have their more literal senses shared by the two constructions but the more figurative the sense, the less likely it is to be shared by the two constructions. As is also the case with other verb groups, some of these verb senses are only shared to a certain extent, that is, sometimes one of the constructions recruits fewer themes than the other. Although this in particular is not directly visible from the summary provided in Table 7.29, this table already offers an insight into the various literal and figurative meanings associated with these verbs and how much meaning is shared by the two constructions, which we will discuss in more detail in the following subsections.

BURN	
Intransitive non-causative construction	Transitive causative construction
<i>burn</i>	
1. “be or cause to be destroyed/damaged by fire” 1.0. with BUILDINGS AND PLACES 1.1. with FABRIC and other objects 1.2. with BODY PARTS 1.3. with SKIN: “hurt from exposition to extreme heat” 2 with COMBUSTIBLES: “combust” 3. with IGNITABLE OBJECTS: “consume or be consumed by fire” 4. with FOOD: “overcook” 5. with certain BODY PARTS: “sting or be stung due to overwhelming emotions” 6. with FEELINGS: “be intense” 7. with <i>calorie, fat</i> : “eliminate”	
<i>chill</i>	
1. with various themes, “(cause to) become colder” 2. with INTERNAL BODY PARTS, “(cause to) become colder (metaphorically) due to fear” 2.1 with PEOPLE, “(cause to) be scared or shocked” 3. with MIND STATES and RELATIONSHIPS, “(cause to) deteriorate” 4. with PEOPLE, “relax” 5. with HUMAN ACTIVITIES, “impede, slow down”	
<i>cool</i>	
1. “(cause to) become less hot” 1. “(cause to) become less intense”	
<i>freeze</i>	
1. with WATER-BASED ELEMENTS, “turn to ice” 2. with FOOD, “preserve at a cold temperature” 2.1 with <i>mixture, cream</i> and <i>food</i> 2.2 with all other FOOD items 3. with BODY PARTS, “make numb with cold” 4. with FLORA, “become rigid with cold” 5. with MOVING IMAGES, “(cause to) become motionless” 6. with ANIMATES and BODY PARTS, “become still” 7. with MONEY, “hold at a given level” 8. with ACTIVITY, “block, immobilise”	
<i>heat</i>	
1. “(cause to) become warm”	
<i>warm</i>	
1. “(cause to) become warm(er)” 1.1 with NATURAL ELEMENTS 1.2 with BODY PARTS 1.3 with OBJECTS & PLACES 1.4 with FOOD 2. “(cause to) become warm(er) metaphorically” 2.1 with RELATIONS, “(cause to) become more friendly” 2.2 with <i>heart</i> and <i>soul</i> , “(cause to) feel better”	

Table 7.29: CHANGE OF TEMPERATURE verbs: shared and construction-specific verb senses

7.5.1 *Burn*

The first of the TEMPERATURE verbs we will discuss is *burn*, which is significantly attracted to the intransitive non-causative construction but is nevertheless more frequently found with the transitive causative construction. It has a rather high degree of overlap, with 13.87%, as visible from Table 7.30. As we will see below, most of the senses associated with *burn* are shared by the two constructions, which may be due to the fact that this verb is not too constrained as to the themes it recruits: many things can burn or be burned, at least in the literal sense of *burn*, which implies fire.

<i>burn</i>			
Instances retained	639	Themes	274
Instances of Cx1	281	Cx1 themes	141
Instances of Cx2	358	Cx2 themes	171
Preferred construction	Cx1	Theme overlap (in %)	13.87%

Table 7.30: Characteristics of *burn*

Since most senses of *burn* are shared, we will start with the most literal senses, those that imply an open flame, and we will progressively move towards more figurative senses of *burn*.

One of the first and most substantial groups identified for both constructions is the BUILDINGS AND PLACES cluster, which is truly shared by the two constructions (cf. Figure 7.45 and Figure 7.46). It is used with a sense of *burn* that is labelled “be or cause to be destroyed by fire” in the OED online. As illustrated in examples (302a) and (302b), the sense of *burn* is constant over the two constructions. However, of course, the choice of construction changes the perspective, in the intransitive non-causative construction the cause of the burning event is unknown or irrelevant while in the transitive causative construction, more emphasis is put on the cause.

(302) **Group 1:** with BUILDINGS AND PLACES, “be or cause to be destroyed by fire”

- a. With the intransitive non-causative construction:
 - i. At least 21 people have died there, and more than 1,600 **homes** have burned.
 - ii. [...] as the Marina **District** burned [...]
- b. With the transitive causative construction:
 - i. In a fit of moralistic fervor, they burned his **barn** and expelled him from their midst.
 - ii. He has plundered our seas, ravaged our coasts, burnt our **towns**, and destroyed the lives of our people.

There are many other things that can burn or can be burned, and they are too varied to be put into one cluster, since there are virtually no particular features associated with “burnability.” Among these various themes, however, a cluster emerges: the FABRIC group, with themes such as *cloth, dress or shirt, uniform, bra* etc. Although this cluster is shared by the two constructions, it is much more densely populated on the semantic map for the themes that occur with the transitive construction, which means that this sense is probably more productive with this construction

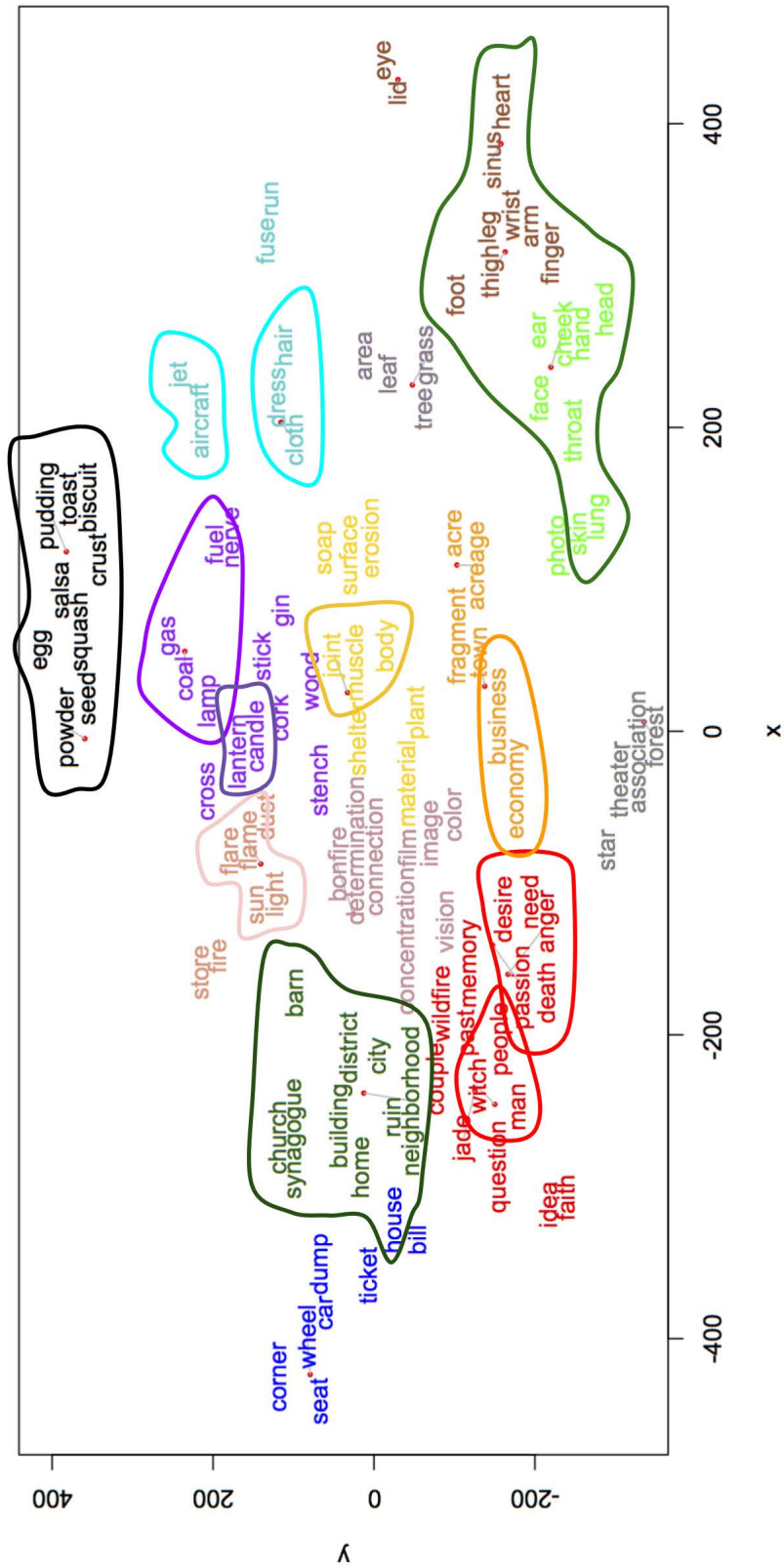

Figure 7.45: Themes that occur with *burn* in the intransitive non-causative construction

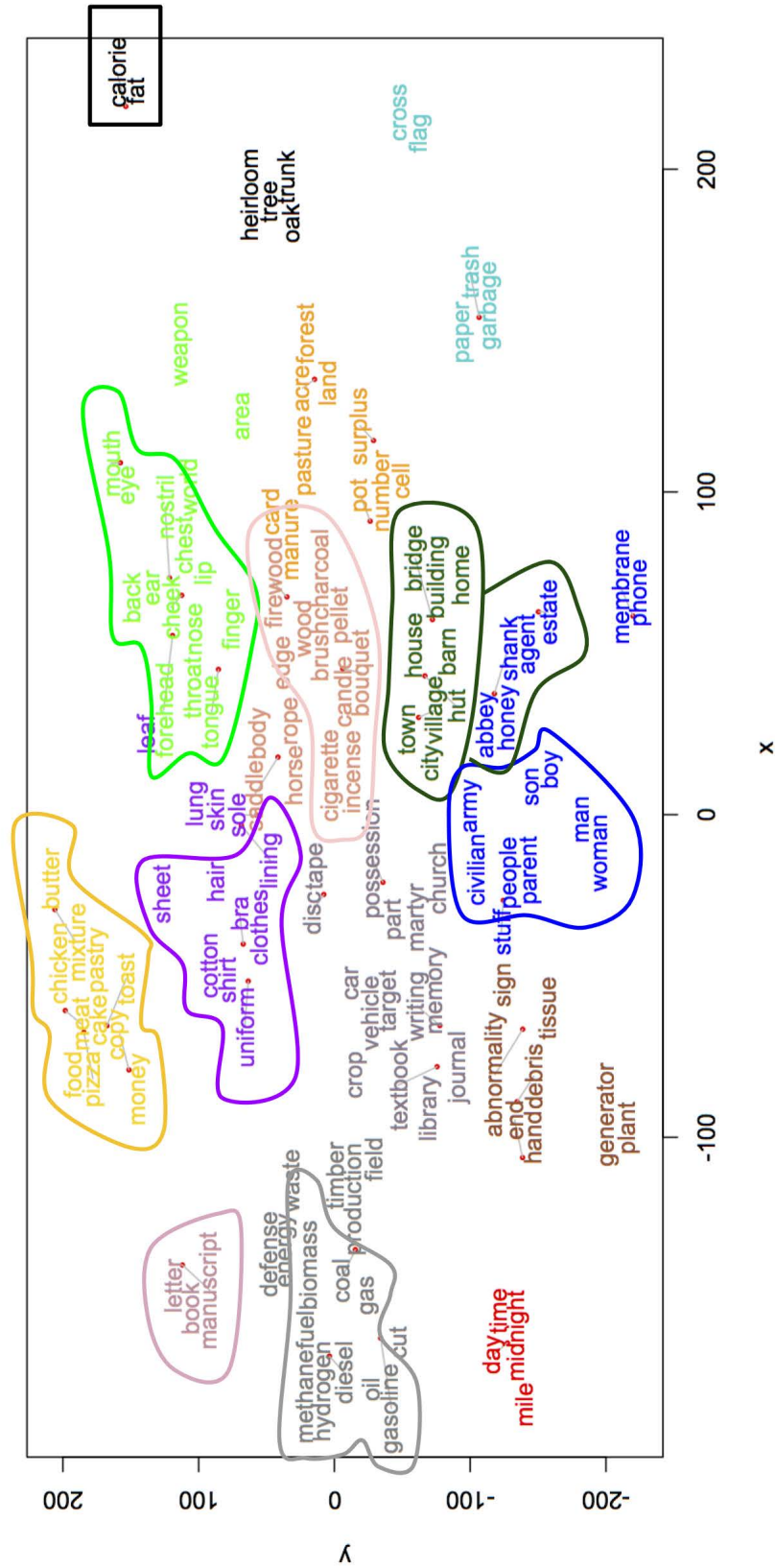

Figure 7.46: Themes that occur with *burn* in the transitive causative construction

than its intransitive non-causative counterpart. The sense of *burn* associated with these themes is virtually the same as that of group 1, but is less specific. The reason why we decided to separate this group from the group of BUILDINGS AND PLACES is that the latter is quite preponderant on both maps, whereas group 1.1, illustrated below in (303), is more varied. Since these groups are found with the same sense of *burn* and that both groups of themes are shared between the two constructions, this group was labelled group 1.1.

- (303) **Group 1.1:** With FABRIC and other themes, “be or cause to be destroyed by fire”
- a. With the intransitive non-causative construction:
 - i. [...] my grandma’s wedding **dress** that mostly burned in a fire.
 - ii. [...] the locomotive slammed the little **car** 200 feet into a ravine, where **it** burned.
 - b. With the transitive causative construction:
 - i. [...] how a woman who had burned **bras** and been arrested for protesting the Vietnam War [...]
 - ii. It was assumed Robert Lincoln burned [the **letters**] [...]

The examples in (303a-i) and (303b-i) contain FABRIC themes, and the other two ((303a-ii) and (303b-ii)) are examples of other various themes that *burn* in the same way.

As with many other verbs, t-SNE clustered together a group of BODY PARTS with each construction. While this makes sense, we also find that there are three different meanings associated with *burn* with these themes. The first two associated with group 1, but yet differ slightly, hence their division into 1.2 and 1.3. The first is rather straightforward: a body part may burn or be burned with fire, as illustrated in (304). This sense seems to be specific to the transitive causative construction, but our limited data points do not allow for too broad a conclusion in this regard. As to the burning event, it can be seen as part of group 1, since in this particular case, the forehead is damaged by fire.

- (304) **Group 1.2:** with BODY PARTS, “be or cause to be damaged by fire”
- a. Then they burnt my **forehead** with a cigarette.

As to the second sense, it is used as a hyperbole, that is, the skin is exposed to intense heat but the event does not necessarily imply actual damage to the skin, it may be limited to pain, as illustrated in (305). Therefore, this is deemed to be part of group 1, and thus labeled 1.3.

- (305) **Group 1.3:** with SKIN, “hurt from exposition to extreme heat”
- a. The steering wheel burns his **fingers** [...]

Another clearly identifiable group is shared by the two constructions which contains themes such as *gas*, *fuel* and *coal* which are all kinds of COMBUSTIBLES. They too imply the presence of an actual flame to burn or be burned and the associated sense of *burn* is “combust.”

- (306) **Group 2:** with COMBUSTIBLES, “combust”
- a. With the intransitive non-causative construction:

- i. [...] but the **coal** burns in the 1,500s Fahrenheit.
- b. With the transitive causative construction:
 - i. Whittle predicted that a system of turbines and compressed air that burned vaporized **fuel** would make propellered craft obsolete.

The COMBUSTIBLES cluster is more densely populated on Figure 7.46, and there are a few more occurrences with the corresponding transitive causative construction than with the intransitive non-causative construction (cf. also the smaller cluster on Figure 7.45).

A third group was identified which is close to the COMBUSTIBLES group, but is made up of objects that are meant to burn/be burned. That is, their function is to actually burn or be burned. They are themes such as *candle*, *incense* and *cigarette*. We decided to group them under the label IGNITABLE OBJECTS, and the verb sense associated with this group is “consume or be consumed by fire.” These are illustrated in the examples in (307) and (308).

(307) **Group 3:** With IGNITABLE OBJECTS, “consume or be consumed by fire”

(307) With the intransitive non-causative construction:

- a. [...] and before that shrine, a **candle** always burns [...]

(308) With the transitive causative construction:

- a. She [...] burned a votary **candle** she kept for such occasions.
- b. She burns a different **incense** everyday [...]

There are many other themes used with both constructions that denote a burning event that does not necessarily require fire, among which the FOOD group. The sense of *burn* as used with this particular group corresponds to “overcook.” A few examples are provided in (309).

(309) **Group 4:** with FOOD, “overcook”

a. With the intransitive non-causative construction:

- i. If [...] the Yorkshire **pudding** burns you can always send out for a pizza
- ii. I can smell the **toast** burning, Josh.

b. With the transitive non-causative construction:

- i. [...] if you burnt a **cake**, you learned.
- ii. Big Bill burnt frozen fried **chicken** for dinner.

Once more, the cluster of FOOD themes is more densely populated on the transitive causative construction map, which may be due to the fact that such events are usually construed as implying human responsibility to some extent, and thus an external cause.

The fifth group is based on the third sense associated with BODY PARTS (cf. groups 1.2 and 1.3 above) and has to do with emotions, that is, body parts such as *eye* and *cheek* are construed as burning when someone is overwhelmed by emotions, as illustrated in examples (310a-310c).

- (310) **Group 5:** with certain BODY PARTS, “sting or be stung due to overwhelming emotions”
- a. Hot tears burned his **eyes**.
 - b. Gerek’s **cheeks** burned with humiliation.
 - c. I felt my **cheeks** burning; my heart was pounding.

Although the majority of verb senses identified for *burn* are shared, there are a couple which are specific to one construction. For instance, t-SNE isolated a cluster of themes that occur with the intransitive non-causative construction only and correspond to FEELINGS (cf. Figure 7.45), with themes such as *anger*, *desire* and *passion*. With these themes, the sense of *burn* is very different from all other senses identified so far. It is a metaphorical use of *burn* where certain aspects of a literal burning event are kept which are close to group 3 in that a feeling may be seen as a candle: it must be kept burning, you can revive it, and sometimes it may lead to (emotional) injury. A few examples are provided in (311) below.

- (311) **Group 6:** with FEELINGS, “be intense” (intransitive non-causative construction only)
- a. **Anger** burned in my chest.
 - b. But that **determination** still burns in her.

The next set is limited to two items: *calorie* and *fat*. It is limited to the transitive causative construction, and the sense associated with *burn* here is “eliminate.” This verb sense is close to that of group 2 since *calorie* and *fat* are construed as being the fuel that allows the body to function; therefore, they are metaphorically related to the themes in group 2. One example of each theme is provided in (312).

- (312) **Group 7:** with *calorie*, *fat*, “eliminate”
- a. [...] dancing can burn as many **calories** as walking, swimming or riding a bicycle.
 - b. But a friend said I would burn more **fat** by doing strength training before cardio.

All in all, we identified seven different senses of *burn*, five of which are shared. What is most notable about *burn* is that when used in a literal or near-literal sense (i.e. events that imply heat), it is shared by the two constructions. However, the two senses of *burn* that are not shared are metaphorical uses of *burn*, such as *be intense* when used with FEELINGS.

7.5.2 *Chill*

Chill is significantly attracted to the transitive causative construction, and it is also much more frequently found with this construction. As indicated in Table 7.31, there are 421 instances of *chill* used with the transitive causative construction in our corpus, against 97 instances with the intransitive non-causative construction. This also results in different numbers of themes with each construction, with 28 themes in the intransitive non-causative construction and 188 themes in the transitive causative construction.

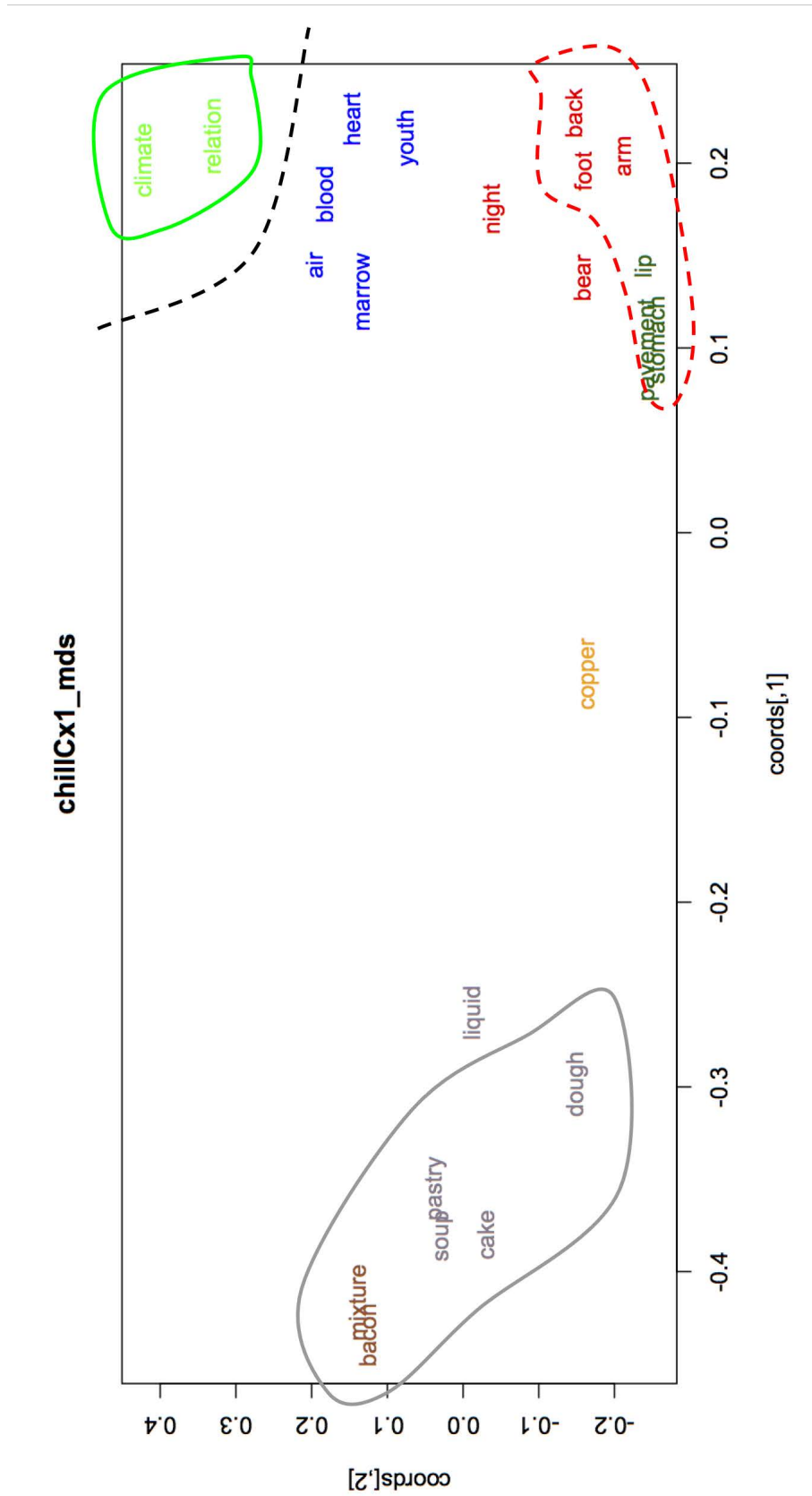

Figure 7.47: Themes that occur with *chill* in the intransitive non-causative construction

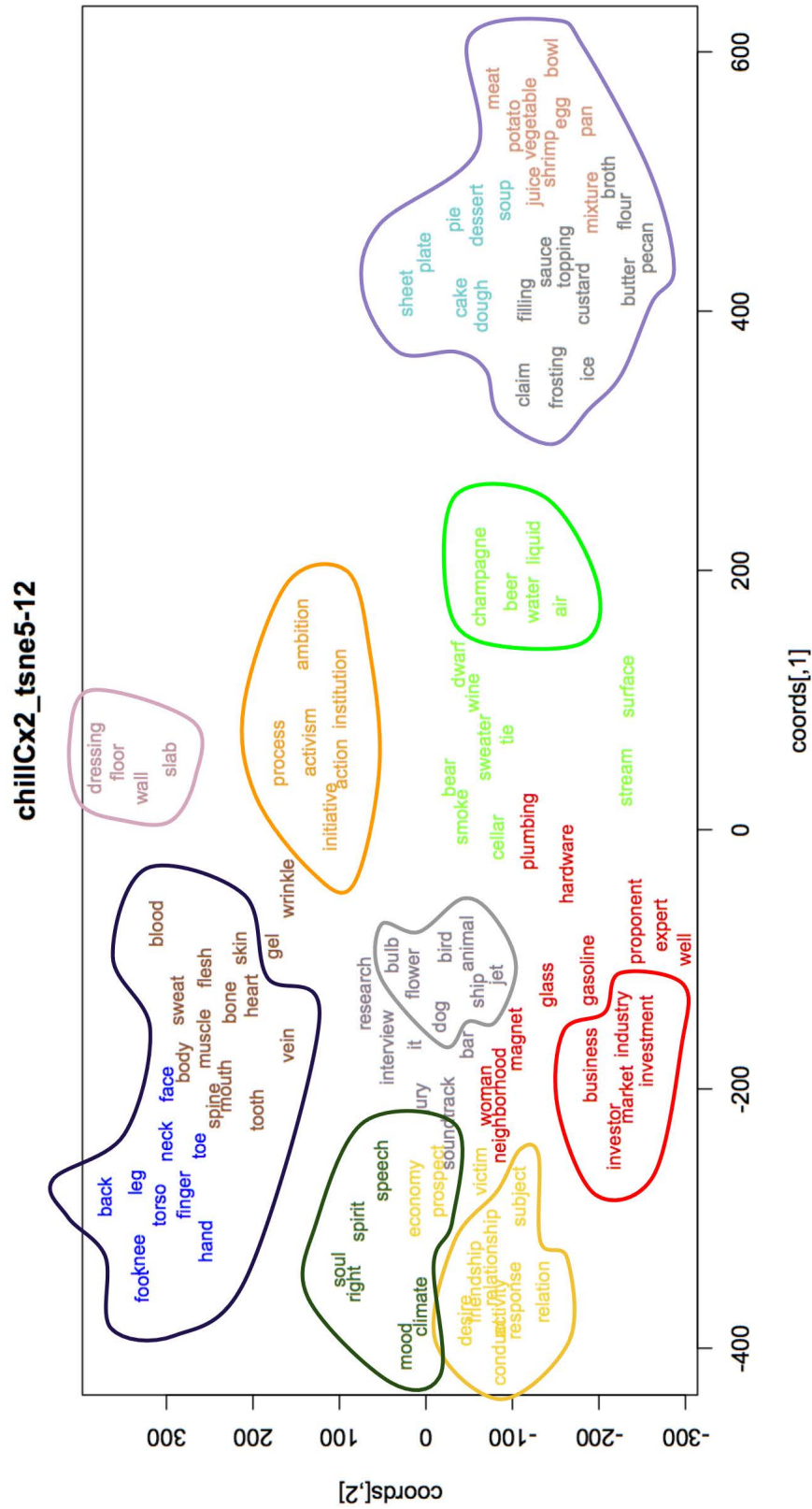

Figure 7.48: Themes that occur with *chill* in the transitive causative construction

<i>chill</i>			
Instances retained	518	Themes	201
Instances of Cx1	97	Cx1 themes	28
Instances of Cx2	421	Cx2 themes	188
Preferred construction	Cx2	Theme overlap (in %)	7.46%

Table 7.31: Characteristics of *chill*

As was the case for *burn*, we found that when *chill* is used with a literal meaning, it is shared by the two constructions. However, the further we go from the literal meaning of this verb, the less it is shared. We identified five different senses for *chill* altogether, three of which are shared.

Among the shared verb senses of *chill*, the first and most literal one is “(cause to) become colder.” This sense is found with a multitude of different themes, with both constructions. Since it is one of the most productive senses of *chill*, we provided examples for each group of themes that was identified by t-SNE and that corresponds to this meaning. First off, in (313a), *chill* is used in combination with EXTERNAL BODY PARTS (which differ from INTERNAL BODY PARTS as we will see below). In (313b) and (313c), it is used for various kinds of FOOD and LIQUIDS respectively. Finally, since there are a few other themes that are a little too varied to be automatically grouped together, we give a couple of examples of other themes used with *chill* in the sense “(cause to) become colder” in (313d).

(313) **Group 1:** with various themes, “(cause to) become colder”

- a. With EXTERNAL BODY PARTS
 - i. What time she spent was in layering up her legs and pulling on sheepskin boots, so that her **feet** didn’t chill without her knowing it.
 - ii. The cold, wet slime-covered wall chilled her **back** as it penetrated the wool of her gown.
- b. With FOOD:
 - i. After **dough** has chilled, roll refrigerated half of it out on a floured surface.
 - ii. Up to 1 day ahead, mix, cover, and chill the **aioli**.
- c. With LIQUIDS:
 - i. [...] the small volume of **liquid** that spills lukewarm from my eye has chilled completely to become cool by the time it flows into my ear [...]
 - ii. If you need more room in the cooler, chill the **beer** and **sodas** in the stream.
- d. With other themes:
 - i. As the **night** chilled, the game neared its end [...]
 - ii. [...] a rock pool decorated with flowers chills the massive wine cellar perched above.

Something that is not necessarily visible from the examples above, but is more striking when we compare the semantic maps in Figure 7.47 and Figure 7.48, is that for most of the

themes mentioned in (313a-313b), the number of similar themes is much bigger for the transitive causative construction, showing a certain amount of discrepancy in the productivity of these two constructions.

As we mentioned before, EXTERNAL BODY PARTS and INTERNAL BODY PARTS are not used with the same sense of *chill*, that is, they do not chill in the same way. While EXTERNAL BODY PARTS are found with the literal meaning of *chill*, INTERNAL BODY PARTS are found with a metaphorical sense of *chill*. As shown in the examples in (314), the sensation of cold that is felt is actually associated with fear, following the FEAR IS COLD conceptual metaphor (Lakoff and Johnson 1980). We also find this sense of *chill* with pronouns and proper names, mostly in the transitive causative construction, cf. (315).

- (314) **Group 2:** with INTERNAL BODY PARTS and PEOPLE, “(cause to) become colder (metaphorically), due to fear”
- a. With the intransitive non-causative construction:
 - i. I might have said the **marrow** in my bones had chilled, had it not already frozen in despair.
 - b. With the transitive causative construction:
 - i. Sparhawk broke off as a sudden thought chilled his **blood**.
- (315) **Group 2.1:** with PEOPLE, “(cause to) be scared or shocked”
- a. **Jada** chilled suddenly, and she hugged her knees to steady herself.
 - b. The thought of the corpse on the floor and the man it had been chilled **me**.

Examples (315a) and (315b) show the use of *chill* in this sense with PEOPLE, but as we will see later, *chill* is also found with PEOPLE with an opposite meaning.

Before we move on to senses of *chill* that are not shared, let us take a look at the last sense that is shared and can also be seen as a metaphorical extension of the literal meaning of *chill*: “(cause to) deteriorate.” This sense is found with themes that refer to MIND STATES and RELATIONSHIPS such as *mood* and *friendship*.

- (316) **Group 3:** with MIND STATES & RELATIONSHIPS, “(cause to) deteriorate”
- a. With the intransitive non-causative construction:
 - i. But for now, **relations** have chilled.
 - b. With the transitive causative construction:
 - i. The drive flare that cut across the constellation chilled his good **mood**.
 - ii. And it has chilled **friendships** among the principal players [...]

Again, this sense of *chill* is more productive in the transitive causative construction; in our corpus it was only found with *relation* in the intransitive non-causative construction.

Now that we have covered all three senses of *chill* that are shared, we will move on to those that are not. The first is specific to the intransitive non-causative construction and to themes

referring to PEOPLE. It is almost an antonym of the sense of *chill* illustrated in (314). Here, *chill* is a synonym of *relax*, as illustrated in (317) below.

- (317) **Group 4:** with PEOPLE, “relax” (Intransitive non-causative construction only)
- a. The LA sunshine beamed to a warm eighty degrees, my **son** chilled in the backseat [...]
 - b. **We** chilled on a bench in the Central Park’ neighborhood’ at night [...]

The second sense of *chill* that is not shared is “impede/slow down” and it is found with HUMAN ACTIVITIES, such as *activism*, *investment*, *business* and *industry*. As illustrated in (318), this sense is specific to the transitive causative construction.

- (318) **Group 5:** with HUMAN ACTIVITIES, “impede/slow down” (transitive causative construction only)
- a. [...] Republicans objected to greater disclosure requirements for coalitions, calling it an effort to chill **activism** by groups like the Christian Coalition.
 - b. [...] they will scatter again if a recession chills the carpet industry [...]

Five senses of *chill* have been identified, some of which apply to more than one group of themes, such as “(cause to) become colder” and “(cause to) become colder (metaphorically) due to fear”, which is further divided into the subsense “scare/shock” and applies to PEOPLE whereas the former applies to INTERNAL BODY PARTS. Once more we see that the sense that is exclusively associated with the intransitive non-causative construction requires themes that can be construed to take part in the event denoted by the verb. In this case, people choose to chill, it is something that they do, not something that merely happens to them. Also, the sense that is exclusively associated with the transitive causative construction requires themes over which a certain amount of control can be exercised.

7.5.3 Cool

Cool is among the minority of verbs that is significantly attracted to the intransitive non-causative construction. However, in terms of raw frequency (cf. Table 7.32), it appears to be almost equally distributed over the two constructions, with 149 occurrences in the intransitive non-causative construction and 159 occurrences in the transitive non-causative construction. Yet, Table 7.32 shows that there are slightly more themes found with the intransitive non-causative construction than with the transitive causative construction. What is more, *cool* is one of the verbs that has a relatively high degree of theme overlap, with 12.72% shared themes.

<i>cool</i>			
Instances retained	308	Themes	173
Instances of Cx1	149	Cx1 themes	100
Instances of Cx2	159	Cx2 themes	95
Preferred construction	Cx1	Theme overlap (in %)	12.72%

Table 7.32: Characteristics of *cool*

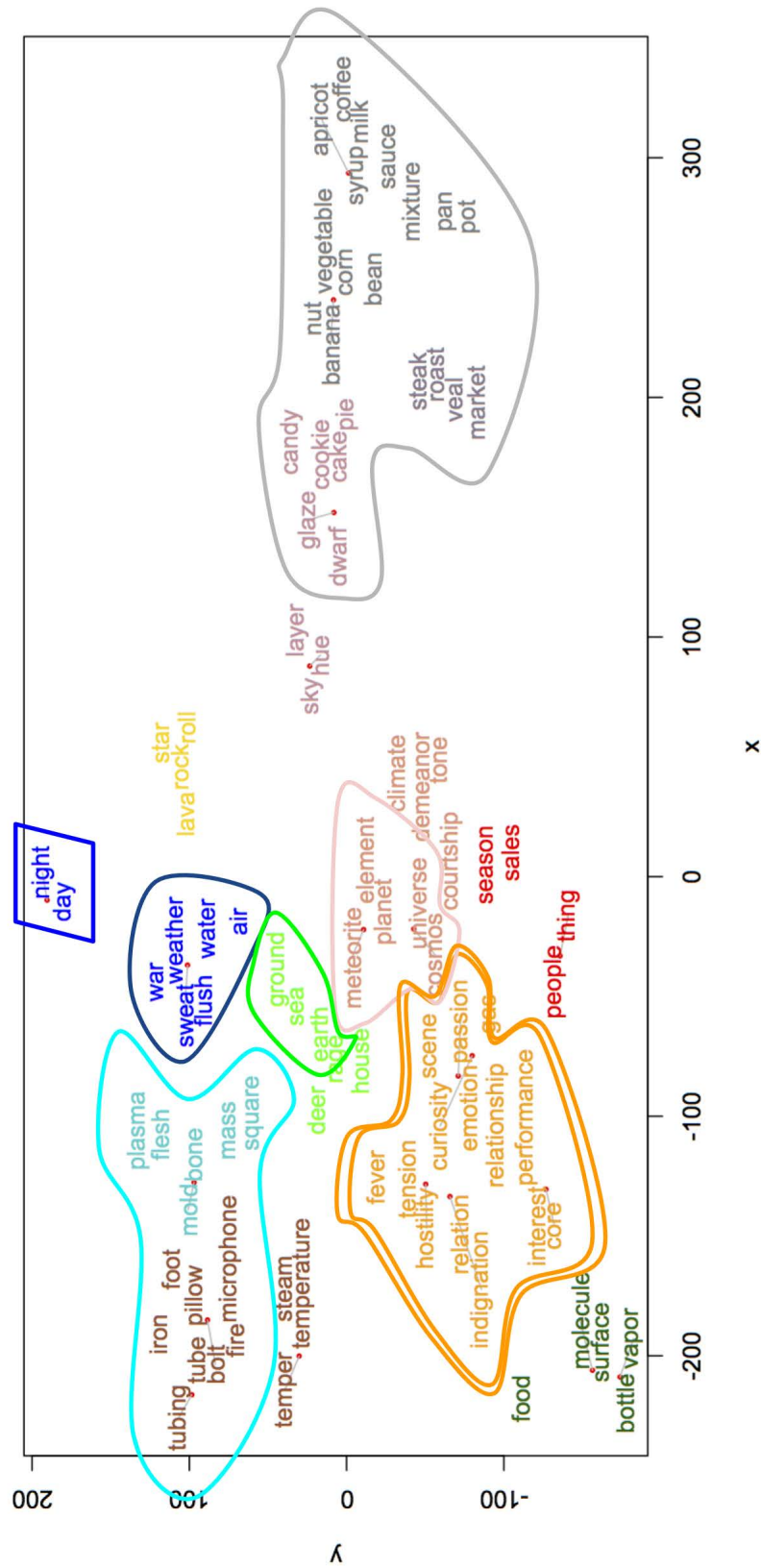

Figure 7.49: Themes that occur with *cool* in the intransitive non-causative construction

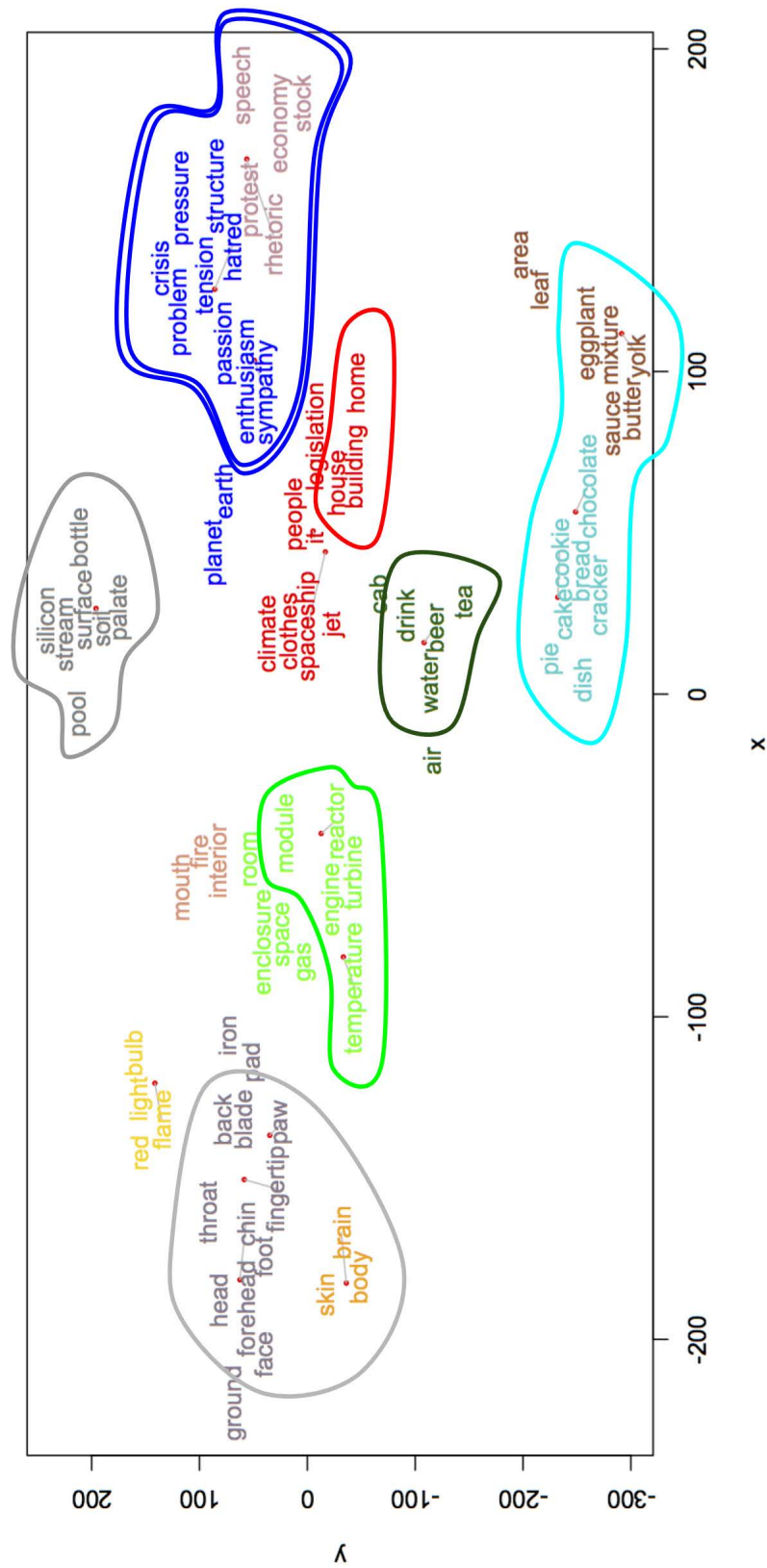

Figure 7.50: Themes that occur with cool in the transitive causative construction

Two main verb senses were identified for *cool*. Roughly, one corresponds to all concrete themes and the other to more abstract themes. This is illustrated in the semantic maps in Figure 7.49 and Figure 7.50, where the cluster of abstract themes is separated from the rest by a double curved line. The first sense identified is the literal meaning of *cool*: “(cause to) become less hot,” and the second, “(cause to) become less intense,” is a metaphorical extension. Both senses are shared by the two constructions.

Several clusters were identified that correspond to the literal sense of *cool*; the themes found with this sense in each of the constructions are quite varied. Although several big clusters were found such as BODY PARTS, NATURAL ELEMENTS and FOOD, virtually all themes referring to concrete items correspond to the same meaning of *cool*. This is illustrated in the examples in (319a) and (319b).

(319) **Group 1:** with various themes, “(cause to) become less hot”

- a. With the intransitive non-causative construction:
 - i. Her **feet** are cooling.
 - ii. The **air** cooled and the sweat on Morgan’s back dried beneath his tunic.
 - iii. If a small amount of cream has seeped through after the **Mascarpone** has cooled [...]
 - i. Harry cools his **face** with a wet cloth.
 - ii. Increased root mass translates into thick top growth that shades out weeds and cools the **ground**, reducing moisture loss.
 - iii. Melt and cool the remaining **chocolate** as indicated above [...]

As to the second sense of *cool*, it is mostly found with two types of themes: themes that denote EMOTIONS and themes that denote RELATIONS. Both groups are used with a sense of *cool* that corresponds to “(cause to) become less intense.” Slightly more specifically, emotions that cool are less strong but relations and relationships deteriorate. In this context, *cool* is a near synonym of *chill* (cf. Section 7.5.2).

(320) **Group 2:** with EMOTIONS and RELATIONS, “(cause to) become less intense”

- a. With the intransitive non-causative construction:
 - i. [...] he would wait until **emotions** cooled before making his decision and took a bit of the pressure off.
 - ii. **Relations** between the United States and Egypt gradually cooled [...]
- b. With the transitive causative construction:
 - i. These problems cooled much of the initial **enthusiasm** of some foreign businesses [...]
 - ii. If Bush could find a way to [...] cool the **hatred** boiling up in the Middle East [...]

As is the case for other verbs for which few senses were identified, we can conclude that *cool* is shared by the two constructions. However, we still note that certain themes prefer one construction or the other. This is notably the case for *relation* and *relationship* which we only found with the intransitive non-causative construction in our corpus, and the BODY PARTS cluster for which only one member was found with the intransitive non-causative construction.

7.5.4 Freeze

Freeze has the specificity of being attracted to the intransitive non-causative construction while showing much more diversity in the themes recruited in the transitive causative construction. As shown in Table 7.33, although *freeze* is more frequently found with the intransitive non-causative construction than with its transitive counterpart, it is found with 84 different themes in the intransitive against 158 different themes in the transitive causative construction.

<i>freeze</i>			
Instances retained	566	Themes	227
Instances of Cx1	311	Cx1 themes	84
Instances of Cx2	255	Cx2 themes	158
Preferred construction	Cx1	Theme overlap (in %)	6.61%

Table 7.33: Characteristics of *freeze*

Altogether, there are two main types of events associated with *freeze*, which can then be decomposed into various verb senses. The first one involves extreme cold, and the second involves interrupted motion. These two broad senses can be further divided into several senses which involve slightly different types of events. Since there are two broadly defined types of events associated with *freeze*, we will divide the discussion as follows. We will first discuss the four senses related to extreme cold, some of which are shared by the two constructions, some of which are not. We will then move on to the four senses related to interrupted motion, only one of which is shared by the two constructions.

Among the senses related to extreme cold is the literal, prototypical meaning of *freeze*: “turn to ice,” which is found with themes that are water-based. These items, when freezing, literally turn to ice. Among these themes are naturally formed bodies of water such as *lake* (321a-i) and less specific water-based elements such as *liquid* (321b-i), and the hyperonym *water* (321b-ii).

(321) **Group 1:** with WATER-BASED ELEMENTS, “turn to ice”

- a. With the intransitive non-causative construction:
 - i. She remembers how the **lake** in the city park froze, how people could skate on it.
 - ii. [...] made **puddles** on the road that at night would freeze.
- b. With the transitive causative construction:
 - i. The bowl freezes **liquid** on contact, so you’ll need to start churning the mixture immediately.
 - ii. Freezing the **water** for a 17,000-square-foot rink is no trivial undertaking [...]

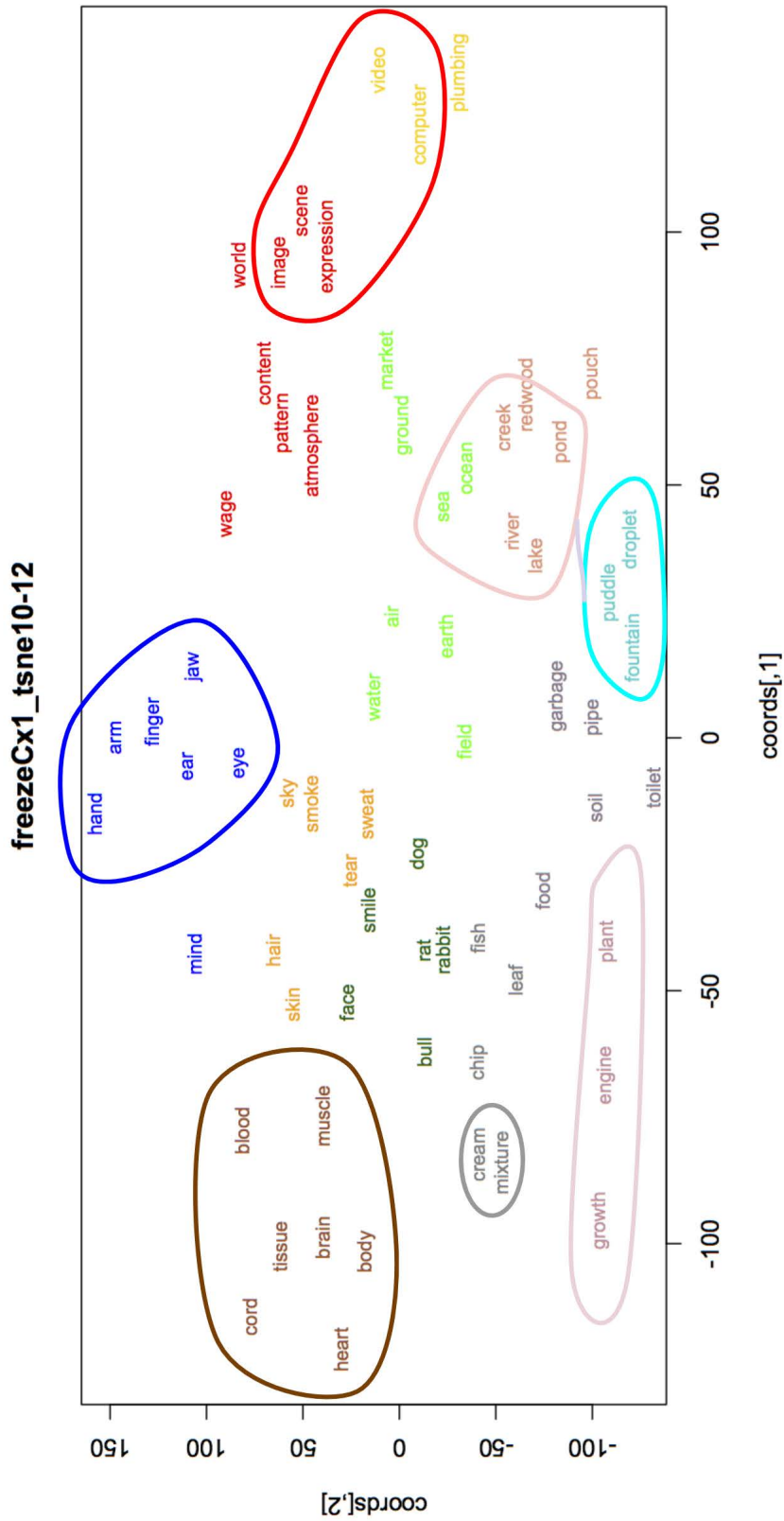

Figure 7.51: Themes that occur with *freeze* in the intransitive non-causative construction

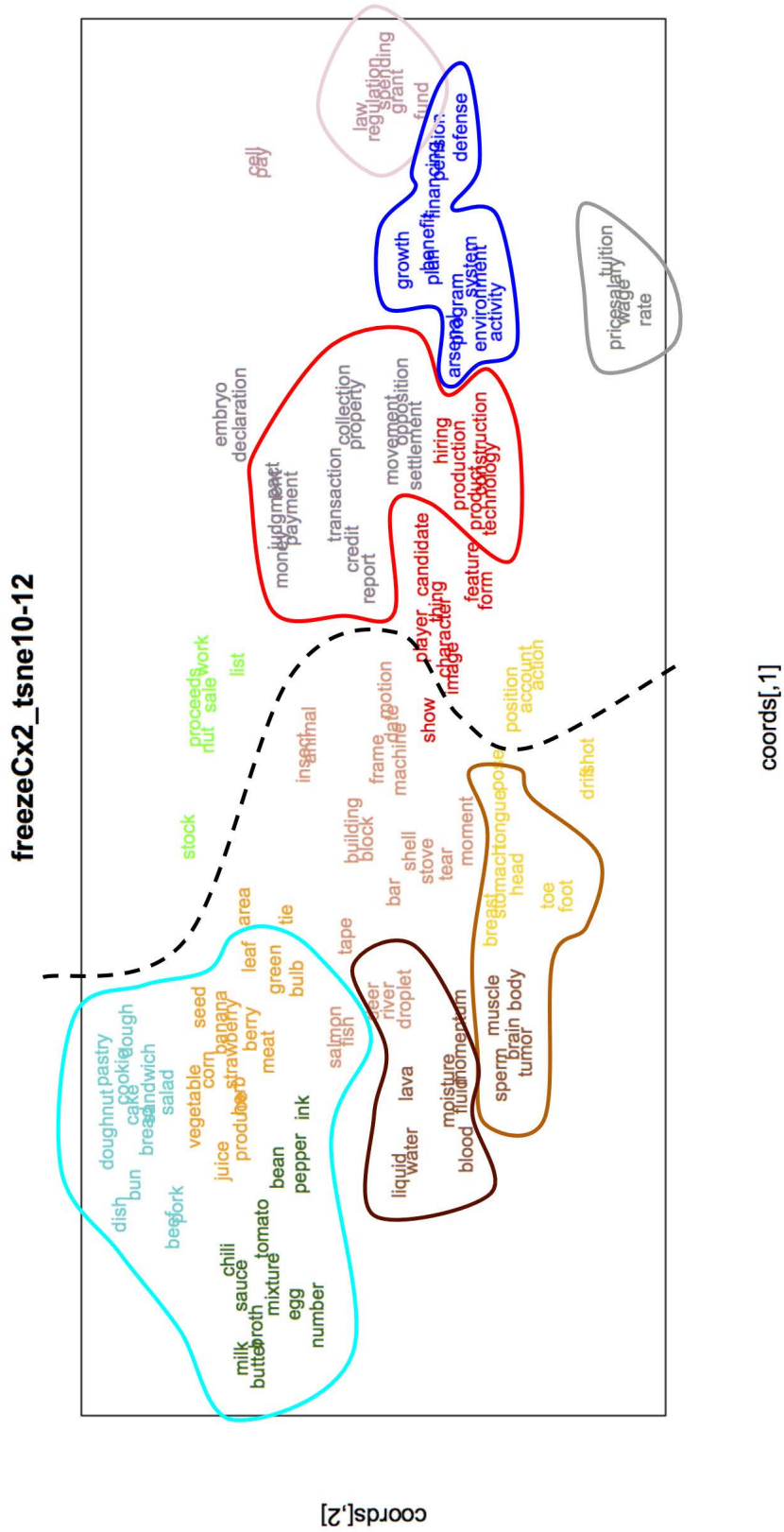

Figure 7.52: Themes that occur with *freeze* in the transitive causative construction

As is visible from the semantic maps in Figure 7.51 and Figure 7.52, the WATER-BASED ELEMENTS cluster is populated with rather different elements depending on which construction it is found with. With the intransitive non-causative construction, there are more themes such as *river, creek, lake, sea, ocean* and so on which are naturally formed bodies of water, whereas with the transitive causative construction, there are themes such as *liquid, fluid, droplet* and *blood* which are more vaguely associated with water and could actually use LIQUID as their hyperonym. However, since they are used with a sense of *freeze* that denotes a similar event, we decided to keep them together in group one.

The next group is also part of the larger group of senses related to extreme cold. However, this time, *freeze* takes on a specific meaning associated with the need to preserve FOOD at very cold temperatures as a means of storage.

(322) **Group 2:** with FOOD, “preserve at a very cold temperature”

- a. **Group 2.1:** with the intransitive non-causative construction (limited)
 - i. [...] by checking to see if the **cream** at the top of the bottles had frozen.
 - ii. [...] and return it to normal after the **mixture** has frozen.
- b. **Group 2.2:** with the transitive causative construction:
 - i. You can also freeze shelly **beans** in their cooking juices.
 - ii. To freeze **dough**, cover loosely with plastic wrap immediately after forming it into a ball [...]
 - iii. Use your school-year lunch-box trick: Freeze **sandwiches** [...] overnight.

As shown in (322a) and (322b) respectively, this sense of *freeze* is shared, at least to some extent, by the two constructions. However, as is often the case, we find some nuance in the way it is used. For example, only three corresponding themes were found with the intransitive non-causative construction: *mixture, cream* and the hyperonym *food*. Nevertheless, as is clearly visible from the map in Figure 7.52, there are many more FOOD themes that occur with the transitive causative construction. This shows that this sense of *freeze* favours the causative construction since it requires at least an instrument (a freezer), and more generally an agent. Also noteworthy is the fact that *mixture* and *cream* are close to LIQUID and therefore have inherent properties that make them more likely to freeze than say, *bread, eggs* or *sandwich* (322b-iii).

The third group also involves extreme cold, but not necessarily literal freezing. This group is made up of BODY PARTS which are caused to become numb with (extreme) cold, as illustrated in (323). This particular sense of *freeze* is specific to the transitive causative construction, since, as we will see later, BODY PARTS freeze differently when used with the intransitive non-causative construction.

(323) **Group 3:** with BODY PARTS, “make numb with cold” (transitive causative construction only)

- a. I did not feel the cold, which had frozen the **feet** and **fingers** of many about me [...]

- b. GABA was initially used pharmaceutically to freeze **muscles** in patients with multiple sclerosis [...]

The fourth group, which is mostly made of themes referring to elements of FLORA, such as *plant* or *leaf*, is found with a sense of *freeze* that corresponds to “become rigid with cold.” In our corpus at least, it is exclusively found with the intransitive non-causative construction. This does not mean that it never occurs with the transitive causative construction, but it shows at least that it is more clearly associated with the meaning of the intransitive non-causative construction. Two examples are provided in (324).

(324) **Group 4:** with FLORA, “become rigid with cold”

- a. For example, on a bean plant, can one **leaf** freeze and another not?
- b. **Plants** that are sheltered from bright morning sun often freeze and thaw slowly enough to avoid real damage [...]

Now that we have discussed all four groups associated with events that are related to extreme cold, we will move on to the four other senses associated with interrupted motion.

First off, the only sense of *freeze* associated with interrupted motion that is shared by the two constructions is found with themes referring to MOVING IMAGES, as shown in (325a) and (325b), and means “(cause to) become motionless.”

(325) **Group 5:** with MOVING IMAGES, “(cause to) become motionless”

- a. With the intransitive non-causative construction:
 - i. The **video** froze and vanished, replaced by an atlas-style road map.
- b. With the transitive causative construction:
 - i. The STRIX’s Freeze mode freezes the **image** on the display screen

Second, group 6, which corresponds to themes that refer either to animates or body parts, is found exclusively with the intransitive non-causative construction. The verb sense associated with this group is “become still” and is illustrated in the examples in (326) below.

(326) **Group 6:** with ANIMATES and BODY PARTS, “become still” (intransitive non-causative construction only)

- a. My **hands** froze in mid-clap.
- b. **Whittemore** had frozen, though, at the mention of hotel pillows.
- c. [...] **rabbits** instinctively freeze when threatened.

These examples show respectively that BODY PARTS (326a), PEOPLE (326b) and ANIMALS (326c) can freeze in the same way, that is, stop all motion they had undertaken.

The next two groups are specific to the transitive causative construction and comprise themes that refer to more abstract concepts such as *money* or *industry*. Group 7 is made up of themes referring broadly to amounts of MONEY, such as *tuition*, *salary*, *price* and *rate*. The sense of *freeze* associated with these themes is “hold at a given level,” that is, the amount of money can no longer be raised or lowered, as shown in examples (327a-327b).

- (327) **Group 7:** with MONEY, “hold at a given level” (transitive causative construction only)
- a. [...] the Rockies joined several other teams this offseason and froze their season-ticket **prices** for 2009.
 - b. [...] workers in Greece staged a national strike today, protesting a government plan to freeze **salaries** and cut bonuses.

Finally, the last group we identified is a rather broadly defined group which contains themes such as *transaction, opposition, hiring, program, defense* and *activity*. This group was labelled ACTIVITY since its themes refer to various human activities. All these themes are found with a particular meaning of *freeze* that corresponds to “block, immobilise.” This sense of *freeze* is only found with the transitive causative construction, since it normally implies that something or someone exerts control over these activities.

- (328) **Group 8:** with ACTIVITY, “block, immobilise” (transitive causative construction only)
- a. [...] but little was achieved until we negotiated the Agreed Framework in 1994, which froze the **production** of plutonium for nuclear weapons in the North [...]
 - b. Santa Fe has frozen **hiring**, except for the police and fire departments.

The examples provided in (328) show that this sense of *freeze* implies that certain activities and processes are stopped or immobilised to some extent.

Once more, verb senses that are close to the literal sense of the verb tend to be more shared than metaphorical extensions of this verb sense. What is more, with a verb such as *freeze*, we see again that even when a meaning is shared, there are some nuances in the way each construction is used, e.g. with FOOD items, which clearly prefer the transitive causative construction or with group 1, which tends to recruit somewhat different themes in each construction.

7.5.5 Heat

Heat is clearly attracted to the transitive causative construction. As is visible in Table 7.34, not only is it significantly attracted to this construction based on the distinctive collocation analysis, but it is also much more frequently found with this construction than its intransitive counterpart, with only 15 occurrences with the intransitive non-causative construction against 319 with the transitive causative construction. The substantial difference in the use of this verb with each construction can also be felt in the number of themes that occur with each construction. The very limited number of themes occurring in the intransitive non-causative construction may be partly responsible for the very low degree of theme overlap: 6.78%.

<i>heat</i>			
Instances retained	334	Themes	118
Instances of Cx1	15	Cx1 themes	13
Instances of Cx2	319	Cx2 themes	113
Preferred construction	Cx2	Theme overlap (in %)	6.78%

Table 7.34: Characteristics of *heat*

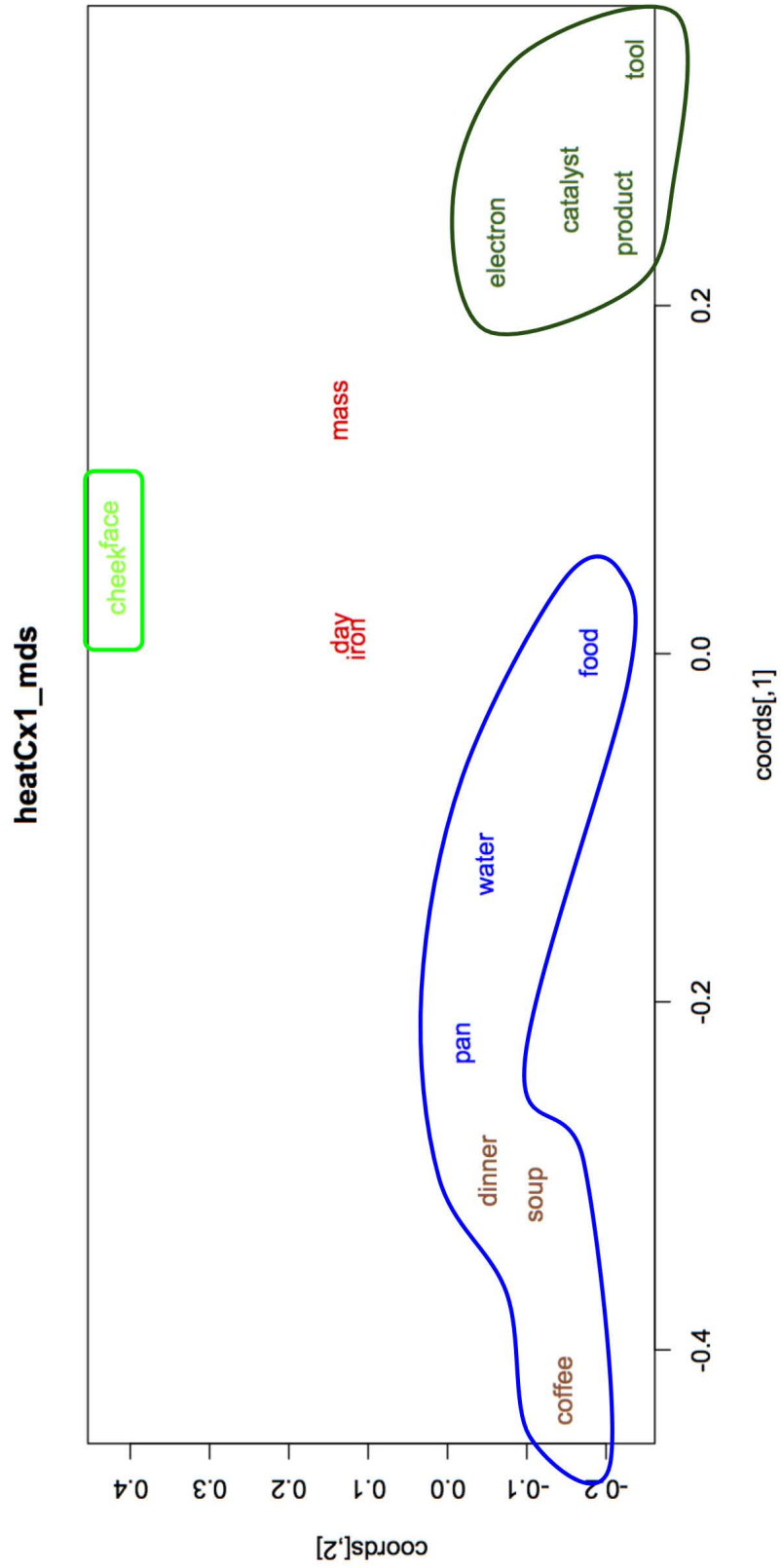

Figure 7.53: Themes that occur with *heat* in the intransitive non-causative construction

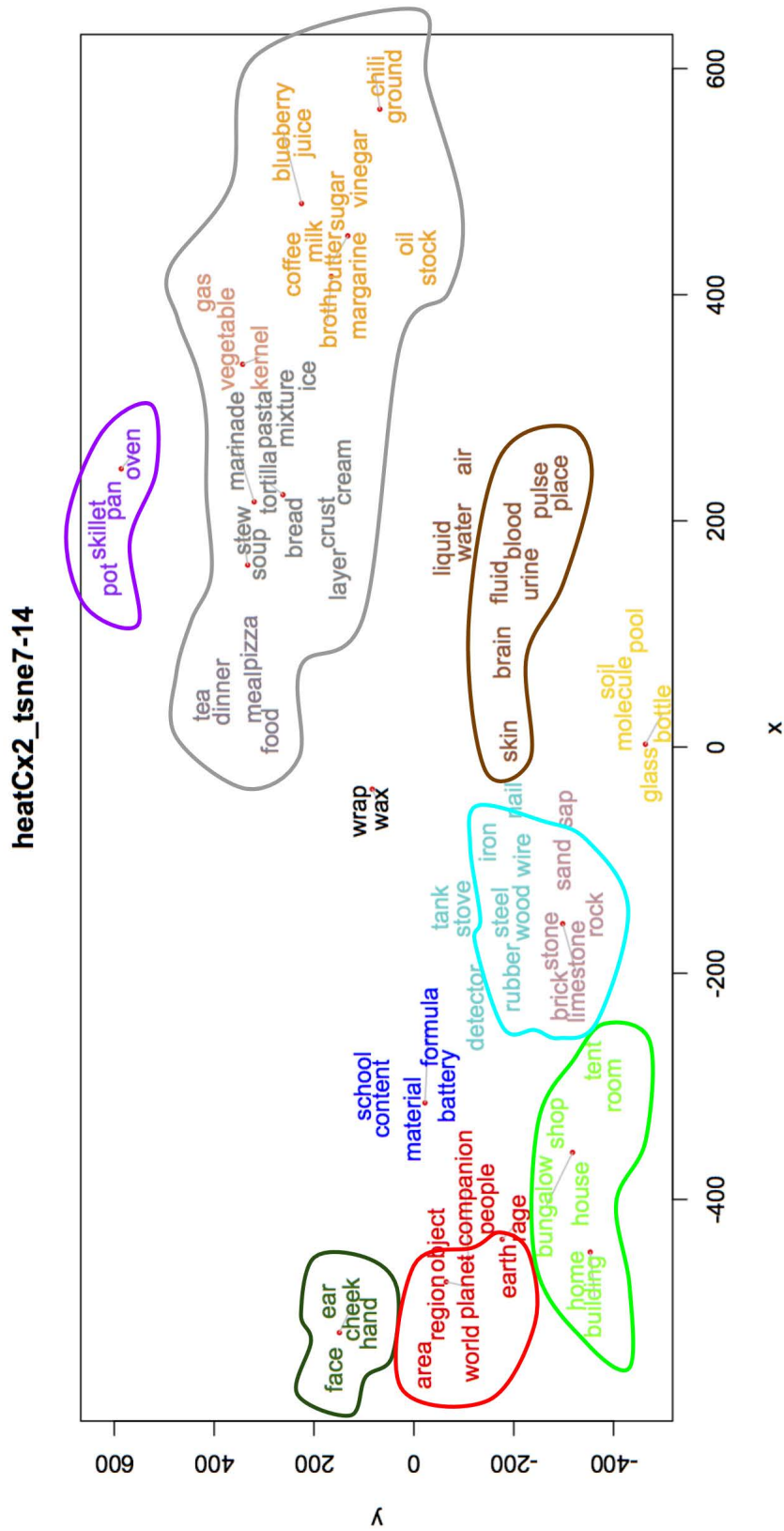

Figure 7.54: Themes that occur with *heat* in the transitive causative construction

With the exception of one theme with which *heat* takes on a figurative meaning, we only found one sense associated with this verb, and it is shared by the two constructions. This sense is literal: “(cause to) become warm.” Although we found very few occurrences of *heat* used with the intransitive non-causative construction, there are still quite a few themes that are used in this construction. However, the preponderance of the transitive causative construction is an indication that this verb is inherently causative. As shown on the semantic map in Figure 7.53, there are three broad groups that come out of the distributional semantics analysis for the intransitive non-causative construction: FOOD, BODY PARTS (although it is limited to *cheek* and *face*), and a more varied group that contains themes such as *electron*, *product* and *tool*. Some of these are given as examples in (329a).

(329) **Group 1:** with various themes, “(cause to) become warm”

- a. With the intransitive non-causative construction:
 - i. Serena felt her **cheeks** heat with embarrassment as the man sauntered to the end of the counter [...]
 - ii. While his **dinner** was heating, he leaned against the sink [...]

As is visible from the examples in (329a), both events imply an external source of heat. For example, in (329a-i), it is provided in an oblique: *with embarrassment*. As to (329a-ii), it is clear that the dinner is not heating on its own but rather in a pot or microwave oven for example. There are, however, a few examples where the theme could be construed as co-participating in the event. Two are provided in (330) and (331).

(330) The **day** heated, and life hid under rocks and roots.

(331) Furthermore, an immature **product** will continue to heat even after it goes in a bag.

In both these examples, the heating event is construed as occurring rather naturally and therefore the theme can more easily be construed as co-participating in the event.

As to the transitive causative construction, Figure 7.54 shows that it is found with members of the two main groups identified for the intransitive non-causative construction (FOOD and BODY PARTS), albeit in greater numbers, but also with other kinds of themes including, but not limited to, BUILDINGS, FLUIDS, KITCHEN UTENSILS, and MATERIALS. A few examples are given in (332).

(332) **Group 1:** with various themes, “(cause to) become warm”

- a. With the transitive causative construction:
 - i. [...] and the rough warmth of his palm heated the back of her **hand**.
 - ii. In a large pot, heat the miso **broth** and add the meatballs to warm through.
 - iii. They heat many of their **buildings** because all the district heating system is using geothermal energy.

As mentioned before, we found one theme with which *heat* is not used in its literal sense. Based on the information found in the OED online, this use of *heat* is archaic but our example dates back to 1998:

(333) Gossart’s remark about God heated his simmering **rage**.

Even though this example is from a book published in 1998, the register is quite formal, which may explain the use of this sense of *heat*. Since we do not have enough data to confirm whether this sense of *heat* can be found with both constructions, we will leave it at that.

To conclude the section on *heat*, it is clear that this verb is almost exclusively used with one sense that is constant over the two constructions. Nevertheless, the substantial difference in the distribution of this verb over the two constructions calls for a word of caution. Although it appears that its meaning is shared, we find that with the intransitive non-causative construction either an external cause is implied or the theme can be construed as being able to co-participate in the event, notably in events that appear to occur “naturally.”

7.5.6 Warm

Warm is one of the many verbs that are attracted to the transitive causative construction. Although there is a substantial difference in both the number of occurrences of this verb between the two constructions and the number of themes with which it was found in each construction, it still displays a relatively high degree of theme overlap with 16.23%. This is all the more relevant since, as shown in Table 7.35, only 52 different themes were found with the intransitive non-causative construction, against 127 with the transitive causative construction.

<i>warm</i>			
Instances retained	400	Themes	154
Instances of Cx1	98	Cx1 themes	52
Instances of Cx2	302	Cx2 themes	127
Preferred construction	Cx2	Theme overlap (in %)	16.23%

Table 7.35: Characteristics of *warm*

The high degree of theme overlap can be explained by the fact that only two different verb senses were identified for this verb, and they are once more divided between a literal meaning, “(cause to) become warm(er)” and a metaphorical extension of this meaning. As we will see, however, even though it seems that all senses and subsenses are shared, a few subtle differences show up between the uses of this verb in these two constructions.

We will start the discussion with the literal sense of *warm*, labelled “(cause to) become warm(er)” and which applies to various groups of themes. The first group is NATURAL ELEMENTS, as illustrated in (334a) and it comprises themes such as *weather*, *climate*, *earth* but also *ocean*, *sea* and *afternoon*. All of these themes become warm in a “natural” way, due to the general temperature on Earth.

(334) **Group 1:** “(cause to) become warm(er)”

a. 1.1 with NATURAL ELEMENTS

- i. When the **weather** warmed, a foul chemical miasma settled over the garrison.
- ii. Heat from the planet’s core could warm an underground **ocean**.

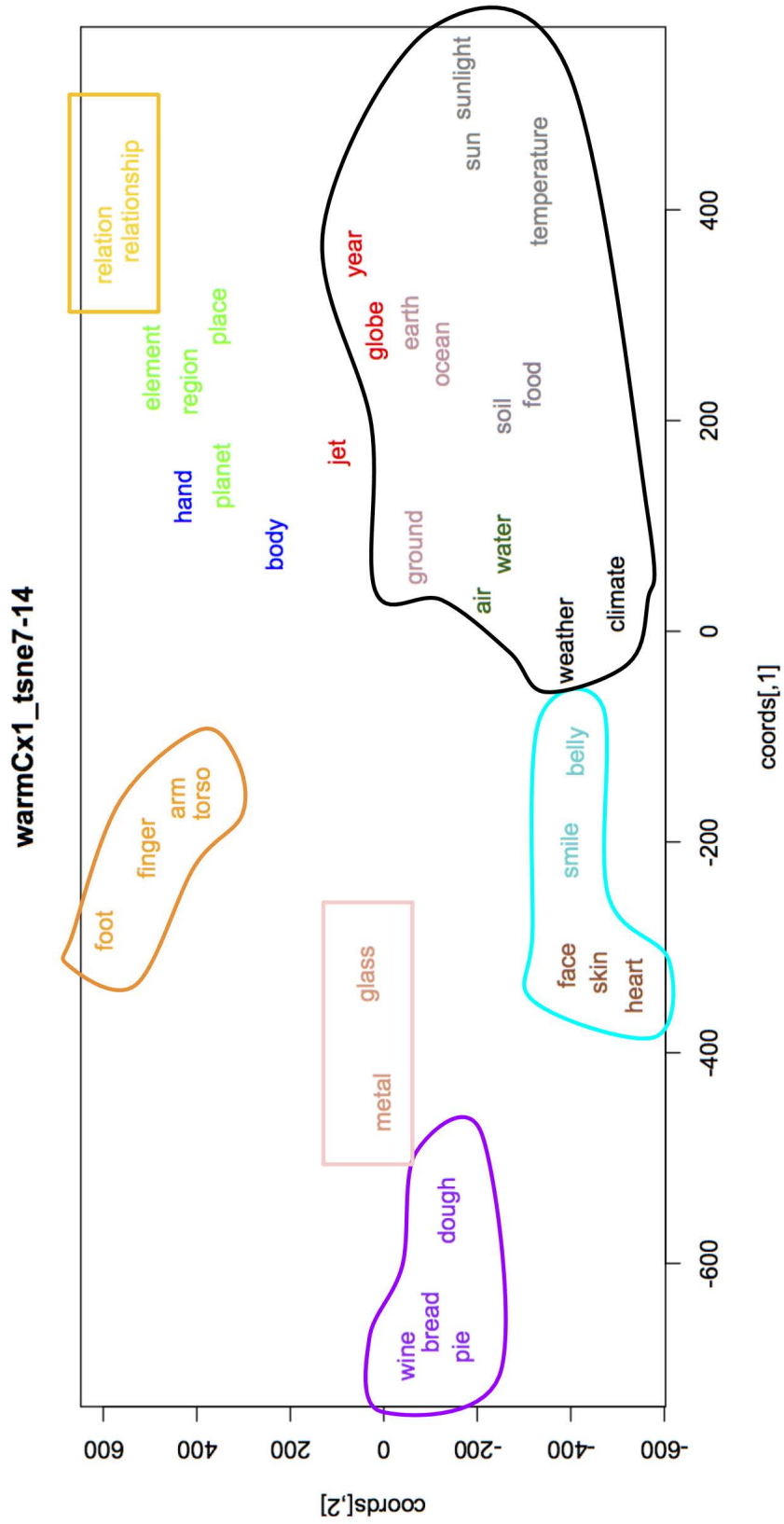

Figure 7.55: Themes that occur with *warm* in the intransitive non-causative construction

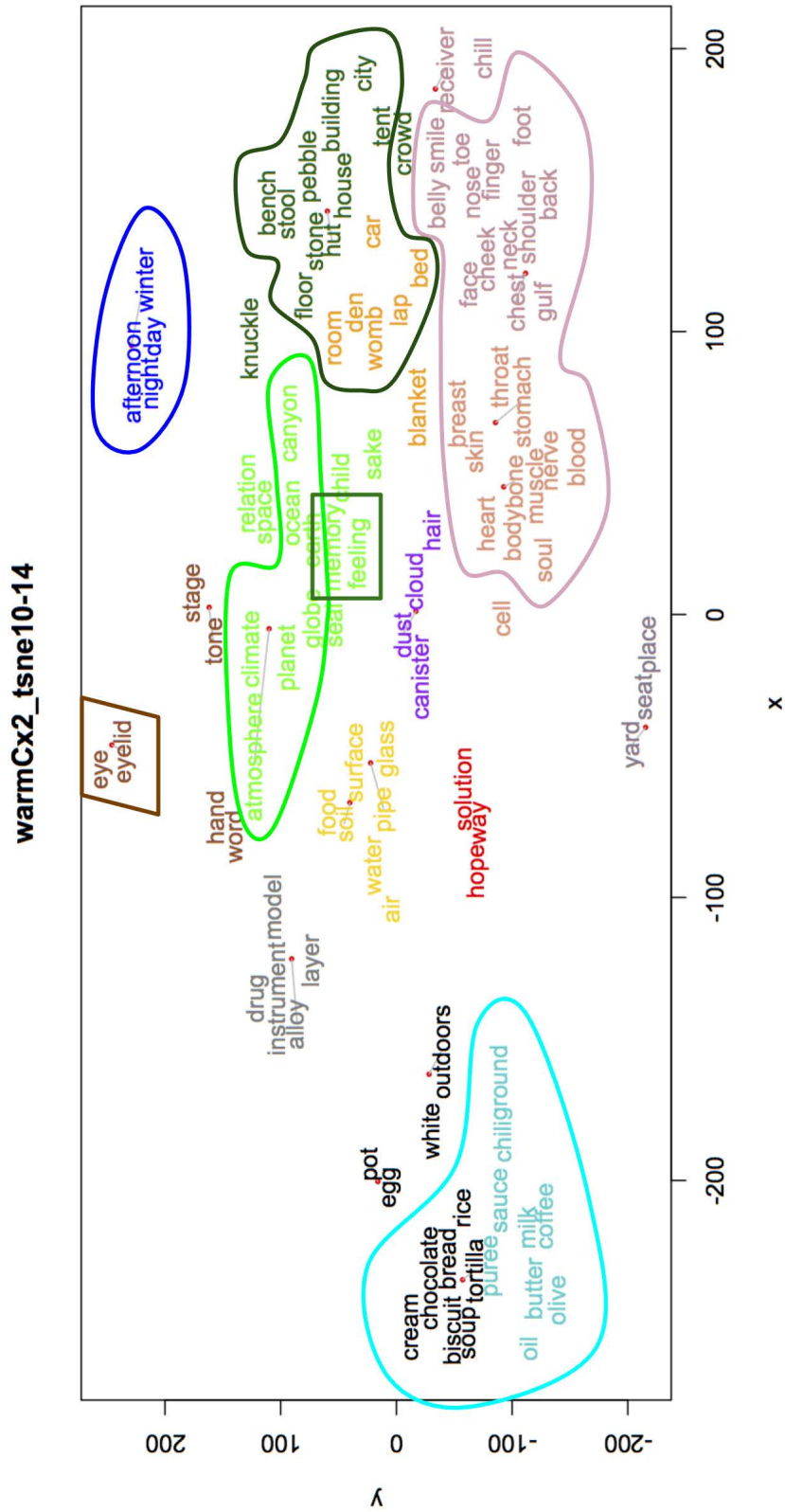

Figure 7.56: Themes that occur with warm in the transitive causative construction

- b. 1.2 with BODY PARTS
 - i. Her **feet**, clammy and stiff all day, seemed to warm, to sweat, as she hurried out of the apartment.
 - ii. When she shivered into my arms, I warmed her **cheeks** with mine [...]
- c. 1.3 with OBJECTS & PLACES
 - i. As it sits in the sun, the **metal** warms.
 - ii. The woodstove ticked and popped, warming the **den**.
- d. 1.4 with FOOD
 - i. The farmer took down three loaves of round **bread** that were warming on the mantel of the hearth and a knife.
 - ii. I go back to the kitchen to warm the **rice** in the microwave.

The second group of themes found with the literal sense of *warm* is BODY PARTS, as illustrated in (334b). This group is made up of various themes referring to corresponding body parts and these become warm due to many reasons. Since it usually takes an external cause to bring the warming event about with these themes, we see that the BODY PARTS cluster is much more populated on the map for the transitive causative construction (Figure 7.56) than on the intransitive equivalent (Figure 7.55). The same is true of the other two groups, respectively OBJECTS & PLACES, illustrated in (334c) and FOOD, illustrated in (334d). Both these groups have clusters that are more densely populated in the transitive causative construction. Yet again, even though the sense of *warm* is constant over the two constructions, it is more frequently associated with the transitive causative construction.

As to the sense that is a metaphorical extension of “(cause to) become warm(er)”, it is found with two sub-senses. The first sub-sense is associated with themes that refer to RELATIONS, and means “(cause to) become more friendly”, as illustrated in (335a). The second sub-sense is “(cause to) feel better”, and is found with themes such as *heart* and *soul*, which are used somewhat metonymically to express the idea that the person feels better, as shown in (335b). As was the case with the literal sense of *warm*, this sense is also more frequently found with the transitive causative construction.

(335) **Group 2: “(cause to) become warm(er) metaphorically”**

- a. 2.1 with RELATIONS, “(cause to) become more friendly”
 - i. The **relationship** between Rotary and the church began to warm in 1979 [...]
 - ii. Although the linguistic tie to Turkey warmed **relations** with that country initially [...]
- b. 2.2 with *heart* & *soul*, “(cause to) feel better”
 - i. Emma smiled, and Lindsay’s **heart** warmed.
 - ii. [...] it seems just right to focus on foods that warm your **soul** and send delicious aromas throughout your home.

Generally, we found that *warm* is used more frequently and with more varied themes in the transitive causative construction. Nevertheless, the verb senses identified and the groups of themes they are used with are shared, albeit not equally used.

7.6 General evaluation

This section will present a general evaluation of the method we implemented to measure a verb's alternation strength, notably the use of distributional semantics to measure the extent to which a verb and its different senses are shared by two constructions, namely the intransitive non-causative construction and the transitive causative construction. We will start with an overview of the performance of this method, and then move on to more general conclusions as to the semantics of each construction and what it implies for the verb's alternation strength.

First and foremost, it is clear that distributional semantics has many advantages. The fact that it measures semantic similarity between a set of nouns in a systematic manner allows for an objective grouping of themes into clusters of similar nouns. It was mostly efficient in this respect with the sets of themes we analysed. It also provides very useful visualisation tools which clearly show the discrepancies in the distribution of themes between the two constructions. Not only does it make it clear when there are different numbers of clusters between the two constructions, but it also shows clearly when a particular cluster is more or less populated. It is also particularly efficient to identify the boundary between themes referring to concrete entities and themes referring to abstract concepts.

Nevertheless, as with almost any technique, a few minor issues arose when analysing the output which did not truly impede our study. The semantic maps created via t-SNE and the “plot” function of R were most of the time easy to read, but when the number of themes is really high and their variety is somewhat limited (i.e. they do not represent a very broad range of nouns), as was the case for *expand* and *increase* for example, the results were more difficult to read and the clusters not as easy to identify. Nonetheless, this issue is limited to a couple of verbs and mostly to their use with the transitive causative construction which tends to recruit a lot of different themes which are not too far apart on the semantic map. Furthermore, the density of these maps also reinforces the notion that these verbs are used with one sense that applies to a variety of themes that are not so semantically distant from one another. Another issue which we briefly mentioned in the introduction to this chapter is that certain aspects of meaning cannot be grasped by distributional semantics since they are subsenses of the same noun and are highly dependent on context. Since our model does not discriminate between different contexts, and it cannot place the same word more than once on the semantic map, it cannot easily elucidate different facets of the meaning of a noun.⁹ Although this may be problematic, the issue was limited to a handful of cases. This also applies to nouns that are highly polysemous and which thus tend to occur regularly in dissimilar contexts, but since they are not too numerous, such instances could be annotated manually and commented upon in this chapter without impeding

⁹A point also made by Desagulier (To appear), who shows the difficulty for distributional semantics models to grasp polysemy and homonymy, a problem he calls “The one-vector-per-word problem.”

the bulk of the analysis.

Overall, this model performed really well, notably in its ability to isolate concrete nouns from abstract nouns and highlighting dissimilarities among nouns that are not always necessarily striking, e.g. the difference between the LAW and PROMISE clusters with *break* in the transitive causative construction, which allowed us to identify two different near-synonyms of *break* that correspond to each cluster.

The results we obtained truly made the discrepancies between the two constructions clearer. Our model of distributional semantics isolated various groups of themes for each verb and each construction, thus leading us to posit collocation-based generalisations. That is, the combination of a verb used with certain themes gives rise to a specific verb sense, all the more so when this cluster is specific to one construction only. The semantic grouping of themes also showed that certain clusters are much more populated on one map than on the other, thus highlighting differences in the productivity and frequency of certain verbs senses.

As mentioned before, although this analysis was run verb by verb, it nevertheless remains constructional in essence. That is, by analysing instances of each construction carefully and at the level of the interaction between verb and theme, it is possible to then abstract away from individual instances to access constructional meaning. When analysing the data, it quickly became apparent that instances of the intransitive non-causative construction used with a variety of verbs (and specific themes) share certain characteristics that reinforce the idea of a united schematic constructional meaning. The same holds for the transitive causative construction.

Overall we came to the conclusion that the themes that are specific to the intransitive non-causative construction share a feature that makes them “likely to V,” where V stands for the event denoted by the verb. This point was also made by Lemmens (1998), who argues that the theme in subject position can be construed as co-participating in the event. Our own conclusion does not go that far, since we consider that “co-participation” is too strong to properly describe the relation between the theme and the event. This is why we simply say that there is a feature common to the themes found in this position that makes them “likely to V,” without supposing any co-participation as such, more of a “facilitation” of the event. As to the themes found with the transitive causative construction, they share the following feature: they have to refer to something that can be acted upon. This also leads to the conclusion that themes that are shared tend to have both features, that is “be likely to V” and “be likely to be acted upon in the manner denoted by the verb.” When a verb sense is restricted to one construction it is likely due to one or two characteristics of this verb: (i) it is inherently (non-)causative (e.g. *crush* for the causative, and *slide* for the non-causative) and/or (ii) the theme associated with it is construed as “not likely to be acted upon in the manner denoted by the verb” or “not likely to V.” The reason for the negation here is that if a theme is specific to one construction (with one verb), then it must have some element of meaning that makes it unlikely to occur with the other construction. That is, themes that are restricted to the intransitive non-causative construction are usually construed as “unlikely to be acted upon in the manner denoted by the verb,” such as PEOPLE with the verb *grow*.

Below, we provide a sample set of instances of the verbs we studied with the intransitive non-causative constructions. These examples are structured as follows. They all are specific to

the intransitive non-causative construction when used in combination with the corresponding verb (and verb sense). Although there is a certain amount of variety in the themes recruited by this construction at a general level, it is still possible to isolate certain clusters such as PEOPLE, as in (336a), MIND STATES & EMOTIONS, as in (336b) and INSTITUTIONS & ORGANISATIONS, as in (336c). The last set, in (336d) contains themes that are not part of the first three clusters but are nonetheless limited to this construction.

(336) Various instances of the intransitive non-causative construction:

- a. With PEOPLE
 - i. The normally laid-back **actor** *snaps* when a reporter makes fun of his costume without seeing a stitch of it.
 - ii. Most **people** I know would have *folded* a long time ago.
- b. With MIND STATES & EMOTIONS
 - i. Clint's **rage** *grew*, clawing to be freed, [...]
 - ii. **Anger** *burned* in my chest.
- c. With INSTITUTIONS & ORGANISATIONS
 - i. Washington Post columnist George Will said the **administration** had *crumpled* "like a punctured balloon."
 - ii. As South Korean banks close, **businesses** *fold* and unemployment lines grow [...]
- d. With other themes
 - i. [...] the **sidewalk** *turned* and ran beside the lot.
 - ii. I looked at the **mob**, saw **it** was *thickening*.
 - iii. In that oil-rich environment, **bacteria** *proliferate*, causing inflammation that shows up in the form of pimples.

If these nouns were to be taken individually, their similarity would not be striking. However, when grouped together in situations where their combination with a given verb gives rise to a specific meaning, it becomes clear that they share at least one characteristic, "to be likely to V." This reinforces the hypothesis put forward by Goldberg (2002) that by comparing instances of the same construction one can reach broader generalisations as to constructional meaning. The same is true of the themes found with the transitive causative construction, as shown in the examples in (337).

(337) Various instances of the transitive causative construction:

- a. With ACTIVITIES
 - i. Republicans objected to greater disclosure requirements for coalitions, calling it an effort to *chill* **activism** by groups like the Christian Coalition.
 - ii. [...] we've talked a little bit about how to *break* bad **habits** [...]
- b. With OBJECTS
 - i. The Quaker *folded* the **map** and held it out for Saturn to take.

- ii. Jeff takes down the tent, packs up his bag, *rolls* his **mattress** [...]
- c. With other themes
 - i. The problem is not that George Bush just *broke* his tax **pledge**.
 - ii. “Do you ever lie?” [...] “Yes. Yes. I *stretch* the **truth** a smidge or, you know, something like that.”
 - iii. [...] dancing can *burn* as many **calories** as walking, swimming or riding a bicycle.

All of the themes in the examples above have two things in common, they are not (necessarily) “likely to V” without the intervention of an external cause and they are “likely to be acted upon in the manner denoted by the verb.” That is, as shown in (337c-iii), calories are hardly ever construed as burning of their own accord, rather, burning a calorie requires an activity instigated by an external cause. As to *mattress* in (337b-ii), due mostly to its flat shape, it is unlikely to roll; however, it can be rolled. Note that this particular feature need not be activated when the theme is used in a different context, it is the semantics of the construction that activate this feature.

As to the verb senses that are shared by the two constructions, they are found with themes that bear both features mentioned before: “be likely to V” and “be likely to be acted upon in the manner denoted by the verb.” We provide a few examples in (338) below to illustrate this phenomenon.

(338) Examples of shared themes and verb senses:

- a. With the intransitive non-causative construction:
 - i. [...] the **glass** cracking almost musically against the blacktop of the parking lot [...]
 - ii. Slice, and serve when **cake** has cooled completely.
 - iii. [...] and return it to normal after the **mixture** has frozen.
- b. With the transitive causative construction:
 - i. The highly focused beam of light could heat and crack the **glass**.
 - ii. Cool the **cakes** in the pans for 20 minutes [...]
 - iii. Cover and freeze **mixture** 1 hour or until frozen around the edges.

Another specificity of the verb senses that are shared by the two constructions is that very often, they are either literal uses of the verb or highly entrenched metaphorical extensions of the literal verb meaning. This is the case for a large variety of verbs such as *break, shatter, snap, tear, bend, roll, drop, move, turn, expand, stretch, thicken, burn, chill, cool, freeze* and *heat*. All these verbs have their literal meaning shared by the two constructions, at least when the themes with which they are used share the features mentioned in the previous paragraph. This applies to the three examples in (338), where the verb meaning is literal, for example in (338a-ii–338a-iii) and (338b-ii–338b-iii), there is an actual change of temperature.

Also, when the verb is not (or hardly) polysemous, it tends to be largely shared by the two constructions. That is, the fewer senses a verb has, the higher the semantic coherence among

themes and the higher the overlap between the two constructions. This is notably the case for verbs such as *crease*, *crinkle* and *wrinkle* which denote highly specific events which apply mostly to nouns that are “likely to V” and “likely to be acted upon in the manner denoted by the verb.” These three verbs share groups of themes that are found with both constructions, as illustrated in (339a), but they are also found with themes that are not shared, as shown in (339b).

(339) Semantically restricted verb senses:

- a. When shared:
 - i. Saving the **dress** for last so **it** wouldn’t wrinkle [...]
 - ii. Her glowing, lily-fair **skin** creases only when she laughs-which she does a lot.
- b. When specific to one construction:
 - i. Once **people** start to stoop and wrinkle they all look alike to me.
 - ii. Six flashing oars creased the **surface** of the river in synchronized strokes [...]

In (339b-i), it is clear that the theme is “not likely to be acted upon in the manner denoted by the verb”. As to (339b-ii), the theme is considered less “likely to V,” since it is not necessarily a natural feature of the surface of the river to *crease*, it requires an external agent to bring about the creasing event.

The use of distributional semantics for this analysis proved to be particularly efficient both through the clustering of semantically related themes and the visualisation techniques offered. Thanks to this method, we managed to identify not only which verb senses are shared by the two constructions and which are not, but also which senses are only partially shared. That is, these verb senses are found with the two constructions but with different themes. This confirms our hypothesis that a proper analysis of argument structure constructions must go below the level of the verb and pay attention to the verb’s interaction with its arguments in order to provide a more accurate description of constructional meaning. By looking at clusters of semantically related themes, we were able to identify important nuances in how each verb is used with each construction and thus get more insight as to a broader, more schematic constructional meaning both for the intransitive non-causative construction and the transitive causative construction.

CHAPTER 8

CONCLUSION

With this research we aimed to investigate the causative alternation in English and through this investigation provide a thorough description of a substantial set of instances of the two constructions that make up this alternation, suggest a method that allows to measure the amount of information shared by the two construction, and show that a finer level of granularity must be added to the discussion of argument structure constructions.

8.1 Summary

In Chapter 2, we introduced the main concepts of construction grammar and its cognitive background. We showed that there are more or less prototypical instantiations of each construction and noted the importance of frame semantics (Fillmore 1977) in the interpretation of argument structure constructions. That is, concepts are understood against a bigger structure of knowledge. As such, we know that a breaking event involves at least a *broken* and potentially a *breaker*. This was followed up by Langacker's notion that event structure is experientially grounded. More specifically, speakers describe events in the way that they conceive them. As Goldberg (1995: 40) argues: "Constructions that correspond to basic sentence types encode as their central senses, event types that are basic to human experience." This is also found in both of Langacker's models, namely the billiard-ball model which encompasses the principles of causation and the stage model which "idealizes a fundamental aspect of our moment-to-moment experience: the observation of external events, each comprising the interactions of participants within a setting" (Langacker 1991: 284). These two models are combined for the production and choice of one argument structure or the other (in the case of the causative alternation).

In Chapter 3, we showed how the conception of an event is what matters most when choosing which arguments and roles should be expressed in an argument structure construction. In this chapter we reviewed some of the extensive literature on thematic roles and concluded that since the mapping from semantic roles to syntactic positions is many to many (Croft 2012: 178), it is more interesting to look at local generalisations. We decided to label the role that is shared by

the intransitive non-causative construction and the transitive causative construction “theme,” which merely expresses the idea that this participant is the one that undergoes the event denoted by the verb. This decision was made on the ground that, although it is under-specified, it still captures a schematic generalisation and then allows for more local generalisations at the level of the interaction between verb, theme and construction.

Chapter 4 drew on the conclusions of the preceding chapter to further argue in favour of local generalisations when it comes to constructional meaning. We used this chapter to provide a more precise definition of the intransitive non-causative construction and the transitive causative construction, highlighting elements that compose these constructions such as the kinds of verbs found in these constructions (verbs that denote a “change of state”) and the type of themes found in subject position in the intransitive and in object position in the transitive. We also concluded that the most appropriate link that connects the two constructions in the structured inventory is a subpart link (Goldberg 1995).

In Chapter 5, we compared different kinds of approaches to the question of argument structure constructions and alternations. We started by showing that both verb-centric approaches, such as lexical-projectionist approaches (Levin 1993) and valency theory (Herbst and Schüller 2008), and surface generalisation approaches have some advantages and should be combined to a certain extent. That is, although we adhere to a constructional approach to argument structure patterns, in that we believe that each construction in an alternation has a specific meaning, we also believe that speakers are aware of a verb’s valency. By paying attention to each construction individually but also by comparing how the two constructions differ and what they share, we reach more realistic conclusions as to the potential organisation of pairs of constructions in a speaker’s constructicon. It is specifically this comparison that we undertook in the last two chapters.

In Chapter 6, after presenting the data used for this research we presented the results of a distinctive collocation analysis (Gries and Stefanowitsch 2004) and concluded that (i) our dataset was not optimal for this type of analysis and (ii) that since it focuses only on the verb, it was not adapted to achieve our goal of measuring a verb’s alternation strength. The second measure we presented in this chapter is theme overlap (Lemmens *forthc.*), which, by counting the number of themes shared by the two constructions, paved the way towards our final step: the semantic grouping of themes. This semantic grouping was conducted via distributional semantics, a method also described in this chapter and which measures the semantic similarity of themes based on their shared collocates.

In Chapter 7, we evaluated the validity and efficiency of our method through a presentation of our results. We presented and described the semantic maps obtained via distributional semantics for each verb in each construction (with the exception of *slide* and *crush* for which only one map was created due to the very limited number of themes found with these verbs either in the intransitive non-causative construction or the transitive causative construction). The clustering of semantically related themes on these maps allowed us to identify varying numbers of verb senses, but it also showed that although some verb senses are shared by the two constructions, they are not always found with the same number of sets of themes.

Our findings and conclusions will be presented in the next sections, following the three goals

we set ourselves (descriptive, methodological and theoretical).

8.2 A corpus-based description of the causative alternation

Through the constitution of a sample corpus we put together 11,554 instances of 29 different verbs used with 4,781 different themes (types) in two different constructions. These 29 verbs were divided into five groups of semantically related verbs, including BREAK verbs (*break, crack, crush, shatter, snap, tear*), BEND verbs (*bend, crease, crinkle, crumple, fold, wrinkle*), ROLL verbs (*roll, drop, move, slide, turn*), GROW verbs (*grow, expand, increase, proliferate, stretch, thicken*) and CHANGE OF TEMPERATURE verbs (*burn, chill, cool, freeze, heat, warm*). These five groups contain verbs that depict various kinds of change of state: change in the physical/emotional integrity of the theme, change of size, shape, location, composition, substance and more. Furthermore, we have shown that these events can be physical but also psychological and emotional. Some are literal, some are metaphorical. The number of occurrences studied makes for a substantial corpus, which, although it does not in any way pretend to cover all the specificities associated with individual instances of the two constructions of the causative paradigm, still accounts for many different uses of the intransitive non-causative construction and its transitive counterpart, and is arguably representative of the variety of events covered by these two constructions. This corpus study also reinforced the importance of data analysis when positing verb senses, cf. notably one of the senses of *crumple* (Section 7.2.4) which we identified but was not found in either the OED online or WordNet, but also a verb's expected valency patterns, e.g. *crush*, which Levin (1993) argues alternates like other BREAK verbs, but is actually extremely marginally used in the intransitive non-causative construction. Only through the careful analysis and annotation of substantial amounts of corpus data will we be able to properly and thoroughly describe linguistic phenomenon, which could then be tested via experiments. Through this research, we aimed to emphasise the importance of usage-based approaches to language. However, usage-based approaches need more than simple corpus annotation to prove efficient and reliable for the formulation of theories of language. Notably, corpus analyses should be both quantitative and qualitative; an effort we made in the development of our method of analysis.

8.3 A method for the analysis of alternations

The bulk of this thesis was the development of a method for the analysis of alternating argument structure constructions. In this regard, our research had two goals: (i) test this method on a substantial amount of data put together for the analysis of the causative alternation and (ii) make it reproducible so that it can be used for other alternating argument structure constructions which share one (schematic) participant. Our method was developed after we realised that in order to capture generalisations over the shared participant in these two constructions we had to actually study carefully the different themes realised in each construction (and with each verb, to preserve verb-level generalisations and semantic coherence) and find a way to properly assess to what extent these themes are found in the two constructions. As we showed, the measure

of theme overlap suggested by Lemmens (forthc.) was not strong enough to account for shared meaning between the two constructions since it counted theme types without taking into account the potential semantic similarity between these themes. We proposed to improve this method by grouping these themes into semantically related clusters. In order to do this, we relied on a solid tool for the measure of semantic similarity: distributional semantics. Thanks to distributional semantics, we avoided similarity judgements based on intuition which could have been not only extremely time-consuming but also biased. By calculating the similarity of sets of themes based on these themes' shared collocates in an entire corpus (a corpus made up of all the nouns in COCA together with their collocates within a two-word window), we achieved an objective and cognitively plausible grouping into clusters of semantically related themes. These clusters were of major importance in the identification of a certain number of verb senses. That is, via the grouping of themes, we not only got a better vision of the quantity of themes shared between the two constructions but also, and most importantly, of the specific types of themes that occur with each construction. This proved to be essential in the analysis since we found that (i) while some verbs alternate between the two constructions, not all their senses are actually shared by the two constructions; and (ii) even when a verb sense is shared, it is sometimes the case that it is shared with certain themes. These are the kind of local generalisations that cannot be achieved via analyses that only take the verb into account. This cannot be achieved via the measure of theme overlap either. In this respect, we suggest a method of analysis that allows researchers to capture generalisations at the level of the interaction between the verb and its argument(s) which in turn allows for broader generalisations at the level of the construction itself.

In conclusion, this method was successful with this data set. Considering the kind of information needed for this analysis, we do not see any reason why it should not be equally successful with other alternating argument structure constructions such as the intransitive motion construction and the transitive motion construction.

8.4 Theoretical implications

As mentioned in the previous section, the analysis of our data set with a mixture of theme overlap and distributional semantics leads us to the conclusion that there are generalisations that can be drawn at the level of the interaction between verb and theme. A careful look at the data shows some discrepancies in the use of two alternating constructions such as the intransitive non-causative construction and the transitive causative construction. In point of fact, we found that even though verbs tend to alternate between the two constructions, they can be further divided into verb senses which do not alternate quite as much. As we showed in Chapter 7, a substantial number of verbs display discrepancies in the distribution not only of their different senses, but also of the themes used with each verb sense across the two constructions. Identifying differences in the use of sets of semantically related themes across the two constructions lead us to the conclusion that identifying local generalisations such as the interaction of verb and theme also provides evidence of available schematic generalisations. That is, abstracting away from the various constraints at the level of verb-theme interaction we managed to identify constraints

that apply to the theme slot in each construction. Notably, what themes have in common is that they refer to the entity undergoing the event denoted by the verb. However, there are different constraints as to their realisation in subject position and in object position. The theme realised in subject position in the intransitive non-causative construction must be construed as being “likely to V” where V stands for the event denoted by the verb. The theme realised in object position in the transitive causative construction must be construed as “likely to be acted upon in the manner denoted by the verb.” While themes may have both characteristics, it is not necessarily the case that both are activated when they are used with either construction. However, we found that themes that cannot be construed as “likely to V” in essence cannot be realised in subject position in the intransitive non-causative construction. By the same token, themes that cannot be construed as “likely to be acted upon in the manner denoted by the verb” cannot be realised in object position in the transitive causative construction.

8.5 Research prospects

This method already proved to be successful in the analysis of the kind of meaning shared by two alternating constructions, namely the intransitive non-causative construction and the transitive causative construction, but it would be interesting to apply it to other alternating constructions such as the (in)transitive motion construction and the (in)transitive resultative construction. On top of being tested with other alternations, there are also several ways in which it could be improved or complemented.

First, as mentioned in Section 7.6, we dropped the precise quantitative feature of theme overlap. This is mostly due to the fact that language is not as neat as one might hope. The consequence is that it does not allow for a clearcut measure in percent of the meaning shared by the two constructions since, despite our efforts to group themes semantically, there remain exceptions to these groups and idiosyncracies of use. Furthermore, the polysemy of some of these themes also impedes their classification into one particular group: different facets match different verb senses. Nonetheless, although such a measure seems difficult to achieve without sacrificing some of the more unusual examples, it would be interesting to compare the frequency of themes in relation to both the verb(s) and the construction(s) they occur with. That is, a semantic map that highlights either the frequency of the collocation between verb and theme or their mutual attraction (via a collexeme analysis) would be even more telling than the “flat” maps obtained for this research.

Second, the entrenchment of these collocations could also allow us to evaluate a theme’s “likeliness to V” or “to be acted upon in the manner denoted by the verb.” Actually, we would also like to run a diachronic version of this analysis where the same verb is tested throughout several periods. This kind of diachronic analysis could help measure whether each construction has become more or less productive over the years or whether it has remained constant. That is, is there an evolution in the kinds of themes found with each construction over the years? This type of work has notably been taken up by Perek (2016a) with an analysis of the way-construction.

Finally, as is the case for many corpus-based studies, testing our findings against experimental

data (similarly to Gries, Hampe, and Schönefeld 2005, 2010) would either reinforce our conclusions or elicit ways in which it could be adjusted to fit the cognitive reality better.

This thesis set out three goals: provide a description of the causative alternation based on corpus data, develop a reliable method for the comparison of shared meaning between two alternating constructions, and add to the discussion on argument structure realisation by highlighting the importance of a regularly overlooked element of the construction: the argument itself. While there are ways in which this work could be refined, the goals were reached.

BIBLIOGRAPHY

- Bencini, Giulia M. L. and Adele E. Goldberg (2000). "The contribution of argument structure constructions to sentence meaning". In: *Journal of Memory and Language* 43, pp. 640–651.
- Berlin, Brent and Paul Kay (1969). *Basic color terms: their universality and evolution*. Berkeley: University of California Press.
- Boas, Hans C. (2011). "Coercion and leaking argument structures in Construction Grammar". In: *Linguistics* 49.6, pp. 1271–1303.
- Boyd, Jeremy K. and Adele E. Goldberg (2011). "Learning what not to say: the role of statistical preemption and categorization in "a"-adjective production". In: *Language* 81.1, pp. 1–29.
- Brown, Roger (1958). "How shall a thing be called?" In: *Psychological Review* 65, pp. 14–21.
- (1965). *Social psychology*. New York: Free Press.
- Cappelle, Bert (2006). "Particle placement and the case for 'allostructions'." In: *Constructions*.
- Chomsky, Noam (1965). *Aspects of the theory of syntax*. Cambridge, MA: MIT Press.
- Clark, Eve V. (1978). "Discovering what words can do." In: *Papers from the parasession on the lexicon, Chicago linguistics society*. Ed. by Donna Farkas, Wesley M. Jacobsen, and Karol W. Todrys. Chicago: Chicago Linguistics Society, pp. 34–57.
- Croft, William (1991). *Syntactic categories and grammatical relations: the cognitive organization of information*. Chicago: University of Chicago Press.
- (1998). "Event structure in argument linking". In: *The projection of arguments: lexical and compositional factors*. Ed. by Miriam Butt and Wilhelm Geuder. Stanford, Calif.: Center for the Study of Language and Information, pp. 21–63.
- (2001). *Radical construction grammar*. Oxford: Oxford University Press.
- (2003). "Lexical rules vs. constructions: a false dichotomy". In: *Motivation in language*. Ed. by Hubert Cuyckens, Thomas Berg, René Dirven, and Klaus-Uwe Panther. Amsterdam: John Benjamins, pp. 49–68.

- Croft, William (2012). *Verbs: aspect and causal structure*. Oxford: Oxford University Press.
- Croft, William and D. Alan Cruse (2004). *Cognitive Linguistics*. New York: Cambridge University Press.
- Cruse, D. Alan (1973). "Some thoughts on agentivity". In: *Journal of Linguistics* 9, pp. 11–23.
- Davidse, Kristin (1991). "Categories of experiential grammar". PhD thesis. K.U. Leuven.
- (1992). "Transitivity/Ergativity: the janus-headed grammar of actions and events". In: *Advances in systemic linguistics*. Ed. by Martin Davis and Louise Ravelli. London: Pinter, pp. 105–135.
- Davies, Mark (2000). *Corpus of Historical American English (COHA)*.
- (2008-). *The Corpus of Contemporary American English (COCA): 520 million words, 1990-present*. Available online at: <https://corpus.byu.edu/coca>.
- (2013). *Corpus of News on the Web (NOW): 3+ billion words from 20 countries, updated everyday*. Available online at: <https://corpus.byu.edu/now/>.
- Delancey, Scott (1984). "Notes on agentivity and causation". In: *Studies in Language* 8, pp. 181–213.
- Desagulier, Guillaume (2016). "A lesson from associative learning: asymmetry and productivity in multiple-slot constructions." In: *Corpus linguistics and linguistic theory* 12.2, pp. 173–219.
- (To appear). *Can word vectors help corpus linguists?* <halshs-01657591>.
- Dinu, Georgiana, Nghia The Pham, and Marco Baroni (2013). "DISSECT: DISTRIBUTIONAL SEMANTICS COMPOSITION TOOLKIT". In: *Proceedings of the System Demonstrations of ACL 2013 (51st Annual Meeting of the Association for Computational Linguistics)*. East Stroudsburg, PA: ACL, pp. 31–36.
- Dixon, Robert M. W. (1991). *A new approach to English grammar, on semantic principles*. Oxford: Clarendon Press.
- Dowty, David (1991). "Thematic proto-roles and argument selection". In: *Language* 67.3, pp. 547–619.
- Dubois, John W. (1985). "Competing motivations". In: *Iconicity in syntax*. Ed. by John Haiman. Amsterdam: John Benjamins, pp. 343–65.
- Faulhaber, Susen (2011). "Idiosyncrasy in verb valency pattern". In: *Zeitschrift für Anglistik und Amerikanistik* 59.4, pp. 331–346.
- Fellbaum, Christiane (1998). "Semantic network of English verbs". In: *WordNet: An electronic lexical database*. Ed. by Christiane Fellbaum. Cambridge, MA: MIT Press, pp. 69–104.
- Fillmore, Charles J. (1968). "The case for case". In: *Universals in linguistic theory*. Ed. by Emmon W. Bach and Robert Thomas Harms. New York: Holt, Rinehart, and Winston, pp. 1–88.
- (1977). "The case for case reopened". In: *Grammatical relations*. Ed. by Peter Cole and Jerrold M. Sadock. Academic Press, pp. 59–82.

- Fillmore, Charles J. (1982/2006). "Frame semantics". In: *Cognitive linguistics. Basic readings*. Ed. by Dirk Geeraerts. Berlin: Mouton De Gruyter.
- (1988). "The mechanisms of construction grammar". In: *General session and parasession on grammaticalization*. Ed. by Shelley Axmaker, Annie Jassier, and Helen Singmaster. Berkeley Linguistics Society, pp. 35–55.
- Fillmore, Charles J., Paul Kay, and Mary Catherine O'Connor (1988). "Idiomaticity and regularity in grammar: the case of let alone". In: *Language* 64, pp. 501–538.
- Firth, John R. (1957). "A synopsis of linguistic theory 1930-1955". In: *Studies in Linguistic Analysis (Special volume of the philosophical society)*, pp. 1–32.
- Francis, Gill, Susan Hunston, and Elizabeth Manning (1996). *Collins Cobuild grammar patterns 1: verbs*. London: Harper Collins.
- Gilquin, Gaëtanelle (2010). *Corpus, cognition and causative constructions*. Ed. by Elena Tognini-Bonelli and Wolfgang Teubert. Vol. 39. Studies in Corpus Linguistics (SCL). Amsterdam and Philadelphia: John Benjamins.
- Goldberg, Adele E. (1995). *Constructions. A construction grammar approach to argument structure*. Chicago: University of Chicago Press.
- (1998). "Patterns of experience in patterns of language". In: *The new psychology of language. Cognitive and functional approaches to language structure*. Ed. by Michael Tomasello. Mahwah, NJ: Lawrence Erlbaum, pp. 203–219.
- (1999). "The emergence of argument structure semantics". In: *The emergence of language*. Ed. by Brian MacWhinney. London: Lawrence Erlbaum.
- (2001). "Patient arguments of causative constructions can be omitted: the role of information structure in argument distribution". In: *Language Sciences* 23, pp. 503–524.
- (2002). "Surface generalizations: An alternative to alternations". In: *Cognitive Linguistics* 13.4, pp. 327–356.
- (2005). "Argument realization: the role of constructions, lexical semantics and discourse factors". In: *Construction grammar(s): cognitive and cross-language dimension*. Ed. by Jan-Ola Östman and Marjam Fried. John Benjamins.
- (2006). *Constructions at work: the nature of generalization in language*. Oxford: Oxford University Press.
- (2014). "Fitting a slim dime between the verb template and argument structure construction approaches". In: *Theoretical linguistics* 40, pp. 113–135.
- Goldberg, Adele E. and Ray Jackendoff (2004). "The English resultative as a family of constructions". In: *Language* 80, pp. 532–68.

- Goossens, Louis (1990). "Metaphonymy: the interaction of metaphor and metonymy in expressions for linguistic action". In: *Cognitive Linguistics* 1.3, pp. 323–340.
- Gries, Stefan T. (2003). *Multifactorial analysis in corpus linguistics: a study of particle placement*. London: Continuum.
- Gries, Stefan T., Beate Hampe, and Doris Schönefeld (2005). "Converging evidence: Bringing together experimental and corpus data on the association of verbs and constructions". In: *Cognitive Linguistics* 16, pp. 635–676.
- (2010). "Converging evidence II: More on the association of verbs and constructions". In: *Empirical evidence in linguistics. Proceedings of the 7th conference on conceptual structure, discourse and language*. Ed. by Sally Rice and John Newman. Stanford: CSLI Publications (UCP).
- Gries, Stefan T. and Anatol Stefanowitsch (2004). "Extending collocation analysis. A corpus-based perspective on 'alternations'". In: *International journal of corpus linguistics* 9.1, pp. 97–129.
- (2010). "Cluster analysis and the identification of collexeme classes". In: *Empirical and experimental methods in cognitive/functional research*. Ed. by Sally Rice and John Newman. Stanford, Calif.: CSLI Publications, pp. 73–90.
- Guerrero Medina, Pilar (2014). "A lexico-paradigmatic approach to English setting constructions". In: *The functional perspective on language and discourse: Applications and implications*. Ed. by María de los Ángeles Gómez González, Francisco José Ruiz de Mendoza Ibáñez, Francisco González-García, and Angela Downing. Pragmatics and Beyond new series. Amsterdam: John Benjamins, pp. 133–148.
- Halliday, M.A.K (1967a). "Notes on transitivity and theme in English 1". In: *Journal of Linguistics* 3, pp. 37–81.
- (1967b). "Notes on transitivity and theme in English 2". In: *Journal of Linguistics* 3, pp. 199–244.
- (1968). "Notes on transitivity and theme in English 3". In: *Journal of Linguistics* 4, pp. 179–215.
- Hampe, Beate (2011). "Discovering constructions by means of collocation analysis: The English Denominative Construction". In: *Cognitive Linguistics* 22.2, pp. 211–245.
- Hampe, Beate and Doris Schönefeld (2006). "Syntactic leaps or lexical creation? More on 'creative syntax'". In: *Corpora in cognitive linguistics: the syntax-lexis interface*. Ed. by Stefan T. Gries and Anatol Stefanowitsch. Berlin: Mouton De Gruyter, pp. 127–157.
- Harris, Zellig (1968). *Mathematical structures of language*. New York: Interscience Publishers.
- (1970). "Distributional structure". In: *Papers in Structural and Transformational Linguistics*. Dordrecht: Springer, pp. 775–794.
- Herbst, Thomas (2011). "The status of generalizations: valency and argument structure constructions". In: *Zeitschrift für Anglistik und Amerikanistik* 59.4, pp. 347–367.

- Herbst, Thomas, David Heath, Ian Roe, and Dieter Götz (2004). *A valency dictionary of English*. Berlin and New York: Mouton De Gruyter.
- Herbst, Thomas and Susen Schüller (2008). *Introduction to syntactic analysis: a valency approach*. Tübingen: Narr.
- Hilpert, Martin (2015). "From *hand-carved* to *computer-based*: Noun-participle compounding and the upward strengthening hypothesis". In: *Cognitive Linguistics* 26.1, pp. 1–36.
- Hilpert, Martin and Florent Perek (2015). "Meaning change in a petri dish: constructions, semantic vector spaces, and motion charts". In: *Linguistic Vanguard*. URL: <https://doi.org/10.1515/lingvan-2015-0013>.
- Hunston, Susan and Gill Francis (2000). *Pattern Grammar: a corpus-driven approach to the lexical grammar of English*. Amsterdam and Philadelphia: Benjamins.
- Jackendoff, Ray (1990). *Semantic structures*. Cambridge, MA: MIT Press.
- Jurafsky, Daniel (1992). "An on-line computational model of human sentence interpretation". In: *Proceedings of the National Conference on Artificial Intelligence (AAAI-92)*. Ed. by American Association for Artificial Intelligence. Cambridge, MA: MIT Press, pp. 302–308.
- Karlgren, Jussi and Magnus Sahlgren (2001). "From words to understanding". In: ed. by Yoshinori; Pentti Kanerva Uesaka and Hideki Asoh. Stanford, Calif.: CSLI Publications, pp. 294–308.
- Kay, Paul (1984). "The kind of/sort of construction". In: *BLS* 10, pp. 157–171.
- (1988). "Even". In: *Berkeley Cognitive Science Report* 50.
- (2013). "The limits of (construction) grammar". In: *The Oxford handbook of construction grammar*. Ed. by Thomas Hoffman and Graeme Trousdale. Oxford University Press, pp. 32–48.
- Kay, Paul and Charles J. Fillmore (1999). "Grammatical constructions and linguistic generalizations: The what's X doing Y? construction". In: *Language* 75, pp. 1–33.
- Kruskal, Joseph B. (1964). "Multidimensional scaling by optimizing goodness of fit to a nonmetric hypothesis". In: *Psychometrika* 29.1, pp. 1–27.
- Kučera, Henry and W. Nelson Francis (1967). *The standard corpus of present-day edited American English (the Brown corpus)*. Providence, RI: Brown University.
- Lakoff, George (1987). *Women, fire, and dangerous things: what categories reveal about the mind*. Chicago: University of Chicago Press.
- Lakoff, George and Mark Johnson (1980). *Metaphors we live by*. Chicago: University of Chicago Press.
- Langacker, Ronald (1987). *Theoretical prerequisites*. Vol. 1: *Foundations of cognitive grammar*. Stanford, Calif.: Stanford University Press.
- (1991). *Descriptive application*. Vol. 2: *Foundations of cognitive grammar*. Stanford, Calif.: Stanford University Press.

- Lemmens, Maarten (1998). *Lexical perspectives on transitivity and ergativity. Causative constructions in English*. Amsterdam: John Benjamins.
- (2005). “De la sémantique lexicale à la typologie sémantique. Vers une sémantique basée sur l’activité langagière.” HDR Thesis (Habilitation à Diriger des Recherches). Université de Lille.
 - (2006). “More on objectless transitives”. In: *Constructions Special Volume 1*.
 - (forthc.). *Usage-based perspectives on lexical and constructional semantics*. Shanghai, China: Shanghai Foreign Language Education Press.
- Lenci, Alessandro (2008). “Distributional semantics in linguistic and cognitive research”. In: *Rivista di linguistica* 20.1, pp. 1–31.
- Levin, Beth (1993). *English verb classes and alternations*. Chicago: Chicago University Press.
- Levin, Beth and Malka Rappaport Hovav (2005). *Argument realization*. Cambridge: Cambridge University Press.
- Levshina, Natalia and Kris Heylen (2014). “A radically data-driven Construction Grammar: Experiments with Dutch causative constructions”. In: *Extending the scope of Construction Grammar*. Ed. by Ronny Boogaart, Timothy Colleman, and Gijsbert Rutten. Berlin and Boston: De Gruyter Mouton, pp. 17–46.
- Lieven, Elena and Claire Noble (2011). “The acquisition of argument structure”. In: *Zeitschrift für Anglistik und Amerikanistik* 59.4, pp. 409–422.
- Lin, Dekang (1998). “Automatic retrieval and clustering of similar words”. In: *Proceedings of COLING-ACL 1998*, pp. 768–774.
- Maaten, Laurens van der (2008). “Visualizing high-dimensional data using t-SNE”. In: *Journal of Machine Learning Research* 9, pp. 2579–2605.
- Matlock, Teenie (2004). “Fictive motion as cognitive simulation”. In: *Memory and Cognition* 32.8, pp. 1389–1400.
- (2006). “Depicting fictive motion in drawings”. In: *Cognitive linguistics investigations: Across languages, fields and philosophical boundaries*. Ed. by June Luchenbroers. Amsterdam: John Benjamins.
 - (2010). “Abstract motion is no longer abstract”. In: *Language and Cognition* 2, pp. 243–260.
- Michaelis, Laura (2004). “Construction grammar. Entity and event coercion in a symbolic theory of syntax”. In: *Construction grammars: Cognitive grounding and theoretical extensions*. Ed. by Jan-Ola Östman and Mirjam Fried. Amsterdam and Philadelphia: John Benjamins, pp. 45–88.
- Miller, George A. and Walter G. Charles (1991). “Contextual correlates of semantic similarity”. In: *Language and Cognitive Processes* 6.1, pp. 1–28.

- Nishimura, Yoshiki (1993). "Agentivity in cognitive grammar". In: *Conceptualizations and mental processing in language*. Ed. by Richard A. Geiger and Brygida Rudzka-Ostyn. Berlin and New York: Mouton De Gruyter, pp. 488–530.
- OED Online (2018). Web. Oxford University Press. URL: <https://en.oxforddictionaries.com>.
- Padó, Sebastian and Mirella Lapata (2003). "Constructing semantic space models from parsed corpora". In: *Proceedings of the 41st Conference of the Association for Computational Linguistics*, pp. 128–135.
- (2007). "Dependency-based construction of semantic space models". In: *Computational Linguistics* 33.2, pp. 161–199.
- Perek, Florent (2014). "Rethinking constructional polysemy: the case of the English conative construction". In: *Corpus methods for semantics. Quantitative studies in polysemy and synonymy*. Ed. by D Glynn and J Robinson. Amsterdam: John Benjamins, pp. 61–85.
- (2015). *Argument structure in usage-based construction grammar. Experimental and corpus-based perspectives*. Amsterdam: John Benjamins.
- (2016a). "Recent change in the productivity and schematicity of the way-construction: a distributional semantic analysis". In: *Corpus linguistics and linguistic theory* 14.1.
- (2016b). "Using distributional semantics to study syntactic productivity in diachrony: A case study". In: *Linguistics* 54.1, pp. 149–188.
- Pinker, Steven (1989). *Learnability and cognition. The acquisition of argument structure*. Cambridge, MA: The MIT Press.
- Princeton University (2010). *About WordNet*. <http://wordnet.princeton.edu>.
- Purandare, Amruta and Ted Petersen (2004). "Word sense discrimination by clustering contexts in vector and similarity spaces". In: *Proceedings of the Conference on Computational Natural Language Learning (CoNLL) May 6-7 2004, Boston, MA*, pp. 41–48.
- Pustejovsky, James (1995). *The generative lexicon*. Cambridge, MA: MIT Press.
- R Development Core Team (2013). *R: A language and environment for statistical computing*. R Foundation for Statistical Computing. URL: www.R-project.org/.
- Romain, Laurence (2017). "Measuring the alternation strength of causative verbs: a quantitative and qualitative analysis of the interaction between verb, theme and construction". In: *Belgian Journal of Linguistics* 31, pp. 213–235.
- (2018). *Rolling with the punches, the clique, and the oddballitude of this new correspondent. A study of the [ROLL with X] construction*. Manuscript in preparation.
- Rosch, Eleanor (1973). "Natural categories". In: *Cognitive Psychology* 4, pp. 328–50.
- (1975). "Cognitive reference points". In: *Cognitive Psychology* 7.532-47.

- Rosch, Eleanor (1978/2004). "Principles of categorization". In: *Fuzzy grammar: a reader*. Ed. by Bas Aarts, David Denison, Evelyn Keizer, and Gergana Popova. New York: Oxford University Press, pp. 91–108.
- Sahlgren, Magnus (2008). "The distributional hypothesis". In: *Rivista di linguistica* 20.1, pp. 33–53.
- Salton, Gerard (1971). *The SMART retrieval system: Experiments in automatic document processing*. Upper Saddle River, NJ: Prentice-Hall.
- Salton, Gerard, Andrew Wong, and Chungshu Yang (1975). "A vector space model for automatic indexing". In: *Communications of the ACM* 18.11, pp. 613–620.
- Saussure, Ferdinand de (1916/1995). *Cours de linuistique générale*. Ed. by Charles Bally and Albert Sechehaye. Paris: Payot.
- Schlesinger, I. M. (1989). "Instruments as agents: on the nature of semantic relations". In: *Linguistics* 25, pp. 189–210.
- Schmid, Helmut (1994). "Probabilistic part-of-speech tagging using decision trees". In: *Proceedings of International Conference on New Methods in Language Processing, Manchester, UK*, pp. 44–49.
- Schütze, Hinrich (1992). "Dimensions of meaning". In: *Proceedings of the 1992 ACM/IEEE Conference on Supercomputing*. Ed. by Robert Werner. Los Alamitos, CA: IEEE Computer Society Press, pp. 787–796.
- (1998). "Automatic word sense discrimination". In: *Computational Linguistics* 24.1, pp. 97–124.
- Slobin, Dan Isaac (1985). "Crosslinguistic evidence for the language-making capacity". In: *A crosslinguistic study of language acquisition*. Ed. by Dan Isaac Slobin. Hillsdale, NJ: Lawrence Erlbaum.
- Stefanowitsch, Anatol and Stefan T. Gries (2003). "Collostructions: investigating the interaction between words and constructions". In: *International journal of corpus linguistics* 8.2, pp. 209–243.
- (2005). "Covarying collexemes". In: *Corpus linguistics and linguistic theory* 1.1, pp. 1–43.
- Talmy, Leonard (1974). "Semantics and syntax of motion". In: *Semantics and syntax*. Ed. by John Kimball. Vol. 4. New York: Academic Press, pp. 181–238.
- (1976). "Semantic causative types". In: *The grammar of causative constructions*. Ed. by Masayoshi Shibatani. Vol. 6. Semantics and syntax. New York: Academic Press, pp. 43–116.
- (1983). "How language structures space". In: *Spatial orientation: Theory, research, and application*. Ed. by Herbert L. Pick Jr. and Linda Acredolo. New York: Plenum Press, pp. 225–282.
- (2000). *Toward a cognitive semantics*. Vol. 1. Cambridge, MA: MIT Press.
- Taylor, J.R. (1998). "Syntactic constructions as prototype categories." In: *The new psychology of language. Cognitive and functional approaches to language structure*. Mahwah, NJ: Lawrence Erlbaum, pp. 177–202.

- Tesnière, Lucien (1959). *Éléments de syntaxe structurale*. 2nd ed. Paris: Éditions Klincksieck.
- Tomasello, Michael (2000). "Do children have adult syntactic competence?" In: *Cognition* 74, pp. 209–253.
- (2003). *Constructing a language*. Cambridge, MA: Harvard University Press.
- Turney, Peter D. and Patrick Pantel (2010). "From frequency to meaning: Vector space models of semantics". In: *Journal of Artificial Intelligence Research* 37, pp. 141–188.
- Van Valin, Robert D. Jr and David P. Wilkins (1996). "The case for 'effector': case roles, agents and agentivity revisited." In: *Grammatical constructions*. Ed. by Masayoshi Shibatani and Sandra A. Thompson. Oxford: Oxford University Press, pp. 289–332.
- Wild, Fridolin (2007). "An LSA package for R". In: *Mini-proceedings of the 1st European Workshop on Latent Semantic Analysis in Technology-Enhanced Learning*. Ed. by Fridolin Wild, Marco Kalz, Jan Van Bruggen, and Rob Koper, pp. 11–12.
- Wittgenstein, Ludwig (1953). *Philosophical investigations*. New York: Macmillan.
- Yoshimura, Kimihiro and J.R. Taylor (2004). "What makes a good middle? The role of qualia in the interpretation and acceptability of middle expressions in English". In: *English Language and Linguistics* 8, pp. 293–321.

