



**HAL**  
open science

# Multiple interface management in smart grid networks

François Lemerrier

► **To cite this version:**

François Lemerrier. Multiple interface management in smart grid networks. Networking and Internet Architecture [cs.NI]. Ecole nationale supérieure Mines-Télécom Atlantique, 2018. English. NNT : 2018IMTA0100 . tel-02095994

**HAL Id: tel-02095994**

**<https://theses.hal.science/tel-02095994>**

Submitted on 11 Apr 2019

**HAL** is a multi-disciplinary open access archive for the deposit and dissemination of scientific research documents, whether they are published or not. The documents may come from teaching and research institutions in France or abroad, or from public or private research centers.

L'archive ouverte pluridisciplinaire **HAL**, est destinée au dépôt et à la diffusion de documents scientifiques de niveau recherche, publiés ou non, émanant des établissements d'enseignement et de recherche français ou étrangers, des laboratoires publics ou privés.

# THÈSE DE DOCTORAT DE

L'ÉCOLE NATIONALE SUPERIEURE MINES-TELECOM ATLANTIQUE  
BRETAGNE PAYS DE LA LOIRE - IMT ATLANTIQUE  
COMUE UNIVERSITE BRETAGNE LOIRE

Ecole Doctorale N° 601  
*Mathématique et Sciences et Technologies  
de l'Information et de la Communication (MathSTIC)*  
Spécialité : Informatique

Par

**François LEMERCIER**

## **Multiple Interface Management in Smart Grid Networks**

Gestion d'interface multiple dans les réseaux smart grids.

Thèse présentée et soutenue à RENNES , le 20/11/2018

Unité de recherche : **Institut de recherche en informatique et systèmes aléatoires (IRISA)**

Thèse N° : 2018IMTA0100

### **Rapporteurs avant soutenance :**

André-Luc BEYLOT – Professeur, ENSEEIHT Engineering School, Université de Toulouse, France

Antoine GALLAIS – Maître de conférences, INRIA, Université de Strasbourg, France

### **Composition du jury :**

Présidente : Mireille BATTON-HUBERT – Professeure, Ecole des Mines de Saint Etienne, France

Examineurs : André-Luc BEYLOT – Professeur, ENSEEIHT Engineering School, Université de Toulouse, France

Antoine GALLAIS – Maître de conférences, INRIA, Université de Strasbourg, France

Nicolas MONTAVONT – Professeur, IMT Atlantique, IRISA, France – Encadrant de thèse

Philippe CHIUMMIENTO – R&D Manager, Itron, France

Dir. de thèse : Laurent TOUTAIN – HDR, IMT Atlantique, IRISA, France – Directeur de thèse



## DECLARATION

---

I hereby declare that except where specific reference is made to the work of others, the contents of this dissertation are original and have not been submitted in whole or in part for consideration for any other degree or qualification in this, or any other university. This dissertation is my own work and contains nothing which is the outcome of work done in collaboration with others, except as specified in the text and Acknowledgments.

*Rennes, September 20, 2018*

---

François Lemerrier

A handwritten signature in black ink, consisting of a large, stylized initial 'F' followed by a cursive name.



6LOWPAN IPv6 over Low power Wireless Personal Area Networks

AMI Advanced Metering Infrastructure

AMR Automated Meter Reading

AODV Ad Hoc On-Demand Distance Vector Protocol

BB Broadband

BLE Bluetooth Low Energy

CSMA/CA Carrier Sense Multiple Access with Collision Avoidance

D8PSK Differential Eight Phase Shift Keying

DADR Distributed Autonomous Depth-First Routing

DAG Directed Acyclic Graphs

DAO Destination Advertisement Object

DBPSK Differential Binary Phase Shift Keying

DC Data Concentrator

DDR Data Delivery Ratio

DIO DAG Information Object

DIS DAG Information Solicitation

DODAG Destination Oriented DAG

DQPSK Differential Quaternary Phase Shift Keying

DSP Digital Signal Processor

ETT Expected Transmission Time

ETX Expected Transmission Count

EV Electric Vehicle

G2V Grid to Vehicle

HAN Home Area Network

HSDPA High Speed Downlink Packet Access

HV High Voltage

IETF Internet Engineering Task Force

IOT Internet of Things

IP Internet Protocol

LLN Low power and Lossy Network

LOAD 6LoWPAN Ad Hoc On-Demand Distance Vector Routing

LOADNG Lightweight Ad hoc On-demand Distance-vector Routing Protocol Next Generation

LQL Link Quality Level

LV Low Voltage

MDMS Meter Data Management Systems

MP2P Multipoint-to-Point

MPTCP Multipath TCP

MRHOF Minimum Rank with Hysteresis Objective Function

MV Medium Voltage

NAN Neighborhood Area Network

NB Narrow Band

NBI Narrow-band Interference

NSA Node State and Attribute

NT Neighbor Table

OF Objective Function

OFO Objective Function Zero

OFDM Orthogonal frequency-division multiplexing

OLSR Optimized Link State Routing Protocol

OS Operating System

P2P Point-to-Point

P2MP Point-to-Multipoint

PAN Premise Area Network

PC Personal Computer

PDR Packet Delivery Ratio

PLC Power Line Communication

PMU Phasor measurement unit

QOS Quality of Service

**RREP** Route Reply

**RREQ** Route Request

**ROBO** Robust Orthogonal Frequency Division Multiplexing

**RPL** IPv6 Routing Protocol for Low-Power and Lossy Networks

**RTU** Remote Terminal Units

**SCADA** Supervisory Control and Data Acquisition

**SM** Smart Meter

**SNR** Signal Noise Ratio

**UNB** Ultra Narrow Band

**V2G** Vehicle to grid

**WAN** Wide Area Network

**WMN** Wireless Mesh Network

**WSN** Wireless Sensor Network





Dedicated to my wonderful wife Gwenaëlle and our fantastic  
daughter Zoé, you bring so much love into my life!



## ABSTRACT

---

The power grid is undergoing a tremendous evolution, toward what is called the Smart Grid. The necessity of incorporate renewable energy sources in the grid, the decentralized productions, the increasing of consumption, etc. are some of the challenges in an energy network where sustainability, security and affordability are required. The grid is actually evolving from a centralized architecture to a decentralized one, taking into account all the unpredictable sources and consumption an energy network should handle in the future.

The Advanced Metering Infrastructure is the network dedicated to the Smart Grid that allows two-ways communications between the consumers and the energy providers. Consumers are linked to the AMI with meters having advanced communication and computing technologies: the Smart Meter. Today Smart Meters are often equipped with multiple communication interfaces but only one is used for principal Smart Grid communication, the other one having a dedicated function (such as firmware update, etc.).

The Smart Meters network is commonly based on Power Line Communications, a technology that is subject to high sensitivity to interference. Despite a dedicated MAC protocol, such as P1901.2, that could face the high variation of the available bandwidth, this technology does not allow to fulfill the requirements of all smart grid applications (i.e. the 99.99% reading rate). Alternative communications technologies exist to tackle the issues of PLC, such as wireless or fiber optic, but using one of those technologies does not appears to be a long term solution. Consequently, mixing multiple heterogeneous technologies allow to cope with all scenarios and interference levels.

Most of the technologies considered for smart meters network are short range, nodes cannot reach the concentrator directly. Consequently, nodes must collaborate using a dedicated routing protocol, to reach a destination that is multiple hops away. RPL is the most popular routing protocol in the IoT community, and specifically designed to operate on Low Power and Lossy networks. But it is mostly used in homogeneous networks with single communication devices.

The goal of this thesis is to adapt RPL as it could work with multiple interfaces, and study how the heterogeneity of the interfaces could increase the reliability and the performance of smart meter networks.

To this end, we propose a new framework to extend RPL by managing multiple heterogeneous interfaces and we introduce three original solutions which are the Parent Oriented, the Interface Oriented and the Multiple Instances. We propose a

new re-transmission mechanism that benefits from the multiple interfaces as well.

Finally, we implemented our solutions in both simulation and hardware environment to validate and compare each one with realistic conditions.

## RÉSUMÉ

---

Le réseau électrique a subi d'importantes évolutions ces dernières décennies, pour devenir ce qu'on appelle le Smart Grid. La nécessité d'intégrer des sources d'énergie renouvelable est un défi dans un réseau d'énergies où l'accessibilité, la maintenabilité et la sécurité sont requis. Le réseau électrique évolue actuellement d'une architecture centralisée vers une architecture décentralisée, tenant compte des consommations et sources d'énergies à caractère imprédictible et irrégulier.

L'Advanced Metering Infrastructure est une architecture clé du Smart Grid qui permet des communications bidirectionnelles entre le consommateur et le fournisseur d'énergie. Cette infrastructure repose sur des compteurs dotés de capacités de communication et de calculs avancés, que nous appelons "compteur intelligent". Les compteurs intelligents d'aujourd'hui sont souvent capables de communiquer avec plusieurs interfaces de communication mais seulement une seule est dédiée aux applications Smart Grid, les autres interfaces étant dédiées à des fonctions spécifiques (comme la mise à jour du firmware, etc.).

Les réseaux de compteurs intelligents reposent communément sur des communications à courant porteur, une technologie qui est hautement sensible aux interférences. Malgré l'utilisation de protocoles de niveau 2 spécifiques (tel que P1901.2) qui peuvent gérer les grandes variations de bande passante, ces technologies ne permettent pas de respecter les exigences de toutes les applications Smart grid. Des technologies de communication alternatives existent pour résoudre les problèmes rencontrés par le courant porteur, comme la radio ou la fibre optique, mais utiliser simplement une seule d'entre elles ne s'avère pas être une solution de long terme. Ainsi, combiner plusieurs technologies hétérogènes permet de répondre à tous les scénarios smart grid à tout niveau d'interférence.

Par ailleurs, la plupart des technologies considérées pour les réseaux de compteurs intelligents sont de courte portée, chaque compteur ne peut communiquer directement avec le concentrateur. Les noeuds doivent donc collaborer entre eux, utilisant un protocole de routage approprié pour atteindre la destination située à plusieurs sauts. Rpl est le protocole de routage le plus populaire dans l'internet des objets, et a été spécifiquement conçu pour les Low power and Lossy networks (LLN), les réseaux à fort taux de perte et à faible puissance en français. Mais celui-ci est utilisé majoritairement dans des réseaux homogènes avec des équipements pourvus d'une seule interface de communication.

Le but de cette thèse est d'adapter RPL à un environnement multi interfaces, et étudier comment l'hétérogénéité des interfaces peut améliorer la fiabilité et les performances d'un réseau de compteurs intelligents.

Dans ce but, nous proposons un cadre d'extension de RPL pour la gestion d'interfaces hétérogènes multiples, en développant trois solutions originales nommées Parent Oriented, Interface Oriented et Multiple Instances. Nous proposons également un nouveau mécanisme de retransmission qui tient compte des multiples interfaces.

Pour finir, nous avons implémenté nos solutions dans un simulateur et une plateforme matérielle pour valider et comparer chaque solution dans des conditions réalistes.

## LIST OF PUBLICATIONS

---

### INTERNATIONAL CONFERENCES

2018

- François Lemerrier and Nicolas Montavont. "Performance Evaluation of a RPL Hybrid Objective Function for the Smart Grid Network." In: *Ad-hoc, Mobile, and Wireless Networks - 17th International Conference on Ad Hoc Networks and Wireless, ADHOC-NOW 2018, Saint-Malo, France, September 5-7, 2018, Proceedings*. 2018, pp. 27–38. DOI: [10.1007/978-3-030-00247-3\\_3](https://doi.org/10.1007/978-3-030-00247-3_3). URL: [https://doi.org/10.1007/978-3-030-00247-3%5C\\_3](https://doi.org/10.1007/978-3-030-00247-3%5C_3)
- François Lemerrier, Nicolas Montavont, Laurent Toutain, and Philippe Chiumminto. "A New Objective Function for Hybrid Network in the Smart Grid." In: *19th IEEE International Symposium on "A World of Wireless, Mobile and Multimedia Networks", WoWMoM 2018, Chania, Greece, June 12-15, 2018*. 2018, pp. 14–16. DOI: [10.1109/WoWMoM.2018.8449744](https://doi.org/10.1109/WoWMoM.2018.8449744). URL: <https://doi.org/10.1109/WoWMoM.2018.8449744>

2016

- François Lemerrier, Nicolas Montavont, Laurent Toutain, Kumaran Vijayasankar, Ramanuja Vedantham, and Philippe Chiumminto Itron. "Support for hybrid network in RPL." In: *2016 IEEE International Conference on Smart Grid Communications, SmartGridComm 2016, Sydney, Australia, November 6-9, 2016*. 2016, pp. 527–532. DOI: [10.1109/SmartGridComm.2016.7778815](https://doi.org/10.1109/SmartGridComm.2016.7778815). URL: <https://doi.org/10.1109/SmartGridComm.2016.7778815>

### INTERNATIONAL JOURNALS

2017

- Guillaume Habault, Maxime Lefrancois, François Lemerrier, Nicolas Montavont, Periklis Chatzimisios, and Georgios Z. Papadopoulos. "Monitoring Traffic Optimization in a Smart Grid." In: *IEEE Trans. Industrial Informatics* 13.6 (2017), pp. 3246–3255. DOI: [10.1109/TII.2017.2742584](https://doi.org/10.1109/TII.2017.2742584). URL: <https://doi.org/10.1109/TII.2017.2742584>



## BOOK

2017

- Francois Lemerrier, G. Habault, G. Z. Papadopoulous, P. Maille, P. Chatzimisios, and N. Montavont. "Communication architectures and technologies for advanced Smart Grid Services." In: *Transportation and Power Grid in Smart Cities: Communication Networks and Services*. UK: John Wiley, 2017. Chap. 8

## POSTERS

2018

- François Lemerrier, Poster presentation, *Performance Evaluation of a RPL Hybrid Objective Function for The Smart Grid Network*, IEEE WoWMoM 2018 International Conference, Chania, Greece, June 2018

2016

- François Lemerrier, Poster presentation, *Support For Hybrid Network In RPL*, RESCOM 2016 Summer School, Guidel Plage, France, June 2016

## ACKNOWLEDGMENTS

---

What an unforgettable journey that definitely changed my life! This fascinating adventure has made me grow personally and professionally, making me develop the passion to actively participate and power the research discourse. I would like to thank the many people that made this thesis possible.

First, my team of supervisors, Laurent Toutain, who worked hard to support our PhD project to finally trap me with the smart grid competence center project and inspired me through his unlimited knowledge and curiosity. Nicolas Montavont, who has kept pushing me towards his scientific rigor and contagious passion for research, and definitely gave me the confidence to grow up in the academic world towards his excellence. Philippe Chiumminto from Itron, who has always been supportive, and always taking as much time as he can to answer my questions and gave me the best advices to stay the course during the difficult times of the PhD process, it has been a real pleasure to talk and learn from you during those three years! Olivier Barais and Anne-Cécile Orgerie who provided me with contrasted views of research.

My reviewers and examiners, André-Luc Beylot, Antoine Gallais, and Mireille Batton-Hubert for their wise comments and the engaged discussion they offered me during the defense.

The OCIF team at IMT Atlantique who gave me innumerable feedback and boost on my work. A very special thanks to Sarah Tarrapey who collaborated with me on the hardware implementation, a very time-consuming task that would not have been possible without her skills and determination.

Itron, the Hardware team and the Simulation team who spent time trying to understand my hazardous questions sometimes, and during the period of work at Itron Issy. It was always a great pleasure to come and confront my ideas with you, giving me the necessary feedback to move forward in my thesis work, especially Yacine, Iskander, Fabrice, Bastien, Viet-Hung, Henri, Laurent, Sylvain, Oltan and Imad.

The folks of IMT Atlantique, especially Xavier and Saad, we were in the same boat! And Tanguy, Benjamin, Baptiste, Qipeng, Laudin, Dareen, Hristina, Aris, Emilia, Georgios, Alexis, Guillaume, Guillaume, Samy, Mathieu, Mauricio, Tomas, Alexandre, Fabien, Roberto, Routa, Farah, Raphael, Indra, Renzo, Edwin, Rodrigo for all the support and the fun during ADER events!

As well as the folks of the Tacoma and DiverSE research group at INRIA, especially Yoann and Fred!

Finally, Françoise Lemerrier, Christian, Yann, and last but not least, i would like to thank Gwénaëlle for her patience and support during those three years by my side.



# Table of Content

<b>I INTRODUCTION</b>	
<b>1 INTRODUCTION</b>	<b>11</b>
1.1 General context . . . . .	11
1.2 Background of this thesis . . . . .	13
1.3 The Contributions . . . . .	15
1.4 Structure of the Thesis . . . . .	15
<b>II MULTIPLE INTERFACES MANAGEMENT</b>	
<b>2 MULTIPLE INTERFACES IN IOT NETWORKS</b>	<b>19</b>
2.1 Introduction . . . . .	19
2.2 Powerline Communications in Smart Grid . . . . .	20
2.2.1 PLC protocols for the Smart Grid . . . . .	22
2.2.2 IEEE P1901.2 . . . . .	23
2.2.3 The AMI and the challenges of the PLC technology . . . . .	25
2.3 Routing . . . . .	26
2.3.1 Routing requirements and examples . . . . .	27
2.3.2 Proactive routing protocol . . . . .	29
2.3.3 Reactive routing protocol . . . . .	35
2.3.4 Performance evaluation . . . . .	39
2.3.5 Summary on routing protocols . . . . .	42
2.4 RPL in the smart grid networks . . . . .	43
2.4.1 RPL and Wireless . . . . .	44
2.4.2 RPL and PLC . . . . .	48
2.4.3 RPL and heterogeneous networks . . . . .	49
2.5 Heterogeneous Multiple Interfaces . . . . .	50
2.5.1 IoT networks . . . . .	51
2.5.2 Smart Grid networks . . . . .	51
2.5.3 Conclusion on multi-interface networks . . . . .	53
2.6 Conclusion . . . . .	53
<b>III HYBRID FRAMEWORK</b>	
<b>3 PROPOSED FRAMEWORK TO MANAGE MULTIPLE INTERFACES IN RPL</b>	<b>57</b>
3.1 Motivations . . . . .	57
3.2 Parent oriented design . . . . .	60
3.2.1 The Parent Oriented concept . . . . .	60
3.2.2 PO DODAG Formation . . . . .	62
3.2.3 Conclusion . . . . .	64
3.3 Interface oriented design . . . . .	65

3.3.1	The Interface Oriented concept . . . . .	65
3.3.2	IO DODAG Formation . . . . .	65
3.3.3	Conclusion . . . . .	67
3.4	Multiple RPL Instance . . . . .	67
3.4.1	Heterogeneous RPL Instances . . . . .	67
3.4.2	MI DODAG Formation . . . . .	69
3.4.3	Conclusion . . . . .	69
3.5	Rank computation . . . . .	70
3.5.1	PO rank . . . . .	71
3.5.2	IO rank . . . . .	72
3.5.3	MI rank . . . . .	72
3.6	Additional mechanisms . . . . .	72
3.6.1	Link evaluation . . . . .	73
3.6.2	Retransmission . . . . .	74
3.7	Conclusion . . . . .	75
<b>IV PRACTICAL EVALUATION</b>		
4	EVALUATION . . . . .	79
4.1	Design of the implementation . . . . .	80
4.1.1	Modules and layers . . . . .	80
4.2	DODAG formation simulator . . . . .	81
4.2.1	Results . . . . .	82
4.3	Discret event simulation . . . . .	85
4.3.1	Simulation scenario . . . . .	86
4.3.2	Results . . . . .	87
4.4	Hardware implementation . . . . .	92
4.4.1	RPL implementation study . . . . .	92
4.4.2	Unstrung Implementation . . . . .	93
4.4.3	Hybrid network demonstration . . . . .	96
4.4.4	Increasing Network Reliability . . . . .	99
4.5	Conclusion . . . . .	101
<b>V CONCLUSION</b>		
5	CONCLUSION AND FUTURE WORK . . . . .	105
5.1	Conclusion . . . . .	105
5.2	Perspectives . . . . .	107
5.2.1	PO improvement . . . . .	107
5.2.2	Duplication . . . . .	107
5.2.3	Multiple Instance . . . . .	108
5.2.4	Large scale scenario . . . . .	108
5.2.5	Long-term perspectives . . . . .	108
<b>VI APPENDIX</b>		
A	RÉSUMÉ EN FRANÇAIS: GESTION D'INTERFACE MULTIPLE DANS LES RÉSEAUX SMART GRIDS . . . . .	113
A.1	Contexte Général . . . . .	113
A.2	Motivations . . . . .	116

A.3	Contributions et organisation du manuscrit . . . . .	117
A.3.1	La gestion d'interface multiple . . . . .	118
A.3.2	Gestion d'interfaces hétérogènes avec RPL . . . . .	119
A.3.3	Implémentation et évaluation des performances . . . . .	121
A.4	Conclusion et perspectives . . . . .	122



# List of Figures

Figure 1.1	The current distribution and transport network topology. . . .	12
Figure 2.1	The current distribution network. . . . .	22
Figure 2.2	The Data Concentrator in the AMI architecture. . . . .	24
Figure 2.3	A routing protocol is required to reach the data concentrator.	26
Figure 2.4	Example of a DAG and a DODAG. . . . .	30
Figure 2.5	Example of an Upward route construction with RPL. . . . .	34
Figure 2.6	Example of an AODV route detection between node A and G.	37
Figure 2.7	Example of a route construction with LOADng. . . . .	38
Figure 2.8	End-to-end delay comparison. . . . .	40
Figure 2.9	RPL Data Delivery Ratio for a 100 nodes topology . . . . .	41
Figure 2.10	LOAD Data Delivery Ratio for a 100 nodes topology . . . . .	41
Figure 2.11	100 nodes topology to compare LOAD and RPL. . . . .	42
Figure 3.1	Physical topology of five hybrid nodes. . . . .	60
Figure 3.2	The Parent Oriented DODAG. . . . .	61
Figure 3.3	Parent Oriented Parent selection algorithm . . . . .	64
Figure 3.4	The Interface Oriented DODAG. . . . .	66
Figure 3.5	Interface Oriented Parent selection algorithm . . . . .	67
Figure 3.6	Two RPL Instances DODAGs. . . . .	70
Figure 3.7	The Parent Oriented metric merging for rank computation. . .	72
Figure 3.8	The Interface Oriented metrics for rank computation. . . . .	72
Figure 3.9	Re-transmission scheme example. . . . .	75
Figure 4.1	Specifications - module interaction . . . . .	80
Figure 4.2	Average Link Quality . . . . .	83
Figure 4.3	Average DAG Depth in hops . . . . .	83
Figure 4.4	Average number of parents per parent set . . . . .	83
Figure 4.5	CDF of the number of removed interfaces before the first parent change . . . . .	84
Figure 4.6	CDF of the number of parent changes to reach 10% of orphans	84
Figure 4.7	CDF of the number of removed interfaces between two con- secutive parent changes . . . . .	85
Figure 4.8	Topology of 11 hybrid RPL nodes . . . . .	87
Figure 4.9	Average number of parent changes . . . . .	87
Figure 4.10	Average number of parent changes . . . . .	88
Figure 4.11	Average end-to-end delay for a one hour time window around PLC failure. . . . .	88
Figure 4.12	CDF of the packet delivery ratio. . . . .	89
Figure 4.13	Packet delivery ratio . . . . .	89
Figure 4.14	Average number of sent DIO messages. . . . .	91



Figure 4.15	CDF of the number of hops. . . . .	91
Figure 4.16	CDF of the rank values. . . . .	91
Figure 4.17	Average number of re-transmissions. . . . .	91
Figure 4.18	CDF of the buffer size. . . . .	91
Figure 4.19	Average number of OF calls . . . . .	91
Figure 4.20	Root behavior - initialization on ACT with Unstrung . . . . .	95
Figure 4.21	Node behavior - initialization on ACT with Unstrung . . . . .	96
Figure 4.22	Testbed topology Meters communicate in PLC and RF. . . . .	97
Figure 4.23	Format of the frame aggregated at each hop. . . . .	98
Figure 4.24	Single interface scenario. . . . .	99
Figure 4.25	Hybrid scenario. . . . .	99
Figure 4.26	Real-time visualization of the path. . . . .	100
Figure 4.27	Packet Delivery Ratio (PDR) depending on noise level over PLC line. . . . .	101
Figure A.1	Le réseau de distribution et de transport d'énergie actuel. . .	114

# List of Tables

Table 2.1	Classification of PLC technologies by frequency range. . . . .	22
Table 2.2	Alternative technologies to PLC between SM and DC. . . . .	25
Table 2.3	LOADng / RPL comparison. . . . .	39
Table 2.4	RPL studies depending on technologies and heterogeneity of the network . . . . .	45
Table 2.5	IoT Communication technologies. . . . .	52
Table 3.1	All supported modulations sorted by capacity. . . . .	63
Table 3.2	Solution comparison . . . . .	76
Table 4.1	RDSim Simulation parameters . . . . .	82
Table 4.2	Simulation parameters . . . . .	88
Table 4.3	Existing RPL implementations . . . . .	92
Table 4.4	Comparison between Unstrung and LibRPL . . . . .	93
Table 4.5	Reliability Experimentation Setup . . . . .	100
Table A.1	Comparaison des solutions proposées . . . . .	122



Part I

INTRODUCTION



## INTRODUCTION

---

### Contents

---

1.1	General context . . . . .	11
1.2	Background of this thesis . . . . .	13
1.3	The Contributions . . . . .	15
1.4	Structure of the Thesis . . . . .	15

---

#### 1.1 GENERAL CONTEXT

Over the past few decades, the demand for electricity has faced a tremendous growth, as the life quality has improved and the number of electrical devices are continuously increasing. At the same time, the electricity sector is undergoing a considerable change, mostly by the shifting from fossil to renewable energies, the evolving of energy policies and the emergence of less-reliable renewable micro-generation. As stated in a 2015 Eurelectric survey [Eur15], the grid requires to take into consideration these modifications while ensuring secure, sustainable, competitive and affordable energy for any individual and business. Proper operation of the electrical network is based on the balance between production and consumption, a great challenge for the network management. Communication on the power grid has been introduced to automatically collect consumption, diagnostic and status of energy and water metering devices. This technology is deployed by providers to reduce the cost of the trip to reach every device for a reading and for a better management of the grid.

Actually, the grid structure is evolving from a rigid and centralized architecture with large production units at the top satisfying demand at the bottom, to a more distributed one with individual premises equipped with local renewable production units. Electrical production is therefore getting more decentralized but at the same time less predictable as renewable sources are sporadic. In order to efficiently balance production and consumption, real-time measurements, predictions and control capabilities are needed in a widespread management system.

The modifications mentioned above are part of a significant change in an electric system, and more usually, in an energy system which is the focus of the energy transition. As many other countries, France has been developing since 2012 political discussions about the energy transition, and how the french economy could benefit from it. In France, the main challenge of the energy transition is to curb the global warming by, among other solutions, progressively shutdown nuclear sources. A

national debate has been launched in 2012 by the ecology minister in order to address 4 challenges:

- Reduce by 4 or 5 the emission of greenhouse gas until 2050.
- Reduce the part of nuclear at 50% of the total energy mix by 2025.
- Develop the decentralized production of renewable energy.
- Find any form of energy efficiency.

France has introduced a schedule for the energy transition to impose some changes in production, consumption and transport, or even how renewable energies should be chosen. Moreover, a smart grid development has been proposed to the french government in July 2013 [Léo+16].

One of the most important feature of a smart grid infrastructure is the possibility to shift specific electrical consumption; which is expensive, external or have a limited availability; to a cheaper, local or more accessible energy. This feature is notably operated by smart meters, by monitoring all the network, targeting the equilibrium of the energy demand/response.

Furthermore, electrical devices have also quickly evolved in recent years. Some are now mobile such as Electric Vehicles (EVs) making demand prediction more difficult and increasing the consumption; others, such as building or house automation connected systems (heating/cooling, lighting devices), offer remote management capabilities. Together, their growing numbers, and in particular the increasing penetration of EVs, make the management of the system even more complex.

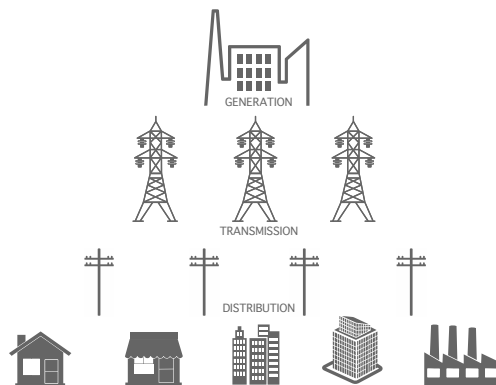

Figure 1.1: The current distribution and transport network topology.

Today, private EVs are charged as soon as they are plugged into the grid, without any management system, which causes all the charging processes occurring at the same time. This behavior happens mainly at peak hours in the evening, which is very challenging for the electrical grid. Since EVs market is slowly growing, the charging of the few existing EVs can be handled by the actual electrical grid. But, as

the EVs rate of adoption is increasing [SE11], we will need to avoid charging all of them on peak hours and so, shift these demands on a time window that will contain the needed power below a given threshold, and/or align the consumption on the production periods. As a result, it is essential for the Smart Grid to benefit from a control system that take care of the charging periods to balance the various energy demands over different periods of time.

In Smart Grids, the legacy communication architecture enabling data collection and device management is called the *Advanced Metering Infrastructure (AMI)* [Bus14, Chap. 7]. This architecture is an evolution of the Automated Meter Reading (AMR) by adding bi-directional communication framework, which was deployed to facilitate meter reading, billing and consumption planning. This two-way communication feature of AMI also offers additional operations on a network. It sure helps the utilities better control their network but several other opportunities are foreseen with such architecture especially if using high-speed Internet Protocol (IP)-based technologies.

In smart grid communication systems, like other communication systems, we can distinguish a core part and a last-mile<sup>1</sup> part. The former involves large storage and computational capabilities used to collect, organize and process data in order to coordinate devices through remote management commands. The latter part consists of uniquely identified and connected objects (e.g., sensors, actuators, smart devices, etc.) as well as communication links between them, possibly by employing various wired or wireless technologies. Energy distribution networks have a tree topology with large production units on top producing most of the required energy, which is then transported via a widespread distribution network towards consumers (called the end-points).

Figure A.1 illustrates this top-down configuration in which consumers can be reached after passing through different aggregating nodes, e.g. transformer. Utilities forecast the consumption of end-points based on their historical consumption and adjust these forecasts based on automated metering. These forecasts are therefore very sensitive to any modification of end-points behavior.

## 1.2 BACKGROUND OF THIS THESIS

The Automatic Meter Reading AMR uses the Power Line Communication (PLC) network to enable automatic and remote electric and gas meter readings and the AMI still uses this technology. However, PLC communication networks are subject to high sensitivity to interference. Errors in such PLC systems come especially from background noise, impulsive noise and Narrow-band Interference (NBI) [Oli+16]. Even-though a MAC protocol could face the high variation of available bandwidth due to the severe noise condition, which is common in PLC networks, smart meter network using only PLC for communication, does not fulfill the primary requirement

<sup>1</sup> specifically, last-hop since some radio technologies allow communications over more than ten miles



of 99.99% reading rates and coverage, because of the limitations cited above.

Although such a dynamic adaptive solution exists, several alternative communication technologies are considered, such as Wireless Sensor Network, Mesh, cellular, Wimax, Internet of Things (IoT) Long Range, etc. Most of them are also highly sensitive to noise and may not work in specific environments, those technologies are consequently considered Low power and Lossy Network (LLN).

In order to enhance the communication capabilities, a commonly used solution consists in mixing multiple heterogeneous technologies to cope with all possible scenarios and interference levels. When one technology is not working well in a specific case, most of the time another technology can be used instead. Personal computer Personal Computer (PC), notebooks or even IoT devices are commonly equipped with several heterogeneous interfaces such as Ethernet, Wi-Fi or Bluetooth. A typical example of such a solution in today devices is the smart-phone, embedding commonly at least three different interfaces: Cellular, Wi-Fi and Bluetooth. Each technology having a predefined utility but can be used independently for common services i.e. using Wi-Fi for calling services.

For these reasons, most of future smart meters will embed several heterogeneous communication technologies to ensure a certain quality of service. However, supporting these multiple interfaces is a challenge. Most of these technologies are short range, and nodes must collaborate to reach a destination that is multiple hops away. Routing protocols play a central role by optimizing the selected paths according to application requirements and field specificity.

IPv6 Routing Protocol for Low-Power and Lossy Networks (RPL) [Win+12a] is the most popular routing protocol in the IoT community, and included in one of the most popular Operating System (OS) used in IoT, Contiki OS. RPL is mostly used on homogeneous network and has been designed to operate on single communication network.

In this thesis, we focus on the way RPL could be adapted to work with multiple interfaces and increase the reliability and performance of smart grid communications.

In the state-of-the-art, we can note that only few works have been done on multiple interfaces devices with RPL, since the release of the RFC. Moreover, few works exist also on heterogeneous networks with RPL. Finally, as RPL is mostly studied with wireless technologies, few works address the specificity of smart grid PLC networks, with a realistic PLC physical model, making complicated the study of large scale smart grid scenario using both PLC and Wireless interfaces.

The goals of this thesis is as follow:

- Propose a framework to extend [RPL](#) to handle multiple heterogeneous interfaces.
- Propose a simulation model to evaluate the performance of the routing solutions.
- Implement the framework on hardware platform to test the performance in real condition.

### 1.3 THE CONTRIBUTIONS

The main contribution of this thesis is the proposition of a multiple interfaces management for [RPL](#). First, this framework propose an original parent selection for [RPL](#) taking all its interfaces into account. Secondly, the solution aims to increase the reliability (Packet Delivery Ratio ([PDR](#))) of a hybrid network by encouraging the use of both available interfaces with a new re-transmission mechanism.

### 1.4 STRUCTURE OF THE THESIS

The reminder of this thesis is organized in three chapters. Chapter [2](#) presents the context of the thesis and more precisely introduces the [AMI](#), a central point of the Smart Grid. We give an overview of the multiple interface solutions in [IoT](#) systems. We discuss the characteristics and physical constraints of the [PLC](#) network and the necessity of a routing protocol.

Finally, we present the two major routing protocol families to locate [RPL](#) in the Smart Grid systems.

In Chapter three, we propose a new framework to extend [RPL](#) by managing multiple heterogeneous interfaces, in order to increase the reliability and the performance of the network. We develop three solutions, which are the Parent Oriented, the Interface Oriented and the Multiple instance.

We present in chapter four the simulation model we developed to validate our propositions and compare each one.

Chapter five presents the general conclusion of this work and the possible research directions.



**Part II**

**MULTIPLE INTERFACES MANAGEMENT**



---

**Contents**

2.1	Introduction . . . . .	19
2.2	Powerline Communications in Smart Grid . . . . .	20
2.2.1	PLC protocols for the Smart Grid . . . . .	22
2.2.2	IEEE P1901.2 . . . . .	23
2.2.3	The AMI and the challenges of the PLC technology . . . . .	25
2.3	Routing . . . . .	26
2.3.1	Routing requirements and examples . . . . .	27
2.3.2	Proactive routing protocol . . . . .	29
2.3.3	Reactive routing protocol . . . . .	35
2.3.4	Performance evaluation . . . . .	39
2.3.5	Summary on routing protocols . . . . .	42
2.4	RPL in the smart grid networks . . . . .	43
2.4.1	RPL and Wireless . . . . .	44
2.4.2	RPL and PLC . . . . .	48
2.4.3	RPL and heterogeneous networks . . . . .	49
2.5	Heterogeneous Multiple Interfaces . . . . .	50
2.5.1	IoT networks . . . . .	51
2.5.2	Smart Grid networks . . . . .	51
2.5.3	Conclusion on multi-interface networks . . . . .	53
2.6	Conclusion . . . . .	53

---

**2.1 INTRODUCTION**

As introduced in the previous chapter, the smart grid is an evolution of the power grid, moving to a decentralized and distributed architecture. This paradigm shift require to make changes in the communications involved in all layers of the transport and distribution network. The energy and environmental challenges are considerable, and it forces us to predict the consumption and production of energy in order to maintain the balance of the energy network at various levels. The circulation of the energy has to be tackled at neighbors, city, country and worldwide scale.

The Smart Meter (**SM**) plays a major role in this evolution, since it allows to finely read the consumption of housing, business and industry activities. It has control and measure capabilities as well, that is necessary to handle cut-offs and shifting of energy demand.

However, the distance and density between **SM** varies significantly depending on location (Urban, Rural, Industrial) and the employed communication technologies are not fully reliable. Consequently, it is required to duplicate the communications technologies in order to be more reliable, and deploy standardized protocols to allow the use of routing solutions.

Section 2.2 introduces the **PLC** protocols in the Smart grid and why it has been selected as a candidate technology to be used in **AMI** networks. Section 2.3 introduces the necessity of routing technology in the Smart grid, and presents in details the two major routing protocols used in Smart grid networks. In 2.4 we discuss the existing work on **RPL** in a smart grid network. Finally, section 2.5 presents the different solutions of multiple interfaces in communication networks, focusing on the **IoT** and the smart grid community and also discusses the related work regarding routing with multiple homogeneous and heterogeneous interfaces in smart grid networks.

## 2.2 POWERLINE COMMUNICATIONS IN SMART GRID

Today electricity network is organized with the following principles:

A generating station produces electricity from fossil, nuclear, or renewable energy, and this electricity is transported at High Voltage (**HV**) to the substations via a transmission network. The substations has the role of step-down, via transformers, it lowers the voltage to distribute the electricity to the final consumer, at a Medium Voltage (**MV**) or Low Voltage (**LV**).

In order to reduce the cost of generation and conversion at the power generation level, a distributed generation approach [Gre+14] [Mül+10] tackles the conventional power plant process by mixing energy sources. Such an approach facilitate the exploitation of the renewable energy resources.

The implementation of distributed generation involves several and complex deployments such as wind turbines, photovoltaics, or micro-turbines. This model imposes communication between all components to manage the energy demand, and must be related to automatic generation control and demand forecasting to meet the demand of consumers.

At the transmission and distribution level, the distributed generation model including renewable energy sources causes some challenges regarding reliability. To integrate energy sources that are mainly based on renewable production, the electricity network needs a control strategy. The intermittent profile of renewable energy sources caused by the unstable and unpredictable climate change, need to be addressed in order to avoid frequency, voltage and power fluctuations. Using enhanced measurement, information and control techniques on the distribution and transmission grid allows to respond quickly or anticipate failures and make the network more reliable.

Phasor measurement unit (PMU) is one of the most used measurement techniques that is installed and is being deployed widely. The purpose of PMU is to monitor the phasor synchronizations, the voltage stability, the load sharing, and power flows [RAB13]. It detects the faulty lines and decides the islanding requirements (when for instance solar panel still deliver power even though being in a power outage), restore the power systems, and so on.

At the distribution level, the required management system is complex, because it has to handle the continuous development of renewable energy sources, the EV, smart home application and energy storage. For example, the massive introduction of the EV in the electricity grid will pose some challenges:

- It involves bidirectional power flow with the Grid to Vehicle (G2V) and Vehicle to grid (V2G) systems [YK13], V2G being an operation mode that is a concept of considering the EV as a battery that can supply electrical energy to the grid. Most of electricity applications is focusing on customer energy providing, going in the opposite way impose drastic changes on the grid control.
- The EV charging need a high availability and intensity of power as quick charging mechanism is a key point of EV attractiveness. Charging require to be adaptable as well, charging station has different mode of operation that increase the complexity of the energy supply.
- The democratization of the EV tends to create a peak hour, when a majority of EV users need to charge at the same time after work or during night. This problem needs to address the question of anticipation and/or prioritization of demand.

Control and communication solutions are not equally deployed in the former architecture. The transport network is more equipped than the distribution network, with high speed communication devices to enable the supervision and the control of the network with the Supervisory Control and Data Acquisition (SCADA). The SCADA system consists of several automation devices to control and monitor the electricity network components, such as Remote Terminal Units (RTU) at transport and distribution level, to collect real-time data at a relatively low granularity (up to 10 samples/s).

At the distribution level, the former power grid only allowed to collect limited information from the consumer, and only in one-way. Consequently, the facility cannot manage the load of the customer and can only make an estimation, the consumer cannot have any influence on the network behavior.

A second and major challenge of the actual electricity network is the consequence of not knowing in real-time the demand of electricity from consumers. To avoid blackout, the energy is provided and maintained with the maximum estimated consumption. Knowing with high precision where and when the charge will occur could allow provider to better shift and smooth consumption.



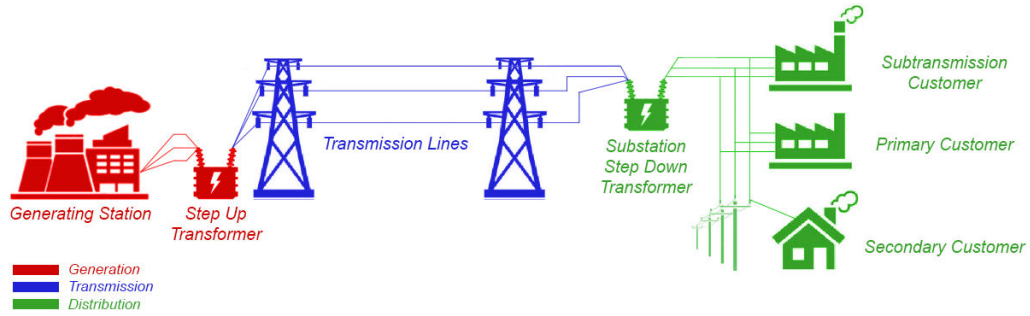

Figure 2.1: The current distribution network.

Categories	Frequency Range	Data Rates	Application
Ultra Narrow Band PLC (UNB-PLC)	0.3 to 3kHz	Hundreds Bps	AMR, Utilities automation.
Narrow Band PLC (NB-PLC)	3 to 500 kHz	up to 500 kbps	AMI, Smart grid
Broadband PLC (BB-PLC)	1.8 to 250 MHz	up to hundreds Mbps	Data, Multimedia

Table 2.1: Classification of PLC technologies by frequency range.

The age of the electricity network and the constant rise in electricity consumption impose to strengthen the electricity network and manage it in a smart way. But improving the electricity network is not economically and ecologically feasible, that is why the distribution must evolve with smart architecture and device on the existing infrastructure.

Since the beginning of the communication in the electricity network, the Power Line Communication (PLC) technology has been employed and still meet the requirements of today metering applications. It has been chosen as a key technology of the smart grid development as well [Gun+13]. But the PLC technology, presented in the next section, has reached some limits in terms of reliability and delay. The last-mile of the AMI network, where PLC faces most of the challenges, needs to be modernized to be managed in a smart way to accommodate, in particular, the smart meters network.

2.2.1 PLC protocols for the Smart Grid

Three different types of PLC exist according to the frequency range used, table 2.1 shows the classification of the PLC technology by the frequency band.

Ultra Narrow Band (UNB) PLC operates at Ultra Low Frequency (0.3-3kHz) band with a very low data rate (around 100bps). However, this category of PLC could

operate through long distances, over 150 km. For decades, it has been used for AMR or automation systems for distributed facilities, an example of such UNB-PLC solution is the Two-Way Automatic Communication System (TWACS) [MM84; MR82], a patented technology to transmit data over power lines for collecting, communicating, and analyzing information and managing utility customer electricity usage. UNB-PLC has many advantages such as the cost, the communication range, the maturity of the technology, or the scalability, but no standard solution exists today, all UNB-PLC solutions deployed by utilities are proprietary.

Narrow Band (NB) PLC operates at Very Low Frequency, Low Frequency and Medium Frequency bands (0.3 to 500kHz) with a data rate from few kbps to 500 kbps. The range of NB PLC is at maximum several kilometers. According to Scaglione et al. [GSW11], we could separate the NB PLC standards in two categories:

- Low Data Rate (LDR): Several standards exist such as ISO/IEC 14908-3 (LonWorks), ISO/IEC 14543-3-5 (KNX), CEA-600.31 (CEBus), IEC 61334-3-1, IEC 61334-5 (FSK and Spread-FSK), etc. Based on single carrier technologies, these standards are capable of data rates of few kbps.
- High Data Rate (HDR): G3-PLC, ITU-T G.hnem, and IEEE P1901.2 are typical examples of HDR NB PLC. Based on multicarrier technologies, such as Orthogonal Frequency Division Multiplexing (OFDM), those solutions are capable of data rates from tens of kbps to 500 kbps.

Broadband (BB) PLC operates at High / Very High Frequency (1.8 to 250 MHz) band with a high data rate from several Mbps to several hundreds of Mbps. The transmission range of BB-PLC technologies is limited to hundred meters, making it most suitable for Home Area Network (HAN). TIA-1113 (HomePlug 1.0), IEEE 1901, ITU-T G.hn (G.9960/G.9961) are the most common standard recommendations used to conform BB-PLC devices.

In the electricity distribution network, from the generation to the consumer, all types of PLC could be deployed. AMI applications have data rates and range requirements that explain why NB-PLC is gaining interest and standardization efforts.

### 2.2.2 IEEE P1901.2

IEEE P1901.2 is one of the most deployed standards in smart grid networks. It is a NB-PLC standard that uses Orthogonal frequency-division multiplexing (OFDM) and can support two modulation schemes:

- A mandatory **Differential mode** modulations: Differential Binary Phase Shift Keying (DBPSK), Differential Quaternary Phase Shift Keying (DQPSK) and Differential Eight Phase Shift Keying (D8PSK).
- An optional **Coherent mode** modulations: BPSK, QPSK, 8PSK and 16QAM.

Both modes have a default robust modulation, the Robust Orthogonal Frequency Division Multiplexing (ROBO).

In smart grid networks, a MAC protocol is required to face the high variation of available bandwidth due to the severe noise condition, which is common in PLC networks.

The MAC layer of IEEE P1901.2 is based on the IEEE 802.15.4 MAC with a similar frame structure and manage the channel access thanks to Carrier Sense Multiple Access with Collision Avoidance (CSMA/CA) with a random back-off time. This back-off time is used to reduce the probability of collisions, devices wanting to transmit a frame need to wait a random period before transmission if the channel is idle. Two CSMA/CA modes are defined for IEEE P1901.2, an unslotted version based on IEEE 802.15.4 and a slotted version, dedicated to beacon-enabled Premise Area Network (PAN).

IEEE P1901.2 define an Inter Frame Spacing (IFS) that is needed between frames in order to face propagation and processing time. Depending on frame type, three different time interval (IFS) are used to ensure that frames do not overlap each other.

Finally, IEEE P1901.2 uses the Tone Map mechanism to determine the modulation to use on a link depending on the quality. A frame is sent with the default modulation and the receiver will estimate the communication link to define the PHY parameters to use.

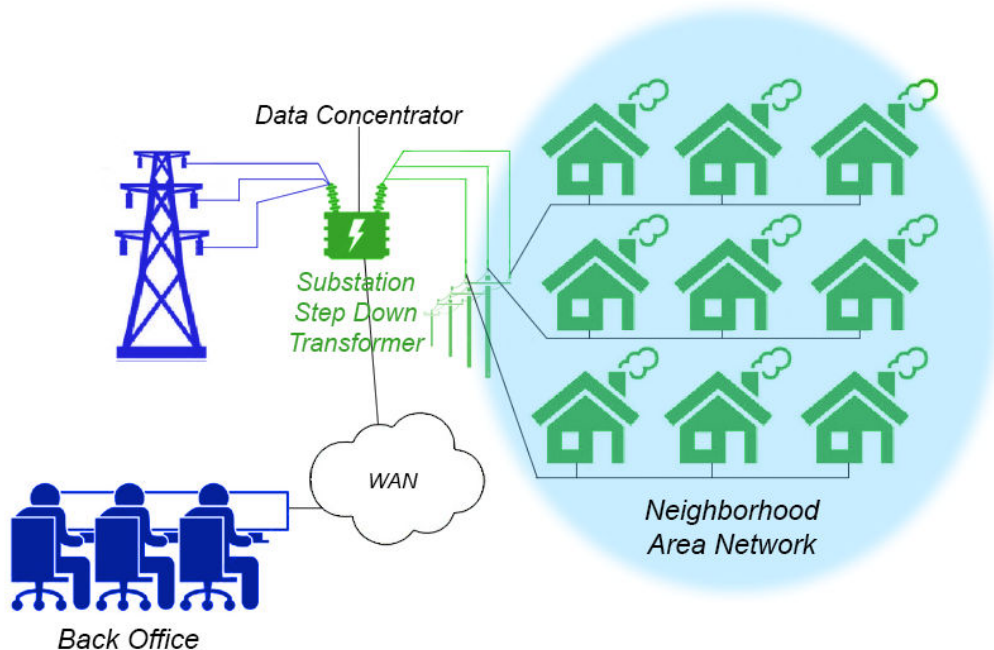

Figure 2.2: The Data Concentrator in the AMI architecture.

<b>Wired (Fiber Optic)</b>	GPON, EPON RFoG-DOCSIS
<b>Wireless</b>	802.16d/e (Wimax) 802.15.4g (RF Mesh) 802.15.4 (ZigBee) 802.11 n/g (WLAN) RF Radio Pto-Mtp/MAS 3G-3GPP/1XRTT/EVDO GPRS/EDGE/HSDPA

Table 2.2: Alternative technologies to PLC between SM and DC.

2.2.3 The AMI and the challenges of the PLC technology

As depicted in figure 2.2, the Advanced Metering Infrastructure (AMI) is a key part of an intelligent grid where the Data Concentrator (DC) allows to connect Smart Meter (SM) to the utilities Meter Data Management Systems (MDMS) [RM11]. It allows two-way communication between smart meters and the distribution system operator, in order to automate the collect of user energy metering and billing [BMM12]. In most of the Europe countries, AMR infrastructure is widely deployed, and European directive have been set to target 80 per cent of customers having electronic meter at the end of 2020 [Bol+11]. The Linky program [DGF13] follows this directive in France, the french operator ERDF targets to install 35 million of Linky electronic meters in customer’s premises.

Generally, the SM are installed in the Neighborhood Area Network (NAN) close to the customer and communicate with the Data Concentrator (DC) using PLC technology. The DC could be viewed as a gateway between the Utilities (Wide Area Network (WAN)) and the NAN.

PLC has several advantages such as:

- The existing infrastructure, offering a low cost deployment.
- The potential location of SM that could not be compatible with wireless solutions, i.e. behind concrete or metal walls.
- The PLC network is the property of the utilities and it has a full control on it , instead of wireless network that uses public frequency band.

However, PLC faces several issues related to noise and interference, which makes PLC technologies not fulfill the primary requirement of 99.99% reading rates and coverage. Indeed, OFDM-based narrow-band PLC systems are weakened by background noise, impulsive noise and Narrow-band Interference (NBI) [ZD02].

Several other technologies than PLC exist in smart grid networks to connect DC and SM, as shown in table 2.2.

### 2.3 ROUTING

In smart grid networks, the majority of smart meters are located in the NAN, but due to the distance, the signal cannot reach directly the Data Concentrator (DC), located in the transformer substation. Consequently, a forwarding is necessary to reach the destination, and a routing is required to compute the path from SM to the sink, and vice versa (Figure 2.3).

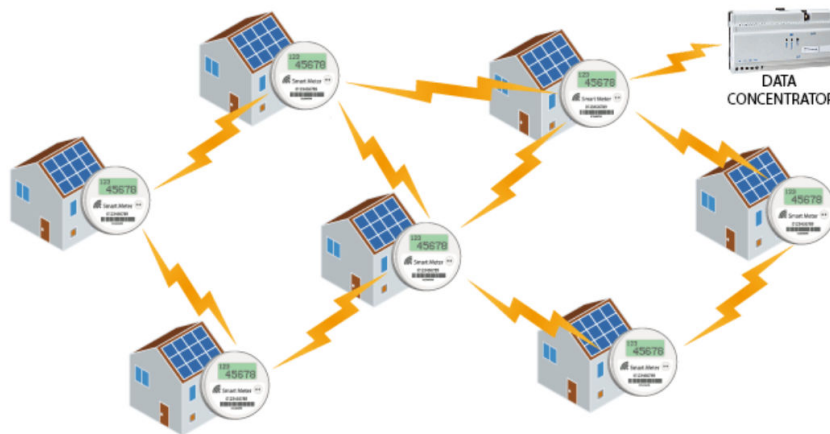

Figure 2.3: A routing protocol is required to reach the data concentrator.

As it was presented in Section 2.2.3, AMI networks mostly utilize technologies that are sensitive to perturbation and have limited capacity. This technologies could be considered as LLNs.

In a dense network, if a relay node is not reachable, the transmitting node needs to choose a different neighbor to reach the destination, that is why routing is necessary.

In NB-PLC and wireless networks, most of the nodes that exist in the infrastructure cannot communicate directly with the sink or with other nodes due to the limited transmission capacity (long distance, external interference and noise). Therefore, the nodes need to collaborate together to forward the data packets to the final destination. Similarly, in a smart grid network, the nodes are the Smart Meter (SM) that route metering information to the Data Concentrator (DC).

Typically, a routing protocol constructs and maintains the best paths in the network for the packets to be routed toward the destination. To do so, routing protocols propagate routing information message using either proactive or reactive models.

High number of hops degrades the network performance as it introduces additional delay in reactive routing or additional overhead in proactive approaches. To

minimize the impact of routing, it is essential to minimize the number of hops in the network. However, it is also important to carefully select the optimal path to the destination according to an objective function and appropriate metrics. Note that the shortest path is not always the optimal solution, i.e., the Expected Transmission Count (ETX) is a popular metric in IoT networks.

In the next section, we introduce the requirements of the routing protocols in Low power and Lossy Network (LLN), focusing on smart grid networks.

Following that, in section 2.3.2 and 2.3.3 we provide a detailed description of two leading families of routing protocols, based on the propagation of the routing information in the network, namely the proactive and the reactive routing protocols, respectively.

In smart grid networks, mainly two routing protocols are emerged, and are widely studied and deployed. J.Yi et al.[JCI13] present how critical the routing protocol is for smart grid networks, and how RPL and Lightweight Ad hoc On-demand Distance-vector Routing Protocol Next Generation (LOADng) could tackle the specifics of smart grid applications. Moreover, we present a performance comparison of the most popular routing protocols such as RPL, Ad Hoc On-Demande Distance Vector Protocol (AODV) and LOADng for LLNs.

### 2.3.1 Routing requirements and examples

Since the 80's, several routing protocols have been proposed and studied for wireless multi-hop networks. These protocols have been envisioned to be composed of mobile nodes without concerns on energy. In 2008, the IETF ROLL working group has been created to standardize a routing protocol that address the issues of a Low power and Lossy Network (LLN). The ROLL approach is to consider static node with high energy-constrained characteristics.

Levis et al. show in [TD09] the requirements of a routing protocol designed for LLN, such as the scalability. For example, a routing state that scales linearly with the number of nodes would not be appropriate. Culler et al. [VC07] recommend for the routing protocol to be robust to high variation in connectivity.

These protocols need to use specific routing metrics that deal with the characteristics of LLN. For instance, the link reliability metric is not used in the Internet routing protocols because technologies employed in such networks are extremely reliable and fast recovery mechanisms exists for failure. But in LLN, taking into account the reliability of the links to build the path is significant because link quality quickly changes over time.

In addition, using the node's energy consumption as a metric allows to consider how the node is powered and what is its remaining lifetime. Such metric is a key-

enabler to enhance the lifetime of a wireless network where devices are mostly battery-operated.

Moreover, a routing protocol for LLN has to use a minimum overhead to discover and maintain the topology and must adapt to the network variations without drastically increase control messages.

Finally, routing protocols have the role of avoiding loops in the network, the routing algorithm must guarantee that loops can never happen by the use of ranking mechanisms or number sequences.

In AMI networks, the majority of the existing routing protocols are focusing on reliability, and automatic neighbors and routes discovery. Smart grid applications are deployed in harsh environment, where links are unstable because of interference and fading effect. We can identify three approaches to address this problem in the community:

- Providing efficient repair mechanism
- Using a multipath algorithm
- Anticipation of the fluctuation by metric modification

There are many routing protocols that are deployed and studied in the smart grid, Saputro et al. [SAU12] propose a survey that covers both transport and distribution networks of the smart grid, and a focus on the Neighborhood Area Network (NAN). Two examples of routing protocols used in AMI application are presented below.

Distributed Autonomous Depth-First Routing (DADR) [Iwa+10] is a distance vector routing protocol but without any repair mechanism for the computed path. The protocol avoids the frequent control overhead required for path maintenance in proactive routing protocols to provide a lightweight routing plane. It only uses periodic HELLO messages that are exchanged only among neighboring nodes. This control message contains routing table information and allows to provide at most  $k$  possible paths for destination. DADR also propose a backtracking mechanism when all next hops fails, the packet is returned back to the previous sender, as it can try, at its turn, all alternate routes. This mechanism could lead to loops problem, a loop detection allows to discard messages based on an identifier (FID) and inform others nodes by route poisoning that a loop exists.

The protocol evaluation reveals good performance on control packets number, which outperforms both AODV and Optimized Link State Routing Protocol (OLSR)[Iwa+10]. The authors show a good scalability of DADR with a real deployment of 1500 nodes and a 2107 nodes simulation experiment. However, the particular process of DADR during forwarding phase impose more memory and CPU overhead for intermediates nodes.

HYDRO [DTC10] is a link-state routing protocol for LLN that use a distributed algorithm to form and maintain a distributed Directed Acyclic Graphs (DAG). This routing graph provides multiple paths to a border router, providing a reliable default route at each node by selecting a neighbor node toward the border router. HYDRO requires the collection of topology information from the network, in order to have a complete view of the topology by the border router. To do so, each node periodically sends a topology report to the border router, containing only top ranked entries in the default route table.

The topology information is added opportunistically to data traffic with an optional extension header. In [DTC10], a simulation of 125 nodes is conducted to show how the default route provided by HYDRO is reliable and robust, with a PDR remaining near 98.7% at the end of every scenario where four random nodes are removed in the topology every four minutes. It has to be noted that HYDRO could support multiple border routers to duplicate the main border router and have the same global view of the topology.

### 2.3.2 Proactive routing protocol

In proactive routing protocols, routes are built *a priori* and, as a result, all nodes in a network are aware of the routes to any destination at any time. Thus, a node may transmit a data packet to any destination independently of the traffic with no delay, since routes should be stored in the routing tables.

Periodic routing-related control packets need to be transmitted to maintain the routing table up-to-date. To control the network overload and mitigate the number of control packets, the periodicity at which these control packets are sent must be accurately defined.

RPL[Win+12b] is today the main protocol in the proactive family of routing protocols chosen in LLN. It is actually a distance vector routing protocol specified by the Internet Engineering Task Force (IETF) ROLL working group [ABC14]. RPL is defined as Link-layer agnostic, so it can operate over Wireless or PLC networks for example.

#### *Topology management under RPL*

RPL defines mechanisms to let nodes discover themselves and carefully select neighbors in order to construct optimal routes. The topology is organized based on a DAG, a graph where the connections between nodes have a direction and a "non-circular" property. Based on the "acyclic" nature of the DAG, the graph comprises at least one root, a node with no outgoing edge. In Figure 2.4 (a), a DAG composed of ten nodes and three DAG roots is illustrated.



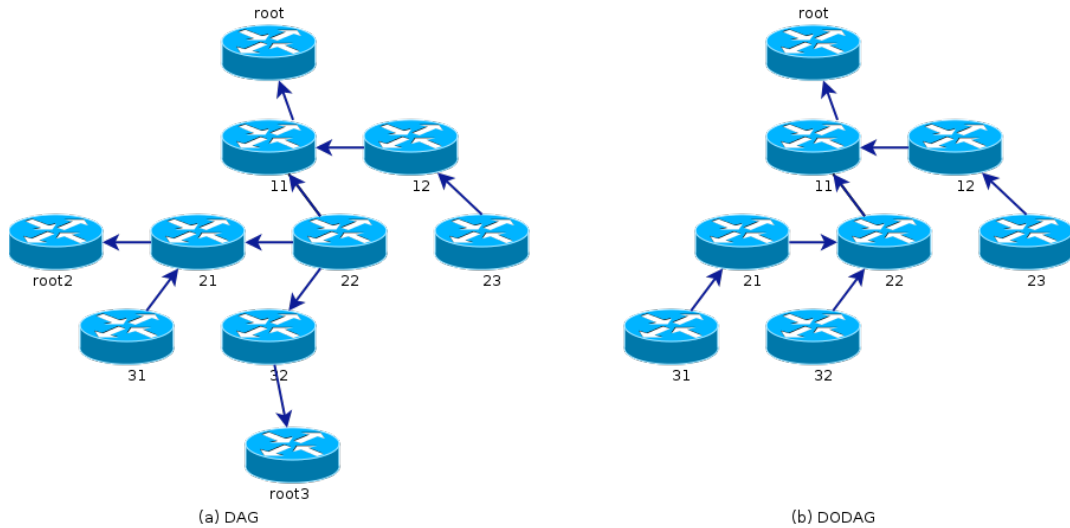

Figure 2.4: Example of a DAG and a DODAG.

To construct a routing topology, RPL employs an extension of DAG: the Destination Oriented DAG (DODAG) which is a DAG with a single DAG root. In a smart grid scenario, the root of a RPL network could be the data concentrator that gathers the metering information. Figure 2.4 (b) depicts a DODAG topology that consists of eight nodes with one root.

To establish and maintain routes, RPL uses three different types of ICMPv6 control packets:

- DAG Information Object (DIO)
- DAG Information Solicitation (DIS)
- Destination Advertisement Object (DAO)

The upward route construction, the one used between smart meters and the core network, is managed by transmitting DIO messages in multicast. DIO messages contain information that allows discovering a RPL instance, calculating its own rank and choosing parents in the DODAG toward the root. The rank contained in the DIO message is the rank of the node sending the DIO message and determines the relative position of a node in the DODAG. The rank is computed by an Objective Function using routing metrics to represent the distance of a node from the root. The closer a node is to the root, the smaller its rank is. To avoid loops, a node can only choose as a parent a node with a smaller rank. A node could have multiple potential parents, it groups these neighbors in what is called a parent set. The potential parent offering the smallest rank among all parent in the parent set is the preferred parent. The preferred parent is the next hop of node.

The downward route construction, which is optional in RPL, is managed by the DAO messages to propagate information about the destination in the upward direction. To construct the downward routes, there are Storing and Non-Storing mode.

In Non-Storing mode of operation, RPL routes messages downward using IP source routing. In Storing mode operation, RPL routes messages downward by the IPv6 destination address.

Finally, DIS control packets are used to solicit a DIO message from a RPL node.

It has to be noted that in all of our implementations, we use RPL in Storing mode.

#### *Routing table maintenance under RPL*

As previously stated, DIO messages are periodically transmitted to build and maintain the RPL DODAG. However, if the network is stable, the DIO message frequency is decreased to reduce the overhead of signaling messages. On the contrary, if the condition of the network is not stable, more DIO messages have to be transmitted. This timing function is called Trickle timer [Lev+11]. If a received DIO message does not imply any change on the receiver in terms of rank, parent set or preferred parent, the DIO is considered consistent. As long as consistent messages are received, the interval between DIO messages is exponentially doubled to reduce the overhead of periodic messages.

Conversely, when the network is not stable and DIO messages are inconsistent with the known topology, more DIS and DIO messages are needed to update the node routing tables. Messages such as multicast DIS without a solicited information option or DIO messages containing infinite rank are considered inconsistent, and cause the trickle timer to reset, and the interval time is set to its minimum value. The Trickle algorithm allows to be reactive in case of a change or failure in the network while minimizing the overhead when the network is stable.

For the downward route construction, a DelayDAO is sent to govern the emission of the DAO messages. At each transmission of a DAO message, a random interval is chosen before the actual transmission.

#### *Routing strategy: metrics and constraints*

A metric in RPL is a quantitative value, used to evaluate the path cost. Vasseur et al. [Vas+12a] define two kinds of metrics that can be used for path calculation:

- The **link metric** that concerns the link's attributes e.g., Link Quality Level (LQL), ETX, latency, throughput.
- The **node metric** that takes into account the Node State and Attribute (NSA) such as energy (remaining energy, power source) or min-hop (number of hops to the root).

RPL supports also a constraint-based routing where a constraint may be applied on both link and nodes. If a link or a node does not satisfy a constraint, it is discarded

from the parent set.

This constraint is used to include or eliminate a link or a node that not meet a specific criteria. For instance, the Objective Function will not select a route that traverses a node that is battery-powered or a link with low ETX. A RPL Objective Function could combine metrics and constraints to select the best parent.

#### *Path computation under RPL*

The way a parent is selected is independent from RPL and rely on a defined Objective Function. To provide optimal routes, an Objective Function plays a major role in RPL. To this aim, the two following algorithms have to be defined:

- the computation of the node's rank according to one or several metrics
- the parent selection operation according to metrics and constraints

Two objective functions have been defined by the ROLL working group: Objective Function Zero (OF<sub>0</sub>) and Minimum Rank with Hysteresis Objective Function (MRHOF) that are presented next.

**THE OBJECTIVE FUNCTION ZERO** The OF<sub>0</sub> [Thu12] computes the rank based on the rank of the parent with the addition of a scalar, representing the link properties with the parent. The scalar value is normalized between 1 and 9 for expressing the link properties with 1 for excellent, and 9 for very poor. Note that any kind of metric could be used for the scalar value.

This objective function allows for finding the closest grounded root (a root that offers connectivity to the application goal) by selecting a preferred parent and potential parents in a parent set.

The rank computation is given by the equations 2.1 and 2.2 below:

$$(2.1) \quad R(N) = R(P) + rank\_increase$$

$$(2.2) \quad rank\_increase = ((Rf * Sp + Sr) * MinHopRankIncrease)$$

where:

- R(P) is the preferred parent's rank
- Sp (the step\_of\_rank) is the expression of the link properties normalized between 1 and 9
- Sr (stretch\_of\_rank) is the maximum augmentation to the step\_of\_rank of a preferred parent to allow the selection of additional potential parents in the parent set

- $R_f$  ( $rank\_factor$ ) is a value used to increase the importance of the link properties.
- $MinHopRankIncrease$  is a multiplying factor that plays a major role in the rank computation by reflecting the impact of the metric on the rank increase. The default value is 256 as it is described in [Win+12b].

$O_Fo$  parent selection is governed by several rules (see Section 4.2.1 of [Thu12]), but the most important is that the selected parent must be the one that causes the lesser resulting rank for the node.

THE MINIMUM RANK HYSTERESIS OBJECTIVE FUNCTION  $MRHOF$  [GL12] optimizes the path to the root that minimizes a defined metric.

$MRHOF$  works with additive metrics and introduces the path cost for the rank computation, that specifies the property of the path to the root regarding the employed metric. The path cost is calculated by the sum of the path cost advertised by the parent and the link metric cost to the parent.

The rank computation for  $MRHOF$  is given by the algorithms 2.3 and 2.4 below:

$$(2.3) \quad path\_cost = parent_{path\_cost} + link\_cost$$

$$(2.4) \quad rank = func(path\_cost)$$

where:

- $parent_{path\_cost}$  is advertised by the parent and represents the path cost of the parent.
- $link\_cost$  is the cost associated with the link with the parent regarding the selected metric.

$MRHOF$  parent selection is governed by an hysteresis function, in order to handle light metrics variations that could lead to frequent parent changes.

This hysteresis function is given by the equation 2.5 where  $P1_{path\_cost}$  and  $P2_{path\_cost}$  are respectively the path cost to Parent 1 and Parent 2.  $PP$  is the selected parent designated as Preferred Parent.  $P1$  is the current best parent and  $P2$  is a candidate parent.

$$(2.5) \quad PP = \begin{cases} P2 & \text{if } P1_{path\_cost} + Threshold > P2_{path\_cost} \\ P1 & \text{else} \end{cases}$$

where  $Threshold$  is the hysteresis function, i.e., the minimum difference between the cost of the path through the preferred parent and the path cost of a candidate parent to trigger the selection of a new preferred parent.

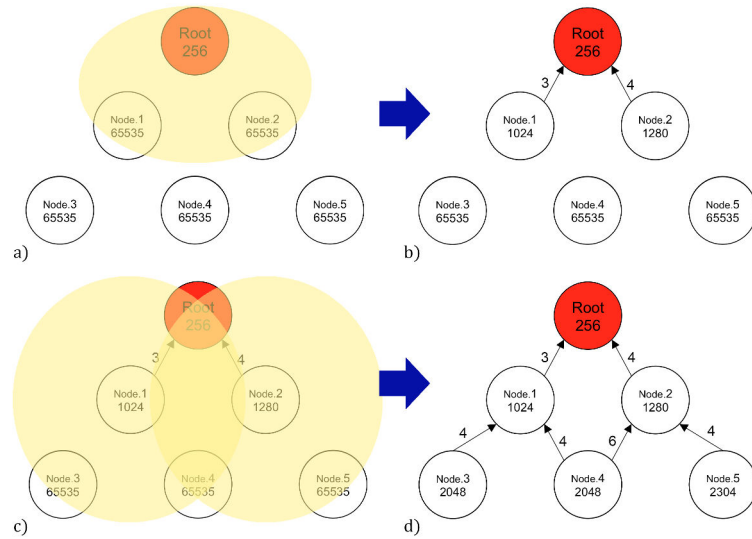

Figure 2.5: Example of an Upward route construction with RPL.

### Summary of the RPL DODAG construction

Figure 2.5 shows an example of the upward route construction using the *ETX* as the metric. Once the trickle timer is expired, the RPL root will broadcast a *DIO* message, containing its rank. Nodes in the coverage area of the root (i.e., yellow circles) will receive the *DIO* message and process it. If the *DIO* message had been corrupted, it would have been discarded. Node 1 and 2 have a rank equal to the *infinite\_rank* value, when receiving the *DIO* from the root, as the rank of the root is smaller than the *infinite\_rank* value, node 1 and 2 will choose the root as their preferred parent and compute their rank.

To test if the root is eligible to be a preferred parent, node 1 and 2 will verify if the rank contained in the received *DIO* message from the root added to a RPL parametric value (*min\_hop\_rank\_increase*) is less than their rank.

The arrows between nodes represents the upward route and when a node installed at least one route, it is considered to have joined the DODAG. It has to be noted that a node may either stay silent and wait for a *DIO* message or it may send a *DIS* message during the initialization process.

Then node 1 and 2 will broadcast their own *DIO* message with their new computed rank. Note that since the root has a smaller rank than the one advertised in nodes 1 and 2 *DIO* messages, nodes 1 and 2 will not be considered as potential parents for the root. It is worth mentioning that ranks shown under node names in this example depends on the objective function and values shown beside edges representing the link quality (i.e., *ETX*).

This RPL introduction shows how a proactive routing protocol could be appropriate for an application that needs all nodes to send traffic to the sink (i.e. a smart grid

metering). Once the [RPL DODAG](#) is built, each node in the topology has a preferred parent that could forward the packet toward the root.

In the next section, we introduce the second family of routing protocols, which builds the routes when needed, in a reactive way.

### 2.3.3 *Reactive routing protocol*

In reactive-based routing protocols, routes are built only when data need to be sent between two nodes and they are maintained as long as there is traffic. These routes are erased once there is no more data traffic. Thus, a delay is added before transmitting a data packet due to the route construction.

Contrary to proactive protocols, reactive protocols do not need to send routing information periodically. However, the quantity of routing messages will greatly depends on the frequency of the data traffic in the network.

#### *Topology management under AODV*

[AODV](#) [[PBD03](#)] is a well known reactive routing protocol designed for use in Mobile Ad Hoc Networks (MANET). It floods the network with broadcasted Route-request messages when a route needs to be created.

To establish and maintain routes, [AODV](#) uses five types of messages:

- RREQ: Route request
- RREP: Route reply
- RERR: Route error
- RREP-ACK: Route Reply Acknowledgment
- HELLO: Link status monitoring

When a source node needs to establish a route to a destination, it broadcasts a Route Request ([RREQ](#)) packet. This [RREQ](#) message is forwarded hop-by-hop by all nodes in the network, a feature called flooding. Once the destination is reached (or an intermediate node that knows the route to the destination), a Route Reply ([RREP](#)) message is sent back to the [RREQ](#) sender. If the source node receive a [RREP](#) message, the route discovery operation is over. Otherwise, after a certain period, the source node repeats the [RREQ](#) message and increases the waiting period. If there is no [RREP](#) message, this process can be repeated several times (by default, `RREQ_RETRIES = 2`). If there is still no response after three attempts, the route search process is aborted. Consequently, a new route request will be initiated after ten seconds.

[AODV](#) use a destination sequence number for each route entry. The destination sequence number is created by the destination and it is included along with any

route information sent to the requesting nodes. The destination sequence numbers ensures to avoid loops. Having the choice between two routes to a destination, a requesting node selects the one with the greatest sequence number.

A node receiving a RREQ packet will send a RREP (route reply) packet if it is the destination or if it has a route to the destination with a sequence number greater or equal to the RREQ packet, otherwise it rebroadcasts the RREQ packet. Each node keeps a trace of the source IPs and the identifier of the RREQ packets. In case of receiving a RREQ packet that they have already processed, they ignore it.

Once the source has received the RREP packet, it can start sending data packets to the destination. If the source subsequently receives an additional RREP containing a higher or equal sequence number but with a smaller number of hop, it will update its routing information to that destination and start using the best route. Note that it is likely that a source receive several RREP messages, one for each path taken by RREQ messages. A route is maintained as long as it continues to be active, in other words, as long as data traverse between the source and the destination. The route expires when there is no more data in transit on the route and after a pre-defined delay. If the root is cut, the destination node sends a RERR (Route Error) packet to the source node to warn that the destination is currently unreachable. If the source node still wants to get a route to that destination, it must start the route discovery process again or use an alternative one that would be created before.

Concerning the routing table, each entry contains nine fields. In addition to IP address of the destination node, the fields contain routing information and information related to the qualitative state of the route for maintenance purposes. Unlike other protocols, AODV only maintains information about the next hop in the route, not the entire routing list. This saves memory and decreases overhead for route maintenance. The routing table also contains routing information enabling a host to share metrics with other nodes when link states change. To ensure the routing information is the latest one available in the route table entry, a sequence number for the IP address is included. This sequence number is called the "destination sequence number". It is updated each time a node receives a RRRER, RREP, RREQ message.

To offer connectivity information, nodes that are part of an active route, can broadcast local HELLO messages. Every HELLO\_INTERVAL, the node will check if it has sent a broadcast message during the last interval, and if it has not, it will broadcast a RREP message with a TTL set to 1. Within a dedicated period, if a node that has received a *Hello* message from a neighbor, does not receive any packet from that neighbor, the node will assume the link is lost, and will send a RRRER route error message.

Figure 2.6 shows a route search on the initiative of the node A in the direction of G. The RREQ message is broadcasted from node A to all its neighbors. When node G receives the message, it returns a RREP message to node A through node E.

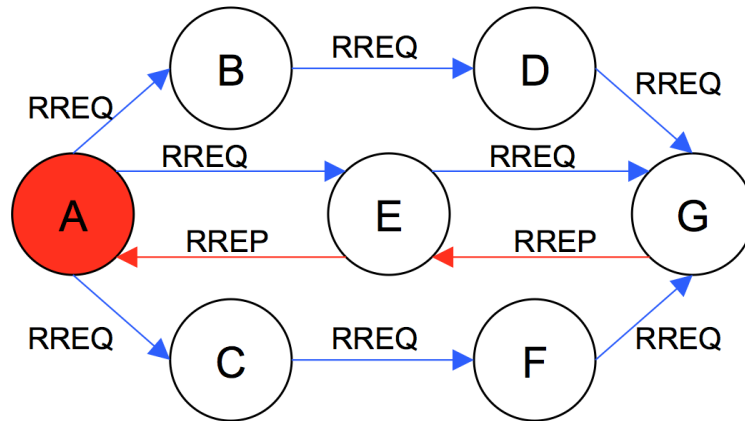

Figure 2.6: Example of an AODV route detection between node A and G.

The RREQ route request message is sent to search for available routes, then the RREP route response to demand message is sent to indicate available routes to the originator of the demand. Next, the RREP is sent to report routes with potential errors to the originator of the demand.

A Route Reply Acknowledgment (RREP-ACK) message is sent in response to a RREP message with the 'A' bit set to 1 when there is unidirectional links preventing the completion of a Route Discovery cycle. It indicates that another available route is already used.

#### *Reactive routing protocol in a constrained network*

Several proposals emerged to simplify and adapt AODV for LLNs. In 2011 and 2012, with the use of an adaptation of AODV in G3-PLC standard in smart grids networks, a LOADng specification emerged, as the next version of AODV.

6LoWPAN Ad Hoc On-Demand Distance Vector Routing (LOAD) and Lightweight On-demand Ad Hoc Distance-vector Routing Protocol Next Generation (LOADng) are both routing protocols based on AODV reactive routing protocol. LOAD is a simplified adaptation of AODV and has been optimized to target Low power and Lossy Network (LLN). LOADng is the latest version of LOAD where many features have been reviewed to make LOADng more efficient and extensible.

In LOADng several extensions have been included to improve the performance under specific scenarios such as LLN, by reducing the network overhead.

Thus, LOADng and LOAD share many common points:

1. A node that has data to transmit to a destination but has no information related to this destination in its routing table: it sends a RREQ message with the referred node as the destination address and the intermediate nodes will broadcast the message. If a node receives a RREQ message, and if it has already transmitted this



RREQ, it will discard it. Consequently, the intermediate nodes build the reverse route to the initiator.

2. When the destination node receive the RREQ message, it can generate a RREP message immediately and, thus, minimize the time to establish the path (It could also wait to receive several RREQ messages with better metric to optimize the path at the cost of a longer path establishment delay).

3. To detect broken or asymmetric links, intermediates nodes can request for an acknowledgment during the forward route to the destination construction.

4. When a node is no longer able to forward packets to the next hop, a local repair mechanism is triggered to solve the problem. In case the local repair mechanism fails, a RRER message is sent to the originator of the message.

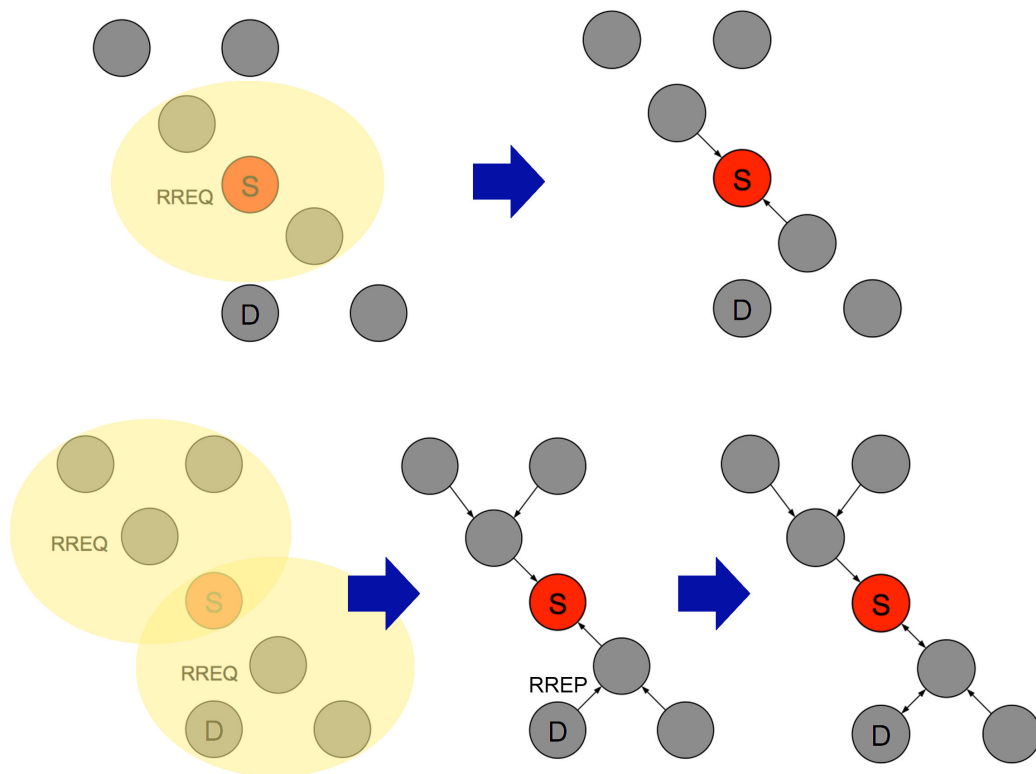

Figure 2.7: Example of a route construction with LOADng.

In Figure 2.7 an example of route construction using LOADng routing protocol is illustrated.

Figure 3.1 shows the route construction between the source node S and the destination node D. Node S starts by broadcasting a RREQ message with node D as the destination. Nodes in its covering area receive the RREQ and build a reverse route to the node S, and broadcast a RREQ message. Upon reception of the RREQ

message, node D generates a RREP message in unicast. When node in charge of the forwarding of the RREP (source node included) receive the RREP message, they construct the corresponding forward route which guarantee the a bidirectional route between node S and node D.

In the next section, we propose a comparison of LOAD and RPL as a confrontation of the two families of routing protocols.

#### 2.3.4 Performance evaluation

As LOAD and RPL are both specifically designed for LLN, hereafter, we present a performance evaluation comparison of these two protocols.

We used an existing implementation of LOADng [Rop+13] to compare with our implementation of RPL in the Riverbed Modeler simulator. We used a simple metering scenario on a PLC network.

A detailed presentation of our implementations is done in 4.3.

Protocol	LOADng	RPL
Type	On-Demand	Proactive
Algorithm	Distance Vector	Distance Vector / Source Routing
Local repair	Yes	Yes
Mobility	Static, Mobile	Static, Mobile
Scalability	High	High
Supported traffic	P2P	MP2P, P2P, P2MP

Table 2.3: LOADng / RPL comparison.

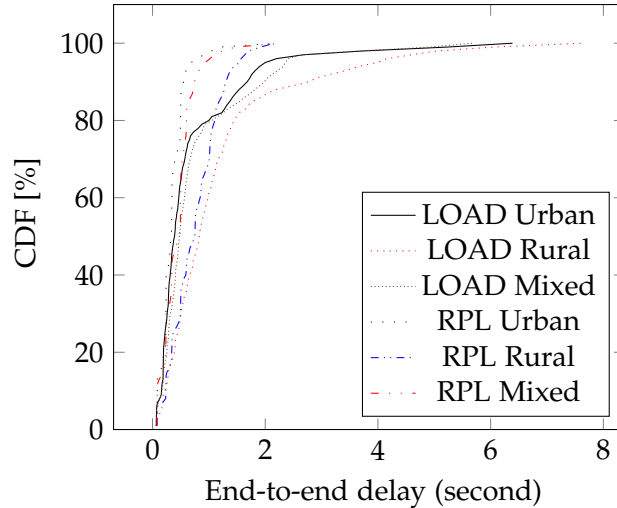

Figure 2.8: End-to-end delay comparison.

Comparing **RPL** and **LOAD** will mainly depend on the topology (e.g., density) and traffic pattern. In a stable network, the round-trip time for a data packet (i.e., end-to-end delay) will tend to be better with **RPL**, due to the time needed to build the path using the **LOAD RREQ** message. Moreover, thanks to the trickle timer, **RPL** will decrease significantly the control traffic as long as the network stays stable. When the condition of the network evolves (i.e., a node loses its parent, a path cost change), **RPL** will reset the trickle timer and send more **DIO** messages to recompute the DODAG. This explains the additional control traffic in **RPL**, and may result in a broadcast storm, caused by the issue of **DIO** messages with increased DODAG version number (Global repair).

A global repair of the **RPL** DODAG is triggered by the root. It re-computes the DODAG resulting in an increasing of the end-to-end delay where the **LOAD** routes will be less impacted by the network variation. In smart grid applications, end-to-end delay tolerance could vary from below than  $10ms$  to more than two seconds (e.g., smart meter reading).

On the other hand, a teleprotection for instance, which ensure the protection of network equipment from severe damage by managing the grid load, requires fast signals to pilot protective relays, no more than  $10ms$  [09].

Figure 2.8 shows the CDF of the End-to-end delay for three different topologies comparing **RPL** and **LOAD**. **RPL** perform slightly better than **LOAD** mainly because of the traffic pattern. As the scenario is multipoint-to-point, and **RPL** starts immediately to build a route for every node to the root, **LOAD** is clearly disadvantaged.

However, there is a huge variety of different traffic patterns and requirements on delay in smart grid, which does not permit to determine if **RPL** or **LOAD** would perform better on the End-to-end delay criteria.

Since in LLNs nodes have constrained memory, smart meters will only store a dozen of entries in IP core routers whereas the routing table usually contains hundred of thousands routes. As a consequence of flooding in a LOAD network, each smart meter receiving a RREQ message will install a route towards the sender resulting in a large number of unnecessary routing entries. The same issue occurs when a node is situated on a route of a RREP message. In contrary, most routers in RPL network have the default entry towards the preferred parent. However, when RPL operates in storing-mode, nodes that are chosen as preferred parent have to store the downward route and may cause critical issues such as loops, in case a node runs out of energy.

Concerning the path efficiency, since RPL compute a DODAG from a sub-topology of the physical network, the traffic has to follow paths along the DODAG even if a more optimal path exists in the physical world. These protocols produce a sub-optimal solution, which can be improved by carefully select parameters for the metrics used to arbitrate the chosen links. For instance, LOAD uses the LQI (Link Quality Indicator) in addition to the Hop distance.

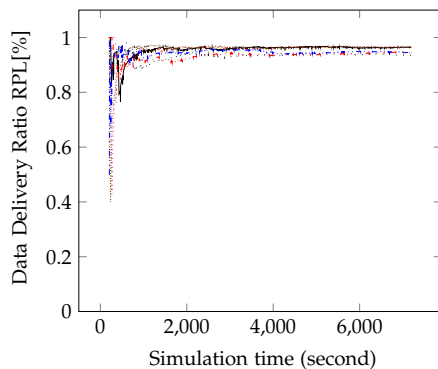

Figure 2.9: RPL Data Delivery Ratio for a 100 nodes topology

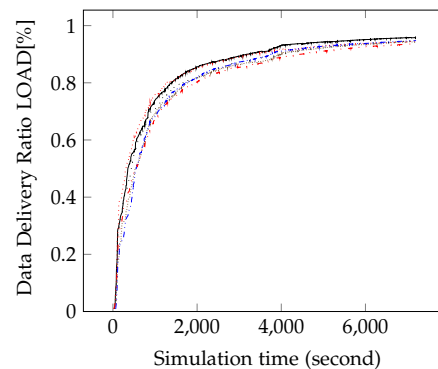

Figure 2.10: LOAD Data Delivery Ratio for a 100 nodes topology

Figures 2.9 and 2.10 shows the Root Data Delivery Ratio of a 100 nodes topology for RPL and LOAD, after two hours of simulation and six runs with different seeds. The nodes are distributed on 3 PLC phases. Each node report a 100 bytes metering packet every 15 minutes. The physical topology of our smart grid scenario is depicted in figure 2.11.

As the traffic is set to start when the simulation initiates, RPL demonstrates additional delay before the actual data packet reception. However, RPL attains high performance once the DODAG is established. Concerning LOAD, results indicate that data is received quickly once the network is initiated, however, it takes time for LOAD to reach the same Data Delivery Ratio (DDR) as RPL.

In RPL, packets are sent only after the DODAG is constructed. Due to the flooding mechanism of LOAD, nodes construct the path using the first RREP message arrived, which is not necessarily the optimal one in terms of hops. The packet will follow a

non-optimal route until subsequent RREP message reception to update the path.

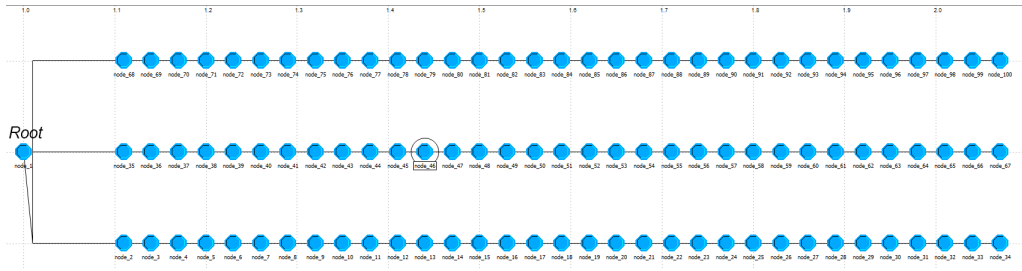

Figure 2.11: 100 nodes topology to compare LOAD and RPL.

In terms of overhead, differences between the protocols will mainly depend on the implementation and parameters. The stability of the network has a significant impact on RPL, its parameters should be carefully selected to handle specific network circumstances. In LOAD, Route Hold Time (RHT) will greatly impact the frequency of the flooding and, consequently, will increase the overhead. The number of nodes in the network is also critical in LOAD since high density in the network will impact the overall overhead. In RPL, we expect the maximum overhead at the beginning of the DODAG construction, and then a reduction as the network become stable, due to the behavior of the trickle algorithm.

### 2.3.5 Summary on routing protocols

Choosing between reactive and proactive routing protocols in a smart grid network depends on multiple factors. The application, which identifies the type of traffic, has a major role in choosing the routing protocol and its corresponding parameters. Several parameters will also depend on the density of smart meters and the type of topology, i.e., number of maximum hops to the root. Furthermore, the priority of the traffic has an impact on the routing strategy as well, i.e., if the application is tolerant to high end-to-end delay. However, each protocol has different implementation issues attaining different performances.

As a result, several parameters need to be properly configured in order to satisfy the requirements of the considered network and application.

RPL for instance is known to work well in Multipoint to Point application, a typical scenario in smart grid network, where data concentrators will receive the data from a large amount of smart meter in the NANs. LOADng address 6LoWPAN Ad Hoc On-Demand Distance Vector Routing (LOAD) Multipoint-to-Point issue and offer a similar performance to RPL at the cost of delay for the route discovery process. In smart grid scenario, for typical monthly readings, the delay could not be a critical issue, so both protocols could be chosen.

The rate of traffic is also a major concern in smart grid networks, where a stable routing graph, such as RPL constantly maintained DODAG will greatly impact the

delay at the cost of energy consuming. On the other hand, if the smart grid traffic is sparse, the need of maintaining a routing graph at the cost of high control traffic is not essential.

According to the few results presented in this section, and the literature, and except a analysis on the real needs and requirements of the applications deployed, there is no reasons to determine which of proactive and reactive routing protocol should be encouraged in a smart grid network.

For example, millions of smart meters using RPL have been installed in California mandated by California Public Utilities Commission (CPUC) while French Enedis has chosen LOADng for the widely deployed Linky smart meters in France.

Furthermore, an interesting fusion of both proactive and reactive concept exists. AODV-RPL [Ana+18] is an extension of RPL with the reactive feature of AODV to enhance point-to-point traffic flows when links are asymmetric. Indeed, when standard RPL build the routing graph, in a case of an asymmetric link between a source node and a target node, it is likely that the number of hops between the two nodes will be greater than 1. In that case, AODV-RPL will probe this link in case of P2P traffic using two paired RPL instances to construct the directional path.

As we have seen previously, the communication issues encountered in a homogeneous smart grid network cannot be faced only with the routing protocol. Having multiple interfaces, and if possible, in a heterogeneous environment, could open new ways to address these problems.

Such a feature allows to enhance reliability and robustness by taking advantages of all available technologies (i.e., PLC and 802.15.4)

## 2.4 RPL IN THE SMART GRID NETWORKS

RPL has been designed by the IETF to support various application for LLN such as the urban environment [Wat+09], the industrial applications [Pis+09], the home automation [PBB10], and the building automation [Mar+10]. Thus, RPL supports different Objective Functions to build the routing topology using a wide variety of node and link metrics, and constraints. Consequently, RPL has the flexibility to support the routing applications of the smart grid network, for both Wireless and PLC environment.

While many contributions on RPL and its performance over a (single interface) wireless network exist, only few works have studied RPL over Smart grid applications, and more specially over a PLC network, which has its own specific characteristics [KBK11].

We accomplished an extensive study of the state of the art to highlight the potential issues of RPL implementations for each technology, and the available solutions.

The next sections presents the most relevant contributions found in the literature. Table 2.4 summarizes these studies.

#### 2.4.1 RPL and Wireless

RPL has been tremendously studied with wireless networks, mainly because of the strong growth of the IoT community, and the availability of numbers of RPL implementations in IoT OS running on wireless hardware platforms.

AMI applications may require high reliability, low latency or high throughput depending on the traffic pattern of the targeted application [KPR14]. To evaluate if RPL fit the requirements of AMI networks among others, RPL has often been studied in conjunction with reactive routing protocol such as AODV and LOAD.

In the literature, we can distinguish two categories of RPL studies in wireless networks with a context of smart grid:

- General evaluation of RPL performance and comparison with other routing protocols.
- Extension of RPL to increase performance or reliability.

The particularities of Wireless Mesh Network (WMN) in Smart grid are the physical topology and the characteristics of the networks such as the attenuation or the interference model. In most of the RPL performance contributions in the literature, the COOJA simulator from contiki OS is used with a random generated topology. Having a realistic link layer data based on real deployment on the field is essential to evaluate the performance of RPL in a smart grid environment. A link failure model is also an asset to fully represent the variability of the link quality over the time.

For example, Tripathi et al. [TOV10] evaluate a 86 nodes, single root substation topology based on real link layer data collected on a smart grid network to compute the PDR of every links. They show the performance of the local repair mechanism of RPL using ETX metric to build the DODAG. Other metrics are observed such as end-to-end delay for different number of hops between two nodes, path quality, control plane overhead.

In [AJA17], a modification of RPL is proposed, based on MRHOF and clustering approach. An evaluation of metrics such as End-to-end delay, energy, and PDR shows few improvements to standard RPL results, especially on network lifetime. The clustering approach provide essentially a improvement on the energy consumption. In [KBS17] authors compare MRHOF and OFo. Using ETX and energy metrics with MRHOF, they show how the Objective Function react to smart grid traffic in terms of end-to-end delay. As the density of the network heavily impact the end-to-end delay of the network, they show that scalability of MRHOF with ETX metric is an issue compared to OFo when network size exceed 100 nodes. They also

Environment		Reference	Implementation	Simulation	Scale	Metric	
PLC	RF					ETX	Others
	✓	[Wan+10]	ns-2	✓	1000	✓	
	✓	[TOV10]	OMNET++	✓	86	✓	
	✓	[Anc+14]	ContikiOS	✓	100	✓	
	✓	[Cha+13]	ContikiOS	✓	6	✓	energy remaining
	✓	[ABC12]	ContikiOS	✓	150	✓	
	✓	[Gad+14]	ContikiOS	✓	100	✓	traffic / packet loss
	✓	[LHG13]	ContikiOS		50	✓	
	✓	[Gua+14]	Contiki/TinyOS	✓	25	✓	
	✓	[Bar+13]	ContikiOS		25	✓	
	✓	[HM13]	ContikiOS		250	✓	
	✓	[ITN13]	WSNet	✓	100	✓	LQI
	✓	[IAC13]	OMNET++	✓	50	✓	
	✓	[TO13]	OMNET++	✓	2242	✓	
	✓	[EKE15]	ContikiOS	✓	25	✓	CORB
	✓	[Kim+17]	TinyRPL	✓	30		queue utilization factor
	✓	[Ren+16]	Mathematica	✓	160	✓	
	✓	[Yan+18]	Matlab	✓	500		CRTF
	✓	[Yan+17b]	Matlab	✓	500		CORPL
	✓	[Rek+16]	ContikiOS	✓	100		Opt-FLQERM
	✓	[KBS17]	ContikiOS	✓	140	✓	Node energy
	✓	[Yan+17a]	Matlab	✓	500	✓	Green-RPL
	✓	[AJA17]	ContikiOS	✓	20	✓	
	✓	[Lon+13]	ContikiOS	✓	35	✓	
✓		[BZ17]	OMNET++	✓	484	✓	
✓		[Cha+10]	ContikiOS		5	✓	
✓		[BCT11b]	WSNet	✓	1600	✓	
✓		[Rop+14]	OPNET	✓	240	✓	
✓		[Rop+13]	OPNET	✓	7	✓	
✓		[Rop+15]	OPNET	✓	400	✓	Channel Occupancy
✓		[BGD18]	OMNET++	✓	484	✓	Signal attenuation
✓	✓	[BCT11a]	ContikiOS	✓	31	✓	
✓	✓	[Cha+10]	ContikiOS	✓	5	✓	
✓	✓	[Pig+12]	ContikiOS	✓	16	✓	
✓*		[Bal+14]	ContikiOS	✓	93	✓	
✓	✓	[Saw+12]	MCCP		5	✓	

\*two interfaces PLC nodes

Table 2.4: RPL studies depending on technologies and heterogeneity of the network



raise the question of selecting the links with ETX metric that cause an increasing of the end-to-end delay because of the resulting number of hops. The same Objective Function (OF) comparison is made in [Gua+14] where the performance of MRHOF in terms of PDR is highlighted. This result is due to the fact that MRHOF considers the entire path to the root whereas OF<sub>0</sub> take into account the preferred parent link quality only.

Heurtefeux et al. [HM13] study the performance of RPL in a dense network. They evaluated several metrics such as the PDR and stability of the DODAG and show that the more dense is the network, the lower the PDR is. They also observed the reliability of the RPL DODAG in the presence of network instability. Results shows a high proportion of RPL control messages compared to application packet and a high number of neighbor update leading to an unstable DODAG when network links are not robust.

Hyung-Sin et al. [Kim+17] raise the issue of congestion at popular forwarding nodes in a DODAG resulting in a load balancing problem. Nodes close to the root are solicited more likely than nodes far away from it. That leads to congestion at small set of nodes. To tackle this behavior in RPL, they use a queue utilization factor a metric to reduce congestion by propagating congestion information with the optional metric container in RPL DIO message. At the cost of a more complex parent selection, they show improvements in terms of end-to-end packet delivery, and scalability. They confirmed that the packet loss problem raised by congestion of such nodes in the standard RPL could be solved.

In [JCI13], [IAC13] and [VTD14] the congestion issues in terms of RPL message overhead is studied. Tripathi et al. [TO13] explain the problem of potential DAO messages congestion that could happen in large networks. In RPL, the sending of DAO message is governed by the *Delay\_DAO* timer. A short *Delay\_DAO* allows to have a fast construction of the DODAG but a high reaction to the DODAG changes, resulting in a DAO storm in large scale network. An optimization is proposed to dynamically adapt the *Delay\_DAO* value according to the network scale and density showing major improvements in DAO congestion.

Ancillotti et al. [ABC13] study specifically MRHOF under smart grid environment, with AMI application scenario. They show that the routing decision made by RPL are inefficient for some nodes and could lead to high loss rate. In [ITN13], the authors extend the work by evaluating the stability of the network. They observed the ETX, LQI and hop-count metrics to show that the ETX metric cause instability to the DODAG, constantly following the link-quality changes. In contrary, they show the stability of the hop-count metric, building short path at the cost of taking bad links. This study confirms that there is a trade-off between stability and efficiency with every evaluated metrics.

The previous contributions are focused on the evaluation of the performance of RPL using the standard metrics and Objective Functions. However, an important part

of the existing work is focused on RPL extension or modifications to increase the performance of the protocol.

In [Yan+18], DMACO-RPL, an original modification of RPL implemented in Matlab is presented. Based on a cognitive and opportunistic solution [ASA15], authors propose an evaluation in a AMI scenario and a comparison with the standard RPL. They use cognitive radio, and artificial intelligence to select the best route from source to gateway using end-to-end delay and hops metrics. The same authors in [Yan+17b] and [Yan+17a] propose another modification of RPL based on cognitive radio in the same AMI scenario, called CRB-RPL. A Competition is introduced in the forwarding process based on the rank of the nodes, as the node will broadcast the data, receiver with a low rank have better chance to forward the packet. This studies shows that RPL could take a real benefit from the cognitive radio network, in terms of energy consumption, PDR and End-to-end delay, but at the cost of a huge modification of RPL.

Rekik et al. [Rek+16] propose a new metric for RPL and compared it to ETX. A holistic metric based on 4 link properties: packet delivery, channel quality, re-transmission and link asymmetry. They evaluated the metric by simulation under a smart grid scenario and compared the solution with the four-bit metric and the standard RPL MRHOF with ETX. They show that the holistic metric provide systematically better results than Four-bit and ETX with MRHOF, and more particularly on the number of parent changes. It is however necessary to put in perspective the fact that the traffic used is relatively low (one packet per minute) and the maximum number of nodes is 120.

In the same way, Gaddour et al. [Gad+14] introduce a new objective Function in order to take into account several metrics by using fuzzy logic. This new OF, OF-FL (Objective Function Fuzzy Logic) allows a better PDR, network lifetime and end-to-end delay compared to OFo and MRHOF. However, this objective function shows a higher number of parent changes, which is assumed to be necessary to select better parent to achieve the improvement of the PDR.

RPL uses a permanent probing to maintain the routing graph, resulting in an overhead managed by the trickle timer. In [Anc+14], the Trickle-L2 mechanism is presented to reduce the RPL overhead. By delaying the bootstrap process of the node waiting for a specific link quality, and sending DIO to estimate link quality, they show that L2 trickle solution allows a lower overhead.

Some studies are focusing on energy consumption, even in the smart grid networks where the nodes are likely to be powered by the infrastructure. In [Cha+13], a new metric is proposed to evaluate the network lifetime in conjunction with the ETX metric. They show an increasing of the network lifetime by 12% by building the DODAG taking into account the remaining energy of nodes. [Bar+13] propose an extension of RPL focusing on energy and resources. Two metrics, battery index and energy consumption, are used to build the DODAG. results shows a better

performance in term of energy consuming without compromising the throughput of the network.

Smart grid application involve large-scale scenario in the order of a thousand or more meters connected to a single root. Large-scale AMI network requirements such as reliability and low-latency are evaluated in [Wan+10] with a modified RPL. Wang et al. propose a reverse path recording mechanism to manage the outwards routes instead of using DAO messages. Each time a node receive a data packet from child node, the node records the source and the last-hop node of the inward data packets in its destination list. In that way, a node can reach its descendant by selecting the last-hop node recorded in its destination list. Authors shows satisfactory results, compared to AODV performance, where PDR and end-to-end delay are not sensitive to distance between a node and the root, contrary to AODV.

RPL has been compared to other protocols in several papers. LOAD and LOADng have been compared and evaluated as potential good candidates for AMI networks. In [JCI13], RPL is compared to LOADng at the advantage to the latter in terms of E2E delay, PDR and overhead. In [TO13], the same study is made focusing on RPL parameters, leading to an advantage to RPL, confirming the potential of both protocols given that results are close and depending mainly parameters. Vucinic et al. propose in [VTD14] also a comparison of RPL and LOADng that shows better performance results regarding overhead, end-to-end delay and memory. In [IAC13], the authors propose a comparison between LOAD and RPL. They show that RPL outperform LOAD in terms of route construction time and End-to-end delay. In [LHG13], authors present a new approach by mixing both approaches of reactive and proactive routing protocols. They propose the use of LOADng to build the downwards routes in a RPL network.

#### 2.4.2 RPL and PLC

Ben-Shimol et al. [BZ17] propose an evaluation of RPL in large scale PLC networks using field measurement to configure the simulation channel. They propose a modified RPL OF in order to improve the rank computation to address the constrains of the PLC network. Their contribution shows improvements in the DODAG formation, at the cost of more control messages for DODAG maintenance.

In 2010, Chauvenet et al. [Cha+10] proposed the very first implementation of RPL in a PLC environment, using a PLC communication based on IEEE 802.15.4 principles with IPv6 over Low power Wireless Personal Area Networks (6LoWPAN). They made also a real test-bed smart grid scenario with ContikiOS-based nodes. With primary RPL parameters and using the ETX metric with the objective function showed an improvement of 45% of the latency compared to the uncompressed IPv6 scenario.

Ben Saad et al. [BCT11b] proposed a real RPL test-bed scenario of 6 PLC nodes with a root and compared it to a simulated scenario under COOJA with a PLC module. They observed the throughput, the latency and the packet delivery ratio of each

scenario to show that real PLC links induce more link layers retries leading to higher latency than the simulation.

Ropitault et al. [Rop+14] present some recommendations for RPL parameters for smart grid networks. They show that RPL parameters selection has to be carefully set for narrow-band PLC networks as well as IEEE 802.15.4 multihop AMI networks.

In [Rop+13], a comparison of LOAD and RPL in a PLC environment is proposed. The authors performed the evaluation of both routing protocols by simulation and a real test-bed scenario. A full node model based on G3-PLC implemented in Opnet simulator, and a real test-bed of nine G3-PLC smart meter are presented. Results of both simulation and real scenario shows similarity, as the purpose of the study was the calibration and the validation of the simulated scenario, in order to simulate large scale scenario with accuracy. Simulation results shows in particular a simulation time much higher for RPL contrary to LOAD, which is mainly due to the proactive nature of RPL that induce a high volume of control message to handle by the simulator.

In [Rop+15], a new Channel Occupancy metric designed for AMI application is proposed. This metric takes into account technologies with multi-modulation schemes and is studied with the PLC IEEE P1901.2 standard. Compared to the ETX metric, with RPL OFo and MRHOF, the channel occupancy metric shows improvements in stability, but also offering better forwarding performances.

Ben-Shimol et al. [BGD18] propose an application layer specific solution that optimizes an AMR application by proposing three algorithms of polling scheme. They simulate a PLC scenario with a single DC with the implementation of both RPL and LOADng to evaluate the performance of the efficient automatic reading schemes proposed. Results show improvements in the reading rate for both RPL and LOADng. It is also observed that the algorithms perform better on large scale scenario, offering a speed up of factor 10 with LOADng.

As far as we know, these works are the only relevant studies about RPL in a smart grid PLC environment. The difficulty of finding or implementing a realistic physical PLC model in popular simulator is one of the reasons limiting the contributions.

### 2.4.3 RPL and heterogeneous networks

Previous section shows some contributions of the community on RPL in PLC networks. Moreover in this section, we will see that only few works have been done using both PLC and wireless communications in a RPL network.

Ben Saad et al. [BCT11a] propose an heterogeneous architecture based on RF-PLC gateways to make a cooperation between RF-only and PLC-only sensors. Such an architecture confers improvements in network lifetime and reliability in small topology but could lead to severe congestion around gateways in large scale scenario.

Chauvenet et al. [Cha+10] propose a cooperation between PLC and RF networks that shows the suitability of RPL for such networks but highlight the importance of an adapted OF to suit PLC networks. Also, as the cooperation of the PLC and RF networks is based on single interface routers and gateways, the multiple interfaces case is not addressed.

Indeed Long et al. [Lon+13] already proposed an interesting multi-instance usage of RPL in a homogeneous network. They studied how to prioritize traffic in a wireless sensor network using cross-layer mechanism based on CSMA and RPL. They defined two RPL instances, one for priority packets and another one for the other packets. Their Cooja simulation showed that the end-to-end delivery latency is decreased.

In the same spirit, but in a hybrid network this time, Pignolet et al. [Pig+12] propose an extension of the contiki network stack to handle multiple interfaces. One instance per technology is created for the routing operation but the interface management is not addressed, an instance is used as a backup of the other. A smart grid simulation scenario is also studied in Cooja simulator to test the repair mechanism benefits of two interfaces nodes.

Balmau et al. [Bal+14] extend this work by evaluating how much a PLC network can be degraded before having an effect on the smart grid application performance. After a period of time to have a stabilized DODAG, a global repair is triggered to show how much time is necessary to valid a DODAG again. The implementation shows satisfactory results when the interval of packet transmission is high, but the network starts to be congested when this interval decrease.

H. Sawada et al. [Saw+12] present a communication protocol to handle the construction of a network infrastructure by following a DODAG routing for multi-interface communication. This study shows that DODAG routing performs well with multi-interfaces architecture (RF and PLC), especially when the DODAG is altered by jamming links.

To address heterogeneous networks management complexity, solutions based on gateways with multiple interface are used by the community. Focusing on RPL, only few works have been done to integrate hybrid network directly in RPL. These works especially use the multiple RPL instance feature.

## 2.5 HETEROGENEOUS MULTIPLE INTERFACES

Today communication devices such as computers, smart phones or IoT devices commonly use multiple interfaces allowing to choose the one offering the best performance for a specific scenario. But the management of those heterogeneous interfaces is not standardized. From a performance point of view, each interface can be chosen as the best interface depending on a specific criteria. The selection of the interface to use is selected by default in the operating system or selected at the

discretion of the user. For instance, the range distance, the delay or the energy consumption of a technology is not taken into account when transmitting or receiving data.

On a smart phone, when the cellular High Speed Downlink Packet Access (HSDPA) and Wifi are on and connected to an access point, wifi is used for data communication even if the HSDPA throughput is better. Moreover, if the user wants to use an interface for a specific type of data stream or wants a combination of all the interfaces to achieve a better throughput, the choice is not possible for the user.

Multipath TCP (MPTCP) [Paa+12] is a well know evolution of TCP that allows to use multiple interfaces for a single connection. It has been standardized [For+13] by the IETF and runs over today's internet. A MPTCP stack is available in the Linux kernel and has been used mainly for a common data center networks scenario, where paths are homogeneous. In a heterogeneous environment, studies shows that the use of MPTCP is not always a valuable solution because of the realistic conditions of the networks [FDA14].

### 2.5.1 *IoT networks*

A multitude of IoT communication technologies exist to interconnect objects together [AIF+15]. WiFi, Bluetooth, IEEE802.15.4, Z-Wave, are common examples of well known short range communication protocols and technologies that are used in many different IoT applications. Table 2.5 summarizes standards and proprietary protocols used in the IoT.

Most of today IoT devices embeds multiple heterogeneous interfaces, but every interface has its own application and limited interface management exists in the OS (i.e. Bluetooth Low Energy (BLE) for configuration with a mobile device and WiFi for internet connection).

In the IoT community, prototyping manufacturers starts to propose dual RF module, but to target long range and short range 802.15.4 applications at the same time [Boc+18]. To face interoperability issues in IoT architecture, a widely adopted architecture relies on middleware solutions, such as a gateway that manages multiple heterogeneous technologies to connect different networks. Thus, no interface management mechanisms are available in any of the IoT OS.

### 2.5.2 *Smart Grid networks*

As we have seen previously, the number of potential communication technologies focusing on smart meters links to DC is substantial. Furthermore, the world's leading manufacturers of meters propose, since almost a decade, smart meters that are able to communicate with both wireless technologies and PLC technologies [ZGL13].

Categories	Technology	Range	Throughput
Short Range	Wifi [IEE16]	up to 1km	Tens of Mbps
	Bluetooth [McDo5]	100m	2Mbps
	IEEE 802.15.4 [Sie+12]	100m	250kbps
	Z-Wave [GP10]	30m	40kbps
	LTE-Advanced [Gho+10]	1km	3.9Gbps
	RFID [AP10]	200m	640kbps
	NFC [Wan11]	20cm	424kbps
	UWB [Ksho9]	Tens of meters	480Mbps
	Wifi-Direct [FTH16]	200m	250Mbps
	BLE [Sie+12]	100m	2Mbps
Long Range	LoRA [Aug+16]	5km	Tens of kbps
	SigFox [Vej+17]	50km	100bps
	Weightless [Wei18]	30km	100kbps
	DASH7 [Erg+15]	2km	167kbps
	INGENU-RPMA [ING18]	Tens of km	Tens of kbps
Cellular	GPRS / 3G [BW97] [Eks+06]	Tens of km	tens of Mbps

Table 2.5: IoT Communication technologies.

Since a decade in most countries, utilities companies have deployed smart meters test programs, becoming a complete households coverage with smart meter deployment for some of them. Looking at the existing solutions, all of smart meters deployment programs uses only a single technology to communicate with the DC, as detailed in the French example below:

In France, ERDF started the Linky project [DGF13] in 2006 with the goal of deploying the 35 millions Linky smart electricity meters by 2021. It has been developed following ERDF specifications, including a breaker for remote power connection and disconnection, an advanced billing management module and a two-way PLC communication modem. ERDF uses G3-PLC OFDM standard to communicate with the DC and a GPRS communication from DC to utilities management solutions. The Linky smart meter project, supported by some major international providers (ITRON, L&G, etc.), uses LOADng routing protocol to manage the route to reach the DC.

However, none of the smart meters deployments meet the multiple requirements of Smart grid applications. As a matter of example, with a data collection of each smart meter data and status per day, and in a scenario of bulk metering in a deep urban environment, the average collection rate doesn't fulfill the primary requirement of 99.5% reliability for reading rates and coverage in a smart grid scenario [KPR14].

To improve reliability on this network, some solutions are explored:

- Increase the rate of the data concentrator requests
- Fine tune the parameters of different layers of the solutions to fit the environment (i e. routing parameter)
- Searching for PLC interferes in the network

As the Linky smart meter is only equipped with a single communication interface, reaching the DC with an other communication technology was not foreseen and could not be a solution in the future.

Across the globe, the technology adoption varies by region. In Europe and North America, PLC and RF mesh are most often deployed, with a greater tendency toward PLC technologies in Europe than in the U.S. In the U.S, there is few homes connected per transformer compared to European grids. Consequently, when a smart meter send data to the DC, the message won't pass through transformers, and the PLC technology used could occupy a wider bandwidth. In North America, in high population density area, RF mesh is employed as the preferred technology for economical reasons, contrary to European countries such as Italy or Sweden, using PLC for the same reason.

### 2.5.3 Conclusion on multi-interface networks

The previous in-deep study of the existing works and standards shows a relative scarce material on how to manage multiple interfaces systems. Moreover, when using heterogeneous networks, except few experimental studies, no existing work seems to answer this issue.

## 2.6 CONCLUSION

In this chapter we introduced a key part of the architecture of the Smart grid network: the Advanced Metering Infrastructure AMI. We showed that multiple type of traffic exists in the smart grid depending on application requirements. The requirements of the smart grid are high challenging because it could needs low delay applications or a high bandwidth, on top of a harsh network with common links breaks and huge interference.

The PLC technologies involved in the smart grid networks is constantly evolving, allowing more bandwidth with the recent work on NB-PLC, or more robustness with multiple modulation scheme and Tone Map procedure to adapt the modulation on the link quality.

The tremendous number of works done by the IoT community on Wireless Sensor Network (WSN), and moreover in the field of the smart grid, demonstrate the interest on providing a new vision of the AMI network to benefit from mature wireless



technologies.

However, the smart grid environment is challenging for both technology and using a second one when the first is not satisfying cannot lead to a long-term solution. It appears that mixing technologies could open up new interesting perspectives.

So why using PLC and Wireless technologies is not sufficient to answer the today and future requirements of the smart grid?

The majority of deployed solutions involve separated heterogeneous networks with protocols designed to work on single interface devices. Most of today SM have several heterogeneous interface but generally use only one interface, or each interface is assigned for a specific application.

The PLC and WSN are considered both as LLN but both have totally different propagation and interference model, making it difficult to compare metrics of each others.

In the routing field, two approaches exists to handle such a network by proactive and reactive routing solutions, each having similar performance. However, none of them actually address the question of multiple interface, or heterogeneity.

When dealing with multiple heterogeneous interface in AMI networks, some questions remain unanswered. On which criteria an interface should be selected instead of the other? How to use multiple interfaces? What existing metric should be used to compare heterogeneous networks?

In the next chapter, we will present several extensions to RPL in order to manage multiple heterogeneous interfaces and a re-transmission procedure that take into account the multiple interfaces in a case of transmission failure.

Part III

HYBRID FRAMEWORK



PROPOSED FRAMEWORK TO MANAGE MULTIPLE  
INTERFACES IN RPL

---

**Contents**

---

3.1	Motivations . . . . .	57
3.2	Parent oriented design . . . . .	60
3.2.1	The Parent Oriented concept . . . . .	60
3.2.2	PO DODAG Formation . . . . .	62
3.2.3	Conclusion . . . . .	64
3.3	Interface oriented design . . . . .	65
3.3.1	The Interface Oriented concept . . . . .	65
3.3.2	IO DODAG Formation . . . . .	65
3.3.3	Conclusion . . . . .	67
3.4	Multiple RPL Instance . . . . .	67
3.4.1	Heterogeneous RPL Instances . . . . .	67
3.4.2	MI DODAG Formation . . . . .	69
3.4.3	Conclusion . . . . .	69
3.5	Rank computation . . . . .	70
3.5.1	PO rank . . . . .	71
3.5.2	IO rank . . . . .	72
3.5.3	MI rank . . . . .	72
3.6	Additional mechanisms . . . . .	72
3.6.1	Link evaluation . . . . .	73
3.6.2	Retransmission . . . . .	74
3.7	Conclusion . . . . .	75

---

3.1 MOTIVATIONS

In the previous sections, we have so far presented the numerous communication standards employed in the smart grid to provide a fast, reliable and efficient distributed network of energies.

Regardless of all these implemented technologies, the electricity network is driven by physical laws that cannot be subverted (i e. electricity cannot be transported on lines without losses). Moreover, this vast transportation network is exposed to unpredictable events that are not avoidable, such as the effect of the lightning on the pylons and lines, or even incident caused by a third party.

As we have seen, the energy transition impose several significant changes in the energy system, going from the greenhouse gas emission reduction to the decentralization of the energy production by the use of renewable energy decentralized production, and by the reduction of the consumption as well.

From the grid point of view, the phasing-out of nuclear energy appear to be the most challenging issue, making the use of distributed and decentralized productions mandatory, forcing the energy provider to abandon the centralized model in place for decades.

The centralized model relies on power plants that generate the electricity to feed into the grid with a high capacity of production. This energy mode of production is not impacted by meteorological conditions and most of the time, is compatible with co-generation, allowing to feed a heating network with the recycling of lost energy.

In return, centralize the production impose to transport the electricity over long distance, leading to energy losses by Joule effect, making the use of high voltage mandatory to reduce the electrical current to minimize the effect.

The integration of renewable energy production, in a decentralized way, into the actual energy network requires some changes in the operating of the network. The perturbations caused by those alternative production has to be handle by the distribution network, imposing a communication between all the production elements of the network.

In the smart grid, requirements on performance in terms of delay, jitter, bandwidth and reliability have high level of importance regarding all the possible applications [Yan+13]. To satisfy the requirements of control system and situation awareness process, a high reliability and availability is needed. Moreover, a real-time analysis of the network is required to manage electricity generation failure (to avoid blackouts), load balancing, electricity network incidents and even the pricing of electricity.

In the NAN, although the rate of metering has been limited for a long time to one data reporting a week/month, the granularity of data reporting is reaching much higher frequency (seconds and minutes) to obtain more accurate power consumption data, enabling more accuracy for load-balancing and demand-response applications.

The communications technologies presented in section 2.2.3 offer different levels of Quality of Service (QoS) that could have a great impact on the routing protocols [Bad+07]. That is why the heterogeneity of the network should be considered to benefit from the variety of QoS and tackle the different resource constraints of each technology.

As the Smart Grid network is not made of single communication between production and consumption sides, but rather a complex multilayers network between all the components of the production area, control and operation systems, transport

and customer premises. The existing communication network is more concentrated in the production and transport part of the big picture of the Smart grid. The major change, is consequently at the distribution side, where a rich variety of technologies is available.

Considering the aforementioned requirements of Smart Grid applications, a large proportion of them could be directly addressed at routing layer, taking constraints of each technologies to build the more accurate route(s) to fit the corresponding application.

However, the blend of communication technologies with the interconnecting of different devices having wide disparity of computation, memory or battery capacity makes the design of routing protocol for smart grid application even more challenging.

IPv6 Routing Protocol for Low-Power and Lossy Networks (RPL), as we have seen above, seems to be the most widespread proactive routing solution chosen in smart grid application at the NAN level. Thus, it has been designed for various application such as urban environment [Wat+09] that satisfy the requirements of large scale AMI networks.

Most of today RPL usage is in an homogeneous wireless network, where nodes are all equipped with a single network interface. In addition, the implementation of RPL in PLC networks is still rare today and majority of the existing homogeneous solutions does not fulfill the primary requirements of smart grid metering.

However, a substantial number of limitations come with homogeneous network, such as deployment issues, network evolution or coverage aspects. Using multiple and heterogeneous interfaces could unlock the real possibilities in smart grids by allowing more applications and communications between devices. For example, it could be used to struggle against interference by using technology diversity.

In the next sections, we present three approaches for the management of the multi-interface of a hybrid node in RPL. We consider that every node in the network is potentially able to communicate via two heterogeneous interfaces, each having their own link qualities with their neighbors. For each neighbor, we store the monitored link quality for each interface in a neighbor table. From these two link qualities, we compute a new metric that allows to determine the best neighbors.

Figure 3.1 depicts a physical topology of five hybrid nodes, randomly generated by our DODAG python simulator, RDSim, presented in section 4.2. Solid links and dashed links represents respectively PLC links and RF links. Nodes are vertices in the graph and an edge between two vertices represent a link between two nodes. Each edge is associated with an integer between 1 and 8, which represents the link quality (this can be viewed as the Expected Transmission Count for example).

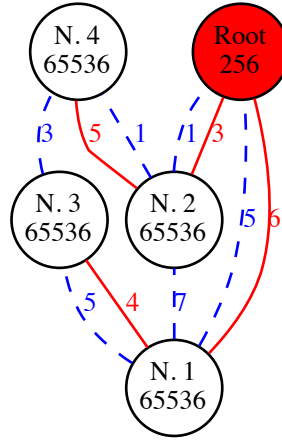

Figure 3.1: Physical topology of five hybrid nodes.

## 3.2 PARENT ORIENTED DESIGN

### 3.2.1 *The Parent Oriented concept*

The approach of the Parent Oriented concept is to define a logical link that would represent several technologies to connect two nodes, to see the hybrid case as a single interface case. We define a single metric that is representative of several links and would allow us to compare two different potential parent nodes, taking into account several physical links.

To build the [RPL DODAG](#), we take into account the multi-interfaces feature of the nodes within a single [RPL](#) instance. Thus a node chooses its best parent according to the cumulated link qualities of both interfaces. Note that once a node is chosen as a parent, any of the two interfaces can be used for data forwarding.

In a Parent Oriented [DODAG](#), each node individual position is defined by a single rank. This rank will depend on the link qualities with the preferred parent, the number of hops between the concerned node and the root node, and the number of communication interface with the preferred parent. If a potential parent is reachable with only one communication interface, the representative link will take this characteristic into account with a penalization, thus, a missing communication link will be considered as a broken link. When a node is registered to the [DODAG](#) and need to advertise neighbors about its new rank, it has to send a [DIO](#) message on all available interface, in order to make neighbors able to collect metrics to compute the representative link. In the case of a neighbor receiving two [DIO](#) messages from the same potential parent with two different communication interfaces, it will use both metrics contained in the DAG metric container of both [DIO](#) messages to compute a

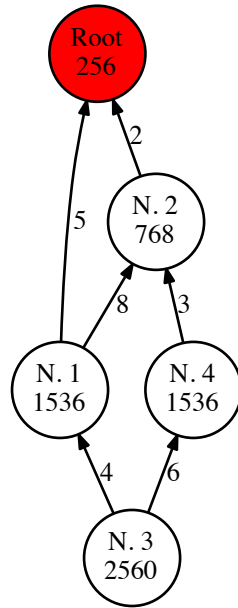

Figure 3.2: The Parent Oriented DODAG.

single one. In the case of a neighbor receiving only one **DIO** message from a potential parent, it will use the metric and the equivalent of a broken link metric to compute a single value to evaluate this node.

In order to make several links between two nodes appear as a single logical link, we need to define a new - single - metric. This metric should represent the quality of both links between two nodes and will be part of the parent selection.

This two-to-one computation could be done in many different ways:

For example, we could use the maximum or the minimum value from both metrics. However, this would not be well representative of the conjoint quality of multiple links. A neighbor having a single very good link with a node would be chosen as the preferred parent, compared to a neighbor having two links both with a slightly lower link quality.

We choose to calculate the mean value of the two metrics, this will produce a logical link that tend to avoid a potential parent with metrics having a big gap.

For a given node having its two interfaces working with a parent, the calculation of the symbolized communication would be formulated as follow:

$$(3.1) \quad M(e) = \frac{M(e1) + M(e2)}{2}$$



Where  $M(e)$  is the calculated metric of a link  $e$ ,  $M(e_1)$   $M(e_2)$  are the metrics of the two communication links.

If only one link exists between two given nodes, the link is penalized and the value associated to the link is given by the formula:

$$(3.2) \quad M(e) = \frac{M(e_1) + M_{max}}{2}$$

Where  $M_{max}$  is the maximum value of a link metric, corresponding to a broken link.

Using the PO concept, Figure 3.2 depicts the resulting DAG constructed with the given physical topology shown in figure 3.1.

Each couple of links between two nodes are symbolized as a single link with a specific value (obtained by the formula given in eq. 3.1).

Each time the objective function is called to perform the parent selection over a parent set, the hybrid metric is computed. To determine which is the best parent to take as the preferred parent, a node compute the hybrid metric for each of its neighbors and anticipate the rank it would have with each of them. The preferred parent will be the one offering the smallest rank to the node.

In order to maintain the DODAG as stable as possible, we propose to keep a preferred parent for a given amount of time even if this parent becomes unreachable through one interface. For example, assume that node A is the preferred parent of node B, and they can communicate through to different interfaces. If node A becomes unreachable through one communication interface but is still reachable with the others, it will remain as preferred parent using the available interfaces until a defined period, or a trigger (i e. upon the reception of a DIO message triggered by the trickle timer). Consequently, the rank of node B is not updated and no DIO message is sent to advertise neighbors. At the end of the aforementioned stability period, node B will compare the potential parents in the parent set, and select the best one the usual way.

Once a preferred parent has been selected, if this preferred parent is reachable through multiple interfaces, any of these interfaces can be used for data forwarding. As we will see later, we chose to select the best interface among those available, if upon failure, we may try with another interface.

### 3.2.2 PO DODAG Formation

When the network bootstraps, the root node sends multicast DIO messages via all its interfaces. It uses the lowest registered modulation (i e. the more robust) in order to reach a maximum of neighbors.

If no modulation information are available to determine the one to use (e.g. the link evaluation returned no results, or has failed), a default modulation is used, which should be the slowest supported by the devices, for both technologies. Finally, those default modulations could be used to start emitting **DIO** messages before the end of the first link evaluation, to obtain a first version of the **DODAG** as soon as possible.

Nodes around the root, which have a default rank value set to infinite, will receive these **DIO** messages. Because the **DIO** messages comes from a node with a lower rank, these nodes will process the **DIO** and select the **DODAG** root (DIO sender) as their **DODAG** parent.

Then these nodes will compute their new rank according to the PO rank computation using the metrics available in the neighbor table. The nodes will finally compute the corresponding path metric (ETX, Hop-count, ETT, etc.).

Then the operations repeat for neighbors of the root neighbors, and so on. Nodes will send **DIO** messages using the lowest registered modulation, or the default one, on all the interfaces and nodes receiving **DIO** for the first time will do the same as described in the last step. If a node does not receive a **DIO** for the first time, and the content of the **DIO** meet the constraint of the **OF**, the node will analyze the **DIO** message and compare the computed rank to the old one.

Depending on the **RPL** parameters, if the new rank is smaller than the old one, the rank is updated and a new **DIO** message is sent, or at least, the node is added to the parent set. If the new rank is greater, the node discard the **DIO** message and keep the position of the node in the **DODAG**.

When a node send or forward a packet, it has to select the interface and the best modulation to use with the destination, using routing information of the neighbor table.

Modulation	Rank	Technology
OFDM 600	1	RF
8PSK	2	PLC
OFDM200	3	RF
QPSK	4	PLC
FSK 75	5	RF
BPSK	6	PLC
LR	7	RF
ROBO	8	PLC

Table 3.1: All supported modulations sorted by capacity.

To select this best modulation, the choice is made over the mix of all the supported modulations of both technologies, sorted from the highest to the lowest max possible bandwidth. An example of the sorting of PLC and RF modulation is given in table 3.1.

Figure 3.3 depicts the parent selection algorithm of the PO design.

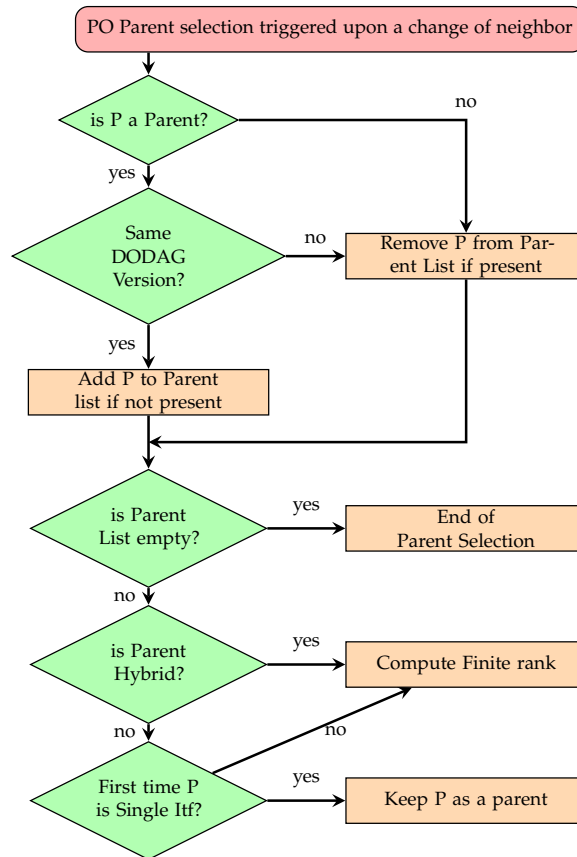

Figure 3.3: Parent Oriented Parent selection algorithm

### 3.2.3 Conclusion

The basis of this approach is to increase the stability of the RPL DODAG by exploiting the diversity and the heterogeneity of the two networks. When a node switches technology to communicate with the same parent, the DODAG remains the same and the rank is not updated. Consequently, no control message is needed to advertise other nodes in the network.

### 3.3 INTERFACE ORIENTED DESIGN

#### 3.3.1 *The Interface Oriented concept*

The principle of the IO solution is to make a **DODAG** in a single **RPL** instance by considering each physical link with a neighbor as independent potential parent. In other terms, if a neighbor is reachable through two different interfaces, it will be considered as two distinct potential parent. In that way, the objective function always chooses the potential parent with the best link as the preferred parent.

In a Interface Oriented **DODAG**, each node individual position is defined by a single rank. This rank will depend on the link qualities with the preferred parent, and the number of hops between the concerned node and the root node.

The rank computation of a node is only based on the metric of the best of all the interface. In this way, the other metrics of the other interfaces have no impact on the rank computation, and no difference exists between a single interface node and a hybrid node.

When a preferred parent becomes unreachable through one interface, the node losing connectivity with this parent will select an other parent in its parent set, even if this preferred parent have multiple other available interfaces. For example, assume that node A is the preferred parent of node B, and they can communicate through to different interfaces. If node A becomes unreachable through one communication interface, node B will select an other parent in the parent set as a preferred parent, even if node A has other interfaces to use.

Depending on the network density and the links quality, the new preferred parent could be another node, or the same parent as the previous one, with another interface which have link metric similar to the last used one.

#### 3.3.2 *IO DODAG Formation*

When the network bootstraps, the root node sends multicast **DIO** messages via all its interfaces. It uses the lowest registered modulation (i.e. the more robust) in order to reach a maximum of neighbors.

If no modulation information are available to determine the one to use (e.g. the link evaluation returned no results, or has failed), a default modulation is used, which should be the slowest supported by the devices, for both technologies.

Nodes around the root, which have a default rank value set to infinite, will receive these **DIO** messages. Because the **DIO** messages comes from a node with a lower rank, these nodes will process the **DIO** and select the **DODAG** root (**DIO** sender) as their **DODAG** parent using the interface offering the best metric.

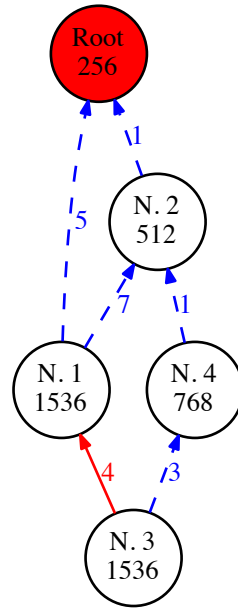

Figure 3.4: The Interface Oriented DODAG.

Note that the other interface, if available, will be as well in the parent set of those neighbors.

Then these nodes will compute their new rank according to the IO objective function rank computation using the metric of the selected interface in the neighbor table. The nodes will finally compute the corresponding path metric (ETX, Hop-count, ETT, etc.).

The next steps are similar to the precedent step, in every iteration, nodes will send **DIO** messages using the lowest registered modulation (or the default one) and corresponding interfaces. Nodes receiving **DIO** for the first time will do the same as described in the last step. If a node does not receive a **DIO** for the first time, and the content of the **DIO** meet the constraint of the OF, the node will analyze the **DIO** message and compare the computed rank to the old one.

Depending on the **RPL** parameters, if the new rank is smaller than the old one, the rank is updated and a new **DIO** message is sent, or at least, the node is added to the parent set. If the new rank is greater, the node discard the **DIO** message and keep the position of the node in the DODAG.

For the hybrid physical topology given in figure 3.1, each node choosing a parent will select the interface of a potential parent with the best metric. As a result, fig-

ure 3.4 depicts the resulting IO DAG constructed by RDSim.

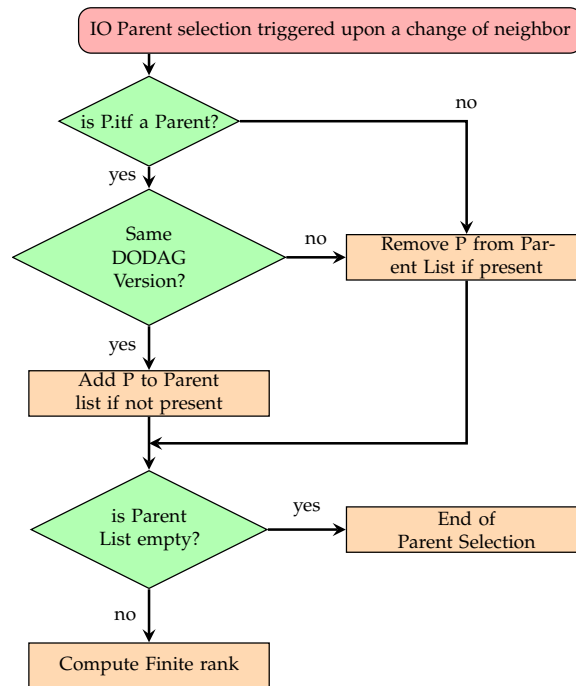

Figure 3.5: Interface Oriented Parent selection algorithm

### 3.3.3 Conclusion

With the IO approach, we focus first on the performance of the individual links, without taking stability into account or the heterogeneity of the nodes.

When the condition of link with a hybrid preferred parent drops, or if the preferred parent becomes unreachable on one of its interfaces, the other interfaces of this preferred parent are not considered to keep particularly this node as preferred parent. Thus, the new preferred parent will be the one having the best metric in the parent set.

## 3.4 MULTIPLE RPL INSTANCE

### 3.4.1 Heterogeneous RPL Instances

With the concept of RPL instances, a node that is running RPL could belong to several instances, even with a single interface.

By considering nodes with two interfaces, we could easily think of two RPL instances: one instance for each technology. Each instance could be governed by its own OF so we could consider different ways to create the route to the sink. Each

instance optimizes the path according to the specific requirements of the technology.

Long et al. [Lon+13] already take benefit from the multiple RPL instances by defining two kinds of nodes (regular nodes and alarm nodes) in order to support priority traffic in the network.

Running multiple instances lead to several ways to leverage the multiple DODAG. First, a node could determine which instance (or technology in case of heterogeneous networks) is the best to use for sending a packet, or for a specific application. Once chosen, the packet / application will stick to the chosen instance until reaching the root.

We could also assume that another RPL instance could be used when the main instance fails. For example, the RF DODAG could be a backup in case of an unreliability issue in the PLC DODAG.

To enable this mode of operation, one has to decide which is the primary technology, and which is the backup one. The primary technology should use a smaller RPLInstanceID because RPL only authorizes a packet to move to a higher RPLInstanceID. For example, let us assume that the PLC interface is chosen as the default communication technology and the RF is only used as a backup interface. At the time of the initial DODAG configuration, the PLC interface of each node joins a specific DODAG for PLC in a specific RPLInstance (e.g. RPLInstanceID 1). The same goes with the RF interface (e.g. the RF interface of a node joins the DODAG RPLInstanceID 2).

These two DODAGs, in two separate instances, have the same node as the DODAG root, each DODAG using one interface of the root device.

In RPL, the DODAG structure of the routing graph guaranties to avoid loops, but loop-free graph can not be guaranteed if packets are switching from one instance to another several times. For instance, two nodes that are parent and child in an instance could be child and parent in the other one.

Consequently, to limit the switch between instance in that case, a solution is to only authorize a single transition from one instance to another. So we keep two distinct instances, and a packet stays in its DODAG instance as long as there is no failure. Upon failure, the packet can switch instance, only once.

Another solution to avoid loops when forwarding could be to focus on the rank of the interface to use. When selecting the interface to forward a packet, choosing the one with the lowest rank guarantee to always get closer to the sink and never move downward. This solution allows to switch indefinitely between instances.

Furthermore, if for some reasons the DODAG is not fully constructed for one technology i.e some nodes could not reach the root, the DODAG from the other technology could never benefit from the potential structure of nodes that could be

physically reachable, but with an infinite rank because not joined to a DAG.

### 3.4.2 MI DODAG Formation

The first step of the construction of the multiple DODAG is the sending of multicast DIO messages on both interfaces. The next step is the reception of the DIO message by the nodes near the root in each instance. Because the DIO messages comes from a node with a lower rank, these nodes will process the DIO and select the DODAG root (DIO sender) as their DODAG parent with the interface corresponding to the instance.

In this concept, each node will have as much rank as the number of instances. Consequently, these nodes will compute their new ranks according to their objective function, and compute the corresponding path metrics (e.g., ETX or Hop-count).

The next steps are similar to the precedent step, in every iteration, nodes will send multicast DIO messages and nodes receiving DIO for the first time will do the same as described in the last steps. If a node does not receive a DIO for the first time, and this content of the DIO meet the constraint of the OF, the node will analyze the DIO message and compare the computed rank to the old one.

In each instance, if the new rank is smaller than the old one, the rank is updated and a new DIO message is sent. If the new rank is greater, the node discard the DIO message and keep the position of the node in the DODAG.

The resulting DODAG of the multiple instance approach is depicted in figure 3.6. We could see the red vectors graph as the first RPL instance DODAG, dedicated to the PLC technology and the dashed blue vectors graph as the backup RPL instance dedicated to the RF technology.

Because the main advantage of a multiple RPL instances architecture is to have a specific OF for each instance, choosing the appropriate OF according to PLC or RF networks is a key point.

### 3.4.3 Conclusion

This approach is not intrusive in the RPL code because it exclusively relies on existing RPL mechanisms. Only the interface policy needs to be coded in order to set up the behavior described above. Note that the RF interface can also be used from a data source node, but in this case, no failure recovery can be provided from the PLC RPL instance, since it is forbidden to switch to a smaller RPLInstanceID.



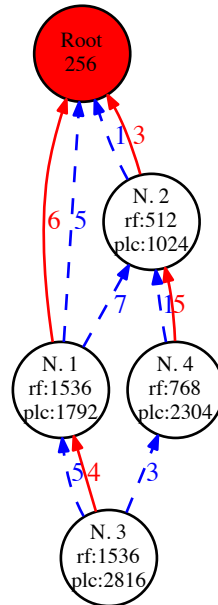

Figure 3.6: Two RPL Instances DODAGs.

### 3.5 RANK COMPUTATION

A [RPL](#) objective function defines the parent selection based on the computation of the rank of the nodes to organize the hierarchy of the [DODAG](#).

Indeed, a [RPL](#) objective function defines how the nodes translate one or more metrics into a rank. [RPL](#) proposes numerous different kind of metric [[Vas+12b](#)] that characterize a node or a link, offering several ways to express the distance of a node from the root.

For our proposals, we based our rank computation on the [OFo](#) objective function, defined by the IETF [[Thu12](#)]. In [OFo](#) the computation relies on the addition of the rank of the preferred parent to a scalar value that represent the property of the link. This value is normalized between 1 and 9 where 1 is considered as excellent and 9 as the worst acceptable link property.

This rank computation is seen as an addition of a rank increase, made of different parameters, and the rank of the preferred parent. To define the impact of the metric on the rank increase, the *rankfactor* value is incorporated as a multiplying factor to the link metric. We chose the Expected Transmission Time ([ETT](#)) metric as the *rankfactor* and the [LQL](#) as the *stepofrank*.

The *MinHopRankIncrease* determine the minimum value added to the parent rank and could be seen as the minimum "distance" between two nodes. As the rank value is finite, the *MinHopRankIncrease* value will determine the maximum number of hops in the [DODAG](#). It is used for the rank comparison process as well, the rank is divided by *MinHopRankIncrease* and rounded down to the nearest whole number when comparing two potential parent ranks.

Consequently, the *MinHopRankIncrease* value plays a significant role in the rank computation and comparison, and need to be selected carefully. It has to be noted that the rank value of the root node is defined in [RPL RFC](#) to be equal to *MinHopRankIncrease*.

### 3.5.1 PO rank

To compute the rank in PO objective function, we propose therefor the equation below:

$$(3.3) \quad R(n) = R(p) + LQL * ETT * MinHopRankIncrease$$

where  $R(p)$  is the rank of the potential parent.

The Link Quality Level (*LQL*) object is used to quantify the link reliability using a discrete value, from 0 to 7, where 0 indicates that the link quality level is unknown and 7 reports the highest link quality level [[Vas+12b](#)]. It has to be noted that the mechanisms and algorithms used to compute the *LQL* are implementation specific and are not defined in the [RPL RFC](#).

The expected transmission time (*ETT*) is a link metric object that is used to represent the time needed to successfully transmit a packet to the MAC layer. It is derived from [ETX](#) by taking into account packet size and link bandwidth. The computation of the *ETT* is implementation dependent as well.

The *LQL* and *ETT* values are updated by the MAC layers and given to the upper layer via the neighbor table [3.2.2](#).

In PO objective function, the *LQL* and *ETT* values of a link with a potential parent is the average values of the two interfaces *LQL* and *ETT* as shown in figure [3.7](#). If a node has a single interface to communicate with a potential parent, the *LQL* value of the failing interface is set to the lowest quality level (0) and the *ETT* value is set to a maximum value.

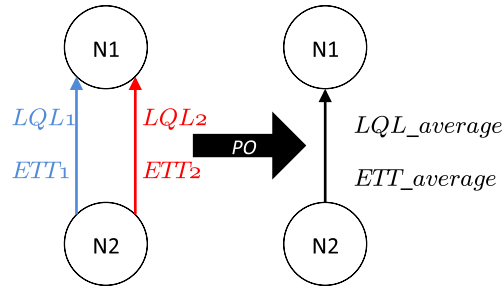

Figure 3.7: The Parent Oriented metric merging for rank computation.

### 3.5.2 IO rank

In IO objective function, as only one link is selected with a parent, the computation of the rank implies the use of the  $LQL$  and  $ETT$  values of the selected interface.

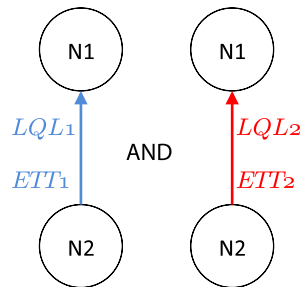

Figure 3.8: The Interface Oriented metrics for rank computation.

### 3.5.3 MI rank

In MI objective function, the computation of the rank is similar to the IO objective function, in each  $RPL$  instance.

As described above, the *MinHopRankIncrease* impacts the rank of all the nodes in the DODAG. Running two instances of  $RPL$  allows to define two different  $OF$ , that means the *MinHopRankIncrease* value may be different for each instance. With a higher value of *MinHopRankIncrease* in one instance, the probability for a node to have a higher rank in the other instance increase. Consequently, when switching instance regarding on the rank values of each interface, the probability to switch to the instance having the higher *MinHopRankIncrease* will decrease.

## 3.6 ADDITIONAL MECHANISMS

In  $AMI$  applications the detection of link failure could take an important amount of time given that the traffic is rather scarce for a majority of metering needs. Moreover,

the **DODAG** maintenance mechanisms included in **RPL** only address major issues in the network which trigger a global or a local repair.

The **RPL** global repair mechanism is triggered by the root node by incrementing the *DODAGVersionNumber*. This process is generally scheduled after a certain period of time, or following a power outage. If all the **DODAG** routes are failing and must be reconstructed, the global repair is the corresponding repair mechanism to be called.

The **RPL** local repair mechanism is called when only one node has lost connectivity with any parent in its parent set. However, this node will poison its routes, it will inform its sub-**DODAG** that is performing a local repair by advertising a rank with an infinite value. In that case, the *DODAGVersionNumber* is not changed.

The two situations described above represent a serious alteration of the **RPL DODAG**. In **RPL**, no mechanism is defined to detect link failure, and no intermediate procedure exists to solve link failure without reconstructing all the **DODAG** or a sub-**DODAG**.

In this section, we present two mechanisms to benefit from the heterogeneity and diversity of a hybrid network before having to trigger a **RPL** repair operation.

### 3.6.1 *Link evaluation*

Both **PLC** and radio interfaces can support multiple modulations. For instance, the IEEE P1901.2 PLC standard imposes to use 4 modulations: **D8PSK**, **DQPSK**, **DBPSK** and **ROBO**. The modulation is chosen by the MAC layer depending on the link quality. After choosing the interface to use, the appropriate modulation has to be selected.

The multi-modulations scheme makes the decision of the path selection more difficult: a direct link to the destination with a low data rate modulation could be chosen for robustness when an intermediate relay node with high data rate modulation could be chosen for high throughput.

The better the link quality, the faster the modulation, and thus, the data rate. Neighbors periodically exchange messages to constantly supervise the link quality.

Once all media are evaluated, the metrics about the link quality (SNR, ETX, etc) in addition to the best modulation are updated in the neighbor table, for each interface of a given neighbor.

These metrics are also updated when a data traffic is exchanged between a node and its neighbors. When a parent node is registered in a routing table, all possible modulations are stored for each interface (if available).

### *The PLC Tone Map procedure*

The adaptive Tone Map procedure [Rop+15] uses periodic exchanges to evaluate the link quality in order to constantly be adapted to the fluctuations of the channel. To do so, a node that does not know which modulation to use with a neighbor, has to send a frame with the lowest modulation (ROBO) and set the Tone map request bit.

When receiving such a frame, the receiver will estimate the link quality thanks to PHY preamble, and determine the physical parameters to use for this link. A tone map response is sent by the receiver, containing the modulation to use, among other PLC parameters (such as the sub-bands to use).

### *The RF evaluation*

In the 802.15.4 RF MAC standard, there is no link evaluation procedure similar to the P1901.2 Tone Map, and the selection of the modulation is implementation dependent.

As stated in [Bac+12], the general idea in most RF MAC layers with several supported modulation and/or coding scheme is to select the appropriate one so that a lower data rate (i.e., a more robust modulation) is used in case of a link with low quality, and a higher data rate when the link has high quality.

The link is considered as low quality in case of a low Signal Noise Ratio (SNR), due to fading problems, shadowing or path loss. Consequently, the use of a more robust modulation is supposed to reduce the probability of errors.

To evaluate the link quality in RF, we propose to send packets using each modulation and determine which modulations are possible. To evaluate the link property and determine the modulation to use first, data packets are sent using the fastest supported modulation, depending on the type of data (i.e. a communication on the control channel has to be sent using a more robust modulation).

Then, if this first transmission failed, the modulation is changed to the next modulation (a slower one) until the packet transmission is successful. During this process, the neighbor table is refreshed with all updated metrics.

### 3.6.2 *Retransmission*

To overcome a transmission failure on hybrid nodes, we propose an algorithm that is applicable to both PO or IO solutions but not applicable to the MI, causing multiple instance switch for re-transmission.

Let us consider a node with two interfaces, interface A which is the preferred interface, (thus it will be chosen for the transmission) and interface B the other one.

If the node sends a packet with interface A and this attempt fails, the first re-transmission happens by changing to the interface B with the highest modulation

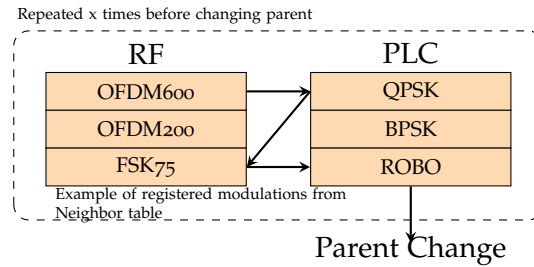

Figure 3.9: Re-transmission scheme example.

registered in the neighbor table.

If this second attempt fails again, the node will change again to interface A and select the lowest modulation registered for this interface. In case of another fail, the node will make a last change to interface B and select the lowest transmission available.

Figure 3.9 depict an example of the proposed re-transmission mechanism.

### 3.7 CONCLUSION

MI, PO and IO present different ways of managing heterogeneous interfaces in RPL. They particularly define how to build a DODAG, and how to combine hybrid interfaces into one or several DODAG. Then, an interface management policy can further be considered to use these interfaces. In MI, there is not much choice: source nodes (nodes which injects data packets destined to the root) can choose between the two RPL instances, given that if the technology with the higher RPLInstanceID is chosen, no backup will be possible using the alternate DODAG.

Using multiple instances makes simple the management of multiple interfaces node as each RPL instance manage one technology, and the associated metrics. There is no need to compare heterogeneous metrics or provide a computed multi communications representation to the OF. However, the potential loops occurring when switching instances will limit the gain of using multiple instances for a same network. Furthermore, each RPL instance will require memory and CPU resources, for routing table management and objective function operation, which can be critical in large scale scenario in a constrained node environment.

Forwarding nodes on the path will generally forward these data packets using the same RPLInstanceID (i.e. technology). In IO, each node will likely choose their preferred parent, along with the technology to use with this node. In the opposite, PO allows for more flexibility. It aims to build a more reliable DODAG taking into account the diversity of communication of the nodes. Its rank computation provide a solution to prevent failure from single communication node by promoting nodes with multiple interfaces.

Solution	MI	PO	IO
Load balancing	-	++	+
Stability	+	++	-
Implementation	++	-	-

Table 3.2: Solution comparison

As shown in Table 3.2, each of the three presented solutions have different characteristics. PO and IO solutions require more modifications to RPL than the MI solution because of the need to build the DODAG according to the two interfaces available on the nodes. On the other hand, the MI solution let RPL only see one interface per RPL instance. Concerning the stability of the DAG, the PO solution should be more stable than the MI and IO solutions, because the OF chooses a preferred parent based on cumulated link qualities of the two interfaces.

In the PO solution, the failure of one link will not trigger a parent change if there is another technology available between the nodes. For the MI solution, because each instance has its own OF, the stability will depend on the usual RPL parameters. Regarding the load balancing possibility, a drawback of the MI solution is the risk of holes in the physical topology that can cause an instance not to be used.

Part IV

PRACTICAL EVALUATION





---

**Contents**

---

4.1	Design of the implementation . . . . .	<b>80</b>
4.1.1	Modules and layers . . . . .	80
4.2	DODAG formation simulator . . . . .	<b>81</b>
4.2.1	Results . . . . .	82
4.3	Discret event simulation . . . . .	<b>85</b>
4.3.1	Simulation scenario . . . . .	86
4.3.2	Results . . . . .	87
4.4	Hardware implementation . . . . .	<b>92</b>
4.4.1	RPL implementation study . . . . .	92
4.4.2	Unstrung Implementation . . . . .	93
4.4.3	Hybrid network demonstration . . . . .	96
4.4.4	Increasing Network Reliability . . . . .	99
4.5	Conclusion . . . . .	<b>101</b>

---

We showed in chapter 2 the relatively rare works on RPL performance and optimization in multi interfaces and heterogeneous networks, and even more scarce in Smart grid environment, with NB-PLC technology. In this chapter, we present the performance evaluation of our approach using different tools. We decided to use both hardware and simulations to study different characteristics of our approach. We set up a demonstration scenario using hardware (concrete smart meters using two physical interfaces) to show the feasibility of our approach. Then, to study more parameters, we used several simulation tools. We first develop a standalone and adhoc simulator to instantiate different topologies and study the resulting DODAG depending on the multiple interfaces management algorithm. Last, we developed a new node model for an existing discrete event simulator (Riverbed Modeler) to add an IEEE 802.15.4 to PLC nodes. This framework allows us to conduct in-depth study of the protocol and our approaches, especially when links between nodes are failing in the runtime.

The remainder of this chapter is organized as follows. We present the implementation design of our RPL modifications proposals in section 4.1. In Section 4.2, we present a tool to evaluate the DODAG formation and discuss the performance evaluation. In section 4.3, we describe node model implementation for the network simulator Riverbed Modeler and we present the results we obtained for Multiple Interfaces, Interface Oriented and Parent Oriented solutions. Finally, we present the hardware implementation in section 4.4 before concluding the chapter.

## 4.1 DESIGN OF THE IMPLEMENTATION

## 4.1.1 Modules and layers

Prior to the simulator and hardware implementation, we design a new framework to implement our approaches presented in the previous chapter, to describe the behavior of a hybrid smart meter running RPL. This design has been made with a modular approach, and can be implemented in both simulation tools and real hardware platform. It has been organized to meet the requirements of the three solutions proposed (PO, IO, and MI).

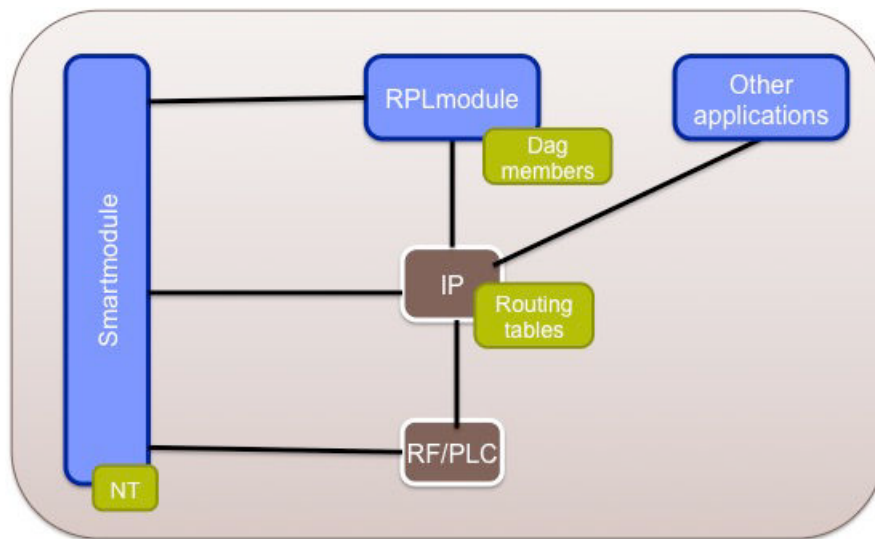

Figure 4.1: Specifications - module interaction

Figure 4.1 depicts the specifications of the implementation modules where:

- **RF/PLC module:** It is in charge of the RF and the PLC MAC.
- **IP module:** It manages the IP interfaces and routing tables.
- **RPL module:** It runs the RPL protocol, and manages the DAG members table.
- **Smart module:** It is a cross-layer module in charge of layer interaction:
  - **At the MAC layer:** It manages a Neighbor Table (NT) with mac addresses, the media type (RF or/and PLC), the modulations, for each neighbor.
  - **At the Layer 3 (IP):** It keeps IPv6 and MAC addresses bindings.
  - **At the routing layer:** It provides metrics to the RPL module.

The modules interactions are described in more details in section 4.4.

## 4.2 DODAG FORMATION SIMULATOR

To help comparing the three solutions of multiple interfaces management presented in chapter 3, we developed a new topology simulator called RDSim in Python. It allows to instantiate a set of nodes and links with different random variables depending on the targeted scenario, and generate the corresponding DODAG following our proposed approaches to manage multiple interfaces. Thus it allows a first evaluation to compare the three approaches from a topology point of view. It also allows to visualize the resulting topologies with a graphical representation. We choose to develop this new tool because other commonly used simulation tools (e.g., Cooja, NS-3) are quite complex and we wanted to have a first idea of resulting DODAG following our approaches without the complexity of link abstraction and message transmission simulation. In the next section, we will complete this evaluation with discrete event simulations though.

RDSim allows to generate a random topology with a specific number of nodes and a specific proportion of hybrid/single interface node. It can also load a predefined topology. Nodes in the topology are the vertices of the graph and all edges have a random computed weight (i.e which could represent a link quality metric between 1 and 7, where 7 is the worst value).

All nodes except the root have a rank attribute set to 65535 during the creation of the graph. The rank attribute of the root is fixed to 256 for both technologies, because in the MI solution, a node has two ranks. The resulting graph, considered as the physical representation of the hybrid network is analyzed iteratively from the root to the next hops to construct the DAG. During this process, node ranks are calculated.

It has to be noted that RDSim does not handle RPL message exchanges and application traffic, its purpose is the graph generation and performance analysis on generated topologies.

For the PO, Interface Oriented and MI solutions, the computation of the rank is given by the formula below, based on the rank calculation given in [Thu12]:

$$(4.1) \quad R(N) = R(P) + Link\_Quality * MinHopRankIncrease$$

Where  $R(N)$  is the calculated rank.  $R(P)$  is the rank of the parent.  $Link\_Quality$  is the edge weight, a value between 1 and 7, between parent P and node N.  $MinHopRankIncrease$  is fixed at 256 as recommended in [Win+12a].

The two DODAGS generated by the MI solution are just superposed and are a good way to highlight the potential issues of loops or hole problems in this kind of architecture. When the Parent Oriented solution is applied on the hybrid graph, all edges are analyzed and each couple of edges between two nodes are symbolized in single "average" edge. The weight value of the single edge is calculated with the

Number of nodes	100, 200			
Proposal	MI, PO, IO			RF only
Hybrid nodes	100%	70%	50%	0%
RF Nodes	0%	15%	25%	100%
PLC Nodes	0%	15%	25%	0%

Table 4.1: RDSim Simulation parameters

formula given in eq. 4.2.

$$(4.2) \quad W(e) = \frac{W(e1) + W(e2)}{2}$$

If only one edge exists between two nodes, a penalization is introduced to the single "average" edge with the formula given in eq. 4.3. The result is a DAG with a single symbolic edge between nodes.

$$(4.3) \quad W(e) = W(e1) + Wmax$$

Regarding the Interface Oriented solution, all edges are analyzed and each couple of edges between two nodes are compared. The edge with the best metric is kept in the graph, the others are deleted. If only one edge exists between two nodes, it is kept. The result is a DAG with single edges between nodes.

#### 4.2.1 Results

We used RDSim to measure the potential gain obtained when nodes have multiple interfaces and to compare the three management proposals. We varied the size of the network (100 and 200 nodes) and the hybrid node proportion as indicated in table 4.1. Each simulation set was performed 1000 times on random topologies. We only present the 200 node topology results for full hybrid and RF only scenario because results for a different proportion of hybrid nodes give the same tendencies.

For each scenario we measured the average link quality (Fig. 4.2), the maximum number of hops (Fig. 4.3) and the average number of parents per node (Fig. 4.4).

The average link quality helps to identify which solution builds the route with the best link quality. As the number of hops is critical in smart grid networks, the maximum number of hops in the DODAG helps us to show which solution gives the minimum depth of the DODAG. The average number of parents per node shows

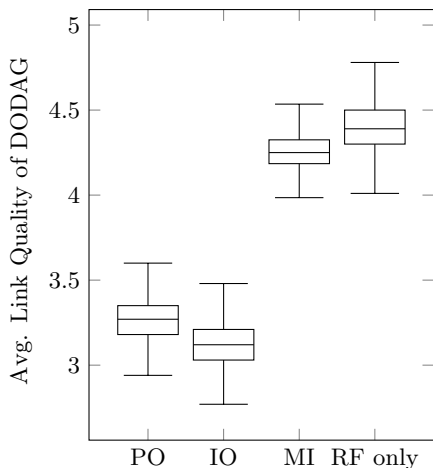

Figure 4.2: Average Link Quality

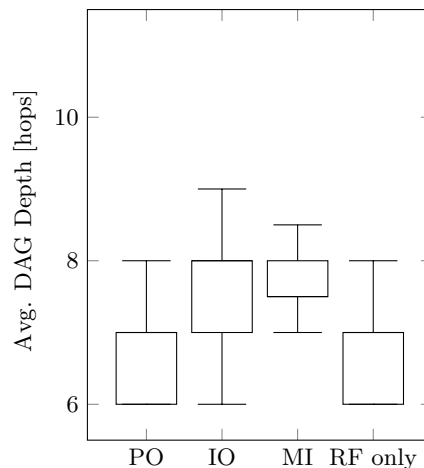

Figure 4.3: Average DAG Depth in hops

the overall possibility of nodes to change parent if necessary.

Then, as we expect a hybrid network to be more resilient to failure, we removed one technology from a node (chosen randomly) and measured how the **DODAG** evolved in all tested proposals. In particular, we counted the number of interfaces that can be removed and the number of parent changes before 10% of the nodes became orphans.

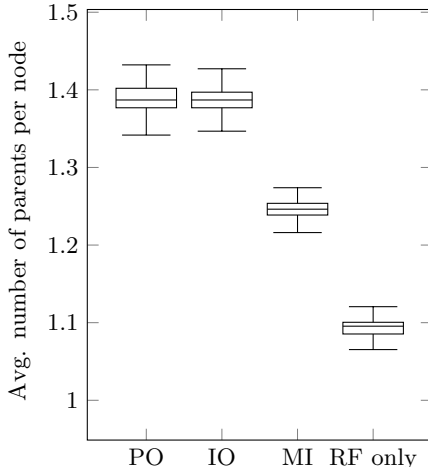

Figure 4.4: Average number of parents per parent set

We can observe that Parent Oriented and Interface Oriented show equivalent results and are generally better than Multiple Instance and RF Only, especially in the link quality metric and the size of the parent set. This is because Parent Oriented and Interface Oriented take full advantage of the hybrid nature of the nodes, and are able to switch from one technology to another. This makes the average link quality to the parent better, and the size of the parent set larger.

Because no jump from one instance to another is allowed, the Multiple Instance approach has an average link quality worst than Parent Oriented and Interface Oriented, and still slightly better than a network where nodes have a single interface. This is because hybrid nodes can select the best DODAG among the RF and PLC ones. The depth of the tree is quite equivalent in each solution. Fig. 4.5, 4.6, 4.7 show the results when we consider failure in the network.

Fig 4.5 shows the CDF of the number of removed interfaces from the initial topology before the first parent change in the DODAG. The first parent change can occur after several interface removals because in a hybrid network, nodes may switch interface upon one technology failure.

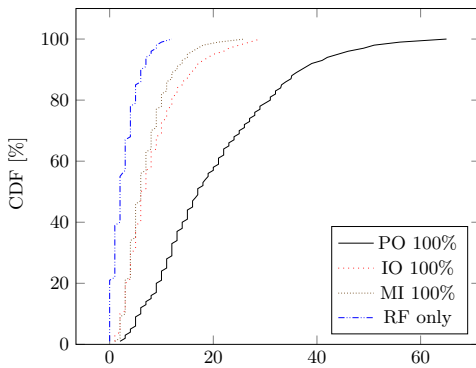

Figure 4.5: CDF of the number of removed interfaces before the first parent change

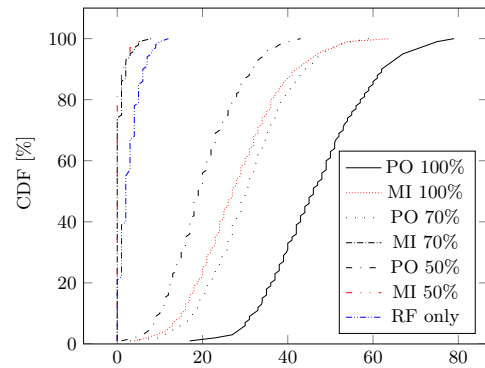

Figure 4.6: CDF of the number of parent changes to reach 10% of orphans

Regarding the parent changes, the Interface oriented and and Multiple Instance approaches show close results, and most of the times there is a parent change before 16 interfaces were removed. In RF only, if the removed link was the one with the parent node, the node must change its parent, so we see that there are very few removed interfaces in the topology before observing an effect on the DODAG.

Fig 4.7 shows the same metric but not only before the first parent change in the topology, but in-between all parent changes that occur when we consecutively remove interfaces (until reaching 10% of orphan nodes). The same observations can be made, but with a smaller number of interfaces, because the DODAG on which a failure occurs is less dense. Fig 4.6 shows the cumulated number of parent changes once we removed so many interfaces that there are 10% of the nodes that become orphans (no link to the DODAG).

For a better readability, we omitted to plot the Interface Oriented approach because it was very close to the Parent Oriented one. The first observation is that the more the network is hybrid, the more interfaces can be removed before 10% of nodes are orphans, meaning that the network is more resilient to failure. This observation stands for the Multiple Instance approach, but in a limited manner.

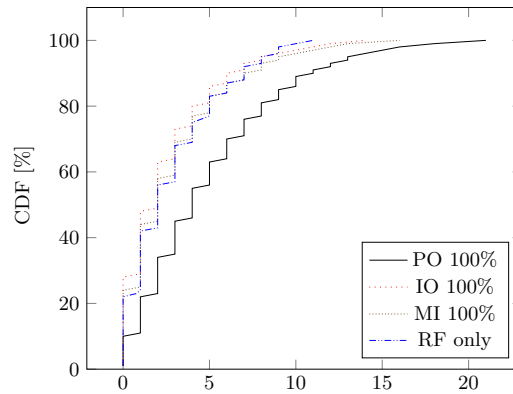

Figure 4.7: CDF of the number of removed interfaces between two consecutive parent changes

This analysis confirms the promising results of both designs. As expected, the Parent Oriented design provides the more resilient **DODAG** and should also require less **RPL** control traffic. The Interface Oriented design offers interesting results with less complexity, but requires more control traffic. The Multiple Instance design cannot be evaluated properly without the simulation of dedicated **RPL** instances switch control. The complexity imposed by this design has led us to prioritize our next works on Parent Oriented and Interface oriented designs.

#### 4.3 DISCRET EVENT SIMULATION

In this section, we describe our simulation platform and the different parameters used to see how much the network could benefit from having two interfaces using the Parent Oriented and Interface Oriented solutions comparing to a single **PLC** interface network.

In the network simulation field, several popular softwares exist such as *ns2*, *ns3*, *OMNET++* or *WSNet* to only cite a few, each of them having their own advantages and drawbacks. We picked Riverbed Modeler 18.5 (formerly known as *OPNET*) to follow up previous works done on **PLC** for smart grid **??**. Riverbed Modeler is widely used in industry for its performance in large scenario, the numerous physical libraries and the graphical environment. Riverbed Modeler architecture uses a proprietary approach based on the *Proto - C* concept:

- The complete C and C++ programming language
- State transition diagrams
- The library of Modeler kernel Procedures (KPs) and state variables
- Temporary variables

Modeler uses the concept of Node Model to represent a device, its internal capabilities are organized with different types of module such as processor, queuing,



transceivers or connection. The implementation of a protocol is made in a process model, which is associated to a processor module of a node model.

Our node model consists of a hybrid node with a network layer, where RPL operates, that shares two separate MAC / Physical layers. Thus, the node could send and receive message via PLC and Wireless 802.15.4e/g. We use a smart controller between the MAC and the network layer that is in charge of the radio and PLC link evaluation and the re-transmission policy scheme.

The propagation model used in our RF model is a Rician fading and interferences are set as probabilistic drops related to the used modulation and RSSI. The RF range distance limit is set to 850m.

It has to be noted that the Multiple Instance approach has not been implemented for several reasons:

- The implementation of the RPL stack is based on Contiki and does not support the multi-instance feature. Changing the RPL implementation would take a huge amount of time and won't be evaluated in comparison of a hardware implementation.
- The Parent Oriented and Interface Oriented solutions seem to promise interesting results with few changes in the standard Objective Function Zero.
- Running a scenario with only wireless links and a different scenario with only PLC links could allow us to anticipate the behavior of such an architecture.

#### 4.3.1 *Simulation scenario*

We have created a smart grid scenario that consists of a simple data collecting application. After the initialization phase where all nodes define their preferred parent toward the root, each node periodically sends data packets to the root (every minutes).

Each scenario consists of a topology made of eleven routers. The PLC has an attenuation of 9dB/m and 3db at derivations and the PLC topology is given in Fig. 4.8.

Simulation parameters are summarized in table 4.2. After a given time, we consider the DODAG stable enough and we analyze how nodes react to the failure of a given node PLC interface. The PLC MAC of the node directly linked to the root is set in a blocked state after six hours, and all metrics will be updated consequently by link evaluation of neighbors in the area. Note that RPL is a dynamic protocol and constantly adapts to the link quality, link failure and link creation.

It is important to note that in a PLC topology, the wired organization of the nodes has no direct correlation with the routing hops. For example, node 3 in fig. 4.8 could have a better link metric with the root than node 2. Moreover, if node 4 loses

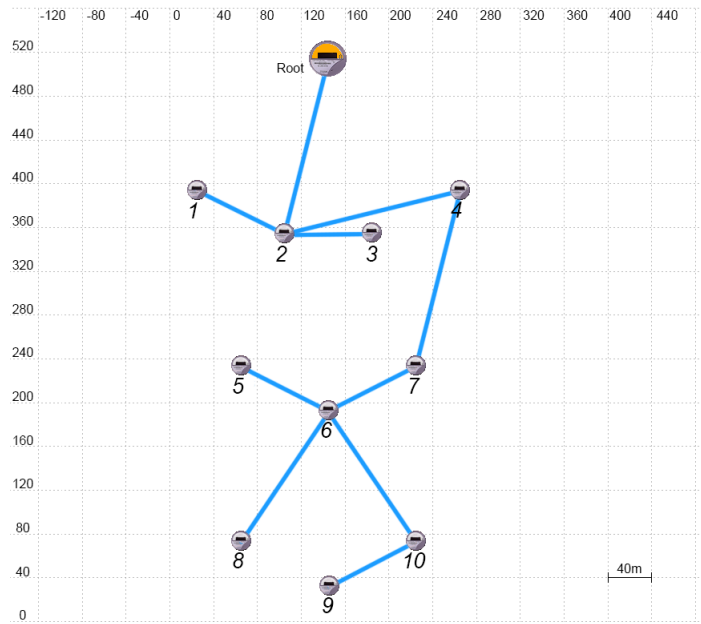

Figure 4.8: Topology of 11 hybrid RPL nodes

connectivity with node 2, it does not mean that node 7 will lose connectivity with node 2 as well. In other words, node 7 could see node 2 at one hop, even traversing node 4 to reach its successor (node 2).

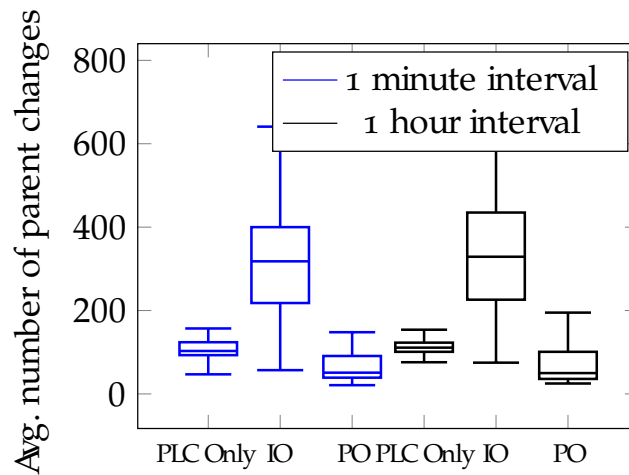

Figure 4.9: Average number of parent changes

#### 4.3.2 Results

Figures 4.10 and 4.9 show the average of the number of parent changes that occurs in the whole DODAG. As the Parent Oriented solution keeps a parent even if it loses an interface, it offers the best stability comparing to the Interface Oriented solution.

Parameter	Value
<b>RPL Objective function</b>	Parent Oriented / Interface Oriented
<b>Radio environment</b>	802.15.4e/g
<b>Simulation duration</b>	720 min
<b>PLC environment</b>	P1901.2, one phase
<b>RPL</b>	MinHopRankIncrease = 256
<b>Propagation model</b>	Rician, $k = 10$
<b>Trickle</b>	$I_{min} = 1048s, I_{max} = 33540s, k = 3$
<b>Number of routers</b>	11
<b>Distance between routers</b>	80 to 120m
<b>Runs</b>	100
<b>Traffic type, rate</b>	MP2P, 1 pkt/min

Table 4.2: Simulation parameters

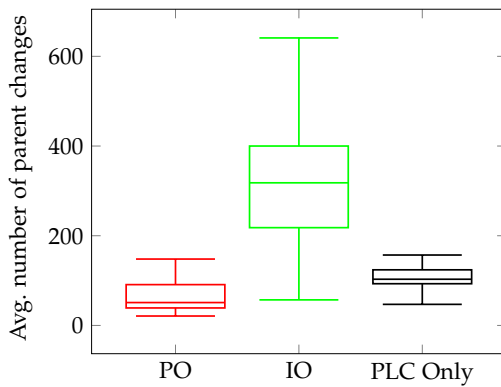

Figure 4.10: Average number of parent changes

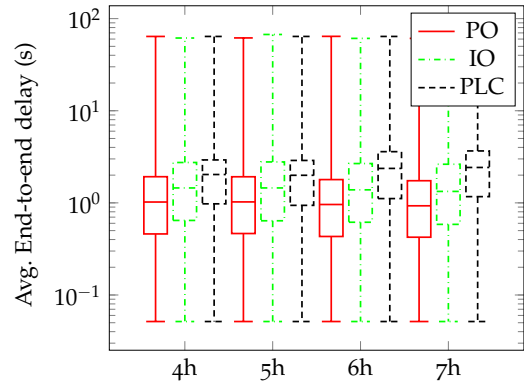

Figure 4.11: Average end-to-end delay for a one hour time window around PLC failure.

The low number of parent changes of the single **PLC** scenario is mainly due to the fact that nodes have less possibility to change parent, having less potential parents in the parent set.

The Interface Oriented solution, selecting the best metric without considering the heterogeneous nature of a node results in an unstable DODAG. However, as the parent selection is also governed by a rank stretching to lower the parent switching phenomenon, carefully selecting the rank stretching value could increase the stability of the **DODAG** at the cost of keeping a parent with the non optimal metric.

In Fig. 4.11, we study the average end-to-end delay of each solution around the failure occurring after six hours of simulation time. We can observe that both Parent Oriented and Interface Oriented solutions give similar results, the failure having

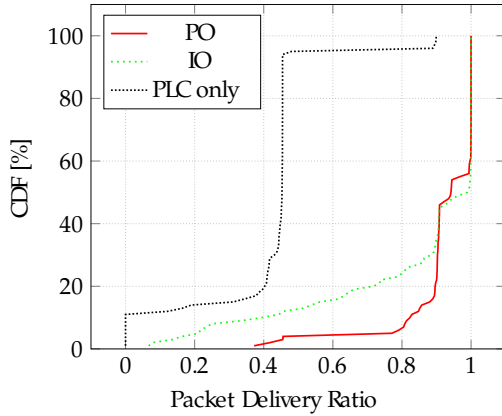

Figure 4.12: CDF of the packet delivery ratio.

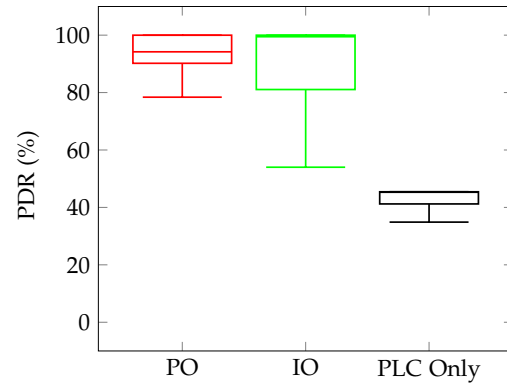

Figure 4.13: Packet delivery ratio

no consequences on the average end-to-end delay: after the failure, the average end-to-end delay remains around 1 second. Concerning the single **PLC** scenario, the failure of the interface results in a slight increase of the end-to-end delay.

In Fig. 4.14 we analyze the number of sent **DIO** messages to maintain the **DODAG**. We show that hybrid networks considerably reduce the number of **RPL DIO** messages in this scenario, taking benefit from the stability of the radio network. The low number of sent **DIO** compared to the high number of parent changes of the Interface Oriented solution is counter-intuitive. This result is due to the way parent changes are counted in Interface Oriented solution. When a parent node stays parent but change interface, this count as a parent change, where in Parent Oriented solution, it does not.

Fig.4.13 and Fig. 4.12 show the packet delivery ratio (**PDR**) at the root. We can observe that the median value of the single **PLC** scenario **PDR** is around 50% because of many re-transmission and packet losses. The Parent Oriented solution offers the best **PDR** taking benefit from the stability of the **DODAG**, where the instability of Interface Oriented solution leads to more packet losses. Concerning the CDF of the **PDR**, for each solution we performed 100 runs of simulation, and we computed the **PDR** at each run. For example, the **PLC** only solution shows a **PDR** below 40% for 20% of the runs where 5% of **PO** runs are under 80% of **PDR**.

In Fig. 4.15 we analyze the global number of hops for every packets received by the root. In smart grid networks, the number of hops is critical as it should result in more delay or more hidden nodes. Showing the maximum hops of the **DODAG** helps to choose the best solution that gives the minimum number of hops. The Interface Oriented solution shows a maximum of six hops where Parent Oriented solution does not exceed four hops.

It has to be noted that our Objective Function goal is not to reduce the number of hops, the consequence of adding a wireless interface and selecting the parent over

the link quality and *ETT* results in a gain on the number of hops for the Parent Oriented solution.

In Fig. 4.16 we show the CDF of the rank values of all the nodes in the DODAG. Because Parent Oriented solution gives a rank based on both interface metrics, contrary to Interface Oriented solution that only takes into account the best link metric, the rank values of the Interface Oriented solution are smaller. The PLC only scenario gives high rank values because of the Parent Oriented rank computation, each node is seen as a single interface node.

In Fig. 4.17 we monitored the number of re-transmissions for each solution. The PLC only scenario shows a number of re-transmissions which indicates that the performance of the network is more impacted by the failure than the other solution.

Fig. 4.18 shows the CDF of the buffer size in the network. The PLC only scenario shows that more than 75% of the nodes have at least tens of packets in buffer, which reflects a high number of re-transmissions. Both Parent Oriented and Interface Oriented solutions show similar buffer size, Parent Oriented being slightly better, suggesting a better performance of the DODAG in terms of throughput, and less re-transmissions than PLC only.

Fig. 4.19 depicts the number of time the Objective function is called by a node to perform a parent selection and a rank computation. This observation reflects somehow the required resources of CPU and energy of the node. Having less potential parents, the number of opportunities to change parent during the simulation is drastically reduced for the PLC only scenario. Parent oriented and Interface Oriented solutions show similar results once more.

Globally, these results confirm the potential improvements of a RPL network managing two heterogeneous interfaces as the two evaluated designs systematically outperform a single interface network, except for the number of Objective Function calls. But given the reasons discussed above, this behavior is attributable to the PLC topology nature. Nevertheless, reducing the number of Objective Function calls is a way of improvements.

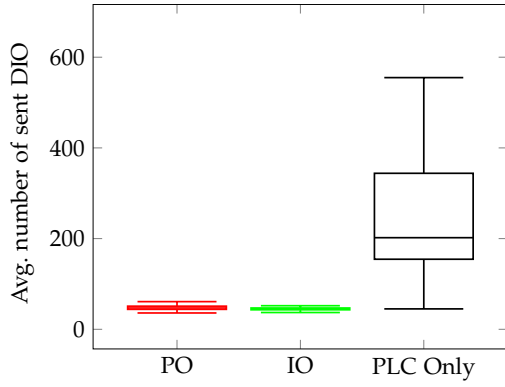

Figure 4.14: Average number of sent DIO messages.

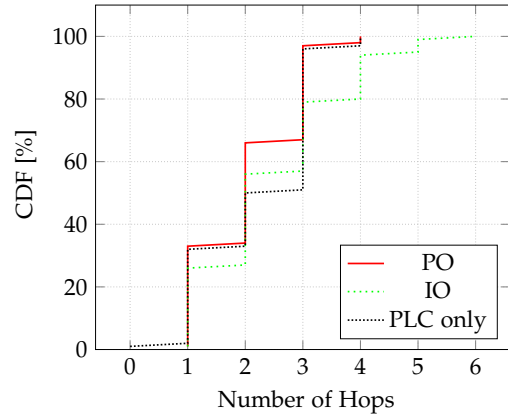

Figure 4.15: CDF of the number of hops.

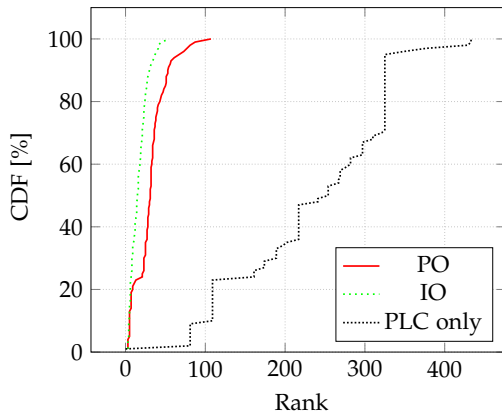

Figure 4.16: CDF of the rank values.

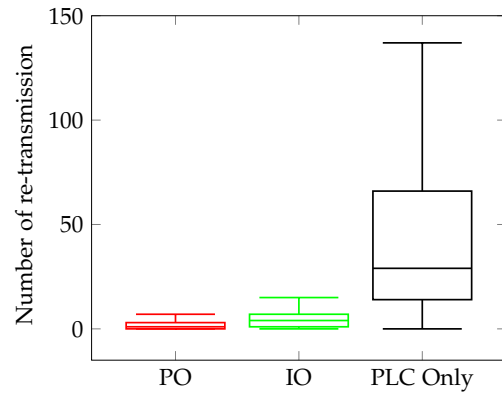

Figure 4.17: Average number of re-transmissions.

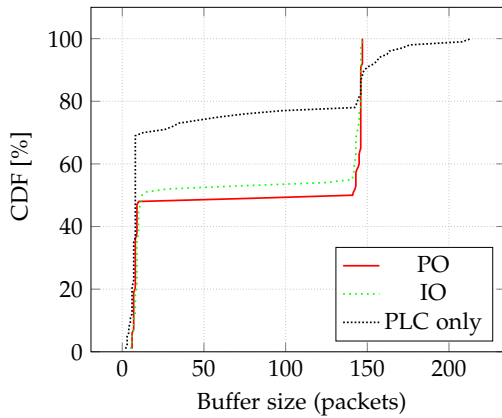

Figure 4.18: CDF of the buffer size.

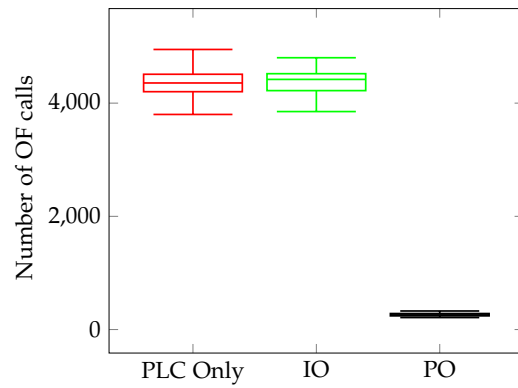

Figure 4.19: Average number of OF calls

Implementation	Last version	Language	OS/Type	OpenSource	Test
<b>SimpleRPL</b>	2013	Python	Linux/user	✓	✗
<b>Unstrung</b>	04/2017	C++	Linux/user	✓	✓
<b>Linux-rpl</b>	2014	C++	Linux/kernel	✓	*
<b>TinyRPL</b>	2016	NesC	TinyOS		*
<b>LibRPL</b>	2012	C	Contiki	✓	✓

\*Cannot be integrated in ACT environment

Table 4.3: Existing RPL implementations

#### 4.4 HARDWARE IMPLEMENTATION

In order to consolidate our contribution and evaluate its feasibility in real hardware, we implemented the Parent Oriented approach in the Itron ACT smart meters. The ACT platform is made of a dual-processor architecture, with a Cortex M3 CPU for the the application development (including routing), and a Digital Signal Processor (DSP) for the networking functions. This platform is based on Linux, so we started by searching for a basic RPL implementation to enhance it with the Parent Oriented approach.

##### 4.4.1 RPL implementation study

Several implementations of RPL exist in different languages for few OS. We performed a comparison of those existing implementations to find the one that suits the best our situation.

All implementations are operating-system dependent, we focused on Linux implementations and implementations for other IoT OS:

- Linux based:
  - SimpleRPL, from the National Institute of Standards and Technology (NIST).
  - Unstrung, from Sandleman Software Works.
  - Linux-RPL, from J. Pedro Taveira.
- IoT Sensors OS:
  - TinyRPL (TinyOS), from University of Berkeley.
  - LibRPL (Contiki adaptation to Linux), from Marcus Becker.

Table 4.3 summarizes the test result.

*SimpleRPL* is written in python and requires several additional programs, and a tremendous number of dependencies. The complexity of the code and installation is incompatible with the ACT environment.

Implementation	DIO	DAO	DIS	Storing Mode	Objective Function
Unstrung	✓	✓	✓	✓	Based on OFo
LibRPL	✓	✗	✗	✓	OFo MRHOF

Table 4.4: Comparison between Unstrung and LibRPL

*Unstrung* is implemented at the user space and could be ran almost straight out-of-the-box on the ACT platform.

*Linux – RPL* is a kernel space implementation, for that reason, it could not be implemented in the ACT platform, because kernel patches are not possible.

*TinyRPL* is written in NesC language, which is specific to TinyOS, a porting to the ACT platform is not realistically feasible.

*LibRPL* is based on ContikiOS and has been ported to linux. It runs on the ACT platform but only a partial part of the RFC has been implemented.

It appears that only two implementations could work properly on the itron linux environment. *LibRPL* implements the two RPL Objective Functions (OFo and MRHOF) but lacks of DAO and DIS management and relies on out-of-date contiki release. *Unstrung* implements both DAO, DIO and DIS messages and the DAO-ack procedure. The Objective Function is derived from OFo. However, as we plan to implement the Parent Oriented solution, which relies on OFo, *Unstrung* appears to be the adequate solution for our purpose.

Table 4.4 summarizes the differences between LibRPL and Unstrung.

#### 4.4.2 *Unstrung* Implementation

The Itron ACT platform already implements a version of RPL, however, the architecture relies on several additional modules in charge of the interface management and metrics, consequently RPL is used on top of all the mechanism that provide the interface and modulation to use.

We added the Unstrung code on the ACT platform in a new sub-repository and it has been modified to start as a new ACT thread.

##### *The meter board architecture*

The ACT platform uses an abstraction layer between the routing layer and the PLC and the RF MAC layers, called the MAS. It is in charge of the link evaluation, metric computation and interface selection. As a consequence, to force the use of a



particular interface, the choice is made by this module.

Each interface of the meter board has a MAC address, and each meter board uses a short and an extended address, which are respectively an identifier with the PAN IP prefix and the entire MAC Address.

To make the use of the Linux IP stack possible, we added a cross-layer module in the user space that is in charge of the packet transmission and reception from the RF and PLC drivers to the IP stack, and vice versa. This module provides the neighbor information to the smart module as well.

The smart module manages the neighbor table, where each neighbor has a complete set of information such as the *pan\_id*, *short\_address*, *modulations*, *LQI*, *rank*, *DODAG\_Version* etc. The neighbor table is updated at each link evaluation and at data reception.

#### *Initialization of the node*

When the node starts, the MAS module and the RF and PLC MAC are started, then RPL (Unstrung) starts on a new thread.

On the root node, a DODAG is created with the default root rank equal to 256 and a new network prefix is assigned to it.

First, the root creates two netlink sockets to communicate with the RPL and the MAS modules. It creates a DBUS to communicate with the Itron ACT Connect Manager to start/stop or dump the neighbor table. Then, the root turns down IP interfaces via a linux command and sends a *WanUp* command to the ACT Connection Manager. This procedure is required to bypass the waiting time of other starting modules, since the root does not need to scan the network. Finally, the root sets PAN information Base (PIB) values, turns on IP interfaces and finalizes the initialization. After the initialization of the MAS module, the RPL thread is started on interface nano.

Figure 4.20 depicts the sequence diagram of the root node start.

On regular nodes, the RPL module is started and waits for DIO messages, having set its rank to RANK\_INFINITE value.

First, the node creates the same sockets and DBUS as the root node. Then, the node turns down IP interfaces via a linux command and waits for the ACT Connection Manager to send a start command. This waiting period allows to know if all modules (RPL-KLM, MAS, and MAC) are started and ready. When the start command is received from the ACT manager, the node sets PIB values, turns on IP interfaces and orders the MAS to perform a MAC scan to connect to a PAN. When a neighbor is found, the *Actd\_unstrung* module finalizes its initialization and RPL is started on interface nano.

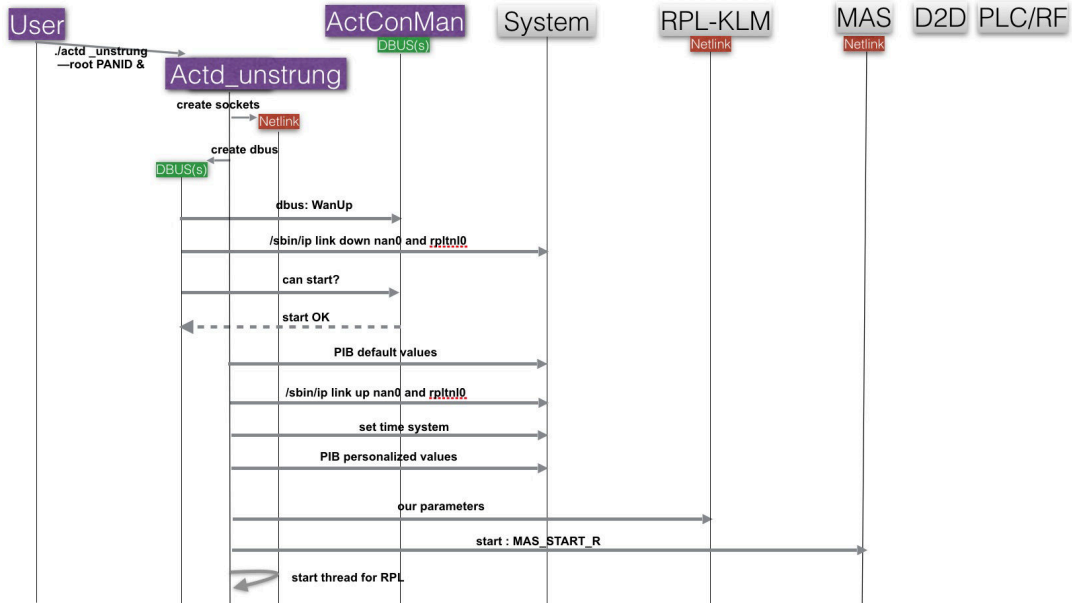

Figure 4.20: Root behavior - initialization on ACT with Unstrung

Figure 4.21 depicts the sequence diagram of a node start.

*RPL messages*

The root node sends the first **DIO** message when the **RPL DODAG** is created. The other nodes will send a **DIO** only once it has received a **DAO-ack** from its best parent.

To schedule the sending of the **DIO** messages, a trickle timer is used and configured to define the time between two **DIO** messages from a node, or in case of inconsistency. As explained in Chapter 2, the trickle timer will double the sending interval when a consistent message is received (**RPL** control message), or any other messages.

The trickle timer is reset when an inconsistency is detected (i.e. a **DIO** with a **RANK\_INFINITE** value).

We use standard trickle parameters, the minimum interval is [4 ms, 8 ms], and the maximum is [1h10, 2h20]<sup>1</sup>.

When a node receives a **DIO** with a lower rank than its best parent (according to the used Objectif Function), it chooses this parent, and calculates an address with the prefix information, then it creates a Linux default route with its new parent for the next hop.

When a node creates its address with the network prefix (with information included in the **DIO** message), it sends an unicast **DAO** message to its parent to advertise it. We use an interval of 10 seconds between 2 consecutive **DAO** messages. The **DAO** is an unicast IPv6 message, from the node to the root to announce its global address.

<sup>1</sup> Contiki uses these intervals: [4 sec, 8 sec ] and [8 min, 17 min].

The DAO-ack message, conversely, is sent from the root to a node, with an unicast IPv6 message. When the root received a DAO message, it sends a DAO-ack message, and adds a linux route to join the node with its global address.

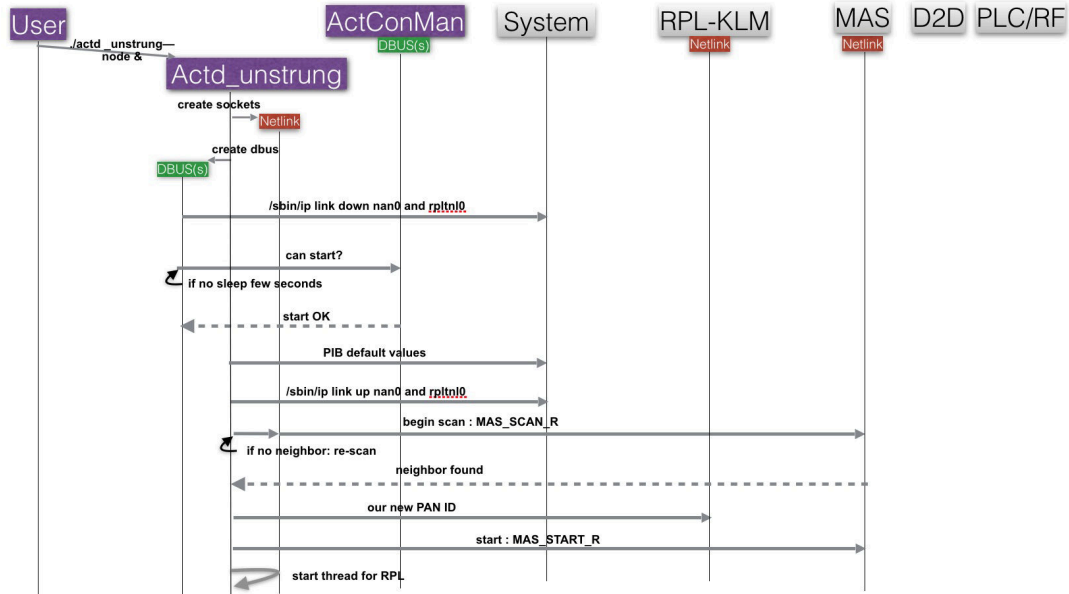

Figure 4.21: Node behavior - initialization on ACT with Unstrung

### Objective Functions

As presented before, *Unstrung* implementation proposes an OF that is derived from OF<sub>0</sub>. This OF has not been used in our implementation.

We implemented both OF<sub>0</sub> and MRHOF using respectively the RFC 6552 [Thu12] and 6719 [GL12]. The base of our OF<sub>0</sub> implementation has been taken from the Contiki implementation.

It has to be noted that our implementation of MRHOF does not use the metric container option when using ETX to compute the rank, as defined in the standard. The ETX value is computed locally by the node (using unicast messages such as DAO) and added to the advertised rank.

### 4.4.3 Hybrid network demonstration

In order to validate the implementation of the Parent Oriented approach, we use a real testbed to represent a simple architecture of smart meters. The testbed consists of five Itron ACT hybrid 802.15.4e / P1901.2 nodes.

The test-bed architecture has been organized as follows:

- One root node acting as a data concentrator, reporting the metrics of the network performance
- One Smart meter node reporting data to the data concentrator
- Three relay smart meters in charge of the data forwarding to reach the data concentrator, with two nodes positioned to be concurrent nodes.
- The Parent Oriented mechanism adapted in [OFo](#) and the ETX as the metric.

The [PLC](#) hops have been created by inserting  $40dB$  T-based attenuators equivalent to 200m of lines. The RF hops have been created by reducing the power of the antennas to limit the coverage area.

The topology of the test-bed scenario is depicted in [Figure 4.22](#).

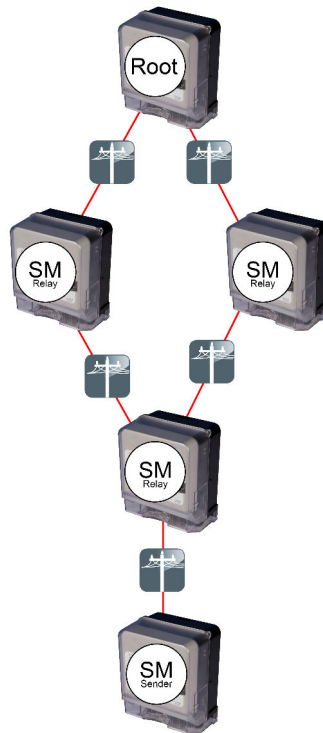

Figure 4.22: Testbed topology Meters communicate in PLC and RF.

The node reporting data to the root sends a specific packet format to allow the analyze of the characteristics of the path taken from the source to the root. Each packet has an incremented ID, in order to identify re-transmissions and to count the number of unique packets received at the root side.

The source node adds a node ID, its rank and the modulation used (corresponding to the [PLC](#) or RF interface) in the packet. At each forwarding, the forwarding node ID, rank and modulation used is aggregated to the packet. [Figure 4.23](#) represents

the packet format used in our demonstration.

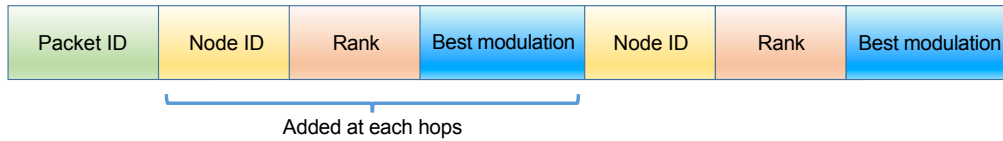

Figure 4.23: Format of the frame aggregated at each hop.

Once the root receives the packet, an application parses the frame to analyze the path taken by the received packet and provides a real-time graphical representation of the path with node ID, ranks and used modulations.

This proof-of-concept had several points to verify:

- Any node in the network can be single or multi-interface
- During the lifetime of the network, an interface or a node could be removed or added.
- Show an improvement of reliability by comparing single interface and hybrid networks

In order to verify those points, we setup two scenarios. The first scenario is a network of nodes having only a single RF interface. The second scenario is a network of hybrid nodes having both PLC and RF interfaces.

Concerning the network quality, we tested two RF conditions, one with excellent link quality and one with poor quality. In the hybrid scenario, the quality of the PLC network is not addressed, and stays the same for both radio conditions.

First, we showed that in a single RF interface network, with excellent link quality, relay node 3 chooses Node 1 as its preferred parent, the DODAG stayed the same during the duration of the demonstration. When decreasing the RF link quality between node 1 and node 3, node 3 started to change parent frequently, between node 1 and node 2. This single interface scenario demonstration is depicted in figure 4.24.

This behavior is typically encountered in OFo when two potential parents have close metrics, as no threshold exists to prevent frequent parent switching, leading to packet loss and bad PDR results.

Next, we showed that in a hybrid scenario, with excellent RF link quality, node 3 chooses node 1 as its preferred parent with either RF or PLC depending on the environment (interference). When decreasing the RF link quality between node 1 and node 3, the node 3 just switches to PLC without changing parent, without loss. This hybrid interface scenario demonstration is depicted in figure 4.25.

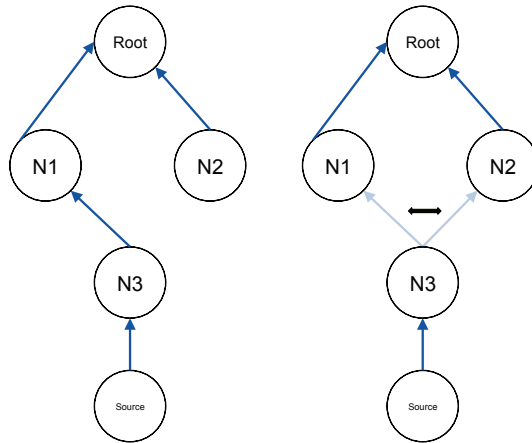

Figure 4.24: Single interface scenario.

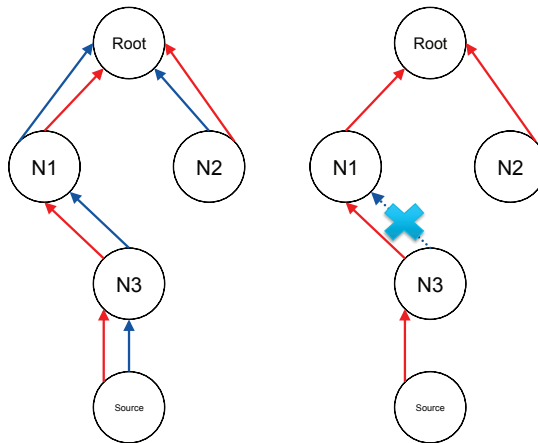

Figure 4.25: Hybrid scenario.

Figure 4.26 shows an example of the graphical interface of the path visualization.

Furthermore, we performed a second real evaluation with hardware platform. We added different levels of white noise on the PLC network to show the resilience of the network taking advantage of the RF links on a two nodes scenario. This evaluation is presented in the next section.

#### 4.4.4 Increasing Network Reliability

As TCP cannot be used at the transport layer over LLNs, and as a reliable mechanism at the application layer would be too costly to implement in a real infrastructure, we investigate how we can make a LLN more reliable at the MAC layer.

In the following, we demonstrate how a PLC line and a wireless link can be degraded due to external noises [Kot+17], [Pap+17], and demonstrate that by using

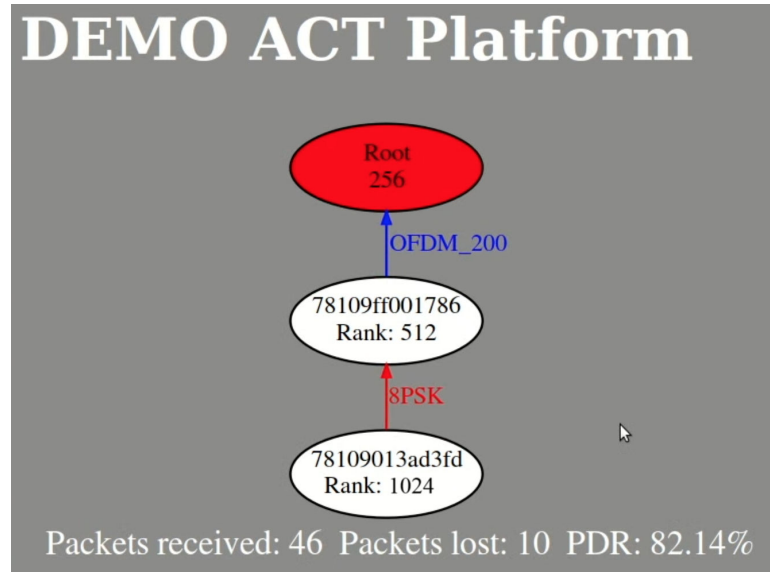

Figure 4.26: Real-time visualization of the path.

multiple interfaces we can enhance the PDR performance.

Parameter	Value
Topology	one-hop
Number of nodes	2 (including the root)
Number of sources	1 source
Noise type	White Noise
Noise Frequency range	0.03Hz to 700kHz
Noise Amplitude	-3 to 10 dBm
Number of packets	200
Routing	RPL
Traffic pattern	1 pkt / 3 sec
Number of packets per run	500
PLC Standard	IEEE P1901.2
RF Standard	802.15.4e
Reliability metric	Packet Delivery Ratio

Table 4.5: Reliability Experimentation Setup

To this aim, we deploy an experiment consisting of two Itron smart meters (see Table 4.5 for setup details). The first meter acts as the source of the data packet (i.e. the monitoring node), while the other as the receiver (i.e. the Management System). Two communication technologies are used on both nodes: PLC and IEEE 802.15.4. We varied the link quality of the two interfaces over time, by introducing white noise on the PLC link and reducing the transmission power for the other. We performed

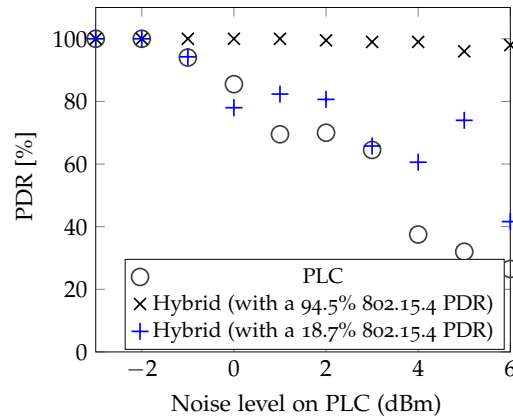

Figure 4.27: Packet Delivery Ratio (PDR) depending on noise level over PLC line.

three experimental campaigns: 802.15.4 only, **PLC** only, and an hybrid configuration, where the two nodes can use both technologies.

In the latter, we extend the algorithm from [Lem+16] that selects the best interface, in order to let the sender use the other one in case of transmission failure.

Figure 4.27 shows a comparison of **PDR** performances between **PLC** only and hybrid scenarios. In the **PLC** only case, when the noise exceeds  $-1\text{dBm}$ , we notice that the link quality is decreasing, and thus the **PDR** performance drops. On the contrary, when using both technologies, the **PDR** is always close to 100% for a radio link not really degraded (94.5% of radio **PDR**). However, even if the radio link is degraded (18.7% of radio **PDR**), the **PDR** decreases but remains above **PLC** only scenario.

Through this second experiment, we can make the following observations. First, we see that the link quality degrades essentially with the noise, leading to have a low **PDR**. Second, we show that by employing a hybrid network, we may maintain high level of **PDR**. However, when both links are bad, we observe a low reliability performance, which explains that mechanisms are required to limit the resulting losses.

## 4.5 CONCLUSION

In this chapter, we presented in detail our implementations of the interface management designs proposed in this thesis. By means of simulations and hardware implementations, we showed how much a smart grid network could benefit from a heterogeneous multiple interfaces architecture.





Part V

CONCLUSION



## CONCLUSION AND FUTURE WORK

---

### Contents

---

5.1	Conclusion . . . . .	105
5.2	Perspectives . . . . .	107
5.2.1	PO improvement . . . . .	107
5.2.2	Duplication . . . . .	107
5.2.3	Multiple Instance . . . . .	108
5.2.4	Large scale scenario . . . . .	108
5.2.5	Long-term perspectives . . . . .	108

---

In this last chapter, we present a summary of the addressed problems and we highlight our contributions and solutions. We finish with the perspectives and the possible future works.

### 5.1 CONCLUSION

In this thesis, we proposed a new framework for multiple interface management in [RPL](#) in a smart grid environment, and more precisely for the Advanced Metering Infrastructure ([AMI](#)) communications. The transport and distribution energy network is complex and requires communication devices at every levels of the infrastructure to handle all the new uses of electricity production and consumption. The [AMI](#) infrastructure faces a large number of challenges, from the bandwidth and delay requirements of the smart grid applications, to the harsh environment that makes difficult communications and may generate link failure.

Relying on mature technologies, in particular, the Power Line Communication ([PLC](#)), we have seen in Chapter 2 that the [AMI](#) communications are widely studied and numerous of different solutions exist to connect the Smart Meter ([SM](#)) to the Data Concentrator ([DC](#)). Most of them are short range and require a routing protocol to compute a multi-hops path from the source to the destination. We showed that the literature is rich of routing protocols, and that many of them could be used for routing in Low power and Lossy Networks. We detailed two of them, namely [LOADng](#) and [RPL](#) because they are the main solutions that have been standardized for the smart grid. We showed that they offer good performance in homogeneous smart grid networks. However, only few proposals address the problem of multiple interfaces, while this feature is promising to improve reliability by providing alternative technology. In the following, we decided to focus on [RPL](#).

In chapter 3, we proposed three different approaches to extend [RPL](#) to manage multiple interfaces. We introduced the Parent Oriented design, by taking all commu-

nication interfaces of a node in consideration when constructing the [DODAG](#). This mechanism allows to provide a more reliable network and better performance. The Interface Oriented design proposes to select a path by choosing the best link with a neighbor among all available, offering a simple way to manage multiple interfaces with high performance, but without any consideration about [DODAG](#) stability. The Multiple Instances design addresses the problem of multiple interface in a different way by building two separate [DODAG](#) in two RPL Instances. This solution offers several advantages such as the possibility to define different Objective Function ([OF](#)) for each technology in order to finally optimize the [DODAG](#) according to the specificity of each communication networks. However this last approach has a limited support of link failure because switching from one [RPL](#) instance to another may generate routing loops.

To tackle the complexity of transmission failure in a hybrid network, we also proposed a re-transmission mechanism that takes into account the multiple interfaces and modulations available on a device. This mechanism takes advantage of the diversity of the technologies to systematically try a different modulation and all available interfaces of a preferred parent before generating a transmission failure. By trying many different ways to send a message to a neighbor, including switching between technologies, we allow to make the [RPL DODAG](#) more stable with less parent changes, and less failure.

Chapter 4 was dedicated to the performance evaluations. We conducted three different evaluation forms: two by simulation, and one with real hardware. We developed an adhoc [DODAG](#) simulator called RDSim to study the performance of our three designs. RDSim allows to randomly generate a graph made of hybrid nodes, and provide statistics on performance of the constructed [DODAG](#) corresponding to each design. In order to study the dynamicity and variability of link quality, we also developed a hybrid node model for RiverBed Modeler - a well-known discrete event simulator; This model implements the modified [RPL](#) stack on top of two MAC layers, P1901.2 and 802.15.4e, with a cross-layer module in charge of the neighbor table management and re-transmission mechanisms. We defined a realistic smart grid scenario, using a field based topology of smart meters sending representative traffic and using dedicated MAC PLC layer with realistic interference and propagation model.

Through the simulations we have done, we first confirmed that using multiple interfaces provide a large benefit for reliability and end-to-end delay. Numbers have to be carefully taken because they are strongly dependent on the scenario parameters, but in a harsh environment with link failure, while we measured a [PDR](#) around 50% for single interface [DODAG](#), we reached more than 95% for IO and PO. Comparing our three approaches, we concluded that the PO design solves most of the issues caused by the deployment of multiple interfaces. It has a simple approach like the IO design and an innovative way to address heterogeneity like the MI design.

Finally, we also worked in real hardware to show the feasibility and benefit of using multiple interfaces on smart meters. We selected the PO approach because it appears as the best compromise among the three proposed approaches. The implementation of a modified version of RPL has been done using the Itron ACT platform with a complete integration of a new RPL stack and our smart module in charge of the Neighbor Table (NT) and the hybrid metrics. This proof of concept allowed us to validate the improvement in the DODAG stability and PDR compared to a single interface network. We also were able to confirm the statistics we obtained by simulation.

## 5.2 PERSPECTIVES

The presented contributions in this thesis open perspectives in different directions, and there is still open questions on how routing protocols could be optimized to the evolution of the smart grid networks. The climate and energy emergency impose to think the smart grid network in a long-term perspective as well. We discuss in the next sections the remaining work and the future challenge of communication networks in the smart grid.

### 5.2.1 PO improvement

The PO design provides performance that match up the initial expectations, but several improvements can be made to have a better adaptation in NAN. The stability mechanism can be extended to define more accurately if a node becoming single interface should stay as the preferred parent. If the probability that the node stays single interface for a long period is high, keeping it as the preferred parent will procure the opposite effect. By monitoring the node interfaces active time, or the number of packets transmitted through them, we could decide to switch directly to a different parent.

### 5.2.2 Duplication

To improve the latency and the reliability of a network, the duplication of the transmission is a well-known technique employed, in particular, in opportunistic networks. Using the potential of the hybrid network by sending - simultaneously - duplicate data on both interfaces would allow to lower the complexity of building hybrid path and may increase reliability and lower the jitter.

However, this technique requires to properly manage the multiple reception of the same packet, the more we get close to the sink. It is also important to take into account the energy and memory consumption required for such a technique, packet duplication leads to a more occupied channel and impacts the MAC layer

performance.

### 5.2.3 *Multiple Instance*

The RPL standard introduces the concept of an *instance* and defines how an instance should be implemented. However, although the use of multiple instances is by design possible according to the standard, the conditions to use more than one instance are out of the scope of the RPL standard.

As we have seen in Chapter 2, there are only few works that study multiple instance feature, and the implementations used are not documented on RPL parameters. This concept is innovative and the results showed in Chapter 4 confirm an interesting perspective for RPL enhancement.

To fully benefit from the multiple instances feature of RPL, the limit of only switching to the instance having the more recent *InstanceID* could be reconsidered. This limit has been taken to avoid loops between instances, and it is too restrictive. An active mechanism to control routing loops is required in order to open new ways to select a path to a destination among multiple choices.

For single or multiple interfaces network with high capacity nodes, this concept would allow nodes to belong to several instances. The application would choose the best path at every hops among all instances, depending on the application requirements, the capacity of the links and the parameters of each Objective Function.

### 5.2.4 *Large scale scenario*

During the experiments under smart grid traffic, we evaluated the performance of our designs using a limited number of nodes, on a single phase. It would be interesting to increase the number of smart meters and the number of phases to evaluate the scalability of our solutions. Indeed, our node model implementation uses realistic simulation parameters (MAC and PHY layers, interference and fading models), increasing the number of nodes to represent a more realistic NAN would allow to measure the real benefit of the proposed solutions.

### 5.2.5 *Long-term perspectives*

In a long-term perspective, it may be interesting to consider Long Range communications as a candidate solution in the heterogeneous mix of technologies in the smart grid network. Since few years, the breakthrough of long range solutions in the network landscape is astonishing. Although long range offers limited bandwidth,

the range distance could allow to connect **SM** and **DC** systematically in one hop.

Considering the priority and the amount of data to transmit to the **DC**, the interface management mechanism could decide, in some cases, to use the availability of the long range technology. However, that technology would impose new information such as the duty cycle to consider at the routing layer. The multiple instance solution could be extended in that way, having a specific instance with a dedicated objective function for Long range networks. This Long Range network could be reserved for a backup network in case of high priority traffic. This instance would also permit to address the cut-offs that require very short delays.

In a more conceptual way, as the electric vehicle market continue to grow every year, we could imagine a wide adoption of personal electric vehicle and consider the **EV** as a mobile smart grid node. First, the **EV** could act as a relay node to optimize communications in area where **EV** are concentrated. For example, a group of **EV** could make a mobile mesh network in order to provide a second layer of connectivity in an urban area. Moreover, an **EV** could act as an aggregator, to collect or send data when it is not mobile. For instance, the **EV** could collect data when charging at home and transfer it to the utilities when plugged at working place. The **EV** could also collect an update on pricing or software at the working place to update the home smart meter when **EV** is plugged back home.

Furthermore, we could envision a mobile extension of this scenario. As the **EV** is moving along the road several days a week, it could make data available when it is in the vicinity of a **AMI** network, in an opportunistic way.

Finally, we could extend the concept of smart grid node at a large scale. Considering that today common devices have minimum capacity of computation and communication we could envisage that most of electric device could meter itself to the utilities and negotiate itself the condition of the electrical supply and billing. The **EV** market is already targeting such a principle to control the load on the electricity network and create a new energy service for **EVs**.

Extrapolate this concept to every electrical devices could lead us to think about an open electricity network where every devices could negotiate a charging or a supply depending on the grid balance or, in a more audacious way, to let devices report their consumption to the utilities in order to bill the user of the device. This could be first an interesting leverage to make consumers responsible of their consumption. This concept could also lead to a new market for energy providers.





Part VI

APPENDIX



## RÉSUMÉ EN FRANÇAIS: GESTION D'INTERFACE MULTIPLE DANS LES RÉSEAUX SMART GRIDS

---

### A.1 CONTEXTE GÉNÉRAL

Depuis plusieurs dizaines d'années, la demande en électricité accuse une très forte hausse, en raison de l'amélioration de la qualité de vie et de l'augmentation constante du nombre d'appareils électriques.

Dans le même temps, un changement considérable s'opère dans le secteur de l'électricité, en partie en raison de l'abandon des énergies fossiles au profit du renouvelable, l'évolution des politiques énergétiques, et l'émergence de la micro-génération.

Comme évoqué dans une enquête de 2015 du groupe Eurelectric [Eur15], le réseau électrique impose de prendre en considération ces modifications tout en maintenant une énergie durable, compétitive, abordable, et sécurisée pour chaque entreprise et particulier.

Le bon fonctionnement du réseau repose sur l'équilibre entre la production et la consommation, qui reste un défi pour la gestion du réseau. Dans le réseau électrique, les communications permettent d'effectuer des relevés automatiques de consommation, faire des diagnostics et contrôler les états des compteurs d'énergie. Ce système est déployé par les fournisseurs d'énergies pour réduire les coûts des déplacements nécessaires aux relevés des compteurs, et pour une meilleure gestion du réseau électrique.

Par ailleurs, la structure du réseau électrique est en pleine mutation. Elle passe d'une architecture figée et centralisée où de grandes centrales de production répondent à la demande en énergie, à une architecture distribuée incluant des sites de production d'énergie renouvelables. La production devient par conséquent plus décentralisée, mais moins prédictible, en raison du caractère intermittent des énergies renouvelables. Pour équilibrer efficacement productions et consommations, des mesures en temps réel, des capacités de contrôle et de prédiction sont nécessaires dans un système de gestion global.

Ces modifications font partie d'un changement important dans le système électrique suivant les politiques de transition énergétique. Comme bon nombre de pays, la France met en place depuis 2012 des discussions politiques sur la transition énergétique, et comment l'économie Française pourrait en tirer bénéfice. En France, le principal défi de la transition énergétique est de freiner le réchauffement climatique

en sortant progressivement du nucléaire. Un débat national a été lancé en 2012 par la ministre de l'écologie dans le but de s'attaquer à 4 grands défis:

- Réduire par 4 ou 5 les émissions de gaz à effet de serre avant 2050
- Réduire la part du nucléaire à 50% du mix énergétique total avant 2025
- Développer une production décentralisée d'énergies renouvelables
- Identifier toute forme d'économies d'énergies possible

La France a défini un calendrier pour la transition énergétique pour imposer des changements dans la production, la consommation et le transport, ou encore dans le choix des énergies renouvelables. Par ailleurs, le développement du smart grid a été proposé au gouvernement Français en Juillet 2013 [Léo+16].

Une des plus importantes fonctionnalités du smart grid est la possibilité de transférer des consommations électriques qui posent problème en période de pic, vers une période d'inactivité, où l'énergie sera moins chère, plus disponible et produite localement. Cette fonctionnalité est notamment prise en charge par les compteurs électriques intelligents, qui en monitorant les comportements des consommateurs, contribuent à équilibrer la demande en énergie à la production.

En outre, les appareils électriques ont évolué très rapidement ces dernières années. Certains deviennent mobiles, comme le véhicule électrique, qui rendent la prédiction de demande en énergie plus complexe et fait globalement augmenter les consommations électriques; d'autres, comme les bâtiments ou maisons connectées, permettent le pilotage à distance (Chauffage / climatisation, systèmes d'éclairage).

Ensemble, ces nouveaux services énergétiques, et plus particulièrement la démocratisation des véhicules électriques font de la question de la gestion du système électrique un sujet complexe.

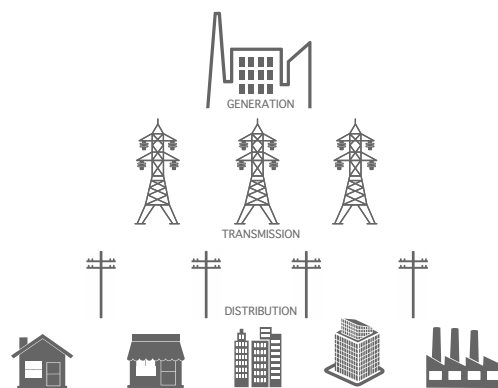

Figure A.1: Le réseau de distribution et de transport d'énergie actuel.

Aujourd'hui, les véhicules électriques personnels sont rechargés dès qu'il sont raccordés à une borne de recharge, sans gestion spécifique, ce qui engendre des charges simultanées à des moments clés de la journée. Ce comportement intervient majoritairement aux heures de pointe le soir, une période déjà délicate pour le réseau électrique.

Puisque le marché des véhicules électriques évolue doucement, la charge du parc de véhicules électriques actuel peut être gérée par le réseau électrique. Mais le taux d'adoption de véhicule électrique espéré entrainera la nécessité d'éviter la charge de l'ensemble du parc sur les heures de pointes du réseau. Il sera donc nécessaire de déplacer ces charges sur une fenêtre de temps qui permettra de recharger ces véhicules tout en maintenant la demande en énergie en dessous d'un certain seuil, et d'aligner ces consommations aux périodes de production. Par conséquent, il est essentiel pour un Smart Grid de tirer profit d'un système de contrôle qui tient compte des périodes de charge pour équilibrer les nombreuses demandes en énergie réparties sur différentes périodes de temps.

Les réseaux Smart Grids héritent d'une architecture de communication permettant la collecte de données et la gestion des équipements, appelée Advanced Metering Infrastructure *AMI* [Bus14, Chap. 7]. Cette architecture est une évolution de l'*AMR*, à laquelle est ajoutée une communication bidirectionnelle, et qui a été développée pour faciliter la relève des compteurs, la facturation et la planification des consommations. Les fonctionnalités de communication bidirectionnelle d'une infrastructure *AMI* permettent également d'autres opérations sur le réseau. Elles participent assurément à un meilleur contrôle des réseaux par les fournisseurs d'énergies, mais d'autres opportunités sont envisagées avec une telle architecture, et plus particulièrement lorsque des technologies IP à haut débit sont utilisées.

Dans les systèmes de communication Smart Grids comme dans tout système de communication, nous pouvons distinguer un coeur de réseau et les éléments de ce que nous identifions "le dernier kilomètre"<sup>1</sup>. Le coeur de réseau implique de grandes capacités de stockage et de calcul pour collecter, organiser et manipuler les données dans le but de coordonner les équipements au travers de commande à distance. Le dernier kilomètre consiste en l'utilisation d'objets connectés identifiés de manière unique (Sondes, actionneurs, équipement intelligent, etc.) et dispose de liens de communication entre eux, en utilisant des technologies filaires ou sans-fil.

Le réseau de distribution d'énergie est organisé en arbre avec des sites de production à son sommet produisant l'énergie requise, puis celle-ci est transportée via un réseau de distribution global vers les consommateurs.

La figure A.1 illustre cette configuration descendante où les consommateurs peuvent être atteints après être passé par différent point d'agrégation, comme un poste de transformation. Les fournisseurs d'énergies estiment les consommations en se basant sur l'historique des consommations et ajustent ces estimations par

<sup>1</sup> plus particulièrement, le dernier saut, puisque certaines technologies radio permettent des communications au delà du kilomètre

les relevés automatiques. Ces estimations sont par conséquent très sensibles au moindre changement de comportement des consommateurs.

## A.2 MOTIVATIONS

La technologie [AMR](#) fait usage des communications par courant porteur [PLC](#) pour permettre la relève automatique des compteurs électriques et gaz. La technologie [AMI](#) repose toujours sur ces technologies CPL.

Cependant, les réseaux de communication par courant porteur sont sujet à une très grande sensibilité aux interférences. Dans ce genre de réseau, les erreurs proviennent essentiellement du bruit de fond, du bruit impulsionnel et des interférences en bande étroite ([NBI](#)) [[Oli+16](#)]. Au delà du fait qu'un protocole de niveau 2 puisse traiter ces grandes variations de disponibilité de la bande passante en raison des conditions de bruit difficiles (qui sont très courantes dans les réseaux CPL), les réseaux de compteurs intelligents utilisant le CPL pour leurs communications ne respectent pas la couverture de 99.99% des relevés imposée par le smart grid.

Bien que des solutions d'adaptation dynamiques existent, plusieurs technologies de communication alternatives sont envisagées, comme les réseaux Mesh, cellulaires, Wimax, les réseaux de capteurs sans fil, ou encore les technologies longue portée.

La majorité de ces technologies est tout autant sensible au bruit et ne peut pas forcément correspondre à une utilisation dans des environnements spécifiques, ces technologies sont par conséquent considérées comme des réseaux faible puissance avec pertes ([LLN](#)).

Dans le but d'améliorer les possibilités de communication, une solution répandue consiste en l'utilisation d'un mix de plusieurs technologies hétérogènes pour faire face à tout scénario et niveau d'interférence. Lorsqu'une technologie ne fonctionne pas pour un cas précis, la plupart du temps une autre technologie peut être utilisée en remplacement. A titre comparatif, les stations de travail, les ordinateurs portables ou encore les objets connectés ([IoT](#)) utilisent couramment plusieurs interfaces hétérogènes comme ethernet, Wi-Fi ou bluetooth. Un exemple typique d'une telle solution est le Smartphone, qui embarque au moins trois interfaces différentes: cellulaire, Wi-Fi et bluetooth. Chaque technologie est destinée à une utilisation prédéfinie, mais peut être utilisée indépendamment pour des services communs e.g. utiliser Wi-Fi pour passer des appels.

Pour ces raisons, la plupart des futurs compteurs intelligents vont disposer de plusieurs technologies de communication hétérogènes pour assurer une certaine qualité de service. Cependant, la gestion de ces interfaces multiples est un défi. La majorité de ces technologies sont de courte portée, les noeuds du réseau doivent collaborer entre eux pour atteindre la destination qui sera distante de plusieurs sauts. Les protocoles de routage jouent un rôle majeur dans ce cas en optimisant le chemin sélectionné en fonction des besoins applicatifs et des contraintes de terrain.

RPL [Win+12a] est le protocole de routage le plus populaire dans la communauté de l'internet des objets, il est notamment intégré dans l'un des systèmes d'exploitation le plus utilisé, Contiki OS. RPL est principalement utilisé dans des réseaux homogènes et a été conçu pour fonctionner sur des réseaux d'équipements à une seule interface.

Dans cette thèse, nous nous concentrons sur la manière dont RPL peut être adapté pour fonctionner avec plusieurs interfaces, dans le but d'augmenter la fiabilité et les performances des communications dans le smart grid.

Par ailleurs, les communications par courant porteur sont incontournables dans les réseaux smart grid. En effet, cette technologie à l'avantage d'exploiter l'infrastructure électrique existante, réduisant notamment ainsi les coûts de déploiement. Nous avons par conséquent basé nos expérimentations et simulations sur le standard de communication CPL en bande étroite P1901.2, un des protocoles les plus répandus dans les communications pour le smart grid. Dans le même sens, nous avons sélectionné le protocole de communication radio 802.15.4 comme seconde interface de communication pour nos travaux. IEEE 802.15.4 est vraisemblablement le standard ayant l'impact le plus fort sur l'internet des objets, et plus précisément sur les communications sans-fils faible puissance.

Dans l'état de l'art de ce domaine, nous pouvons remarquer qu'il n'existe que très peu de contributions sur la gestion d'interface multiple dans RPL, depuis la publication du RFC de RPL (2009). Par ailleurs, peu de travaux existent également sur RPL dans les réseaux hétérogènes. RPL est principalement étudié dans des réseaux sans-fil, et peu de travaux concernent la spécificité des réseaux smart grid fonctionnant sur CPL, comme les interférences. Par ailleurs, les études par simulation sont les plus courantes, mais n'emploient que rarement un modèle physique CPL réaliste, rendant compliqué les études à grande échelle de scénario smart grid utilisant conjointement des technologies CPL et sans-fil.

Les objectifs de cette thèse sont alors les suivants:

- Proposer un cadre d'extension de RPL dans le but de gérer plusieurs interfaces hétérogènes
- Proposer un modèle de simulation pour évaluer les performances de la solution de routage
- Proposer une implémentation de l'extension sur une plateforme matérielle pour évaluer les performances en conditions réelles.

### A.3 CONTRIBUTIONS ET ORGANISATION DU MANUSCRIT

Nous présentons dans ce manuscrit une proposition de gestion d'interface multiple pour le protocole de routage RPL. Premièrement, cette extension de RPL propose un mécanisme original de sélection de parents en prenant en compte toutes les interfaces disponibles d'un noeud. Deuxièmement, cette solution a pour but d'augmenter



la fiabilité (centrée sur le PDR) d'un réseau hybride en encourageant l'utilisation de toutes les interfaces par un nouveau mécanisme de retransmission.

Le manuscrit est organisé en 3 chapitres. Le chapitre 2 présente le contexte de la thèse et introduit plus précisément l'infrastructure de télé-relève avancée (AMI), un point central du Smart Grid. Nous donnons également une vue d'ensemble des solutions de gestion d'interface multiple dans l'internet des objets. Nous abordons ensuite les caractéristiques physiques et les contraintes d'un réseau CPL et la nécessité d'un protocole de routage qui en découle.

Enfin, nous présentons les 2 principales familles de protocoles de routage pour situer RPL dans les systèmes Smart Grid.

Dans le chapitre 3, nous proposons un nouveau framework d'extension du protocole RPL pour la gestion d'interface multiple et hétérogènes, dans le but d'améliorer la fiabilité et les performances d'un réseau smart grid. Nous présentons trois solutions, la première appelée "Parent oriented", la seconde "Interface Oriented" et la troisième "multiple Instances".

Nous présentons dans le chapitre 4 le modèle de simulation que nous avons développé pour valider nos propositions, et les comparer.

Le chapitre 5 propose une conclusion générale de notre travail et les possibles directions de recherche complémentaires.

Les sous-sections suivantes présentent les contributions discutées en détail dans le corps du manuscrit.

#### A.3.1 *La gestion d'interface multiple*

L'Advanced Metering infrastructure (AMI) est un élément majeur d'un réseau Smart Grid, et les applications qui en découlent montrent qu'il existe de nombreux types de trafic différents en fonction de leurs exigences respectives. Les critères d'exigence des réseaux Smart grids sont multiples car les applications peuvent nécessiter des délais très courts ou une très grande bande passante, sur un réseau imparfait sur lequel les ruptures de liens et les interférences sont nombreuses.

Les technologies CPL utilisées dans les réseaux Smart grids sont en constante évolution, permettant des bandes passantes toujours plus importantes, tel que les récents travaux sur le CPL en bande étroite (NB-PLC). Les méthodes multi modulations et les procédures d'évaluation de la qualité des liens telles que l'adaptative Tone-Map permettent d'améliorer également la robustesse.

Par ailleurs, l'intérêt de la communauté pour les réseaux de capteurs sans-fil (WSN) et plus particulièrement dans le domaine des Smart Grids démontre la volonté de proposer une nouvelle vision du réseau AMI tirant partie des avantages d'une

technologie mature tel que le sans-fil.

Cependant, l'environnement Smart Grid reste un défi pour chacune des technologies, et utiliser l'une lorsque l'autre n'est pas satisfaisante ne peut être une solution de long terme. Il apparaît que l'utilisation conjointe de deux technologies peut permettre d'ouvrir de nouvelles perspectives.

Alors pourquoi l'utilisation des technologies CPL et sans-fil n'est pas suffisante pour répondre aux besoins actuels et futurs du Smart Grid?

La majorité des solutions déployées reposent sur des réseaux homogènes, avec des protocoles conçus pour fonctionner avec des équipements utilisant une seule interface. La plupart des compteurs intelligents actuels disposent de plusieurs interfaces hétérogènes mais n'utilisent généralement qu'une seule interface, ou chaque interface est dédiée à une application spécifique.

Les réseaux CPL et sans fil sont chacun considérés comme des réseaux à perte et à faible puissance (LLN) mais chacun d'entre eux ont des propriétés physiques (propagation et interférences) totalement différentes, rendant difficile la comparaison de chacun.

Dans le domaine du routage, deux approches existent pour appréhender ce genre de réseaux fortement contraints, par l'utilisation de solution de routage proactive et réactive, chacune ayant des performances similaires. Cependant, aucune d'entre elle n'aborde la question des interfaces multiples, ou l'hétérogénéité.

Lorsqu'il s'agit de gérer plusieurs interfaces hétérogènes dans un réseau AMI, des questions restent sans réponses.

Sur quels critères une interface devrait être choisie plutôt qu'une autre? Comment peut-on utiliser plusieurs interfaces simultanément? Quelle métrique existante devrait être utiliser pour comparer des réseaux hétérogènes?

Dans les sections suivantes, nous présentons nos solutions d'extensions de RPL dans le but de gérer plusieurs interfaces hétérogènes et un mécanisme de retransmission qui tient compte des interfaces multiples en cas d'erreur de transmission.

### A.3.2 *Gestion d'interfaces hétérogènes avec RPL*

Nous proposons trois nouvelles approches pour gérer les interfaces hétérogènes d'un noeud hybride dans RPL. Nous considérons que chaque noeud dans le réseau est potentiellement capable de communiquer via deux interfaces, chacune ayant ses propres qualités de lien avec ses voisins. Pour chaque voisin, nous stockons les métriques de qualité de lien dans une table de voisins.

### *Solution orientée parents*

La solution orientée parent propose de construire un DODAG RPL en créant une nouvelle métrique hybride découlant des métriques de chaque interface entre deux noeuds. Un nouveau lien représentatif de la communication hybride entre 2 noeuds sert à construire le graphe de routage RPL. Pour améliorer encore la stabilité du graphe de routage, et pour lutter contre les changements de parents trop fréquents, nous introduisons un mécanisme de stabilité permettant de changer d'interfaces avant de changer de parent. Un noeud fils qui perd la possibilité de communiquer sur 2 interfaces avec son parent préféré, changera simplement d'interface pour la transmission. Si la transmission échoue à nouveau après ce changement d'interface, un changement de parent sera autorisé.

La base de cette approche est d'accroître la stabilité du DODAG RPL en exploitant la diversité et l'hétérogénéité des deux réseaux. Lorsqu'un noeud change de technologie pour communiquer avec le même parent, le DODAG n'est pas modifié et les rangs ne sont pas mis à jour. En conséquence les messages de contrôle RPL ne sont pas nécessaires.

### *Solution orientée interface*

La solution orientée interface propose de construire un DODAG RPL en choisissant l'interface offrant le meilleur lien avec un potentiel parent, parmi les interfaces disponibles. En d'autres termes, si un voisin est joignable via deux différentes interfaces, il sera vu comme deux parents potentiels.

L'approche orientée interface se base sur les performances des liens individuels sans tenir compte de la stabilité ou encore du caractère hétérogène des noeuds. Lorsque les conditions de communication se dégradent avec un parent hybride, ou si le parent préféré n'est plus joignable, l'autre interface disponible (de ce parent préféré) n'est pas considérée en priorité pour conserver ce parent comme préféré. En effet, le nouveau parent préféré sera le noeud offrant la meilleure métrique parmi les noeuds présents dans le groupe de parents potentiels.

### *Solution Multiple Instances*

Dans RPL, le concept d'instances multiples permet à un noeud d'appartenir à plusieurs instances de RPL, y compris avec des noeuds ne possédant qu'une seule interface.

En considérant des noeuds avec deux interfaces, on peut facilement envisager l'utilisation de deux instances RPL: une pour chaque technologie. Chaque instance RPL peut utiliser sa propre fonction objective, nous pouvons donc envisager différentes façons de créer les routes vers les noeuds racine (Root). Chaque instance optimise le chemin vers la racine en se basant sur les caractéristiques propres de chaque technologie.

L'avantage de cette solution est qu'elle n'est pas intrusive dans le code RPL puisqu'elle se base sur des fonctionnalités existantes de RPL. La politique de choix d'interface doit cependant être développée pour permettre de passer d'une instance à l'autre et tirer profit des deux réseaux hétérogènes.

### A.3.3 Implémentation et évaluation des performances

Nous proposons une évaluation des performances de nos solutions d'extension de RPL au moyen de plusieurs outils. Nous avons décidé d'utiliser aussi bien la simulation que l'implémentation matérielle pour étudier les différentes caractéristiques de nos propositions.

Nous avons premièrement développé un simulateur autonome spécialement conçu pour étudier la phase de construction des DODAG RPL, et ce pour chacun des algorithmes proposés (Orientée Parent, Orientée Interface, Multiple Instances). Nous avons également proposé un nouveau modèle de noeud dans un simulateur à évènement discret (Riverbed Modeler) équipé d'une interface IEEE 802.15.4 et PLC P1901.2. Ce modèle de simulation nous permet de conduire des études approfondies du protocole RPL et de nos approches, plus particulièrement lorsqu'un lien entre deux noeuds se dégrade pendant l'exécution.

Nous avons également mis en place un scénario de démonstration utilisant du matériel (des compteurs électriques intelligents équipés de deux interfaces) pour montrer la faisabilité de nos approches. Une expérimentation plus avancée a été également menée sur ces compteurs pour étudier la résilience des communications hybride en fonction du bruit présent sur un réseau CPL.

Les résultats de simulation et de l'implémentation matérielle ont confirmé les résultats prometteurs de chacune des solutions. La solution orientée Parent permet de produire un DODAG plus stable tout en réclamant moins de messages de signalisation RPL. Le concept orienté interface montre des résultats de qualité de liens intéressants (permettant une meilleure bande passante en comparaison des autres solutions) tout en offrant une implémentation moins complexe, mais réclame plus de messages de signalisation. La complexité de la solution multiple instance de nous a pas permis une évaluation sur une plateforme matérielle, mais les simulations ne performance des DODAG RPL ont montré le potentiel de cette solution. En situation concrète de trafic smart grid, les résultats d'implémentation matérielle ont montré de nettes améliorations des performances du réseau. En utilisant le concept orienté parent, nous avons remarqué des améliorations tant au niveau de la stabilité que de la fiabilité des communications.

La table [A.1](#) résume les résultats de nos expérimentations.

Solution	MI	PO	IO
Qualité des liens	-	+	++
Stabilité	+	++	-
Implémentation	++	-	-

Table A.1: Comparaison des solutions proposées

#### A.4 CONCLUSION ET PERSPECTIVES

Dans cette thèse, nous proposons un cadre d'extension de RPL pour la gestion d'interfaces multiples dans un environnement smart grid. L'infrastructure AMI fait face à de grands défis, notamment sur la fiabilité et la stabilité des communications. Le réseau smart grid repose essentiellement sur des technologies CPL, mais nous avons vu qu'aujourd'hui d'autres technologies alternatives existent. Toutes ces technologies nécessitent l'utilisation d'un protocole de routage pour que les noeuds puissent collaborer entre eux afin d'atteindre le destinataire du message. Parmi toutes les solutions de routage existantes, nous avons montré que toutes pouvaient convenir aux différents scénarios smart grid, leurs performances variant en fonction des exigences des applications correspondantes (par exemple le délai, ou la bande passante). Se basant sur RPL, nous avons montré comment gérer plusieurs interfaces hétérogènes pour améliorer les performances d'un réseau smart grid, en proposant plusieurs approches différentes.

Par la simulation et l'expérimentation matérielle, nous avons pu confirmer les importants bénéfices que procurent les noeuds multiples interfaces dans un réseau smart grid. La solution orientée parent résout en grande partie les problèmes rencontrés dans la gestion d'interfaces multiples grâce à une approche simple tel que la solution orientée interface, et une façon innovante de traiter l'hétérogénéité comme le propose la solution multiples Instances.

## BIBLIOGRAPHY

---

- [AP10] Sanjay Ahuja and Pavan Potti. "An Introduction to RFID Technology." In: *Communications and Network* 2.3 (2010), pp. 183–186. DOI: [10.4236/cn.2010.23026](https://doi.org/10.4236/cn.2010.23026). URL: <https://doi.org/10.4236/cn.2010.23026>.
- [ASA15] Adnan Aijaz, Hongjia Su, and Abdol-Hamid Aghvami. "CORPL: A Routing Protocol for Cognitive Radio Enabled AMI Networks." In: *IEEE Trans. Smart Grid* 6.1 (2015), pp. 477–485. DOI: [10.1109/TSG.2014.2324022](https://doi.org/10.1109/TSG.2014.2324022). URL: <https://doi.org/10.1109/TSG.2014.2324022>.
- [ALF+15] Ala I. Al-Fuqaha, Mohsen Guizani, Mehdi Mohammadi, Mohammed Aledhari, and Moussa Ayyash. "Internet of Things: A Survey on Enabling Technologies, Protocols, and Applications." In: *IEEE Communications Surveys and Tutorials* 17.4 (2015), pp. 2347–2376. DOI: [10.1109/COMST.2015.2444095](https://doi.org/10.1109/COMST.2015.2444095). URL: <https://doi.org/10.1109/COMST.2015.2444095>.
- [AJA17] S. A. Alharthi, P. Johnson, and M. A. Alharthi. "IoT architecture and routing for MV and LV smart grid." In: *2017 Saudi Arabia Smart Grid (SASG)*. Dec. 2017, pp. 1–6. DOI: [10.1109/SASG.2017.8356507](https://doi.org/10.1109/SASG.2017.8356507).
- [Ana+18] Satish Anamalamudi, Mingui Zhang, Abdur Rashid Sangi, Charles E. Perkins, S.V.R Anand, and Bing Liu (Remy). "Asymmetric AODV-P2P-RPL in Low-Power and Lossy Networks (LLNs)." In: *draft-ietf-roll-aodv-rpl-04* (July 2018). Work in Progress. URL: <https://datatracker.ietf.org/doc/html/draft-ietf-roll-aodv-rpl-04>.
- [ABC12] E. Ancillotti, R. Bruno, and M. Conti. "RPL routing protocol in advanced metering infrastructures: An analysis of the unreliability problems." In: *2012 Sustainable Internet and ICT for Sustainability (SustainIT)*. Oct. 2012, pp. 1–10.
- [Anc+14] E. Ancillotti, R. Bruno, M. Conti, E. Mingozzi, and C. Vallati. "Trickle-L2: Lightweight link quality estimation through Trickle in RPL networks." In: *Proceeding of IEEE International Symposium on a World of Wireless, Mobile and Multimedia Networks 2014*. June 2014, pp. 1–9. DOI: [10.1109/WoWMoM.2014.6918951](https://doi.org/10.1109/WoWMoM.2014.6918951).
- [ABC13] Emilio Ancillotti, Raffaele Bruno, and Marco Conti. "The role of the RPL routing protocol for smart grid communications." In: *IEEE Communications Magazine* 51.1 (2013), pp. 75–83. DOI: [10.1109/MCOM.2013.6400442](https://doi.org/10.1109/MCOM.2013.6400442). URL: <https://doi.org/10.1109/MCOM.2013.6400442>.
- [ABC14] Emilio Ancillotti, Raffaele Bruno, and Marco Conti. "Reliable Data Delivery With the IETF Routing Protocol for Low-Power and Lossy Networks." In: *IEEE Trans. Industrial Informatics* 10.3 (2014), pp. 1864–1877. DOI: [10.1109/TII.2014.2332117](https://doi.org/10.1109/TII.2014.2332117).

- [Aug+16] Aloÿs Augustin, Jiazi Yi, Thomas H. Clausen, and William Mark Townsley. "A Study of LoRa: Long Range and Low Power Networks for the Internet of Things." In: *Sensors* 16.9 (2016), p. 1466. DOI: [10.3390/s16091466](https://doi.org/10.3390/s16091466). URL: <https://doi.org/10.3390/s16091466>.
- [Bac+12] Nouha Baccour, Anis Koubâa, Luca Mottola, Marco Antonio Zúñiga, Habib Youssef, Carlo Alberto Boano, and Mário Alves. "Radio Link Quality Estimation in Wireless Sensor Networks: A Survey." In: *ACM Trans. Sen. Netw.* 8.4 (Sept. 2012), 34:1–34:33. ISSN: 1550-4859. DOI: [10.1145/2240116.2240123](https://doi.org/10.1145/2240116.2240123). URL: <http://doi.acm.org/10.1145/2240116.2240123>.
- [Bad+07] Leonardo Badia, Marco Miozzo, Michele Rossi, and Michele Zorzi. "Routing schemes in heterogeneous wireless networks based on access advertisement and backward utilities for QoS support [Quality of Service based Routing Algorithms for Heterogeneous Networks]." In: *IEEE Communications Magazine* 45.2 (2007), pp. 67–73. DOI: [10.1109/MCOM.2007.313397](https://doi.org/10.1109/MCOM.2007.313397). URL: <https://doi.org/10.1109/MCOM.2007.313397>.
- [Bal+14] Oana Balmau, Dacfez Dzung, Abdulkadir Karaagac, Vukasin Nesovic, Aleksandar Paunovic, Yvonne Anne Pignolet, and Niloufar Alipour Tehrani. "Evaluation of RPL for medium voltage power line communication." In: *2014 IEEE International Conference on Smart Grid Communications (SmartGridComm)* (2014), pp. 446–451. DOI: [10.1109/SmartGridComm.2014.7007687](https://doi.org/10.1109/SmartGridComm.2014.7007687). URL: <http://ieeexplore.ieee.org/lpdocs/epic03/wrapper.htm?arnumber=7007687>.
- [Bar+13] Antimo Barbato, Marica Barrano, Antonio Capone, and Nicolo Figiani. "Resource oriented and energy efficient routing protocol for IPv6 wireless sensor networks." In: *IEEE Online Conference on Green Communications, OnlineGreenComm 2013, October 29-31, 2013*. 2013, pp. 163–168. DOI: [10.1109/OnlineGreenCom.2013.6731046](https://doi.org/10.1109/OnlineGreenCom.2013.6731046). URL: <https://doi.org/10.1109/OnlineGreenCom.2013.6731046>.
- [BCT11a] Leila Ben Saad, Cedric Chauvenet, and Bernard Tourancheau. "Heterogeneous IPv6 Infrastructure for Smart Energy Efficient Building." In: (Sept. 2011). URL: <https://hal.inria.fr/hal-00646061>.
- [BCT11b] Leila Ben Saad, Cedric Chauvenet, and Bernard Tourancheau. "Simulation of the RPL Routing Protocol for IPv6 Sensor Networks: two cases studies." In: *International Conference on Sensor Technologies and Applications SENSORCOMM 2011*. Nice, France: IARIA, Sept. 2011. URL: <https://hal.inria.fr/hal-00647869>.
- [BGD18] Y. Ben-Shimol, S. Greenberg, and K. Danilchenko. "Application-Layer Approach for Efficient Smart Meter Reading in Low-Voltage PLC Networks." In: *IEEE Transactions on Communications* (2018), pp. 1–1. ISSN: 0090-6778. DOI: [10.1109/TCOMM.2018.2828849](https://doi.org/10.1109/TCOMM.2018.2828849).
- [BZ17] Y. Ben-Shimol and Y. Zohar. "Routing in large realistic PLC smart-grids." In: (Apr. 2017), pp. 1–6. DOI: [10.1109/ISPLC.2017.7897115](https://doi.org/10.1109/ISPLC.2017.7897115).

- [Boc+18] P. Boccadoro, G. Piro, D. Striccoli, and L. A. Grieco. "Experimental Comparison of Industrial Internet of Things Protocol Stacks in Time Slotted Channel Hopping Scenarios." In: *2018 IEEE International Conference on Communications (ICC)*. May 2018, pp. 1–6. DOI: [10.1109/ICC.2018.8422899](https://doi.org/10.1109/ICC.2018.8422899).
- [Bol+11] R. Bolla, R. Bruschi, F. Davoli, and F. Cucchietti. "Energy Efficiency in the Future Internet: A Survey of Existing Approaches and Trends in Energy-Aware Fixed Network Infrastructures." In: *IEEE Communications Surveys Tutorials* 13.2 (Second 2011), pp. 223–244. ISSN: 1553-877X. DOI: [10.1109/SURV.2011.071410.00073](https://doi.org/10.1109/SURV.2011.071410.00073).
- [BMM12] F. Bouhafs, M. Mackay, and M. Merabti. "Links to the Future: Communication Requirements and Challenges in the Smart Grid." In: *IEEE Power and Energy Magazine* 10.1 (Jan. 2012), pp. 24–32. ISSN: 1540-7977. DOI: [10.1109/MPE.2011.943134](https://doi.org/10.1109/MPE.2011.943134).
- [BW97] G. Brasche and B. Walke. "Concepts, services, and protocols of the new GSM phase 2+ general packet radio service." In: *IEEE Communications Magazine* 35.8 (Aug. 1997), pp. 94–104. ISSN: 0163-6804. DOI: [10.1109/35.606036](https://doi.org/10.1109/35.606036).
- [Bus14] S. F. Bush. *Smart Grid: Communication-Enabled Intelligence for the Electric Power Grid*. Wiley-IEEE Press, 2014.
- [Cha+13] L. Chang, T. Lee, S. Chen, and C. Liao. "Energy-Efficient Oriented Routing Algorithm in Wireless Sensor Networks." In: *2013 IEEE International Conference on Systems, Man, and Cybernetics*. Oct. 2013, pp. 3813–3818. DOI: [10.1109/SMC.2013.651](https://doi.org/10.1109/SMC.2013.651).
- [Cha+10] C. Chauvenet, B. Tourancheau, D. Genon-Catalot, P.-E. Goudet, and M. Pouillot. "A Communication Stack over PLC for Multi Physical Layer IPv6 Networking." In: *Smart Grid Communications (SmartGridComm), 2010 First IEEE International Conference on* (2010), pp. 0–5. DOI: [10.1109/SMARTGRID.2010.5622052](https://doi.org/10.1109/SMARTGRID.2010.5622052).
- [DTC10] S. Dawson-Haggerty, A. Tavakoli, and D. Culler. "Hydro: A Hybrid Routing Protocol for Low-Power and Lossy Networks." In: *2010 First IEEE International Conference on Smart Grid Communications*. Oct. 2010, pp. 268–273. DOI: [10.1109/SMARTGRID.2010.5622053](https://doi.org/10.1109/SMARTGRID.2010.5622053).
- [DGF13] J. Duplex, S. Gosswiller, and S. Fagnoni. "A better knowledge of electricity consumption for residential customers through the Linky smart meter." In: *22nd International Conference and Exhibition on Electricity Distribution (CIRED 2013)*. June 2013, pp. 1–4. DOI: [10.1049/cp.2013.1188](https://doi.org/10.1049/cp.2013.1188).
- [Eks+06] H. Ekstrom, A. Furuskar, J. Karlsson, M. Meyer, S. Parkvall, J. Torsner, and M. Wahlqvist. "Technical solutions for the 3G long-term evolution." In: *IEEE Communications Magazine* 44.3 (Mar. 2006), pp. 38–45. ISSN: 0163-6804. DOI: [10.1109/MCOM.2006.1607864](https://doi.org/10.1109/MCOM.2006.1607864).



- [EKE15] Mina Elias, Ahmed Khattab, and Khaled M. F. Elsayed. "CORB: Context-aware opportunistic resource-based routing for stationary wireless sensor networks." In: *International Conference on Computing, Networking and Communications, ICNC 2015, Garden Grove, CA, USA, February 16-19, 2015*. 2015, pp. 166–170. DOI: [10.1109/ICCNC.2015.7069335](https://doi.org/10.1109/ICCNC.2015.7069335). URL: <https://doi.org/10.1109/ICCNC.2015.7069335>.
- [Erg+15] G. Ergeerts, M. Nikodem, D. Subotic, T. Surmacz, B. Wojciechowski, P. D. Meulenaere, and M. Weyn. "DASH7 Alliance Protocol in Monitoring Applications." In: *2015 10th International Conference on P2P, Parallel, Grid, Cloud and Internet Computing (3PGCIC)*. Nov. 2015, pp. 623–628. DOI: [10.1109/3PGCIC.2015.93](https://doi.org/10.1109/3PGCIC.2015.93).
- [Eur15] Eurelectric. *Power Statistics and Trends: The Five Dimensions of the Energy Union*. <http://www.eurelectric.org/media/249736/power-statistics-and-trends-the-five-dimensions-of-the-energy-union-lr-2015-030-0641-01-e.pdf>. Accessed on: 2016-11-04. 2015.
- [FDA14] Simone Ferlin, Thomas Dreiholz, and Ozgu Alay. "Multi-path transport over heterogeneous wireless networks: Does it really pay off?" In: *IEEE Global Communications Conference, GLOBECOM 2014, Austin, TX, USA, December 8-12, 2014*. 2014, pp. 4807–4813. DOI: [10.1109/GLOCOM.2014.7037567](https://doi.org/10.1109/GLOCOM.2014.7037567). URL: <https://doi.org/10.1109/GLOCOM.2014.7037567>.
- [For+13] Alan Ford, Costin Raiciu, Mark J. Handley, and Olivier Bonaventure. *TCP Extensions for Multipath Operation with Multiple Addresses*. RFC 6824. Jan. 2013. DOI: [10.17487/RFC6824](https://doi.org/10.17487/RFC6824). URL: <https://rfc-editor.org/rfc/rfc6824.txt>.
- [FTH16] Colin Funai, Cristiano Tapparello, and Wendi B. Heinzelman. "Supporting Multi-hop Device-to-Device Networks Through WiFi Direct Multi-group Networking." In: *CoRR abs/1601.00028 (2016)*. arXiv: [1601.00028](https://arxiv.org/abs/1601.00028). URL: <http://arxiv.org/abs/1601.00028>.
- [Gad+14] O. Gaddour, A. Koubâa, N. Baccour, and M. Abid. "OF-FL: QoS-aware fuzzy logic objective function for the RPL routing protocol." In: *2014 12th International Symposium on Modeling and Optimization in Mobile, Ad Hoc, and Wireless Networks (WiOpt)*. May 2014, pp. 365–372. DOI: [10.1109/WIOPT.2014.6850321](https://doi.org/10.1109/WIOPT.2014.6850321).
- [GSW11] S. Galli, A. Scaglione, and Z. Wang. "For the Grid and Through the Grid: The Role of Power Line Communications in the Smart Grid." In: *Proceedings of the IEEE* 99.6 (June 2011), pp. 998–1027. ISSN: 0018-9219.
- [Gho+10] Amitava Ghosh, Rapeepat Ratasuk, Bishwarup Mondal, Nitin Mangalvedhe, and Timothy A. Thomas. "LTE-advanced: next-generation wireless broadband technology [Invited Paper]." In: *IEEE Wireless Commun.* 17.3 (2010), pp. 10–22. DOI: [10.1109/MWC.2010.5490974](https://doi.org/10.1109/MWC.2010.5490974). URL: <https://doi.org/10.1109/MWC.2010.5490974>.
- [GL12] O. Gnawali and P. Levis. *The Minimum Rank with Hysteresis Objective Function*. RFC 6719 (Proposed Standard). Internet Engineering Task Force, Sept. 2012. URL: <http://www.ietf.org/rfc/rfc6719.txt>.

- [GP10] Carles Gomez and Josep Paradells. "Wireless home automation networks: A survey of architectures and technologies." In: *IEEE Communications Magazine* 48.6 (2010), pp. 92–101. DOI: [10.1109/MCOM.2010.5473869](https://doi.org/10.1109/MCOM.2010.5473869). URL: <https://doi.org/10.1109/MCOM.2010.5473869>.
- [Gre+14] Christopher Greer et al. "NIST framework and roadmap for smart grid interoperability standards, Release 3.0." In: *NIST*. Vol. Special Publication (NIST SP). 1108r3. Oct. 2014.
- [Gua+14] L. Guan, K. Kuladinithi, T. Pötsch, and C. Goerg. "A deeper understanding of interoperability between TinyRPL and ContikiRPL." In: *2014 IEEE Ninth International Conference on Intelligent Sensors, Sensor Networks and Information Processing (ISSNIP)*. Apr. 2014, pp. 1–6. DOI: [10.1109/ISSNIP.2014.6827680](https://doi.org/10.1109/ISSNIP.2014.6827680).
- [Gun+13] Vehbi Cagri Gungor, Dilan Sahin, Taskin Koçak, Salih Ergüt, Concettina Buccella, Carlo Cecati, and Gerhard P. Hancke. "A Survey on Smart Grid Potential Applications and Communication Requirements." In: *IEEE Trans. Industrial Informatics* 9.1 (2013), pp. 28–42. DOI: [10.1109/TII.2012.2218253](https://doi.org/10.1109/TII.2012.2218253). URL: <https://doi.org/10.1109/TII.2012.2218253>.
- [Hab+17] Guillaume Habault, Maxime Lefrancois, François Lemerrier, Nicolas Montavont, Periklis Chatzimisios, and Georgios Z. Papadopoulos. "Monitoring Traffic Optimization in a Smart Grid." In: *IEEE Trans. Industrial Informatics* 13.6 (2017), pp. 3246–3255. DOI: [10.1109/TII.2017.2742584](https://doi.org/10.1109/TII.2017.2742584). URL: <https://doi.org/10.1109/TII.2017.2742584>.
- [HM13] Karel Heurtefeux and Hamid Menouar. "Experimental evaluation of a routing protocol for wireless sensor networks: RPL under study." In: *6th Joint IFIP Wireless and Mobile Networking Conference, WMNC 2013, Dubai, United Arab Emirates, 23-25 April, 2013*. 2013, pp. 1–4. DOI: [10.1109/WMNC.2013.6548990](https://doi.org/10.1109/WMNC.2013.6548990). URL: <https://doi.org/10.1109/WMNC.2013.6548990>.
- [IEE16] IEEE Computer Society. *IEEE Draft Standard for Information Technology-Telecommunications and Information Exchange Between Systems-Local and Metropolitan Area Networks-Specific Requirements-Part 11: Wireless LAN Medium Access Control (MAC) and Physical Layer (PHY) Specifications: Amendment 2: Sub 1 GHz License Exempt Operation*. Draft. Sept. 2016.
- [ING18] INGENU. *INGENU-RPMA specifications*. <https://www.ingenu.com/technology/rpma/>. Accessed: 2018-09-24. 2018.
- [ITN13] Oana-Teodora Iova, Fabrice Theoleyre, and Thomas Noël. "Stability and efficiency of RPL under realistic conditions in Wireless Sensor Networks." In: *24th IEEE Annual International Symposium on Personal, Indoor, and Mobile Radio Communications, PIMRC 2013, London, United Kingdom, September 8-11, 2013*. 2013, pp. 2098–2102. DOI: [10.1109/PIMRC.2013.6666490](https://doi.org/10.1109/PIMRC.2013.6666490). URL: <https://doi.org/10.1109/PIMRC.2013.6666490>.
- [Iwa+10] T. Iwao, K. Yamada, M. Yura, Y. Nakaya, A. A. Cardenas, S. Lee, and R. Masuoka. "Dynamic Data Forwarding in Wireless Mesh Networks." In: *2010 First IEEE International Conference on Smart Grid Communications*. Oct. 2010, pp. 385–390. DOI: [10.1109/SMARTGRID.2010.5622074](https://doi.org/10.1109/SMARTGRID.2010.5622074).

- [IAC13] Gopalakrishnan Iyer, Prathima Agrawal, and Ruben Salazar Cardozo. "Performance comparison of routing protocols over smart utility networks: A simulation study." In: *Workshops Proceedings of the Global Communications Conference, GLOBECOM2013, Atlanta, GA, USA, December 9-13, 2013*. 2013, pp. 969–973. DOI: [10.1109/GLOCOMW.2013.6825116](https://doi.org/10.1109/GLOCOMW.2013.6825116). URL: <https://doi.org/10.1109/GLOCOMW.2013.6825116>.
- [JCI13] J. Yi, T. Clausen, and Y. Igarashi. "Evaluation of routing protocol for low power and lossy networks: LOADng and RPL." In: *IEEE Conf. Wireless Sensor (ICWISE)*. IEEE, 2013, pp. 19–24.
- [KBS17] Ines Kechiche, Inès Bousnina, and Abdelaziz Samet. "A comparative study of RPL objective functions." In: *Sixth International Conference on Communications and Networking, ComNet 2017, Hammamet, Tunisia, March 29 - April 1, 2017*. 2017, pp. 1–6. DOI: [10.1109/COMNET.2017.8285595](https://doi.org/10.1109/COMNET.2017.8285595). URL: <https://doi.org/10.1109/COMNET.2017.8285595>.
- [Kim+17] Hyung-Sin Kim, Hongchan Kim, Jeongyeup Paek, and Saewoong Bahk. "Load Balancing Under Heavy Traffic in RPL Routing Protocol for Low Power and Lossy Networks." In: *IEEE Trans. Mob. Comput.* 16.4 (2017), pp. 964–979. DOI: [10.1109/TMC.2016.2585107](https://doi.org/10.1109/TMC.2016.2585107). URL: <https://doi.org/10.1109/TMC.2016.2585107>.
- [KBK11] Yocheol Kim, Jung Nam Bae, and Jin Young Kim. "Performance of power line communication systems with noise reduction scheme for smart grid applications." In: *IEEE Trans. Consumer Electronics* 57.1 (2011), pp. 46–52. DOI: [10.1109/TCE.2011.5735480](https://doi.org/10.1109/TCE.2011.5735480). URL: <https://doi.org/10.1109/TCE.2011.5735480>.
- [Kot+17] Vasileios Kotsiou, Georgios Z. Papadopoulos, Periklis Chatzimisios, and Fabrice Theoleyre. "Is Local Blacklisting Relevant in Slow Channel Hopping Low-Power Wireless Networks?" In: *Proc. of the IEEE ICC*. 2017.
- [Ksh09] R. S. Kshetrimayum. "An introduction to UWB communication systems." In: *IEEE Potentials* 28.2 (Mar. 2009), pp. 9–13. ISSN: 0278-6648. DOI: [10.1109/MPOT.2009.931847](https://doi.org/10.1109/MPOT.2009.931847).
- [KPR14] Murat Kuzlu, Manisa Pipattanasomporn, and Saifur Rahman. "Communication network requirements for major smart grid applications in HAN, NAN and WAN." In: *Computer Networks* 67 (2014), pp. 74–88. DOI: [10.1016/j.comnet.2014.03.029](https://doi.org/10.1016/j.comnet.2014.03.029). URL: <https://doi.org/10.1016/j.comnet.2014.03.029>.
- [LHG13] C. La, M. Heusse, and A. D. Grenoble. "Link reversal and reactive routing in Low Power and Lossy Networks." In: *2013 IEEE 24th Annual International Symposium on Personal, Indoor, and Mobile Radio Communications (PIMRC)*. Sept. 2013, pp. 3386–3390. DOI: [10.1109/PIMRC.2013.6666733](https://doi.org/10.1109/PIMRC.2013.6666733).

- [Lem+17] Francois Lemerrier, G. Habault, G. Z. Papadopoulos, P. Maille, P. Chatzimisios, and N. Montavont. "Communication architectures and technologies for advanced Smart Grid Services." In: *Transportation and Power Grid in Smart Cities: Communication Networks and Services*. UK: John Wiley, 2017. Chap. 8.
- [LM18] François Lemerrier and Nicolas Montavont. "Performance Evaluation of a RPL Hybrid Objective Function for the Smart Grid Network." In: *Ad-hoc, Mobile, and Wireless Networks - 17th International Conference on Ad Hoc Networks and Wireless, ADHOC-NOW 2018, Saint-Malo, France, September 5-7, 2018, Proceedings*. 2018, pp. 27–38. DOI: [10.1007/978-3-030-00247-3\\_3](https://doi.org/10.1007/978-3-030-00247-3_3). URL: [https://doi.org/10.1007/978-3-030-00247-3%5C\\_3](https://doi.org/10.1007/978-3-030-00247-3%5C_3).
- [Lem+18] François Lemerrier, Nicolas Montavont, Laurent Toutain, and Philippe Chiummiento. "A New Objective Function for Hybrid Network in the Smart Grid." In: *19th IEEE International Symposium on "A World of Wireless, Mobile and Multimedia Networks", WoWMoM 2018, Chania, Greece, June 12-15, 2018*. 2018, pp. 14–16. DOI: [10.1109/WoWMoM.2018.8449744](https://doi.org/10.1109/WoWMoM.2018.8449744). URL: <https://doi.org/10.1109/WoWMoM.2018.8449744>.
- [Lem+16] François Lemerrier, Nicolas Montavont, Laurent Toutain, Kumaran Vijayasankar, Ramanuja Vedantham, and Philippe Chiummiento Itron. "Support for hybrid network in RPL." In: *2016 IEEE International Conference on Smart Grid Communications, SmartGridComm 2016, Sydney, Australia, November 6-9, 2016*. 2016, pp. 527–532. DOI: [10.1109/SmartGridComm.2016.7778815](https://doi.org/10.1109/SmartGridComm.2016.7778815). URL: <https://doi.org/10.1109/SmartGridComm.2016.7778815>.
- [Léo+16] C. Léonard, S. Chartres, F. Chiappini, M. Drouineau, A. Nekrassov, and N. Hadjsaïd. "Methodology, results and key success factors of Smart grid assessment in France." In: *2016 IEEE Power and Energy Society General Meeting (PESGM)*. July 2016, pp. 1–5. DOI: [10.1109/PESGM.2016.7741856](https://doi.org/10.1109/PESGM.2016.7741856).
- [Lev+11] P. Levis, T. Clausen, J. Hui, O. Gnawali, and J. Ko. *The Trickle Algorithm*. RFC 6206. Mar. 2011.
- [Lon+13] Nguyen Thanh Long, Marie-Paule Uwase, Jacques Tiberghien, and Kris Steenhaut. "QoS-aware cross-layer mechanism for multiple instances RPL." In: *2013 International Conference on Advanced Technologies for Communications (ATC 2013)* (2013), pp. 44–49. ISSN: 21621039. DOI: [10.1109/ATC.2013.6698074](https://doi.org/10.1109/ATC.2013.6698074). URL: <http://ieeexplore.ieee.org/lpdocs/epic03/wrapper.htm?arnumber=6698074>.
- [MM84] S. T. Mak and T. G. Moore. "TWACS<sup>TM</sup>, A New Viable Two-Way Automatic Communication System for Distribution Networks. Part II: Inbound Communication." In: *IEEE Transactions on Power Apparatus and Systems PAS-103.8* (Aug. 1984), pp. 2141–2147. ISSN: 0018-9510. DOI: [10.1109/TPAS.1984.318524](https://doi.org/10.1109/TPAS.1984.318524).

- [MR82] S. T. Mak and D. L. Reed. "TWACS, A New Viable Two-Way Automatic Communication System for Distribution Networks. Part I: Outbound Communication." In: *IEEE Transactions on Power Apparatus and Systems* PAS-101.8 (Aug. 1982), pp. 2941–2949. ISSN: 0018-9510. DOI: [10.1109/TPAS.1982.317621](https://doi.org/10.1109/TPAS.1982.317621).
- [Mar+10] Jerry Martocci, Pieter Mil, Nicolas Riou, and Wouter Vermeulen. *Building Automation Routing Requirements in Low-Power and Lossy Networks*. RFC 5867. June 2010. DOI: [10.17487/RFC5867](https://doi.org/10.17487/RFC5867). URL: <https://rfc-editor.org/rfc/rfc5867.txt>.
- [McDo05] P. McDermott-Wells. "What is Bluetooth?" In: *IEEE Potentials* 23.5 (Dec. 2005), pp. 33–35. ISSN: 0278-6648. DOI: [10.1109/MP.2005.1368913](https://doi.org/10.1109/MP.2005.1368913).
- [Mül+10] Christian Müller, Sebastian Subik, Andreas Wolff, and Christian Wietfeld. "A system design framework for scalability analysis of geographic routing algorithms in large-scale mesh networks." In: *3rd International Conference on Simulation Tools and Techniques, SIMUTools '10, Malaga, Spain - March 16 - 18, 2010*. 2010, p. 23. DOI: [10.4108/ICST.SIMUT00LS2010.8717](https://doi.org/10.4108/ICST.SIMUT00LS2010.8717). URL: <https://doi.org/10.4108/ICST.SIMUT00LS2010.8717>.
- [Oli+16] L. G. de Oliveira, G. R. Colen, M. V. Ribeiro, and A. J. H. Vinck. "Narrow-band interference error correction in coded OFDM-based PLC systems." In: (Mar. 2016), pp. 13–18. DOI: [10.1109/ISPLC.2016.7476279](https://doi.org/10.1109/ISPLC.2016.7476279).
- [Paa+12] Christoph Paasch, Gregory Detal, Fabien Duchene, Costin Raiciu, and Olivier Bonaventure. "Exploring Mobile/WiFi Handover with Multipath TCP." In: *Proceedings of the 2012 ACM SIGCOMM Workshop on Cellular Networks: Operations, Challenges, and Future Design*. CellNet '12. Helsinki, Finland: ACM, 2012, pp. 31–36. ISBN: 978-1-4503-1475-6. DOI: [10.1145/2342468.2342476](https://doi.org/10.1145/2342468.2342476). URL: <http://doi.acm.org/10.1145/2342468.2342476>.
- [Pap+17] Georgios Z. Papadopoulos, Antoine Gallais, Guillaume Schreiner, Emery Jou, and Thomas Noel. "Thorough IoT testbed Characterization: from Proof-of-concept to Repeatable Experimentations." In: *Computer Networks* 119 (2017), pp. 86–101.
- [PBD03] Charles E. Perkins, Elizabeth M. Belding-Royer, and Samir R. Das. "Ad hoc On-Demand Distance Vector (AODV) Routing." In: *RFC 3561* (2003), pp. 1–37. DOI: [10.17487/RFC3561](https://doi.org/10.17487/RFC3561). URL: <https://doi.org/10.17487/RFC3561>.
- [Pig+12] Yvonne Anne Pignolet, Ilias Rinis, Dacfez Dzung, and Abdulkadir Karaagac. "Heterogeneous multi-interface routing: networking stack and simulator extensions." In: (2012), pp. 1–6. DOI: [10.1109/MASS.2012.6708526](https://doi.org/10.1109/MASS.2012.6708526). URL: <https://doi.org/10.1109/MASS.2012.6708526>.
- [Pis+09] Kris Pister, Tom Phinney, Pascal Thubert, and Sicco Dwaras. *Industrial Routing Requirements in Low-Power and Lossy Networks*. RFC 5673. Oct. 2009. DOI: [10.17487/RFC5673](https://doi.org/10.17487/RFC5673). URL: <https://rfc-editor.org/rfc/rfc5673.txt>.

- [PBB10] Giorgio Porcu, Jakob Buron, and Anders Brandt. *Home Automation Routing Requirements in Low-Power and Lossy Networks*. RFC 5826. Apr. 2010. DOI: [10.17487/RFC5826](https://doi.org/10.17487/RFC5826). URL: <https://rfc-editor.org/rfc/rfc5826.txt>.
- [RM11] M. M. Rahman and A. Mto. "Technologies required for efficient operation of a smart meter network." In: *2011 6th IEEE Conference on Industrial Electronics and Applications*. June 2011, pp. 809–814. DOI: [10.1109/ICIEA.2011.5975697](https://doi.org/10.1109/ICIEA.2011.5975697).
- [Rek+16] Sana Rekik, Nouha Baccour, Mohamed Jmaiel, and Khalil Drira. "Holistic link quality estimation-based routing metric for RPL networks in smart grids." In: *27th IEEE Annual International Symposium on Personal, Indoor, and Mobile Radio Communications, PIMRC 2016, Valencia, Spain, September 4-8, 2016*. 2016, pp. 1–6. DOI: [10.1109/PIMRC.2016.7794925](https://doi.org/10.1109/PIMRC.2016.7794925). URL: <https://doi.org/10.1109/PIMRC.2016.7794925>.
- [Ren+16] Joao R. R. Renofio, Marcelo Eduardo Pellenz, Edgard Jamhour, Altair Olivo Santin, Manoel Camillo Penna, and Richard Demo Souza. "On the dynamics of the RPL protocol in AMI networks under jamming attacks." In: *2016 IEEE International Conference on Communications, ICC 2016, Kuala Lumpur, Malaysia, May 22-27, 2016*. 2016, pp. 1–6. DOI: [10.1109/ICC.2016.7511150](https://doi.org/10.1109/ICC.2016.7511150). URL: <https://doi.org/10.1109/ICC.2016.7511150>.
- [Rop+13] T. Ropitault, A. Lampropulos, R. Vedantham, and P. Chiummiento. "Realistic model for narrowband PLC for advanced metering infrastructure." In: *2013 IEEE International Conference on Smart Grid Communications (SmartGridComm)*. Oct. 2013, pp. 624–629. DOI: [10.1109/SmartGridComm.2013.6688028](https://doi.org/10.1109/SmartGridComm.2013.6688028).
- [Rop+15] T. Ropitault, A. Pelov, L. Toutain, R. Vedantham, and P. C. Itron. "Channel occupancy - Faster, better, stronger." In: *2015 IEEE International Conference on Smart Grid Communications (SmartGridComm)*. Nov. 2015, pp. 695–700. DOI: [10.1109/SmartGridComm.2015.7436382](https://doi.org/10.1109/SmartGridComm.2015.7436382).
- [Rop+14] Tanguy Ropitault, Alejandro Lampropulos, Alexander Pelov, Laurent Toutain, Ramanuja Vedantham, and Philippe Chiummiento. "Doing it right - Recommendations for RPL in PLC-based networks for the Smart Grid." In: (2014), pp. 452–457. DOI: [10.1109/SmartGridComm.2014.7007688](https://doi.org/10.1109/SmartGridComm.2014.7007688). URL: <https://doi.org/10.1109/SmartGridComm.2014.7007688>.
- [RAB13] A. J. Roscoe, I. F. Abdulhadi, and G. M. Burt. "P and M Class Phasor Measurement Unit Algorithms Using Adaptive Cascaded Filters." In: *IEEE Transactions on Power Delivery* 28.3 (July 2013), pp. 1447–1459. ISSN: 0885-8977. DOI: [10.1109/TPWRD.2013.2238256](https://doi.org/10.1109/TPWRD.2013.2238256).
- [SAU12] Nico Saputro, Kemal Akkaya, and Suleyman Uludag. "A survey of routing protocols for smart grid communications." In: *Computer Networks* 56.11 (2012), pp. 2742–2771. DOI: [10.1016/j.comnet.2012.03.027](https://doi.org/10.1016/j.comnet.2012.03.027). URL: <https://doi.org/10.1016/j.comnet.2012.03.027>.

- [Saw+12] Hisashi Sawada, Hiroshi Kuriyamat, Naoki Yusat, Tadanori Mizuno, and Hiroshi Mineno. "Mutually Complementary Communication Protocol based on Destination Oriented Directed Acyclic Graph." In: (2012), pp. 275–279.
- [Sie+12] Matti Siekkinen, Markus Hienkari, Jukka K. Nurminen, and Johanna Nieminen. "How low energy is bluetooth low energy? Comparative measurements with ZigBee/802.15.4." In: *2012 IEEE Wireless Communications and Networking Conference Workshops, WCNC Workshops 2012, Paris, France, April 1, 2012*. 2012, pp. 232–237. DOI: [10.1109/WCNCW.2012.6215496](https://doi.org/10.1109/WCNCW.2012.6215496). URL: <https://doi.org/10.1109/WCNCW.2012.6215496>.
- [SE11] Eric Sortomme and Mohamed A. El-Sharkawi. "Optimal Charging Strategies for Unidirectional Vehicle-to-Grid." In: *IEEE Trans. Smart Grid* 2.1 (2011), pp. 131–138. DOI: [10.1109/TSG.2010.2090910](https://doi.org/10.1109/TSG.2010.2090910). URL: <https://doi.org/10.1109/TSG.2010.2090910>.
- [TD09] Arsalan Tavakoli and Stephen Dawson-Haggerty. *Overview of Existing Routing Protocols for Low Power and Lossy Networks*. Internet-Draft draft-ietf-roll-protocols-survey-07. Work in Progress. Internet Engineering Task Force, Apr. 2009. 26 pp. URL: <https://datatracker.ietf.org/doc/html/draft-ietf-roll-protocols-survey-07>.
- [Thu12] P. Thubert. *Objective Function Zero for the Routing Protocol for Low-Power and Lossy Networks (RPL)*. RFC 6552 (Proposed Standard). Internet Engineering Task Force, Mar. 2012.
- [TOV10] J. Tripathi, J. C. de Oliveira, and J. P. Vasseur. "Applicability Study of RPL with Local Repair in Smart Grid Substation Networks." In: *2010 First IEEE International Conference on Smart Grid Communications*. Oct. 2010, pp. 262–267. DOI: [10.1109/SMARTGRID.2010.5622054](https://doi.org/10.1109/SMARTGRID.2010.5622054).
- [TO13] Joydeep Tripathi and Jaudelice Cavalcante de Oliveira. "On adaptive timers for improved RPL operation in low-power and lossy sensor networks." In: *Fifth International Conference on Communication Systems and Networks, COMSNETS 2013, Bangalore, India, January 7-10, 2013*. 2013, pp. 1–10. DOI: [10.1109/COMSNETS.2013.6465581](https://doi.org/10.1109/COMSNETS.2013.6465581). URL: <https://doi.org/10.1109/COMSNETS.2013.6465581>.
- [Vas+12a] J.P. Vasseur, M. Kim, K. Pister, N. Dejean, and D. Barthel. *Routing Metrics Used for Path Calculation in Low-Power and Lossy Networks*. RFC 6551. Mar. 2012.
- [Vas+12b] JP. Vasseur, M. Kim, K. Pister, N. Dejean, and D. Barthel. *Routing Metrics Used for Path Calculation in Low-Power and Lossy Networks*. RFC 6551 (Proposed Standard). Internet Engineering Task Force, Mar. 2012. URL: <http://www.ietf.org/rfc/rfc6551.txt>.
- [VC07] JP Vasseur and Dave L. Cullerot. *Routing Requirements for Low Power And Lossy Networks*. Internet-Draft draft-culler-rl2n-routing-reqs-01. Work in Progress. Internet Engineering Task Force, July 2007. 11 pp. URL: <https://datatracker.ietf.org/doc/html/draft-culler-rl2n-routing-reqs-01>.

- [Vej+17] Benny Vejlgaard, Mads Lauridsen, Huan Nguyen, István Z. Kovács, Preben Mogensen, and Mads Sørensen. "Coverage and Capacity Analysis of Sigfox, LoRa, GPRS, and NB-IoT." In: *85th IEEE Vehicular Technology Conference, VTC Spring 2017, Sydney, Australia, June 4-7, 2017*. 2017, pp. 1–5. DOI: [10.1109/VTCspring.2017.8108666](https://doi.org/10.1109/VTCspring.2017.8108666). URL: <https://doi.org/10.1109/VTCspring.2017.8108666>.
- [VTD14] Malisa Vucinic, Bernard Tourancheau, and Andrzej Duda. "Performance Comparison of the RPL and LOADng Routing Protocols in a Home Automation Scenario." In: *CoRR abs/1401.0997* (2014). arXiv: [1401.0997](https://arxiv.org/abs/1401.0997). URL: <http://arxiv.org/abs/1401.0997>.
- [Wan+10] D. Wang, Z. Tao, J. Zhang, and A. A. Abouzeid. "RPL Based Routing for Advanced Metering Infrastructure in Smart Grid." In: *2010 IEEE International Conference on Communications Workshops*. May 2010, pp. 1–6. DOI: [10.1109/ICCW.2010.5503924](https://doi.org/10.1109/ICCW.2010.5503924).
- [Wan11] Roy Want. "Near Field Communication." In: *IEEE Pervasive Computing* 10.3 (2011), pp. 4–7. DOI: [10.1109/MPRV.2011.55](https://doi.org/10.1109/MPRV.2011.55). URL: <https://doi.org/10.1109/MPRV.2011.55>.
- [Wat+09] Thomas Watteyne, Tim Winter, Dominique Barthel, and Mischa Dohler. *Routing Requirements for Urban Low-Power and Lossy Networks*. RFC 5548. May 2009. DOI: [10.17487/RFC5548](https://doi.org/10.17487/RFC5548). URL: <https://rfc-editor.org/rfc/rfc5548.txt>.
- [Wei18] Weightless. *Weightless specifications*. <http://www.weightless.org/>. Accessed: 2018-09-24. 2018.
- [Win+12a] T. Winter, P. Thubert, A. Brandt, J. Hui, R. Kelsey, P. Levis, K. Pister, R. Struik, JP. Vasseur, and R. Alexander. *RPL: IPv6 Routing Protocol for Low-Power and Lossy Networks*. RFC 6550 (Proposed Standard). Internet Engineering Task Force, Mar. 2012.
- [Win+12b] T. Winter, P. Thubert, A. Brandt, J. Hui, R. Kelsey, P. Levis, K. Pister, R. Struik, JP. Vasseur, and Alexander R. *RPL: IPv6 Routing Protocol for Low-Power and Lossy Networks*. RFC 6550. 2012.
- [09] "Wireless Systems for Industrial Automation: Process Control and Related Applications (ISA100.11a), International Society of Automation (ISA), Sep. 2009." In: *ANSI/ISA-100.11a-2011* (2009), pp. 1–792.
- [Yan+13] Ye Yan, Yi Qian, Hamid Sharif, and David Tipper. "A Survey on Smart Grid Communication Infrastructures: Motivations, Requirements and Challenges." In: *IEEE Communications Surveys and Tutorials* 15.1 (2013), pp. 5–20. DOI: [10.1109/SURV.2012.021312.00034](https://doi.org/10.1109/SURV.2012.021312.00034). URL: <https://doi.org/10.1109/SURV.2012.021312.00034>.
- [Yan+17a] Zhutian Yang, Yiming Gu, Zhilu Wu, Nan Zhao, and Xianbin Wang. "An Energy-Efficient Routing Protocol for Cognitive Radio Enabled AMI Networks in Smart Grid." In: *86th IEEE Vehicular Technology Conference, VTC Fall 2017, Toronto, ON, Canada, September 24-27, 2017*. 2017, pp. 1–5. DOI: [10.1109/VTCfall.2017.8287965](https://doi.org/10.1109/VTCfall.2017.8287965). URL: <https://doi.org/10.1109/VTCfall.2017.8287965>.



- [Yan+18] Zhutian Yang, Shuyu Ping, Adnan Aijaz, and Abdol-Hamid Aghvami. "A Global Optimization-Based Routing Protocol for Cognitive-Radio-Enabled Smart Grid AMI Networks." In: *IEEE Systems Journal* 12.1 (2018), pp. 1015–1023. DOI: [10.1109/JSYST.2016.2580616](https://doi.org/10.1109/JSYST.2016.2580616). URL: <https://doi.org/10.1109/JSYST.2016.2580616>.
- [Yan+17b] Zhutian Yang, Shuyu Ping, Hongjian Sun, and Abdol-Hamid Aghvami. "CRB-RPL: A Receiver-Based Routing Protocol for Communications in Cognitive Radio Enabled Smart Grid." In: *IEEE Trans. Vehicular Technology* 66.7 (2017), pp. 5985–5994. DOI: [10.1109/TVT.2016.2617874](https://doi.org/10.1109/TVT.2016.2617874). URL: <https://doi.org/10.1109/TVT.2016.2617874>.
- [YK13] M. Yilmaz and P. T. Krein. "Review of the Impact of Vehicle-to-Grid Technologies on Distribution Systems and Utility Interfaces." In: *IEEE Transactions on Power Electronics* 28.12 (Dec. 2013), pp. 5673–5689. ISSN: 0885-8993. DOI: [10.1109/TPEL.2012.2227500](https://doi.org/10.1109/TPEL.2012.2227500).
- [ZGL13] J. Zheng, D. W. Gao, and L. Lin. "Smart Meters in Smart Grid: An Overview." In: (Apr. 2013), pp. 57–64. ISSN: 2166-5478. DOI: [10.1109/GreenTech.2013.17](https://doi.org/10.1109/GreenTech.2013.17).
- [ZDo2] M. Zimmermann and K. Dostert. "Analysis and modeling of impulsive noise in broad-band powerline communications." In: *IEEE Transactions on Electromagnetic Compatibility* 44.1 (Feb. 2002), pp. 249–258. ISSN: 0018-9375. DOI: [10.1109/15.990732](https://doi.org/10.1109/15.990732).



---

**Titre : Gestion d'interface multiple dans les réseaux smart grids.**

**Mot clés :** Routage, Réseau Smart grid, Réseaux hétérogènes, RPL, Internet des objets

**Résumé :** Le réseau électrique a subi d'importantes évolutions ces dernières décennies, pour devenir ce qu'on appelle le Smart Grid. Le réseau électrique évolue actuellement d'une architecture centralisée vers une architecture décentralisée, tenant compte des consommations et sources d'énergies à caractère imprédictible et irrégulier. L'Advanced Metering Infrastructure est une architecture clé du Smart Grid qui permet des communications bidirectionnelles entre le consommateur et le fournisseur d'énergie. Les réseaux de compteurs intelligents qui constituent notamment cette architecture reposent communément sur des communications à courant porteur, une technologie qui est hautement sensible aux interférences. Malgré

l'utilisation de protocoles de niveau 2 spécifiques, les technologies employées ne permettent pas de respecter les exigences de toutes les applications Smart grid. La plupart des technologies considérées pour les réseaux de compteurs intelligents sont de courte portée, chaque compteur ne peut communiquer directement avec le concentrateur. Les noeuds doivent collaborer entre eux, utilisant un protocole de routage tel que RPL pour atteindre la destination. Le but de cette thèse est d'adapter RPL à un environnement multi interfaces, et étudier comment l'hétérogénéité des interfaces peut améliorer la fiabilité et les performances d'un réseau de compteurs intelligents.

---

**Titre : Multiple Interface Management in Smart Grid Networks**

**Keywords :** Routing, Smart grid, Heterogeneous networks, RPL, IoT

**Abstract :** Since decades, the power grid is undergoing a tremendous evolution, toward what is called the Smart Grid. The grid is actually evolving from a centralized architecture to a decentralized one, taking into account all the unpredictable sources and consumption. The Advanced Metering Infrastructure is the network dedicated to the Smart Grid that allows two-ways communications between the consumers and the energy providers. Smart Meters networks, that are part of this architecture, rely on powerline communications, a technology that is highly sensitive to interference.

Despite dedicated layer 2 protocols, the employed technologies cannot fulfill most of smart grid applications requirements. The majority of smart meter network technology candidates are short range, each meter cannot reach the concentrator in one hop. Nodes need to collaborate, using a routing protocol like RPL to reach the destination. The goal of this thesis is to modify RPL to a multi interfaces environment, and study how interface heterogeneity could increase the reliability and the performance of a smart meter network.