



**HAL**  
open science

# Interactive and connected rehabilitation systems for e-health

Halim Elie Tannous

► **To cite this version:**

Halim Elie Tannous. Interactive and connected rehabilitation systems for e-health. Biomechanics [physics.med-ph]. Université de Technologie de Compiègne, 2018. English. NNT : 2018COMP2436 . tel-02097103

**HAL Id: tel-02097103**

**<https://theses.hal.science/tel-02097103>**

Submitted on 11 Apr 2019

**HAL** is a multi-disciplinary open access archive for the deposit and dissemination of scientific research documents, whether they are published or not. The documents may come from teaching and research institutions in France or abroad, or from public or private research centers.

L'archive ouverte pluridisciplinaire **HAL**, est destinée au dépôt et à la diffusion de documents scientifiques de niveau recherche, publiés ou non, émanant des établissements d'enseignement et de recherche français ou étrangers, des laboratoires publics ou privés.

Par Halim Elie TANNOUS

*Interactive and connected rehabilitation systems for e-health*

Thèse présentée  
pour l'obtention du grade  
de Docteur de l'UTC

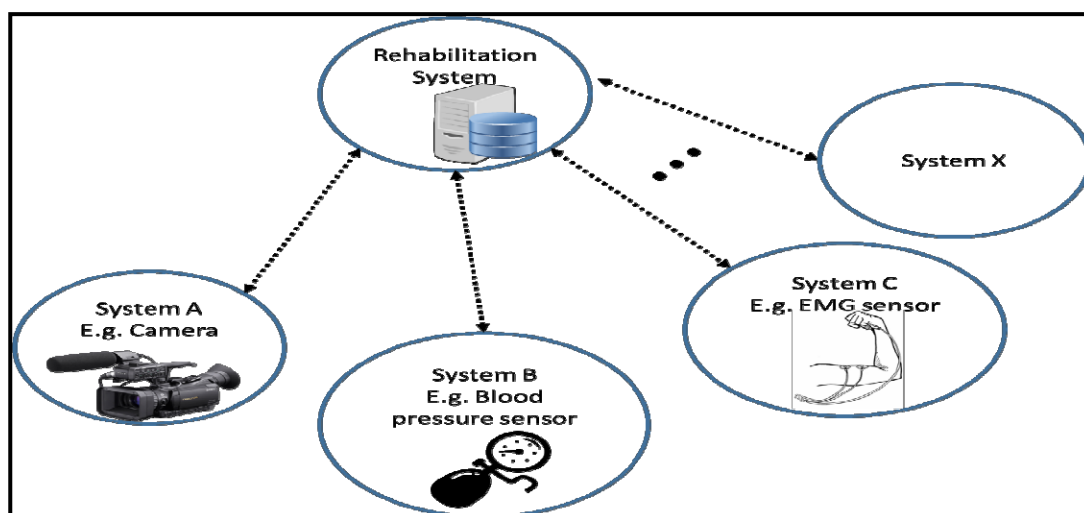

Soutenue le 17 octobre 2018

**Spécialité :** Bio-ingénierie et Sciences et Technologies de l'Information et des Systèmes : Unité de Recherche Biomécanique et Bio-ingénierie (UMR-7338)

D2436

# Interactive and Connected Rehabilitation Systems for E-Health

A THESIS DEFENDED ON 17 OCTOBER 2018  
IN COMPUTER ENGINEERING AND BIOMECHANICS

Presented to the doctoral school ED71 of the Université de technologie de  
Compiègne in partial fulfilment of the requirements for the degree of doctor

Spécialité : Bio-ingénierie et Sciences et Technologies de l'Information et des Systèmes

## Halim Elie Tannous

### Jury Members

---

**BOUKOUR Fouzia** Directrice de Recherche IFSTTAR, Reviewer

**DEMONGEOT Jacques** Professeur des Universités, UGA Grenoble émérite, Reviewer

**MARQUE Catherine** Professeure des Universités, Université de technologie de Compiègne, Examinor

**FLEURY Anthony** Maitre de Conférences, Ecole de Mines Telecom Lille, Examinor

**EL YACOUBI Mounim** Professeur des Universités, Institut Mines Télécom - Télécom SudParis, Examinor

**BENLARBI-DELAÏ Aziz** Professeur des Universités, Sorbonne Université, Supervisor

**DAO Tien Tuan** IR CNRS (HDR), Université de technologie de Compiègne, Supervisor

**ISTRATE Dan** ECC Rang A, Université de technologie de Compiègne, Supervisor

**SARAZIN Julien** Maitre de Conférences, Sorbonne Université, Invited Guest

**PERROCHON Anaïck** Maitre de Conférences, Université de Limoges, Invited Guest

---



# Abstract

Conventional musculoskeletal rehabilitation consists of therapeutic sessions, home exercise assignment, and movement execution with or without the assistance of therapists. This classical approach suffers from many limitations, due to the expert's inability to follow the patient's home sessions, and the patient's lack of motivation to repeat the same exercises without feedback. Serious games have been presented as a possible solution for these problems.

This thesis was carried out in the eBioMed experimental platform of the Université de technologie de Compiègne, and in the framework of the Labex MS2T. The aim of this thesis is to develop a real-time, serious gaming system for home-based musculoskeletal rehabilitation.

First, exergames were developed, using a codesign methodology, where the patients, experts and developers took part in the design and implementation procedures. The Kinect sensor was used to capture real-time kinematics during each exercise. Next, data fusion was implemented between the Kinect sensor and inertial measurement units, to increase the accuracy of joint angle estimation, using a system of systems approach. In addition, graphical user interfaces were developed, for experts and patients, to suit the needs of different end-users, based on the results of an end-user acceptability study.

The system was evaluated by patients with different pathologies through multiple evaluation campaigns. Obtained results showed that serious games can be a good solution for specific types of pathologies. Moreover, experts were convinced of the clinical relevance of this device, and found that the estimated data was more than enough to assess the patient's situation during their home-based exercise sessions.

Finally, during these three years, we have set the base for a home-based rehabilitation system that can be deployed at home or in a clinical environment. The implementation of such systems would maximize the efficiency of rehabilitation program, while saving the patient's and expert's time and money. On the other hand, this system would also reduce the limitation that are currently present in classical rehabilitation programs, allowing the patients to visualize their movements, and the experts to follow the home exercise execution.

**Keywords:** Functional rehabilitation, serious games, real-time monitoring, rehabilitation at home, multisensory fusion.

# Acknowledgments

The success of this PhD cannot be attributed to one person. Therefore, I would like to thank my supervisors Tien Tuan Dao, Dan Istrate and Aziz Benlarbi-Delai, for always advising, correcting and believing in my work. I would also like to thank Julien Sarrazin for his equally important contributions to my thesis.

I would also like to give my gratitude for the members of the jury for their interest in my work, and their desire to examine it.

I appreciate the Université de technologie de Compiègne for granting me this opportunity, for their financing and their professionalism. I also thank the laboratory BioMécanique et BioIngénierie (BMBI) for accepting me as part of its staff. In addition, I thank the Centre Hospitalier de Limoges, patients and medical staff, who allowed me to test my designs and gave me feedback to improve my work.

Many scientific personnel have contributed to my work. I thank the master's students Mohammad Idriss, Foued Chaouche and Cyrille Grebonval for their important work and effort. I am also very thankful to Anaick Perrochon, Jean Christophe Daviet and Didiet Gamet who provided me with crucial information allowing me to succeed in various tasks.

I thank my parents and family for pushing me to achieve my dreams, helping me with every step, and allowing me to become the person I am today.

Finally, I would like to thank Sally El Kantar who stood by me in good and difficult times.

This work was funded within the framework of E-BIOMED Chair – IUIS (Institut Universitaire d'Ingénierie en Santé). This work was carried out in the framework of the Labex MS2T, which was funded by the French Government, through the program "Investments for the future" managed by the National Agency for Research (Reference ANR-11-IDEX-0004-02).

I dedicate this work to the scientific community, since every step I took while working on this PhD is the result of its existence, and every contribution I made after finishing aims for its progress.

# Table of Content

<b>ABSTRACT .....</b>	<b>3</b>
<b>TABLE OF CONTENT .....</b>	<b>6</b>
<b>LIST OF FIGURES.....</b>	<b>10</b>
<b>LIST OF TABLES.....</b>	<b>13</b>
<b>LIST OF ABBREVIATIONS.....</b>	<b>14</b>
<b>CHAPTER 1 INTRODUCTION .....</b>	<b>15</b>
1.1 SOCIOECONOMIC AND HEALTHCARE CONTEXT .....	15
1.1.1 <i>Aging of the population and health problems</i> .....	15
1.1.2 <i>Medical Desertification</i> .....	18
1.1.3 <i>Traditional functional rehabilitation: fixing issues in the current process</i> .....	21
1.2 SYSTEM OF SYSTEMS.....	24
1.2.1 <i>Definition</i> .....	24
1.2.2 <i>Challenges</i> .....	26
1.2.3 <i>SoS for healthcare applications</i> .....	27
1.3 OBJECTIVES: A NEW ENGINEERING SOLUTION FOR HOME-BASED REHABILITATION .....	29
1.3.1 <i>Development of serious games for health</i> .....	29
1.3.2 <i>Personalized healthcare</i> .....	30
1.3.3 <i>Conception of a multisensory fusion algorithm</i> .....	30
1.3.4 <i>End-user acceptability</i> .....	32
1.3.5 <i>Home-based rehabilitation</i> .....	32
1.4 DOCUMENT ORGANIZATION .....	34
<b>CHAPTER 2 STATE OF THE ART .....</b>	<b>35</b>
2.1 SERIOUS GAMES FOR REHABILITATION .....	35
2.1.1 <i>Definition and clinical relevance</i> .....	35
2.1.2 <i>Implementation</i> .....	37
2.1.3 <i>Academic research</i> .....	41
2.1.3.1 <i>Serious games for general health</i> .....	41
2.1.3.2 <i>Serious games for Parkinson’s disease rehabilitation</i> .....	45
2.1.3.3 <i>Serious games for post stroke rehabilitation</i> .....	46
2.1.3.4 <i>Serious games for various other rehabilitations</i> .....	48
2.1.4 <i>Commercial games for rehabilitation</i> .....	50
2.1.5 <i>Advantages and limitations</i> .....	51
2.2 PORTABLE MOTION CAPTURE TECHNOLOGY .....	53
2.2.1 <i>Quaternions and spatial rotation</i> .....	53
2.2.2 <i>Vision-based portable motion capture tools</i> .....	57



2.2.3 <i>Inertial sensors and measurement units</i> .....	60
2.2.3.1 Communication standards .....	61
2.2.3.2 Inertial sensors for joint angle estimation.....	62
2.2.3.3 Inertial sensors and body segment calibration.....	64
2.2.3.4 Inertial sensors and data fusion using various methods.....	66
2.2.4 <i>Combining visual and inertial sensors</i> .....	67
2.2.5 <i>Data processing using estimation filters</i> .....	69
2.2.5.1 Kalman filter and its derivatives .....	69
2.2.5.2 Madgwick filter.....	73
2.3 HOME-BASED REHABILITATION .....	76
2.4 CONCLUSION: APPROACH BASED ON THE LITERATURE.....	79
<b>CHAPTER 3 DEVELOPMENT OF SERIOUS GAMES.....</b>	<b>81</b>
3.1 DEVELOPMENT WORKFLOW .....	81
3.1.1 <i>Three dimensional mesh modelling</i> .....	82
3.1.2 <i>Physics modelling</i> .....	83
3.1.3 <i>Scenario design</i> .....	85
3.1.4 <i>Implementation</i> .....	86
3.1.4.1 Kinematic data translation.....	86
3.1.4.2 Game engine programming.....	87
3.2 TASK ORIENTED AND IN SITUATION SERIOUS GAMES.....	88
3.2.1 <i>Football game</i> .....	88
3.2.2 <i>Object Manipulation Game</i> .....	89
3.3 EVALUATION METHODOLOGY .....	90
3.3.1 <i>First evaluation campaign</i> .....	92
3.3.1.1 Evaluation metrics.....	92
3.3.1.2 Evaluation campaign.....	92
3.3.1.3 User result and feedback analysis .....	93
3.3.1.4 Game improvement .....	98
3.3.1.5 Discussion .....	99
3.3.1.6 Limitations .....	101
3.3.2 <i>Second evaluation campaign</i> .....	101
3.3.2.1 Evaluation metrics.....	101
3.3.2.2 Evaluation campaign.....	103
3.3.2.3 User result and feedback analysis .....	104
3.3.2.4 Game improvement.....	107
3.3.2.5 Discussion .....	108
3.4 FINAL GAME IMPROVEMENTS.....	109
3.4.1 <i>Subject specific game personalization</i> .....	110
3.4.2 <i>Serious game for functional and cognitive rehabilitation</i> .....	112
3.5 CONCLUSION .....	114
<b>CHAPTER 4 MULTISENSORY FUSION IN SERIOUS GAMES.....</b>	<b>117</b>

4.1 ORIENTATION-BASED MULTI-SENSOR FUSION .....	117
4.1.1 Multi-sensor fusion scheme .....	117
4.1.2 Evolution model .....	118
4.1.3 Measurement model .....	119
4.1.4 Studying the sources of error for IMU and Kinect .....	120
4.1.4.1 IMU sources of errors .....	120
4.1.4.1.1 Synchronization .....	120
4.1.4.1.2 Orientation estimation algorithm .....	122
4.1.4.1.3 Sensor position .....	123
4.1.4.2 Kinect sources of error .....	124
4.1.5 Data fusion algorithm .....	124
4.1.5.1 Accuracy analysis .....	126
4.1.6 Results .....	126
4.1.6.1 IMU measurement error .....	126
4.1.6.1.1 Synchronization and orientation estimation algorithm .....	126
4.1.6.1.2 Sensor position .....	128
4.1.6.2 Kinect measurement error .....	129
4.1.6.3 Data fusion .....	129
4.1.7 Discussion .....	132
4.2 IMU POWER CONSUMPTION .....	135
4.2.1 IMU battery life .....	135
4.2.2 IMU average current consumption .....	135
4.2.3 IMU real-time current consumption .....	136
4.2.4 Results .....	137
4.2.4.1 Battery life .....	137
4.2.4.2 Average current consumption .....	138
4.2.4.3 Real-time current consumption .....	139
4.2.5 Discussion .....	140
4.3 APPLYING MULTISENSORY FUSION IN SERIOUS GAMES .....	141
4.3.1 System of systems solution .....	141
4.3.2 Results .....	142
4.4 CONCLUSION .....	143
<b>CHAPTER 5 SOCIAL STUDIES CONCERNING SERIOUS GAMES .....</b>	<b>145</b>
5.1 ACCEPTABILITY STUDY .....	145
5.1.1 Questionnaire preparation .....	146
5.1.2 Observations and results .....	148
5.1.2.1 Data presentation and processing in serious games .....	148
5.1.2.2 Graphics and game scenarios .....	149
5.1.2.3 Complementary visual data .....	151
5.1.2.4 Limitations of the use of serious games .....	152
5.1.2.5 Difficulty adjustment .....	152
5.1.2.6 Rehabilitation Tutorial .....	152

5.1.3 Discussion and proposed solutions .....	152
5.2 ETHICAL QUESTIONS WHEN IMPLEMENTING SERIOUS GAMES FOR HOME-BASED REHABILITATION .....	155
5.3 CONCLUSION .....	157
<b>CHAPTER 6 HOME-BASED REHABILITATION APPLICATION.....</b>	<b>159</b>
6.1 USER INTERFACES.....	159
6.1.1 Patient interface.....	159
6.1.2 Expert interface.....	161
6.1.2.1 Evaluation campaign.....	163
6.1.2.2 Results.....	163
6.2 DATABASE.....	165
6.3 FINAL SYSTEM SETUP.....	166
6.4 CONCLUSION .....	168
<b>CHAPTER 7 GENERAL DISCUSSION AND PERSPECTIVES.....</b>	<b>169</b>
7.1 OVERVIEW OF THE ACHIEVED SYSTEM.....	169
7.2 MAIN SCIENTIFIC, TECHNOLOGICAL AND CLINICAL CONTRIBUTIONS .....	170
7.2.1 Developing serious games.....	170
7.2.2 Multisensory fusion .....	171
7.2.3 End-user acceptability .....	172
7.2.4 Home-based rehabilitation.....	173
7.3 CONCLUSIONS AND PERSPECTIVES.....	175
<b>MY PUBLICATIONS .....</b>	<b>179</b>
<b>REFERENCES .....</b>	<b>181</b>
<b>APPENDICES.....</b>	<b>191</b>
APPENDIX A: FIRST SERIOUS GAMES EVALUATION STUDY.....	191
APPENDIX B: SECOND SERIOUS GAMES EVALUATION STUDY.....	192
APPENDIX C: EXPERT INTERFACE EVALUATION CAMPAIGN .....	195

# List of Figures

FIGURE 1. THE AVERAGE NUMBER OF ACTIVE DOCTORS FOR 100000 HABITANT, IN DIFFERENT FRENCH REGIONS, PUBLISHED IN OCTOBER 2017 BY THE CNOM (LIGHT BLUE IS LESS THAN 282.1, MEDIUM BLUE IS BETWEEN 282.1 TO 330.7 AND DARK BLUE IS ABOVE 330.7).....	18
FIGURE 2. AVERAGE NUMBER OF PHYSICAL THERAPISTS FOR 10000 HABITANTS IN EACH FRENCH REGION (ACCORDING TO THE OLD DIVISION) IN 2017.....	20
FIGURE 3. SOS ARCHITECTURES (DOTTED LINES REPRESENT INDIRECT OR INEXISTENT COMMUNICATION).....	25
FIGURE 4. ADOPTED SoS ARCHITECTURE FOR HOME-BASED REHABILITATION .....	28
FIGURE 5. HOME-BASED REHABILITATION SYSTEM ARCHITECTURE .....	33
FIGURE 6. DOCUMENT ORGANISATION .....	34
FIGURE 7. INTERACTION TOOLS USED IN SERIOUS GAMES UNTIL 2013.....	40
FIGURE 8. SERIOUS GAME SYSTEMS DEVELOPED FOR THE WELLBEING OF THE GENERAL POPULATION (FIGURES A TO L REPRESENT REFERENCES 56 TO 67).....	42
FIGURE 9. SERIOUS GAME SYSTEMS DEVELOPED FOR PD PATIENT (FIGURES A TO E REPRESENT REFERENCES 68, 33, 69 TO 71).....	45
FIGURE 10. SERIOUS GAME SYSTEMS DEVELOPED FOR STROKE PATIENT (FIGURES A TO F REPRESENT REFERENCES 72 TO 77) .....	47
FIGURE 11. SERIOUS GAME SYSTEMS DEVELOPED FOR VARIOUS REHABILITATION PATIENTS (FIGURES A TO G REPRESENT REFERENCES 78, 79, 33, 80 TO 83).....	49
FIGURE 12. COMMERCIAL TOOLS FOR REHABILITATION AND FITNESS (FIGURES A TO F REPRESENT REFERENCES 86 TO 91) .....	51
FIGURE 13. ROTATION OF A VECTOR IN A 3D REFERENCE (SOURCE: WIKIPEDIA) .....	54
FIGURE 14. GIMBAL LOCK PROBLEM FOR EULER ANGLES (A: NO GIMBAL LOCK, B: YAW AND ROLL ANGLES ARE LOCKED) .....	55
FIGURE 15. KINECT CAMERA AND ITS COMPONENTS (SOURCE: REFERENCE 94).....	58
FIGURE 16. GENERATED SKELETON DATA FROM KINECT .....	59
FIGURE 17. THE IMPLEMENTATION OF ACCELEROMETERS IN INERTIAL SENSORS .....	60
FIGURE 18. HALL EFFECT .....	61
FIGURE 19. STUDIES USING INERTIAL SENSORS TO ESTIMATE BODY JOINT ANGLES (FIGURE A TO G REPRESENT REFERENCES 95 TO 101).....	64
FIGURE 20. STUDIES CALIBRATING JOINT ANGLE ESTIMATION TO ANATOMICAL REFERENCES (FIGURE A TO G REPRESENT REFERENCES 102 TO 105).....	65
FIGURE 21. SETUP OF SYSTEMS COMBINING VISUAL AND INERTIAL SENSORS (A REPRESENTS REFERENCE [119] AND B REPRESENTS REFERENCE [121]).....	69
FIGURE 22. KALMAN FILTER SCHEME.....	71
FIGURE 23. EXTENDED KALMAN FILTER SCHEME.....	72
FIGURE 24. MEASUREMENT DATA FUSION USING KALMAN FILTERS.....	73
FIGURE 25. MADGWICK ALGORITHM FOR ORIENTATION ESTIMATION .....	74

FIGURE 26. THE ERROR IN DYNAMIC ANGLE ESTIMATION BETWEEN THE KALMAN FILTER AND THE MADGWICK FILTER.....	76
FIGURE 27. PROPOSED SERIOUS GAME SYSTEMS FOR HOME-BASED REHABILITATION (FIGURE A TO F REPRESENT REFERENCES 123 TO 128).....	78
FIGURE 28. THE ROUTE TO FOLLOW FOR OUR SERIOUS GAME DEVELOPMENT.....	80
FIGURE 29. REHABILITATION-ORIENTED SERIOUS GAME: DEVELOPMENT GUIDELINE.....	82
FIGURE 30. GAME SCENE DESIGN .....	83
FIGURE 31. HUMAN MODEL WITH APPLIED ARMATURE .....	84
FIGURE 32. ASSOCIATION OF COLLISION SPHERES TO AVATAR BONES.....	85
FIGURE 33. CHILDREN JOINTS REFERENCE SYSTEM BASED ON THEIR PARENT JOINT.....	87
FIGURE 34. A: FOOTBALL GAME WORKFLOW AND B: SCENE.....	89
FIGURE 35. A: OBJECT MANIPULATION GAME (MEDIUM LEVEL) WORKFLOW AND B: SCENE.....	90
FIGURE 36. REHABILITATION-ORIENTED SERIOUS GAME: EVALUATION GUIDELINE.....	91
FIGURE 37. GAME PERFORMANCE: PATIENT GROUP VS. HEALTHY CONTROL GROUP: EASY LEVEL OF THE FOOTBALL SCENARIO.....	94
FIGURE 38. GAME PERFORMANCE: PATIENT GROUP VS. HEALTHY CONTROL GROUP: MEDIUM LEVEL OF THE FOOTBALL SCENARIO .....	94
FIGURE 39. GAME PERFORMANCE: PATIENT GROUP VS. HEALTHY CONTROL GROUP: HARD LEVEL OF THE FOOTBALL SCENARIO .....	95
FIGURE 40. GAME PERFORMANCE: PATIENT GROUP VS. HEALTHY CONTROL GROUP: EASY LEVEL OF THE OBJECT MANIPULATION SCENARIO .....	95
FIGURE 41. GAME PERFORMANCE: PATIENT GROUP VS. HEALTHY CONTROL GROUP: MEDIUM LEVEL OF THE OBJECT MANIPULATION SCENARIO .....	96
FIGURE 42. GAME PERFORMANCE: PATIENT GROUP VS. HEALTHY CONTROL GROUP: HARD LEVEL OF THE OBJECT MANIPULATION SCENARIO .....	96
FIGURE 43. FOOTBALL GAME: KNEE FLEXION (A1), HIP ABDUCTION (B1) AND HIP FLEXION ( $\Delta 1$ ) (TOP); OBJECT MANIPULATION GAME: ELBOW FLEXION (A2), SHOULDER ABDUCTION (B2) AND SHOULDER FLEXION ( $\Delta 2$ ) (BOTTOM) .....	102
FIGURE 44. PATIENT PLAYING THE OBJECT MANIPULATION GAME WITH SENSORS ATTACHED TO HIS UPPER LEFT BODY SECTION .....	103
FIGURE 45. KNEE FLEXION ANGLE ESTIMATED DURING THE PATIENTS' FIRST FOOTBALL GAME TRIAL USING THE KINECT CAMERA (TOP), AND DURING THE SECOND TRIAL USING THE MULTI-SENSOR FUSION ALGORITHM (BOTTOM) .....	105
FIGURE 46. ANALYSIS OF THE PATIENTS' RESPONSES TO THE IMMERSION QUESTIONNAIRE.....	107
FIGURE 47. A: PROGRAM CREATION AND PERSONALIZATION SCREEN AND B: PERSONALIZED MOVEMENT VISUALIZATION.....	111
FIGURE 48. PERSONALIZED FOOTBALL SCENE .....	112
FIGURE 49. A: COGNITIVE GAME WORKFLOW AND B: SCENE.....	114
FIGURE 50. SCHEMATIC ILLUSTRATION OF THE DEVELOPED ORIENTATION-BASED MULTI-SENSOR FUSION SCHEME .....	118

FIGURE 51. DATA FLOW OF SENSOR SYNCHRONIZATION ALGORITHM.....	122
FIGURE 52. GONIOMETER PROTOCOL SET-UP FOR TESTING.....	123
FIGURE 53. TESTED SENSOR POSITIONS (LEFT: SENSOR ON THE THIGH DIRECTLY; MIDDLE: SENSOR ABOVE THE KNEECAP; RIGHT: SENSOR IN THE SAGITTAL PLANE).....	124
FIGURE 54. QUATERNION-BASED EXTENDED KALMAN OBSERVER SCHEME FOR FUSION .....	125
FIGURE 55. ANGLE ERROR RMS (°) AND ANGLE CC CALCULATED FOR THE KINECT, IMU AND THE PROPOSED FUSION ALGORITHM VS THE UNIVERSAL GONIOMETER, WHEN IMU SENSORS ARE PLACED IN THE FRONTAL PLANE POSITION .....	130
FIGURE 56. ANGLE ERROR RMS (°) AND ANGLE CC CALCULATED FOR THE KINECT, IMU AND THE PROPOSED FUSION ALGORITHM VS THE UNIVERSAL GONIOMETER, WHEN IMU SENSORS ARE PLACED IN THE SAGITTAL PLANE POSITION .....	131
FIGURE 57. ANGLE ERROR RMS (°) AND ANGLE CC CALCULATED FOR THE KINECT, IMU AND THE PROPOSED FUSION ALGORITHM VS THE UNIVERSAL GONIOMETER, WHEN IMU SENSORS ARE PLACED IN DIRECTLY ON THE MUSCLE.....	131
FIGURE 58. KNEE ANGLE ESTIMATED USING GONIOMETER, KINECT, GRADIENT DESCENT AND SENSOR FUSION, WHEN IMU SENSORS ARE PLACED IN THE SAGITTAL PLANE POSITION.....	132
FIGURE 59. ELECTRIC SCHEME FOR AVERAGE CURRENT MEASUREMENT.....	136
FIGURE 60. ELECTRIC SCHEME FOR AVERAGE REAL-TIME CURRENT MEASUREMENT.....	137
FIGURE 61. BATTERY DEPLETION TIME FOR DIFFERENT DISTANCES AT DIFFERENT SAMPLING RATES.....	137
FIGURE 62. CURRENT DISSIPATED DURING THE TEST UNTIL BATTERY DEPLETION AT 51.2 HZ .....	138
FIGURE 63. MEAN AVERAGE CURRENT FOR DIFFERENT DISTANCES AT DIFFERENT SAMPLING RATES .....	139
FIGURE 64. REAL-TIME DISSIPATED CURRENT DURING STREAMING AT 51.2HZ.....	140
FIGURE 65. DELAY BETWEEN SAMPLES RECEIVED BY THE PC WHILE STREAMING AT 51.2HZ.....	140
FIGURE 66. CONFIGURATION OF IMU PLACEMENT FOR SERIOUS GAMES.....	143
FIGURE 67. THREE DISTINCT TYPES OF SERIOUS GAMES FOR REHABILITATION.....	150
FIGURE 68. TYPE 1 GAMES A: WORKFLOW AND B: SCENE .....	153
FIGURE 69. THE PATIENT’S INTERFACE (A: PROGRAM SELECTION, B: GAME PERSONALIZATION, C: GAME TUTORIAL AND D: CHAT WITH EXPERT) .....	160
FIGURE 70. PATIENT RESULTS PAGE .....	160
FIGURE 71. THE EXPERT’S INTERFACE (A: ADD PATIENT, B: ADD PROGRAM, C: ASSIGN PROGRAM TO PATIENT AND D: CHAT WITH PATIENT).....	162
FIGURE 72. THE EXPERT’S INTERFACES FOR PATIENT MONITORING (A: NUMBER OF TRIALS WITH STATISTICS, B: JOINT ANGLE GRAPHS, C: JOINT POSITION VIDEOS AND D: GENERATED REPORT) .....	163
FIGURE 73. EXPERTS’ RESPONSES TO THE INTERFACE EVALUATION QUESTIONNAIRE .....	164
FIGURE 74. DATABASE DIAGRAM .....	165
FIGURE 75. OPTIMAL ROOM CONFIGURATION FOR HOME-BASED REHABILITATION USING SERIOUS GAMES .....	167
FIGURE 76. ACHIEVED SYSTEM USED FOR HOME-BASED REHABILITATION .....	170

# List of Tables

TABLE 1. SOFTWARE REQUIREMENT FOR THE DEVELOPMENT OF SERIOUS GAMES.....	37
TABLE 2. MOST COMMONLY USED GAME ENGINES .....	38
TABLE 3. STUDIES WITH DATA FUSION BETWEEN KINECT AND IMUs .....	68
TABLE 4. USERS’ RESPONSES TO THE FOOTBALL AND OBJECT MANIPULATION GAME QUESTIONNAIRES.....	97
TABLE 5. PATIENTS’ RESPONSES TO THE FOOTBALL AND OBJECT MANIPULATION GAME QUESTIONNAIRES.....	106
TABLE 6. RMS (°) AND CC BETWEEN KNEE ANGLES ESTIMATED USING DIFFERENT ALGORITHMS VS UNIVERSAL GONIOMETER .....	127
TABLE 7. RMS (°) AND CC BETWEEN KNEE ANGLES ESTIMATED USING DIFFERENT SENSOR POSITIONS VS UNIVERSAL GONIOMETER.....	128
TABLE 8. RMS (ANGLE IN °, ANGULAR VELOCITY IN °/S) AND CC BETWEEN KNEE ANGLES AND ANGULAR VELOCITIES ESTIMATED USING KINECT VS UNIVERSAL GONIOMETER.....	129
TABLE 9. SUBJECTS OF THE USER ACCEPTABILITY STUDY .....	146
TABLE 10. EXPERTS’ EXPECTATIONS FROM SERIOUS GAMES AND OUR PROPOSED SOLUTION .....	154
TABLE 11. COMPARISON WITH EXISTING HOME-BASED SOLUTIONS.....	173

# List of Abbreviations

## 2

2D: Two Dimensional 30, 37, 38, 39, 43, 46, 57, 58, 65, 83

## 3

3D: Three Dimensional ...37, 38, 39, 41, 43, 44, 47, 48, 53, 54, 55, 56, 57, 63, 64, 79, 81, 82, 83, 84, 85, 92, 115, 161, 174

## A

API: Application Programming Interface .... 79, 120  
AR: Augmented Reality ..... 40, 46, 48

## B

BMI: Body Mass Index ..... 123

## C

CC: Correlation Coefficient..... 126, 127, 128, 129, 130, 131  
CNOM: Conseil National de l'Ordre des Médecins ..... 18, 19  
CNOMK: Conseil National de l'Ordre des Masseurs-Kinésithérapeutes ..... 19, 20

## E

EMG: Electromyography .27, 47, 77, 173, 174, 176

## G

GPS: Global Positioning System ..... 42  
GUI: Graphical User Interface..... 86

## I

ICT: Information and Communications Technology ..... 29, 86  
IDE: Integrated Development Environment ..... 38  
IMU: Inertial Measurement Unit.. 31, 32, 34, 39, 53, 60, 62, 63, 64, 65, 66, 67, 68, 69, 76, 77, 79, 86,

87, 102, 117, 118, 119, 120, 124, 125, 126, 129, 130, 131, 132, 133, 134, 135, 136, 141, 142, 143, 166, 169, 171, 172

## L

LPWAN: Low Power Wide Area Network..... 62

## M

MAX: Maximum ..... 126, 127, 128, 129  
MIN: Minimum..... 126, 127, 128, 129  
MSDs: Musculoskeletal Disorders ... 16, 18, 21, 50, 81, 92, 99, 100

## P

PC: Personal Computer... 40, 41, 43, 57, 61, 86, 88, 121, 136, 137, 139, 140, 141, 143, 167  
PD: Parkinson's Disease..... 45, 46

## R

RGB: Red Green Blue ..... 57, 58  
RMS: Root Mean Square .... 63, 120, 124, 126, 127, 128, 129, 130, 131, 133

## S

SD: Standard Deviation 92, 93, 104, 126, 127, 128, 129, 139, 163  
SDK: Software Development Kit..... 39, 41, 59, 79  
SoS: System of Systems.. 24, 25, 26, 27, 28, 31, 79, 117, 142, 144, 172, 176

## T

ToF: Time of Flight ..... 57

## V

VR: Virtual Reality ..... 36, 40, 47, 112



# Chapter 1 Introduction

What are the main health related problems that we are currently trying to solve? What strategies can we adopt to solve these problems and how can science contribute to these solutions? In this chapter, we try to answer these questions and begin the investigation to improve the current situation of healthcare.

## 1.1 Socioeconomic and healthcare context

### 1.1.1 Aging of the population and health problems

Recent advances in technology and healthcare have promoted an increase in the lifespan of the population. According to the United Nations there are currently over 962 million people over the age of 60 (13% of the world population) [1]. This number is estimated to double by the year 2050, and triple by 2100 to reach 3.1 billion. Currently, Europe has the highest percentage of people over the age of 60 (25%), and France is one of the leading countries with 25.7% of the population, according to the “Institut national de la statistique et des études économiques” [2]. The United Nations warns, in their 2017 report, that this demographic change will put European countries under fiscal and political pressure, with respect to public systems of healthcare and social protection. Moreover, the ratio of workers to retirees is expected to decrease, which further complicates the prevised situation. This motivates current research towards finding affordable solutions to treat and monitor the elderly.

This situation comes as a consequence of many factors. The first element is the phenomenon called “the baby boom” which occurred after the second World War [3]. In addition, a decrease in fertility has been noticed in most of the advanced countries [4]. In France, the fertility rate has dropped from 2.8 to 1.8 child per woman between 1960 and 1970. Furthermore, the life expectancy has been increasing since the second World War, with the advancements in healthcare and pension systems [4].

This increase in the number of elderly people will subsequently lead to an increase in the number of patients suffering from chronic diseases such as diabetes, arthritis, stroke, and obesity. Currently in the United States of America, 4 out of 5 people who are above 60 suffer from chronic illness [5]. These numbers are less worrying in France, where a little more than

55% of people above 65 declared having a chronic disease [6]. Moreover, most of the affected elderly people experience a decrease in their ability to perform daily activities after contracting these illnesses, which could further complicate their situation. However, there is a lack of diagnosis and treatment for easy and preventable diseases all around the globe.

In addition to these diseases, older adults suffer from many health problems that might interfere with their ability to live a normal life. For instance, musculoskeletal disorders (MSDs) are very common among adults, and could affect the working performance and well-being of the involved people [7, 8]. This term is used to describe a variety of conditions that affect the muscles, bones, and joints. Examples of types of MSDs are neck, shoulders, wrists, back (upper and lower), hips, and legs, which can be caused due to occupation, activity level, and lifestyle. Another reason is age. From about age 30, the density of bones begins to diminish in men and women. As a result, bones become more fragile and are more likely to break. Similarly, joints are affected by changes in cartilage and connective tissue. The cartilage inside a joint becomes thinner, which can make the joint less resilient and more susceptible to damage. Finally, the loss of muscle or sarcopenia is a process that also starts around the age of 30 and progresses throughout the lifetime. In this process, the amount of muscle tissue and the number and size of muscle fibers decrease gradually. The result of sarcopenia is a gradual loss of muscle mass and muscle strength. According to the World Health Organization, musculoskeletal diseases are the second largest contributor to disability worldwide, with low back pain being the leading cause of disability globally. Furthermore, these conditions can affect 1 in 3 adults worldwide and cause great pains that persist during a person's lifetime [9]. These problems are mainly seen in people who practice laborious jobs, and can lead to losses for business owners and for the countries. In France, a little more than 48000 cases of work related musculoskeletal problems were reported in 2012, a number that keeps increasing since 2005 [10]. This amounts to 1 billion euros spent per year by the social security to cover all of the affected patients, and 10 million annual days of leave of absence covered by the companies.

There are 4 main biomechanical factors that could cause MSDs in the working environment:

- Adopting a bad posture during work, which could lead to stretching or compression of certain areas, most notably the spinal area.
- Executing a certain amount of force, or muscular contraction, that may hurt tendons and even bones.

- Repeating the same movements.
- Working for long hours without rest.

In addition, many other environmental factors can affect the workers, such as vibrations and shocks.

To combat these issues many countries have adopted additional measures and new legislatures. In France, a Handicap law was established in 2005 to highlight the equal opportunities, rights and responsibilities between any person with a handicap and the healthy population. This was the first step, taken by the French government, to fight against disability, and provide all the people equal opportunities. The law also obligates any establishment to provide accessibility to every person. In addition, the French government handed Luc Broussy a mission to investigate the ways to adapt the society to the problem of aging. Broussy issued a report in 2013 that provides a clear view on how the French government should act against the problems related to aging, in ten main points [11]:

- Habitat adaptation to support home care for seniors.
- The development of accommodation options that are intermediary between homes and nursing units, similar to housing units.
- Adaptation of the cities (infrastructures, services, accessibility).
- Adaptation of the transport to allow seniors to remain mobile, therefore autonomous, for as long as possible.
- The organization of the various territories of the country, affected in an extremely varied way by the aging.
- Benefitting from aging for productive growth and employment.
- The development of a real industrial sector and services around technologies for autonomous living (Gerontechnology).
- The integration of the elderly person into the family perimeter.
- The fight against age discrimination.
- The establishment of single points of contact and governance.

The novelty of this report is the focus that the author gave to the development of new technologies that could help keep senior autonomous at home. This field of research has been given the name Gerontechnology, defined as “*an interdisciplinary field that links existing and developing technologies to the aspirations and needs of aging and aged adults*”. Recently, Gerontechnology research has boomed in order to find solutions for different problems. In

addition, this report was one of the main motivator for many bills that were discussed by the French national assembly, most notably the bill of 17 September 2014, on the adaptation of the society to aging. This bill proposes some measures where the state takes financial responsibility to help the adaptation of homes for seniors.

Moreover, when it comes to fighting against the burden of MSDs related to work and aging, the labor laws in France have explicitly stated the responsibility of the employer to guarantee a safe work environment for their workers (article L. 4121-1). All of these efforts show that the preservation of the people’s wellbeing, against the many problems facing current and future societies, is a priority that must be acknowledged by every nation.

### 1.1.2 Medical Desertification

Medical desertification is a new term that is being used in France to describe the lack of medical personnel in certain areas, whether its general practitioners or medical specialists. Figure 1 shows the state of healthcare in France, and highlights the medical desertification phenomenon.

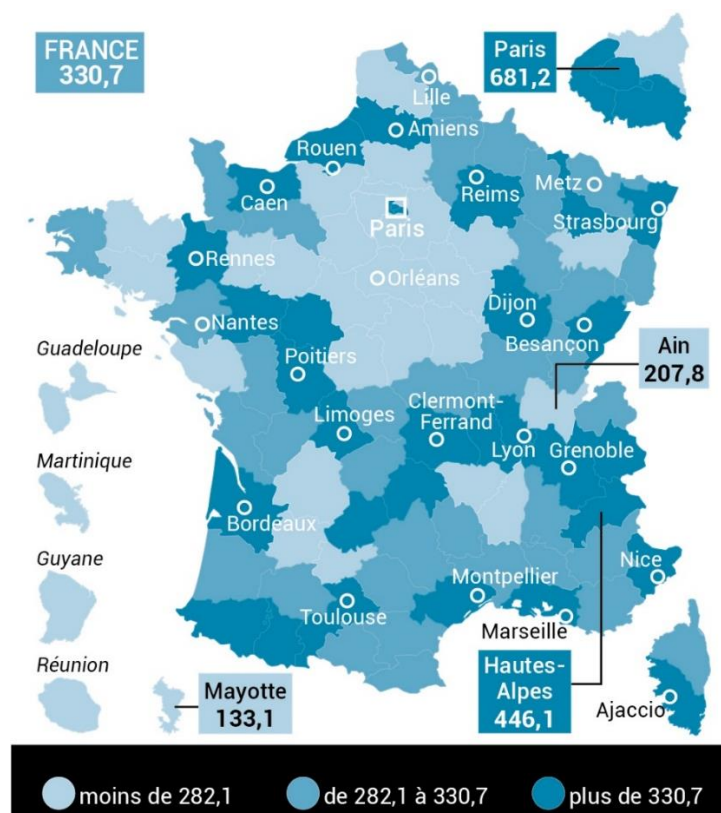

Figure 1. The average number of active doctors for 100000 habitant, in different French regions, published in October 2017 by the CNOM [12] (light blue is less than 282.1, medium blue is between 282.1 to 330.7 and dark blue is above 330.7)

The map shows an uneven distribution of doctors throughout the country: doctors and medical practitioners are more likely to be present in departments that contain university hospitals, which would allow them to practice their profession without needing to open a private clinic. In addition, doctors tend to require excess sums for routine check-ups, which are not covered by social security, due to the decreasing number of doctors in several areas. A recent report published by the “Conseil National de l’Ordre des Médecins” (CNOM), in October 2017, shows that there are 290 974 registered doctors in France, and only 215 941 are currently active. In other words, there is an average of 330.7 doctor for each 100000 citizens [12]. The CNOM also highlights that doctors registered in regular activities average 51.2 years. Those aged 60 and over represent 28% of the workforce, while those under 40 years represent 20% of the workforce. Eight regions (according to the old division) have a higher than average density of doctor. In the lead is the “Provence-Alpes-Cote d’Azur” region, then “Aquitaine”, “Limousin” and “Poitou-Charentes” followed by “Bourgogne” and “Franche-Comté”. The “Ile-de-France” region ranks fifth among the densest regions. The French offshore regions, with the exception of “La Réunion”, are conversely the least dense, followed by the “Centre-Val de Loire”, “Pays de la Loire”, “Nord-Pas-de-Calais” and “Picardie”, “Bretagne” and “Corse” regions. The report also states that the number of foreign doctors, coming to France has been increasing in the last 10 years. However, like their French colleagues, they do not settle in the departments suffering from medical desertification. This comes to oppose the idea that foreign doctors can be the solution to medical desertification.

This phenomenon extends to other areas in healthcare like physical rehabilitation. For instance, a recent report published by the “Conseil national de l’ordre des masseurs-kinésithérapeutes” (CNOMK), in August of 2017, highlights this problem [13]. The report states that there are 85 223 registered physiotherapists in France as of August 2017, divided equally between males and females. In other word, France has an average of 12.6 physiotherapists for each 10000 citizens, half the number that we see in other developed countries (Belgium, Netherlands). Figure 2 shows the distribution of physiotherapists on the French territories. Similarly to the distribution of doctors, there are some regions with values much higher than the average, and others that are much lower. Coincidentally, this distribution seems to be similar to that of the doctors, since some regions seem to be affected by the medical desertification in both cases (“Picardie”, “Centre”). This bad distribution and low number of physiotherapists will obstruct the rehabilitation of patients and especially older adults, as they

will struggle to find therapists and experts that are close to their homes. For example, in Picardie, 82% of patients need to travel in order to benefit from rehabilitation sessions [14].



Figure 2. Average number of physical therapists for 10000 habitants in each French region (according to the old division) in 2017

The CNOMK gave some recommendations to limit this problem and increase the number of active medical personnel in their recent report. They suggested that the state should increase the wages of the active physiotherapists, facilitate their work, allow them to execute their profession in the public and private sector at the same time and include the current professionals in European formation session, to benefit from foreign experience.

The French government has long been aware of this situation and is actively trying to fight it by proposing new bills and laws. The government set up the territory-health pact in 2012, to guarantee access to healthcare for all French people throughout the country. They also included strategies to fund medical student internships and increase their recruitment in hospital centers. Moreover, the strategy includes a complementary remuneration for young doctors guaranteeing a net monthly salary of 3 640 euros. However, the current situation proves that these actions were not effective enough to reduce this growing crisis, even with the additional actions that were taken by the regions separately from the national efforts. New and improved strategies need to be studied and implemented in the near future, in order to insure

the treatment and/or rehabilitation of current patients. These strategies should include the use of technology to facilitate the task of medical experts and allow them to perform their duty in a more efficient method.

### 1.1.3 Traditional functional rehabilitation: fixing issues in the current process

This thesis concentrates on finding solutions for musculoskeletal rehabilitation. For this reason, this section will focus on describing the classical approach to functional rehabilitation and how it can be altered. We will therefore focus on functional rehabilitation, as it is our main area of interest.

Human movement is a combination of efforts done by muscles, bones, and joints. In order to perform a correct movement, the three components, which constitute the musculoskeletal system, must be functioning properly, and links between them must be established. Normally, the skeletal muscles of the human body are connected to the bones by tendons in a way that, when muscle activation occurs, the tendon is affected by the contraction or dilatation, which allows the force generated by a muscle to move the related bone. This accurate and precise system can be severely influenced or damaged due to various reasons. Some of these reasons are MSDs and chronic diseases, described in Section 1.1.1.

For the human body to regain part of its initial musculoskeletal functions, the patient must follow a musculoskeletal rehabilitation program by practicing a series of rehabilitation exercises. These programs can often improve functional capacities, reduce symptoms, and improve the well-being of the patient. Even though these programs are common, their cost and efficiency depend on the team leading the recovery phase of the patient. Generally, a rehabilitation team can consist of an orthopedist/orthopedic surgeon, neurologist/neurosurgeon, physiatrist, internist, other specialty doctors, rehabilitation specialists, registered dietitians, and many more specialists, which could make the rehabilitation process a bit costly and cause stress for the patient [15, 16]. In 2015, 1 847 establishments declared follow-up care and rehabilitation activities in metropolitan France and in the offshore regions [17]. In addition, 1.5 million stays and 38 million days of complete or partial hospitalization have been accounted for.

In such programs, the therapists must always be involved with the patient, monitor their progress closely, and help them perform their exercises, examine them periodically, and assign

them home exercises to insure a rapid recovery. These direct therapist intervention methods can present many limitations. The first is that the therapist must always help the patient with the exercises, which means that the efficiency of the rehabilitation program is a function of the therapist's physical strength that would allow them to carry and support their patient. This might affect the rehabilitation of some patients in a negative way. Secondly, due to the repetitive and insistent exercises, the mental state of the patient might be affected, and their performance might decrease because of the repeated exercises, which could cause them to "cheat" their therapist and skip their home exercises [18]. Finally, there is no current tool that allows therapists to monitor the situation of the patients, during their home exercise sessions, to insure the correctness of their movements.

These limitations may delay the recovery of the patients and limit the role of home exercises in the rehabilitation program, which have proven to be very important to maximize the recovery of affected functions in different pathologies [19–22]. In addition, many research has been conducted to identify the importance of home exercises and to highlight the role that should be played by the medical experts during these sessions. For instance, the absence of therapist intervention, in home-based exercise sessions during rehabilitation, has proven to be a negative factor in the effectiveness of the rehabilitation program. *Capan et al.* showed that performing home-based exercises after temporomandibular joint condylar discopexy, without monitoring and coaching, yielded less significant improvements when compared to classical supervised rehabilitation programs [23]. On the other hand, *Hwang et al.* compared the differences between home-based exercises, delivered twice a week via videoconference, and traditional clinical rehabilitation session of the same length [24]. They showed that the clinical relevance of supervised home-based rehabilitation is still similar to that of traditional rehabilitation programs. Similar results were observed by *Holmqvist et al.* who reported no significant differences in clinical relevance, between supervised home-based rehabilitation and traditional programs for stroke patients [25]. However, a follow up study, after 5 years of the same group, showed that the patients that were assigned home-based rehabilitation achieved better results when compared to those that underwent a classical rehabilitation program [26]. Thus, these studies show that home-based rehabilitation have at least similar clinical relevance compared to traditional rehabilitation methods. In particular, home-based rehabilitation showed high clinical relevance in the case of long-term rehabilitation programs. However, the implementation of home based exercise sessions faces some challenges related to the supervision capacities, patient motivation, and quantitative indicators for patient monitoring



and follow-up. Therefore, innovative engineering solutions should be investigated to promote home-based rehabilitation as a new routine clinical practice. In particular, a home-based rehabilitation solution needs a high level of patient motivation to be successful [18]. In addition, quantitative indicators of the rehabilitation's effectiveness need to be accurately provided, to assist clinicians in making their decision to assign rehabilitation programs [27].

Serious games have established their ability to improve the patient's motivation during functional rehabilitation [28–33]. This new concept combines the motivational aspects of computer games and adds a primary objective in the scene. The primary objective can be either rehabilitation, military training, education, and so on. In our case, this technology can also offer medical experts the ability to monitor the patient's progress [34]. A study by *Burke et al.* on stroke survivors concluded that well-suited serious games can be very engaging for patients [35]. Furthermore, many developed systems have shown positive impacts on patients [36]. Nonetheless, there are many critics of this technology that point out the need to personalize the games, developed by health professionals and engineers together, in order to adapt them to the patient's situation [37].

The answer to the question of what is missing and needed to make such complex technological solutions clinically relevant remains unclear. However, with the limitations in the current rehabilitation methodology that were stated above, a serious game system, implemented at home, could be a multipronged approach to complement the current process. Such systems would be able to motivate the patient by substituting the repetitive exercises with games that are personalized to fit their pathological profiles. Moreover, this will add audiovisual feedback to the process, allowing the patient to see and or hear the effect of their actions in a virtual environment. This is currently an issue since the patient cannot contemplate their movements unless they face a mirror at home, which could demotivate them even more. On the other hand, these systems will allow the expert to assign rehabilitation program for their patients, and check their performances after each rehabilitation session. They can possibly include communication windows between patients and experts to stay in touch between clinical sessions.

The integration of serious games in the clinical and home environments can be beneficial for both patients and experts. These systems would be destined for patients who are in advanced stages of their rehabilitation, and have the capability to be autonomous and move without regular supervision. Additionally, they will limit the clinical visits of the patients, and

help save the time of medical expert. Currently, the medical experts hold group rehabilitation session, because of the high number of patients with respect to the number of available physiotherapists. The implementation of monitored home-based exercises will allow them to perform a more analytical task, using the data saved after their patients' rehabilitation sessions at home, and hold clinical visits when they deem it necessary, based on the patient's performances.

## 1.2 System of systems

### 1.2.1 Definition

System of systems (SoS) is a new concept that emerged recently with the advancement of different technologies in different fields with complementary data output. *Poper et al.* defined these systems, in 2004, as “*a collection of task-oriented or dedicated systems that pool their resources and capabilities together to obtain a new, more complex ‘meta-system’ which offers more functionality and performance than simply the sum of the constituent systems*” [38]. There is a common confusion between a system and a SoS, given that both are destined to accomplish a given task using key elements. Moreover, a SoS can be classified as a system but the opposite is not true. *Broadman et al.* defined key elements that are required for a system to be classified as a SoS [39]:

- **Autonomy:** the subsystems must be autonomous in their pursuit to fulfil the purpose of the whole system.
- **Belonging:** the subsystems choose to belong or not to the system based on optimization functions and protocols.
- **Connectivity:** there exists a dynamic determination of connectivity, with interfaces and links forming and vanishing as the need arises.
- **Diversity:** the subsystem must be diverse, which will be possible due to the autonomous nature of these sub systems.
- **Emergence:** the main system must predict and analyze emergent behavior, especially undesirable behavior.

*Broadman* also clarifies the differences between systems and SoS. Systems tend to control their elements, whereas SoS benefit from additional data that could be sent by their different subsystems, and insures their autonomy.

There are 4 recognized architectures of SoS based on the relationship between the SoS and the subsystems (Figure 3) [40–42]:

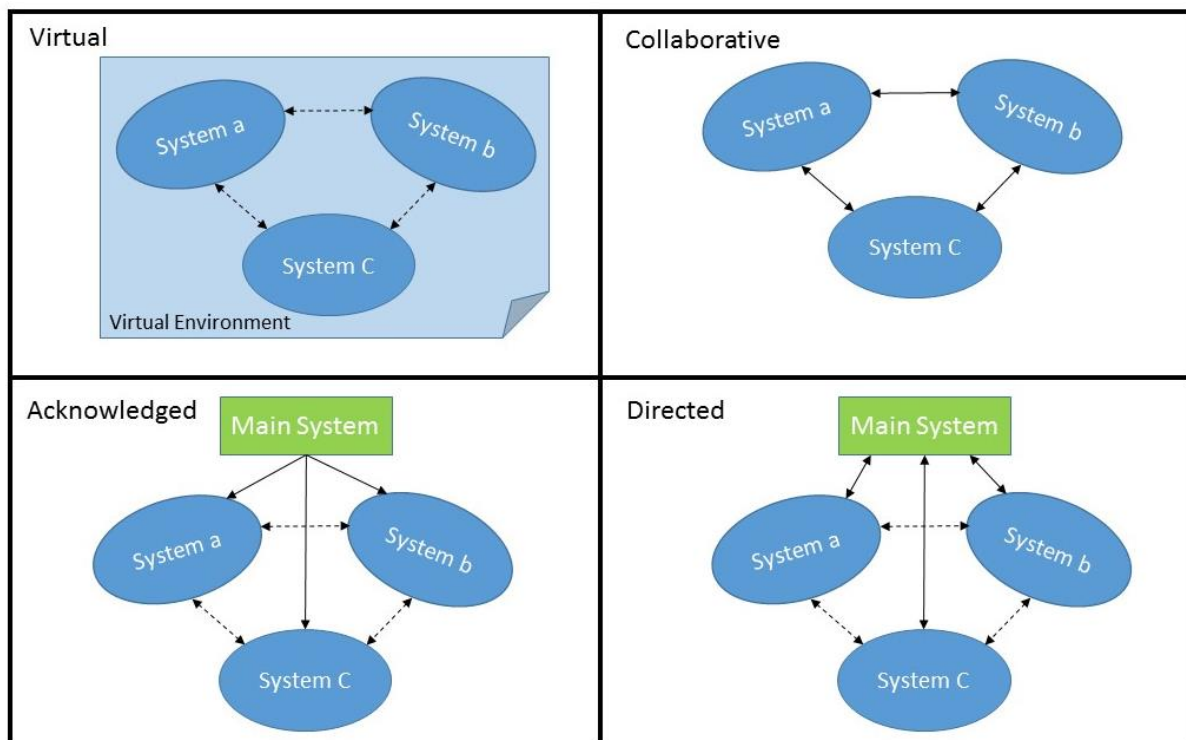

Figure 3. SoS architectures (dotted lines represent indirect or inexistent communication)

- **Directed:** these systems are managed centrally, and the subsystems' normal operational mode follows the requirements of the central management unit (main system). For example, a healthcare unit where the chief officer is responsible of all their subordinates, who are executing different tasks.
- **Virtual:** these systems do not have a central management unit. An example of this type of SoS is the internet, and all the entities that are integrated in it.
- **Collaborative:** these systems differ from Directed systems when it comes to the minimal authority given to the main system. The subsystems must collaborate to fulfil the requirement of the central management unit, but this unit cannot run the SoS. An example might be the regional area crisis response system, where each agency is responsible for its own region.
- **Acknowledged:** the constituent systems retain their independent ownership, objectives, funding, and development and sustainment approaches. An example of this type of system is military control. Here, a main centered management unit acknowledges the

separate work of each sub unit that will ultimately be in the benefit of the complicated final task.

Different architectures can offer different advantages for numerous applications. It is ultimately up to the user to identify their needs and priorities to adopt the adequate scheme.

## 1.2.2 Challenges

The adoption of SoS in different fields could offer immense benefits, from independent and autonomous subsystem deployment and update, to controlling different aspects of a system through a minimalistic control approach. However, in order to implement these architectures, engineers and scientists need to understand the challenges. The International Council on Systems Engineering highlighted some of these challenges in their 2015 handbook [43]:

- **SoS Authorities:** in a SoS architecture, each system has a different local owner or stakeholder, and as a result most SoS do not have a single point of authority. The challenge is to agree on the degree of authority given to each subsystem, in order to maximize the collective task between systems.
- **Leadership:** normally, there is no question of leadership in an engineering system, where a head entity is controlling other sub-entities. However, in SoS the question of authority will subsequently lead to the question of leadership of any system with respect to other systems.
- **Constituent Systems' Perspectives:** most subsystems that will be used in a SoS are independent systems that were developed to achieve a specific task autonomously, and generate specific results based on their conception. The challenge that would face the integration of subsystems in a SoS architecture is whether they could adhere to the needs of the SoS and offer new alternative approaches to meet these needs.
- **Autonomy, Interdependencies and Emergence:** the autonomy of subsystems in a SoS could lead to a lot of emerging issues. The subsystem could, at any point, be subject to change and update, which leaves many questions on how the SoS could take these changes into consideration, especially in a SoS with interdependent relationships.
- **Testing, Validation, and Learning:** testing is normally difficult even when one system is concerned. When it comes to a SoS where the independent systems are concerned, testing and validation become an issue. However, the SoS must maintain a fully

functional architecture despite the independent processes that could be performed by the subsystems.

- **SoS Principles:** SoS is a relatively new concept, therefore we should look to identify key principles to apply these architectures in general, and work on implementing working examples of them.

These are the general challenges that are facing the implementation of SoS in different fields. We could imagine them extending to any application that would be currently implemented. The implementation of a SoS is a current trend in many fields, such as autonomous cars where different sensors work together to insure maximum estimation accuracy and data processing capability. In addition, each car could be regarded as a separate system, and the communication between cars follows a SoS approach. In this thesis, we will concentrate on using a SoS approach implemented in the healthcare field, more particularly in home monitoring and home-based rehabilitation.

### 1.2.3 SoS for healthcare applications

The application of SoS in healthcare has long been an area of interest for many researchers. Due to the complex nature of healthcare management, different healthcare entities can be regarded as different systems with separate functionalities. *Wickramasinghe et al.* were the first to propose this idea, claiming that the current architecture of the healthcare industry can be incorporated in a SoS, where the subsystems are care units, hospitals, physicians, clinics and governmental agencies [44]. However, this is not our case of interest, since we tend to decompose the process of home-based functional rehabilitation using a SoS approach. *Hata et al.* proposed a SoS in health management, described as the first step in human monitoring for subjects with suspected health risks [45]. This example established separate systems for each sensor used to monitor a patient: an ultrasonic oscillator and an air pressure sensor. Each of these sensors measures different characteristic for patients lying on a bed. The air pressure sensor measures the difference in pressure based on the movement of the patient in bed, while the ultrasonic oscillator obtains information about the whole bed since it is placed beneath it. Our application will resemble that described by *Hata et al.* using different type of sensors. Moreover, home-based rehabilitation requires the use of portable motion tracking sensors that could differ in type and functionality, as well as other biomedical sensors like Electromyography (EMG) sensors and blood pressure sensors.

For these reasons, we will adopt a SoS approach in our study to combine the data captured from different devices, highlighted in Figure 4.

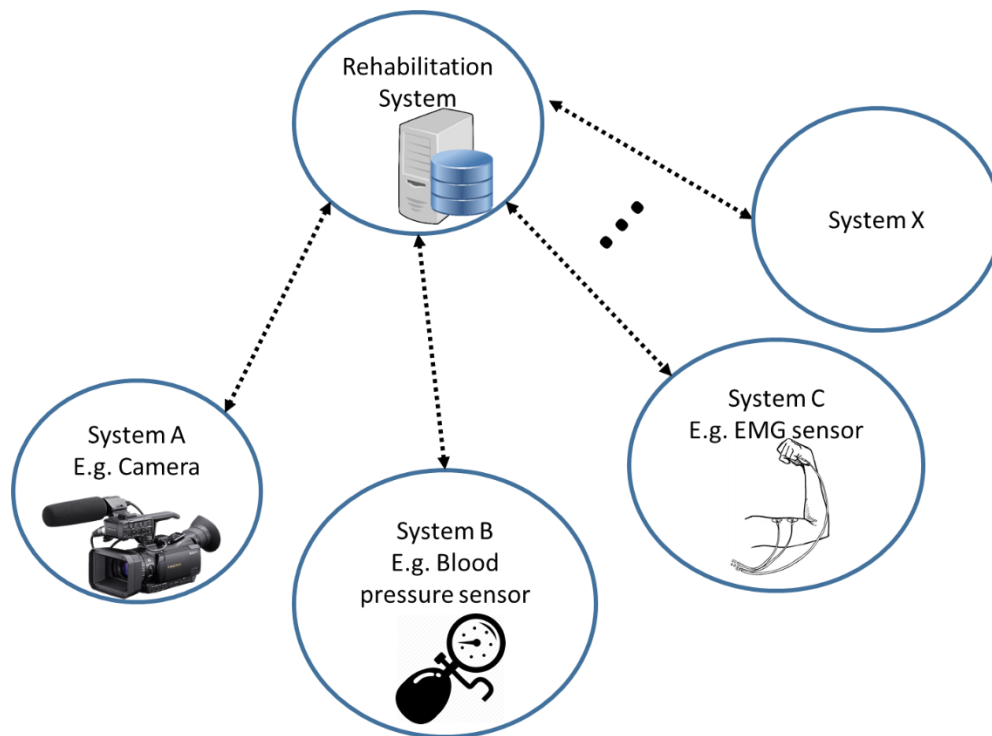

Figure 4. Adopted SoS architecture for home-based rehabilitation

These instruments of measurement will act as different systems and will function independently of the main controlling system. Therefore, we will adopt a directed SoS architecture where the global rehabilitation system represents the main system, and the sensors represent the subsystems. The rehabilitation system will send commands and receive data from the subsystems, while maintaining an autonomous behavior: in case of absence of any sensor, the main system will process the available data, and disregard any missing data. Moreover, any addition of new subsystems would be easy to implement under these conditions, and the absence of any subsystem would not affect the behavior of the main system. To answer the challenges that are common in SoS implementation, we give the full authority and leadership to the main system and maintain the autonomy of different subsystems while forcing their end goal to serve the main system. This ultimately adheres to the principles of SoS since the addition of subsystems will offer more information. The main area that will be studied in this thesis concern motion tracking at home; therefore, the subsystems that will be used in this architecture are principally destined for that purpose.

## 1.3 Objectives: a new engineering solution for home-based rehabilitation

The end goal of this PhD is to develop a home-based rehabilitation system, implemented for personalized pathologies, to serve as a monitoring tool between clinical sessions. The system will also help in motivating patients as it will provide audio-visual feedback to maximize their motivation. Therefore, in order to achieve this final goal, we have divided our studies into 5 main categories: development of serious games, personalization of the user's rehabilitation movements in serious game, conception of a multisensory fusion algorithm, the end-user acceptability of home rehabilitation systems, and the implementation of a home-based rehabilitation system with different user interfaces. This section will detail these 5 objectives.

### 1.3.1 Development of serious games for health

Recently, the progress in information and communication technology (ICT) led to the development of a new rehabilitation scheme called “serious game for functional rehabilitation”. In fact, the coupling of game technologies and functional rehabilitation allows for a better interaction between patients and rehabilitation programs. Moreover, the use of serious game scenarios may be a potential solution to improve the patient's motivation in future rehabilitation sessions. As stated in Section 1.1.3, serious games have proven to be effective in resolving the limitations of the traditional rehabilitation approach.

Our main goal is to develop pathologically oriented serious games that could allow medical experts to monitor the patient's progress at home, between rehabilitation sessions. Therefore, experts will be involved in the design and conception of physical exercises and movements, to be implemented in a virtual environment through serious games. In addition, we will aim to develop games destined for a specific pathology that can benefit from such technology, based on the medical personnel's recommendations. The serious games will vary for the rehabilitation of different body parts (upper and lower limbs), and in difficulty based on the patient's situation. The games will also integrate adequate real-time audiovisual feedback that is pleasant for the patient, without causing them to lose their immersion or motivation. Moreover, the games will allow the patient to choose different avatars to represent them in the virtual environment. Finally, the games will be diverse to try to please every patient no matter the gender, age, or interest.

### 1.3.2 Personalized healthcare

This objective can be viewed as a subpart of the development of serious games for functional rehabilitation. The idea is to give an option for the medical experts to personalize the exercise based on the patient's needs. For instance, the expert should have the ability to choose the target joint angles that should be attained by the patient during their session. This goal can be beneficial for both experts and patients:

- The experts will be given more authority and control over the rehabilitation programs of their patients. They will have a record of these personalization parameters, in order to take them into consideration when analyzing the rehabilitation sessions, or when changing the program.
- The patients will receive real-time feedbacks that highlight whether they are performing the targeted personalized movement, in order to correct their movement during their session.

In order to use serious games at home, portable motion capture tools will be deployed and studied, to insure a good compromise between usability and expert analysis accuracy. These sensors will be highlighted in the next section, with the possibility of combining them to benefit the rehabilitation program.

### 1.3.3 Conception of a multisensory fusion algorithm

Different portable data acquisition systems are used in order to capture the position, movements, and angles of the human body landmarks. Two main categories can be distinguished: the nonphysical controllers and the physical controllers.

The first category of interfaces is also referred to as vision-based systems, and assumes great importance. These systems use cameras in order to collect data from the users. The most accurate example of these interfaces is the Microsoft Kinect, which uses a camera to collect two dimensional (2D) pictures, and an infrared laser and sensor to calculate the depth of the visualized image. Using these systems, the number of sensors on the body can be minimized, when trying to calculate the body joint angles. However, these sensors suffer from low accuracy, which might be an issue for experts trying to analyze angular data. Previous studies have shown that the Kinect camera could estimate knee angle with an error of about 14.5° [46, 47]. This error is high when compared to the values accepted by medical experts to analyze



joint data ( $6^\circ$  for higher extremities [48] and  $5.5^\circ$  for lower extremities [49]). In addition, they suffer from the occlusion of object, since the superposition of body parts can cause high errors in joint position and angle estimations.

The second category represents all the tools that use haptic interface to estimate user movement. These kinds of interfaces produce high spatial precision, and can solve the occlusion problem since the sensor can send data even if they are not in a visible plane. On the other hand, these tools can render the system more expensive, and affect the movement of a person. Some examples of interfaces in this category are the Nintendo Wii, Sony PlayStation Move, inertial measurement units (IMU), etc.

An advantageous approach to data acquisition might be to include both vision-based and haptic systems to increase the accuracy of angular estimation. For example, one can use a Kinect camera with IMU body sensors that measure the joint angles. This hybrid approach helps in creating a more accurate system that can handle both occlusion problems and movement difficulties.

Therefore, our main goal in this study is to combine vision-based sensors with IMU body worn sensors in real-time, using a fusion algorithm. The idea is to offer the expert a possibility to prioritize the portability of the system or the accuracy of body joint angle estimation by choosing to use, or not use, the fusion algorithm. This goal will be achieved through the application of a SoS approach, where each type of sensor is regarded as a separate system, as discussed in Section 1.2. The Kinect will be used to estimate the body joint angles and positions, of all the body joints, with a low accuracy, and any additional data captured from extra IMU sensors will trigger the use of the fusion algorithm to maximize the accuracy of the estimation of the specific joint angles where the IMUs are used. An additional goal of this study is to describe the power consumption of the chosen inertial sensors, and study any environmental variables that could affect this consumption, in order to evaluate the suitability of the system's autonomy with respect to users' expectations.

Moreover, the addition of wireless sensors and the necessity to recharge them between sessions could influence the user acceptability for these solutions. In this part of the study, we will focus on the power consumption of the IMU sensor that we will use for our functional rehabilitation system (Shimmer 3 IMU sensor [50]). We will detail our studies concerning the battery and current consumption, as a function of different environmental factors (effect of multisensory streaming, effect of motion, effect of communication distance, and effect of

sending data through sensors placed behind human organs), and internal factors (effect of sampling rate). We will also compare results with other IMU sensors.

### 1.3.4 End-user acceptability

The development of any medical application cannot be given the full trust of the people unless it is conceived by the people and for the people. In this context, one of the goals of this thesis is to study the user acceptability of home rehabilitation tools, from the point of view of patients and experts. The results of these studies will be taken into consideration, in order to develop a more acceptable tool that resolves any predefined judgment that could be imagined by patients. Studies will be conducted by human science students through interviews with medical experts and patient groups, which could help create solution that are co-designed by patients, experts and developers, and that are accepted by end-users.

### 1.3.5 Home-based rehabilitation

The architecture of a serious game platform for home-based rehabilitation is divided into 3 phases. The assessment phase which is done by the computer or the console, the planning phase performed by the therapist, and the execution phase where the game is played by the patient [18]. First, there is a necessity for an initial assessment of the patient's status by conducting several tests in order to determine an accurate treatment plan to attribute, after which the therapist assigns electronically, the specific exercises and appropriate difficulties for the patient. During each exercise or game performed, feedback is transferred using specific technics, from the patient's body to the game's interface in order for it to change the visual scenes in the game, and to give a feedback to the therapist. The therapist finally, decides whether the patient is making progress or not, and if there is a need to change the type or difficulty of the exercises.

The big limitation of serious games implemented currently is that, these games, allow the therapist to judge the patient's progress as a function of the results, without considering the biological feedback from the patient's damaged area. Moreover, all the developed virtual rehabilitation systems focus on simple gestures in order to build the rehabilitation programs for the patients. These simple gestures are generally captured by vision-based motion capture systems in order to developed low cost systems to be implemented in the patient's home.

In order to address all these limitations, we aim at building a serious game for rehabilitation, focusing on the rehabilitation of lower and upper limbs, which allows the expert to assign both simple and complex exercises to be executed in the clinic or at home.

Our approach consists of several steps. First, we focus on using the Kinect camera alone, in order to evaluate its ability to correctly assess the serious games, and its precision of capturing the movement of the limbs. Next, and to add more precision to our system, a fusion between multiple sensor systems is applied. This fusion approach will include both vision (Kinect camera) and physical sensors (IMU sensors).

Finally, we aim to achieve the system described in Figure 5.

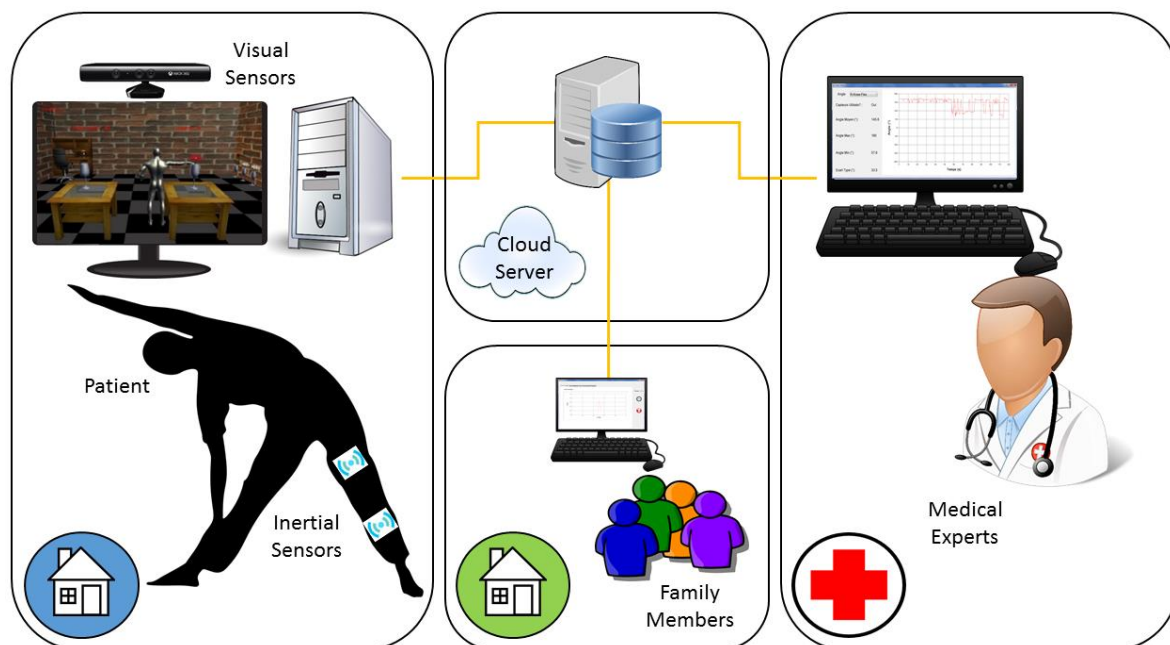

Figure 5. Home-based rehabilitation system architecture

In an ideal scenario, the patient starts their rehabilitation program with a first clinical visit. The expert then decides if they are able to execute home exercises. If so, they will assess their case and assign them a home-based program. The program is then sent from the expert interface to the cloud server. At home, the patient plays the rehabilitation exercises that were assigned in their rehabilitation program. At the end of each session, data regarding the movement of the patient will be sent via the cloud server to the expert, and optionally to family members, in order to follow and monitor the patient's progress. Finally, the expert will decide to change the rehabilitation program, or the difficulty of the assigned exercises, based on the results that they monitor after each session.

This home-based tool will allow the medical expert to delay clinical rehabilitation session if they deem necessary, based on the patient's performance. This will save the time of the medical expert, as well as the time and effort taken by patients to travel to clinics. In addition, the expert will always have a saved record that allows them to monitor patients.

## 1.4 Document organization

This manuscript has 7 chapters (Figure 6). The second chapter presents a state of the art on serious gaming for rehabilitation, portable motion capture for rehabilitation and existing home-based rehabilitation systems. The third chapter will describe the serious games that were developed. The fourth chapter will highlight the multisensory fusion algorithm that we developed between the Kinect camera and IMU sensors. The fifth chapter will give an idea on the patient and expert acceptability of this system. The sixth chapter will describe the home-based rehabilitation interfaces that were developed. Finally, the seventh chapter concludes the manuscript and highlights the perspectives that are envisioned in future work.

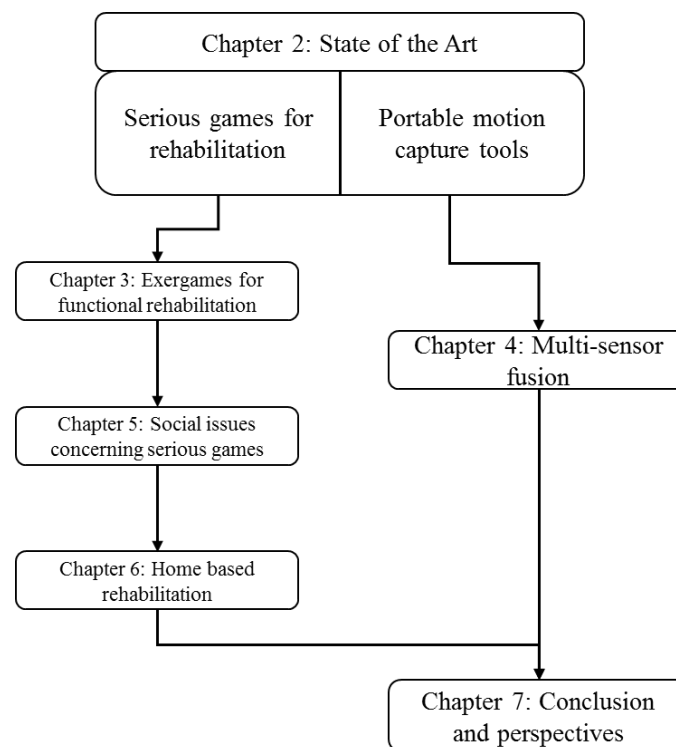

Figure 6. Document organisation

# Chapter 2      State of the Art

Is serious game development for functional rehabilitation difficult, and what is the current state of the art in this field? What about portable motion capture tools; how can we use different portable sensors as interaction tools for serious games?

## 2.1 Serious games for rehabilitation

In the past few decades, videogames have taken over the entertainment business in a storm, thus becoming one of the main attractions for several age groups, especially young adults. These games evolved and became too complex for all but the most hard-core players in the industry. Recently, several new console releases helped shift the audience of games from young adults to a wider fan base. The most notable releases were interaction-based interfaces like the Kinect and Wii games. In light of the social acceptance and interest of the population, and especially older people towards the new interaction-based interfaces, new possibilities started gaining momentum. Serious games were designed for many purposes including training, and education among others. However, a lot of question remain unanswered. What are serious games? What makes a game serious? And how can a tool designed for entertainment serve a different purpose?

### 2.1.1 Definition and clinical relevance

Serious games for functional rehabilitation were presented in Chapter 1 as a possible solution to fix the issues in the current rehabilitation process. These games are a subpart of the recent trend named “*Gamification*” defined in 2011 as “*the use of game design elements in non-game contexts*” [51]. However, there is no clear definition for serious games, but researchers agree that these are games used for purposes other than entertainment [27]. This purpose can be to train military personnel, to educate children, to evaluate a worker’s performance and many more applications. This definition can raise many questions, since these purposes seem to be at odds with entertainment purposes [52]. Therefore, while serious games share the same definition of normal games, and must integrate 4 main components found in regular games, a 5<sup>th</sup> component based on the implicit objective of these games is included for these serious games:

- **Rule/Gameplay:** this component defines the possible interaction between the player and the virtual environment.
- **Challenge:** this component highlights the good actions that need to be rewarded, and the bad actions that must be punished.
- **Interaction tools:** these tools are responsible for mapping the action of the user, in the virtual environment, and can differ in nature and functionality (mouse, camera, handheld object, etc.).
- **Explicit objective:** the explicit objective of games is to entertain the user.
- **Implicit objective:** this is an additional component, specific to serious games, which changes based on the end-user groups targeted by the developed application.

In the field of health sciences, the idea of using video games was born recently. The interest of combining healthcare with games was never present in past decades, as doctors and medical personnel viewed the intensive practice of video games as a primary source of physical and mental injuries. Moreover, these experts have long linked video games to “repetitive stress injuries” caused by repetitive movement executed by a person’s joints while playing [36]. In mental health research, games were deeply studied as a possible link to aggression, which has also caused a worldwide debate on this subject with scientists and lawmakers making arguments for and against the issue. However, recent studies, showing the positivity that can be gained from using serious games in different healthcare fields, have influenced a change in the point of view of medical experts [35, 36].

This change in the ideology of medical experts has pushed serious games to become one of the biggest areas of interest for academic research and commercial applications. When it comes to gaming, the user is always the center of attention. This is comparable to healthcare applications, where the patient is the center of action [35]. This fact has led to the high deployment of games in this field. From patient monitoring and evaluation, to physical and cognitive rehabilitation, the applications of serious games are countless in this area of interest. When used for physical rehabilitation, serious games can also be identified as “*Exergames*”.

Recently, Dr. Wielderhold, cofounder of the virtual reality medical center (San Diego, California, United States of America), talked about virtual reality (VR) and its potential use in healthcare, during a 2004 presentation at the serious game Summit [52]. He highlighted the big possibilities to use VR coupled with games to:

- Distract patients during painful procedures and surgeries.

- Improve the recovery of the range of motion for patients undergoing rehabilitation.
- Improve motor skills for different types of patients.
- Enhance the process of therapeutic intervention.

He also presented and discussed the importance of personalized applications for specific pathologies. This presentation, and many other research outcomes, have created a consensus about the utility of serious games in healthcare. In this section of this second chapter, we will highlight the implementation of serious games, and the ongoing research and commercially available tools in the field of exergaming.

### 2.1.2 Implementation

The implementation and development of serious games must adhere to a set of rules, and define certain technologies and processes to be used during its conception. These rules include some common points for the implementation of games in different fields, and other specific points for their deployment in particular contexts.

- **Programming tools:** These are the first component in developing serious games. Table 1 shows these programming tools and software requirements.

Table 1. Software requirement for the development of serious games

Tool	Functionality
Game engine	<ul style="list-style-type: none"> <li>• Contains code that controls how the system operates</li> <li>• Implements physical laws</li> <li>• Receives input</li> <li>• Computes</li> <li>• Generates output</li> </ul>
Design software	<ul style="list-style-type: none"> <li>• Creates all the assets in 2D and 3D</li> <li>• Exports output to game engine</li> </ul>
Middleware (Optional)	<ul style="list-style-type: none"> <li>• Processes the raw data from sensors</li> <li>• Gives the high level data to the game engine</li> </ul>
Database (Optional)	<ul style="list-style-type: none"> <li>• Contains the parameters</li> <li>• Sets the player's information</li> <li>• Saves the player's rehabilitation data</li> </ul>

These programming tools are categorized in many subcategories, based on their role in the development process. Three main software are necessary to develop serious games, in addition to the classical integrated development environment (IDE). The most important software is the game engine, which is the basis of building games. Game engines generally are the virtual environment builders that take the variable inputs after data processing from sensors, and also the designed three dimensional (3D) and 2D models and avatars, in order to integrate them all in one program to be executed as a virtual game. Several game engines have been used and performed well in serious game development [53], Table 2 shows the most notable ones. The choice of game engine should be based on the language that the developers are most familiar with, as well as the ease of use of the IDE to develop the game. The developers should also take into consideration whether the game engine allows the use of certain connected objects that they will implement as interaction tools for the game, and also the cost and open source characteristics of the game engine.

Table 2. Most commonly used game engines

<b>Engine</b>	<b>Developer</b>	<b>Licensing</b>	<b>Opensource status</b>	<b>Language</b>
jMonkey	The jME core team	Free	Yes	JAVA
OGRE	The OGRE Team	Free	Yes	C++
Unity	Unity Technologies	Non commercial free to use license	No	C#
Unreal	Epic Games	Non commercial free to use license	Yes	C++
XNA	Microsoft	Non commercial free to use license	Yes	C# with Visual studio.Net IDE

The second software in degree of importance is the design software. This software is responsible for the avatar modeling, 3D characters and scene development. Moreover, the software is used to build meshes (3D object and shape) and to add armatures to them in order to allow executing motion using the game engine. Finally, the output from this software serves



as an input for the game engine to control 3D assets. The most notable 3D design software is called Blender (Blender Foundation), it is an open source, free to use and heavily documented software. Other purchasable software are available such as 3DS Max (Autodesk, Inc) and Cinema 4D (MAXON Computer GmbH).

The third software can be used optionally, if input devices generate data that cannot be used immediately as input for the game engine but need to be processed and cherry picked. This software is called a middleware. Middleware are, as their name indicates, software that come in the middle, in between the game input device and the game engine. For instance, this software is used when a motion capture technology gives data that needs to be processed before handing it to the game engine. For example, when we use Kinect camera, that yields only 2D and 3D images as output, we need a middleware called Kinect software development kit (SDK) (Microsoft) in order generate to every joint position, orientation and angle.

Finally, a serious game system can also benefit from a database software, mainly used to achieve subject specific gaming. The database saves the accounts of every player in order to keep track of their progress. Some games, which require age, sex or height registration, benefit from the database to keep this information available for the game engine. Some of the most notable database software are SQL server (Microsoft), MySQL (Oracle Corporation) and Cassandra (Apache License).

- **Interaction tools:** some serious games can choose to integrate special tools to be used as interaction devices between the user and the game engine. These items are used when the game needs different types of data input. For instance, if the game needs motion data, the developers must use cameras and IMUs as interaction tools. *Wattanasoontorn et al.* studied the proportion of use of different interaction tools in serious games until 2013 [27], and Figure 7 shows these proportions. This figure shows that the mouse is the most used tool for serious games; however, these serious games would most likely be used for educational purposes. When it comes to mapping the physical actions of users in game scenes, the Wii peripheral is tied with the Kinect camera in first place.

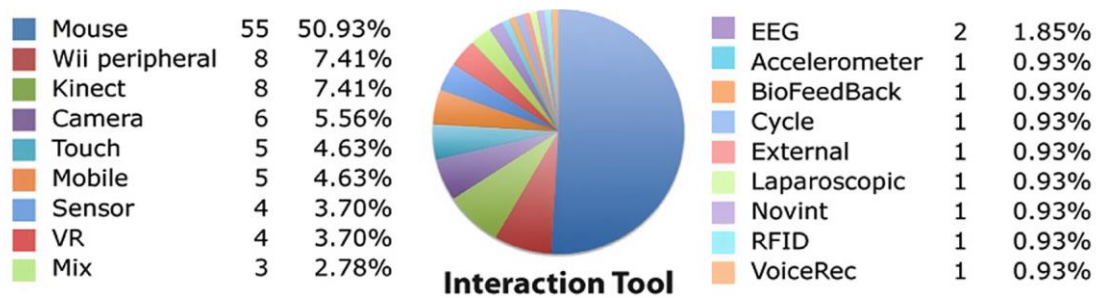

Figure 7. Interaction tools used in serious games until 2013

- Gaming platform:** this refers to the specific hardware that will be used to deploy the serious game system. This hardware must be easily attainable and accessible to the end-user, destined to use serious game system. For instance, in home-based rehabilitation, a patient needs to be familiar with the hardware that he must manipulate at home in order to execute their rehabilitation session. The same study by *Wattanasoontorn et al.* showed that personal computers (PC) were the most used gaming platform for deploying serious games, with 70.37% of these games being implemented on PC devices [27]. This is understandable as PCs have been spreading all across the world for many decades and are easily accessible by different users. PCs are followed by console platforms with 11.11% as a distant second.

- Information presentation:** the choice of how the information related to the serious game environment needs to be presented is an important one. Two technologies are currently competing when it comes to presenting the game to the user. The first technology is VR and the second is augmented reality (AR). The Oxford dictionary defines VR as “*The computer-generated simulation of a three-dimensional image or environment that can be interacted with in a seemingly real or physical way by a person using special electronic equipment, such as a helmet with a screen inside or gloves fitted with sensors*” [54]. This means that VR integrates the person in a complete virtual environment in order to play the game. On the other hand, AR is “*A technology that superimposes a computer-generated image on a user's view of the real world, thus providing a composite view*” [55]. In other words, AR places the user in the real world scene, and can choose to add virtual objects to it, in order to accomplish a specific task. It is up to the developer to choose the technology that is most fitting to present the game to the end-users, and find a compromise between engaging the users in the game and their acceptability of the system.

Finally, the presence of all of these elements is necessary to build a successful serious game; however, there are also social elements that need to be considered. Moreover, the

conception and choice of interaction tools, information presentation and platform are not only made by developers, but should be influenced by the social profiles of end-users. For instance, in serious games for health, the patient's pathology and the medical expert should dictate these choices, in order to have a usable and acceptable device. This dialogue between developers medical experts and patients can help to break the boundary that plays a negative role in the acceptability of patients and experts to use newly developed medical technologies.

### 2.1.3 Academic research

When it comes to games developed for non-commercial purposes, many research were conducted, using different technologies, in order for the games to be deployed in environments such as homes and rehabilitation centers. Since 2004, many different approaches were used, based on various 3D engines and middleware, to assess different cases of rehabilitation. In addition, these research projects targeted different types of pathologies, from general health for adults and the elderly, to chronic diseases and motor deficiencies. Moreover, in 2011 the Kinect camera was re-released as an extension tool for PCs, with a SDK for developers that was later released in 2012. This sudden shift from targeting console gaming to PC gaming made it easier for developers to use the Kinect as an interactive tool for serious games. This caused a boom of research in serious games that require motion tracking, which started in 2012 and is growing ever since. In 2017, the serious game industry's market revenue was evaluated at 3.2 billion dollars, and is expected to reach 8.1 billion dollars by 2022 [55]. In this section, we will focus on the recently developed serious games for health, with a special focus on functional and cognitive rehabilitation. The described systems will be classified based on the destined pathology of the end-users.

#### 2.1.3.1 Serious games for general health

We start first with the games that were developed for the general health and wellbeing of adults and the elderly. These games aim at improving the health of the population rather than targeting a specific group of people. Moreover, they make up a large part of the serious games developed for health. We will present 12 research papers that vary in goal and validation style, they are depicted in Figure 8. *Kim et al.* developed a 3D serious games to improve the health of the elderly, especially in Japan, based on the well-known gate ball game [56]. Their system presented an originally designed device that attaches a ball to several sensors, to measure the velocity and acceleration of the ball when hit by the users, and the position of contact between

the ball and the stick. They also implemented the user interface design, respecting the font size, colors and designs that are generally appealing to the elderly. The game was tested by 20 subject that normally play gate ball, most of them are above 60 years old, and was validated through a questionnaire that was answered by the users after their trial. The results showed that 60% of the users were very satisfied with the games.

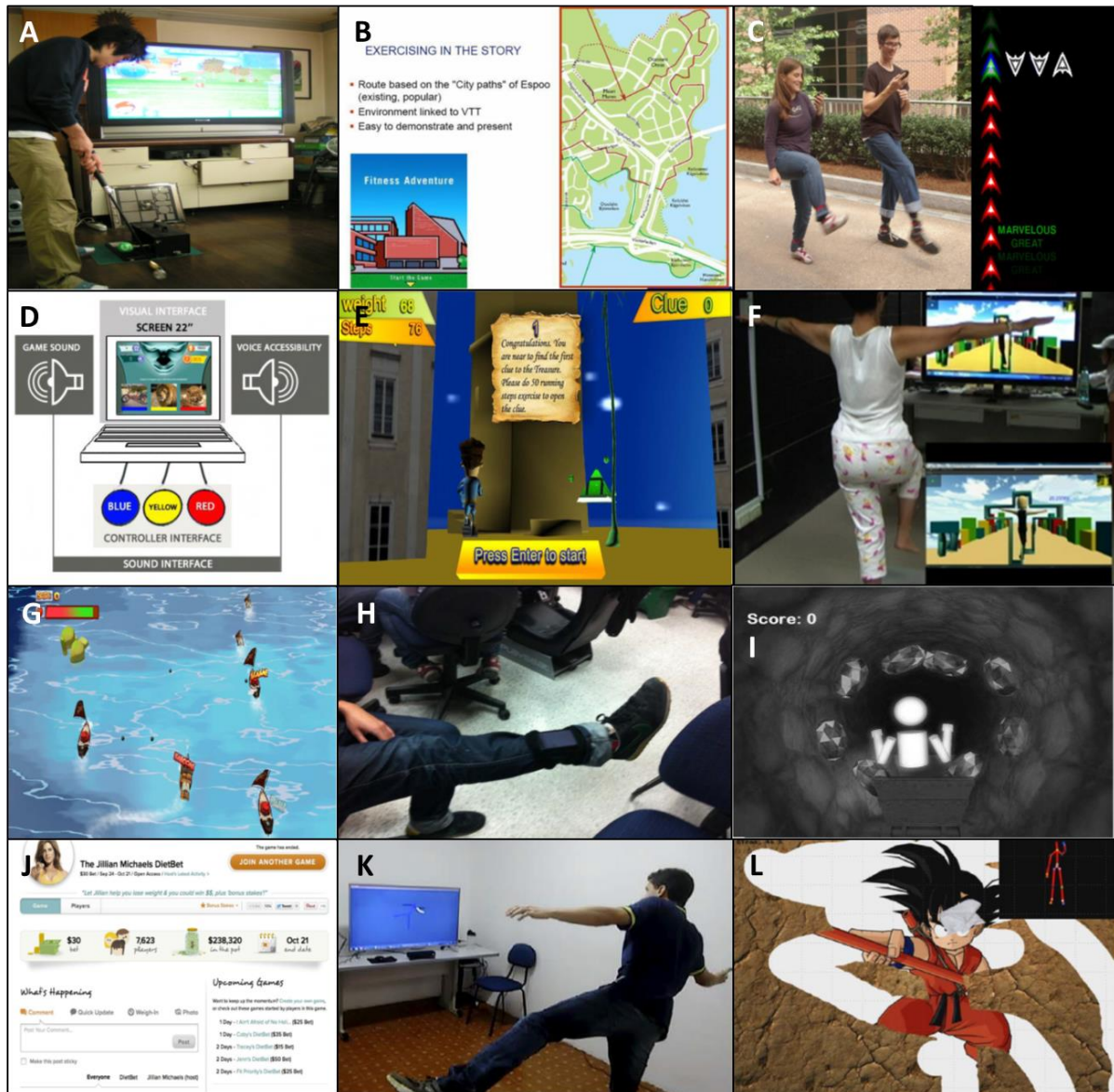

Figure 8. Serious game systems developed for the wellbeing of the general population (Figures A to L represent references 56 to 67)

A study conducted in 2009 by *Laikari et al.* investigated the use of mobile phones to promote exercises and healthy living among the general population [57]. They presented two exergaming concepts; the first one uses the mobile phone and a global positioning system (GPS) receiver, connected via Bluetooth. This game leads the user through a specific path and details the important monuments and landmarks they pass by. The second game concept

connects the mobile device to the internet and uses the subjects' exercise data as an input to an online game, competing with other users. This concept was new in 2009 but is commonly seen nowadays. *Clawson et al.* focused on combating obesity through deploying exergames on mobile phones [58]. Their system uses 2 wireless sensors, that contain 3D accelerometers, and links these wireless sensors to the game installed on the mobile phone. The game is called "Dancing in the Streets" and it follows the principles of the well-known game "Dance Dance Revolution". The users must move their right and left legs to follow the arrow sequence appearing on the mobile screen. Fifty high school students tested the game, and most of them were satisfied with the application, and indicated that the wireless sensors did not obstruct or interfere with their movements. *Martins et al.* studied a serious game application to combat mental deficiency [59]. The game was designed with the help of mental health associations, and was deployed on PCs with online and offline modes. The game asks the user a question and gives them 3 options with different colors. A device containing 3 buttons is linked to the PC and serves as an input for the game. In the online mode, each user has a profile, in which their credentials are saved, in addition to the level of difficulty and time of response that are decided by a tutor. Finally, the tutor follows the progress of the patient and changes the online settings based on that performance. *Alamri et al.* evaluated the impact of cloud-based serious games on obese people [60]. The game serves as a monitoring tool for users, and promotes physical activity through monitoring multiple biofeedback variables using different sensors: ECG sensors, Wii balance board, Wii push up bar and accelerometers used to detect different postures (walking, standing, lying), the heart rate variability and the physical activity of the user. The implemented game is a 2D environment based on a treasure hunting scenario, and requires the users to perform physical tasks to get specific rewards. The system was tested by university students suffering from obesity, and was evaluated through questionnaires and biofeedback. In the survey, the students were satisfied with the system and they were motivated to perform the tasks. *Sun and Lee* developed in 2013 a balance training game using Unity 3D game engine with the Kinect camera, that consisted of a system asking patients to try to imitate the position of an avatar [61]. A force plate was used to monitor the progress of the center of pressure changes during game time. The patient is asked to fit their virtual avatar inside a predefined frame, while leaving one foot on the force plate. The game was tested with 23 healthy individuals and evaluated the difference in center of pressure statistics between static frame postures and dynamic frame postures. The research team did not elaborate on the importance of this game in training the balance of users. *Loreto et al.* developed a game for the general wellness of people called "Hammer and Planck" [62]. The game offers a 2D interface,

in which the player moves the ship left and right, up and down, in order to destroy enemy ships without being destroyed. The novelty of this game is that it can be played using the Kinect or the Wii board, and with different playing styles (standing up, seated, using the whole body or the hand alone). The system also gives the possibility for experts to personalize the parameters of the game. Finally, they tested the game at a social event, while asking if it appealed to different age groups, and they found encouraging results. *Prada-Dominguez et al.* proposed a smartphone-based system to promote lower limb exercises [63]. The game uses the accelerometer within the smartphone, coupled with the microphone, to study the evolution of the knee angle while performing knee flexion. The game scores the effort of the user compared to a baseline identified prior to the use of the system, however, the system was not validated through different studies. *Lange et al.* developed a Kinect-based game system that controlled a game programmed with Unity 3D game engines for the balance rehabilitation of patients, in which the patient would try to capture gems using their arms and hands [64]. The system tracks the patient's position using specific software compatible with Kinect. The objective is to collect gems that are appearing on the screen using the hands. Finally, this system was tested by 20 patients with balance problems, and was validated through comments alone. However, the system only focused on hand and arm gestures which does not include every limb that can limit the balance of patients. *Leahey and Rosen* created a web-based serious game to promote weight loss [65]. The system presents an interface where people subscribe to the service, initially placing a bet that they would lose 4% of their bodyweight in 4 weeks. The people who achieve the goal will split all the money in the betting pot. The platform was tested for 8 months, with 39387 participants and an average initial bet of 27 dollars. Winners won an average of 59 dollars and users lost a mean 4.9% of their bodyweight. The system showed a lot of promise when it comes to giving users with obesity problems an incentive to lose weight. *Rodrigues et al.* presented a game to help people stretch their arms and legs at home or at work [66]. The system uses a Kinect camera and Unity 3D engine, and demonstrates the stretching strategies using a stick avatar. The person must then imitate the stretching position to win the round. The game was tested by 20 healthy users and demonstrated good gameplay, in terms of relevance, ease of use, effectiveness of the stretching exercises and overall satisfaction. More importantly, the visual feedback seemed to help people and motivate them to do their stretching exercises. *Bonnechère et al.* proposed a serious game to assess motor development during the lifespan of a healthy person [67]. The game uses the Kinect camera to detect the movement of a player, and the objective is to clear the dust of a screen to obtain a clear background image. The player can choose to play using their legs, trunk or hands. The time taken to finish the game and the

accuracy were calculated during a study with 81 healthy subjects. The study proposes finally quadratic fitting curves for these captured parameters, that can be used later to compare them to movement of pathological patients.

Our area of interest however remains serious games specifically developed for rehabilitation purposes, for different pathologies. Most of these projects focus on chronic diseases like Parkinson's disease (PD), stroke, diabetes, and other commonly found health problems, while others focus on curing motor and cognitive impairment. Therefore, we start with games conceived for chronic diseases.

### 2.1.3.2 Serious games for Parkinson's disease rehabilitation

Research in PD rehabilitation has largely benefited from the new technology of gamification. We present 5 studies shown in Figure 9. *Assad et al.* investigated the use of serious games for PD patients, and they implemented a series of games that use the Sony PlayStation EyeToy as a motion capture tool [68]. Four different PD adapted games were developed and tested by 13 PD patients. The system was evaluated using a questionnaire completed by the patients after performing the exercises. This study concluded that the patients enjoyed the exercises. *Paraskevopoulos et al.* developed serious games adapted to PD patients [33]. They defined a guideline to successfully design serious games adapted to PD through a detailed literature review of related works, and developed 2 games using the Wii Mote and the Kinect camera. They tested the games on 5 PD patients and concluded that serious games have the potential to increase the level of engagement for such patients.

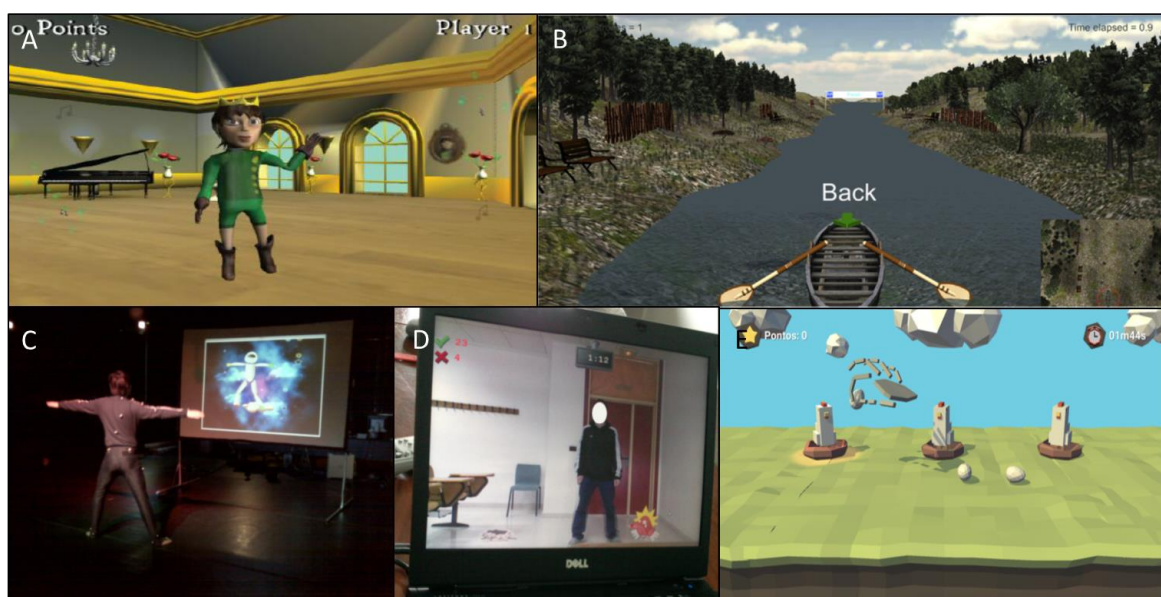

Figure 9. Serious game systems developed for PD patient (Figures A to E represent references 68, 33, 69 to 71)

*Yu et al.* developed a real-time Parkinson mediated rehabilitation environment [69]. They implemented a system applied in a clinical space to treat PD symptoms by improving the patient's ability to reach and step as far and as fast as possible. Patients are required to execute repetitive and variable tasks in order to learn new movement patterns and to perform the transition from one movement to another by performing mixed and multiple tasks. A virtual avatar is shown on the screen and mimics the patient's movements. However, the system was never tested on PD patients. *Palacio-Navarro et al.* developed an AR platform for the rehabilitation of PD patients [70]. The system uses the Kinect camera to capture the player's position and adds virtual personas to the 2D captured image. The aim is to step on appearing moles in order to kill them. The game was tested by 7 healthy subjects, and gathered the average time taken by each user to kill moles, in different levels of difficulty, as an output. The study finally extrapolated linear models, based on Fitt's law, which could describe the normal behavior of users when playing this game. *Foletto et al.* presented the development and assessment of a system of serious games for fine motor skills rehabilitation of PD patients using the leap motion technology [71]. Moreover, 3 serious games were developed, and were inspired from daily tasks, requiring the use of the player's hands to play. The games were evaluated by 20 healthy adults, through the game experience questionnaire. The results showed that the games were challenging and caused a good immersion of the patients in the created environment.

### 2.1.3.3 Serious games for post stroke rehabilitation

In addition to PD rehabilitation, serious games for stroke rehabilitation are very common in academic research. Six research papers will be presented in this paragraph and are highlighted in Figure 10. *Cho et al.* developed a proprioception rehabilitation system for stroke patients [72]. The user moves a connected cylinder to interact with the game. The objective was to hold the connected cylinder under a table to move the virtual cylinder from an initial position to a destination position. The study was tested with 10 healthy subjects and 10 stroke patients and showed significant improvement in patients. However, this improvement might have been attributed to patients becoming accustomed to the game. Another system used a commercial Wii Fit game and 2 Wii balance boards to adapt commercial games to stroke survivors [73]. Each balance board captures the center of pressure of the foot. The weak leg's signal is multiplied by a higher weight than the healthy leg's signal so that the patient applies more load on the weak leg. The system was tested on 3 post stroke patients (2 participants and



1 control) and showed that after 7 to 12 sessions, the patients began to rely more on their weak legs and began to tend to normal load ratios observed in healthy subjects. *Ibarra Zannatha et al.* also developed a serious for game stroke rehabilitation using the Kinect camera, EMG sensors, and a humanoid robot [74]. The system consists of 4 games for the upper limbs. This system was not tested on stroke patients.

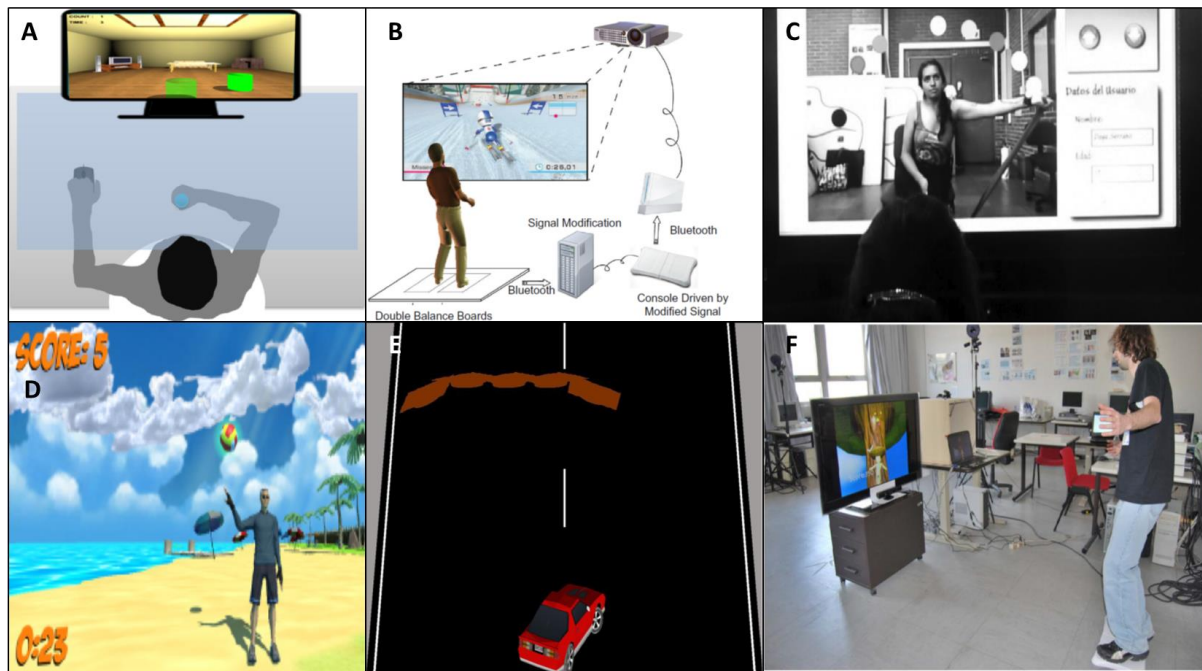

Figure 10. Serious game systems developed for stroke patient (Figures A to F represent references 72 to 77)

Another system called “Motion Rehab AVE 3D” was developed using the Kinect camera for post stroke patients [75]. The originality of this work is that the game can be displayed on television screens or using Oculus rift (Oculus VR). Six games were integrated, where the patient is represented by a virtual avatar on a beach and they need to balance a beach ball using different parts of the body (upper or lower limbs). The system was validated through a questionnaire, and the results showed that all participant classified the games as an interesting and excellent experience for the elderly. However, they were not as comfortable using the Oculus rift and would rather use the television screen to play.

There were also some smartphone applications developed for stroke patients. *Ferreira et al.* developed 2 smartphone games for stroke rehabilitation [76]. The first game is played by rotating the phone on its Z axis to avoid blocks while driving a car, and the second game requires the user to flex and extend their arms to avoid arrows that could pop a balloon. The games were tested by 1 patient and therefore the results were not convincing. Finally, *Borghese et al.* developed 2 mini rehabilitation serious games, as a part of their Rewire project that aims

to develop a framework linking between the hospital and the patient undergoing rehabilitation [77]. The first game is called animal feeder, where the patient kneels on a Wii board, in front of a Kinect camera, and uses their hands to feed hungry animals, avoiding some obstacles, while the second one is fruit catcher, where the patient must remain standing up as he catches fruits falling from a tree. The validation of these games was not presented and was only described in brief details.

#### 2.1.3.4 Serious games for various other rehabilitations

Finally, some researchers were interested in functional and cognitive rehabilitation for different pathologies. Seven studies are presented in this category, shown in Figure 11. *Chen et al.* developed a lower limb power rehabilitation system [78]. Each user needs to execute a squat motion, with sufficient power, to correctly build a virtual tower made of blocks. The system was tested with 20 participants, whereas 20 control participants executed normal exercises for 6 weeks. The results showed that the participants using the developed system achieved greater improvements in power and velocity of movement. *Lozano-Quilis et al.* developed a system based on the Kinect camera, that uses natural user interfaces with AR [79]. The system is called RemoviEM and consisted of 3 games for the rehabilitation of balance and the upper limbs as well, with an ability given to the therapist to choose between the exercises. The study showed that virtual rehabilitation adds more motivation for the patients. In this work, we see that an interface is not based on any avatar movement, but only on the player's captured images, which means that there would be no virtual world to interact with. *González-Ortega et al.* developed a 3D computer vision system for cognitive assessment and rehabilitation based on the Kinect camera, intended for individuals with body scheme dysfunctions and left-right confusion [30]. In their first step, they detected the skeleton of the subject; next, they monitored the exercises executed by the patient. They also developed a face recognition algorithm in order to evaluate the performance. The exercises required patients to identify parts of their faces using their hands in order to check for signs of Autotopagnosia (Inability to localize one's own body parts). They tested the system on 15 users and achieved a successful monitoring percentage of 96.28%. *Scardovelli and Frère* used the webcam to create a very simple game for the rehabilitation of children with motor impairment [80]. The game uses a webcam and image processing algorithms to move an avatar in a 3D environment, in order to collect objects. The developed game was evaluated by normal subjects and patients with severe motor limitations of the upper limbs. The study proved that motor impairment did not affect the performance of the volunteers when they used the system developed in this study. *Anton et al.*

studied the feasibility and user acceptance of using a serious game system called KiReS in a real scenario, with patients attending repeated rehabilitation sessions after total hip replacement [81]. The game shows a computer-generated avatar performing simple hip movements, and the player must move their own avatar to imitate those movements. The movement of the patient is captured using the Kinect, and was validated by 7 patients that underwent hip replacement surgery, through questionnaires and data collected from the patients' movements. The results show that the computer-generated avatar confused the patients, since they were not sure which avatar they were controlling. When it comes to the movements, most of the patients were able to imitate the avatar at a minimum of 90% of correctness.

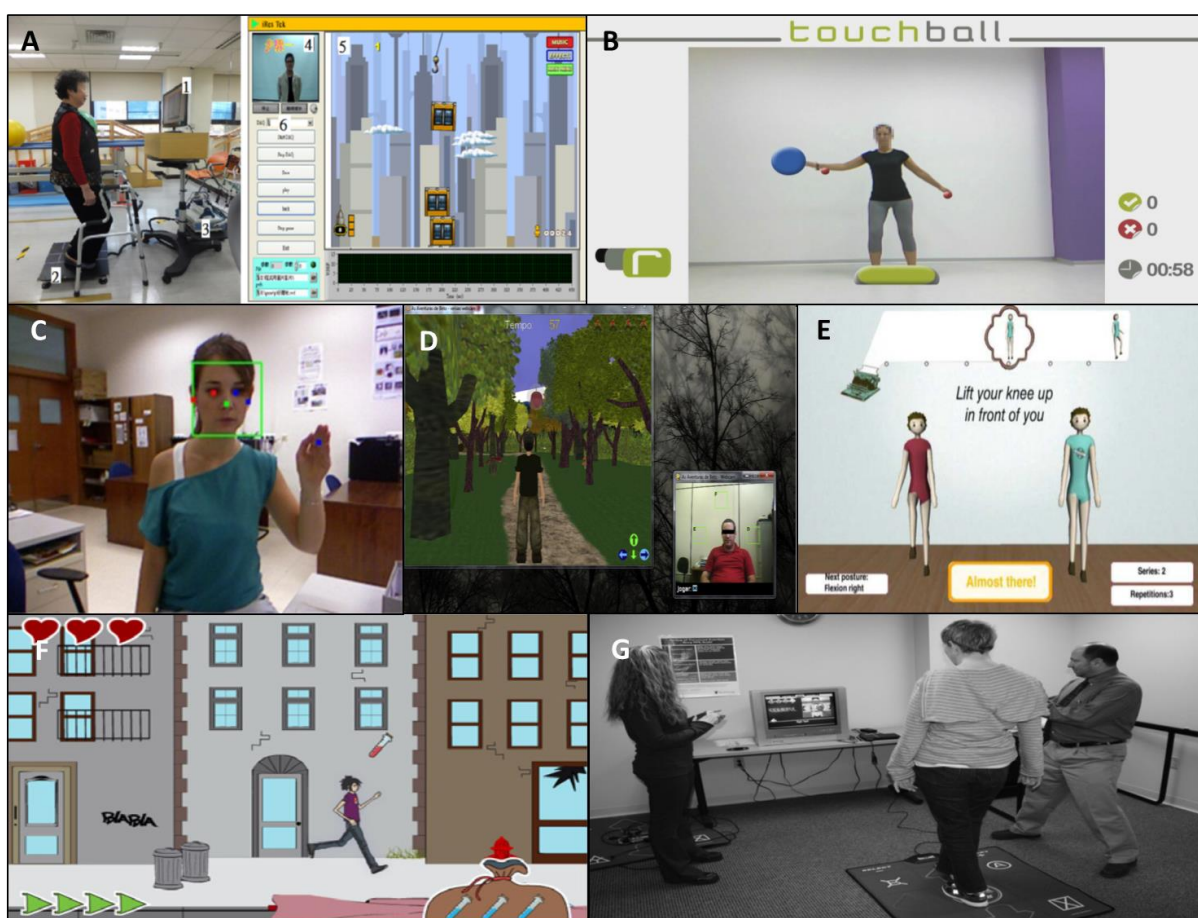

Figure 11. Serious game systems developed for various rehabilitation patients (Figures A to G represent references 78, 79, 33, 80 to 83)

*Fuchslocher et al.* developed a serious game called “Balance” to raise awareness for young adults with diabetes [82]. The story of the game follows a young adult that is walking in the street whose health deteriorates with time. The player must collect the correct amount of potions (mode 1) or food (mode 2) in order to remain healthy. Twenty young diabetes patients tested the games, and they concluded that the patients accepted and associated to the game with

the potions, more than the one with food, since it relates to their case and makes them feel involved. Our final example is the work by *Natbony et al.* who proposed the use of the dance pad for the cognitive rehabilitation of patients, where the patient is shown a sequence of arrows on the screen, and they need to step in the right direction to improve their scores [83]. Sixteen patients evaluated the system, using a qualitative approach, and concluded that the game was fun for patients and could help increase their dopamine levels while undergoing cognitive rehabilitation.

Literature shows that serious games have been intensively studied for general health and specific disease management. One of the most important aspects of serious games is the game playing scenario to motivate the patient. Moreover, user acceptability also plays an important role in promoting this new technology to clinical practice. Finally, the user security aspect needs particular attention to avoid new clinical complications for patients. Different game systems have been developed and tested. However, there is still lack of consensus on the development and evaluation guidelines to achieve these important aspects. It is important to note that the game performance depends on the designed scenario. Some authors have attempted to propose specific guidelines for game development-based learning [84] or for Parkinson disease rehabilitation [33]. However, methodologies and best practices related to the development of customized serious games for MSDs for the recovery of complex joint and muscle functions are still lacking.

#### 2.1.4 Commercial games for rehabilitation

One of the first attempts to develop interaction games was the Dance Dance Revolution game (Konami) released in 1991 [85] which consisted of a dance pad, with directional arrows as outputs, that gives feedback of the evolution of the game on a screen. However, the purpose of this game was neither fitness nor rehabilitation. In 2005, Yourself!Fitness was released by responDESIGN with clear purposes of improving the health and fitness of the user [86]. In addition, the release of the Wii system gave the potential to implement fitness games for every age group. Therefore, we saw the rise of games like WiiFit destined to make the user practice sport-based exercises at home [87]. Recently, several commercial systems have emerged, such as SeeMe, which uses the Kinect Camera to implement a serious gaming system for rehabilitation of patients, both in the clinic or at home [88]. Nonetheless, this system emphasizes on basic gestures for rehabilitation, especially for the upper body with simple motions. Jintronix is another commercial serious game for rehabilitation that uses the Kinect as a home-

based motion capture tool [89]. They also implemented expert interfaces to monitor the patient's situation. Finally, some of these deployed commercial tools have been a result of previous academic work, like the MediMoov tool that is the commercial implementation of the “Hammer and Plank” game mentioned in Section 2.1.3.1 [90]. These commercial tools are represented in Figure 12.



Figure 12. Commercial tools for rehabilitation and fitness (Figures A to F represent references 86 to 91)

However, most of the developed systems are not conceptualized with the help of medical experts, which poses a big question about their clinical relevance and acceptability. In addition, most of the deployed tools seem to be destined for the general population, and more particularly for the elderly, but without a specific targeted pathology in mind. This could present a significant limitation in these systems, since every pathology requires different types of games and scenarios. Moreover, the systems do not address the accuracy limitations of the Kinect cameras and the problems that can be caused by the occlusion of limbs by other limbs or objects.

### 2.1.5 Advantages and limitations

Based on the works presented in this section, and on some of the review works that discuss serious games for health [27, 91], we discuss the advantages and current limitations of using serious games in the medical environment, and especially for rehabilitation. We start with the possible advantages that serious games could offer:

- Increasing the users' compliance with health interventions.
- Improving the users' ability to manage their health condition.
- Raising the patient's self-esteem especially when they improve their performance over time.
- Increasing the patient's motivation to perform gamified rehabilitation exercises.
- Making health exercises fun and enjoyable.
- Increasing the social skills of patients who are required to play together or to communicate their situation to their experts.
- Promoting healthy changes in the patient's daily activities.

On the other hand, these advantages are met with a lot of limitations and criticism:

- The effectiveness of the games is always questioned since the patient's progress could only remain in the virtual world, and not exhibit equivalent progress in the real world.
- There exist no unified frameworks to develop serious games.
- A unified guideline to develop clinically relevant games does not exist.
- The interest and motivation of the users can decline over time.
- Users do not take the game seriously, since it feels more like a game than a rehabilitation program.
- Some of the developed games are not user centered and can be generalized to meet the needs of a specific pathology without taking into consideration the diversity found even in a single pathology.
- Serious game systems do not integrate the medical experts in conceptualizing the games.
- Users might tend to cheat to get their rewards without putting additional effort.

This discussion about advantages and limitations of serious games for health must contribute to the advancement of this field. The next step after developing a game must always concentrate on validating the tool in a clinical environment, in order to authenticate the system as a medically viable solution. Next, most researchers share the interest of deploying these serious games in a home-based environment, to serve as a monitoring system as well as a support for home exercises practiced by different patients currently. These systems will also be discussed at the end of this chapter, but first we must highlight the current state of the art on portable

motion capture tools, that can be used to deploy serious games in home and clinical-based environments.

## 2.2 Portable motion capture technology

A large range of sensors like the Microsoft Kinect, Wii Mote, Wii Fit, force plates, and IMUs have been used as interactive tools between the subject and the virtual environment of the developed exergaming systems. The most commonly used sensor is the Microsoft Kinect, due to its low price and big success with Xbox games. In order to use these visual or inertial sensors for body tracking in serious games, the sensor needs to be able to estimate the orientation of any considered limb as well as body joint angles. Several tools can help estimate these parameters. The universal goniometer was the most famous tool for estimating joint angles, and more recently, the VICON motion capture system is commonly used for the same purpose [92]. However, even though these two tools are considered as the golden standards for orientation and angle estimation, they are neither portable nor cost efficient. Consequently, they are usually substituted with IMU sensors that contain accelerometers, gyroscopes and magnetometers, that can be used to estimate joint orientation. The data is sent wirelessly to servers or computing stations to process raw data and generate the desired output. In this section we will describe some of the most used systems for portable motion capture. Therefore, we will concentrate on the Kinect camera and IMU sensors, describing the state of the art of the current algorithms used for orientation estimation. However, we will first define the notion of quaternions, recently used to describe the orientation of a vector, instead of the classical Euler angles.

### 2.2.1 Quaternions and spatial rotation

The rotation of a rigid body in a 3D reference system is described in Figure 13.

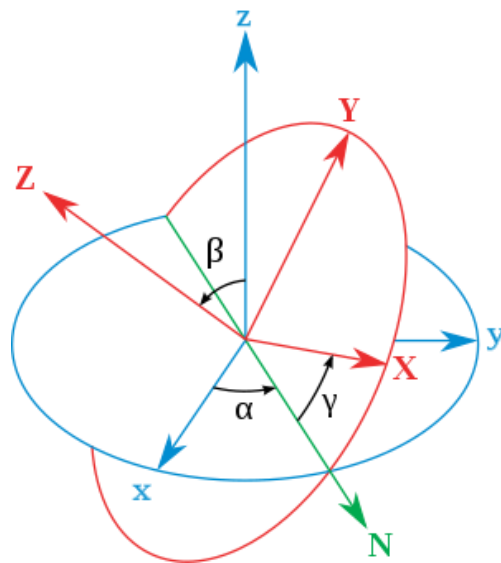

Figure 13. Rotation of a vector in a 3D reference (source: Wikipedia)

The first attempt at describing this 3D rotation was made by Leonhard Euler using the 3 angles presented on Figure 13, later named “Euler Angles”. To describe such an orientation in 3D Euclidean space 3 parameters are required: the yaw angle ( $\alpha$ ), the pitch angle ( $\beta$ ) and the roll angle ( $\gamma$ ). To rotate a rigid body with respect to a fixed space, we first rotate around the Up axis ( $Z$  in Figure 13), then around the resulting axis ( $N$  in Figure 13), and then we rotate around the orthogonal resulting vector ( $N'$  hidden in Figure 13). Moreover, the calculation of these angles follows the application of the inverse trigonometric formulas. Let  $S$  be a rigid body with  $(X, Y, Z)$ , rotated around the fixed space  $(x, y, z)$ . Let  $(Y_1, Y_2, Y_3)$  be the projection of the rotated  $Y$  axis on the fixed space  $(x, y, z)$ , and  $(Z_1, Z_2, Z_3)$  be the projection of the rotated  $Z$  axis on the same fixed space

$$\alpha = \arccos\left(-\frac{Z_2}{\sqrt{1 - Z_3^2}}\right) \quad (1)$$

$$\beta = \arccos(-Z_3) \quad (2)$$

$$\gamma = \arccos\left(\frac{Y_3}{\sqrt{1 - Z_3^2}}\right) \quad (3)$$

However, this mathematical representation of the orientation of a rigid body suffers from a critical issue, commonly referred to as “Gimbal lock”. The idea is highlighted in Figure 14.



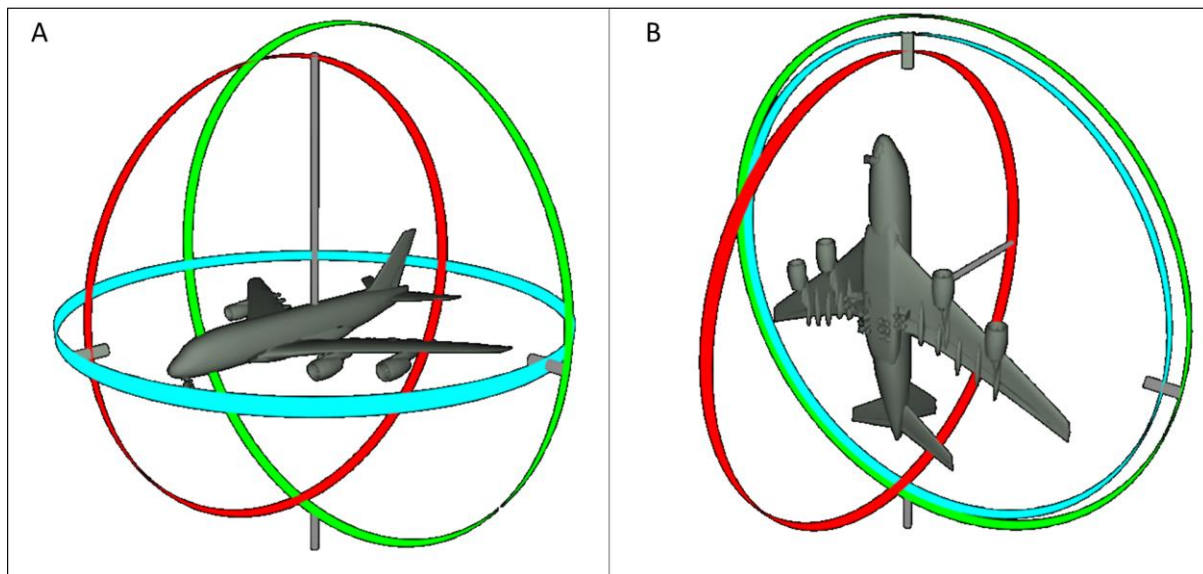

Figure 14. Gimbal lock problem for Euler angles (A: no gimbal lock, B: yaw and roll angles are locked)

The Euler angle mathematical theory forces a given order on the yaw, pitch and roll planes of rotations. Generally, the yaw axis is the parent plane, followed by pitch then roll. This means that any movement in the parent can cause changes in the children. The Gimbal lock problem occurs when we rotate the pitch by  $90^\circ$ , which causes the superposition of the yaw and roll planes. Therefore, any rotation around the yaw or the roll plane will lead to the same result, and we say that the planes are locked. This is highlighted in Figure 14 B, where yaw is the green plane, pitch is the cyan plane and roll is the red plane. These mathematical singularities can occur no matter the order of the rotation planes, and have caused a lot of problems especially in the field of 3D animation, and recently space exploration. However, in aeronautics, this does not present a problem since some singularities can be avoided (planes do not fly straight up or down).

The mathematical solution to this problem was to adopt a more complex approach to represent spatial rotation. Two of the most used representation are rotation matrices and quaternions. First, the rotation matrix is a technique to represent the rotation of every axis of the rotated reference of the rigid body with respect to one axis of the fixed space. For instance, the rotation presented in Figure 13 can be written using this rotation matrix:

$$R = R_z(\gamma) * R_y(\beta) * R_x(\alpha) \quad (4)$$

$$R_x(\alpha) = \begin{bmatrix} 1 & 0 & 0 \\ 0 & \cos(\alpha) & -\sin(\alpha) \\ 0 & \sin(\alpha) & \cos(\alpha) \end{bmatrix} \quad (5)$$

$$R_y(\beta) = \begin{bmatrix} \cos(\beta) & 0 & \sin(\beta) \\ 0 & 1 & 0 \\ -\sin(\beta) & 0 & \cos(\beta) \end{bmatrix} \quad (6)$$

$$R_z(\gamma) = \begin{bmatrix} \cos(\gamma) & -\sin(\gamma) & 0 \\ \sin(\gamma) & \cos(\gamma) & 0 \\ 0 & 0 & 1 \end{bmatrix} \quad (7)$$

$$\text{with } \begin{bmatrix} X \\ Y \\ Z \end{bmatrix} = R \begin{bmatrix} x \\ y \\ z \end{bmatrix}$$

However, and since moving objects using these geometrical calculations demands a lot of computational power, quaternions have been the dominating calculation tools used in 3D animation lately. In 3-dimensional space, according to Euler's rotation theorem, any rotation or sequence of rotations of a rigid body or coordinate system about a fixed point is equivalent to a single rotation by a given angle  $\theta$  about a fixed axis (called Euler axis) that runs through the fixed point. Let us consider a unit vector  $\vec{u}$  rotating around its axis with an angle  $\theta$ , this vector is defined by  $\vec{u} = (u_x, u_y, u_z) = u_x i + u_y j + u_z k$ . The quaternion representation of this vector, rotating around its axis is defined by

$$Q = e^{\frac{\theta}{2}(u_x i + u_y j + u_z k)} = \cos \frac{\theta}{2} + (u_x i + u_y j + u_z k) \sin \frac{\theta}{2} \quad (8)$$

$$\text{Where } \cos \frac{\theta}{2} = q_0, u_x \sin \frac{\theta}{2} = q_1, u_y \sin \frac{\theta}{2} = q_2, u_z \sin \frac{\theta}{2} = q_3$$

Hamilton introduced the notion of quaternions in the 19<sup>th</sup> century, but it was not meant for its current usage. The notion came as a result of his famous equation  $i^2 = j^2 = k^2 = ijk = -1$ . Adding a 4<sup>th</sup> dimension solves the Gimbal lock problem that is inherited by using Euler angles, and the computational power needed to use quaternions to move object is much less than when using rotation matrices. To move an ordinary vector  $P = P(P_x, P_y, P_z)$  with the previous rotation of vector  $u$ , we simply calculate the following product:

$$P' = QPQ^{-1} \quad (9)$$

Where  $Q^{-1}$  is the conjugate of the quaternion, obtained by rotating the vector  $\vec{u}$  by  $-\theta$ .

We note that the multiplications of quaternions are not commutative and the order of multiplication is of importance. In addition, quaternions must be unitary 4-dimensional vectors, and would cause problems in rotation if they were not.

Finally, the relationship between Euler angles and quaternions is the following:

$$\begin{bmatrix} \alpha \\ \beta \\ \gamma \end{bmatrix} = \begin{bmatrix} \arctan \frac{2(q_0 q_1 + q_2 q_3)}{1 - 2(q_1^2 + q_2^2)} \\ \arcsin(2(q_0 q_2 - q_1 q_3)) \\ \arctan \frac{2(q_0 q_3 + q_1 q_2)}{1 - 2(q_2^2 + q_3^2)} \end{bmatrix} \quad (10)$$

These formulas will not be needed to animate objects in 3D, since most of the modern game engines offer compatibility with quaternion mathematics. However, it might be used to calculate the angles of vectors, in order to represent them in an easier way for the end-users of the application. We note that when computing these Euler angles from quaternions, the algorithm must take note of some singularities that might exist. An inverse relationship between these mathematical notions also exists, but will be presented and analyzed in another chapter.

### 2.2.2 Vision-based portable motion capture tools

Vision-based sensors for motion capture have been widely used in serious games as stated in Section 2.1. Moreover, time of flight (ToF) cameras are currently some of the most used motion portable motion capture sensors. These cameras emit a source of light and measure the time until it receives it back, in order to estimate the depth of objects in a scene. Other tools are basic 2D Red-Green-Blue (RGB) cameras like webcams. In this section, we will present the Kinect camera in detail, which is one of the most used ToF cameras commercially available by Microsoft for different operating systems.

Kinect is a line of motion sensing input devices by Microsoft for Xbox 360, Xbox One video game consoles and Windows PCs. Based around a webcam-style add-on peripheral, it enables users to control and interact with their console/PC without the need for a game controller, through a natural user interface using gestures. Contrary to regular 2D cameras, the Kinect camera allows the capture of 3D environments, using infrared-based technology sensors. The system contains several sensors, cameras and microphones. In addition to the RGB camera, already existing in ordinary 2D cameras, the Kinect disposes of two 3D Depth sensors, in order to generate the 3D depth images. Figure 15 shows the Kinect and its different components [93].



Figure 15. Kinect camera and its components (source: reference 94)

The concept of depth sensing is simple. The Kinect sends a sequence of structured infrared light, and receives the reflection of this pattern from the captured scene. Based on the changes in the infrared speckle, we can calculate the depth of each object in the scene. Kinect also differs between body parts, based on a randomized decision tree algorithm, which learned from over one million training samples. So based on the depth image, we can differentiate between the different parts of the user's body. Because of these two generated data information, the Kinect can give many different data as output, starting with the normal RGB 2D image, then the Depth image, finally we can use the capability to differentiate the body parts in the depth image to generate the user's skeleton.

The Kinect allows the generation of a human skeleton through data processing techniques, using the results of the randomized decision tree to estimate body joint positions. Figure 16 shows the generated skeleton that can be obtained from the Kinect.

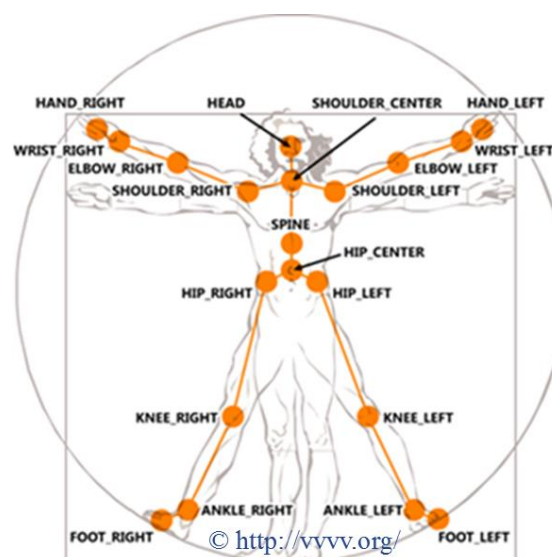

Figure 16. Generated skeleton data from Kinect

Twenty joints can be distinguished after processing the captured images, with the chance to exploit multiple variables for each one among them. The orientation and position (both in meters and pixel) of these joints can be saved in variables to be exploited later.

The orientation of each joint can be obtained after data processing, in different forms such as Euler angles, rotation matrices and quaternions. They can also be calculated with respect to a fixed reference system (the center of the Kinect camera) or with respect to the parent body joint position. For instance, to estimate the joint orientation left elbow, we can choose to calculate it with respect to the Kinect camera position or to the left Shoulder joint position. The hip center joint is the parent of the whole skeleton, and its children are the spine, the hip left and the hip right joints. The same logic is applied in order to reach each of the body's extremities. Finally, the Kinect reference system has the Y axis pointing upwards, the Z axis forward and the X axis is the orthogonal axis following the right-hand rule.

Most of the notable research involving the Kinect revolves around the accuracy of its algorithms to determine joint orientations and angles. The results of most of the studies show that the Kinect does not have good accuracy when estimating these quantities, but its advantages reside in its low cost and high portability. As mentioned in Chapter 1, the Kinect's error in estimating the knee angle, for example, is  $14.5^\circ$  in average according to recent studies [46, 47]. Other research involves using multiple Kinect cameras to increase the accuracy of estimation. For example, *Kim et al.* used 8 Kinect sensors to estimate joint angles while users were dancing [94]. After reconstructing the skeletal data from multiple Kinect data, they showed that using 8 cameras increases the accuracy of estimation by a significant amount (from an average of 65% of accuracy to 85%, compared to a golden reference orientation estimation system). Finally, researchers were mostly interested in using the Kinect for home-based applications. This is due to the fact that the Kinect SDK offers libraries to estimate joint angles without the need to write a separate code. Therefore, there is a limited ability to change in these libraries to better estimate joint angles.

The Kinect camera is a good solution for home rehabilitation, but offers limited accuracy compared to golden reference systems. However, its portability and acceptability by the general public has increased its use in serious game for health research. Another solution could be to use inertial sensors that offer more accuracy but less portability. These sensors will be presented in the next section, along with the research that has been done in the orientation

estimate field using accelerometers, gyroscopes and magnetometers, the base components of the currently available IMU sensors.

### 2.2.3 Inertial sensors and measurement units

IMUs are sensors that possess one or many inertial sensor, such as accelerometers, gyroscopes and magnetometers. We start by describing these different components and how they are currently implemented in electronic sensor modules.

First the accelerometers measure the acceleration of the sensors by measuring the changes in capacitance that is caused by the acceleration of a small mass implemented inside the accelerometer chip (Figure 17). A slight acceleration of the mass will change the position of the middle armature, and subsequently the values of the capacities that is calculated. Finally, the value of the acceleration is deduced from the changes in these values.

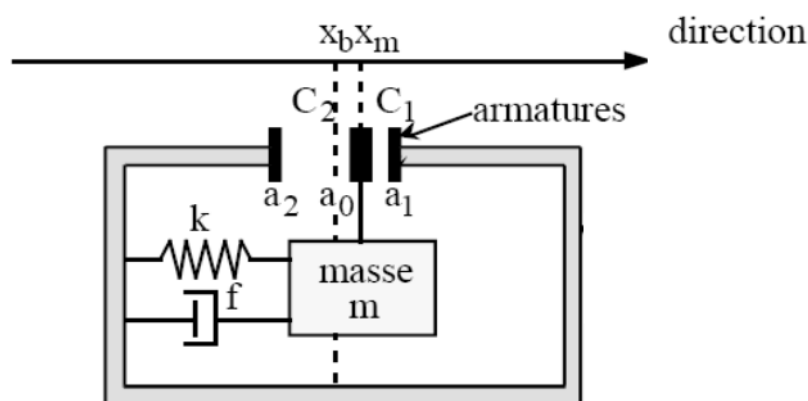

Figure 17. The implementation of accelerometers in inertial sensors

When it comes to gyroscopes, they are implemented in a similar way shown in the figure above, but the direction of movement is perpendicular to the direction shown in the figure. The gyroscopes measures the angular velocity using the principals of the Coriolis effect. When moving in a straight direction, any application of an angular rate to the sensor will cause a Coriolis effect that moves the armature attached to the mass in a perpendicular direction relative to the direction of the movement. This will lead to a change in the capacitances in a similar way that was described for the accelerometer.

Finally, magnetometers that are implemented in inertial sensors use the Hall effect to measure the earth's magnetic field. The principal of this effect is shown in Figure 18. A current is applied to a current carrying conductor. In the absence of any magnetic field will cause a

direct transfer of electron inside the conductor, and no difference of voltage would be observe if the extremities of the conductor is measured. However, the presence of a magnetic field will cause the electrons to shift to one side of the conductor, producing a difference in voltage between the two extremities. Therefore, the magnetometer will attribute to different voltages, different magnetic values in order to measure the earth's magnetic field.

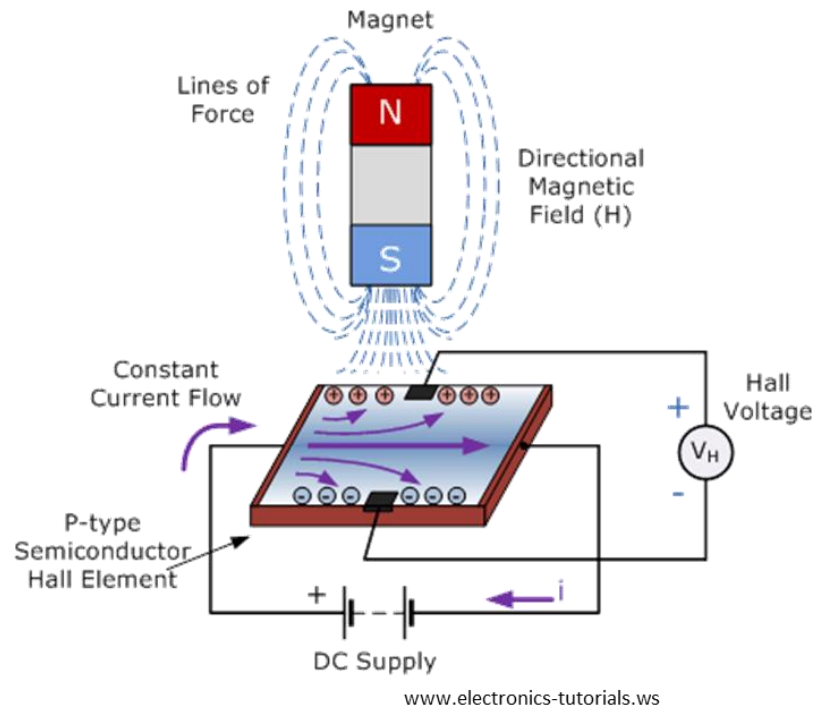

Figure 18. Hall effect

In recent years, these sensors have been a subject of interest for many researchers to try to estimate joint angles.

### 2.2.3.1 Communication standards

Using IMUs for portable motion capture requires sending data from the sensors to processing servers or PCs, or processing the data locally on the chip. However, locally processing data could lead to rapid battery depletion. Therefore, many communication standards have been used to send data from IMUs to PCs, varying based on the application's needs.

First, the ZigBee standard (IEEE 802.15.4) was conceptualized to save the battery life of a sensor. This standard is used for applications that can tolerate low bandwidth (20-40 Kbps). It is most commonly used for domestic sensors, connected lightbulbs and security systems. They have a range that varies between 10m and 100m based on the version of the ZigBee

implementation. More recently, a new low bandwidth standard called Low Power Wide Area Network (LPWAN) for connected sensors and internet of things applications is being studied. This new standard will have a long range and a slow battery consumption rate (10 years). However, it does not offer more than 10Kbps as a bandwidth.

Generally, applications using IMU for portable motion capture need a higher bandwidth than that offered by the standards proposed previously. This is due to the fact that sending accelerometer, magnetometer and gyroscope data, along with timestamps cannot be done through low bandwidth standards. Therefore, other standards like WiFi (Wireless Fidelity - IEEE 802.11) have been used by IMU portable sensors to transmit data. It offers a much higher bandwidth (6-11 Mbps) and a longer range of use (300m), however it does cause fast battery depletion. Therefore, Bluetooth standard was later invented to benefit from the high bandwidth of the WiFi standard, while optimizing the battery life. It uses the same frequencies used by WiFi with a 2.1Mbps and a range of 5-15m. In addition, a low energy version was conceptualized in 2011 to be implemented in sensors with small battery capacities. This version cuts the power consumption in half while also reducing the latency. Since its invention, Bluetooth has been widely used by connected sensors for close range applications. As a result, most of the IMU sensors have adopted it as a communication standard.

### 2.2.3.2 Inertial sensors for joint angle estimation

Several researchers were interested in exploiting IMUs for this purpose. These studies are presented in Figure 19. *Williamson et al.* used two biaxial accelerometers and two uniaxial gyroscopes, attached to the subject's thigh and shank, to determine the knee angle using several algorithms [95]. First, the algorithm determines an angle and the angular velocity of the thigh and shank, using classical trigonometrical formulas, and normalizes these values over 50 samples. After the first 50 samples, the angles will be estimated using the integration of angular velocities, and the resulting knee angle will be the difference between the two estimated angles. Finally, the study implemented some algorithms to auto null the gyroscope and reset the integrators, when the knee is approximately fully extended. The angle estimation was compared to a universal goniometer, and the results showed that the algorithm integrating the gyroscope's angular velocity and automatically nulling the angular velocity integrator, using the accelerometer data, was the closest to the knee angle measured using a goniometer. *Myagoitia et al.* obtained good results when they calculated the angles and angular velocities using two uniaxial gyroscopes, and the linear and angular acceleration using four uniaxial



accelerometers, with one gyroscope and two accelerometers on the thigh and shank, respectively [96]. The results were compared to those measured to the universal goniometer, and to other body worn sensors that estimate the same values. They obtained low root mean square (RMS) error when comparing their estimations to the golden reference system. *Favre et al.* then explained that there is an error due to the difference in the alignment of the sensors references [97]. They developed an algorithm that considers this problem using two 3D accelerometers and two 3D gyroscopes, and achieved good results for knee angle calculation with respect to a golden standard. Their algorithm uses a camera first, to obtain geometric data of the lower part of the subject's body. The researchers then identified 2 points: the position of placement of the sensors on the thigh, the position of placement of the sensors on the shank. Their idea is to move the rotation from the local references of the sensors to the same reference system, in order to obtain a more accurate estimation. Finally, the obtained quaternions using the sensors on the thigh and shank will be recalculated in the new reference, to calculate the knee angle.

Recent advances in integrated circuits have led to a higher availability of IMU's and thus research on this topic has flourished. *Liu et al.* developed their own IMU using biaxial accelerometers and 3D gyroscopes [98]. After combining data from both sensors and correcting the measurement based on a prior calibration, they achieved a RMS error of about  $5^\circ$  for knee angle estimation compared to an optical reference. *Perez et al.* studied a commercially available IMU for upper limb orientation estimation [99]. The IMUs calculated the Euler angles internally, and the researchers transformed these angles to quaternions to estimate joint angles between sensors. They compared their outputs with a visual motion tracking reference and found inaccurate results for angle estimation. However, they applied calibration for one sensor to determine shoulder internal external rotation, and obtained a good RMS of  $0.8^\circ$  using one sensor and a simple gesture.

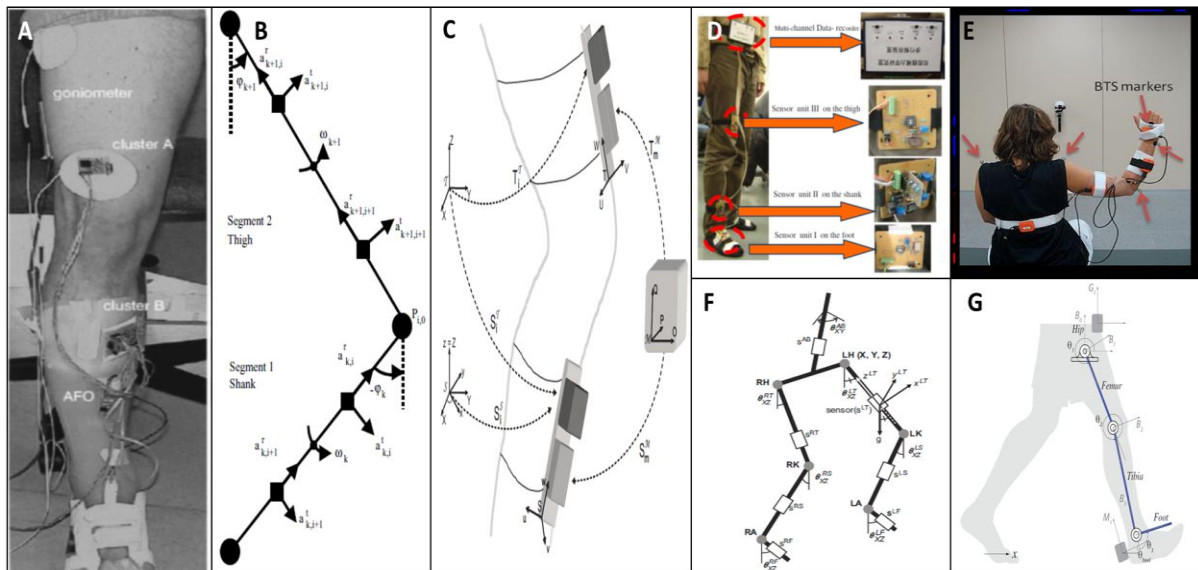

Figure 19. Studies using inertial sensors to estimate body joint angles (Figure A to G represent references 95 to 101)

*Takeda et al.* used several accelerometers placed on the lower part of the body to try and calculate the position of each joint and the angles between them, starting from the bottom and moving upwards [100]. Unfortunately, the results were not significant since their system was too complex, and the study only used accelerometers to estimate joint angles. *Hu et al.* used IMUs containing 3D gyroscopes and accelerometers to estimate the joint angles of the lower body during gait trials [101]. The displacement of the IMU sensor placed on the heel is estimated first through a double integration of the acceleration component extracted from accelerometer data. Then, the linear velocity of the hip is estimated by dividing the calculated displacement over the time needed to raise the heel off the floor. Finally, the angles are calculated using inverse trigonometrical formulas applied on accelerometer data. They reported errors less than  $10^\circ$  in estimating joint angles when compared to a vision-based golden reference.

### 2.2.3.3 Inertial sensors and body segment calibration

Another area of study using IMU sensors takes interest in calibrating IMUs to the body of each subject. The main idea is that human anatomy is not constant and can change from one person to another; therefore, using IMUs to estimate body joint angles must take this anatomy in consideration. The solution is to personalize the joint angle estimation based on the anatomical variables extracted from subject data. Some of the work in this area of research is presented in Figure 20.

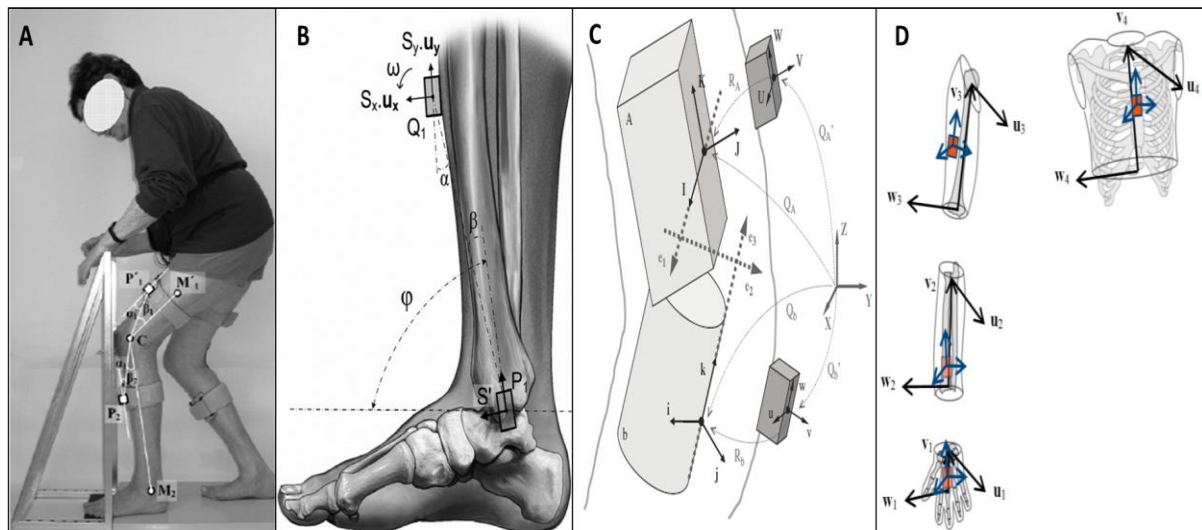

Figure 20. Studies calibrating joint angle estimation to anatomical references (Figure A to G represent references 102 to 105)

*Dejnabadi et al.* focused their work on trying to find the accurate knee, hip, and shank angles with respect to the subject's personalized musculoskeletal system [102, 103]. Their idea was that using sensors attached directly to the patient will not yield the correct joint angles, so they used two biaxial accelerometers, two uniaxial gyroscopes, and a 2D image of the subject, to calculate the joint angles. The study calculated the rotation matrices using the inertial sensors and then multiplied these matrices by variables related to the displacement between the sensors and the body joints, calculated from the captured images. They found good results compared to a golden standard reference system ( $1.57^\circ$  error for thigh angle and  $0.78^\circ$  error for shank angle for subjects walking at medium speed with a low range of motion). *Favre et al.* proposed, in a study that follows [97], to move the joint angle computation to a personalized musculoskeletal model for each subject, using calculations prior to the measurements [104], and obtained better results. The study defines fixed quaternions that describe the displacement between the thigh and shank sensors reference system, and the anatomical references of the thigh and shank, using personalized medical imaging techniques. Then, when the orientation is estimated by these sensors, these values are multiplied by the fixed quaternions, to finally calculate the knee angle in an internal reference system. *Bouvier et al.* studied the effect of applying different sensor-to-segment calibration method on upper limb kinematics [105]. They applied three different calibration techniques and used 10 subjects for their study. The first technique is called TECH and assumes that the IMU axis is the same as the segment axis, and neglects the difference between them. The second technique is called STATIC where the patient is asked to take particular poses in order to estimate the joint positions and axis, and the final technique is named FUNCT and estimates the joint positions while the patient is doing

dynamic movements. They concluded that all three methods showed similar results (a range of 5 to 10 degrees of error).

#### 2.2.3.4 Inertial sensors and data fusion using various methods

Data fusion between different inertial sensors became very interesting recently. Moreover, filtering techniques like Kalman filters [106], complementary filters [107], particle filter [108] and other developed filters have been employed to estimate angles and orientations using inertial data. Some of these methods will be described in other section in this current chapter. *Marins et al.* proposed an algorithm using the extended Kalman filter for quaternion-based orientation estimation using an IMU with tri-axis accelerometer, gyroscope, and magnetometer [109]. The results of the orientation estimation were not compared to a reference; however, the team studied the convergence of the measured quaternions. In addition, *Abayarjoo et al.* used a similar IMU with a linear Kalman filter to determine the angle directly from the sensor, without passing through a quaternion analysis [110]. The proposed algorithm helped to overcome the limitations of the accelerometer, because accelerometers generally measure two components: an acceleration and a gravitational component. The acceleration component needs to be eliminated to determine the orientation, and thus Kalman filtering with gyroscopes was presented as the best solution. *Madgwick et al.* studied a new type of algorithm based on gradient descent using quaternions, in order to fuse tri-axial accelerometers, gyroscopes and magnetometers [111]. They compared their algorithm and the extended Kalman filter approach with a reference optical measurement system and proved that the new algorithm was better than the older approach in both static and dynamic cases. Later on, *Madgwick's* algorithm was implemented in many commercially available IMUs, e.g., Shimmer3 sensors. *Miezial et al.* proposed two new extended Kalman filters and a sliding window optimization approach to estimate upper limb joint angles [112]. The authors also studied the effect of sensor to segment calibration through the use of simulated data. The study concluded that the proposed methods were more efficient in estimating upper limb joint angles, with the sliding optimization approach being the best algorithm among them. *Meng et al.* used the particle filter to estimate body joint angles and positions and introduce some constraints based on biomechanical movement properties [113]. The study suggests that adding biomechanical constraints to the estimation can improve the accuracy of computed angles and joint positions. This idea was applied to the knee angle, adding the constraint that the knee does not execute flexion in the frontal plane. The study does not validate the computed angles against a golden reference system. *Yadav et al.* proposed to correct the IMU angle estimation using

data from the magnetometer to limit magnetic distortion [114]. They used the particle filter to estimate the orientation of the sensor, while correcting this estimation when the magnetic dip angle, calculated between the acceleration vector and the magnetic vector, exceeds a specific threshold. The study showed less deviation in its estimation compared to other techniques, but a comparison with a golden standard orientation estimation system was not performed. *Mourcou et al.* compared smartphone orientation estimation using several filters, with commercial IMUs and considered a robotic arm as reference [115]. The results showed a great orientation estimation using smartphone, however, in order to use a smartphone to measure the subject's knee angle, they need to be seated and the phone attached to the shank, which constraints the uses of such studies, since the patient cannot move freely. *Wang et al.* used the gradient descent algorithm to extract the quaternion from the accelerometer data, and corrected this estimation using data from the gyroscope using an extended Kalman filter [116]. Finally, the yaw angle is estimated using the magnetometer data. The result of this study shows a decrease in deviation compared to different algorithms, but it was not compared to golden reference systems.

These are the most commonly used filters to estimate orientation from inertial sensor data. However, the application of data fusion is not only applied between inertial sensors, some researchers have taken interest in combining data from different types of sensors.

#### 2.2.4 Combining visual and inertial sensors

Our main area of interest are the studies combining Kinect camera with inertial sensors and IMUs in order to estimate body joint angles and positions. Table 3 describes these studies and their characteristics. *Feng et al.* used a linear multi-rate Kalman filter implanted to compute the position of some joints using data from both the Kinect and IMUs [117]. The study resulted in a better estimation of the positions of joints compared to a reference system. Another study done by *Destelle et al.* tried to use Kinect first to determine the initial positions and then calculate the positions and angles of the joints using IMUs [118].

Table 3. Studies with data fusion between Kinect and IMUs

Study	Fusion method	Fusion input	Fusion output	Targeted application	Test
Feng et al.	Multi-rate linear Kalman filter	Acceleration and computed quaternion data (IMU) and Kinect joint position	Joint position	Hand tracking	Raise hand, walk, lower hand (1 subject)
Destelle et al.	Each system is used separately	Linear acceleration (IMU) and Kinect joint position	Joint position and angle	Whole body tracking	Knee flexion (1 subject)
Atrsaei et al.	Unscented Kalman filter	Gyroscope and computed quaternion (IMU) and Kinect joint position and orientation	Joint position and angle	Upper body tracking	Arbitrary hand motion (1 subject)
Kalkbrenner et al.	Linear Kalman filter	Unit orientation vectors (IMU) and Kinect joint position	Joint position	Upper body tracking	Shoulder abduction (10 subjects)
Tian et al.	Unscented Kalman filter	Acceleration and magnetometer data (IMU) and Kinect joint position	Joint position and angle	Upper body tracking	Hand to mouth (1 subject)
Glonek et al.	Weighted averaging	Computed quaternion (IMU) and Kinect joint position and orientation	Joint position and angle	Upper body tracking	Four tasks with different ranges of motion (1 subject)

*Atrsaei et al.* published a study where they proposed a fusion algorithm between the Kinect and inertial sensors using an unscented Kalman filter, applied to the upper body [119] (Figure 21 A). The suggested method was efficient in reducing the error of joint position calculation; however, the orientation estimation accuracy did not improve significantly. *Kalkbrenner et al.* used a linear Kalman filter to estimate joint positions, using unit orientation vectors acquired from IMUs and joint positions given by the Kinect [120]. The study used 10 subjects to validate their method, but did not compare the joint positions with a reference system. *Tian et al.* proposed an unscented Kalman filter for fusion between IMUs and the Kinect camera [121] (Figure 21 B). They compared the estimated joint positions with a reference system but did not study the error of the elbow angle estimation. Finally, *Glonek et al.* proposed a joint position and angle estimation method, based on averaging inputs from the Kinect and IMU sensors

[122]. The study was validated with one subject, performing exercises with different ranges of motion and thus the results could not be considered as homogeneous.

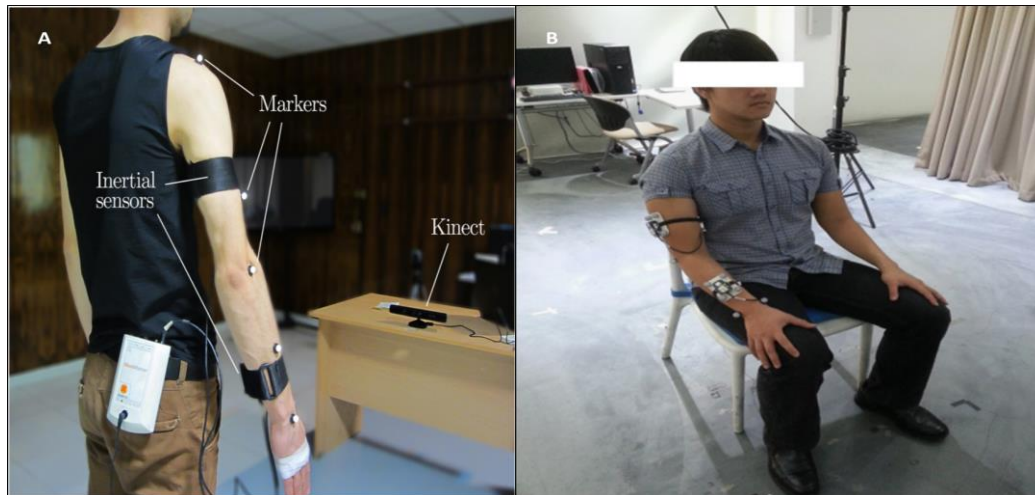

Figure 21. Setup of systems combining visual and inertial sensors (A represents reference [119] and B represents reference [121])

Therefore, there is still a lack of efficient orientation estimation techniques based on a fusion between Kinect and IMU. Studies in this area of science can present a good solution to overcome the limitations of both tools. For instance, this can allow the integration people in virtual rehabilitation games, while also allowing experts to obtain accurate data for some joints that might be important to assess the patient's progress.

## 2.2.5 Data processing using estimation filters

The acceleration, angular velocity and magnetic data from inertial sensors need to be processed in order to estimate the orientation of the sensor. The output of the data processing can be angles, matrices or quaternions. In this section, we will present two of the most used orientation estimation filters: the Kalman filter and its derivatives, and the Madgwick gradient descent filter.

### 2.2.5.1 Kalman filter and its derivatives

Kalman filters are optimal estimation filter, in the sense that they estimate an output and correct it based on measurement data. They are also recursive filters that process data as they arrive. First, let us define some variables:

- $x(t)$  is the state vector at time  $t$ .
- $\dot{x}(t)$  is the derivative of the state vector at time  $t$ .

- $y(t)$  is the measurement vector at time  $t$ .
- $u(t)$  is the input vector a time  $t$ .
- $x_k$  is the state vector at iteration  $k$ , a set of unknowns to be determined, of size  $n$ .
- $\hat{x}_{k|k}$  is the estimation of the state vector at iteration  $k$ .
- $e_{k|k}$  is the estimation error, or the difference between  $\hat{x}_{k|k} - x_k$ .
- $P_{k|k}$  is the covariance matrix of estimation error, of size  $(n, n)$ .
- $\hat{x}_{k+1|k}$  is the prediction of the state vector for the next iteration.
- $e_{k+1|k}$  is the prediction error, or the difference between  $\hat{x}_{k+1|k} - x_{k+1}$ .
- $P_{k+1|k}$  is the covariance matrix of prediction error, of size  $(n, n)$ .
- $y_k$  is the measurement vector at iteration  $k$ , of size  $m$ .
- $u_k$  is the input vector at iteration  $k$ .
- $\alpha_k$  is the white model noise, with covariance matrix  $Q$ , of size  $n$ .
- $\beta_k$  is the white observation noise with covariance matrix  $R$ , of size  $m$ .
- $K$  is the gain of the Kalman filter, of size  $(n, m)$ .

Kalman filters use an estimation prediction approach to generate the state vector while optimizing the errors and the gain of the filter. First, we start by identifying a state equation and an observation equation:

$$\dot{x}(t) = f(x(t), u(t)) \quad (11)$$

$$y(t) = g(x(t), u(t)) \quad (12)$$

The state equation links the derivative of the state vector to the state vector, using linear or non-linear equations describing the real laws of physics, while the observation equation links the measurement to the state vector. The Kalman filter is a linear filter and thus we will consider the case where function  $f$  and  $g$  are linear. After discretization the equations 11 and 12 become:

$$x_{k+1} = Ax_k + Bu_k + \alpha_k \quad (13)$$

$$y_k = Cx_k + \beta_k \quad (14)$$

The measurement and observation noise are added on the basis that the observation model is not perfect and the sensors can produce measurements that include some errors. We assume that the noises  $\alpha_k$  and  $\beta_k$  are independent and with a mean  $E(\alpha_k \cdot \beta_k^T) = 0$ . The matrices  $A$ ,  $B$  and  $C$  are determined after discretization of the previous equations. We then propose a state



observer in order to estimate the state of  $x$  at iteration  $k$  and predict its value for the next iteration:

$$\hat{x}_{k|k} = \hat{x}_{k|k-1} + K(y_k - C\hat{x}_{k|k-1}) \quad (15)$$

$$\hat{x}_{k+1|k} = A\hat{x}_{k|k} + Bu_k \quad (16)$$

The estimation of the state vector is linked to the prediction from the previous iteration, with a correction based on the difference between the current measurement and the prediction, multiplied by the gain  $K$  that is recursively changed at each iteration. On the other hand, the prediction is linked directly to the estimation using the observation model. The covariance matrices of estimation error and prediction error will be used to dynamically change the gain  $K$ . These matrices are calculated at each iteration using:

$$P_{k|k} = (I - KC)P_{k|k-1} + (I - KC)^T + K RK^T \quad (17)$$

$$P_{k+1|k} = AP_{k|k}A^T + Q \quad (18)$$

These equations are determined after replacing the state equations in  $e_{k|k} = \hat{x}_{k|k} - x_k$  and  $e_{k+1|k} = \hat{x}_{k+1|k} - x_{k+1}$ . Finally,  $K$  is updated using the equation;

$$K = P_{k+1|k}C^T(C P_{k+1|k}C^T + R)^{-1} \quad (19)$$

Figure 22 shows the steps of the Kalman filter

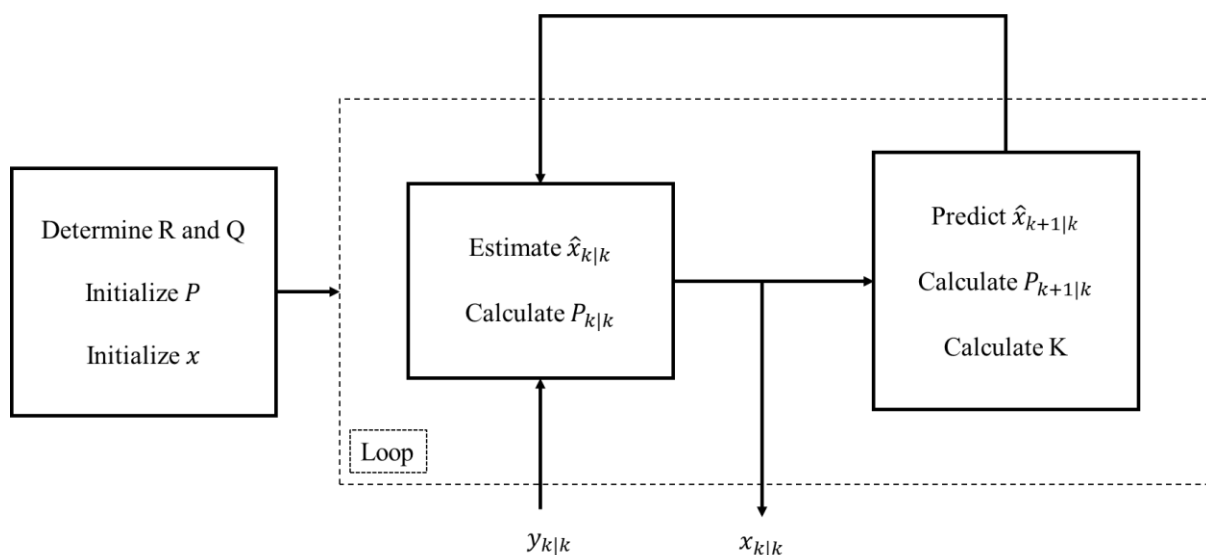

Figure 22. Kalman filter scheme

This is the case where the observation equations are linear. However, these equations are not applicable when the function  $f$  and  $g$  are non-linear, and in that case some variations of this

algorithms have been implemented. Algorithms like the extended Kalman filter and the unscented Kalman filter have been conceptualized for non-linear state estimation. We will present the extended Kalman filter in the following paragraph.

The extended Kalman filter uses Jacobian matrices to linearize the observer and measurement models. The matrices  $A$  and  $C$  become linearized based on the Jacobian approximation from observer and measurement functions, at each iteration  $k$ . This means that at each iteration, the partial derivative of functions  $f$  and  $g$  are computed with respect to  $x$  and the values of  $A_k$  and  $C_k$  are calculated using:

$$A_k = \left[ \frac{\partial f}{\partial x}(\hat{x}_{k|k}, u_k) \right] \quad (20)$$

$$C_k = \left[ \frac{\partial g}{\partial x}(\hat{x}_{k|k-1}) \right] \quad (21)$$

$A_k$  is calculated from the estimated value of the state vector, while  $C_k$  is calculated from the predicted value of the estimated vector. Figure 23 shows the scheme of the extended Kalman filter.

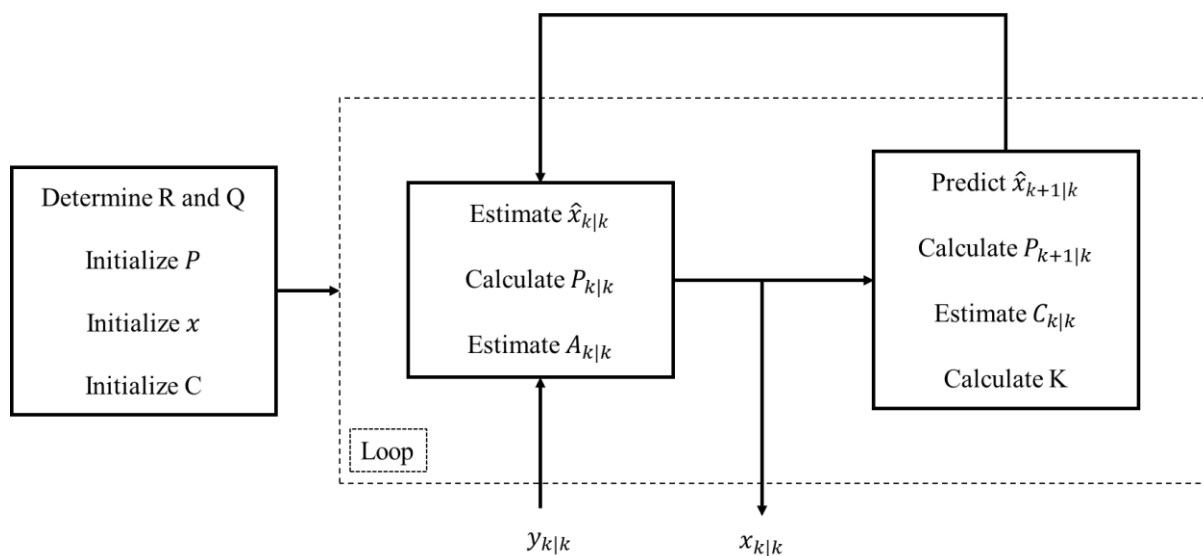

Figure 23. Extended Kalman filter scheme

Finally, Kalman filters can be used as a fusion algorithm to fuse data from different sensors (Figure 24). For instance, instead of taking into consideration one measurement vector  $y$ , the algorithm uses multiple measurement vectors to estimate and then predict a state vector. Each measurement vector will have an independent measurement noise vector with separate

covariance matrices. Also, there will be multiple matrices that describe the relation between the measurement and the state vectors instead of having only one matrix  $C$ . Thus, the scheme of a linear Kalman filter for fusion between two input measurement vectors becomes:

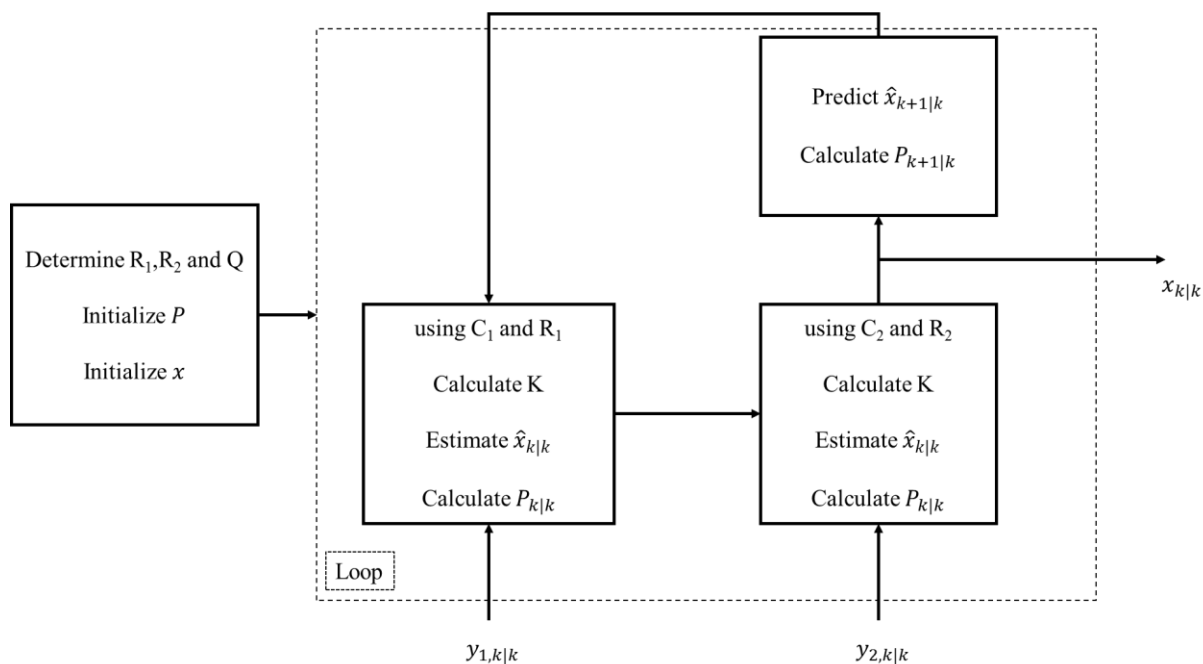

Figure 24. Measurement data fusion using Kalman filters

There are many applications that use the Kalman filter for estimation in different fields. For instance, one can link the acceleration with the position through the observer model and estimate the position of an object using acceleration data. In the field of orientation estimations, many researchers have implemented nonlinear Kalman filters to estimate the quaternion of an object. Using the relationship between the quaternion vectors and the angular velocity, we can estimate orientations of joints, or objects. This idea was first proposed by, *Marins et al.* who suggested using the extended Kalman filter to estimate the quaternions [109]. However, some researchers have found better methods to achieve this purpose, one of them was Madgwick, who proposed using gradient descent algorithms to estimate the orientation of sensors [111].

### 2.2.5.2 Madgwick filter

The Madgwick filter is based on the gradient descent optimization algorithm. Figure 25 shows the algorithm described by Madgwick in [111]. Let us first define some variables:

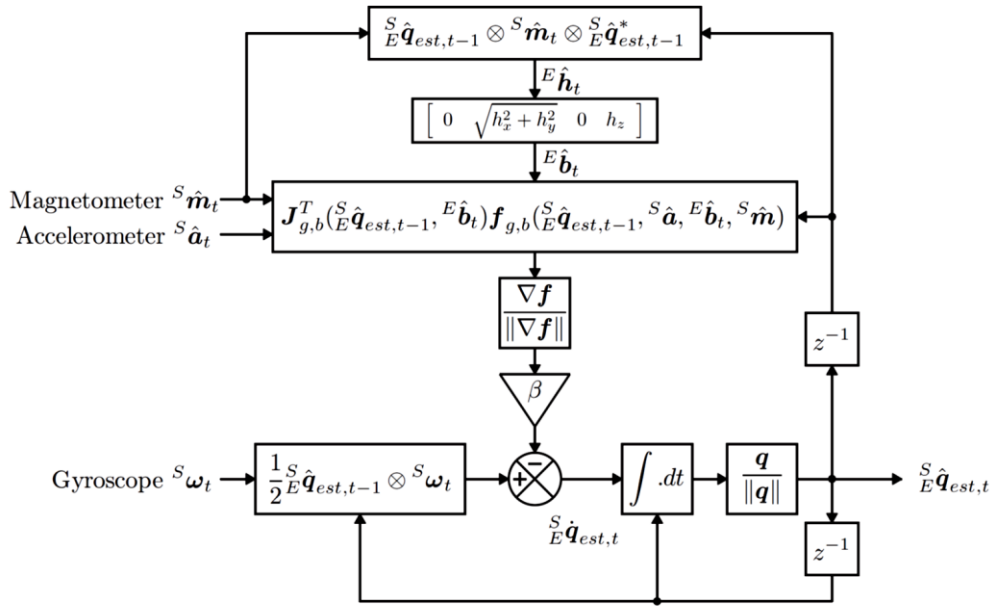

Figure 25. Madgwick algorithm for orientation estimation

- ${}^S \hat{\mathbf{q}}_{est,t}$  is the sensor's orientation estimation with respect to the earth frame at time  $t$ .
- ${}^S \hat{\mathbf{m}}_t$  is the magnetometer measurement.
- ${}^S \hat{\mathbf{a}}_t$  is the accelerometer measurement.
- ${}^S \omega_t$  is the gyroscope measurement.
- ${}^E \hat{\mathbf{h}}_t$  is the measured direction of the earth's magnetic field in the earth frame.
- ${}^E \hat{\mathbf{b}}_t$  is the predefined magnetic reference direction in the earth frame.
- $f_{g,b}$  is the objective function used for optimization.
- $\mathbf{J}_{g,b}^T$  is the Jacobian of the objective function.
- $\nabla f$  is the error of the objective function.
- $\beta$  is the divergence rate of the quaternion.

We note that the accent ^ symbolizes that the variable is normalized. First the algorithm takes the magnetometer data and uses it to define the direction of the earth's magnetic field  ${}^E \hat{\mathbf{h}}_t$ . Next, the algorithm calculates  ${}^E \hat{\mathbf{b}}_t$  which is the normalization of  ${}^E \hat{\mathbf{h}}_t$  to have only components in the earth's x and z axes as stated in Figure 25. Then, the gradient descent algorithm is used to find the best quaternion that minimizes the objective function  $f$ . The objective function describes a quaternion that rotates from the earth's frame to the sensor's frame. However, and since the accelerometer and magnetometer data are collected separately,  $f$  will have two components relative to both sensors. In both cases, the objective function can be written as:

$$f(\underset{E}{S}\hat{q}, {}^E\hat{d}, {}^S\hat{s}) = \underset{E}{S}\hat{q}^* \times {}^E\hat{d} \times \underset{E}{S}\hat{q} - {}^S\hat{s} \quad (22)$$

Where  ${}^E\hat{d}$  is the direction of in the earth's frame (from accelerometer or magnetometer) and  ${}^S\hat{s}$  is the direction of the sensor in its frame. The error of the objective function is calculated also:

$$\nabla f(\underset{E}{S}\hat{q}, {}^E\hat{d}, {}^S\hat{s}) = J^T(\underset{E}{S}\hat{q}, {}^E\hat{d})f(\underset{E}{S}\hat{q}, {}^E\hat{d}, {}^S\hat{s}) \quad (23)$$

This error of the objective function is normally used in several iterations in order to optimize the quaternion using the equation:

$$\underset{E}{S}q_{k+1} = \underset{E}{S}\hat{q}_k - u \frac{\nabla f(\underset{E}{S}\hat{q}, {}^E\hat{d}, {}^S\hat{s})}{\|\nabla f(\underset{E}{S}\hat{q}, {}^E\hat{d}, {}^S\hat{s})\|} \quad (24)$$

However, if we choose  $u$  to be large when compared to the rate of change in the orientation at each iteration, we can lead to the convergence in the same iteration step. Now, as we said before this objective function and its Jacobian can be minimized based on data from accelerometer and magnetometer. Substituting  ${}^E\hat{d}$  with  ${}^E\hat{b}$  and  ${}^S\hat{s}$  with  ${}^S\hat{m}$  we obtain the objective function and the related Jacobian for magnetometer data:

$$f_b(\underset{E}{S}\hat{q}, {}^E\hat{b}, {}^S\hat{m}) = \begin{bmatrix} 2b_x(0.5 - q_3^2 - q_4^2) + 2b_z(q_2q_4 - q_1q_3) - m_x \\ 2b_x(q_2q_3 - q_1q_4) + 2b_z(q_1q_2 + q_3q_4) - m_y \\ 2b_x(q_1q_3 + q_2q_4) + 2b_x(0.5 - q_2^2 - q_3^2) - m_z \end{bmatrix} \quad (25)$$

$$J_b^T(\underset{E}{S}\hat{q}, {}^E\hat{b}) = \begin{bmatrix} -2b_zq_3 & 2b_zq_4 & -4b_xq_3 - 2b_zq_1 & 2b_zq_2 - 4b_xq_4 \\ 2b_zq_2 - 2b_xq_4 & 2b_xq_3 + 2b_zq_1 & 2b_xq_2 + 2b_zq_4 & 2b_zq_3 - 2b_xq_1 \\ 2b_xq_3 & 2b_xq_4 - 4b_zq_2 & 2b_xq_1 - 4b_zq_3 & 2b_xq_2 \end{bmatrix} \quad (26)$$

The same can be done for the accelerometer data, and finally we combine the two objective functions and Jacobians to obtain:

$$f_{g,b}(\underset{E}{S}\hat{q}, {}^S\hat{a}, {}^E\hat{b}, {}^S\hat{m}) = \begin{bmatrix} f_g(\underset{E}{S}\hat{q}, {}^S\hat{a}) \\ f_b(\underset{E}{S}\hat{q}, {}^E\hat{b}, {}^S\hat{m}) \end{bmatrix} \quad (27)$$

$$J_{g,b}(\underset{E}{S}\hat{q}, {}^E\hat{b}) = \begin{bmatrix} J_g^T(\underset{E}{S}\hat{q}) \\ J_b^T(\underset{E}{S}\hat{q}, {}^E\hat{b}) \end{bmatrix} \quad (28)$$

Finally, equations 27 and 28 are multiplied and corrected by a  $\beta$  coefficient to account the divergence rate of the estimated quaternion ( $\beta$  includes the coefficient  $u$ ). The result is then subtracted with the previously estimated quaternion angular rate (previously estimated

quaternion multiplied by the angular rate acquired from the gyroscope). Finally, the result is integrated and normalized to obtain the estimated orientation quaternion.

This algorithm was compared to an extended Kalman filter to estimate the yaw, pitch and roll of an inertial sensor with respect to the earth's frame. The Madgwick algorithm outperformed the Kalman filter in estimating all the angles in static and dynamic situations (Figure 26). This led commercial companies to adopt it in their applications to calculate the orientation of IMU sensors. For example, Shimmer3 sensors implement the Madgwick filter in their data collection application for orientation estimation. In addition, gradient descent optimization demands less computational power than Kalman filters. Finally, some filters, like the particle filter and the Mahony filter, were not presented in this study since we did not use them based on the results they achieved in the literature, but they are also largely studied for orientation estimation. Moreover, the particle filter demands a lot more computational power and time in order to be implemented which could negatively impact our application. As for the Mahony filter, recent work in orientation estimation has shown that the Madgwick filter surpasses it in accuracy [115].

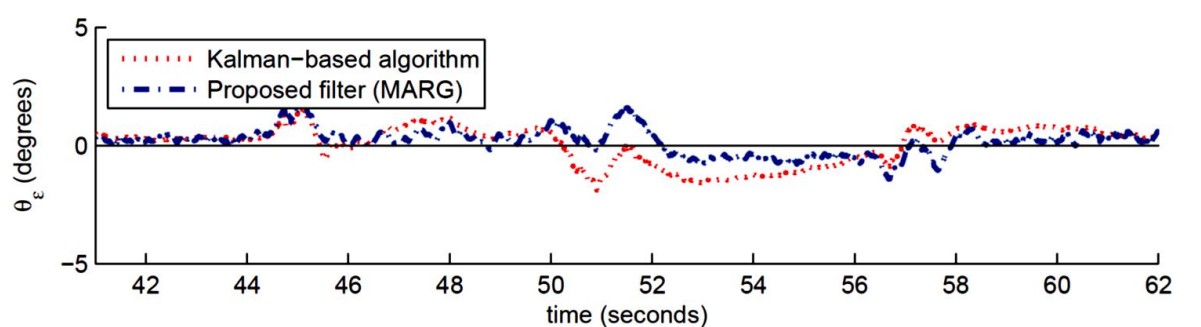

Figure 26. The error in dynamic angle estimation between the Kalman filter and the Madgwick filter

## 2.3 Home-based rehabilitation

In Chapter 1, we highlighted the ability of supervised home-based rehabilitation, when used correctly, to maximize the recovery of patients after an accident [18–25]. In addition, we proposed combining this concept with serious game to achieve a sustainable solution to the problems of classical rehabilitation programs. This is not a novelty proposed in this thesis and has been deployed by several researchers in the past few years.

Many researchers have developed serious games for home-based rehabilitation [123–126]. *Martins et al.* proposed a web platform for centralized management of games for physical therapy [123]. This web platform allows the medical team to manage the games and check the

results, while researchers can continually upgrade or deploy games to be used by patients. *Chatzitofis et al.* described their approach for home-based rehabilitation using different databases and components [124]. They used a low-cost Kinect camera for kinematic tracking. They tested the designed games on six patients with cardiovascular disease. Some patients responded positively to the new gaming solution, while others were not interested. *Rybarczyk et al.* presented an architecture of a home-based rehabilitation system using serious games [125]. Their system uses a Kinect camera to assess the games. The games display two avatars, one that presents the exercise to be performed and another that mimics the patient. However, this approach has caused confusion for patients in other studies [81]. *Su et al.* used the Kinect camera to develop serious games that can be implemented at home [126]. Their system can evaluate some of the patient's gestures, using fuzzy logic, in order to help them correctly play the games. Nevertheless, they did not show how this system can be implemented at home. Moreover, clinicians are not always included in the conception of these systems. *Vasconcelos et al.* developed several serious games using a smartphone, EMG sensors and IMUs [127]. The games use virtual objects like balls and walls, and requires the user to contract or extend their muscles, while moving their hands, to achieve different objectives. The games were tested with 10 potential users who were motivated to continue using it at home. However, the games are not yet tested in a home-based environment. *Jonsdottir et al.* proposed a system called Rehab@Home, that uses the Kinect camera to implement arm and hand exercises for multiple sclerosis [128]. The system was validated through a randomized controlled pilot study, where 10 patients tested the games and 6 patients used games implemented by Nintendo on the Wii console. After 7 months, the results show a positive feedback from the patients overall. In addition, the group that underwent serious game rehabilitation showed a higher improvement in hand function compared to the group that used the Wii games. However, the system is yet to be tested at home, and the authors acknowledged this limitation. Figure 27 shows all of these systems.

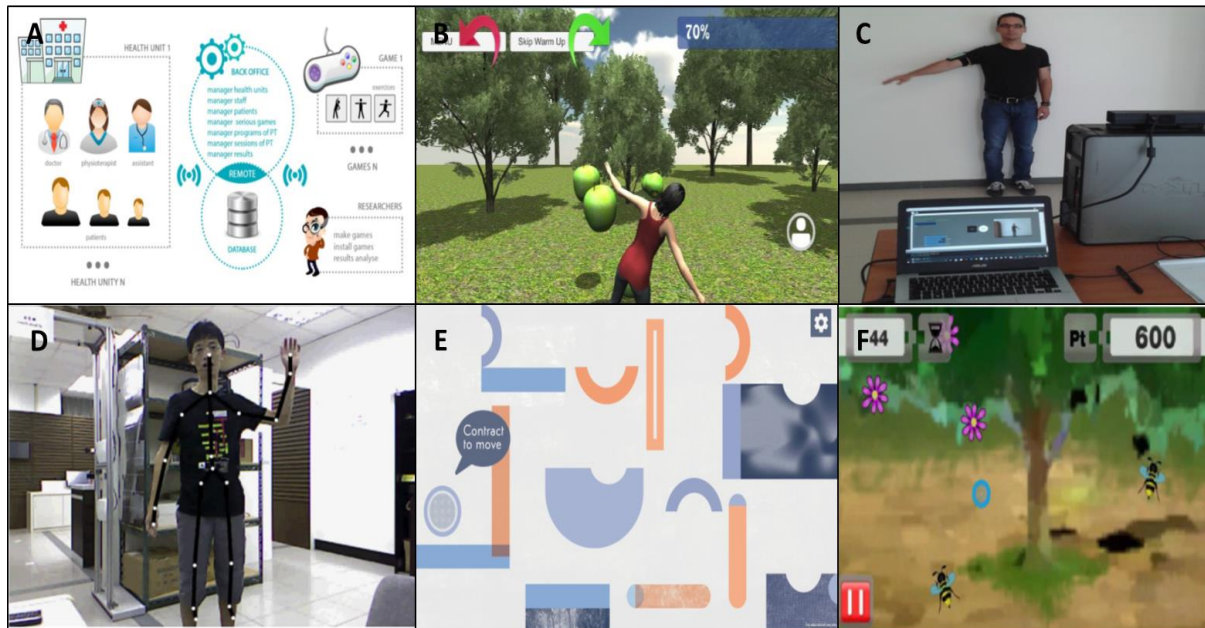

Figure 27. Proposed serious game systems for home-based rehabilitation (Figure A to F represent references 123 to 128)

In addition to academic research, some commercial systems also exist as home based tools. For instance, some of the tools that we described in Section 2.1.4 have implemented home based versions (Medimovv, Jintronix and SeeMe).

The limitations in the current implementation of serious games at home remain clear. When it comes to academic research, most of the games have not been validated, and we see a resemblance in the applications that are proposed. There is an absence in originality, since most of the proposed system use the Kinect camera. This is seen also in the commercial tools, where the Kinect is the number 1 used tool. In addition, this leads to other problems related to the accuracy of joint angle and position estimation. How can the therapeutic follow up of the patient be confident of the angles and data that they are analyzing? How can they explain instances of occlusion of objects that cause spikes in data? And how can the patients remain focused when the game is behaving strangely because of errors in estimation?

In addition to these questions, the implementation of serious games at home seem to be arbitrary and unified guidelines seem absent. Therefore, there is a need to conceptualize a guideline, by researchers and clinicians, in order to evaluate serious games and compare results between different studies. In addition, an evaluation criterion for serious games at home is none existent. Researchers tend to use qualitative questionnaires and data analysis to evaluate their systems. Finally, there should be sufficient studies done in different areas before declaring a



serious game to be beneficial for patients. Moreover, patient and medical expert acceptability studies should be performed to approve the concepts of games before testing them.

If these criteria are not met, we cannot convince medical experts to use scientifically advanced tools, even if the studies show that home-based rehabilitation with supervision could be beneficial. In the end, we must converge all scientific efforts, from different fields of study, in order to achieve acceptable solutions to help patients and experts.

## 2.4 Conclusion: approach based on the literature

After consulting the previous work and literature, we formulated our approach to develop our real-time home-based virtual rehabilitation system. When it comes to the design software, Blender will be used to model the avatar and the 3D scene. Kinect SDK will also be used to process the needed data from the captured images from the Kinect camera. The XNA Studio game engine will be used as the game engine for many reasons. On one hand, XNA Studio is completely compatible with Visual Studio.Net, and with the Kinect camera and is a powerful tool for game development. On the other hand, XNA uses C#, and thus is compatible with the Kinect application programming interface (API) that was previously developed, which would help in reducing programming time. Next, we will develop an interface for patient and expert in order to visualize the game, results and the captured data using different sensors. A database will be built with Windows SQL Server in order to allow access to the interface by different users with different functionalities. The Shimmer3 IMU sensors [50] will be used to implement data fusion algorithms between Kinect and IMU sensors.

Finally, when it comes to the study direction, we have identified a clear route to follow (Figure 28):

- Develop and evaluate games for the rehabilitation destined for all pathologies.
- Launch a user acceptability study in parallel, conducted by academic personnel that specialize in human science studies.
- Use the Kinect as a tool to play the games.
- Evaluate the games with different patients and determine a pathology that can benefit from these games.
- Study and evaluate a fusion of Kinect and IMU sensors to achieve a better accuracy of angle estimation.
- Apply the multisensory fusion algorithm in serious games, using a SoS approach.

- Evaluate the games with patients suffering from the selected pathology.
- Develop and evaluate user interfaces for patients and experts using the results from the end-user acceptability study.
- Consider the expert and patient evaluation studies to modify the games and interfaces.
- Elaborate on the home-based system that will be implemented through these games.

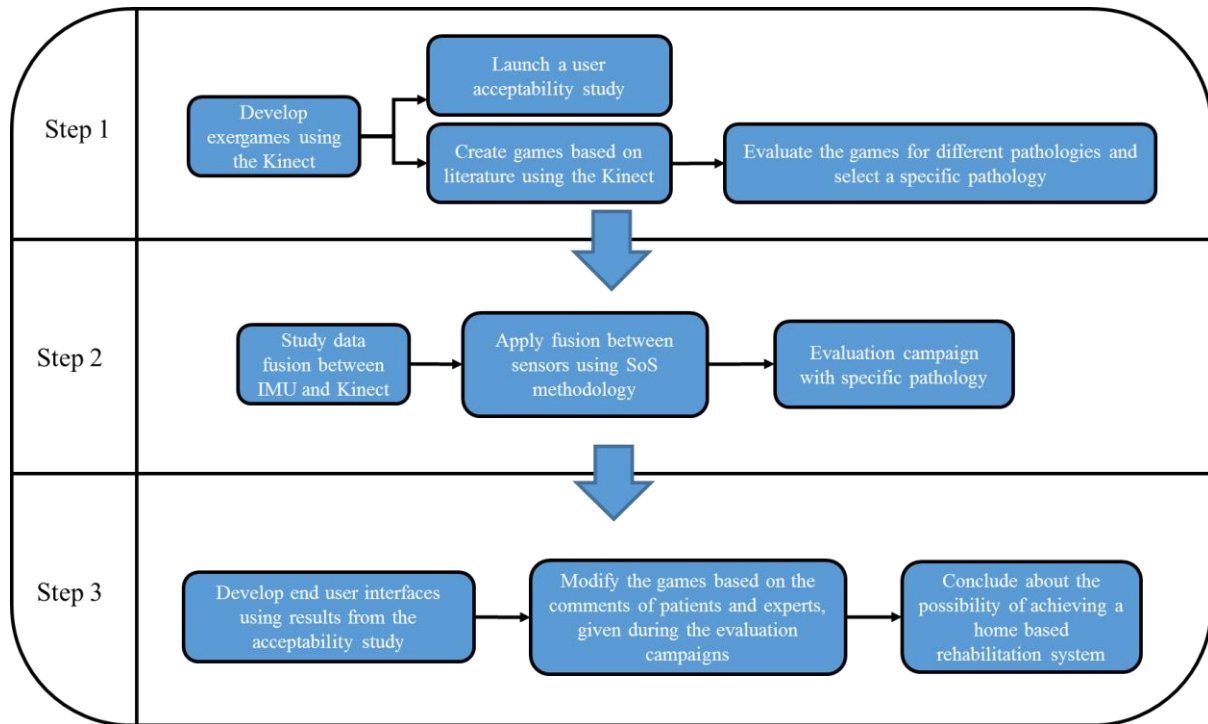

Figure 28. The route to follow for our serious game development

# Chapter 3                      Development of Serious Games

What is our approach to develop and evaluate serious games? In this chapter, we show important scientific contributions in the field of guideline conception for the development and evaluation of serious games for rehabilitation. We also describe two developed serious games, and several evaluation campaigns that allowed us to achieve clinically relevant games. These contributions have been validated through a published article in JMIR serious game journal [129] and presented in an oral presentation at the national French conference JETSAN2017 and at the 2018 IEEE System of Systems Engineering conference.

## 3.1 Development Workflow

The development of serious games for functional rehabilitation of MSDs is a complex engineering task. To deal with such complexity, a two-stage workflow was proposed. The first workflow relates to the development guideline (Figure 29), whereas the second workflow concerns the evaluation guideline. The development workflow includes the selection of 3D computer graphic technologies and tools, the modelling of physical aspects, the design of rehabilitation scenarios, and the implementation of the proposed scenario. This workflow aims to design fun but useful game scenarios to motivate end-users to perform functional rehabilitation tasks. This section describes the work done using a proposed development guideline to create specific serious games for functional rehabilitation of MSDs. Moreover, the evaluation guideline will be presented in another section. We should note that these guidelines were developed using a specific theoretical framework [130]. This theoretical approach has been commonly used to determine important factors that influence implementation results.

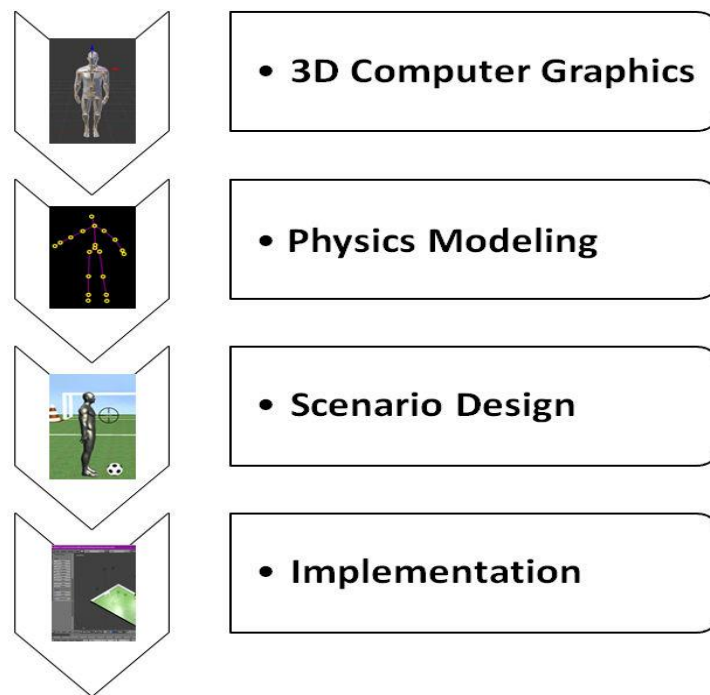

Figure 29. Rehabilitation-oriented serious game: development guideline

### 3.1.1 Three dimensional mesh modelling

To model a virtual scene we chose Blender software. Our choice was built on several aspects. For instance, Blender is a free and open source design software that has already proven its efficiency when it comes to 3D modeling. In addition, Blender allows the import and export of several mesh formats, which gives us a wider range of internet models to download from. Another aspect is that Blender allows exporting the created models in different formats, including the .fbx format supported by XNA Studio to load a model into the game engine.

First, 3D meshes need to be created, or added, to the program. A mesh is a collection of vertices, edges and faces that defines the shape of an object in 3D computer graphics and solid modeling. The faces usually consist of triangles (triangle mesh), quadrilaterals, or other simple convex polygons. Blender allows us to begin from a small cube and create any mesh we desire. Nonetheless, this needs a lot of expertise in 3D graphics and modeling, something we avoided by simply searching for free available meshes online. In addition, the user can define any scene with multiple object (Figure 30). The same principals are applied when modelling human avatars.

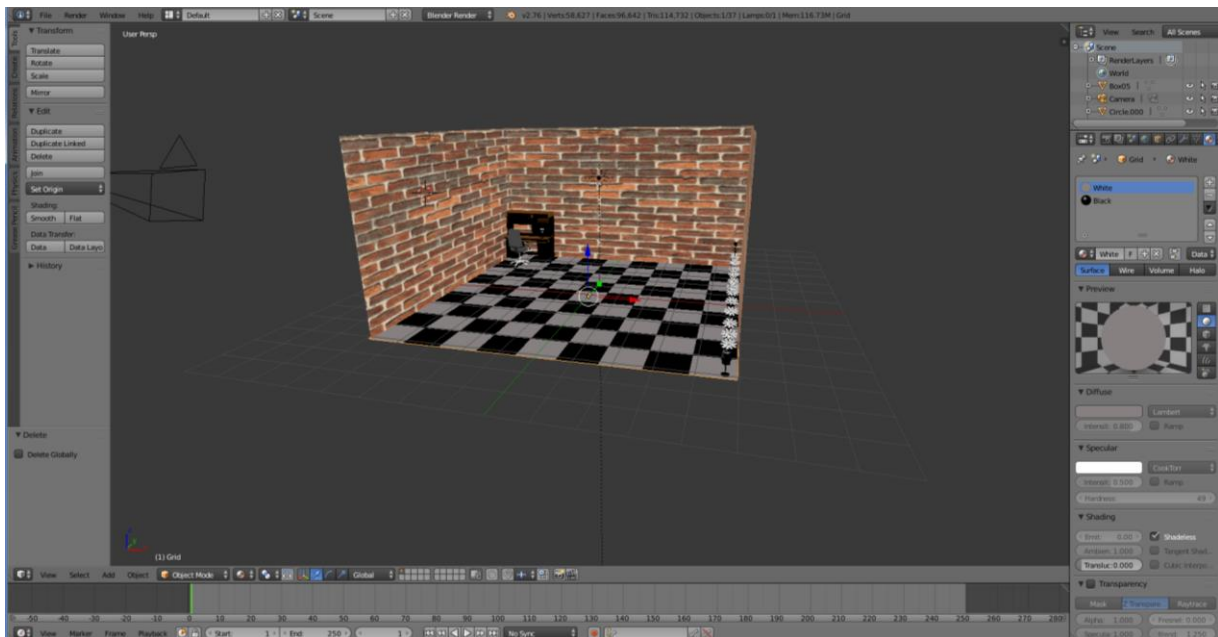

Figure 30. Game scene design

The developer should take the sizes of the objects and their starting positions into consideration, as that will be later needed when exporting the scene to the game engine and integrating the human avatar inside it. Finally, if the developer wishes to apply textures to the 3D model, the model should go through texture mapping, called UV unwrapping, where U and V represent the 2D texture map axes. UV unwrapping is the modeling process of making a 2D image representation of a 3D model's surface. For instance, if a user wants to make a human model wear a green shirt, one needs to unwrap the human model in a way to separate the upper body of the model alone, in order to color it in 2D or to add a shirt to the texture using a photo editing software. Using this methodology, we developed game scenes that will be presented later.

### 3.1.2 Physics modelling

Avatar modelling is not different from scene modelling, however, some additional steps are required. In order to successfully move a human model body parts must be separated in order to allow separate movement of the specific bones. Blender allows the user to add an armature, which consists of bones, to be moved separately both in blender and in the game engine. A bone will be created as the “Root” bone, which makes it the main parent bone that must have all other bones referenced as its children. The architecture adopted to model the armature must adhere to the basic relationships between bones in the human body. The most important point is that the avatar should be compatible with the skeleton generated by the Kinect. It was previously stated that the Kinect estimates the positions and angles of 20

different joints. This will be taken into consideration when designing a human avatar. For our model we chose the spine as the “Parent Bone” and all of the others as its children. The result of our armature is shown in Figure 31.

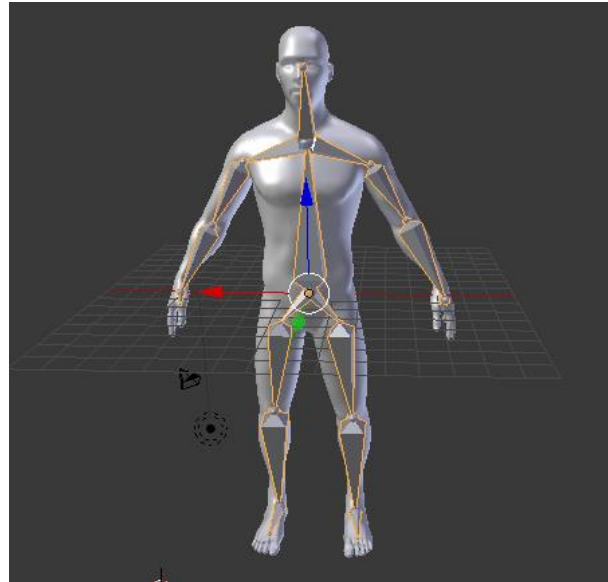

Figure 31. Human model with applied armature

In addition to the physics modelling of the relationships between bones and joints, games with 3D interactive objects need to establish interaction rules between them. An algorithm was designed and implemented to detect collisions between objects within the scene. The challenge was to find a way to differentiate between the detection of different avatar bones and 3D objects; therefore, we created spheres around each bone of the body (Figure 32). Note that the radius and positions of these spheres are adjustable to a specific subject’s body. The assessment of the collisions is done by calculating the distance between the spheres of objects and bones.

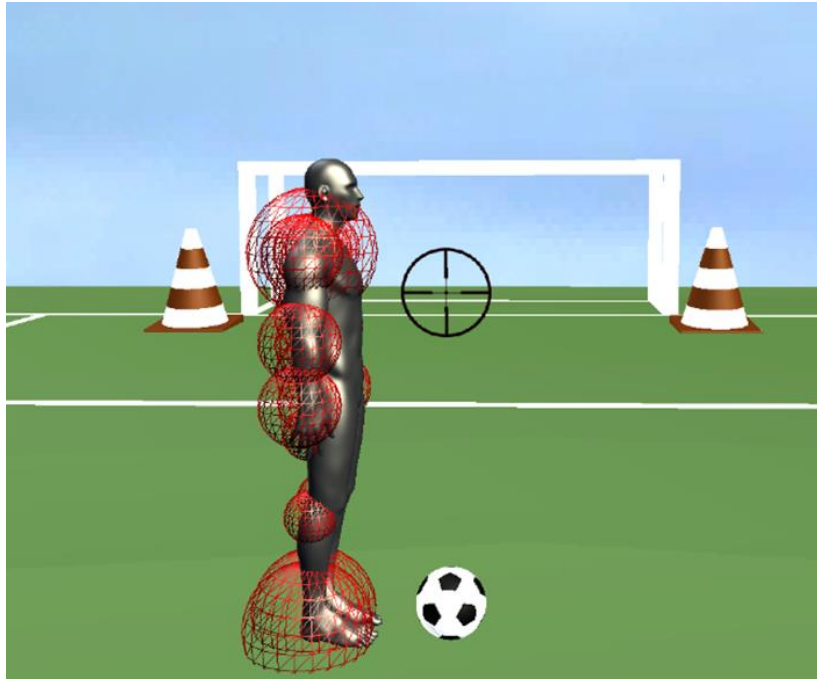

Figure 32. Association of collision spheres to avatar bones

Let  $S_1$  be a sphere with a 3D center  $C_1 = (C_{1x}, C_{1y}, C_{1z})$ , and a radius  $r_1$ , and  $S_2$  another sphere with center  $C_2 = (C_{2x}, C_{2y}, C_{2z})$  and radius  $r_2$ . The distance between the 2 centers of the spheres is  $d$  computed using the following equation:

$$d = \sqrt{[(C_{1x} - C_{2x})^2 + (C_{1y} - C_{2y})^2 + (C_{1z} - C_{2z})^2]} \quad (29)$$

This distance is computed between every 2 objects at each updated iteration during the game. If  $d$  is found to be less than the sum of the 2 radiuses  $r_1$  and  $r_2$ , a collision is detected, and the game reacts to it through a certain preprogramed reaction.

### 3.1.3 Scenario design

The design of the scenario must adhere to a set of rules and to the recommendations of medical experts. The game should be based around movements that are regularly done during rehabilitation programs, to help people achieve improvement in their range of motion. Some other aspects can also be added. For instance, stroke survivors regularly develop cognitive impairment, thus, cognitive activity can be added to scenes. More importantly, the games should consider the diversity that their auditions can bring, and must try to please different categories, which motivates the need to personalize and create patient specific games. In additions, the games must be accepted by different users. Finally, medical experts should have the option between different levels of difficulty that vary based on the patients' situation.

Using these important factors, medical expert recommendations, and our in-depth investigation in the state of the art of serious games, two task-oriented game scenarios (football and object manipulation) were designed and implemented. The football game aims at practicing body stabilization and lower limb motion, allowing the rehabilitation of the spine and the lower body. The object manipulation aims to practice the upper limb and lower limb motions with a focus on hand skills. Each game will be described later in details.

### 3.1.4 Implementation

The selection of available computer graphics technologies and tools plays a crucial role in the success of the rehabilitation game. To ensure a user-friendly implementation, cutting-edge technologies benefiting from the most recent progress of ICT solutions need to be used. In this study, XNA Game Studio was selected as game engine. In a first evaluation campaign, Microsoft Kinect camera was selected as human motion capture tool. Then, in a second evaluation campaign, we used the fusion between IMUs and Kinect camera as the interaction tool. A PC screen was used as the human-system interface. Visual Studio.Net, with C# programming language, was adopted for image acquisition and processing, body tracking, object manipulation, as well as for the development of graphical user interfaces (GUIs).

#### 3.1.4.1 Kinematic data translation

The main visual aspect of our game consists of the virtual avatar that imitates the player's body movements in a natural way. The Kinect is capable of generating a quaternion for each detected bone. Before sending the Kinect Data to the Serious Game, they have to be processed and saved in a class. This class is updated automatically in real-time at each arrival of a new Kinect frame. In addition, Kinect can detect multiple skeletons that need to be filtered out before processing the data. We chose to select the skeleton of the person that is closest to the Kinect. The orientation of the "Spine" joint will be calculated in the frame of the Kinect, while the orientation of the children joints will be calculated in the frame of their parent joint. In other words, the orientation of the elbow joint will describe the rotation of the elbow with respect to the shoulder. Figure 33 shows the different relative frames for the children joints with respect to their parent joint.



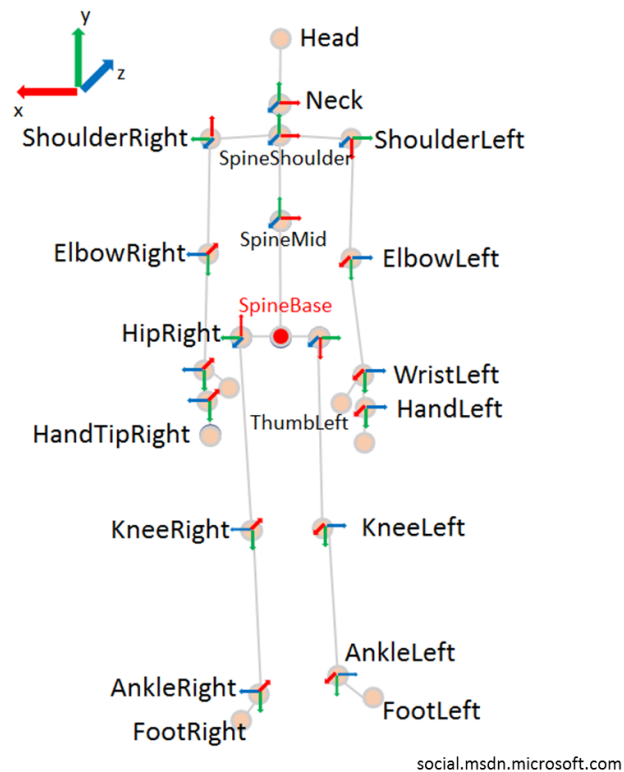

Figure 33. Children joints reference system based on their parent joint

In the case where the multisensory fusion algorithm will be used, some joints will benefit from this fusion, while others will be manipulated using the Kinect data alone. Moreover, the fusion algorithm will take the data from IMUs and from the Kinect, to generate an output quaternion for the particular joint. The output will then be sent to the game engine to change the bones orientation.

### 3.1.4.2 Game engine programming

In our serious game, the game engine must accomplish four different tasks. The responsibility of the game engine is to implement the rules that were previously put in place and to design the scene by importing different models.

- **Model Import:** in order to load the model into the game we need to fetch the exported object, and add it to the project content so that the game can use it as resource. In addition to loading the model, if the model contains an armature, the developer should save the base orientation in an initial matrix to be modified later.
- **Model Drawing:** to draw the model, we need to write our code in the “Draw” method on the XNA code. The processor executes this method periodically; therefore, the scene

can be redrawn at any time. The visual effects of the model can be changed and a texture can be applied in order to change the model's color.

- **Model Movement:** the position and orientation of objects or armatures can be changes at any iteration. The movement of the model is updated regularly. For instance, the Kinect camera has a frequency of 30 frames per second, and this needs to be implemented in the game. This can be coded in the "Update" method presented in the XNA code, which is also executed periodically, but is mainly responsible for the movement of objects.
- **Model collisions:** the collisions between objects, defined during the physics modelling phase, are implemented in the XNA code as well. In the "Update" method, the game should check for collisions and change the game scene accordingly.

## 3.2 Task oriented and in situation serious games

### 3.2.1 Football game

This game aims at the rehabilitation of several parts of the body. It targets balance, since the users rotate to target a cone. In addition, it includes a decision-making action, since players have to verify the pointer's position. Finally, the lower limbs are also affected, since the patient has to kick the ball. First, players have to stand in front of the Kinect and the PC screen. Then, they need to target the left or right cones by pivoting their body. Once the target is reached, the player has to verify that the pointer in the bottom right corner of the screen is in the green zone. If the pointer is green, they kick the ball to hit the cone and score one point. Otherwise, if they kick while the pointer is red, the ball will miss. When the cone is hit, the user needs to pivot back to the original position to get another ball. A point is awarded for every cone hit. We developed three levels of difficulty because patients playing the game might be in different phases of their rehabilitation. Using the different developed levels, experts can configure the difficulty of the exercises to be executed by their patients according to their rehabilitation progress. In the easy level, the cones are big and the green or red pointer is slow. The medium level decreases the size of the cones. Finally, to make it harder, the pointer will move faster on the hard level. Experts can also define the duration for each exercise, which gives them more control over the rehabilitation program. We note that a soccer stadium was designed for this specific game.

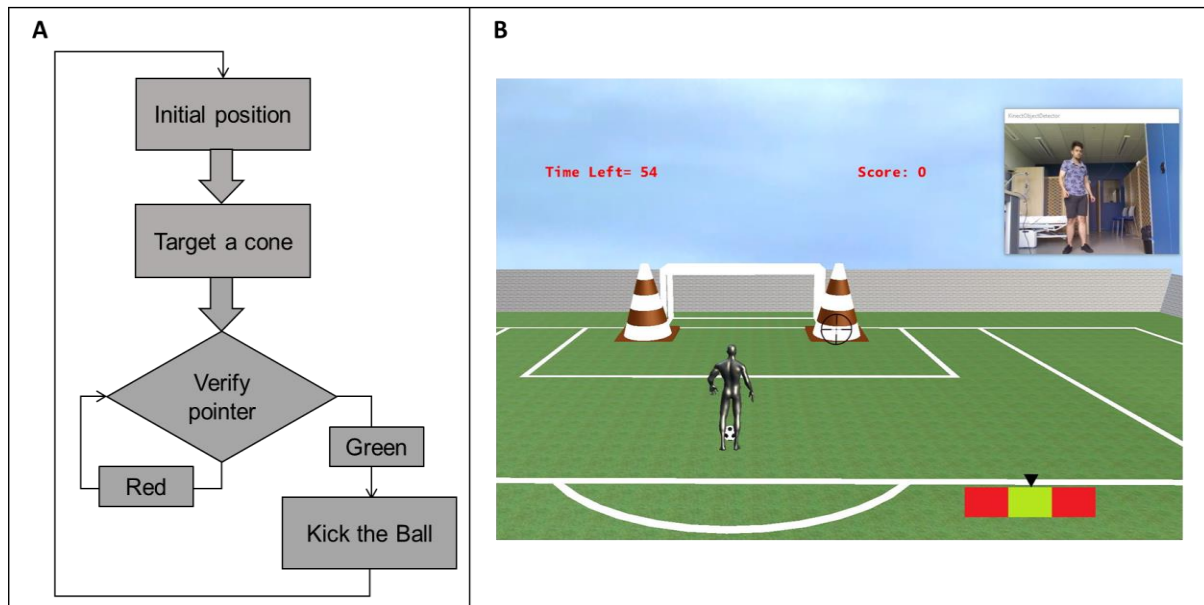

Figure 34. A: Football game workflow and B: scene

### 3.2.2 Object Manipulation Game

This game targets several parts of the body. The upper limbs are targeted in all the levels, whereas the lower limbs are targeted only by the second and third levels. Moreover, the third level targets lower limb movement speed recovery, since the timer would force the users to move quicker. In this scene, the user needs to take a flower from a vase and put it in the other one (Figure 35). They repeat the same actions from right to left until the game-time expires. Three levels of difficulty (easy, medium, and hard) are defined. In the first level, the virtual avatar is fixed between 2 tables and must only move their hands. In particular, the player is rewarded 4 points for a combination of 3 successive gestures: take the flower with the first hand from the first vase, switch the flower to the second hand, and put the flower in the second vase. The second level of this game requires the player to move left and right to cover a certain distance that separates the tables. Therefore, players have to move one step left and then get the flower. They switch it to the other hand and then move one step to the right in order to put the flower in the other vase. Finally, the third level of difficulty is similar to the second one but the challenge is to put the flower in the other vase before the expiration of a timer that appears on the bottom of the screen. We note that a surrounding living room was designed for this specific rehabilitation game.

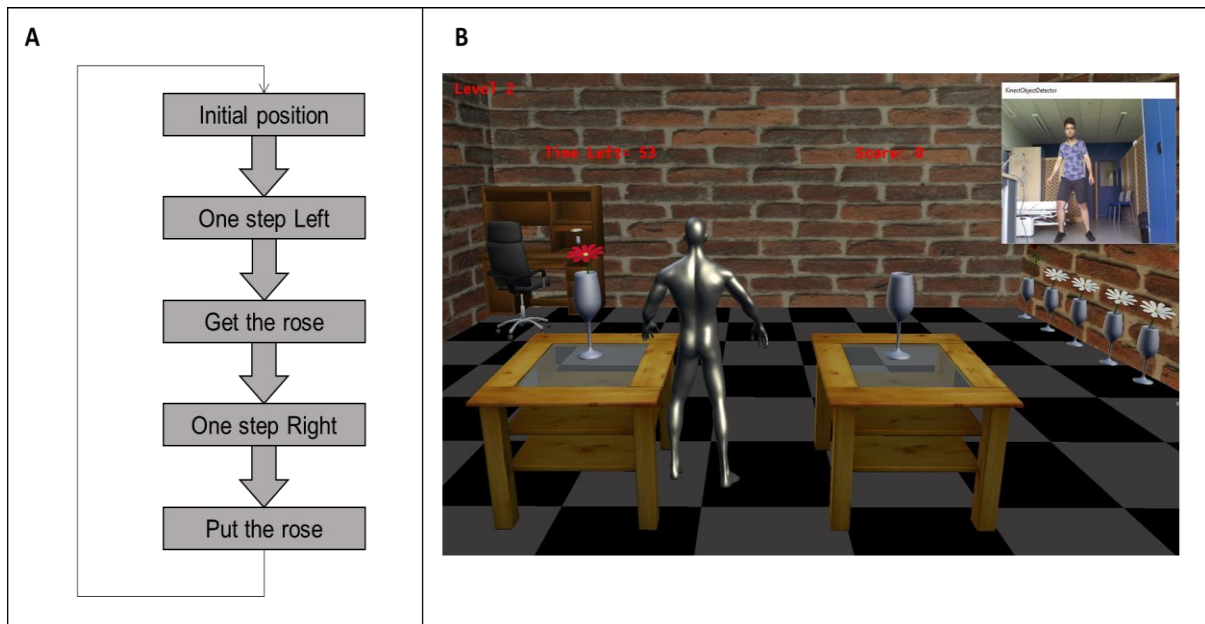

Figure 35. A: Object manipulation game (medium level) workflow and B: scene

### 3.3 Evaluation methodology

As stated before, we have developed an evaluation guideline, in addition to the game development guideline presented previously. Figure 36 shows the basic points in this guideline. The evaluation guideline consists of the definition of the evaluation metrics, the execution of the evaluation campaign, the analysis of user results and feedbacks, and the improvement of the designed game. The evaluation metrics can vary from qualitative questionnaire, to quantitative angular data. Finally, the improved game is re-evaluated in a closed-loop technique, if the evaluation's results deem it necessary. The re-evaluation takes into account the user's performance and their results. This user-centered game design approach allows different users (e.g. patients and medical experts) to participate actively in the design and evaluation stages.

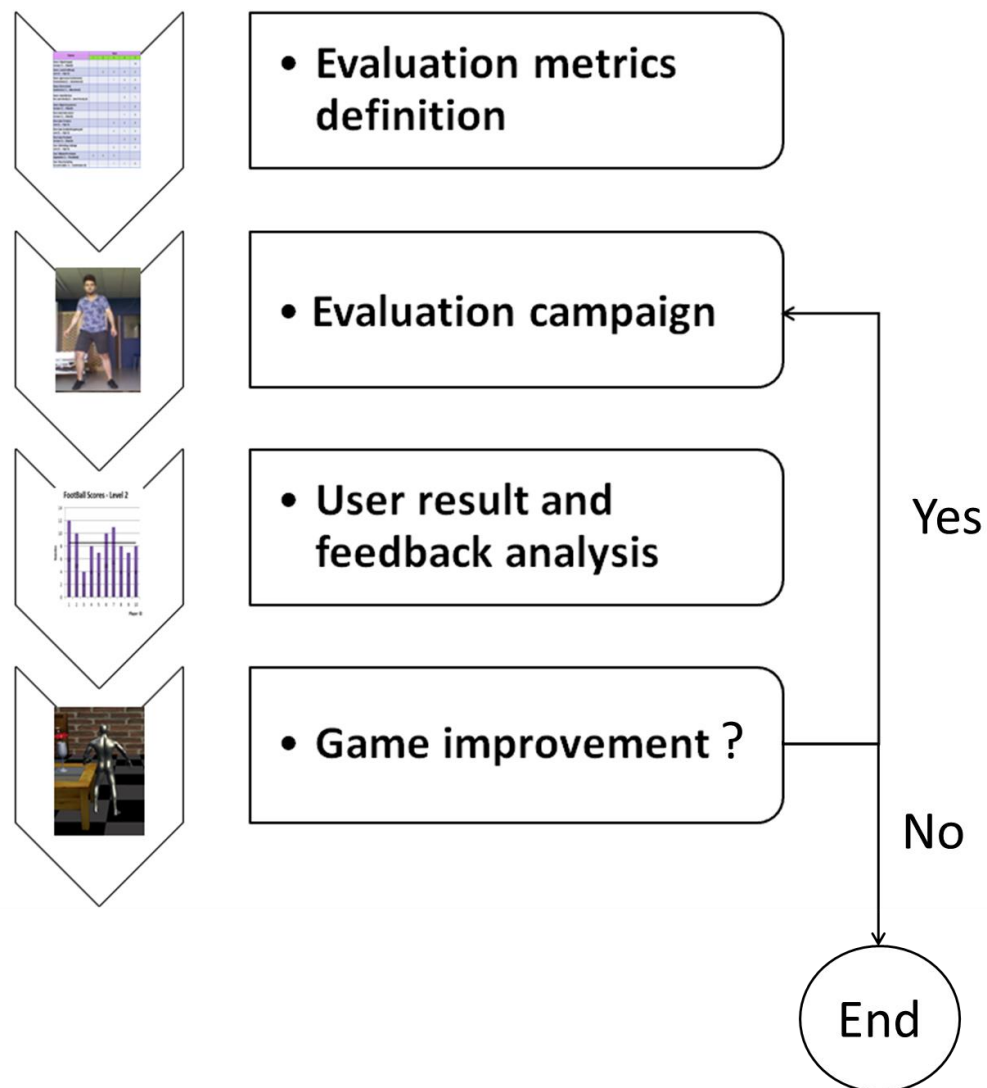

Figure 36. Rehabilitation-oriented serious game: evaluation guideline

This diagram is in accordance to the co-design principal, where patients, medical experts and developers contribute to implement the best solution for the problem in hand [131]. This method presents a new and innovative approach to develop solutions that are accepted by the user groups that helped design them. In our case, the end-users (patients and medical experts) will have participated in co-designing the games and the user interfaces. Thus, after a first step of development of serious games, different users will perform the evaluation of the games and user interfaces. Moreover, the feedback from these tests will allow the developers to change the applications and adapt them to the needs of the end-users.

We will now describe two evaluation campaigns that were performed with healthy and pathological patients. The evaluation metrics and purpose of these two campaigns were complementary. We should note that in addition to the user feedback analysis taken into

consideration to improve the games, supervising medical personnel's opinion was also considered.

### 3.3.1 First evaluation campaign

#### 3.3.1.1 Evaluation metrics

The user's performance was evaluated by the points acquired at the end of each scenario. For the usage acceptability aspect of the designed games, a questionnaire was defined. At the end of each game scene, players were required to fill out a questionnaire. The questionnaire consists of 13 questions for each specific game scenario. The feedback focuses on the game, exercise, and user aspect. For the game, the objective, the level of difficulty, the ignorance of achievement, the attractiveness of the 3D environment and GUI, and the game management (begin, end) were investigated. For the exercise, the game instructions, the variation of scenarios, the suitability of the game to the goal, and the clearness of the feedback were examined. For the user, the motivating challenge, the possibility to make mistakes, and the security feeling were investigated.

#### 3.3.1.2 Evaluation campaign

The developed game scenarios were evaluated by a normal healthy group (10 subjects: 6 males and 4 females with a mean age of 26.8 [standard deviation (SD) 5.65]), to ensure the security condition. Then, the games were evaluated by a population of 20 pathological subjects (13 males and 7 females with a mean age of 49.75 [SD 18.68]) at the "Centre Hospitalier Universitaire de Limoges" (France). The patient group included different MSDs (3 amputee patients, 8 hemiplegia patients, 1 hereditary spastic paraplegia patient, 1 patient with ankle arthrodesis, 1 stroke patient, 1 patient with shoulder capsulitis, 1 patient with low back pain, 1 patient with carpal tunnel, 1 patient with prosthesis, 1 patient with muscle disease, and 1 patient with walking difficulty due to a car accident). Each participant signed an informed consent agreement before playing the rehabilitation games. It is important to note that the execution of rehabilitation serious games was monitored by clinicians, to ensure the ability and the security of the patients when using this new rehabilitation tool, and to give their own feedbacks. Each healthy subject was asked to play every level of difficulty of each game, which means a total of 6 trials per subject. Some patients were not able to try all levels or even one of the two games due to the severity of their state (amputation, leg prosthesis, and paralysis). Medical experts were given the decision to accept or decline the participation of their patient in a game or a

level of a certain game. Therapists accompanied their patients by standing behind them and supporting them, to ensure their security. The duration of each game level was around 60 seconds. A rest time of around 2 mins was also allowed for each participant when necessary (i.e. recovery from fatigue) after each game execution. The total time of the test for one subject was approximately 20 min.

### 3.3.1.3 User result and feedback analysis

For the control group, the scores did not change so much when increasing the level of difficulty for the football scenario (Figure 37, Figure 38, Figure 39). The mean and SD scores of the easy, medium, and hard levels were 8.5 [SD 1.8], 8.5 [SD 2.2], and 8.5 [SD 2.7], respectively. Maximal scores were 11, 12, and 13 for the easy, medium, and hard levels of difficulty, respectively. Note that when a score is achieved, this means that the player finished a game with all requirements. Statistical test (*t*-test, implemented in Matlab R2010b software [The MathWorks Inc.]) showed no significant difference. In particular, some subjects (ID4 or ID6) increased their score when enhancing the level of difficulty. According to the healthy control group, the performance of the pathological population was significantly (*t*-test,  $P < .005$ ) lower for all levels of difficulty (Figure 37, Figure 38, Figure 39).

The mean and SD scores of the easy, medium, and hard levels were 2.7 [SD 1.3], 2.5 [SD 1.7], and 3.9 [SD 1.8], respectively. Maximal scores were 6, 6, and 7 for the easy, medium, and hard levels of difficulty, respectively. In particular, some patients (ID17 or ID24) increased their score when enhancing the level of difficulty. This might be explained by the fact that the designed games stimulated the user motivation. Thus, they felt the challenge to perform better when they got familiar with the game. However, the number of the patients able to perform on harder levels was reduced from 19 patients for easy level to 8 patients for the hard level. Regarding the object manipulation game, the same results were noted (Figure 40, Figure 41, Figure 42). The normal population showed mean and SD scores of 51.6 [SD 13.3], 59.2 [SD 14], and 60.4 [SD 25] for the easy, medium, and hard levels, respectively. Maximal scores were 72, 88, and 116 for the easy, medium, and hard levels of difficulty, respectively. The pathological population showed mean and SD scores of 22.8 [SD 12.3], 22 [SD 12.2], and 25.3 [SD 21.7] for the easy, medium, and hard levels, respectively. Maximal scores were 52, 44, and 68 for the easy, medium, and hard levels of difficulty, respectively. Thus, the performance of the pathological population was significantly (*t*-test,  $P < .05$ ) lower than that of the normal

population. The number of patients able to perform harder levels was also reduced from 17 patients for the easy level to 5 patients for the hard level.

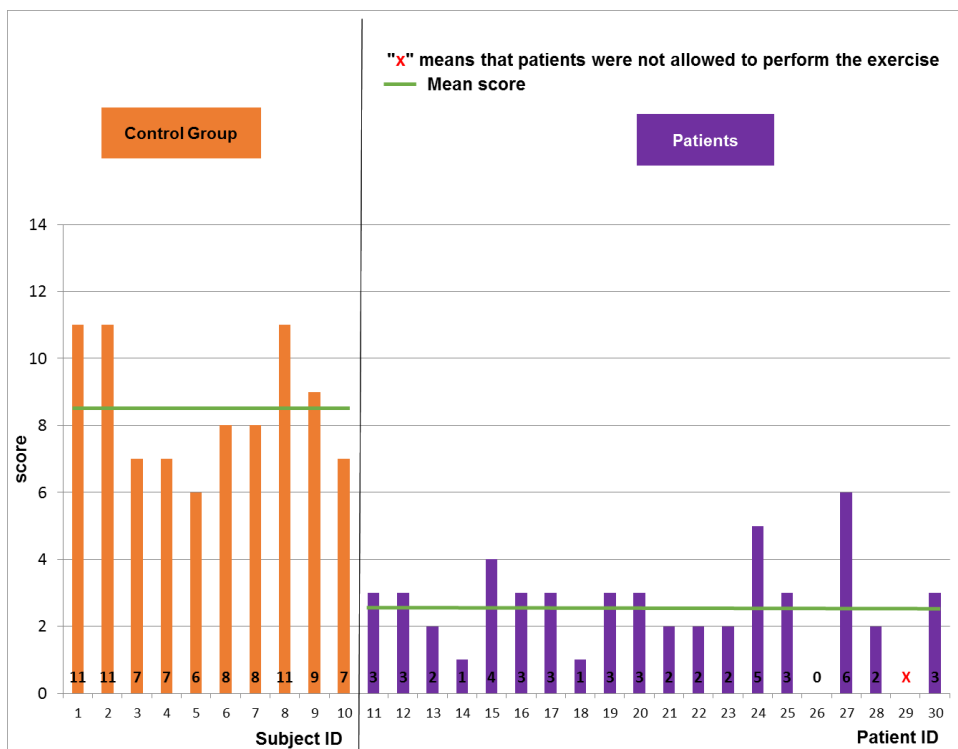

Figure 37. Game performance: patient group vs. healthy control group: easy level of the football scenario

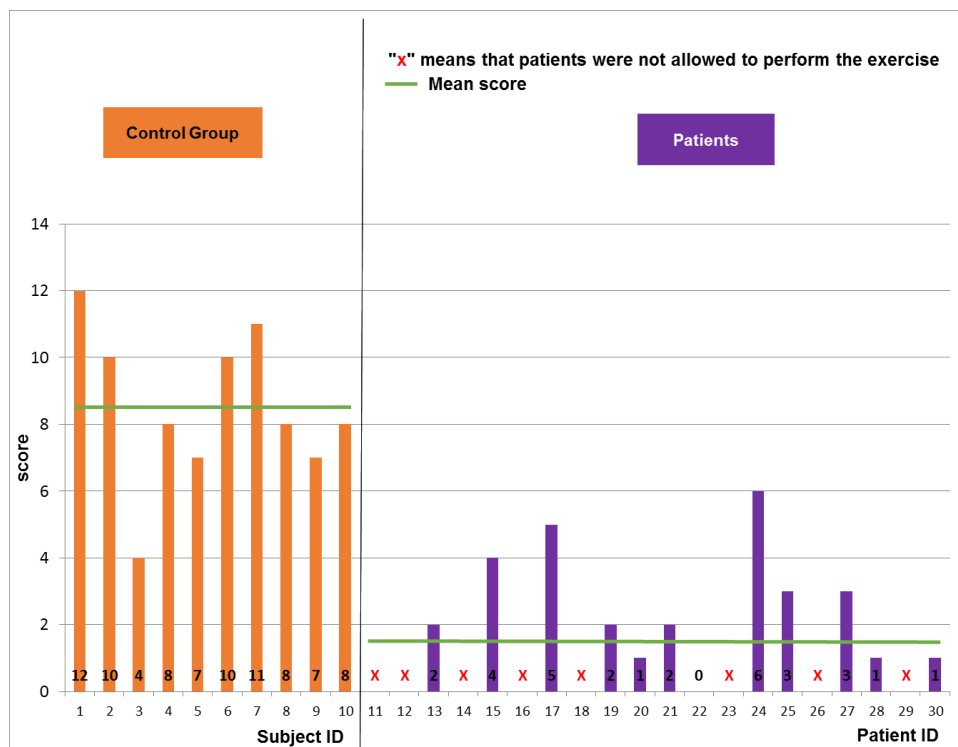

Figure 38. Game performance: patient group vs. healthy control group: medium level of the football scenario



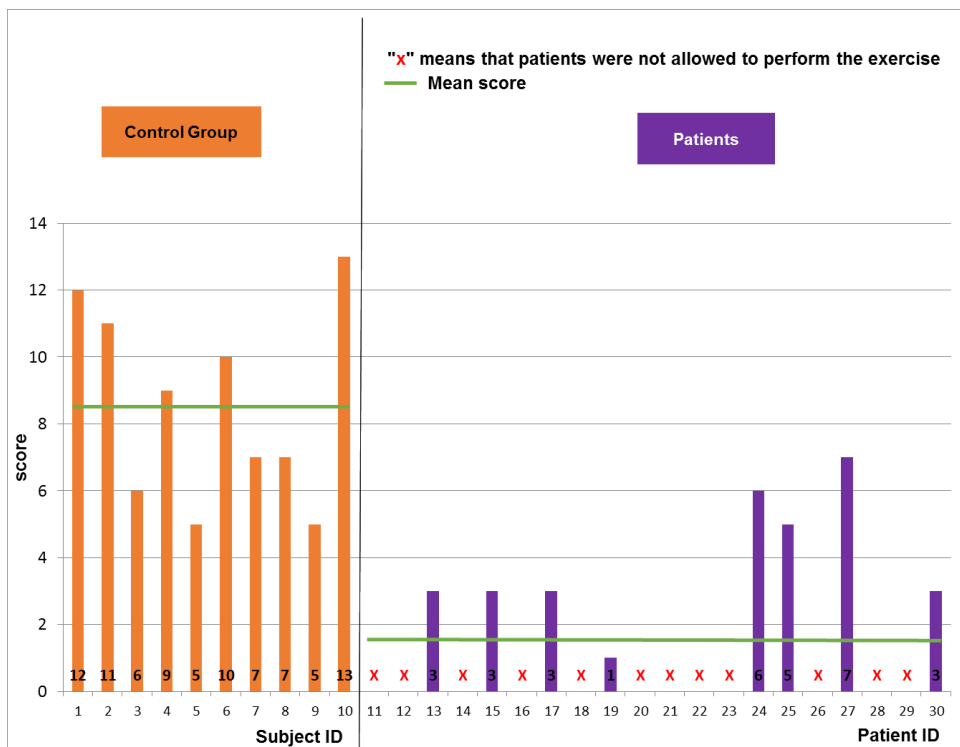

Figure 39. Game performance: patient group vs. healthy control group: hard level of the football scenario

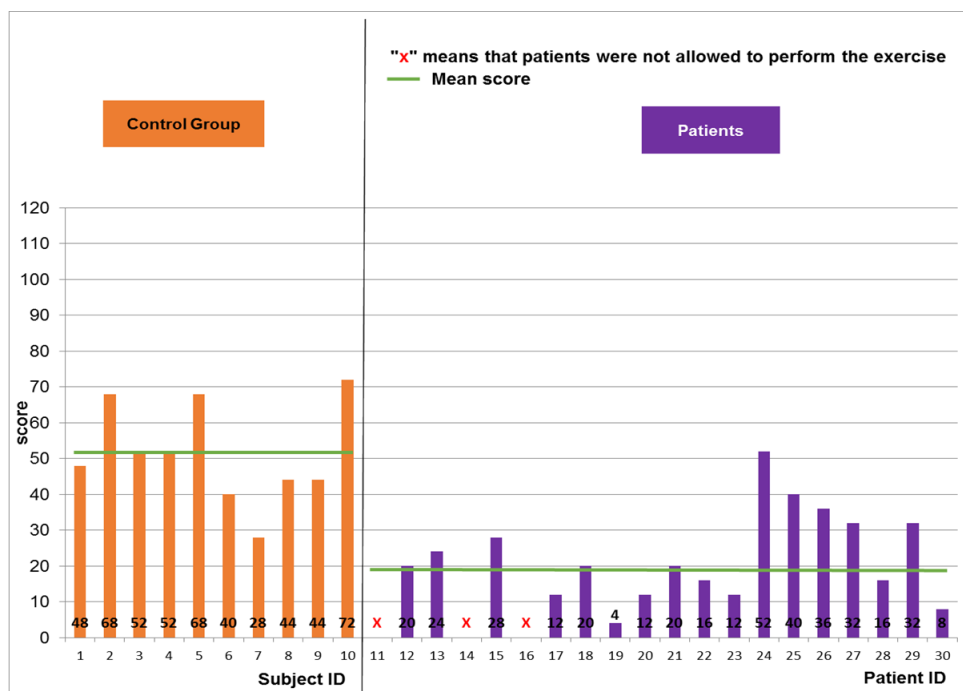

Figure 40. Game performance: patient group vs. healthy control group: easy level of the object manipulation scenario

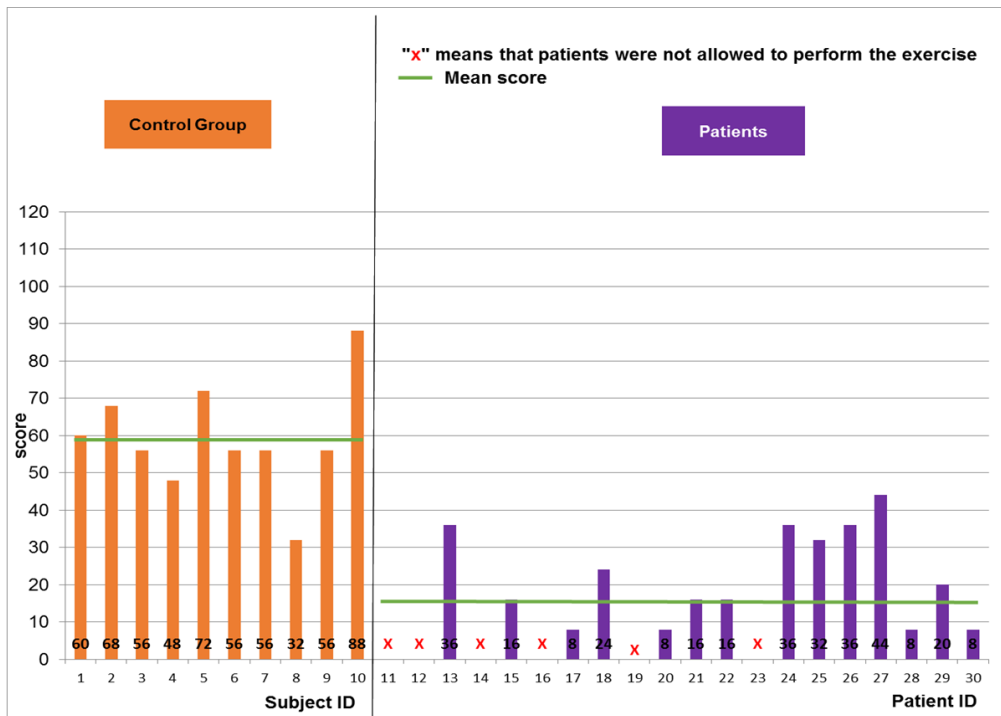

Figure 41. Game performance: patient group vs. healthy control group: medium level of the object manipulation scenario

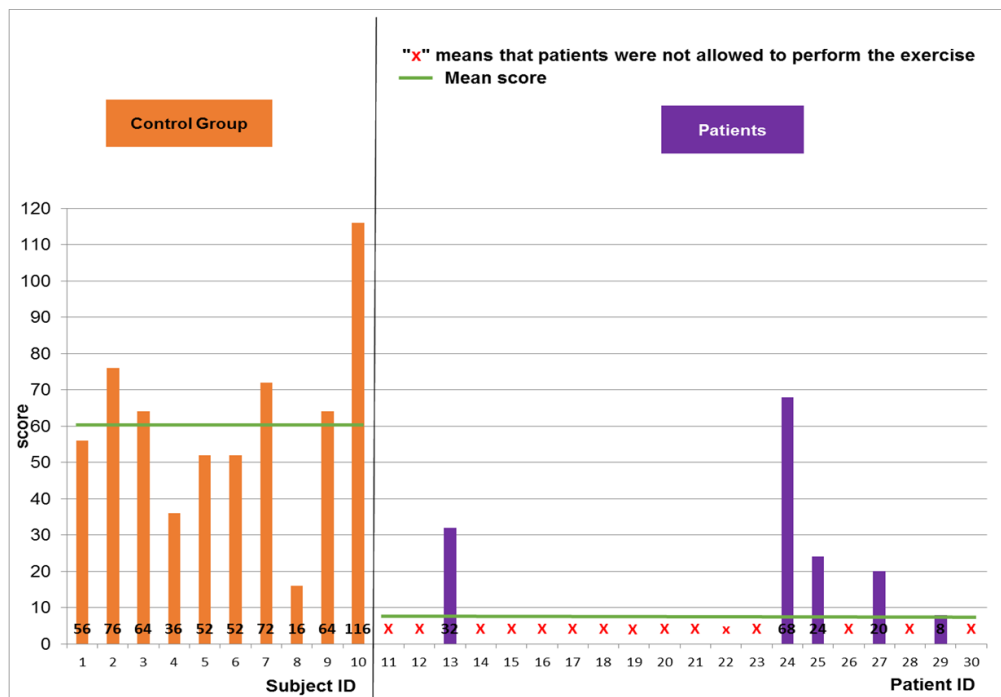

Figure 42. Game performance: patient group vs. healthy control group: hard level of the object manipulation scenario

For the responses to the questionnaires, 29 users (patients and healthy subjects) rated the football game, and 27 rated the object manipulation game. Regarding the user acceptability of the evaluated games, all healthy subjects found the 2 developed games motivational, attractive,

and challenging. A synthesis of the patients' responses to the football game questionnaire and to the object manipulation questionnaire are depicted in Table 4. Moreover, they enjoyed all the levels of difficulty. Note that the answers about the accuracy of the human movement detection varied. That can be interpreted by the limitations of the Kinect due to occlusion of limbs, which could affect the accuracy of movement detection. Most of the participants assumed that they were comfortable with the system, whereas some patients, having balance disorders, worried about some levels of difficulty. Finally, there were no risks and accidents associated with the execution of these 2 games, not only for the normal population but also for the pathological population.

Table 4. Users' responses to the football and object manipulation game questionnaires

Criteria	Rank									
	Object					Football				
	1	2	3	4	5	1	2	3	4	5
<b>Game: Objective/goal</b> Unclear (1) → Clear (5)	1		1	2	15		1	2		14
<b>Game: Level of difficulty</b> Low (1) → High (5)	3	4	7	2	3	3	2	3	6	3
<b>Game: Ignorance of achievement</b> Unawareness (1) → Awareness (5)			3	2	14	1	1	3	1	11
<b>Game: Environment</b> Unattractive (1) → Attractive (5)	1		1	5	12			4	1	12
<b>Game: User Interface</b> Not user-friendly (1) → User-friendly (5)			3	2	14		1	1	3	12
<b>Game: Beginning and end</b> Unclear (1) → Clear (5)	1		1	3	14			1	1	15
<b>Exercises: Instructions</b> Unclear (1) → Clear (5)	1			1	17			1	1	15
<b>Exercises: Variation</b>		3	1	6	9		2	2	3	10

Low (1) → High (5)										
<b>Exercises: Suitable for game goal</b> Low (1) → High (5)		2	5	3	9		1	2	3	11
<b>Exercises: Feedback</b> Unclear (1) → Clear (5)		1	3	4	11			4	4	9
<b>Participant: Challenge</b> Low (1) → High (5)	2	2	1	4	10		1	2	3	11
<b>Participant: Mistake Permission</b> Impossible (1) → Possible (5)	6	2	7	1	3	6	2	4	3	2
<b>Participant: Security feeling</b> Uncomfortable (1) → Comfortable (5)			3		16		1		4	12
<b>Total</b>	<b>15</b>	<b>14</b>	<b>36</b>	<b>35</b>	<b>147</b>	<b>10</b>	<b>12</b>	<b>29</b>	<b>33</b>	<b>137</b>

### 3.3.1.4 Game improvement

Finally, players were asked to give some specific comments on this project and the developed games. Comments and suggestions from the patient groups were as follows:

- *Interesting project and this game needs to be developed in bigger scales.*
- *The games are amusing, motivational and not bad at all. It made me really move my legs.*
- *The football scene is excellent. I am a football fan and I watch all the games.*
- *I recommend you to force the player to hit the left cone at first and then rotate towards the right cone. This improves the efficiency of spine rehabilitation.*
- *In my opinion, this can really help patients. Even if I am not a florist!*
- *The exercises are adapted to rehabilitation at the final stages.*
- *The project is suitable for younger players.*
- *The project is very fun, helps in performing rehabilitation while enjoying it. It should please young and old people.*
- *Very attractive games.*
- *Very interesting project for movement coordination.*

- *The avatar's movements should be improved.*
- *Difficult but interesting. More games need to be developed.*

Based on these suggestions, our game scenarios were updated to take them into consideration. Note that only technical feedbacks for improvement were considered in the updated version. In particular, the order of the football game, as suggested in the 4<sup>th</sup> comment above, was redefined to adapt to the rehabilitation of spinal patients. Moreover, the avatar's movement has been improved by using multi-sensor fusion approach. Some patients did not try the football game because they could not stand up on their feet. This could be an initiative to create exercises for patients sitting in wheelchairs in future versions of our serious game system.

### 3.3.1.5 Discussion

Serious gaming technologies target audience ranging from the young to the elderly population. The simplicity and challenging aspect are the main advantages of this new technology. In previous works, we do not find any unified development or evaluation guideline for functional rehabilitation scheme. The experience that we got from the case study of MSDs showed the usefulness and applicability of the established task-oriented development and evaluation guidelines.

Regarding our case study, patients' scores were lower than those of the healthy group. Some of them were not able to play the football scene because of their amputation. Others could not try the object manipulation scene because they cannot move their hands at all. In general, all of them accepted the challenge and wanted to participate in this study. Hemiplegic patients were the top testers among all patients. Medical doctors and physiotherapists thought that these task-oriented games were more adapted to this particular disorder. Previous studies came to the same conclusion about the use of the task-oriented games for these patients [72, 73]. We can see that all hemiplegic patients were able to try at least one level of difficulty from each game, and their achieved scores depended largely on the severity of their disorder. Amputees tried our system and showed great motivation even though they failed to achieve high scores; they felt the challenge even in the absence of any achievement. Moreover, the Kinect had some difficulty recognizing the shape of their body, which might influence the virtual avatar's behavior. Overall, patients' results depend on the state of each patient. Moreover, even though the difficulty of the games increased, some patients and healthy subjects achieved higher scores even at the hard level of difficulty, which could indicate an increase in their motivation when they got accustomed to the games. However, more

quantitative measurements on user's motivation need to be performed to confirm this finding. Moreover, the higher scores by patients occurred when they played their favorite game. Thus, the choice of the game scenario for the profile of each patient may potentially enhance the achieved scores.

The design of rehabilitation game scenarios plays a crucial role in the success of the serious game for health. The game scenario must not only be attractive but also needs to be clinically useful. The football and object manipulation games respond to the challenging objective: patient practices rehabilitation exercises without recognizing that it is a rehabilitation exercise when playing the game. Thus, the football game allows the player to practice two motor tasks (body rotation motion and the leg motion) and two decision-making actions (observation of time and identification of right moment). The object manipulation game allows the player to practice two motor tasks (leg and arm motion) and two decision-making actions (localization of rose or vase, and observation of time). This first study suggests that rehabilitation game scenarios should be designed, implemented, and evaluated with similar strategies.

The design of motivating, challenging, and safe serious games for functional rehabilitation requires particular attention on the development and evaluation processes. The development and evaluation of the 2 games (football and object manipulation) followed the proposed guidelines. In general, a guideline is defined as a principle to determine a set of actions in a standard way. We have aimed to propose a coherent set of development and evaluation steps for rehabilitation-oriented serious games for MSDs. It is important to note that some published works already followed some guidelines [61, 78, 79] but other works did not conduct some important steps like the improvement of game from user feedback [72] or the evaluation on patients [74]. Thus, this study may serve to highlight the important steps to develop and evaluate a serious game for MSDs.

Our developed system used the Kinect camera as motion capture sensor. Currently, the virtual avatar imitates player movements correctly. However, clinical experts require more accuracy to analyze the joint behavior during the exercise. It is well known that the accuracy of this device is limited for joint angle estimation. A deviation range of  $11^{\circ}$  to  $14^{\circ}$  was noted for the knee joint angle [46, 47]. To overcome this drawback, a multisensory fusion is proposed in the next chapter. However, the use of the Kinect camera alone leads to higher feasible and potential translation of such a rehabilitation game into clinical routine practice, especially in a

home-based setting, thanks to the low cost and portable nature of this specific device. More complex sensors need to be optimized before they are used in a clinical setting. In particular, within the context of a “game” implemented at home, the accuracy may be sacrificed for the portability and ease-of-use criteria. On the other hand, implementing this system at the clinic can compromise the ease of use for more accuracy.

### 3.3.1.6 Limitations

The main limitation of this study is that the user questionnaire was based on the one defined previously by our team, with the help of medical and human sciences experts. This questionnaire covers many aspects including the game, the exercise, and the user. However, the user engagement aspect is still simple in the created questionnaire. Thus, the use of a validated questionnaire that focuses more on the user aspects to analyze the game engagement is presented in the next section [132].

## 3.3.2 Second evaluation campaign

### 3.3.2.1 Evaluation metrics

The evaluation of this second campaign focuses on stroke patients. Moreover, the study focused on both quantitative and qualitative assessment of the patients’ situations. The quantitative assessment was done through angle measurements. For the football game, 3 angles are of interest: the knee flexion ( $\alpha_1$ ), the hip abduction ( $\beta_1$ ) and the hip flexion ( $\delta_1$ ). For the object manipulation game, 3 angles are also recorded: the elbow flexion ( $\alpha_2$ ), the shoulder abduction ( $\beta_2$ ) and the shoulder flexion ( $\delta_2$ ). These angles are tracked and saved for clinical exploitation. Figure 43 shows these games and the tracked angles.

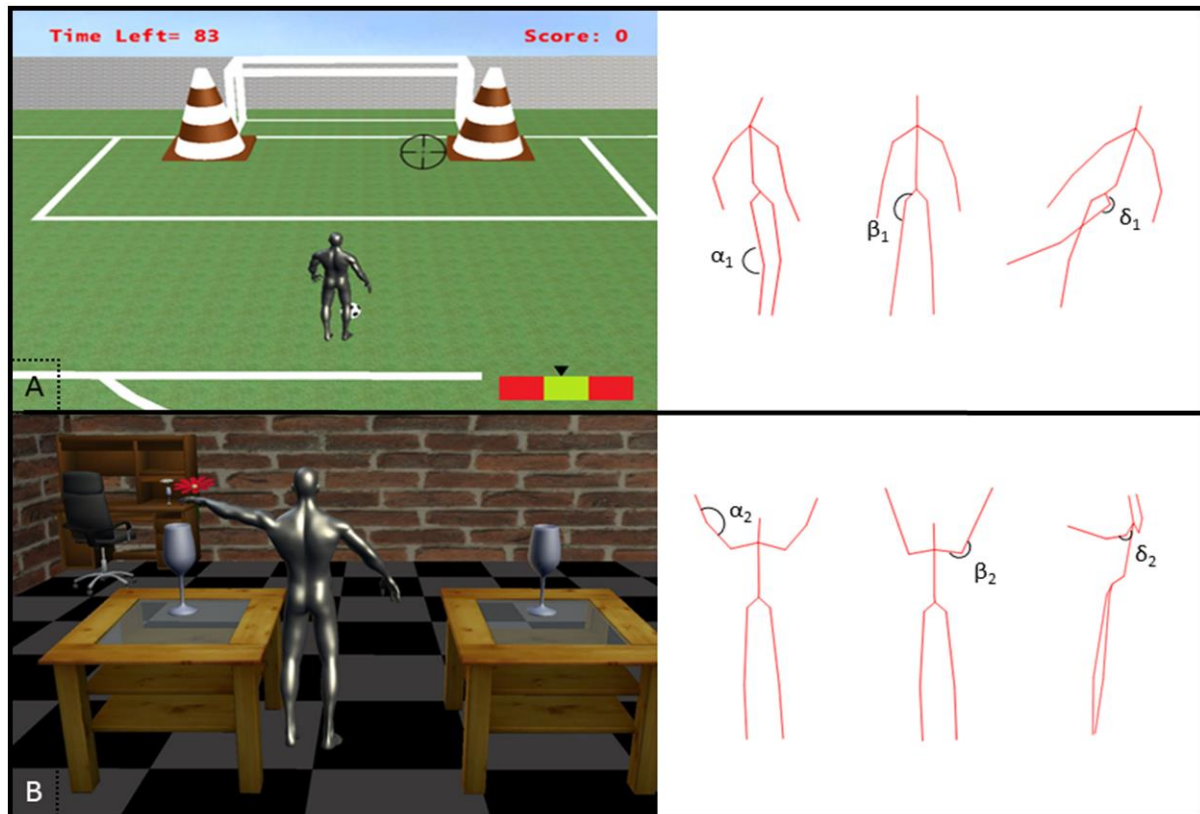

Figure 43. Football game: knee flexion ( $\alpha_1$ ), hip abduction ( $\beta_1$ ) and hip flexion ( $\delta_1$ ) (top); Object manipulation game: elbow flexion ( $\alpha_2$ ), shoulder abduction ( $\beta_2$ ) and shoulder flexion ( $\delta_2$ ) (bottom)

Note that these angles are calculated using the Kinect quaternion estimation algorithm, to avoid errors that can occur from using Euler angles. The algorithm calculates the relative quaternion between two vectors representing the rotation of each child limb with respect to its parent (e.g. the forearm is the child of the arm, the elbow angles are the result of the algorithm's estimation). The quaternion result can be obtained using the following formulas:

$$Q_x, Q_y, Q_z = \text{Cross}(\vec{u}, \vec{v}) \quad (30)$$

$$Q_w = \|\vec{u}\| * \|\vec{v}\| + \text{Dot}(\vec{u}, \vec{v}) \quad (31)$$

Where  $Q$  is the 4 dimensional quaternion  $Q = (Q_x, Q_y, Q_z, Q_w)$ ,  $\vec{u}$  and  $\vec{v}$  are the parent and child unitary vectors. A network of inertial sensors, placed on different body segments, and a Kinect camera were used in the integrative system (Figure 44). The real-time Kalman-based multi-sensor fusion algorithm that will be presented in the next chapter was used to combine data from the Kinect and the IMUs. Note that the system does not require any calibration for the sensors prior to the session, and that the position of the sensor has been optimized in the multisensory fusion study that will be presented later.





Figure 44. Patient playing the object manipulation game with sensors attached to his upper left body section

The qualitative assessment was done using different questionnaires. At the end of the session, each participant evaluates the games using three questionnaires. Two of the questionnaires were already used in our previous study, with two added questions concerning the comfort/discomfort of mounting sensors on the patient's limbs (i.e. effect of sensors on the game and on the body). One question, concerning the variation in the level of difficulty of each scenario was removed, since we did not test different levels of difficulty for each game. These two questionnaires evaluate the game interface and the level of comfort of the patients during the trials. The third questionnaire does not focus on the different games in particular, but on the level of immersion of the patients in these games. The chosen questionnaire comes from a well-cited study conducted by *Jennett et al.* where they measured the level of immersion of people in virtual games, using 5 criteria: challenge, control, real world dissociation, emotional involvement and cognitive involvement [133]. Note that two experienced clinicians supervised these trial sessions to ensure the safety of the patients. They also gave suggestions and comments about the tested games. Patients were also asked to choose their favorite game.

### 3.3.2.2 Evaluation campaign

The developed system was evaluated by patients. The evaluation was performed at the "Centre Hospitalier de Limoges" (France) under supervision of experienced clinicians (Jean

Christophe Daviet (MD) and Anaick Perrochon (PhD)). A panel of eight stroke patients (2 female and 6 male, mean age 66.37 years old [SD 7.03]) participated in this evaluation campaign. Subjects were chosen according to the following inclusion criteria: the absence of a musculoskeletal condition that could potentially affect the ability to balance safely; the absence of serious visual impairments or hearing disorders. The exclusion criteria were as follows: severe dementia or aphasia; unable to follow instructions; unable to stand alone. Each participant signed an informed consent agreement before participating in the evaluation process.

Each scenario was tested twice, with and without the use of inertial sensors attached on particular body parts. For the football game, the patient used the Kinect camera alone to play this game, then, two inertial sensors were attached on the patient's thigh and shank, to measure the knee angle with our fusion algorithm. Note that the sensors are always attached on the affected areas of the patient (either right or left knee). Regarding the object manipulation game, during each of the patients' second trial, two inertial sensors are attached on their arm and forearm, to measure the elbow angle with our fusion algorithm.

### 3.3.2.3 User result and feedback analysis

Each patient tested both games two times. During the first trial, only Kinect camera was used to estimate joint angles. Inertial sensors were used in the second trial to estimate the joint angle of one particular joint (i.e. knee angle for the football game, and elbow angle for the object manipulation game). The mean and SD game scores of all football trials were 4.83 and 2.94 respectively (trial #1: 4.33 [SD 3.5] and trial #2: 5.33 [SD 2.5]), while the object manipulation mean and SD game scores were 6.66 and 6.45 respectively (trial #1: 6 [SD 5.51] and trial #2: 7.33 [SD 7.76]). Figure 45 shows the estimated angles during the two different trials using the Kinect camera alone and multi-sensor fusion solution. Note that the angles estimated by the Kinect camera were subject to errors caused by object superposition and low accuracy. This could lead to some abnormal joint data behavior. On the other hand, the data estimated using the fusion algorithm is more accurate and the movement pattern can be clearly tracked and examined. Note that this higher level of accuracy when comparing the Kinect camera to the sensor fusion will be describe in the next chapter. Moreover, a statistical test (*t*-test, implemented in Matlab R2010b software [The MathWorks Inc.]) was performed to verify if both trials (with and without using sensors) show significant differences or not. The results confirmed that there is no difference between trials with and without using sensors for both

rehabilitation games ( $P=0.581$  for the football game and  $0.738$  for the object manipulation game). This means that using sensors during the designed games does not affect the player's performance. Moreover, when comparing the game scores obtained by the same patient during the two games (football and object manipulation), we found that the results are significantly different ( $P<0.05$ ). This can be explained by the fact that the performance of each game scenario depends on the specificity of patient's pathological situation and/or their game preference.

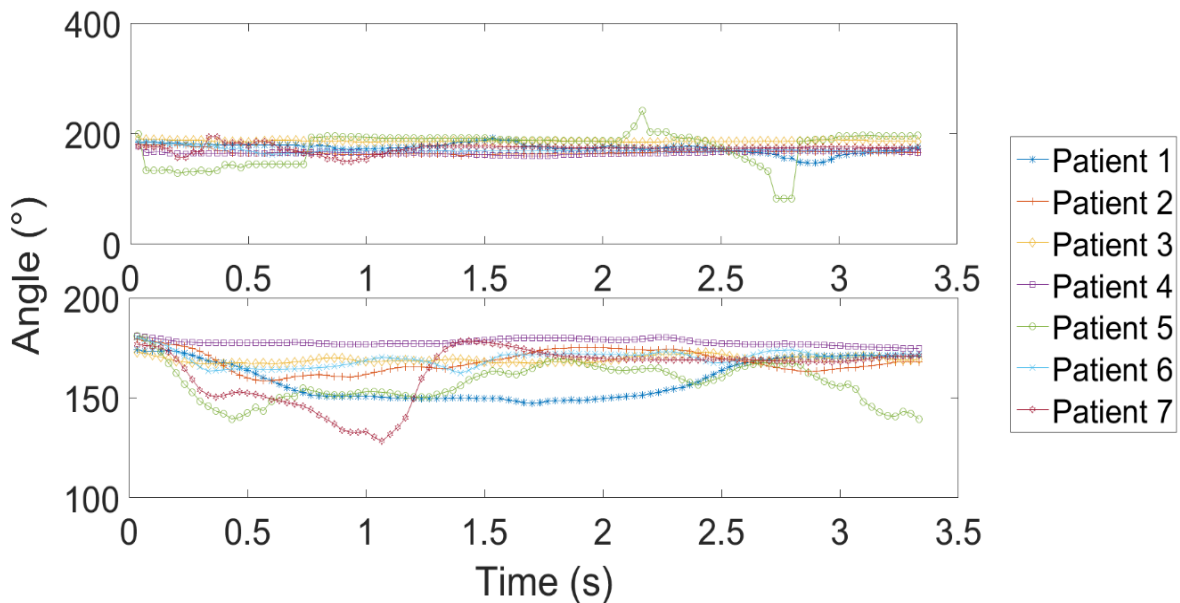

Figure 45. Knee flexion angle estimated during the patients' first football game trial using the Kinect camera (top), and during the second trial using the multi-sensor fusion algorithm (bottom)

After completing the trials, each patient evaluated different aspects (game design, exercises, and participant perception) of the serious games. The answers are depicted in Table 5. The results show that most of the patients gave the highest ranks for both games (56 for football and 70 for object manipulation). The second most given rank for both games was 3 (22 for football and 11 for object manipulation). Note that 11% (11 out of 98 answers) of the participants require a significant improvement (rank 1) of the proposed solution. The main problems are the games' level of difficulties and challenges, as well as the mistake permission. Note that Table 5 contains 7 responses for the football questionnaire and 7 for the object manipulation questionnaire. This is due to the fact that two different patients could not perform one of the two games based on the expert's recommendation.

Table 5. Patients' responses to the football and object manipulation game questionnaires

Criteria	Rank									
	Object					Football				
	1	2	3	4	5	1	2	3	4	5
<b>Game: Objective/goal</b> Unclear (1) → Clear (5)					7				2	5
<b>Game: Level of difficulty</b> Low (1) → High (5)	3		1	1	2	2		3		2
<b>Game: Ignorance of achievement</b> Unawareness (1) → Awareness (5)				1	6				1	6
<b>Game: Environment</b> Unattractive (1) → Attractive (5)				1	6			1	1	5
<b>Game: User Interface</b> Not user-friendly (1) → User-friendly (5)			2	1	4	3			1	3
<b>Game: Beginning and end</b> Unclear (1) → Clear (5)					7	1				6
<b>Exercises: Instructions</b> Unclear (1) → Clear (5)					7					7
<b>Exercises: Suitable for game goal</b> Low (1) → High (5)					7	1		2		4
<b>Exercises: Feedback</b> Unclear (1) → Clear (5)					7	1		1		5
<b>Exercises: Effect of sensors on the game</b> No effect(1) → Improvement (5)			5	1	1			7		
<b>Participant: Effect of sensors on the body</b> Uncomfortable (1) → Comfortable (5)					7				1	6
<b>Participant: Challenge</b>	3		1	1	2	2	1	2	1	1

Low (1) → High (5)										
<b>Participant: Mistake Permission</b> Impossible (1) → Possible (5)	5		2			1		6		
<b>Participant: Security feeling</b> Uncomfortable (1) → Comfortable (5)					7				1	6
<b>Total</b>	<b>11</b>	<b>0</b>	<b>11</b>	<b>6</b>	<b>70</b>	<b>11</b>	<b>1</b>	<b>22</b>	<b>8</b>	<b>56</b>

Regarding the evaluation of the immersion level of the participant in the serious games, the responses of the patients gave ideas about six different parameters shown on the boxplot of Figure 46. The total immersion had a median value of 0.796, maximum and minimum values of 0.935 and 0.632 respectively. First and third quartile values of 0.677 and 0.858 were noted. All of the different parameters had above average medians.

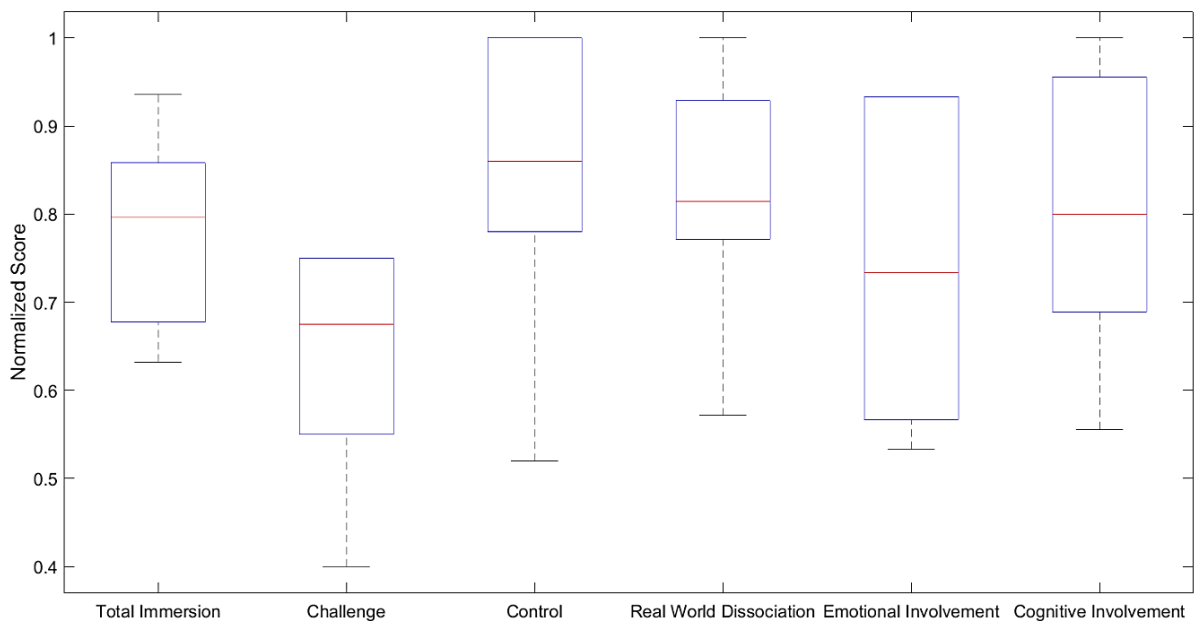

Figure 46. Analysis of the patients' responses to the immersion questionnaire

### 3.3.2.4 Game improvement

Finally, patients were asked to comment on these games. Some of the answers were the following:

- *I felt good playing these games.*

- *This can be good for certain people, but not for me since I do not spend a lot of time in front of a computer.*
- *Very interesting games for me.*
- *This is really amusing, researchers should really evolve this technology.*
- *This reminds me of the games that we play during ergotherapy sessions, but here I can see my arms in the virtual game, which I find motivating. My arm guides me here, but during the ergotherapy sessions, it is the object that guides me.*
- *I think that these games can be beneficial for my arm rehabilitation. The system is really good. It would be great if rehabilitation centers could buy it, or maybe use it at patient homes.*

In addition, experts supervising these games gave their opinion. They suggested adding a level of difficulty below the easy level of football, where the slider is ignored to disregard the cognitive aspect in the game. Next, they suggested adding the option of playing the objects manipulation game in a seated position, for patients that cannot stand. Finally, they gave some ideas on how to implement new games for stroke patients. These recommendations were taken into consideration, especially the new seated mode for the object manipulation game.

### 3.3.2.5 Discussion

Regarding the system's evaluation by patients, the responses to our previously developed questionnaire showed that most of the patients attributed the highest marks when judging our games. Moreover, the questions that got some low marks inquired about the level of difficulty and the challenge faced during the games, which can vary based on the patient's situation. Note that these answers might change if the patients experience the higher levels of difficulties, which they did not test. Moreover, the answers show that our user interface and environment pleased the patients. Most of the patients found that the objective of our games are clear and that they could imagine having to play them during their rehabilitation program (suitable for game goals). Finally, the questions concerning the use of sensors in the games showed that the patients did not feel that the sensors affected their performance, and that they felt comfortable while wearing them. This is in accordance with our objective, since we know that the increased accuracy, which the sensors can add to the game, will not necessarily be felt by the patients (not visually significant in the virtual environment). However, this increase in accuracy will be significant for experts, when analyzing the results. More precisely, clinical

experts could use accurately processed data and rehabilitation outcomes to validate one specific rehabilitation step to allow the patient to continue to the next rehabilitation phase.

When it comes to patient immersion, we note that patients were well immersed in the games (median immersion normalized score 0.796 and mean normalized score 0.779). The challenge exhibited by the patients had the lowest median score of 0.675, which is in accordance with the finding of our questionnaire, since the games' difficulty levels varied based on the patients' situations. This shows the need to personalize the games based on the patient's profile, and create subject specific serious games. The study also shows that the patients were emotionally and cognitively involved in the game, but still felt in control. To give more significant context to these values, we compared our results to those obtained by other studies for different kinds of games. Note that the total immersion score was the only parameter compared between the studies, since most of these studies used a different and preliminary definition by *Jennett et al.* in 2008 to calculate the different factors [133]. *Fierro et al.* created a serious game for knee rehabilitation that uses the Kinect camera to move the player on a flying platform, and where the player needs to jump and clap to reload a gun and shoot the boss [134]. The study compared patient immersion for the same game, with and without using music in the scene. They found that adding music increased the mean normalized immersion score from 0.658 to 0.74. These scores are lower than the ones that we obtained without using music, which could mean that we might be able to enhance the immersion of patients if we added music to our scenes. A study by *Iacovides et al.* compared between two versions of the same commercial game (Battlefield 3), with and without giving real-time instruction for the players [135]. The results showed that, depending on the player's experience, the mean level of immersion varied between 0.767 and 0.863, which seems to be in the same magnitude of the results that we obtained. This means that our patients are as immersed in these serious games, as players are immersed normally in commercial games.

### 3.4 Final game improvements

The previously explained studies yielded significant results, but also a lot of remarks and comments from patients and experts. Some of those remarks were dealt with immediately, like forcing subjects to pivot to both sides during the football scenes, and implementing a seated mode for the object manipulation games. However, some other comments were not taken into consideration, as they required heavier work that could not be performed during the studies. In

this section, we highlight two implemented concepts that were later added, in order to satisfy the needs and comments of the patients and medical personnel.

### 3.4.1 Subject specific game personalization

The pathological profiles of patients participating in rehabilitation sessions can be different, and the medical experts did not seem convinced that varying the levels of difficulty alone might be beneficial for all patients. Therefore, the games were altered and improved, with the help of medical personnel, to achieve a subject specific game. In particular, the football scene was used as a case study. In this scene, the patient is required to flex their knee and hip in order to achieve the recommended rehabilitation movement. For this reason, we offered the medical expert the possibility to define target flexion angles that the patient must achieve during the session. In addition, the patient will be notified whether their movement is adequate or not, in real-time.

To use this option, the medical personnel also recommended using a preliminary football scene testing window, in order to initialize the assessment of the patient's case. Next, the experts will define a rehabilitation program, while personalizing it using threshold angles for knee flexion and hip flexion, based on their initial assessment. They will also be given the option to check the threshold they set up through a virtual avatar that performs the personalized movement. Figure 47 shows the personalization option for the football scene, and the virtual avatar movement visualization screen.



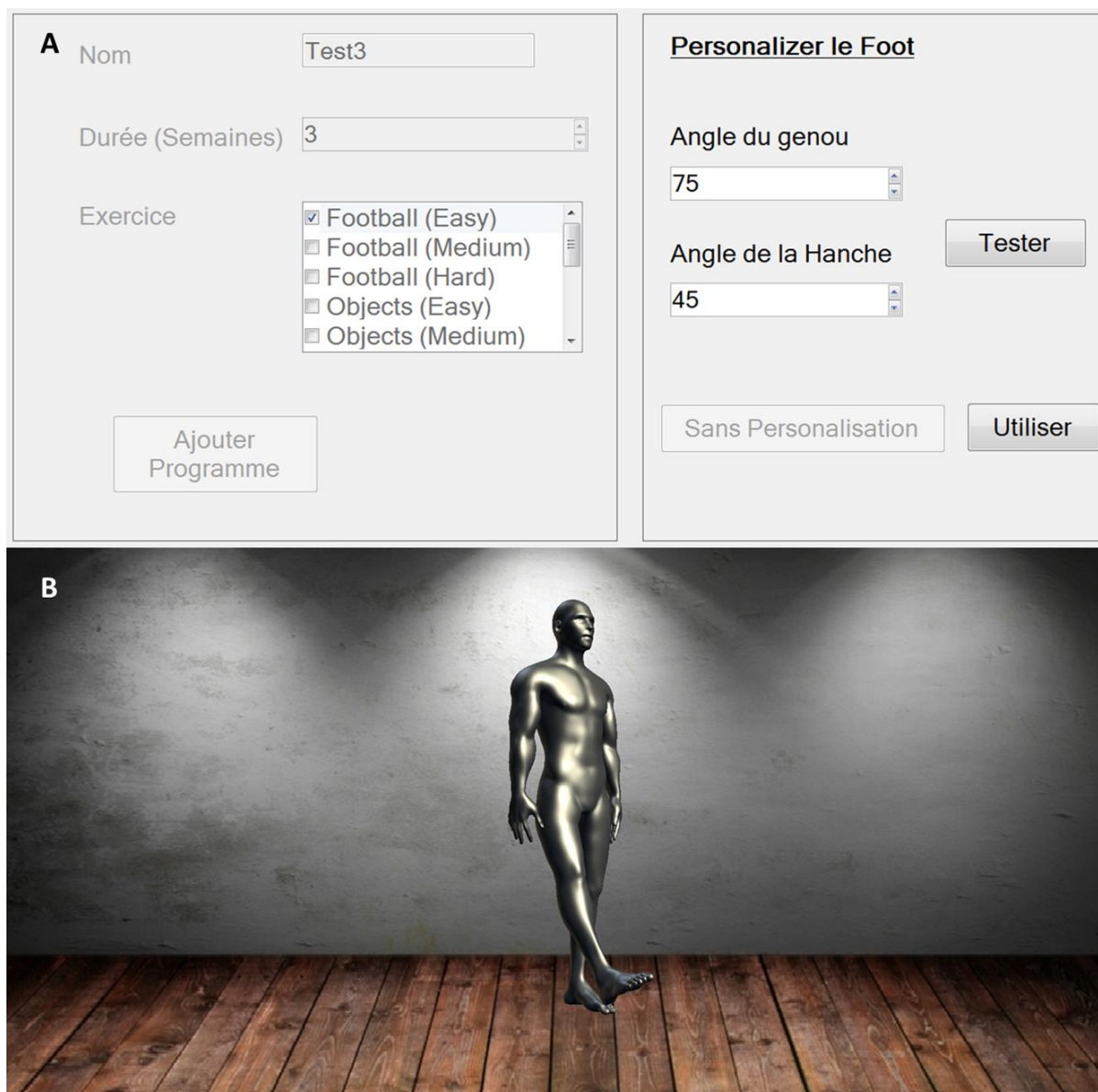

Figure 47. A: Program creation and personalization screen and B: personalized movement visualization

The patient will then be given real-time feedback in order to achieve a movement that satisfies the assigned thresholds. Figure 48 shows the changes made in the football game scene to account for the personalization mechanism.



Figure 48. Personalized football scene

The patient's knee and hip angles will be collected in real-time, at each movement attempt. Then, the algorithm will wait until the knee angle is relaxed ( $180^\circ$  between thigh and shank), and the hip angle is at zero in order to assess the movement. If the patient reached the knee and/or thresholds during this attempt, they will see a correct sign next to the knee/hip angle on the topmost right of the screen. If the opposite is true, the patient will see a false sign next to the angle. This will allow the patient to adequately change their movements in order to satisfy their personalized rehabilitation condition.

### 3.4.2 Serious game for functional and cognitive rehabilitation

Another worrying point for experts is the little implication of cognitive tasks in the rehabilitation games. Even though the football scene integrates a pointer that adds cognitive functions to the rehabilitation program, experts do not deem this as enough. Moreover, most stroke patients suffer from cognitive impairment that needs to be dealt with in order to minimize its effect. Therefore, experts requested that we add a new game that integrates cognitive and functional aspects into one game. They proposed using the dance pad, coupled with the Kinect camera, to develop a VR scenario. The pad has been previously used for cognitive rehabilitation [83]. These games generally consist of arrows appearing on the screen in different direction, requiring the patient to step on the correct dance pad section to gain points and win the game. However, these studies did not consider the immersion of the patient in the game, since the user should constantly look beneath them to identify the arrows. This could inhibit the patient from performing the correct cognitive actions. The novelty of our

developed exergame is that it integrates cognitive functions and motor functions. Generally, cognitive rehabilitation games are implemented using a mouse or joystick, we present a game that uses Kinect and inertial sensors, coupled with a dance pad. The game scene is an outdoor park, with a virtual avatar imitating the patient. The avatar is placed on a virtual dance pad. Meanwhile, the patient is placed on a dance pad in real-life, in front of the Kinect and with (or without) additional inertial sensors. The game starts with randomly colored arrows appearing at certain intervals (depending on the chosen difficulty), and the patient needs to step on the correct dance pad section to win points. They will also have a visual feedback, and will not have to look on the real dance pad. This scenario was proposed by medical experts. Our approach also presented a difference from normal cognitive games that use dance pads. In addition, these kinds of direction games do not generally imitate the patient in the virtual environment.

The game has several levels of difficulties, which can be selected based on the patient's situation. The first level has arrows appearing and the patient needs to step in the same direction to get a point (attentional functions). In the second level, the patient needs to step in the opposite direction to get the point (inhibition function). The final level increases the speed of the appearing arrows. Note that several scenarios can also be implemented in the future. Figure 49 presents a typical scenario for our exergame, and the exergame played by a healthy subject.

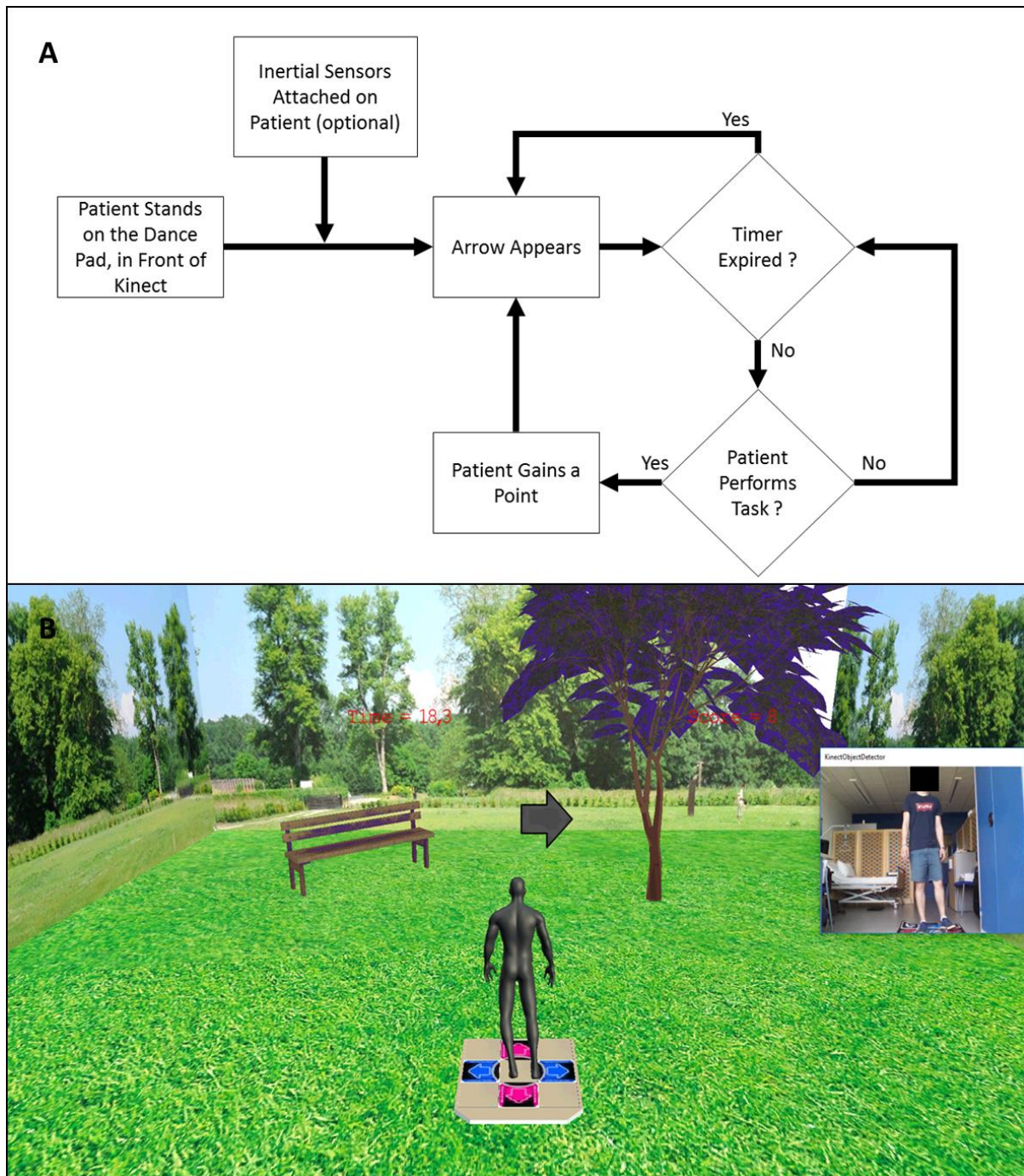

Figure 49. A: Cognitive game workflow and B: scene

This scene has not yet been tested, but was approved by medical experts.

### 3.5 Conclusion

In this chapter, we explained the development and evaluation of serious games for rehabilitation. Moreover, we proposed guidelines to try and unify these two steps in serious game research for health applications. These guidelines were then applied in 2 separate studies to develop and evaluate serious games for functional rehabilitation. In the first study, we

showed the effectiveness and usefulness of these guidelines and associated games. The developed serious game system used the Kinect camera to allow users to interact with two 3D environment scenes (football and object manipulation). Healthy subjects and patients enjoyed the games and found them challenging and amusing. The limitations of the first study were taken into consideration in the second study, through the adoption of a validated questionnaire to study the immersion of the patients in our serious games. Similar results were observed in the second study, where a panel of stroke patients and clinical experts evaluated the system using different questionnaires and quantitative methods. Using the fusion algorithm to estimate joint angles yielded better and cleaner estimation results, and stroke patients seem to be very immersed in the games that they played. Finally, the medical experts' comments, supervising the patient trials, were taken into consideration in order to add a personalization option for the football scene, and introduce the concept of personalized rehabilitation programs based on knee and hip angle thresholds. In addition, the medical personnel recommended the development of a new scene designed for functional and cognitive rehabilitation, combining the dance pad with the Kinect camera, and approved the implemented game. We note that the user acceptability of these games was also considered in a separate study that will be presented in a separate chapter.



# Chapter 4      Multisensory Fusion in Serious Games

How can we map the patient's movement in a virtual environment with an acceptable degree of accuracy? Can a fusion between multiple types of sensors improve the accuracy of angle estimation during rehabilitation sessions? In this chapter, we highlight our scientific contribution in the field of multi-sensor fusion, through the fusion of data from inertial and visual-based sensors. We also describe the implementation of such technology through a SoS approach, and we study environmental conditions that might affect the battery life of our inertial sensors. These contributions have been validated through a published article in *Sensors* journal [136], a poster presentation the 2016 IEEE EMBC conference [137] and an oral presentation at the 2018 IEEE System of Systems Engineering conference.

## 4.1 Orientation-based multi-sensor fusion

The objective of this work is to develop and validate an orientation-based fusion scheme between visual and inertial sensors to improve the body joint orientation estimation. The estimation of the knee flexion kinematics, during functional rehabilitation movement of the lower limbs, has been identified as a case study. Our motivation derives from the fact that experts require a high degree of accuracy when analyzing angular data. Therefore, and since the Kinect alone cannot fulfill this requirement, we chose to add IMUs to our system to benefit from their high degree of accuracy. In addition, we decided to attempt a fusion between the data from the two types of sensors to offer even more accuracy in angle estimation.

An extended Kalman filter will be used as a fusion technique between the Kinect and IMU sensors. This type of filter was chosen because some of its variations were previously used for similar purposes [117, 119–121].

### 4.1.1 Multi-sensor fusion scheme

A real-time, quaternion-based, extended Kalman filter was developed to fuse the outcomes of one Kinect visual sensor and two Shimmer IMU sensors. The overview of our developed fusion scheme is shown in Figure 50.

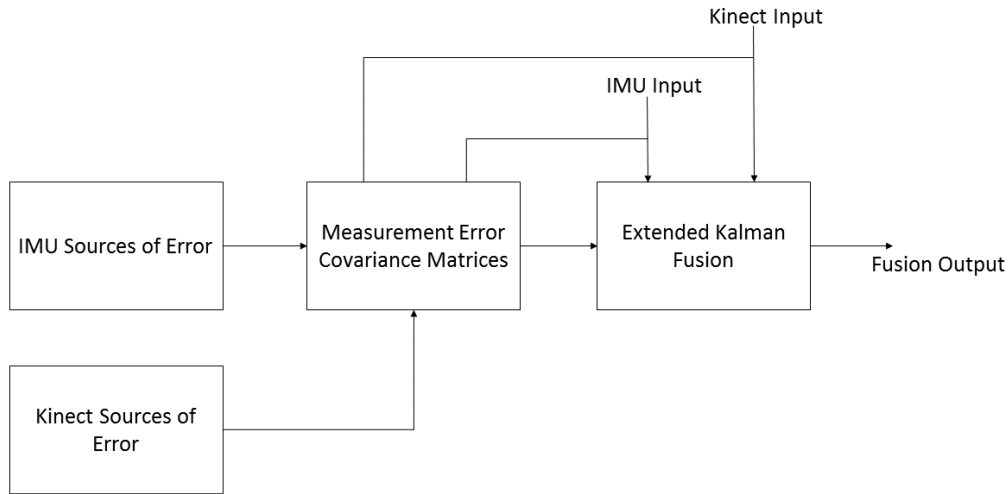

Figure 50. Schematic illustration of the developed orientation-based multi-sensor fusion scheme

The estimation of the measurement noise covariance matrices is performed using the results of the Kinect and IMU sources of errors analysis. Then, these matrices are integrated into an extended Kalman algorithm with Kinect and IMU signals to estimate the knee joint kinematics in real-time conditions. Each component of the proposed multi-sensor fusion scheme is detailed in the following sections.

#### 4.1.2 Evolution model

The fusion algorithm will use the evolution model that links the quaternion  $q(t) = (q_{w_t}, q_{x_t}, q_{y_t}, q_{z_t})$ , rate quaternion  $\dot{q}(t) = (\dot{q}_{w_t}, \dot{q}_{x_t}, \dot{q}_{y_t}, \dot{q}_{z_t})$  and angular velocity  $\omega(t) = (\omega_{x_t}, \omega_{y_t}, \omega_{z_t})$  through the following equation:

$$\dot{q}(t) = \frac{1}{2} \begin{bmatrix} 0 & -\omega_{x_t} & -\omega_{y_t} & -\omega_{z_t} \\ \omega_{x_t} & 0 & \omega_{z_t} & -\omega_{y_t} \\ \omega_{y_t} & -\omega_{z_t} & 0 & -\omega_{x_t} \\ \omega_{z_t} & \omega_{y_t} & -\omega_{x_t} & 0 \end{bmatrix} q(t) \quad (32)$$

This equation can be rewritten after discretization as:

$$\begin{bmatrix} q_{w_{k+1}} \\ q_{x_{k+1}} \\ q_{y_{k+1}} \\ q_{z_{k+1}} \end{bmatrix} = \frac{1}{2} \begin{bmatrix} \Delta t(-\omega_{x_k} q_{x_k} - \omega_{y_k} q_{y_k} - \omega_{z_k} q_{z_k}) + 2q_{w_k} \\ \Delta t(\omega_{x_k} q_{w_k} + \omega_{z_k} q_{y_k} - \omega_{y_k} q_{z_k}) + 2q_{x_k} \\ \Delta t(\omega_{y_k} q_{w_k} - \omega_{z_k} q_{x_k} - \omega_{x_k} q_{z_k}) + 2q_{y_k} \\ \Delta t(\omega_{z_k} q_{w_k} + \omega_{y_k} q_{x_k} - \omega_{x_k} q_{y_k}) + 2q_{z_k} \end{bmatrix} \quad (33)$$



To simplify the evolution model, we assumed that the angular velocity is constant over the sampling rate period ( $T=33\text{ms}$ ), in order to add the angular velocity to our evolution model. Finally, our evolution model becomes:

$$X_{k+1} = f(X_k) + Q \quad (34)$$

Where  $X_k = [q_{w_k}, q_{x_k}, q_{y_k}, q_{z_k}, \omega_{x_k}, \omega_{y_k}, \omega_{z_k}]^T$  is the state vector,  $f$  is a nonlinear function linking the state vector to its previous state, and  $Q$  is the model noise covariance matrix. The Jacobian of this matrix with respect to the state vector can be written as:

$$J = \left( \frac{\partial f}{\partial X} \right)_k = \frac{1}{2} \begin{bmatrix} 2 & -\Delta t \omega_{x_k} & -\Delta t \omega_{y_k} & -\Delta t \omega_{z_k} & -\Delta t q_{x_k} & -\Delta t q_{y_k} & -\Delta t q_{z_k} \\ \Delta t \omega_{x_k} & 2 & \Delta t \omega_{z_k} & -\Delta t \omega_{y_k} & \Delta t q_{w_k} & -\Delta t q_{z_k} & \Delta t q_{y_k} \\ \Delta t \omega_{y_k} & -\Delta t \omega_{z_k} & 2 & -\Delta t \omega_{x_k} & -\Delta t q_{z_k} & \Delta t q_{w_k} & -\Delta t q_{x_k} \\ \Delta t \omega_{z_k} & \Delta t \omega_{y_k} & -\Delta t \omega_{x_k} & 2 & -\Delta t q_{y_k} & \Delta t q_{x_k} & \Delta t q_{w_k} \\ 0 & 0 & 0 & 0 & 2 & 0 & 0 \\ 0 & 0 & 0 & 0 & 0 & 2 & 0 \\ 0 & 0 & 0 & 0 & 0 & 0 & 2 \end{bmatrix} \quad (35)$$

Finally the model noise covariance matrix was calculated using the same equations as in [116], which alters the matrix at each computational step.

### 4.1.3 Measurement model

The measurement model is the same for both types of sensors and consists of a measurement vector  $Y$  identical to the state vector, coming from the Kinect and IMU sensors separately. The measurement noise covariance matrices, relative to both sensors, are computed at each iteration. Our approach changes the measurement noise matrices dynamically based on the current angle measurement. The measurement noise covariance matrix is a  $7 \times 7$  diagonal matrix, since the measurement vector has seven elements (four quaternion and three angular velocity components). The quaternion error components are estimated from the knee angle estimation and knee angle errors using transformations in [138]. We supposed that the error of estimation for the three angles, between two sensors or two segments for the Kinect, is the same in all dimensions. Thus, the calculated error on knee angles is the same for the three Euler angles. We then took the quaternion calculation formula from Euler angles and partially derived those formulas to obtain the following equations:

$$R_1 = \left( \frac{\Delta \phi}{2} \left[ \left( -\cos \left[ \frac{\psi}{2} \right] + \sin \left[ \frac{\psi}{2} \right] \right) \left( \sin \left[ \frac{\theta}{2} \right] \cos \left[ \frac{\phi}{2} \right] + \sin \left[ \frac{\phi}{2} \right] \cos \left[ \frac{\theta}{2} \right] \right) - \cos \left[ \frac{\theta}{2} \right] \cos \left[ \frac{\phi}{2} \right] \sin \left[ \frac{\psi}{2} \right] + \cos \left[ \frac{\psi}{2} \right] \sin \left[ \frac{\theta}{2} \right] \sin \left[ \frac{\phi}{2} \right] \right] \right)^2 \quad (36)$$

$$R_2 = \left( \frac{\Delta\phi}{2} \left[ \left( \cos \left[ \frac{\psi}{2} \right] - \sin \left[ \frac{\psi}{2} \right] \right) \left( \cos \left[ \frac{\theta}{2} \right] \cos \left[ \frac{\phi}{2} \right] - \sin \left[ \frac{\phi}{2} \right] \sin \left[ \frac{\theta}{2} \right] \right) - \cos \left[ \frac{\theta}{2} \right] \sin \left[ \frac{\phi}{2} \right] \sin \left[ \frac{\psi}{2} \right] - \cos \left[ \frac{\psi}{2} \right] \sin \left[ \frac{\theta}{2} \right] \cos \left[ \frac{\phi}{2} \right] \right] \right)^2 \quad (37)$$

$$R_3 = \left( \frac{\Delta\phi}{2} \left[ \left( \cos \left[ \frac{\psi}{2} \right] + \sin \left[ \frac{\psi}{2} \right] \right) \left( \cos \left[ \frac{\theta}{2} \right] \cos \left[ \frac{\phi}{2} \right] - \sin \left[ \frac{\phi}{2} \right] \sin \left[ \frac{\theta}{2} \right] \right) - \sin \left[ \frac{\theta}{2} \right] \cos \left[ \frac{\phi}{2} \right] \sin \left[ \frac{\psi}{2} \right] + \cos \left[ \frac{\psi}{2} \right] \cos \left[ \frac{\theta}{2} \right] \sin \left[ \frac{\phi}{2} \right] \right] \right)^2 \quad (38)$$

$$R_4 = \left( \frac{\Delta\phi}{2} \left[ \left( \cos \left[ \frac{\psi}{2} \right] + \sin \left[ \frac{\psi}{2} \right] \right) \left( -\cos \left[ \frac{\theta}{2} \right] \sin \left[ \frac{\phi}{2} \right] - \cos \left[ \frac{\phi}{2} \right] \sin \left[ \frac{\theta}{2} \right] \right) + \cos \left[ \frac{\theta}{2} \right] \cos \left[ \frac{\phi}{2} \right] \cos \left[ \frac{\psi}{2} \right] + \sin \left[ \frac{\psi}{2} \right] \sin \left[ \frac{\theta}{2} \right] \sin \left[ \frac{\phi}{2} \right] \right] \right)^2 \quad (39)$$

where  $\theta$  is the knee pitch angle,  $\psi$  the knee yaw angle,  $\phi$  the knee roll angle, and  $\Delta\phi$  the error calculated on roll angle considered similar to errors in pitch and yaw angles. The value of  $\Delta\phi$  varies between Kinect and Shimmer sensors and is determined from the results of the analysis of the sources of errors of these sensors. We consider that the knee does not have a yaw component, relative to the thigh, since the knee joint cannot execute an internal external rotation motion when considering the high knees exercise adopted for our test. Consequently, the term  $\psi$  is taken equal to 0 for the remaining of the study. The measurement noise matrix is dynamically calculated at each step of the Kalman filter since it needs the current estimated values of the knee pitch and roll angles. For the rest of the diagonal values, related to angular velocities, Shimmer manufacturers have given a description of the sensor's gyroscope accuracy [50], and the Kinect's error ( $\Delta\omega$ ) was calculated from the RMS error of the angular velocity, obtained from experimental results.

Therefore, our study will not only focus on data fusion between Kinect and IMU sensors, but also determining constant errors in order to adapt our measurement model to reality. Moreover, we implemented a study that focuses on determining the principal sources of errors for each sensors, in order to estimate the values of  $\Delta\phi$  for Kinect and IMU sensors and  $\Delta\omega$  for the Kinect.

#### 4.1.4 Studying the sources of error for IMU and Kinect

##### 4.1.4.1 IMU sources of errors

To estimate the errors of an IMU, three main sources of errors are analyzed and quantified: sensor synchronization, orientation estimation algorithm, and sensor displacement due to muscle artefacts [139].

###### 4.1.4.1.1 Synchronization

One of the leading sources of errors, when coupling two inertial sensors at the same frequency rate is caused by the lack of synchronization. The Shimmer sensor API does not give access to a universal clock measurement from each sensor, and thus, synchronization is not an

easy task to perform. The sensor also streams data continuously and without waiting for requests from the PC, and synchronization methods similar to those proposed in [140] cannot be applied. However, we did have access to a local clock from each sensor, which starts the count at each program start, and so we proposed the following synchronization algorithm. The data flow of our developed real-time synchronization method is shown in Figure 51. Let us consider two Shimmer sensors communicating with a PC via a Bluetooth module at a sampling rate of  $f_s = \frac{1}{T_s} = 51.2$  Hz. These sensors send data constantly at each multiple of  $T_s$ , without a data request message from the PC. The data includes sensor measurements and a local timestamp that indicates sending time (which can be interpreted as a counter that indicates the number of the sample that was sent). The two sensors start streaming data after receiving a “StartStreaming” request message from the PC.  $dt$  is the tested quantity that will be measured between two samples sent from the two sensors, and that indicates their compatibility if its value is equal to zero. Let us consider that sensor 1 sends the first sample. The program then initializes a local clock on the PC, waits for the first sample from sensor 2, then computes the time difference between the two samples in the PC’s local time. If the difference is lower than  $T_s$ , the value  $dt$  that will be computed at each sample reception will be the difference between the two local timestamps of two samples from the two sensors. If it is higher,  $dt$  will include a component based on the first delay between the two sensors, measured by the PC; this will allow the correction of local time differences between sensors. Then, when the PC receives a sample from any sensor, it puts the value inside a specific buffer and orders the buffer by increasing timestamp, then checks if the buffer of the other sensor has any data. If data exists in the buffer of the other sensor, and  $dt$  between the first sample in each of the two buffers is null, we de-queue both buffers and calculate. If not, then there is a loss in data from either sensor 1 or 2, so we de-queue one of the buffers based on the value of  $dt$  and the current thread. The case of sensor 1 is presented in Figure 51.

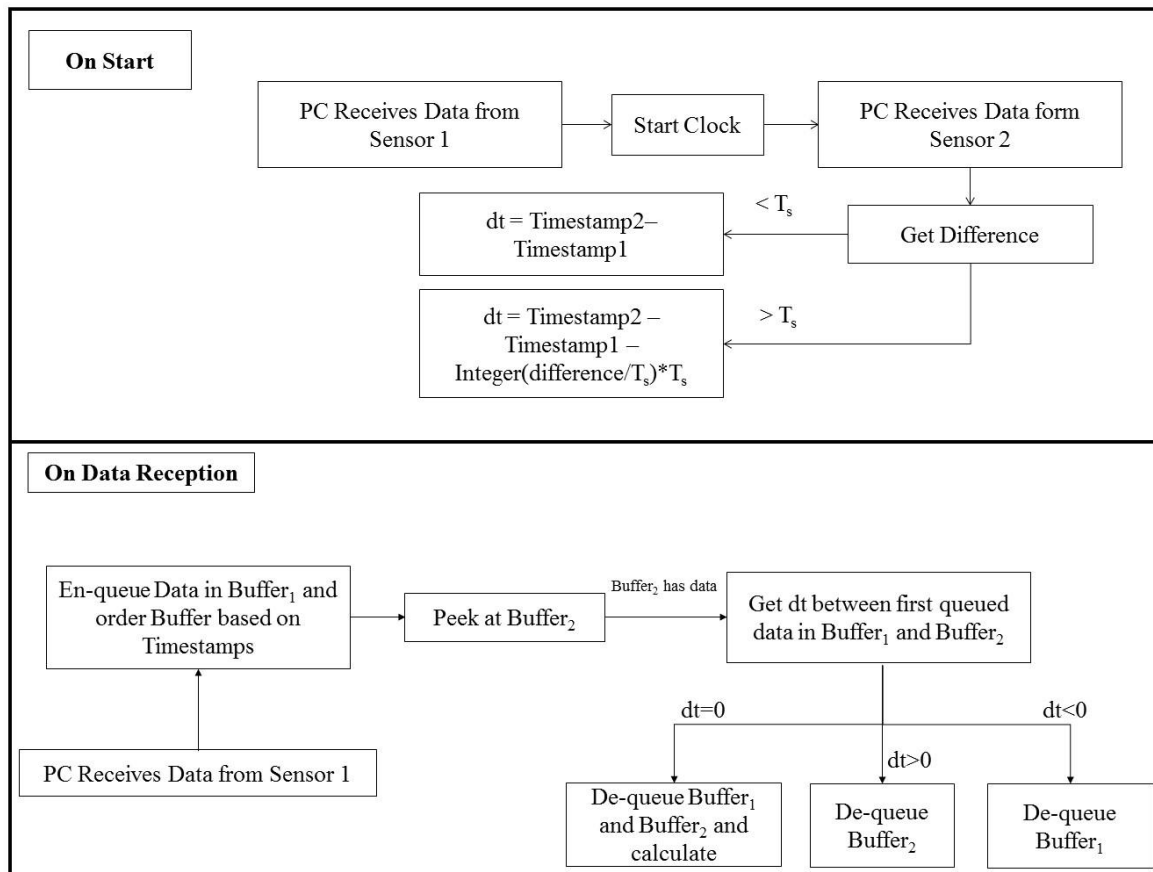

Figure 51. Data flow of sensor synchronization algorithm

#### 4.1.4.1.2 Orientation estimation algorithm

Extended Kalman [109] and gradient descent [111] algorithms are used to estimate the sensor orientation. To assess the accuracy of the estimation, we compare the angle between two inertial sensors, with a universal goniometer, while varying the velocity of the angle movement between three states: fast, slow, and a combination (fast followed by slow). The sensors are mounted directly on the goniometer to prevent sensor displacement due to muscular flexion or extension. The test consists in repeatedly moving the goniometer's arms closer then farther. Three trials are conducted at each speed, with and without application of our synchronization algorithm. Figure 52 shows the material used during this test.

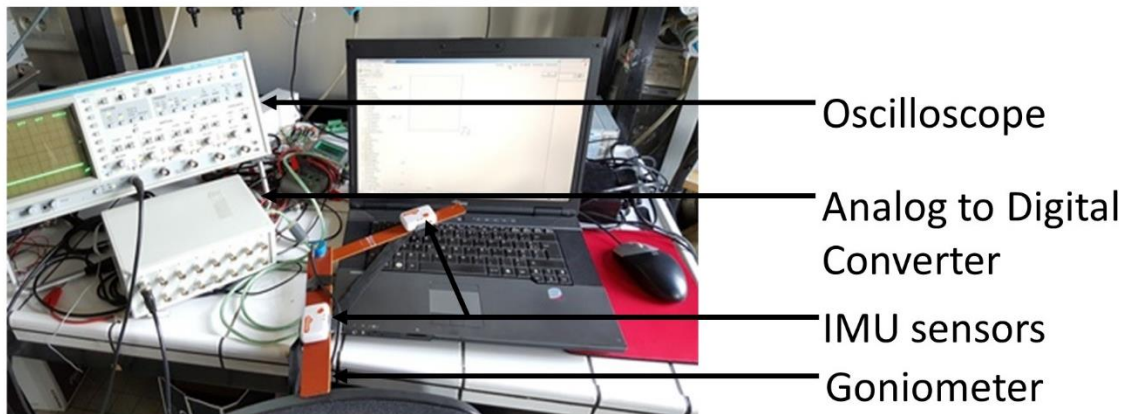

Figure 52. Goniometer protocol set-up for testing

#### 4.1.4.1.3 Sensor position

The position of sensors on the thigh and shank is an important aspect since it is affected by artefacts due to muscle flexion and extension, and tissue displacement. One healthy subject was chosen for this test (male, 23 years old, 177 cm body height, 70 kg body weight, and 22.3 kg/m<sup>2</sup> body mass index (BMI)), in order to estimate the value of  $\Delta\phi$  to serve as constant for the measurement noise matrix. This subject signed an informed consent agreement before participating in the evaluation process. The high knees exercise was used as a testing movement. We varied the position of the sensors on the thigh and shank in order to study the best possible position to place them. To do so, we tested three different positions, based on previous works in gait measurement [141], and activity detection [142], and then compared the three estimated knee flexion angles with those measured from the universal goniometer as shown in Figure 53. Each test was repeated three times to ensure the reproducibility of the error estimation. The goniometer was adjusted so that the connecting pin, between both segments, is aligned on the knee joint and does not move when executing the high knee movement.



Figure 53. Tested sensor positions (Left: sensor on the thigh directly; Middle: sensor above the kneecap; Right: sensor in the sagittal plane)

#### 4.1.4.2 Kinect sources of error

Using the Kinect does not give the user the possibility to change parameters in the orientation estimation algorithm. The camera uses a quaternion-based algorithm to estimate the quaternion values for each bone. This leads to one unique source of error integrated from the camera itself, and out of our control. Therefore, we compared the result of the Kinect's knee flexion estimation algorithm directly to that of the universal goniometer, in order to obtain RMS values of the error of its angle and angular velocity estimation (derivation of the knee flexion angle). Three high knees trials were also conducted using Kinect and the goniometer, performed by the healthy subject described in Section 4.1.4.1.3.

#### 4.1.5 Data fusion algorithm

Finally, after determining all of our pre-required parameters (angle and angular velocity estimation errors from IMUs and Kinect) for data fusion, we adopted the following scheme shown in Figure 54. Note that these parameters are calibrated with only one subject due to their little effect on the fusion outcome, if they varied in small degrees. We obtained the range of value for ten tested subjects and found that this range is similar to the range obtained with one subject. Precisely, the mean error for IMU placement was within the margin of error of the values taken from one subject for all sensor positions. The same can be stated for the Kinect sensor. Thus, we decided to use this information for all subjects to perform the sensor fusion

in real-time conditions. This will help avoid additional tests on each subject when the data fusion is applied.

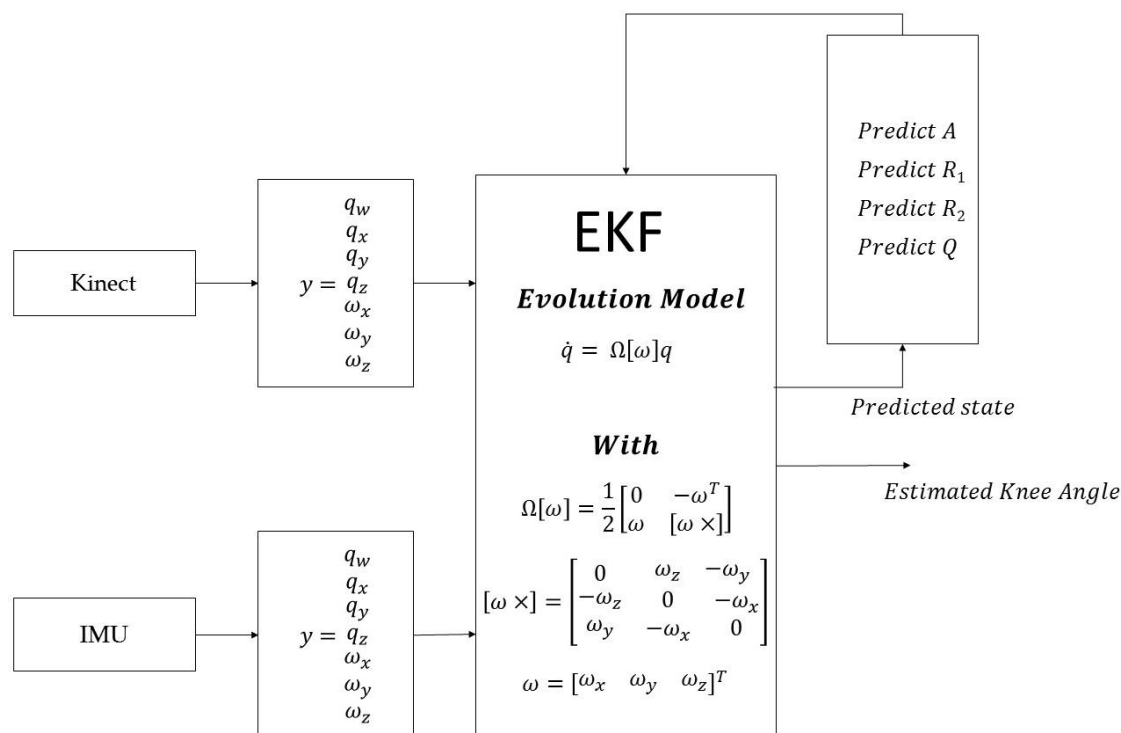

Figure 54. Quaternion-based extended Kalman observer scheme for fusion

The input from each separate source is the vector  $y$ , the state vector is composed from the four components of the normalized quaternion and three components of the angular velocity. The sources are processed in the extended Kalman filters using the evolution model shown in Figure 54. After each Kalman step, the predicted state is used to update the measurement noise covariance matrices ( $R_1$  and  $R_2$ ), the update matrix ( $A$ ) calculated from the Jacobian of the evolution model and the process noise covariance matrix ( $Q$ ). The state quaternion was normalized after each step to avoid any problems related to the quaternion unit length. The Kinect frequency (30 Hz) was adopted for the fusion algorithm, for several reasons. On one hand, the Kinect frequency was enough to assess the exercises that were developed in our previous work. On the other hand, in order to keep a real-time aspect for our system, we avoided recording data from both sensors, and interpolating the data from the Kinect at IMU sample reception (51.2 Hz) in an offline analysis. Finally, to assess the synchronization between the two systems, at each Kinect sample reception, we chose the synchronized samples, from both IMUs, that are the closest to the received Kinect sample.

#### 4.1.5.1 Accuracy analysis

The proposed real-time quaternion-based extended Kalman filter was tested on 10 healthy subjects (mean age 25.4 years [SD 3.30], mean height 178.2 cm [SD 5.35] and mean weight 75.8 Kg [SD 11.58]). Each subject signed an informed consent agreement before participating in the evaluation process. The high knees exercise was used as a testing movement, and three trials were performed on each subject for each sensor position, which amounts to nine trials per subject. Note that to test the developed real-time synchronization algorithm, we computed the value of  $dt$  with synchronization and the difference between two received timestamp from different sensors without synchronization. Finally, the outcome of the fusion algorithm was evaluated against the goniometer measurement. The output signals were aligned, during our offline analysis, so that the correlation between each two signals is at its maximum value.

### 4.1.6 Results

#### 4.1.6.1 IMU measurement error

##### *4.1.6.1.1 Synchronization and orientation estimation algorithm*

The synchronization algorithm prevents data with different timestamps to be coupled with each other. During the experiments, we did not obtain any time difference between the coupled samples of the two sensors after applying our synchronization algorithm. However, without synchronization, differences between timestamps varied between  $\pm 100$ ms. This could lead to high errors when estimating knee angles since the sensitivity of knee flexion angle estimation at high speeds is around  $0.492^\circ/\text{ms}$  (computed as the tangent of the knee flexion angle). In other words, if a person is rotating the knee at high speed, a difference of one timestamp between IMU samples can lead to an error of  $9.6^\circ$  in the estimation of the knee angle.

The outcomes of the three trials of the synchronized (synced for abbreviation) and not-synchronized (not synced for abbreviation) algorithms against the goniometer measurements are presented in Table 6. The RMS difference between the knee angle estimated by the algorithms and measured by the goniometer was calculated, as well as the correlation coefficient (CC) (mean, SD, maximum (MAX), minimum (MIN)) derived from three experiments). The results showed that a higher speed of motion led to a higher RMS error for



all of our tested algorithms. This phenomenon was observed when considering the Slow speed data in the test with Fast then Slow movement, which yielded values close to those obtained from the Slow test. Furthermore, a difference of RMS was observed between synced and not synced outputs, e.g., the gradient descent output showed a mean RMS error of  $3.246^\circ$  at slow speeds without synchronization and a mean RMS error of  $1.8057^\circ$  with synchronization. Moreover, the synchronization provided accurate data outcome according to goniometer output, especially at high speeds. Furthermore, the CC of the outputs of algorithms without synchronization decreased at higher speeds, while the synchronized algorithms were less affected by the same factor. The gradient descent synced algorithm also yielded the best mean, SD, MAX and MIN error for all of the tested speeds, while the extended Kalman not synced algorithm gave the worst. Thus, gradient descent synced algorithm was selected as an orientation estimation filter.

Table 6. RMS ( $^\circ$ ) and CC between knee angles estimated using different algorithms Vs universal goniometer

<b>Algorithm induced errors</b>									
<b>Speed</b>	<b>Algorithm</b>	<b>Parameters</b>							
		<b>Mean (Angle Error RMS)</b>	<b>SD (Angle Error RMS)</b>	<b>MAX (Angle Error RMS)</b>	<b>MIN (Angle Error RMS)</b>	<b>Mean (Angle CC)</b>	<b>SD (Angle CC)</b>	<b>MAX (Angle CC)</b>	<b>MIN (Angle CC)</b>
<b>Slow (90°/s)</b>	<b>Kalman synced</b>	6.109	2.242	8.512	2.481	0.997	0.001	0.998	0.996
	<b>Kalman not synced</b>	7.665	2.012	9.839	4.957	0.993	0.003	0.995	0.986
	<b>Gradient descent synced</b>	1.805	0.383	2.288	1.29	0.999	0.0003	0.999	0.999
	<b>Gradient descent not synced</b>	3.246	0.999	4.813	2.220	0.997	0.001	0.999	0.995
<b>Fast (400°/s)</b>	<b>Kalman synced</b>	21.854	6.141	30.143	16.333	0.897	0.066	0.963	0.812
	<b>Kalman not synced</b>	31.546	6.507	37.089	22.291	0.753	0.108	0.910	0.677
	<b>Gradient descent synced</b>	9.414	2.650	12.993	6.709	0.980	0.014	0.996	0.960

	<b>Gradient descent not synced</b>	22.095	6.432	27.217	12.690	0.873	0.068	0.972	0.813
<b>Fast followed by Slow</b>	<b>Kalman synced</b>	10.847	2.283	12.207	8.210	0.976	0.006	0.983	0.971
	<b>Kalman not synced</b>	13.486	1.687	14.632	11.548	0.963	0.003	0.966	0.960
	<b>Gradient descent synced</b>	4.995	1.157	5.893	3.689	0.995	0.001	0.997	0.993
	<b>Gradient descent not synced</b>	6.747	1.603	8.435	5.245	0.991	0.003	0.994	0.988

#### 4.1.6.1.2 Sensor position

Table 7 shows the results (RMS error and CC) obtained with the different tested sensor positions using the gradient descent synced algorithm. The sensor placed on the muscle led to the highest values of error (mean RMS = 8.03°) while the other two positions exhibited better performance: mean RMS error in frontal plane is equal to 4.75° while mean RMS deviation in sagittal plane is equal to 4.48°.

Table 7. RMS (°) and CC between knee angles estimated using different sensor positions Vs universal goniometer

<b>Sensor position errors</b>									
<b>Algorithm</b>	<b>Position</b>	<b>Parameters</b>							
		<b>Mean (Angle Error RMS)</b>	<b>SD (Angle Error RMS)</b>	<b>MAX (Angle Error RMS)</b>	<b>MIN (Angle Error RMS)</b>	<b>Mean (Angle CC)</b>	<b>SD (Angle CC)</b>	<b>MAX (Angle CC)</b>	<b>MIN (Angle CC)</b>
<b>Gradient descent synced</b>	<b>On the muscle</b>	8.030	1.159	8.965	6.732	0.995	0.001	0.997	0.995
	<b>Frontal plane</b>	4.759	0.727	5.572	4.171	0.996	0.0005	0.997	0.996
	<b>Sagittal plane</b>	4.481	0.869	5.661	3.654	0.997	0.001	0.998	0.995

All the positions show high correlations with the goniometer output. The mean RMS values were used as constant parameters in our fusion filter for later trials ( $\Delta\phi$  for IMU measured data).

#### 4.1.6.2 Kinect measurement error

The Kinect's measurement error is presented in Table 8. The RMS error and CC of the angle and angular velocity were calculated with respect to the goniometer. The accuracy of the Kinect camera for calculating knee angles is very poor compared to that of IMUs. The mean RMS error of angle estimation is  $14.65^\circ$  compared to a  $4.48^\circ$  error using the gradient descent algorithm. However, a high correlation is achieved between the estimated angle using the Kinect and the one measured by the goniometer (mean CC = 0.974). The angular velocity yielded a  $1.33^\circ/\text{s}$  mean RMS error. These values are used later as inputs for our fusion algorithm ( $\Delta\phi$  and  $\Delta\omega$  for Kinect measured data).

Table 8. RMS (angle in  $^\circ$ , angular velocity in  $^\circ/\text{s}$ ) and CC between knee angles and angular velocities estimated using Kinect Vs universal goniometer

<b>Kinect errors</b>								
<b>Measured quantity</b>	<b>Parameters</b>							
	<b>Mean (Error RMS)</b>	<b>SD (Error RMS)</b>	<b>MAX (Error RMS)</b>	<b>MIN (Error RMS)</b>	<b>Mean (CC)</b>	<b>SD (CC)</b>	<b>MAX (CC)</b>	<b>MIN (CC)</b>
<b>Angle</b>	14.652	2.241	16.204	12.082	0.974	0.003	0.978	0.970
<b>Angular velocity</b>	1.332	0.222	1.480	1.076	0.882	0.030	0.909	0.849

#### 4.1.6.3 Data fusion

After choosing the gradient descent algorithm as an orientation estimation filter for IMU sensors, data from the estimation of this filter and the Kinect were fused using an extended Kalman observer. Figure 55, Figure 56 and Figure 57 show the results of our real-time, quaternion-based, extended Kalman observer algorithm for fusion, for IMU sensors placed in the three proposed positions. Figure 58 presents the real-time knee flexion angle estimation using the three different techniques. The fusion output shows a better estimation, when

compared to IMU and Kinect outputs, for the three different IMU positions. When measuring the mean RMS error of the fusion output, we observed a decrease in the error compared to the same value obtained using IMUs, for all subjects and every IMU position. When using IMU sensors in the sagittal plane we obtained a decrease in the mean knee flexion angle error (mean of all 10 subjects over three trials each) using our fusion algorithm ( $3.96^\circ$ ) compared to the use of Kinect ( $14.76^\circ$ ) and IMU ( $5.04^\circ$ ). The proposed fusion also showed improvement in the angle error for IMUs placed in the frontal plane and on the muscle directly, however the error was slightly higher than those of the IMUs placed in the sagittal plane. This shows that the sagittal plane is the most accurate position to estimate the knee flexion angle. The CC remained high for all of the tested estimation techniques, for every subject. Finally, the fusion output (in Figure 58) follows the goniometer signal, when IMU sensors are placed in the Sagittal plane position, and almost covers it, while the IMU and Kinect outputs are less accurate. Statistical test ( $t$ -test, implemented in Matlab R2010b software (The MathWorks Inc., Natick, MA, USA)) showed a significant difference ( $p < 0.005$ ) between the error from the Kinect and those from the IMU and Kinect-IMU. A significant difference ( $p < 0.005$ ) was also noted between errors estimated from the IMU and Kinect-IMU fusion outcome.

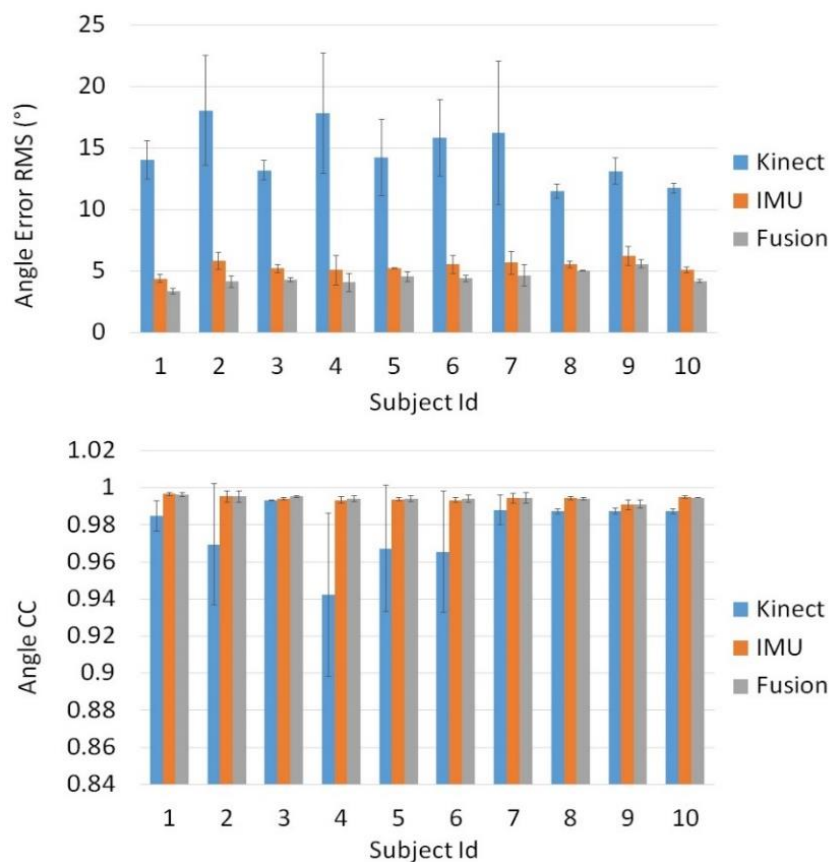

Figure 55. Angle error RMS ( $^\circ$ ) and angle CC calculated for the Kinect, IMU and the proposed fusion algorithm Vs the universal goniometer, when IMU sensors are placed in the frontal plane position

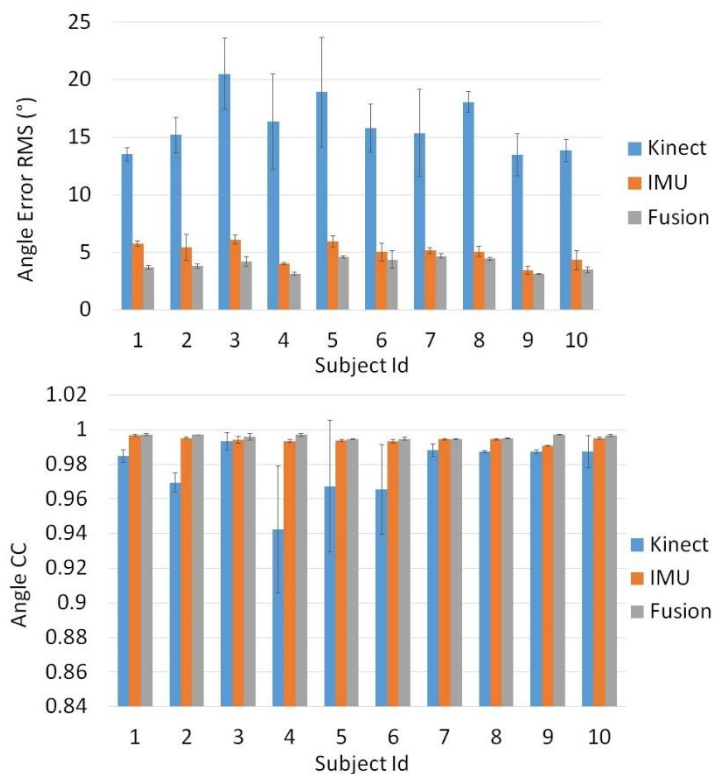

Figure 56. Angle error RMS (°) and angle CC calculated for the Kinect, IMU and the proposed fusion algorithm Vs the universal goniometer, when IMU sensors are placed in the sagittal plane position

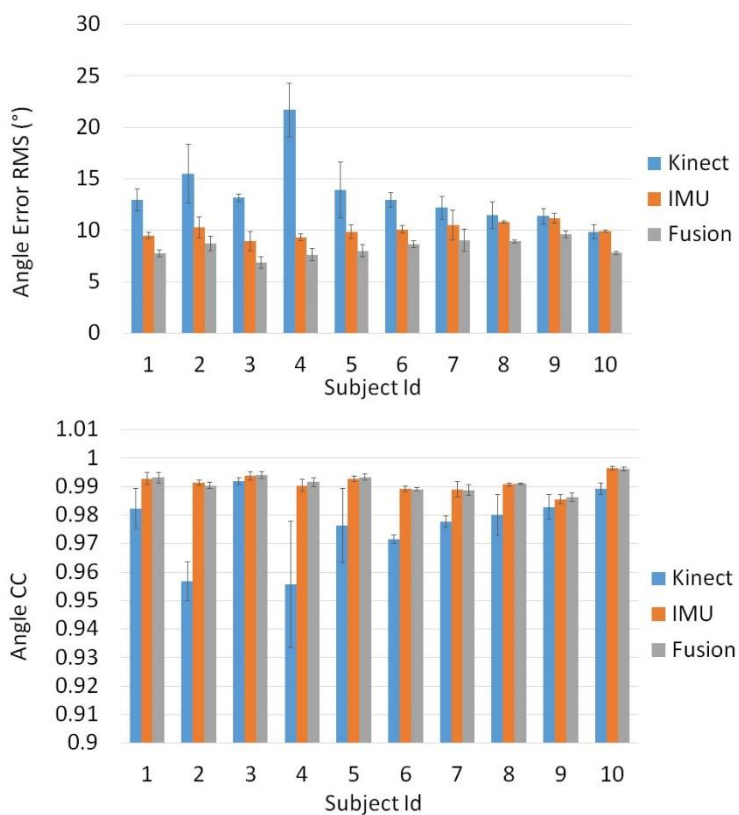

Figure 57. Angle error RMS (°) and angle CC calculated for the Kinect, IMU and the proposed fusion algorithm Vs the universal goniometer, when IMU sensors are placed in directly on the muscle

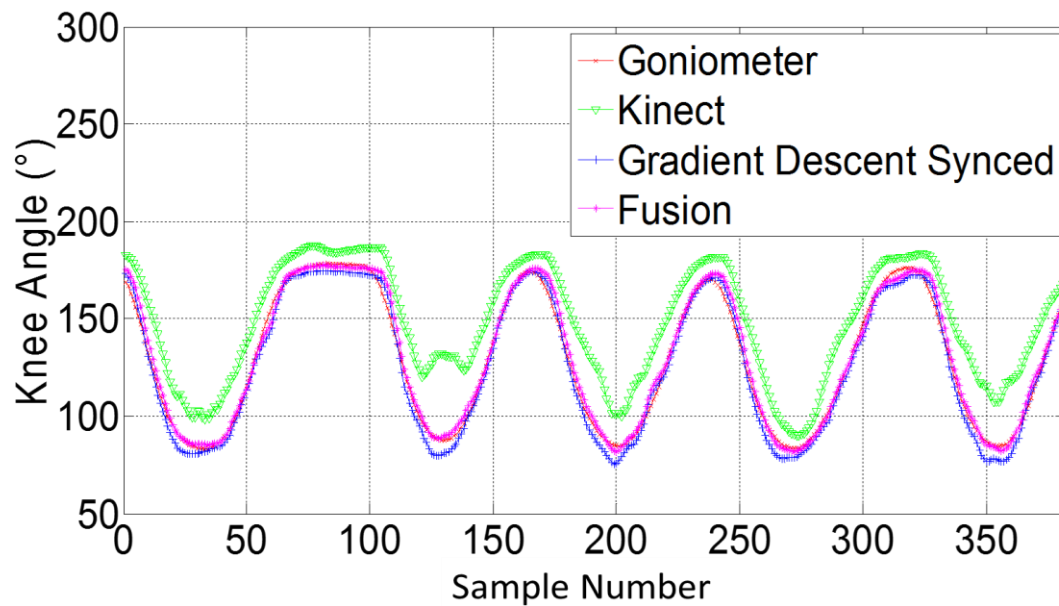

Figure 58. Knee angle estimated using goniometer, Kinect, gradient descent and sensor fusion, when IMU sensors are placed in the sagittal plane position

#### 4.1.7 Discussion

In this study, we proposed a multi-sensor fusion scheme to improve the accuracy of knee joint kinematics. To these ends, a real-time orientation-based extended Kalman algorithm was developed and tested.

The first analysis, where we attempted to synchronize two inertial sensors, proved that a lack of synchronization would lead to a significant total measurement error. It is important to note that the synchronization is a technical issue, necessary and required to improve the accuracy of sensor data acquisition and processing, in general for any system, and especially for real-time systems [141, 143]. In this present study, a great improvement in angle estimation between the synced and not synced angle estimations was observed (33% mean improvement when applying synchronization compared to data without synchronization). Our synchronization algorithm proves to be effective in fixing de-synchronized samples and the time difference between the samples used to calculate the angle is always at zero. Thus, one of the leading sources of error for our specific study, when coupling two inertial sensors at the same frequency rate, is caused by the lack of synchronization. In this present study, we proposed a real-time synchronization scheme and the result shows a great improvement according to the test without synchronization.

In our second analysis, we tested the two chosen algorithms (gradient descent and extended Kalman) with and without synchronization against a universal goniometer. These algorithms already showed their robustness in many applications [109, 111]. Table 6 shows that gradient descent with synchronization is the best algorithm to estimate the angle, with an RMS of  $1.80^\circ$  at slow speeds. Although, this RMS increases when repeating the same test at higher speeds, it is still better than the obtained values using other techniques. Moreover, the values of this RMS decreases when repeating the test with a fast followed by a slow motion, and is found to be close to values obtained in slow movements when only considering data registered during the slow phase. Finally, this experiment also highlights the success of our synchronization algorithm. Furthermore, it is clearly shown that in any speed, the gradient descent or extended Kalman synchronized algorithms are better at estimating the correct angle. This study allows us to eliminate extended Kalman orientation estimation and not synced algorithms, and thus gradient descent synced was the best algorithm.

The third analysis shows that muscle artefacts can add significant errors to the knee angle estimation. Following three tests with different sensor positions, we deduced that the sagittal plane is the least affected position by these artefacts. When comparing the sensors mounted directly on the thigh muscle with a goniometer, we obtain an error of  $8.03^\circ$  on knee angle estimation. This can be interpreted by the fact that the muscle's flexion and extension is at its maximal range in that area of the thigh. Moreover, placing the sensor above the kneecap in the frontal plain yields an error of  $4.75^\circ$ , slightly higher than the  $4.48^\circ$  obtained in the sagittal plane. In another experiment, the error obtained from the Kinect's angle estimation is dramatically higher ( $14.65^\circ$ ) than that of two sensors placed in the sagittal plane, and was compatible with values found in previous works that studied similar angle error using the Kinect [46, 47]. Finally, we compared our fusion filter between two IMUs, mounted in three different positions, and a Kinect camera, against the goniometer. The fusion algorithm was tested on 10 subjects and the error behaviors between Kinect, IMU and Kinect-IMU solutions seem to be stable and similar over all subjects (see Figure 55, Figure 56 and Figure 57). The fusion output shows a greater resemblance to the goniometer signal, as it almost overlaps it in Figure 58. These results are also consistent since the fusion output gives a lower mean RMS angle error for all subjects, over different IMU position (Figure 55, Figure 56 and Figure 57). Both IMU and fusion results were acceptable with respect to the accuracy recommended by the experts, when considering IMUs in frontal or sagittal plane position. The results also

showed that placing the IMUs in the sagittal plane gave the best estimation for the knee flexion angle.

In addition, according to available multi-sensor fusion schemes in the literature, we proposed one of the first orientation-based fusion schemes of visual and inertial sensors. Some previous works concentrated on determining joint positions through fusion between IMU and Kinect [117, 120], while others were interested in some joint angles but did not compare estimated values to reference systems [121]. Our achieved angle estimation error can be compared to other works presented in Chapter 2. The study presented in [118] used no actual fusion between IMU and Kinect, as each sensor is used separately. This work helped remove Kinect limitations caused by occlusion of limbs, but failed to combine orientation measurements from both sensors, and compared instead knee angles calculated by IMUs and those calculated by the Kinect. The achieved error for knee angle estimation, while performing knee flexion, was  $6.79^\circ$  for left knee and  $8.98^\circ$  for right knee. Results in [119] showed a good position estimation for the upper body using a fusion approach between IMU and Kinect, however, the orientation estimation suffered from high errors. They measured the error of Euler angles relative to each bone (not joint), and found errors ranging from  $1.71^\circ$  to  $24.64^\circ$ . This error would become bigger when studying angles between two bones. Finally, the study presented in [122] evaluated their fusion algorithm using four different movements with one subject. Two of the movements had ranges of motion from zero to  $90^\circ$ , while the other two had hardly any motion. They concluded that their system showed a mean angle estimation error of  $2.5^\circ$  for elbow angle. However, they combined results from exercises with different movement characteristics, which cannot be done in order to obtain an objective estimation error.

In summary, a quantitative comparison between our fusion outcomes with existing IMU-Kinect fusion methods [118, 119, 122] was performed. Both IMU and Kinect-IMU approaches achieved acceptable results, however our aim is to obtain the least error possible. Generally, the therapist requires more accuracy for a certain part of the body during a specific rehabilitation movement. The use of Kinect alone cannot provide this accuracy. Our strategy was to use IMU sensors on specific locations to achieve better accuracy. Thus, this fusion scheme helps to avoid the use of 10 additional IMU on the whole body.

Moreover, according to the related works on data fusion using Kinect and IMU sensors, existing studies investigated the use of IMU and Kinect fusion to estimate the position of joints



and not their orientation while our study used the IMU and Kinect orientation data and angular velocity to estimate the orientation in the form of a 4D quaternion. Furthermore, our method described a detailed calculation of the filter covariance matrices. Finally, our system was designed as a real-time orientation estimation system, while other systems obtain their fusion outputs through offline calculations.

## 4.2 IMU power consumption

In addition to the data fusion study, IMU power consumption was investigated in order to elaborate on the possibility of using these sensors in a home environment. This test was performed on Shimmer3 IMU sensors [50], to identify how many sessions a patient can perform, without recharging the sensor. The sensor contains a tri-axial accelerometer, gyroscope, and magnetometer that are always switched on during our tests. All these signals are needed to achieve a more accurate estimation of joint angles. The study can be divided into two parts: battery life study and current consumption study.

### 4.2.1 IMU battery life

The battery life study includes 3 tests:

- Effect of communication distance and sampling rate on battery life.
- Effect of motion on battery life.
- Effect of multisensory streaming on battery life.

The sensors are charged until their batteries are full. Then, the sensors are connected to a developed application that saves their data to a file in real-time. The application allows streaming data from one to seven different sensors, using the Bluetooth communication protocol. The objective is to determine the effect of different conditions on battery life. Note that these tests were performed until battery depletion.

### 4.2.2 IMU average current consumption

The current consumption study includes 5 tests:

- Current consumption until battery depletion at 51.2 Hz.
- Effect of communication distance and sampling rate on current consumption.
- Effect of motion on current consumption.
- Effect of multisensory streaming on current consumption.

- Effect of placing sensor behind human body on current consumption.

For these tests, the sensor is taken out of its box, and the electronic chip is modified to allow the use of a multimeter (Figure 59). Three trials were done for each test to ensure the reproducibility. The same application described above is used to connect the sensor to the PC. The multimeter is connected to the PC via a USB port, and an application allows us to save multimeter data to a file. The first test was performed to make sure that current consumption is homogenous for a certain amount of time, which can allow us to record multiple trials continuously without recharging the sensor. For the other tests, the sensor(s) streamed for 10 minutes and the current was collected from the multimeter. Note that the test that requires moving the sensor was done manually.

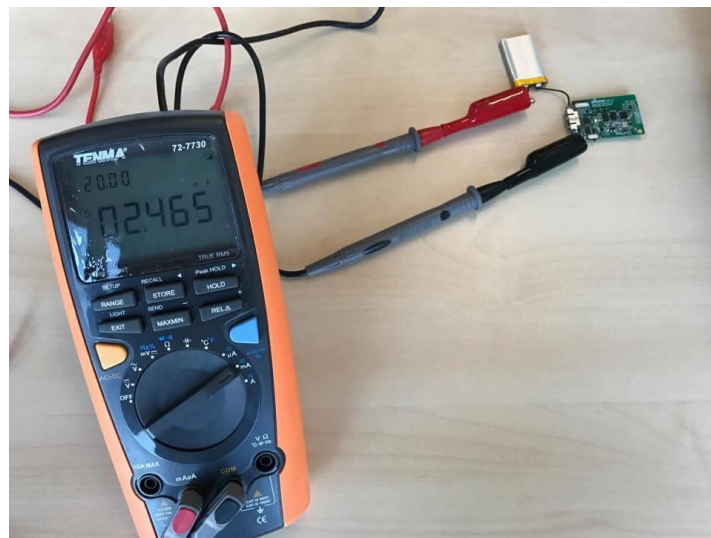

Figure 59. Electric scheme for average current measurement

### 4.2.3 IMU real-time current consumption

This study aimed to provide a detailed description of the current consumption pattern in real-time, when the sensor is streaming to the PC. For this reason, we adopted the same scheme described above, but we replaced the multimeter with a digital oscilloscope. The current was recorded for 10 minutes at different streaming sampling rates. The delay between the received packets was also calculated to better understand the sending/reception mechanism put in place by the IMU manufacturers.

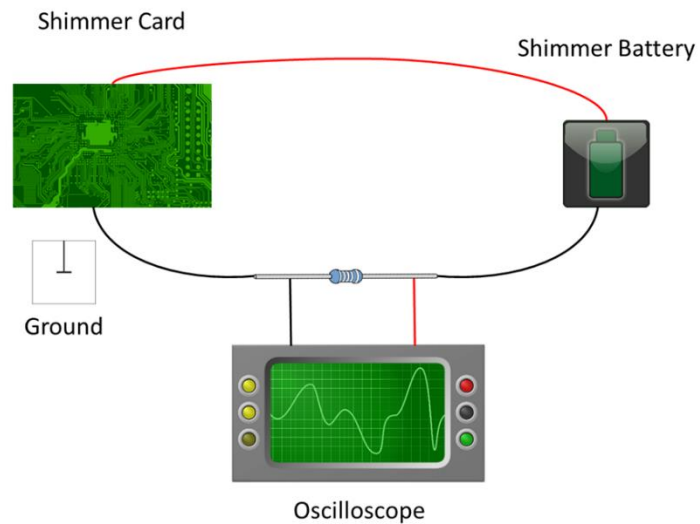

Figure 60. Electric scheme for average real-time current measurement

## 4.2.4 Results

### 4.2.4.1 Battery life

First, the effect of communication distance and sampling rate on battery life was studied. The results of this study are shown in Figure 61. The results obtained with two different distances (10 cm and 5 m) from the PC were compared to results obtained in a previous study done on Shimmer1 [144].

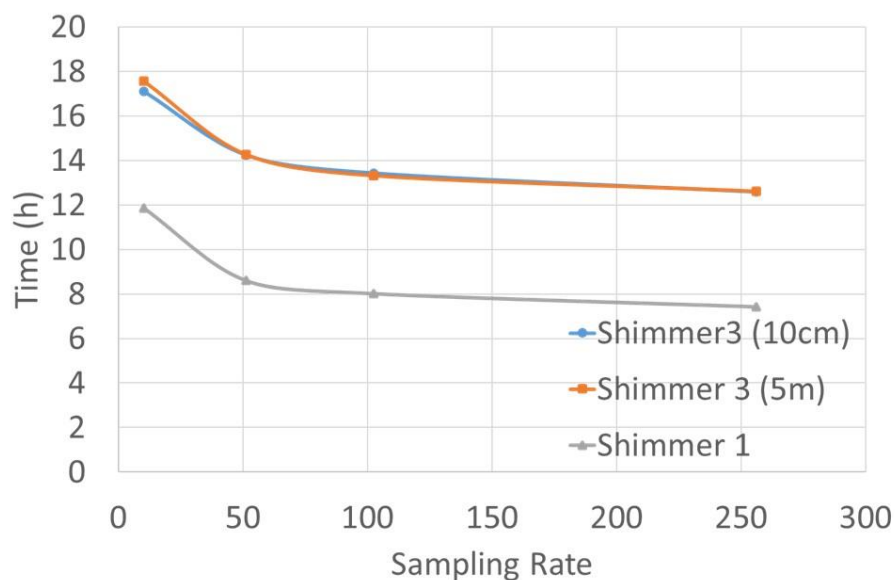

Figure 61. Battery depletion time for different distances at different sampling rates

The second study investigates the effect of motion on battery life. Since we needed to simulate motion for a long period of time, we attached the sensors to a small electric fan, and let it run continuously. The test was performed at 51.2 Hz. The results show that when attaching the sensor to an electric fan at 51.2 Hz, the sensor streamed for 14.88h, compared to 14.9h for a static sensor.

The third study shows the effect of multisensory streaming on battery life. The test was performed with 7 sensors versus 1 sensor, streaming continuously at 51.2Hz, until battery depletion. The results show that when connecting 7 sensors at the same time at 51.2 Hz, they streamed for a mean battery depletion time of 14.71h compared to 14.9h when using one sensor.

#### 4.2.4.2 Average current consumption

The first current consumption study investigated the changes in the average current consumed, for every 10mins, in order to figure out if this average changes overtime. If the average is constant during a period of time, the measured current averages can be reliable, and we will avoid the need to recharge the sensor before each current consumption test. The result of this study is shown in Figure 62.

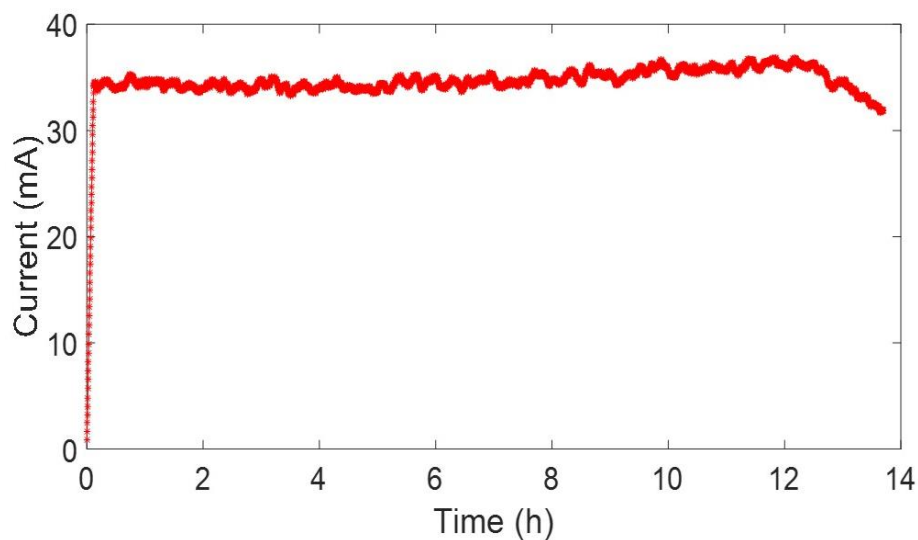

Figure 62. Current dissipated during the test until battery depletion at 51.2 Hz

The effect of the distance and sampling rate on average current consumption is shown in Figure 63. The mean average current consumed presents the mean of 3 trials of 10 minutes each.

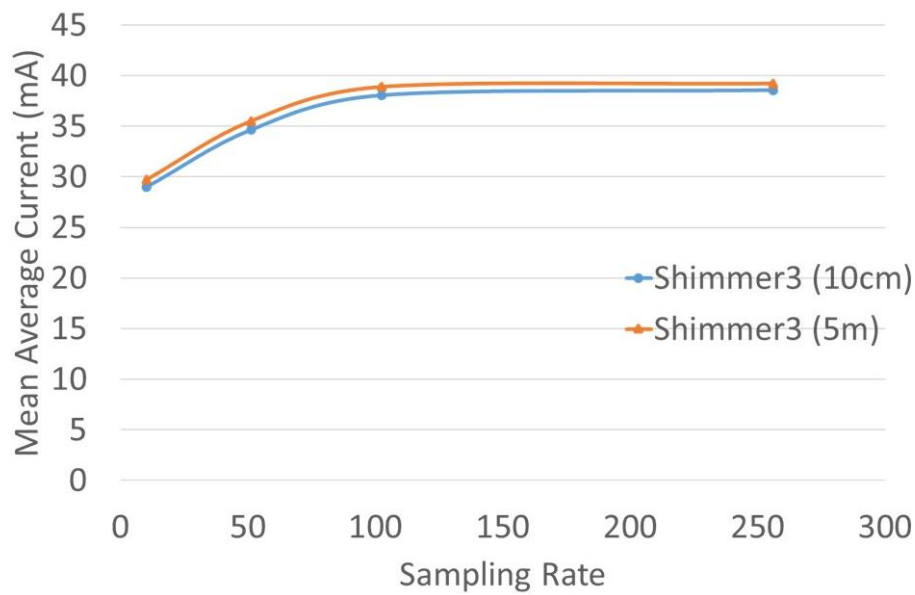

Figure 63. Mean average current for different distances at different sampling rates

When moving the sensor for 10 minutes we obtained a mean average current equal to 34.8 mA [SD 4.46] versus 34.63 mA [SD 4.52] for a static sensor. Multisensory streaming was studied for 2 different sampling rates 51.2 Hz and 256 Hz. Three trials were tested for each sampling rate. At 51.2 Hz, when streaming 1 sensor we obtained a mean average current of 34.63 mA [SD 4.52] vs 34.48 mA [SD 2.41] for 7 sensors. At 256 Hz, when streaming 1 sensor we obtained a mean average current of 38.55 mA [SD 4.49] vs 34.48 mA [SD 1.92] for 7 sensors. Finally, when placing the sensor behind a human body with respect to the remote central node, we obtained a mean average current of 35.14 mA [SD 4.62] vs 34.8 mA [SD 4.52] for a sensor placed next to the PC.

#### 4.5.4.3 Real-time current consumption

The real-time current dissipated during streaming at 51.2Hz was recorded using a digital oscilloscope. The results are presented in Figure 64. The figure shows that there are periodically peaks of current consumption, and almost a constant current during the rest of the time. The period of these peaks is about 40ms. Other tests at different sampling rates showed no difference in these periods of peaks, and only a slight change in the average constant current consumed. We also measured the delays between samples received by the PC, presented in Figure 65.

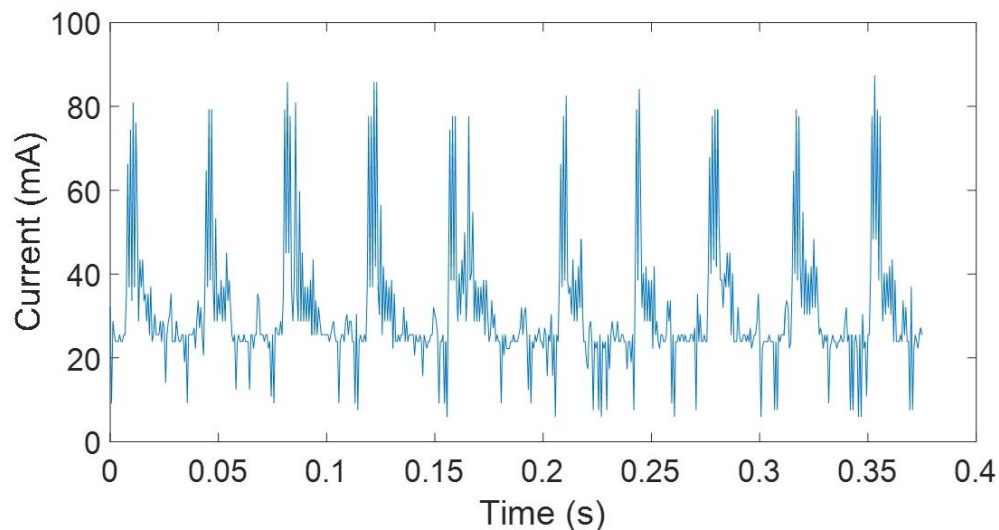

Figure 64. Real-time dissipated current during streaming at 51.2Hz

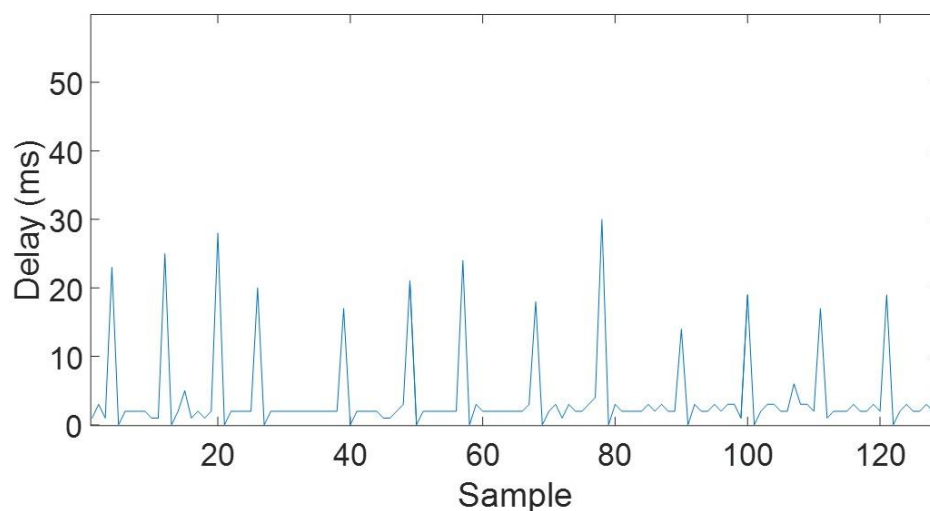

Figure 65. Delay between samples received by the PC while streaming at 51.2Hz

## 4.2.5 Discussion

The battery life and current consumption study shows that the usage conditions rarely affect the Shimmer3 sensor's efficiency. The first battery life test showed that the distance and the sampling rate do not affect battery life. Figure 61 shows that Shimmer1 battery life is lower than that of Shimmer3 but varies in the same manner. Shimmer 1.0 does not contain a magnetometer, and its battery has a capacity of 280 mAh versus 450 mAh in Shimmer3, which could explain these results. The second battery life test, concerning sensor movement showed no significant different in battery life between a static and a dynamic sensor. The same observation was noted when comparing multisensory streaming versus single sensor streaming.

The current consumption seemed homogenous for the first 8h (Figure 62) when we performed a test until battery depletion. This means that we can test current consumption without recharging the sensor after each trial. The average current seems to be slightly affected by distance (Figure 63). However, when it comes to sensor movement, multisensory streaming and on body streaming, the current consumption does not exhibit significant changes. These results show that Shimmer3 sensor is not affected by environmental factors. The only constraint of the system is a maximum number of 7 sensors, which is forced by the maximum number of entities in a Bluetooth piconet.

The third study was to investigate the real-time current dissipated during streaming. The figure shows that there are peaks of current consumption at times. Since the frequency of current consumption peaks did not change with different sampling rates, we proposed a hypothesis that the sensor saves the samples recorded at a particular sampling rate, and then allocates periods of 20ms to send all the saved data. Thus, with higher sampling rates, there is no increase in the number of peaks, but an increase in the mean current dissipated, which causes the battery to deplete much faster. To confirm this hypothesis, we measured the delay between the received samples by the PC, presented in Figure 65. The results of this study confirmed our hypothesis, as there are some samples that are received with big delays. These delays happen when the sensor sends a sample at the end of a sending window, and then sends the next one at the beginning of next sending window. After these peaks, the delays get smaller as the sensor sends the samples continuously.

## 4.3 Applying multisensory fusion in serious games

### 4.3.1 System of systems solution

Motion capture sensors like Kinect or IMU are commonly used in exergames to track user movements. The use of Kinect sensor has the advantages of portability and low cost which could lead to a home-based rehabilitation solution (Chapter 2). However, the lack of accuracy of joint kinematic estimation is one of the main obstacles for the use of this sensor in a medical setup. This aspect is of great importance since medical experts, interested in analyzing joint angles, require an accuracy of six degrees for upper extremities [48] and 5.5 degrees for lower limbs [49]. The multisensory fusion approach presented in Section 4.1 proved to be more accurate in estimating joint angles. The challenge remains in deploying this technology in serious games.

A SoS approach presents a promising solution for applying sensor fusion to a serious game, or to any system, that requires communication with sensors. In our case, Kinect sensors and IMU sensors are used. The Kinect was chosen for its ease of use, acceptability and portability, while the inertial sensors were chosen for their accuracy. When these two systems are available, data fusion is performed on the data sent separately from each sensor. If the Kinect is available alone, the data sent from it will be directly used by the application. This concept is in agreement with the SoS approach, since each input device is regarded as a separate system by the application. The more data the application collects from different sensors the better the results, but, the absence of any type of sensor must be accounted for and the system must be able to work with whatever data it gets. In addition, each sensor performs data acquisition and treatment separately, while the main system uses data fusion if both systems are working correctly. This is also in accordance to the autonomy principle attributed to each subsystem in SoS architectures.

Our idea is to offer the opportunity to select joints that require more precision, in a configuration panel. Medical staff make this selection. The user places the IMU sensors on the selected joints and starts the game. The application will be aware of the selected joints and will use data fusion between IMU and Kinect on these selected joints, while using the Kinect on the rest of the body. This will help reduce the number of sensors on the body. For instance, if an expert requires additional precision on knee angles, the user configures the application to add only 4 sensors on each thigh and shank. This represents an intermediate solution between the high precision that we gain from using 10 to 12 sensors on the whole body, which reduces portability and comfort, and the low precision that we get from using the Kinect alone.

### 4.3.2 Results

To implement a SoS approach between IMU and Kinect, these two entities must function separately in separate codes, and combine when both entities are available. Figure 66 shows the configuration panel that requires the user to identify the joints that require more precisions.



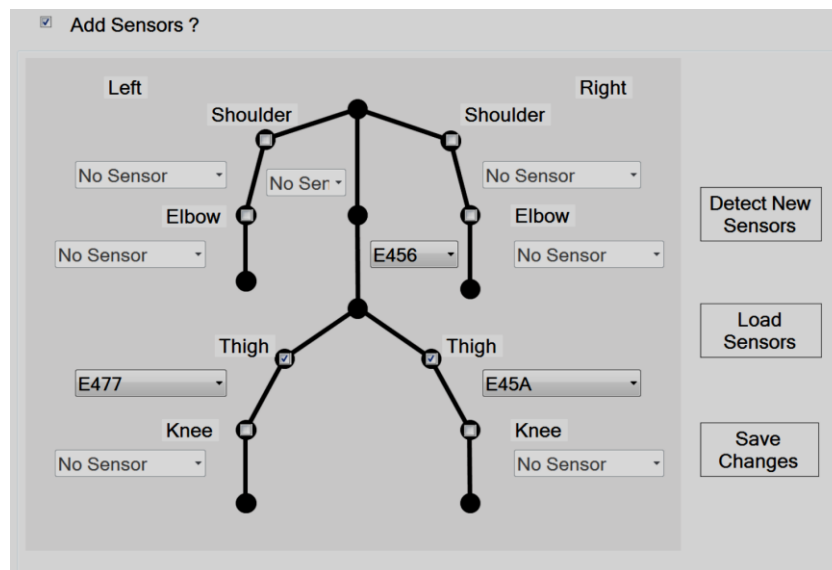

Figure 66. Configuration of IMU placement for serious games

After configuring the IMU placement, the user selects the sensors to place on each body part. The user then starts the game. The algorithm uses the Kinect for all body joints and combines the IMU with the Kinect for the selected body parts. Note that the IMUs are auto-calibrated to certain references based on the selected joints.

## 4.4 Conclusion

In this chapter, we presented three studies to implement IMU-Kinect fusion in serious games for home rehabilitation. First, we developed a new real-time, quaternion-based, extended Kalman observer for fusion between IMUs and Kinect sensors for knee angle estimation. We studied the different sources of error induced by IMUs and Kinect, and used this information to dynamically calculate a measurement correlation matrix for each specific sensor. We also proposed a synchronization approach, without the use of the sensor's universal clock data, or request-response messages between PC and sensor. Our multi-sensor fusion approach showed a better estimation accuracy compared to other approaches.

A second study investigated the energy consumption of Shimmer3 IMU sensors, which could be deployed as IMUs for our home-based rehabilitation system. This technical study shows that shimmer sensors can hold up to 15 hours when streaming continuously at 51.2Hz. The study also investigated how the current is consumed in real-time, which could help us understand how to optimize the use of these sensors. Finally, the sensors do not seem to be affected by any environmental and physical factors.

Finally, we presented our approach to use multiple sensors in serious games for functional rehabilitation. Moreover, multisensory fusion was applied between these sensors to obtain more accuracy for joint kinematic estimation using a SoS approach.

# Chapter 5      Social Studies Concerning Serious Games

How can we develop acceptable solutions for functional rehabilitation? And what are the main ethical implications that should be considered? As scientists, we do not always consider social issues when developing and implementing new technologies. Therefore, in this chapter, we highlight our contributions in the field of end-user acceptability concerning serious games for rehabilitation and we describe the main ethical questions that were considered during this work. These contributions have been submitted as an article to the Innovation and Research in BioMedical engineering journal that is currently under review.

## 5.1 Acceptability study

In addition to the development of serious games, an acceptability study was performed to determine the patient and medical expert acceptability regarding serious games for stroke rehabilitation. The study proposed some videos showing the games to the users, and collected feedback through different questionnaire techniques. This acceptability study was conducted for a period of 5 months from February 2016 to June 2016. It was carried out through field observations and interviews of physiotherapists. The investigation was carried out at the “Centre Hospitalier Esquirol de Limoges” in the service of Physical Medicine and Rehabilitation (M.P.R) with the help of Jean Christophe Daviet (MD) and Anaïck Perrochon (PhD), and interviews were conducted with physiotherapists of the hospital service as well as a group of second year physiotherapy students training at the University of Limoges. It should be noted that the opinion of practitioners comes mainly from their experience with stroke rehabilitation practice in hospital environment. For practicing physiotherapists, the study is based on 8 individual interviews with a semi-directive questionnaire lasting from 30 to 45 minutes each. While the interviews with the students were conducted collectively in focus groups. Thus, 15 students were organized in three groups. The first focus group lasted almost an hour with 5 students from 20 to 22 years old, the second 37 minutes with 4 students between 20 and 21 years old, and the last one lasted 45 minutes with 6 students from 20 to 26 years old. This information is presented in Table 9.

Table 9. Subjects of the user acceptability study

<b>Subjects</b>	<b>Interview strategy</b>	<b>Duration</b>
8 physiotherapists	Individual semi-directive questionnaires	Between 30 and 45 minutes
5 students aged 20 to 22	Focus group	1 hour
4 students aged 20 to 21	Focus group	37 minutes
6 students aged 20 to 26	Focus group	45 minutes

It is important to point out that one of the limitations of our study is not to have included follow-up and interviews with patients who have had a stroke. Some patients, as well as the stroke patient association in France, were asked several times to participate in this investigation to provide advice and feedback from a patients' perspective, but unfortunately, the requests did not receive a positive answer.

### 5.1.1 Questionnaire preparation

The difference between the individual interview and the collective interview involves different techniques in harvesting the information. The interviews that use semi-directive questionnaire have questions that do not follow a previously established order and the topics addressed may deviate, to a certain extent, from the previously established questions. These deviations are accepted if they make sense to the interviewee and, in this case, if they can provide new questions and answers to the questionnaire. It is then possible to readjust the questionnaire according to these contributions and if possible re-use the words of physiotherapists in order to get as close as possible to the notions of their profession and to make conversations easier. In the case of students in training, the approach of the collective interview is different because the students have less practice than actual practicing physiotherapists and also because the group interview implies different approach of questioning.

In both cases, the interviews begin with reading a booklet presenting the serious games under development. Then, the personnel watch a video presentation of the device that allows

to visualize how serious games can be used in rehabilitation. For the collective interview, the session begins with a collective conversation where everyone's opinion is asked, and then a discussion starts, where the group discusses each notice, and agreements or oppositions of participants. This is not primarily meant to cause a conflict between participants, but to have enriched discussion that help us obtain, from the students' perspectives, long interviews with a good amount of information. Thus, the questionnaire is divided into three main parts.

The first part focuses on the current objects and technologies that therapists use during rehabilitation programs. We question here the practice of rehabilitation with technological devices, and the way the physiotherapists use them in the rehabilitation of stroke patients. In additions, questions concentrate on the frequency and the need for material in rehabilitation, and material choice in order to detect the needs that lead physiotherapists to choose a material rather than the other. The aim is to identify the forms of use of these tools, i.e. if the physiotherapists proceed to particular habits in rehabilitation programs, in order to identify their adoption or diversion from using different machines. In addition, the experts are asked about their knowledge of serious games for rehabilitation, and their familiarization with this type of technology. Actually, prior knowledge of a technical object can particularly play on the acceptability of this object, through a phenomenon known as cultural proximity. Finally, a number of questions target the classical rehabilitation of stroke survivors and the relationship that physiotherapists maintain with their patients.

Next, in section 2, the questionnaire delves into exercises and movements that medical staff integrates in functional rehabilitation. It will then be possible to identify rehabilitation movements that could be integrated into serious games. Moreover, we try to investigate the interaction between the patient and practitioner during rehabilitation. This helps in separating the different rehabilitation phases: when does the practitioner make the patient collaborate in their rehabilitation, or, on the contrary, when is the patient totally passive and the intervention of the practitioner is inexistent, or finally when and under which criteria the practitioner gives the patient the means to be autonomous during their rehabilitation. Similarly, during the interviews, questions were asked about the innovation and fun aspects that physiotherapists put in place during their sessions. Depending on these aspects, we can also identify how physiotherapists face the repetitiveness of the rehabilitation exercises and whether games are a part of functional rehabilitation programs. These two axes of playfulness and therapeutic education correspond to two dimensions that influence the acceptability of serious game in rehabilitation. In this case, we can anticipate the benefits and the estimated limits of playfulness

in motor rehabilitation based on the experience of physiotherapists. At the end, the experts are asked about their opinion concerning whether the device could both accompany and help the patient in their rehabilitation and also improve the follow-up by the physiotherapist.

Finally, in section 3, the questionnaire investigates the therapists' current state of knowledge concerning serious games, and their recommendations and expectations from such technologies. These questions attempt to measure the cultural proximity of physiotherapists and students to this kind of device, and their intent to integrate serious games in the practice routine. Then, the questionnaire addresses patient categories for which physiotherapists believe that using such devices can cause some complications. In particular, the questions highlight the motivation of different age groups to play serious games. Moreover, it was asked if, in their professional experiences, the physiotherapists had been confronted to forms of rejection to the playfulness in the rehabilitation games, and if the patients expect their programs to be more serious than fun. Next, the questions target the more technical expectations of physiotherapists from the serious game, especially the type of information they would like the device to capture, and how would they like these results to be presented. Additionally, what health information they would like to see for patients playing the games at home, and what margin of modification they would like to have on the exercises and exercise programs. Finally, they are asked if they would be willing to acquire such a device or make use of it in their rehabilitation routines.

During the interviews, additional questions were added based on the conversations. They are mainly related to the possible risks of patient autonomy during home rehabilitation, if the supervision and remote support of the physiotherapist would provide effective rehabilitation and whether the patient should be allowed to exercise more than amount prescribed by the physiotherapist.

## 5.1.2 Observations and results

### 5.1.2.1 Data presentation and processing in serious games

The group of physiotherapists interviewed for this survey have previously used a physio-game, deployed at the hospital center that processes and captures data in real-time while providing diagnostic assistance. The existence of this type of device can present an advantage and a limitation for our study since the interviewees could have only similar systems as expectations of a serious game for rehabilitation, since they are used to the type of results that

it can produce. However, this also presents benefits because the physiotherapists can identify the positive points and the limits in the already existing device.

When it comes to data presentation at the end of each session, the experts desire to have a simplicity in analysis, a synthesis of the data collected and a simplicity in data presentation. For example, they want a simple but technically accurate information of gained limb amplitude by the patient after the sessions. For them, this precision that they cannot see through "The naked eye" is mostly an advantage, but they want it simplified. According to the physiotherapists, it represents an asset for the patient since in cases where the gains of amplitude and improvements in balance are made slowly, this precision could be very encouraging.

The results of a serious game make it possible to quantify the effects of rehabilitation. These objectified data can also become points of communication between various health professionals who intervene with stroke patients. The developed serious games should be easy to understanding for any user, with little or no gaming experience. The data presented should be the very simplified for the patient and based on graphic representations, color codes or animations visual.

Finally, the experts classified data presentation into 3 separate categories:

- The first would be for the patient user with a presentation using graphs, simplified pictograms or animations, which represent the gestures, a numerical average and a curve of progression. This presentation would summarize the session of rehabilitation that was carried out with the result.
- The second category would be for physiotherapists where they could instantly have the results, the overall analysis and the assistance to diagnosis of a patient's session as well as the progression curve.
- The third level would include raw and statistical data of the patient's rehabilitation session retracing each exercise chronologically from the data collected during the patient's sessions for each key rehabilitation movement such as flexion and extension of the knees, ankles and hip.

### 5.1.2.2 Graphics and game scenarios

From the data analysis, the expectations of physiotherapists and their recommendations will enable us to adapt the implementation of the serious games for rehabilitation deployed

between a health practitioner and a patient. The first idea is about the type of game scenarios as well as the type of graphic interfaces that could be proposed by the game in development. We can then represent these recommendations in three different types of serious games which is a progression from serious game scenarios to scenarios more playful (Figure 67):

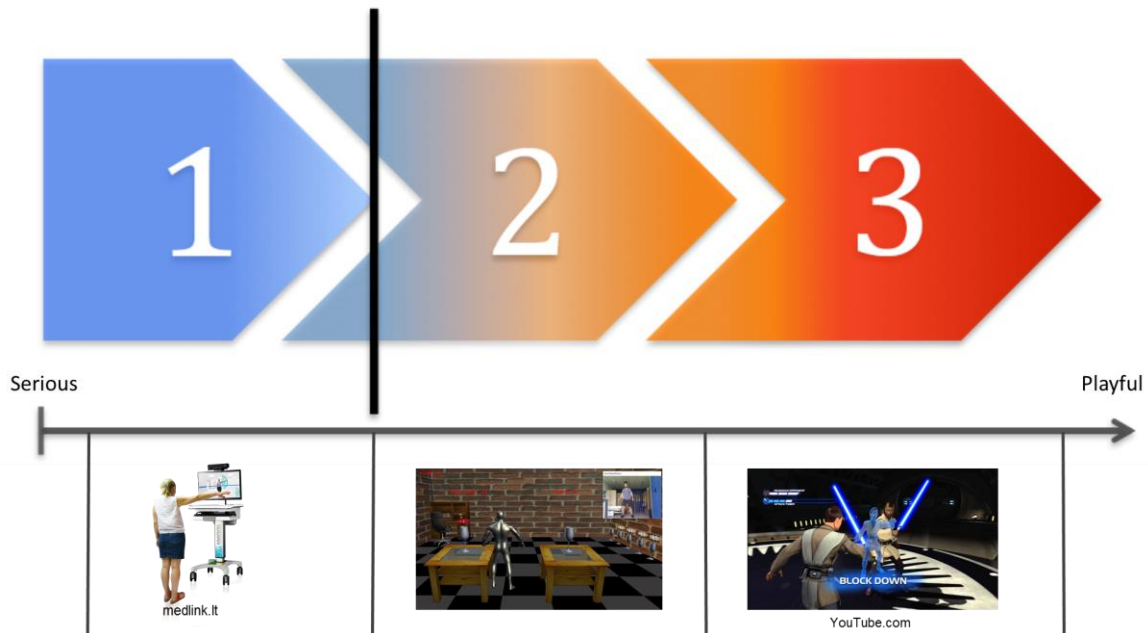

Figure 67. Three distinct types of serious games for rehabilitation

In the first phase, the serious game could offer an interface that abandons its gaming aspect; this allows physiotherapists to remove all playful aspects of the rehabilitation exercises, while implementing only the avatar of the patient that demonstrates the exercise. We can, in this case speak of a neutral scenario where the serious game offers rehabilitation exercises under the purely formal and educational aspect. It allows the patient and the physiotherapist to visualize the execution of the movement to be performed, and check if the realization of the movement is correct or not. On the diagram, this phase is separated by a black line from the second because it consists of a completely different approach. This option must necessarily be at the physiotherapist's disposal, to be used when they consider that it would be better for the patient to approach rehabilitation from a serious perspective. This option can also be chosen by the patient who is performing the exercises at home, and who prefers this formal aspect. In addition, the first stages of the stroke rehabilitation can lead the patient to misunderstand the purpose of the games, or perceive them as inappropriate. Inappropriate because the game aspect could be perceived as inadequate with respect to the gravity of the patient's situation, and not serious enough for a therapy session. The patient can also misunderstand the purpose of the game if they only retain the playful aspect, therefore they do not perceive the purpose and



medical utility of the proposed exercises. These cases may cause forms of rupture or rejection of rehabilitation by the patient. Finally, a neutral phase may be a necessary option if the patient or the physio is bored, or completely rejects, the playful scenarios that the serious games offer, but still wants to use the device.

Phase 2 scenarios would focus on reproducing common and realistic situations. They would allow the patient to play games reproducing life scenes, where they could project and imagine themselves in these environments. Moreover, this would allow them to anticipate how they could adapt with their physical limitations to these everyday life situations. What we observed during the field survey, and was reaffirmed by the interviewed physiotherapists, is that one of the objectives that motivate patients, at the beginning of the rehabilitation, is the possibility of being able to walk again, which is most often associated with the patient's ability to be autonomous again. Some game examples that can be included in this phase are hand manipulation exercises, where the physiotherapist proposes to the patients that they try to raise a shopping bag. By proposing exercises of rehabilitation simulating life contexts, physiotherapists can then anchor their exercises in life experiences that help in motivating the patients by putting them in a real-life situation.

Finally, phase 3 would present the design of scenarios that offer the most playful, fictional and imaginary situations. These scenarios can offer to the player to embody characters or more imaginary and playful situations closer to what is done in the video game field. For physiotherapists already accustomed to serious games, they have underlined the importance that the serious game can offer several types of games to avoid the boredom of the patient if they repeat the same scenarios.

### 5.1.2.3 Complementary visual data

After seeing a video presenting the serious games and the data that are currently available, physiotherapists recommended the addition of complementary visual data. In addition to the encrypted data that were mentioned previously, in order to better visualize the patient's movements, there should be a video retracing the patient's rehabilitation sessions. However, with regard to risks and the intrusion that this type of data represents, the video must be anonymous and only identify the movements of the patient. This video would allow physiotherapists to identify and retrace the session and to check cases of bad movements executed by the patient.

#### 5.1.2.4 Limitations of the use of serious games

Even if physiotherapists recommend that patients execute rehabilitation exercises as much as possible outside the sessions, there is nevertheless a consensus that there are limits to the physical efforts that the patient must provide. This limit is due to two main reasons: the first is that the patients must allow themselves a necessary time to rest their muscles to avoid pain and wounds. The second is that physiotherapists readjust the rehabilitation as the patient's recovery progresses; therefore, some exercises are only useful at a certain point in a rehabilitation program. This could also lead to undesirable weight compensation and bad movement execution. To solve these problems, the serious game should integrate a sound signal or a visual color that alerts the patients while they execute bad movements that are not desired by their therapists. Then the second feature that could be integrated allows the therapists to limit the daily usage time of the serious game by the patient if they were performing home-based rehabilitation.

#### 5.1.2.5 Difficulty adjustment

One of the main ideas that were identified and recalled throughout this study, is that physiotherapists use their tools and their instruments to innovate the rehabilitation programs and to adjust this use according to the patient. This adjustment corresponds to the ability of varying the difficulty of an exercise in real-time. Physiologists should have the ability to adjust the difficulty during a session to make it more difficult, but also to be able to reduce the difficulty if the patient finds the exercise too complicated.

#### 5.1.2.6 Rehabilitation Tutorial

The serious game device should allow the patients to familiarize with the games before using them; therefore, a rehabilitation tutorial must be available before playing the games. This can take the form of oral or visual explanation, in order for the patients to achieve the movement correctly and its therapeutic purpose. Physiotherapists and students agreed that this feature is important, but did not give precise feedback on the content of these tutorials.

### 5.1.3 Discussion and proposed solutions

The user acceptability study showed that the recorded data must take into consideration the different users. Session results should be presented in an intuitive format, and should be brief and summarized. However, the experts should be able to check the details of each

movement during the sessions, using anonymous videos and chronological joint angle graphs. On the other hands, the games themselves could affect the user acceptability. These expectations will be accounted for through the expert interface, designed to monitor the patient's progress, which will be presented in the next chapter.

Moreover, the system should offer the possibility of choosing between 3 types of games. The first type includes games that describe a movement to be performed, and the patient performs the simple gesture using their virtual avatar. This might be explained by the fact that some patients do not take games seriously, and only require visual feedback during rehabilitation exercises, to insure the correctness of their gestures. The second type of games should be derived from real-life scenarios, and should present a more complex virtual scene. This can target people that are motivated when they are able to complete complex tasks, and want the games to be relatable to their daily lives. Finally, the last type of games concentrates on virtual games that recreate imaginary scenarios, and have high levels of virtual graphics. This targets patients that are accustomed to playing video games, and who may be interested in complex scenarios with advanced three-dimensional graphics. Since our patients are mostly older adults, we concentrated on developing games in the first and second types only. The second type was previously accounted for through the two developed games presented and studied in Chapter 3. However, we added some type 1 games, that were previously developed by our team, to the possible exercises that can be added to rehabilitation sessions [145, 146]. The games integrate the patient in a virtual room, where an avatar starts by showing them the exercise to be performed, and then the patients have to repeat the movement for the assigned duration. The scene and the workflow are shown in Figure 68.

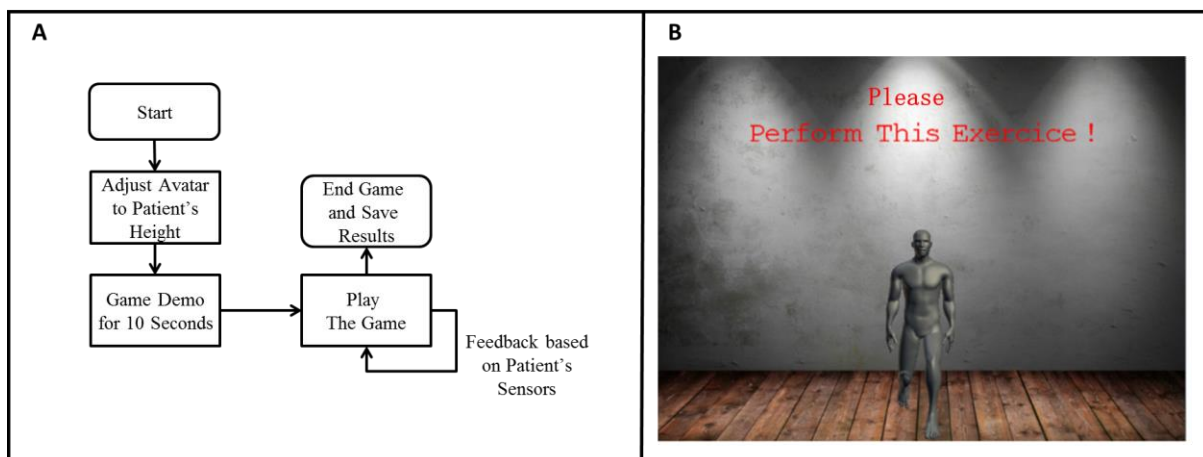

Figure 68. Type 1 games A: workflow and B: scene

The games include several types of movements, classified in different levels of difficulty. The easy movements include jumping and hip adduction/abduction exercises, the medium movements include high knees, hamstring curls and one leg stance exercises, and the hard movement is the squat exercise.

Another main issue is to give patient feedback to correct their movements while playing the games. This was accounted for through the personalization approach that was introduced in Chapter 3. Additionally, the therapists gave several technical recommendations that can influence the user's motivation (pausing the game, audio and visual feedbacks). Finally, the therapists seem to be open to the idea of a home-based rehabilitation system that can allow them to create rehabilitation programs and monitor the patient results. Table 10 shows the expectations that were given by the therapists with our proposed solutions.

Table 10. Experts' expectations from serious games and our proposed solution

<b>Problem</b>	<b>Solution</b>
Data presentation	<ul style="list-style-type: none"> <li>• Include brief important data after each session</li> <li>• Include joint angles graphs</li> </ul>
Graphics and game scenarios	<ul style="list-style-type: none"> <li>• Include type 1 games to the system</li> </ul>
Complementary visual data	<ul style="list-style-type: none"> <li>• Include a stickman video describing the patient's movements</li> </ul>
Limitations of the use of serious games	<ul style="list-style-type: none"> <li>• Accounted for through the personalization of the serious games</li> </ul>
Difficulty adjustment	<ul style="list-style-type: none"> <li>• Accounted for through different levels of difficulty in serious games</li> </ul>
Rehabilitation Tutorial	<ul style="list-style-type: none"> <li>• Include rehabilitation tutorials in the patient's interface</li> </ul>

## 5.2 Ethical questions when implementing serious games for home-based rehabilitation

The development and conceptualization of healthcare applications presents many ethical challenges and questions. These issues increase when these applications are deployed in homes and nursing homes, and can save and process raw data acquired from several patients. It would then be very dangerous to install a serious gaming system, equipped with a camera and collecting data, without adopting a pre-planned approach to solving ethical issues as they unfold. This approach is known as “Ethics by design”, where the developers tend to confront the issues as they develop their system, rather than waiting for a feedback from the users to solve the emerging problems. The main question to be asked revolves around the compromise between security and freedom. Is it truly ethical to sacrifice freedom for security?

The system we implemented falls in the same category as personal healthcare monitoring systems, when confronting ethical barriers. In this context, some research has been done to quantify and discuss the ethics of patient monitoring in healthcare. In addition, some literature reviews attempted to combine the results from health monitoring studies to elaborate on the ethical interrogations when deploying these systems [147]. Therefore, we can identify some of the main ethical themes and talking points:

- **Autonomy:** this includes the right of the patients to freedom and making their own decision.
- **Obtrusiveness and visibility:** this theme concerns the physical aspect of the monitoring technology. For instance, a system that monitors patients and is visible to the public can lead to a disregard from the patients due to the need to adapt to the social context.
- **Stigma and identity:** this theme is largely linked to the autonomy and visibility factors. A system that is visible can cause a stigma for patients and reduce their self-esteem.
- **Social isolation:** there are concerns of social isolations since these systems will require less direct intervention from medical personnel, who would follow the patient from a distance.
- **Delivery of care:** implementing systems at home can have a negative impact on the medical personnel, as they could feel less important or replaced by intelligent systems.

- **Medicalization:** this refers to the concept of transforming the patient's home through deploying the monitoring technology. Thus, the patient would not feel at home and is reminded of their situation when using the device.

In our work, we tried to have answers to these questions. When it comes to autonomy, our serious game offers the patient the chance to choose which game to play, from their assigned program. In addition, they can choose the time and number of repetitions to practice between clinical sessions. The second theme linked to visibility of the system can be easily accounted for since our system can be presented as a normal game using ordinary commercial motion capture tools and technology. As for the third theme, the self-esteem of the patient would theoretically increase through the use of our games, since they will be shown, through the gameplay, that they are able to accomplish everyday tasks during recovery. This point was also highlighted in the acceptability study. The social isolation theme is more difficult to handle, since home-based rehabilitation can lead people to stay at home for longer periods. However, our system is not supposed to replace clinical sessions, and they should always be scheduled periodically. Therefore, our system will not increase the loneliness and non-interaction of patients with their social environment. Next, our system will not aim to replace the medical personnel, but to complement their work and offer them more information to follow the patient's progress. Finally, the medicalization of the patient's home can be answered in the same manner as the obtrusiveness and visibility themes.

In addition to the questions that follow the implementation of the system in the healthcare context, some additional questions target the recorded data that are saved during the rehabilitation process [148]. The main themes in this area of ethics are the following:

- **Privacy and confidentiality:** this includes the features that can be shared with the patient's entourage, the privacy that can be insured even when using visible sensors and the fear of leaking personal data.
- **Data security:** this includes the security aspect to insure the safety of the collected data.
- **Legal environment:** the developed systems must adhere to a set of legal rules defined by the state in which the system is deployed.

To answer all of these questions we adopted different strategies for different types of saved data. When it comes to the patients' and experts' profiles, they can choose to be anonymous, and their passwords are saved in the database using hash functions, in order to prohibit hackers from stealing user profiles. When it comes to the sensor's saved data, we proceeded to save

only numerical data (for example, the Kinect does not register any visual data, but only saves numerical data based on the angles and positions of the body joints). These data will be encrypted later, when a cloud-based server is implemented, in order to ensure the confidentiality and privacy of the patient's progress.

It is dangerous to implement systems at home, linked to the internet, without taking these additional precautions that ensure the safety and privacy of the patient. In addition, the patient would not be convinced by the positivity of these systems if they feel violated. Finally, it is up to the developers to insure the respect of the conditions stated above, and to develop ethical devices used for patient monitoring at home.

### 5.3 Conclusion

In this chapter, we detailed the social issues that are confronted by scientists when developing serious games for functional rehabilitation. The first part focused on studying the factors that can influence the acceptability of serious games by patients and experts. This survey focused on observing the practices of paramedical profession as well as interviewing them. The reflection and observation of this study focused on the use of the tools and machines by physiotherapists in their professional practice and the fun and innovation that they incorporate into rehabilitation exercises to combat the boredom of repetition. The study resulted in identifying some key factors that need to be implemented in order to ensure an acceptable implementation of games for health. The second part of the chapter discussed the ethical questions that are frequently confronted when implementing solutions for patient monitoring and rehabilitation. We attempted to answer these questions during the design and development of our solution, following the ethics by design principals.

These studies will help us develop a tool that is validated scientifically, socially and medically, and that convinces patients and experts. The next chapter will describe the final setup of this system that was developed to follow all of these recommendations.





# Chapter 6 Home-Based Rehabilitation Application

How can we present the rehabilitation data for experts and patients? And how can we implement this rehabilitation system at home? In this chapter, we describe the different interfaces that we develop for the end-users, based on the recommendations following the end-user acceptability study. We also highlight a possible method to implement this system in a home or clinical environment. These contributions have been submitted to the Innovation and Research in BioMedical engineering journal and the International Journal of Human-Computer Studies and are currently under review.

## 6.1 User interfaces

In this chapter, we present the development and evaluation of the user interfaces, that help implement games in home environments. We will also present the database model that can be implemented on a cloud server in order to insure correct queries between users and the server. Finally, we will give recommendations on how the system should be set up at home. We will start by presenting the different user interfaces that we developed, while describing scenarios that can be performed by patients or experts.

### 6.1.1 Patient interface

The patient interface allows them to choose between the rehabilitation programs assigned by different medical experts (Figure 69 A), they can select to play a game from the selected program, and they can personalize the game by choosing an avatar from 3 available options (Figure 69 B). The patients can also, based on the expert's recommendation, select to place sensors on their body to benefit from the sensor fusion during the session (Figure 69 B). In addition, before playing any game, the patient can choose to read the tutorial of any specific game ((Figure 69 C). At the end of each session, the patient can leave a comment about their performance for their expert. Finally, the patient can send messages to their supervising experts (Figure 69 D). The interfaces and tutorials were designed and implemented in French and English and can be changed based on the user's preference. The interfaces were not tested with actual patients but were shown to experts in order to elaborate on their usability by different patients. The experts agreed that they were good for pathological subjects, however, they did

not think that stroke survivors would be able to manipulate and place inertial sensors on their body while they are at home. Based on the recommendations given by experts during the user acceptability study (Chapter 5), a page highlighting the important results was added for patients. An example is shown in Figure 70, where a patient can view the results of the object manipulation game trials. The interface offers the patient the possibility of viewing previous scores, the number of attempts that were successful with each hand and the number of missed attempts.

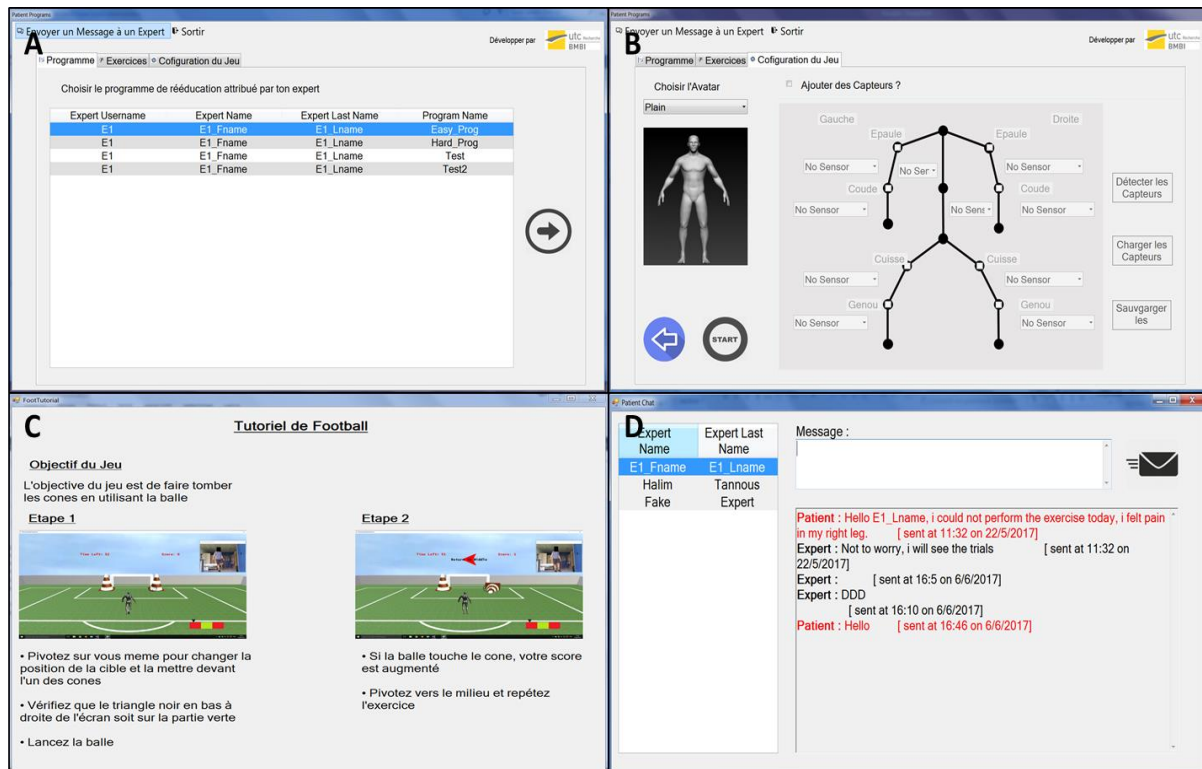

Figure 69. The patient's interface (A: program selection, B: game personalization, C: game tutorial and D: chat with expert)

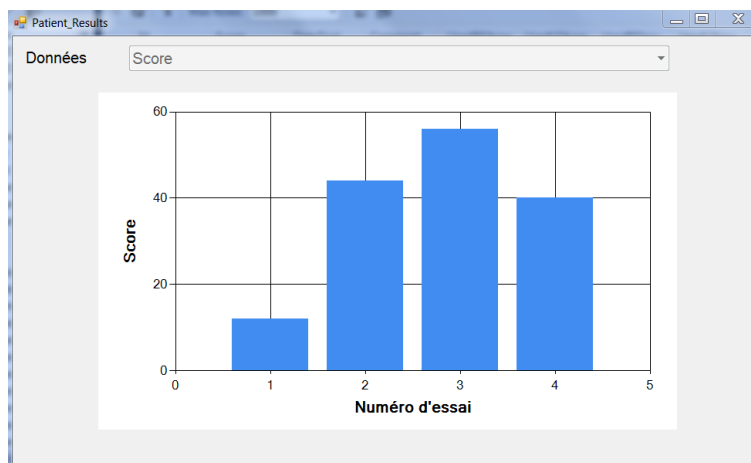

Figure 70. Patient results page

This result page offers a simple design, in order to satisfy the requirements given by medical experts.

### 6.1.2 Expert interface

The expert interface allows the user to add a patient (Figure 71 A) and a rehabilitation program (Figure 71 B). They can also assign programs to their patients (Figure 71 C), and send them messages (Figure 71 D).

For each exercise in each rehabilitation program, the expert can visualize statistics about the different trials (Figure 72 A). They also can view the trials in more details, by using separate interfaces. The first one shows the angle details for the interesting joint angles (Figure 72 B). The interface also shows some statistical variables calculated from each angle. Finally, the interface indicates whether data fusion was used to collect a given angle, in order to elaborate on the accuracy of the graphs. The data presented in this interface follow the type 3 data recommendation that was identified during the user acceptability study (Chapter 5).

The second interface shows the movement of the patient's joints, in three different planes (3D), as a stick avatar (Figure 72 C). The expert has the possibility to start the video, and move between the top view, side view and frontal view while the video progresses. The expert can also choose to pause the video, or play it in slow motion, in order to analyze a movement. The data presented in this interface follow the type 3 data recommendation that was identified during the user acceptability study (Chapter 5).

Finally, the expert can see a generated report (designed by medical experts) that highlights important statistical variables for each trial (Figure 72 D). For instance, the football game, designed to rehabilitate balance, cognition, and knee/hip movement contains certain indicators that can help analyzing the progress for each separate theme. The cognitive aspect is highlighted by the time needed to aim at the cones. The balance aspect interferes in the angle of the knee that is used to balance the body before hitting the ball and the rotation of the torso while hitting the ball. In addition, the movement of the lower limbs is highlighted by the angle of the knee before launching the ball, the angle of the hip while launching the ball and the time related to these balancing and launching phases. The same statistics that are presented to the patients are also presented to the experts to determine the number of hit/miss related to each leg attempts. This interface is generated through data processing technics performed on raw data captured from the sensors using Matlab. The data presented by this interface follow the

type 2 data recommendation that was identified during the user acceptability study (Chapter 5).

A feature was later added, after discussing with experts, which allows them to conduct a game test with a patient before assigning the game. This helps experts in identifying the requirements of their patient before assigning the first rehabilitation program. For instance, a typical expert scenario for assigning a football game to a patient becomes:

- Test the football game.
- Check the patient’s report, and identify the personalization parameters that should be allocated to this patient.
- Assign the rehabilitation program, and personalize the knee and hip threshold angles.
- Wait for the patient to play the games to check the results.
- Change the rehabilitation program and personalization parameters as the patient progresses in their rehabilitation.

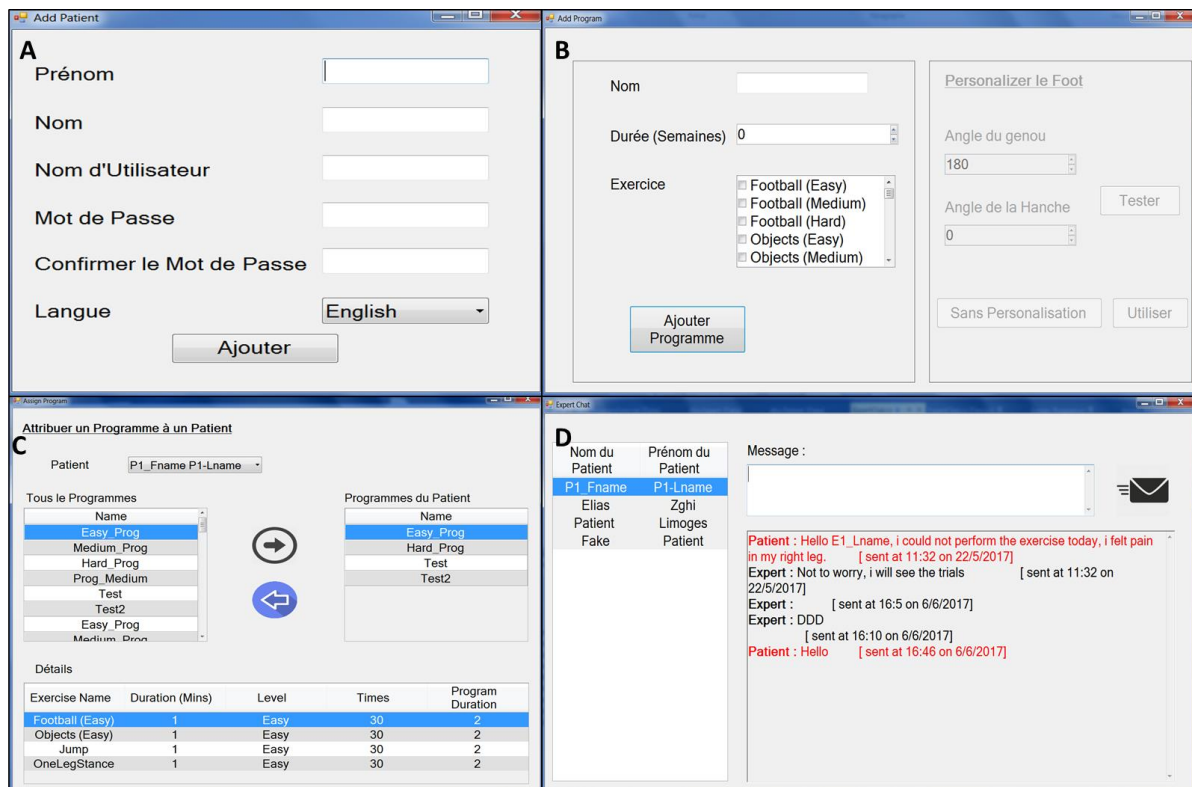

Figure 71. The expert’s interface (A: add patient, B: add program, C: assign program to patient and D: chat with patient)

We note that all expert interfaces are programmed in English and French and can be changed based on the expert’s preference.

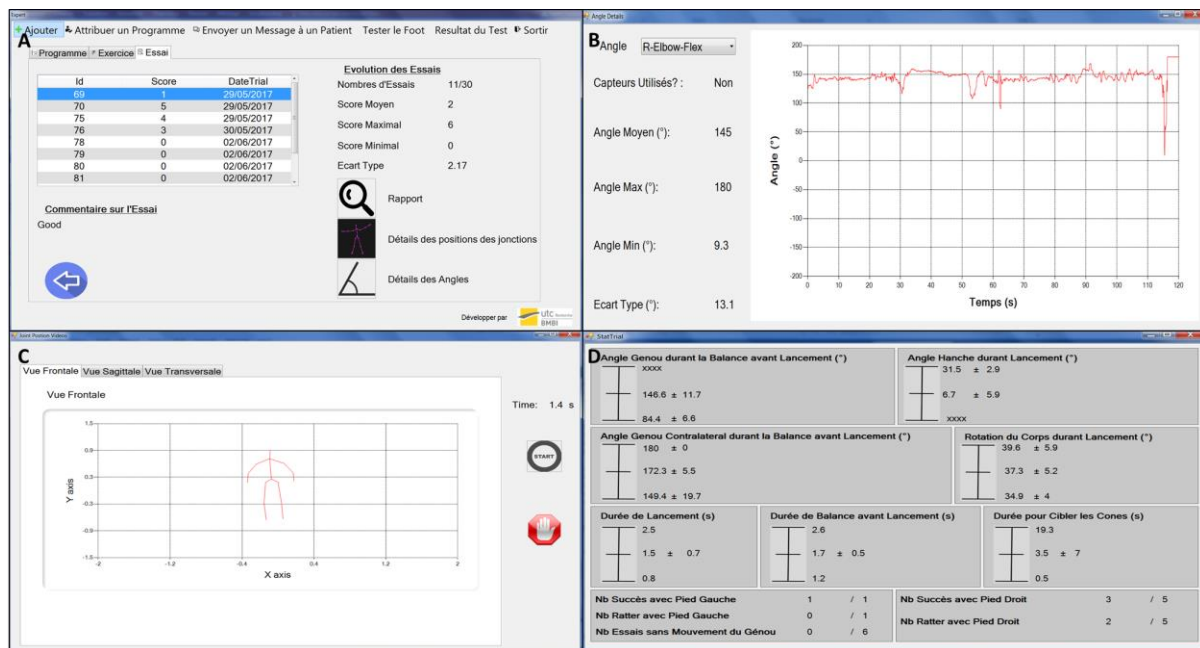

Figure 72. The expert's interfaces for patient monitoring (A: number of trials with statistics, B: joint angle graphs, C: joint position videos and D: generated report)

### 6.1.2.1 Evaluation campaign

A panel of four physical therapists (female, mean age of 42 [SD 11.76]) participated in this evaluation campaign. First, the system's objective and the different graphical user interfaces were explained to all participated experts. Then, each evaluation was performed individually. The testing protocol using the developed system was established with the following tasks: 1) Add a rehabilitation program; 2) Add a patient; 3) Assign a rehabilitation program to a patient; 4) Send a message to the patient; 5) Examine the patient's results (statistical results, angular results and joint position results); and 6) Evaluate the interface using a questionnaire. The selected questionnaire to evaluate our interface is a well cited computer usability evaluation questionnaire, developed by IBM [149]. This evaluation gives indications on 4 different factors: overall satisfaction score, system usefulness, information quality and interface quality. Moreover, at the end of the test, experts were asked to leave a comment about the interface in general and their interest in using it.

### 6.1.2.2 Results

The results of the expert interface evaluation are shown in Figure 73. The answers of the experts yielded above average medians. The overall satisfaction score of our interface had

a median value of 0.778, maximum and minimum values of 0.849 and 0.676 respectively. The first and third quartile values of 0.721 and 0.819.

At the end of the questionnaire-based evaluation, general comments from experts were acquired for the improvement of the proposed system. 1) First recommendation relates to the design of a more affordable interface (that can be deployed at home), simpler, easier to use and more fun for patients. 2) Other point deals with the adaptation of the developed interfaces for professional people with visual difficulties.

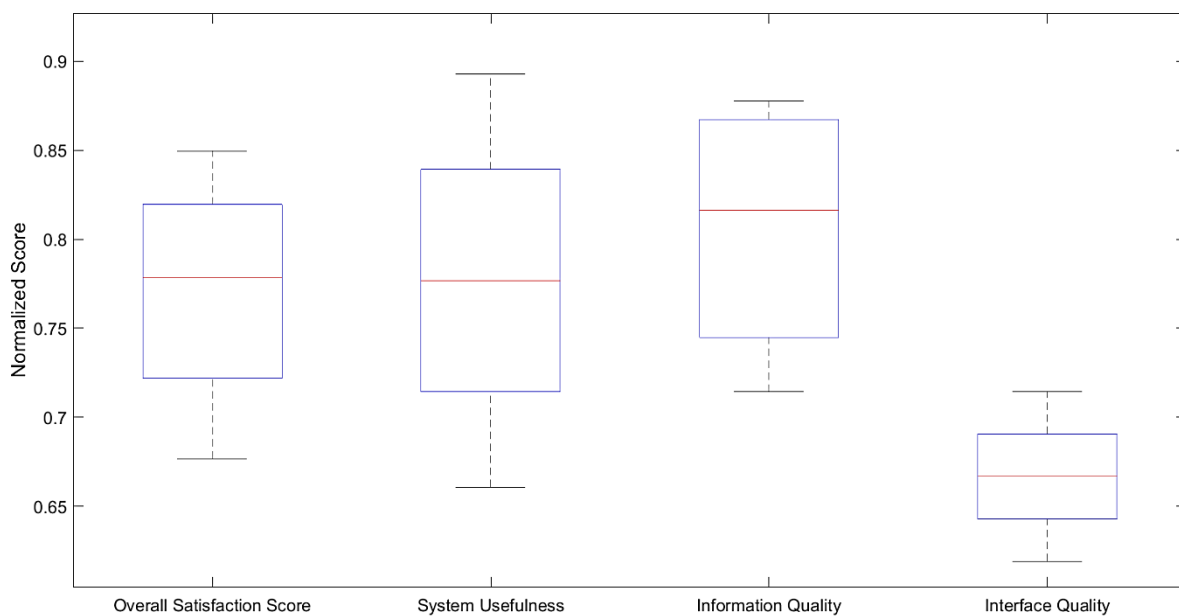

Figure 73. Experts' responses to the interface evaluation questionnaire

Clinical experts who evaluated our interface were globally satisfied (median normalized overall satisfaction score of 0.778). The experts also felt that the data we present is more than enough to assess the situation of the patient with a median normalized information quality score of 0.816. However, the interface quality score was lower than the others, but remains higher than average. This means that we need to increase the attractiveness of the interface, and take into consideration the different users (medical expert comment #2 stated above). Finally, we compared these results with studies that evaluated medical interfaces. *Kao et al.* developed a user interface to monitor patients' blood sugar and blood levels [150], where medical experts evaluated the interface using the same questionnaire. Our system had better usefulness and information quality scores, while theirs had the better interface quality. *Ling et al.* designed serious games for patients who underwent hip replacement surgery [151]. They also developed and evaluated a monitoring interface for experts using the questionnaire designed in [152]. Our

interface proved to be more useful. Moreover, comments on the games from the physiotherapist suggest that their games were too difficult for patients.

## 6.2 Database

A database was developed for this project to include information about patients, experts, programs and exercise trials. We developed a model for the database to be integrated into the program. The database model is shown in Figure 74.

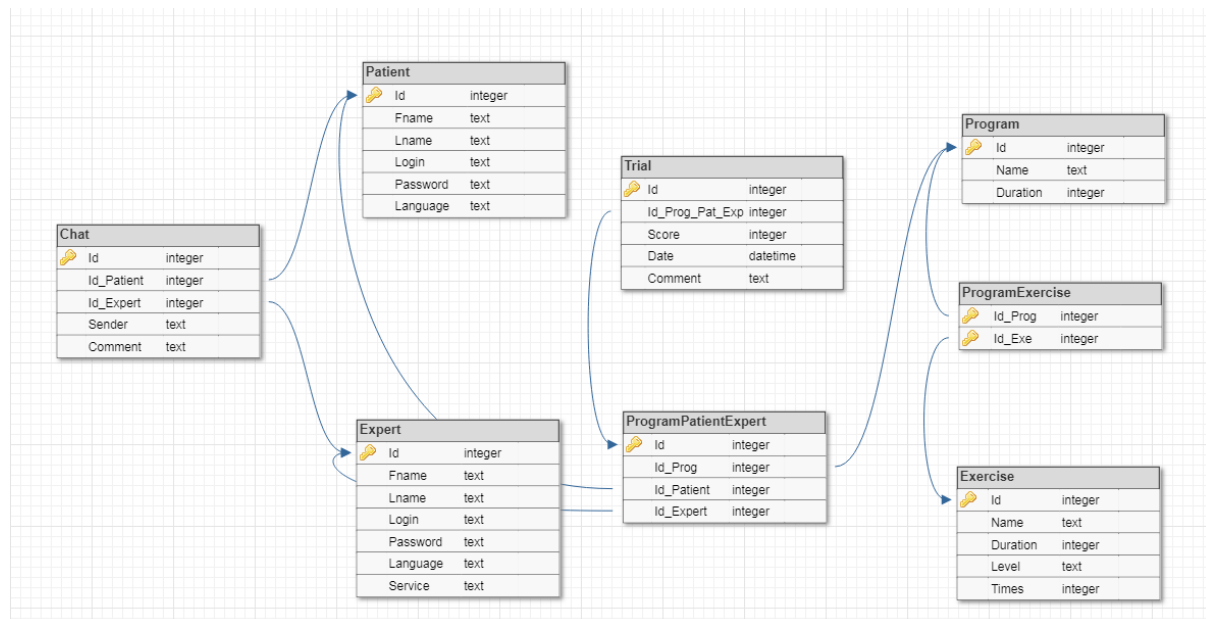

Figure 74. Database diagram

The database diagram shown in the Figure 74 is simply based on the project's needs. First, two tables are created for patients and experts. Another table is created for the exercises and one for the programs. Each program contains many exercises, and one exercise can be found in many programs, so the Exercise and Program tables are connected together to a third table "ProgramExercise" in a "Many to Many" connection. Each patient has programs assigned by experts in a way that, one expert can assign many programs to many patients, and several experts can assign the same program to different patients. Thus, the three tables are connected together in a fourth table "ProgramPatientExpert". Finally, each exercise in each program, specific to a patient and an expert has many trials. For this reason, we connected Trial, to the "ProgramPatientExpert" table.

In addition, and in order to protect our user, we suggested the use of a cryptographic method to save passwords inside the database. For instance, the HMAC MD5 algorithm will be used to hash the values entered by the subscribing user, then the result will be saved to

database. The algorithm will “salt” the password chosen before hashing it and saving it inside the database. After saving each patient and expert in the database, when a new user logs in, the program will test the input values of this user (password and username), execute the HMAC MD5 algorithm and compare with the database. If the result and the saved value match, the user enters their desired page. Finally, this database should be implemented on the cloud in order to link between patient and expert interfaces.

### 6.3 Final system setup

Finally, through the different studies that were conducted during this thesis, we obtained a system that can be implemented similarly to what we planned to achieved at the beginning. The final system setup follows the scheme shown in Figure 75. The patient, who experts deem ready for home-based rehabilitation, will have their state assessed by the experts in a test game, to determine some key variables to personalize a home-based rehabilitation program. The expert then designs a rehabilitation program for their patient. At home, the patient plays the games periodically, and communicates with their experts through a messaging window. Meanwhile, the expert analyzes the different statistical variables that are obtained by patients during their home exercise execution. The expert has the option to include games that imitate real-life scenarios, or virtual serious scenarios that offer objective feedback to the patient. In addition, they can choose to vary the period between clinical sessions based on the patient’s home exercise performance.

The studies conducted on the IMU sensors power consumption, the Kinect camera’s accuracy and the user acceptability allow us to propose an optimal configuration to set up a serious game system at home. We recommend a minimal distance of 2 meters between the user and the visual sensor, this requires a room of at least 4x4 meters, where the furniture is not between the player and the sensors. Moreover, the visual sensor works best when the room is well lit. When it comes to inertial sensors, the type of clothes worn by the user affects them generally. That is why we recommend that the users wear shorts and t-shirts, or clothes that are not larger than their size, in order to maximize the contact between the sensor and the body.



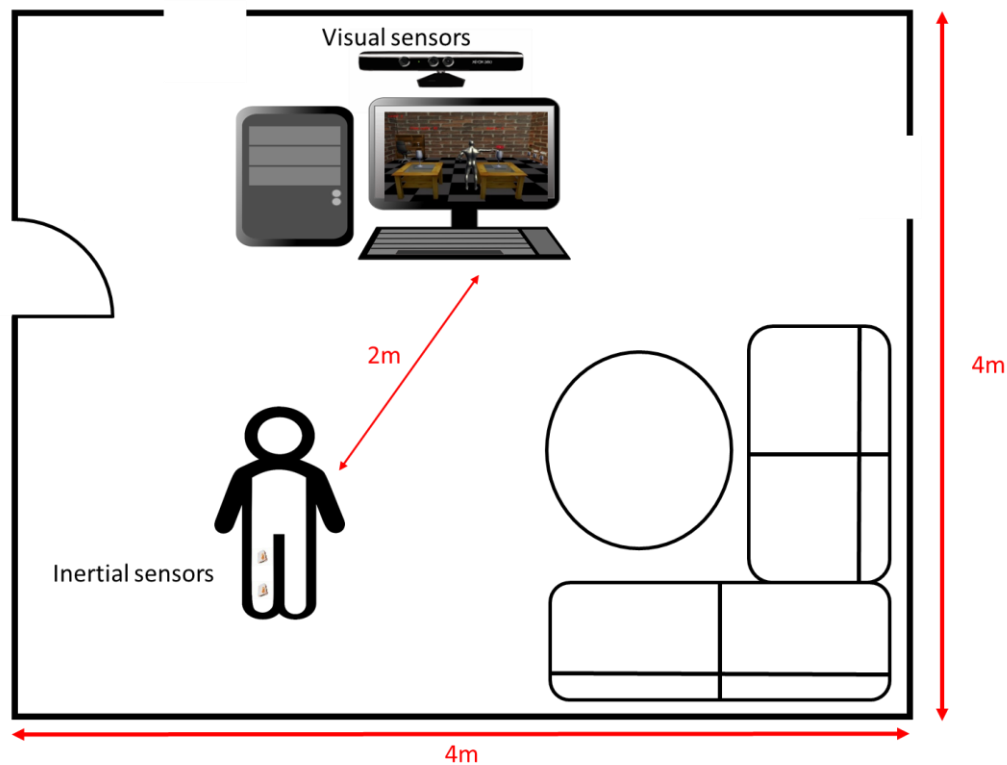

Figure 75. Optimal room configuration for home-based rehabilitation using serious games

In addition, the sensors should be recharged after each 25 rehabilitation sessions (given that a rehabilitation session last 30 mins), regardless of the environmental factors in the room. To the best of our knowledge, this system is the first one providing a high level of accurate kinematics data for functional rehabilitation while keeping a low cost for the proposed solution. Moreover, only one Kinect camera (around 200 euros) and two inertial sensors to use on any joint (700 euros) are needed for the system installation. A PC (costs around 500 euros) is also required. Thus, the whole system now costs approximately 1400 euros showing that a home-based setting is reasonably possible. Note that the use of inertial sensor is optional and this could be avoided in specific conditions. Moreover, the inertial sensors need to be calibrated only once before using them at home.

However, experts were really skeptical about the ability of patients to use inertial sensors at home, due to their inability to precisely manipulate small objects and attach them to their bodies. As a solution, the experts and the scientific team adopted a new approach to use the tool as a rehabilitation device. Thus, two different protocols were identified:

- At the clinic, inertial sensors are placed on vital joints, with Kinect camera, in order to benefit from the accuracy of the data fusion output to determine joint angles. This

configuration can be regarded as an assessment tool to determine the accurate progress of the patient after their home rehabilitation efforts.

- At home, the Kinect is used alone to play the games. The camera has enough accuracy to assess games, and offers some basic data that can help experts in keeping an eye on their patients. This will allow patients to practice the exercises in a fun way, without having the trouble of attaching sensors to their body.

## 6.4 Conclusion

In this chapter, we presented the user interfaces that were implemented for our serious game system. A panel of clinical experts evaluated the interfaces, using different questionnaires. The results showed that our interfaces were easy to use, and provided suitable information for experts. The medical staff also recommended some changes that were taken into consideration. The user acceptability results were also studied to improve the interfaces that we proposed. Finally, we gave some recommendations on optimal room and user conditions to use serious games at home. In addition, after discussion with experts, we proposed two different modes to use the system as a patient assessment tool or as a patient rehabilitation tool.

# Chapter 7      General Discussion and Perspectives

In this chapter, we summarize the major scientific, technological and clinical contributions that we achieved during this thesis. We also present perspectives that we plan on pursuing in the near future.

## 7.1 Overview of the achieved system

The objective of this thesis was to answer questions in the field of home-based rehabilitation. How can we quantify the progress of a patient undergoing rehabilitation? Can we motivate these patients through serious games and induce their total immersion in virtual scenarios? How can we integrate different sensors to offer medical experts with the best data related to the patient's movement?

Different studies were conducted to attempt to answer these questions, which led to the development of a rehabilitation system. Therefore, we can say that we achieved the system we proposed in Chapter 1. This system aims to complement the clinical rehabilitation sessions for patients, while helping physiotherapists to keep an eye on them. The expert starts by assessing the state of the patient that is in an advanced stage of their rehabilitation, and suspected to have enough autonomy that allows them to practice home exercises. This will allow the experts to personalize a rehabilitation program for these patients. At home, the patient will play the games and contact their therapists in case of emergency. Finally, the therapist will analyze the session results and decide to change or keep the current rehabilitation session.

In the technological context, the system uses a Kinect camera as a main system of portable motion capture. The experts can choose to add IMUs to increase the accuracy of estimation of certain body joints, that might help describe the patient's advancement. This can help create two different setups for this system, destined for patient use at home or for patient evaluation at the clinic. The patient home-based setup uses the Kinect alone to assess the patient's movements, allowing them to play their games without needing to attach sensors on their bodies. The evaluation setup allows the experts to quantify the patient's progress using Kinect and IMU sensors attached to specific joints. This helps in evaluating the progress of the

patient's rehabilitation. The use of these different setups and the ideal scenario for this system is depicted in Figure 76.

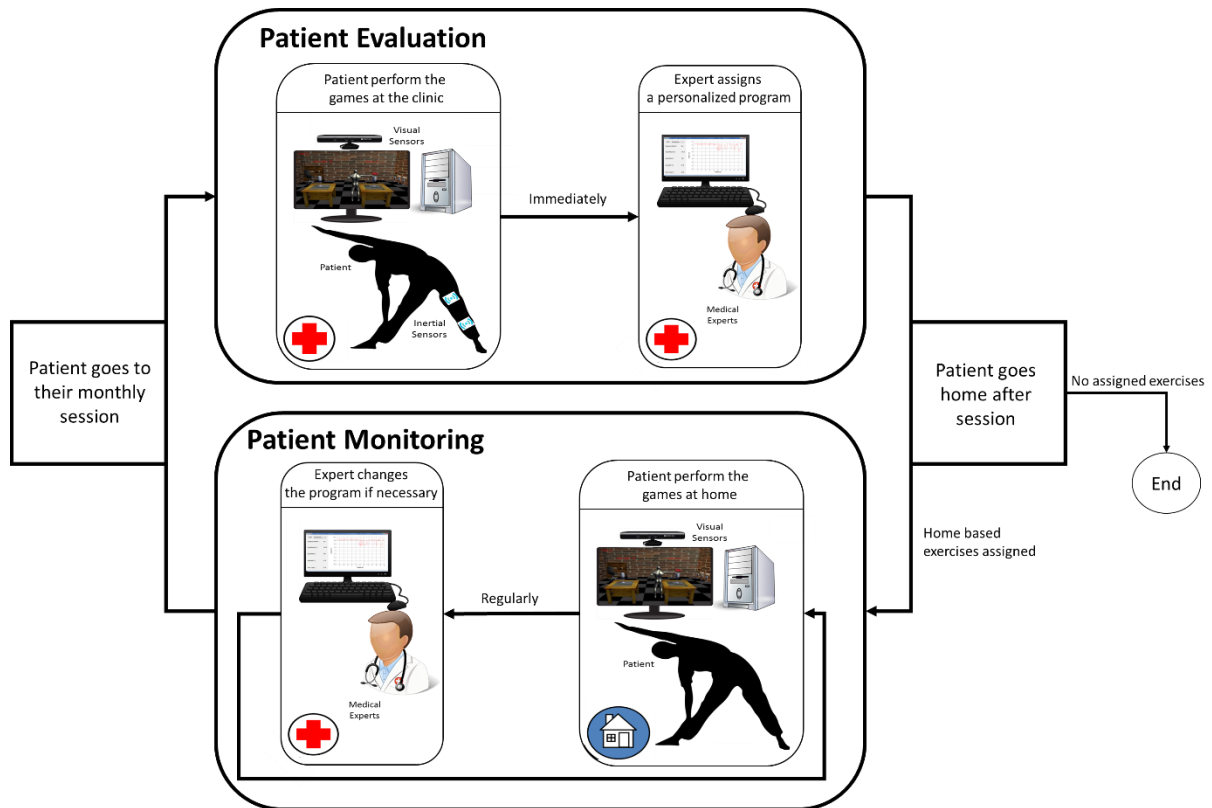

Figure 76. Achieved system used for home-based rehabilitation

## 7.2 Main scientific, technological and clinical contributions

To achieve the previously described system, we focused on 4 different aspects: developing the serious game, applying data fusion between different sensors, optimizing the games with an end-user acceptability study and creating different interfaces for different users to achieve a home rehabilitation tool. We will summarize the different results from each study in the current section.

### 7.2.1 Developing serious games

We developed two serious games that place the patient in a real-life scene, in order to test their ability to move their upper and lower limbs, balance their bodies and use their cognitive abilities. The development of these games followed two proposed guidelines that depict rules for the development and evaluation of serious games for rehabilitation. In this approach, the development team, the medical experts and the patients help design, test and improve the outcome of the games. This approach follows the recently trending concept of co-

design in healthcare, where different end-users are directly involved in the development process of medical tools.

The games were tested by healthy and pathological subjects in a first evaluation campaign, where the results showed that patients can increase the scores with increasing levels of difficulties when they are motivated. In addition, patients can perform better when they like the game, as the highest scores achieved by patients were directly linked to their preferred game. Stroke patients were identified as potential end-users, since they can benefit the most from these types of games, according to medical experts. These results also highlighted many limitations in our system, especially those related to the accuracy of joint angle estimation, since the Kinect camera was used as the sole motion capture tool.

The second campaign evaluated the immersion of stroke patients in serious games using validated questionnaires. In addition, a multisensory fusion algorithm was used to acquire angle data from the patient's affected area, rather than using the Kinect camera alone. The results showed a high immersion for patients in both games, similar to the level of engagement of young adults when playing commercial games.

Finally, experts proposed some improvements to the games. Thus, a personalization concept was added to the football game, where the experts have the ability to choose threshold knee and hip angles that need to be reached at each ball hit attempt. In addition, a new cognitive game was added, where the cognitive aspect in rehabilitation of stroke patients is heavily involved and combined with the functional aspect.

### 7.2.2 Multisensory fusion

The Kinect camera cannot provide the accuracy required by the experts to analyze angle data. Therefore, a new real-time multisensory fusion algorithm was developed to fuse data from Kinect and IMU sensors. The algorithm uses the extended Kalman filter to combine similar input vectors from both types of sensors, and generate a better outcome. The different sources of error related to angular data estimation by both types of sensors were quantified and used as constant values for the fusion algorithm. The algorithm was also tested by placing the IMUs in different positions to estimate the knee angle during the high knee exercise. Healthy subjects tested this algorithm, where we compared the real-time output to the universal goniometer. The results showed that the fusion algorithm offers a more accurate knee angle estimation, compared to the IMU estimation and the Kinect estimation.

In addition, a study was conducted to analyze the battery consumption of IMU sensors in different environmental conditions. This would give ideas on the battery autonomy that can be expected from a system that might use IMU sensors and Kinect camera. The results showed that environmental factors do not affect the battery consumption of IMU sensors, and that they can stream data for up to 15 hrs (30 rehabilitation sessions at 30 min/session).

Finally, the IMU-Kinect fusion algorithm was integrated in serious games through a SoS approach, where each subsystem works separately from the other and the main system can benefit from additional subsystems to offer better angle estimation accuracy.

### 7.2.3 End-user acceptability

An end-user acceptability study was launched in parallel with the development of the serious games in order to insure the development of a usable medical tool. Human science researchers conducted interviews with medical students and expert physiotherapists. The medical students were interviewed in focus groups, while medical experts were interviewed separately using semi-directive questionnaires.

The first results highlighted the expectations that medical experts have when imagining a serious game for functional rehabilitation. There should be 3 types of data that can be visualized by the different users: level 1 for the patients, where they can see their results through easy graphs and colorful schemes, level 2 which generate useful and concise reports for experts, and level 3 where the joint positions and angles are saved for experts, to be consulted whenever necessary. In addition, the experts recommend the development of different types of games. Type 1 where the patient benefits only from the visual feedback related to their movements, and where there is no game to be played. The second type places the patient in a scenario relating to real-life situations, and where they need to perform tasks to get rewards. The third type includes imaginary scenarios with advanced visual graphics.

Finally, the experts suggested adding anonymous videos highlighting the different joint positions during the session. In addition, they agreed that there should be a daily usage time limitation for the device, in order to insure a good recovery time for patients undergoing home rehabilitation.

These results were taken into consideration in the final implementation of the games and user interfaces.

## 7.2.4 Home-based rehabilitation

In the context of combining different outcomes of the different studies, a final study was conducted to create different interfaces for the end-users of our system. These interfaces will be used by patients at home, and experts in their clinics. The developed interfaces were conceived to corroborate the remarks and expectations that resulted from the end-user acceptability study, and from the medical team that followed the development of this system. The expert interface, which allowed them to check on the results of their patients during their home rehabilitation, was evaluated using a validated questionnaire. The results showed that our interface was easy to use and offered more than enough data for experts to analyze the patient's situation. A database was also implemented, in order to concretize the relationships between patients, experts, rehabilitation programs and exercises. Table 11 shows a comparison between our system and some existing commercial and academic home-based rehabilitation solutions. We clearly see that there is no unified development and evaluation methodology when it comes to creating these solutions. Moreover, the commercial tools seem to disregard the evaluation phase, necessary to prove the clinical relevance of these rehabilitation tools. In addition, while most systems offer session report capacity for medical experts, all of the available systems do not describe the level of accuracy that their sensors offer. Therefore, we see once more that the need to create a unified framework for developing and evaluating serious games for rehabilitation is imminent.

Table 11. Comparison with existing home-based solutions

System	GAMEREHAB @HOME	Medimoov [90]	Chatzitofis et al. [124]	Jintronix [89]	SeeMe [88]	Rehab@Home [128]	Vasconcelos et al. [127]
<b>Development methodology</b>	Co-design, co-conception	Discussion with medical experts	Not specified	Not specified	Not specified	Not specified	Conceptualized by developers
<b>Kinematic devices</b>	Kinect alone and/or multisensory fusion	Kinect	Kinect and/or inertial sensors	Kinect	Kinect	Kinect	Cell phone and EMG sensors
<b>Kinematics accuracy</b>	14° with Kinect and 3.5° with multisensory fusion	Not specified	Not specified	Not specified	Not specified	Not specified	Not specified
<b>Serious games</b>	<ul style="list-style-type: none"> <li>• Football</li> <li>• Object manipulation</li> <li>• Simple task exergames</li> </ul>	<ul style="list-style-type: none"> <li>• Hammer and plank</li> </ul>	<ul style="list-style-type: none"> <li>• Exergames (jumping, running)</li> </ul>	<ul style="list-style-type: none"> <li>• Moving the ball on a ledge</li> <li>• Skiing</li> </ul>	<ul style="list-style-type: none"> <li>• Clean the Window</li> <li>• Hit the ball</li> </ul>	<ul style="list-style-type: none"> <li>• Touch the flours and avoid the bees</li> </ul>	<ul style="list-style-type: none"> <li>• Gates game</li> <li>• Bridges game</li> </ul>

				<ul style="list-style-type: none"> <li>• Hit the ball</li> <li>• Move the fish</li> </ul>	<ul style="list-style-type: none"> <li>• Catch the objects</li> </ul>	<ul style="list-style-type: none"> <li>• Move the basket on the Table</li> <li>• Move object in correct trajectory</li> <li>• Put objects on kitchen shelf</li> </ul>	<ul style="list-style-type: none"> <li>• Escape the labyrinth game</li> </ul>
<b>Rehabilitated members</b>	Upper and lower limbs	Upper limbs	Upper and lower limbs	Upper and lower limbs	Upper and lower limbs	Upper limbs	Upper limbs
<b>Type of rehabilitation</b>	Functional and cognitive	Functional	Cardiovascular	Functional	Functional	Functional	Functional
<b>Real-time feedbacks</b>	Virtual avatar movement (joint positions and angles in 3D)	Upper body joint movement speed and angles	Virtual avatar movement (joint positions and angles in 3D)	Virtual avatar movement (joint positions and angles in 3D)	Patient movement on screen	Hand position	Hand position and EMG activity
<b>Exercise personalization</b>	Defined by expert	Dynamic difficulty during gameplay	Not specified	Defined by expert	Defined by expert	Not specified	Not specified
<b>Software architecture</b>	Standalone and cloud-based applications	Standalone application	Cloud-based application	Standalone and cloud-based applications	Standalone and cloud-based applications	Standalone application	Standalone application
<b>Reporting</b>	Exercise and session statistics on patient movement in 3D and joint angles with high accuracy	Movement speed and joint angles	Not specified	Exercise and session statistics on balance and stability, strength and reaching distance	Activity of both left and right body sides	Exercise and session statistics on reaching distance and grasping strength	Not specified
<b>System evaluation</b>	User (patient and expert) acceptability based on questionnaires	Not specified	Not specified	Not specified	Not specified	Single-blind randomized controlled trial	Not specified
<b>Exercise evaluation</b>	Short-term usefulness and applicability	Not specified	Not specified	Not specified	Not specified	Long term usefulness	Not specified
<b>Approximate cost</b>	500-700 euros	200 euros/month	Not specified	Not specified	Not specified	Not specified	Not specified



Finally, we gave some recommendation on implementing similar serious game systems at home, describing the ideal environmental conditions. Based on this information, we proposed the two different usages of the developed system, described in the beginning of this chapter.

### 7.3 Conclusions and perspectives

A robust and user-friendly serious gaming system was developed during this 3-year thesis. Thus, we achieved our initial objective and developed a rehabilitation system that links the patient to the expert and quantifies the progress of rehabilitation patients through statistical data. This ultimate objective was realized through the identification of 4 sub studies that were conducted by a team of scientists, medical experts, human science experts and university students. The results of these studies helped us surpass some boundaries in the field of games for health and data fusion. Moreover, the different questions that were initially asked by our team were answered throughout the different studies and the overall achieved system.

Results show that our system improves the attitude of the patients towards their rehabilitation. In fact, the patients seem to be more excited to perform their rehabilitation in a virtual environment as opposed to classical supervised movements. General feedback from patients show their intent on using the games, and their perception that these are not only to be enjoyed but also to benefit their situations. The patients did not seem to disregard the seriousness of our device. As for the experts, they were surprised by the amount of data that we provided and saw it as sufficient to assess the patients' situation. They also saw the device as a possible tool that could be implemented at home. Therapists also highlighted the need of this device in the clinical environment to motivate and follow the patient. Moreover, this device will be one of the first to offer the experts highly accurate data to analyze the patients' movements while contributing to the enjoyment of the rehabilitation sessions. We imagine improving our system in the next several years. In two years, the system should have an improved interface with better looking graphics, and a home-based option should be implemented, with a cloud-based server to link experts in their office and patients at home. In five years, the system should have a highly developed library of games and the possibility to create games by the experts without the developers' contribution. We also imagine adding and adapting our system to any new sensors that could improve the results obtained from the games.

In addition, although we recognize the excellent framework and execution that our team set up and performed, we do not deny that our studies and final results have some limitations.

First, the system has not yet been tested through a long-term patient-control group study, in order to prove the clinical relevance of this tool in the context of improving the rehabilitation's effect for patients. This is one of the main studies that will later be conducted in order to validate the ability of serious games to motivate, and help decrease the recovery time for patients.

This thesis contributed in different fields and created the foundation for a home-based rehabilitation system, the current system setup needs to be optimize and improved. More games will be added, in accordance with expert recommendations, to offer more attractive game scenarios and reach a wider audience. Thus, we will investigate and elaborate on guidelines to create relevant serious game exercises for rehabilitation. Additionally, we will investigate the different virtual aspects that render a game more or less "serious". This will eventually lead to the question about the relevance of graphic technologies and input/output devices in improving the patients' rehabilitation progress. Therefore, the different games will be evaluated through additional studies in different fields, to prove their ability in the recovery of patients' movements.

Moreover, the SoS architecture will be revisited to accommodate for other types of additional sensors such as EMG sensors to measure the muscle responses during each session. It is important to note that this integration will lead to new questions about the SoS architecture and communication between the sensors. This might lead us to improve the current SoS model based on our quality of service needs. For instance, the main system could prioritize some subsystem outputs more than others, in order to insure a correct execution of the session. However, it remains true that adding complex system engineering tasks could cause a negative impact on the developers' performances when creating serious gaming solution. This problem needs to be accounted for through appropriate training programs for developers and software engineers. This thesis showed how SoS can be implemented in healthcare engineering, through the integration of different sensors together to perform a more complex task. Nevertheless, and even though a SoS was successfully implemented for functional rehabilitation, this SoS solution should be integrated, in the future, in a bigger SoS that englobes more medical diagnosis and monitoring capacities in hospitals and clinical centers. Thus, the main system can control the rehabilitation subsystem, the intensive care subsystem, the patients' drug treatment subsystem, etc, in order to coordinate and link between the different medical tasks and render them more effective in improving the situation of patients.

At the developed system level, our aspirations do not stop here, and we look forward to improving and expanding our designed and developed system. The team looks to conduct different system upgrades in different fields. First, a team of biomechanical experts will look to use the different data, gathered by the different sensors, to estimate the muscle forces during the patient's movement, and provide new indicators to optimize the rehabilitation program [153]. Next, the developed database will be deployed on a cloud server in order to connect the patient to the expert across long distances, and achieve a sustainable home-based rehabilitation system. Moreover, the data saved on the cloud will be encrypted to respect the ethical background for patient monitoring. Furthermore, the team will look for industrial partners that can take this scientific project, and improve the graphical aspects of the developed scenes. In addition, we imagine offering the experts the ability to create various movement libraries, linking them together to create complex movement exercises, personalized for different patients. This can be performed through capturing the expert's movements using the Kinect camera, while the expert repeats some voice commands in order to record a particular movement and add it to a movement library.

Finally, progress does not stop at the end of this project, as we find ourselves asking more questions now than we were 3 years ago. Therefore, we find an even bigger motivation to enhance our findings and upgrade our achieved system through new scientific studies, and using available state of the art technologies. Finally, our team hopes that this scientific study adds new ideas to the common knowledge of our scientific community, in the hope of improving the wellbeing of the human species.



# My Publications

## Journal Articles (n=7)

- Tannous, H., Istrate, D., Ho Ba Tho, M. C., & Dao, T. T. (2016). **Serious game and functional rehabilitation for the lower limbs**, *European Research in Telemedicine*.
- Tannous, H., Istrate, D., Ho Ba Tho, M. C., & Dao, T. T. (2016). **Feasibility study of a serious game based on Kinect system for functional rehabilitation of the lower limbs**, *European Research in Telemedicine*.
- Dao, T. T., Tannous, H., Pouletaut, P., Gamet, D., Istrate, D., & Ho Ba Tho, M. C. (2016). **Interactive and Connected Rehabilitation Systems for E-Health**, *Innovation and Research in BioMedical Engineering*.
- Tannous, H., Istrate, D., Benlarbi-delai, A., Sarrazin, J., Gamet, D., Ho Ba Tho, M. C., & Dao, T. T. (2016). **A New Multi-sensor Fusion Scheme to Improve the Accuracy of Knee Flexion Kinematics for Functional Rehabilitation Movements**, *Sensors*.
- Idriss, M., Tannous, H., Istrate, D., Perrochon, A., Salle, J. Y., Ho Ba Tho, M. C., & Dao T. T. (2017). **Rehabilitation-oriented serious game development and evaluation guidelines for musculoskeletal disorders**, *JMIR Serious games*.
- Tannous, H., Istrate, D., Benlarbi-Delai, A., Sarrazin, J., Ho Ba Tho, M. C., Chaouche, F., Kleinpeter, E., & Dao, T. T. (2018). **Serious Games for Home Based Rehabilitation: Inertial Sensor Energy Consumption and User Acceptability Study**, *Innovation and Research in BioMedical Engineering* (Under Review).
- Tannous, H., Istrate, D., Perrochon, A., Daviet, J. C., Benlarbi-Delai, A., Sarrazin, J., Ho Ba Tho, M. C., & Dao, T. T. (2018). **GAMEREHAB@HOME: a new engineering system using serious game and multi-sensor fusion technologies toward functional rehabilitation at home**, *International Journal of Human-Computer Studies* (Under Review).

## International Conference Papers (n=4)

- Tannous, H., Dao, T. T., Istrate, D. & Ho Ba Tho, M. C. (2015). **Serious Game for Functional Rehabilitation**, *IEEE 3rd International Conference on Advances in Biomedical Engineering, Beirut, Lebanon*.
- Tannous, H., Istrate, D., Benlarbi-delai, A., Sarrazin, J., Idriss, Ho Ba Tho, M. C., & Dao, T. T. (2016). **Exploring Various Orientation Measurement Approaches Applied to a Serious Game System for Functional Rehabilitation**, *IEEE Engineering in Medicine and Biology Society, Orlando, Florida*.
- Tannous, H., Idriss, M., Benlarbi-delai, A., Sarrazin, J., Istrate, D., Ho Ba Tho, M. C., & Dao T. T. (2017). **Rehabilitation at Home with real time feedback**, *ICCB 2017, Compiègne, France*.
- Tannous, H., Grébonval, C., Istrate, D., Perrochon, A., Dao T. T. (2018). **Cognitive and functional rehabilitation using serious games and a system of systems approach**, *SOSE 2018, Paris, France*.

## **National Conference Papers (n=4)**

- Dao, T. T., Tannous, H., Pouletaut, P., Gamet, D., Istrate, D., & Ho Ba Tho, M. C. (2015). **Interactive and Connected Rehabilitation Systems for E-Health**, *JETSAN 2015, Compiègne, France*.
- Guettari, T., Istrate, D., Tannous, H., Dao, T. T. (2015). **Multimodal fusion for functional rehabilitation at home In**, *8e congrès européen de la Société Française de Télémedecine, 30-31 octobre 2015, Paris, France*.
- Tannous, H., Idriss, M., Benlarbi-delai, A., Sarrazin, J., Istrate, D., Perrochon, A., Salle, J. Y., Ho Ba Tho, M. C., & Dao T. T. (2017). **Tele-Rehabilitation Serious Game**, *JETSAN 2017, Bourges, France*.
- Tannous, H., Istrate, D., Benlarbi-delai, A., Sarrazin, J., Dao T. T. (2018). **A Home-Based Tool for Functional Rehabilitation**, *LAAS 2018, Lebanon*.

# References

- [1] P. D. United Nations, Department of Economic and Social Affairs, “World Population Prospects The 2017 Revision Key Findings and Advance Tables,” 2017.
- [2] INSEE, “Estimations de Population,” 2017. [Online]. Available: [insee.fr/fr/statistiques/1892086?sommaire=1912926](http://insee.fr/fr/statistiques/1892086?sommaire=1912926).
- [3] C. Bonvalet, C. Clément, and J. Ogg, “Renewing the Family: A History of the Baby Boomers,” vol. 4, p. 268, 2015.
- [4] D. Beland and J.-P. Viriot Durandal, “Aging in France: Population Trends, Policy Issues, and Research Institutions,” *The Gerontologist*, vol. 53, no. 2, pp. 191–197, 2013.
- [5] AARP Public Policy Institute, “Chronic Conditions Among Older Americans,” 2014.
- [6] N. Fourcade, F. von Lennep, I. Grémy, F. Bourdillon, L. Luciano, S. Rey, E. Bauchet, I. Grémy, and M. Vernay, “L’état de santé de la population en France - RAPPORT 2017,” p. 434, 2017.
- [7] H. Aroui, I. Merchaoui, M. Adnène Henchi, I. Rassas, N. Belhadj, N. Chaari, and C. Amri, “Musculoskeletal disorders of the hand and wrist and population attributable fraction of risk of exposure to biomechanical constraints,” *Annals of Physical and Rehabilitation Medicine*, vol. 59, pp. e113–e114, 2016.
- [8] J. Cox, S. Varatharajan, P. Côté, and Optima Collaboration, “Effectiveness of Acupuncture Therapies to Manage Musculoskeletal Disorders of the Extremities: A Systematic Review,” *Journal of Orthopaedic & Sports Physical Therapy*, vol. 46, no. 6, pp. 409–429, 2016.
- [9] T. Vos, A. Abajobir, and A. Alemu, “Global, regional, and national incidence, prevalence, and years lived with disability for 328 diseases and injuries for 195 countries, 1990-2016: A systematic analysis for the Global Burden of Disease Study 2016,” *The Lancet*, vol. 390, no. 10100, pp. 1211–1259, 2017.
- [10] INRS, “Les troubles musculosquelettiques du membre supérieur,” 2001.
- [11] L. Broussy, “L’adaptation de la société au vieillissement de sa population: FRANCE: ANNEE ZERO!,” 2013.
- [12] Conseil National de l’Ordre des Médecins, “L’Atlas de la démographie médicale en France en 2015,” 2011.
- [13] Conseil National de l’Ordre des Masseurs-Kinésithérapeutes, “Démographie des kinésithérapeutes,” 2017.
- [14] “Eco-Santé.” [Online]. Available: [ecosante.fr/index2.php?base=DEPA&langh=FRA&langs=FRA](http://ecosante.fr/index2.php?base=DEPA&langh=FRA&langs=FRA).
- [15] C.-M. Chen, Y.-H. Yang, C.-H. Chang, C.-C. Chen, and P.-C. Chen, “The Utilization of Rehabilitation in Patients with Hemophilia A in Taiwan: A Nationwide Population-Based Study,” *Plos One*, vol. 11, no. 9, p. e0164009, 2016.
- [16] M. V. G. B. Serra, P. R. Camargo, J. E. Zaia, M. G. M. Tonello, and P. R. V. Quemelo, “Effects of physical exercise on musculoskeletal disorders, stress and quality of life in workers,” *International Journal of Occupational Safety and Ergonomics*, vol. 3548, no. October, pp. 1–6, 2016.
- [17] “Ministère des Solidarités et de la Santé.” [Online]. Available: [drees.solidarites-sante.gouv.fr/etudes-et-statistiques](http://drees.solidarites-sante.gouv.fr/etudes-et-statistiques).
- [18] J. C. Perry, J. Andureu, F. I. Cavallaro, J. Veneman, S. Carmien, and T. Keller, “Effective game use in neurorehabilitation : user- centered perspectives,” pp. 1–44, 2009.
- [19] A. Noites, C. P. Freitas, J. Pinto, C. Melo, A. Vieira, A. Albuquerque, M. Teixeira, F. Ribeiro, and J. M. Bastos, “Effects of a Phase IV Home-Based Cardiac Rehabilitation Program on Cardiorespiratory Fitness and Physical Activity.,” *Heart Lung and Circulation*, no. pagination, p. 2016, 2016.
- [20] D. Rice, S. Janzen, A. McIntyre, J. Vermeer, E. Britt, and R. Teasell, “Comprehensive Outpatient

- Rehabilitation Program: Hospital-Based Stroke Outpatient Rehabilitation,” *Journal of Stroke and Cerebrovascular Diseases*, vol. 25, no. 5, pp. 1158–1164, 2016.
- [21] P. J. Wijkstra, R. Van Altena, J. Kraan, V. Otten, D. S. Postma, and G. H. Koeter, “Quality of life in patients with chronic obstructive pulmonary disease improves after rehabilitation at home,” *European Respiratory Journal*, vol. 7, no. 2, pp. 269–273, 1994.
- [22] A. Moe and H. V. Brataas, “Interdisciplinary collaboration experiences in creating an everyday rehabilitation model: A pilot study,” *Journal of Multidisciplinary Healthcare*, vol. 9, pp. 173–182, 2016.
- [23] N. Capan, S. Esmailzadeh, A. Karan, D. Diracoglu, U. Emekli, A. Yıldız, A. Baskent, and C. Aksoy, “Effect of an early supervised rehabilitation programme compared with home-based exercise after temporomandibular joint condylar discopexy: a randomized controlled trial,” *International Journal of Oral and Maxillofacial Surgery*, vol. 46, no. 3, pp. 314–321, 2017.
- [24] R. Hwang, J. Bruning, N. R. Morris, A. Mandrusiak, and T. Russell, “Home-based telerehabilitation is not inferior to a centre-based program in patients with chronic heart failure: a randomised trial,” *Journal of Physiotherapy*, vol. 63, no. 2, pp. 101–107, 2017.
- [25] J. Almazán, “A Randomized Controlled Trial of Rehabilitation at Home After Stroke in Southwest Stockholm,” *Stroke*, vol. 29, pp. 591–597, 1998.
- [26] A.-M. Thorsen, L. Wides Holmqvist, J. de Pedro-Cuesta, and L. von Koch, “A Randomized Controlled Trial of Early Supported Discharge and Continued Rehabilitation at Home After Stroke: Five-Year Follow-Up of Patient Outcome,” *Stroke*, vol. 36, no. 2, pp. 297–303, 2005.
- [27] V. Wattanasoontorn, I. Boada, R. García, and M. Sbert, “Serious games for health,” *Entertainment Computing*, vol. 4, no. 4, pp. 231–247, Dec. 2013.
- [28] K. Seaborn and D. I. Fels, “Gamification in theory and action: A survey,” *International Journal of Human Computer Studies*, vol. 74, pp. 14–31, 2015.
- [29] M. Pasch, N. Bianchi-Berthouze, B. van Dijk, and A. Nijholt, “Movement-based sports video games: Investigating motivation and gaming experience,” *Entertainment Computing*, vol. 1, no. 2, pp. 49–61, 2009.
- [30] D. González-Ortega, F. J. Díaz-Pernas, M. Martínez-Zarzuela, and M. Antón-Rodríguez, “A Kinect-based system for cognitive rehabilitation exercises monitoring,” *Computer Methods and Programs in Biomedicine*, vol. 113, no. 2, pp. 620–631, 2014.
- [31] E. P. Cherniack, “Not just fun and games: Applications of virtual reality in the identification and rehabilitation of cognitive disorders of the elderly,” *Disability and Rehabilitation: Assistive Technology*, vol. 6, no. 4, pp. 283–289, 2011.
- [32] D. Webster and O. Celik, “Systematic review of Kinect applications in elderly care and stroke rehabilitation.(Review)(Report),” *Journal of NeuroEngineering and Rehabilitation*, vol. 11, 2014.
- [33] I. T. Paraskevopoulos, E. Tseklevs, C. Craig, C. Whyatt, and J. Cosmas, “Design guidelines for developing customised serious games for parkinson’s disease rehabilitation using bespoke game sensors,” *Entertainment Computing*, vol. 5, no. 4, pp. 413–424, 2014.
- [34] S. McCallum, “Gamification and serious games for personalized health,” in *Studies in Health Technology and Informatics*, 2012, vol. 177, pp. 85–96.
- [35] J. W. Burke, M. D. J. McNeill, D. K. Charles, P. J. Morrow, J. H. Crosbie, and S. M. McDonough, “Optimising engagement for stroke rehabilitation using serious games,” *Visual Computer*, vol. 25, no. 12, pp. 1085–1099, 2009.
- [36] T. M. Connolly, E. A. Boyle, E. Macarthur, T. Hainey, and J. M. Boyle, “A systematic literature review of empirical evidence on computer games and serious games,” *Computers & Education*, vol. 59, no. 2, pp. 661–686, 2012.
- [37] D. Charsky, “From edutainment to serious games: A change in the use of game characteristics,” *Games and Culture*, vol. 5, no. 2, pp. 177–198, 2010.
- [38] “Systems-of-Systems Symposium: Report on a Summer Conversation,” 2004. [Online]. Available:



- [http://en.wikipedia.org/wiki/Sysyems\\_of\\_Systems](http://en.wikipedia.org/wiki/Sysyems_of_Systems).
- [39] J. Boardman and B. Sauser, "System of Systems - the meaning of of," *2006 IEEE/SMC International Conference on System of Systems Engineering*, pp. 118–123.
- [40] J. S. Dahmann and K. J. Baldwin, "Understanding the Current State of US Defense Systems of Systems and the Implications for Systems Engineering," *2008 2nd Annual IEEE Systems Conference*, pp. 1–7, 2008.
- [41] M. W. Maier, "Architecting Principles for Systems-of-Systems," *INCOSE International Symposium*, vol. 6, no. 1, pp. 565–573, 1996.
- [42] J. A. Lane, "What is a System of Systems and Why Should I Care?," pp. 1–14, 2013.
- [43] D. Walden and G. Roedler, *INCOSE Systems Engineering Handbook: A Guide for System Life Cycle Processes and Activities, 4th Edition*. 2015.
- [44] N. Wickramasinghe, S. Chalasani, R. V. Boppana, and A. M. Madni, "Healthcare System of Systems," *2007 IEEE International Conference on System of Systems Engineering*, pp. 1–6, 2007.
- [45] Y. Hata, S. Kobashi, and H. Nakajima, "Human health care system of systems," *Systems Journal, IEEE*, vol. 3, no. 2, pp. 231–238, 2009.
- [46] P. Plantard, E. Auvinet, A.-S. Le Pierres, and F. Multon, "Pose estimation with a Kinect for ergonomic studies: evaluation of the accuracy using a virtual mannequin.," *Sensors (Basel, Switzerland)*, vol. 15, no. 1, pp. 1785–803, Jan. 2015.
- [47] B. Bonnechère, B. Jansen, P. Salvia, H. Bouzahouene, L. Omelina, F. Moiseev, V. Sholukha, J. Cornelis, M. Rooze, and S. Van Sint Jan, "Validity and reliability of the Kinect within functional assessment activities: comparison with standard stereophotogrammetry.," *Gait & posture*, vol. 39, no. 1, pp. 593–8, Jan. 2014.
- [48] R. W. Bohannon, "Clinical Measurement of Range of Motion Review of Goniometry Emphasizing Reliability and Validity," vol. 67, no. 12, pp. 1867–1872, 1987.
- [49] L. Brosseau, M. Tousignant, J. Budd, N. Chartier, L. Duciaume, S. Plamondon, J. P. O'Sullivan, S. O'Donoghue, and S. Balmer, "Intratester and intertester reliability and criterion validity of the parallelogram and universal goniometers for active knee flexion in healthy subjects," *Physiotherapy Research International*, vol. 2, no. 3, pp. 150–166, Aug. 1997.
- [50] "Shimmer Sensing." [Online]. Available: [shimmersensing.com](http://shimmersensing.com).
- [51] M. Koch, F. Ott, S. Oertelt, M. Minge, J. Bürglen, H. Chen, K. Gerling, M. Masuch, S. Deterding, D. Dixon, R. Khaled, L. Nacke, J. J. J. Lee, and J. Hammer, "From game design elements to gamefulness," *Schriften zur soziotechnischen Integration, Band 3*, vol. 15, no. 2, p. 2797, 2011.
- [52] D. R. Michael and S. L. Chen, "Serious Games: Games That Educate, Train, and Inform," *Education*, vol. October 31, pp. 1–95, 2005.
- [53] A. Navarro, J. V. Pradilla, and O. Rios, "Open Source 3D Game Engines for Serious Games Modeling."
- [54] "Oxford Dictionary." [Online]. Available: [www.oxforddictionaries.com](http://www.oxforddictionaries.com).
- [55] S. S. Adkins, "The 2017-2022 Global Game-based Learning Market," *Serious Play Conference*, no. July, pp. 1–20, 2017.
- [56] J. A. Kim, K. K. Kang, H. R. Yang, and D. Kim, "A sensory gate-ball game for the aged people and its user interface design," *Proceedings of the 2009 Conference in Games and Virtual Worlds for Serious Applications, VS-GAMES 2009*, pp. 111–116, 2009.
- [57] A. Laikari, "Exergaming - gaming for health," *The 13th IEEE International Symposium on Consumer Electronics (ISCE2009)*, pp. 665–668, 2009.
- [58] J. Clawson, N. Patel, and T. Starner, "Dancing in the streets: The design and evaluation of a wearable health game," *Proceedings - International Symposium on Wearable Computers, ISWC*, vol. 1, pp. 1–4, 2010.

- [59] T. Martins, V. Carvalho, F. Soares, and M. F. Moreira, "Serious game as a tool to intellectual disabilities therapy: Total challenge," *2011 IEEE 1st International Conference on Serious Games and Applications for Health, SeGAH 2011*, 2011.
- [60] A. Alamri, M. M. Hassan, M. A. Hossain, M. Al-Qurishi, Y. Aldukhayyil, and M. Shamim Hossain, "Evaluating the impact of a cloud-based serious game on obese people," *Computers in Human Behavior*, vol. 30, pp. 468–475, 2014.
- [61] T.-L. Sun and C.-H. Lee, "An impact study of the design of exergaming parameters on body intensity from objective and gameplay-based player experience perspectives, based on balance training exergame.," *PLoS one*, vol. 8, no. 7, p. e69471, Jan. 2013.
- [62] I. Di Loreto, B. Lange, A. Seilles, W. Dyce, I. Di Loreto, B. Lange, A. Seilles, W. Dyce, and S. A. G. De-, "Game Design for All : The Example of Hammer and Planks To cite this version : Designing Health Games and Interfaces for General Public Adoption : the Example of Hammer and Planks," 2014.
- [63] E. Prada-Dominguez, S. Valdivia-Trujillo, A. Uribe-Quevedo, and B. Perez-Gutierrez, "Lower member complimentary exercise gaming app," *2014 IEEE Colombian Conference on Communications and Computing, COLCOM 2014 - Conference Proceedings*, 2014.
- [64] B. Lange, C.-Y. Chang, E. Suma, B. Newman, A. S. Rizzo, and M. Bolas, "Development and evaluation of low cost game-based balance rehabilitation tool using the Microsoft Kinect sensor.," *Conference proceedings : ... Annual International Conference of the IEEE Engineering in Medicine and Biology Society. IEEE Engineering in Medicine and Biology Society. Annual Conference*, vol. 2011, pp. 1831–4, Jan. 2011.
- [65] T. Leahey and J. Rosen, "DietBet: A web-based program that uses social gaming and financial incentives to promote weight loss," *Journal of Medical Internet Research*, vol. 16, no. 2, 2014.
- [66] M. A. F. Rodrigues, Y. R. Serpa, D. V. Macedo, and E. S. Sousa, "A serious game to practice stretches and exercises for a correct and healthy posture," *Entertainment Computing*, no. June 2016, pp. 0–1, 2017.
- [67] B. Bonnechère, V. Sholukha, L. Omelina, M. Van Vooren, B. Jansen, and S. Van Sint Jan, "Suitability of functional evaluation embedded in serious game rehabilitation exercises to assess motor development across lifespan," *Gait and Posture*, vol. 57, no. January, pp. 35–39, 2017.
- [68] E. S. De Lima, B. Feijó, S. D. J. Barbosa, A. L. Furtado, A. E. M. Ciarlini, and C. T. Pozzer, "Entertainment Computing – ICEC 2011," *Icec*, vol. 6972, no. January 2016, pp. 1–12, 2011.
- [69] W. Yu, C. Vuong, and T. Ingalls, "An Interactive Multimedia System for Parkinson s Patient Rehabilitation," *Virtual and Mixed Reality - Systems and Applications, Part II, HCI 2011*, pp. 129–137, 2011.
- [70] Á. Rocha, A. M. Correia, S. Costanzo, and L. P. Reis, "New Contributions in Information Systems and Technologies," *Advances in Intelligent Systems and Computing*, vol. 353, pp. III–IV, 2015.
- [71] A. A. Foletto, M. Cordeiro d'Ornellas, and A. L. Cervi Prado, "Serious Games for Parkinson's Disease Fine Motor Skills Rehabilitation Using Natural Interfaces.," *Studies in health technology and informatics*, vol. 245, pp. 74–78, 2017.
- [72] S. Cho, J. Ku, Y. K. Cho, I. Y. Kim, Y. J. Kang, D. P. Jang, and S. I. Kim, "Development of virtual reality proprioceptive rehabilitation system for stroke patients," *Computer Methods and Programs in Biomedicine*, vol. 113, no. 1, pp. 258–265, 2014.
- [73] Q. Ding, I. H. Stevenson, N. Wang, W. Li, Y. Sun, Q. Wang, K. Kording, and K. Wei, "Motion games improve balance control in stroke survivors: A preliminary study based on the principle of constraint-induced movement therapy," *Displays*, vol. 34, no. 2, pp. 125–131, Apr. 2013.
- [74] J. M. Ibarra Zannatha, A. J. M. Tamayo, Á. D. G. Sánchez, J. E. L. Delgado, L. E. R. Cheu, and W. A. S. Arévalo, "Development of a system based on 3D vision, interactive virtual environments, ergonomic signals and a humanoid for stroke rehabilitation," *Computer Methods and Programs in Biomedicine*, vol. 112, no. 2, pp. 239–249, 2013.
- [75] M. Trombetta, P. P. Bazzanello Henrique, M. R. Brum, E. L. Colussi, A. C. B. De Marchi, and R.

- Rieder, "Motion Rehab AVE 3D: A VR-based exergame for post-stroke rehabilitation," *Computer Methods and Programs in Biomedicine*, vol. 151, pp. 15–20, 2017.
- [76] P. Carlos Ferreira Fraunhofer Portugal AICOS, Porto, P. Vânia Guimarães Fraunhofer Portugal AICOS, Porto, P. António Santos Fraunhofer Portugal AICOS, Porto, and P. Inês Sousa Fraunhofer Portugal AICOS, Porto, "Gamification of Stroke Rehabilitation Exercises Using a Smartphone," *Proceeding PervasiveHealth '14 Proceedings of the 8th International Conference on Pervasive Computing Technologies for Healthcare*, pp. 282–285, 2014.
- [77] N. A. Borghese, R. Mainetti, M. Pirovano, and P. L. Lanzi, "An intelligent game engine for the at-home rehabilitation of stroke patients," *SeGAH 2013 - IEEE 2nd International Conference on Serious Games and Applications for Health, Book of Proceedings*, 2013.
- [78] P.-Y. Chen, S.-H. Wei, W.-L. Hsieh, J.-R. Cheen, L.-K. Chen, and C.-L. Kao, "Lower limb power rehabilitation (LLPR) using interactive video game for improvement of balance function in older people.," *Archives of gerontology and geriatrics*, vol. 55, no. 3, pp. 677–82, 2012.
- [79] J.-A. Lozano-Quilis, H. Gil-Gómez, J.-A. Gil-Gómez, S. Albiol-Pérez, G. Palacios-Navarro, H. M. Fardoun, and A. S. Mashat, "Virtual Rehabilitation for Multiple Sclerosis Using a Kinect-Based System: Randomized Controlled Trial," *JMIR Serious Games*, vol. 2, no. 2, p. e12, Nov. 2014.
- [80] T. A. Scardovelli and A. F. Frère, "The design and evaluation of a peripheral device for use with a computer game intended for children with motor disabilities," *Computer Methods and Programs in Biomedicine*, vol. 118, no. 1, pp. 44–58, 2015.
- [81] D. Anton, M. Nelson, T. Russell, A. Goni, and A. Illarramendi, "Validation of a Kinect-based telerehabilitation system with total hip replacement patients.," *Journal of telemedicine and telecare*, vol. 22, no. 3, pp. 192–197, 2016.
- [82] A. Fuchslocher, J. Niesenhaus, and N. Krämer, "Serious games for health: An empirical study of the game 'Balance' for teenagers with diabetes mellitus," *Entertainment Computing*, vol. 2, no. 2, pp. 97–101, 2011.
- [83] L. R. Natbony, A. Zimmer, L. S. Ivanco, S. A. Studenski, and S. Jain, "Perceptions of a Videogame-Based Dance Exercise Program Among Individuals with Parkinson's Disease," *Games for Health Journal*, vol. 2, no. 4, pp. 235–239, 2013.
- [84] B. Wu and A. I. Wang, "A guideline for game development-based learning: A literature review," *International Journal of Computer Games Technology*, vol. 2012, 2012.
- [85] "Dance Dance Revolution." [Online]. Available: [en.wikipedia.org/wiki/Dance\\_Dance\\_Revolution](http://en.wikipedia.org/wiki/Dance_Dance_Revolution).
- [86] "YourselfFitness." [Online]. Available: [ign.com/articles/2005/03/03/yourselffitness](http://ign.com/articles/2005/03/03/yourselffitness).
- [87] "WiiFit." [Online]. Available: [wiifit.com](http://wiifit.com).
- [88] "SeeMe." [Online]. Available: [virtual-reality-rehabilitation.com/products/seeme/what-is-seeme](http://virtual-reality-rehabilitation.com/products/seeme/what-is-seeme).
- [89] "Jintronix." [Online]. Available: [jintronix.com](http://jintronix.com).
- [90] "Medimoov." [Online]. Available: [medimoov.com](http://medimoov.com).
- [91] L. Sardi, A. Idri, and J. L. Fernández-Alemán, "A systematic review of gamification in e-Health," *Journal of Biomedical Informatics*, vol. 71, pp. 31–48, 2017.
- [92] "Vicon." [Online]. Available: [vicon.com](http://vicon.com).
- [93] J. McCormick, "How does the Kinect work." [Online]. Available: [docplayer.net/102893-How-does-the-kinect-work-john-maccormick.html](http://docplayer.net/102893-How-does-the-kinect-work-john-maccormick.html).
- [94] Y. Kim, S. Baek, and B.-C. Bae, "Motion Capture of the Human Body Using Multiple Depth Sensors," *ETRI Journal*, vol. 39, no. 2, pp. 181–190, 2017.
- [95] R. Williamson and B. J. Andrews, "Detecting absolute human knee angle and angular velocity using accelerometers and rate gyroscopes," *Medical & Biological Engineering & Computing*, vol. 39, no. 3,

- pp. 294–302, May 2001.
- [96] R. E. Mayagoitia, A. V. Nene, and P. H. Veltink, “Accelerometer and rate gyroscope measurement of kinematics: an inexpensive alternative to optical motion analysis systems,” *Journal of Biomechanics*, vol. 35, no. 4, pp. 537–542, Apr. 2002.
- [97] J. Favre, B. M. Jolles, R. Aissaoui, and K. Aminian, “Ambulatory measurement of 3D knee joint angle.,” *Journal of biomechanics*, vol. 41, no. 5, pp. 1029–35, Jan. 2008.
- [98] T. Liu, Y. Inoue, and K. Shibata, “Development of a wearable sensor system for quantitative gait analysis,” *Measurement*, vol. 42, no. 7, pp. 978–988, Aug. 2009.
- [99] R. Pérez, Ú. Costa, M. Torrent, J. Solana, E. Opisso, C. Cáceres, J. M. Tormos, J. Medina, and E. J. Gómez, “Upper limb portable motion analysis system based on inertial technology for neurorehabilitation purposes,” *Sensors*, vol. 10, no. 12, pp. 10733–10751, 2010.
- [100] R. Takeda, S. Tadano, M. Todoh, M. Morikawa, M. Nakayasu, and S. Yoshinari, “Gait analysis using gravitational acceleration measured by wearable sensors.,” *Journal of biomechanics*, vol. 42, no. 3, pp. 223–33, Feb. 2009.
- [101] Xinyao Hu and Gim Song Soh, “A study on estimation of planar gait kinematics using minimal inertial measurement units and inverse kinematics,” *2014 36th Annual International Conference of the IEEE Engineering in Medicine and Biology Society*, pp. 6911–6914, 2014.
- [102] H. Dejnabadi, B. M. Jolles, E. Casanova, P. Fua, and K. Aminian, “Estimation and visualization of sagittal kinematics of lower limbs orientation using body-fixed sensors.,” *IEEE transactions on bio-medical engineering*, vol. 53, no. 7, pp. 1385–93, Jul. 2006.
- [103] H. Dejnabadi, B. M. Jolles, and K. Aminian, “A new approach to accurate measurement of uniaxial joint angles based on a combination of accelerometers and gyroscopes.,” *IEEE transactions on bio-medical engineering*, vol. 52, no. 8, pp. 1478–84, Aug. 2005.
- [104] J. Favre, R. Aissaoui, B. M. Jolles, J. a de Guise, and K. Aminian, “Functional calibration procedure for 3D knee joint angle description using inertial sensors.,” *Journal of biomechanics*, vol. 42, no. 14, pp. 2330–5, Oct. 2009.
- [105] B. Bouvier, S. Duprey, L. Claudon, R. Dumas, and A. Savescu, “Upper limb kinematics using inertial and magnetic sensors: Comparison of sensor-to-segment calibrations,” *Sensors (Switzerland)*, vol. 15, no. 8, pp. 18813–18833, 2015.
- [106] G. Welch and G. Bishop, “An Introduction to the Kalman Filter,” *In Practice*, vol. 7, no. 1, pp. 1–16, 2006.
- [107] R. Mahony, T. Hamel, P. Morin, and E. Malis, “Nonlinear complementary filters on the special linear group,” *International Journal of Control*, vol. 85, no. 10, pp. 1557–1573, 2012.
- [108] R. Van Der Merwe, A. Doucet, N. De Freitas, and E. Wan, “The Unscented Particle Filter,” *Advances in Neural Information Processing Systems*, vol. 96, no. 6080, pp. 584–590, 2001.
- [109] J. L. Marins, E. R. Bachmann, R. B. McGhee, and M. J. Zyda, “An extended Kalman filter for quaternion-based orientation estimation using MARG sensors,” *Proceedings 2001 IEEE/RSJ International Conference on Intelligent Robots and Systems. Expanding the Societal Role of Robotics in the the Next Millennium (Cat. No.01CH37180)*, vol. 4, pp. 2003–2011, 2003.
- [110] F. Abyarjoo, A. Barreto, J. Cofino, and F. R. Ortega, “Implementing a Sensor Fusion Algorithm for 3D Orientation Detection with Inertial / Magnetic Sensors.”
- [111] S. O. H. Madgwick, A. J. L. Harrison, and A. Vaidyanathan, “Estimation of IMU and MARG orientation using a gradient descent algorithm.,” *IEEE ... International Conference on Rehabilitation Robotics : [proceedings]*, vol. 2011, p. 5975346, Jan. 2011.
- [112] M. Miezal, B. Taetz, and G. Bleser, “On inertial body tracking in the presence of model calibration errors,” *Sensors (Switzerland)*, vol. 16, no. 7, pp. 1–34, 2016.
- [113] X. L. Meng, Z. Q. Zhang, S. Y. Sun, J. K. Wu, and W. C. Wong, “Biomechanical model-based displacement estimation in micro-sensor motion capture,” *Measurement Science and Technology*, vol.

- 23, no. 5, 2012.
- [114] N. Yadav and C. Bleakley, “Accurate orientation estimation using AHRS under conditions of magnetic distortion,” *Sensors (Switzerland)*, vol. 14, no. 11, pp. 20008–20024, 2014.
- [115] Q. Mourcou, A. Fleury, C. Franco, F. Klopčič, and N. Vuillerme, “Performance Evaluation of Smartphone Inertial Sensors Measurement for Range of Motion.,” *Sensors (Basel, Switzerland)*, vol. 15, no. 9, pp. 23168–87, Jan. 2015.
- [116] L. Wang, Z. Zhang, and P. Sun, “Quaternion-Based Kalman Filter for AHRS Using an Adaptive-Step Gradient Descent Algorithm,” *International Journal of Advanced Robotic Systems*, vol. 12, no. 9, pp. 1–12, 2015.
- [117] R. Murray-Smith, “Fusing Kinect Sensor and Inertial Sensors with Multi-rate Kalman Filter,” *IET Conference on Data Fusion & Target Tracking 2014: Algorithms and Applications*, p. 2.3-2.3, 2014.
- [118] A. Ahmadi, N. E. O. Connor, and K. Moran, “LOW-COST ACCURATE SKELETON TRACKING BASED ON FUSION OF KINECT AND WEARABLE INERTIAL SENSORS Franc Insight Centre for Data Analytics Dublin City University Dublin , Ireland Anargyros Chatzitofis , Dimitrios Zarpalas , Petros Daras Information Technologies,” *European Signal Processing Conference*, pp. 371–375, 2014.
- [119] A. Atrsaei, H. Salarieh, and A. Alasty, “Human Arm Motion Tracking by Orientation-Based Fusion of Inertial Sensors and Kinect Using Unscented Kalman Filter,” *Journal of Biomechanical Engineering*, vol. 138, no. 9, p. 091005, 2016.
- [120] C. Kalkbrenner, S. Hacker, M. Algorri, and R. Blechschmidt-trapp, “Motion Capturing with Inertial Measurement Units and Kinect - Tracking of Limb Movement using Optical and Orientation Information,” *Proceedings of the International Conference on Biomedical Electronics and Devices*, pp. 120–126, 2014.
- [121] Y. Tian, X. Meng, D. Tao, D. Liu, and C. Feng, “Upper limb motion tracking with the integration of IMU and Kinect,” *Neurocomputing*, vol. 159, no. 1, pp. 207–218, 2015.
- [122] G. Glonek and A. Wojciechowski, *Hybrid Method of Human Limb Joints Positioning—Hand Movement Case Study*, vol. 472. Cham: Springer International Publishing, 2016.
- [123] T. Martins, V. Carvalho, and F. Soares, “Web Platform for Serious Games’ Management,” *Procedia Computer Science*, vol. 64, pp. 1115–1123, 2015.
- [124] A. Chatzitofis, D. Monaghan, E. Mitchell, F. Honohan, D. Zarpalas, N. E. O’Connor, and P. Daras, “HeartHealth: A Cardiovascular Disease Home-based Rehabilitation System,” *Procedia Computer Science*, vol. 63, pp. 340–347, 2015.
- [125] Y. Rybarczyk, J. K. Deters, A. A. Gonzalvo, M. Gonzalez, S. Villarreal, and D. Esparza, “ePHoRt Project: A Web-Based Platform for Home Motor Rehabilitation,” no. November, 2017, pp. 609–618.
- [126] C.-J. Su, C.-Y. Chiang, and J.-Y. Huang, “Kinect-enabled home-based rehabilitation system using Dynamic Time Warping and fuzzy logic,” *Applied Soft Computing*, vol. 22, no. November 2010, pp. 652–666, 2014.
- [127] A. Vasconcelos, F. Nunes, A. Carvalho, and C. Correia, “Mobile, Exercise-agnostic, Sensor-based Serious Games for Physical Rehabilitation at Home,” *Proceedings of the Twelfth International Conference on Tangible, Embedded, and Embodied Interaction - TEI ’18*, pp. 271–278, 2018.
- [128] J. Jonsdottir, R. Bertoni, M. Lawo, A. Montesano, T. Bowman, and S. Gabrielli, “Serious games for arm rehabilitation of persons with multiple sclerosis. A randomized controlled pilot study,” *Multiple Sclerosis and Related Disorders*, vol. 19, no. October 2017, pp. 25–29, 2018.
- [129] M. Idriss, H. Tannous, D. Istrate, A. Perrochon, J.-Y. Salle, M.-C. Ho Ba Tho, and T.-T. Dao, “Rehabilitation-Oriented Serious Game Development and Evaluation Guidelines for Musculoskeletal Disorders,” *JMIR Serious Games*, vol. 5, no. 3, p. e14, 2017.
- [130] P. Nilsen, “Making sense of implementation theories, models and frameworks,” *Implementation Science*, vol. 10, no. 1, pp. 1–13, 2015.
- [131] G. Robert, J. Cornwell, L. Locock, A. Purushotham, G. Sturmey, and M. Gager, “Patients and staff as

- codesigners of healthcare services,” *BMJ (Online)*, vol. 350, no. February, p. 1DUMMUY, 2015.
- [132] J. H. Brockmyer, C. M. Fox, K. A. Curtiss, E. Mcbroom, K. M. Burkhart, and J. N. Pidruzny, “Journal of Experimental Social Psychology The development of the Game Engagement Questionnaire : A measure of engagement in video game-playing,” *Journal of Experimental Social Psychology*, vol. 45, no. 4, pp. 624–634, 2009.
- [133] C. Jennett, A. L. Cox, P. Cairns, S. Dhoparee, A. Epps, T. Tijs, and A. Walton, “Measuring and defining the experience of immersion in games,” *International Journal of Human Computer Studies*, vol. 66, no. 9, pp. 641–661, 2008.
- [134] A. Fierro, “Musical rhythm,” 2012.
- [135] I. Iacovides, A. Cox, R. Kennedy, P. Cairns, and C. Jennett, “Removing the HUD: the impact of non-diegetic game elements and expertise on player involvement,” *CHI PLAY '15: Proceedings of the 2015 Annual Symposium on Computer-Human Interaction in Play*, pp. 13–22, 2015.
- [136] H. Tannous, D. Istrate, A. Benlarbi-Delai, J. Sarrazin, D. Gamet, M. C. Ho Ba Tho, and T. T. Dao, “A new multi-sensor fusion scheme to improve the accuracy of knee flexion kinematics for functional rehabilitation movements,” *Sensors (Switzerland)*, vol. 16, no. 11, 2016.
- [137] H. Tannous, D. Istrate, A. Benlarbi-Delai, J. Sarrazin, M. Idriss, M. C. Ho Ba Tho, and T. T. Dao, “Exploring various orientation measurement approaches applied to a serious game system for functional rehabilitation,” *Proceedings of the Annual International Conference of the IEEE Engineering in Medicine and Biology Society, EMBS*, vol. 2016–Octob, pp. 1987–1990, 2016.
- [138] “NASA Mission Planning and Analysis Division. Euler Angles, Quaternions, and Transformation Matrices.” [Online]. Available: [www.ntrs.nasa.gov/archive/nasa/casi.ntrs.nasa.gov/19770024290.pdf](http://www.ntrs.nasa.gov/archive/nasa/casi.ntrs.nasa.gov/19770024290.pdf).
- [139] S. Chen, J. S. Brantley, T. Kim, S. A. Ridenour, and J. Lach, “Characterising and minimising sources of error in inertial body sensor networks,” *International Journal of Autonomous and Adaptive Communications Systems*, vol. 6, no. 3, p. 253, 2013.
- [140] J. Wähslén, I. Orhan, and T. Lindh, “Local Time Synchronization in Bluetooth Piconets for Data Fusion Using Mobile Phones,” *2011 International Conference on Body Sensor Networks*, pp. 133–138, May 2011.
- [141] R. B. Davis, S. Ounpuu, D. Tyburski, and J. R. Gage, “A gait analysis data collection and reduction technique,” *Human Movement Science*, vol. 10, no. 5, pp. 575–587, 1991.
- [142] I. Cleland, B. Kikhia, C. Nugent, A. Boytsov, J. Hallberg, K. Synnes, S. McClean, and D. Finlay, “Optimal placement of accelerometers for the detection of everyday activities,” *Sensors (Basel, Switzerland)*, vol. 13, no. 7, pp. 9183–9200, 2013.
- [143] E. Olson and A. Arbor, “A Passive Solution to the Sensor Synchronization Problem,” pp. 1059–1064, 2010.
- [144] A. Burns, B. R. Greene, M. J. McGrath, T. J. O’Shea, B. Kuris, S. M. Ayer, F. Stroiescu, and V. Cionca, “SHIMMERTM - A wireless sensor platform for noninvasive biomedical research,” *IEEE Sensors Journal*, vol. 10, no. 9, pp. 1527–1534, 2010.
- [145] H. Tannous, D. Istrate, M. C. Ho Ba Tho, and T. T. Dao, “Serious game and functional rehabilitation for the lower limbs,” *European Research in Telemedicine*, vol. 5, no. 2, pp. 65–69, 2016.
- [146] H. Tannous, D. Istrate, M. C. Ho Ba Tho, and T. T. Dao, “Feasibility study of a serious game based on Kinect system for functional rehabilitation of the lower limbs,” *European Research in Telemedicine*, vol. 5, no. 2, pp. 97–104, Jun. 2016.
- [147] B. Mittelstadt, B. Fairweather, M. Shaw, and N. McBride, “The Ethical Implications of Personal Health Monitoring,” *International Journal of Technoethics*, vol. 5, no. 2, pp. 37–60, 2014.
- [148] R. Cushman, A. M. Froomkin, A. Cava, P. Abril, and K. W. Goodman, “Ethical, legal and social issues for personal health records and applications,” *Journal of Biomedical Informatics*, vol. 43, no. 5, pp. S51–S55, 2010.
- [149] J. R. Lewis, “IBM computer usability satisfaction questionnaires : Psychometric evaluation and

- instructions for use IBM Computer Usability Satisfaction Questionnaires : Psychometric Evaluation and Instructions for Use,” *International Journal of Human- Computer Interaction*, vol. 7, no. 1, pp. 57–78, 1995.
- [150] H. Y. Kao, Y. T. Cheng, and Y. K. Chien, “Develop and evaluate the mobile-based self-management application for tele-healthcare service,” *Lecture Notes in Computer Science (including subseries Lecture Notes in Artificial Intelligence and Lecture Notes in Bioinformatics)*, vol. 8481 LNAI, no. PART 1, pp. 460–469, 2014.
- [151] Y. Ling, L. P. Ter Meer, Z. Yumak, and R. C. Veltkamp, “Usability Test of Exercise Games Designed for Rehabilitation of Elderly Patients After Hip Replacement Surgery: Pilot Study,” *JMIR Serious Games*, vol. 5, no. 4, p. e19, 2017.
- [152] P. J. Hu, P. Y. K. Chau, O. R. L. Sheng, and K. Y. Tam, “Examining the Technology Acceptance Model Using Physician Acceptance of Telemedicine Technology,” *Journal of Management Information Systems*, vol. 16, no. 2, pp. 91–112, 1999.
- [153] T. T. Dao, H. Tannous, P. Pouletaut, D. Gamet, D. Istrate, and M. C. Ho Ba Tho, “Interactive and Connected Rehabilitation Systems for E-Health,” *Irbm*, vol. 37, no. 5–6, pp. 289–296, 2016.





# Appendices

## Appendix A: First Serious Games Evaluation Study

Patient data

<b>Patient</b>				
<b>ID</b>	<b>Age</b>	<b>M/F</b>	<b>Pathology</b>	<b>State</b>
1	38	M	Hemiplegia	Severe
2	62	M	Amputee left leg	Severe
3	48	M	Hemiplegia	Normal
4	74	F	Hemiplegia	Severe
5	61	M	Hemiplegia	Normal
6	79	M	Amputee left leg	Severe
7	35	M	Hemiplegia	Normal
8	22	M	Hereditary spastic paraplegia	Normal
9	32	M	Ankle arthrodesis	Normal
10	71	M	Hemiplegia	Normal
11	20	F	Hemorrhage	Normal
12	50	F	Shoulder capsulitis	Normal
13	51	M	Amputation right leg	Severe
14	35	M	Hemiplegia	Good
15	17	M	Walking difficulty, following a car accident	Good
16	72	F	Back pains	Normal
17	55	F	Carpal tunnel	Good
18	50	F	Hemiplegia	Severe (Left Arm)
19	66	F	Shoulder and leg prosthesis	Normal
20	57	M	Paralysis of foot elevator muscles	Normal

## Appendix B: Second Serious Games Evaluation Study

Hemiplegic patient data

<b>Patient</b>			
<b>Id</b>	<b>Sex</b>	<b>Age</b>	<b>Affected Part</b>
1	F	69	Left
2	M	79	Right
3	M	60	Left
4	M	65	Right
5	F	72	Left
6	M	54	Left
7	M	65	Right
8	M	67	Right

Patient immersion questionnaire

<b>Question</b>	<b>Circle the Answer</b>						
To what extent did the game hold your attention?	Not at All	1	2	3	4	5	A lot
To what extent did you feel you were focused on the game?	Not at All	1	2	3	4	5	A lot
How much effort did you put into playing the game?	Very little	1	2	3	4	5	A lot
Did you feel that you were trying your best?	Not at All	1	2	3	4	5	Very much so
To what extent did you lose track of time?	Not at All	1	2	3	4	5	A lot
To what extent did you feel consciously aware of being in the real world whilst playing?	Not at All	1	2	3	4	5	Very much so
To what extent did you forget about your everyday concerns?	Not at All	1	2	3	4	5	A lot
To what extent were you aware of yourself in your surroundings?	Not at All	1	2	3	4	5	Very aware
To what extent did you notice events taking place around you?	Not at All	1	2	3	4	5	A lot

Did you feel the urge at any point to stop playing and see what was happening around you?	Not at All	1	2	3	4	5	Very much so
To what extent did you feel that you were interacting with the game environment?	Not at All	1	2	3	4	5	Very much so
To what extent did you feel as though you were separated from your real-world environment?	Not at All	1	2	3	4	5	Very much so
To what extent did you feel that the game was something you were experiencing, rather than something you were just doing?	Not at All	1	2	3	4	5	Very much so
To what extent was your sense of being in the game environment stronger than your sense of being in the real world?	Not at All	1	2	3	4	5	Very much so
At any point did you find yourself become so involved that you were unaware you were even using controls?	Not at All	1	2	3	4	5	Very much so
To what extent did you feel as though you were moving through the game according to your own will?	Not at All	1	2	3	4	5	Very much so
To what extent did you find the game challenging?	Not at All	1	2	3	4	5	Very difficult
Were there any times during the game in which you just wanted to give up?	Not at All	1	2	3	4	5	A lot
To what extent did you feel motivated while playing?	Not at All	1	2	3	4	5	A lot
To what extent did you find the game easy?	Not at All	1	2	3	4	5	Very much so
To what extent did you feel like you were making progress towards the end of the game?	Not at All	1	2	3	4	5	A lot
How well do you think you performed in the game?	Very poor	1	2	3	4	5	Very well
To what extent did you feel emotionally attached to the game?	Not at All	1	2	3	4	5	Very much so
To what extent were you interested in seeing how the game's events would progress?	Not at All	1	2	3	4	5	A lot
How much did you want to "win" the game?	Not at All	1	2	3	4	5	Very much so
Were you in suspense about whether or not you would win or lose the game?	Not at All	1	2	3	4	5	Very much so
At any point did you find yourself become so involved that you wanted to speak to the game directly?	Not at All	1	2	3	4	5	Very much so
To what extent did you enjoy the graphics and the imagery?	Not at All	1	2	3	4	5	A lot

<b>How much would you say you enjoyed playing the game?</b>	<b>Not at All</b>	<b>1</b>	<b>2</b>	<b>3</b>	<b>4</b>	<b>5</b>	<b>A lot</b>
<b>When interrupted, were you disappointed that the game was over?</b>	<b>Not at All</b>	<b>1</b>	<b>2</b>	<b>3</b>	<b>4</b>	<b>5</b>	<b>Very much so</b>
<b>Would you like to play the game again?</b>	<b>Definitely not</b>	<b>1</b>	<b>2</b>	<b>3</b>	<b>4</b>	<b>5</b>	<b>Definitely yes</b>

Calculated immersion variables based on patients' answers

<b>Patient</b>	<b>Total Immersion (Max 155)</b>	<b>Challenge (Max 20)</b>	<b>Control (Max 25)</b>	<b>Real World Dissociation (Max 35)</b>	<b>Emotional Involvement (Max 30)</b>	<b>Cognitive Involvement (Max 45)</b>
<b>1</b>	98	13	13	27	18	27
<b>2</b>	101	10	19	20	16	36
<b>3</b>	109	15	25	28	16	25
<b>4</b>	145	14	25	35	28	45
<b>5</b>	117	15	22	27	21	35
<b>6</b>	131	8	20	32	28	43
<b>7</b>	135	15	25	29	23	43
<b>8</b>	130	12	21	33	28	36

## Appendix C: Expert Interface Evaluation Campaign

Expert Data

Expert		
ID	M/F	Age
1	F	42
2	F	35
3	F	30
4	F	61

Expert interface evaluation questionnaire

Question	1	2	3	4	5	6	7	Not Applicable
Overall, I am satisfied with how easy it is to use this system								
It was simple to use this system								
I can effectively complete my work using this system								
I am able to complete my work quickly using this system								
I am able to efficiently complete my work using this system								
I feel comfortable using this system								
It was easy to learn to use this system								
I believe I became productive quickly using this system								
The system gives error messages that clearly tell me how to fix problems								
Whenever I make a mistake using the system, I recover easily and quickly								
The information (such as online help, on-screen messages, and other documentation) provided with this system is clear								
It is easy to find the information I needed								
The information provided for the system is easy to understand								

The information is effective in helping me complete the tasks and scenarios								
The organization of information on the system screens is clear								
The interface of this system is pleasant								
I like using the interface of this system								
This system has all the functions and capabilities I expect it to have								
Overall, I am satisfied with this system								

1: Strongly disagree; 7: Strongly agree

Calculated variables based on experts' answers

<b>Expert</b>	<b>The Overall Satisfaction Score</b>	<b>System Usefulness</b>	<b>Information Quality</b>	<b>Interface Quality</b>
<b>1</b>	5.37	5.50	5.43	4.67
<b>2</b>	5.95	6.25	6.14	4.67
<b>3</b>	5.53	5.38	6.00	5.00
<b>4</b>	4.74	4.63	5.00	4.33