



HAL
open science

Vehicle-to-grid and flexibility for electricity systems : from technical solutions to design of business models

Olivier Borne

► **To cite this version:**

Olivier Borne. Vehicle-to-grid and flexibility for electricity systems : from technical solutions to design of business models. Electric power. Université Paris Saclay (COMUE), 2019. English. NNT : 2019SACLCO23 . tel-02101210

HAL Id: tel-02101210

<https://theses.hal.science/tel-02101210v1>

Submitted on 16 Apr 2019

HAL is a multi-disciplinary open access archive for the deposit and dissemination of scientific research documents, whether they are published or not. The documents may come from teaching and research institutions in France or abroad, or from public or private research centers.

L'archive ouverte pluridisciplinaire **HAL**, est destinée au dépôt et à la diffusion de documents scientifiques de niveau recherche, publiés ou non, émanant des établissements d'enseignement et de recherche français ou étrangers, des laboratoires publics ou privés.

Vehicle-To-Grid and Flexibility for Electricity Systems: from Technical Solutions to Design of Business Models

Thèse de doctorat de l'Université Paris-Saclay
préparée à CentraleSupélec

École doctorale n°575 Electrical, optical, bio: physics and engineering
(EOBE)
Spécialité de doctorat: Génie Electrique

Thèse présentée et soutenue à Gif-sur-Yvette, le 19 Mars 2019, par

Olivier Borne

Composition du Jury :

Éric Labouré <i>Professeur, Université Paris-Sud</i>	Président du Jury
Pablo Frias-Marin <i>Professeur, Universidad Pontificia Comillas</i>	Rapporteur
Seddik Bacha <i>Professeur, Université Grenoble Alpes</i>	Rapporteur
Willett Kempton <i>Professeur, University of Delaware</i>	Examineur
Marc Petit <i>Professeur, CentraleSupélec</i>	Directeur de thèse
Yannick Perez <i>Maître de Conférence, CentraleSupélec</i>	Co-Directeur de thèse
Virginie Dussartre <i>RTE</i>	Invitée
Bernard Sahut <i>PSA Groupe</i>	Invité

TABLE OF CONTENTS

TABLE OF CONTENTS	I
LIST OF FIGURES	V
LIST OF TABLES.....	IX
CHAPTER 1. INTRODUCTION: ELECTRIC VEHICLES AT THE CONVERGENCE OF TWO INDUSTRIES IN MUTATION.....	1
1 Mutation of the Automotive Industry: The Emergence of Electric Vehicles	2
1.1 Environmental Impacts of the Transport Industry.....	2
1.2 Involvement of Policy Makers in the Development and Diffusion of Electric Vehicles	5
2 Mutation of the Electricity Industry: Liberalization and Decarbonization	10
2.1 Liberalization of Electric Industries and Design of Electricity Markets	10
2.2 Towards Massive Penetration of Renewables and Distributed Energy Resources	13
2.3 The Challenge of Increasing Flexibility Requirements	15
3 Using Electric Vehicles as Distributed Flexibility Assets	16
3.1 Challenges and Opportunities of Massive Diffusion of EVs for Electricity Systems	16
3.2 Which Flexibility Services for Fleet of EVs?	18
3.3 A Literature Review on Smart Charging of Electric Vehicles	23
3.4 Toward the Elaboration of Business Models for Aggregator	25
4 Thesis Organization	26
CHAPTER 2. IMPACT OF MARKET RULES ON PROVISION OF FLEXIBILITY BY DISTRIBUTED ENERGY RESOURCES: A QUALITATIVE ANALYSIS	27
1 Barriers to Entry for New Entrants in Flexibility Markets.....	28
2 Modular Analysis of Barriers to Entry	29
2.1 Module A: Administrative Rules Regarding Aggregation of Distributed Energy Resources 29	
2.2 Module B: Definition of Products	30
2.3 Module C: Remuneration Scheme	31
2.4 A Tool for Investors and Policy Makers	32
3 Costs Associated with the Opening of Markets	33
4 Two Case Studies: Geographic Comparison and Evolution of Regulatory Framework 34	
4.1 Comparison of Four Market Zones in 2016	34
4.2 Evolution of Regulation in France: Towards the Creation of a Single Market Zone in Central Western Europe	39
5 Partial Conclusion	45

CHAPTER 3. REVENUES AND PROFITABILITY ANALYSIS OF A FLEET OF ELECTRIC VEHICLES PROVIDING FLEXIBILITY SERVICES	47
1 Simulation of Fleets Participating to Frequency-Containment-Reserve.....	48
1.1 Description of the Model	48
1.2 Validation of the Model.....	55
2 Revenue Analysis of a Fleet of Bidirectional EV Chargers Providing Frequency Containment Reserve	57
2.1 Market-Designs and Rated Power Scenarios	57
2.2 Results	58
3 Net-Present-Value Analysis of an Investment in Bidirectional EV Chargers.....	61
3.1 Model and Base-Case Scenario	61
3.2 Sensitivity Analysis.....	66
4 Partial Conclusion.....	73
CHAPTER 4. EVALUATION OF THE VALUE OF COOPERATION BETWEEN AGGREGATOR AND CAR MANUFACTURER.....	75
1 Roles of the Aggregator And Value Chain Of Smart Charging	76
2 Presentation of the Model: Actors and Case Studies	77
2.1 Actors	77
2.2 Calculation of Net Present Value of Car Manufacturer and Aggregator	80
2.3 Presentation of Case-Studies	83
3 Results	87
3.1 Smoothing of Revenues Function	87
3.2 Case-Study 1.....	88
3.3 Case-Study 2.....	90
3.4 Case-Study 2bis: Introduction of bargaining power of the Manufacturer.....	92
3.5 Case-Study 3.....	94
4 Analytic Model.....	98
4.1 Reference 1.....	99
4.2 Reference 2.....	100
4.3 Case-Study 1.....	101
4.4 Case-study 2.....	102
4.5 Case-Study 3.....	104
4.6 Validation of Analytic Model	107
4.7 Sensitivity Analysis.....	108
5 Partial Conclusion.....	111
CONCLUSION AND RECOMMENDATIONS	113
REFERENCES	119
LIST OF PUBLICATIONS	125

SUMMARY IN FRENCH	127
Chapitre 1 : Le Véhicule Electrique à La Convergence de Deux Industries en Mutation ...	127
Chapitre 2 : Impact des Règles de Marché sur la Fourniture de Flexibilité par des Ressources Décentralisés	128
Chapitre 3 : Etude des revenus et de la Valeur Actuelle Nette d'une flotte de Véhicules fournissant de la Réserve Primaire	129
Chapitre 4 : Valeur d'une coopération entre Agrégateur et Constructeur Automobile	130

LIST OF FIGURES

Figure 1.1 Global anthropogenic CO ₂ emissions. Source: (IPCC, 2014a).....	2
Figure 1.2 Concentration of CO ₂ in the atmosphere.	2
Figure 1.3 Human Contribution to Change in Surface Temperature between 1951 and 2010. Source: (IPCC, 2014a)	3
Figure 1.4 CO ₂ Emissions in the next decade to reach Paris Agreement Target Source: (International Energy Agency, 2017)	3
Figure 1.5 Global Greenhouse gas emissions by economic sector. Source: (IPCC, 2014b)	4
Figure 1.6 Evolution of CO ₂ emissions of transport industry between 1970 and 2010. Source: (IPCC, 2014b).....	4
Figure 1.7 Carbon Intensity of Electricity Generation in 2014 in European Union Source:(European Environment Agency, 2016)	6
Figure 1.8 Lifecycle GHG emissions of 24 kWh BEV and ICE vehicle. Source: (European Parliament, 2018)	6
Figure 1.9 Average CO ₂ emissions per km by Manufacturer in European Union in 2010. Source: (European Environment Agency, 2017)	8
Figure 1.10 Average CO ₂ emissions per km by Manufacturer in European Union in 2016. Source: (European Environment Agency, 2017)	8
Figure 1.11 Lithium-ion price developments. Source: (International Energy Agency, 2018)	9
Figure 1.12 EV stock in major regions and in Top 10 countries. Source: (International Energy Agency, 2018).....	9
Figure 1.13 Market Share and Sales in Top-Ten Countries. Source: (International Energy Agency, 2018).....	10
Figure 1.14 Electricity markets general architecture	12
Figure 1.15 Electricity Generation by Technology in European Union between 2004 and 2016. Source: (Eurostat, 2017)	14
Figure 1.16 Share of Renewables in Electricity Generation in 2016. Source: (Eurostat, 2017)	14
Figure 1.17 Learning curve of photovoltaic cells. Source: (IRENA, 2017)	14
Figure 1.18 The duck-curve in California – Residual Consumption between 2012 and 2020. Source: (US Department of Energy, 2017)	15
Figure 1.19 Average Hourly Price in California	15
Figure 1.20 Attributes of flexibility assets. Source; (Eid et al., 2016)	16
Figure 1.21 Flexibility Potential for Unidirectional and Bidirectional Capabilities	18
Figure 1.22 Average Spot Prices in 2017	19
Figure 1.23 Daily Range of variation of Spot Price in 2017 in France	19
Figure 1.24 Costs of charging over year 2016 for different charging patterns	20
Figure 1.25 Value of Bidirectionality for Energy Arbitrage (Compared to Uni-2 Scenario)	20
Figure 1.26 Balancing Reserve as defined by ENTSO-e	21

Figure 1.27 Power-Frequency curve for FCR Provision (generator convention).....	22
Figure 1.28 Histogram of Activation Rate in Continental Europe for FCR in 2016.....	22
Figure 1.29 Histogram of Activation Rate in France for aFRR in 2016	23
Figure 2.1 Impact of Bid Increment and Duration of Product on Reserve bid on market	30
Figure 2.2 Decision Tree for provision of Flexibility Services with DERs	32
Figure 2.3 Organization of FCR Procurement in France before January 2017	40
Figure 2.4 Organization of FCR procurement in the FCR Cooperation.....	40
Figure 2.5 Merging procurement of reserves in two countries.....	42
Figure 3.1 Methodology for Simulation of Participation of an EV Fleet to FCR.....	49
Figure 3.2 Histogram of Distance Data and Fitted Lognormal Distribution	50
Figure 3.3 Average Speed in function of Distance (Observations and Boundaries)	50
Figure 3.4 Graphical Representation of Different Situations of Battery State of Charge.....	52
Figure 3.5 Graphical Representation of Computation of POP and Reserve for one time-step.	52
Figure 3.6 Minimum and Maximum Available Reserve for 100 EVs over 500 simulations	53
Figure 3.7 Minimum and Maximum Available Reserve for 2000 EVs over 500 simulations	53
Figure 3.8 Average Available Reserve not bid.....	53
Figure 3.9 Reserve available and Reserve offered for a fleet of 500 EVs with a 3 kW EVSE at home and a 7 kW EVSE at work.....	54
Figure 3.10 Validation test without forecast error and $\beta = 0$	56
Figure 3.11 Validation test with forecast error and $\beta = 0$	56
Figure 3.12 Validation test with forecast error and $\beta = 20\%$	56
Figure 3.13 Evolution of FCR Cooperation price between January 2017 and November 2018....	58
Figure 3.14 Revenues in Function of the Size of the Fleet for Different Scenarios (see Table 3.4 for definitions of different scenarios)	59
Figure 3.15 Computation of Minimum Size of Fleet for a given Target Revenue.....	60
Figure 3.16 Minimum Size of the Fleet in function of Target Revenue. EVSE-2 scenario.	60
Figure 3.17 Evolution of Investment Costs with Size of the Fleet.....	63
Figure 3.18 Evolution of Recurrent Costs with Size of the Fleet	63
Figure 3.19 Influence of Maximum NPV per EV and Minimum Size of the Fleet on Business Model	65
Figure 3.20 Evolution of NPV per EV with Size of the Fleet for Different Market-Designs.....	65
Figure 3.21 Maximum NPV per EV for Base-Case Scenario	66
Figure 3.22 Minimum Size of the Fleet for Base-Case Scenario.....	66
Figure 3.23 Evolution of FCR Cooperation Price between 2015 and 2018.....	67
Figure 3.24 Sensitivity Analysis on Base-Case Scenario Parameters	68
Figure 3.25 Maximum NPV per EV for Fleet 1.....	69
Figure 3.26 Maximum NPV per EV for Fleet 2a.....	70

Figure 3.27 Minimum Size of Fleet for Fleet 2a	70
Figure 3.28 Maximum NPV per EV for Fleet 2b	71
Figure 3.29 Minimum Size of Fleet for Fleet 2b	71
Figure 3.30 Profitability Boundaries.....	72
Figure 4.1 Demand for V2G in function of User's NPV	78
Figure 4.2 Model for calculation of manufacturer and aggregator NPVs	79
Figure 4.3 Manufacturer NPV in function of selling price P for different value of annual fee F.....	80
Figure 4.4 Manufacturer NPV in function of selling price P for different value of demand intensity a	81
Figure 4.5 Aggregator NPV in function of annual fee for different value of selling price P	82
Figure 4.6 Aggregator NPV in function of annual fee for different value of demand intensity a	82
Figure 4.7 Aggregator NPV in function of annual fee for different market designs	83
Figure 4.8 Relations between actors in Case-Study 1	85
Figure 4.9 Relations between actors in Case-Study 2	86
Figure 4.10 Relations between actors in Case-Study 3	87
Figure 4.11 Initial Revenue function and Smoothed Function	88
Figure 4.12 Smoothed Revenue function	88
Figure 4.13 Sum of NPVs in Case-Study 1	89
Figure 4.14 Share of Total Value for Aggregator and Manufacturer	89
Figure 4.15 Annual Fee and Selling Price of the V2G function in Case-Study 1	90
Figure 4.16 Demand for V2G function in Case-Study 1	90
Figure 4.17 Sum of NPVs in Case-Study 2	91
Figure 4.18 Individual NPVs in Case-Study 2	91
Figure 4.19 Annual Fee and Selling Price in Case-Study 2	91
Figure 4.20 Demand for V2G function in Case-Study 2	92
Figure 4.21 Individual Net-Present-Value in Case-Study 2bis	93
Figure 4.22 Annual Fee and Selling Price in Case-Study 2bis	93
Figure 4.23 Demand for V2G function in Case-Study 2bis	93
Figure 4.24 Loss of Gain in Case-Study 2bis compared to Case-Study 2 for different values of π	94
Figure 4.25 Sum of NPVs in Case Study 3	95
Figure 4.26 Individual NPVs in Case Study 3	95
Figure 4.27 Annual Fee, Selling Price and Manufacturer Fee in Case-Study 3	95
Figure 4.28 Demand for V2G function in Case-Study 3	96
Figure 4.29 Individual NPVs for different Bargaining Power	96
Figure 4.30 Annual Fee, Selling Price and Manufacturer Fee for different Bargaining Powers.....	96
Figure 4.31 NPVs and Demand for Low Demand Intensity ($a=0.5$)	97

Figure 4.32 NPVs and Demand for Medium Demand Intensity ($a=1$)	97
Figure 4.33 NPVs and Demand for Medium Demand Intensity ($a=2$)	98
Figure 4.34 Analytic Total Revenue Function	98
Figure 4.35 Comparison between Simulation Model and Analytic Model for Aggregator NPV and $\pi = 0$	107
Figure 4.36 Comparison between Simulation Model and Analytic Model for Manufacturer NPV and $\pi = 1$	107

LIST OF TABLES

Table 1.1 Direct Emission of Fuels. Source: (Ademe, 2017)	5
Table 1.2 CO ₂ Intensity for different electricity generation technologies. Source: (Ademe, 2017) 13	
Table 1.3 Gaps in the relevant literature	25
Table 2.1 RES Capacity and Reserve Requirements	34
Table 2.2 Assessment of the Parameters of the Survey in France	35
Table 2.3 Average capacity remuneration for FCR and aFRR in Germany in 2015 (€/MW/h).....	37
Table 2.4 Assessment of the Parameters of the Survey for Germany	37
Table 2.5 Average Remuneration of FCR in Denmark DK1 in 2015 (€/MW/h).....	37
Table 2.6 Assessment of the Parameters of the Survey for Denmark-DK1	38
Table 2.7 Assessment of the Parameters of the Survey in Great Britain.....	39
Table 2.8 Changes in the rules when joining the FCR Cooperation	41
Table 2.9 Assessment of the rules in France (before 2017) and in the FCR cooperation	41
Table 2.10 Cost for TSOs and producers surplus with different remuneration schemes.....	43
Table 2.11 Increase of social welfare in country A and country B when merging.....	43
Table 3.1 Characteristics of the Vehicles	50
Table 3.2 Statistical Distribution of Trip Patterns for Commuting Fleet.....	50
Table 3.3 Statistical Distributions with Forecast Errors	55
Table 3.4 Different Scenarios of Market-Design and EVSE.....	57
Table 3.5 Parameters of Base-Case Scenario Calculation	62
Table 3.6 Statistical Distribution of Trip Patterns for Company Fleet.....	70
Table 4.1 Parameters used in the framework	87
Table 4.2 Parameters used in Equations	99
Table 4.3 Parameters for Base-Case	108
Table 4.4 Sensitivity Analysis on Manufacturer NPV for $a = 0.5$ and $\pi = 1$	109
Table 4.5 Sensitivity Analysis on Manufacturer NPV for $a = 1$ and $\pi = 1$	109
Table 4.6 Sensitivity Analysis on Manufacturer NPV for $a = 2$ and $\pi = 1$	109
Table 4.7 Sensitivity Analysis on Aggregator NPV for $a = 0.5$ and $\pi = 0$	110
Table 4.8 Sensitivity Analysis on Aggregator NPV for $a = 1$ and $\pi = 0$	110
Table 4.9 Sensitivity Analysis on Aggregator NPV for $a = 2$ and $\pi = 0$	110

CHAPTER 1. INTRODUCTION: ELECTRIC VEHICLES AT THE CONVERGENCE OF TWO INDUSTRIES IN MUTATION

1	Mutation in the Automotive Industry: The Emergence of Electric Vehicles.....	2
1.1	Environmental Impacts of the Transport Industry.....	2
1.2	Involvement of Policy Makers in the Development and Diffusion of Electric Vehicles .	5
1.2.1	The Necessity for Public Intervention	5
1.2.2	Some examples of public intervention.....	7
2	Mutation of the Electricity Industry: Liberalization and Decarbonization	10
2.1	Liberalization of Electric Industries and Design of Electricity Markets	10
2.2	Towards Massive Penetration of Renewables and Distributed Energy Resources ...	13
2.3	The Challenge of Increasing Flexibility Requirements	15
3	Using Electric Vehicles as Distributed Flexibility Assets	16
3.1	Challenges and Opportunities of Massive Diffusion of EVs for Electricity Systems...	16
3.2	Which Flexibility Services for Fleet of EVs?	18
3.2.1	Energy Arbitrage	18
3.2.2	Reserve Provision.....	21
3.2.3	Other Sources of Value	23
3.3	A Literature Review on Smart Charging of Electric Vehicles	23
3.3.1	Characteristics of Vehicles	24
3.3.2	Control Strategy of the Operator.....	24
3.3.3	Objective of the Algorithm.....	24
3.3.4	Optimization Method.....	25
3.4	Toward the Elaboration of Business Models for Aggregator	25
4	Thesis Organization	26

1 MUTATION OF THE AUTOMOTIVE INDUSTRY: THE EMERGENCE OF ELECTRIC VEHICLES

1.1 Environmental Impacts of the Transport Industry

The 21st Conference of Parties on Climate Change was held in Paris, from 30 November to 12 December 2015, and ended with the signature of a historical agreement by the 196 parties represented. They agreed on a common goal to “hold the increase in the global average temperature to well below 2°C above pre-industrial levels and pursuing efforts to limit the temperature increase to 1.5°C” (UNFCCC Secretariat, 2015).

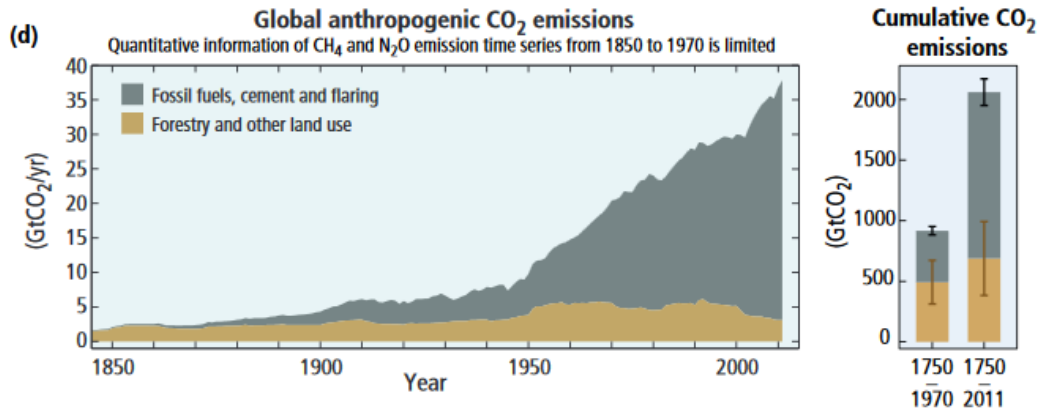

Figure 1.1 Global anthropogenic CO₂ emissions. Source: (IPCC, 2014a)

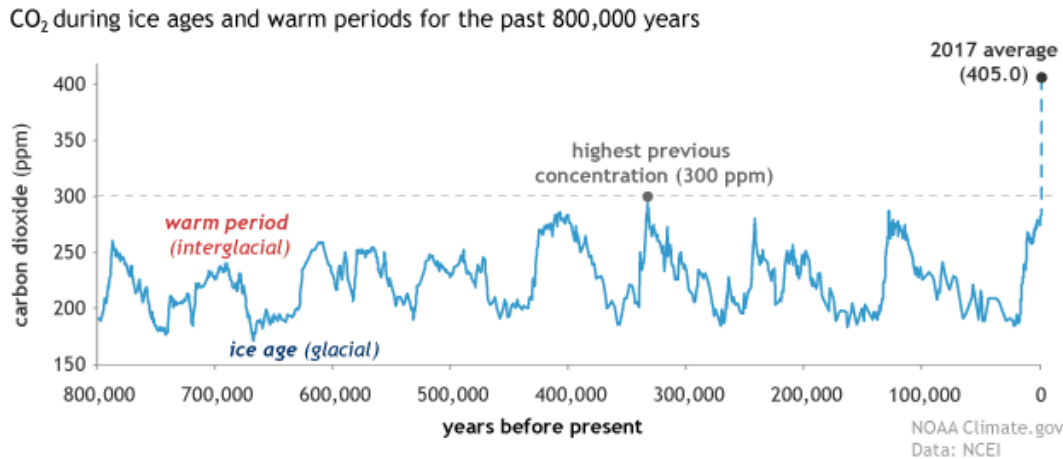

Figure 1.2 Concentration of CO₂ in the atmosphere.

There is now a clear evidence of the human contribution to climate change: Intergovernmental Panel on Climate Change (IPCC) stated in its 2014 Synthesis Report: “Human influence on the climate system is clear and warming of the climate system is unequivocal. Anthropogenic greenhouse gas emissions [...] are extremely likely to have been the dominant cause of the observed warming since the mid-20th century” (IPCC, 2014a). Figure 1.1 shows the level of anthropogenic CO₂ emissions between 1850 and 2011, Figure 1.2 the concentration of CO₂ in the atmosphere and Figure 1.3 the human contribution to global warming.

Global warming could have major impacts on both natural and human systems. In (Thomas et al., 2004), it is shown that between 15 and 37% of species could be “committed to extinction” in 2050 on a sample of selected regions and species. According to a report released for the UK Government by Nicholas Stern, if no action is taken, the costs of climate change would be equivalent to the loss

of 5% of global GDP every year (Stern, 2007). This loss would be due to increase of extreme events such as floods, drought, cyclones or wildfire, impact on food production, increased sea level etc.

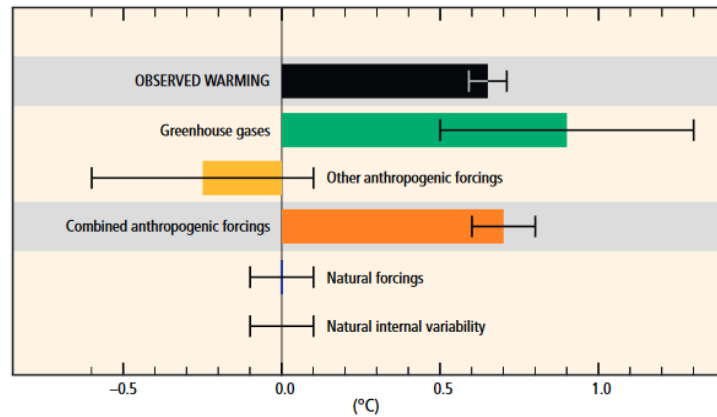

Figure 1.3 Human Contribution to Change in Surface Temperature between 1951 and 2010. Source: (IPCC, 2014a)

To reach global warming target set by the Paris Agreement, global emissions of CO₂ should drastically decrease in the coming decades. The International Energy Agency (IEA) published in the Energy Technology Perspectives 2017 the CO₂ emissions in three different scenarios. The Reference Technology Scenario (RTS) takes into account today's commitment by countries to limit emissions. The emissions of this scenario would result in a global increase of the temperature of 2.7°C. The Two Degree Scenario (2DS) represent a pathway to limit global increase to 2°C, while the Below Two Degree Scenario (B2DS) represent the maximum practicable pathway of reduction of emissions.

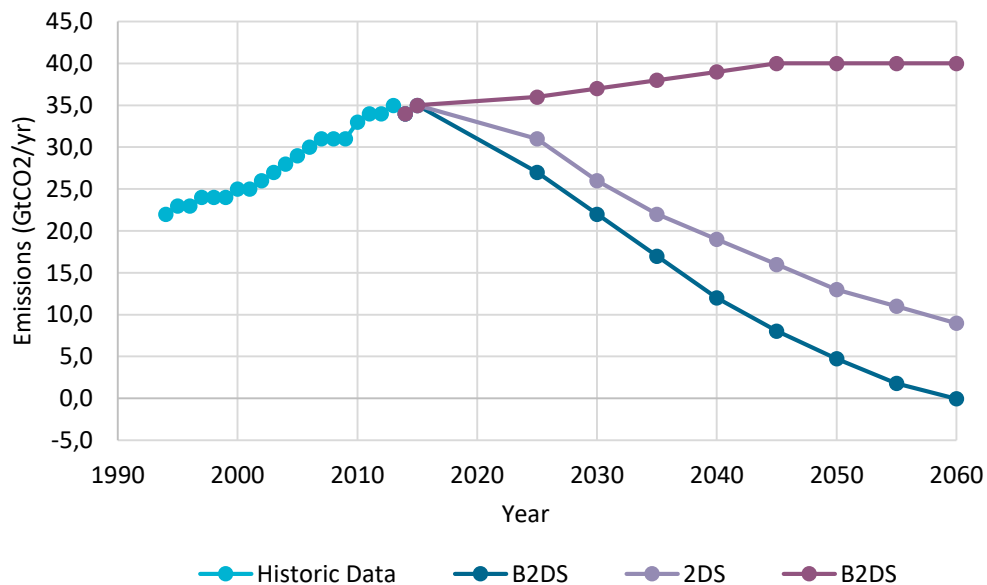

Figure 1.4 CO₂ Emissions in the next decade to reach Paris Agreement Target Source: (International Energy Agency, 2017)

Emissions of greenhouse gases mainly come from the burning of fossil fuels (oil, gas or coal). Figure 1.5 shows emissions by economic sector and distinguishes between direct emissions and indirect emissions (emissions for electricity and heat production). Transport sector represents 14 % of global emissions. Figure 1.5 shows the evolution of transport sector emissions between 1970 and 2010 and the breakdown of emission by mean of transport. Road represents 72% of the total

transport emission with a sharp increase over the four last decades (1.73 GtCO₂eq/year in 1970 and 5.11 tCO₂eq/year in 2010). Road transport is during this period almost only composed of Internal Combustion Engine (ICE) vehicles. Reduction of global CO₂ emissions will inevitably mean first stabilization and then a reduction from emissions from road transport.

Moreover, concerns are rising on the impact of road transport on local pollutant emission. The combustion of the fuel creates side products such as Carbon Monoxide, Nitrogen Oxides, Ozone and Particulate Matters. These pollutants can have effect on health and induce lung cancer and other respiratory illnesses.

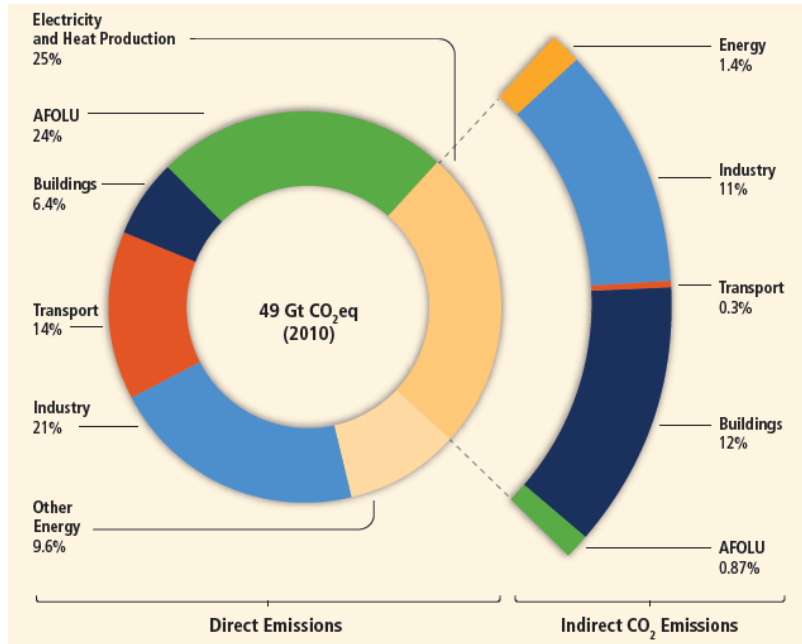

Figure 1.5 Global Greenhouse gas emissions by economic sector¹. Source: (IPCC, 2014b)

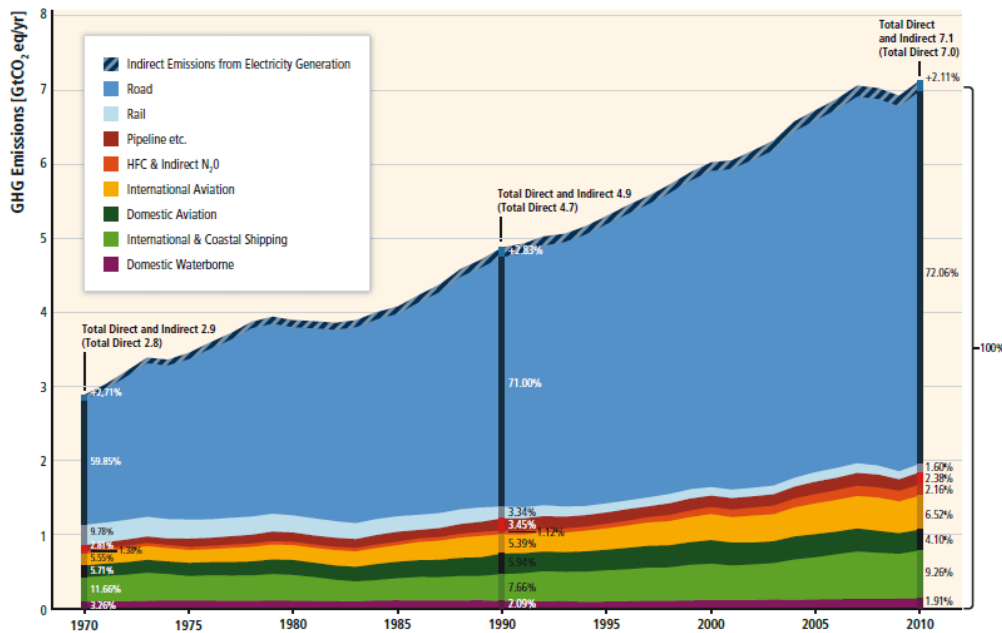

Figure 1.6 Evolution of CO₂ emissions of transport industry between 1970 and 2010. Source: (IPCC, 2014b)

¹ AFOLU stands for Agricultural Forestry and Other Land Use

1.2 Involvement of Policy Makers in the Development and Diffusion of Electric Vehicles

1.2.1 *The Necessity for Public Intervention*

CO₂ emissions from road transportation is the product of three factors: 1) Demand for road transport in km, 2) Energy intensity of the vehicles in MJ/km and 3) Fuel Carbon Intensity of the vehicles in tCO₂/MJ (IPCC, 2014b). Policy makers should target these three factors to achieve reduction of CO₂ emissions of road transport.

It is possible to decrease energy intensity of the vehicles by either improving efficiency (increase the efficiency of the engine, reduce air resistance by changing the shape) or by reducing the weight of the vehicles. However, it will not be possible to completely decarbonized ICE vehicles. Direct Carbon Emissions for average vehicle on the road and new ICE vehicles sold in France are given in Table 1.1.

Table 1.1 Direct Emission of Fuels. Source: (Ademe, 2017)

		Emission factor (gCO ₂ /L) ²	Consumption (L/ 100 km)	Direct emission (gCO ₂ /km)
Average vehicle	Gasoline	2280	7.84	179
	Diesel	2510	6.64	167
Average new vehicle	Gasoline	2280	5.1	117
	Diesel	2510	4.2	110

It is thus necessary to change the fuel of the vehicle to obtain lower Fuel Carbon Intensity. This is the aim of Electric Vehicles, where fossil fuel is partly or totally replaced by electricity. It requires the addition of electricity storage in the vehicle (an electrochemical battery) and the replacement of the Internal Combustion Engine by an Electric Engine.

If the vehicle only uses electricity as fuel, we will talk of Battery Electric Vehicle (BEV). If the vehicle uses both fossil fuel and electricity, we talk about Hybrid Electric Vehicle (HEV). If the battery of a HEV can be charged through an external plug, we talk of Plug-in Hybrid Electric Vehicle (PHEV).³

Electric Vehicles (BEV or HEV) have no direct (or Tank-to-Wheel) emission of CO₂ when the electric engine is running. However, in order to compare EVs and ICE vehicles, it is necessary to take into account CO₂ emissions of the electricity used to charge the vehicle (Well-to-Wheel emissions). Before taking any action to develop electric cars, policy makers should therefore make a thorough assessment of the carbon footprint of electric cars taking into consideration the carbon footprint of the electricity generation. If indirect emissions for EVs were higher than direct emissions for ICE vehicles, the impact of a public policy to develop and diffuse electric cars would be negative on global warming⁴.

Figure 1.7 shows the CO₂ intensity of electricity generation in 2014 for European Union countries. With efficiency from the plug to the wheel around 80% and a consumption of the vehicle of 0.2kWh/km, it appears that in most of EU countries, it would be beneficial to replace ICE cars by EVs. However, in some countries such as Poland, Estonia or Greece, where electricity generation is largely based on coal, the benefits from EVs are not clear.

² Emission factor is intrinsic to the nature of the fuel. It represents the emission of CO₂ for one liter of fuel

³ In the following of the thesis, EV will stand for Battery Electric Vehicle

⁴ As we have seen in Paragraph 1.1, impact of other pollutants of the ICE vehicles might be taken into account in a cost/benefit analysis of the Electric Vehicle

To complete this analysis, full life cycle of the vehicle should be taken into account to assess the impact of electric vehicles on greenhouse gas emissions, including production of the vehicle and the battery storage. Figure 1.8 shows the results of a study commissioned by the European Parliament. EV emits less greenhouse gas on its full life cycle with the European Union mix. However, when electricity mix is mainly based on coal generation, EV emits almost 15 tons of CO₂eq more than ICE vehicle on its life cycle.

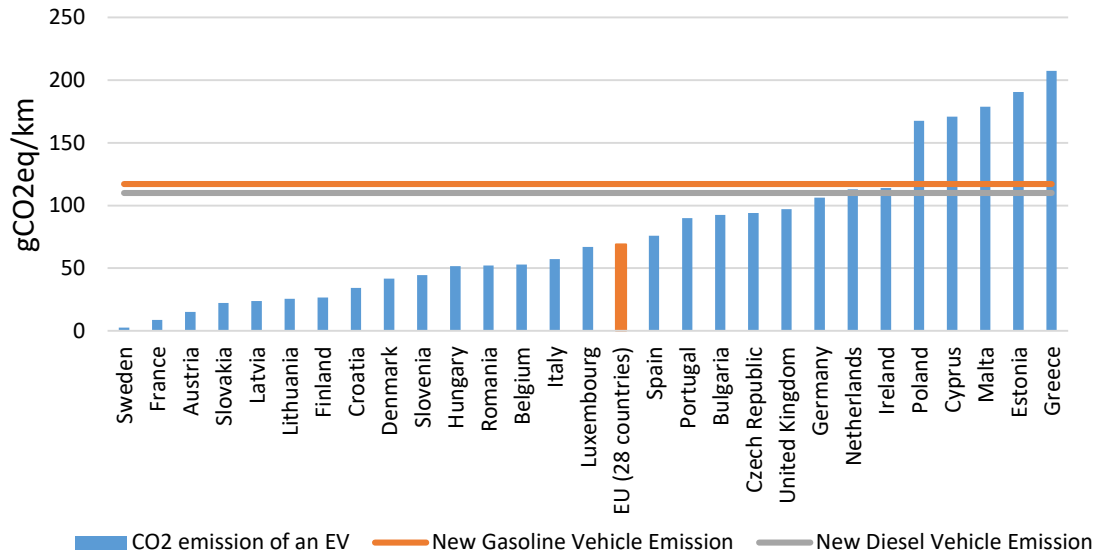

Figure 1.7 Carbon Intensity of Electricity Generation in 2014 in European Union Source: (European Environment Agency, 2016)

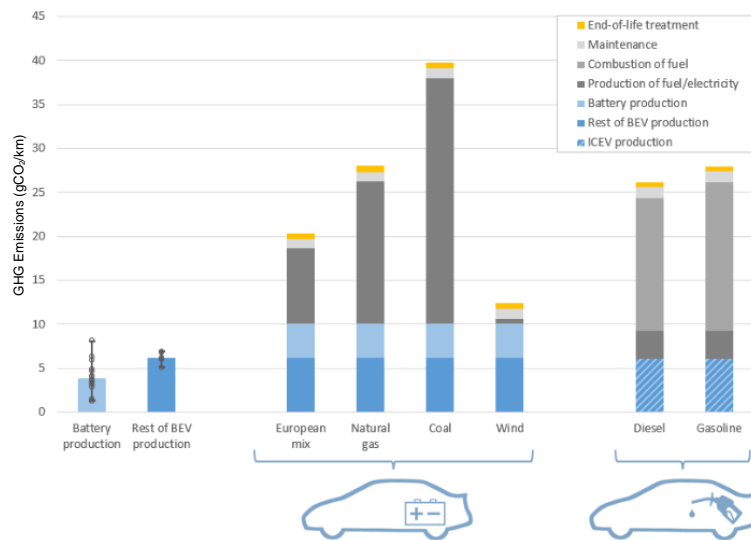

Figure 1.8 Lifecycle GHG emissions of 24 kWh BEV and ICE vehicle. Source: (European Parliament, 2018)

Based on these results, it appears that switching from ICE vehicle to EVs would be beneficial for policy makers to reach their target on CO₂ emissions if electricity is produced with low carbon intensive technologies. However, back in the beginning of 2010' decade, EVs were suffering multiple drawbacks for consumers compared to ICE vehicles.

First, the entire road mobility system was built during the last century around ICE cars. It is a mature system, with an already existing complete infrastructure. There is a dense network of gas stations to fill-in the cars when necessary. On the contrary, there are very few public charging points (no more than 3,000 in Europe).

Moreover, electrochemical storage was still an immature technology, with low energy density and high costs. First EVs commercialized at this period had low autonomy and were more expensive than similar ICE vehicles.

As a result, consumers were reluctant to buy an electric vehicle, first because of “range anxiety” (fear of having an empty battery without being able to charge the car) and because of high price of EVs. There were only 11,000 EVs sold back in 2011 in Europe, which represented a market share of only 0.01%. Because of this limited market, car manufacturers were reluctant to deeply invest in Research and Development in electric vehicles and to install new assembly lines.

In (Greene et al., 2014), the authors list six economic barriers that “lock in” ICE vehicles and “lock out” electric vehicles:

- Technological limitations of electric power-drives
- High costs that can be reduced by experience
- High costs that can be reduced by volume
- Consumer’s aversion to novel products
- Lack of diversity of choice
- Limited infrastructure for EVs

There are some positive externalities to the adoption of electric vehicles (global warming reductions, air quality), which are not reflected in the price of EVs and require the intervention of policy makers. The public intervention can take multiple forms and we will give some examples.

1.2.2 *Some examples of public intervention*

Public intervention can target supply, infrastructures provision or demand side public policies. On the supply side, policy makers can decide to impose stringent regulation on emission of pollutants, in order to stimulate private R&D efforts in both Energy efficiency for ICE cars and Battery technologies and electric engines for EV cars. It will also incentivize manufacturer to diversify their offer of EVs and to make the appropriate marketing efforts to sell these vehicles. This type of regulation was first put in place in 1975 in the US (“Corporate Average Fuel Economy” - CAFE standard). The production-weighted average consumption of vehicles produced by each manufacturer is calculated. If this score is higher than the standard, the manufacturer should pay a civil penalty or buy credits to other manufacturer below the standard. A similar regulation was put in place in 2010 in the European Union, with a 2015 target set at 130 gCO₂/km⁵ and a 2021 target set at 95 gCO₂/km.

Figure 1.9 and Figure 1.10 show the average CO₂ emissions by manufacturer in 2010 and in 2016. Manufacturers have lowered their emissions during this period in order to meet up this target, showing the efficacy of the regulation. With the 2021 target, manufacturers have to find other ways to reduce this average emission, which mean selling more EVs.

Public intervention can also target the development of the charging infrastructure. It is done at the local level, at the national level or at the supra-national (European) level. For example, in France the Advenir program gives a subsidy corresponding to 40 % to 50 % of the costs for installation of public or private charging point. More than 4000 installations have benefited from this program.

It is also possible to intervene on pushing demand, through direct financial support in cash and/or non-financial incentives like bus-lane access or free parking fees. Many countries in Europe decided to put in place public subsidies for buyer of electric cars: France introduced a fixed subsidy of 6,000 € for electric vehicles, Norway an exemption of VAT and registration taxes and the possibility to use bus-lanes for EVs (Haugneland and Kvisle, 2015).

⁵ Target for an average weight of the fleet corresponding to the average weight of Passenger cars in Europe. The target is lower if the average weight of the fleet is lower and higher in the other case, as can be seen on Figure 1.9

CHAPTER 1

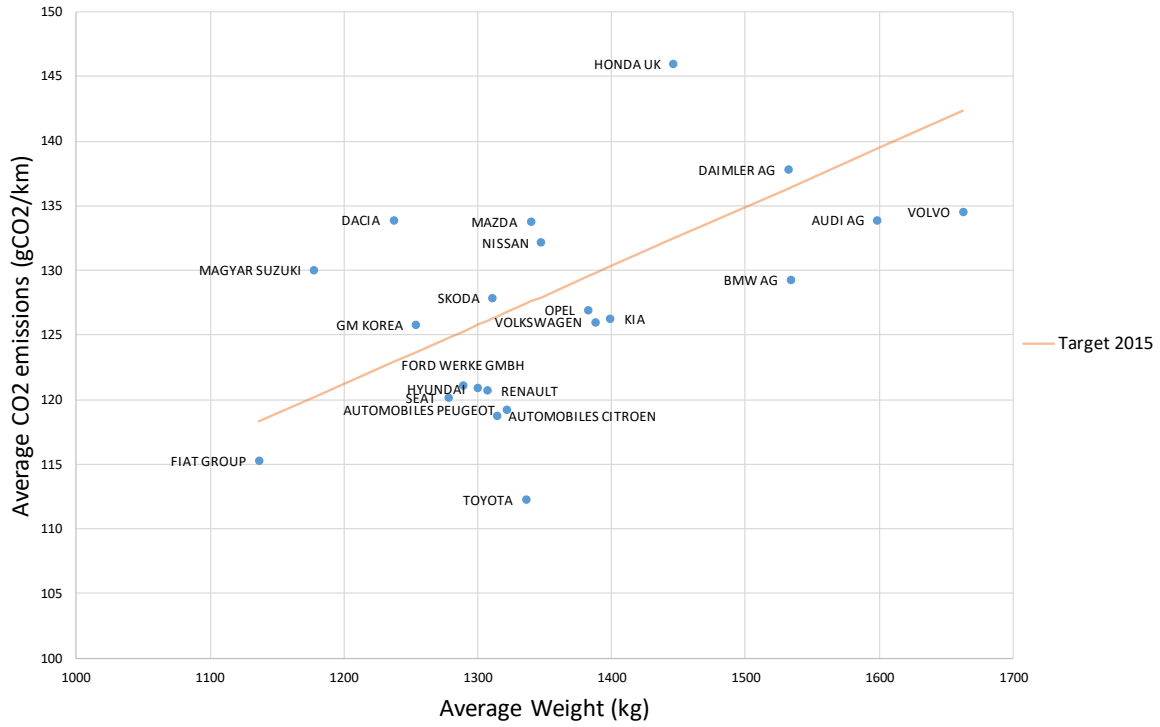

Figure 1.9 Average CO2 emissions per km by Manufacturer in European Union in 2010. Source: (European Environment Agency, 2017)

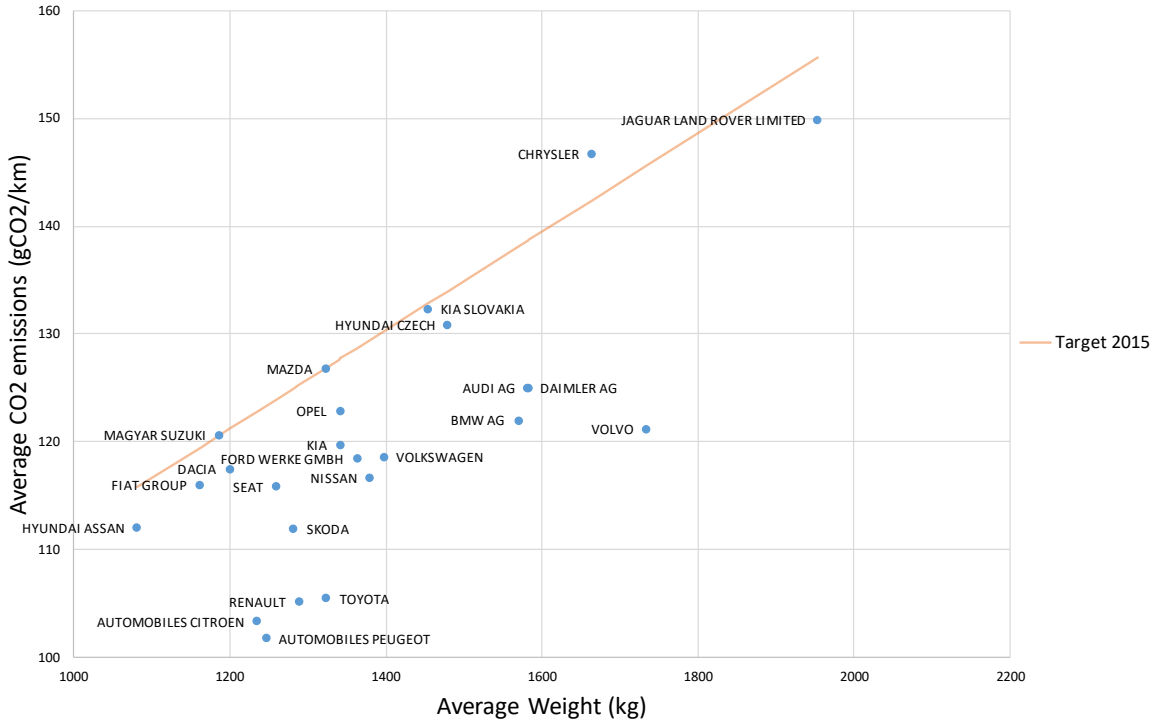
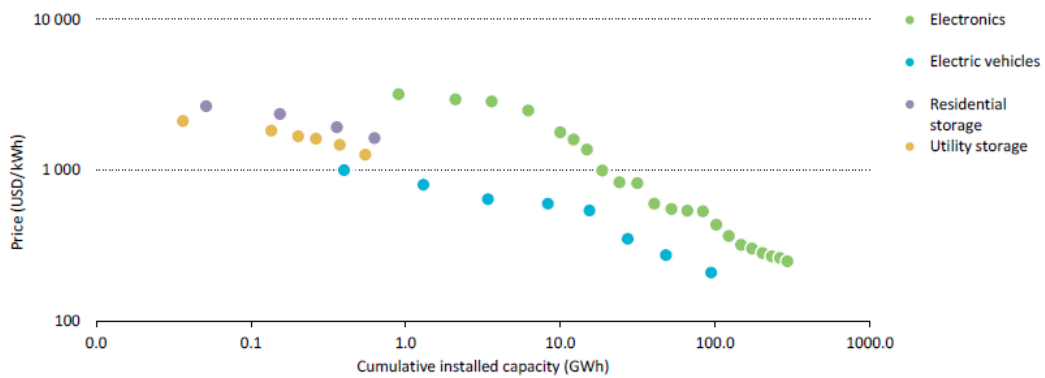

Figure 1.10 Average CO2 emissions per km by Manufacturer in European Union in 2016. Source: (European Environment Agency, 2017)

These different schemes resulted in a lowering of the different aforementioned barriers. On the supply-side, stringent standards have incentivized manufacturers to invest in R&D to develop new electric vehicles and in marketing to sell them, which allowed them to gain experience and to increase volume production. In particular, battery prices have decreased drastically during the last decade, as can be seen in Figure 1.11. It also led to a diversification of EV models proposed by manufacturers. Energy density of the battery increased, which allowed increasing the capacity of the installed battery and the density of the charging infrastructure increased, reducing “range anxiety” issues.

Number of EVs on the road has more than tripled between 2015 and 2017 (Figure 1.12). There are now more than 3 million EVs on the road, two thirds being BEVs. China is the first country in term of stock, with almost 1 million EVs on the road at the end of 2017. However, EV sales remain limited in most of top-10 countries, ranging from 0 to 2%, apart from Norway where EV sales now represent 40% of market share (Figure 1.13).



Notes: Axes are on a logarithmic scale. Electronics refer to power electronic batteries (only cells); electric vehicles refer to battery packs for EVs; utility and residential storage refer to Li-ion battery packs plus power conversion system and includes costs for engineering, procurement and construction.

Source: Adapted and updated from Schmidt et al. (2017).

Figure 1.11 Lithium-ion price developments. Source: (International Energy Agency, 2018)

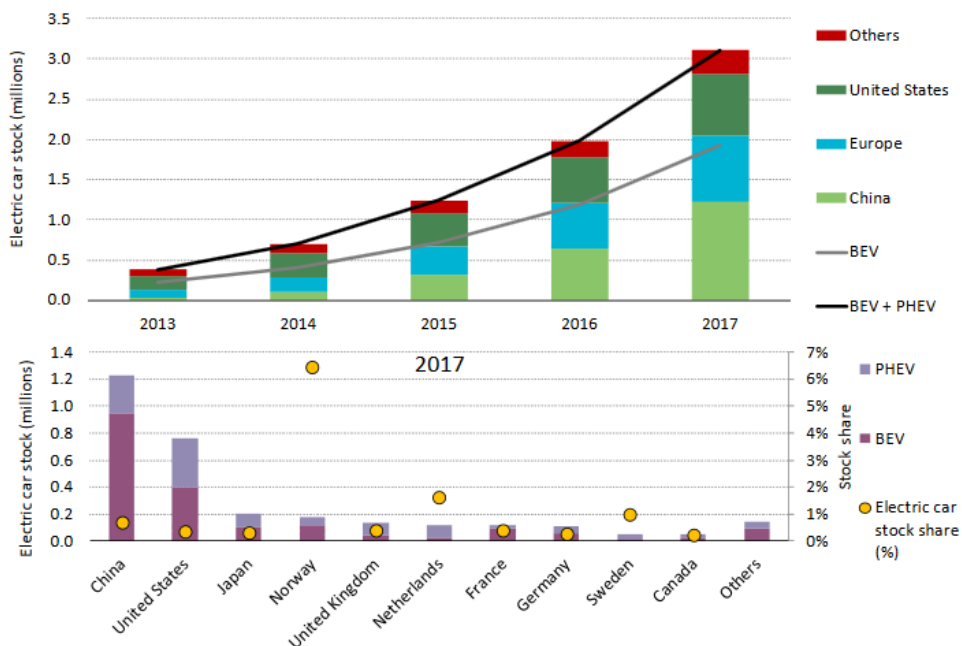

Figure 1.12 EV stock in major regions and in Top 10 countries. Source: (International Energy Agency, 2018)

The transition from the ICE vehicle road system to a coexistence of ICE vehicles and EVs is a lengthy and costly process, which implies the modification of an existing mature transportation system and the creation of a new ecosystem. It implies the creation of interfaces between the different actors of the system and the standardization of the communication between them to allow interoperability of solutions (Brown et al., 2010).

In particular, there will be new interactions between EVs and the electricity system. We will see in the second section of this chapter how electricity systems have completely mutated in the last decades and how EVs and electricity systems might interact in the third section.

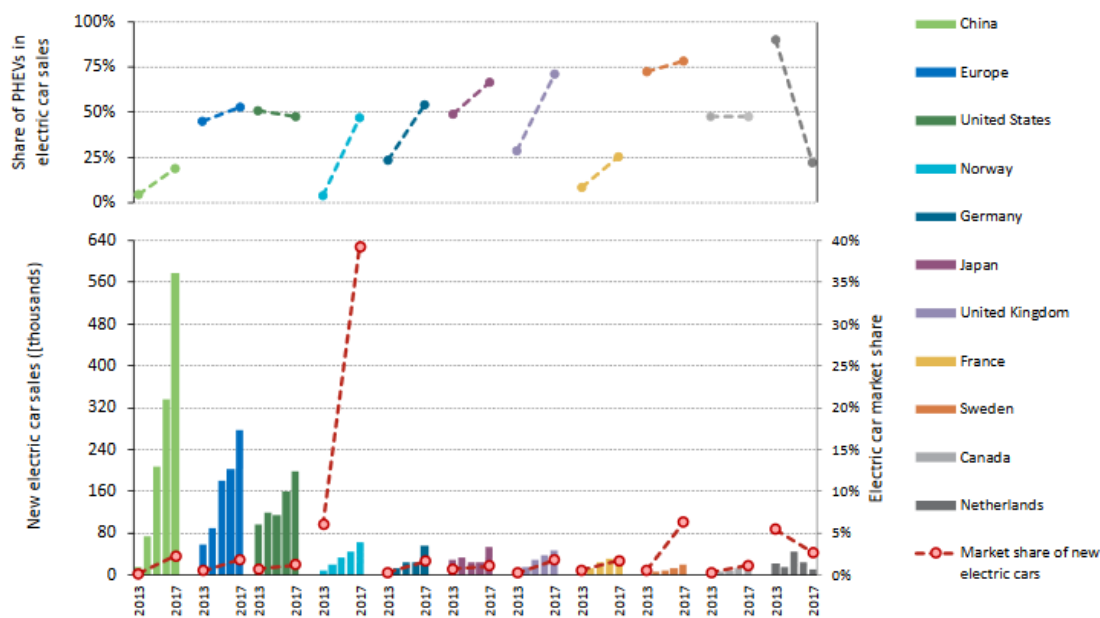

Figure 1.13 Market Share and Sales in Top-Ten Countries. Source: (International Energy Agency, 2018)

2 MUTATION OF THE ELECTRICITY INDUSTRY: LIBERALIZATION AND DECARBONIZATION

2.1 Liberalization of Electric Industries and Design of Electricity Markets

At the beginning of the second half of the 20th century, following the expansion and the interconnection of electricity networks at the national level, state-owned regulated monopolies were in charge of the entire value chain of the electricity industry in most developed countries. This value chain is split in four different parts: generation of electricity, transmission (which includes management of High Voltage networks and System Operations), distribution (Medium and Low voltage networks) and retail of electricity to final consumers. This type of architecture was the results of different factors:

- The need for large public investments at the end of Second World War to electrify countries to allow economic growth;
- The nature of electricity, which cannot be stored and requires high level of coordination between the different part of the value chain, in both short term and long term;
- Electricity sector was thought to be a natural monopoly, meaning that it would be more costly to have multi-firm production than to have a monopoly, due to high capital costs.

However, in the end of the 20th century, this architecture began to be criticized (Joskow and Schmalensee, 1988). Arrival of new and more efficient generation technologies such as CCGT questioned the fact that generation was a natural monopoly. Competition at the generation and

retail level was believed to foster innovation and efficiency and would allow reducing retail prices for final consumers. There was a consensus that liberalizing this sector would benefit to society in the long-term (Joskow, 2008). Distribution and transmission levels, due to their high investment costs, have always been considered as natural monopolies. However, there was also a need to give them better incentives to be more efficient.

Opening of competition on the generation and retail businesses also required to unbundle legal monopolies by separating transmission and distribution structures from generation and retail, to avoid conflict of interests and allow new competitors to enter the market. Moreover, an independent body should be created, which will be in charge of creating the rules of new markets and supervise competition. This process was first put in place in UK in the 80s, followed by some US States and European Union.

However, there was still a need for coordination between the different elements of the value chain, as the physics of electricity remained the same. The process to allow this coordination was internalized before reforms in the vertical-integrated companies. With liberalization, this coordination is done through markets, by confronting supply of electricity and demand. These markets must be organized, meaning that rules should be set in order to allow coordination, from short-term to long-term, in an efficient way, while ensuring security of supply.

It is possible to distinguish different sequences in electricity markets. Electricity being a flow, it is impossible to store it in the form of electricity, (it is possible to store it in another form of energy – chemical, electrostatic, mechanical, thermal...). Every Watt produced at one point of the system should be consumed at another point. The main objective of electricity markets is to ensure a balance between supply and demand, at the most effective cost. Figure 1.14 gives an overview of these different sequences.

Market actors are called Balance Responsible Parties (BRP) in power markets. A BRP can have generation assets and/or retailer, but it can also be a pure energy trader, without any generation or consumers. A Balance Responsible Party has the legal duty to have a balanced perimeter, meaning that every generated or bought energy has to be either consumed by its clients or sold in the market.

The different markets where BRPs can trade energy are in blue in Figure 1.14. There are three different type of markets: future energy markets, where BRPs can trade energy for the coming years, months or weeks; Day Ahead Market (DAM) where BRPs can trade energy for the next day; and intraday market, where BRPs can trade energy for the coming hours. On these markets, the price of energy for a certain delivery period will be determine by confrontation of offer and demand: BRPs wanting to sell energy (e.g. producers) will make offer bids, based on their costs, while BRPs wanting to buy energy (e.g. retailer) will make demand bids based on their willingness to pay.

The price and the amount of energy traded for this delivery period is the point where demand curve (demand bids sorted in decreasing order) meets offer curve (offer bids sorted in increasing order). BRP will trade on these different markets based on the information they have on forecast of generation and consumption. The closer from real-time, the better will be this information. However, it will also be more costly to balance near real-time, as resources might be scarce.

In parallel, Transmission System Operator (TSO), in charge of balancing the system, procures reserve. Reserve is provided by flexible actors (Balancing Services Provider – BSP) able to adjust their consumption or generation output to rebalance the system in case of imbalance. It means these actors will not produce or consume at the maximum or the minimum output, in order to be able to change it when required.

There are different types of reserve, depending on the reactivity of the resources to an imbalance and the duration of the deviation from its original output. BSPs can be paid based on the capacity (in MW) they offer and on the activated reserve (in MWh).

There are two types of reserve:

- Upward reserve: activated when there is more consumption than generation on the network and correspond to an increase of generation or a decrease of consumption,
- Downward reserve activated when there is more generation than consumption.

Finally, BRPs can offer energy they were not able to trade in the different market sequences on the balancing mechanism to the TSO. It increases the amount of available balancing energy for the TSO, but BRPs is only remunerated for this energy if the reserve is activated.

In real-time, based on the observed imbalance on the system, TSO will activate the different reserves in order to rebalance the system. Frequency deviations around its nominal value are the reflection of imbalance of the network. If frequency is above its nominal value, it means that there is more generation than consumption and vice-versa.

TSO activates reserve based on administrative rules (e.g. pro-rata activation) or merit-order rules. For upward reserve, TSO remunerates the BSPs for extra-energy generated: TSO activates reserve in increasing order of bid prices. For downward reserve, BRPs remunerate TSOs for energy not produced due to reserve activation: TSO activates reserve in decreasing order of bid prices.

After real-time, TSO calculates imbalance of each BRP. If BRP perimeter is negative (meaning consumption and energy sold is higher than generation and energy bought), BRP remunerates TSO for energy not generated or bought on markets. It will buy this energy at a high price, reflecting costs for TSO to rebalance the network. If perimeter is positive, TSO remunerates BRP for extra-energy bought or generated at a low price. This imbalance settlement process gives an incentive to BRPs to balance their perimeter before real-time.

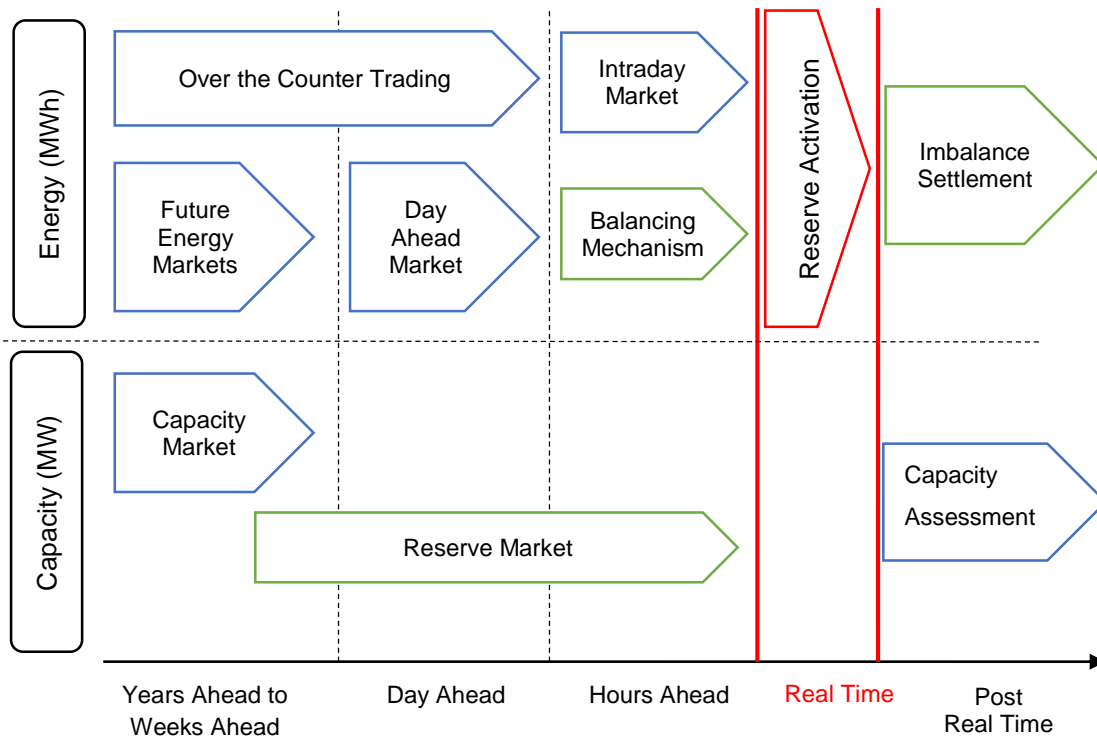

Figure 1.14 Electricity markets general architecture

2.2 Towards Massive Penetration of Renewables and Distributed Energy Resources

We have seen in Paragraph 1.2 that decarbonization of the electricity sector was a prerequisite to an efficient decarbonization of road transport through electric vehicles diffusion. More generally, decarbonization of electricity generation is the major goal to achieve CO₂ emissions target. Table 1.2 gives CO₂ emissions per kWh of different electricity generation technology.

Table 1.2 CO₂ Intensity for different electricity generation technologies. Source: (Ademe, 2017)

	Technology	kgCO ₂ eq/kWh
Thermal Generation	Coal	1.06
	Oil	0.73
	Gas	0.418
	Nuclear	6.10 ⁻³
Renewable Generation	Onshore Wind	0.0127
	Offshore Wind	0.0148
	Hydroelectric	6.10 ⁻³
	Photovoltaic	0.055
	Geothermic	0.045

It appears clearly that decarbonization of the electricity sector could be achieved by replacement of fossil fuels generation assets by renewable energy assets and nuclear assets. However, there are main economic barriers to this shift:

- At the beginning of the 21st century, renewable technologies are costly and relatively immature compared to thermal technologies
- Electricity networks have been designed for centralized large generation assets, whereas renewable generation is decentralized and distributed technology.
- Wind and photovoltaic technologies are non-dispatchable technologies and generation is not synchronized with consumption
- There is mistrust toward nuclear energy generation in public opinion after Fukushima catastrophe in 2011.

As for electric vehicles, there are negative externalities with associated with generation from fossil fuels that are not reflected in market prices. Policy makers designed different instruments to foster penetration of renewable energy in the electricity generation mix:

- Following Kyoto conference, a market for CO₂ emissions was created in European Union (called European Union Trading Scheme – ETS). Policy makers fix an annual global level of CO₂ emissions at the European level and allocate quotas to companies, which then can trade quotas with each other.
- Subsidies to renewable energy generation, which can take different forms (feed-in tariff, feed-in premium, green certificates...).
- Tax credit for the installation of renewable energy generation assets

These different schemes allowed for an increasing penetration of renewable energies in the two last decades, in particular photovoltaic and wind generation, in most European countries, with contrasted results in different countries (Figure 1.15 and Figure 1.16). This diffusion allowed a reduction of costs for solar and wind technologies, as shown in Figure 1.17. The governments in the coming decades will pursue this transition toward low carbon generation of electricity. In the middle to long term, it could mean having a 100% renewable energy mix in order to meet targets of the COP21.

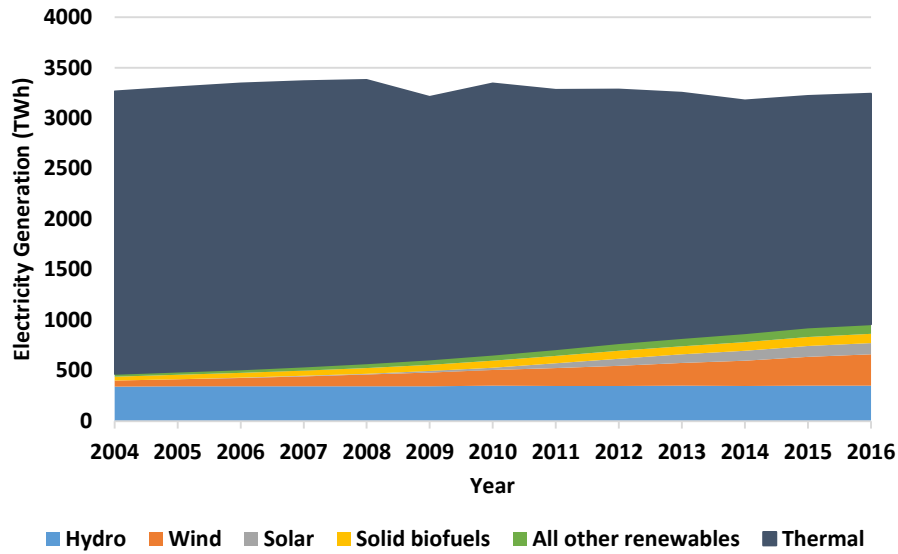

Figure 1.15 Electricity Generation by Technology in European Union between 2004 and 2016. Source: (Eurostat, 2017)

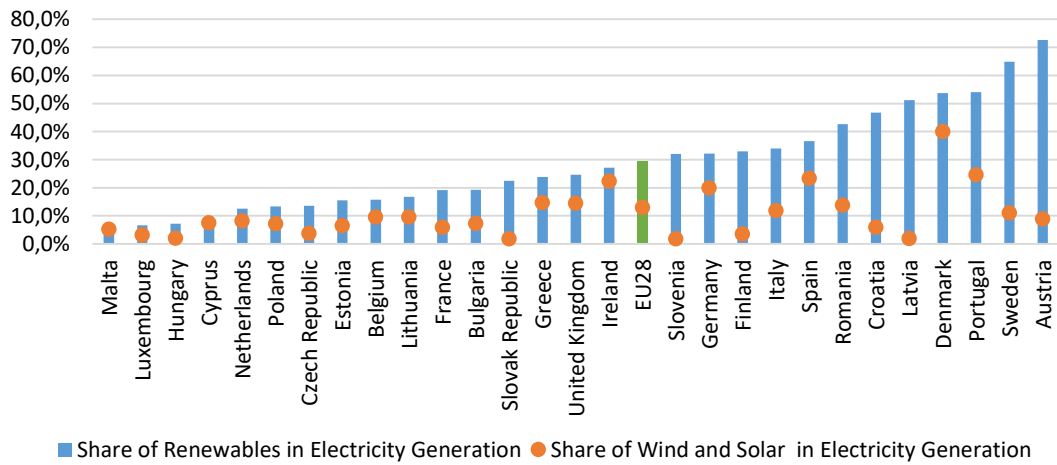

Figure 1.16 Share of Renewables in Electricity Generation in 2016. Source: (Eurostat, 2017)

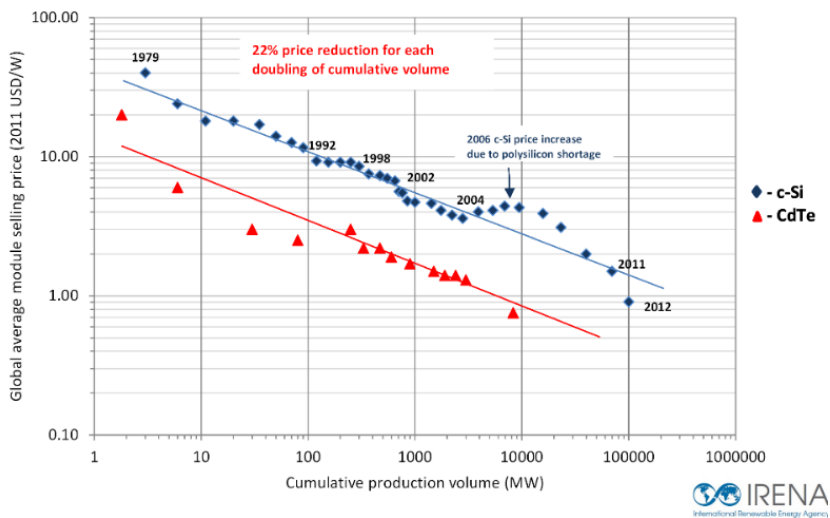

Figure 1.17 Learning curve of photovoltaic cells. Source: (IRENA, 2017)

2.3 The Challenge of Increasing Flexibility Requirements

The massive penetration of renewables in the electricity generation mix will have major impacts on the operation of electricity networks. Photovoltaic and wind electricity is by nature non-dispatchable. Generation cannot be controlled according to market needs but is a function of the availability of the resource (irradiation of sun or wind speed). We call residual consumption the part of consumption not fed by non-dispatchable resources. Thermal or hydro generation units must feed this residual consumption. System operators might face issues of ramp-up of the residual consumption, due to intermittency of renewable resources (Navid and Rosenwald, 2012) (called duck-effect, see Figure 1.18). This effect can also be seen in the price curve, with higher peak price due to ramp-up issues (Figure 1.19).

Moreover, photovoltaic and wind assets are not synchronized to the frequency of the electricity network, meaning they do not participate to the global inertia of the system. Imbalances between consumption and generation will have bigger impacts on the frequency of the system (Ahmadyar et al., 2018)(Hirth and Ziegenhagen, 2015).

Finally, photovoltaic and wind generation cannot be perfectly forecasted, meaning System Operators should be able to face increasing short-term imbalances on the network.

In order to manage these different effects, System Operators will need more flexibility from the actors of the electricity system. They will require faster ramping-up assets to follow residual consumption and more and faster reserves in order to manage balancing between generation and consumption.

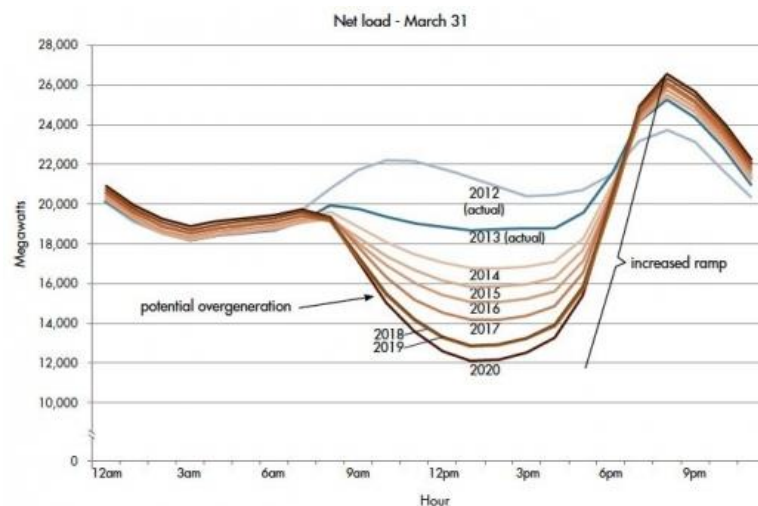

Figure 1.18 The duck-curve in California – Residual Consumption between 2012 and 2020. Source: (US Department of Energy, 2017)

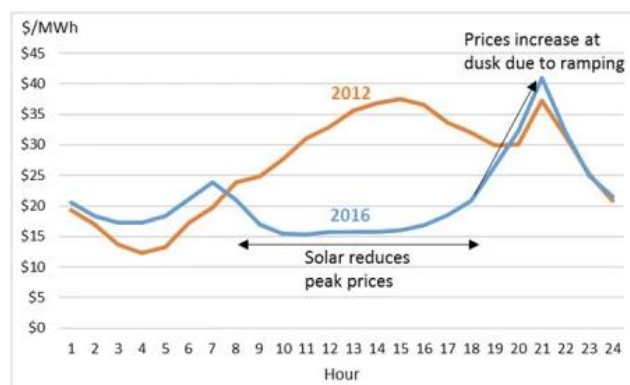

Figure 1.19 Average Hourly Price in California

The flexibility of an asset can be described by different essential attributes (Eid et al., 2016)(Ulbig and Andersson, 2015). These attributes are illustrated in Figure 1.20:

- The direction of power adjustment (upward or downward).
- The availability in time
- The power capacity of the adjustment (in MW)
- The maximum duration of the adjustment
- Energy
- The delay between notification and activation
- The location on the grid

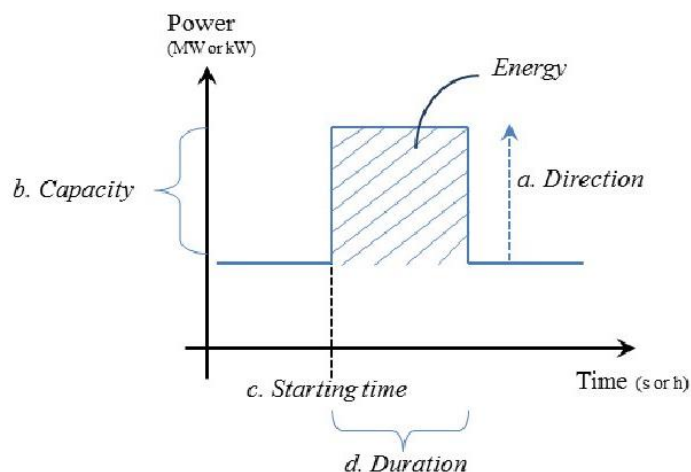

Figure 1.20 Attributes of flexibility assets. Source; (Eid et al., 2016)

TSOs will define technical requirements (maximum delay, minimum ramping capabilities, minimum duration etc.) in different flexibility markets to be able to manage effectively balancing of the network. Depending on their characteristics, assets will bid their flexibility on the markets where they are able to meet technical requirements while getting the better remuneration.

In conclusion, there is now a clear need for more flexible assets on the electricity system to cope with the integration of renewable systems. Price signals in the electricity markets should reflect these middle/long term needs for new investments.

Moreover, every sources of flexibility should be considered to participate in the markets, including demand-side flexibilities.

3 USING ELECTRIC VEHICLES AS DISTRIBUTED FLEXIBILITY ASSETS

3.1 Challenges and Opportunities of Massive Diffusion of EVs for Electricity Systems

In addition to the massive penetration of renewable energy generation, a massive uptake of EVs will represent another challenge for System Operators. This new electricity consumption could in the coming years impact the long-term adequacy between offer and demand, for both energy and power and both in term of generation asset and network (distribution and transmission).

It is possible to calculate some order of magnitude of these impacts. For example in France, the annual mileage of a personal car is about 17,000 km. With a consumption of 0.20 kWh/km, the

annual consumption of 1 million EVs would be about 3.4 TWh, which represent an increase of the 2017 electricity consumption (475 TWh) by 0.7 %.

With respect to the capacity increase, if every vehicle charge at the same time with a power plug of 3 kW, the instantaneous consumption of these vehicles would be 3 GW, which represent an increase of 3 % compared to the historical peak consumption in France and the generation output of about two nuclear units. Moreover, as people typically plug-in when they come back from home, the consumption from Electric Vehicles would be synchronized with peak consumption and could aggravate the so-called “duck-curve”.

These order of magnitude shows that EVs will represent a major challenge in term of capacity, which is the major determinant of electricity networks. Indeed, System Operator will size the network in order to fit the maximum peak consumption. In case of a major diffusion of Electric Vehicles and if these vehicles charge as soon as plugged (“dumb” charging), System Operators will have to reinforce the entire network, which would imply massive investments. It would be particularly true for distribution networks, in places where EVs would diffuse rapidly, such as cities. However, it is possible to pilot charging pattern of the vehicle in order to reduce stress to the network and provide flexibility services to System Operators.

Personal vehicles have on average very low utilization rates. According to a survey conducted by the French government in 2008 (Ministère de la Transition Ecologique et Solidaire, 2008), 42 % of vehicles are circulating less than two hours a week, which represents a utilization rate of 1.1% and 89 % of the vehicles are circulating less than 8 hours a week (utilization rate of 4.7%). Moreover, 75% of vehicles have a daily mileage of less than 42 km. For EVs, it means that, potentially, the car is plugged to the network 95 % of the time and need a daily recharge of less than 8 kWh (if we consider an average consumption of 0.2 kWh/km). Considering that the typical EVSE at home is about 3 kW, it means that it would take only 3 hours to charge completely the car for daily trips.

We have seen in the previous paragraph that System Operators might face an issue of increasing peak consumption in case of “dumb charging”. Personal cars are often at home during the entire night, the vehicle might be plugged to the network for more than 8 hours. It might not be necessary, in most cases, to charge the vehicle as soon as plugged. It would be preferable to delay charging hour to charge the vehicle during period of low consumption. This process is called load-shifting as consumption is delayed from peak to off-peak period

It is required to have a price signal to allow this delay of charging pattern. Different types of price signals have been studied in the literature (Gyamfi et al., 2013). From the simplest to the more complex price structure:

- Time-of-Use (TOU) price: electricity is charged at predefined different prices within predefined time periods
- Critical Peak Pricing (CPP): electricity is charged at a very high price for a certain number of days or hours during the year with extreme peak situations
- Real-Time-Pricing (RTP): electricity is charged at a price reflecting real-time evolutions of electricity markets

Simple price structure like TOU will not ensure a perfect load shifting as consumption is displaced to a fixed period, which might not match with volatility of consumption, and might create secondary peaks of consumption as vehicles will start charging at the same time. However, they are simpler to implement (TOU tariffs exist in France since the 50s) and do not expose client to price risks. RTP price could perform more effective load shifting but might be more complex to put in place and expose the client to significant price risks. Allowing bidirectional flows between the battery and the grid would increase the flexibility potential of the vehicle, as shown in Figure 1.21. This technology was called Vehicle-to-Grid (V2G)⁶.

⁶ In the following of the thesis, V2G and bidirectional capability will be used as synonyms

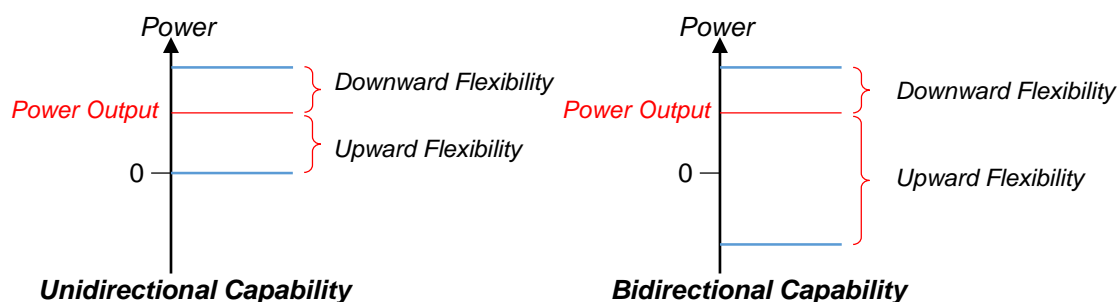

Figure 1.21 Flexibility Potential for Unidirectional and Bidirectional Capabilities

Moreover, it is possible to use flexibility of the EV to offer services to TSO on reserve markets and balancing mechanisms, to increase the value of this flexibility. These services being remunerated by TSOs, provision of flexibility would allow reducing cost of recharge of the Vehicles. We will see in the next paragraph which types of flexibility could be addressed with electric vehicles.

3.2 Which Flexibility Services for Fleet of EVs?

First and priority service provide by an Electric Vehicle is mobility. Flexibility provision should not endanger the delivery of this service to the customer. We can distinguish two time-scales in the provision of mobility services:

- Short time scale: flexibility provision should not endanger capability of the user to do its next trip at the end of the charging session, meaning that battery should have enough energy to run for the desired mileage.
- Long time scale: battery capacity is affected by the number of cycles that will occur during its lifetime. Car manufacturer guarantee the battery for a certain mileage of the vehicle and for a certain capacity fading. Provision of flexibility should not reduce extensively battery lifetime. (Wang et al., 2016)

It is necessary to manage smartly charging pattern of the vehicles to reduce these two constraints but also to find the appropriate services, which allow maximizing value while fitting with the characteristics of EVs.

We will give an overview of main flexibility services in Europe and the associated technical requirement. Then we will analyze if these services fit with EVs characteristics (with unidirectional or bidirectional capabilities), and give order of magnitude on possible remuneration. These different services are not accessible by a single user. It will be necessary to pool a fleet of EVs to make offers on the markets. The party that will manage charging patterns of the vehicles and make offers on the markets is called aggregator.

3.2.1 Energy Arbitrage

The first way to use flexibility of EVs charging pattern is to do energy arbitrage: with unidirectional capabilities, the principle, explained in Paragraph 3.1 is to charge the battery at the least costs given volatility of electricity price. With bidirectional capabilities, it is also possible to feed electricity into the grid when electricity prices are high. Figure 1.22 shows average prices in Day Ahead Market for year 2017 in six different countries. The trend of price evolution during the day is the same in every countries: peak price around 8:00 and 18:00 and low prices during night. However, the range of variation is not the same in every countries and shows high seasonality, as can be seen if Figure 1.23.

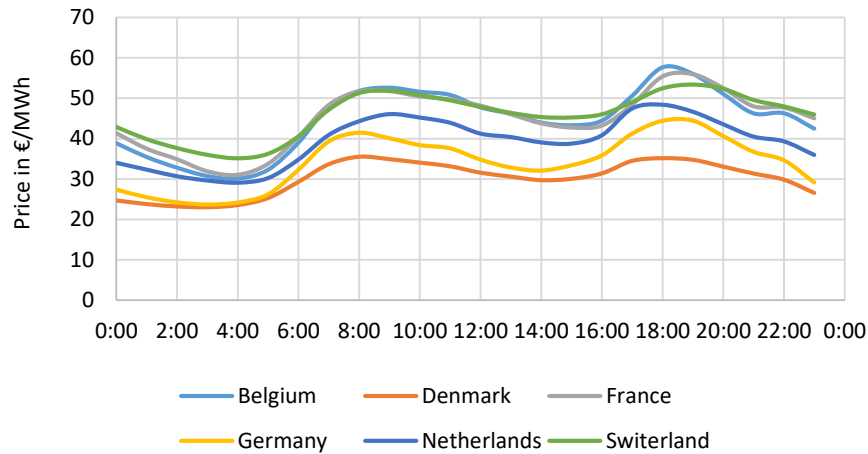

Figure 1.22 Average Spot Prices in 2017

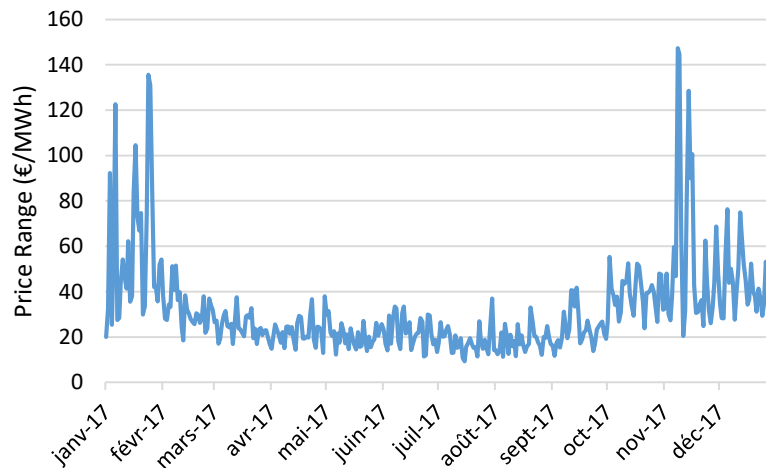

Figure 1.23 Daily Range of variation of Spot Price in 2017 in France

We can assess potential savings through energy arbitrage on a simple case: a vehicle has to charge 6 kWh of energy on 3 kW power plug every night. The vehicle is plugged at 6 pm. We look at seven different scenarios:

- Unidirectional-0: Charge as soon as plugged
- Unidirectional-1: Charge between 3am and 5am each night
- Unidirectional-2: Charge during the two hours with lowest price each night
- Bidirectional-1: Charge during the two hours with lowest price each night. Discharge of 1 hour during the 10 days when it is the most economically efficient (days with high range of price variation).
- Bidirectional-2: Charge during the two hours with lowest price each night. Discharge of 1 hour during the 50 days when it is the most economically efficient
- Bidirectional-3: Charge during the two hours with lowest price each night. Discharge of 1 hour during the 100 days when it is the most economically efficient

Figure 1.24 shows the cost of charging over year 2016 for different countries. It is clear that most of the value is captured with scenario Uni-1 and this value is higher in countries with high amplitude between peak and off-peak periods (France and Belgium). In these countries, bidirectional charging also allows decreasing substantially costs of charging.

However, most of the value can be captured with a limited number of discharging hours. Figure 1.25 shows the additional savings compared to scenario Uni-2 in function of the number of hours of discharge. It shows that marginal value of each additional hour of discharging is decreasing rapidly. This is due to seasonality of volatility of electricity price.

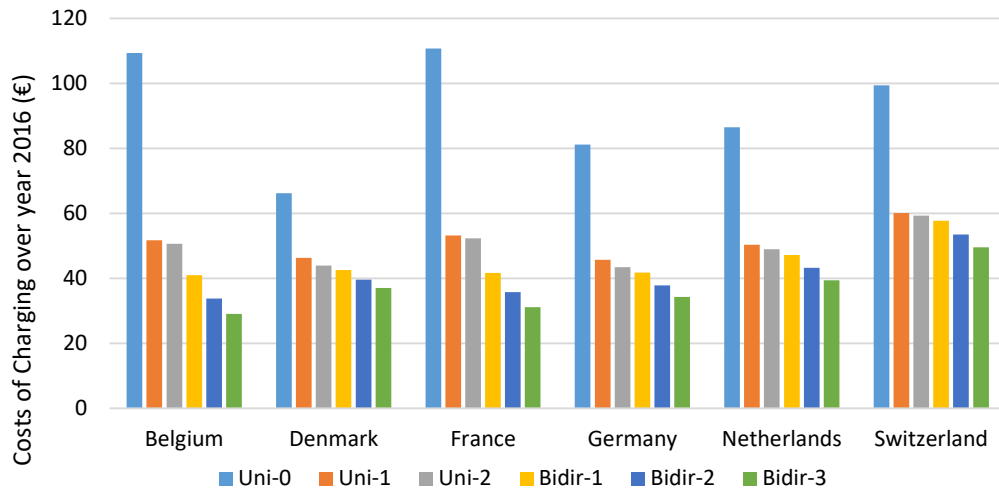

Figure 1.24 Costs of charging over year 2016 for different charging patterns

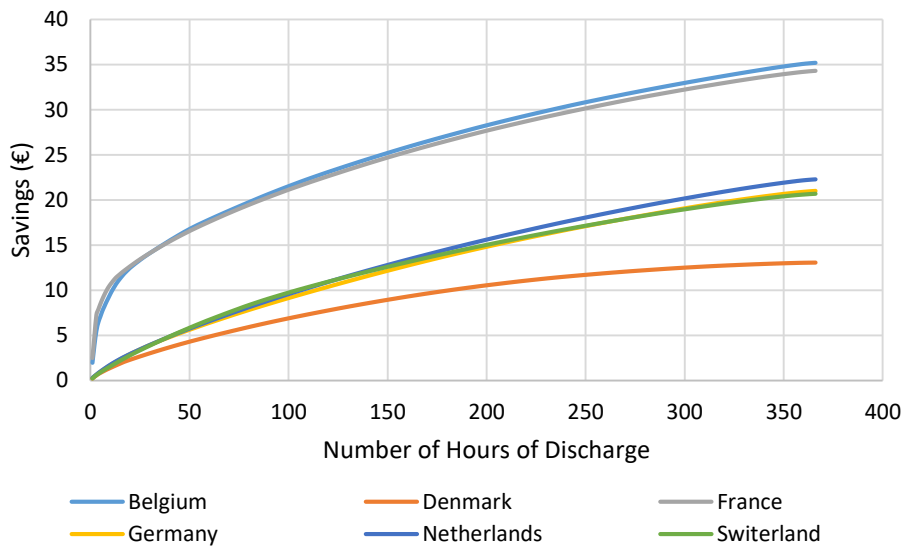

Figure 1.25 Value of Bidirectionality for Energy Arbitrage (Compared to Uni-2 Scenario)

For unidirectional capability, energy arbitrage will have no impact on battery degradation, as there are no additional cycles on the battery. For short-term mobility needs, the user of the vehicles would have to inform its next hour of departure and minimum amount of energy required to perform the trip, in order to manage charge pattern to meet these targets.

For bidirectional capabilities, discharging the battery will induce more cycles, which might affect battery lifetime and create extra-costs for the user (Thompson, 2018). As we have seen, the marginal value of each hour of discharging is decreasing. The aggregator should select the hours where discharging will have a higher value than battery degradation. The implementation of energy arbitrage would be relatively simple.

3.2.2 Reserve Provision

As seen in Paragraph 2.1, Transmissions System Operators are in charge of balancing the system. To do so, they contract with flexibility actors, able to adjust their generation or consumption in order to rebalance the network.

By managing power rate of the EVSE of the fleet in their pool, aggregators could provide such flexibility services. However, depending on the characteristics of the product provided, impact on mobility needs and battery degradation might differ.

We will focus on design of reserve in continental Europe in this section.

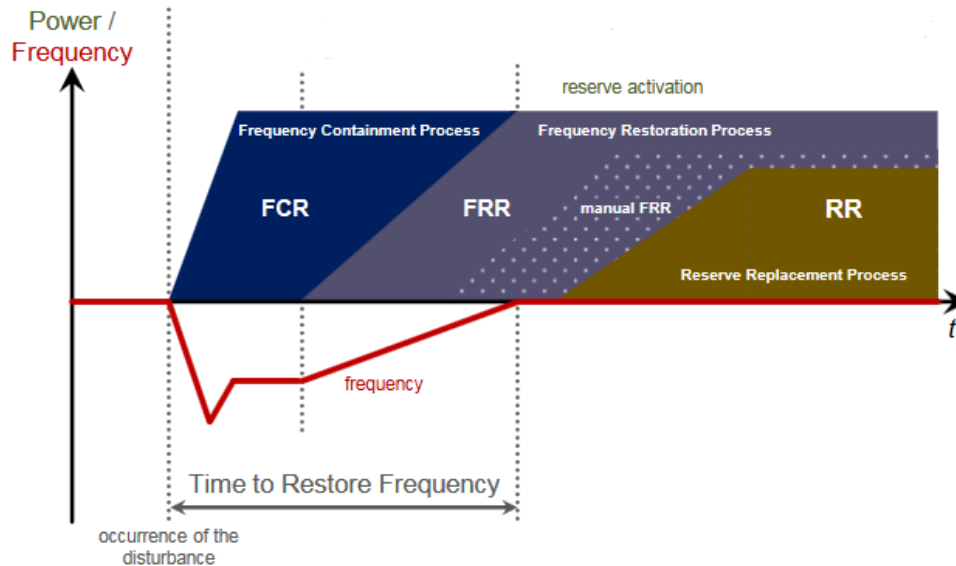

Figure 1.26 Balancing Reserve as defined by ENTSO-e

The ENTSO-e has created three types of reserve, harmonized across all continental Europe, which differs in the delay of activation and length of the adjustment:

- Frequency Containment Reserve (FCR): it is the first activated reserve. Activation is based on frequency deviations, which reflects imbalances. BSPs have to measure frequency and to react to frequency deviations (following characteristics showed in Figure 1.27). The BSP should completely activate reserve within 30 seconds after a frequency deviation and be able to maintain reserve activation for at least 15 minutes. Remuneration is based on capacity offered.
- Frequency Restoration Reserve (FRR): it is activated only in the bidding zone responsible for the imbalance. It should have a delay of activation of 15 seconds and be fully activated in less than 15 minutes. It can be activated automatically (aFRR) by a signal sent by the TSO, with dynamic profile (meaning activation rate⁷ is a linear variable between 0 and 1), or manually activated (mFRR) and static profile (activation rate is binary). Remuneration is based on capacity offered and on energy delivered.
- Replacement Reserve (RR): reserves activated in more than 15 minutes. Remuneration is based on capacity and on energy delivered. It is static profile reserve only.

Aggregators should privilege services with high remuneration of capacity, low activation rate of the reserve and short duration of reserve activation. This type of service will have lower impact on short-term and long-term mobility needs.

⁷ Activation rate is the percentage of offered reserve that is activated at a certain time.

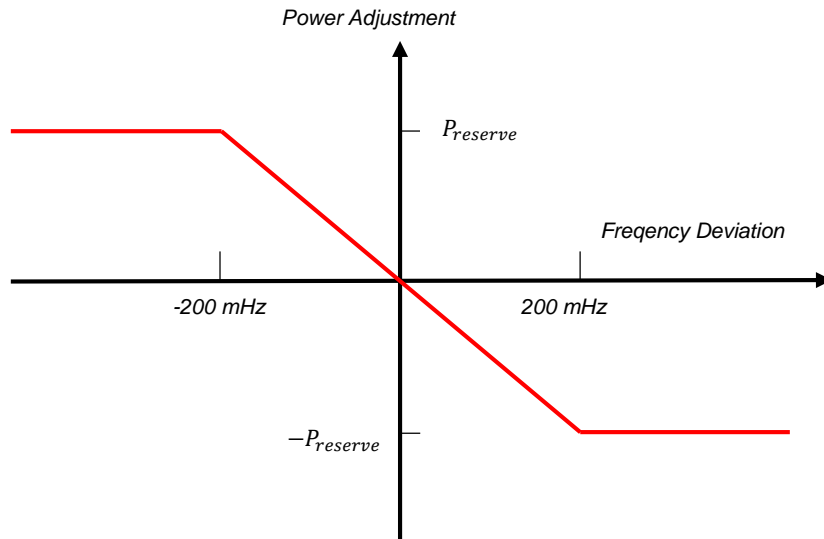

Figure 1.27 Power-Frequency curve for FCR Provision (generator convention)

As energy storage is limited, it will not be possible to offer the entire capacity of the EVSE if duration of reserve activation or activation rate is high. Moreover, if activation rate is low, there will be less impact on battery degradation for bidirectional vehicles. For unidirectional vehicles, availability of the vehicle is low as a vehicle cannot provide reserve as soon as battery is fully charged. Provision of reserve will have low impacts on battery degradation (as it will not affect number of cycles). Impacts on mobility needs will depend on the direction of reserve provision: if downward reserve is provided (increase of consumption), there will be no impact on mobility needs whereas upward reserve provision (decrease of consumption) could have impacts, as charge will be delayed.

FCR has ideal characteristics for bidirectional EVs: remuneration is only based on capacity, activation rate is very low (as shown in Figure 1.28) and duration of reserve activation is only 15 minutes. However, implementation of these types of services would be more complicated, as EVSE should be able to react rapidly enough to frequency deviations and store data on power adjustments.

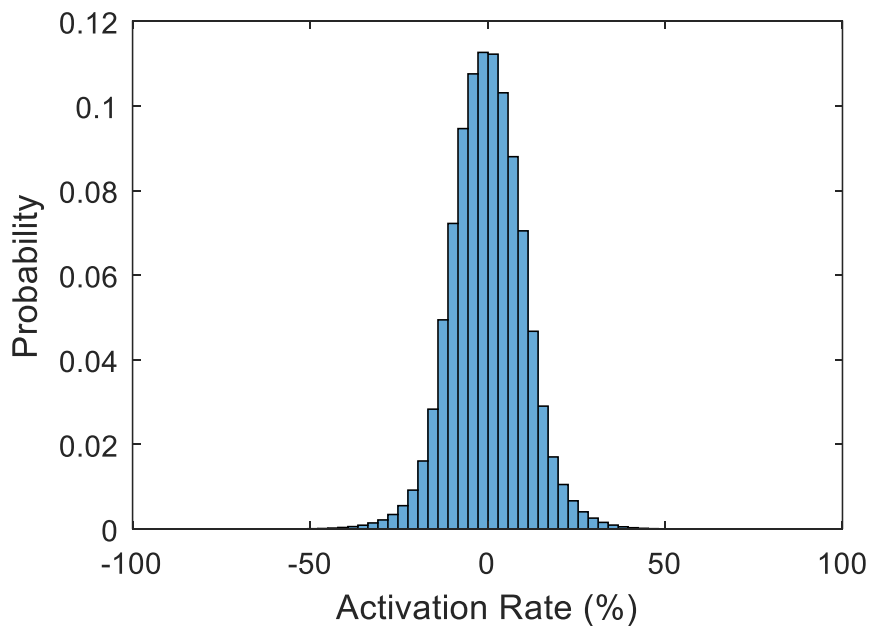

Figure 1.28 Histogram of Activation Rate in Continental Europe for FCR in 2016

Automatic FRR have activation rate and duration of reserve activation much higher than FCR, which could have high impacts on mobility needs. For static services (mFRR and RR), unidirectional strategy should be preferred: the vehicle will stop charging on request of the TSO. It will not affect battery degradation but will have impacts on mobility needs. It is simpler to implement, as delay to activate reserve is longer and provision of reserve is binary.

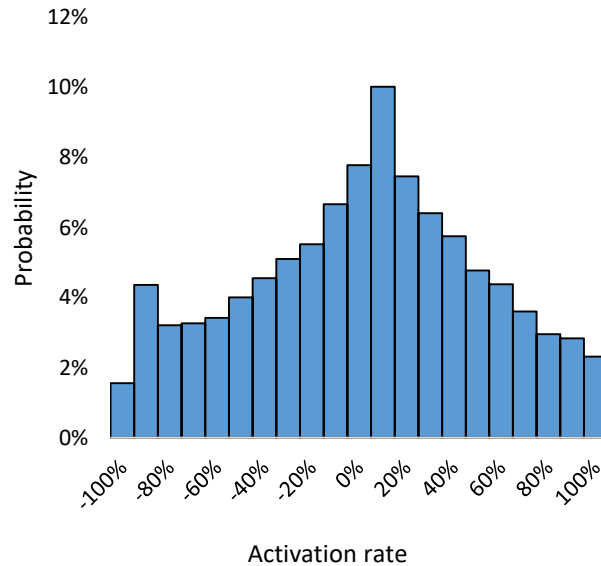

Figure 1.29 Histogram of Activation Rate in France for aFRR in 2016

3.2.3 Other Sources of Value

It exists other types of sources of value for unidirectional and bidirectional vehicles:

- Self-consumption if user possess a generation asset. The value of self-consumption will depend on the spread between 1) the retail price of electricity and 2) the Feed-in-Tariff for renewable generation. The higher the spread, the higher the value of maximizing self-consumption.
- Value on capacity markets, created in some European countries. EVs have to curtail consumption or reinject electricity during a certain number of peak hours. It reflects the value of investing in new generation assets to cope with peak consumption hours.
- Value for distribution grids. By managing charging patterns of EVs, it is possible to avoid local congestion on distribution grids. Electricity Distribution Companies could avoid new investments on transformers to cope with peak consumption situations. EVs could also provide voltage regulation.

3.3 A Literature Review on Smart Charging of Electric Vehicles

We have seen in the previous paragraph that charging patterns of Electric Vehicles can be managed by aggregators to offer flexibility services and reduce charging costs. However, this process should take into consideration mobility needs of the user to ensure that he will have sufficient amount of energy for his next trip, through algorithms.

Extensive reviews of the literature was performed in (García-Villalobos et al., 2014) and (Hu et al., 2016). According to these two reviews, algorithms can be categorized according to four main parameters: Characteristics of vehicles studied, control strategy of the operator, objective of the algorithm and optimization method.

3.3.1 *Characteristics of Vehicles*

When assessing possible value of smart charging, it is necessary to decide on the characteristics of the vehicles in the fleet:

- Battery capacity and limitations on the State-of-Charge
- Maximum power of the EVSE
- Unidirectional or Bidirectional capabilities
- Trip patterns
- Efficiency of the charger

It is possible to include heterogeneity in the vehicles of the fleet. Moreover, the aggregator can have or not perfect foresight on the parameters of the vehicles.

3.3.2 *Control Strategy of the Operator*

We can distinguish between centralized and decentralized control.

- In centralized control, EVs will send data on their status (State of Charge of the battery, hour of departure etc.) to a central controller. Based on data, central controller will decide on a charging pattern, which will be sent to every vehicle of the fleet (Han et al., 2010) (Sortomme et al., 2011) (Kang et al., 2013)
- In decentralized control, the aggregator will send a price signal to each EV, which will decide on their charging patterns according to this price signal. Optimization is performed at the local level (Vaya and Andersson, 2012).
- In (Hu et al., 2016), authors also identified transactive control, where EVs will send back their charging patterns to the aggregator, which will adapt its price signal until an equilibrium is reached.

Centralized control will be more costly to implement and computation requirements for aggregator will be high, as he should get all information necessary to decide its strategy.

Decentralized control will be less expensive to implement and ensure a good level of privacy for the users regarding data they send to the aggregator. However, it is necessary for the aggregator to forecast the reaction of aggregated units to the price signal.

3.3.3 *Objective of the Algorithm*

There is a variety of objectives of the aggregator in the literature. According to the classification used in (Hu et al., 2016), we can distinguish four types of objectives:

- Providing ancillary services to Transmission System Operators, typically provision of reserve services (Kempton and Tomić, 2005)(Codani et al., 2016)(Sortomme and El-Sharkawi, 2011)(Jargstorf and Wickert, 2013)
- Providing ancillary services to Distribution System Operators, which can include limitation of congestion, power losses, imbalance between phases in three-phased systems, voltage regulation (Deilami et al., 2011)(García-Villalobos et al., 2016)
- Providing storage services to renewable energy source supplier (e.g. self-consumption) (van der Kam and van Sark, 2015) (Soares M.C. Borba et al., 2012)
- Minimizing charging cost for electric vehicle owner (Sundström and Binding, 2012)

These different objectives can be cumulated by the aggregator and might conflict against one another. Associated with these different objectives, the algorithm will minimize a cost function, which can be an economic cost (if it is possible to monetize the service) or a technical cost.

3.3.4 Optimization Method

Finally, the aggregator will have to define a method of optimization. We will not go in the detail of the different algorithms.

There is a trade-off for the aggregators between computation time and accuracy of the optimization.

3.4 Toward the Elaboration of Business Models for Aggregator

If the above-mentioned literature is extensive and explored a wide diversity of algorithms and control strategies, there is however a lack of understanding of the value of this technology and how it could come to market. Business model can be defined as *“the rationale of how an organization creates, delivers, and captures value in economic, social, cultural or other contexts”* (https://en.wikipedia.org/wiki/Business_model). Elaboration of business model should therefore take into account:

- Possible revenues of the solution under realistic hypothesis of market rules
- Costs of implementation of the solution
- Risks associated with the development of the solution
- Willingness of users to adopt the solution
- Cooperation with other actors of the value chain and interfaces to develop

We identified different level of gaps in the literature to go from smart charging algorithm definition to realistic business models.

First, it is needed to transcribe technical results in possible monetary value, either for the system or for the users. Moreover, if there is no market to monetized this value, there is no possible viable business-value for the solution.

Second, evaluation of revenues should be done in realistic conditions in term of market-design. Indeed, market-design could hinder participation of the fleet.

Then, costs of the implementation of the solution should be thoroughly assessed. The different risks that could affect the value of the solution should also be taken into consideration, by performing sensitivity analysis.

Finally, designing a viable business model means assessing how the value should be shared between the different actors of the value chain and the client.

These different gaps identified in the relevant literature are presented in Table 1.3.

Table 1.3 Gaps in the relevant literature

Gap in the literature	Papers where the gap was identified	Papers trying to bridge this gap
<i>Revenues of the smart charging solution is not evaluated, only technical results are given</i>	(Han et al., 2010) (Sortomme et al., 2011) (Kang et al., 2013) (Vaya and Andersson, 2012) (Deilami et al., 2011) (Garcia-Villalobos et al., 2016) (van der Kam and van Sark, 2015) (Soares M.C. Borba et al., 2012) (Sundström and Binding, 2012)	(Kempton and Tomić, 2005) (Codani et al., 2016) (Sortomme and El-Sharkawi, 2011) (Jargstorf and Wickert, 2013) (Dang et al., 2015) (Tomić and Kempton, 2007) (Noori et al., 2016) (Gough et al., 2017) (DeForest et al., 2018)
<i>Smart charging solution cannot be monetized due to inexistent market</i>	(Dang et al., 2015)	
<i>Smart charging solution revenues are assessed in unrealistic conditions, not taking into account market-design and its possible evolutions</i>	(Sortomme and El-Sharkawi, 2011)	(Codani et al., 2016) (Jargstorf and Wickert, 2013) (Tomić and Kempton, 2007) (Noori et al., 2016) (Gough et al., 2017) (DeForest et al., 2018)

<i>Cost of implementing the solution are not considered</i>	(Codani et al., 2016) (Sortomme and El-Sharkawi, 2011) (Jargstorf and Wickert, 2013) (DeForest et al., 2018)	(Kempton and Tomić, 2005) (Tomić and Kempton, 2007) (Noori et al., 2016) (Gough et al., 2017)
<i>No sensitivity analysis is performed on the value of the solution</i>	(Kempton and Tomić, 2005) (Tomić and Kempton, 2007) (DeForest et al., 2018)	(Noori et al., 2016) (Gough et al., 2017)
<i>User willingness to adopt the solution is not taken into account</i>	(Tomić and Kempton, 2007) (Noori et al., 2016) (Gough et al., 2017) (DeForest et al., 2018)	(Parsons et al., 2014) (Geske and Schumann, 2018)
<i>Value sharing between different actors of the value chain is not taken into account</i>	(Codani et al., 2016) (Sortomme and El-Sharkawi, 2011) (Jargstorf and Wickert, 2013) (Dang et al., 2015) (Tomić and Kempton, 2007) (Noori et al., 2016) (Gough et al., 2017) (DeForest et al., 2018)	

4 THESIS ORGANIZATION

These gaps are complex to bridge but crucial to assess the viability of a smart charging solution. We will try to do so in this thesis, adopting the point of view of an investor. We take the following hypothesis and restrictions in our studies. We will focus on European markets, which offers the opportunity to study diversified and evolving markets, with an increasing development of Electric Vehicles. We will restrict our study to EVs equipped with bidirectional chargers and on markets offering high value services, i.e. reserve market. Finally, we will use rather simple algorithms, which will allow us to simulate large fleets in reasonable computation times, in order to have realistic order of magnitude on the value of the technology.

We will proceed in three steps, corresponding to the following three chapters:

Chapter 2: we perform in this chapter a qualitative evaluation of market rules, to identify barriers to entry an aggregator might face when investing in a market. We build a framework to perform this analysis and apply it on two case studies: 1) a comparison of four different market zones in 2016 2) evolution of rules in France in 2017.

Chapter 3: we evaluate revenues of a fleet of EVs participating in reserve services, with different set of rules identified in Chapter 1. We evaluate these revenues for small fleets to understand how these rules will influence the entry of actors. Then we evaluate profitability of participation on reserve markets, taking into account costs of provision. We perform this analysis with larger size of fleets as we try to identify the long-term profitability of the solution.

Chapter 4: we analyze value sharing between different actors and with the final user, based on results on profitability obtained in chapter 3. We try to evaluate the value of a cooperation between the actors and to identify which forms this cooperation could take.

CHAPTER 2. IMPACT OF MARKET RULES ON PROVISION OF FLEXIBILITY BY DISTRIBUTED ENERGY RESOURCES: A QUALITATIVE ANALYSIS

1	Barriers to Entry for New Entrants in Flexibility Markets	28
2	Modular Analysis of Barriers to Entry	29
2.1	Module A: Administrative Rules Regarding Aggregation of Distributed Energy Resources.....	29
2.1.1	Technical Discrimination against Aggregated Resources (A1)	29
2.1.2	Interoperability among DSOs and TSOs (A2)	29
2.1.3	Aggregation Level (A3)	29
2.2	Module B: Definition of Products	30
2.2.1	Minimum Bid Size and Bid Increment (B1).....	30
2.2.2	Time Definition of Products (B2).....	30
2.2.3	Distance to Real-Time Reservation (B3)	31
2.2.4	Symmetry of Products (B4).....	31
2.3	Module C: Remuneration Scheme	31
2.3.1	Nature of Payment (C1).....	31
2.3.2	Extra-Bonus for Flexibility (C2).....	32
2.4	A Tool for Investors and Policy Makers	32
3	Costs Associated with the Opening of Markets	33
4	Two Case Studies: Geographic Comparison and Evolution of Regulatory Framework	34
4.1	Comparison of Four Market Zones in 2016	34
4.1.1	France.....	35
4.1.2	Germany	36
4.1.3	Denmark	37
4.1.4	Great-Britain.....	38
4.2	Evolution of Regulation in France: Towards the Creation of a Single Market Zone in Central Western Europe	39
4.2.1	Modification of Rules in France	39
4.2.2	Rationale of Market Integration.....	41
4.2.3	On-going Process of Modification of Rules	44
5	Partial Conclusion	45

1 BARRIERS TO ENTRY FOR NEW ENTRANTS IN FLEXIBILITY MARKETS

In this chapter, we will perform a qualitative analysis of the existence of barriers to entry in reserve markets for new entrants with innovative technologies, in particular aggregator of Distributed Energy Resources (Demand Side Response – DSR, distributed generation assets or distributed storage).

In (Bain, 1956), barriers to entry were defined as “*an advantage of established sellers in an industry over potential entrant sellers, which is reflected in the extent to which established sellers can persistently raise their prices above competitive levels without attracting new firms to enter the industry.*”

Electricity markets, including reserve markets, were designed in the last decades with the idea that large and centralized generation units were the only assets able to deliver flexibility products such as reserve at an affordable cost. This idea was true at the beginning of the liberalization of the electricity industry, as technology did not allow controlling consumption units and there was no decentralized generation.

The technical and economic feasibility of power reserve provision by different types of DERs has been studied in the literature. In (Singarao and Rao, 2016) and (Díaz-González et al., 2014), the authors analyzed the provision of electricity by wind farms, respectively in United States and in the United Kingdom. Participation of domestic loads has been analyzed in (Samarakoon et al., 2012) and (Trovato et al., 2017). In (García-Villalobos et al., 2014), the authors presented a review of the current EV charging algorithms, including for participation in frequency regulation reserves.

Reserve provision processes were designed with the involvement of System Operators and generation companies. It led to a variety of set of rules in different countries, with however a common point: they had not be thought to be open to other technologies and actors such as aggregator. Often, rules were referring explicitly to generation units connected to High-Voltage network as only provider of reserve, excluding de facto any other type of resources. Advantage of established seller is then clearly established by the fact that the appearance of new actors was not anticipated in the design of rules.

Other rules might limit participation of DERs in an indirect manner, as we will see in Paragraph 2. Rules were designed to fit with operations of large centralized units, which have completely different characteristics than DERs, in term of size of the units, availability and predictability. It might not be possible for aggregators to enter the market because of these rules, even if it is possible for them to provide the same product with equivalent technical characteristics. The aggregator might also enter the market at the expense of partnership with other actors, which would represent a transaction costs for aggregators and a loss of value.

Established sellers also have an advantage in the sense that they are stakeholder in the design process of the rules and might lobby to prevent an opening of the market to new actors, which might affect price of the service by increasing offer volume.

In our view, however, there is still a lack of a general framework enabling us to analyze the participation of DERs in different markets. It is thus necessary to perform a detailed analysis of 1) which rules are possible barriers to entry for DERs, 2) the importance of these barriers, 3) the way to redesign rules in order to remove these barriers.

In Section 2 of this chapter, we will present a modular framework that could be used as a tool for investors and policy makers to assess the existence of barriers to entry in the different markets. In Section 3, we will see that opening markets is a costly process for TSOs and it might be the result of a trade-off. Finally, in Section 4, we will apply the framework to two different cases: first, an

analysis of four different European market zones (France, Germany, Denmark and Great-Britain) performed in 2016; then, an analysis of the evolution of French rules in 2017.

2 MODULAR ANALYSIS OF BARRIERS TO ENTRY

In this section, we will present a framework to analyze the presence of barriers to entry in reserve markets. We decided to use a modular framework for description of rules, which allows a clear understanding of the different levels of barriers for aggregators. Three modules are used in this framework:

- Module A: Administrative rules regarding aggregation of Distributed Energy Resources
- Module B: Definition of products
- Module C: Remuneration scheme

We will first describe different rules in each of these modules and the way they can act as barriers to entry for aggregators. Then we will look at how this framework could be used by policy makers to redesign rules or by aggregators to assess in which markets to invest.

2.1 Module A: Administrative Rules Regarding Aggregation of Distributed Energy Resources

2.1.1 *Technical Discrimination against Aggregated Resources (A1)*

Some rules may discriminate against some players regarding their participation in reserve markets. TSO can discriminate resources based on their voltage level (for example resources should be connected to TSO's network) or their type (consumption units, non-dispatchable resources, storage). TSO can explicitly forbid participation of DERs in the rules or implicitly, by not defining storage and consumption units as potential providers. In this case, there is no possible participation of DERs to reserve services.

TSO can also fix a maximum volume of reserve provided by DERs, give priority to some type of actors in the provision of reserve or define specific technical requirement for DERs. TSO might also not allow the aggregation of different type of units (e.g. consumption and generation units), which limits the possibility of aggregation. In these cases, participation of DERs is not forbid but limited in volume.

2.1.2 *Interoperability among DSOs and TSOs (A2)*

There is a large diversity of DSOs in European countries, depending on the history of the electricity system, its construction, and market reforms in the last 20 years. For example, there is only one major Distribution System Operator in France (Enedis – representing a 97% market share) and few others (115) delivering electricity to a limited number of customers (3%), whereas there are 65 EDCs in Denmark and 869 in Germany. There are also countries with multiple TSOs such as Germany (four TSOs).

To ensure that aggregation is possible, new entrants should be able to aggregate units among multiple DSOs and TSOs. If it is not the case, aggregators will be limited to a geographical zone, which will limit the volume of reserve they can offer.

2.1.3 *Aggregation Level (A3)*

Two methods of aggregation are identified in (Codani et al., 2016): telemetry and financial aggregation. Telemetry allows the aggregator to combine bids and power flows. The aggregators handle dispatching by using algorithms to optimize the dispatching of energy, based on characteristics of each unit.

On the contrary, financial aggregation only allows for the aggregation of bids while the dispatch of energy is controlled by the TSO. This solution does not allow the aggregators to use their own dispatching algorithm to take account of different availability and flexibility characteristics of the different units pooled.

2.2 Module B: Definition of Products

2.2.1 Minimum Bid Size and Bid Increment (B1)

The minimum bid size of an offer will define the minimum level of aggregation necessary to deliver reserve and is a key parameter for the participation of DERs. If the minimum bid is set too high, it will be difficult for aggregators to participate, as it would require managing an overly cumbersome number of small generation resources. Aggregators can decide to engage in partnership with incumbents or other aggregator to reach this volume, which implies transaction costs and a loss of value.

Bid increment also plays an important role. If bid increment is similar to minimum bid, it will be as difficult for aggregator to reach the level of bid (twice the minimum bid) as to reach the minimum bid. Having a high bid increment will induce threshold effects, as revenues of the aggregator will not increase proportionally to the number of units pooled.

However, market designers may want to set bid size at a high level to minimize the number of market players and the related transaction costs on the market.

2.2.2 Time Definition of Products (B2)

The time definition is the period of time during which providers must have their power available. This parameter is essential for new participants who aggregate consumption units or EVs since the availability of reserves is highly dependent on consumers' habits or industrial process. The amount of reserves they are able to provide is highly variable in function of hour of the day, day of the week (working or non-working day).

If time-definition is long, compared to the periodicity of availability of reserve, aggregators will bid on the market based on the period where availability is the lowest, which will affect their revenues.

Figure 2.1 shows a simplified representation of the impact of minimum size, bid increment and time definition of products.

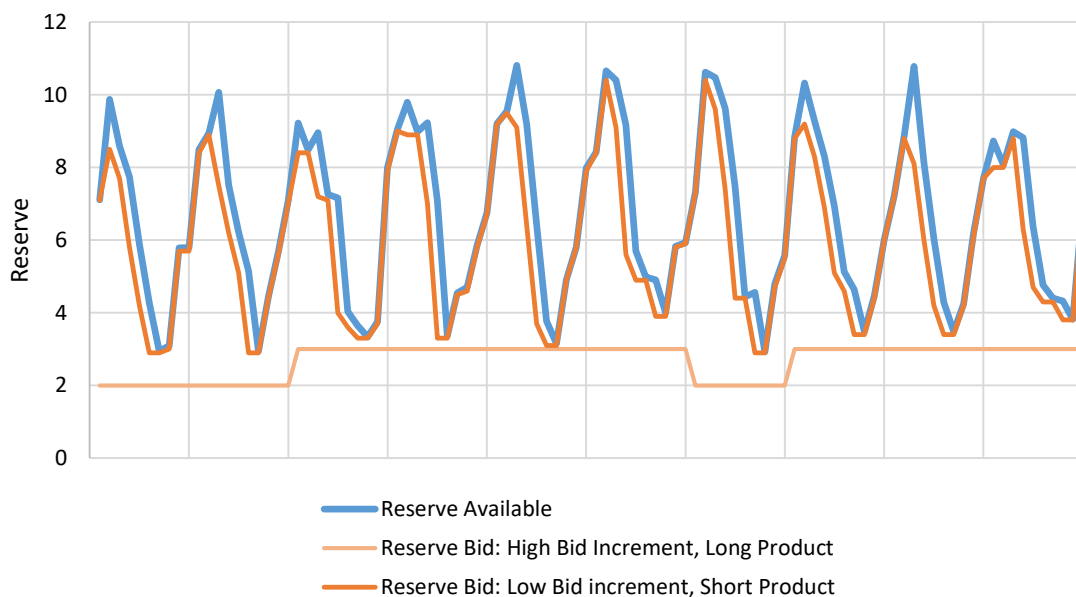

Figure 2.1 Impact of Bid Increment and Duration of Product on Reserve bid on market

2.2.3 *Distance to Real-Time Reservation (B3)*

This parameter defines how long the procurement of reserves is made ahead of delivery. This may have an impact on new participants such as aggregators due to the uncertainty it may induce in the decision-making process. Indeed, if the procurement is made long before delivery, aggregators must make assumptions that have an impact on the amount of reserve they can provide (behavior of consumers, number of aggregated units, etc.). To limit risks of not being able to deliver the amount of reserve they bid, aggregators will tend to make bids that are more conservative.

2.2.4 *Symmetry of Products (B4)*

Two types of products can be sold in a reserve market: upward products – increase in generation or decrease in consumption – or downward products – decrease in generation or increase in consumption. Some markets allow for differentiated bids between upward and downward provision while other markets only allow for symmetrical bids, meaning the provider must deliver the same amount of downward and upward reserve simultaneously.

Depending on the type of unit providing flexibility, it might be better to have symmetric or asymmetric products. For example, in the case of unidirectional EVs, asymmetric products are better as the EV can only provide downward reserve when it is not charging (when the battery is not full). However, for bidirectional EVs, symmetric products are better because it allows having zero-net energy delivery (meaning the amount of upward energy delivered is the same than the amount of downward energy). With asymmetric bids, the aggregator would face the risks of having only one of its bid accepted, meaning the battery would only either charge or discharge.

In order to fit with these two profiles, it is possible to have linked bids, meaning upward bid will be accepted only if downward bid is accepted and vice-versa.

2.3 Module C: Remuneration Scheme

2.3.1 *Nature of Payment (C1)*

Different schemes exist to remunerate reserves: regulated tariffs, pay-as-bid, and uniform pricing. These schemes are not equivalent regarding the provision of reserve, in particular concerning the entry of new actors. Indeed, the level of remuneration and bid strategies will be impacted by the remuneration scheme.

The use of a regulated tariff is associated with mandatory provision by a few participants (often large producers) since there is no information to select providers based on their costs. Even if the rules allow for new entrants such as aggregators to propose reserves, the selection of the reserve will be made by an administrative rule preventing new participants from competing effectively with incumbent players. Moreover, regulated tariffs do not take account of the market value of electricity generation. In the European EPEX power spot market, real-time prices vary considerably. With a fixed and guaranteed yearly remuneration, a generator receives cross-subsidies.

The two market solutions – pay-as-bid and uniform pricing – allow for aggregators to compete with large producers and to enter the market effectively. In a pure and perfect market setting (including perfect competition), the allocation of reserves should be optimal for both arrangements (Kahn et al., 2001).

However, under real-world conditions the bidding strategies will not be the same. With uniform pricing, market players have an incentive to bid at the marginal cost of service provision, whereas with pay-as-bid, participants will bid at what they expect to be the highest accepted bid to maximize their revenues. It is difficult for new entrants to perform well in guessing the maximum bid, as they enter a new market and have less information about the market. They would not capture the entire benefit as they might under a uniform pricing scheme.

2.3.2 Extra-Bonus for Flexibility (C2)

Technical requirements for frequency regulation have been defined based on capabilities of large generators since historically this was the only available or economic option. As these producers have time responses intrinsic to their generation assets and cannot adapt their output instantaneously when the TSO requires it, an acceptable time delay for the delivery of reserves has been defined. New DERs capable of participating in reserve provision are able to adapt their production or consumption faster than large producers. Increased flexibility can allow for more renewable sources of energy to be integrated, which can lower carbon emissions and air pollution.

Value for the electricity system of faster reserve depends largely on the size of the system and penetration of renewables. If system is relatively small, increased penetration of renewables will decrease the inertia of the system. Faster reserve might have a high value for the system, allowing reducing impact of imbalances on the frequency deviations (Greve et al., 2017). However, if remuneration scheme is the same for both slow and fast acting sources, there is no incentive to invest in faster technologies.

2.4 A Tool for Investors and Policy Makers

The framework developed in this section allows having a clear view on the different rules that might constitute barriers to entry for new entrants in reserve markets. Moreover, it is possible to see this framework as a decision tree, as shown in Figure 2.2. Indeed, different modules will not have the same consequences for aggregators and shall be treated as consecutive barriers.

Module A rules (administrative rules regarding aggregation of DERs) constitute first-order barriers as they could hinder partly or completely participation of aggregator to market, with no way to skirt them by having partnership with incumbents or aggregators.

Rules in Module B (Definition of Products) are second-order barriers to entry. They do not hinder directly possibility of aggregation of distributed units. However, their design might not fit with operations of aggregators, who will bid only part of their available reserve on the market. If Module A allows for aggregation of resources, aggregators could skirt the rules of Module B by having partnership, which will affect their revenues.

Finally, rules in Module C (Remuneration Scheme) constitute third-order barriers. They will influence value of the reserve bid on the market but not the possibility of offering reserve.

When a TSO wants to open reserve market, it is essential to redesign first Module A, then Module B and finally Module C. If Module B or C is redesigned without reducing all possible barriers in Module A, impact on entry of aggregators will be very limited.

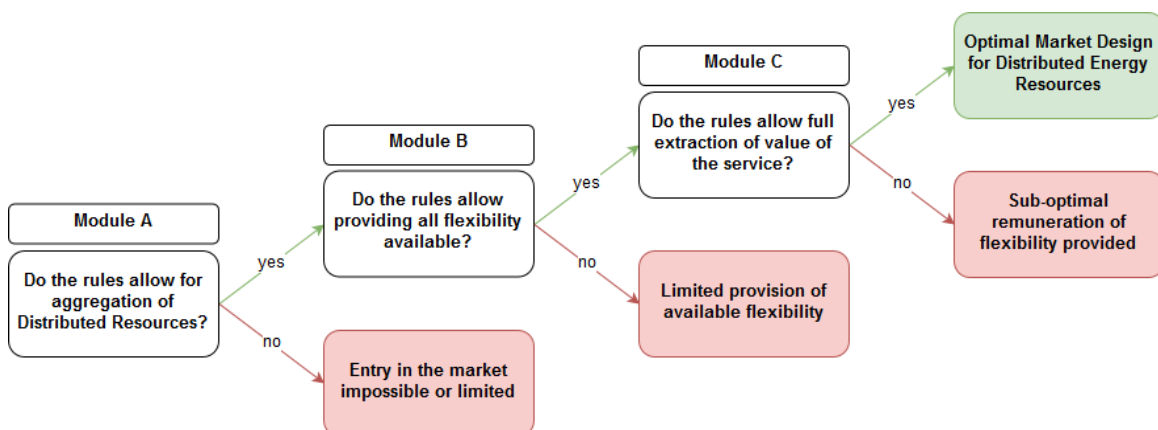

Figure 2.2 Decision Tree for provision of Flexibility Services with DERs

Investors willing to invest in DERs able to provide reserve could also use this framework and, to evaluate in which zone in which market the investment would be the more profitable. Markets with high barriers in Module A will be more difficult to penetrate than markets with barriers in Module B or Module C.

3 COSTS ASSOCIATED WITH THE OPENING OF MARKETS

Opening the provision of frequency-regulation reserves to DERs is necessarily associated with costs for TSOs. The impacts of such costs should be assessed in order to be sure that opening this market is beneficial.

We have seen in the previous section that opening and redesigning the market could be made in three steps:

- Removal of administrative barriers to aggregation for DERs
- Redefinition of products in order to allow greater flexibility in their provision
- Granting appropriate remuneration to DERs

First, TSOs will have to learn how to manage the provision of frequency-regulation reserves by DERs, and how to define their prequalification tests. The prequalification tests for centralized resources are well known by TSOs and are relatively easy to implement: producers must be able to correctly respond to a predefined pattern of frequency deviations. However, prequalification of distributed resources, such as the aggregation of consumers or EVs, will be more complicated and probably more expensive. TSOs will need to build new prequalification processes to adequately certify that new players are reliable. Then, TSOs will need to verify *ex-post* if providers have really delivered the power reserve they have been called on to provide. This supervision will also be more costly with new actors as the amount of units providing reserves will increase. Thus TSOs and DSOs must build new processes to share information effectively and to redefine the roles and duties of each of the players.

The redefinition of reserve products will be associated with increased transaction costs. Indeed, with reduced minimum bids and time-steps in addition to asymmetrical products, the number of transactions in the market will increase as along with the associated costs (management of data, communications with the providers, and transfers of money).

Given a hypothetical example where the provision of reserves is made through week-long products with a minimum bid of 10 MW symmetrical products where the TSO requires 500 MW of reserve, the maximum number of transactions the TSO will have to manage is 2,600 in one year. If this TSO were to shift to half-day asymmetrical products with a minimum bid of 1 MW, it would be necessary to manage a maximum of 730,000 transactions.

It is clear that security and stability of supply should not be jeopardized by opening the markets. Opening the provision of reserves to DERs will increase volume risks for TSOs: the number of participants will increase, they will be less identifiable, and the number of time-slots will increase. Therefore, as TSOs are responsible for balancing generation and demand, a risk management strategy should accompany the opening of markets.

For example, TSOs could hedge some reserves through long-term contracts with large producers when markets are opened to reduce system risks through a strike price option contract (Rebours, 2009). This hedging would not be a permanent solution but would allow for a transition period. The decision maker could also impose a minimum participation in the market for large producers or let the aggregators hedge their positions in the market by implementing secondary markets where different players could buy and sell their reserves.

TSOs could also reduce their risks by mutualizing reserves across Europe. This, however, requires a harmonization of rules, which is the aim of the Network Codes, which will also lead to increased

learning costs and transaction costs. Another way is to mutualize imbalances in order to limit secondary reserves requirements. This strategy has been implemented among several European countries through International Grid Control Cooperation (IGCC).

It is beyond the scope of this work to evaluate these risks and costs. However, as the decarbonization of the electricity mix is in progress and should intensify in the next 10 years, it will become unavoidable at some point to shift from the previous model (provision of reserves by centralized generators) to a new one (provision of reserves open to new participants).

Costs and risks could be better managed if this process is anticipated and well managed. We think it is necessary for TSOs to initiate this shift long before they are forced to do so owing to a serious lack of available flexibility. It would be beneficial to open service provision gradually in order to accompany the roll-out of new technologies (distributed generation, demand response, EVs, etc.).

4 TWO CASE STUDIES: GEOGRAPHIC COMPARISON AND EVOLUTION OF REGULATORY FRAMEWORK

4.1 Comparison of Four Market Zones in 2016

We will now describe four market designs for Frequency Containment Reserve (FCR) and automatic Frequency Restoration Reserves (aFRR) reserves in France, Germany, Denmark, and the United Kingdom. These countries were chosen owing to their diversity in terms of generation mix and market design.

Table 2.1 provides some key characteristics regarding penetration of intermittent RES, flexibility needs, and future objectives for wind penetration.

According to the European Wind Energy Association's central scenario, the share of intermittent RES should increase significantly in every country of our study, which implies there will be an increasing need for the efficient management of reserves.

This case study was performed in 2016. There are some on-going modifications in rules and conclusions of this part are only valid in this context.

Table 2.1 RES Capacity and Reserve Requirements

	France	Germany	Denmark	UK
Wind farm capacity (MW) ³	12,518	51,173	4,845	15,621
Solar capacity (MW) ³	7,170	40,849	601	8,566
Share of intermittent RES capacity	11%	39%	37%	22%
Primary reserve ¹ (MW)	570	590	47	500-900
Secondary reserve (MW)	700	2,000	200	1,100-1,400
Central scenario 2030 EWEA Wind capacity (MW) ⁴	43,360	85,000	9,300	37,500
Annual load (TWh)	482	538.7	34.1	324.8
Reserve requirements by 2030 ² (MW)	2,800 (+89%)	4,281 (+83%)	470 (+62%)	2,700-3,400 (+74%)

¹ Primary reserve need for France, Germany and Denmark is decided by ENTSO-E based on consumption of the country

² Assuming there is a 5% increase of reserve for each MW of new installed wind capacity - mean value based on the literature (Hirth and Ziegenhagen, 2015)

³ <http://transparency.entsoe.eu>

⁴ (Wind Europe, 2017)

4.1.1 France

Rules are issued by Réseau de Transport d'Electricité (RTE) and are described in (RTE, 2016a).

Historically the procurement process is based on mandatory provision by large producers and prorated to their generation. Each day RTE informs each producer the reserve he must provide to the system for the next day with a 30-minute time-step based on individual generation schedules and technical capabilities of the unit. The minimum capacity that an aggregation of production units must be able to deliver is 1 MW with symmetrical capacities. The system of allocation of reserve is the same for FCR and aFRR.

The regulator sets remuneration with a fixed and annually regulated tariff. There is remuneration for capacity (18.2 €/MW/h) and for energy (10.47 €/MWh, payment to the provider if regulation is upward, payment to the TSO if regulation is downward).

However, rules have evolved in the last two years to allow new participants (consumers connected to the distribution network and storage units) to deliver reserve. These units are not subject to mandatory provision and they can provide asymmetrical products. The minimum amount of reserve they can prequalify is 1 MW. They have to sell reserve through bilateral negotiation to large producers, through a process called “*Notification d'Echange de Réserve*”.

The total amount that can be prequalified was limited to 40 MW for 2016 and the maximum amount for one individual aggregator to 20 MW. The selection of this volume is made based on a “*First Come, First Served*” rule. This rule is inefficient, since providers are not selected on the basis of their operating costs, contrary to a market solution where providers have an incentive to reveal their costs.

It should be noted that most of these rules are transitory and could/should evolve in the coming years, creating uncertainty about the possible evolution of the market design.

As a conclusion, Table 2.2 provides an assessment of these different rules regarding provision of frequency-regulation reserves by DERs. The opening of the market is still limited by administrative rules and is in a testing phase. There is currently no information available about the level of reserves actually provided by RES. The results of this testing phase and the orientation that will follow will allow us to improve our assessment of this market opening.

Remuneration is the main issue in France as a regulated tariff is still used. We cannot assess what is the impact of this tariff (is it at a low or high level compared with the costs of provision by DERs?). There is high uncertainty about the viability of this tariff as the French regulator has regularly called for the implementation of a market-based procurement approach (Commission de Régulation de l'Energie, 2014)(Commission de Régulation de l'Energie, 2015).

Table 2.2 Assessment of the Parameters of the Survey in France

	FCR	aFRR
A1	-/+	-/+
A2	+	+
A3	+	+
B1	+	+
B2	+	+
B3	+	+
B4	+	+
C1	-	-
C2	-	-

4.1.2 Germany

Auctions in Germany are held on a common platform (www.regelleistung.net) for the four TSOs (Consentec GmbH, 2014). Switzerland, Austria, the Netherlands and Belgium have joined this platform, called FCR Cooperation. Auction rules were revised in 2011 by the Federal Network Agency, to allow an increased participation of small electricity producers such as RES in addition to demand-side management aggregators and storage systems (Bundesnetzagentur, 2011)(Koliou et al., 2014). To further facilitate market entry by DERs, another revision of rules for secondary and tertiary reserve is currently underway as of 2015/2016 (Bundesnetzagentur, 2015)(Federal Ministry for Economic Affairs and Energy, 2015).

There is no technical discrimination for either FCR or aFRR.

For FCR, a call for tenders is organized on a weekly basis. The minimum bid is 1 MW and the products are symmetrical. However, it is possible to aggregate plants that can only contribute positive or negative reserves in a pooled bid (Bundesnetzagentur, 2011). The bidder must provide reserves for an entire week. In order to allow small reserve providers to comply more fully with the time requirement, it is possible to contract prequalified third parties to provide collateralization.

Remuneration is based on pay-as-bid and offered for capacity provision alone, without separate remuneration for energy. In 2011, more far-reaching adjustments in favor of DERs were discussed (i.e. daily tenders, shorter product duration, asymmetrical bids), but they were rejected owing to trade-offs with system stability and transaction costs. Accordingly, rules for FCR provision remain unaffected by the current revision.

For aFRR, products are asymmetrical. A call for tenders is currently organized on a weekly basis. A change to daily auctions, however, is being considered to facilitate bids by distributed flexibility resources including intermittent RES (Bundesnetzagentur, 2015). Also, a shortening of product duration is being discussed. Currently, bidders can propose reserves for peak periods (working days, 8:00 am to 8:00 pm) or off-peak periods (the rest of the time).

Under the new regime, they would bid for six timeslots of four hours each on the day following the auction. The minimum bid of 5 MW will remain but the revised rules propose to allow bids of 1 MW, 2 MW, 3 MW, and 4 MW so long as bidders only make one bid per secondary reserve product within the balancing zone. This is to give small generators or aggregators of small-scale flexibility resources another participation option besides pooling (Bundesnetzagentur, 2015).

Secondary reserve remuneration is pay-as-bid. Bids are selected on the basis of capacity prices, but remuneration is offered both for capacity and energy if a reserve is activated. A change to uniform pricing (with bids based on energy prices) is being discussed but viewed critically by the Federal Network Agency.

Under the current system, successful bids with low capacity prices and high energy prices are common. Since reserve scheduling follows a merit order based on reserves' energy prices, the consequences for total reserve provision costs are limited. With a uniform pricing rule, all utilized reserves would be remunerated at the energy price of the last successful bid in the market, which could lead to significant cost increases (Bundesnetzagentur, 2015).

Table 2.3 shows average remuneration for the provision of secondary reserves.

The German market design does not have any administrative barriers to entry but still has major issues concerning technical optimization, especially with the provision of FCR, as can be seen in Table 2.4.

Table 2.3 Average capacity remuneration for FCR and aFRR in Germany in 2015 (€/MW/h)

	Off-Peak	Peak
aFRR upward	5.67	6.12
aFRR downward	2.97	2.21
FCR	21.9	

¹Data: www.regelleistung.net

Table 2.4 Assessment of the Parameters of the Survey for Germany

	FCR	aFRR
A1	+	+
A2	+	+
A3	+	+
B1	+	-/+
B2	-	+
B3	-/+	+
B4	-	+
C1	-/+	-/+
C2	-	-

4.1.3 Denmark

In Denmark, rules are issued by the Danish TSO Energinet.dk (Energinet.dk, 2012). There are two control areas in Denmark (Western Denmark, DK1, and Eastern Denmark, DK2) and the procurement of reserves is differentiated between these two zones. We will focus for our study on the DK1 zone as the DK2 zone is connected to the Nordic Synchronous Area where the procurement system is different.

In DK1, FCR and aFRR can be provided by both production and consumption units. For FCR, the provision of reserves is made through a daily auction. Bids can be submitted for the next day for a period of 4 hours. The minimum bid is 300kW and the bids can be made for upward or downward regulation. Remuneration is based on uniform pricing: each accepted bidder is remunerated at the price of the highest bid (one price for upward and one price for downward reserves). Energinet.dk procures on average 25 MW where 10 MW is provided by long-term contracts.

Average payments for upward and downward reserves are presented in Table 2.5.

Secondary reserves are procured on a monthly basis. The products are symmetrical and remuneration is based on pay-as-bid scheme. However, Energinet.dk has a long-term contract until 2020 with the Swedish interconnection for the provision of secondary reserves, so the procurement system will only be used if the interconnection is out of service or insufficient.

Denmark is paving the way in Europe for the opening of frequency-regulation reserve markets to aggregators, especially for FCR. The return on experience of this process could be useful for other countries as it should now be extended to aFRR as well.

Table 2.5 Average Remuneration of FCR in Denmark DK1 in 2015 (€/MW/h)

	Upward reserve	Downward reserve
00:00 – 04:00	8.92	2.35
04:00 – 08:00	11.94	2.09
08:00 – 12:00	16.90	1.12
12:00 – 16:00	15.64	1.05
16:00 – 20:00	15.94	1.15
20:00 – 24:00	13.04	1.17

Data: <http://energinet.dk/EN/EI/Engrosmarked/Udtraek-af-markedsdata/Sider/default.aspx>

Table 2.6 Assessment of the Parameters of the Survey for Denmark-DK1

	FCR	aFRR
A1	+	-
A2	+	N/A
A3	+	N/A
B1	+	N/A
B2	+	N/A
B3	+	N/A
B4	+	N/A
C1	+	N/A
C2	-	N/A

4.1.4 Great-Britain

The main procurement system used by National Grid for reserves is mandatory provision by large producers (National Grid, 2016a). However, a complementary scheme, Firm Frequency Regulation (FFR) has been implemented to allow other participants to enter the market (National Grid, 2017). The participants can, each month, make a bid to provide different services (based on response lag and duration of utilization).

There are three different products and product taxonomy is different from CWE area:

- Primary response: provision of upward reserve, maximum lag of 10 seconds and provision has to be sustained for 30 seconds
- Secondary response: provision of upward reserve, maximum lag of 30 seconds and provision has to be sustained for 30 minutes
- High Frequency response: provision of downward reserve, maximum lag of 10 seconds and provision has to be sustained for 30 minutes

The bid can be made for one or several months at a time and can schedule reserve provision for only part of the day (only one window is authorized), which can be different for weekdays, Saturdays, and Sundays. However, it is not possible to change the amount of reserve provided during the day or during the month.

All products are asymmetrical with a minimum bid of 10 MW. The selection criterion for reserves on this complementary scheme is based on the total cost of provision for the National Grid. To be selected, the provision of reserves with FFR must be cheaper than mandatory provision. However, given the number of parameters included in a bid (number of months and period of the day during which the reserve is provided, price and volume for differentiated services), the selection criterion is not transparent. (Rebours, 2009) and (Chao and Wilson, 2002) have shown that even two-part multi-dimensional procurement is complicated and the current bid process includes more than 20 parameters.

In order to allow aggregators with lower volumes than 10 MW to participate, NG has implemented the FFR bridging contract. This contract lasts one or two years, and remuneration is regulated and increases as more MWs are aggregated. The payment rates have not been made public.

Besides this complementary scheme, NG is now implementing a new scheme to procure ultra-fast reserves, which would be ideal for DERs such as EVs (National Grid, 2016b). Provider should be able to respond to frequency deviations in 1 second, minimum bid is 1 MW. The provider should be available at every hours for 4 years. In the first organized tender, 8 different projects were selected, all being large stationary storages.

The conclusions of this case are presented in Table 2.7. NG is implementing new schemes but the products that can be sold in these schemes do not correspond to what DERs could provide (e.g.,

full provision during one or two years for the FFR Bridging Contract). This gives mixed signals about the willingness to open the market to DERs. We think NG should work on a unified market design for all players⁸. However, the implementation of a scheme to remunerate very fast reserves is positive. The return on experience that NG will receive with this implementation could be useful for other countries. The UK synchronous area is rather small compared to the Continental Europe synchronous area and is therefore more exposed to flexibility issues.

Table 2.7 Assessment of the Parameters of the Survey in Great Britain

	FCR	aFRR
A1	-/+	-/+
A2	+	+
A3	+	+
B1	-	-
B2	-	-
B3	-	-
B4	+	+
C1	-/+	-/+
C2	+	+

4.2 Evolution of Regulation in France: Towards the Creation of a Single Market Zone in Central Western Europe

4.2.1 Modification of Rules in France

In October 2016, France decided to change completely its market design for the provision of Frequency Containment Reserve (FCR) (Commission de Régulation de l'Énergie, 2016), which gives the opportunity to test this analytical framework on a real case. Before the change came into force, the French TSO (Réseau de Transport d'Électricité, RTE) procured reserves through mandatory provision by centralized large units, with an annual fixed regulated tariff. Other players could sell reserves to large units, after a pre-qualification agreement with RTE, with a negotiated price. The French regulator had asked RTE to change its rules to implement a call for tender, to comply with the requirements of the ENTSO-e Network Code (Commission de Régulation de l'Énergie, 2015).

Several choices were possible; one of them was to create a national call for tender, based on original French rules. The second option was to join an existing reserve market. RTE decided to join the FCR Cooperation. The French regulator pointed out the limits of this option: the duration of the reservation product (an entire week from Monday 0 a.m. to Sunday 12 p.m.) was judged too long by the regulator and some of the French players (RTE, 2016b). However, the regulator considered that it could be in a better position to change the rules from within the Cooperation and that market integration was a priority to procure reserves at the lowest cost.

In the FCR Cooperation, National TSOs are still in charge of prequalification tests and contracts with reserve providers (post assessment, penalties for non-delivery), which are not harmonized among countries. France keeps its limit of 40 MW of DERs that can be prequalified by RTE. TSOs give their reserve requirements to the platform. BSPs can make offers on the platform until market clearing. Offers are selected based on their Merit-Order. Exports are limited to 30% of the size of the national reserve.

⁸ NG launched a project in 2018 to “improve the information we share, simplify our balancing services and remove barriers for new entrants” (National Grid, 2018)

The exchange of reserves between BSPs from different countries is not allowed. However, France retains its notification mechanism, which still allows French BSPs to exchange reserves through bilateral negotiation or secondary market. BSPs are remunerated using the “pay as bid” rule. Costs are allocated to the TSOs pro-rata their reserve requirements at the average cost of reserve for the overall Cooperation. We will now analyze the implications of the French decision for aggregators.

Organization of procurement of Reserve in France before 2017 and in the FCR Cooperation is given in Figure 2.3 and Figure 2.4. The framework developed in Section 2 gives an opportunity to understand the impact of changes in the rules of the FCR procurement on aggregators.

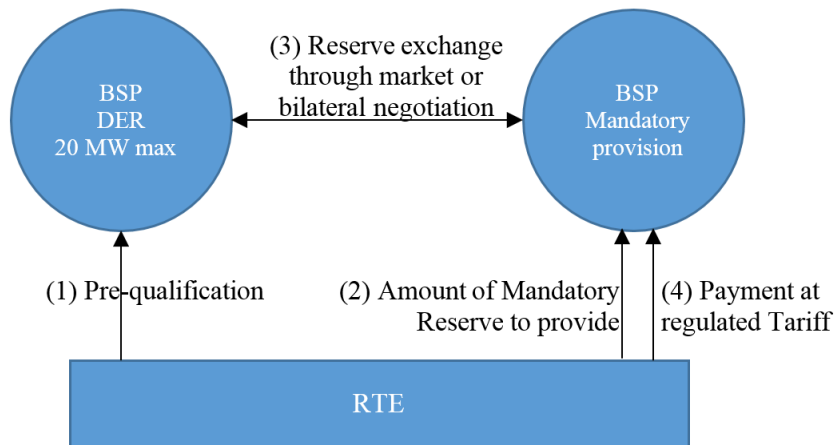

Figure 2.3 Organization of FCR Procurement in France before January 2017

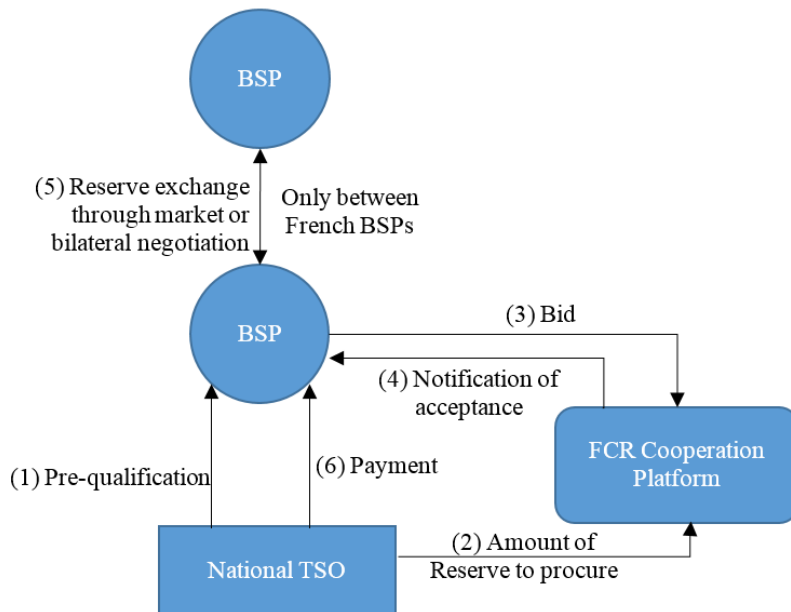

Figure 2.4 Organization of FCR procurement in the FCR Cooperation

France keeps its volume limit for aggregators, so no improvement is made in the first module. By joining FCR cooperation, France is adopting a week-long, symmetric product. It will be disadvantageous for aggregators who have uncertainties about their resource availability.

Even if it will still be possible to transfer reserves from one BSP to another, with shorter products and closer to real time, this secondary market may not be liquid enough, and cross-border exchanges are forbidden. In the third module, improvement is made by adopting a market solution, even if pay-as-bid is not the most efficient one (Kahn et al., 2001).

By applying the above-mentioned framework, it seems that France will impose new technical barriers to entry (Module B) for aggregators. There is no change in Module A and an improvement in Module C.

Table 2.8 Changes in the rules when joining the FCR Cooperation

	Former French Market- Design	FCR Cooperation
Module A	Status quo	
	Status quo: 1MW	
Module B	30 minutes	168 hours
	Day Ahead	Week Ahead
	Asymmetric	Symmetric
Module C	Administrative Tariff	Pay-as-Bid
	Status quo	

Table 2.9 Assessment of the rules in France (before 2017) and in the FCR cooperation

	Former French Market-design	FCR Cooperation - France
A1	+/-	+/-
A2	+	+
A3	+	+
B1	+	+
B2	+	-
B3	+	+/-
B4	+	-
C1	-	+/-
C2	-	-

However, changes in Module B and Module C will not be balanced. Indeed, the framework is a decision tree (Figure 2.2). Improvements in Module C will have less impact for aggregators while Module B is disadvantageous for them.

By analyzing the decision through this framework, we have shown that this new market design is not to the advantage of aggregators. However, this is not the only parameter to consider when assessing the implications of this decision: by joining the FCR Cooperation, it is now possible for French producers to export reserves or for RTE to import them when economically efficient. Additionally, it could allow provision of reserves at a lower cost for the TSO, as will be seen in the next section.

There therefore existed for France a trade-off between time granularity, which allows new innovative technologies to enter the market, and market integration, which allows higher liquidity in the market and the import/export of reserves.

4.2.2 Rationale of Market Integration

In its deliberation, the French regulator argues that joining a cross-border market would make it possible to reduce the cost of procuring ancillary services while ensuring security of supply and allowing better integration of RES (*Commission de Régulation de l'Énergie*, 2016). This is in line with the European Commission's goal of creating integrated markets for electricity, reiterated once again in the Winter Package (European Commission, 2016).

Efforts had first been concentrated on wholesale electricity markets, by coupling different markets (France, Belgium, and the Netherlands in 2006, joined by Germany in 2010), to allocate implicitly

cross-border capacities, and minimize price differences between different countries (Newbery *et al.*, 2016)(Meeus *et al.*, 2009). This process is still ongoing in Europe. The European Commission is now pushing for the implementation of common markets for ancillary and balancing services such as FCR, which is still lagging behind. In (Mott MacDonald, 2013), the authors estimated the potential welfare gains for Great-Britain and France from joining the balancing services at 50 M€/year. (Flinkerbusch and Heuterkes, 2010) calculated the potential cost reduction achieved by joint procurement of balancing reserves of four TSOs in Germany to be 17%. In (Drees and Moser, 2016), the potential savings of market integration of balancing services in Central Europe, with the introduction of core portions (portion of the balancing service which must be supplied by the national market), was estimated at 87 M€/y. Market integration would also foster competition between players and reduce the market power of dominant players. However, these studies concentrate on automatic and manual FRR and there is no study assessing the potential cost reduction of joint auctions for FCR.

The rationale behind market integration is the maximization of the sum of social welfare across all countries. Let us take a simple example of two countries and compare the situations with and without cooperation (Figure 2.5):

- Country A wants to procure 500 MW of primary reserves. There are three producers: the first one can supply 300 MW of reserves at a price of 5 €/MW, the second one is able to provide 300 MW at 10 €/MW, the third is able to provide 300 MW at 15 €/MW
- Country B wants to procure 600 MW of primary reserves. There are two producers: the first one is able to supply 200 MW of reserves at a price of 12 €/MW, the second one is able to provide 500 MW at 20 €/MW

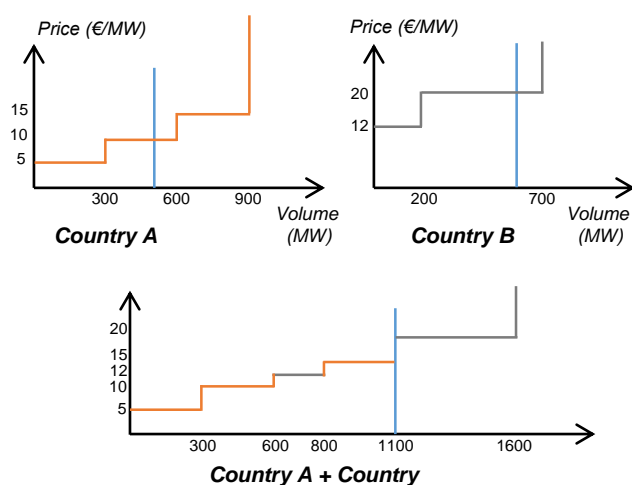

Figure 2.5 Merging procurement of reserves in two countries

When TSO are in autarky (reference case), there is no exchange of reserves between the two countries:

- If the remuneration scheme is pay-as-bid (Reference 1), the cost of procurement for TSO A will be 3.5k€, and 10.4 k€ for TSO B. There is no surplus for producers, assuming they bid at their marginal cost.
- If the remuneration scheme is marginal pricing (Reference 2), the cost of procurement for TSO A will be 5 k€, and 12 k€ for TSO B. The producers' surplus will be 1.5 k€ for producers in A and 1.6 k€ for producers in B.

When merging, Country A will export 400 MW of reserves to country B (Figure 2.5).

If TSOs implement a pay-as-bid scheme when merging (solution 1), the total cost of reserves is 11.4 k€, and the revenues for the producers A & B are respectively 9 k€ and 2.4 k€. There is a decrease of 2.5 k€ in the cost to procure reserves, as the producer in country B is partially replaced by the producer in country A, which is cheaper.

Costs can be allocated to the TSO in two different ways:

- Solution 1.1: Costs are allocated on the basis of the average price (here 10.36 €/MW) and the reserve requirement of TSO (500 MW for TSO A and 600 MW for TSO B). In this case, TSO A would pay 5.18 k€ and TSO B 6.22 k€.
- Solution 1.2: each TSO is paying for the less expensive offers in their zones; the importing TSO paying for the reserve it is importing from other countries. In this case, TSO A would pay 3.5 k€ and TSO B would pay 7.9 k€.

If marginal pricing were used (solution 2), the price is 15 €/MW and the total cost for both TSOs is 16.5 k€. Costs are allocated among TSO based on the marginal price and the reserve requirement of each TSO. TSO A will pay 7.5 k€ and TSO B will pay 9 k€. The producers in country A will sell 900 MW of reserve (total value = 13.5 k€), and the producers in country B will sell 200 MW (total value = 3 k€). With a comparison with the solution 1, the surplus for the producer in country A will be 4.5 k€ and 0.6 k€ in country B.

The results of these different schemes are summarized in Table 2.10. Whatever the chosen scheme, there will be an increase of 2.5 k€ in the total surplus of {TSO A + TSO B + Producer A + Producer B}.

Table 2.10 Cost for TSOs and producers surplus with different remuneration schemes

	Cost for TSO A	Cost for TSO B	Surplus of producer A	Surplus of producer B	Total surplus
Ref 1	3.5 k€	10.4 k€	0	0	- 13.9 k€
Ref 2	5 k€	12 k€	1.5 k€	1.6 k€	-13.9 k€
Sol. 1.1	5.18 k€	6.22 k€	0	0	-11.4 k€
Sol. 1.2	3.5 k€	7.9 k€	0	0	-11.4 k€
Sol. 2	7.5 k€	9 k€	4.5 k€	0.6 k€	-11.4 k€

Depending on the chosen solution for cost allocation and remuneration, the increase in the total surplus will not be allocated to the players the same way. With Solution 1.1, there is a welfare transfer from the country with the lower average cost to the country with the higher average cost. This is the solution chosen in the FCR Cooperation. With solution 1.2, the surplus increase is entirely allocated to country B. With solution 2, the surplus increase is divided between country A and country B.

Table 2.11 Increase of social welfare in country A and country B when merging

	{TSO A + Producer A}	{TSO B + Producer B}
Sol 1.1-Ref 1	-€1.68k€	+€4.18k€
Sol 1.2 – Ref 1	€0k€	+€2.5k€
Sol. 2 – Ref 1	+€0.5k€	+€2k€

To generalize this example, with Solution 1.1, there would be a transfer of social surplus from reserve-exporting countries having a low average price – as TSOs would pay a high average price compared to autarky and there would be no extra-rent for generators due to pay-as-bid rules – to reserve-importing countries with a high average price.

However, it should be noted that players would not bid at their marginal cost with a pay-as-bid solution. They would rather bid what they guess would be the price of the last selected offer, to maximize their revenue. This would result in lower transfers of social surplus among countries.

As solution 1.1 was chosen in the Cooperation, if France is exporting its reserve and has a low average price, it could negatively impact its total surplus, while allowing other countries to increase their surplus. On the contrary, if France imports reserves and has a high price compared to the market, other countries will see a decrease in their social surplus.

4.2.3 On-going Process of Modification of Rules

On January 9, 2017, the TSOs involved in the FCR Cooperation launched a consultation to every stakeholder on the potential changes in market design in the FCR Cooperation (50 Hertz *et al.*, 2017a). Various aspects were covered in the consultation, including auction frequency, product duration minimum bid, bid resolution and TSO-BSP Settlement.

Results of the consultation and positions of the TSOs on these subjects were published on May 31, 2017 (50 Hertz *et al.*, 2017b). Twenty-nine BSPs prequalified for more than 20 MW and 28 BSPs prequalified for less than 20 MW responded to the consultation.

Big BSPs were more in favor of keeping a weekly auction, with week-long products, whereas small BSPs asked for daily auctions with 1-hour products.

When looking at the minimum bid, most of the stakeholders (78%) did not ask to reduce it. However, as most of the stakeholders were already prequalified, they had no interest in reducing the minimum bid. It should also be noted that results vary considerably depending on the type of technology used: 4 out of 7 storage units and 4 out of 8 aggregators of consumption units asked for a lower minimum bid whereas 29 out of 31 generation units asked for keeping this minimum bid. The proposal to keep a minimum bid of 1 MW and to lower bid increment was not in the consultation.

For TSO-BSP settlement, 53% of the stakeholders asked for marginal pricing. Surprisingly, none of the aggregators of consumption units asked for marginal pricing, whereas most of storage units asked for it.

Based on this consultation, the TSOs proposed a target-market design:

- Within 9 months after approval from all National Regulatory Agencies (NRA), go for marginal pricing
- Within 18 months after approval from all NRAs, implement daily auctions with 4 hours' product, while keeping 1 MW minimum bid.

The reason adduced by stakeholders and the TSOs for keeping a 1 MW minimum bid is that “there is hardly a business case below 1 MW” and that pooling resources would make it possible to easily reach this 1 MW threshold. This argument is questionable, since it is not the role of TSOs to decide where possible business is and that the pooling of resources can be limited for some new innovative players who do not own any generation assets. When considering lowering minimum bid, the analysis of the regulators should be driven by evaluating the costs and benefits for the system of this change and not by prejudging the possibility for BSPs to have a profitable business model.

Moreover, a large majority asked for a harmonization of different market rules, such as prequalification criteria, penalty schemes and monitoring, to create a level playing field for all stakeholders among all countries. This should be implemented in a third step.

In April 2018, this schedule was detailed by TSOs (50hertz *et al.*, 2018):

- In November 2018, daily auctions will be implemented, with daylong products⁹.
- In July 2020, product duration will be 4 hours
- In July 2019, marginal pricing will be implemented

⁹ This change was since postponed to July 2019.

5 PARTIAL CONCLUSION

In this Chapter, we presented a qualitative framework to identify barriers to entry for new entrants in reserve markets. These barriers to entry results from market-design that do not take into account the potential entrance of new actors in these services and fit the operational requirements of large centralized assets. We identified three different types of barriers to entry. First barriers are administrative rules that can exclude some types of resources from participation to market. Second types of barriers are rules regarding designs of products. Third types of barriers are those regarding remuneration on these markets.

Investors and policy makers could use this framework to assess if it is possible for new actors to enter these different markets. We gave two different case studies to illustrate this. First, we provided a geographical benchmark of four different market zones, with two different products (Frequency Containment Reserve and automatic Frequency Restoration Reserve). This assessment was done in 2016. Second, we explored the modification of rules in France in 2017 in a context of harmonization of rules in Continental Europe, to understand its implications on provision of reserve by aggregators.

CHAPTER 3. REVENUES AND PROFITABILITY ANALYSIS OF A FLEET OF ELECTRIC VEHICLES PROVIDING FLEXIBILITY SERVICES

1	Simulation of Fleets Participating to Frequency-Containment-Reserve	48
1.1	Description of the Model.....	48
1.1.1	Individual Mobility Needs.....	48
1.1.2	Calculation of Individual Reserve Available	51
1.1.3	Reserve Bid on the Market.....	52
1.2	Validation of the Model	55
2	Revenue Analysis of a Fleet of Bidirectional EV Chargers Providing Frequency Containment Reserve.....	57
2.1	Market-Designs and Rated Power Scenarios	57
2.2	Results.....	58
3	Net-Present-Value Analysis of an Investment in Bidirectional EV Chargers	61
3.1	Model and Base-Case Scenario.....	61
3.1.1	Costs Associated with Bidirectionality and Aggregation.....	61
3.1.2	Base-Case Scenario.....	62
3.1.3	Results.....	64
3.2	Sensitivity Analysis	66
3.2.1	Parameters of the Net-Present-Value Analysis.....	67
3.2.2	Parameters of the Fleet	69
3.2.3	Profitability Boundary.....	71
4	Partial Conclusion	73

In the previous chapter, we presented a qualitative framework to evaluate the impact of rules on flexibility provision by Distributed Energy Resources. We used this framework to compare rules in four different market-zones and to understand implications for aggregator of modification of rules in France.

In this chapter, we will make a quantitative study of these rules on an aggregator of Electric Vehicles with bidirectional capabilities. We will focus more specifically on rules defining products (Module B) and on provision of Frequency Containment Reserve. In the first section, we will present our model to simulate participation of the fleet in flexibility services. In the second section, we will analyze revenues of fleets. It will allow us to understand quantitatively the impact of these rules on small to medium size fleets. Then, we will look at the profitability of an investment in bidirectional chargers on large fleets, through Net-Present-Value analysis.

1 SIMULATION OF FLEETS PARTICIPATING TO FREQUENCY-CONTAINMENT-RESERVE

1.1 Description of the Model

In this section, we will present the different modules to simulate participation of fleets of electric vehicles.

The methodology used to build the model is described in the Figure 3.1. First, based on statistical characteristics of a fleet, the module 1 assigns trip patterns and corresponding mobility needs to each individual user. Then, with the module 2, we calculate reserve available over a definite horizon of time, based on a frequency deviations dataset. To compute the total reserve available for the entire fleet, we run Module 1 and Module 2, as many times as there are EVs in the fleet (N_{ev}). To take into account diversity of frequency deviation patterns and trip patterns, we run N times this simulation. Based on these simulations and on product definition, we compute reserve offered on the market by the aggregator in Module 3.

1.1.1 Individual Mobility Needs

In this first module, we assign to each vehicles of the fleet its daily mobility needs. We use statistical distribution of daily trip patterns to do so.

Each individual user is doing two daily commuting trip between home and work. We do not take into account non-working days, meaning trip patterns are the same for working days and non-working days. These two daily commuting trips are characterized by (i) a distance, (ii) a hour of departure (in the morning for trip from home to work and in the afternoon for return trip) and (iii) an average speed. In the following of the thesis, whenever it is not explicitly stated, we will use statistical distributions presented in Table 3.2 for distance and hour of departure. These statistical distributions are derived from a survey conducted by the French government in 2008 (Ministère de la Transition Ecologique et Solidaire, 2008). Figure 3.2 shows the histogram of trip distances from this study and the fitted lognormal distribution adopted. Figure 3.3 shows average speed in function of commuting trip distance. We chose to assign an average speed based on a uniform distribution between a lower and an upper bound depending on the distance as shown the figure. Equation 3.1 gives the calculation of the minimum required State of Charge of the battery at each time step, represented in Figure 3.4.

$$SOC_m(t) = \max(SOC_{min}, SOC_{departure} - \frac{(t_{departure} - t)}{E} * P_{plug}) \quad 3.1$$

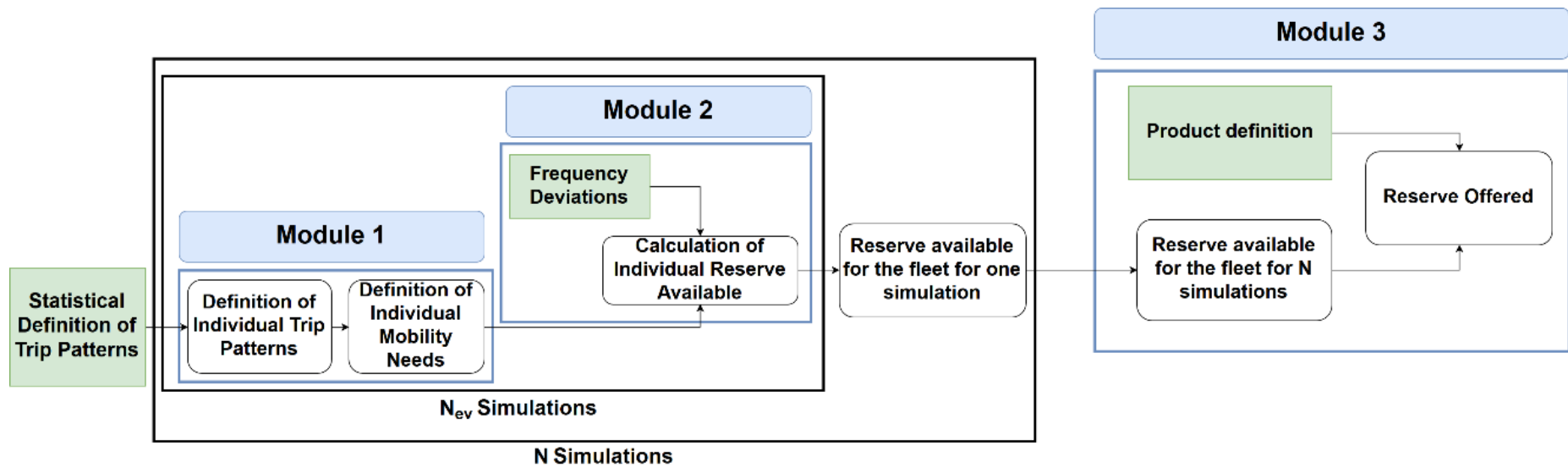

Figure 3.1 Methodology for Simulation of Participation of an EV Fleet to FCR

Table 3.1 Characteristics of the Vehicles

Energy Capacity of the Battery	E	50 kWh
Minimum SOC	SOC_{min}	20%
Maximum SOC	SOC_{max}	90%
Power of the EVSE	P_{plug}	Variable
Consumption	c	0.18 kWh/km

Table 3.2 Statistical Distribution of Trip Patterns for Commuting Fleet

Parameter	Type	μ	σ
Trip Distance (km)	LogNormal	2.75	0.736
Departure From Home (h)	Normal	8	2
Departure From Work (h)	Normal	17.5	2

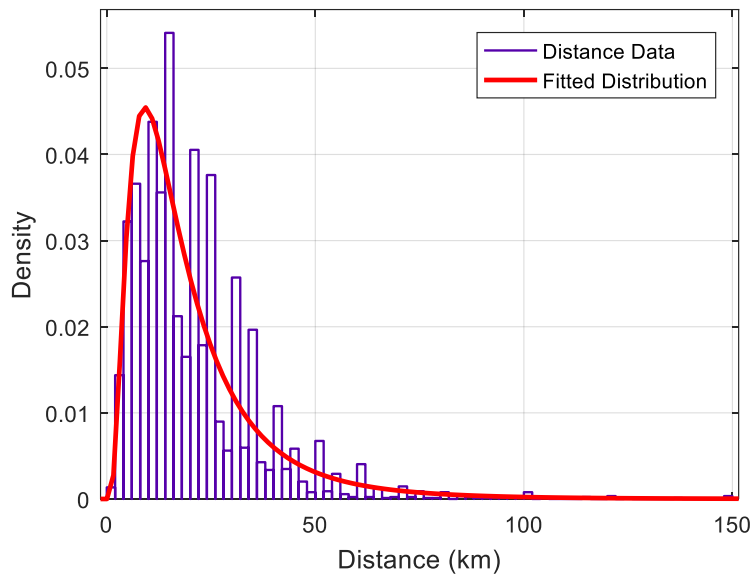

Figure 3.2 Histogram of Distance Data and Fitted Lognormal Distribution

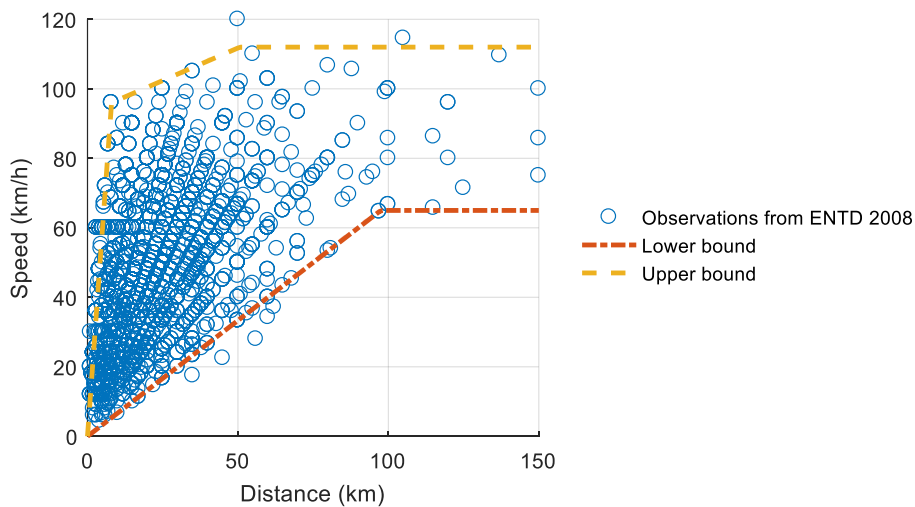

Figure 3.3 Average Speed in function of Distance (Observations and Boundaries)

1.1.2 Calculation of Individual Reserve Available

Based on energy needs for mobility calculated in Module 1, we want now to compute for each vehicles the Frequency Containment Reserve available during each charging session. Available reserve is limited by 1° minimum required energy at each time-step as calculated before, 2° maximum State of Charge of the Battery (SOC_{max}), 3° rated power of the EVSE (P_{plug}) and 4° minimum duration of reserve activation. As explained in Chapter 1, Frequency Containment Reserve is activated based on measured frequency deviations from its nominal value. In continental Europe, the entire reserve is activated for a deviation of ± 200 mHz and full activation should be sustained for at least 30 minutes.

To take this minimum duration of activation into account, we calculate reserve activated with a time-step of $\delta t = 30$ minutes. Each 30 minutes, vehicles calculate their Preferred Operating Point (POP) and available reserve ($R_{available}$) based on their State-of Charge at the beginning of the time-step and limitations given before. We first calculate maximum power that can be injected into and withdrawn from the battery (respectively $P_{h,batt}$ and $P_{b,batt}$) and during the 30 minutes time-step (Equations 3.2 and 3.3). As we take a load convention, a positive sign correspond to an injection into the battery. Then, we compute maximum power that can be injected or withdrawn by the supply equipment, taking into account efficiency of the charger ($P_{h,SE}$, and $P_{b,SE}$) and Equations 3.4 and 3.5). Finally, as provision of reserve should be symmetric, we set the POP as the average of $P_{b,SE}$ and $P_{h,SE}$ and $R_{available}$ as the remaining power available (Equations 3.6 and 3.7). During the time-step, we compute the power injected by the EVSE and State of Charge of the battery for each second ($\delta s = 1$ second) based on the Preferred Operating Point and Reserve calculated before and the measured frequency deviation (Equations 3.8 and 3.9). Figure 3.4 and Figure 3.5 show graphical representations of computation of POP and Available reserve in different situations.

Module 1 and Module 2 gives us reserve available for one EV. By running it multiple times and adding individual contributions to reserve, we can have reserve available for an entire fleet over a definite horizon of times for a certain pattern of frequency deviation.

$$P_{b,batt} = -\min\left(\frac{P_{plug}}{\eta}, E * \frac{SOC - SOC_m}{\delta t}\right) \quad 3.2$$

$$P_{h,batt} = \min\left(\eta * P_{plug}, E * \frac{SOC_{max} - SOC}{\delta t}\right) \quad 3.3$$

$$P_{b,SE} = \begin{cases} \eta * P_{b,batt}, & P_{b,batt} < 0 \\ P_{b,batt}/\eta, & P_{b,batt} \geq 0 \end{cases} \quad 3.4$$

$$P_{h,SE} = \begin{cases} \eta * P_{h,batt}, & P_{h,batt} < 0 \\ P_{h,batt}/\eta, & P_{h,batt} \geq 0 \end{cases} \quad 3.5$$

$$POP = \frac{P_{h,SE} + P_{b,SE}}{2} \quad 3.6$$

$$R_{EV} = P_{plug} - P_{h,SE} \quad 3.7$$

$$\forall t \in [t_{arr}, t_{dep}] \quad P_{SE}(t) = POP + \frac{f(t) - 50Hz}{0.2Hz} * R_{EV} \quad 3.8$$

$$\forall t \in [t_{arr}, t_{dep}] \quad SOC(t) = \begin{cases} SOC(t - \delta s) + \delta s * \frac{\eta * P_{SE}(t)}{E}, & P_{SE}(t) > 0 \\ SOC(t - \delta s) + \delta s * \frac{P_{SE}(t)}{\eta * E}, & P_{SE}(t) < 0 \end{cases} \quad 3.9$$

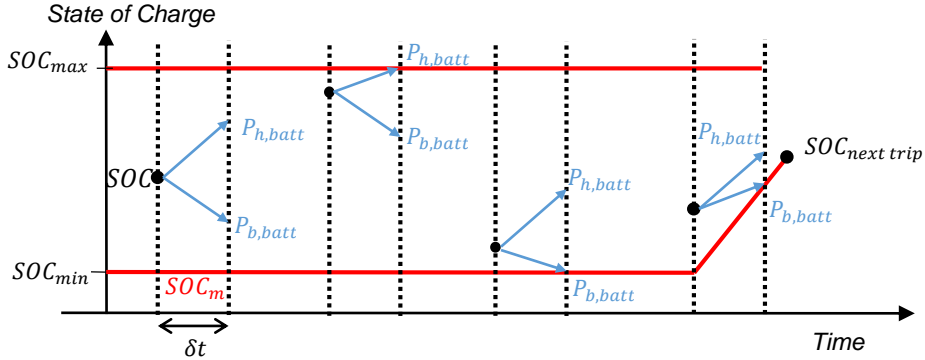

Figure 3.4 Graphical Representation of Different Situations of Battery State of Charge

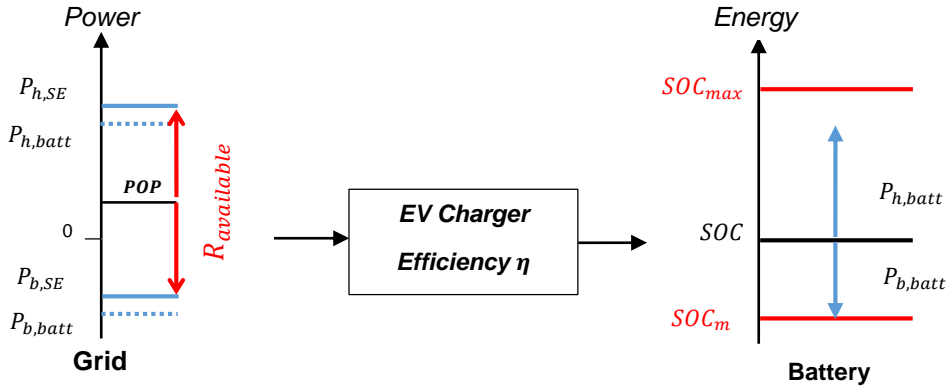

Figure 3.5 Graphical Representation of Computation of POP and Reserve for one time-step.

1.1.3 Reserve Bid on the Market

In Module 3, we compute the reserve the aggregator could bid on the market. The aggregator should take into account – when making its offer – both uncertainties on trip patterns and frequency deviations patterns. To do so, we compute Module 1 and Module 2 for the entire fleet N times with different trip patterns and with a different dataset of frequency deviations each time. We consider that available reserve for the fleet is the minimum available reserve over the N simulations for each time step of an entire day (Equation 3.10). Figure 3.6 and Figure 3.7 show minimum and maximum reserve available for two fleets (first with 100 EVs and second with 2,000 EVs) over 500. Figure 3.8 shows average proportion of reserve not offered over these 500 simulations for each time step. The aggregator can then apply a security margin β between 0 and 1 to be able to tackle unexpected situations (unexpected trips, vehicles not plugged, forecast errors in trip patterns).

$$R_{fleet} = (1 - \beta) * \min_{s \in [1, N]} \sum_{n=1}^{N_{ev}} R_{available, EV}^{n, s} \quad 3.10$$

We now have available reserve of the fleet for each time-step of 30 minutes over an entire day, taking into account diversity of trip patterns and frequency deviations patterns. However, the aggregator must make a bid complying with market rules: minimum size of the bid, bid increment and duration of products. To do so, he will make its bid based on the minimum reserve available over each market period while respecting minimum bid and bid increment. Figure 3.9 shows bid made by the aggregator for different duration of products and bid increments.

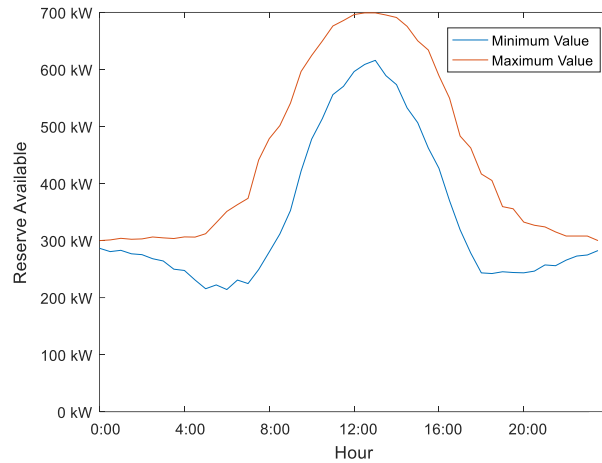

Figure 3.6 Minimum and Maximum Available Reserve for 100 EVs over 500 simulations

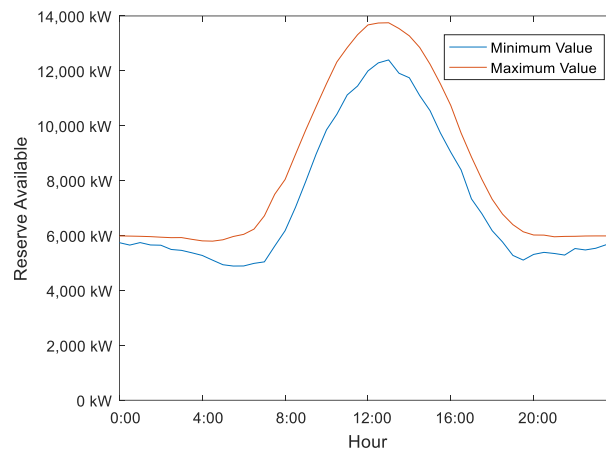

Figure 3.7 Minimum and Maximum Available Reserve for 2000 EVs over 500 simulations

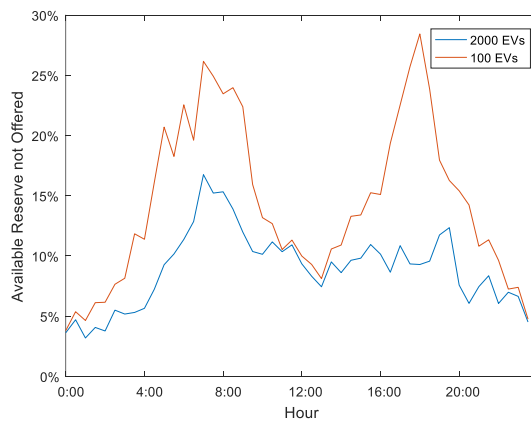
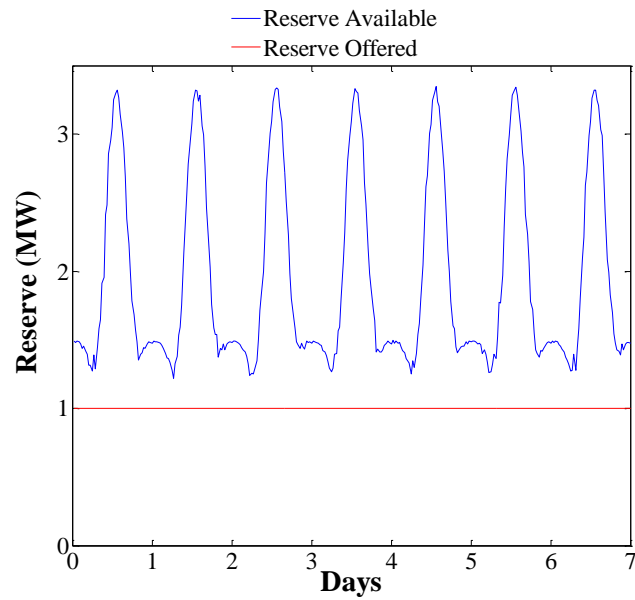
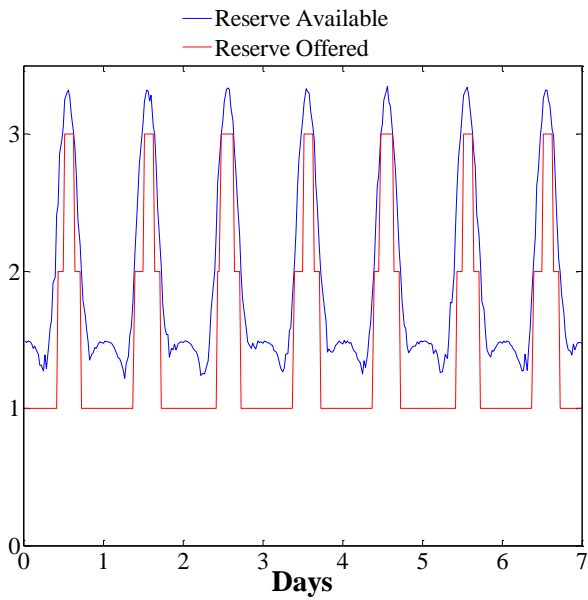

Figure 3.8 Average Available Reserve not bid



(a) Product of one week
Bid Increment: 1MW



(b) Product of one hour
Bid increment: 1 MW

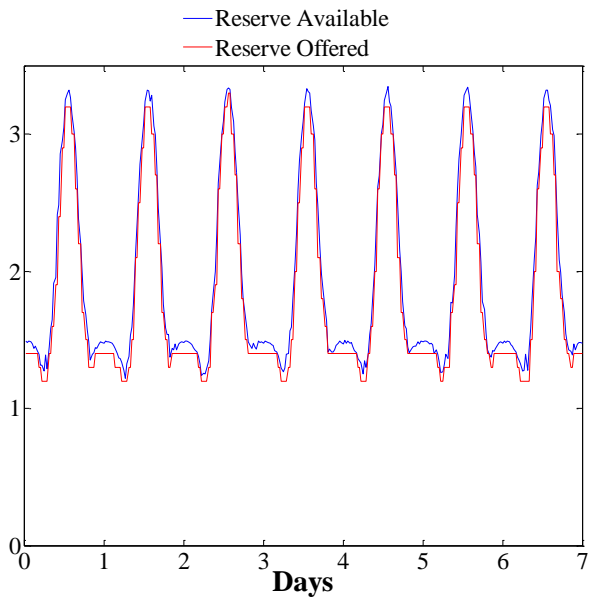

(c) Product of one hour
Bid increment: 0.1 MW

Figure 3.9 Reserve available and Reserve offered for a fleet of 500 EVs with a 3 kW EVSE at home and a 7 kW EVSE at work

1.2 Validation of the Model

We now want to validate that the aggregator would really be able to deliver reserve he offered on the market with the model described above, considering new frequency deviation patterns and trip patterns. The idea is to demonstrate the reliability of the bid, which could impact the size of the margin and the risk of penalties.

To do so, we run Module 1 and Module 2, but instead of computing individual reserve available for each time-step, we affect to each vehicle part of the reserve offered on the market. We run 100 simulations on two consecutive days. If it is possible to deliver reserve bid with the fleet for every simulations, the model is validated. Otherwise, we will look at the maximum number of 30 minutes time-steps where reserve cannot be provided by the fleet over the 100 simulations and the maximum amount of reserve that cannot be provided over the 100 simulations.

We use two different validation tests. First, we set individual trip patterns based on statistical distribution presented in Table 3.2, considering the aggregator has perfect knowledge of these distributions. Second, we introduce forecast errors on statistical distributions as shown in Table 3.3: each parameters is affected according to a normal distribution. Mean of the distribution is the reference value and standard deviation is 10% of the reference value (except for mean hour of departure, where standard deviation is half an hour).

We will perform this validation for two different set of product design: first, products of one week and bid increment of 1 MW; second, products of 1 hour and bid increment of 0.1 MW. We look at five sizes of fleet: 30, 100, 300, 1000 and 3000 EVs.

Figure 3.10 shows results of the validation procedure without forecast errors on statistical distribution for different sizes of fleet. For this simulations, we take a coefficient β equals to zero, meaning there is no security margin. There is no error for {1 week; 1 MW} over the 100 simulations. For {1 hour; 0.1 MW} market-design, there is limited number of time-steps with error (maximum 3 errors over the 100 simulations for 3000 EVs) and a maximum non-delivered reserve of 360 kW for a fleet of 3000 EVs. This error could easily be reduced using algorithms that are more sophisticated.

Figure 3.11 shows results when we introduce forecast errors, keeping β equals to zero. Non-delivered reserve is much higher in this case (maximum above 3 MW) and number of time-steps with errors can reach 50 with {1 hour; 0.1 MW} products, meaning the aggregator does not have enough reserve more than half the time. This could be problematic considering penalties in case of failure to deliver reserve.

Increasing coefficient β to 20 % helps to reduce this issue, as shown in Figure 3.12. Maximum forecast error is reduced to a maximum of 500 kW with {1 hour; 0.1 MW} products and there is no error for {1 week; 1 MW} products. We see here the importance of keeping a security margin when there is uncertainty on the statistical parameters of the fleet, especially when size of the fleet is important and granularity of products is important. We consider that this security margin of 20 % allows keeping insufficient delivery of reserve within an acceptable range.

Table 3.3 Statistical Distributions with Forecast Errors

Parameter	Type	μ	σ
Trip Distance (km)	Lognormal	$\mathcal{N}(2.75,0.27)$	$\mathcal{N}(0.736,0.07)$
Departure From Home (h)	Normal	$\mathcal{N}(8,0.5)$	$\mathcal{N}(2,0.2)$
Departure From Work (h)	Normal	$\mathcal{N}(17.5,0.5)$	$\mathcal{N}(2,0.2)$

- ✖ Product Duration: 1 hour
Bid Increment : 0.1 MW
- Product Duration: 1 week
Bid Increment: 1 MW

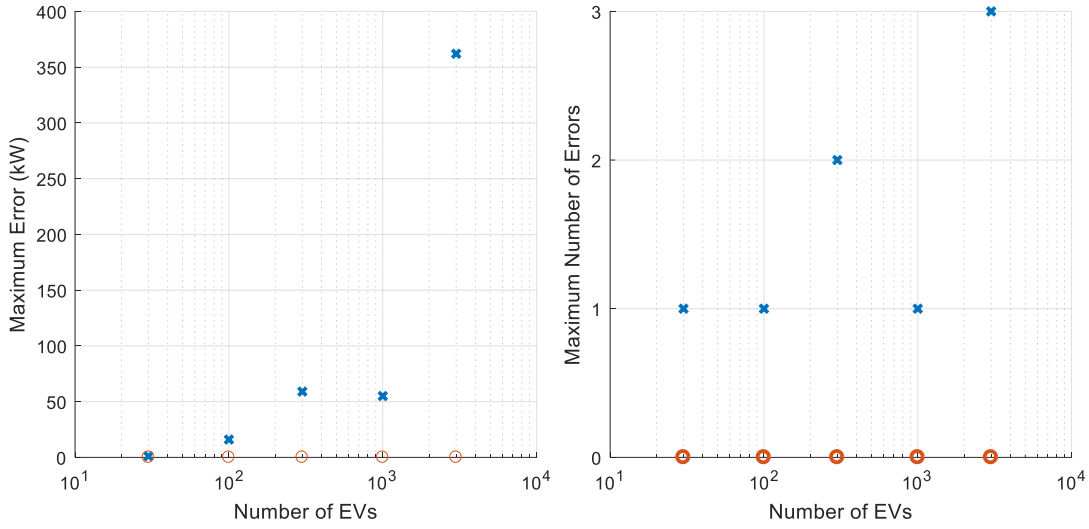

Figure 3.10 Validation test without forecast error and $\beta = 0$

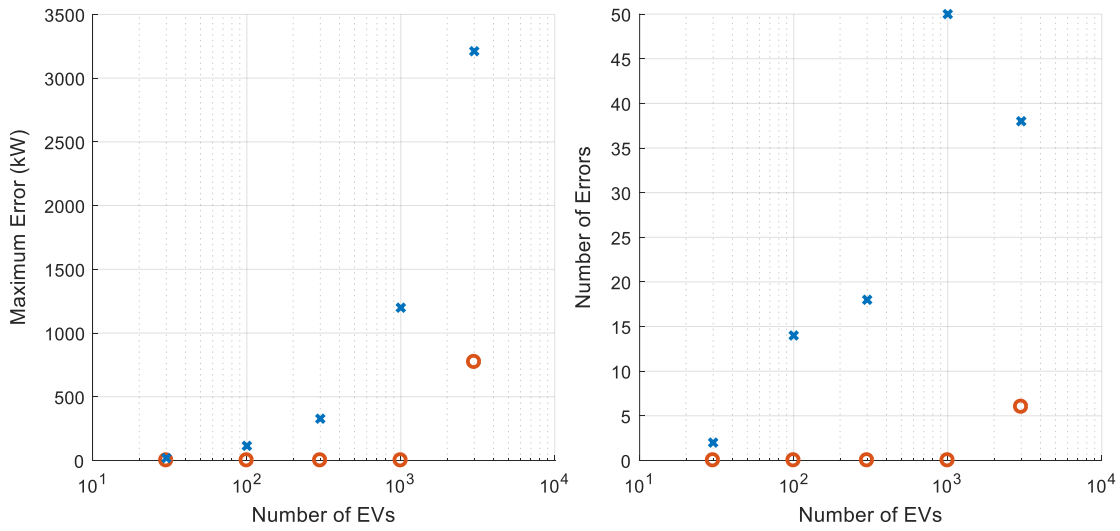

Figure 3.11 Validation test with forecast error and $\beta = 0$

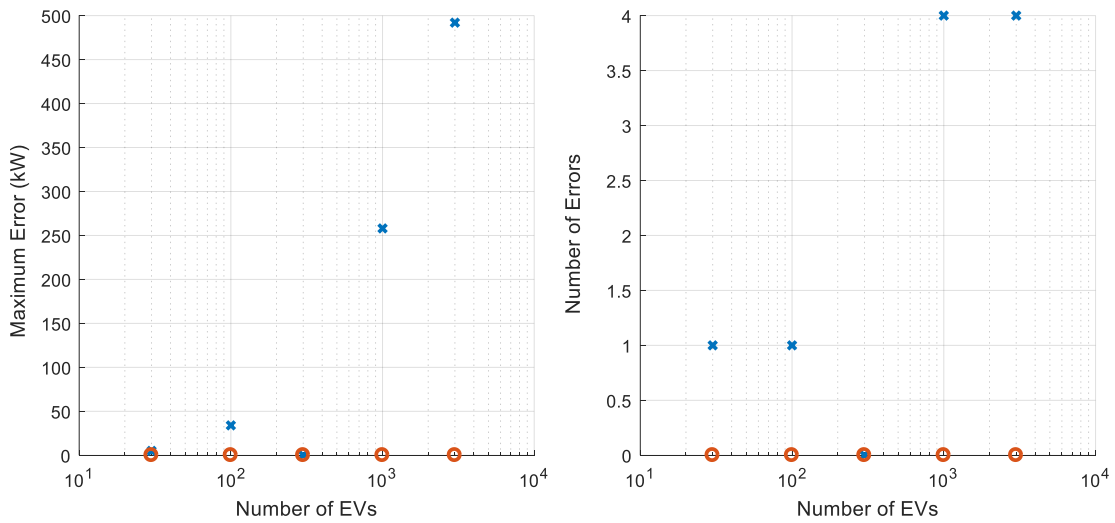

Figure 3.12 Validation test with forecast error and $\beta = 20\%$

2 REVENUE ANALYSIS OF A FLEET OF BIDIRECTIONAL EV CHARGERS PROVIDING FREQUENCY CONTAINMENT RESERVE

In the previous section of this chapter, we described the model used to simulate participation of a fleet of EVs to FCR. In this section, we will use this model to analyze revenues of participation to FCR. We will analyze the influence of market-design, size of the fleet and rated power of the EVSE on the revenues of the fleet. In the first section, we will present different market-designs studied and rated power of the EVSEs. In the second section, results of this analysis are presented.

2.1 Market-Designs and Rated Power Scenarios

In the previous chapter, we have seen that there is a diversity of market design in Europe concerning flexibility products. Moreover, there is an ongoing process of harmonizing markets while redesigning rules in order to facilitate participation of new actors. It is important, in this analysis to understand in detail the influence of market-design on the revenues of the fleet. We have seen in previous section (Figure 3.9) that temporal granularity (duration of products) and volume granularity (minimum bid and bid increment) will have a high influence on the possibility to bid the available reserve, which will affect directly the revenues of the fleet.

Moreover, it is important to study revenues in different hypothesis of EVSE rated power as it will be the main determinant of amount of reserve that can be provided. Different set of rated power at home and at work are presented in Table 3.4. In the first scenario (EVSE-1), we consider EV can charge only at home, with a 3 kW power plug. This represents a business-as-usual scenario, as we consider here standard rated power for residential EVSE and that it is not possible with a single EV to provide reserve at different locations (meaning EVSE are aggregated rather than EVs).

In a second scenario, we consider it is possible to provide reserve with a single EV at different locations and we take a rated power of 7 kW for the EVSE at work. Finally, the third scenario represents a more disruptive scenario, where we consider each user has a 7 kW EVSE at home and a 22 kW EVSE at work.

We will study three different temporal granularities, three different volume granularities and three different hypothesis on rated power of EVSE, as shown in Table 3.4. Scenario Temp-1 (one-week products) and Vol-1 (Minimum bid and bid increment of 1 MW) represent actual rules in the FCR Cooperation. Temp-2 (4-hours product) represents the target temporal granularity for FCR Cooperation (see Chapter 2).

Table 3.4 Different Scenarios of Market-Design and EVSE

<i>Temporal Granularity</i>	Temp-1	One-week
	Temp-2	4 hours
	Temp-3	1 hour
<i>Volume Granularity</i>	Vol-1	Minimum bid 1 MW, Bid Increment 1 MW
	Vol-2	Minimum bid 1 MW, Bid Increment 0.1 MW
	Vol-3	Minimum bid 0.1 MW, Bid Increment 0.1 MW
<i>EVSE¹⁰</i>	EVSE-1	Home: 3 kW, Work: 0 kW
	EVSE-2	Home: 3 kW, Work: 7 kW
	EVSE-3	Home: 7 kW, Work: 22 kW

¹⁰ If AC bidirectional charging is used, maximum charging power can be limited by the rated power of the on-board charger

For this part of the study, as we want to evaluate maximum revenue the aggregator could make by participating to these markets, we consider he does not take any security margin, meaning coefficient β is set to zero. Parameters of the EV and of trip patterns are described in Table 3.1 and Table 3.2.

2.2 Results

Figure 3.14 shows the results for different scenarios of temporal granularity, volume granularity and EVSE rated power. On each figure, different temporal granularities are represented for a defined volume granularity and EVSE scenario. On left-side of the graphics is given the average reserve provided by one EV in kW and on right-side the corresponding revenue per EV per year.

To convert average reserve provided in revenue, we need to know the price of reserve. Figure 3.13 shows the evolution of the weekly weighted average price of reserve in FCR Cooperation and the 2-years average price. We assume that the aggregator would always provide reserve whatever the price of reserve (short-term marginal cost of provision being null) and would be price taker on the market. We can thus compute directly revenues by multiplying average reserve provided by the average price of reserve. The two-year average price of reserve is 13.5 €/MW/hour. To be conservative, we consider that the average future price of reserve is 12 €/MW/hour. Equation 3.11 gives the computation of revenue.

$$Revenue \text{ [€/yr]} = Reserve \text{ [kW]} * Price \text{ [€/MW/hr]} * \frac{8760}{1000} \quad 3.11$$

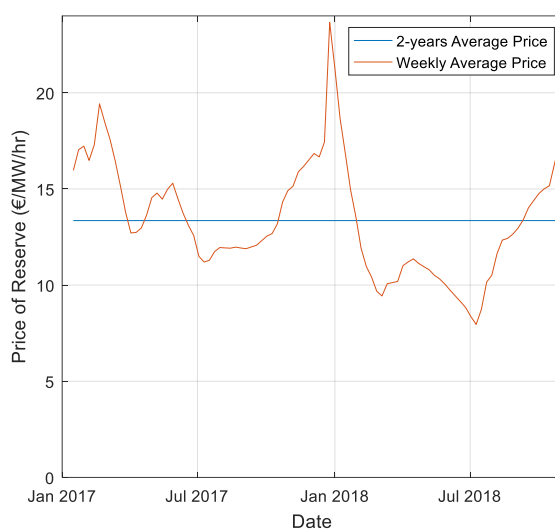

Figure 3.13 Evolution of FCR Cooperation price between January 2017 and November 2018

Figure 3.14 gives the results for all different scenarios. We can first observe that entering market with one-week product is not possible when only EVSE at home are aggregated, because EVs are not available during daytime. This is the only case where entering is not possible for size of fleet lower than 5,000 EVs.

We can then observe the effect of volume granularity. When volume granularity is low (Scenario Vol-1), revenue per EV is not monotonously increasing with the number of EVs. We can see for certain sizes of fleet peaks of remuneration. This effect is particularly present for low EVSE power (EVSE-1 and EVSE-2), low temporal granularity (Temp-1) and small fleets. For example, for scenario {Temp-1 ; Vol-1 ; EVSE-2} we can see revenue per EV decreases from 263 € for 400 EVs to 134 € for 776 EVs. This effect is explained by the size of the bid increment: before reaching the size of fleet which would allow increasing the bid (for example from 1 MW to 2 MW), the total

revenue of the aggregator stays constant when adding new vehicles, which means the revenue per EV decreases. We can observe decreasing the bid increment to 0.1 MW completely suppress this effect for every scenario and increasing temporal granularity reduces it partly. This will have a huge importance for the business-model of the aggregator: it will be easier to forecast properly the revenues per EV when temporal granularity is higher and to design an appropriate offer for customer. We can also observe reducing minimum bid to 0.1 MW allows entering the market with smaller fleets, particularly for low rated power of EVSE and for low temporal granularities.

Finally, we can see higher temporal granularities allow reaching higher revenues per EV. For EVSE-1 scenario, it is not possible to enter with one-week products. For fleet of 5,000 EVs, going from 4-hours to 1-hour products increases revenues per EV by 34 % (37.5 €). For EVSE-3 scenario, going for weeklong to 4-hours long products increases revenues by 34 %, and from 4-hours to 1-hour by 18%.

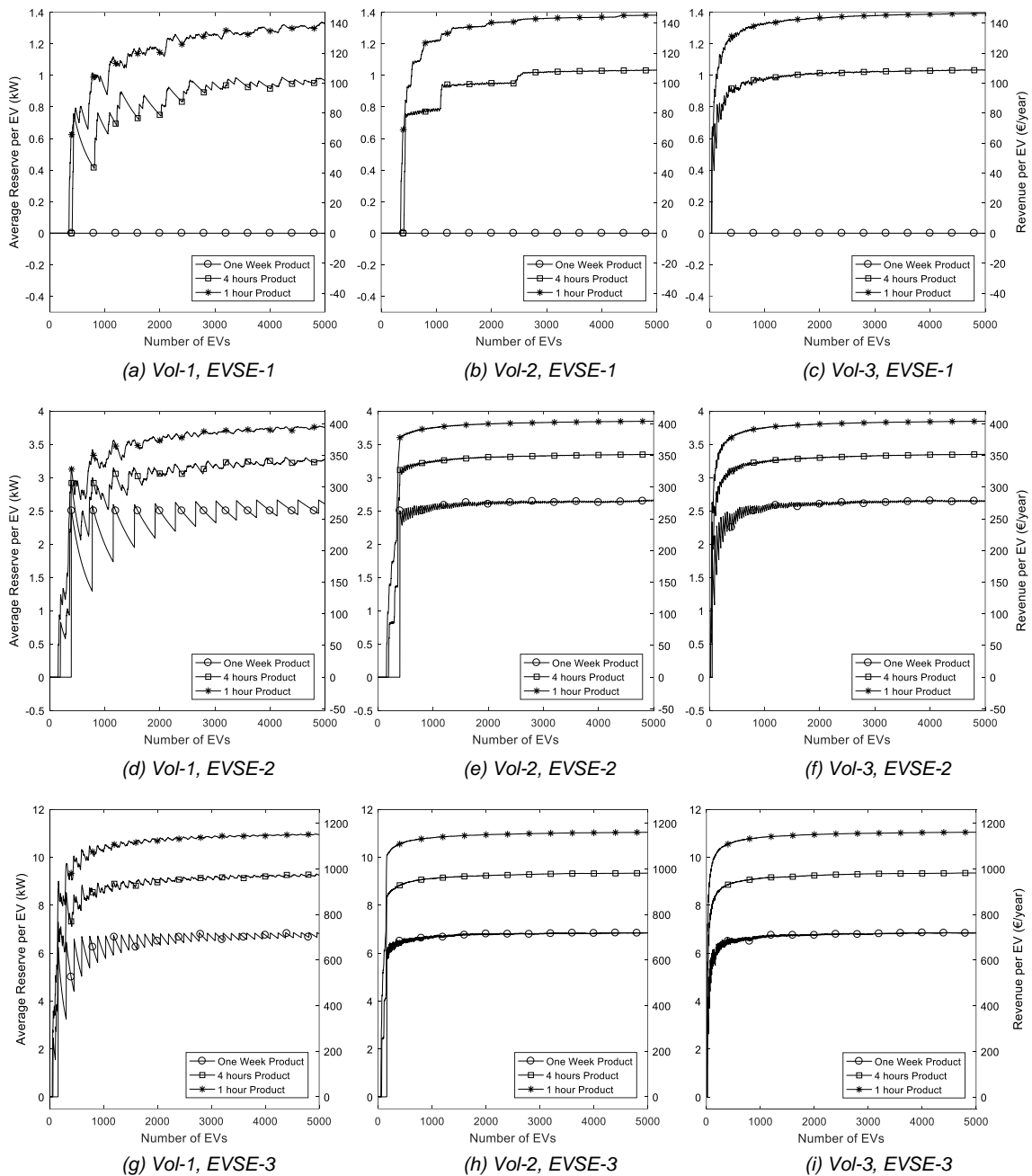

Figure 3.14 Revenues in Function of the Size of the Fleet for Different Scenarios (see Table 3.4 for definitions of different scenarios)

These different results allows us to captur the importance of market-design when trying to assess the viability of a business-model for provision of flexibility by EVs. Not only increasing volume and temporal granularity will increase revenues of the aggregator, but it will also guaranty that each EV added to the fleet will indeed participate to reserve provision and increase revenues. To show this, it is possible to take the problem in reverse: which size of fleet will allow the aggregator reaching a certain target revenue necessary to have a viable business model?

This is represented in Figure 3.16: we compute the minimum size of the fleet that should be aggregated to reach a certain level of revenue per EV. Above this size of fleet, revenue per EV will always stay above target revenue, as shown in Figure 3.15 in the {Temp-1, Vol-1, EVSE-2} scenario for a target revenue of 250 €/EV. We show results for EVSE-2 scenario and three different set of market-design: {Temp-1, Vol-1} (actual rules in FCR Cooperation), {Temp-2, Vol-1} (target rules) and {Temp-3, Vol-3} (highest granularity studied here). For example, to reach a revenue of 100 €, at least 414 EVs should be aggregated with {Temp-1, Vol-1}, 360 EVs for {Temp-2, Vol-1} and 28 for {Temp-3, Vol-3}. It is not possible to reach a revenue of 300 € per EV with {Temp-1, Vol-1}, while respectively 1426 and 80 EVs should be aggregated for {Temp-2; Vol-1} and {Temp-3; Vol-3}.

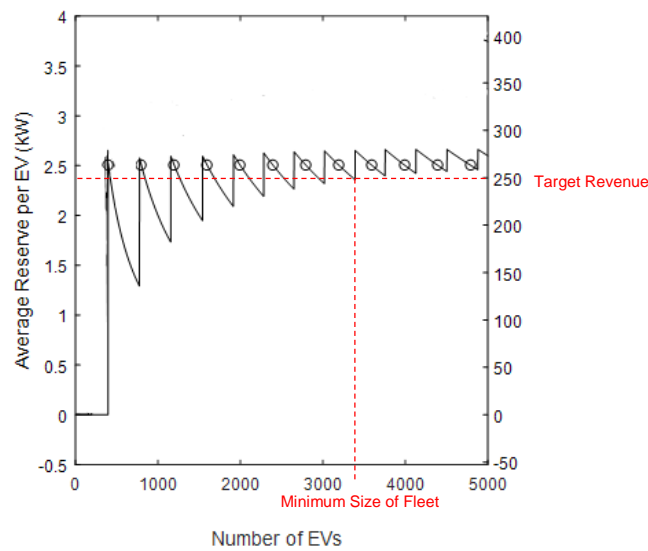

Figure 3.15 Computation of Minimum Size of Fleet for a given Target Revenue

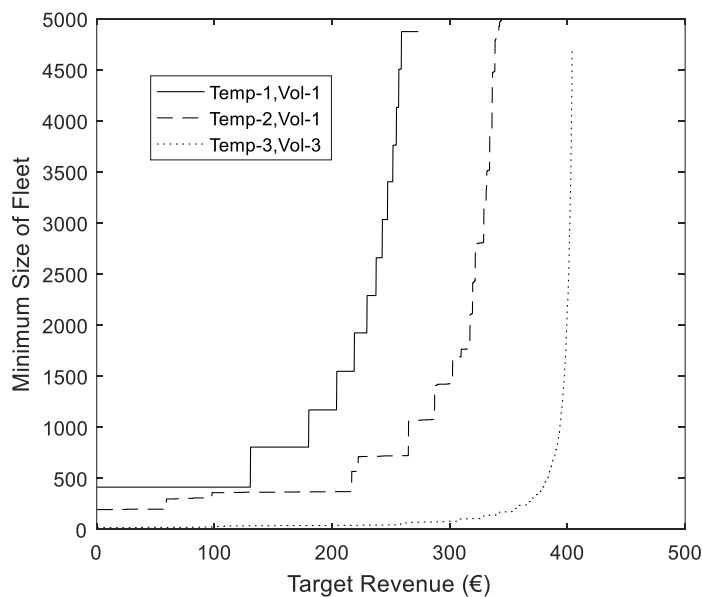

Figure 3.16 Minimum Size of the Fleet in function of Target Revenue. EVSE-2 scenario.

We have seen in this section how market-design could influence revenues of an EV fleet providing FCR. Based on our simulations, we were able to identify the minimum size of a fleet the aggregator should constitute in function of its targeted revenue.

The aggregator will set its target revenue first in function of the cost caused by the provision of reserve. Indeed, revenues should at least balance costs to make it possible to have a profitable business-model. In the next section of this chapter, we will look at this issue, by studying the Net-Present-Value of an investment in EVs equipped with bidirectional EV chargers.

3 NET-PRESENT-VALUE ANALYSIS OF AN INVESTMENT IN BIDIRECTIONAL EV CHARGERS

In the first part of this section, we will identify the different sources of costs associated with provision of FCR with bidirectional EV fleets and present the model for evaluation of Net-Present-Value of the investment in bidirectional EV fleets, parameters of our base-case scenario and results of this scenario, based on framework analysis used in (Roques et al., 2006). Finally, we will present different sensitivity analysis to study the different risks the aggregator could face.

3.1 Model and Base-Case Scenario

3.1.1 *Costs Associated with Bidirectionality and Aggregation*

Implementation of bidirectional functions on the vehicles and operations associated with aggregation will be associated with additional costs on the vehicle. It is important to identify these different sources of costs carefully before making an investment in bidirectional chargers.

We can identify two different types of costs. First, investment costs (CAPEX), and operating costs (OPEX).

- Investments Costs are every costs incurred at the installation of the charger (on-board or off-board) and specifically dedicated to the provision of FCR. It includes searching for clients, installing bidirectional capabilities on the vehicle (as we make the hypothesis that bidirectional capabilities is only used for provision of reserve), developing Human Machine Interface, upgrading the telecommunication and metering equipment in order to comply with requirements of provision, going through prequalification process. Investment costs will occur once before starting to operate the fleet.
- Recurrent Costs is including costs such as management of data, management of contracts with users and TSO, extra Operation and Maintenance costs on chargers due to reserve provision, market operations. These costs will occur every year of operation.

These costs could differ in function of the technological options (e.g. AC on-board or DC off-board bidirectional charger), the different requirement on metering and telecommunication (e.g. is it necessary to install a new certified metering device for power? is it required to measure frequency at every points of connection? how fast should the measurement be send to the TSO?). They might also differ from one actor to another, considering its competencies and infrastructure already in place.

Moreover, costs might evolve in function of the number of aggregated units. Investors might benefit from economies of scale if aggregating a large number of units: infrastructure could be shared between a large number of units, which will reduce the cost per unit (Burger et al., 2016). Investor could also benefit from leaning effect if having a large fleet: first bidirectional charger installations, prequalification process, contractual design might be costly because different processes have to be established. The investor will benefit from the experience acquired before for each new vehicle added to the fleet.

However, investors might face diseconomies of scale above a certain number of units. This might be due to cost of managing a large structure, non-scalability of the operational solution to aggregate data. Investors will also target first clients for which costs of implementation are low (for example company fleets or clients in a certain geographical scope); when these clients are already in the pool of units, investor will have to reach clients for which the implementation of the solution will be more costly.

3.1.2 Base-Case Scenario

We want first to build a base-case to calculate Net-Present-Value under different market-designs scenario in function of the size of the fleet. Net-Present-Value is the sum of the Discounted Cash Flow during the lifetime of an asset as shown in Equation 3.12. The discount rate represents the cost of capital for the company. The higher the discount rate, the lower will be future cash-flows.

Net-Present-Value provides an evaluation of the profitability of the asset. If the Net-Present-Value is positive, investors should pursue the investment, since future cash-flows exceed the amount of the initial investment. Moreover, it allows comparing mutually exclusive projects, meaning it is not possible to invest in both project at the same time (in our case, the different mutually exclusive projects will be the different sizes of fleets). Parameters of the base-case are presented in Table 3.5.

Table 3.5 Parameters of Base-Case Scenario Calculation

Investment Costs	I_0	500 €/EV
Scale Factor	α	10 % every 10,000 EVs
Recurrent Cost	C_0	200 €/EV
Minimum Recurrent Cost	c_n	75 % of Recurrent Costs
Size where $C = C_n$	N_n	25,000 EVs
Margin Security	β	20 %
Lifetime	T	10 years
Inflation	τ	1 %/yr
Average Price of Reserve	p	12 €/MW/hr
Discount Rate	r	8 %/yr

$$NPV = -Investment + \sum_{t=1}^T \frac{Revenues(t) - Costs(t)}{(1 + DiscountRate)^t} \quad 3.12$$

For investment costs, the price of the first bidirectional charger added to the fleet is 500€. Then, we take into account economies of scale through the parameter α . The investment cost is a function of the size of the fleet N_{ev} and is calculated using Equation 3.13. When 10,000 vehicles are added to the fleet, investment costs per EV is reduced by 10%. Figure 3.17 shows the evolution of the investment cost with the number of vehicles in the fleet.

$$I(N_{ev}) = I_0 * (1 - \alpha)^{\left(\frac{N_{ev}}{10000}\right)} \quad 3.13$$

Recurrent costs occur at each period of the Net-Present-Value analysis. The recurrent cost for the first EV is 200€/EV/year¹¹. They are decreasing with the fleet size for $N_{ev} < N_n$ (polynomial function with coefficient a and b , as shown in Equation 3.15) and constant for $N_{ev} \geq N_n$ (Equation 3.14). We take N_n equals to 25,000 EVs. To calculate a and b , we use Equations 3.17 and 3.18. Figure 3.18

¹¹ In (E-Cube, 2013) and (Rious et al., 2015), recurrent costs was evaluated to 50 €/year/client for basic load shifting. We take a higher value to consider complexity of FCR provision (10-seconds measurement of every site should be available in real-time to the TSO).

shows the evolution of recurrent costs with the number of vehicle. Finally, we take into account inflation with the parameter τ as shown in Equation 3.19.

$$C(N_{ev}) = \max(c_n * C_0, a * N_{ev}^2 + b * N_{ev} + C_0) \quad 3.14$$

$$C(N_n) = a * N_n^2 + bN_n + C_0 = c_n * C_0 \quad 3.15$$

$$C'(N_n) = 2 * a * N_n + b = 0 \quad 3.16$$

$$a = \frac{(1 - c_n)}{N_n^2} * C_0 \quad 3.17$$

$$b = -2 * \frac{(1 - c_n)}{N_n} * C_0 \quad 3.18$$

$$C(N_{ev}, t) = C(N_{ev}) * (1 + \tau)^t \quad 3.19$$

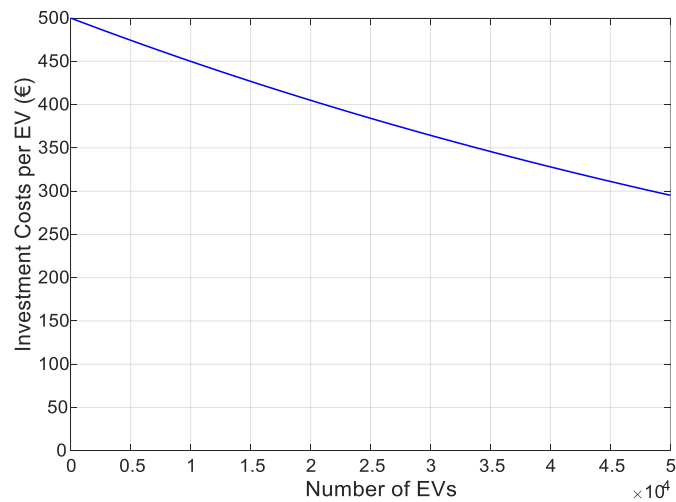

Figure 3.17 Evolution of Investment Costs with Size of the Fleet

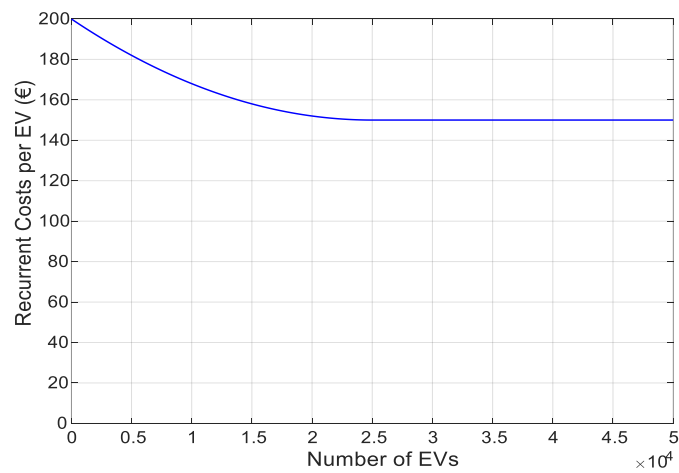

Figure 3.18 Evolution of Recurrent Costs with Size of the Fleet

We introduce a security margin β for the aggregator in order to cope with situations where some EVs would not be available or there would be an error of forecast in the statistical distributions (see first section). The aggregator will apply this security margin on the available reserve before bidding on the market. We then calculate the annual revenue based on a function M , which gives the offered reserve in function of available reserve and market-design (Equation 3.20, see first section). We can then calculate Net-Present-Value of the investment (Equation 3.21).

$$R = p * \sum M((1 - \beta) * P_{available}) \quad 3.20$$

$$NPV = -I(N_{ev}) + \sum_{t=1}^T \frac{R - C(N_{ev}, t)}{(1 + r)^t} \quad 3.21$$

To take into account diversity of deviations patterns of the frequency and of trip patterns, we run 500 simulations with 2,000 EVs on two consecutive days taken randomly for each simulation during year 2017, with frequency data published by RTE (RTE, 2018). We compute available reserve for fleets going from 10 to 50,000 EVs. For size of fleets under 2,000 EVs, we sum reserve patterns of EVs taken randomly over the 2,000 EVs simulated. To compute reserve available for fleets with more than 2,000 EVs, we duplicate the profile of some EVs in order to reach the appropriate size of fleet. Available reserve is then computed as the minimum reserve for each time-step over the 500 simulations.

3.1.3 Results

Figure 3.20 is presenting the evolution of the Net-Present-Value per EV in function of the size of the fleet with base-case parameters, for EVSE-2 scenario (3 kW at home and 7 kW at work) and for four different market designs:

- *Scenario 1*: Temporal Granularity of 1 week and volume granularity of 1 MW.
- *Scenario 2*: Temporal Granularity of 4 hours and volume granularity of 1 MW
- *Scenario 3*: Temporal Granularity of 4 hours and volume granularity of 0.1 MW
- *Scenario 4*: Temporal Granularity of 1 hour and volume granularity of 0.1 MW

We take into account a maximum prequalified volume of 150 MW that can be delivered by a single Balance Service Provider. This limitation is imposed by ENTSO-e to ensure that the failure of one reserve provider would not affect the security of the system. This represents 5% of the total volume of FCR that should be delivered in Continental Europe¹². It causes a decrease of the Net-Present-Value per EV in the three last market-design scenarios, as revenues stops increasing with the size of the fleet when this volume is reached. From these curves, we can calculate two results:

- The maximum Net-Present-Value per EV, which reflects the level of profitability of installing bidirectional chargers. It will influence the offers the aggregators would make to users. Indeed, in order to enroll clients, aggregators will reverse part of their benefits to user of EVs. If value of bidirectional chargers is high, aggregators will be able to propose a significant remuneration to clients, which will make their offer more attractive. Moreover, a high level of profitability ensures
- The minimum number of EVs to reach a positive Net-Present-Value. It will be an essential feature for the aggregator, as it can represent a high risk for the investor to start aggregating a fleet without being certain to reach a sufficient size.

Figure 3.19 shows how these two indicators might allow aggregator to reach a profitable business model.

¹² In some country, the size of reserve can be lower than 150 MW, which reduces the maximum reserve that can be provided

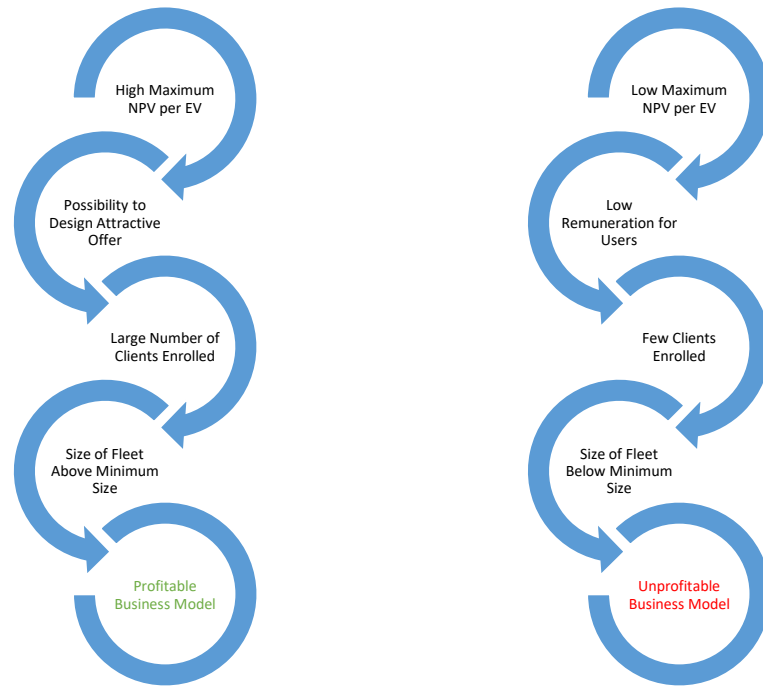

Figure 3.19 Influence of Maximum NPV per EV and Minimum Size of the Fleet on Business Model

Results are presented in Figure 3.21 and Figure 3.22. It is possible to reach a positive Net-Present-Value in every scenario. However, increasing temporal granularity allows increasing significantly NPV. Maximum Net-Present-Value per Electric Vehicle is multiplied by four when going from week-long products to hour-long products.

Volume granularity has no significant effect on the maximum Net-Present-Value per EV. The minimum size of the fleet to reach positive NPV is highly influenced by granularity of products. With week-long products, the minimum size is more than 19,000 EVs whereas it is only 240 EVs with hour-long products. We can also see the effect of volume granularity: with four-hours products, going from 1 MW to 0.1 MW allows to divide by more than two the minimum size of the fleet.

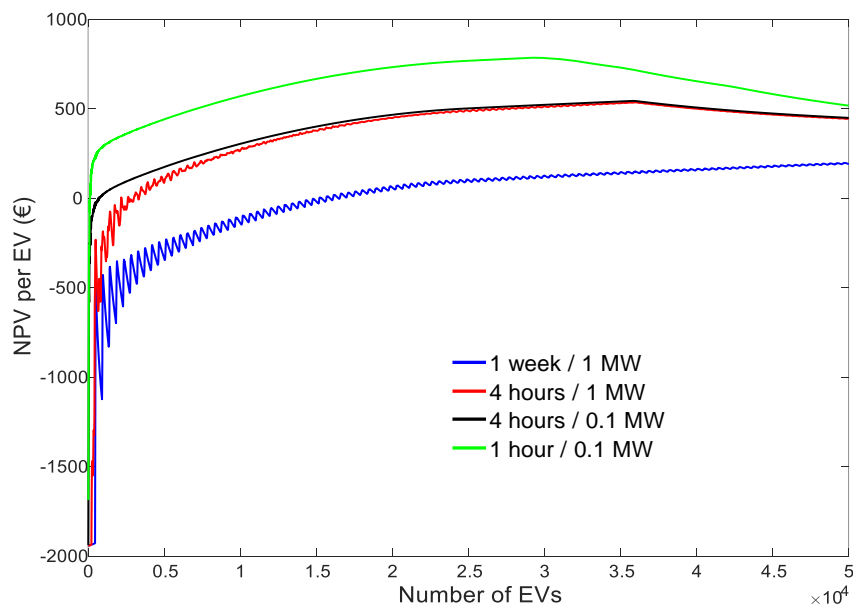

Figure 3.20 Evolution of NPV per EV with Size of the Fleet for Different Market-Designs

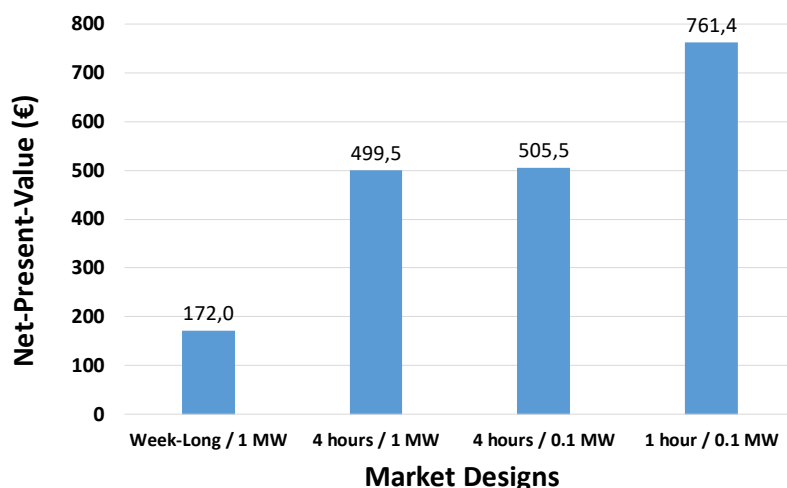

Figure 3.21 Maximum NPV per EV for Base-Case Scenario

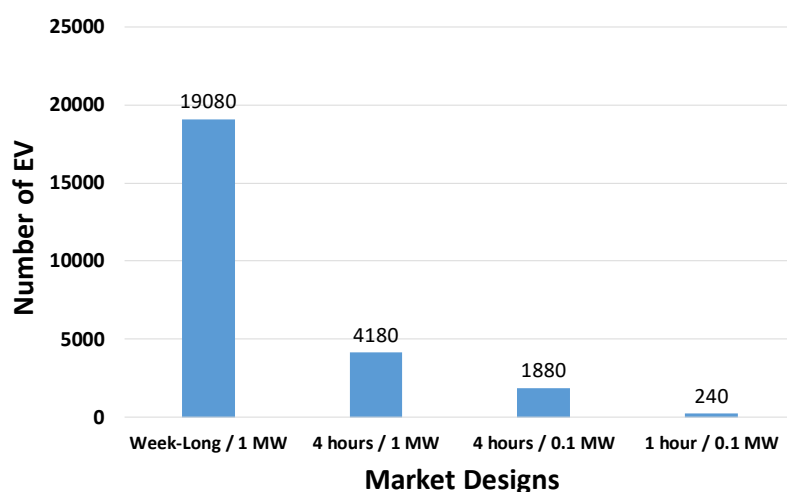

Figure 3.22 Minimum Size of the Fleet for Base-Case Scenario

3.2 Sensitivity Analysis

The precedent analysis allowed identifying the level of profitability of a fleet of bidirectional vehicles providing Frequency Containment Reserve, as well as the minimum size of the fleet to reach a profitable business model, with different possible market-design. This study was performed with fixed parameters. These parameters are considered as realistic, based on the experience of experts interviewed.

However, it is necessary to perform some sensitivity analysis, in order to capture the impact of a variation of these parameters. Indeed, the investor might face different uncertainties when assessing the profitability of the investment:

- Investment costs and recurrent costs might be difficult to assess ex-ante, as the business model of aggregators is new. For example, recruiting client to participate to flexibility services might be a costly task if users are reluctant to let a third party control the charging process of their vehicle. Moreover, depending on the already existing activities of the aggregator and on its experience, some tasks might be less costly (e.g., it might be easier to build the appropriate IT architecture for a player already involve in electricity markets).

- The security margin could be refined when the aggregator has more knowledge on the habits of the users and the type of fleets aggregated.
- The average price of reserve might decrease in the future, due to the arrival of new technology able to provide reserve: large stationary batteries, other distributed assets... Figure 3.23 shows the evolution of the price in the FCR Cooperation from January 2015 to July 2018 (lowest bid and highest accepted bid). This trend is clearly visible, even if FCR prices is highly volatile (due to correlation with energy prices).
- Fleets with different trip patterns might affect the Net-Present-Value due to different availability of the cars and power of the EVSE (for example a company fleet).

We will perform in this section three different types of sensitivity analysis to capture these different uncertainties.

First, we want to see the effect on maximum NPV and minimum size of the fleet of a small variation ($\pm 20\%$) of each of the parameter of the NPV calculation around the base-case scenario value, all things being equals. It will allow us to identify the most sensitive parameters for the investor. It represents a situation where the investor has already a precise view on its costs structure and on the price of the service and want to assess the risk associated with the variation of each of these parameters.

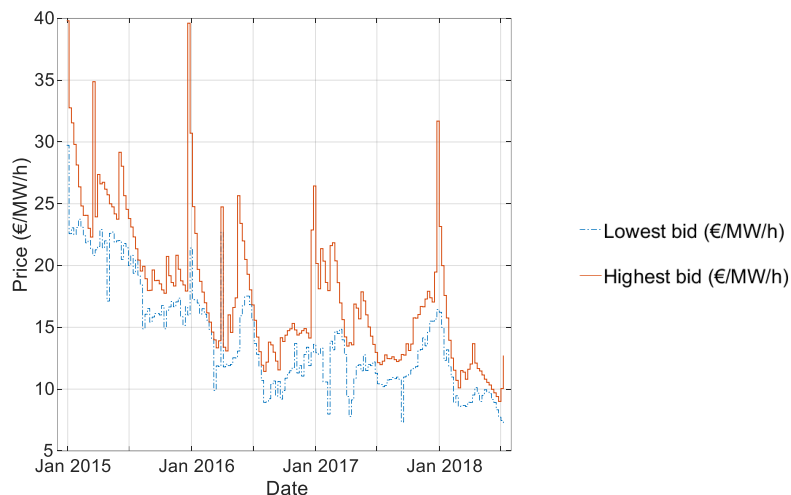

Figure 3.23 Evolution of FCR Cooperation Price between 2015 and 2018

Second, we will calculate the value of the two indicators on different fleets, in term of availability of EV Supply Equipment and trip patterns. It allows the investor to target its offer to specific type of clients in order to maximize its profitability.

Finally, we will look at profitability boundaries in function of investment cost, recurrent cost and price of reserve.

3.2.1 Parameters of the Net-Present-Value Analysis

As parameters in the base-case are uncertain for the aggregator, we will now perform a sensitivity analysis. In order to capture the impact of a variation of one of the parameter on the two values analyzed here (maximum Net-Present-Value and minimum size of the fleet), we calculate again NPV in function of the size of the fleet with one of the parameter in Table 3.5 set at $\pm 20\%$ of its original value, all things being equal.

Figure 3.24 gives the results of this sensitivity analysis. Each figure represents, for four different market-designs, the impact of the variation of one parameter on the maximum NPV (left-hand side) and the minimum size of the fleet (right-hand side).

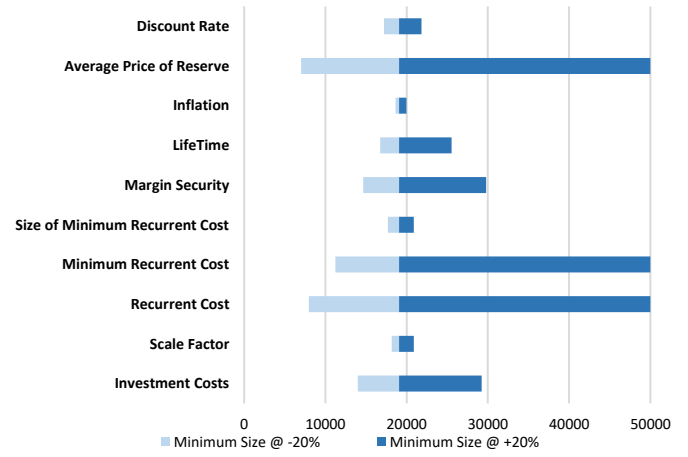
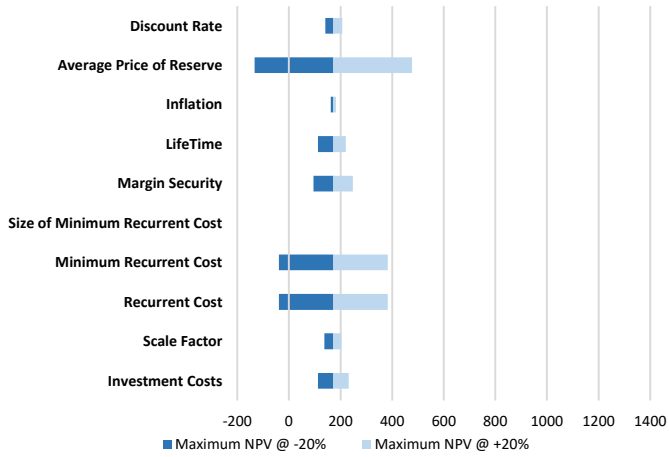

(a) Maximum NPV and Minimum Size for Scenario 1

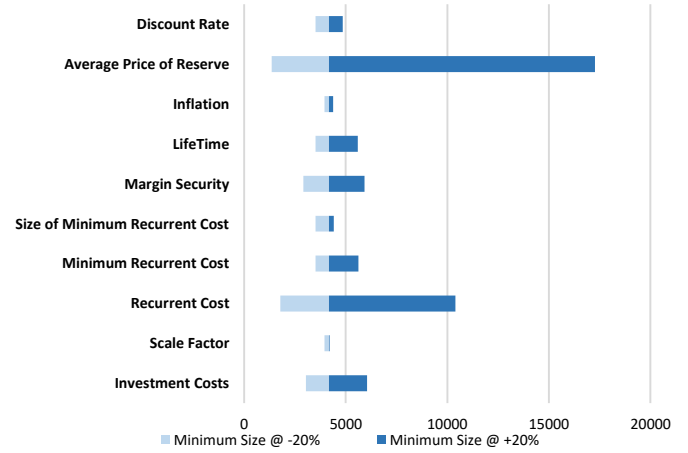
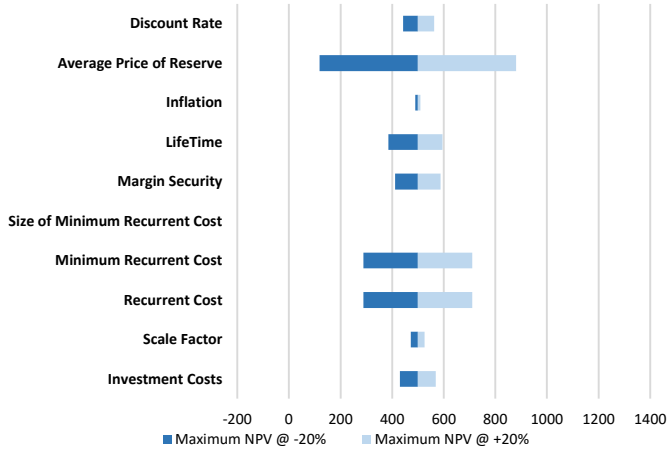

(b) Maximum NPV and Minimum Size for Scenario 2

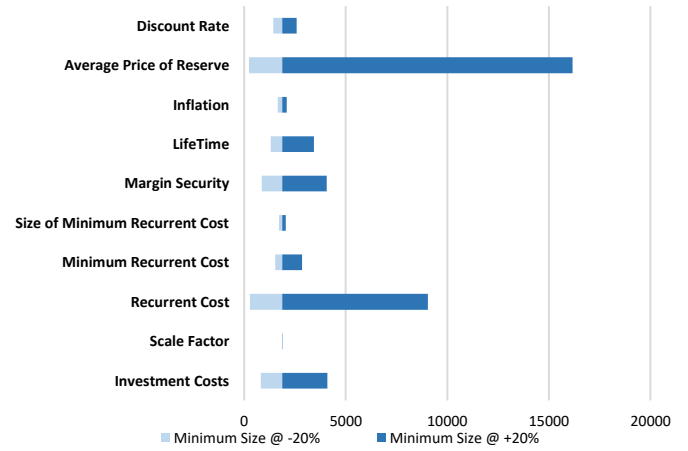
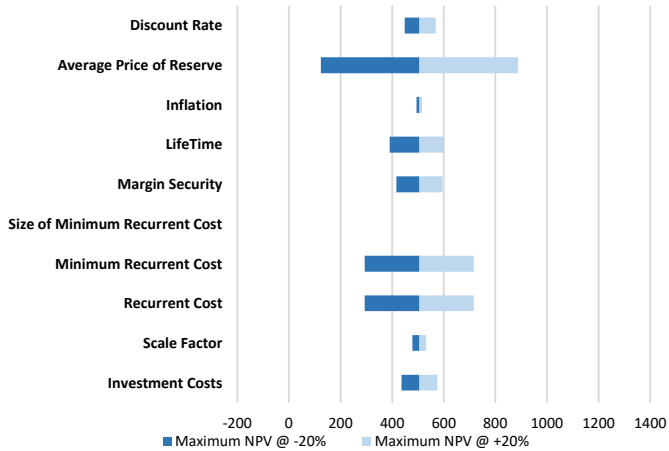

(c) Maximum NPV and Minimum Size for Scenario 3

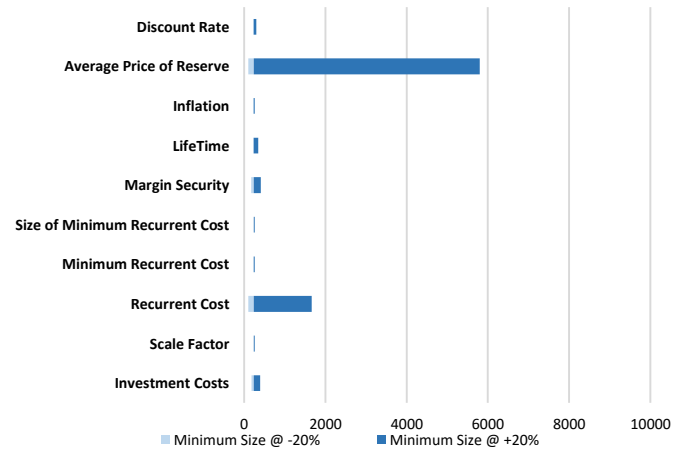
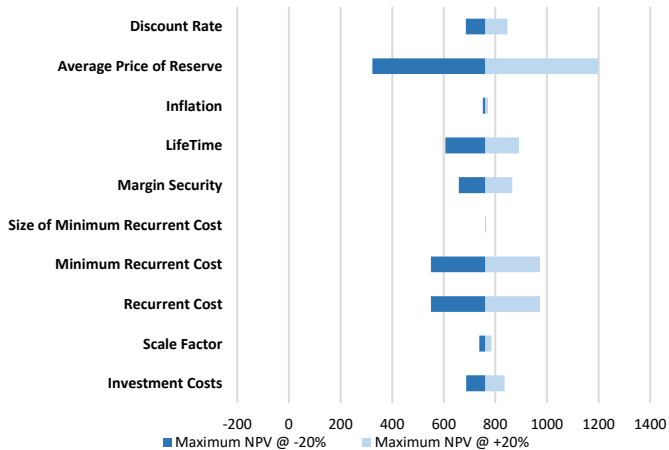

(d) Maximum NPV and Minimum Size for Scenario 4

Figure 3.24 Sensitivity Analysis on Base-Case Scenario Parameters

A decrease of 20 % of the price or an increase of 20 % of recurrent costs makes the investment unprofitable for low granularity products (scenario 1). Revenues of the investment do not balance costs associated. This sensitivity to price of reserve should be considered carefully by investor as a decrease of price of reserve is likely to happen. For other market-designs, even if there is no case where the investment is unprofitable, we can see that average price has still a high influence on the maximum NPV (± 400 € of the maximum NPV for price variation of $\pm 20\%$). The other parameters that have an influence are, by order of magnitude, recurrent costs, lifetime of the asset, margin security, investment costs and discount rate.

Every parameters have a large influence on the minimum size of the fleet for scenario 1. An increase of 20% of the price reduces by about 10,000 EVs the number of EVs to be aggregated. When granularity is increasing, the minimum size becomes less sensitive to a variation of the parameters. For high granularity (scenario 4), recurrent costs and average price become the only influencing parameters. A decrease of 20% of the average price correspond to an increase of more than 14,000 EVs for a temporal granularity of 4 hours, and more than 5,000 EVs for a temporal granularity of 1 hour.

This sensitivity analysis demonstrates the risks associated with the investment in a fleet of EVs equipped with bidirectional chargers. Aggregators should assess these different risks before starting to invest, as this could affect viability of their business models.

3.2.2 Parameters of the Fleet

In order to catch the influence of the parameters of the fleet, we perform analysis with three other fleets. In this sensitivity analysis, we take all parameters as in base-case and make a sensitivity analysis on the average price of reserve, which is the most sensitive parameters to assess profitability of the fleet.

First fleet studied (Fleet 1) has the same parameters as base-case fleet but no plug available at work. Results can be seen in Figure 3.25 for maximum Net-Present-Value per EV. There is no scenario in that case where reaching a positive NPV is possible, even with an increase of reserve price of 20 %. It shows that availability rate of EVs is a crucial parameter to reach profitability.

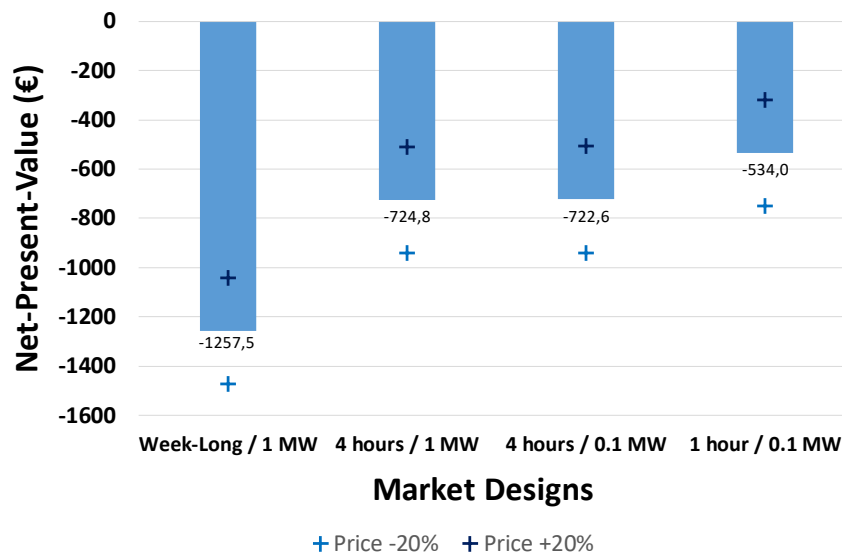

Figure 3.25 Maximum NPV per EV for Fleet 1

The second and third fleets studied are company fleets. Cars are leaving in the morning and are coming back at lunchtime, then leave in the afternoon and come back in the evening. They are plugged in for the entire night. EVs of Fleet 2a have a 7 kW power plug and EVs of fleet 2b have a 22 kW power plug. Parameters of the stochastic distributions for these fleets are given in Table 3.6.

Table 3.6 Statistical Distribution of Trip Patterns for Company Fleet

Parameter	Type	μ	σ
Trip Distance (km)	Normal	40	5
Departure From Home (h)	Normal	8	1
Departure From Work (h)	Normal	14	1
Average Speed (km/h)	Normal	15	5

Figure 3.26 and Figure 3.28 show results for maximum NPV and Figure 3.27 and Figure 3.29 for minimum size of the fleet. With 7 kW plug, NPV is negative in scenario 1 (week-long products), due to periods of very low availability of the vehicles during working hours. Maximum NPV is lower in scenario 2 and 3 (4-hour products) than for base-case fleet, and profitability is not ensured in case of a decrease of the price. However, NPV is higher in scenario 4 (hour-long product) than for base-case fleet.

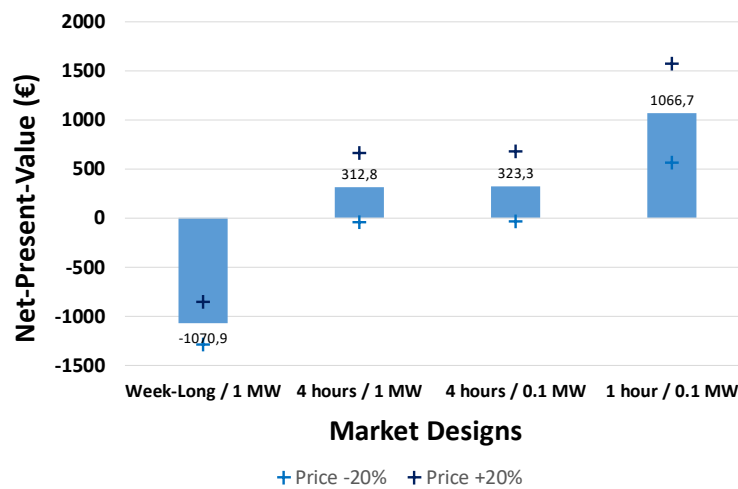

Figure 3.26 Maximum NPV per EV for Fleet 2a

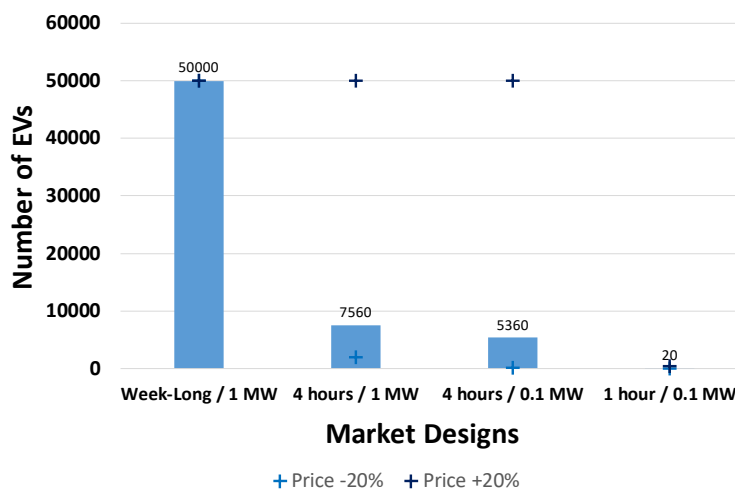

Figure 3.27 Minimum Size of Fleet for Fleet 2a

With 22 kW plug, NPV is similar than for base-case fleet in scenario 1. Even if availability of EVs is very low during working hours, high rated power of EVSE allows making relatively high bids with few vehicles. For scenario 2, 3 and 4, maximum NPV is more than 5 times higher than for base case, due to high maximum power of the EVSE.

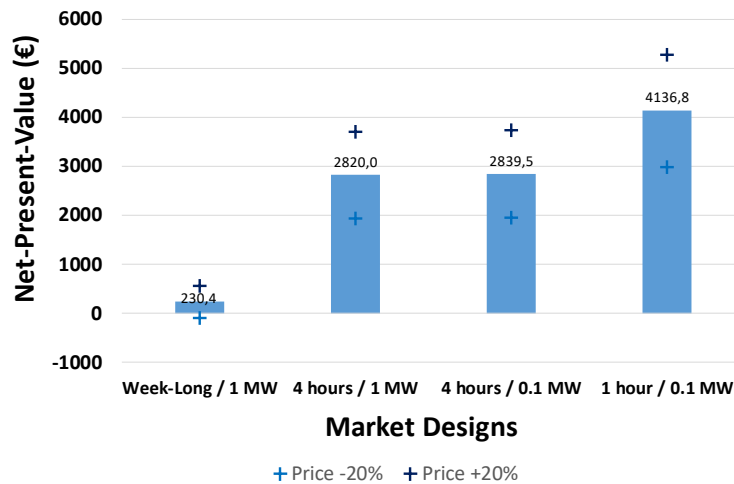

Figure 3.28 Maximum NPV per EV for Fleet 2b

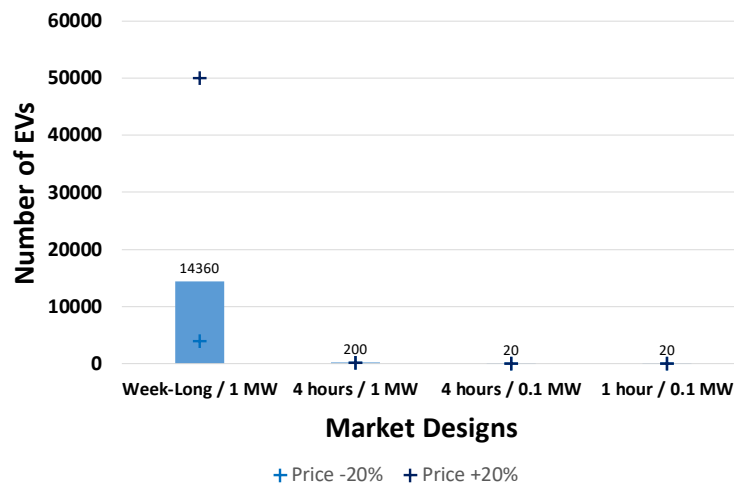

Figure 3.29 Minimum Size of Fleet for Fleet 2b

This sensitivity analysis is demonstrating that revenues of the fleet will be highly dependent on the trip patterns of EVs and rated power of the EVSE. With low availability and low rated power, it will be difficult to ensure profitability of the investment even if there is an increase of the price of the reserve. Company fleets, due to low availability during daytime would be less appropriate in case of low granularity of the products. However, for high granularity products and high rated power, level of profitability could surpass base-case scenario fleet.

3.2.3 Profitability Boundary

This sensitivity analysis has shown the great impact of a diminution of price on profitability of the investment. Recurrent costs and investments costs can also be sensitive for the profitability of the investment. However, we only analyzed the variations on the different parameters on a small range ($\pm 20\%$) and with only one factor varying, all things being equal. The investor might have a higher level of uncertainty on the different parameters (scale factor, minimum recurrent costs) and might not be able to evaluate them properly before pursuing the investment.

Therefore, it is important to anticipate in which zone of investment costs and recurrent costs the investment should be pursued at different level of price and size of the fleet. In order to capture this, we calculate a profitability boundary. It represents the parametric curve where NPV changes of sign for a determined level of price of reserve and size of the fleet, in function of the investment costs (x-axis) and the recurrent costs (y-axis). These curves do not show the level of profitability.

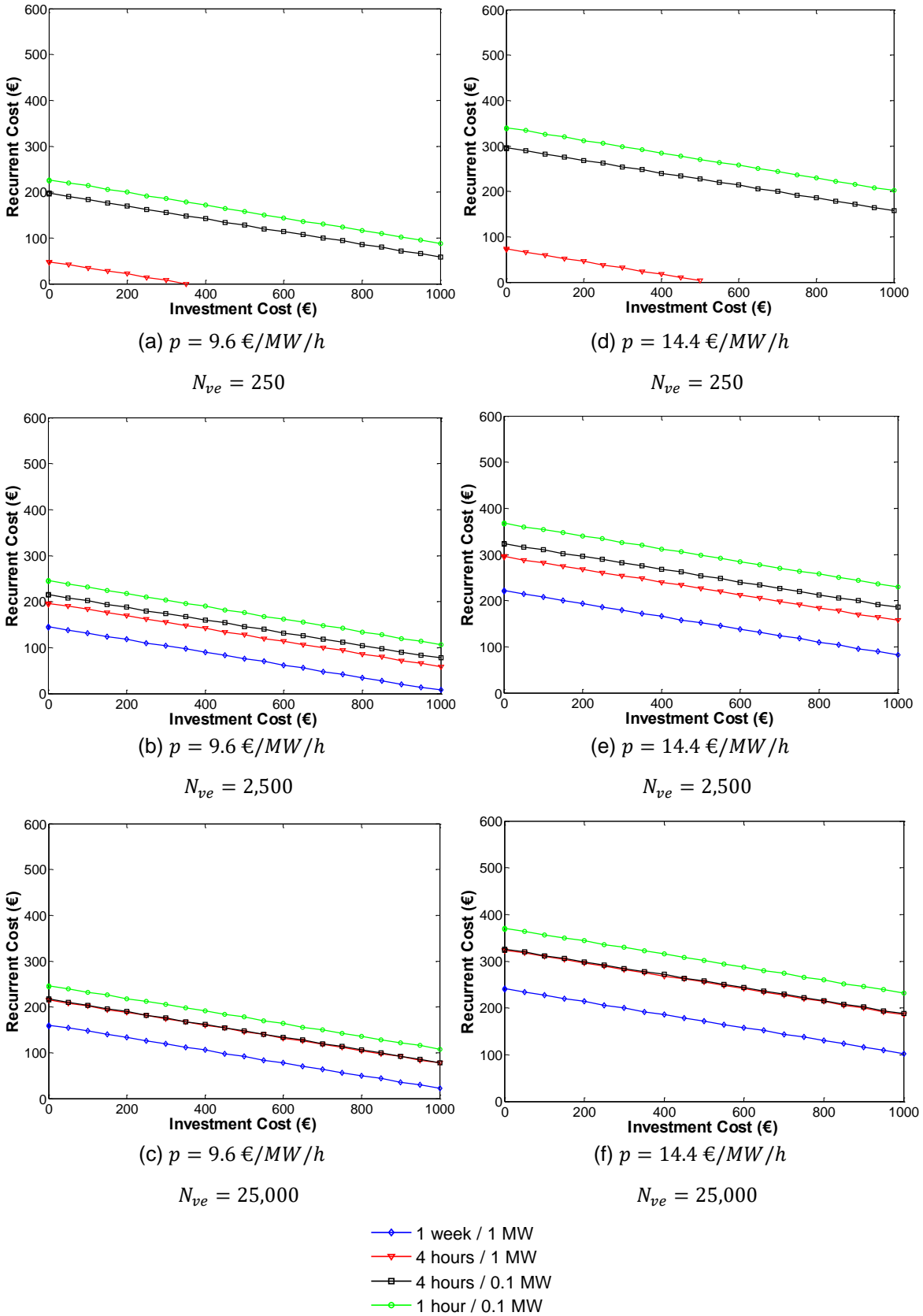

Figure 3.30 Profitability Boundaries

Figure 3.30 provides some example of profitability frontiers for the different scenarios of market-designs. If the point is below the curve for a determined level of investment cost and recurrent cost, the NPV is positive and the investment should be pursued. For example, with an investment costs of 400 €/EV and a recurrent cost of 50 €/EV, with a price of 9.6 €/MW/h and a size of 250 EVs, the investment will not be profitable in scenarios 1 and 2 but would be profitable in scenario 3 and 4.

We can see the effect of volume granularity for small fleet (250 EVs) on the profitability frontier. The gap between two curves is very large and increases with the price. There is no gap with larger fleets (25,000 EVs). The gap between different temporal granularities also increases when price increases.

The slop of the frontier does not depend on the granularity of the product, the size of the fleet or the average price. In every situation, an increase of the recurrent costs of 100€ corresponds to a diminution of the maximum possible investment costs of about 700 €. This might influence the choices of infrastructure of the aggregator: it might be beneficial to have larger investment costs if it allows to reduce recurrent costs, e.g. choose between owning servers or using cloud solutions for data management.

4 PARTIAL CONCLUSION

In the first section of this chapter, we have described a model to simulate participation of EV fleets in reserve provision. This model can be described with three different modules: first module is allocating to each vehicle of the fleet trip patterns according to statistical distributions, which are used to identify mobility needs of each individual user. Then we simulate reserve available over a definite time horizon for each vehicle and each time-step based on a frequency deviation dataset. Then, we use these simulations to identify bid the aggregator would be able to make on each market period. We then run validation tests to assess if it would be possible to deliver offered reserve.

In the second section, we assessed revenues of the aggregator under different scenarios of market-design. We showed the importance of volume and temporal granularities of product: while temporal granularity will affect the revenues of the fleet, whatever the size of the fleet, low volume granularity will create threshold effect, which could affect early development of the fleet.

Finally, in the third section, we looked at profitability of the investment in bidirectional chargers, to see if revenues could balance costs of the technology. We did it first on a base-case scenario, looking at the maximum Net-Present-Value per EV the aggregator could reach and the minimum size of the fleet to reach a positive NPV. Then, we did three different sensitivity analysis on these results: first by looking at low-range variations of each parameter of the calculation; then by looking at fleets with different availability rates and trip patterns; third, looking at the profitability boundary of the investment.

CHAPTER 4. EVALUATION OF THE VALUE OF COOPERATION BETWEEN AGGREGATOR AND CAR MANUFACTURER

1	Roles of the Aggregator And Value Chain Of Smart Charging.....	76
2	Presentation of the Model: Actors and Case Studies.....	77
2.1	Actors.....	77
2.1.1	Car Manufacturer.....	77
2.1.2	Aggregator.....	77
2.1.3	Users.....	77
2.2	Calculation of Net Present Value of Car Manufacturer and Aggregator.....	80
2.3	Presentation of Case-Studies.....	80
2.3.1	Reference 1.....	84
2.3.2	Reference 2.....	84
2.3.3	Case Study 1: Non-cooperative situation.....	84
2.3.4	Case-study 2: Cooperative situation without financial exchange.....	86
2.3.5	Case-Study 3: Cooperative situation with financial exchanges.....	86
3	Results.....	87
3.1	Smoothing of Revenues Function.....	87
3.2	Case-Study 1.....	88
3.3	Case-Study 2.....	90
3.4	Case-Study 2bis: Introduction of bargaining power of the Manufacturer.....	92
3.5	Case-Study 3.....	94
4	Analytic Model.....	98
4.1	Reference 1.....	99
4.2	Reference 2.....	100
4.3	Case-Study 1.....	101
4.4	Case-study 2.....	102
4.4.1	For $\pi = 0$	102
4.4.2	For $\pi = 1$	103
4.5	Case-Study 3.....	104
4.5.1	For $\pi = 0$	105
4.5.2	For $\pi = 1$	106
4.6	Partial Conclusion.....	107

1 ROLES OF THE AGGREGATOR AND VALUE CHAIN OF SMART CHARGING

In the previous chapter, we analyzed revenues and Net-Present-Value of reserve provision by EV fleets. We understood the importance of market-design, availability of the fleet and power of the EVSE in the profitability of the technology.

This analysis was a first step toward a business model. It gives necessary conditions for profitability but leaves some open questions: what share of value for the users of EVs and for each actors of the value chain?

Indeed, the hypothesis was that only one actor would be in charge of all the roles of the aggregator and therefore bear all the costs and take all the revenues. However, there are many different tasks lying behind the term of aggregator.

The first task would be to enroll clients to constitute the fleet. Then, all the equipment required to provide flexibility services should be implemented on the vehicle or the external charger, including bidirectional chargers, metering and telecommunication infrastructure. It can also include capital provision on possible accelerated degradation of the battery due to provision of flexibility services. Finally, the fleet should be operated during its entire lifetime. Operating the fleet includes transfer from the vehicles to a central controller, management of data, making offer on the reserve markets, dispatching the reserve between the vehicles. It also includes customer service and maintenance of the different equipment.

Different types of actors might get involved in these different tasks. First, car manufacturers will be directly involved, as they should design the vehicles to allow provision of flexibility services. They can implement AC bidirectional charger and other equipment directly in the vehicle. Otherwise, these equipment can be included in a DC external charger; manufacturers should still upgrade the vehicle in order to allow communication between the off-board charger and the Battery Management System. Manufacturers have also a role to play in the enrollment of client, as sellers of V2G equipped vehicles.

Energy providers, electricity producers as well as independent aggregators will also be involved in the different tasks of management of the fleet. Energy providers and electricity producers have existing competencies in electricity markets, which could be beneficial in an efficient management of the assets. However, EVs require some specific knowledge, which could be brought by independent aggregators or EVSE operators.

Each actor will have to decide on the tasks he wants to get involved in, depending on its existing competencies already in place. Actors will have different options for tasks where there is no or few competencies internally: either leaving consumers to decide which actors they turn to, either building cooperation with a specific actor to have common offer, or internalize this competency either by acquiring another company or by developing this competency internally.

The different choices of the actors will define new value chains and ecosystem. The aim of this chapter will be to analyze a simplified ecosystem: a car manufacturer selling EVs with bidirectional chargers and an energy provider, offering FCR with these vehicles. This model will allow understanding the interactions and interdependencies between these two actors, how their decisions can influence demand for V2G function on vehicles and which type of cooperation they could build.

In the second section of the chapter, we will describe the model to study these interactions: the actors, their decisions and the different case studies, which will reflect the different levels of cooperation between actors. In the third part, we will present the results of these case studies, based on the model presented in previous chapter. Finally, in the fourth section, we will present a simplified analytical framework to perform sensitivity analysis.

2 PRESENTATION OF THE MODEL: ACTORS AND CASE STUDIES

2.1 Actors

2.1.1 Car Manufacturer

In this model, car manufacturer will be in charge of installing bidirectional function on the vehicles, which includes bidirectional charger and all metering and telecommunication equipment. It means he will bear the majority of investment costs. To simplify the analysis, we make the hypothesis he will bear the entire investment costs I and does not benefit from economies of scale. However, as he does not take part to the management of the fleet, he does not bear any of the recurrent costs.

He can be remunerated via a margin on the sale of V2G function: he will fix a sale price of the V2G function P and users will have the option to integrate it on the vehicle or not.

2.1.2 Aggregator

The aggregator will be in charge of managing the fleet and making offers in reserve markets based on the availability of the fleet of EVs equipped with V2G function sold by car manufacturer.

He will get the revenues from flexibility services and decide on a fixed annual fee F paid to users of the cars. He will bear all recurrent costs c but no investment cost.

2.1.3 Users

Users will take the decision to have a V2G function integrated on their vehicle based on the selling price decided by the car manufacturer and the annual fee decided by the aggregator. There is heterogeneity among users, which means for a certain selling price and fee, some of them will adopt the technology while others will not. This heterogeneity will be modeled through a demand function, which represents the amount of users who will buy the V2G option in function of the selling price and the annual fee. This demand function is exogenous for the manufacturer and the aggregator, meaning they have no other option to change the selling price or the fee to change the number of users adopting V2G.

Buying V2G option and contracting with the aggregator are perfectly complementary: no user buy the V2G option without joining the aggregator's fleet and it is not possible to join the fleet without having bought the V2G option.

Users choose to buy V2G option depending on the Net Present Value of the option (Equation 4.1-4.3). We consider NPV cannot be negative, as no user will buy V2G function in such a case. Users are expecting a reward for the delegation of the charging process of the battery and the engagement to plug the vehicle when possible. Some users expect a higher reward than others for this engagement. The Net-Present-Value will represent this reward. The higher the reward, the more clients will buy V2G option.

We consider users have a discount rate r_u different from the discount rate of aggregator and manufacturer (as in previous Chapter, we consider a discount rate of 8% for them, which is in a usual range in finance literature, see for instance (Roques et al., 2006)).

There is a large literature on the estimation of individual discount rates (Hausman, 1979), (Coller and Williams, 1999), (Harrison et al., 2002), (Harrison et al., 2010) through experimental economy. This literature tends to find discount rates higher than market interest rates, with a large range. In the smart-charging literature, there have been two attempts to identify discount rate of individuals: (Parsons et al., 2014) found discount rates ranging from 41% to 56% and (Geske and Schumann, 2018) from 11% to 21%, both using discrete choices experiments. Given novelty of electric vehicles and even more of V2G technology, these high discount rates are not surprising and in line with

other references in the domain of electric vehicles (Aksen et al., 2009; Horne et al., 2005; Mau et al., 2008).

We will take in the following of the chapter r_u equals to 12%, which is in the lower range of results found in the literature but larger than discount rate of manufacturer and aggregator. It means that present-value for users of being paid annual fees will be lower than present-value for aggregator to pay these annual fees.

$$NPV_{user} = \max(0, s_u * F - P) \tag{4.1}$$

$$s_u = \sum_{t=1}^T \frac{1}{(1 + r_u)^t} \tag{4.2}$$

$$D(P, F) = (a * NPV_{user}(P, F))^2 \tag{4.3}$$

The parameter a in Equation 4.3 reflects the intensity of demand. The higher this parameter, the more users will buy V2G function for a certain NPV. As we do not have any information on this intensity of demand, we will look at the different results in function of this parameter. Figure 4.1 shows evolution of demand for V2G technology in function of user NPV for different levels of demand intensity. For a NPV of 300€, there would be only 900 users implementing the function for $a = 0.1$ while there would be 90,000 for $a = 1$.

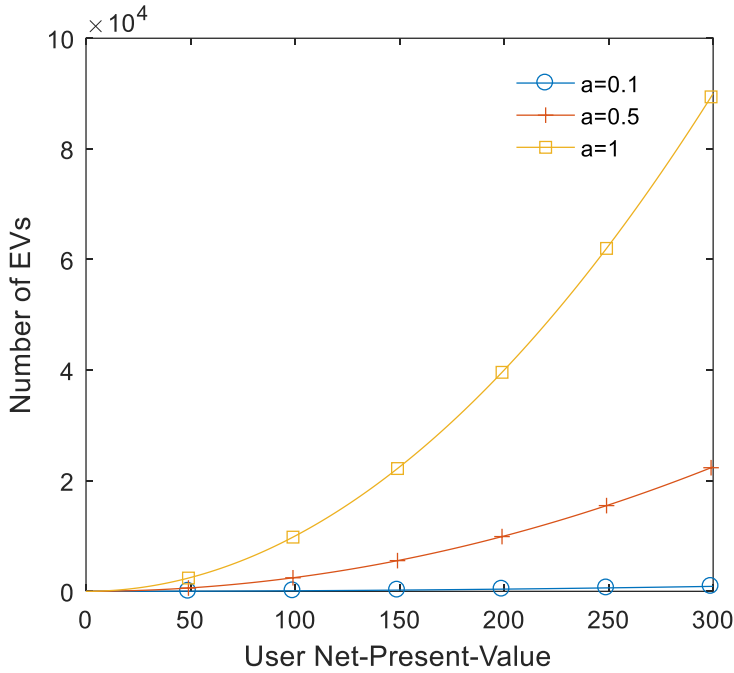

Figure 4.1 Demand for V2G in function of User's NPV

It is possible to calculate elasticity of demand to Net-Present-Value, as in Equation 4.4. This elasticity is equals to 2, whatever the user's NPV. It means if user's NPV increases by 10%, the demand for V2G function will increase by 20%.

$$\varepsilon = \frac{dD}{dNPV_u} * \frac{NPV_u}{D} = 2 \tag{4.4}$$

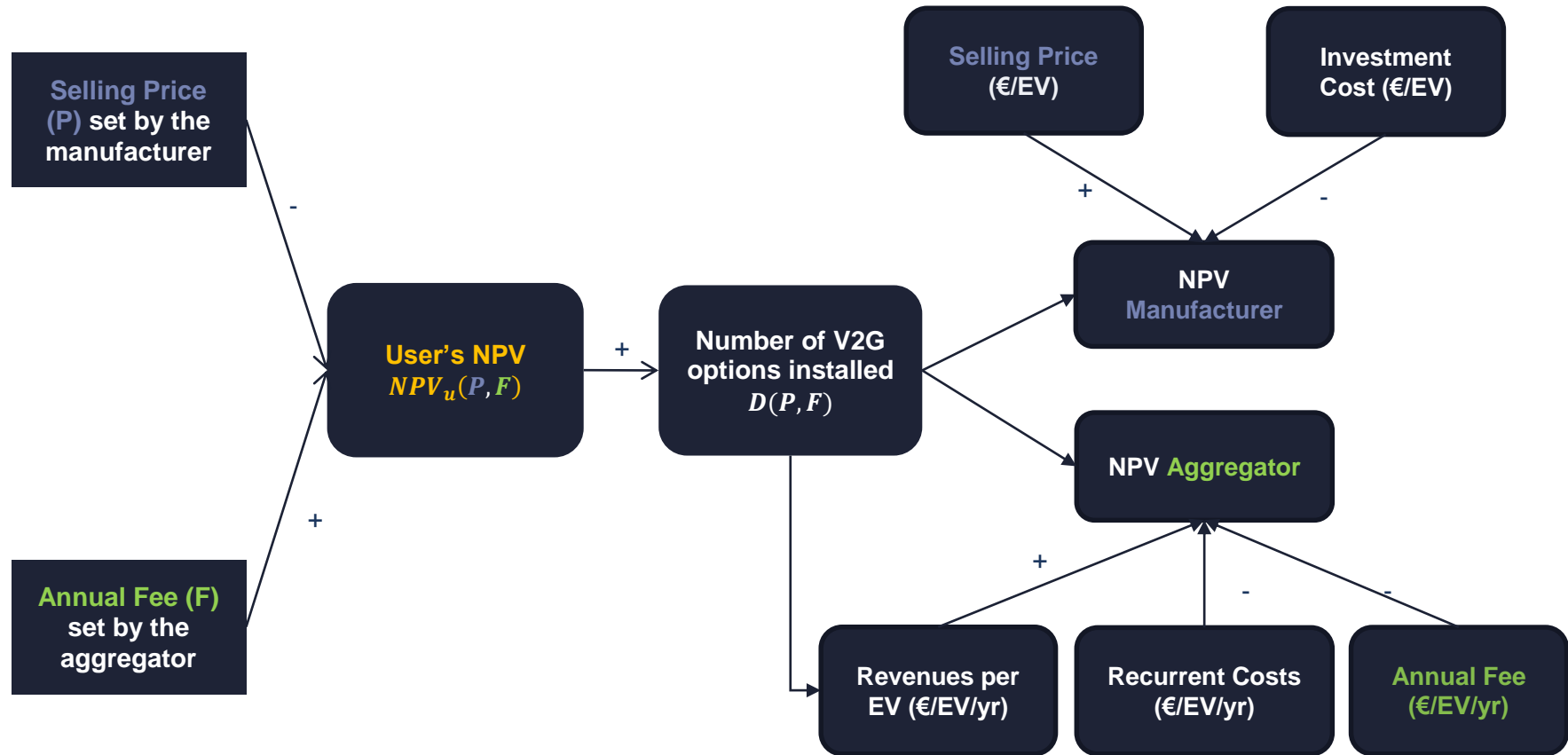

Figure 4.2 Model for calculation of manufacturer and aggregator NPVs

2.2 Calculation of Net Present Value of Car Manufacturer and Aggregator

With the behavior of the different actors we described above, we can now calculate NPV of the manufacturer and the aggregator.

The selling price of the option P fixed by the manufacturer and the annual fee F fixed by the aggregator will determine the number of vehicles equipped with V2G function, as explained before. As the manufacturer does not have any recurrent costs to bear, its Net Present Value is simply the margin on the sale of the option multiplied by the number of vehicles equipped with V2G. NPV calculation for the manufacturer is described in Equation 4.5.

$$NPV_{Man}(P, F) = \max (D(P, F) * (P - I), 0) \quad 4.5$$

As manufacturer shall have a positive margin, he should fix his selling price higher than investment costs. NPV can be expressed as in Equation 4.6.

$$NPV_{Man}(P, F) = \begin{cases} 0, & P < I \\ (a * NPV_{user}(P, F))^2 * (P - I), & P \geq I \end{cases} \quad 4.6$$

Moreover, as there is no demand if user's NPV is null, manufacturer should not set selling price at a level which would not ensure profitability for users. We can then adapt formula as in Equation 4.7.

$$NPV_{Man}(P, F) = \begin{cases} 0, & P < I \text{ or } P > s_u * F \\ (a * NPV_{user}(P, F))^2 * (P - I), & \text{otherwise} \end{cases} \quad 4.7$$

Figure 4.3 shows the evolution of NPV of the manufacturer in function of P for different values of F (we take $a = 0.5$, $I = 300 \text{ €/EV}$) and Figure 4.4 for different values of a (with F equal to 100 €/EV/year). Manufacturer NPV increases when the annual fee or the intensity of demand increases as demand for V2G increases in both cases. Moreover, we can see manufacturer can increase his margin on the sell of the V2G option when F increases.

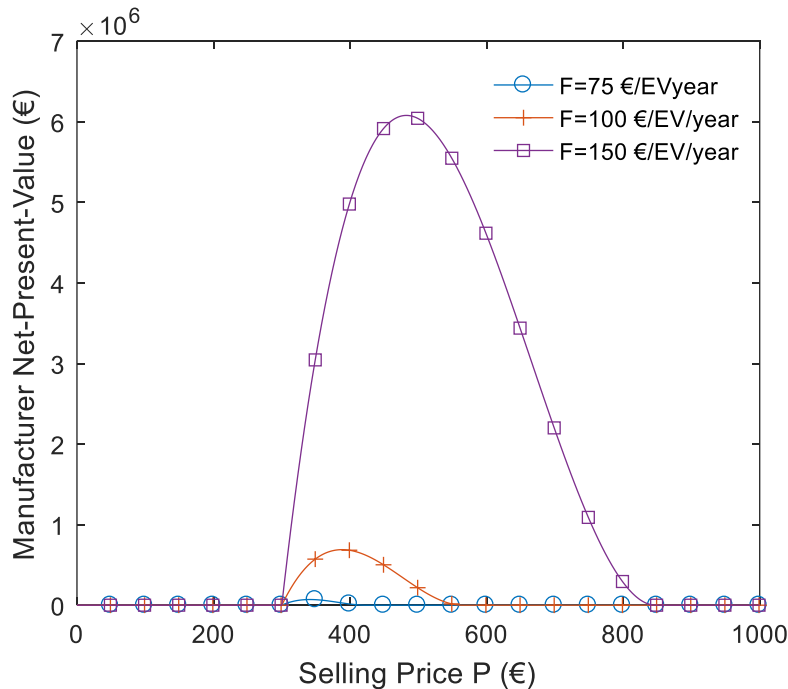

Figure 4.3 Manufacturer NPV in function of selling price P for different value of annual fee F

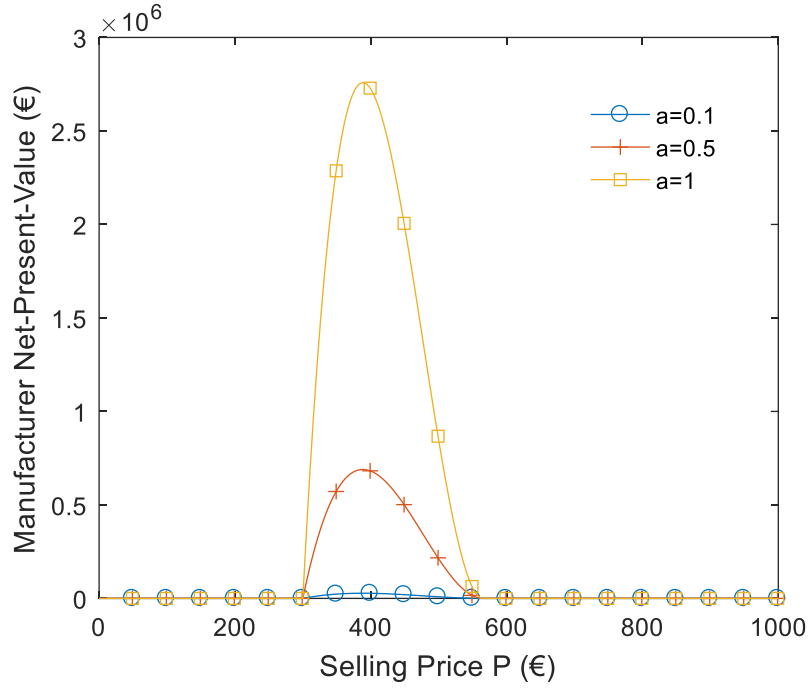

Figure 4.4 Manufacturer NPV in function of selling price P for different value of demand intensity a

We can now find the Net Present Value of the aggregator. NPV of the aggregator can be expressed as in Equation 4.8-4.10, where s is calculated as in Equation 4.11 and r_{EV} represents the annual revenue per EV, which can be calculated based on model presented in previous chapter. We have seen this annual revenue would depend on market-design, price of reserve, availability of EVs and number of EVs in the fleet. It is not a monotonic function of the number of EVs, due to threshold of volumes and maximum amount of reserve that can be provided (150 MW).

Figure 4.5 shows the evolution of aggregator NPV with the annual fee for different values of selling price, Figure 4.6 for different values of demand intensity and Figure 4.7 for different market-design. We take annual recurrent costs c of 150 €/EV and the EVSE-2 scenario (3 kW plug at home and 7 kW plug at work).

Maximum aggregator NPV increases when price decreases, when demand intensity increases and when temporal granularity increases. When selling price increases, the aggregator should increase his annual fee in order to maintain demand. He will however loose margin and its revenues will decrease. When demand intensity increases, the aggregator can decrease his margin to increase demand, which will allow increasing his NPV.

$$r_{EV}(D(P, F)) = r_{EV}(P, F) \quad 4.8$$

$$NPV_{Agg}(P, F) = \max [D(P, F) * [s * (r_{EV}(P, F) - c - F), 0]] \quad 4.9$$

$$NPV_{Agg}(P, F) = \begin{cases} 0, & s_u F < P \text{ or } F > r_{EV}(D) - c \\ D(P, F) * [s * (r_{EV}(P, F) - c - F)], & \text{otherwise} \end{cases} \quad 4.10$$

$$s = \sum_{t=1}^T \frac{1}{(1+r)^t} \quad 4.11$$

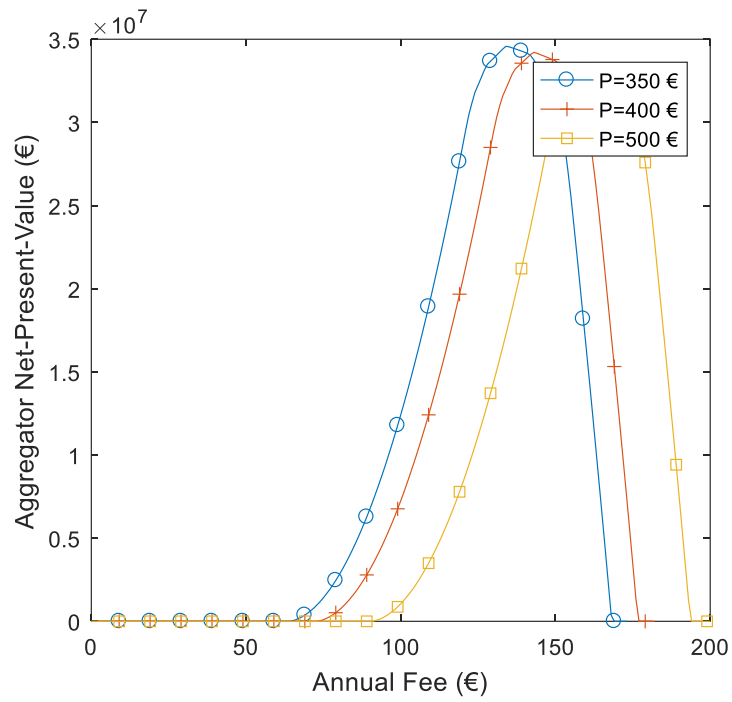

Figure 4.5 Aggregator NPV in function of annual fee for different value of selling price P

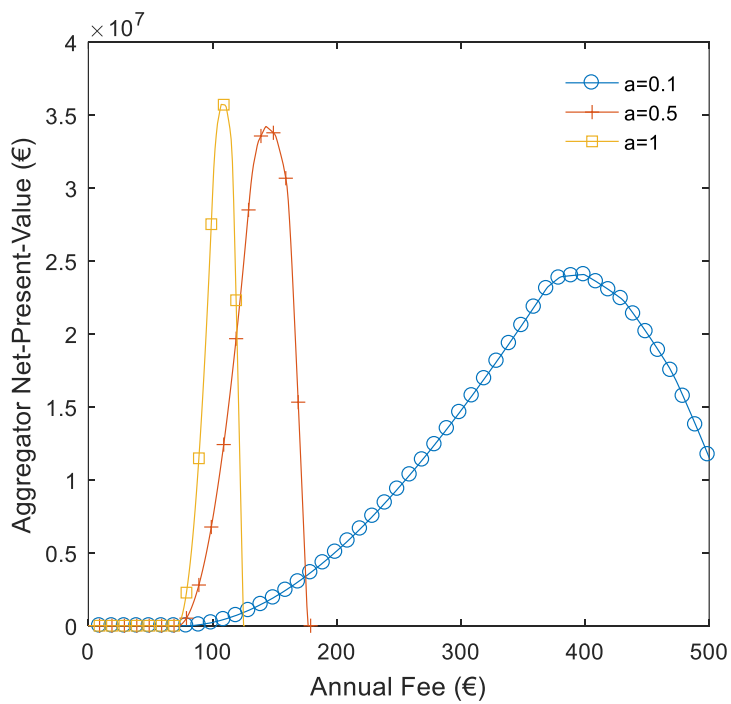

Figure 4.6 Aggregator NPV in function of annual fee for different value of demand intensity a

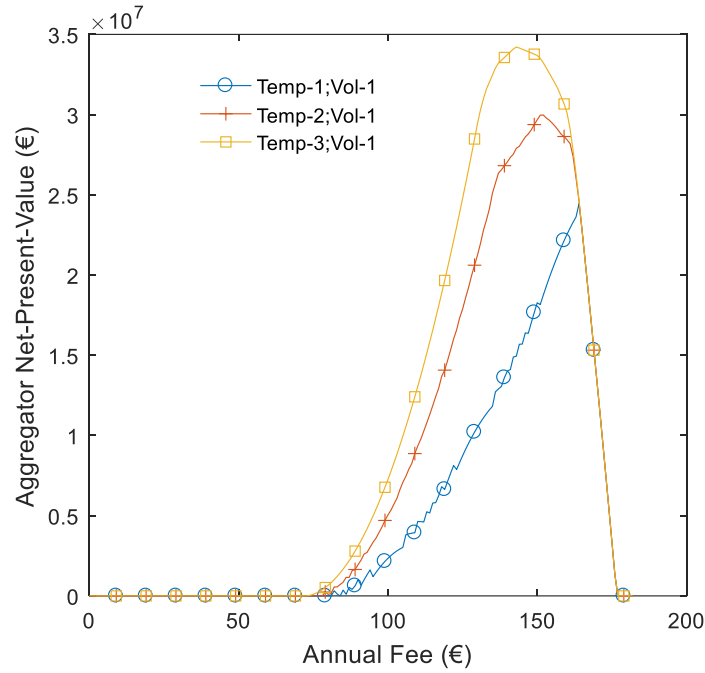

Figure 4.7 Aggregator NPV in function of annual fee for different market designs

Finally, if for a certain couple $\{P, F\}$, one of the actor has a null Net-Present-Value, he will not invest in the technology, meaning the other actor will also have a null NPV (Equation 4.12-4.13)

$$NPV_{Agg}(P, F) = \begin{cases} 0, & NPV_{Man} = 0 \\ NPV_{Agg}(P, F), & otherwise \end{cases} \quad 4.12$$

$$NPV_{Man}(P, F) = \begin{cases} 0, & NPV_{Agg} = 0 \\ NPV_{Man}(P, F), & otherwise \end{cases} \quad 4.13$$

We can see interdependences that can exist between choices of the aggregator and those of the manufacturer. If the manufacturer changes the selling price of the V2G options, it will affect the number of EVs equipped, which will change the revenue per EV of the aggregator, which might react by changing its offer and vice-versa. Figure 4.2 shows a graphical representation of the calculation of NPVs.

2.3 Presentation of Case-Studies

Based on the equations presented before, we want now to study value of a cooperation between manufacturer and aggregator using game theory. Game theory has been widely studied to understand interaction between different actors in a system and how they will share value (Wolters and Schuller, 1997)(Jia and Yokoyama, 2003)(Dabbagh and Sheikh-El-Eslami, 2015).

The behavior of the car manufacturer and the aggregator can be modeled in game theory as a strategic, non-zero-sum game (Muthoo et al., 1996). The players are the manufacturer and the aggregator. The set of actions are defined by the vector of possible selling price \bar{P} and annual fee \bar{F} ¹³. The payoff matrix is the matrix of NPV of car manufacturer and aggregator considering every possible strategies, computed as explained in the previous section. Moreover, we make the

¹³ We consider car manufacturer and aggregator can fix value of P and F with a granularity of 0.01 €. As \bar{P} and \bar{F} are bounded, the game can also be described as finite.

hypothesis players know payoff matrix of the other, meaning aggregator knows investment costs, car manufacturer knows recurrent costs and both actors know demand function.

We will derive three case studies to study this cooperation. Case study 1 (CS1) is a non-cooperative situation. In this situation, we will find the Nash equilibrium of the game. Case study 2 (CS2) is a cooperative situation without financial exchanges. Finally, Case study 3 (CS3) is a cooperative situation with financial exchanges.

We will compare these cases with two baseline reference cases: in the first reference, only one actor cumulates both function of manufacturer (R1), which will try to maximize his gains; in second reference, there are two actors, who only require having a positive NPV (R2) and try to maximize the sum of their gains.

2.3.1 Reference 1

In this first Reference, we study how an integrated actor, cumulating role of manufacturer and aggregator, would fix selling price and annual fee. This is done by solving optimization problem described in Equation 4.14 and 4.15.

$$\max_{P,F} D(P, F) * [P - I + s * (r_{EV}(P, F) - F - c)] \quad 4.14$$

$$\text{subject to } \begin{cases} P \geq 0 \\ F \geq 0 \end{cases} \quad 4.15$$

2.3.2 Reference 2

In this second Reference, we study how two actors would fix selling price and annual fee, under the constraint that they have a positive NPV. The optimization problem is described in Equation 4.16 and 4.17.

$$\max_{P,F} NPV_{Man}(P, F) + NPV_{Agg}(P, F) \quad 4.16$$

$$\text{subject to } \begin{cases} NPV_{Man}(P, F) > 0 \\ NPV_{Agg}(P, F) > 0 \end{cases} \quad 4.17$$

2.3.3 Case Study 1: Non-Cooperative Situation

We want first to evaluate gains of both actors in a non-cooperative game. We will find Nash-equilibrium considering each actor have perfect information on the intensity of demand. In the Nash equilibrium, no player can increase his payoff by changing its strategy (Muthoo et al., 1996): increasing or decreasing the selling price for the manufacturer or the annual fee for the aggregator. It is therefore a steady-state situation where players have no interest in changing their strategy unilaterally.

We can see in Figure 4.3 that there is a value of P optimizing manufacturer NPV. We will call this value P^* . We can obtain optimal price by finding where derivative of Equation 4.7 is null between I and $s * F$. This value will depend on F but not on a .

$$\frac{\partial NPV_{Man}}{\partial P} = a^2 * (s_u F - P) * (s_u * F + I - 3 * P) \quad 4.18$$

$$\frac{\partial NPV_{Man}}{\partial P}(P^*) = 0 \quad 4.19$$

$$P^*(F) = \frac{s_u * F + 2 * I}{3} \quad 4.20$$

This strategy is valid only if couple $\{P^*, F\}$ allows the aggregator to have a positive Net-Present-Value, meaning that annual revenues per EV $r_{EV}(P^*, F)$ should be strictly greater than $(c + F)$.

Otherwise, manufacturer will fix the selling price $P^*(F)$ to maximize his Net-Present-Value with the constraint that the aggregator should have positive Net-Present-Value (Equations 4.21 and 4.22)

$$\max_P NPV_{man}(P, F) \quad 4.21$$

$$\text{subject to } r_{EV}(P, F) - c - F > 0 \quad 4.22$$

We make the hypothesis in this case-study that the aggregator knows the behavior of the manufacturer and can thus anticipate which will be the price he will set for a certain annual fee. We can thus adapt Equation 4.23 in Equation 4.24.

The aggregator will then fix the annual fee F^* in order to maximize its NPV. Revenue per EV being the results of simulations, it is not possible to find an analytical form of F^* .

$$\begin{cases} D^*(F) = D[P^*(F), F] \\ NPV_{Agg}^*(F) = \max [D^*(F) * [s * (r_{EV}(P^*, F) - c - F)], 0] \end{cases} \quad 4.23$$

$$NPV_{Agg}^*(F^*) = \max_F NPV_{Agg}(F) \quad 4.24$$

We can solve the problem of non-cooperative situation by solving Equation 4.24, which will give us the optimal annual fee for the aggregator, and then by solving Equation 4.20 with $F = F^*$, which will give us the optimal selling price of the V2G option for the manufacturer (Equation 4.25). Net Present Value of both actors are given in Equation 4.26 and 4.27.

In this situation, manufacturer cannot increase his gains by changing selling price nor the aggregator by changing annual fee. Increasing gains, if possible, would necessitate a coordinated action from both manufacturer and aggregator, which would require a certain level of cooperation. This position is an equilibrium action as no actor can act unilaterally to increase his gains.

Moreover, the gains find in this non-cooperative situation are the minimum gains the actors will accept in a cooperative situation. Indeed, they would not accept to cooperate if it comes with a loss of gains. These values are the reservation gains for both actor in a cooperative game.

$$\begin{aligned} F^{CS1} &= F^* \\ P^{CS1} &= P^* \end{aligned} \quad 4.25$$

$$NPV_{Agg}^{CS1} = NPV_{Agg}^*(F^*) \quad 4.26$$

$$NPV_{Man}^{CS1} = NPV_{Man}(P^*, F^*) \quad 4.27$$

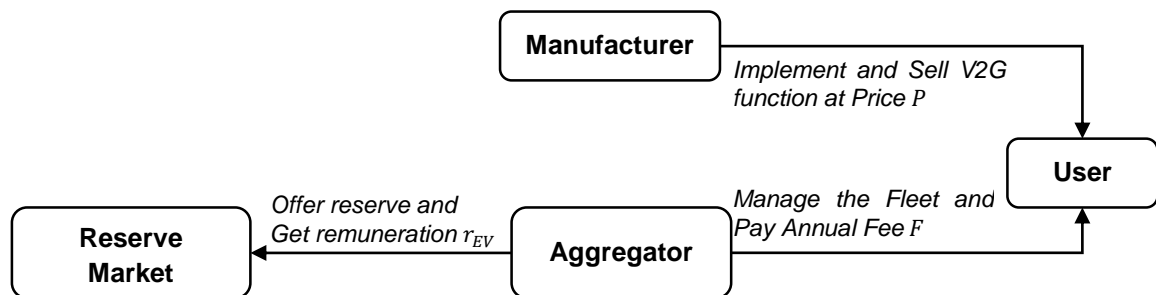

Figure 4.8 Relations between actors in Case-Study 1

2.3.4 Case-study 2: Cooperative Situation without Financial Exchange

In a cooperative situation, aggregator and manufacturer will try to set selling price and annual fee together, in order to maximize the total value of the V2G function. It means clients would buy at the same time the V2G function and the energy services with the aggregator.

As explained earlier, it is possible to create this cooperation only if both actors are beneficiary. The objective is to find the optimal sum of NPVs given the constraints that individual NPVs should be higher than non-cooperative NPVs. This problem is presented in Equations 4.28 to 4.29

$$\max_{P,F} \quad NPV_{Man}(P, F) + NPV_{Agg}(P, F) \tag{4.28}$$

$$\text{subject to } \begin{cases} NPV_{Man}(P, F) \geq NPV_{Man}^{CS1} \\ NPV_{Agg}(P, F) \geq NPV_{Agg}^{CS1} \end{cases} \tag{4.29}$$

Net-Present-Values of the manufacturer and the aggregator are noted NPV_{Man}^{CS2} and NPV_{Agg}^{CS2} . This position is not an equilibrium position, contrary to Case-Study 1. It means that if one of the actor decides to change unilaterally either selling price (for the manufacturer) or annual fee (for the aggregator) he could increase his gains to the detriment of the other. This would bring back naturally to the situation of equilibrium found in Case-Study 1. Cooperation should therefore be framed by a contractual arrangement, even if there is no financial exchanges between both actors, to avoid unilateral changes of behavior.

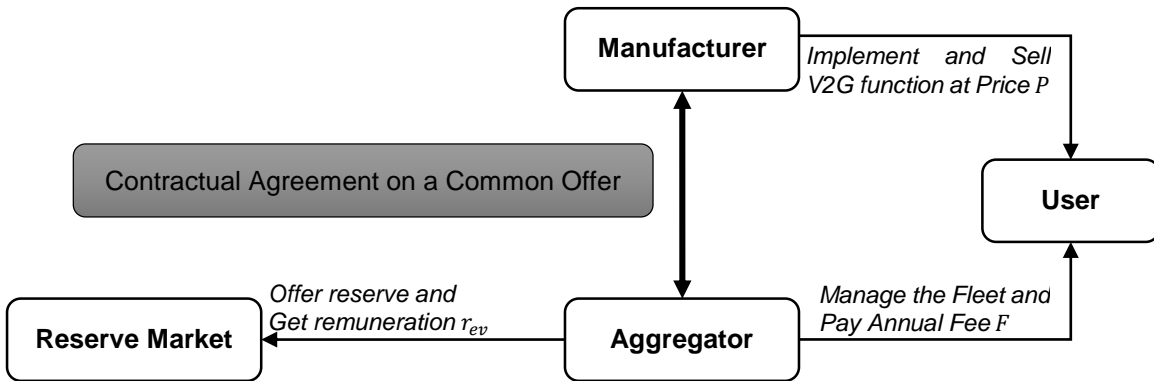

Figure 4.9 Relations between actors in Case-Study 2

2.3.5 Case-Study 3: Cooperative Situation with Financial Exchanges

In this Case-Study, the frame is the same than for Case-Study 2: manufacturer and aggregator will cooperate to elaborate a common offer that can maximize value of V2G for both actors. However, this cooperation includes the possibility for manufacturer to be remunerated by reserve market participation, through the aggregator.

This remuneration will take the form of a fixed annual fee F_m paid by the aggregator to the manufacturer, which will depend on the number of EVs equipped with V2G sold by the aggregator. In this situation, NPVs of aggregator and manufacturer are calculated as in Equations 4.30 and 4.31. This will allow the manufacturer to reduce his selling price and to increase demand. Optimization problem is given with Equations 4.32 and 4.33. NPVs of aggregator and manufacturer in this situation should be higher than in Case-Study 2. Otherwise, stakeholders will not accept cooperation.

$$NPV_{Man}(P, F, F_m) = \max [D(P, F) * (P - I + sF_m), 0] \tag{4.30}$$

$$NPV_{Agg}(P, F, F_m) = \max [D(P, F) * [s * (r_{EV}(D) - c - F - F_m), 0]] \quad 4.31$$

$$\max_{P, F, F_m} NPV_{Man}(P, F, F_m) + NPV_{Agg}(P, F, F_m) \quad 4.32$$

$$\text{subject to } \begin{cases} NPV_{Man}(P, F, F_m) \geq NPV_{Man}^{CS2} \\ NPV_{Agg}(P, F, F_m) \geq NPV_{Agg}^{CS2} \end{cases} \quad 4.33$$

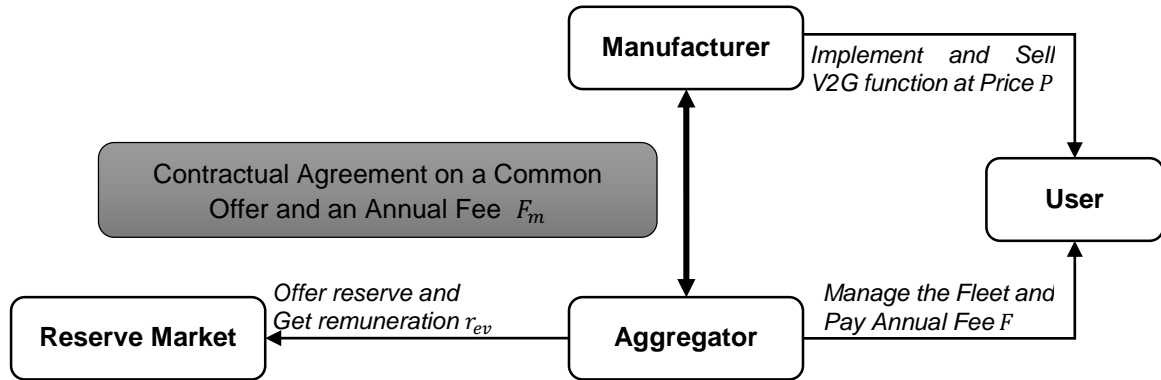

Figure 4.10 Relations between actors in Case-Study 3

3 RESULTS

We will now look at the different results for each Case Study presented in previous section. As explained before, the intensity of demand, characterized by parameter a is exogenous for the aggregator and the manufacturer. We will look at the different results in function of this parameter.

For other input parameters of the model, we take values shown in Table 4.1. We consider target market-design in FCR Cooperation for temporal and volume granularities. In order to maintain reasonable complexity, we do not include economies of scale in this model.

Table 4.1 Parameters used in the framework

Investment Costs	300 €/EV
Recurrent Costs	150 €/EV/year
Power at Home	3 kW
Power at Work	7 kW
Duration of Products	4 hours
Minimum Bid	1 MW
Bid Increment	1 MW
Price of Reserve	12 €/MW/h

3.1 Smoothing of Revenues Function

We have seen in previous chapter that, due to high bid increments, the function of revenue per EV r_{EV} is not monotonously increasing with size of the fleet. This creates threshold effect, which will have a repercussion in the calculation of Net-Present-Values in the different Case Studies.

However, to have robust results, we should try to remove these thresholds effects. Indeed, the exact location of the threshold might be dependent on availability of the fleet, trip patterns etc. We will try to smooth the revenue function, taking a lower envelop of the function to be conservative in our results.

Figure 4.11 shows the initial revenue per EV function and the smoothed function for market-design considered in Table 4.1 for size of fleet below 14,000 EVs and Figure 4.12 shows the smoothed function for size of fleet up to 100,000 EVs .

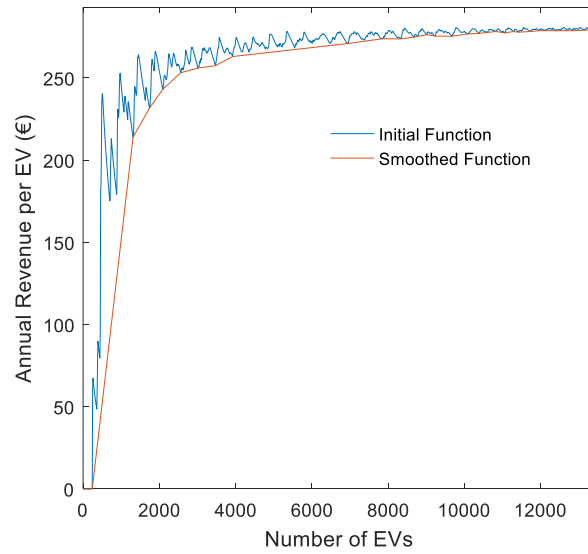

Figure 4.11 Initial Revenue function and Smoothed Function

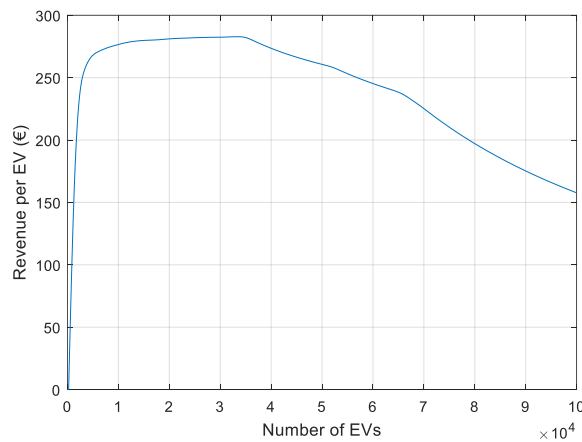

Figure 4.12 Smoothed Revenue function

3.2 Case-Study 1

We will now study results for Case-Study 1. Figure 4.13 shows the evolution of NPV of both aggregator and manufacturer with Parameter a , as well as NPVs for Reference 1 and Reference 2.

We can first observe that it is not possible to reach NPV of Reference 2 for this Case, whatever the intensity of demand. We can also see that above a certain level of intensity of demand ($a \approx 0.88$), manufacturer NPV are decreasing, which is counterintuitive.

The gains are not evenly distributed and the distribution depends on the intensity of demand. For high intensity of demand, the aggregator captures most of the value. His share decreases when intensity decreases. Figure 4.14 shows the share of value captured by each actor.

Below a certain value of intensity ($a \approx 0.27$), the total value decreases suddenly and becomes almost null. Moreover, the NPV for Reference 1 becomes null below $a \approx 0.19$.

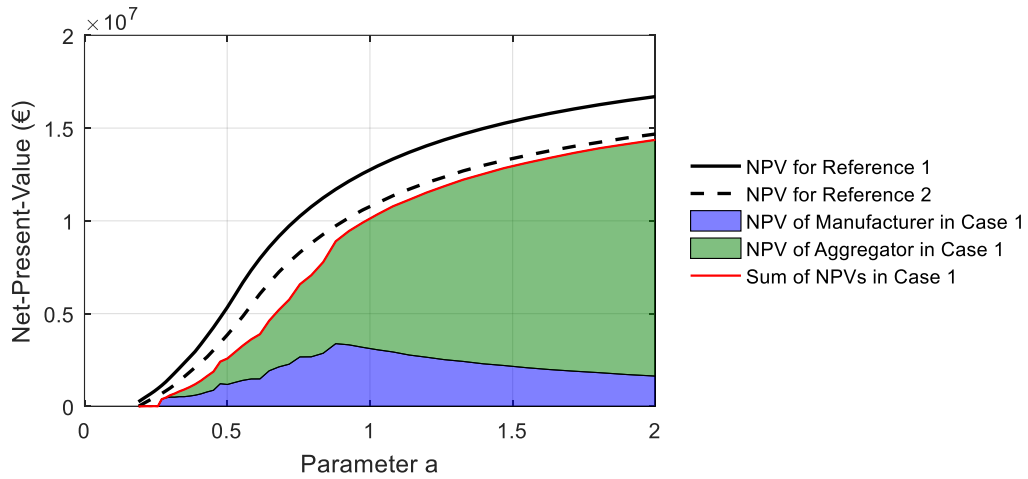

Figure 4.13 Sum of NPVs in Case-Study 1

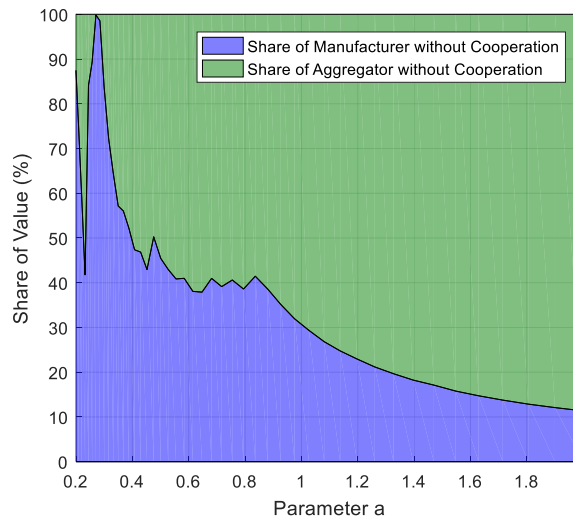

Figure 4.14 Share of Total Value for Aggregator and Manufacturer

We will now look at the corresponding selling price and annual fee fixed by the aggregator and the manufacturer. They are shown in Figure 4.15.

We can identify regimes in function of the intensity of demand, which are corresponding to the different regimes identified for Net Present Values. Above $a \approx 0.27$, selling price is the reflection of annual fee, which corresponds to Equation 4.20. For $a \leq 0.88$, annual fee and selling price of the option are roughly constant. Little variations can be seen. They are consequences of little variations observed in the smoothed function. Above this level, annual fee and selling price decrease.

For low intensity of demand, selling price is not anymore set by the manufacturer according to Equation 4.20, as this would not allow aggregator to have a positive NPV. The manufacturer reduces his margin in order to attract more clients, which allows the manufacturer to enter the market. The lower the intensity below this threshold, the higher the fee to attract more clients. This explains the sudden fall of sum of NPVs below this threshold.

Finally, we can look at the number of V2G options sold, which is shown in Figure 4.16. We find again the different regimes presented before. The number of V2G options is decreasing between $a \approx 0.19$ and $a \approx 0.27$, increases rapidly until reaching $a \approx 0.88$ and increases slowly after. As manufacturer's margin decreases in this regime, this explains the decrease of his Net-Present Value after this value. Demand stays below 35,000 EVs, which is the size of fleet where revenue per EV starts decreasing.

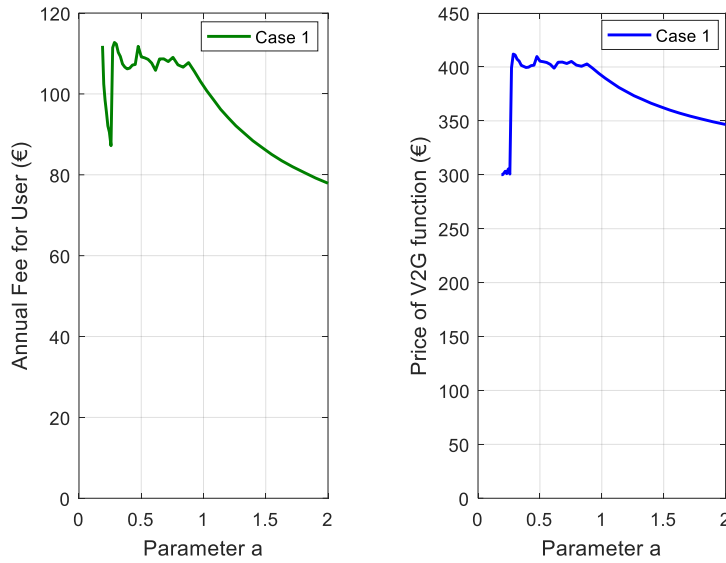

Figure 4.15 Annual Fee and Selling Price of the V2G function in Case-Study 1

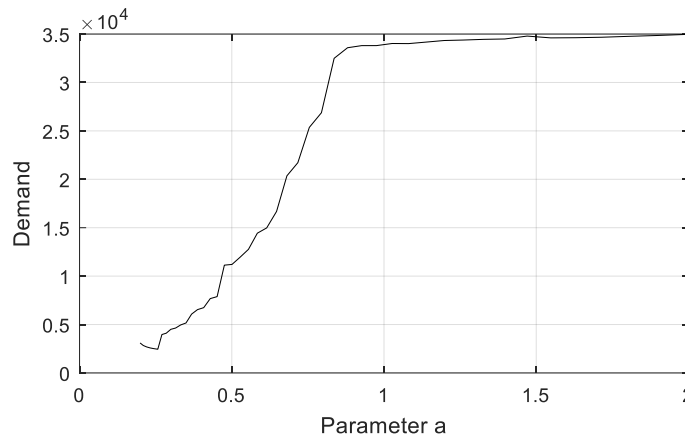

Figure 4.16 Demand for V2G function in Case-Study 1

3.3 Case-Study 2

Let us now look at the results of the model for Case-Study 2, where manufacturer and aggregator will cooperate to have a common offer, which will maximize the sum of NPVs for both actors.

Figure 4.17 shows the sum of NPVs in function of demand intensity (red dashed curve) with the different results of Case-Study 1. We observe cooperation allows increasing sum of NPVs for the first two regime identified before ($a \leq 0.88$) but has no impact for higher intensity of demand. For $a \leq 0.6$, it is even possible to reach Theoretical Maximum NPV with cooperation.

In Figure 4.18, we can see how this value is shared between both actors. We can clearly see that the aggregator captures most of the value of cooperation.

Figure 4.19 presents the selling price and annual fee for this case and Figure 4.20 demand for V2G function. We can see the different regimes found before: for $a \leq 0.6$, selling price and annual fee are constant. Selling price is reduced by about 50 € compare to Case 1 and annual fee is increased by about 10 €, which allows increasing demand for V2G option. For $a \geq 0.6$, selling price increases and buy price decreases with demand intensity. Demand is constant, at 35,000 users, the maximum level of demand found before.

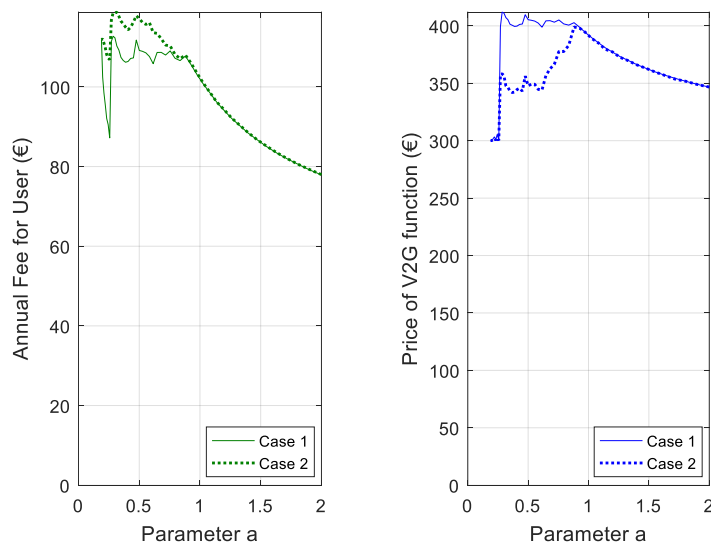
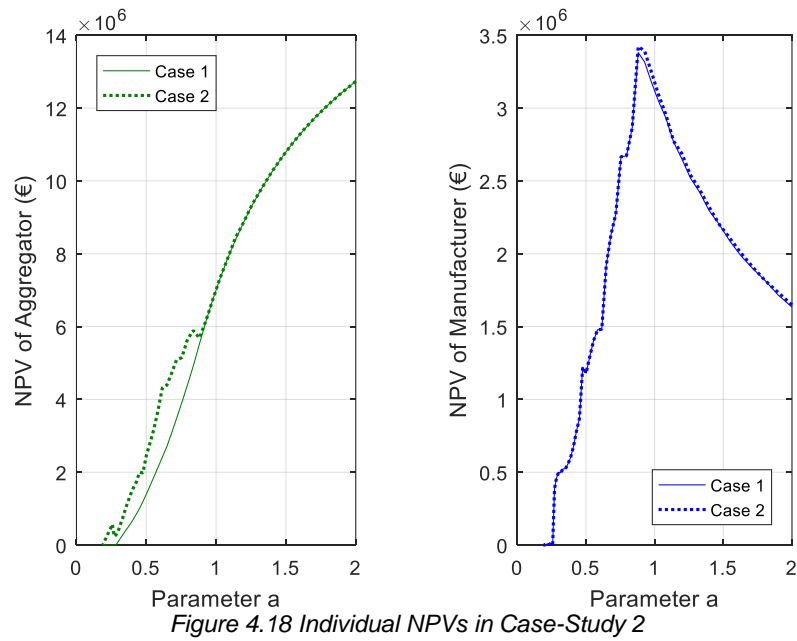
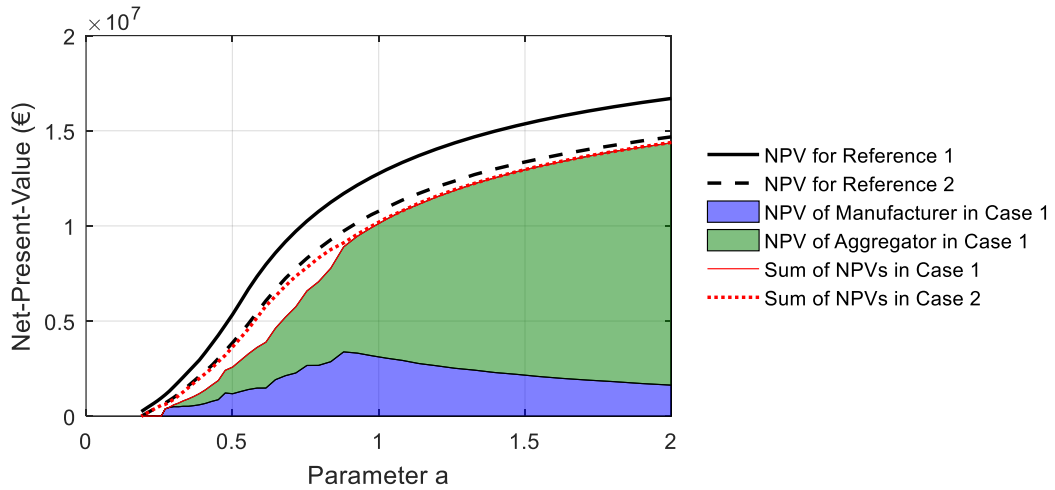

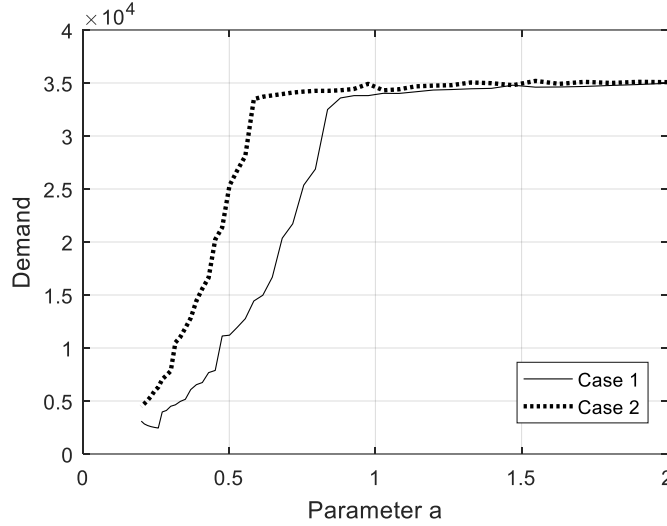

Figure 4.20 Demand for V2G function in Case-Study 2

3.4 Case-Study 2bis: Introduction of bargaining power of the Manufacturer

We can question the viability of this cooperation, as the manufacturer does not benefit from it. He might indeed negotiate with the aggregator in order to fix a selling price and a fee that would allow him getting part of the value of the cooperation. We have to adapt Equation 4.28 to model this negotiation.

The new optimization problem is described in Equation 4.34 and 4.35 (Binmore et al., 1986). The parameter π represents the bargaining power of the manufacturer. The higher the bargaining power, the more weight will be attributed to the benefits of the manufacturer from the cooperation. For $\pi = 0$, the manufacturer has no bargaining power and the solution of the optimization will be to maximize benefits of the aggregator under the constraint that the manufacturer does not loss benefit, and vice-versa for $\pi = 1$. For $\pi = 0.5$, value of cooperation will be shared equally between both actors.

Figure 4.21 is showing NPVs of both actors for a bargaining power of 0.5 and Figure 4.22 the corresponding selling price and annual fee. We can observe that bargaining power of the manufacturer will indeed allow him to increase his benefits from cooperation. This is possible by increasing margin of the manufacturer and increasing annual fee. This has no consequence on the demand for V2G option as shown in Figure 4.23.

However, it should be noted that this bargain is done at the expense of a loss of the total benefits of the cooperation, which is shown in Figure 4.24. The higher the bargaining power of the manufacturer, the higher the loss of total NPV.

$$\max_{P,F} [NPV_{Man}(P, F) - NPV_{Man}^{CS1}]^\pi * [NPV_{Agg}(P, F) - NPV_{Agg}^{CS1}]^{(1-\pi)} \quad 4.34$$

$$\text{subject to } \begin{cases} NPV_{Man}(P, F) \geq NPV_{Man}^{CS1} \\ NPV_{Agg}(P, F) \geq NPV_{Agg}^{CS1} \end{cases} \quad 4.35$$

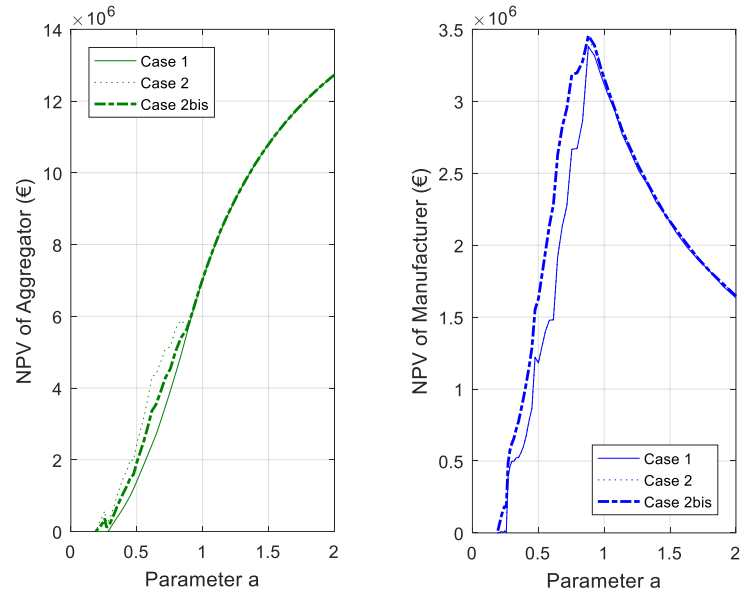

Figure 4.21 Individual Net-Present-Value in Case-Study 2bis

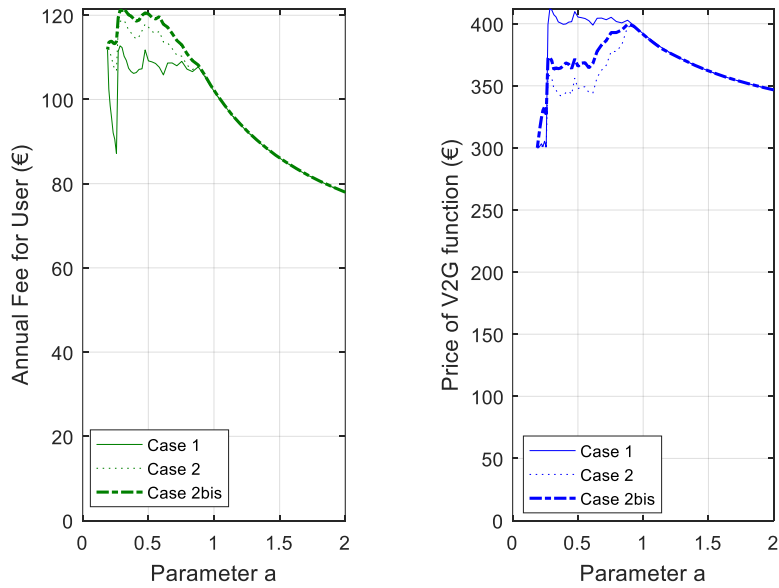

Figure 4.22 Annual Fee and Selling Price in Case-Study 2bis

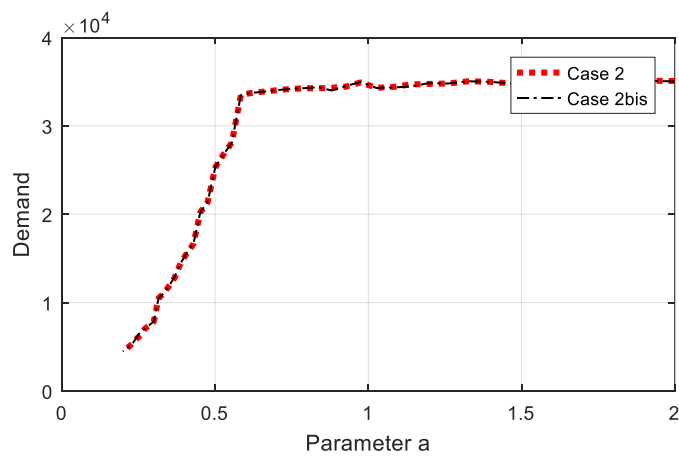

Figure 4.23 Demand for V2G function in Case-Study 2bis

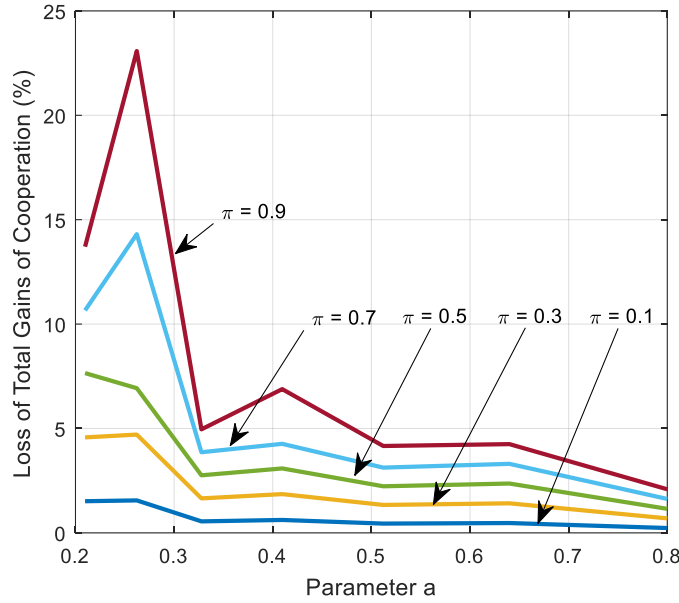

Figure 4.24 Loss of Gain in Case-Study 2bis compared to Case-Study 2 for different values of π

3.5 Case-Study 3

Finally, we can analyze results of Case-Study 3. To be coherent with Case 2bis presented before, we adapt Equation 4.32 to take into account bargaining power of the manufacturer. New optimization problem is presented in Equations 4.36 and 4.37 and sum of NPVs of both actors is presented in Figure 4.25, with $\pi = 0.5$.

This cooperation allows actors to reach NPV in Reference 1 (integration of different roles in one actors). It represents a large increase of NPV compared to “simple” cooperation without financial exchanges (up to 2,600 k€ on the ten years of life of the asset). With $\pi = 0.5$, benefits of cooperation are equally distributed between the manufacturer and the aggregator.

Figure 4.27 shows annual fee for users, selling price of V2G option and annual fee for manufacturer. The increase of value of the cooperation is obtained by lowering selling price, which becomes almost null. Manufacturer gets remuneration only from the aggregator, who can reduce the annual fee to users. This allows increasing demand for V2G technology.

Figure 4.29 is showing NPVs of each actor for different bargaining power of the manufacturer and the corresponding annual fee for user, selling price of the V2G option and annual fee for manufacturer. The higher the bargaining power, the higher the annual fee for manufacturer and his NPV. However, annual fee for user and price of the V2G function stay constant with the bargaining power. Bargaining power will just affect the share of value each actor will get, but not the total value of the cooperation.

$$\max_{P, F, F_m} [NPV_{Man}(P, F, F_m) - NPV_{Man}^{CS1}]^\pi * [NPV_{Agg}(P, F, F_m) - NPV_{Agg}^{CS1}]^{(1-\pi)} \quad 4.36$$

$$\text{subject to } \begin{cases} NPV_{Man}(P, F) \geq NPV_{Man}^{CS2} \\ NPV_{Agg}(P, F) \geq NPV_{Agg}^{CS2} \end{cases} \quad 4.37$$

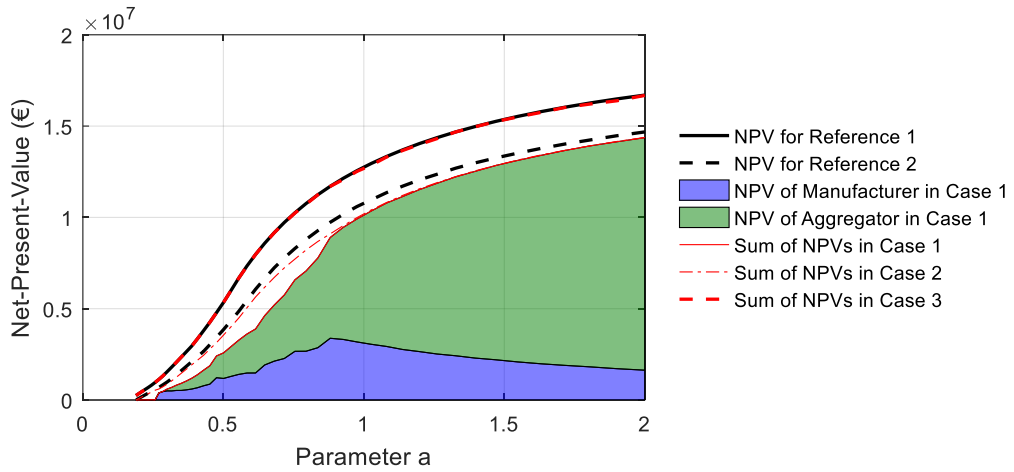

Figure 4.25 Sum of NPVs in Case Study 3

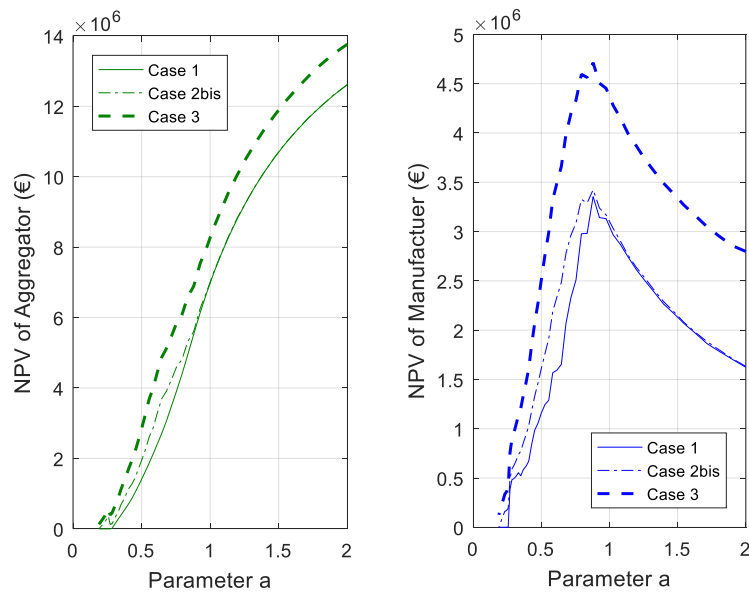

Figure 4.26 Individual NPVs in Case Study 3

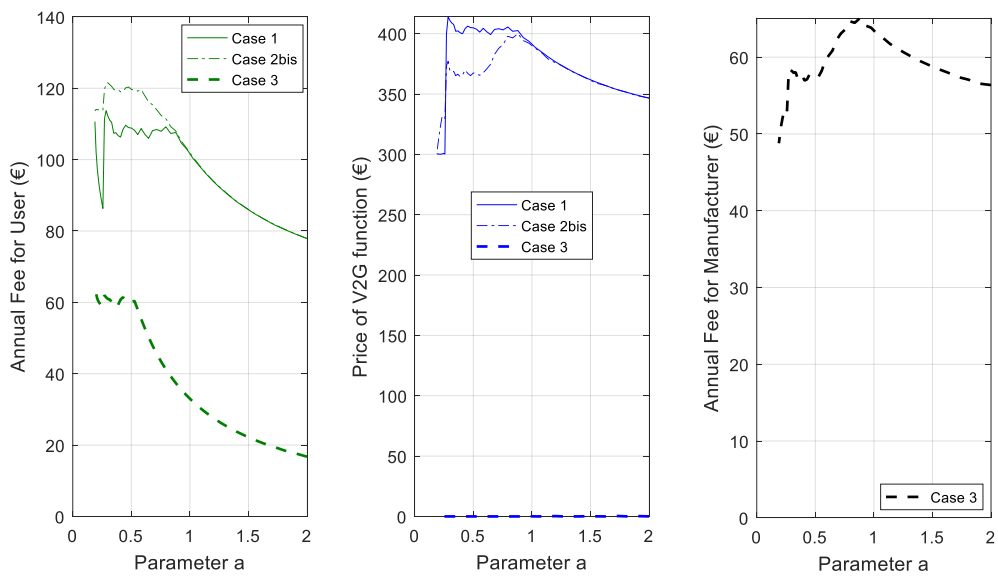

Figure 4.27 Annual Fee, Selling Price and Manufacturer Fee in Case-Study 3

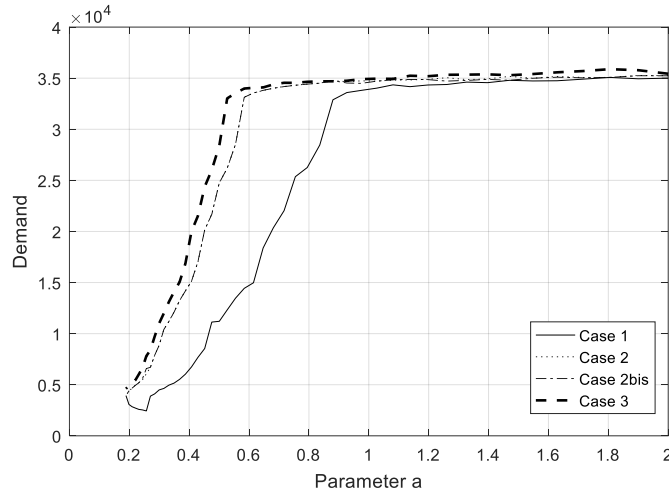

Figure 4.28 Demand for V2G function in Case-Study 3

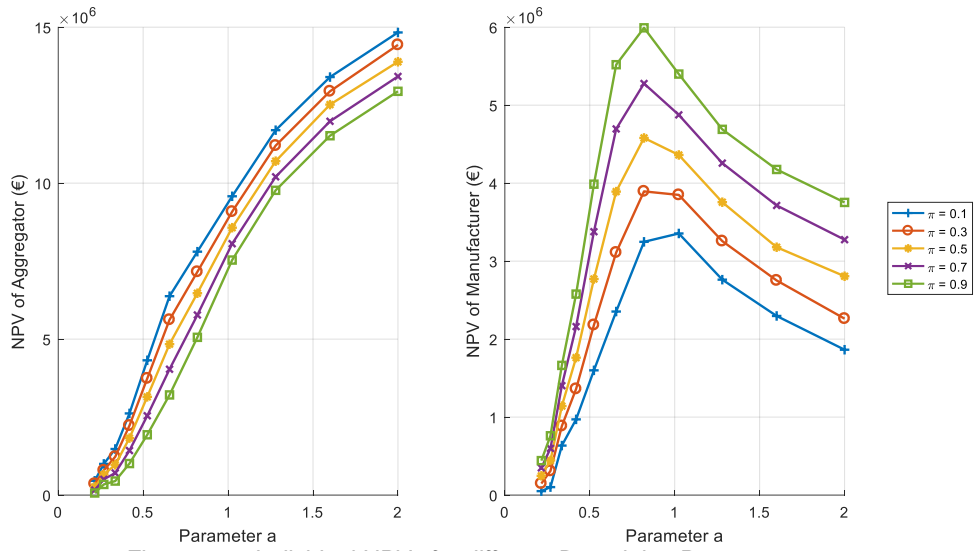

Figure 4.29 Individual NPVs for different Bargaining Power

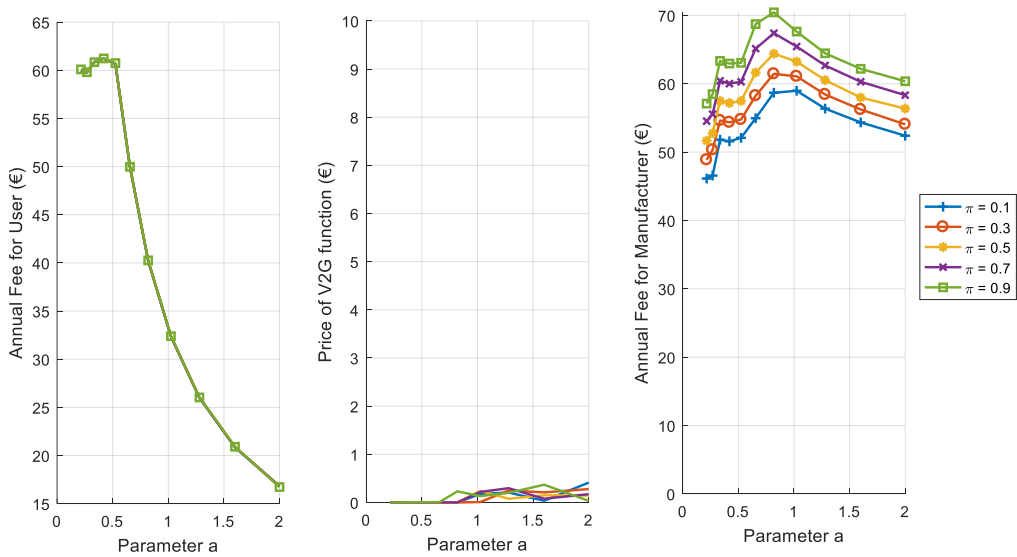

Figure 4.30 Annual Fee, Selling Price and Manufacturer Fee for different Bargaining Powers

Figure 4.31, Figure 4.32 and Figure 4.33 give a summary of results for three different level of intensity of demand and bargaining power of 0.5:

- For low level, benefits are almost evenly distributed between actors and relative benefits of cooperation are high, for simple cooperation (CS2) as well as reinforced cooperation (CS3). Cooperation allows increasing the number of equipped vehicles. For reinforced cooperation, about 28,400 vehicles are equipped and total NPV is 5.3 M€.
- For medium level, manufacturer gets about one-third of the benefits. Simple cooperation does not increase significantly benefits while reinforced cooperation does. Cooperation does not results in a significant increase of equipped vehicles. About 35,000 vehicles are equipped. For CS3, total NPV is 12.7 M€
- For high level of demand, manufacturer gets only one-tenth of the benefits. Simple cooperation does not increase significantly benefits while reinforced cooperation does. Cooperation does not results in a significant increase of equipped vehicles. About 35,000 vehicles are equipped. For CS3, total NPV is 16.7 M€.

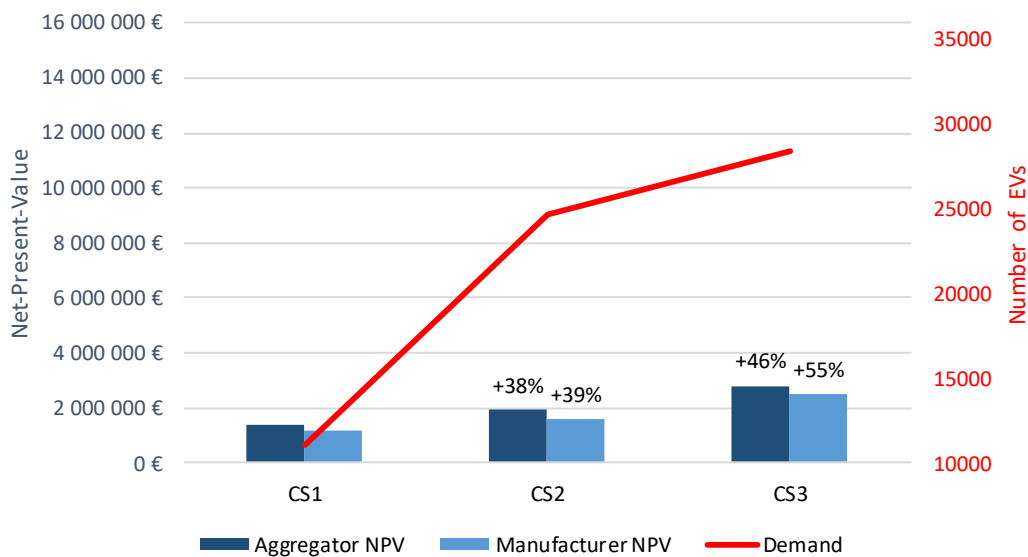

Figure 4.31 NPVs and Demand for Low Demand Intensity ($a=0.5$)

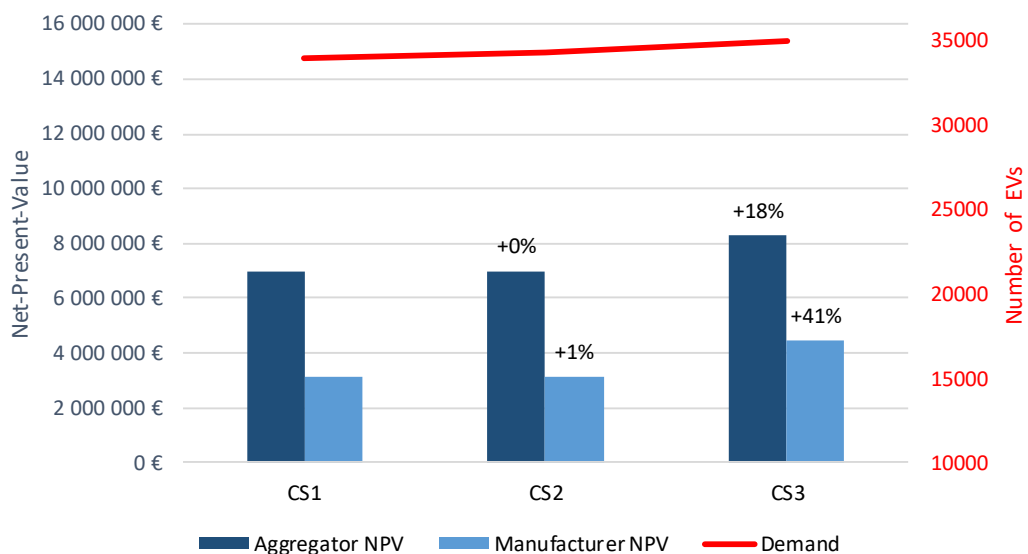

Figure 4.32 NPVs and Demand for Medium Demand Intensity ($a=1$)

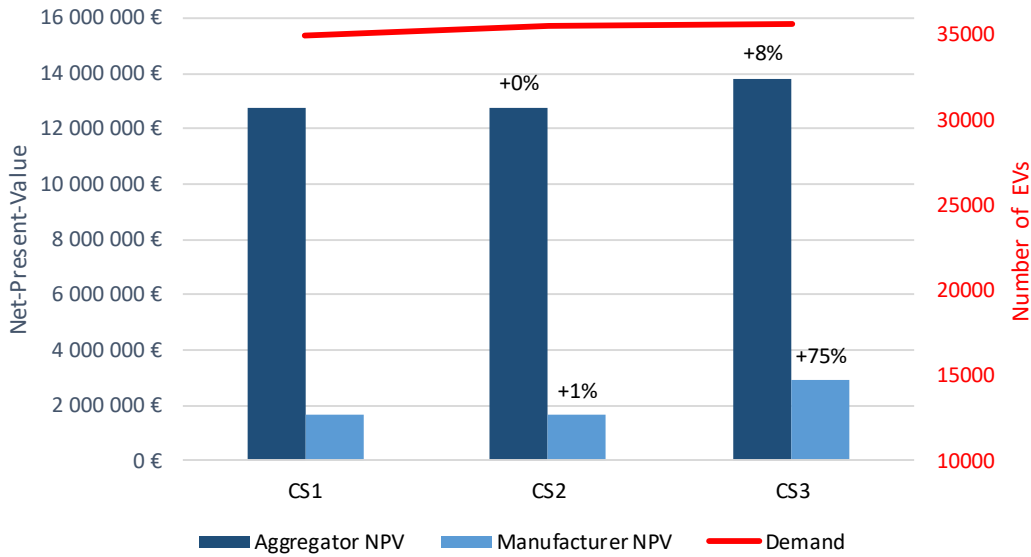

Figure 4.33 NPVs and Demand for Medium Demand Intensity ($a=2$)

4 ANALYTIC MODEL

In the previous section of this chapter, we used simulations of EV fleets to determine the revenues from FCR participation. If results presented allow determining the benefits of each actor in a realistic case and the price and fee they would fix, they do not allow us to capture the effect each parameter could have on these benefits. In order to express them analytically, we have to define a simplified revenue function.

The total revenue function of the fleet is presented in Figure 4.34. This shape is obtained by linearization of the total revenue obtained from simulation (Figure 4.12). Before reaching a size of fleet N_M , each EV added to the fleet brings an additional revenue r_{EV} . After this threshold, total revenue do not increase when an EV is added to the fleet.

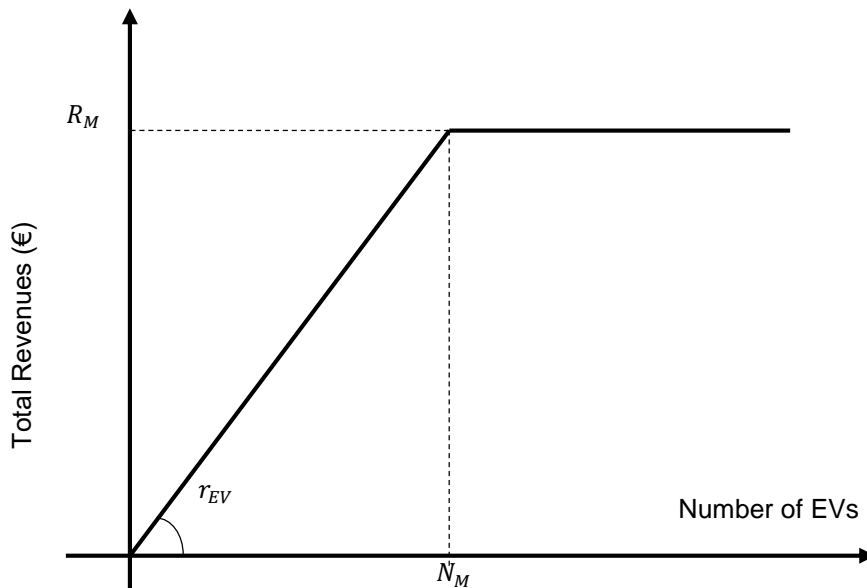

Figure 4.34 Analytic Total Revenue Function

To have a more general model, we also adapt demand function given in Equation 4.3. We introduce demand elasticity b , which gives us a new demand function (Equation 4.38)

$$D(P, F) = (a * NPV_u(P, F))^b \quad 4.38$$

We will first present different equations of selling price, annual fee and NPVs resulting from this simplified revenue function for the two References and the three Case Studies using model for calculation of NPVs presented in the second Section of this Chapter¹⁴. Then, we validate these Equations, comparing them with results obtained from simulation. Finally, we present a sensitivity analysis on the different parameters of the calculation.

Table 4.2 gives a reminder of the different notations used in this Section and Equations 4.39 and 4.42 the calculation of s and s_u from discount rate r and r_u .

Table 4.2 Parameters used in Equations

Selling Price	P
Annual Fee	F
Manufacturer NPV	NPV_{Man}
Aggregator NPV	NPV_{Ag}
Demand Intensity	a
Demand Elasticity	b
Maximum Size	N_M
Revenue per EV	r_{EV}
Players' Discount Rate	r
Users' Discount Rate	r_u
Recurrent Costs	c
Investment Costs	I
Bargaining Power of the Manufacturer	π

$$s = \sum_{t=1}^T \frac{1}{(1+r)^t} \quad 4.39$$

$$s_u = \sum_{t=1}^T \frac{1}{(1+r_u)^t} \quad 4.40$$

4.1 Reference 1

In this Case, we fix selling price and annual fee in order to maximize the total NPV of an integrated actor, playing both role of car manufacturer and aggregator.

There are two regimes in this Reference, depending on the value of demand intensity a . For a below a_1 given in Equation 4.41, maximum size N_M is not reached at optimal couple $\{P, F\}$. Above this threshold, maximum size is reached and size stays constant with a at optimal couple.

In this case, selling price P will always be set to zero. If b is higher than 1, meaning demand is highly elastic with user's NPV, there is an inflexion point at a_1 , meaning the marginal benefit of increasing a will be decreasing.

¹⁴ For commodity of reading, we do not provide demonstration of these results. Different comments on the results are deduced from the analysis of these equations.

The higher the maximum size of the fleet N_M and the ratio between s and s_u , the higher a_1 . However, a_1 is decreasing with b . Selling price will be set to zero whatever the value of a , and annual fee will be constant for a lower than a_1 and decreasing after.

For a given value of intensity of demand a , NPV is increasing with demand elasticity b , with maximum size N_M and with revenue r_{EV} , and decreasing with discount rates r and r_u and with investment and recurrent costs I and c .

$$a_1 = \frac{b+1}{b} * \frac{s}{s_u} * \frac{\sqrt[b]{N_M}}{s * (r_{EV} - c) - I} \quad 4.41$$

$$\left\{ \begin{array}{l} \forall a < a_1 \\ P = 0 \\ F = \frac{b}{b+1} * \frac{1}{s} * (s * (r_{EV} - c) - I) \\ NPV = a^b * \frac{b^b}{(b+1)^{b+1}} * \left(\frac{s_u}{s}\right)^b * (s * (r_{EV} - c) - I)^{b+1} \end{array} \right. \quad 4.42$$

$$\left\{ \begin{array}{l} \forall a \geq a_1 \\ P = 0 \\ F = \frac{1}{s_u} * \frac{\sqrt[b]{N_M}}{a} \\ NPV = N_M * \left(s * (r_{EV} - c) - I - \frac{s}{s_u} * \frac{\sqrt[b]{N_M}}{a} \right) \end{array} \right. \quad 4.43$$

4.2 Reference 2

In this Case, we fix selling price and annual fee to maximize sum of NPVs of both actors, with an additional to constraint to have positive NPV for both actors.

The shapes of the evolution of F and NPV in this case present similar characteristics than in Reference 1. However, the maximum revenue is reached for a value of a given in Equation 4.44 which is higher than in Reference 1, while NPV is always lower, given that interest rate of users is higher than interest rates of aggregator and manufacturer.

Selling price is fixed to compensate investment costs I , meaning benefits of manufacturer are null. It cannot be fixed at a lower level; otherwise, manufacturer NPV would be strictly negative. To compensate for higher selling price, annual fee must be higher than in Reference 1.

$$a_2 = \frac{b+1}{b} * \frac{\sqrt[b]{N_M}}{(s_u * (r_{EV} - c) - I)} \quad 4.44$$

$$\begin{cases}
 \forall a < a_2 \\
 P = I \\
 F = \frac{1}{s_u} * \left(I + \frac{b}{b+1} * (s_u * (r_{EV} - c) - I) \right) \\
 NPV = a^b * \frac{b^b}{(b+1)^{b+1}} * \frac{s}{s_u} * (s_u * (r_{EV} - c) - I)^{b+1}
 \end{cases} \quad 4.45$$

$$\begin{cases}
 \forall a \geq a_2 \\
 P = I \\
 F = \frac{1}{s_u} * \left(I + \frac{\sqrt[b]{N_M}}{a} \right) \\
 NPV = N_M * \frac{s}{s_u} * \left(s_u * (r_{EV} - c) - I - \frac{\sqrt[b]{N_M}}{a} \right)
 \end{cases} \quad 4.46$$

4.3 Case-Study 1

In this Case-Study, actors adopt a non-cooperative strategy. Two different regimes of evolution are found, depending on the value of a . Size of the fleet is increasing for a below a_3 given in Equation 4.47. Value of a_3 is higher than a_2 . For a above a_3 , size of the fleet is constant, equals to N_M .

For a below a_3 , benefits of manufacturer and aggregator are increasing with a . Selling price P and annual fee F are constant. Above this level, benefits of the manufacturer decrease with a . Indeed, aggregator can decrease its fee when a is increasing, which means manufacturer should decrease selling price P . He will therefore decrease his margin while keeping the volume of equipped vehicles constant and his benefits will decrease. This is coherent with results found in Section 3 of this Chapter. If demand elasticity b is higher than one, a_3 is an inflexion point for Aggregator NPV.

As manufacturer fix a selling price higher than recurrent costs, to have a positive margin on the installation of the V2G option, the sum of NPVs will be lower than in Reference 2, whatever the value of a .

$$a_3 = \left(\frac{b+1}{b} \right)^2 * \frac{\sqrt[b]{N_M}}{(s_u * (r_{EV} - c) - I)} \quad 4.47$$

$$\begin{cases}
 \forall a < a_3 \\
 P = I + \frac{b}{(b+1)^2} * (s_u * (r_{EV} - c) - I) \\
 F = \frac{1}{s_u} * \left(I + \frac{b}{b+1} * (s_u * (r_{EV} - c) - I) \right) \\
 NPV_{Man} = a^b * \frac{b^{2b+1}}{(b+1)^{2b+2}} * (s_u * (r_{EV} - c) - I)^{b+1} \\
 NPV_{Ag} = a^b * \frac{b^{2b}}{(b+1)^{2b+1}} * \frac{s}{s_u} * (s_u * (r_{EV} - c) - I)^{b+1}
 \end{cases} \quad 4.48$$

$$\forall a \geq a_3$$

$$\left\{ \begin{array}{l} P = I + \frac{b+1}{b} * \frac{b\sqrt{N_m}}{a} \\ F = \frac{1}{s_u} * \left(I + \frac{b+1}{b} * \frac{b\sqrt{N_M}}{a} \right) \\ NPV_{Man} = N_M * \frac{1}{b} * \frac{b\sqrt{N_M}}{a} \\ NPV_{Ag} = N_m * \frac{s}{s_u} * \left(s_u * (r_{EV} - c) - I - \frac{b+1}{b} * \frac{b\sqrt{N_M}}{a} \right) \end{array} \right. \quad 4.49$$

4.4 Case-study 2

In this Case-Study, actors adopt a cooperative behavior, trying to maximize the sum of NPVs under constraint to have higher individual NPV than in Case-Study 1. Value will be shared between both player according to their bargaining power

To simplify this analysis, we only give results in case where the manufacturer (the aggregator) has no bargaining power. It is equivalent to maximizing the NPV of the aggregator (the manufacturer) given that NPV of the manufacturer (the aggregator) should be equal to Case-Study 1.

It results in having three different regimes in function of a . For a below a_2 , maximum size N_m is not reached. For a below a_3 and above a_2 , maximum size is reached in Case-Study 2 but not in Case-Study 1. Finally, for a higher than a_3 , maximum size is reached for both Case-Studies.

Equation 4.53 and 4.57 gives the relative gain from cooperation compared to Case-Study 1 for $\pi = 0$ and $\pi = 1$, respectively for the aggregator and the manufacturer. We can see this relative gain only depends on demand elasticity b .

For values considered in Section 3, the gain for the aggregator would be of 58 % if $\pi = 0$, and the gain for the manufacturer would be of 87% if $\pi = 1$. Gains of the aggregator are increasing with demand elasticity b while gains of the manufacturer are decreasing.

When demand intensity increases, gain of cooperation will be decreasing and become null when a is above a_3 .

4.4.1 For $\pi = 0$

$$\forall a < a_2$$

$$\left\{ \begin{array}{l} P = I + \frac{b^{b+1}}{(b+1)^{b+2}} * (s_u * (r_{EV} - c) - I) \\ F = \frac{1}{s_u} * \left(I + \frac{b}{b+1} * \left(1 + \frac{b^b}{(b+1)^{b+1}} \right) * (s_u * (r_{EV} - c) - I) \right) \\ NPV_{Man} = a^b * \frac{b^{2b+1}}{(b+1)^{2b+2}} * (s_u * (r_{EV} - c) - I)^{b+1} \\ NPV_{Ag} = a^b * \frac{b^b}{(b+1)^{b+1}} * \left(1 - \left(\frac{b}{b+1} \right)^{b+1} \right) * \frac{s}{s_u} * (s_u * (r_{EV} - c) - I)^{b+1} \end{array} \right. \quad 4.50$$

$$\forall a_2 \leq a < a_3$$

$$\left\{ \begin{array}{l} P = I + \frac{a^b}{N_m} * \frac{b^{2b+1}}{(b+1)^{2b+2}} * (s_u * (r_{EV} - c) - I)^{b+1} \\ F = \frac{1}{s_u} * \left(I + \frac{b^{\sqrt{N_m}}}{a} + \frac{a^b}{N_m} * \frac{b^{2b+1}}{(b+1)^{2b+2}} * (s_u * (r_{EV} - c) - I)^{b+1} \right) \\ NPV_{Man} = a^b * \frac{b^{2b+1}}{(b+1)^{2b+2}} * (s_u * (r_{EV} - c) - I)^{b+1} \\ NPV_{Ag} = N_m * \frac{s}{s_u} * \left(s_u * (r_{EV} - c) - I - \frac{b^{\sqrt{N_m}}}{a} - \frac{a^b}{N_m} * \frac{b^{2b+1}}{(b+1)^{2b+2}} * (s_u * (r_{EV} - c) - I)^{b+1} \right) \end{array} \right. \quad 4.51$$

$$\forall a \geq a_3$$

$$\left\{ \begin{array}{l} P = I + \frac{1}{b} * \frac{b^{\sqrt{N_m}}}{a} \\ F = \frac{1}{s_u} * \left(I + \frac{b+1}{b} * \frac{b^{\sqrt{N_m}}}{a} \right) \\ NPV_{Man} = N_m * \frac{1}{b} * \frac{b^{\sqrt{N_m}}}{a} \\ NPV_{Ag} = N_m * \frac{s}{s_u} * \left(s_u * (r_{EV} - c) - I - \frac{b+1}{b} * \frac{b^{\sqrt{N_m}}}{a} \right) \end{array} \right. \quad 4.52$$

$$\forall a < a_2$$

$$\Delta_{CS2-CS1}^{Ag} = \left(\frac{b+1}{b} \right)^b - \frac{2b+1}{b+1} \quad 4.53$$

4.4.2 For $\pi = 1$

$$\forall a < a_2$$

$$\left\{ \begin{array}{l} P = I + \frac{1}{b+1} * \left(1 - \left(\frac{b}{b+1} \right)^b \right) * (s_u * (r_{EV} - c) - I) \\ F = \frac{1}{s_u} * \left(I + \left(1 - \frac{b^b}{(b+1)^{b+1}} \right) * (s_u * (r_{EV} - c) - I) \right) \\ NPV_{Man} = a^b * \frac{b^b}{(b+1)^{b+1}} * \left(1 - \left(\frac{b}{b+1} \right)^b \right) * (s_u * (r_{EV} - c) - I)^{b+1} \\ NPV_{Ag} = a^b * \frac{b^{2b}}{(b+1)^{2b+1}} * \frac{s}{s_u} * (s_u * (r_{EV} - c) - I)^{b+1} \end{array} \right. \quad 4.54$$

$$\begin{aligned}
& \forall a_2 \leq a < a_3 \\
& \left\{ \begin{aligned}
P &= s_u * (r_{EV} - c) - \frac{\sqrt[b]{N_M}}{a} - \frac{a^b}{N_M} \frac{b^{2b}}{(b+1)^{2b+1}} * (s_u * (r_{EV} - c) - I)^{b+1} \\
F &= r_{EV} - c - \frac{a^b}{N_M} \frac{b^{2b}}{(b+1)^{2b+1}} * (s_u * (r_{EV} - c) - I)^{b+1} \\
NPV_{Man} &= N_M * \left(s_u * (r_{EV} - c) - I - \frac{\sqrt[b]{N_M}}{a} - \frac{a^b}{N_M} \frac{b^{2b}}{(b+1)^{2b+1}} * (s_u * (r_{EV} - c) - I)^{b+1} \right) \\
NPV_{Ag} &= a^b * \frac{b^{2b}}{(b+1)^{2b+1}} * \frac{s}{s_u} * (s_u * (r_{EV} - c) - I)^{b+1}
\end{aligned} \right. \tag{4.55}
\end{aligned}$$

$$\begin{aligned}
& \forall a \geq a_3 \\
& \left\{ \begin{aligned}
P &= I + \frac{1}{b} * \frac{\sqrt[b]{N_M}}{a} \\
F &= \frac{1}{s_u} * \left(I + \frac{b+1}{b} * \frac{\sqrt[b]{N_M}}{a} \right) \\
NPV_{Man} &= N_M * \frac{1}{b} * \frac{\sqrt[b]{N_M}}{a} \\
NPV_{Ag} &= N_M * \frac{s}{s_u} * \left(s_u * (r_{EV} - c) - I + \frac{b+1}{b} * \frac{\sqrt[b]{N_M}}{a} \right)
\end{aligned} \right. \tag{4.56}
\end{aligned}$$

$$\begin{aligned}
& \forall a < a_2 \\
& \Delta_{CS2-CS1}^{Man} = \left(\frac{b+1}{b} \right)^{b+1} - \frac{2b+1}{b} \tag{4.57}
\end{aligned}$$

4.5 Case-Study 3

In Case-Study 3, actors adopt a cooperative strategy, with a possibility to have financial flows between the aggregator and the car manufacturer. We give results for $\pi = 0$ and $\pi = 1$. We find three different regimes of evolution depending on the value of a .

For a smaller than a_1 , maximum size of the fleet N_M is not reached. For a between a_1 and a_3 , maximum size is reached in this Case-Study but not in Case-Study 1. Finally, for a higher than a_3 , maximum size is reached for both Case-Studies.

Whatever the value of a , it is possible to reach the total NPV found in Reference 1. Selling price and annual fee are fixed as in this reference: selling price is set to zero, meaning user should not pay to have the V2G function in their vehicle. The annual fee for car manufacturer allows redistributing gains from fleet participation to reserve between both actors.

For $\pi = 0$, this annual fee is set in order to have manufacturer NPV equals to the one found in Case-Study 1, whereas for $\pi = 1$, annual fee will be fixed to have aggregator NPV equals to the one found in Case-Study 2.

Equation 4.61 and 4.65 gives relative gains between Case-Study 3 and Case-Study 1 for a below a_3 , respectively for aggregator for $\pi = 0$ and for manufacturer for $\pi = 1$. With values of Section 3, these relative gains are respectively 132 % and 236%.

4.5.1 For $\pi = 0$

$$\left. \begin{aligned}
 & \forall a < a_1 \\
 & P = 0 \\
 & F = \frac{b}{s + b} * s * (r_{EV} - c) - I \\
 & F_M = \frac{1}{s} * \left(I + \left(\frac{s}{s_u} \right)^b * \frac{b^{b+1}}{(b+1)^{b+2}} * \frac{(s_u * (r_{EV} - c) - I)^{b+1}}{(s * (r_{EV} - c) - I)^b} \right) \\
 & NPV_{Man} = a^b * \frac{b^{2b+1}}{(b+1)^{2b+2}} * (s_u * (r_{EV} - c) - I)^{b+1} \\
 & NPV_{Ag} = a^b * \frac{b^b}{(b+1)^{b+1}} * \left(\left(\frac{s_u}{s} \right)^b * (s * (r_{EV} - c) - I)^{b+1} - \left(\frac{b}{b+1} * (s_u * (r_{EV} - c) - I) \right)^{b+1} \right)
 \end{aligned} \right\} \quad 4.58$$

$$\left. \begin{aligned}
 & \forall a_1 < a < a_3 \\
 & P = 0 \\
 & F = \frac{1}{s_u} * \frac{b \sqrt[b]{N_M}}{a} \\
 & F_M = \frac{1}{s} * \left(I + \frac{a^b}{N_M} * \frac{b^{2b+1}}{(b+1)^{2b+2}} * (s_u * (r_{EV} - c) - I)^{b+1} \right) \\
 & NPV_{Man} = a^b * \frac{b^{2b+1}}{(b+1)^{2b+2}} * (s_u * (r_{EV} - c) - I)^{b+1} \\
 & NPV_{Ag} = N_M * \left(s * (r_{EV} - c) - I - \frac{s}{s_u} * \frac{b \sqrt[b]{N_M}}{a} - \frac{a^b}{N_M} * \frac{b^{2b+1}}{(b+1)^{2b+2}} * (s_u * (r_{EV} - c) - I)^{b+1} \right)
 \end{aligned} \right\} \quad 4.59$$

$$\left. \begin{aligned}
 & \forall a > a_3 \\
 & P = 0 \\
 & F = \frac{1}{s_u} * \frac{b \sqrt[b]{N_M}}{a} \\
 & F_M = \frac{1}{s} * \left(I + \frac{1}{b} * \frac{b \sqrt[b]{N_M}}{a} \right) \\
 & NPV_{Man} = N_M * \frac{1}{b} * \frac{b \sqrt[b]{N_M}}{a} \\
 & NPV_{Ag} = N_M * \left(s * (r_{EV} - c) - I - \frac{s}{s_u} * \frac{b \sqrt[b]{N_M}}{a} - \frac{1}{b} * \frac{b \sqrt[b]{N_M}}{a} \right)
 \end{aligned} \right\} \quad 4.60$$

$$\begin{aligned}
 & \forall a < a_1 \\
 & \Delta_{CS3-CS1}^{Ag} = \left(\frac{b+1}{b} \right)^b * \left(\frac{s_u}{s} \right)^{b+1} * \left(\frac{s * (r_{EV} - c) - I}{s_u * (r_{EV} - c) - I} \right)^{b+1} - \frac{b}{b+1} * \frac{s_u}{s} - 1
 \end{aligned} \quad 4.61$$

4.5.2 For $\pi = 1$

$$\left\{ \begin{array}{l} \forall a < a_1 \\ P = 0 \\ F = \frac{b}{s + b * s} * (s * (r - c) - I) \\ F_M = \frac{1}{s} * \left(I + \frac{1}{b + 1} * (s * (r_{EV} - c) - I) - \left(\frac{s}{s_u} \right)^{b+1} * \frac{b^b}{(b + 1)^{b+1}} * \frac{(s_u * (r_{EV} - c) - I)^{b+1}}{(s * (r_{EV} - c) - I)^b} \right) \\ NPV_{Man} = a^b * \frac{b^b}{(b + 1)^{b+1}} * \frac{s}{s_u} * \left(\left(\frac{s_u}{s} * (s * (r_{EV} - c) - I) \right)^{b+1} - \frac{b^b}{(b + 1)^b} * (s_u * (r_{EV} - c) - I)^{b+1} \right) \\ NPV_{Ag} = a^b * \frac{b^{2b}}{(b + 1)^{2b+1}} * \frac{s}{s_u} * (s_u * (r_{EV} - c) - I)^{b+1} \end{array} \right. \quad 4.62$$

$$\left\{ \begin{array}{l} \forall a_1 < a < a_3 \\ P = 0 \\ F = \frac{1}{s_u} * \frac{b \sqrt[b]{N_M}}{a} \\ F_M = \frac{1}{s_u} \left(s_u * (r_{EV} - c) - \frac{a^b}{N_m} * \frac{b^{2b}}{(b + 1)^{2b+1}} * (s_u * (r_{EV} - c) - I)^{b+1} - \frac{b \sqrt[b]{N_M}}{a} \right) \\ NPV_{Man} = N_M \left((s * (r_{EV} - c) - I) - \frac{s}{s_u} * \left(\frac{a^b}{N_m} * \frac{b^{2b}}{(b + 1)^{2b+1}} * (s_u * (r_{EV} - c) - I)^{b+1} + \frac{b \sqrt[b]{N_M}}{a} \right) \right) \\ NPV_{Ag} = a^b * \frac{b^{2b}}{(b + 1)^{2b+1}} * \frac{s}{s_u} * (s_u * (r_{EV} - c) - I)^{b+1} \end{array} \right. \quad 4.63$$

$$\left\{ \begin{array}{l} \forall a > a_3 \\ P = 0 \\ F = \frac{1}{s_u} * \frac{b \sqrt[b]{N_M}}{a} \\ F_M = \frac{1}{s_u} * \left(I + \frac{1}{b} * \frac{b \sqrt[b]{N_M}}{a} \right) \\ NPV_{Man} = N_M * \frac{s}{s_u} * \left(\left(\frac{s - s_u}{s} \right) * I + \frac{1}{b} * \frac{b \sqrt[b]{N_M}}{a} \right) \\ NPV_{Ag} = N_m * \frac{s}{s_u} * \left(s_u * (r_{EV} - c) - I - \frac{b + 1}{b} * \frac{b \sqrt[b]{N_M}}{a} \right) \end{array} \right. \quad 4.64$$

$$\forall a < a_1 \\ \Delta_{CS3-CS1}^{Ag} = \left(\frac{b + 1}{b} \right)^{b+1} * \left(\frac{s_u}{s} \right)^b * \left(\frac{s * (r_{EV} - c) - I}{s_u * (r_{EV} - c) - I} \right)^{b+1} - \frac{b + 1}{b} * \frac{s}{s_u} - 1 \quad 4.65$$

4.6 Validation of Analytic Model

We want to validate the analytic model developed before to evaluate if this tool can give similar results to those found by simulations. Figure 4.35 is giving results for aggregator NPV when $\pi = 0$ and Figure 4.36 for manufacturer NPV when $\pi = 1$.

We have good precision in the analytic model for every cases. However, there are some discrepancies between both model for low values of a and around threshold values.

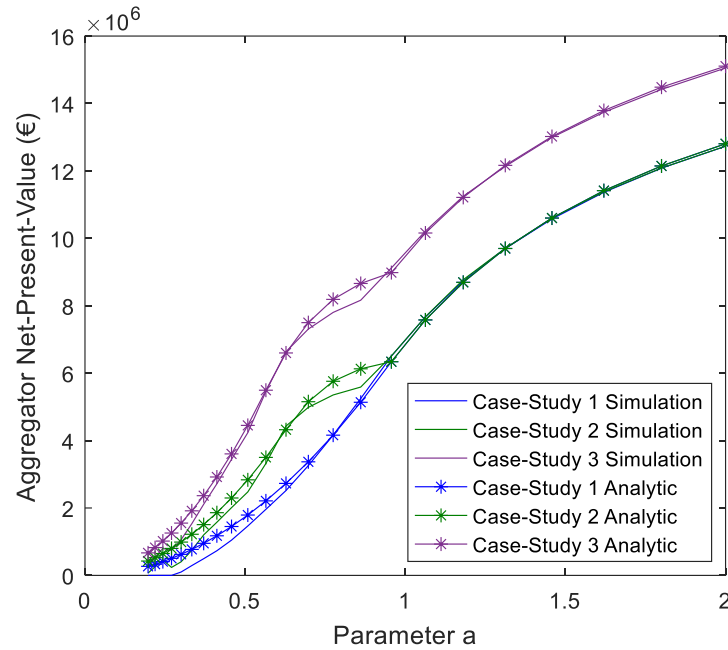

Figure 4.35 Comparison between Simulation Model and Analytic Model for Aggregator NPV and $\pi = 0$

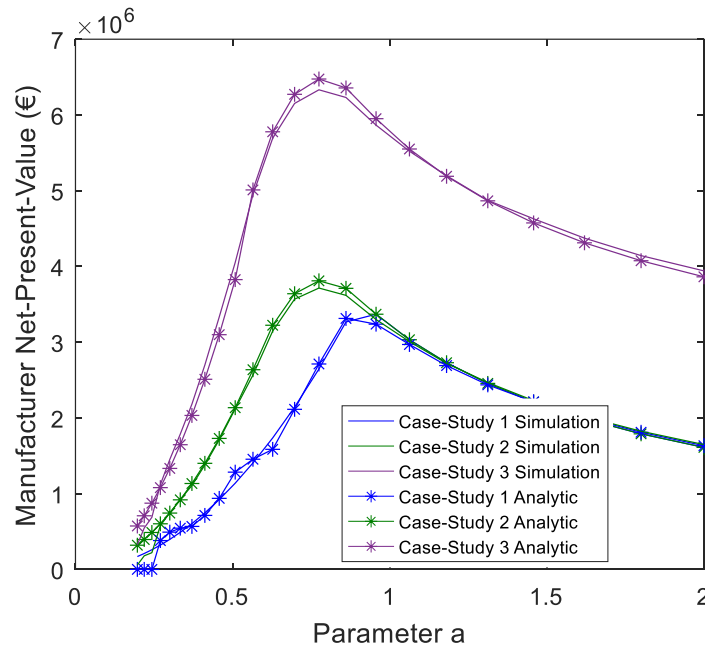

Figure 4.36 Comparison between Simulation Model and Analytic Model for Manufacturer NPV and $\pi = 1$

4.7 Sensitivity Analysis

Table 4.4 to Table 4.9 provide sensitivity analysis on the benefits of the manufacturer and the aggregator for three different values of intensity of demand (0.5, 1 and 2), for three different Case-Studies, using equations of the analytic model.

As we have developed Equations only in case where one of the player has no bargaining power, we give results for manufacturer NPV when aggregator has no bargaining power and vice-versa. Therefore, these values represent upper bounds and would be lower if value of cooperation had to be shared among players.

We look at the relative variation of the NPV, with a parameter increasing or decreasing of 20%, all things being equals. First line of the tables gives value of the NPV for base-case parameters given in Table 4.3.

Table 4.3 Parameters for Base-Case

Demand Elasticity	b	2
Maximum Size	N_M	35,000 EVs
Revenue per EV	r_{EV}	280 €/EV/year
Players' Discount Rate	r	8%
Users' Discount Rate	r_u	12%
Recurrent Costs	c	150 €/EV/year
Investment Costs	I	300 €/EV/year

It is possible with this analysis to validate results of Section 3 in base-case. For low value of demand intensity ($a = 0.5$), simple cooperation (CS2) allows increasing benefits for both actors as well as reinforced cooperation (CS3). However, when demand is medium or high ($a = 1$ or $a = 2$), only reinforced cooperation allows increasing benefits. We also find that manufacturer NPV is lower for high level of demand intensity than for medium level.

Some parameters will influence NPV of both actors in an intuitive manner. For example, a decrease of 20% of the revenue per EV will always have a negative influence, whatever actor, level of demand and Case-Study considered. It is also true for Maximum Size. An increase – decrease – of this parameter will always have a positive – negative – influence on NPV, for medium or high demand intensity. It is also true for player's discount rate and recurrent costs.

Other parameter will play an ambiguous role on benefits, especially for manufacturer. In particular, we can observe that the effect of a variation of demand elasticity is difficult to forecast. It is also true for users' discount rate and investment costs, at a lower level. This can be explained by the non-monotonic nature of manufacturer NPV function with demand intensity.

Finally, we can see that the level of a variation of each parameter will depend on the type of cooperation in place and the demand intensity. For example, an increase of 20 % of the revenue per EV have a large influence on manufacturer NPV is low, but no influence at all when demand is high.

This sensitivity analysis gives a good complement to the one performed in the last Chapter, and shows that level of complexity is largely increased when value is shared between different actors. It is clear, considering this analysis that shape of demand function will play a predominant role in the design of a coherent business model.

Table 4.4 Sensitivity Analysis on Manufacturer NPV for $\alpha = 0.5$ and $\pi = 1$

		Case-Study 1	Case-Study 2	Case-Study 3
Base-Case Manufacturer NPV		900 k€	1 688 k€	4 388 k€
Demand Elasticity	-20%	-87%	-87%	-87%
	+20%	153%	35%	7%
Maximum Size	-20%	0%	0%	0%
	+20%	0%	0%	0%
Revenue per EV	-20%	-98%	-98%	-96%
	+20%	416%	268%	113%
Players' Discount Rate	-20%	0%	0%	22%
	+20%	0%	0%	-18%
User's Discount Rate	-20%	64%	64%	19%
	+20%	-39%	-39%	-15%
Recurrent Costs	-20%	169%	162%	64%
	+20%	-77%	-77%	-72%
Investment Costs	-20%	47%	47%	33%
	+20%	-36%	-36%	-27%

Table 4.5 Sensitivity Analysis on Manufacturer NPV for $\alpha = 1$ and $\pi = 1$

		Case-Study 1	Case-Study 2	Case-Study 3
Base-Case Manufacturer NPV		3 274 k€	3 274 k€	5 858 k€
Demand Elasticity	-20%	-89%	-79%	-71%
	+20%	-65%	-65%	-43%
Maximum Size	-20%	-28%	-28%	-26%
	+20%	10%	30%	26%
Revenue per EV	-20%	-98%	-96%	-87%
	+20%	0%	0%	0%
Players' Discount Rate	-20%	0%	0%	21%
	+20%	0%	0%	-19%
User's Discount Rate	-20%	0%	0%	-27%
	+20%	-33%	-7%	23%
Recurrent Costs	-20%	0%	0%	0%
	+20%	-75%	-53%	-36%
Investment Costs	-20%	0%	0%	-7%
	+20%	-30%	-5%	3%

Table 4.6 Sensitivity Analysis on Manufacturer NPV for $\alpha = 2$ and $\pi = 1$

		Case-Study 1	Case-Study 2	Case-Study 3
Base-Case Manufacturer NPV		1 637 k€	1 637 k€	3 914 k€
Demand Elasticity	-20%	-33%	28%	33%
	+20%	-65%	-65%	-32%
Maximum Size	-20%	-28%	-28%	-24%
	+20%	31%	31%	26%
Revenue per EV	-20%	-82%	-67%	-37%
	+20%	0%	0%	0%
Players' Discount Rate	-20%	0%	0%	28%
	+20%	0%	0%	-25%
User's Discount Rate	-20%	0%	0%	-35%
	+20%	0%	0%	37%
Recurrent Costs	-20%	0%	0%	0%
	+20%	0%	0%	0%
Investment Costs	-20%	0%	0%	-10%
	+20%	0%	0%	10%

Table 4.7 Sensitivity Analysis on Aggregator NPV for $\alpha = 0.5$ and $\pi = 0$

		Case-Study 1	Case-Study 2	Case-Study 3
Base-Case Aggregator NPV		1 604 k€	2 539 k€	4 022 k€
<i>Demand Elasticity</i>	-20%	-86%	-86%	-87%
	+20%	452%	248%	180%
<i>Maximum Size</i>	-20%	0%	0%	0%
	+20%	0%	0%	0%
<i>Revenue per EV</i>	-20%	-98%	-98%	-95%
	+20%	416%	299%	223%
<i>Players' Discount Rate</i>	-20%	8%	8%	25%
	+20%	-7%	-7%	-21%
<i>User's Discount Rate</i>	-20%	48%	48%	13%
	+20%	-33%	-33%	-12%
<i>Recurrent Costs</i>	-20%	169%	163%	126%
	+20%	-77%	-77%	-72%
<i>Investment Costs</i>	-20%	47%	47%	32%
	+20%	-36%	-36%	-27%

Table 4.8 Sensitivity Analysis on Aggregator NPV for $\alpha = 1$ and $\pi = 0$

		Case-Study 1	Case-Study 2	Case-Study 3
Base-Case Aggregator NPV		6 397 k€	6 397 k€	8 981 k€
<i>Demand Elasticity</i>	-20%	-89%	-83%	-82%
	+20%	110%	110%	74%
<i>Maximum Size</i>	-20%	-5%	-5%	-10%
	+20%	0%	12%	14%
<i>Revenue per EV</i>	-20%	-98%	-97%	-92%
	+20%	206%	206%	146%
<i>Players' Discount Rate</i>	-20%	8%	8%	19%
	+20%	-7%	-7%	-17%
<i>User's Discount Rate</i>	-20%	36%	36%	8%
	+20%	-33%	-15%	3%
<i>Recurrent Costs</i>	-20%	110%	110%	78%
	+20%	-77%	-64%	-51%
<i>Investment Costs</i>	-20%	39%	39%	23%
	+20%	-36%	-21%	-13%

Table 4.9 Sensitivity Analysis on Aggregator NPV for $\alpha = 2$ and $\pi = 0$

		Case-Study 1	Case-Study 2	Case-Study 3
Base-Case Aggregator NPV		12 229 k€	12 229 k€	14 506 k€
<i>Demand Elasticity</i>	-20%	-83%	-73%	-66%
	+20%	29%	29%	23%
<i>Maximum Size</i>	-20%	-16%	-16%	-17%
	+20%	15%	15%	16%
<i>Revenue per EV</i>	-20%	-96%	-93%	-81%
	+20%	108%	108%	91%
<i>Players' Discount Rate</i>	-20%	8%	8%	14%
	+20%	-7%	-7%	-13%
<i>User's Discount Rate</i>	-20%	14%	14%	3%
	+20%	-15%	-15%	-3%
<i>Recurrent Costs</i>	-20%	58%	58%	49%
	+20%	-58%	-58%	-49%
<i>Investment Costs</i>	-20%	20%	20%	14%
	+20%	-20%	-20%	-14%

5 PARTIAL CONCLUSION

In this Chapter, we have studied how value could be shared between a car manufacturer, who would be in charge of installing V2G function on the vehicles and an aggregator, who would be in charge of operating the fleet to provide Frequency Containment Reserve. We have looked at three different Case-Studies. For each Case-Studies, we developed results on a simulation model of EVs providing FCR, as in Chapter 3, and on an analytical model.

In a first Case-Study, both actors adopt a non-cooperative behavior, meaning they will try to maximize their own Net-Present-Value, observing the behavior of the other actor. This situation would end in an equilibrium situation, which would be suboptimal due to double marginalization. Moreover, due to the limited size of the market, above a certain level of demand intensity, NPV of the manufacturer would decrease with demand intensity.

In a second Case-Study, actors adopt a cooperative behavior, meaning they fix together selling price and annual fee for customers, to maximize the Net-Present-Value of both actors, under the constraints that each actor could not earn less than in the non-cooperative case. Actors would share the additional value given a certain bargaining power.

Finally, we analyze a cooperation that includes the possibility of having financial flows between the aggregator and the manufacturer. This type of cooperation is equivalent to an integration of both activities as it allows redistributing value between the manufacturer and the consumer. As in Case-Study 2, the share of value that will be affected to actors will be the result of a negotiation and will depend on their relative bargaining power. However, this type of cooperation could lead to a higher risk for the manufacturer, as he will be tied to the aggregator with a long-term contract and will share price risks on the FCR market with the aggregator. Therefore, he might prefer to secure part of the value by setting a non-zero price to the V2G function.

To conclude, we have seen the complexity of designing a coherent offer for users that will ensure profitability for both manufacturer and aggregator. We used here a deterministic framework where the actors know all the parameters on costs, price of reserve and shape of demand. However, there is high uncertainty on these different values. In particular, it will be essential in the coming years to evaluate clearly demand for this type of service on the different market segments. Actors of the value chain should evaluate the types of vehicles and usage that are the most valuable in order to target them in their marketing. It means identify which vehicles could bring the more revenues and which are expecting low remuneration.

We have also looked at a setting with only one possible offer and one type of usage. It could be interesting for both manufacturer and aggregator to have a menu of contracts where remuneration will depend on the rated power of EVSE, the minimum time of connection required during the week etc. However, this should not be done at the expense of the readability of the offer.

In this framework, we have only looked at the provision of one service, Frequency Containment Reserve, which is the service with the higher value for V2G applications. We have looked at the effect of a saturation in this market. Other sources of value could be found to limit this effect of a saturation, such as energy arbitrage or other balancing services. Another solution, which is increasingly studied, is the provision of services to distribution network, to relieve congestion or provide voltage regulation services. However, there is currently no market-design put in place for these services.

Finally, in our framework, both actors are in a monopolistic situation. However, there is already a competition in both car manufacturing market and energy provision. We can expect to have competing offers in the V2G market, with different cooperative agreement between actors. This would result in lower benefits compared to the monopolistic situation. Future work could consider this type of competition.

CONCLUSION AND RECOMMENDATIONS

The concept of smart charging and Vehicle-to-Grid emerged more than two decade-ago. At that time, Electric Vehicles were nearly inexistent in the street. There is now a large consensus that Electric Vehicles will play a major role in the future of mobility. **The First Chapter** of this thesis exposed the background of this emergence. Transport industry is one of the first CO₂ emitter. There is an urgent need to decarbonize this sector, which could be achieved by the conjunction of an electrification of the vehicles and a decarbonization of the electricity generation. It requires a public intervention, as transport system based on fossil fuel is already mature after one century of experience: we are facing a “lock-in” situation and without an intervention, transport system based on Electric Vehicles could not emerge. This public intervention took different forms in different areas. It led to a decrease in price of batteries, a diversification of the models proposed by car manufacturer, a development of charging infrastructure and finally an increase of sales, which is very likely to continue and accelerate in the future.

However, the decarbonization of the electricity sector raised new challenge for System Operators, due to the intermittency of Renewables Energy Resources (RES). In particular, more flexibility is required in a system with high penetration of RES, to be able to face high ramp-up situations and to balance the system. In parallel with decarbonization of the system, reforms were conducted in different regions of the world to liberalize the sector.

In this context, development and massive diffusion of EVs could be seen as a new source of constraints for System Operators: they could induce high congestions on both distribution networks and transmission networks when charging as well as aggravate ramp-up periods, especially if vehicles are charging as soon as plugged. However, considering mobility requirements, there is a flexibility in the charging pattern of vehicles, which could be used to charge when price of electricity is low, but also to offer flexibility services to System Operators, using smart-charging algorithms. Moreover, if it is possible to have reverse flow from the battery to the grid (Vehicle-to-Grid – V2G – or bidirectional capability), it would be possible to increase this flexibility.

A large number of smart-charging algorithms were studied in the literature, to offer different services – balancing services to the TSO, flexibility services to the DSO, reducing energy bills of the user of the vehicle, allowing increased penetration of RES in the grid etc. However, the design of a technical solution does not make a business-model and some gaps of the literature were identified. First, how could this solution be monetized? Second, what is the institutional framework, in particular market rules, in which this solution could be implemented? Third, what are the costs associated with the implementation of this solution? Fourth, what is the willingness from users to adopt the solution? Finally, how the value would be shared among the different actors in the value chain?

Based on this finding, the three following chapters of this thesis try to answer these different questions, focusing on provision of reserve by EVs equipped with bidirectional chargers, identified as the most valuable option already existing. We reduce the scope to European Union and use simple algorithms, to limit computation time when simulating large fleets.

In the **Second Chapter**, we develop a framework to evaluate barriers to entry in reserve markets for aggregator of Distributed Energy Resources. We chose to have a generic framework, not focusing on Electric Vehicles. We distinguish three types of barriers.

- *First-Order Barriers: Administrative rules regarding the aggregation of DERs.* We focus here on conditions to aggregate DERs to make an offer on these markets. For example, is it possible to offer reserve from different types of units, connected at different voltage

levels? How can the aggregator dispatch reserve between the different units? Does aggregated resources have to comply with specific technical requirements?

- *Second-Order Barriers: Definition of products.* These are the rules defining the products exchanged in the market: length of products, minimum bid and bid increment, distance of Gate Closure Time to delivery and symmetry of products. These different rules might fit or not with operations of aggregators of DERs
- *Third-Order Barriers: Remuneration scheme.* These rules define how the provider of reserve will be remunerated on the market. If no market is existing, provision will be based on administrative allocation and remuneration on regulated tariff. If a market is in place, remuneration can be based on pay-as-bid or uniform pricing. The latter will be more convenient for new entrants, as player just bid their marginal cost and do not have to guess the highest accepted bid. Moreover,

Policy makers when designing markets could use this framework, as well as investors wanting to assess which markets are the most adapted.

As an illustration, we provided first a benchmark of four different market zones with two different products (FCR and aFRR). This comparative assessment was performed in 2016 and results are only valid in this context. Denmark was considered as a frontrunner in the opening of market to new resources. France was characterized by an administrative mechanism of allocation of reserve, making it complicated for new entrants to offer reserve. In Germany, if market is open to any type of reserve, the definition of products was considered as non-optimal, due to high length of products. Finally, in Great Britain, if there is a move to open market to new types of actors, and to remunerate faster reserve, the number of markets and the lack of transparency was considered as a serious obstacle for new actors.

Finally, we analyzed the effect of a modification of rules in France. French regulator requested this change, in order to create a market mechanism for provision of FCR. It was decided to join a common market between Germany and other neighboring countries, called FCR Cooperation. As explained before, this market is characterized by high length of products, which could have a negative impact on entrance of new actors. However, creation of a unique European wide market could help to reduce costs of provision of reserve. We gave some insights on the ongoing process of modification of rules in the FCR Cooperation. It is now planned to move to 4-hours products and marginal pricing, but not to change minimum bid or bid increment.

The Third Chapter provides a quantitative evaluation of the impact on a fleet of Electric Vehicles providing FCR of two rules: bid increment (volume granularity of offers) and length of product (temporal granularity of products).

First, we describe our model to simulate participation of fleets in FCR market. We distinguish three modules in this model. In the first module, we assign to each vehicle of the fleet according to stochastic distributions of trip patterns, which allows knowing the mobility constraint on the vehicle. In the second module, we evaluate for each vehicle the power available for reserve participation considering historic record of frequency deviation and assigned trip patterns over a definite time horizon. Iterating module 1 and 2 several times, with different frequency deviation patterns, we have a set of available reserve for each period of the day, which is used to evaluate the offer that could be made by the aggregator on the market in the third module. We validate this model, with and without uncertainty on the stochastic distributions of trip patterns.

We then use this model to evaluate revenues of a fleet of EVs, considering different scenarios on volume and temporal granularities and on the rated power of EVSE at home and at work. We simulate size of fleets up to 5,000 EVs. We find that volume granularity and temporal granularity play a significant role in the revenues of the fleet. Low temporal granularity induces a loss of

revenue, whatever the rated power of EVSE considered. With week-long products, it is not possible to enter the market if vehicles are not available during daytime. Low volume granularity induces threshold effect: the total revenue of the fleet will not increase when new vehicles are added and the corresponding revenue per EV is therefore decreasing. In our best scenario (products of 1 hour, bid increment of 0.1 MW, 7 kW EVSE at home and 22 kW EVSE at work), the revenue per EV is about 1200 €/year. In a central scenario (products of 4 hours, bid increment of 1 MW, 3 kW at home and 7 kW at work), the revenue per EV is 350 €/year.

In the third section of this chapter, we perform a Net-Present-Value analysis of the provision of FCR with EVs, considering costs associated with the provision:

- Investment costs to enroll clients, implement bidirectional charger and other functions on the vehicle, Human Machine Interface and telecommunication equipment
- Recurrent costs for management of the fleet, contractual relations with the clients and maintenance of the equipment

We simulate fleets up to 50,000 EVs, considering a maximum volume of 150 MW that can be offered by one Balance Service Provider according to ENTSO-e rules (to diversify the number of actors providing FCR). We consider first a base-case scenario, with fixed parameters for NPV computation. We look at two different indicators for four different market-designs: the maximum NPV per EV that can be reached and the minimum size of the fleet to reach a positive NPV. We find that market-design has a large influence on both indicators. Maximum NPV ranges from 170 €/EV for worst scenario to 760 €/EV for best one, and minimum size from 19,000 EVs for worst scenario to 240 EVs for best one. We perform sensitivity analysis on each of the parameter of the calculation on the NPV, for both indicators. We find that price of reserve has a large influence: a decrease of price of reserve of 20 % could decrease significantly the maximum NPV as well as the minimum size of the fleet for all scenario of market-design studied. This parameter is subject to high uncertainty, because a large increase of offer coming from storage units could lead to a depreciation of the value of reserve. We perform other sensitivity analysis on the parameters of the fleet studied.

This study is not considering how the value would be shared between different actors of the value chain and with the user of the vehicle. **The Fourth Chapter** gives a framework to study this question. We model the interactions between a car manufacturer and an aggregator, considering demand for V2G technology. The car manufacturer implements the V2G technology on the vehicle and fix a selling price for the option. The aggregator manages the fleet and makes offers on the markets. He fixes an annual fee to reward users. Users will react to the selling price and annual fee, buying or not the V2G option, which is modeled with a demand function.

Benefits of the car manufacturer and the aggregator are studied in three different scenario, using a game theory framework. In a first Case-Study, they do not cooperate when deciding their strategies. This situation leads to a Nash equilibrium where the players cannot increase their payoff by modifying their strategy unilaterally. In the second Case-Study, the players cooperate to reach a higher benefits for each actor. They cooperate only if the benefits is higher than in the non-cooperative game. The share of the benefits of these cooperation will be attributed to each player according to their bargaining power. In the third Case-Study, players are cooperating, with the possibility of having a financial flow between them. This situation allows the car manufacturer to have a remuneration directly from the aggregator and therefore to reduce his selling price.

We use this framework first with a revenue function resulting from simulations presented in Chapter 3 and then with a simplified revenue function, which allows having an analytical form of the different results. Main outcomes of this study are:

- There is a significant value of designing a cooperation between a car manufacturer and an aggregator, especially if this cooperation includes the possibility of financial flows between parties and users are sensitive to high upfront payment when buying the V2G option. This value will be shared between actors according to their bargaining power. In our model, we found possible increase of 5.7 M€ to 16.7M€ on the entire lifetime of the asset (10 years), depending on demand intensity.
- Manufacturer Net-Present-Value is not monotonic with demand intensity for V2G technology and decrease above a certain tipping point. This is due to the limitation on volume that can be offered by the aggregator.
- In a cooperative framework with possibility of financial flows, the car manufacturer would fix a null selling price and be remunerated only by the aggregator.

The sensitivity analysis showed the complexity in designing such a cooperation, due to the interdependencies between the two actors and non-linearity. In particular, demand function for V2G function will play a predominant role. It appears important now to have a better understanding of this demand (Who will buy V2G cars? What reward they expect? Which form should take this reward?)

It is important to understand that this framework is rather simple compared to a real-life situation. Strong hypothesis were made to be able to model this cooperation: absence of competition on both car markets and energy provision markets, perfect knowledge of the demand function and payoff matrix of each player and no economies of scale in costs.

To conclude, we have been able, in this thesis, to follow the different steps any actors willing to participate in smart-charging activities should study:

- Prospecting the different solutions that smart-charging and V2G could offer
- Assessing the institutional framework, in particular market rules, to evaluate the barriers to entry that he could encounter
- Evaluate the possible revenue and the value of the asset, considering costs to implement the solution
- Understand the demand for the solution
- Identify which role he should take in the value chain depending on his competencies and elaborate cooperation with other actors of the value chain

Based on this work, we can make the following recommendations:

Recommendations for Regulators, Policy makers and System Operators:

If relative improvement was proposed in the evolution of rules in the FCR Cooperation (going from 1-week to 4-hours duration, even if bid increment has not be changed), which could allow entrance of aggregators in this market, it is also still needed to clarify the status of Electric Vehicles as provider of flexibility services.

As mobile energy storage, Electric Vehicles are nothing near any other type of assets. There is a need to define a clear status for electric vehicles in grid connection rules, especially when equipped with bidirectional chargers, which would open the door to an entire set of specific rules taking into consideration the mobile nature of EVs, allowing to exploit completely their flexibility? Some clarification should be made regarding prequalification procedures, measurement of power and post-assessment of delivery – for example, to allow sub-metering in the EV or the external charger.

Emergence of smart charging and V2G fosters the need for reinforced cooperation between Transmission System Operators and Distribution System Operators. This cooperation is required at local level, to anticipate the impact of diffusion of electromobility on some constrained areas and

at the national and European level, to create common process for the usage of flexibility from EVs and exchange of information.

Indeed, as EVs might offer services for both DSOs and TSOs, there might be conflict of interest in the usage of these resources. For example, if a DSO takes some corrective actions in one area because of extreme events, it might endanger the ability of the TSO to balance the grid if EVs provide ancillary services in this area. This cooperation will not emerge ex nihilo and policy makers should create the appropriate platforms at the different levels (local, national and European).

More globally, any initiative to foster cooperation between different actors of the value chain would allow better anticipation of changes to come and TSOs and DSOs should proactively involve in the different pilot projects on electromobility to test new regulations and share their experience and feedbacks at the national and European level.

Recommendations for Actors of the Value Chain:

Smart charging and V2G starts now to get outside of laboratories to be implemented in pilot projects: 50 V2G projects were identified in the world, 25 being in Europe (Everoze Partners, 2018). Commercial propositions are starting to emerge and different cooperation are appearing. Different actors should define their strategies: What will be their place in the value chain? With who can they cooperate? Which type of users will they target in their offers?

We have studied mainly in this thesis provision of ancillary services with bidirectional chargers. However, the number of services that will emerge in the near future is still unsure and there might be many other opportunities for Electric Vehicles. Actors of the value chain should be versatile and agile. There is no “one fit all” solution: depending on the usage of the vehicle, the expected reward, the type of vehicle, the type of customer, different markets and services should be addressed. There is place for “low value” smart charging (unidirectional peak shaving for example) to “high value” smart charging (bidirectional provision of reserve) with many intermediary solutions.

Recommendations for Future Research:

There is still a large scope for research on the interaction between electromobility and electric systems. Following are five subjects that, in our sense, should be studied by different actors in the coming years.

What will be the consequence on smart-charging of other innovations in the mobility industry, such as car sharing, autonomous mobility or very fast charging?

These different innovations might radically change the usage of the vehicle and reduce the availability for provision of flexibility services.

What will be the customer engagement in smart-charging? What remuneration does he expect for participation? Will it be possible to influence his behavior through contracts?

This subject will be central to evaluate the profitability of smart-charging. If pilot projects can give some insights on this question, participants of these projects are often biased toward EVs and environmental issues. It will be interesting to know if V2G can reach mass market or will be limited to specific usages. Moreover, tools such as gamification could be useful to modify behaviors, beyond simple rewards.

How local electricity markets will develop in the future, what will be the institutional framework around these markets and what will be the place of EVs in these markets?

EVs could be very valuable assets to provide local flexibility. However, it is difficult to design an institutional framework for these markets, due to the diversity of networks (there is no “typical” distribution network) and the risk of high market power for potential providers.

What is the scalability of the smart-charging technologies?

The issue of scalability is essential in the design of the solution. However, literature on this subject is nearly inexistent. Provision of high value services means being able to manage in real-time a large fleet, with very low delay on data transmission and very low error rate and outage probability. Moreover, data should be available to the TSO in real-time. Aggregator will have to choose the most appropriate technology in order to perform these services while having high reliability, which could affect costs of the solution.

What will be the impact of Electric Buses and Electric Trucks in the future?

Research has mainly focused on individual transportation. However, electric public transportation and freight transport might have a growing influence in the coming years. Possibility of smart charging and V2G with this type of assets could be explored.

REFERENCES

- 50 Hertz, Amprion, APG, Elia, Energinet, RTE, Swissgrid, Tennet, Transnet BW, 2017a. Public consultation on “ FCR cooperation ” potential market design evolutions.
- 50 Hertz, Amprion, APG, Elia, Energinet, RTE, Swissgrid, Tennet, Transnet BW, 2017b. Consultation report.
- 50hertz, Amprion, APG, Elia, Energinet, RTE, Swissgrid, Tennet, Transnet BW, 2018. TSOs' proposal for the establishment of common and harmonised rules and processes for the exchange and procurement of Balancing Capacity for Frequency Containment Reserves (FCR) in accordance with Article 33 of Commission Regulation (EU) 2017/2195 establ.
- Ademe, 2017. ADEME - Site Bilans GES [WWW Document]. URL <http://bilans-ges.ademe.fr/> (accessed 9.18.18).
- Ahmadyar, A.S., Riaz, S., Verbic, G., Chapman, A., Hill, D.J., 2018. A Framework for Assessing Renewable Integration Limits with Respect to Frequency Performance. *IEEE Trans. Power Syst.* doi:10.1109/TPWRS.2017.2773091
- Axsen, J., Mountain, D.C., Jaccard, M., 2009. Combining stated and revealed choice research to simulate the neighbor effect: The case of hybrid-electric vehicles. *Resour. Energy Econ.* doi:10.1016/j.reseneeco.2009.02.001
- Bain, J.S., 1956. Barriers to new competition: their character and consequences in manufacturing industries, Harvard University series on competition in American industry 3. doi:10.4159/harvard.9780674188037
- Binmore, K., Rubinstein, A., Wolinsky, A., 1986. The Nash Bargaining Solution in Economic Modelling. *RAND J. Econ.* doi:10.2307/2555382
- Brown, S., Pyke, D., Steenhof, P., 2010. Electric vehicles: The role and importance of standards in an emerging market. *Energy Policy.* doi:10.1016/j.enpol.2010.02.059
- Bundesnetzagentur, 2015. Festlegungsverfahren zur Weiterentwicklung der Ausschreibungsbedingungen und Veröffentlichungspflichten für Sekundärregelung und Minutenreserve - Konsultation von Eckpunkten -.
- Bundesnetzagentur, 2011. Festlegungsverfahren zu den Ausschreibungsbedingungen und Veröffentlichungspflichten für Primärregelleistung. Bundesnetzagentur.De.
- Burger, S., Chaves-Avila, J.P., Battle, C., Pérez-Arriaga, I., 2016. The Value of Aggregators in Electricity Systems.
- Chao, H.P., Wilson, R., 2002. Multi-dimensional procurement auctions for power reserves: Robust incentive-compatible scoring and settlement rules. *J. Regul. Econ.* doi:10.1023/A:1020535511537
- Codani, P., Perez, Y., Petit, M., 2016. Financial shortfall for electric vehicles: Economic impacts of Transmission System Operators market designs. *Energy* 113, 422–431. doi:10.1016/j.energy.2016.07.070
- Coller, M., Williams, M.B., 1999. Eliciting individual discount rates. *Exp. Econ.* doi:10.1007/BF01673482
- Commission de Régulation de l'Energie, 2016. Decision of the French Energy Regulatory Commission of 2 June 2016 concerning guidance on methods for the procurement of Frequency Containment Reserve for ancillary services.
- Commission de Régulation de l'Energie, 2015. Délibération de la Commission de régulation de l'énergie du 3 décembre 2015 portant approbation des Règles Services Système.
- Commission de Régulation de l'Energie, 2014. Délibération de la Commission de régulation de l'énergie du 12 juin 2014 portant approbation des Règles Services Système.
- Consentec GmbH, 2014. Description of load-frequency control concept and market for control reserves 43.

- Dabbagh, S.R., Sheikh-El-Eslami, M.K., 2015. Risk-based profit allocation to DERs integrated with a virtual power plant using cooperative Game theory. *Electr. Power Syst. Res.* doi:10.1016/j.epsr.2014.11.025
- Dang, X.L., Petit, M., Codani, P., 2015. Transformer operating conditions under introduction of PV and EVs in an eco-district, in: *IEEE Power and Energy Society General Meeting.* doi:10.1109/PESGM.2015.7286380
- DeForest, N., MacDonald, J.S., Black, D.R., 2018. Day ahead optimization of an electric vehicle fleet providing ancillary services in the Los Angeles Air Force Base vehicle-to-grid demonstration. *Appl. Energy.* doi:10.1016/j.apenergy.2017.07.069
- Deilami, S., Masoum, A.S., Moses, P.S., Masoum, M.A.S., 2011. Real-time coordination of plug-in electric vehicle charging in smart grids to minimize power losses and improve voltage profile. *IEEE Trans. Smart Grid.* doi:10.1109/TSG.2011.2159816
- Díaz-González, F., Hau, M., Sumper, A., Gomis-Bellmunt, O., 2014. Participation of wind power plants in system frequency control: Review of grid code requirements and control methods. *Renew. Sustain. Energy Rev.* doi:10.1016/j.rser.2014.03.040
- Drees, T., Moser, A., 2016. Macroeconomic benefit of integrated markets for reserve balancing in Europe, in: *2016 13th International Conference on the European Energy Market (EEM).* IEEE, pp. 1–5. doi:10.1109/EEM.2016.7521255
- E-Cube, 2013. Etude des avantages que l'effacement procure à la collectivité et de leur intégration dans un dispositif de prime.
- Eid, C., Codani, P., Perez, Y., Reneses, J., Hakvoort, R., 2016. Managing electric flexibility from Distributed Energy Resources: A review of incentives for market design. *Renew. Sustain. Energy Rev.* 64, 237–247. doi:10.1016/j.rser.2016.06.008
- Energinet.dk, 2012. Ancillary services to be delivered in Denmark Tender conditions 49.
- European Commission, 2016. Proposal for a REGULATION OF THE EUROPEAN PARLIAMENT AND OF THE COUNCIL on the internal market for electricity. European Commission, Brussels.
- European Environment Agency, 2017. CO2 emissions by car manufacturer [WWW Document]. URL https://www.eea.europa.eu/data-and-maps/daviz/cars-co2-emissions-trends-by-manufacturer-4#tab-chart_1 (accessed 9.19.18).
- European Environment Agency, 2016. CO2 emission intensity — European Environment Agency [WWW Document]. URL https://www.eea.europa.eu/data-and-maps/daviz/co2-emission-intensity-3#tab-googlechartid_chart_11_filters=%7B%22rowFilters%22%3A%7B%7D%3B%22columnFilters%22%3A%7B%22pre_config_ugeo%22%3A%5B%22European%22%5D%7D%7D (accessed 9.19.18).
- European Parliament, 2018. Battery- powered electric vehicles : market development and lifecycle emissions. doi:10.2861/038794
- Eurostat, 2017. SHARES (Renewables) [WWW Document]. URL <https://ec.europa.eu/eurostat/web/energy/data/shares> (accessed 9.25.18).
- Everoze Partners, 2018. V2G Global Roadtrip: Around the World in 50 Projects – everoze.
- Federal Ministry for Economic Affairs and Energy, 2015. An Electricity Market for Germany's Energy Transition. White Pap. by Fed. Minist. Econ. Aff. Energy.
- Flinkerbusch, K., Heuterkes, M., 2010. Cost reduction potentials in the German market for balancing power. *Energy Policy* 38, 4712–4718. doi:10.1016/j.enpol.2010.04.038
- García-Villalobos, J., Zamora, I., Knezović, K., Marinelli, M., 2016. Multi-objective optimization control of plug-in electric vehicles in low voltage distribution networks. *Appl. Energy.* doi:10.1016/j.apenergy.2016.07.110
- García-Villalobos, J., Zamora, I., San Martín, J.I.I., Asensio, F.J.J., Aperribay, V., 2014. Plug-in electric vehicles in electric distribution networks: A review of smart charging approaches. *Renew. Sustain. Energy Rev.* 38, 717–731. doi:10.1016/j.rser.2014.07.040

- Geske, J., Schumann, D., 2018. Willing to participate in vehicle-to-grid (V2G)? Why not! *Energy Policy* 120, 392–401. doi:10.1016/j.enpol.2018.05.004
- Gough, R., Dickerson, C., Rowley, P., Walsh, C., 2017. Vehicle-to-grid feasibility: A techno-economic analysis of EV-based energy storage. *Appl. Energy* 192, 12–23. doi:10.1016/j.apenergy.2017.01.102
- Greene, D.L., Park, S., Liu, C., 2014. Analyzing the transition to electric drive vehicles in the U.S. *Futures* 58, 34–52. doi:10.1016/j.futures.2013.07.003
- Greve, T., Teng, F., Pollitt, M., Strbac, G., 2017. A system operator's utility function for the frequency response market. *Cambridge Work. Pap. Econ.*
- Gyamfi, S., Krumdieck, S., Urmee, T., 2013. Residential peak electricity demand response - Highlights of some behavioural issues. *Renew. Sustain. Energy Rev.* doi:10.1016/j.rser.2013.04.006
- Han, S., Han, S., Sezaki, K., 2010. Development of an optimal vehicle-to-grid aggregator for frequency regulation. *IEEE Trans. Smart Grid.* doi:10.1109/TSG.2010.2045163
- Harrison, G.W., Lau, M.I., Rutström, E.E., 2010. Individual discount rates and smoking: Evidence from a field experiment in Denmark. *J. Health Econ.* doi:10.1016/j.jhealeco.2010.06.006
- Harrison, G.W., Lau, M.I., Williams, M.B., 2002. Estimating Individual Discount Rates in Denmark: A Field Experiment. *Am. Econ. Rev.* doi:10.1257/000282802762024674
- Haugneland, P., Kvisle, H.H., 2015. Norwegian electric car user experiences. *Int. J. Automot. Technol. Manag.* 15, 194. doi:10.1504/IJATM.2015.068548
- Hausman, J.A., 1979. Individual Discount Rates and the Purchase and Utilization of Energy-Using Durables. *Bell J. Econ.* doi:10.2307/3003318
- Hirth, L., Ziegenhagen, I., 2015. Balancing power and variable renewables: Three links. *Renew. Sustain. Energy Rev.* 50, 1035–1051. doi:10.1016/j.rser.2015.04.180
- Horne, M., Jaccard, M., Tiedemann, K., 2005. Improving behavioral realism in hybrid energy-economy models using discrete choice studies of personal transportation decisions. *Energy Econ.* doi:10.1016/j.eneco.2004.11.003
- Hu, J., Morais, H., Sousa, T., Lind, M., 2016. Electric vehicle fleet management in smart grids: A review of services, optimization and control aspects. *Renew. Sustain. Energy Rev.* doi:10.1016/j.rser.2015.12.014
- International Energy Agency, 2018. *Global EV Outlook 2018.* doi:10.1787/9789264302365-en
- International Energy Agency, 2017. *Energy Technology Perspective: Data Visualisation [WWW Document].* URL <https://www.iea.org/etp/explore/> (accessed 9.18.18).
- IPCC, 2014a. *Climate Change 2014 Synthesis Report Summary Chapter for Policymakers.* doi:10.1017/CBO9781107415324
- IPCC, 2014b. *Summary for Policymakers, Climate Change 2014: Mitigation of Climate Change. Contribution of Working Group III to the Fifth Assessment Report of the Intergovernmental Panel on Climate Change.* doi:10.1017/CBO9781107415324
- IRENA, 2017. *Costs [WWW Document].* URL <http://www.irena.org/costs> (accessed 9.25.18).
- Jargstorf, J., Wickert, M., 2013. Offer of secondary reserve with a pool of electric vehicles on the German market. *Energy Policy* 62, 185–195. doi:10.1016/j.enpol.2013.06.088
- Jia, N.X., Yokoyama, R., 2003. Profit allocation of independent power producers based on cooperative Game theory, in: *International Journal of Electrical Power and Energy System.* doi:10.1016/S0142-0615(02)00180-1
- Joskow, P.L., 2008. *Lessons Learned from Electricity Market Liberalization.* *Energy J.* 29. doi:10.5547/ISSN0195-6574-EJ-Vol29-NoSI2-3
- Joskow, P.L., Schmalensee, R., 1988. *Markets for Power: An Analysis of Electrical Utility Deregulation,* MIT Press Books.
- Kahn, A.E., Cramton, P.C., Porter, R.H., Tabors, R.D., 2001. *Uniform Pricing or Pay-as-Bid Pricing.*

Electr. J. 14, 70–79. doi:10.1016/S1040-6190(01)00216-0

- Kang, J., Duncan, S.J., Mavris, D.N., 2013. Real-time scheduling techniques for electric vehicle charging in support of frequency regulation, in: *Procedia Computer Science*. doi:10.1016/j.procs.2013.01.080
- Kempton, W., Tomić, J., 2005. Vehicle-to-grid power fundamentals: Calculating capacity and net revenue. *J. Power Sources* 144, 268–279. doi:10.1016/j.jpowsour.2004.12.025
- Koliou, E., Eid, C., Chaves-Ávila, J.P., Hakvoort, R.A., 2014. Demand response in liberalized electricity markets: Analysis of aggregated load participation in the German balancing mechanism. *Energy*. doi:10.1016/j.energy.2014.04.067
- Mau, P., Eyzaguirre, J., Jaccard, M., Collins-Dodd, C., Tiedemann, K., 2008. The “neighbor effect”: Simulating dynamics in consumer preferences for new vehicle technologies. *Ecol. Econ*. doi:10.1016/j.ecolecon.2008.05.007
- Meeus, L., Vandezande, L., Cole, S., Belmans, R., 2009. Market coupling and the importance of price coordination between power exchanges. *Energy* 34, 228–234. doi:10.1016/j.energy.2008.04.013
- Ministère de la Transition Ecologique et Solidaire, 2008. Enquête nationale transports et déplacements (ENTD) 2008 [Sources et Méthodes, Opérations statistiques et production d'indices, Transports]: Observation et statistiques [WWW Document]. URL <http://www.statistiques.developpement-durable.gouv.fr/sources-methodes/enquete-nomenclature/1543/139/enquete-nationale-transports-deplacements-entd-2008.html> (accessed 10.16.17).
- Mott MacDonald, 2013. Impact Assessment on European Electricity Balancing Market.
- Muthoo, A., Osborne, M.J., Rubinstein, A., 1996. A Course in Game Theory. *Economica*. doi:10.2307/2554642
- National Grid, 2018. Wider Access to the Balancing Mechanism Roadmap Wider BM Access Roadmap 38.
- National Grid, 2017. Firm Frequency Response Frequently Asked Questions.
- National Grid, 2016a. Mandatory response services [WWW Document]. URL <https://www.nationalgrideso.com/balancing-services/frequency-response-services/mandatory-response-services?overview> (accessed 10.10.18).
- National Grid, 2016b. Enhanced Frequency Response 44, 1–29.
- Navid, N., Rosenwald, G., 2012. Market solutions for managing ramp flexibility with high penetration of renewable resource. *IEEE Trans. Sustain. Energy*. doi:10.1109/TSTE.2012.2203615
- Newbery, D., Strbac, G., Viehoff, I., 2016. The benefits of integrating European electricity markets. *Energy Policy* 94, 253–263. doi:10.1016/j.enpol.2016.03.047
- Noori, M., Zhao, Y., Onat, N.C., Gardner, S., Tatari, O., 2016. Light-duty electric vehicles to improve the integrity of the electricity grid through Vehicle-to-Grid technology: Analysis of regional net revenue and emissions savings. *Appl. Energy* 168, 146–158. doi:10.1016/j.apenergy.2016.01.030
- Parsons, G.R., Hidrue, M.K., Kempton, W., Gardner, M.P., 2014. Willingness to pay for vehicle-to-grid (V2G) electric vehicles and their contract terms. *Energy Econ*. 42, 313–324. doi:10.1016/j.eneco.2013.12.018
- Rebours, Y., 2009. A Comprehensive Assessment of Markets for Frequency To cite this version : A Comprehensive Assessment of Markets for Frequency and Voltage Control Ancillary Services 322.
- Rious, V., Perez, Y., Roques, F., 2015. Which electricity market design to encourage the development of demand response? *Econ. Anal. Policy*. doi:10.1016/j.eap.2015.11.006
- Roques, F.A., Nuttall, W.J., Newbery, D.M., 2006. Using Probabilistic Analysis to Value Power Generation Investments under Uncertainty. EPRG Work. Pap.
- RTE, 2018. RTE - Portail clients - Fréquence du réseau [WWW Document]. URL <https://clients.rte->

- france.com/lang/fr/visiteurs/vie/vie_frequence.jsp (accessed 7.5.18).
- RTE, 2016a. Règles Services Système.
- RTE, 2016b. Constitution des réserves primaire par appel d'offres transfrontalier.
- Samarakoon, K., Ekanayake, J., Jenkins, N., 2012. Investigation of domestic load control to provide primary frequency response using smart meters. *IEEE Trans. Smart Grid*. doi:10.1109/TSG.2011.2173219
- Singarao, V.Y., Rao, V.S., 2016. Frequency responsive services by wind generation resources in United States. *Renew. Sustain. Energy Rev.* doi:10.1016/j.rser.2015.11.011
- Soares M.C. Borba, B., Szklo, A., Schaeffer, R., 2012. Plug-in hybrid electric vehicles as a way to maximize the integration of variable renewable energy in power systems: The case of wind generation in northeastern Brazil. *Energy*. doi:10.1016/j.energy.2011.11.008
- Sortomme, E., El-Sharkawi, M.A., 2011. Optimal charging strategies for unidirectional vehicle-to-grid. *IEEE Trans. Smart Grid* 2, 119–126. doi:10.1109/TSG.2010.2090910
- Sortomme, E., Hindi, M.M., MacPherson, S.D.J., Venkata, S.S., 2011. Coordinated charging of plug-in hybrid electric vehicles to minimize distribution system losses. *IEEE Trans. Smart Grid*. doi:10.1109/TSG.2010.2090913
- Stern, N.H., 2007. Stern Review: The Economics of Climate Change. *Stern Rev. Econ. Clim. Chang.* 17, 712. doi:10.1177/0027950107077111
- Sundström, O., Binding, C., 2012. Flexible charging optimization for electric vehicles considering distribution grid constraints. *IEEE Trans. Smart Grid*. doi:10.1109/TSG.2011.2168431
- Thomas, C.D., Cameron, A., Green, R.E., Bakkenes, M., Beaumont, L.J., Collingham, Y.C., Erasmus, B.F.N., de Siqueira, M.F., Grainger, A., Hannah, L., Hughes, L., Huntley, B., van Jaarsveld, A.S., Midgley, G.F., Miles, L., Ortega-Huerta, M.A., Townsend Peterson, A., Phillips, O.L., Williams, S.E., 2004. Extinction risk from climate change. *Nature* 427, 145–148. doi:10.1038/nature02121
- Thompson, A.W., 2018. Economic implications of lithium ion battery degradation for Vehicle-to-Grid (V2X) services. *J. Power Sources*. doi:10.1016/j.jpowsour.2018.06.053
- Tomić, J., Kempton, W., 2007. Using fleets of electric-drive vehicles for grid support. *J. Power Sources* 168, 459–468. doi:10.1016/J.JPOWSOUR.2007.03.010
- Trovato, V., Sanz, I.M., Chaudhuri, B., Strbac, G., 2017. Advanced Control of Thermostatic Loads for Rapid Frequency Response in Great Britain. *IEEE Trans. Power Syst.* doi:10.1109/TPWRS.2016.2604044
- Ulbig, A., Andersson, G., 2015. Analyzing operational flexibility of electric power systems. *Int. J. Electr. Power Energy Syst.* doi:10.1016/j.ijepes.2015.02.028
- UNFCCC Secretariat, 2015. Paris Agreement.
- US Department of Energy, 2017. Confronting the Duck Curve: How to Address Over-Generation of Solar Energy | Department of Energy [WWW Document]. URL <https://www.energy.gov/eere/articles/confronting-duck-curve-how-address-over-generation-solar-energy> (accessed 10.2.18).
- van der Kam, M., van Sark, W., 2015. Smart charging of electric vehicles with photovoltaic power and vehicle-to-grid technology in a microgrid; a case study. *Appl. Energy*. doi:10.1016/j.apenergy.2015.04.092
- Vaya, M.G., Andersson, G., 2012. Centralized and decentralized approaches to smart charging of plug-in Vehicles, in: *IEEE Power and Energy Society General Meeting*. doi:10.1109/PESGM.2012.6344902
- Wang, D., Coignard, J., Zeng, T., Zhang, C., Saxena, S., 2016. Quantifying electric vehicle battery degradation from driving vs. vehicle-to-grid services. *J. Power Sources* 332, 193–203. doi:10.1016/j.jpowsour.2016.09.116
- Wind Europe, 2017. Wind energy in Europe: Scenarios for 2030. *Wind Eur.* 32.

Wolters, H., Schuller, F., 1997. Explaining supplier-buyer partnerships: A dynamic game theory approach. *Eur. J. Purch. Supply Manag.* doi:10.1016/S0969-7012(97)00011-7

LIST OF PUBLICATIONS

International Journals

Published

Borne, O., Korte, K., Perez, Y., Petit, M., Purkus, A., 2018. Barriers to entry in frequency-regulation services markets: Review of the status quo and options for improvements. *Renew. Sustain. Energy Rev.* 81. doi:10.1016/j.rser.2017.08.052

Borne, O., Perez, Y., Petit, M., 2018. Market integration or bids granularity to enhance flexibility provision by batteries of electric vehicles. *Energy Policy* 119, 140–148. doi:10.1016/j.enpol.2018.04.019

Submitted

Borne, O., Perez, Y., Petit, M., 2019. Net-Present-Value Analysis of Bidirectional EV Chargers providing Frequency Containment Reserve. *IEEE Trans. Power Syst.*

International Conferences

Borne, O., Perez, Y., Petit, M., 2018. Net-Present-Value Analysis for Bidirectional EV Chargers Providing Frequency Containment Reserve, in: 2018 15th International Conference on the European Energy Market (EEM) . IEEE, Lodz. doi:10.1109/EEM.2018.8469840

Borne, O., Petit, M., Perez, Y., 2018. Provision of Frequency-Containment-Reserve by Electric Vehicles: Impact of Technical Requirements, in: 2018 IEEE PES Innovative Smart Grid Technologies Conference Europe (ISGT-Europe). Sarajevo, pp. 1–6. doi:10.1109/ISGTEurope.2018.8571804

Borne, O., Petit, M., Perez, Y., 2017. Market integration VS temporal granularity: How to provide needed flexibility resources?, in: International Conference on the European Energy Market, EEM. doi:10.1109/EEM.2017.7981971

Borne, O., Petit, M., Perez, Y., 2016. Provision of frequency-regulation reserves by distributed energy resources: Best practices and barriers to entry, in: 2016 13th International Conference on the European Energy Market (EEM). IEEE, pp. 1–7. doi:10.1109/EEM.2016.7521215

SUMMARY IN FRENCH

CHAPITRE 1 : LE VEHICULE ELECTRIQUE A LA CONVERGENCE DE DEUX INDUSTRIES EN MUTATION

Les ventes de Véhicules Electriques ont été en constante augmentation ces dix dernières années, stimulées par l'adoption de politiques publiques favorisant la décarbonation du secteur automobile : imposition de normes restrictives d'émission sur les modèles vendus, soutien à la demande par la mise en place de primes ou d'exemptions de taxes à l'achat du véhicule, développement du réseau d'infrastructure de recharge. Ces différentes mesures devraient permettre de réduire les coûts liés à la fabrication de la batterie, d'augmenter l'autonomie des véhicules, de diversifier les modèles proposés par les constructeurs et d'aboutir à la mise en place d'un système de mobilité cohérent autour du véhicule électrique.

Dans un contexte d'accroissement des énergies renouvelables dans le mix énergétique, entraînant des besoins plus importants en flexibilité, la diffusion massive des véhicules électriques pourrait constituer une nouvelle source de contrainte si la recharge n'est pas gérée de manière intelligente. En particulier, la recharge non contrôlée des véhicules pourrait contribuer à l'augmentation des pics de consommation journaliers, et introduire des congestions sur les réseaux de distribution, nécessitant des investissements importants pour redimensionner les différents éléments du réseau.

La gestion de la recharge des flottes de Véhicules Electriques peut aussi constituer une opportunité pour apporter cette flexibilité. La batterie des véhicules étant dimensionnée pour des trajets longue distance, son autonomie est largement surdimensionnée pour des trajets pendulaires quotidiens, ce qui laisse place à une flexibilité dans la gestion du processus de recharge. Cette flexibilité pourrait être renforcée par la mise en place d'un chargeur bidirectionnel, permettant la réinjection d'électricité sur le réseau.

Plusieurs options sont possibles dans la mise en place d'une recharge intelligente. La première est l'arbitrage en énergie sur les marchés de l'électricité. Cette solution vise à diminuer les coûts de recharge, en déplaçant la recharge aux heures où l'électricité est peu chère, et dans le cas où le véhicule est équipé d'un chargeur bidirectionnel, à réinjecter de l'électricité les heures où elle est chère. Cette première solution est relativement simple à mettre en place car elle ne nécessite pas une gestion fine de la recharge. En revanche, les gains attendus sont limités et dépendent de la volatilité journalière du prix de gros de l'électricité.

Pour une stratégie unidirectionnelle, des gains peuvent être réalisés en décalant la recharge sur une plage horaire fixe (entre 3h00 et 5h00) où les prix sont en moyenne les plus bas (entre 20€/an au Danemark et 60€/an en France). De faibles gains supplémentaires seront réalisés si la charge est optimisée de façon journalière. Dans le cas d'une recharge bidirectionnelle, les gains sont réalisés en effectuant une décharge les jours où la volatilité du prix est la plus importante. Des gains de 10€/an par rapport à une recharge unidirectionnelle optimisée peuvent être attendus en France pour 10 heures de décharge dans l'année (20 €/an si 100 heures de décharge sont autorisées). Il peut être intéressant de limiter les heures de décharge de la batterie, car cela peut avoir un impact sur sa durée de vie.

Les flottes de Véhicules Electriques peuvent également proposer des services de flexibilité aux Gestionnaires de Réseaux de Transport : ce sont les réserves. Un acteur met à disposition une capacité à moduler sa production ou sa consommation afin de rétablir l'équilibre du réseau. Plusieurs types de réserve existent, suivant une classification établie par l'ENTSO-e. Les services ayant une valorisation importante sur la capacité mise à disposition et étant faiblement sollicités sont les plus intéressants pour des flottes de VE, car leur fourniture aura un impact moindre tant sur la durée de vie de la batterie que sur les contraintes liées à la mobilité de l'utilisateur.

La recherche s'est principalement intéressée à la conception d'algorithmes permettant cette recharge « intelligente », qui prennent en compte les besoins en mobilité des utilisateurs, tout en fournissant différents services de flexibilité. Cependant, un algorithme de recharge ne suffit pas à évaluer l'intérêt d'une solution. Différents aspects doivent être pris en compte : comment la solution pourra être valorisée dans un cadre institutionnel ? Quels sont les coûts liés à l'implémentation de la solution ? Quel est l'attrait des utilisateurs pour la solution, quelle rémunération attendent-ils pour leur participation ? Comment répartir la valeur entre les différents acteurs de la chaîne de valeur ?

Cette thèse s'attache à aller au-delà de l'aspect algorithmique, en balayant l'ensemble des aspects qui permettraient d'aboutir à un modèle d'affaire viable, et en se focalisant sur la fourniture d'un type de service : la réserve primaire (Frequency Containment Reserve), qui constitue le service identifié comme ayant la plus forte valeur pour des flottes de Véhicules équipés de chargeurs bidirectionnels.

CHAPITRE 2 : IMPACT DES REGLES DE MARCHE SUR LA FOURNITURE DE FLEXIBILITE PAR DES RESSOURCES DECENTRALISEES

Une première étape pour évaluer l'intérêt de rentrer sur un marché est d'évaluer les barrières à l'entrée qui existent sur ce marché. Ces barrières à l'entrée résultent de la construction des marchés en question, réalisée à une époque où seuls des moyens de production centralisés pouvaient fournir de la réserve. Avec l'arrivée de nouveaux moyens pour fournir ces réserves, il est nécessaire de redéfinir les règles de marché pour leur permettre de participer.

Trois différents types de barrières à l'entrée ont été identifiés, qui constituent des niveaux successifs.

Le premier niveau est constitué par les **Règles administratives concernant l'agrégation de ressources décentralisées**. On distingue ici des règles qui peuvent empêcher explicitement l'agrégation de ressources, ou exclure certains types d'unité du marché (les unités de consommation, les actifs connectés au réseau de distribution...). L'agrégation de ressources connectées à plusieurs Gestionnaires de Réseau de Distribution ou de Transport peut aussi être empêchée.

Le deuxième niveau est celui constitué par les **Règles définissant les caractéristiques des produits échangés**. On distingue la durée des produits, le volume minimum et le pas de volume des offres, le délai entre la clôture du marché et la livraison du produit et la symétrie des offres entre réserve à la hausse et à la baisse. Ces règles peuvent ne pas convenir aux opérations d'un agrégateur. Par exemple si la durée des offres est longue et que les actifs agrégés sont disponibles de manière périodique (ce qui est le cas pour des véhicules électriques), l'agrégateur dimensionnera sa réserve offerte sur le plus bas volume de la période de livraison. Ces barrières peuvent être contournées par l'agrégation d'actifs aux caractéristiques différentes, quand les règles du premier niveau le permettent.

Finalement le troisième niveau est constitué des **Règles définissant la rémunération des offres**. On distingue des processus de marché se basant sur des offres faites par les participants, des mécanismes administratifs, où la rémunération est faite sur un tarif régulé. Dans les mécanismes de marché, on peut distinguer deux alternatives : la rémunération au prix offert, ou la rémunération au prix marginal. La rémunération au prix offert est moins favorable à de nouveaux acteurs, car elle nécessite d'anticiper la valeur de la dernière offre acceptée afin de tirer la rémunération la plus haute possible, et donc une bonne connaissance du marché.

Afin d'illustrer l'utilisation de ce cadre d'analyse, on réalise deux études de cas : une comparaison de quatre pays (France, Allemagne, Danemark et Grande-Bretagne), réalisée en 2016, sur les

réserves primaire et secondaire ; et une analyse de la modification des règles de marché sur la réserve primaire en 2017.

La comparaison des quatre zones de marché révèle de grandes disparités entre les différents pays. La France se distingue par un mécanisme administratif d'allocation des réserves. Les unités de production centralisées se voient allouée une partie de la réserve au prorata de leur production, rémunérée à un tarif régulé décidé annuellement. Cependant, des actifs décentralisés peuvent obtenir une préqualification (dans la limite de 20 MW par agrégateur et 40 MW au total). Ces agrégateurs peuvent ensuite vendre de la réserve aux producteurs centralisés à un prix fixé par une négociation bilatérale, via une Notification d'Echange de Réserve. Ce mécanisme ne permet pas d'avoir une visibilité suffisante sur la rémunération possible de la réserve. L'Allemagne se distingue elle par la longueur des produits, qui est d'une semaine pour la réserve primaire comme pour la réserve secondaire. Cette durée rend difficile l'entrée d'actifs ayant une disponibilité sur la journée. Le Danemark possède des règles plus avantageuses, avec des durée d'offre de 4 heures avec un pas de temps de 0,1 MW. Enfin, la Grande-Bretagne est caractérisée par une diversité de mécanisme, avec une complexité et un manque de transparence sur chacun de ces mécanismes rendant complexe l'arrivée de nouveaux acteurs.

En 2017, la France a changé les règles citées précédemment, pour adopter un mécanisme de marché sur la réserve primaire, en rejoignant le marché constitué par l'Allemagne et les pays avoisinant. Elle s'est donc calée sur une durée de produit d'une semaine, défavorable aux agrégateurs. Ce changement s'inscrit dans un processus d'harmonisation des règles au niveau européen afin de créer des zones de marché pan-européenne. Ces règles devraient être amenée à évoluer dans les années à venir, pour adopter des durées de produits de 4 heures, plus favorables à de nouveaux entrants.

CHAPITRE 3 : ETUDE DES REVENUS ET DE LA VALEUR ACTUELLE NETTE D'UNE FLOTTE DE VEHICULES FOURNISSANT DE LA RESERVE PRIMAIRE

Nous souhaitons maintenant connaître la valeur d'un investissement dans des véhicules équipés de chargeur bidirectionnel capables de fournir de la réserve primaire.

Nous utilisons pour cela des simulations de flotte de Véhicules Electriques et procédons en deux étapes : une évaluation des revenus de la flotte, suivant plusieurs scénarios de règles de marché (durée des offres et pas de volume) et de puissance de bornes de charge. Nous considérons ensuite les coûts associés à l'implémentation des chargeurs et à la gestion de la flotte pour déterminer la Valeur Actuelle Nette de l'investissement.

Le modèle de simulation de la flotte se découpe en trois module. Le premier module permet d'affecter à chaque véhicule des trajets quotidiens sur l'horizon de temps de la simulation à partir de distributions stochastiques sur ces trajets. On établit à partir de ces trajets les contraintes sur l'utilisation de la batterie, afin d'être capable de satisfaire les besoins en mobilité de l'utilisateur. Dans le second module, on simule la participation de la flotte à la réserve primaire, en considérant des relevés historiques de fréquence du réseau européen. L'algorithme utilisé permet de maximiser la réserve fournie tout en satisfaisant les besoins en mobilité de chaque utilisateur et les requis techniques de fourniture de réserve primaire. On obtient en sortie de ce module la réserve disponible pour la flotte considérée sur l'horizon temporel de la simulation. En répétant ces deux premiers modules N fois avec des affectations de trajet différentes et des données de fréquence différentes, on prend en compte la variabilité sur ces deux paramètres. A partir de ces différentes simulations, on peut déterminer dans le troisième module l'offre qui permette de satisfaire les règles de marché tout en s'assurant que la réserve sera effectivement disponible.

Nous validons ensuite ce modèle sur deux tests différents : le premier avec une distribution stochastique des trajets connue par l'agrégateur, un deuxième avec une incertitude sur les caractéristiques de la distribution stochastique. Dans le deuxième cas, l'introduction d'un coefficient de sécurité permet de valider le modèle.

On évalue les revenus sur trois scénarios de durée des offres (une semaine, 4 heures et 1 heure), trois scénarios de pas de volume (volume minimum de 1 MW et pas de volume de 1 MW, volume minimum de 1 MW et pas de volume de 100 kW, volume minimum de 100 kW et pas de volume de 100 kW) et trois scénarios de puissance de prise, avec des flottes allant jusqu'à 5000 VE.

Le pas de volume de 1 MW introduit des effets de seuils : en effet les revenus de l'agrégateur restent constants tant qu'un nouveau palier de puissance n'est pas atteint, diminuant le revenu par véhicule. Ces effets de seuils sont d'autant plus importants que la durée des offres est importante. Ces effets de seuils disparaissent lorsque le pas de volume est de 100 kW. Par ailleurs, la diminution de la durée des offres permet d'augmenter substantiellement les revenus par véhicule. Dans le meilleur des scénarios étudiés, on atteint un revenu de 1200 €/VE/an. Le scénario central aboutit à un revenu de 280 €/VE/an.

On veut ensuite connaître la valeur d'un investissement dans une flotte de véhicules équipés de chargeurs bidirectionnels. Il est important de prendre en compte les différents coûts liés à la fourniture de réserve primaire. D'une part, les coûts d'investissement liés à l'implémentation sur le véhicule des fonctions nécessaires à cette fourniture. D'autre part, les coûts récurrents liés à la gestion de la flotte en temps réel. La rentabilité de l'investissement est évaluée par le calcul de la Valeur Actuelle Nette (VAN). Si elle est positive, l'investissement peut être considéré comme rentable.

On simule des flottes allant jusqu'à 100 000 VE. On prend par ailleurs en considération une limitation sur le volume maximal pouvant être fourni par un agrégateur de 150 MW. Cette limite est imposée par l'ENTSO-e pour assurer une diversification des fournisseurs de réserve. Pour quatre scénarios de règles de marché, on identifie la Valeur Actuelle Nette par VE maximale pouvant être atteinte ainsi que le nombre minimum de véhicule à agréger pour atteindre une VAN positive. La VAN maximale varie entre 170 € et 760 €, et la taille minimale de la flotte entre 200 VE et 19,000 VE.

Une analyse de sensibilité est menée afin d'identifier les paramètres qui ont le plus d'influence sur ces deux indicateurs. Le prix de la réserve est celui qui a le plus d'impact, quel que soit le scénario de règle de marché. On mène également une analyse de sensibilité sur les paramètres de la flotte (disponibilité et puissance des bornes de charge).

CHAPITRE 4 : VALEUR D'UNE COOPERATION ENTRE AGREGATEUR ET CONSTRUCTEUR AUTOMOBILE

Dans le Chapitre précédent, nous avons exploré dans quelles conditions l'investissement dans des véhicules équipés de chargeurs bidirectionnels pourrait s'avérer rentable. Cela n'est cependant pas suffisant pour conclure à la viabilité du business model. En effet, la chaîne de valeur est complexe et plusieurs acteurs vont intervenir dans cette chaîne de valeur, en fonction des compétences de chacun.

En particulier, deux acteurs vont être directement impliqués dans cette chaîne de valeur : le constructeur automobile, chargé d'intégrer la fonction bidirectionnelle sur le véhicule, et l'agrégateur, chargé d'opérer la flotte et de faire les offres sur les marchés. Dans ce quatrième chapitre, nous développons un cadre d'analyse permettant d'appréhender les interactions entre ces deux acteurs et d'identifier les gains qu'ils auraient à établir une coopération afin de construire

leurs offres. Par ailleurs, nous introduisons une courbe de demande pour la fonction bidirectionnelle, qui modélise l'attrait des consommateurs pour cette technologie.

Dans ce cadre, le constructeur réalise l'intégration de la fonction et supporte donc les coûts d'investissement. Il est chargé de fixer un prix de vente pour l'option de chargeur bidirectionnel, qui doit lui permettre au moins d'amortir ses coûts d'investissement. L'agrégateur est lui en charge de la gestion de la flotte et supporte donc les coûts récurrents. Il doit également fixer le versement annuel aux utilisateurs pour leur participation.

Les utilisateurs observent le prix de vente et la rémunération et décident de l'achat ou non de la fonction bidirectionnelle avec le véhicule. Nous modélisons l'hétérogénéité des utilisateurs par une fonction de demande, qui fait correspondre à une Valeur Actuelle Nette perçue par l'utilisateur un nombre de véhicules équipés de la fonction. Plus la VAN des utilisateurs est importante, plus le nombre de véhicule équipés est grand.

Le modèle nous permet de calculer les gains des deux utilisateurs. Le gain du constructeur est le produit du nombre de véhicules équipés et de la marge qu'il réalise sur l'installation. Le gain de l'agrégateur est également le produit du nombre de véhicules dans la flotte et de la marge qu'il peut réaliser (qui dépend de la taille de sa flotte, puisque le revenu par véhicule dépend du nombre de véhicule, comme nous l'avons vu dans le chapitre précédent). Le nombre de fonctions installées dépendant des prix de vente et versement annuel, il existe une interdépendance entre les deux acteurs. Ainsi, le constructeur ne peut pas fixer un prix de vente trop élevé s'il constate que le versement est faible et vice-versa.

On cherche à modéliser les interactions entre les deux acteurs et leurs stratégies (la fixation du prix de vente pour le constructeur et du versement pour l'agrégateur) dans trois cas d'étude en s'inspirant du cadre de la théorie des jeux :

- Dans le premier cas d'étude, les deux acteurs ne coopèrent pas et cherchent à maximiser leurs gains en anticipant le comportement de l'autre acteur. On cherche à identifier le point d'équilibre (qui constitue un équilibre de Nash) où aucun des acteurs ne peut augmenter ses gains en changeant sa stratégie unilatéralement.
- Dans le deuxième cas d'étude, les deux acteurs vont collaborer pour établir une stratégie qui permette d'augmenter les gains des deux acteurs par rapport au premier cas d'étude. Cette stratégie ne sera plus un point d'équilibre de Nash car un des acteurs pourrait modifier sa stratégie unilatéralement en vue d'augmenter ses gains.
- Enfin, le troisième cas d'étude est similaire au précédent mais inclus la possibilité d'échange financier entre les deux acteurs. L'agrégateur verse une partie de son gain annuel au constructeur, qui peut donc fixer le prix de vente en dessous du coût d'investissement.

Ces différents résultats sont étudiés en fonction de l'intensité de la demande pour l'option (une forte intensité signifiant que les utilisateurs n'attendent pas une rémunération importante). Les résultats de ces trois cas d'analyse démontrent l'intérêt à mettre en place une coopération entre les deux acteurs : les gains attendus augmentent uniquement quand l'intensité de la demande est faible dans le cas d'une coopération sans échange financier, et quelle que soit l'intensité de la demande dans le cas d'une coopération avec échange financier. Par ailleurs, on observe que le gain du constructeur diminue avec l'intensité de la demande au-delà d'une certaine valeur, ceci étant dû à la limitation sur le volume offert de 150 MW (voir chapitre précédent). Enfin, dans le cas d'une coopération avec échange, le constructeur adapte sa stratégie en fixant le prix de vente de la fonction à zéro, sa rémunération venant entièrement du versement de l'agrégateur.

Nous introduisons ensuite une fonction de revenu de la flotte simplifiée, afin de pouvoir exprimer les gains des acteurs de manière analytique. Ce cadre est validé par une comparaison avec les résultats de simulation et une analyse de sensibilité est menée. Les résultats de cette analyse

SUMMARY IN FRENCH

montrent des effets de non-linéarité, ce qui démontre la complexité à mettre en place un business-model optimal sur ces services.

Titre : Vehicle-To-Grid et Flexibilité pour les Réseaux d'Electricité : de la Solution Technique à la Construction de Business Model

Mots clés : Véhicule Electrique – Recharge Intelligente – Business Model

Résumé : Les ventes de Véhicules Electriques ont été en constante augmentation ces dix dernières années, stimulées par l'adoption de politique publique favorisant la décarbonation du secteur automobile. Dans un contexte d'accroissement des énergies renouvelables dans le mix énergétique, entraînant des besoins plus important en flexibilité, la diffusion massive des véhicules électriques pourrait constituer une nouvelle source de contrainte pour les gestionnaires de réseaux d'électricité si la recharge n'est pas gérée de manière intelligente.

La gestion de la recharge des flottes de Véhicules Electriques peut aussi constituer une opportunité pour apporter cette flexibilité, en particulier si les véhicules sont équipés de chargeurs bidirectionnels, capables de réinjecter de l'électricité dans le système pour équilibrer les réseaux.

La recherche s'est principalement intéressée à la conception d'algorithmes permettant cette recharge « intelligente », qui prennent en compte les besoins en mobilité des utilisateurs, tout en fournissant différents services de flexibilité.

Cette thèse s'attache à aller au-delà de l'aspect algorithmique, en balayant l'ensemble des aspects qui permettraient d'aboutir à un modèle d'affaire viable, et en se focalisant sur la fourniture d'un type de service : la réserve primaire (Frequency Containment Reserve), qui constitue le service identifié comme ayant la plus forte valeur pour des flottes de Véhicules équipés de chargeurs bidirectionnels.

Title : Vehicle-To-Grid and Flexibility for Electricity Systems: from Technical Solutions to Design of Business Models

Keywords : Electric Vehicles – Smart Charging – Business Models

Abstract: Transport industry being one of the first CO2 emitters, there is an urgent need to decarbonize this sector, which could be achieved by the conjunction of the electrification of the vehicles and decarbonization of the electricity generation mix. In conjunction with increasing flexibility needs to support the introduction of Renewable Energy Sources, the development of Electric Vehicles could add new constraints for System Operators if charging process is not managed in a smart way.

However, considering mobility requirements, there is a flexibility in the charging pattern of the vehicles, which could be used to offer flexibility

services to System Operators, using smart-charging algorithms. Moreover, this flexibility could increase with the possibility to have reverse flow from the battery to the grid.

Research focused mainly, during last years, on the design of algorithms to provide services with electric vehicles, taking into account mobility needs of users. In this thesis, we try to go beyond this design of algorithms, going through the different steps to elaborate a viable business model. We focus on the provision of one service – Frequency Containment Reserve – identified as the most valuable for Electric Vehicles equipped with bidirectional chargers.

