



**HAL**  
open science

# Enrichment of functional analysis for the construction sector by the integration of systems engineering and constructibility: application to the multifunctional metro

Nicolas Ziv

## ► To cite this version:

Nicolas Ziv. Enrichment of functional analysis for the construction sector by the integration of systems engineering and constructibility: application to the multifunctional metro. Civil Engineering. Université Paris-Est, 2018. English. NNT: 2018PESC1065. tel-02144013

**HAL Id: tel-02144013**

**<https://theses.hal.science/tel-02144013>**

Submitted on 29 May 2019

**HAL** is a multi-disciplinary open access archive for the deposit and dissemination of scientific research documents, whether they are published or not. The documents may come from teaching and research institutions in France or abroad, or from public or private research centers.

L'archive ouverte pluridisciplinaire **HAL**, est destinée au dépôt et à la diffusion de documents scientifiques de niveau recherche, publiés ou non, émanant des établissements d'enseignement et de recherche français ou étrangers, des laboratoires publics ou privés.

---

---

Enrichment of Functional Analysis for the construction sector  
by the integration of Systems Engineering and Constructibility

Application to the multifunctional metro.

*Thesis supervised by Christophe GOBIN*

---

---

**A thesis in fulfilment of the requirements for the degree of Doctor of Philosophy at  
Université Paris Est**

**Department of Civil Engineering**

**Presented by Nicolas ZIV**

**November 2018**

*Jury:*

*PhD. Jennifer WHYTE*

*Professor/Imperial College*

*Rapporteur*

*PhD. Yann POLLET*

*Professor/CNAM*

*Rapporteur*

*PhD. Charles-Edouard TOLMER*

*PhD/Egis*

*Reviewer*

*PhD. Youssef DIAB*

*Professor/Université Paris-Est*

*Reviewer*

*Jérémie SIMON*

*Project manager/Egis*

*Co-tutor*

*PhD. Christophe GOBIN*

*Professor/ESTP*

*Thesis Director*

*PhD. Andrea KINDINIS*

*Professor/ESTP*

*Co-tutor*



*Au Magicien  
et à la Princesse*



## Table of contents

Abstract.....	7
Résumé .....	8
Acknowledgements.....	9
1. Introduction.....	10
1.1. The global trend: an urban inrush.....	12
1.1.1. Increase of the urban population.....	12
1.1.2. Increase in urban construction needs.....	13
1.2. An increasing complexity of construction systems.....	13
1.2.1. More interactions: The compact city.....	14
1.2.2. More functions: multifunctional systems.....	15
1.2.3. New challenges: environmental requirements.....	19
1.3. Costs, Delays, Quality: the haunted house.....	20
1.3.1. Costs and delays in the construction industry.....	20
1.3.2. Quality in the construction industry.....	21
1.3.3. A productivity gap.....	23
1.4. Specific characteristics of the construction industry.....	25
1.4.1. Adapt space to carry human related activities.....	25
1.4.1.1. Human activities.....	25
1.4.1.2. Physical Space and Human space.....	27
1.4.2. Uniqueness of construction systems.....	31
1.4.3. Organization of construction projects in France and abroad.....	33
1.4.3.1. Stakeholders of construction projects.....	33
1.4.3.2. Laws and contracts.....	35
1.5. Scientific issues and thesis organization.....	39
1.5.1. Problem n°1: consideration of space in design methods.....	39
1.5.2. Problem n°2: consideration of the Enabling System in design methods.....	39
1.5.3. Insights for the thesis reading.....	39
2. State of the art: Functional Analysis, Systems Engineering and Constructability.....	43
2.1. The System paradigm.....	46
2.1.1. What is a system?.....	47
2.1.2. Construction systems and Complex systems.....	48
2.1.3. Construction systems and System-of-Systems (SoS).....	53
2.1.4. The triadic decomposition of any function.....	56
2.1.5. Systems as « black boxes ».....	57
2.2. Functional analysis.....	58
2.2.1. What is Functional Analysis?.....	58
2.2.2. Functional analysis goals.....	59
2.2.3. Functional analysis methods.....	60
2.2.4. Evaluate the capability of technical solutions to realize functions.....	80

2.3.	Consideration of production constraints: the concept of Constructability .....	89
2.3.1.	Why constructability? .....	89
2.3.2.	Constructability, manufacturability, buildability and Lean Construction .....	91
2.3.3.	The concept of Constructability and its evolutions .....	96
2.3.4.	Conclusion: Constructability and design methodologies .....	122
2.4.	The management of complexity: Systems Engineering .....	122
2.4.1.	History .....	122
2.4.2.	Definition and objectives of Systems Engineering .....	123
2.4.3.	Lifecycle meta-models .....	125
2.4.4.	Systems of Interest and Enabling Systems .....	135
2.4.5.	Requirements Engineering (RE) .....	144
2.4.6.	Model-Based System Engineering (MBSE) .....	151
2.4.7.	Systems Engineering in the construction industry .....	160
	Lessons learn .....	171
3.	Enrichment of Functional Analysis to the construction industry through Systems Engineering and Constructibility integration.....	175
3.1.	Adaptation of System Engineering and Constructability methods for integration in Functional Analysis.....	179
3.1.1.	Integrate spatial characteristics of construction systems in Functional Analysis and Systems Engineering.....	179
3.1.2.	Improvement of the Constructibility concept.....	199
3.2.	Enrichment of Functional Analysis by the integration of Constructibility and Systems Engineering .	219
3.2.1.	Functional Analysis and Systems Architecture .....	219
3.2.2.	SysML and Functional Analysis .....	221
3.2.3.	Integration of Constructibility in Functional Analysis .....	225
3.3.	Development of tools at the crossroad of Functional Analysis, Systems Engineering and Constructibility.....	230
3.3.1.	Development of a tool to link SysML requirements and BIM models.....	230
3.3.2.	Development of a tool to assess Constructibility of a construction system at different phases ..	237
	Conclusion of part 3.....	244
4.	Application of the method on case studies .....	249
4.1.	Presentation of case studies .....	254
4.2.	Case Study n°1: Application of the method at the system level: the 5 <sup>th</sup> metro line of Lyon.....	257
4.3.	Case Study n°2: Application of the method at the sub-system level: the broadband network of the line 16 of the Greater Paris project.....	296
5.	General conclusion.....	327
5.1.	Contributions of the thesis .....	329
5.2.	Avenues for research .....	330
	Figures .....	332
	Bibliography .....	345

## Abstract

---

Objectives of the thesis is to enrich Functional Analysis, a design method oriented on the definition of functions, by the integration of two methodological corpuses: Constructability and Systems Engineering in order to adapt it to complex construction products. The enriched method is used and applied on an innovative concept: the multifunctional metro. This new concept consists in the integration of new functions in a metro system: not only transport people but also energy, information, wastes, merchandises, water etc. in order to answer to several city needs with a unique infrastructure.

In the introduction, after having describe challenges faced by the construction industry (budget overruns, delays, quality), we highlight that Functional Analysis has been used extensively in other industries to face similar issues. However, its application in the construction industry is limited due to its particularities: each project is unique, construction projects are complex and needs construction projects answer consist in adapting space in order to carry human or related activities. The identification of such particularities have led on one hand to the integration of constructability concepts and principles in Functional Analysis to better integrate development constraints of each project in the product development. On the other hand, to the adaption of Systems Engineering, a methodological corpus which objective is to manage complexity of the development of complex systems by the integration of spatial characteristics of construction products.

Firstly, Functional Analysis, Constructability and Systems Engineering corpuses are presented and issues are identified in these three methods to adapt them to complex construction projects for their integration.

Secondly, an enriched Functional Analysis method is proposed which integrates adapted Constructability and Systems Engineering concepts. Constructability notably, is improved with the integration of constraints from Design and Planning phases and a proposition is presented to shift from *Constructability* to *Constructibility*. Systems Engineering for its part is adapted by the integration of *spatial* characteristics of systems which is a main characteristic of construction products. A SysML tool (Systems Modeling Language) has been developed and linked with a BIM modeling tool to improve the capacity to model and verify requirements related to construction systems. The Constructibility matrix, a tool to ease the implementation and analysis of constructibility of construction products has also been developed.

Thirdly, the enriched Functional Analysis method developed in this thesis is applied on case studies. Case studies concern two different phases (planning and design) in two different projects where multifunctionality concepts have been investigated: the 5<sup>th</sup> metro line of Lyon where the evaluation of the integration of new functions in the metro line have been studied. And the line 16 of the Greater Paris Project where the integration of a broadband network was the opportunity to study the integration of a new function more at the design phase (transport information).

In conclusion we shall suggest some ways forward by outlining avenues for further researches: Other design methods exist for different purpose (innovation for the C-K theory) or which apply to different types of systems (System of Systems), how to define a unified design methodology for complex construction systems? How to measure Constructibility criteria at different systemic levels? How to apply such methodologies in different legal and contractual contexts? How to model abstract views of space in SysML or similar tools? Are questions which are potential avenues for future researchs.

**Key words:** Functional Analysis – Systems Engineering – Constructibility – Multifunctional Systems – Construction systems



## Résumé

---

L'objectif de la thèse est d'enrichir l'Analyse Fonctionnelle, une méthode de conception orientée sur la définition des fonctions d'un produit, pour le développement d'ouvrages complexes dans le domaine de la construction. Pour cela les concepts et pratiques de deux corpus méthodologiques sont adaptés et intégrés dans l'Analyse Fonctionnelle : l'Ingénierie Système et la Constructibilité. Cette méthode enrichie est appliquée sur un concept innovant de métro multifonctionnel qui consiste à utiliser un système unique pour répondre à plusieurs besoins de la ville : non seulement transporter des passagers mais aussi de l'eau, des déchets, de l'électricité, de la chaleur, de l'information, des marchandises et bien d'autres selon les particularités de chaque projet.

Dans l'introduction après avoir brièvement décrit les enjeux rencontrés dans le domaine de la construction, qui justifient le besoin de nouvelles méthodes, nous soulignons que l'Analyse Fonctionnelle a essentiellement été utilisée dans d'autres domaines que celui de la construction pour faire face aux mêmes problèmes. En revanche, son application au domaine de la construction est limitée du fait de la non prise en compte des particularités de ce secteur : le besoin auquel répondent les systèmes dans ce domaine sont d'adapter l'*espace* pour que s'y réalise des *activités humaines*, mais aussi que chaque projet est unique. L'unicité de chaque projet nous a amené à prendre en compte la constructibilité, soit les contraintes liées au développement de l'ouvrage, à différentes étapes de l'Analyse Fonctionnelle. L'Analyse Fonctionnelle est aussi mal adaptée pour le développement de systèmes complexes, ainsi, les concepts et outils de l'ingénierie Système, dont l'objectif est la maîtrise des systèmes complexes, sont intégrés à l'Analyse Fonctionnelle (V&V, SysML).

La première partie de la thèse consiste en un état de l'art des trois méthodes étudiées : l'Analyse Fonctionnelle, l'Ingénierie Système et la Constructibilité. Dans cette partie les blocages et des adaptations nécessaires sont identifiés.

Dans une deuxième partie, la méthode d'Analyse Fonctionnelle enrichie par la Constructibilité et l'Ingénierie Système est présentée. Le concept de Constructibilité notamment est étendu à la prise en compte non seulement des contraintes liées aux activités de réalisation mais aussi aux contraintes de conception et de planification/programmation (soit l'ensemble du système pour faire). L'Ingénierie Système pour sa part est adaptée en prenant en compte les caractéristiques spatiales des systèmes, composantes essentielles dans la construction. Deux outils ont été développés pendant la thèse permettant d'implémenter la méthode : un outil de modélisation des exigences basé sur le langage de modélisation SysML qui permet de lier les exigences avec des modèles BIM (Building Information Modelling) améliorant ainsi leur traçabilité et la facilitation de leur vérification, et la matrice de constructibilité qui permet d'analyser la constructibilité d'un système en prenant en compte l'ensemble des contraintes liées à son développement.

Troisièmement, la méthode d'Analyse Fonctionnelle enrichie est appliquée sur 2 cas d'études liés au métro multifonctionnel : l'application de ce concept sur les études de la 5<sup>ème</sup> ligne de Lyon vers Alaï et l'intégration d'un réseau de fibre optique alimentant l'île de France dans la ligne 16 du projet du Grand Paris.

En conclusion des pistes de recherche pour le futur sont proposées : d'autres méthodologies de conception existent avec des objectifs différents (innovation pour la théorie C-K) ou des nouveaux concepts (System of Systems). Comment développer une méthode de conception unifiée prenant en compte l'ensemble de ces aspects pour les systèmes complexes dans le domaine de la construction ? Ou comment mesurer et quantifier les critères de constructibilité ? Comment appliquer ces méthodes dans différents contextes législatifs et contractuels ? Comment modéliser des vues abstraites de l'espace dans un langage de modélisation tel que SysML ? Sont autant de questions qui méritent de nouvelles recherches ultérieures.

**Mots clés :** Analyse Fonctionnelle – Ingénierie Système – Constructibilité – Métro multifonctionnel – Construction

## Acknowledgements

---

First and foremost I would like to thank all the people who participated in my thesis supervision, specifically my thesis director Christophe GOBIN who directed my researches, took the time to share his experiences and knowledge, exchange and orient my researches.

Jérémie SIMON who was my tutor at Egis for its constant support, its wise advises, the quality of our exchanges, its great help all along the thesis and the time he dedicated to my works. Andrea KINDINIS my tutor at ESTP, for its time, its availability and all his research advises.

I would like to thank all the jury members who took the time to read and comment my thesis and for their constructive criticisms, interrogations and feedbacks on my works: Jennifer WHYTE, Yann POLLET, Youssef DIAB and Charles-Edouard TOLMER.

To all my colleagues at Egis who participated directly or indirectly to my researches and allowed me participating to Egis projects. Vincent KELLER, Didier LOMBARD, Emilie BURQUIER, Stéphane DUMARTY, Dominique URBAIN, Jean-Philippe RAMAUT. All the people from the DEAI (Département Etudes Amont et Innovation) department at Egis with whom I have shared most of my time during my three years at Egis and who shared their experiences and their point of view on my researches but also more globally on the infrastructure and transport domains.

To Pierre MARX with whom I shared my office during my three years in Lyon at Egis.

Thanks also to all the researchers and students at ESTP with whom I have worked and shared a lot and particularly to Francesca CONTRADA, Gilles THING LEO and Francis CLAUDE.

Many thanks also to Christophe CASTAING who integrated me into MINnD (Modélisation des INformations INteropérables pour les INfrastructures Durables) a French research group.

To my father, my mother my sisters and friends without whom none of this work would have been possible.

To all the people I have forgotten for accepting my apologies.

And to the SNCF for all the go and backs between Paris and Lyon.

# 1. Introduction

---

## Résumé de l'introduction en Français

Dans l'introduction nous présentons tout d'abord les enjeux auxquels est confrontée l'industrie de la construction : dépassement des couts, dépassement des délais (98% des projets subissent des retards de plus de 20 mois et des surcouts de plus de 80%), d'un manque de productivité en comparaison avec d'autres industries, d'une augmentation des besoins en infrastructures et en bâtiments (exode urbain, usages en évolution) et d'une augmentation de la complexité des projets (nombre d'interactions, multifonctionnalité des infrastructures). Le concept d'infrastructure multifonctionnelle est présenté, il sera appliqué au cas du métro multifonctionnel dans la dernière partie de cette thèse sur la 5<sup>ème</sup> ligne de Lyon et la ligne 16 du Grand Paris comme cas d'étude de la méthode développée.

Pour répondre à l'ensemble de ces enjeux il est nécessaire de développer de nouvelles approches, méthodes et outils. Ces éléments existent pour la plupart (comme l'Analyse Fonctionnelle, l'Ingénierie Système ou encore la Constructibilité qui seront présentés dans l'état de l'art) mais ont été utilisés dans d'autres industries comme l'aéronautique, l'automobile ou le secteur de la défense. Il est donc nécessaire dans un premier temps d'identifier les particularités du domaine de la construction afin d'évaluer leur applicabilité dans ce secteur. 3 particularités de ce domaine sont donc présentées dans cette partie : le ou les besoins auxquels répondent les produits de la construction, *aménager l'espace pour y développer des activités humaines*, l'unicité des produits de la construction et l'organisation des acteurs de ce secteur.

Enfin, 2 verrous scientifiques sont identifiés et feront l'objet de la méthode développée dans cette thèse : comment intégrer la dimension spatiale dans les méthodes d'ingénierie développée dans d'autres industries où cette dimension n'est quasiment pas mentionnée ? L'unicité des projets implique une meilleure prise en compte du « système pour faire » et des exigences qui y sont liées dans les méthodes de conception, comment définir le ou les « systèmes pour faire » dans le domaine de la construction et comment considérer ces éléments dans les méthodes de conception issues d'autres industries ?

## 1.1. The global trend: an urban inrush

### 1.1.1. Increase of the urban population

*“We are in a world I don’t belong to anymore. The one I have known, the one I have loved had 1.5 billion inhabitants. The current world counts 6 billion human beings. This is not mine anymore.”*

This quote of Levi-Strauss (2005) highlights that the current world is living major changes, in one century the world population has quadrupled. Meanwhile in 1800 only 2% of the population was living in cities, this proportion has grown to 54% in 2014 and could reach 72% in 2050 (Zhang, 2015). Indeed, numbers in 2025 are edifying: earth will certainly counts more than 9 billion inhabitants more than 1 human beings over 2 will live in city, 40 conurbations will have more than 10 million inhabitants and population of medium size cities will grow up for more than 50%. Theses megatrends lead to new urban problematics and exacerbate current ones in most parts of the world (Figure 1).

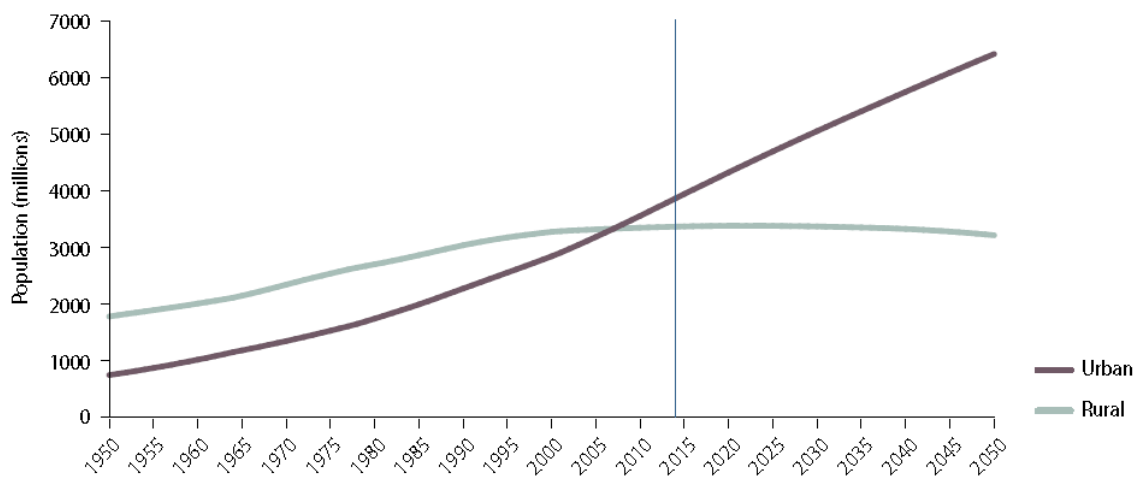


Figure 1: Evolution of rural and urban population in the world, 1950-2050 (United Nations, 2014)

Urban growth in cities is due to two factors, in one hand a global increase of the world population and in the other hand because of the agglomeration effects which accentuate this phenomena (Henderson, 2001), (Venables, 2007) and (Strange, et al., 2004). These authors also mentioned that the agglomeration effect enhances productivity and that activities are reinforce and preserve their local concentration. They notably distinguish two distinct agglomeration “forces”:

- **Economy of location:** the first reason which leads population to regroup in city centers comes from the concentration of jobs and activities in cities. To improve their productivity companies are brought to regroup to benefit from the effects of “agglomeration externalities”: services for companies are numerous, the number of opportunities is more important and there is a higher probability to find required competencies and conversely workers are more eager to find a job. Moreover, cities are usually the place of decision making.
- **Economy of urbanization:** Secondly, knowledge externalities are other points which can lead companies and populations to live in cities. Some non-codifiable information are more easily accessible which make cities a privileged place to foster exchanges, share knowledge, research and innovation. Geographic concentration also promotes transmission of knowledge and access to education (Henderson, 2001), (Prager, et al., 2013).

For all these reasons, increase of the world population is traduced by an important urban growth. A study leads by Ernst and Young and the Urban Land Institute in 2013 (EY and Urban Land Institute, 2013) insists on these effects

of agglomeration and the importance of infrastructures: “The need for infrastructure is becoming even more pressing as more of the world’s population crowds into urban centers. The world’s vast gateway cities—London, New York, Shanghai, Singapore, Mumbai, São Paulo, and Mexico City, among others—concentrate commerce, culture, businesses, government, universities, and medical centers. Surrounded by rapidly urbanizing areas, they generate jobs and wealth”.

**1.1.2. Increase in urban construction needs**

This increase in urban population impacts the way cities are functioning: traffic congestion, air pollution, noise disturbances, urban spread, diseases transmission, social inequalities, criminality etc. and more essentially for the construction industry new and more services for inhabitants: access to housing, water supply, energy supply, mobility systems, waste management, telecom services... The demand for all these services is increasing and the construction industry is part of the answer. Many international institutions such as the World Bank (World Bank, 2009) and the OECD (OECD, 2007) highlight the same statement: “Infrastructure can be a vector of change in addressing some of the most systemic development challenges of today’s world: social stability, rapid urbanization, climate change adaptation and mitigation and natural disasters. Without an infrastructure that supports green and inclusive growth, countries will not only find it harder to meet unmet basic needs, they will struggle to improve competitiveness. Today, the infrastructure gap in low and middle-income countries is estimated at US\$1 trillion. More and more, countries need to turn to the private sector as well as the public sector to build and operate their essential infrastructure. Infrastructure, comprising transport, water, energy and information and communications technology, has become the single largest business line for the World Bank Group, with \$26 billion in commitments and investments in 2011. This is the result of a major scale-up, starting in 2003.” (World Bank, 2015)

As well as private companies as ENGIE (Engie and Global Cities Institute, 2015) or McKinsey (McKinsey Global Institute, 2013) have highlighted this phenomena (Figure 2). McKinsey notably forecasts \$57 billion of investments in urban infrastructures in all sectors for the next 30 years which would represent 3.5% of the world GNP (Gross National Product).

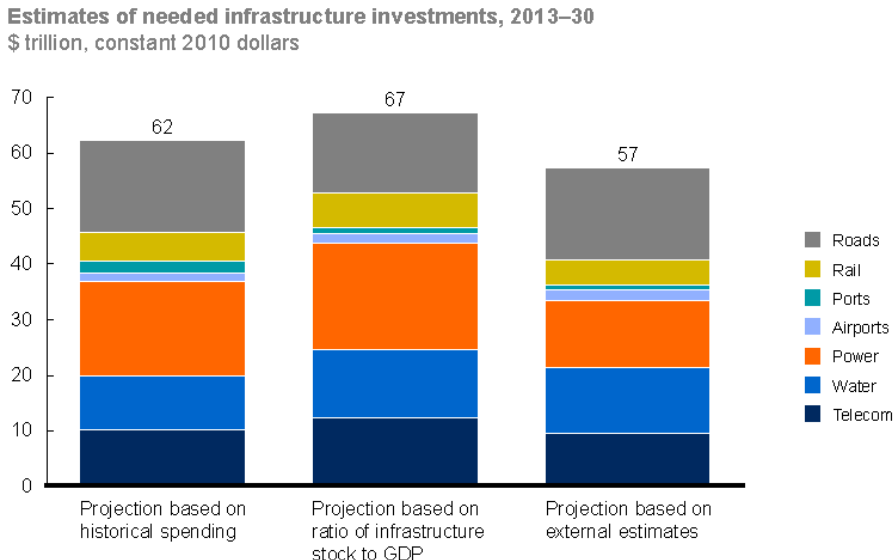


Figure 2 : Forecasts of investments in infrastructures for the 2013-2030 period (McKinsey Global Institute, 2013)

**1.2. An increasing complexity of construction systems**

In (Baccarini, 1996), Baccarini says that construction projects are the most complex projects of all industries. He differentiates two types of complexity construction projects have to face: technological complexity which are related to the product itself, interactions between its parts and its environment, the number of parameters and non-linear behaviors, and organizational complexity which consists in numerous actors, the number of decision levels, number of organizational units and departments and personal specializations. In this part, we will show that complexity of construction systems is even increasing for many reasons: increase of urban density, development of multifunctional systems and environmental challenges.

### 1.2.1. More interactions: The compact city

One consequence of urban population increase is urban spread. This phenomena is usually not suitable as it limits the use of lands for other purposes such as agriculture or natural lands. Impacts of urban spread are now well identified and most of cities are trying to limit it: waste of resources, congestion, decrease of agricultural land and biodiversity, social segregation or health of citizens (Laugier, 2012), (James, et al., 2013), (Zhang, 2015).

One possible way to limit urban spread and while increasing the urban population is to build “compact cities”. Increase density is one way to limit impacts of urban spread by limiting the number of kilometers traveled, save space for other purposes, optimize energy consumption enhance social diversity and access to urban services (Haugthon, et al., 1994) and (Lehmann, 2010). It is also what encourages the UN-Habitat to plan urban space around 4 main ideas: urban spaces would be compact, connected, territorially and socially integrated (Velasquez, 2013).

However, build compact cities is not without consequences on constructions systems: construction systems are more nested, interlinked and dependent between each others from planning, design, construction to operation phases. As shown in the scheme of Locuratolo (Figure 3) which represents the city of Paris (one of the densest city in the world), metro infrastructures, buildings, coffee shops, bookstores, streets etc. are all imbricated. This scheme highlights well how density implies more complexity for the development of construction systems.



Figure 3 : « La ville compacte » (Locuratolo, 2014). This scheme highlights the complexity induced by compact cities.

The underground map of Tokyo (Figure 4) is another example of the complexity of construction systems in dense cities. And it becomes even more complex if all other underground networks would have been added (sewage, drinkable water, tunnels for electric cables etc.).

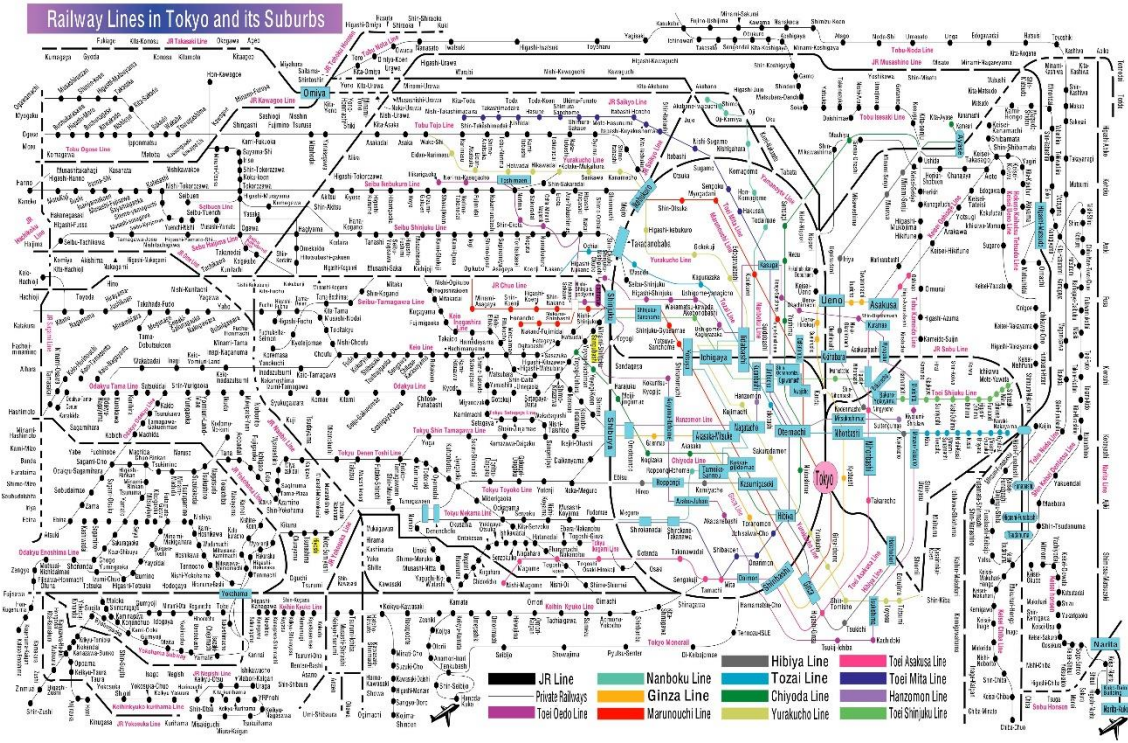


Figure 4 : Map of the metro in Tokyo. The map of the Tokyo metro illustrates complexity of its management and operation in dense cities such as Tokyo.

More than density, Stransky (Stransky, 2013) highlights that it is more the functional mix over space and at different scales which would allow reducing negative impacts related to urbanization: it reduces travel distances, optimizes energy consumption or mutualizes infrastructures as an instance. It is from this statement that we have developed the concept of the multifunctional metro which is detailed further in this thesis.

**1.2.2. More functions: multifunctional systems**

While most of urban sectors are interdependent we continue to plan, develop and manage them separately. A new way of planning, designing and building infrastructures is required: system thinking. A large part of this shift is the development of multipurpose and multifunction infrastructures (Berger, 2009). The idea is to use a unique system to address multiple needs and generate multiple benefits through a new kind of infrastructures (Vechio, June 2012).

The Cartesian method has consisted to the reduction of the analysis of phenomenon in elements which composed them individually (reductionist precept). It is the application of this method which has led to the management of cities in “silos”: transport, housing, energy, economy etc. and to the development of under optimized monofunctional infrastructures. This type of analysis is now considered as reductionist and does not allow understanding well urban phenomenon: interactions between sectors are not studied (or barely studied) which can lead to under optimization, dysfunctions, or choices which can lead to pervert effects from a sector to another. That is another reason which explains our choice of methodologies related to the system thinking theory in this thesis such as Functional Analysis and Systems Engineering as explained further in the thesis.

In this part we give several examples where the concept of multipurpose infrastructure has been applied in different places, different historical periods both above the ground and underground.



- Multipurpose infrastructures over time

Using a unique asset for different functions is not a new trend and many infrastructures in history have been built to be used for different purposes. A good example is the Khaju Bridge in Isfahan (Figure 5), Iran which is still under operation. This bridge was used as a dam (or a weir) to irrigate the valley, a bridge to cross the river, a building, and a meeting place for citizens (Mainstone, 2001).



**Figure 5: The Khaju bridge by night. The Khaju bridge is an example of a multifunctional bridge built in 1650 by the Persians.**

- Stormwater systems and multipurpose infrastructures

Ann-Ariel Vechio (Vechio, June 2012) has studied the concept of multipurpose infrastructure in the case of stormwater systems with three case studies in the USA: San Francisco, City of Lincoln and Cleveland.

In her thesis, Vechio highlights that: multipurpose infrastructures can create additional community benefits depending on the context; functions to add are different in each case depending on spatial and social characteristics; coordination of city agencies can foster the development of multipurpose infrastructures and makes dense urban area more livable.

- Multipurpose underground infrastructures: Utility galleries

Utility galleries are other good examples of transversal multipurpose infrastructures; they have been built in different countries over the world (France, UK, Czech Republic, Switzerland, USA...) but are still the exception for urban networks development (Figure 6). Nowadays, urban networks are developed independently in silos. Alternatively, Utility galleries allow incorporating several urban networks in a single place: water, gas, energy, information and more, depending on the context (Clé de sol, 2005). They are easy accessible which allows improving maintenance and operation tasks, avoiding the deconstruction of pavements and reducing disturbances for citizens. Below an example of an utility gallery in Geneva, Switzerland.



**Figure 6: Utility Gallery, Geneva, Switzerland. The utility gallery is a multifunctional structure which welcomes all types of urban utilities (electricity, water, optical fiber, gas).**

In (Clé de sol, 2005), reasons to develop utility galleries are presented: they allow eliminating road works, giving a better maintenance (accessibility and observation are improved), concentrating utilities gives economics benefits and they allow insulating networks and pipes from outside events (site works, weather conditions...).

- **Eco-logical Principles for Next-Generation Infrastructure**

In her book *Eco-logical Principles for Next-Generation Infrastructure* Hillary Brown (Brown, 2014) suggests to merge the concept of multipurpose infrastructure with natural systems: *“Infrastructural systems are man-made extensions of natural flows of carbon, water, and energy, so appropriate modeling might be based on the symbiotic relationships of natural ecosystems. Based on this whole-system perspective, we might reinvent an ecologically informed, post-industrial generation of infrastructure.”*

To illustrate her thoughts, Hillary Brown gives the example of the *Wadi Hanifah: Bioremediation of dry weather flow* in Saudi Arabia: Instead of building a new water treatment plant this streambed has been renovated to provide quality water for the city of Riyadh, restore the natural habitat and for agriculture irrigation (Figure 7).

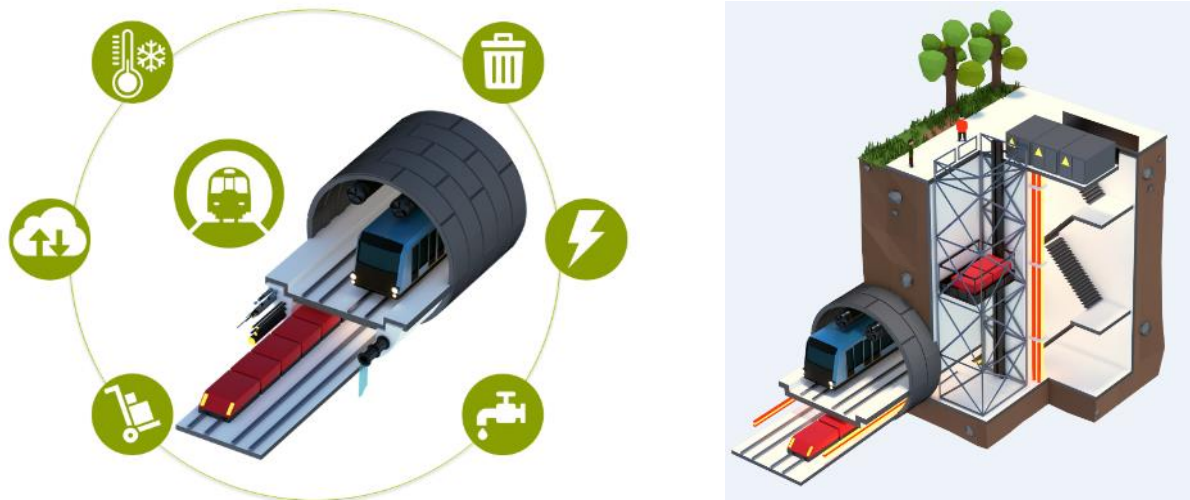


**Figure 7: The Wadi Hanifah, Riyadh, Saudi Arabia. This treatment plant has been designed also to restore natural habitat and for agriculture irrigation.**

- Lessons learned from cited examples on multipurpose/multifunction infrastructures:

Nowadays multipurpose infrastructures are the fruit of opportunity, a system thinking approach doesn't exist in planning authorities which hinder most of the possibilities for mutualization while it has numerous advantages for all stakeholders: Multipurpose infrastructures allow: sharing resources across different systems reducing costs and environmental impacts, improving project bearing (more stakeholders are involved, acceptability of the project is increased and more services are offered to the population), reducing worksites inconvenience (works are done only once), making dense areas more livable, improving maintenance and operation.

- Multifunctional metro systems



**Figure 8: Tunnel and stations with multiple functions, Egis, 2016. This conceptual scheme of the multifunctional metro illustrates the different possibilities to integrate new functions into metro systems.**

In the light of this statement, we have applied the concept of multipurpose infrastructures on metro systems (Figure 8). The metro market is currently growing very fast (UITP, 2015) offering opportunities to answer globally to other city needs. Several examples show that it is possible to add a function in a rail system: in Switzerland, integration of High Voltage cables in the railway tunnel of Grimsel has allowed saving 520 million Swiss Francs (Meillasson, 2016). The same principle has been applied on the line B of the Lyon (France) metro and has allowed saving the construction of a tunnel under the Rhône (RTE, 2016). In Rennes (France), integration of geothermal systems in diaphragm walls and inverts allows energy supply of residential and office buildings which has allowed saving the construction of energy piles (Egis, 2014). In the Parisian metro, operation of optical fiber brings a turnover of 20 million euros per year to Telcité a subsidiary of the metro operator (RATP) (Chicheportiche, 2015). As shown in these examples, integration of new functions in a metro system is profitable for the community: a unique infrastructure answers to many needs. Nevertheless, these opportunities are far from being studied for each metro project and are the results of local opportunities. The aim of our approach is to generalize this analysis of possible mutualizations to all metro projects.

Underground metro systems seem particularly adapted to incorporate new functions as they require large infrastructures. One possible solution among others would be to integrate new systems under inverts in metro tunnels as shown in the picture below. Stations and shafts are opportunities to link incorporated underground networks with the subsurface.

This concept will be applied on the 5<sup>th</sup> metro line of Lyon and is one of the case study used for the application of the methodology developed in this thesis.

### **1.2.3. New challenges: environmental requirements**

New environmental considerations add a lot of complexity in the development of construction systems:

- Construction systems have to fulfill more and more challenging performance in terms of energy consumption as attested by the numerous labels and certifications created in the building industry particularly in the energy sector (HQE, Leed, CSTBat...). But also performance related to air quality, noise isolation, biodiversity, recycling of removal materials and many more. These requirements are related to a better respect of the environment, to the consideration of interactions between the construction system and its surroundings to reduce its impacts and to improve comfort of inhabitants. As instance, the ASHRAE (American Society of Heating Refrigerating and Air-conditioning Engineer) says that it is necessary to decrease energy consumption of building by 30% and that greater reduction would lead to complex interactions between systems and their environment.
- Requirements related to the interactions between the environment and construction systems go in both ways: construction systems have to react to current environmental challenges and required to stay functional in a changing environment or/and to be easily and quickly repairable in case of an environmental disaster. These requirements are related to resilience of the construction system. They imply new requirements to consider when planning, designing and realizing construction systems (Toubin, 2014).

The consideration of the interactions between construction systems and its environment whereas it is to keep it functional under some difficult circumstances or to decrease its impacts necessarily add new interactions to consider, which lead to more requirements, more internal interconnections between components of the system and finally more complexity in the development process of construction systems (Higgings, 2018).

### **1.3.Costs, Delays, Quality: the haunted house**

---

In previous parts we have seen that needs in infrastructures and more precisely in urban infrastructures are increasing. Nevertheless, infrastructures are very costly and can be hard to finance particularly in developing countries where the needs are the most urgent. From the World Bank, financing needs which are not satisfied rise \$270 billion per year in developing countries (World Bank, 2009).

In this context, productivity issues in the construction industry are crucial to answer the demand. It is urgent to improve productivity and quality and to avoid overruns and delays. The IMF (International Monetary Fund) also says that *“Increasing public investment may lead to limited output gains if efficiency in the investment process is not improved [...] When public investment is inefficient, higher levels of spending may simply lead to larger budget deficits, without increasing the quantity or quality of roads, schools, and other public assets that can help support economic growth.”* (IMF, 2014).

#### **1.3.1. Costs and delays in the construction industry**

Complexity of construction systems identified in the last chapter leads to numerous productivity and quality issues in the construction industry: delays, and over costs are the norm, requirements of project owners are not always met and conversely construction products suffer from over quality (wastes). These phenomenon have been highlighted by several studies, articles and researches all over the world: in 2007 the American Institute of Architects highlighted that the construction industry suffers from 30% of wastes related to over quality, that productivity has decreased since 1964 while other industries have increased their productivity by over 200% and that lack of interoperability in AEC (Architecture, Engineering and Construction) software cost \$15.8B annually to the US construction industry (The American Institute of Architects, 2007). Some projects are even canceled while they are still under construction. It was the case as example of the “Second Stage Expressway” which was canceled after \$3.1 billion have been invested (D. Breyse, 2009). 20 000 mistakes were identified during the construction of the airport of Berlin which was initially scheduled for 2012 and delayed to 2018 and then 2019. Operation and maintenance of the airport costs more than \$16 million per month to the municipality (Hammer, 2015). 77% of highway projects in the U.S. suffered from cost overruns (Kaliba, Muya, & Mumba, 2008). These different examples show that this phenomenon affects both developing and developed countries and different types of construction projects (roads, airports...).

Other studies have the same statement on the construction industry, a McKinsey study (McKinsey, 2015) notably shows that construction projects (infrastructures, oil & gas and mining) have in average 20 months of delay and overrun of 80% (Figure 9).

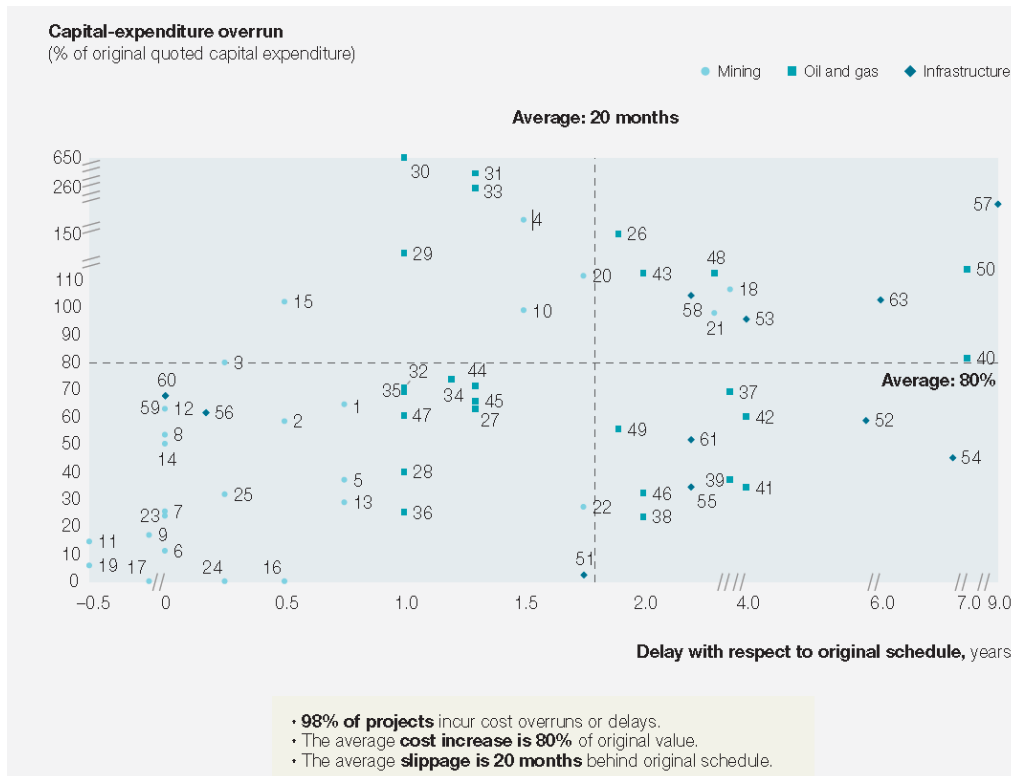
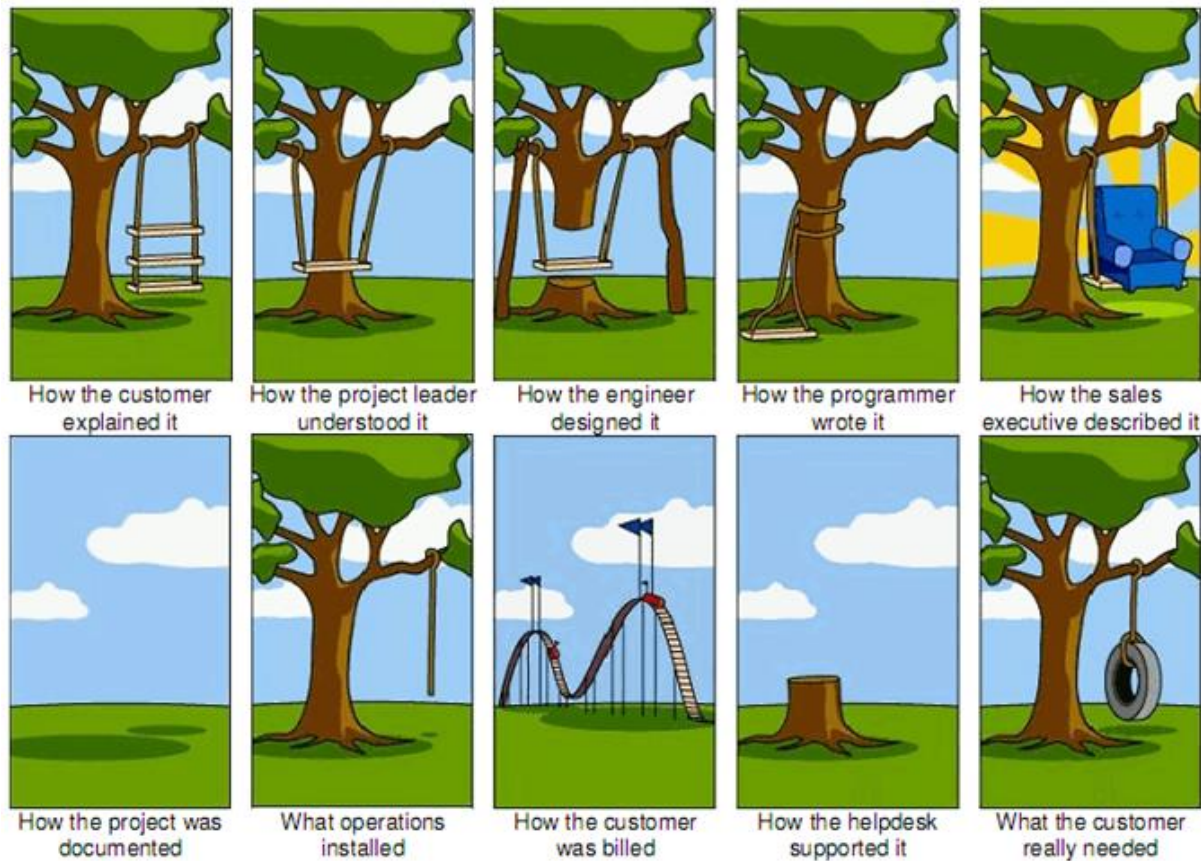


Figure 9 : Companies' public annual reports; IHS Herold Global Projects Database, November 19, 2013; press releases. This figure shows that in average construction projects suffer overcosts of 80% and delays of 20 months.

### 1.3.2. Quality in the construction industry

More than delays and overruns, the construction industry is also facing quality issues. Requirements of project leaders, future leaders and operators are not always met (Abbasnejad, 2013), (Gambatese, Pocock, & Dunston, 2007). Even if compliance of the product with requirements is sometimes hard to verify for construction systems neither costs of these non-compliance, in the US, a study from Carnegie Mellon's University shows that 6 to 15% of the total costs of construction products are due to defective elements or modifications and 5% of the construction cost is wasted due to modifications during the operation phase (Philip, 2009). In France, experts in the construction domain consider that only 70% of the total cost of construction systems are related to added value and 30% are wasted in non-quality (IRC, 2013).

Figure 10 illustrates part of the non-quality problem in the construction industry, the multiplicity of stakeholders notably which potentially have different objectives can lead to communication issues and finally to a mismatch between clients' expectations and what is realized. Assuming that stakeholders have different positions and evaluating impacts on the future product is part of the objective of this thesis.



**Figure 10 : Illustration of non-quality issues in the construction industry and the different point of views of different stakeholders of the same product.**

Not all researchers do agree that productivity issues, non-quality, delays and over costs are due to the complexity of construction systems. Flyvbjerg notably (Flyvbjerg, 2007), (Cantarelli, Flyvbjerg, Molin, & van Wee, 2010) considers that technical complexity of construction project is already well mastered and that delays and cost overruns come from other issues:

- Political: Costs and delays are voluntary underestimated in order to increase the chance of project acceptance;
- Psychological: decision makers and politicians can be affected by *Optimism bias*, which leads to optimism forecasts related to delays, costs and performance of the future system;
- Economic: due to a lack of resources, project owners have to choose between different projects and project promoters voluntary underestimate costs and delays.

In Transport infrastructures, Flyvbjerg says that needs the future system should answer are often overestimated by 80% in order to justify realization of new infrastructures. It highlights that objectives of stakeholders are not always clear particularly for large and public projects. Political objectives notably are often not assumed by project leaders.

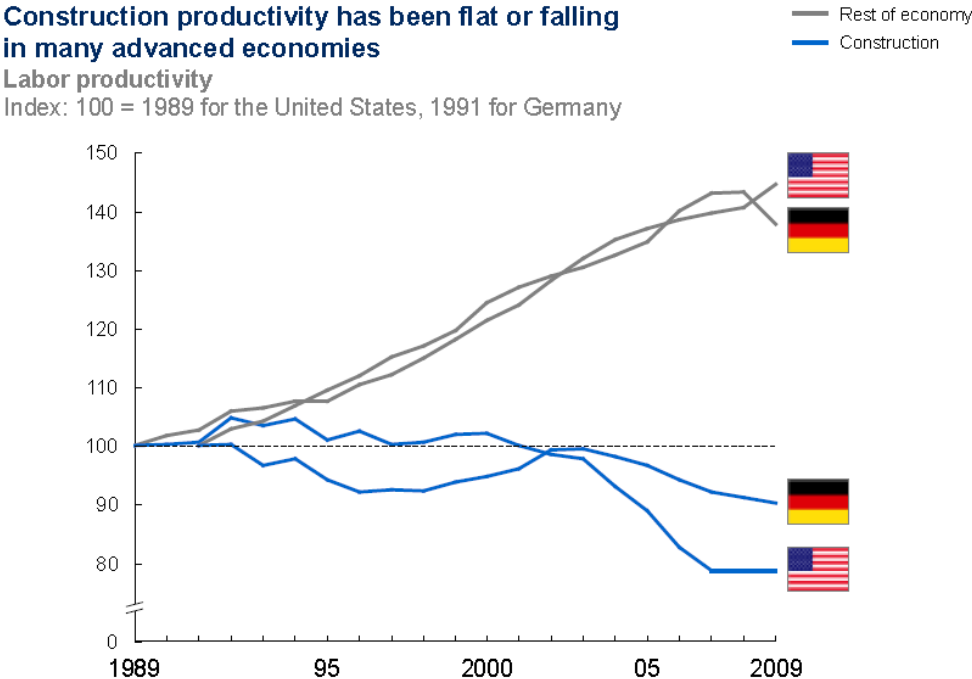
This interpretation of over costs and delays highlight that issues related to construction system don't necessarily lie in the product itself (later called System of Interest in this thesis) but also to all the processes required to develop it (later called Enabling System). This interpretation of Flyvbjerg asks the question of what is complex in construction systems. The product itself? The development process required? Both? Or interactions between them? Moreover, arguments presented by Flyvbjerg concern public projects where decision-makers are mostly politicians. How to justify that private projects like in the real-estate business, stadiums and even airports suffer

similar delays and costs overruns? How to justify that PPP (Public Private Partnerships) suffer as well of delays and overcosts (as instance the high speed rail project in south west of France has seen its budget doubled between 1999 and 2013 mainly because of unforeseen environmental issues (Capital, 2013), and that from the 56 PPP projects launched in Philippines only 4 have been completed in time notably because of land acquisition issues (The Manila Times, 2017))?

In this thesis we will show that more than the issues identified by Flivbjerg to justify over costs and delay overruns the construction industry lacks an adapted methodological background to master complexity of construction systems.

**1.3.3. A productivity gap**

Compared with other industries productivity of the construction industry is stagnating and even decreasing as shown in (Figure 11).



SOURCE: OECD Labour Productivity by Industry (ISIC Rev. 3); McKinsey Global Institute analysis

**Figure 11 : Comparison between productivity of the construction industry and other industries (McKinsey Global Institute, 2013). This graph shows that compared to other industries, productivity of the construction sector has decreased in the US and in Germany.**

Nevertheless, this graph (Figure 11) doesn't indicate how productivity is measured and compared. Each construction project is unique, it is therefore very difficult to compare productivity of two different projects while it is not the same objects which are compared. Hence, the construction industry regroups objects as different as houses, airports or tunnels comparing productivity of an underground tunnel and of a hospital can be disappointing. More than that, comparing productivity of two different tunnels as instance is not necessarily pertinent as geological and geotechnical can be radically different leading to totally different products.

Comparison of productivity between the construction industry and other industries rises the question of what is productivity. In France, the INSEE (Institut National de la Statistique et des Etudes Economiques) gives the following definition of productivity: « *Productivity is defined as the ratio in volume between a production and required resources to obtain it. Production designates goods or produced services. Resources applied named*



*production factors can designate the working force, the technical capital (engines and tools), invested capital, intermediary consumptions (raw materials) and factors harder to grasp as accumulated know-how.”*

Therefore productivity can be formulated as a ratio:  $Productivity = \frac{services/goods}{required\ resources}$ . The difference between other industrial domains and the construction industry is that services/goods offered by the construction industry are never the same: while a “classic” industrial product always offer the same service (a car allows driving, a plane allows flying, a boat allows navigating etc.) a construction product allows “*offering a space to carry human or related activities*”. This service may change depending on the space to adapt and the human (or related) activity to carry. Therefore, an appropriate comparison of productivity between the construction industry and other industries should differentiate services offered by construction products (i.e. like offering a space to “live”, offering a space for “rail traffic” etc.) as well as the space to adapt to carry these activities (urban, rural, cross-border, regional etc.). In other words, putting in the same scale productivity of a 3 storeys building in the countryside and a 20m diameter tunnel under the sea with a complex geological context is a non-sense.

That being said, construction projects still have similarities which we will be detailed in the next part of this thesis.

## 1.4. Specific characteristics of the construction industry

---

Several methods have been developed over the years to master complexity of industrial systems. Most of them, as we will present in this thesis, are coming from manufactured systems and the software industry notably Functional Analysis and Systems Engineering. In order to apply them to the construction industry, it is necessary first to identify particularities of the construction industry and then to integrate such particularities into the previously mentioned methodologies.

Construction is the process of assembling, dispose materials or the different parts to constitute a functional building or infrastructure. Construction differs from manufacturing in that manufacturing typically involves mass production of similar items without a designated purchaser, while construction typically takes place on location for a known client (W. Halpin, 2010).

Three elements highlight the difference between the construction industry and other industries:

- “*Construction typically takes place on location*”. Mauger in (Mauger, 2015) also highlights that space is “*proper to the Architecture-Engineering-Construction discipline. Other engineering domains do not define this concept as it is not required.*”
- “*Construction typically takes place on location for a known client*”: stakeholders and particularly the client are not always known and often different. And each construction project is unique.
- Another particularity of the construction industry compared to other domains comes from the separation of the “enabling system” in different entities depending on the phase of the project (planning, design or realization). In some countries like France, this separation is even written in the law (*Loi relative à la Maitrise d’Ouvrage Publique, loi MOP*).

These are the three particularities of construction systems which make the construction industry different from other sectors.

The first point may be the biggest difference with other domains. Indeed, the fact that construction products *take place on location* anchors construction in the domain of Geography and Architecture. To be more specific, we don’t say that other industrial products don’t consider space, an aircraft, a car, a spacecraft exist over space and required to be physically realized and assembled. However, the main difference comes from that in construction systems, space is an essential part of needs, functions and components whereas in industrial systems it only concerns the components.

### 1.4.1. Adapt space to carry human related activities

The first particularity identified is related to needs construction systems are answering: « *adapt space to carry human related activities* ». This trait is common to all construction systems and may be what unify them into a unique domain. This first common definition of construction systems is composed of several terms which would require more precisions.

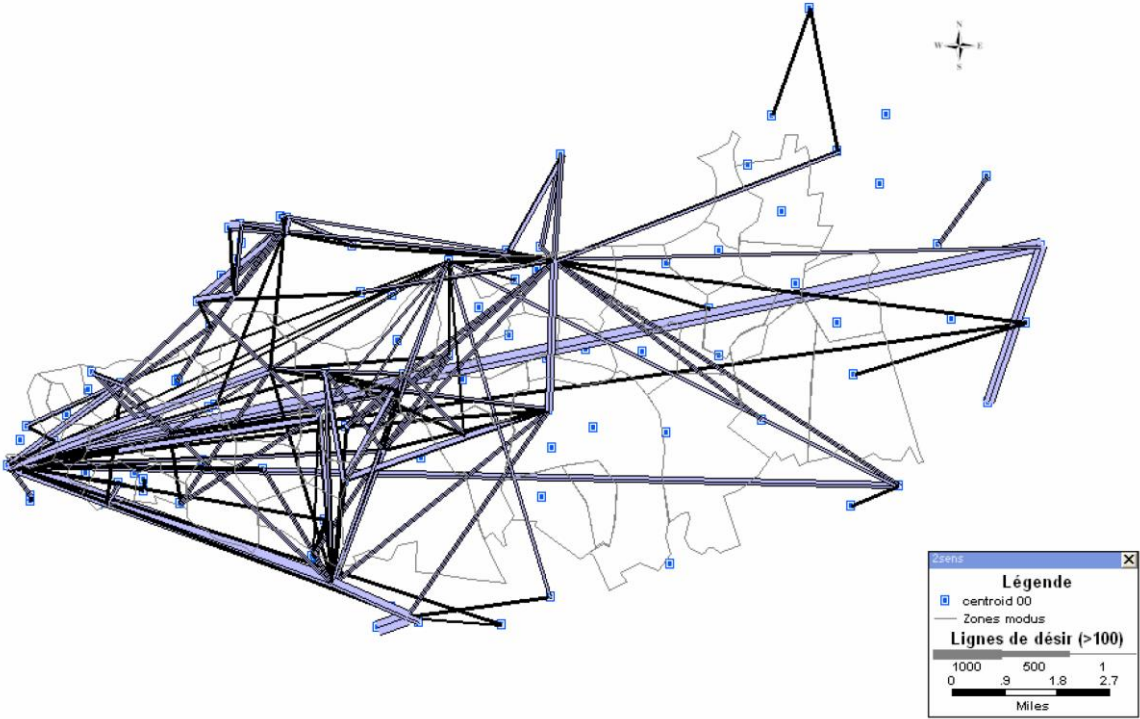
#### 1.4.1.1. Human activities

Human activities are very diverse: sleep, eat, work, practice leisure, move, practice sport etc. each activity potentially leads to a certain type of construction systems (housings, parks, stadiums, tunnels, airports, hospitals). Even if these activities are somehow practiced similarly upon the different populations, it is important to notice that cultural, historical, political and even economical backgrounds imply specificities in how activities are undertaken in the different countries. These specificities imply that needs construction system answer can vary but have general properties. The perceived part of human activities are carried over “space” and are called

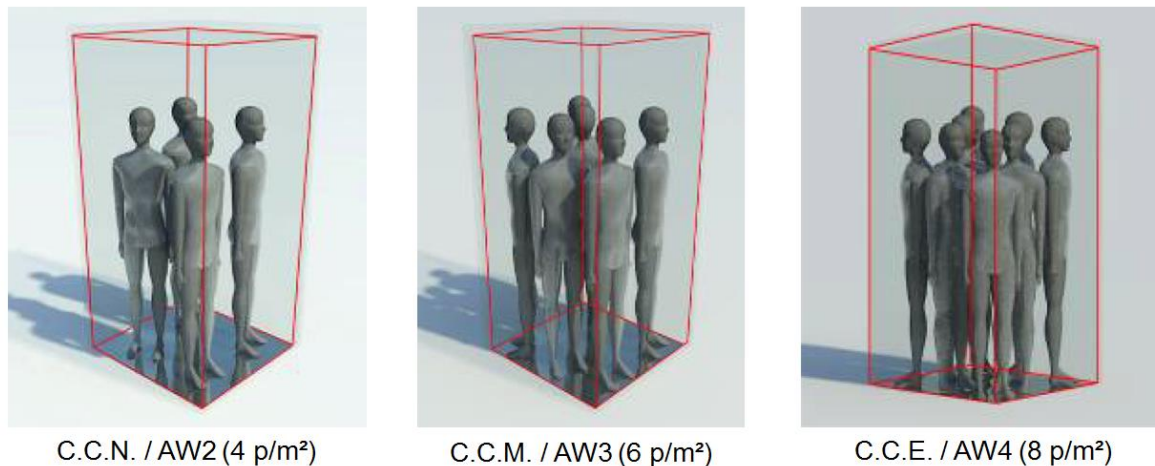
phenomenon. These concrete aspects of human activities are analyzed in phenomenology, a philosophical and architectural trend which consists in studying lived experience and phenomenon.

Without getting too much in detail in the description of human activities, such activities have spatial description: they “take” place somewhere, in an environment and are often concurrent with other activities. At the level of individuals, activities can be described over space, their volume, and how they are perceived over space: noise, aesthetic, olfactory environment, touch, taste.

Moreover, when talking about human activities, a distinction can be made about human activities related to individuals and activities of a group of individuals. Behavior of groups of individuals is totally different than for individuals, each level have to be considered but it is important to notice their differences. At the level of a group of individuals, activities can also be described over space. As instance, for a mobility infrastructure, global mobility trends are analyzed at the level of group of individuals (Figure 12) and concurrently it is analyzed how individuals can perceived the infrastructure at their level (Figure 13): aesthetic of stations, feelings of materials, ambient scenting, volume etc. There are at least two levels of analysis of behavior of human activities depending on their purposes: group of individuals and individuals themselves.



**Figure 12 : Example of a spatial mobility analysis at the territorial level (Leurent). This figure shows representation of forecast mobility needs over space at the territorial level.**



**Figure 13 : Example of comfort analysis for a transport system at the human level (Fruin, 1971). This figure represents different level of spatial comfort at the human level.**

When designing a construction system both level required to be considered to analyze human activities. This first example shows that space can be considered at different levels of abstraction.

Now that we have given what could look like human activities over space and that different levels of abstraction can correspond to it, it is necessary to give more precisions about space and about which elements of space we adapt in the construction industry.

#### **1.4.1.2. Physical Space and Human space**

Space is a very abstract concept and has different definitions. As instance in the French dictionary we find the following definitions of space (translated):

- *“Space is a particular property of an object which makes it having a stretch, a certain volume within a stretch, with a volume necessarily bigger than it and which can be measured” (Larousse, 2018).*

Or:

- *“A portion of a stretch occupied by something or the distance between two things, two points.” (Larousse, 2018)*
- *“A stretch, a surface or a volume we need around us”. (Larousse, 2018)*

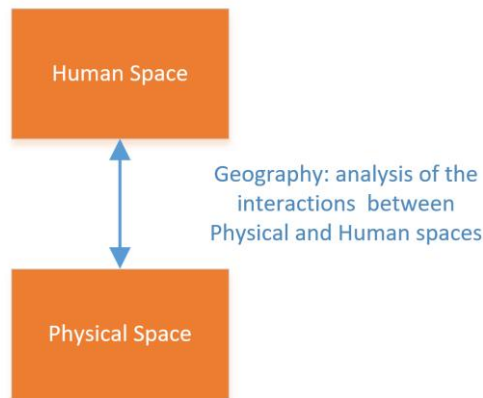
These different definitions reveal that space doesn't have a very clear definition and regroups a large panel of concepts. The first definition refers to geometry of objects and that they exist in the 3 spatial dimensions composing our world. It also mentions that an object and its spatial characteristics are always contained in another space bigger than itself. The space the *Larousse* is referring to can also be measured, and as we will see it is not the case of all spatial phenomenon at the moment. The second definition refers to distances and geometric relations between objects and consider topological aspects of space. The last definition insists on the fact that we “need” space around us, it shows that space can be seen as resource to carry activities.

Architecture and Geography are two domains dedicated to the analysis of space and more especially on the relations and rules between human beings and space. These two domains are strongly linked with the AEC industry.

Geography notably is very rich in the study of spatial phenomenon, geographical space being one of the major branch of geography:

“Geographical space is used in Geography to designate spaces organized by a society, it is a space where humans live together and interact with their environment” translated from (L'Espace Géographique, 2013).

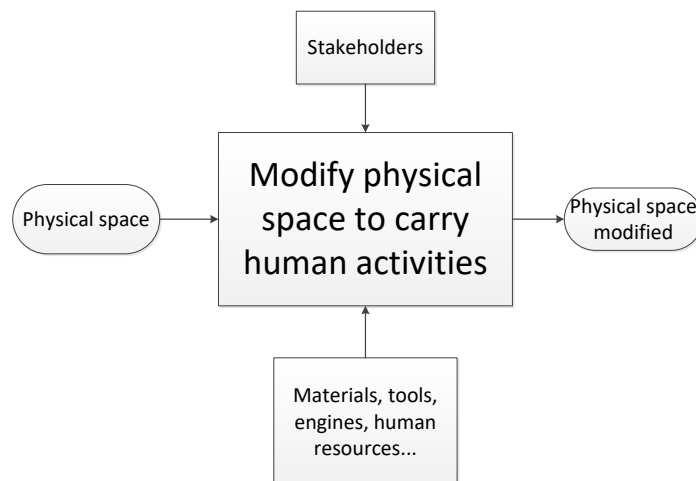
In the *American Heritage Dictionary*, geography is defined as “a field of science devoted to the study of the lands, features, inhabitants and phenomena of Earth” (American Heritage Dictionary, 2018). Geography is usually divided in two branches, human and physical geography (Figure 14). Human geography being dedicated to the study of people, their community, cultures, economies and their relations with environment. Physical geography is dedicated to the study of processes and patterns of the natural environment, atmosphere, biosphere, hydrosphere, climate etc. Geography can be seen as “the bridge between human and physical science” (Pattison, 1964).



**Figure 14 : Geography as the domain related to the analysis of interactions between Physical and Human science (Pattison, 1964)**

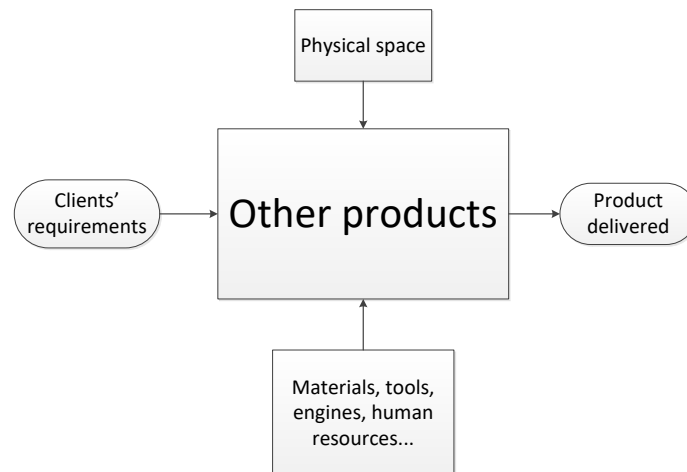
Distinction between these two aspects of geography is interesting for our purpose, if geography is the link between human and physical science, the construction domain aims to adapt physical space in order to modify human space.

More precisely, the particularity of construction systems is that the need construction products answer is to adapt physical space (physical space as a subsystem of geographical space) in order to carry human activities (modify the human space). The diagram below illustrates this particularity (Figure 15):



**Figure 15 : The construction industry: modify Human space by modifying physical space**

In other domains, physical space can be considered as a constraint but not as a resource to use, modify or adapt (Figure 16):



**Figure 16 : In other industries, space is only considered as a constraint in comparison with the construction industry**

The aim of the construction industry is to adapt physical space (as a subsystem of the geographical space) to improve and simplify the functioning of other systems (industrial products, humans' activities...) which are supported by the physical space.

In physical geography, space is the physical environment at the earth surface. It consists in the analysis of soil constitution (geology), climate (climatology), or ocean (oceanography) as instance and in general terms to all elements required to the understanding of the earth dynamic (Veyret, et al., 2002). The earth surface is therefore constituted of numerous elements with different characteristics: surface and subsurface are solid, ocean, rivers, lakes are liquids and the atmosphere is constituted of gaz. Understand all these phenomenon, and modify physical space consequently is an element of complexity of construction systems particularly when considering all environmental interactions.

Di Meo (MEO, 1998) and Le Moine (Le Moine, 2014), also propose three dimensions of the geographical space:

- Materiality of space (physical, natural or anthropogenic space);
- Individual psyche (perceived and lived space);
- Collective representations (social and cultural space).

The first dimension is related to physical space, and the other dimensions refer to the human space. The distinction between the perceived space and social space highlights the same distinction we have made in the last paragraph about the different scales of analysis of human activities: at the level of individuals (perceived space) or at the level of groups of individuals (social space).

Behind the separation of geography between human and physical space, numerous authors have proposed different ways to analyze interactions between both (Figure 17, Figure 18), notably through the concept of *territory*:

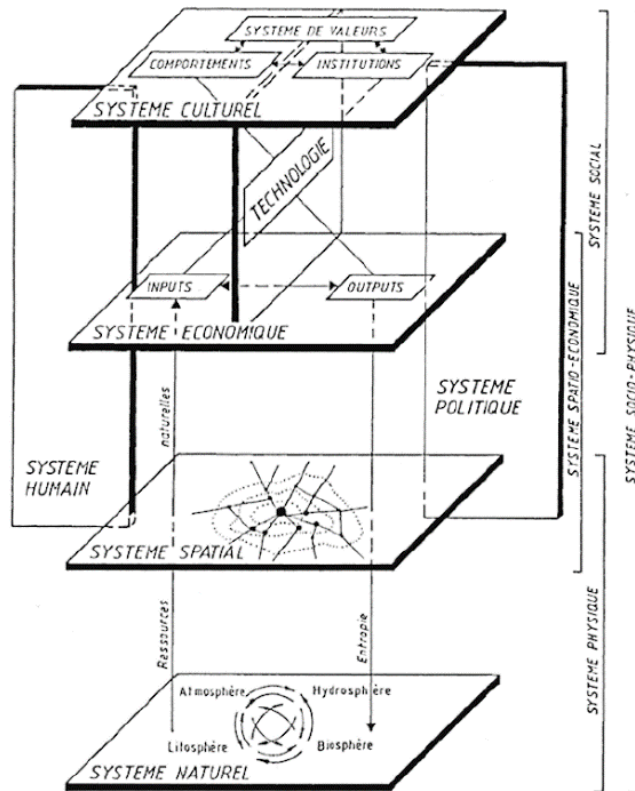


Figure 17 : Territory decomposition in systems (Cunha, 1988). This diagram represents one possible systemic analysis of a territory

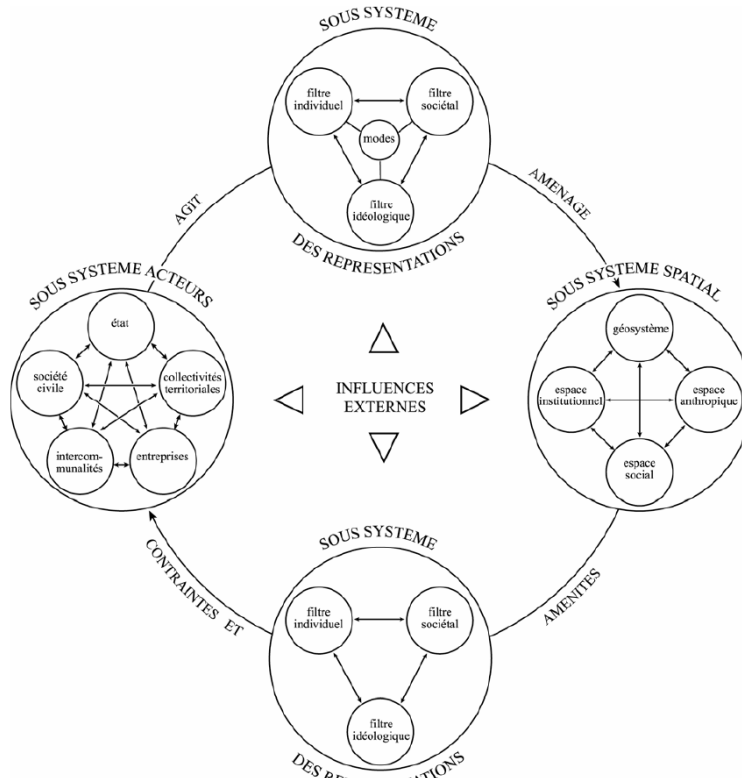


Figure 18 : Territory decomposition in systems (Le Moine, 2014). This diagram represents another systemic way to describe a territory

Finally, physical space is a very heterogeneous resource: its composition, the number and the type of its interactions vary. Indeed, physical space we are considering is not an “abstract space”, it is part of a larger system which is the geographical space. Therefore physical space is in relation with other subsystems: social space, political space, legal space, administrative space etc. This heterogeneity makes construction products and projects complex and unique. As each project is in a different location, it is interacting with different elements of the physical geography and human geography subsystems. Therefore, analysis of the environment and of the geographical space is a crucial step of construction projects as physical space (as a subsystem of the geographical space) is the resource to process. In this thesis, we haven’t investigated more in depth how the construction domain interferes with the different subsystems of geography, however, it is clear that the physical space has inevitably interactions with other geographical subsystems. Analyzing such interactions and evaluating its impacts in a systemic way is a possible avenue for further researches.

### **1.4.2. Uniqueness of construction systems**

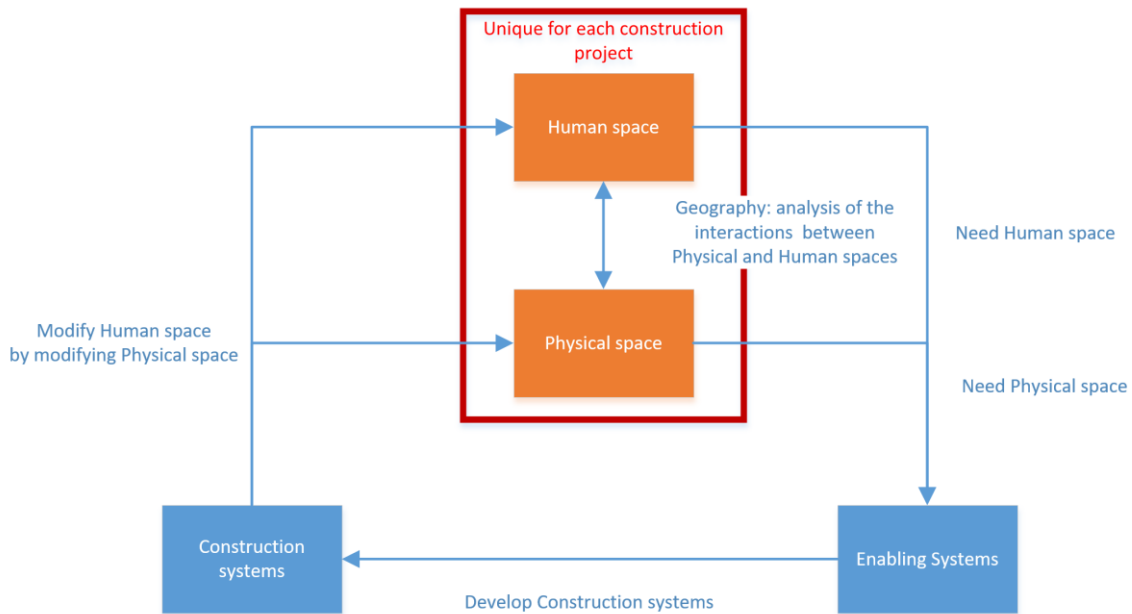
The direct consequence of the fact that construction systems aim to modify Human spaces by modifying Physical spaces is *Uniqueness* of construction products and projects. Indeed, each Human and Physical spaces are unique depending on their location (their characteristics can even change over time) as well as interactions between both.

To be more specific, let see what is unique in construction systems and what could be considered as common (Figure 19 and Figure 20):

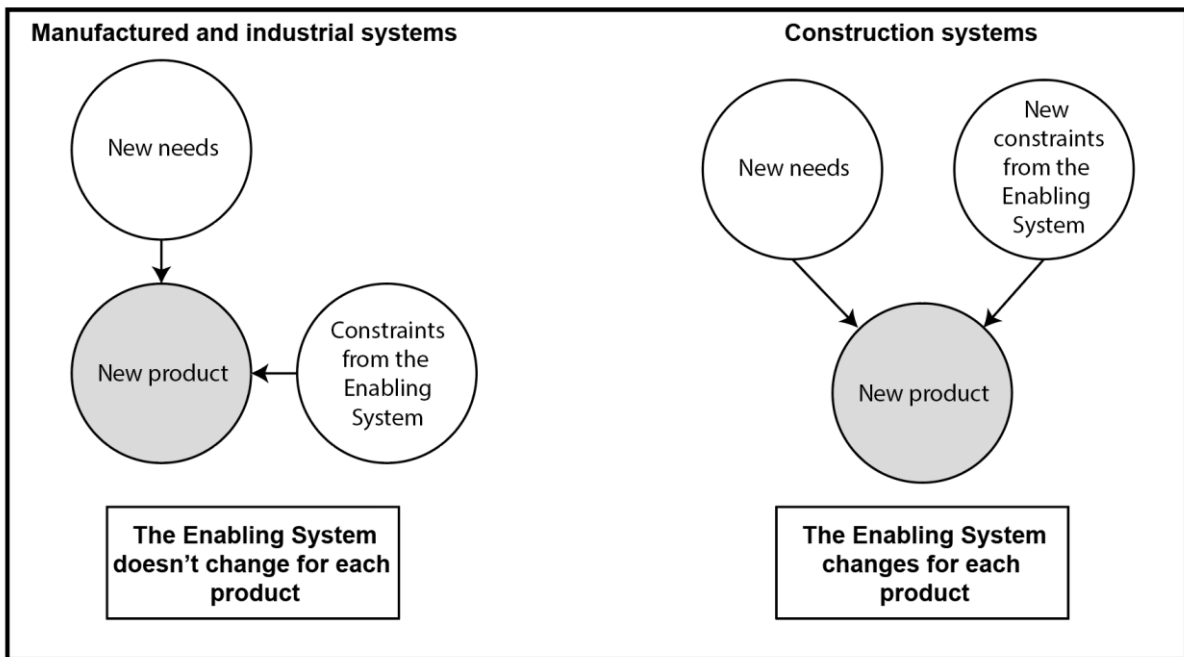
- Because physical space, human space and interactions between each are never the same, construction systems never answer to similar needs and constraints. Environment of the system is never the same, physical spaces always have particular properties which required to be modeled and calculated for each project. Needs are also specific to each project (mobility needs, housing needs, comfort needs etc. are always recalculated). The Human space to modify (cultural, social, economic, systems) is also always different between spaces implying different interactions and constraints to consider. For all these reasons, all construction systems are unique in the sense that they answer to different needs at each project.
- To develop construction systems, it is required to mobilize different other systems (later called Enabling systems) such as logistic, political, raw materials extraction, workforce etc. Firstly, it is important to highlight that Enabling Systems require Physical spaces (logistic, raw materials etc.) as well as Human spaces (political, economic as instance). In the case of construction systems, because the space to modify is always different, spaces required for Enabling Systems are also always different. It implies that for each construction systems it is necessary to adapt Enabling Systems to specific spaces related to construction project.

This last point makes construction systems very different from other industrial systems (Figure 20). Whereas other industries also develop continuously new products which answer to new needs, what hinder a similar industrialization in the construction industry is the continuous adaptation required for Enabling Systems due to impacts of uniqueness of Physical and Human spaces.





**Figure 19 : Impacts of space on uniqueness of construction systems. This figure shows that because each space is unique and because purpose of the construction industry is to adapt space, each construction system is unique.**



**Figure 20 : Uniqueness of construction systems and implications on the Enabling System. This uniqueness implies that the Enabling system is necessarily unique for each project.**

In current design methodologies and notably Functional Analysis and Systems Engineering which will be used in this thesis, constraints from the Enabling System are hardly considered in the development of the product. This is mainly because, in other industries, these constraints are not changing very much during the development process or if they change it is often for reasons independent from the product to develop, whereas in the construction industry both spaces related to the construction system and its Enabling systems are intimately related. Consequently, they are, at best, considered as constraints on the product to develop. Analyzing impacts of such constraints on the product to develop at different levels of abstraction is not integrated in current design methods.

For this reason, we will precise how constructability and later constructibility which objectives are to analyze constraints from Enabling Systems can be integrated in Functional Analysis and Systems Engineering methods.

### 1.4.3. Organization of construction projects in France and abroad

Another particularity of the construction industry is the organization of the sector. In some countries like in France, public projects are regulated by law (the MOP law, Maitrise d’Ouvrage Publique) which defines roles of the different stakeholders. In this part we quickly introduce how stakeholders interact between each others in construction projects.

#### 1.4.3.1. Stakeholders of construction projects

Construction project Stakeholders are “a person or group of people who has a vested interest in the success of the project and the environment within which the project operates. He further referred to them as, representatives of the various interests that will be affected during the different stages of the construction project from initiation to handover both positively and negatively” (Olander, 2007).

In (Molwus, 2014), Molwus enumerates a list of common stakeholders in construction projects: Owner/client, Senior managers/executives, facilities managers, project managers, staff/employees, purchasers, subcontractors, suppliers, and other process or service providers, tenants, residents, community representatives, neighbors, visitors, customers (potential and future), users, partners and design team members. These stakeholders can be classified in Internal/external stakeholders and in the Demand/supply side and Private/public stakeholders (Figure 21).

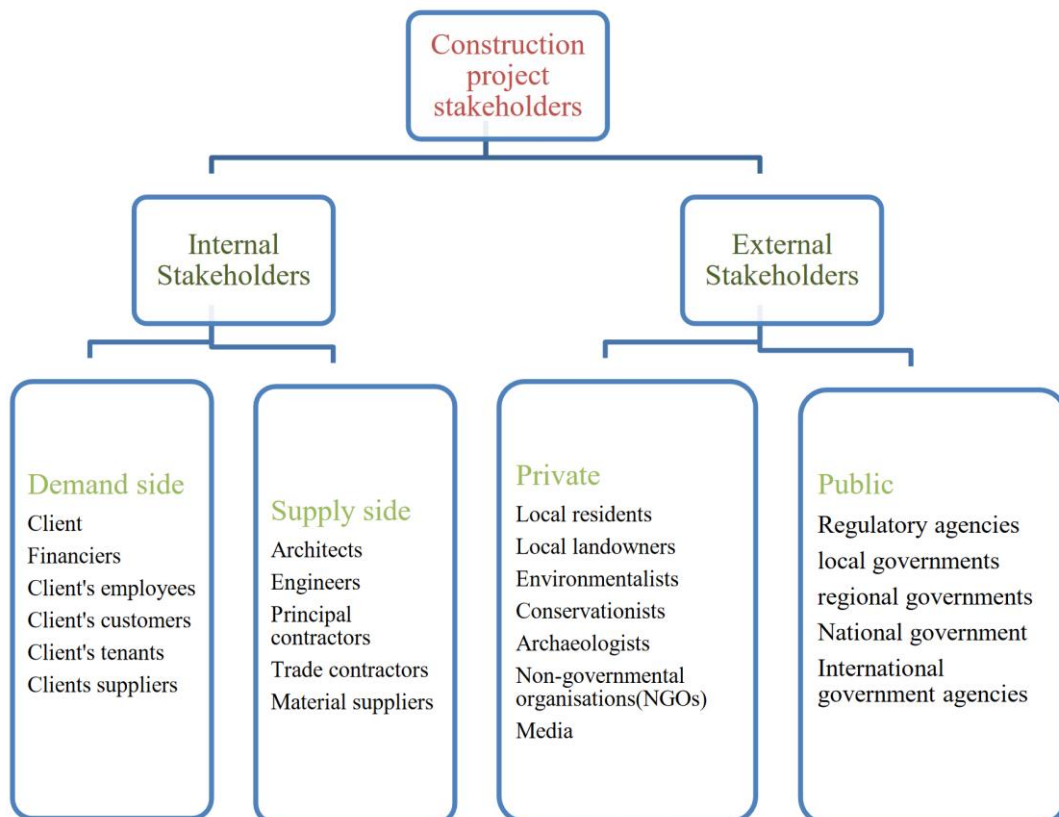


Figure 21 : Construction project stakeholders classification (Winch G. , 2010). Another particularity of the construction sector is the numerous and different type of stakeholders and that they change at each project.

In the AEC (Architecture Engineering and Construction) industry, some actors take an important place in the project lifecycle and deserve more precisions (Molwus, 2014):

- The project owner/client

The project owner is responsible for setting up the project, defining the program, finding the appropriate funds, setting the organization of other actors by defining the type of contract to engage (procurement), Return-on-Investment of the project (in case of public projects essentially). The project owner is also responsible of the delivery of a purpose-built facility.

- Designer/consultants

Designers and consultants can be part of the client organization or independent (in France, the MOP laws forces having an independent consultant). They are responsible for the design of the future product: architecture, techniques, economic etc. Depending on the contracts, he can assist the project owner for the procurement process, the coordination of works on site, execution and receipt of the works.

- Contractor

Usually a “general contractor” is responsible for the coordination of subcontractors or, the contract can be separated by technical state bodies. Objective of the contractor is to carry out construction works with success as designed by designer and consultants and essentially to meet contract terms. It ensures logistic and purchase of materials, engines and workforce as well as subcontracting.

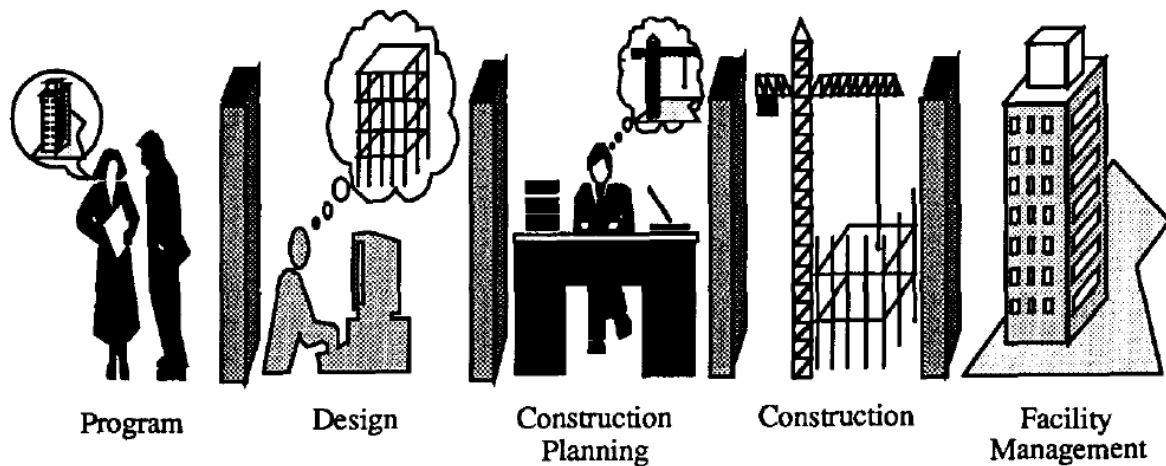
One main characteristic of construction actors is that they are ephemeral. Because actors are changing from one project to another, relations between them are short (Kubicki, 2006).

Generally speaking there is a lack of communication between actors in the construction industry. Whereas it is between different projects as shown in the comic in Figure 22 or internally in the same project as show in Figure 23.



Figure 22 : Interactions between different stakeholders in construction projects. This scheme illustrates conflicts between construction stakeholders because of a lack of communication and coordination.

The comic in Figure 22 highlights a lack of communication between projects and essentially between clients and project owners who are not always aware of other projects currently under development in the same area. This is mainly due to the reductionist precept which has led to organize cities in silos by urban functions (water, transport, energy, communication), each urban department is carrying its own project without considering others'. Organization in silos and lack of communication between urban departments inevitably lead to conflicts between projects.



**Figure 23 : Separation of tasks and lack of communication in construction projects. Internally, construction stakeholders manage their activity in silos with low consideration of other actors' problematics.**

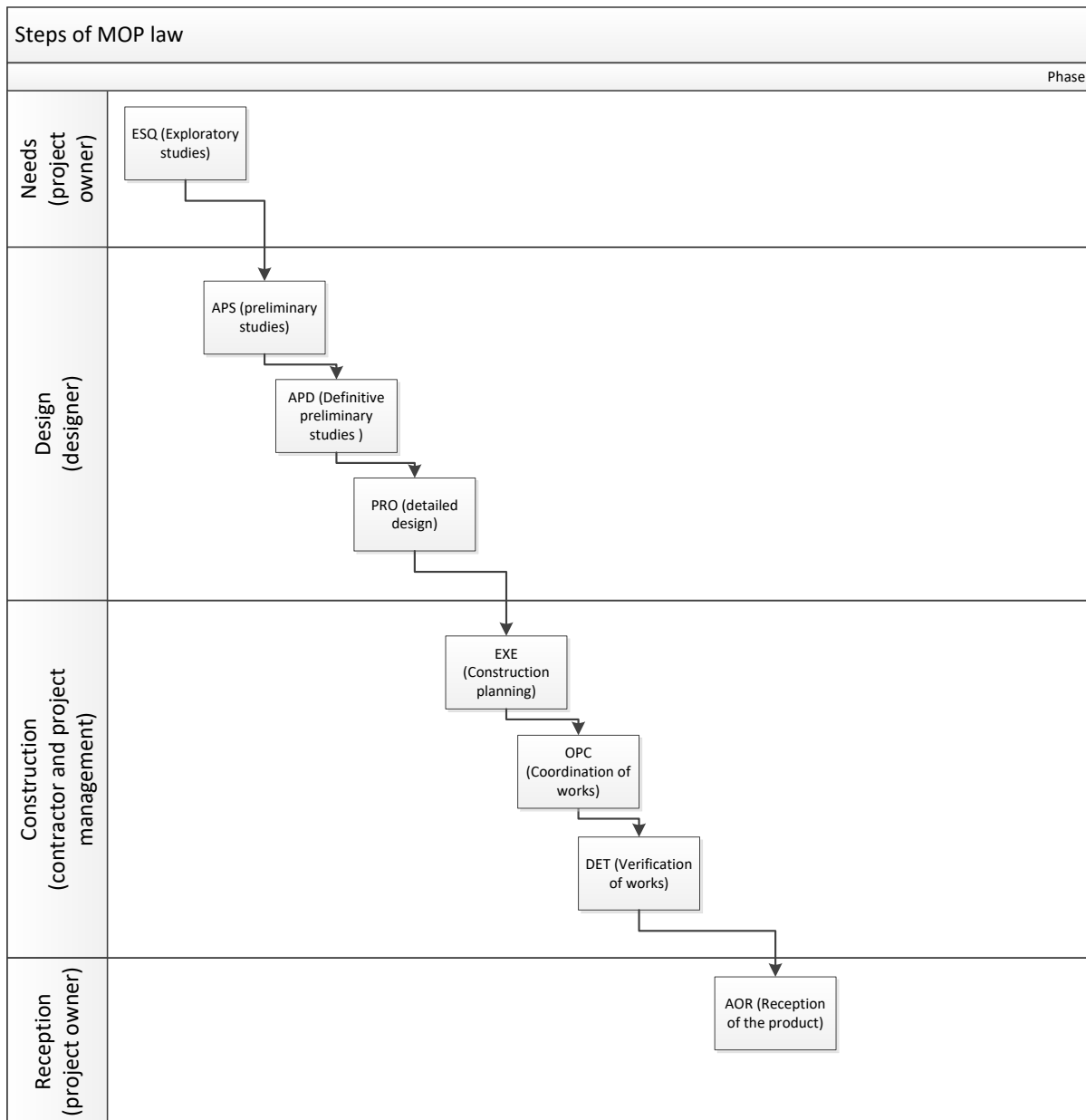
Figure 23 shows that communication issues also occur internally between project stakeholders: the client, consultants, contractors, subcontractors and operators can have different objectives and don't necessarily share information or complete information between them which can lead to unmet requirements, redesign, errors, interoperability issues, over costs and delay overruns.

#### 1.4.3.2. Laws and contracts

Unlike other industrial sectors, roles of construction stakeholders in the construction industry are sometimes regulated by laws. As instance, a contractor cannot express the needs (at least for public projects and some specific private projects), a consultant cannot realize a project etc.

- In France: MOP law.

In France, the law regulating roles in public construction projects is called the "MOP law" (Maitrise d'Ouvrage Publique). While in other industries, the actor responsible for the construction of the product could also be the actor responsible for the design or for the definition of needs in the construction industry in France, all the missions of stakeholders are described in the law. The MOP law not only defines actors' roles but also the different steps a project should undertake (Figure 24):



**Figure 24 : Steps of a construction project as defined in the MOP law (Legifrance, 1985). The MOP law in France implies a “cascade” working flow between different steps.**

Process of the MOP law is a “cascade/waterfall” process, this type of process has several drawbacks as we will explain in this thesis. Notably: Each separation between missions undertaken by different stakeholders necessarily means losses of information and knowledge about the project. Each actor has a partial view of the project depending on its own objective and mission. It implies several feedback loops in the development process at different stages and often between different stakeholders. These feedback loops are part of the reason of cost overruns, delays and non-quality particularly when they occur at a late stage of development. As instance, requirements related to the realization of the infrastructure are carried only at the “EXE” step by the contractor while they have inevitably impacts on the previous step carried by designers to design the future product. Modifications will have to be carried between different actors (the designer and the contractor) who don’t necessarily have the same objectives which will lead to conflicts. These modifications will be costly and time

consuming and risk to challenge the design and lead to unmet requirements. Moreover, as designers are not implicated in the realization phase they might lose the knowledge and the experience and less and less consider such requirements in the design in future projects. Similarly contractors lose experience on the design of construction systems and don't understand choices made at previous steps stressing the divisions between actors. Similar phenomenon occur between planning and design phases.

Other types of contracts exist in France with other modes of collaboration such as Design and Build contracts (Conception – Réalisation). In this case, the design and realization steps are carried by the same “economic group” (eventually composed of a classic contractor and a designer, or a contractor on its own). However, this kind of contract is limited to “*products which the realization process influences the design or/and to products which have exceptional dimensions, particular technical difficulties, require the specific knowledge and technicity of the economic group*” (traduced from (marche-public.fr, 2018)). The terms “exceptional dimensions”, “technical difficulties” being very vague and subjective. Concerning the first part of the sentence, all realization processes have inevitably impacts on the design of the construction product adding this specification shows that it is not commonly and that it is only the case in specific cases which is obviously false in our point of view as we will highlight in the thesis.

- Abroad: FIDIC contracts (Design and build, Turnkey...), alliances

In other countries other types of contract exist which apply to different types of project and collaboration modes. FIDIC (international Federation of Consulting Engineers) contracts notably are famous types of contracts used internationally (Figure 25) (FIDIC, 2018).

- The Red book: the Red book is dedicated for contracts where the design is carried by the client and/or a consultant engineer.
- The Yellow book: The Yellow book is dedicated for contracts where majority of the design is carried by the contractor.
- The Orange book: The Orange book is dedicated for Design and Build contracts.
- The Silver book: In the Silver book, most of the risks related to the project are undertaken by the contractor. In this type of contract the contractor is responsible for the majority of the design.
- The Pink book: The Pink book is an adaptation of the Red book for projects where the financing comes from different development banks (World Bank, JBIC, Giz, AFD etc.)
- The Gold book: The Gold book is dedicated for Design, Build and operate contracts. In this contract, the contractor is not only responsible for the design and realization of the project but also for its operation.

Alliances, are other types of contract used abroad and notably in the UK (as instance for the extension of the Birmingham tramway) where all stakeholders are collaborating from start of the project to its operation. Each participant can influence equally the decision making process. Risks are shared between all stakeholders and managed collectively, meaning that all losses and gains are also shared.



**Figure 25 : FIDIC contracts and how to use them (FIDIC, 2018). FIDIC contracts are example of the different types of contracts existing for construction systems abroad.**

In this thesis we will propose a process to better consider requirements related to the development of construction systems. This process necessarily have impacts on collaboration among stakeholders and therefore on how it is defined in Laws and contracts. Particularly, it implies more collaboration about stakeholders all along the process. Alliances seem to be the type of contract the most adapted to the method developed in this thesis. However, impacts on existing contracts and laws have not been studied in the thesis and would require more researches to be evaluated and eventually to propose new types of laws, contracts and collaboration modes.

## 1.5. Scientific issues and thesis organization

---

Objectives of the thesis is to adapt Functional Analysis, to develop a robust design method for the construction industry. To reach this objective we have identified 2 scientific issues we will answer in the thesis: the consideration of Space and of the Enabling System in Functional Analysis methods. This new method should allow a form of “industrialization” of the construction industry. Hence, even if each construction product is unique, methods are always repeatable. By analyzing what makes unicity of each project (space and the Enabling System have been identified as such in this thesis) it would be possible to identify what could be repeatable in other projects. Even if projects are unique, they all have similarities which are important to identify in order to avoid unnecessary work and to avoid “reinventing the wheel” each time.

### 1.5.1. Problem n°1: consideration of space in design methods

The first problem identified comes from the consideration of space in design methods for the construction industry. As mentioned above, needs the construction industry answer is to “*adapt space to carry human or related activities*”. This specificity implies that space required to be considered in design methods. Therefore it is necessary to assess when and how space should be integrated in the method. The different aspects of space (political space, physical space, social space, economic space, cultural space etc.) have different impacts at different stage of the development of construction systems which required to be identified, analyzed and integrated: when, how and why space should be integrated in a Functional Analysis method adapted for the construction industry?

### 1.5.2. Problem n°2: consideration of the Enabling System in design methods

The second problem and direct consequence of the consideration of space in design methodology is the unicity of construction systems: as all spaces are different in terms of interactions or characteristics, inevitably all construction projects are different. This unicity implies that the necessary systems required to develop the construction projects are also confronted to unique environments and require to be adapted to local constraints related to the space to adapt. This unicity implies, more than any other systems to consider the constraints related to the development of the product (later called the Enabling System) in Functional Analysis, the design methodology to adapt. Similarly to the consideration of space, it is worth asking, when, how and why to consider constraints from the Enabling System in Functional Analysis? One objective notably is to ensure that decisions are made considering impacts on all stakeholders of the construction projects. This issue will notably lead to the definition of Constructibility criteria, constructibility matrices and a Requirement Modelling tools, concepts which are detailed in the thesis, to better consider constraints from the Enabling System.

### 1.5.3. Insights for the thesis reading

First of all, it is important to remind that the thesis is undertaken through a Convention Industrielle de Formation par la REcherche (CIFRE) 3 years contract between Egis and the Ecole Spéciale des Travaux Publics, du Bâtiment et de l’Industrie (ESTP).

Egis is a design and consulting company specialized in the design and operation of buildings and infrastructures (Figure 26). Egis regroups more than 13.000 employees and is present in all continents (Figure 27).



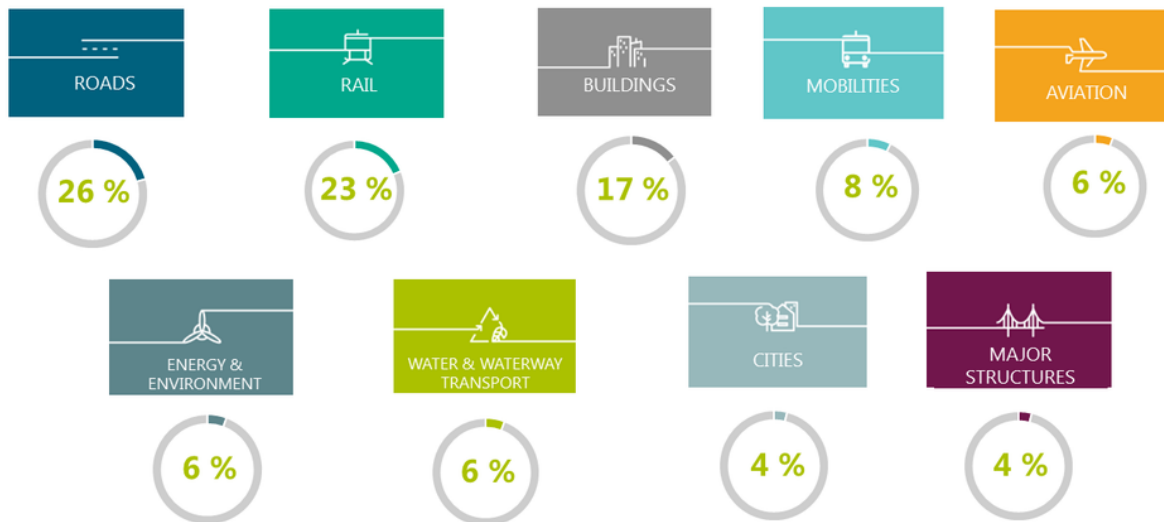


Figure 26 : Egis breakdown activities between sectors (Egis, 2018)

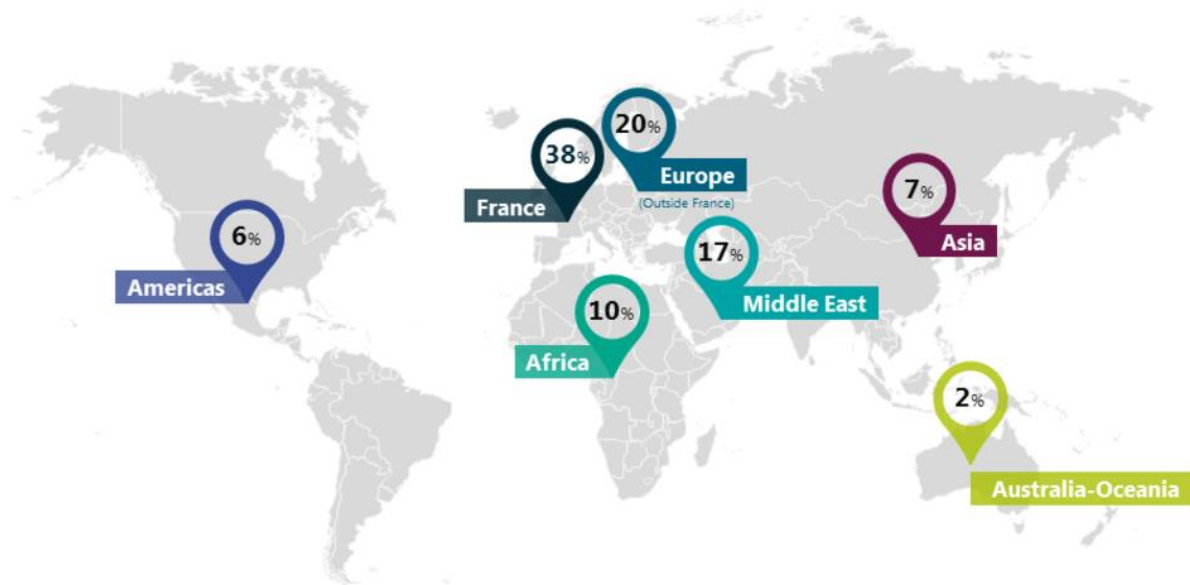


Figure 27 : Egis activities in the world (Egis, 2018)

ESTP is a civil engineering school created in 1891, based in Paris and part of Université Paris-Est. The thesis was carried as part of the Institut de Recherche en Constructibilité (IRC) the research laboratory of ESTP.

In the State of the art, issues are identified in Functional Analysis, System Engineering and Constructibility for their application in the construction domain. Issues are highlighted by “red boxes”:

**Issue n°X:**

...  
...

16 issues have been identified for the application of Functional Analysis, Systems Engineering and Constructibility for complex construction systems. Some of them are directly answered in the State of the art by one of the other method and others will be answered in the Enriched Functional Analysis method developed in part 3.

Improvements are elements which answer to the issues identified in the State of the Art. 23 improvements are presented in this thesis, some are directly coming from System Engineering and Constructibility and require to be

integrated in Functional Analysis and other require specific developments and are explained in Part 3. Improvements are highlighted with blue boxes as follows:

**Improvement n°X:**

...  
...

Finally, application and use of the defined improvements are developed in the Part 4 in the two case studies used for this thesis. The use of improvements is highlighted in green boxes as follows:

**Improvement n°X:**

...  
...

The organization of the thesis can be sum up as represented in Figure 28 with the different parts, issues, improvements and their application in case studies.

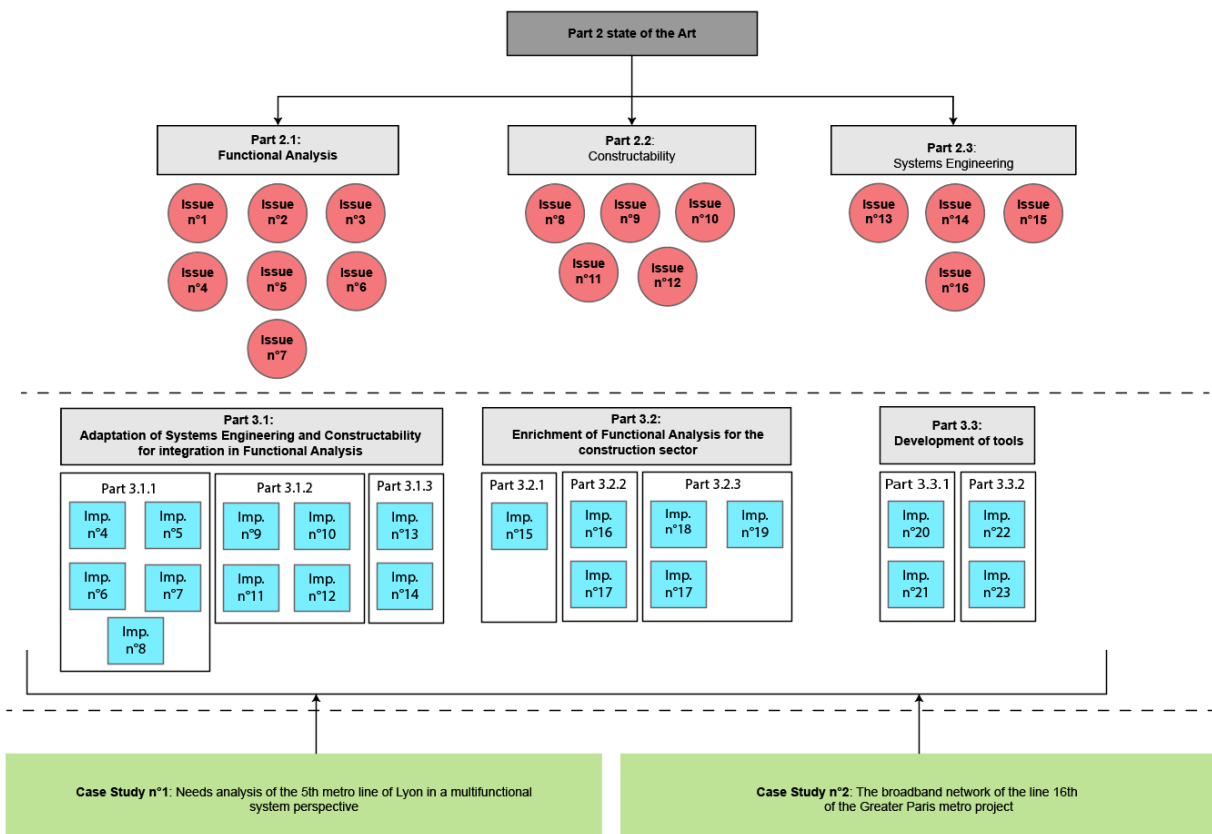


Figure 28 : Thesis organization. 16 issues are identified in the second part (state of the art) for the application of Functional Analysis, Systems Engineering to the construction sector and the integration of Constructability. In the third part 23 improvements are explained to develop an Enriched Functional Analysis method applicable to complex construction projects. In the fourth part, the Enriched method is applied on two case studies.



## **2. State of the art: Functional Analysis, Systems Engineering and Constructability**

---



## Résumé de l'Etat de l'Art en Français

Avant de présenter les différentes méthodes utilisées dans cette thèse, nous présentons rapidement quelques éléments de la *Théorie des Systèmes* ou *Systémique* (notamment les termes de système, système complexe, système de systèmes, fonction, boîte noire) dont sont issues l'Analyse Fonctionnelle et l'Ingénierie Système.

Dans une première partie les différentes méthodes d'Analyse Fonctionnelle sont présentées (SADT, FAST, GRAFCET, QFD, APTE/MISME) et comparées pour leur application dans le domaine de la construction. Les méthodes Quality Functional Deployment (QFD) et Méthode d'Inventaire Systémique des Milieux Extérieurs et Environnants (APTE®/MISME) sont développées avec plus de détails étant donné qu'elles seront réutilisées ultérieurement dans la thèse. Des méthodes permettant d'évaluer comment un système répond à des fonctions sont aussi présentées telles que les méthodes Suivi de Projet En cours de Conception (SPEC) et Data Envelopment Analysis (DEA). Ces méthodes ne seront pas utilisées ici mais elles permettent de montrer qu'il existe des moyens pour évaluer la capacité d'un système à répondre à des fonctions et surtout de définir le terme de *performance*, des recherches ultérieures permettraient d'intégrer ces éléments dans la méthode proposée dans cette thèse.

Deuxièmement, le corpus méthodologique de la *Constructability* est présenté. Nous définissons d'abord deux termes proches et qui ont été à la base de la Constructibilité : la *Manufacturability* qui consiste à prendre en compte les contraintes de production dans l'industrie manufacturière, et la *Buildability* qui consiste à prendre en compte les contraintes liées exclusivement à la réalisation de l'ouvrage. La *Constructability* rassemble des éléments de ces 2 corpus et consiste à prendre en compte l'ensemble des contraintes liées à la réalisation de l'ouvrage dans les phases de planification et de conception. Nous présentons dans cette partie ses principaux concepts et principes. Aujourd'hui, la définition la plus récente de la *Constructability* consiste à la définir comme l'analyse des interactions entre le Produit et le Projet. Nous présentons aussi comment certains ont permis de lier la *Constructability* et le Building Information Modelling (BIM). Dans la suite de cette thèse nous prolongerons cette définition pour proposer un nouveau terme : la *Constructibility* comme l'analyse des interactions entre le Système à faire et le Système pour faire.

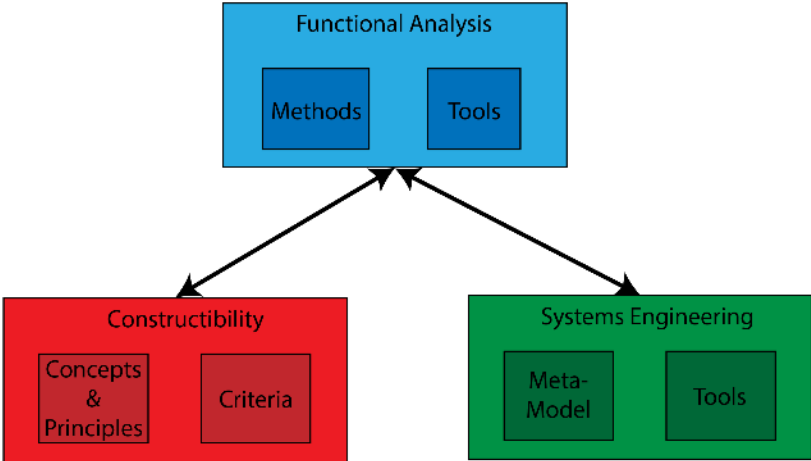
La dernière partie de l'Etat de l'Art concerne l'Ingénierie Système dont l'objectif est de maîtriser le développement des systèmes complexes. Après un bref rappel de l'historique de cette méthode, nous présentons les principaux éléments que nous allons reprendre pour enrichir l'Analyse Fonctionnelle, notamment les méta-modèles (cycle en V), l'Architecture Système, la méthode V&V (Validation et Vérification), la distinction Système à faire/Système pour faire, l'Ingénierie des Exigences (RE) et le Model Based System Engineering et son langage de modélisation dédié à l'Ingénierie Système : System Modelling Language (SysML). Les liens possibles entre Ingénierie Système et BIM sont aussi évoqués et seront développés plus en détail lors de la présentation d'Exegis un outil de modélisation des exigences dans la partie suivante.

Mis à part la *Constructability* qui est dédié au domaine de la construction, nous présentons également les différentes initiatives qui ont été menées pour appliquer l'Analyse Fonctionnelle et l'Ingénierie Système dans ce secteur. En conclusion de l'Etat de l'Art nous soulignons comment l'Ingénierie Système et la Constructibilité pourront apporter à l'Analyse Fonctionnelle ainsi que les limites de leur application dans le domaine de la construction : notamment de la non prise en compte de *l'espace* dans ces méthodes.

Many industries such as aeronautics, defense and aerospace, have had similar problems developing complex systems under constraints of costs, delays and quality. To face these challenges, they have developed methodological corpuses... allowing or enabling them to do what? This thesis aims to adapt these methods to the construction industry by taking into consideration its particularities, such as functional analysis, Constructability, and Systems Engineering. In this chapter these knowledge and methodological corpuses are presented and their application to the construction industry is evaluated. Presented methodologies have different objectives and goals, each of them has its own interest concerning challenges faced by the construction industry, which will be dealt with in the last chapter.

As most of these methods are based on system thinking we first present the basic concepts developed in this theory as an introduction. Figure 29 presents the structure of the state of the arts. In a first step we present Functional Analysis methods with a focus on the MISME method which is the most used and applied in the construction industry. In a second step, constructability concepts, practices and criteria are developed as this methodological corpus is dedicated to the construction industry and highlights its particularities. The last part treats about enrichment of the previously defined methods in order to better manage complexity and enhance innovation in the construction industry.

These methods are at the heart of the proposed method and will be developed in this thesis in the third part of this work. The idea is to integrate these methods in order to define a method which allows the development of complex systems in the construction industry within costs, delays and quality standards.



**Figure 29: State of the art structure.** The state of the art is divided in three parts: Functional Analysis, Constructability and Systems Engineering. It also shows that objective of the thesis is the integration of Constructability and Systems Engineering elements in Functional Analysis for complex construction systems.

**2.1. The System paradigm**

Most of the methodologies for the development of complex products and management of complexity are inspired by *System Thinking* theories developed in the 60's. Both, Functional Analysis and Systems Engineering methods used in this thesis are derived from System thinking concepts applied to industrial man-made systems. In this part, fundamentals elements of System thinking are presented and defined as they will be used in presented methodologies.

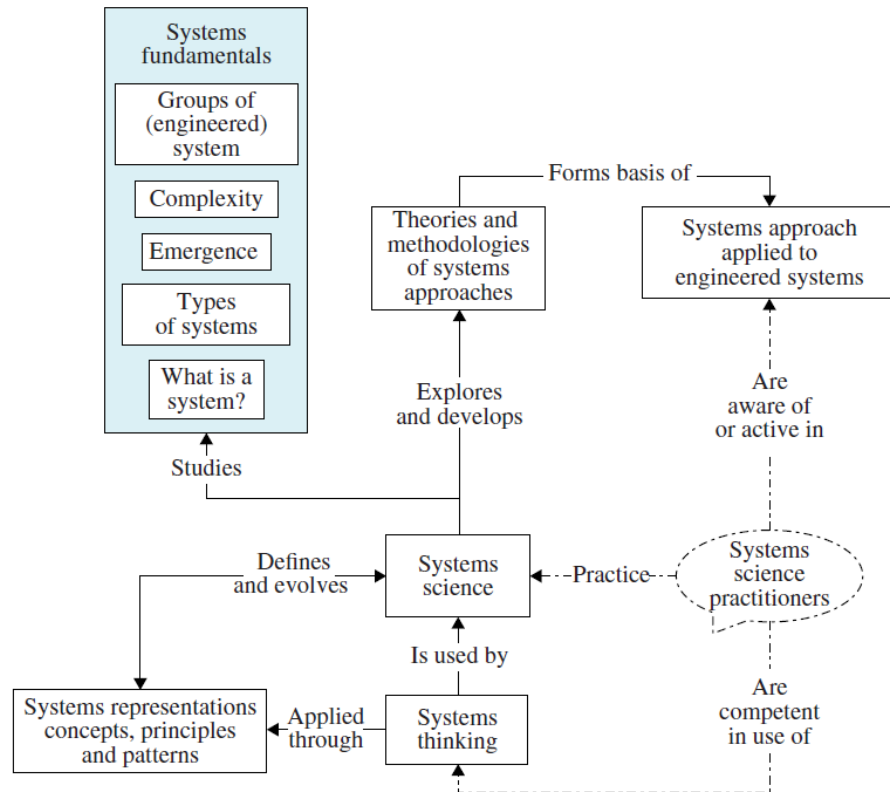


Figure 30 : Systems Thinking, Systems science and Systems Engineering, (INCOSE, 2015). This diagram shows how Systems thinking and Systems science influence Systems Engineering methodologies and approaches. Functional Analysis as well has been very much influenced by System thinking theories.

*System Thinking* offers methods, definitions and concepts which will be used in this thesis. The concepts of “Systems”, “Complex Systems”, “Functions”, “Processes” and “Black box” are basic elements of presented methodologies. In this part we will introduce these concepts briefly and how they can be applied to construction products.

### 2.1.1. What is a system?

Luther Von Bertalanffy (1950, 1968) gives the following definition of a system: “A *system is a whole consisting of interacting parts*”. More precisely the norm ISO 15288 gives the following definition for man-made systems: “A *man-made system is a whole consisting of interacting parts created and utilized to provide products or services in defined environment for the benefits of users and other stakeholders*”.

Krob in (Krob, 2014) distinguishes two types of systems: *formal systems* and *real systems*.

**Formal System:** A formal system  $S$  is characterized by the sets of input data  $X$ , output data  $Y$ , internal states  $Q$  and the following two behaviors which link variables  $X$ ,  $Y$  and  $Q$ :

- A functional behavior which produces an output  $y(t)=Y$  according to an input  $x(t)=X$  and internal states  $q(t)=Q$ ;
- An internal behavior which makes internal states of the system evolved over time towards the action of an input data  $x(t)=X$  of the system.

**Real system:** an object of the real world is called a *real system* if its structure and its behavior can be described by a *formal system*. The formal system is therefore called a model of the real system.



It is important to keep in mind that a formal system is only an abstraction of a real system. It means that the *formal system* only represents a portion of the *real system* in order to analyze it for a particular purpose of the modeler. Any other conclusions about the real system made upon the formal system are very risky as some elements of the real system have been voluntarily deleted to simplify its analysis.

From this very general definition a construction product (infrastructure, building) can be considered as a system: it is composed of different interacting parts (civil engineering, electrical, plumbing...) for the benefits of users (dwellers, travelers, inhabitants...) or/and stakeholders (politicians, private companies, fauna and flora...). A typology of systems has been developed over time like Complex Systems or Systems-of-Systems.

### 2.1.2. Construction systems and Complex systems

There is not a commonly accepted definition of what is a complex systems but we can highlight some usually accepted characteristics. We will then evaluate if systems from the construction industry are complex systems or not.

For Bar-Yam (Bar-Yam, 2000) studying complex systems consists in analyzing how parts of a system are working together and to understand its functioning. It is focused on relationships between systems elements more than the studying of elements of systems themselves.

Herbert Simon in *The Architecture of complexity* (Simon, 1962) gives the following definition of a complex system: “*by a complex system I mean one made up of a large number of parts that interact in a non-simple way. In such system the whole is more than the sum of the parts not in an ultimate, metaphysical sense, but in the important pragmatic sense that, given the properties of the parts and the laws of their inter-action, it is not a trivial matter to infer the properties of the whole.*”

Cilliers (Cilliers, 1998) enumerates 10 characteristics defining a complex system:

1. It has a great number of elements;

This criteria is the most understandable, a complex system is composed of a large number of elements.

2. Its elements interact dynamically;

A large number of elements is necessary but not sufficient to define a complex system. Interactions between the components have to be dynamic. Cilliers adds that the interactions do not have to be physical but require a transfer of information.

3. Interactions are numerous, each element of the system could be influenced by others;

Any element of the system is influenced and influences many other elements.

4. Interactions are nonlinear;

Cilliers stresses that a large system composed of linear interactions can be collapsed into a smaller system. Non-linearity of interaction is a prerequisite of complexity.

5. Interactions have a short range;

In most of complex systems information is received from close neighbors and are not long range interactions.

6. Interactions consist in positive and negative retroactions;

Interactions constitute loops, meaning that activity of the system can, sometimes after several steps, have impacts on the activity itself.

7. The system is open;

Complex systems are usually open meaning that they interact with their environment, borders of a complex system are often difficult to define with accuracy and depends on the position of the observer.

8. It functions under certain conditions leading to a disequilibrium;

A constant flow of energy is required for the system to “survive” or to be operational.

9. It has an history;

History of the system has an impact on its functioning and its behavior.

10. Its elements ignore the behavior of the general system they are part of.

Each element of the system is functioning on its own without considering the global system it is part of. It only considers information it has access to locally. Complexity is the result of the interactions of simple elements which have limited knowledge and information about the global system.

Berrard in (Berrard, 2010) cites Sterman (Sterman J. , 2000) and gives the following definition of a complex system: A complex system is characterized by the multiplicity of its components (natural, technic, economic, social) and of their interactions, but also from the diversity of their dynamic behaviors. She adds 5 more criteria allowing its characterization:

1. Actors of the system have strong interactions between each other;
2. They have an important time dependency;
3. Feedback loops between elements of the system;
4. Behaviors are hardly predictable and counterintuitive;
5. Behaviors are subject to long time delays;

Berrard also presents two classifications of the different levels of complexity from Von Bertalanffy and Le Moigne:

Von Bertalanffy (1968)		Le Moigne (1997)	
Level	Description	Level	Description
1	Static structure	1	Passive system
2	"Watch movements"	2	Active system
3	Self-regulated mecanismes	3	Regulated system
4	Open systems	4	Informed system
5	Low level organisms	5	Deciding system
6	Animals	6	Memorizing system
7	Humans	7	Organizing system
8	Socio-cultural systems	8	Self-organizing system
9	Symbolic systems	9	Self-finalizing system

**Figure 31 : Levels of complexity. Adapted from (Berrard, 2010). This table shows different level of complexity of systems and how definition of system complexity has evolved over the years.**

We can notice that a commonly accepted definition of a complex system doesn't exist. Differences exist on the definition of criteria to consider complex systems. Sterman establishes 5 criteria to define complex systems while Cilliers considers 10 criteria. Do Construction systems are complex? And if they are, what is their level of complexity? The question is worth asking in order to apply appropriate methodologies to the appropriate objects. Several authors have tried to evaluate the complexity of construction systems, a synthesis of their work is presented in the paragraphs below:

In (Sterman, 1992), Sterman explains that construction projects are “*extremely complex, consisting of multiple interdependent components*”. The main reasons highlighted by Sterman to demonstrate that “Large Scale projects” are complex dynamic systems are:

- Construction products are composed of multiple interdependent components;

Sterman takes the example of a change in the fitting of a construction system element. This change will have impacts on other subsystems such as electrical subsystems or HVAC implying reworks on the design of these last subsystems and therefore delays and over-costs.

- Are highly dynamic;

Hiring policies is taken as an example of the dynamic aspect of construction projects. Hiring new workers will require experienced workers to train them impacting their work productivity in the short term.

- Involve multiple feedback processes;

Sterman takes the example of a project which falls behind schedule. Different solutions exist and one is to increase the use of overtime. But, this solution could imply fatigue and burn outs over workers which has impacts on productivity and leads to new and more delays in the project.

- Involve nonlinear relationships;

The same example is taken to showcase nonlinear relationships in construction projects: increasing working time of a worker by 10% does not increase its productivity by 10% as it will imply more fatigue which leads to more errors and less quality. This example highlights that the relation between working time and productivity is not linear.

- Involve both hard and soft data.

A construction project is composed of “hard” elements such as drawings, pipes, materials, wiring etc. but it is essentially a human enterprise and will concern managerial decision making.

It is important to notice that most of the examples taken by Sterman to highlight complexity of construction systems come from the construction “project” and not necessarily from the “product” itself. In other words, examples taken by Sterman don’t show that the functioning of a construction system is complex but rather the project enabling its development that is complex.

Baccarini in (Baccarini, 1996), also highlights the complexity of construction systems. He distinguishes two types of complexity: organizational and technical complexity:

- Organizational complexity refers to allocation of responsibilities and allocation of tasks. From an organizational point of view, construction systems are complex because they involve many different specializations and they lead to the creation of temporary multiorganizational structures (contractors, designers, clients etc.).
- Technological complexity refers to the diversity of inputs, tasks to produce and number of specialties involved in a project and their interdependency. According to Baccarini, this type of complexity applies to construction products as many types of construction exist (buildings, infrastructures, utilities etc.), design and construction overlap, difficulties related to location of projects and interdependences of operations.

The distinction made by Baccarini between organizational complexity and technical complexity is similar to the distinction we will make later between complexity of the project and complexity of the product. Nevertheless,

regarding complexity criteria defined previously, not all criteria are fulfilled to consider construction products complex.

We can notice that criteria to evaluate complexity over projects are not the same depending on the authors, there is not a globally accepted definition of complexity from a technical perspective.

In (Bertelsen, 2003), Bertelsen explains why Construction products can be considered as complex systems and takes the example of an underground metro system to highlight this complexity. Bertelsen makes another distinction in project complexity than Baccarini by defining Internal and External complexity.

- Internal complexity refers to “*issues which are caused by the participants in design and construction processes*”. Internal complexity is characterized by a considerable amount of details, relationships between components, the enormous amount of information to process, the number of companies implied in the planning, design and construction of the project, the variety of needed expertise, the difficulties to transfer knowledge between projects, the variety of local environment conditions, the different bureaucracies depending on the countries, the duration of projects which can last decades and are therefore subject to unexpected events, integration difficulties.
- External complexity includes “*the complexity which is specifically caused by the conditions and situations of metro project*”. External complexity refers to the complexity of the environment of construction products are more particularly underground projects. The environment is changing and interactions between the construction system and its environment need to be managed properly.








Examining how the different mentioned authors have explained why construction systems can be considered as complex and comparing it with the criteria defined by Cilliers (Cilliers, 1998) and Berrard (Berrard, 2010), we can deduce the following conclusion:

First it depends what we consider as a construction system and the questions of boundaries of the system is crucial here. Is a construction system only the concrete structure? Or with all other subsystems composing it? Do we consider as well all systems involved in its development stage (organizations, humans, tools, engines etc. used for its development)? Are the people/companies responsible for its maintenance and operation part of the system as well? Answering these questions and defining boundaries of the system is the first step to evaluate the complexity of a construction system.

For instance, in a metro system, where one of the sub-system is an infrastructure (whereas it is underground, at grade or above ground) do we also consider the rolling stock and the driverless system as part of the construction system?

**Example of the complexity of a metro system:**

In this example we try to evaluate complexity level of metro systems by analyzing it with different boundaries of the system and different levels of detail. It is interesting to highlight that the complexity level can greatly change depending on the defined boundaries and level of detail.

Product	 Metro network	 Metro infrastructure (tunnel)	 Metro infrastructure + other subsystems	 Metro infrastructure + other subsystems + operation system
Complexity	Level 3	Level 2	Level 3	Level 7
Project	 Metro network + governance system + financial system + planning...	 Metro infrastructure + design + construction	 Metro infrastructure and other subsystems + design + construction	
Complexity	Level 7	Level 7	Level 7	

**Figure 32 : Complexity levels of metro systems. This figure shows that complexity of a system depends of its frontier/limit and what is considered in or outside the system. This is even more true if the system is not limited to its functioning under operation but also to all the required subsystems for its development.**

Different views of a metro system are given in Figure 32:

- A metro network

A metro network is composed of several interconnected metro lines which allow moving people in different points of the city. Functioning of a metro network depends on a lot of external events (especially in the long term) as instance: modal choices of urban dwellers, urban evolutions, natural events (e.g. flooding, earthquakes). Considering all these interdependencies a metro network can be considered as a complex system level 3: it is a self-regulated system as a steam engine which stops accelerating when overheated, a metro network has limited capability when the transport demand is too high. Similarly when a problem occur on one line (flood as instance), part of the transport demand is transferred to other lines etc.

- A metro tunnel

A metro tunnel can be considered as a complex system level 2, its functioning consists in resist earth pressure. It is not a regulated system but it “operates” as the movement of a switch.

However, if we consider not only functioning of the tunnel but the necessary systems required for its realization it becomes complex: the geology is changing and is very difficult to predict, information about geology are difficult to gather, the underground has a lot of interactions with other systems (buildings foundations, underground utilities etc.). Here again it how boundaries of the system have been delineated.

- A metro tunnel and all other subsystems related to the transportation system

If we consider not only the infrastructure (e.g. tunnel) but also other subsystems, it can be considered as a complex system level 4 or 5 for driverless metro: it is a regulated system which receives information.

The system reacts to external events such as an obstacle on the permanent way and is able to take decisions. It is interesting to highlight that while a metro network has been identified in our analysis as a complex system level 3, a metro system analyzed at another level of detail would be a complex system level 4 or 5.

- All metro subsystems and systems required for its development

When considering not only the metro system itself but also all systems required for its development such as planning authorities, design companies, architects, and contractors etc. the system becomes even more complex: it is capable of imagining and elaborating new form of actions and to learn from past experiences. In the Le Moigne levels of complexity it corresponds to level of complexity 7.

Finally, what are we talking about when one says a “metro system is a complex system”? A metro network? A metro infrastructure and all transportation subsystems? A metro infrastructure and all transportation subsystems as well as all the elements required for its development (financing, contracting, tools, human resources etc.)? Boundaries of the system will define its level of complexity and appropriate methodologies to set up to manage this complexity. It highlights that defining what a metro system is varies greatly as well as its level of complexity depending on what is considered or not in the system.

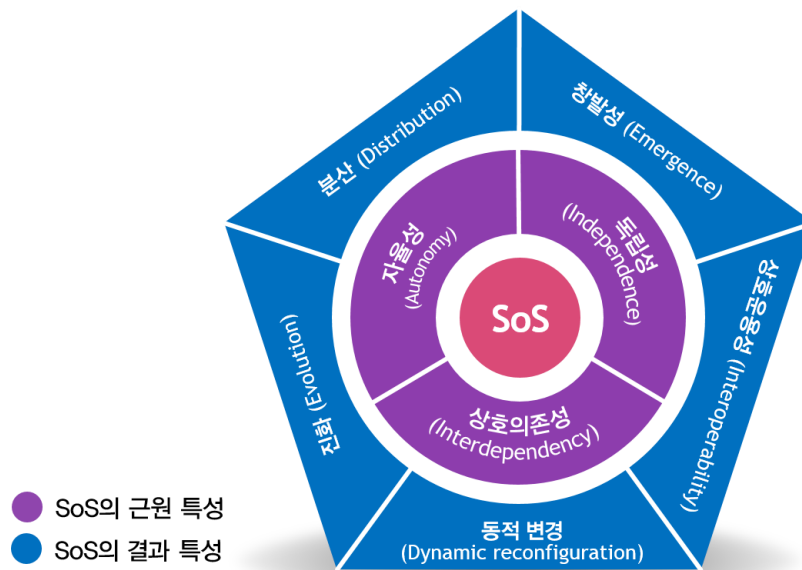
In this thesis, when we refer to construction systems we consider only the system which has the function of adapting space (geographical space) as well as systems required for its development. If we take back the example of a metro system, we only consider the metro infrastructure (later called the System of interest) and all systems required for its planning, design and construction (later called the Enabling System). As instance, would be excluded of the study internal functioning of the rolling stock, of the signaling system, of the driverless system etc. as well as interfaces between them. Nevertheless, interfaces and interactions between the infrastructure system and transportation systems would be considered.

In the next section we will see that another type of system exists which can be composed in parts of complex systems: System-of-systems (SoS). The question will rise if construction systems can or not be considered as SoS.

### 2.1.3. Construction systems and System-of-Systems (SoS)

System of Systems (SoS) is another type of manmade system with particular properties. Like the concept of complex systems, a definition of SoS is not widely accepted and is still in construction. For some authors (Shenhar, 1995), (Eisner, Marciniak, & McMillan, 1991)) SoS are necessarily large, complex, geographically distributed, and composed of components that are significant systems in their own right. Maier (Maier, 1998) and (Kazman, Nielsen, & Shmid, December 2013) propose five properties defining Systems of Systems (Figure 33):

- ***Operational Independence of the components:*** *They have a collaborative rather than directed structure. Its components fulfilled valid purposes in their own right and continued to operate to fulfill those purposes if disassembled from the overall system. The integrated system exists because of deliberate decisions by the subsystems to collaborate.*
- ***Managerial Independence of the components:*** *The component systems not only can operate independently, they do operate independently. The component systems are separately acquired and integrated but maintain a continuing operational existence independent of the system of systems.*
- ***Evolutionary development:*** *The system of systems does not appear fully formed. Its development and existence is evolutionary with functions and purposes added, removed, and modified with experience.*
- ***Emergent Behavior:*** *The system of systems performs functions and carries out purposes that do not reside in any component system. These behaviors are emergent properties of the entire system of systems and cannot be localized to any component system. The principal purposes of the systems of systems are fulfilled by these behaviors.*
- ***Geographic Distribution:*** *The geographic extent of the component systems is large. Large is a nebulous and relative concept as communication capabilities increase, but at a minimum it means that the components can readily exchange only information and not substantial quantities of mass or energy.”*



**Figure 33 : System of Systems definition (SE LAB Kaist, 2018).** This figure sums up the different properties of a System of Systems.

From this definition, a system composed of complex subsystems that do not have operational and managerial independence is not a “systems-of-systems”.

Maier adds that Systems-of-systems are necessarily more costly than integrated systems because of their redundancies: *“Since components can operate independently they possess capabilities duplicated in other components. By eliminating that redundancy one could reduce costs”*. Maier identified at least two reasons implying the development of Systems-of-systems whereas they are more costly (Maier, 1998):

- *“The disaggregated operational modes carry more value than the additional costs;*
- *The total Systems-of-Systems cost is not borne by a single identifiable customer and so there is no decision-maker to whom minimizing total cost is important.”*

SoS can then arise intentionally if they benefit of the redundancy or by accident if no decision-maker is aware of implied higher costs or if they don’t care. SoS are then fundamentally collaborative and arise only because of the goodwill of stakeholders involved. It cannot be taken for granted that the collaboration allowing the functioning of the SoS will last forever, new collaboration can arise and other can disappear.

The following question is: are construction products (buildings or/and infrastructures) Systems-of-Systems? Considering a construction product alone, some of them like large infrastructures fit with the definition of SoS from Sheinhar and Eisner ( (Shenhar, 1995), (Eisner, Marciniak, & McMillan, 1991)): SoS are *“large, complex, geographically distributed, and composed of components that are significant systems in their own right”*. Here again, as well as the definition of complex systems the question of boundaries of the system is crucial.

In (Zhu, Whyte, & Mostafavi, 2017) and (Zhu & Mostafavi, 2014) Zhu explains that megaprojects can be considered as Systems-of-Systems. Megaprojects are large-scale infrastructures, cost more than US1\$ billion, take many years to develop and build, involve several stakeholders (public and private), are transformational and impact millions of people. Examples of megaprojects are: airports, high-speed rail lines, Olympics infrastructures, seaports. Zhu explains that the main aspect of mega-projects that makes it a SoS is its socio-technical nature. It is interesting to note that the concept of SoS is applied to *projects* and even *megaprojects* and not the system itself. In other words, from Zhu explanations, what makes a construction system a SoS is the necessary system (the Enabling System) to set up for its development more than the construction system itself (Figure 34): processes,

activities, tasks, resources, information and human agents required to plan, design and build the system (System of Interest) as well as their interactions is a SoS.

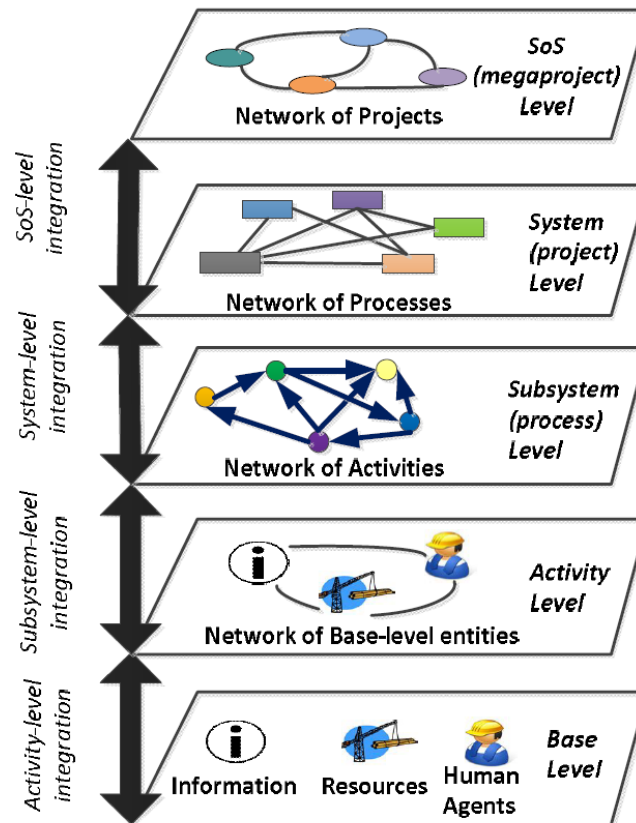


Figure 34 : Megaproject system-of-systems conceptualization (Zhu, Whyte, & Mostafavi, 2017). This diagram shows the different systemic levels of a construction/infrastructure project. It shows that it can be considered as a System of Systems. However, does it also apply on a construction product?

However, in some cases, the construction system itself can also be considered as a SoS:

- Operational Independence of the components

Usually, elements of construction products are not managed for their own purposes rather than of the whole. However, in some cases a construction product is functioning because of the *deliberate decisions of the subsystems to collaborate*. It is the case when studying a set of infrastructures: as instance electrical infrastructures and transportation infrastructures need to collaborate as transportation systems require energy to operate. However, both systems have different purposes.

- Managerial independence of the components

This aspect is more unusual, usually components of an infrastructure or a building are not managed independently. As the last criteria, this criterion might be fulfilled when studying a set of different infrastructures. Similarly, electrical infrastructures and transport infrastructures are operated separately.

- Evolutionary development

Construction products can have an evolutionary development with functions and purposes added or removed. But this is again more obvious when studying different infrastructures: electrical infrastructures in a city are evolutionary and don't have the same evolution as other types of infrastructures such as transportation infrastructures.



- Emergent behavior

This criterion is fulfilled by any complex system and is not particular to SoS. As we have mentioned in the last part, if construction systems are considered as complex they might fulfill this criterion.

- Geographic distribution

Usually, components of construction products can exchange materials or energy. However, this aspect is changing with the development of IoT (Internet of Things) in the construction industry: more and more buildings and infrastructures are connected between each other to offer more services for inhabitants.

Finally, it is difficult to assess if a construction system can be considered as a SoS or not, it seems that it is the case at the city or territorial level more than at the infrastructure/building scale. Nevertheless, If we expand boundaries of construction systems to groups of infrastructures/buildings used for different urban purposes (cities), or if we integrate projects elements in the system, it could be considered as System-of-Systems. For instance, Smart Grid, and Smart city can be considered as Systems-of-Systems (Eusgeld, Nan, & Dietz, 2011), (Cavalcante, Cacho, Lopes, & Batista, 2017).

Moreover, as mentioned in (Zhu, Whyte, & Mostafavi, 2017), the Enabling System required to develop complex mega-projects such as large infrastructures can be considered and analyzed as a SoS.

Therefore, as Maier stated that SoS are more resource consuming than integrated systems, there is a need (at least an economical need) to have more integrated infrastructures essentially to avoid redundancies. Actual functioning of infrastructures networks as a Systems-of-systems leads to more wastes in terms of resource consumption and from an economic perspective. In a period of time when humanity uses more natural resources than their natural regeneration and in a constraint economic context, the development of more integrated systems is part of the solution to improve both impacts of urban development projects on the environment and mutualize investments. This integration has a cost as stated by Maier: it allows less operational independency for the management of urban systems.

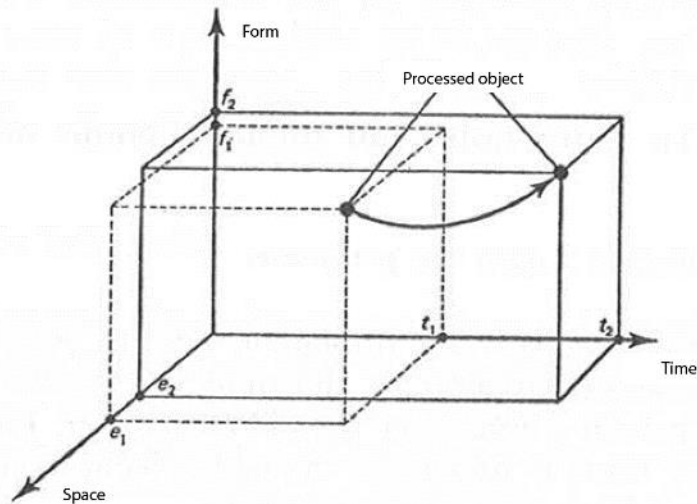
Mutualization of urban systems also raises the question of responsibilities: a SoS allows to “dilute” responsibilities over several actors each responsible for one system. At the opposite in an integrated system all responsibilities are clustered amongst one actor. The political risk is therefore higher in case of failure of the system.

#### **2.1.4. The triadic decomposition of any function**

Another important concept developed in the system thinking theory is the concept of *function*. Both in Functional Analysis and Systems Engineering the concept of function is central.

The European Norm EN NF 50-151 gives the following definition of a *function*: “*Action of a product (system) or from one of its components express exclusively in terms of finality*”.

Le Moigne, a French specialist of Systemic details the composition of a function. More generally than the term *function* Le Moigne uses the term *process* and cites Miller to define it: “*A process is any change of material, energy or information over time*” (Miller, 1965). However, Le Moigne considers that this definition is incomplete and he adds that a process, i.e. a function is “*any change of material, energy or information always over time and sometimes over space and form*” (Le Moigne, 2006). Intervene, proceed, do, function, change an object it is affecting its position at least over time, space or its form.



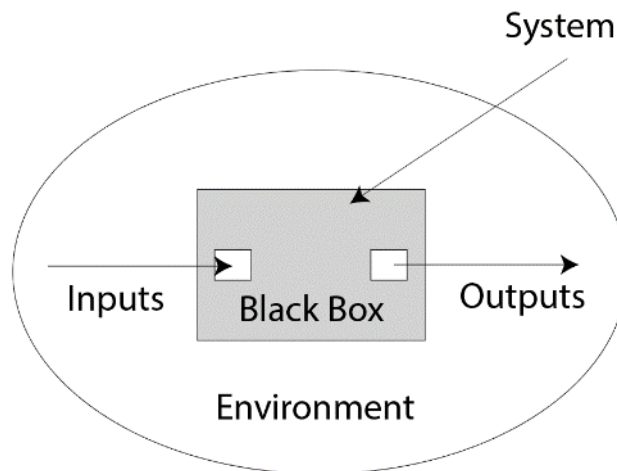
**Figure 35 : The triadic decomposition of any function. Adapted from (Le Moigne, 2006). Any processing function of a system can be decomposed in the three dimensions: time, space and form. These last elements (space and form) will be of great importance for the application of Functional Analysis in the construction sector.**

The addition of space as a dimension on which a function can intervene is of great importance in this thesis and is very rich considering the construction industry. As we explained in the first chapter, the main activity of the construction industry is to adapt *space* in order to carry activities. Therefore, if the question is does a construction product have functions? The answer is yes, considering the definition of a function above-mentioned: it adapts space over time to carry activities.

As instance, a tunnel adapts a space located underground to offer the possibility to carry activities like move trains, water, cars, trains etc. It processes an underground soil to adapt a space over time to carry activities. The processed object is the underground soil and the processor object is the tunnel. This first simple modeling of a tunnel function shows that the system thinking theory has an application on construction products.

### 2.1.5. Systems as « black boxes »

Functional analysis notably consists to model and analyze a system from the point of view of “what the system is doing” instead of “what it is composed of”.



**Figure 36 : Systems as black boxes. Adapted from (Le Moigne, 2006). Any system can be seen as a black box surrounded by an environment with which it is interacting and processing inputs from this environment to outputs.**

In the System theory, any system can be modeled as a “Black box”: it has a behavior in an environment; it receives and emits other objects which are processed (over time, space or shape) and is itself subject to modifications over time, space and shape.

A system can be decomposed in subsystems which themselves can be considered as black boxes processing Materials, Energy or Information (MEI).

## **2.2. Functional analysis**

### **2.2.1. What is Functional Analysis?**

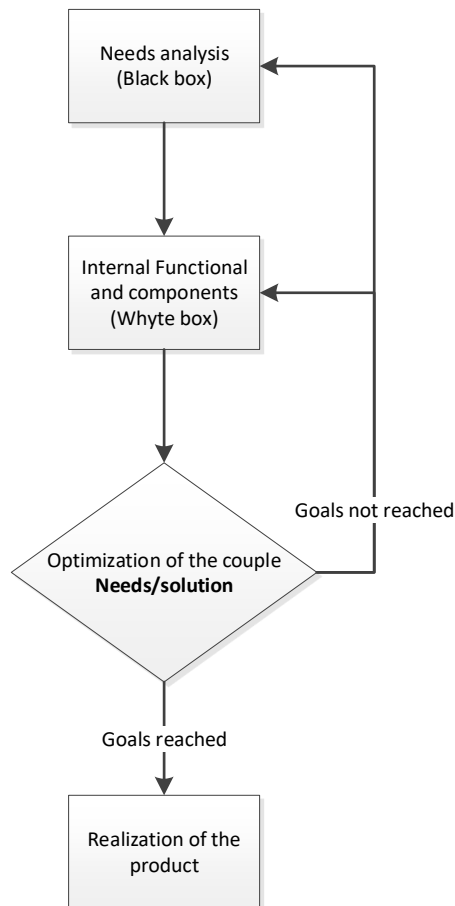
Functional analysis is a methodology which allows designing systems by defining its functions. The considered system is not only composed by components but most of all by its functions whether they are external or internal. Functional analysis can be applied to all kinds of systems (organizations, physical, and non-physical) (Allaire, 2012).

Concepts of “black box” and “functions” previously defined in the System Thinking theory are central in this methodology.

An essential point of the methodology that we will develop more in the following parts is to make the difference between functions, which express goals to accomplish (problem domain) and solutions, which express the means to achieve them (solution domain).

In Europe, Functional Analysis is standardized by the norm EN 16271, and norm NF X50-151 in France. These norms explain and normalize how to write a “design brief” essentially for industrial products in terms of functions (goals to accomplish). One objective of this thesis is to enrich this method to apply it to the construction industry and to extend its application for the management of complexity.

The main principle of functional analysis can be summarized by the following scheme:



**Figure 37 : Functional Analysis Principle (Peyras, 2003). Most of Functional Analysis methods follow the same process: it starts with the definition of needs and by considering the system as a black box. Then the system is analyzed internally as a whyte box, internal functions and subsystems are defined. A feedback loop allows optimizing the couple needs/solution. Finally the product is realized when the couple needs vs solution is considered as satisfactory.**

We can already notice that in this scheme, realization of the system is considered only at the end of the process whereas realization constraints could have had impacts on the design of the product. Consideration of such constraints is one of the modifications we will make to Functional Analysis by including constructability concepts and principles of constructability.

In this part we will sum up and compare most used Functional Analysis methods (Azarian & Pollet, 2016) and (Allaire, 2012). Two methods will be developed more in detail as they have been used more extensively in the construction industry (APTE and QFD) and will be at the base of the Enriched Functional Analysis method presented in this thesis.

### 2.2.2. Functional analysis goals

Functional Analysis is used for different purposes as mentioned in (Azarian & Pollet, 2016): the main objective of Functional Analysis methods is to optimize the design of man-made products in a Value Analysis/Design to value approach. In other words, it consists in optimizing a system to offer maximum value for its users, by adding or improving functions or by reducing costs (Design-to-cost).

Another domain where Functional Analysis is used is to optimize maintenance and operation of systems (Zwingelstein, 1996). Functions are identified and maintenance and operation tasks are carried to optimize functioning of the system. It is also used to improve resilience of systems and notably urban infrastructure systems to evaluate impacts of external events on functions of the system and carry appropriate interventions on the system to improve its resilience (Gonzva, Mireia, & Barroca, 2015).

We can immediately notice that aim of Functional Analysis is more to optimize systems than to master complexity of their development. This is the first reason why this method requires some adaptations to be applicable on complex construction projects.

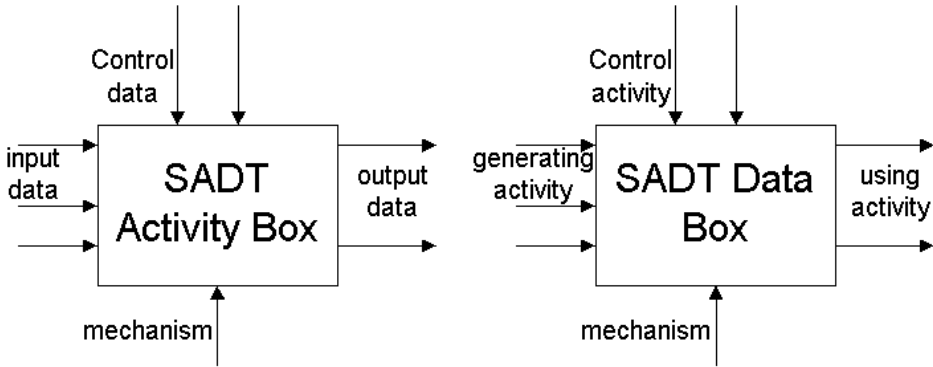
Functional Analysis is also applicable at different stages of development of products (Azarian & Pollet, 2016). To define functions of a new systems in early phases of the product development and properly define needs it will answer in Value Analysis approach, to re-design an existing system by improving its functions or its components to better fit to the functions (re-engineering) and in maintenance and operation phases to optimize maintenance and operation tasks.

**2.2.3. Functional analysis methods**

**2.2.3.1. SADT-IDEF0 Method**

Structured Analysis and Design Technics (SADT) has been developed by Softech (USA) in the 70's to specify functionalities of complex systems, easily exchange between users, foster team working. It avoids omissions, contradictions, redundancies, lack of clarity and poor communication. This method is also sometimes called IDEF0 (Icam DEFINition for Function Modelling) (Ross, 1977).

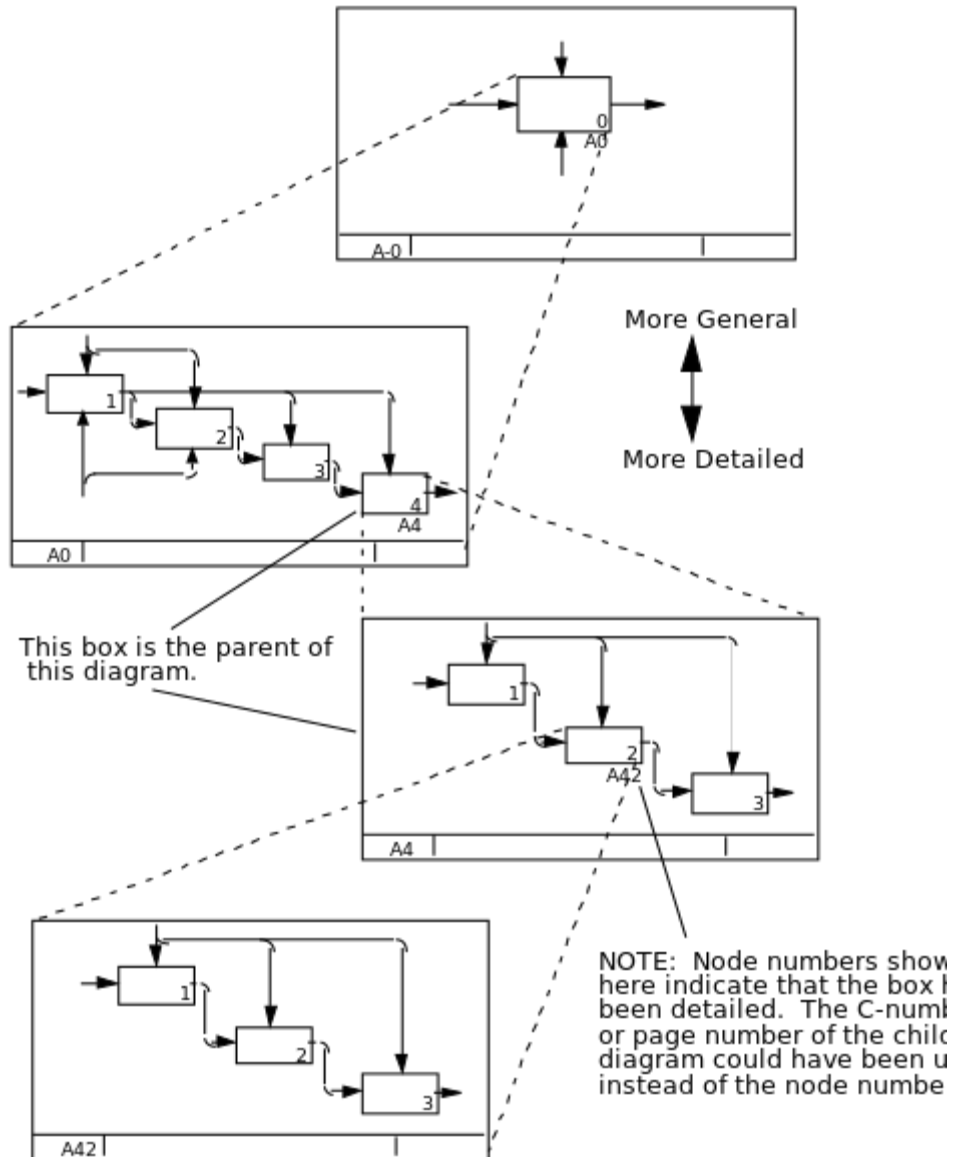
SADT has been mostly used in telecommunications, aeronautics and defense industries. It consists in modeling a system by its functions with diagrams and texts in a hierarchical manner (Figure 38):



**Figure 38 : SADT Activity and Data diagrams. In this method the system is represented as a box. Arrows from the left side of the box are inputs of the process and arrows on the right side output of the process. Arrows at the top are control activities of the process eventually constraining its progress and arrows at the bottom mechanisms required for the process which also potentially impact its progress.**

- Arrows on the left side represent inputs (data, materials, consumables) of the function;
- Arrows on the right side represent outputs of the function;
- Arrows on the top represent commands and conditions influencing the function;
- Arrows on the bottom represent means, tools, equipment to accomplish the function;

Activity (function) boxes are connected when they are at the same hierarchical level (systemic levels) and each box can be subdivided in another diagram representing its sub-functions:



**Figure 39 : The different systemic levels in SADT diagrams. In the SADT method, the different systemic levels are represented through different levels. A0 represents the highest level, then the system is decomposed in A1...An schemes where the lower systemic levels are described. Subsystems are also represented as boxes similarly to the system level.**

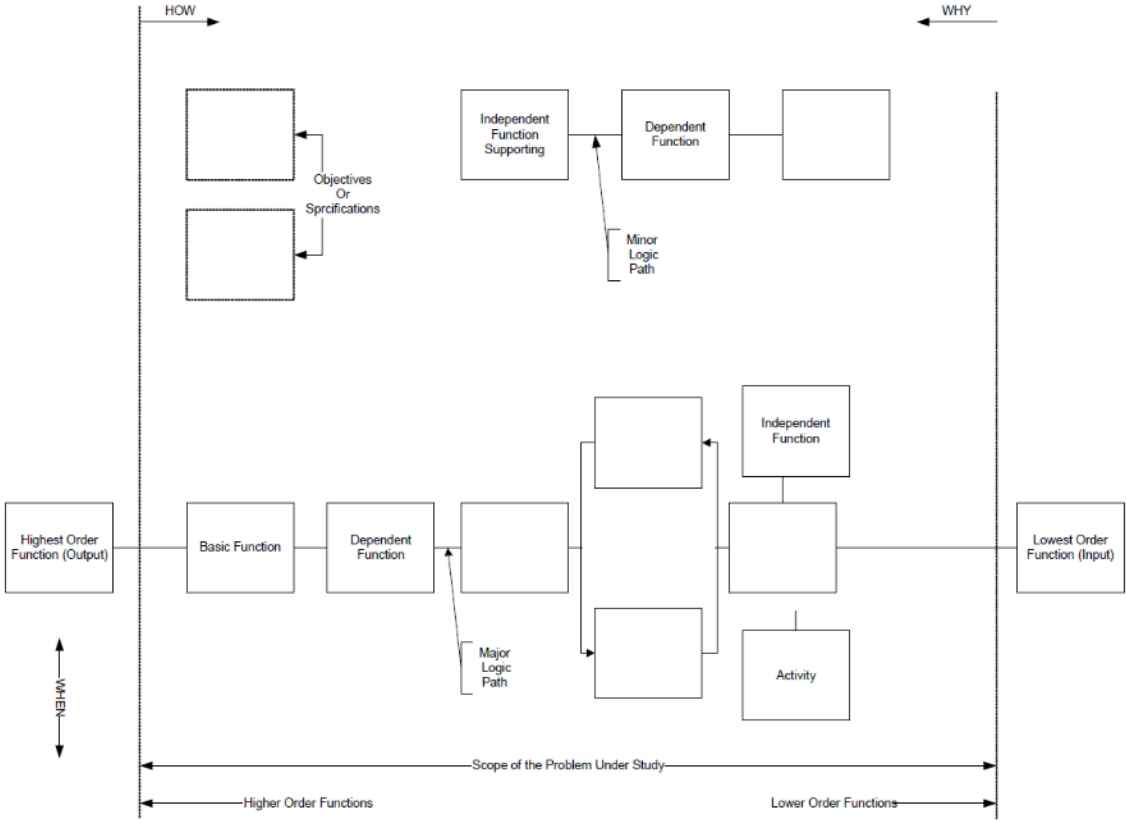
All functions are then completely described from the system level to components levels. An adaptation of SADT for Real Time Systems has also been developed (SA-RT), the main difference with SADT lies in the description of the behavior of the system (states, processes) (Lakhoua, 2012).

External elements interacting with the system are represented at the A0 level where Main Functions of the system are defined. In lower levels A1, A2...An define internal functions of the system are defined. Under each activity box in diagrams, arrows indicate the component that will accomplish the defined functions.

### **2.2.3.2. FAST Method**

Functional Analysis System Technique (FAST) is another method of Functional Analysis. This method is coming from value engineering and has been developed in the 60's by Charles Bytheway in the US (Bytheway, 2007).

The method provides graphical representation and logical structures to visualize, organize and model functions: the diagram is composed of boxes, each box representing a function. Functions are connected by the logical links: “How?” (arrows going to the right), “Why?”(arrows going to the left) and “When?” (arrows going to the bottom) (Figure 40):



**Figure 40 : The basic FAST Model (Bytheway, Society of American Value Engineers, 1964). In this figure an example of a system decomposed in functions with the FAST method is represented. Going from the left to the right are represented the different functional levels, higher order functions are on the left side and they are decomposed in lower order functions the more we go on the right side. Going from the left to the right answers to the question “How?”, from the right to the left to the question “Why?” and from the top to the bottom to the question “When?”.**

Functions at the left side of the diagram express external functions/needs (problem domain) of the client and the more we move to the right side of the diagram the more we get into internal functions of the system (solution domain).

Drawbacks of the FAST model are that elements of the environment are not represented and the concept of black box is not used in this method, it focuses essentially on the functional decomposition of the system. However, it is a very efficient way to organize, prioritize, trace and classify functions of a system.

The FAST diagram can be used to determine the “Critical Path Function”: two types of functions are defined in the diagram, independent functions and dependent functions. Independent functions don’t have a “why link” with another function, in other words, they are “design function” and are not related to a function of a higher order. Therefore, dependent functions are on the Critical Path and are compulsory to answer needs of the system. Independent functions at the opposite are optional or can be replaced (Borza, 2011).

### 2.2.3.3. GRAFCET

Graphe Fonctionnel de Commande des Etapes de Transition (GRAFCET) is dedicated to the representation and analyze of automatic systems which have a sequential evolution. It has been developed in 1975 by Association Française de Commande Etape-Transition (AFCET) in France.

In comparison with other methods only the behavior of the system and its logical functioning (its functions) are represented in GRAFCET. Elements from the environment, needs the system will answer or its composition are not defined in this methodological tool.

States of the system are represented by boxes with numbers. Links between the boxes represent the different possibilities of evolution of the system from one state to another. Between each box a feature indicates the condition the system must fulfill to reach the next state (as instance combinatorial conditions). Beyond an example of a GRAFCET applied to an elevator (Figure 41):

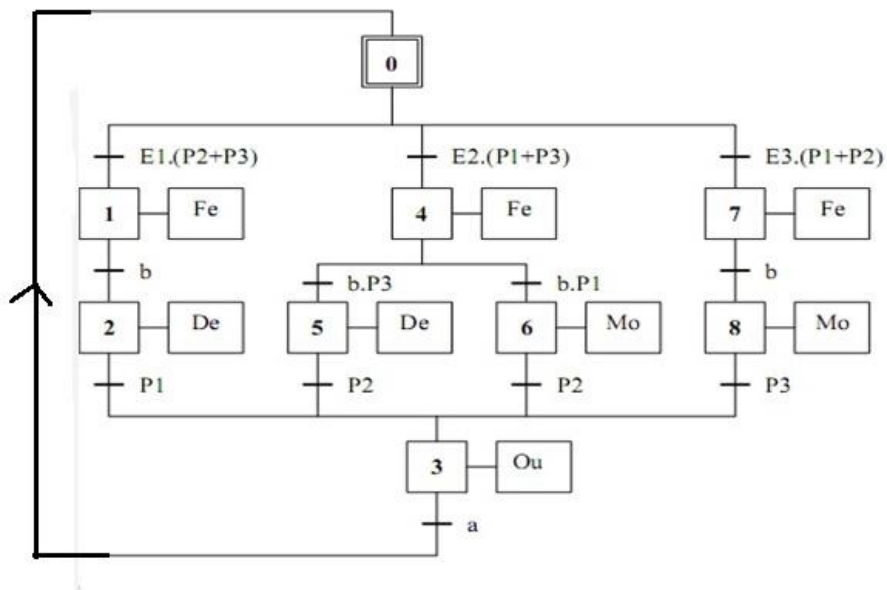


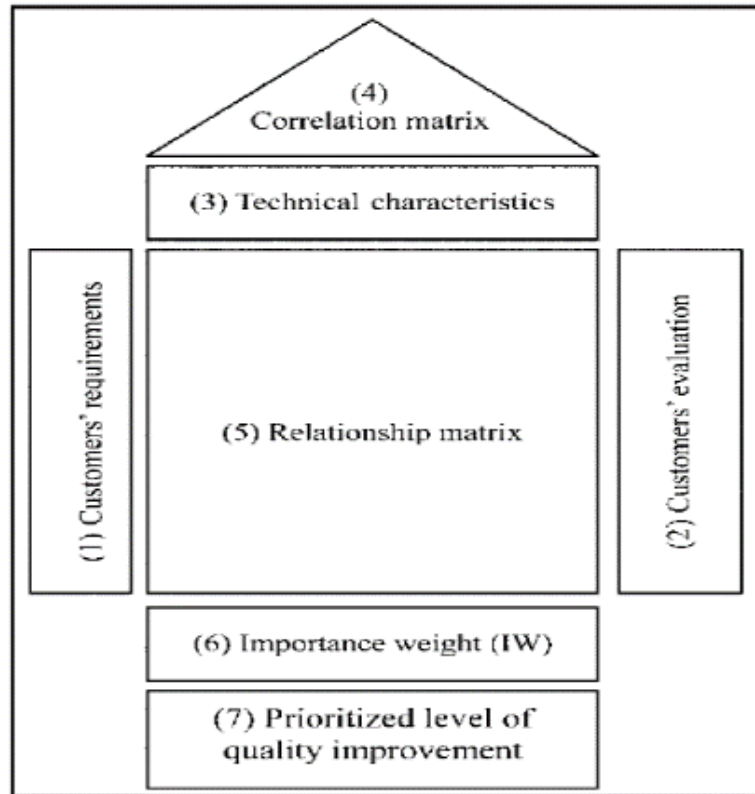
Figure 41 : GRAFCET example applied to an elevator. This figure gives an example of the application of the GRAFCET method. It starts at the state (0), then going from top to the bottom logical equations (E1.(P2+P3), E2.(P1+P3), E3.(P1+P2)) indicate the following state of the system (1, 4, 7). Then other logical equations make evolve the system in other states until it ends up to the last state (3) where it comes back to the initial state (0) when the last logical equation (a) is true.

This method is mostly used for automatic systems with a lot of possible different states. For this reason, GRAFCET has not been used in civil engineering (David & Alla, 1997).

### 2.2.3.4. Quality Functional Deployment (QFD)

Another Functional Analysis method which has been used in the construction industry is the Quality Functional Deployment method (QFD). QFD method is driven by the use of HOQ (House of Quality) matrices which are planning and communication tools (Figure 42):





**Figure 42 : QFD matrices scheme (Azam Haron & Mohd Khairudin, 2012).** This figure details the QFD method. On the left side are the Customers' requirements in rows. On the top the technical characteristics of the system, the roof represents interfaces between technical characteristics, on the right customers' evaluation of the capacity of the system to answer their requirements and at the bottom the importance of the different technical characteristics of the system ponderated by customers' requirements which leads to the prioritization of uality improvement to the system.

This tool takes the shape of a house: exterior walls represent customer requirements (the “What”), the ceiling the technical solutions which answer to customer requirements (the “How”), interior of the house represents the relations between customers' requirements and possible technical solutions, the roof the interfaces between technical solutions and the foundations the chosen technical solutions chosen for the project.

QFD are similar to Suh matrices (Suh, 2005) developed in axiomatic design where functions of the system are represented in lines and the technical solutions are represented in column. QFD are also very close to DSM (Design Structure Matrix) and MDM (Multidomain Design Matrices) which will be explored further in the next chapter when presenting the constructability matrix (Eppinger, et al., 2012).

QFD is a client oriented approach; it is very useful when different technical solutions are possible to answer to clients' requirements. In the QFD approach clients' needs are directly linked with the technical solution while in other methodologies there is an intermediary step: internal Functional Analysis. In this method, the functioning of the system is not represented.

QFD matrices are one of the rare Functional Analysis method which has been used and studied in the construction industry (mostly on buildings) (Figure 43). Dikmen (Dikmen, Birgonul, & Kiziltas, 2005) says that QFD matrices should be used as soon as possible in the development process to obtain good results. Indeed, QFD matrices are mostly used with “macro” elements at the system level, using it in a later stage would imply a large number of requirements and elements which would be very difficult to analyze and manipulate with such tool. Moreover, it is much more difficult to analyze all potential interactions between elements at different system levels when it has not been undertaken previously, it is more convenient to use QFD matrix from the beginning of the project and

complete during the project progress. He also says that inaccuracy of input data can considerably reduce reliability of the tool.

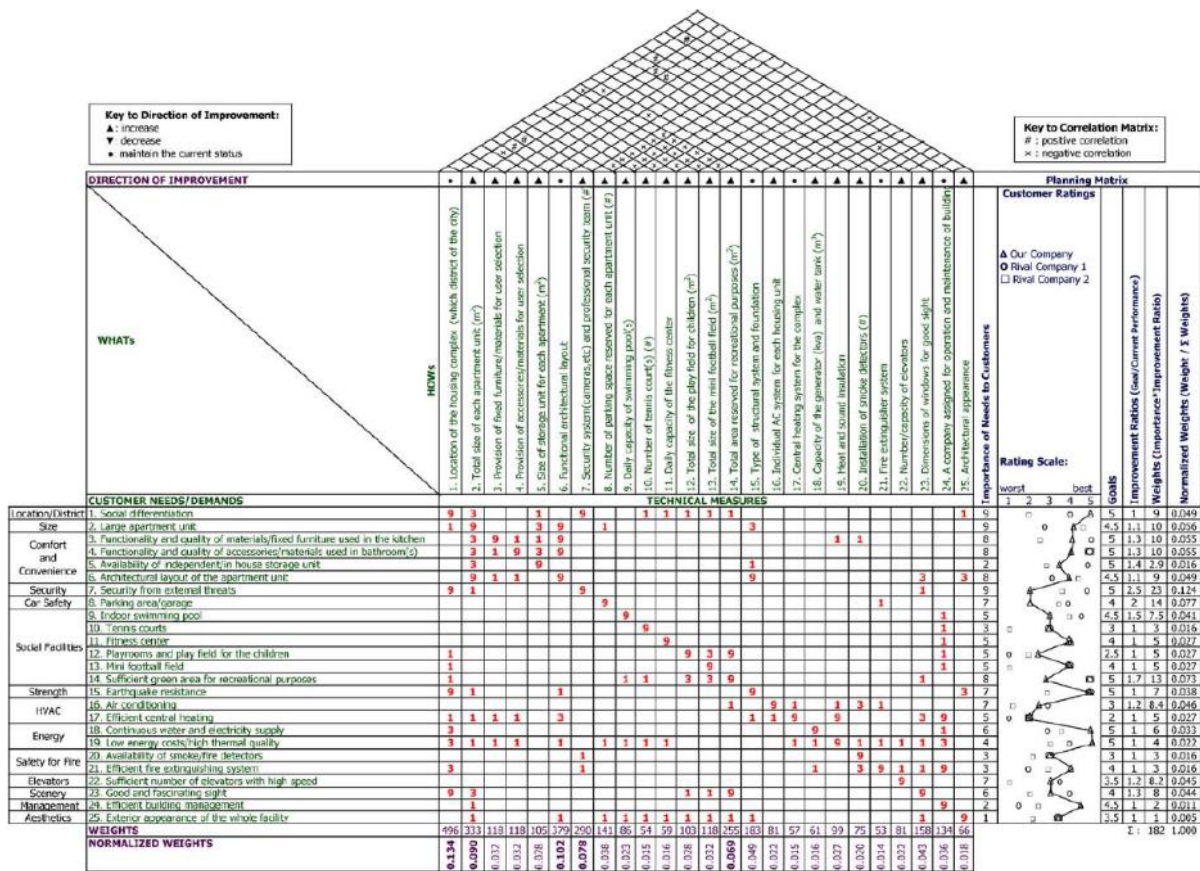


Figure 43 : example of a QFD matrix in the construction industry (apartments buildings) (Dikmen, Birgonul, & Kiziltas, 2005)

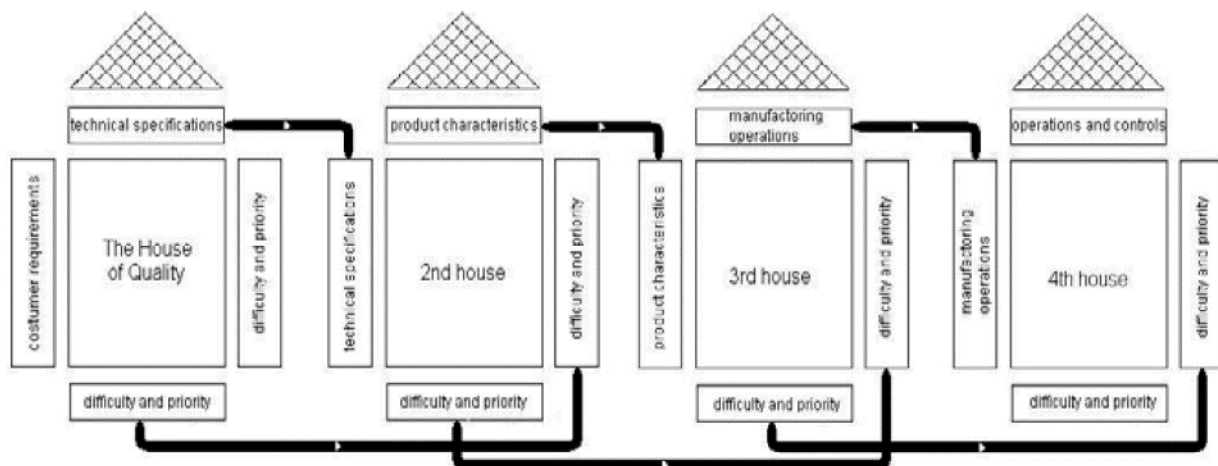
Requirements of final users are represented in rows and take the form of functions the system has to fulfill. Technical solutions are represented in columns. We can notice that technical solutions are at a high systemic level: size of apartments, size of storage units for each apartment, size of the playfield etc. We can also notice that location of the building has been identified as part of the solution domain. The number of technical solutions and functions involved are limited in this example (25 functions and 25 technical solutions) however for more complex systems this number can greatly increase which asks the question of the relevance of this for more complex systems. Roof the HOQ represents interactions between technical solutions, if they are negative or positive for the system.

The QFD matrix allows better understanding of how one technical solution can fulfill several functions as well as interactions between those functions. Nevertheless, quantification and the capability of a technical solution to answer a function remains very subjective and approximate. Moreover, in the QFD matrix interactions between the system and its environment are not clearly identified as well as realization conditions of technical solutions (these last ones will be considered when studying combined QFD matrices). Such considerations will be taken into account when defining constructability matrices in the next chapter.

The use of QFD matrices in Functional Analysis and its complementarity with the APTE method (method we will present in the next part), would be in the Internal Functional Analysis to evaluate the capability of technical solutions to answer functions of the system. It is complementary to functional specifications documents where functions are characterized with criteria. Eventually if criteria related to functions are quantified they could be used directly in the matrix to evaluate solutions, otherwise the criteria needs to be quantified.

In (Loenen & Mroczkowski, 2010), Loenen defines multiple interconnected QFD matrices for different purposes (Figure 44): not only functions and technical solutions are represented but also product characteristics, manufacturing operations and operations and control. Technical specifications evaluated against functions of the system in the first matrix are then inputs of the second matrix. Product characteristics are evaluated against technical specifications in the second matrix. And are inputs of the third matrix. Manufacturing operations are evaluated against product characteristics and are inputs of the 4<sup>th</sup> matrix. And finally Operations and control are evaluated in the 4<sup>th</sup> matrix against manufacturing operations. Combining QFD matrices from customers' requirements to manufacturing activities is a first attempt for the integration of constructability in a Functional Analysis method, however it considers only constraints from realization of the product and not other phases of development.

Combined QFD matrices can be resumed in a unique matrix (MDM matrices) as we will see in the next chapter. Consideration of realization and manufacturing constraints is the main objective of *constructability* describe further in this chapter. Therefore combining QFD matrices is a good way to improve constructability in projects.



**Figure 44 : Linked QFD matrices (Loenen & Mroczkowski, 2010).** In this figure, different QFD matrices are used in combination to consider the different development phases of a construction system. It starts with the customers' requirements through technical and product characteristics and ends up with the manufacturing operations.

Imbrication of these 4 matrices shows how clients' and customers' requirements can easily be lost in technical considerations. It highlights how late changes in the development process can alter needs of the final user as everything is interconnected.

Improvements of QFD matrices could be a better integration of risks and uncertainties concerning the capability of technical solutions to fulfill functions. Indeed, there always an uncertainty concerning the behavior of systems to perform a function, the application of fuzzy logic to QFD matrices could be a way to integrate such considerations in QFD.

Another possible improvement of QFD matrices is to evaluate the costs of the different technical solutions as well as their capability to fulfill customers' requirements as proposed by Fung in (Fung, Xu, & Wang, 2000).

### **2.2.3.5. Méthode d'Inventaire Systématique des Milieux Extérieurs et Environnants (APTE®/MISME) Method**

The APTE® method (Application des Techniques d'Entreprise) also called MISME (Méthode d'Inventaire Systématique des Milieux Extérieurs et Environnants) has been developed in France by Gilbert Barbey in 1964 and is now the property of the APTE company (APTE, 2018), (Azarian & Pollet, 2016). This method is inspired

by the works of Larry Milles in VA-VE (Value Analysis – Value Engineering) after the Second World War in the United States. MISME method is the method which has been used the most extensively in the construction industry in France (Allaire, 2012) but mostly for maintenance or reengineering of existing infrastructures to improve resilience or maintenance costs (Gonzva, 2017), (Morize, 2018), (Serre, 2005) and surprisingly not during the design and development phase of the product. This is the method we have chosen to enrich and to adapt in this thesis to use it in the construction industry, for this reason we will get more in detail in its description compared to other methods described above.

The main principle of the MISME method is to consider the product as a black box which fulfills different functions (Azarian & Pollet, 2016), (Jacquiot, 2010), (Tassinari, 2006).

The issue is then: what should be the functions of the product to satisfy requirements of users or groups of users?

The APTE® is divided in three steps:

- Analysis and characterization of needs
- Analysis and characterization of functions
- Writing of functional specifications

However, it is not indicated in the MISME at which step of the product development it should be applied and at which systemic level. Can the MISME method be applied successively at all systemic levels? How to link and integrate different Functional Analysis at different systemic levels? The MISME method is not clear on these aspects which highlights the need for meta-models, i.e. models of models which give a framework in which different Functional Analysis can be carried.

**Issue n°1:**

The first issue identified in the application of Functional Analysis is the need of a “meta-model” in which the method will be applied in order to give the systemic framework in which different the different Functional Analysis steps are carried from planning at the system level to realization of components.

- Needs analysis

The first step of the MISME method is to collect information about needs and market expectations. In Value Analysis, the following definition of “need” is given: “A need is a necessity or a wish experienced by users. It can be explicitly expressed or be implicit, admitted or hidden, latent or potential. In any case, it constitutes the need to satisfy that the user is willing to make an effort for” (AFNOR, 2009). By user we also consider a company, an administration, a community, a collectivity etc.

Hence, needs can be classified in three different classes:

- Latent needs: which pertain to the fundamental requirements of people;
- Identified needs: which result from market surveys, needs analysis, users’ behaviors, statistics etc. Identified needs are an approximation of latent needs.
- Created needs: it originates after the launch of a new product or service (ex: technological innovation, Transport Oriented Development...).
- Efforts users are willing to make (spend money, physical efforts etc.) to use a service or buy a product is ruled by complex rules. Even if it is realized with an utilitarian purpose it always includes an emotional and affective dimension.

Perception of needs depends on the context of users and is influenced by external elements of their environment.

Three categories of clients are usually distinguished:

- Individual clients;
- Clients who represent a group;
- Professional clients;

In the construction industry, the 3 types of clients are possible depending on the system to build (a building, an infrastructure...). In public works the client is of the second type: a client who represents a group of people (a municipality, a state, a collectivity etc.).

For each of these categories must be added the fact that the price is not always paid by the final user. Public projects such as urban infrastructures fall into this last category.

The needs analysis method relies on two hypothesis:

- Hypothesis 1: Satisfaction of the identified needs is fulfilled by the use of the product to design.
- Hypothesis 2: Needs are satisfied by the transformation/modification/change of state of work materials.
- Characterization of the needs

To characterize the needs the product is answering the 5W method is used. It consists of answering the following questions:

- **What:** What are the needs the product is answering?
- **Who:** Who is concerned by the needs?
- **Where:** Where the needs are located?
- **When:** When the needs are expressed?
- **How:** in which form the need is expressed?
- **Why:** What are the reasons revealing the needs?
- **How many:** How many people are concerned by the needs?

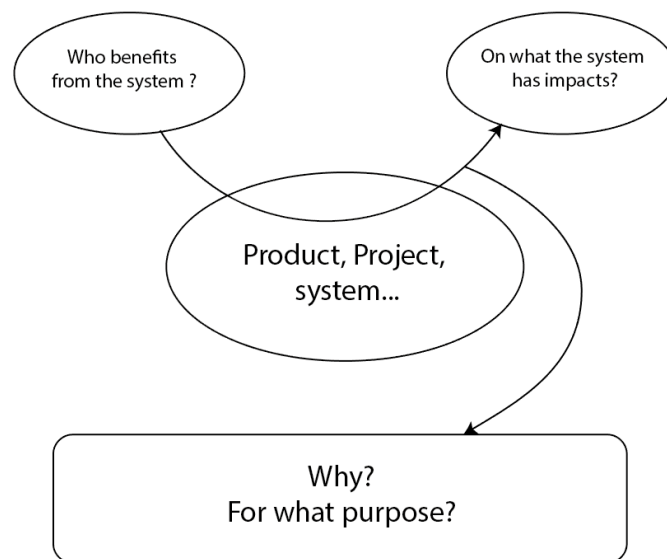
Below an example is given with a computer mouse:

	Questions to answer	Example with a computer mouse
What?	What are the needs the product is answering?	Move the pointer on the screen.
Who?	Who is concerned by the needs?	Computer users.
Where?	Where the needs are located?	In a desk on a table.
When?	When the needs are expressed?	At each use of a computer.
How?	In which form the need is expressed?	Computer users move frequently the pointer on the screen. This action has to be simple and quick.
Why?	What are the reasons revealing the needs?	Software/program functions can be activated with a pointer.
How many?	How many people are concerned by the needs?	All computer users.

Table 1 : 5W method to characterize needs (Tassinari, 2006)

Scheme: the “fundamental expression of the need”

In the MISME method need(s) the system answers can be modeled and formalized with the “fundamental expression of the need” scheme (Figure 45):



**Figure 45 : The « fundamental expression of the need » in the MISME method, adapted from (Tassinari, 2006). This scheme allows formalizing needs the system will fulfill.**

In the left horn, is indicated who benefits from the realization of the system. Answer to this question refers to the end user of the system, operators, maintainers or companies which are stakeholders of the project. In most cases, the answer refers to a physical or moral person (Azarian & Pollet, 2016). Eventually, the answer refers to several people: as instance a metro system benefits to urban dwellers, but also to politicians, it gives jobs for engineers and workers etc. For complex systems the answer to this question is not always straightforward and can implies multiple actors.

In the right horn on what the system has an impact. To answer this question we exclude elements of the environment which benefit from the system (they have already been mentioned in the last section) but only those which are impacted by the system but not necessarily have benefits from it. As instance a metro system has social impacts as it potentially links different social groups, it has impacts on the location of jobs, a metro system also requires energy for its operation and its development etc.

Finally, at the bottom is indicated need(s) the system answers, why it has to be realized, for what purpose. Eventually, a system can answers to several needs.

- Needs validation

Needs can be fleeting, fugitive or last several years. It can evolve quickly or disappear suddenly. Therefore, when answering to a need, it is crucial to evaluate the risks: what are the reasons for a need to disappear or to increase? What is the probability? What is the expiry date?

To evaluate the risks related to the identified needs, the following questions can be asked:

- What can modify the needs?
- What can postpone the needs?
- What can cancel the needs?
- How needs can evolve over time and when?

A simple way to represent the risks related to the identified needs is to do a risk matrix: in line is represented the probability of modification and in column the expiry date.

	Expiry date				
		Short term	Mid term	Long term	Very long term
Probability of modification or cancellation of the needs	4	D	D	D	C
	3	D	C	C	B
	2	C	B	B	A
	1	B	A	A	A

Table 2 : Risk matrix (Tassinari, 2006)

Risks can be quantified with letters A, B, C, D, a risk with a grade of A is low and at the opposite a risk with a grade of D is high.

- External Functional Analysis

After having defined the needs, the following step consists to define Service and Constraint functions of the system, what the system will do to answer the needs. However, at this stage the system is still considered as a block box.

Functional analysis is based on two hypotheses:

- **Hypothesis 1:** Needs are satisfied by the system utilization.
- **Hypothesis 2:** The product is a generator of services.

Functions are categorized into two different types:

**Service functions:** actions of the product on external elements of the system contributing to the satisfaction of identified needs. Therefore, main functions always link at least two external elements: element(s) impacted by the system to perform the function and external element(s) profiting from the provided services.

Service functions can be separated into two types:

**Main functions:** functions which directly answer to the reasons why the system should be produced.

**Complementary functions:** they improve and facilitate provided services

**Constraint functions:** they result from limitations of freedom in the design of the product. As instance it could be norms, laws, environment etc. They are imposed by external elements of the system; they therefore link the system with only one external element (they don't profit to any external element).

In the MISME method three types of constraint are proposed:

- Constraints from Norms and rules;
- Constraints from the design of the product: lifetime, architecture;
- Constraints from industrial processes and organization of works.

Some of the constraint functions are coming from the interaction between the "System of Interest" (also called product) and the "Enabling System" (also called project). The consideration of these interactions in the functional analysis is part of the enrichment we will provide in this thesis.

External functions are traditionally modeled with an environmental/interaction diagram or with a table representing external elements of the system: Constraint Functions involving only one external element are represented in the diagonal and Main Functions involving two external elements are represented in other boxes.

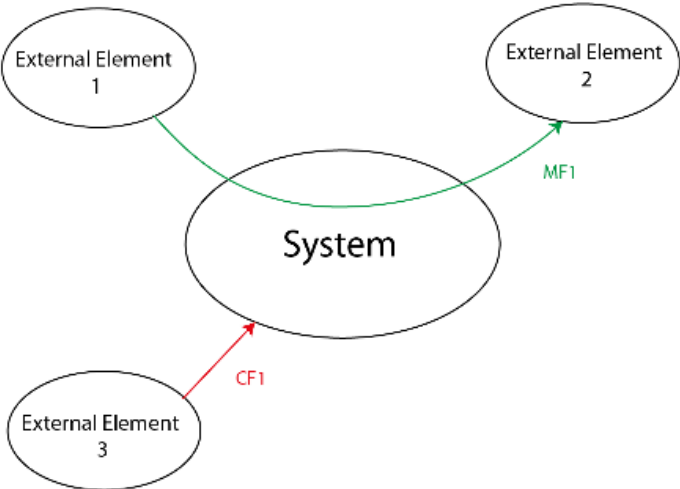


Figure 46 : Context diagram, MISME method. The context diagram allows identifying and formalizing Main Functions and Constraint functions of the system. The system is seen as a black box and functions are interactions with the environment. A main function links two or more elements of the environment with the system and a constraint function only links one element of the environment with the system.

In the context diagram above, Main Functions (MF) are represented in green, Constraint Functions (CF) are represented in red.

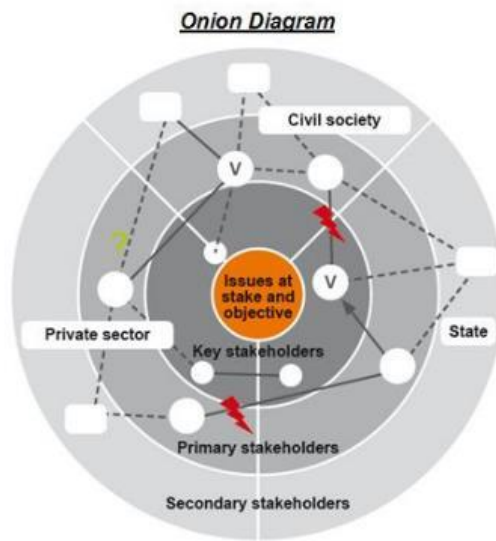
	EE1	EE2	EE3	EE4	EE5	...
EE1						
EE2				MF1		
EE3			CF1			
EE4						
EE5		MF2			CF2	
...						

Table 3 : Tabular representation of External Functions. This table allows representing interactions between the system and its environment. Elements of the environment are in rows and columns. Constraint functions are located in the diagonal as they involve only one element of the environment. Main functions are located in other boxes as they involve two elements from the environment.

In the table above, External Elements of the system (EE) are represented in columns and lines. Constraint Functions (CF) are represented in the diagonal of the table, Main Functions (MF) are represented at the interaction between two External Elements (EE), EE representing working elements are in lines and EE representing beneficiaries of the system’s functions are in columns.

Defining External Elements of the system and therefore Main and Constraint Functions requires analyzing its environment through its entire lifecycle. External elements of the system could be user(s), owner(s), client(s), maintainer(s), operator(s), physical elements (climate, geology, buildings...), standards and norms, signals, connections etc. (Azarian & Pollet, 2016). It is hard to define exhaustively all External Elements and they don’t all interact the same way with the system: different types of interactions exist (physical, informational, energetic) and some elements are strongly interacting with the system while others only have weak interactions. One way to represent this heterogeneity of interactions is to use the “onion” diagram:





**Figure 47 : Example of an onion diagram. The onion diagram represents how stakeholders interact with the system under development. The further a stakeholder is far from the center the less it interacts with it.**

External Elements interacting the most with the system are represented at the center of the diagram and External Elements interacting the less at the borders.

Interactions between the environment and the system is a recursive process in the Functional Analysis methodology:

External Elements and Functions are then characterized by attributes for EE and criteria for MF and CF.

EE1	MF1	EE2
Description and attributes of EE1	Description and criteria of MF1	Description and attributes of EE1
...	...	...

**Table 4 : Characterization of a Main Function and its related External Elements. This table allows describing Element from the environment in oth sides of the table and the main function is described in the middle.**

- Internal Functional Analysis

It is at this step that the system is not anymore considered as a block box and we enter in the solution domain.

Internal Functional Analysis concerns the definition of internal functions of the system, what the system will do to carry Main Functions and Constraint Functions. Internal Functions are also sometimes called Design functions or Technical Functions. They are not directly linked to External elements of the system.

The definition of Internal Functions comes from a choice of “technical principles”. These technical principles are usually defined by previous practices in the organizational structure where the Functional Analysis is carried. Sometimes, when innovation is an objective for the development of the system new internal functions can be imagined and defined to better answer to Main functions and Constraint Functions.

In order to represent this decomposition of the system in terms of functions (Services/Constraint Functions and Internal Functions) it is possible to realize a “Functional tree” representing the hierarchy between functions of the system. These functions are at the same time allocated to sub-systems (sub-sub-systems and components) of the system. The functional tree is therefore is the symmetric of a “Product Breakdown Structure” diagram representing the decomposition of the system in sub-systems.

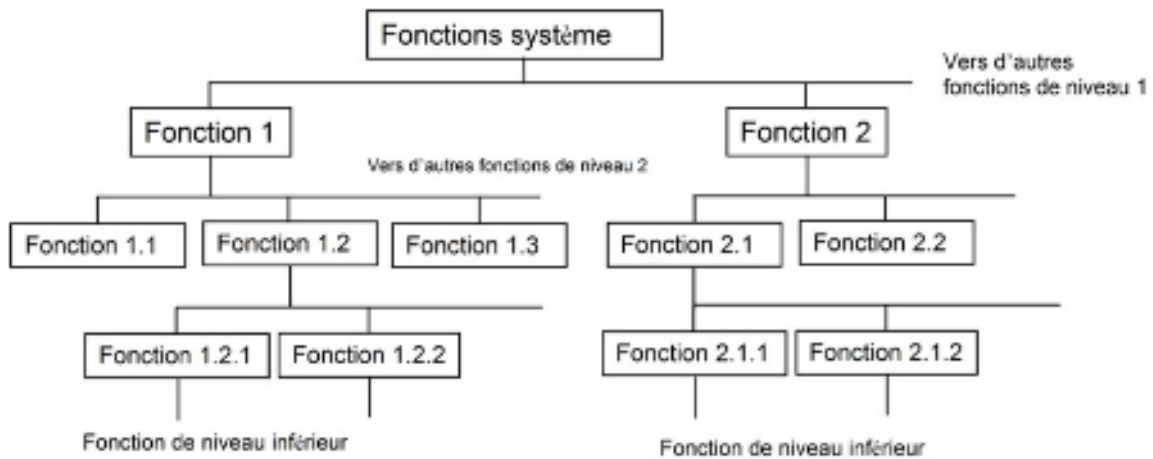


Figure 48 : Example of a Functional Tree. A functional tree allows representing the hierarchical links between functions of a system.

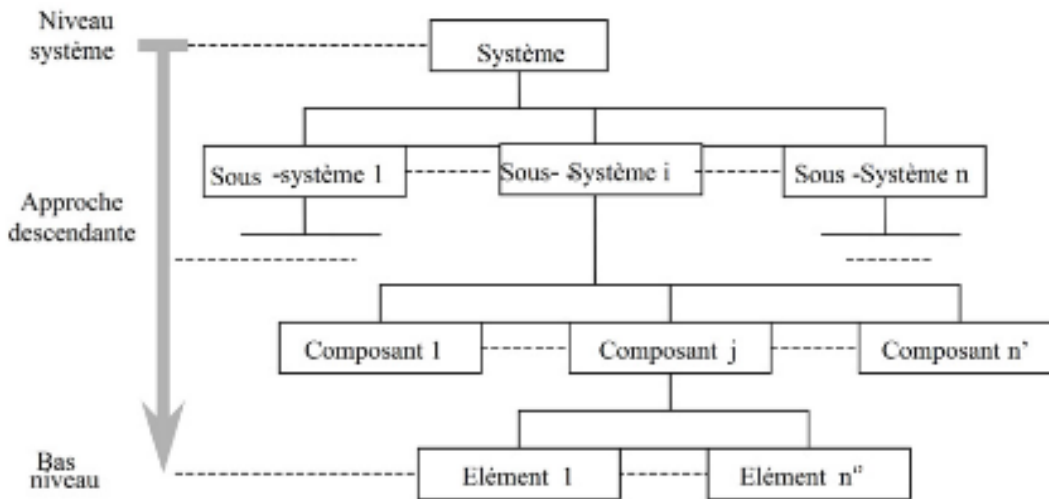


Figure 49 : Example of a Product Breakdown Structure. A product breakdown structure diagram allows representing the different systemic levels of a system: its sub-systems, sub-sub-systems, components.

The Functional Bloc Diagram is used to represent internal functional relations between elements of the system (its sub-systems) as well as functional relations between internal elements of the system and the environment (Services and Constraint functions). Internal functions are represented by arrows between sub-systems. It is complementary to the functional tree diagram as in the FBD both functions and sub-systems are represented in a single figure, but, usually only two systemic levels are represented (system and sub-system).

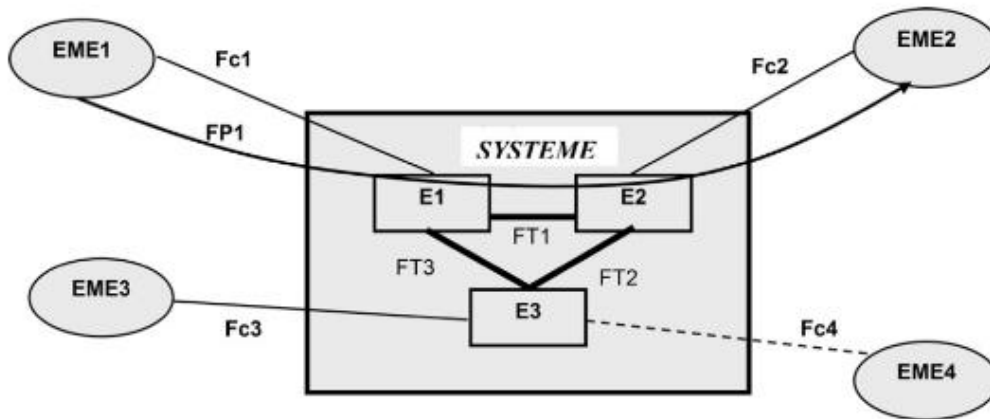


Figure 50 : example of an Internal Function Diagram (Azarian & Pollet, 2016). An internal function diagram allows representing links between internal functions, subsystems and main functions of the system.

- Functions characterization

Characterization of functions is crucial in the method as it allows qualifying and quantifying requirements the system has to follow. It allows evaluation, measure and comparison of requirement and therefore their verification and validation. Qualify the need consists in expressing with words impacts of the system on its environment. Quantify the need consists in defining criteria and precise a value to reach.

Thereby, a function can be described with a designation (words), criteria, a level to reach and eventually flexibility.

$$A \text{ fonction} = \text{Designation} + \text{criteria} + \text{level} + \text{flexibility}$$

At least 3 types of criteria can be defined to characterize a function:

Nominal criteria: these criteria are directly linked to the function. As instance, for the function “transport people”, the number of people to transport per hour and per direction (PPHPD) is a nominal criterion.

Operating and maintenance criteria (RAMS): it is unrealistic to imagine that a function is always fully operational, that the system can be instantly repairable or that it is 100% safe for users. Therefore, it is possible and even recommended to define RAMS (Reliability, Availability, Maintainability, and Safety) criteria associated to functions of the system. Reliability the capability of the system to carry the function in a period of time, Availability is the capability of a system to carry the function at a given point in time in certain conditions, Maintainability is the capability of the system to restore a function in its operational state, Safety is the capability of the system not to lead to unacceptable accidents.

Societal criteria: societal criteria are “constraints” applied to functions which are not related to the end user by to the society, a group of individuals. As instance, resource consumption or greenhouse effect emissions. These criteria are related to inputs and outputs of the function instead of its effect for the end user.

Example of function formalization:

		Characteristics						
N°	Designation	K	Nominal Criteria		O&M Criteria		Societal Criteria	
			Level	Flexibility	Level	Flexibility	Level	Flexibility

Table 5 : Functional formalization table adapted from (Tassinari, 2006). This table allows formalizing functions of a system with its related criteria. It can be used as a functional specification document.

K designs the importance coefficient of the function

F is the flexibility class of the function

**Issue n°2:**

The second issue consists in the lack of a common language to describe system elements in Functional Analysis: functions, parts of the system, how elements of the system are in interaction. This common standard would allow improving communication between stakeholders but is also better “understandable” by computers in order to automatize verification of functions or to manage functions of the system during its development.

- The two types of functions : passive and active

A system can carry two types of functions: active and passive functions. Active functions are functions which have an impact on the environment. Passive functions at the opposite are functions which react to the external event of the environment.

- The functional brief

The functional brief is a communication document between the applicant and the designer. It expresses what the applicant requires in terms of functions and not necessarily how it will be realized. It is a dynamic communication tool (document, functional model...), it evolves depending on the level of uncertainty and the initial “blur”. The functional brief contains all the functions which are described, characterized and eventually allocated to subsystems.

**Issue n°3:**

In the MISME method functions and functional requirements are described with documents, i.e. with a paper-based method. In complex projects where numerous functions are defined, it becomes very hard to ensure that the future system fulfill all defined functions. For these kind of projects which is sometimes the case for buildings and almost always for infrastructures, it is necessary to shift from a paper-based approach to a model-based approach.

- Definition of the solution

Following the definition of external and internal function, the solution, i.e. a concrete definition of the system is defined: the technological solutions to use, geometry of the system, its composition (the materials to use) the required energy for its functioning. In the construction industry, CAD tools (Computer Aided Design) are usually used to model the “solution domain”.

It is at this phase that the system is “implemented” concretely, it is described “*what*” is the system whereas in other parts, only the “Why” and the “How” were explained.

**Issue n°4:**

It is required to verify if solutions developed answer to functional requirements, particularly for complex systems with numerous elements and functions. The current paper-based Functional Analysis method doesn't allow such verification in an efficient and easy way.

- Functional Analysis and constraints from the enabling system

In Functional Analysis, constraints from the “Enabling System”, i.e. all the constraints related to the development of the product from its planning to its realization are considered at best as “Constraint Functions”.

We estimate that it is not enough to evaluate impacts of Enabling Systems on the product development particularly in construction projects where Enabling Systems are always different. Indeed, each function will need to be analyzed, model and eventually simulate, technical solutions which will fulfil this function will have to be

designed, realized, assembled, tested and validated. All these activities depend on each function and each technical solution and can't be modeled only with generic "Constraint Functions".

**Issue n°5:**

The current Functional Analysis method doesn't explicitly consider constraints from Enabling systems at the different stages of development. There is a need to improve Functional Analysis methods to better integrate constraints and objectives from Enabling Systems required for the product development from planning to design, realization, verification and commissioning phases.

- Integration of spatial considerations in Functional Analysis

The main construction products answer (whereas it is buildings or infrastructures) is to adapt space in order to carry different activities. Nevertheless, the consideration of "*spatial characteristics*" of systems have not been analyzed extensively in actual Functional Analysis methods. What is the "*place of space*" in Functional Analysis? What are spatial characteristics of construction systems ? How and When to consider them in FA methods? Are example of questions which are not addresses in the actual method and require to be investigated more in order to apply efficiently FA to construction systems.

**Issue n°6:**

Define what are "*spatial characteristics*" of construction systems and identify how and when they should be considered in Functional Analysis methods and its different steps.

- Functional Analysis at different systemic levels and Functional Analysis Embodiment

In the MISME method, little attention is said about the different systemic levels of a system and how to apply the method at the system, subsystem or sub subsystem levels. Nothing is said about the applicability of the method at these different systemic levels.

**Issue n°7:**

The seventh issue consists in defining how the method can be applied at different systemic levels, how to define interactions between different systemic levels and to identify the redundant information between system elements at different systemic levels (if there are).

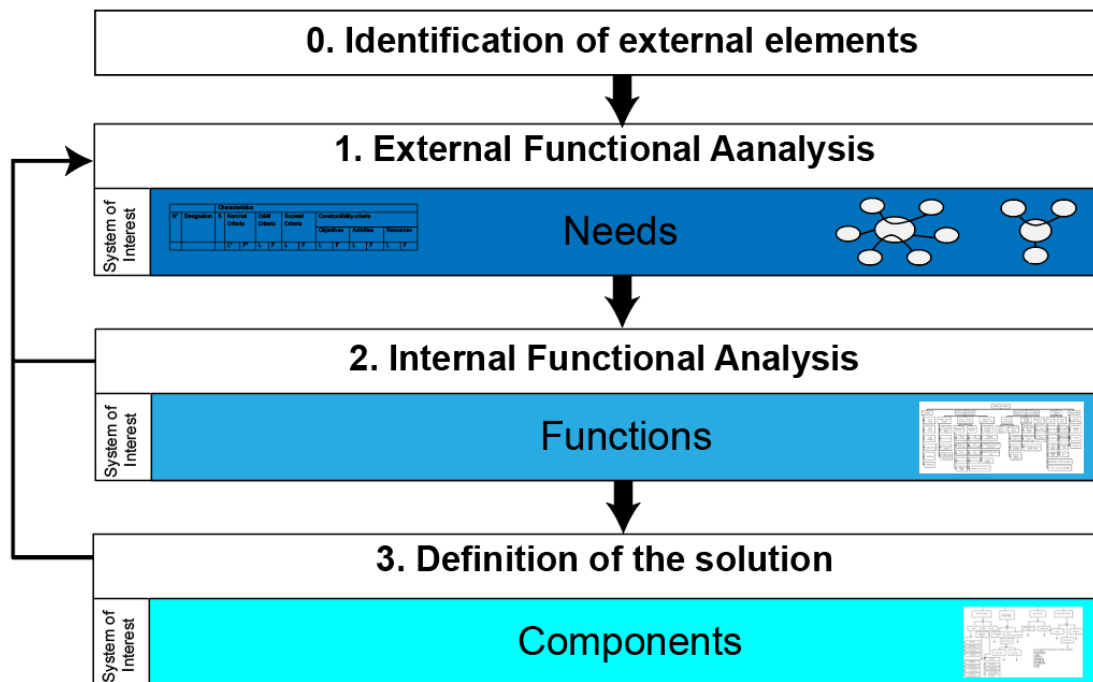


Figure 51 : The 3 steps of Functional Analysis from the APTE®/MISME method. This diagram sums up the different phases of a standard Functional Analysis with its dedicated tools. It starts with the identification of external elements of the system, then the definition of needs the system will fulfill by using both the interaction diagram and the fundamental expression of the needs diagram. Then internal functions are defined, hierarchical relations between functions can be formalized through a functional tree and an internal function diagram. Then components (subsystems, subsystems) are defined as technical solutions to carry functions of the system. The hierarchical relations between components can be formalized through a product breakdown structure. Feedback loops between the different step of the analysis allows optimizing the couple needs/solutions of the future system. This diagram will be improved all along the thesis by adding new elements developed for the application of FA for complex constructions systems in part 3.

Figure 51, sums up the 3 different steps of Functional Analysis: Needs analysis, Function analysis and Solution analysis. The different tools used to model the different elements are also represented (functional specification table, interaction diagram, functional tree, component tree etc.). Objective of this thesis is to improve this method and related tools to adapt them for complex construction systems.

### 2.2.3.6. Comparison of Functional Analysis methods

In the following table, the different Functional Analysis tools and methods presented above are compared and their applicability to the construction industry is assessed:

	Advantages	Disadvantages	Application in the construction industry
<b>SADT – IDEF0</b>	SADT – IDEF is efficient to represent the different embedded systemic levels (A0, A1...), functions of the system with flows of materials, energy and information between them.	SADT – IDEF is not efficient to represent hierarchically functions of the system and it does not separate the problem and the solution domains. SADT is more a tool to represent systems and its	SADT can be applicable in the construction industry as a tool to represent the construction product as a system or/and the production system. Interactions between the System of

		parts than a method to follow to carry Functional Analysis.	Interest and the Enabling System are not well represented in SADT whereas it would be fundamental for the construction industry. Spatial characteristics of systems are not easily represented.
<b>FAST</b>	FAST diagrams allow representing easily the hierarchy between functions. It is easy to understand and implement. It is also useful to identify to which functions a solution answers and to differentiate the solution and problem domains.	FAST diagrams is a tool and not a method to carry Functional Analysis. Relations between system elements are not modeled in the FAST diagram.	Like SADT, FAST diagram is not suited to integrate constraints from the Enabling System. Spatial characteristics of systems are not easily represented.
<b>GRAFCET</b>	GRAFCET are useful to model logic sequences between states of a system over time. GRAFCET language is standardized which improves communication between project stakeholders and is the first step for future automatization.	As construction products don't evolve much over time, GRAFCET are not of great use to model construction products.	GRAFCET could be useful in the construction industry to model construction processes and engines.
<b>QFD matrices</b>	QFD matrices are useful to model interactions between functions of the system and technical solutions answering these functions. It can be considered as the best way to assess to what extent a system is able to fulfill its functions, to evaluate multifunctional system elements and/or to define modular systems. The possibility to combine different QFD matrices allow considering the Enabling	QFD matrices don't allow modeling different systemic levels. QFD matrices are only tools and not a method to carry Functional Analysis.	QFD matrices are well suited to evaluate interdependencies between construction products and its production system. However, the question of how they can be integrated at different systemic levels still remains. Consideration of spatial characteristics of systems in QFD matrices needs to be clarify.

	System (like the production process).		
<b>APTE ® – MISME</b>	The APTE®/MISME Functional Analysis method is the only one which can be considered properly as such. It gives the different steps to follow to carry a Functional Analysis from description of the environment to the characterization of functions. It also gives simple but efficient methodological tools to realize Functional Analysis such as the interaction diagram.	Most of the disadvantages of the MISME method have been highlighted through the definition of 6 objectives: <ul style="list-style-type: none"> <li>- Lack of a meta-model to integrate different FA at different systemic levels;</li> <li>- There is not a standard language to define functions and system elements;</li> <li>- MISME method is paper-based and not model-based;</li> <li>- In complex projects it is hard to assess if technical solutions fulfil functions defined in FA;</li> <li>- The Enabling System is not well considered and integrated in the actual method;</li> </ul>	The MISME method has been used extensively for different purposes in the construction industry. However it would be necessary to adapt it in order to better consider Enabling system constraints and spatial characteristics of construction products.

Finally, amongst the different Functional Analysis methods analyzed, the APTE®/MISME method seems to be the most adapted for the construction industry and it is the only one which describes roughly the workflow and the different steps to follow to carry a Functional Analysis. However, several challenges have been identified for its application for complex systems of the construction sector.

Other methods studied essentially offer ways to represent in different ways and with different focuses on functioning of systems: the SADT method insists on the systemic hierarchy of the system and flows of information/energy/materials between its different parts. The FAST method is very efficient to represent hierarchical links between functions. GRAFCET allows describing the different states of the system and the logical relations between these states and therefore the global actions/functions of the system over time. QFD matrices are methodological tools to evaluate if a system satisfies or not customers' requirements putting in relation requirements of the system and its technical characteristics. These other methods can eventually be used complementary with the APTE®/MISME method for a specific purpose however their integration within this method has not been investigated in this thesis.



## 2.2.4. Evaluate the capability of technical solutions to realize functions

In this part we briefly define the concept of performance, how to represent it and its different facets in order to be able to evaluate technical alternatives against functions the system has to carry. Two methods are presented to evaluate such performance: the DEA (Data Envelopment Analysis) and the SPEC method.

### 2.2.4.1. What is Performance?

Gibert in (Gibert, 1980) defines performance at the center of the triangle composed of pertinence, efficiency and efficacy (Figure 52):

- The objective-results axis defines efficacy as related to the use of means to obtain results, in other words achievements of objectives;
- The results-means axis defines efficiency as the ratio between means used in a process and the effort produced: achievement of objectives at minimum cost;
- The means-objectives axis defines pertinence as the link between means used and objectives to reach. In other words the good allocation of resources.

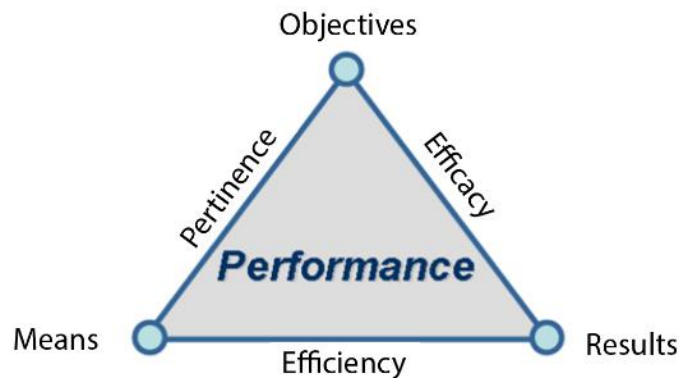


Figure 52 : Performance defined by (Gibert, 1980). This figure shows the three different ways to define performance and how they are related between each other: Pertinence, Efficacy and Efficiency.

Bouquin and Sénéchal and Allaire (Allaire, 2012) have added *processes* in the triangle (Figure 53 : Adaptation of the performance concept by integrating processes Figure 53):

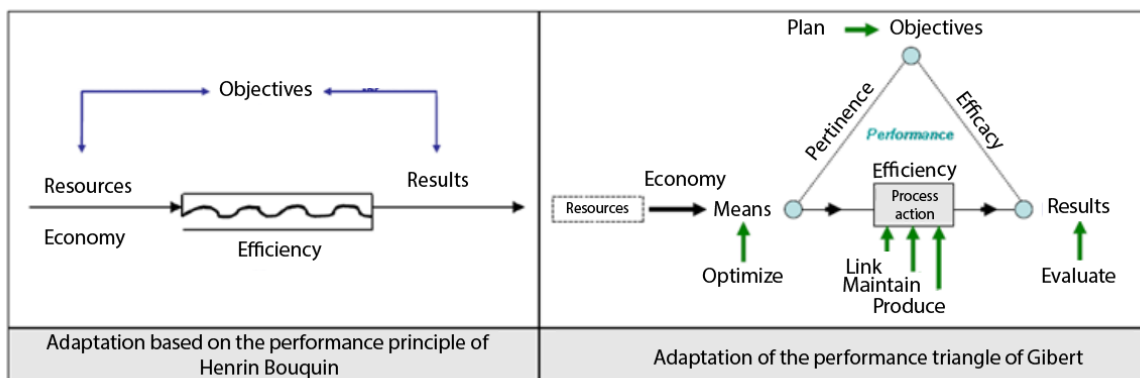


Figure 53 : Adaptation of the performance concept by integrating processes (Allaire, 2012).

### 2.2.4.2. Product and project performance

Performance can be related both to the product and the project: the performance directly related to the system to build and allowing evaluation of technical solutions to answer functions, and performance related to the project execution allowing evaluation of resources used to realize project processes (cost, delays as instance). The first type of performance can be considered as *product performance* and the second type as *project performance*. Constructibility goal, as we will explain in §2.2. consists in ensuring product performance while optimizing project performance.

Project performance are the same than performance described in the Gibert triangle (Figure 52).

However Product performance require some adaptations:



Figure 54 : Product performance adapted from (Gibert, 1980). Objectives and Mean have been replaced respectively by Needs and Functions.

In the case of a « product », performance can be defined at the center of the triangle adapted from Gibert:

- The needs-function axis defines pertinence of the product. Functions represent what the product does, they have to be in adequacy with needs the product have to answer. A system is *pertinent* if what it does (its functions) answer to needs the system has to answer.
- The function-results axis concerns efficiency of the system. This type of performance is related to resources used to perform functions of the system. A system is efficient if it uses a small amount of resources to function.
- The needs-results axis defines efficacy of the product. A system is effective if results of the system functions reach the needs the system has to answer.

Pertinence is a performance measure *a priori* while efficacy is a performance measured *a posteriori*.

### 2.2.4.3. Performance Metrics

To evaluate the capability of a technical solution to realize a function, functions can be quantified. In other words, *performance metrics* have to be defined associated to functions to evaluate the capability of technical solutions to realize them.

In (Deru & Torcellini, 2005), the definition of a *performance metric* is given: “a standard definition of a measurable quantity that indicates some aspect of performance”. A metric has to be:

- Measurable (or able to be determined from other measurements);
- Have a clear definition, including boundaries of the measurements;
- Indicate progress toward a performance goal;
- Answer specific questions about the performance.

Results are evaluated with measuring devices which are inevitably subjected to inaccuracy and failure of methods (choice of appropriate indicators) and realized measuring processes and procedures (collect and entering data) (Allaire, 2012). Evaluation of performance of systems is therefore necessarily multicriteria and multi-actor (Jacot & Micaelli, 1996).

Two types of performance metrics can be defined:

- Results performance metrics which evaluate results of an action
- Follow-up performance metrics which evaluate the achievement state of a process or an action.

#### 2.2.4.4. DEA (Data Envelopment Analysis)

DEA (Data Envelopment Analysis) is a linear analysis and non-parametric method to compare technical solutions and evaluate their performance regarding performance metric (Cariaga, El-Diraby, & Hesham, 2007). Performance of a technical alternative is evaluated by dividing weighted outputs and inputs. Technical alternatives are also evaluated depending on their value for the different Decision Making Unit (DMU). A technical alternative is composed of a set of solutions which answer to several functions. Solutions and functions can eventually be modeled with a QFD (Quality Functional Deployment) matrix or any other method which allows to link functions and solutions. The different alternatives are then compared depending on several criteria: cost, performance, planning, constructability etc.

The following formula is used to evaluate technical alternatives:

$$E_k = \frac{u_1 O_{1,k} + \dots + u_m O_{m,k}}{v_1 I_{1,k} + \dots + v_n I_{n,k}}$$

Where :

m = number of outputs

n= number of inputs

O<sub>i,j</sub> = value of the output i for the DMU j

I<sub>i,j</sub> = value of the input i for the DMU j

u<sub>i</sub> = weight of output i

v<sub>i</sub> = weight of input j

Then, the formula is maximized:

$$E_i^k = \frac{u_1 O_{1,k} + \dots + u_m O_{m,i}}{v_1 I_{1,i} + \dots + v_n I_{n,i}} \leq 1$$

i=1,...,n

u<sub>1</sub>, ..., u<sub>m</sub> and v<sub>1</sub>, ..., v<sub>m</sub> ≥ 0

For each input and for each DMU the efficacy of Technical Alternatives is maximized (Figure 55 :Figure 55):

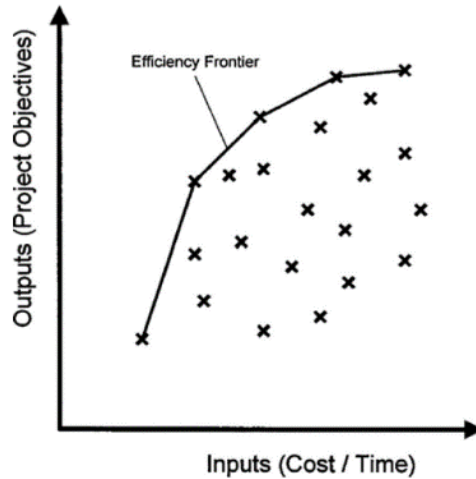


Figure 55 : Optimization of Technical Alternatives (Cariaga, El-Diraby, & Hesham, 2007). Points in the figure represent different possible solutions and the efficiency frontier the optimum performance of the system.

One of the main difficulty for the use of this technique is the necessary quantification of performance with performance metrics.

In (Cariaga, El-Diraby, & Hesham, 2007), Cariaga uses together Functional Analysis, QFD and DEA methods (Figure 56):

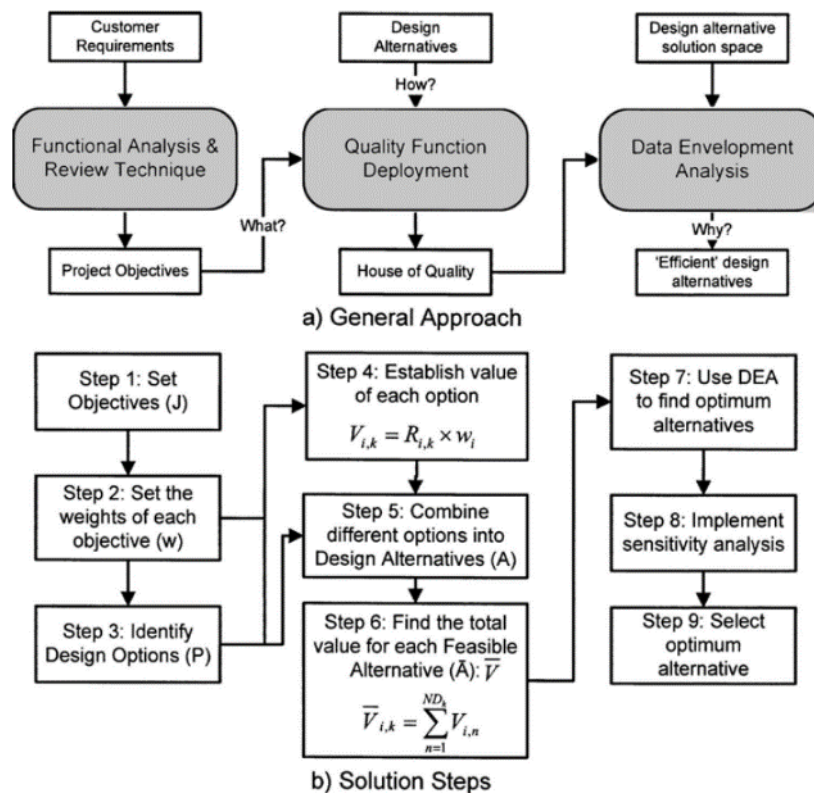


Figure 56 : Functional Analysis, QFD and DEA used in conjunction (Cariaga, El-Diraby, & Hesham, 2007). This figure details the step to follow to evaluate the capacity of a system to answer functional requirements through Functional Analysis, QFD matrices and DEA.

Functions of the system are first defined with a Functional Analysis method (MISME method, FAST etc.) in a second step solutions are defined and weighted and compared in the QFD matrix. Finally the DEA method allows

to evaluate how a Technical Alternative (composed of several solutions) answer the best globally to functions of the system as well as other criteria such as cost, time or constructability.

#### 2.2.4.5. The Suivi de Projet en cours de Conception (SPEC) method

The SPEC (Suivi de Projet En cours de Conception) method is developed by Yannou (Yannou & Limayem, 2000), it is a Functional Analysis and project tracking tool used to optimize Technical Alternatives and re-engineering of products.

- Use cases of the SPEC method

The SPEC method can be used in two distinct cases: firstly in upstream studies when technical solutions are not yet defined. And secondly to assess capability of technical solutions to answer functions of the system (Figure 57).

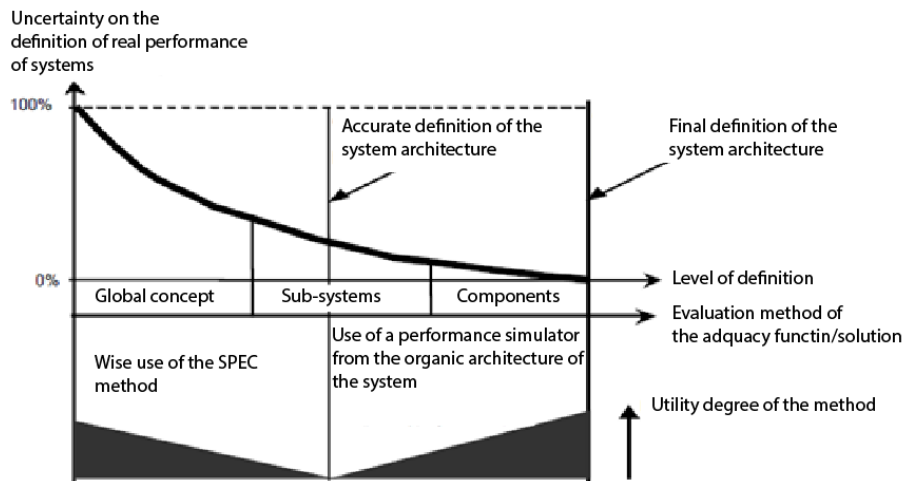


Figure 57 : Use of the SPEC method in the development of a system. Adapted from (Yannou & Limayem, 2000)

The SPEC method can be sum up in the 3 following objectives (Figure 58):

1. In upstream studies, the SPEC method allows detailing the functional specification documents by a detailed satisfaction model.
2. Description of solutions performance by a probabilistic approach which allows estimating solutions performance.
3. It gives an estimation at any point of the project to compare estimated performance of technical solutions with performance metric objectives of functions defined in the functional specification document.

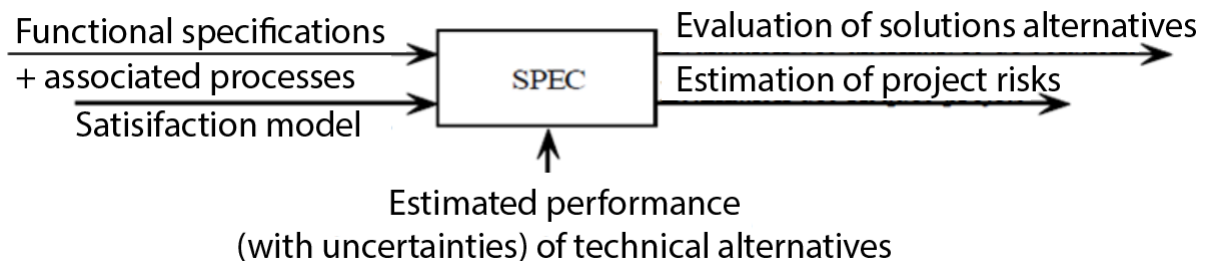


Figure 58 : Objectives of the SPEC method. Adapted from (Yannou & Limayem, 2000)

In classical value analysis methods as well as QFD methods, functions are weighted depending on their utility for stakeholders. However, weighted functions underlies that all criteria of each function has the same importance which is not necessarily the case. This is why in the SPEC method a satisfaction model has been developed. This model is based on the three following mechanisms:

- In linear cases, weights are associated to uncertainties modeled by probabilistic functions. These weights can stem from a decision process like the Monte-Carlo method.
- Non-linear cases can be modeled by fuzzy-logic;
- Acceptance levels expressing admissibility and non-admissibility zones in the satisfaction of functions.

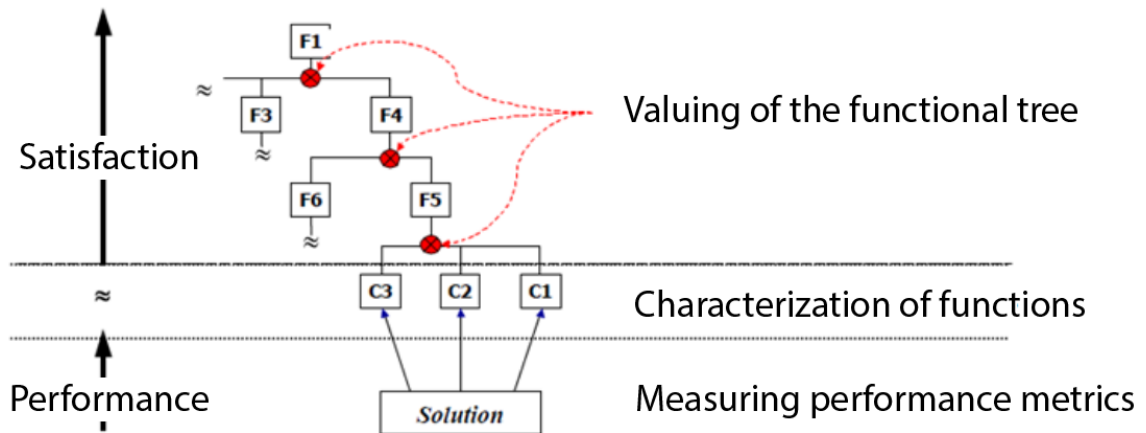


Figure 59 : Satisfaction model in the STEP method. Adapted from (Yannou & Limayem, 2000). F1...Fn are functions of the system, C1..Cn Functional criteria.

- Consideration of uncertainties

Classic Functional Analysis methods do not consider uncertainties due to inaccuracy of solutions which will be set up. In the SPEC method, uncertainties are considered in different steps in the analysis:

- In weights factor of functions;
- In performance of technical solutions;
- In the calculation mechanisms of performance metrics (with probabilistic distributions).

- Help to choose between solutions alternatives

A synthesis of capacities of solutions to answer functions of the system is given in a dashboard in the tool (Figure 60). In this dashboard, each solution is represented with a risk indicator representing chances of success and failure of the capability of the function to answer functions of the system.

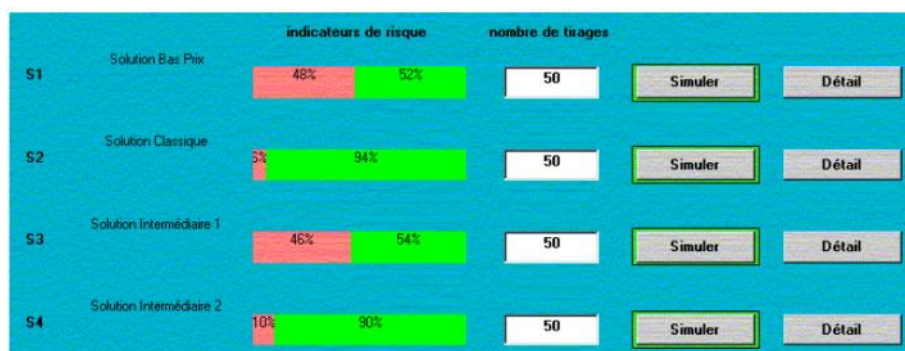


Figure 60 : Dashboard summarizing capacities of solutions to answer functions. (Yannou & Limayem, 2000)

For each solution a detailed window allow visualizing its capability to perform functions against functional criteria defined in the functional specification document.

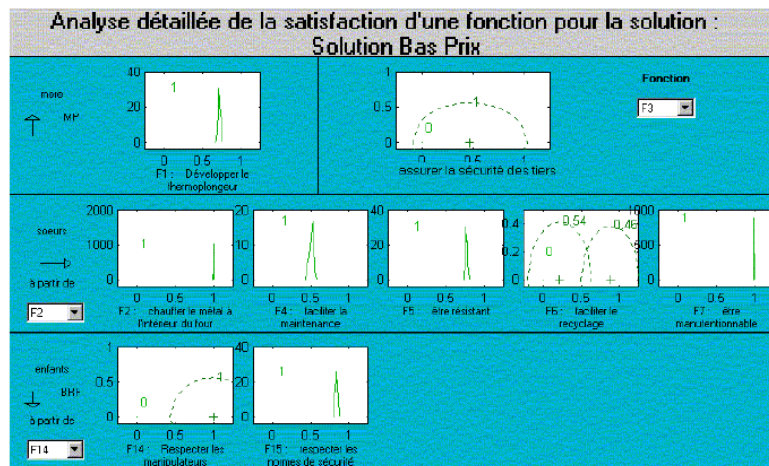


Figure 61 : The dashboard allowing a detailed representation of the capability of solutions to answer functional criteria. (Yannou & Limayem, 2000)

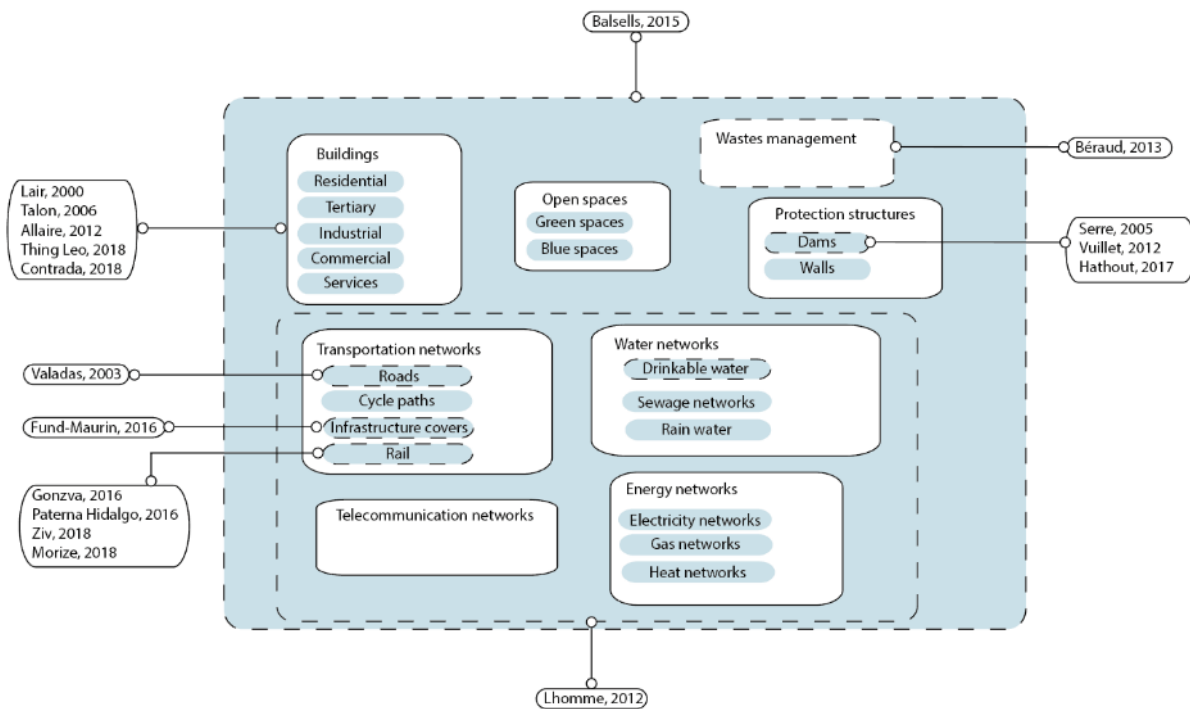
Both methods (SPEC and DEA) allows evaluating capacities of Technical Alternatives to realize functions of the system. In both cases it supposes that feedbacks about technical solutions are available and relevant when designing the system which is not always the case. The SPEC method goes more in detail in the capability of solutions to answer functions of the system criteria by criteria, while in the DEA method it is more a global approach which is expected.

#### 2.2.4.6. Use of functional analysis in the construction industry

Globally, the use of Functional Analysis methodologies is not usual in the construction industry particularly during the design phase within design and consultancy companies while it has proven its efficiency to improve quality and cost of industrial products. Another application of Functional Analysis in the construction industry is to define and classify functions of a construction system in order to ensure its functioning in case of external events. As instance, Gonzva in (Gonzva, 2017) has used Functional Analysis to define functions of a metro system and how they are affected in case of a flood in the case of the Parisian metro. Morize in (Morize, 2018) has used Functional Analysis to define functions of tramway systems in France to optimize their maintenance in an asset management objective.

(Gobin, Conformation programmatique - principes d'une étape clé de l'efficience du bâti, 2017), (Gobin, L'usage comme valeur référence de la construction, 2013), (Gobin, Enrichissement de l'analyse fonctionnelle, les apports

de la construction, 2013), (Van Loenen & Mroczkowski, 2010), (Dikmen, Birgonul, & Kiziltas, 2004).



**Figure 62 : Uses of Functional Analysis in the construction industry in different domains, adapted from (Gonzva, 2017)**

- Examples of Functional Analysis applied to geographical systems at two different scales (city and building);

At the city scale, in the Charter of Athens, Le Corbusier (Charte d'Athènes, 1933) defines the 4 functions of a city, i.e. for what purposes a city has to adapt space:

- **The residential city:** a city has to allow people living;
- **The mobile city:** a city has to allow people moving;
- **The equipped city:** a city has to allow people having access to utilities;
- **The active city:** a city has to allow people having access to culture, sport, education;

However, interpretations of the Charter of Athens have led to the allocation of these functions to “exclusive” spaces: functional zoning. Without value judgment on this urban planning practice, we want to insist on the distinction between functions of a geographic system (a territory, a city, an infrastructure, a building etc.) and spaces supporting these functions: a function can be allocated to several spaces and one space can support several functions.

Moreover, even if the term “function” is used in the charter of Athens, the use of Functional Analysis methods such as the MISME (APTE®) method is not mentioned in the Charter.

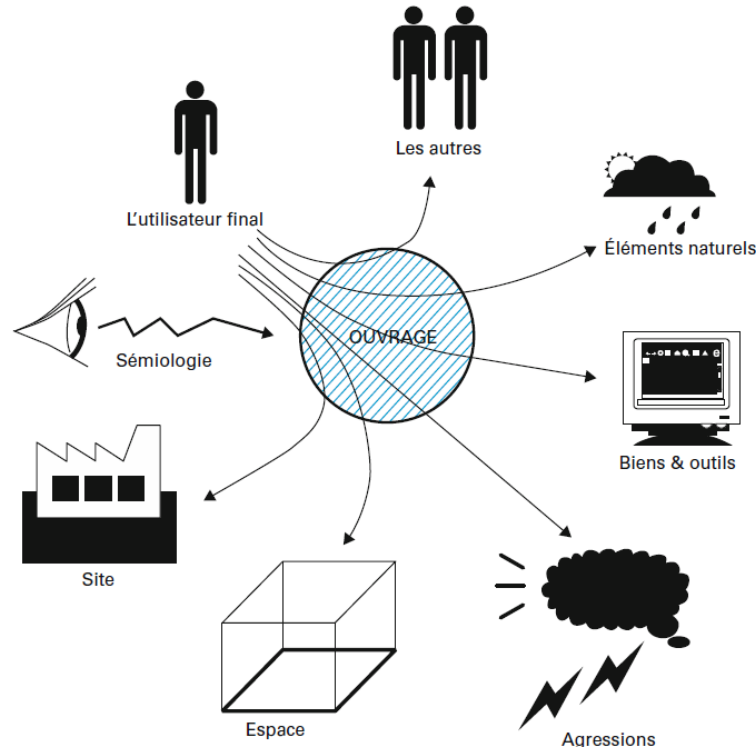
These two elements (the mismatch between space and functions and the non-application of Functional Analysis methods) have led to a wrong application of Functional Analysis and explain in part actual criticisms of “functionalism urbanism”.

At a different scale Gobin (Gobin, 2017) defines the 8 functions of buildings : The 8 functions of buildings , i.e. for what purposes a building has to adapt space (Figure 63):



- **Protect:** One function of building is to protect inhabitants from external events whereas they are natural (rain, wind, earthquake, flood etc.) or intentional (terrorist attack, theft etc.);
- **Offer a “space”:** Another function mentioned by Gobin is to offer and maintain a space to carry human activities and to offer the possibility to reach the location of this space. Actually, “space” refers here more to a volume than a “space”, the notion of space being more general.
- **Create an atmosphere:** A building also has to offer appropriate atmosphere for the activities to carry. By atmosphere Gobin refers to comfort conditions (thermic, lighting, olfactory, acoustic, dynamic anthropology);
- **Store:** store and give the possibility of functioning to tools and devices required for human activities;
- **Manage human relations:** preserve privacy of building occupants, interact with the external environment without being annoyed;
- **Interact with the site:** benefit from the site capacities (landscape, sun orientation etc.) and embellish the site (respect its previous characteristics and integrate the site from an aesthetic point of view);
- **Semiology:** A building also gives a self-image of occupants to other inhabitants and a personal feeling of the location;

Contrary to the Charter of Athens, to define functions of buildings Gobin has applied Functional Analysis methods and more precisely the MISME (APTE®) method. However, Gobin does not describe how to represent these processes over space neither how to model them.



**Figure 63 : The 8 functions of buildings (Gobin, 2017)**

It is interesting to see that functions of construction systems are not the same for buildings, infrastructures or cities.

## 2.3. Consideration of production constraints: the concept of Constructability

### 2.3.1. Why constructability?

#### 2.3.1.1. Origins

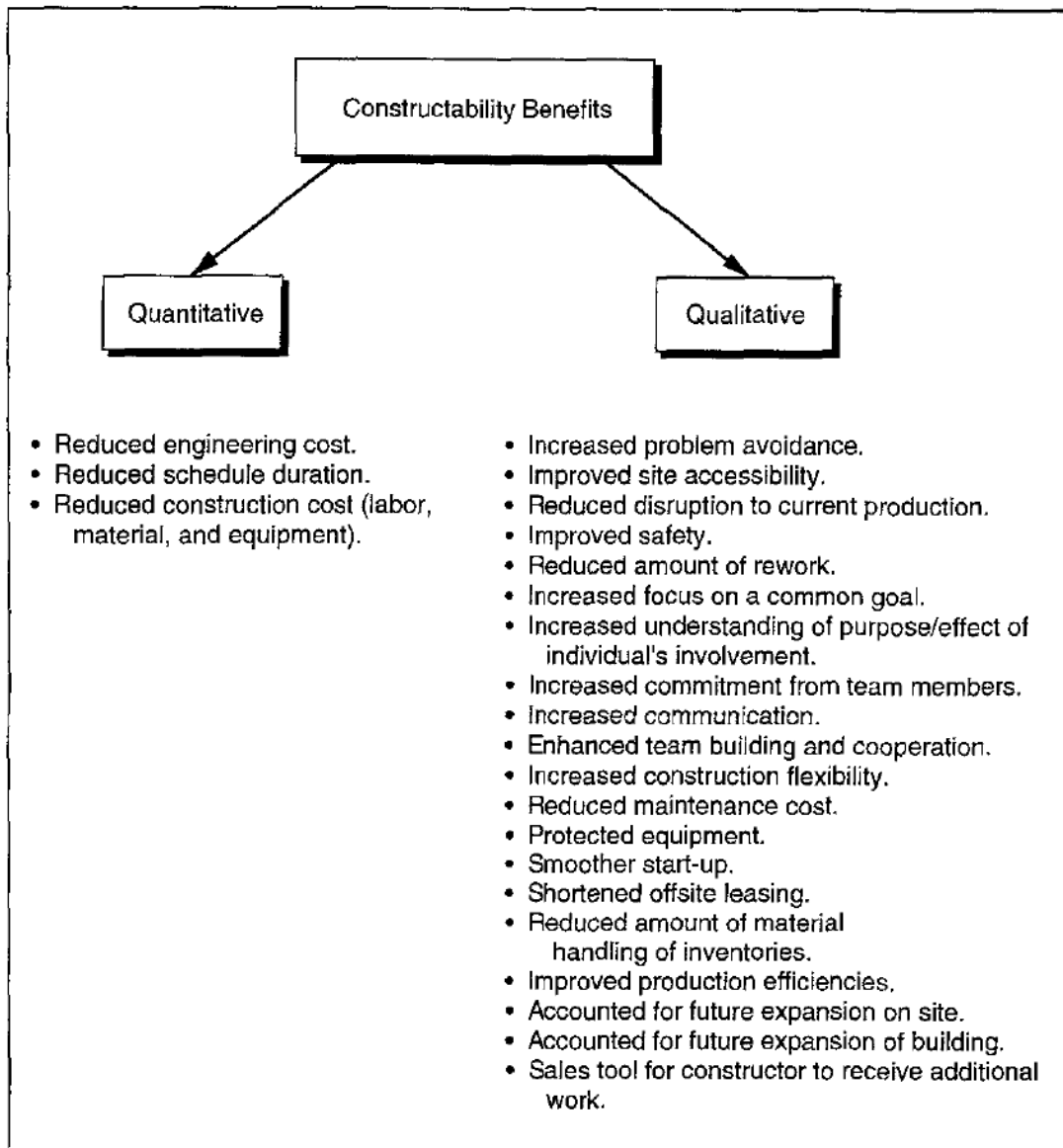
The development of Constructability started in the US in the 70s (Gambatese, Pocock, & Dunston, 2007). Hitherto, this concept is very new in France and is under development at IRC (Institut de Recherche en Constructibilité) – ESTP Paris.

#### 2.3.1.2. Constructability objectives

In (Kifokeris & Xenidis, 2016), Kifokeris sums up challenges addressed by constructability since the beginning of its development in the 60's (past and present):

- *“Managerially dysfunctional or not-optimal contractual strategies (Ireland, 2006);*
- *The profound lack of automation in the AEC industry in spite of the tremendous possibilities for it (Fischer & Tatum, 1989)*
- *The problematic dissemination of construction knowledge and experience among professionals (Tatum, 1993)*
- *The increasing complexity of construction projects and the need for innovation (Senescu & Haymaker, 2011), (Orstavik, Dainty, & Abbott, 2015)*
- *The insufficient partition, communication and dissemination of the enormous amount of chaotic knowledge and information accessed by practitioners (Ganah, 2003) (Nielson & Erdogan, 2005), (Senescu & Haymaker, Design process communication methodology: Improving the efficiency and effectiveness of collaboration, sharing and understanding, 2011)*
- *The ongoing, global financial recession that is prominent in the AEC industry, and the need for robust financial and risk management (Haider, 2009)*
- *An finally the modern contractual and social types of relationships between clients, designers, contractors, subcontractors, such as the popular design-and-build process and all its respective subsystems.” (Akintoye, 2006), (Haroglu, Glass, & Thorp, 2010), (Tsai & Yang, 2010), (Lam & Wong, 2011), (Rahmani, Khalfan, Maqsood, Noor, & Alshabri, 2013)*

In (Russell, Swiggum, Shapiro, & Alaydrus, 1994), Russel presents benefits of constructability both in qualitative and quantitative terms:



**Figure 64 : Constructability benefits divided into quantitative and qualitative types (Russell, Swiggum, Shapiro, & Alaydrus, 1994)**

In (Gambatese, Pocock, & Dunston, 2007), Gambatese highlights that non-consideration of constructability issues in the development process of construction products leads to costly reworks and changes and time losses. Development of constructability mostly in the US and UK in the 70's was an attempt to improve productivity in the construction industry by improving ease of implementation, costs and safety of construction products.

The Institut de Recherche en Constructibilité (IRC) considers Constructability as a way to (IRC, 2013) :

- Improve ease of implementation of construction products and their components;
- Study any element which can possibly impact performances of construction products during its development;
- As shown in the figure below, one aim of constructability, highlighted by IRC, is also to reduce the gap of 30% between what a project owner actually pays for its project and the actual earned value of the product.

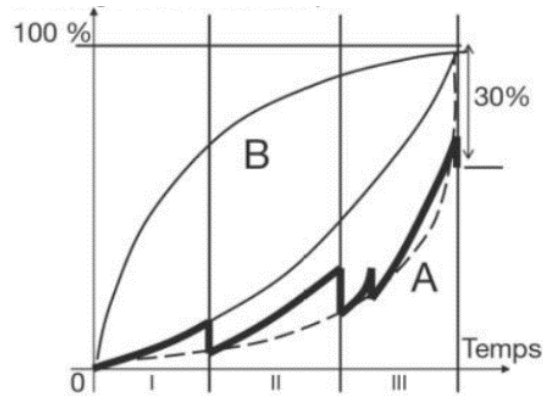


Figure 65 : The gap between earned value of the product and cost of projects in France (adapted from (IRC, 2013)). Curve A represents expenditures of the project and curve B commitments progressively locked by stakeholders.

This gap corresponds to time losses due to waiting time to make decisions, overconsumption of materials, reworks etc. These expenses are incurred by the project owner while they don't add any value to the product. Hence, one objective of Constructability is to improve earned value of construction products by eliminating dysfunctions in the project.

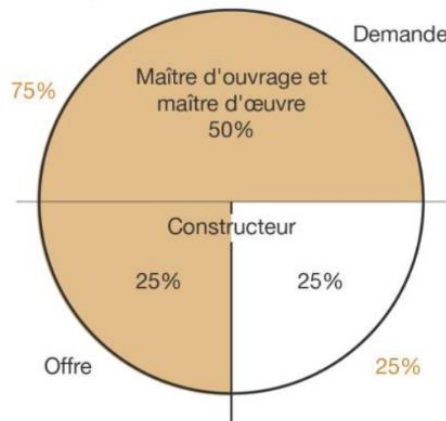


Figure 66 : Origin of non-quality costs (adapted from (IRC, 2013))

More precisely, the IRC (Institut de Recherche en Constructibilité) (IRC, 2013) considers that 75% of non-quality costs resulting to malfunctions can be solved by an intellectual work during the design phase whereas only 25% are due to a lack of knowledge during the implementation phase.

Finally, objectives pursued by the development of constructability correspond to challenges faced by the construction industry identified in the introduction of this thesis:

- Improve productivity of the construction industry (time, resources and costs);
- Ensure quality of construction products (manage complexity of their development);

Therefore, in this part, we will develop the concept of constructability and how is it possible to integrate it into the previously presented methodologies (Functional Analysis).

### 2.3.2. Constructability, manufacturability, buildability and Lean Construction

Several similar terms to constructability are used in the literature like manufacturability, buildability or Lean Construction. As these concepts are linked with the development of constructability or are simply parts of it, the definition of these concepts help to define constructability.

### 2.3.2.1. Constructability and manufacturability

Other industries have integrated the production process within the design process in the different development phases to improve cost effectiveness and quality (Jiang, 2016 July) by developing *Manufacturability* also called *Design For Manufacturing (DFM)*. Design for Manufacturing, “refers to the effort of ensuring that the engineering design satisfies the customer requirements and complies with the manufacturing facilities of a company, e.g. machines, staff knowledge and resources available” (Sandberg, 2007). It is also “the systematic early selection of material and process combinations for the manufacture of parts, which can then be ranked accordingly to various criteria” (Boothroyd, Dewhurst, & Knight, 2002).

In (Shankar, 1993) and (Shankar & Jansson, 1993) Shankar develops the manufacturability concept and identifies factors and sub-categories of factors affecting manufacturability in the design:

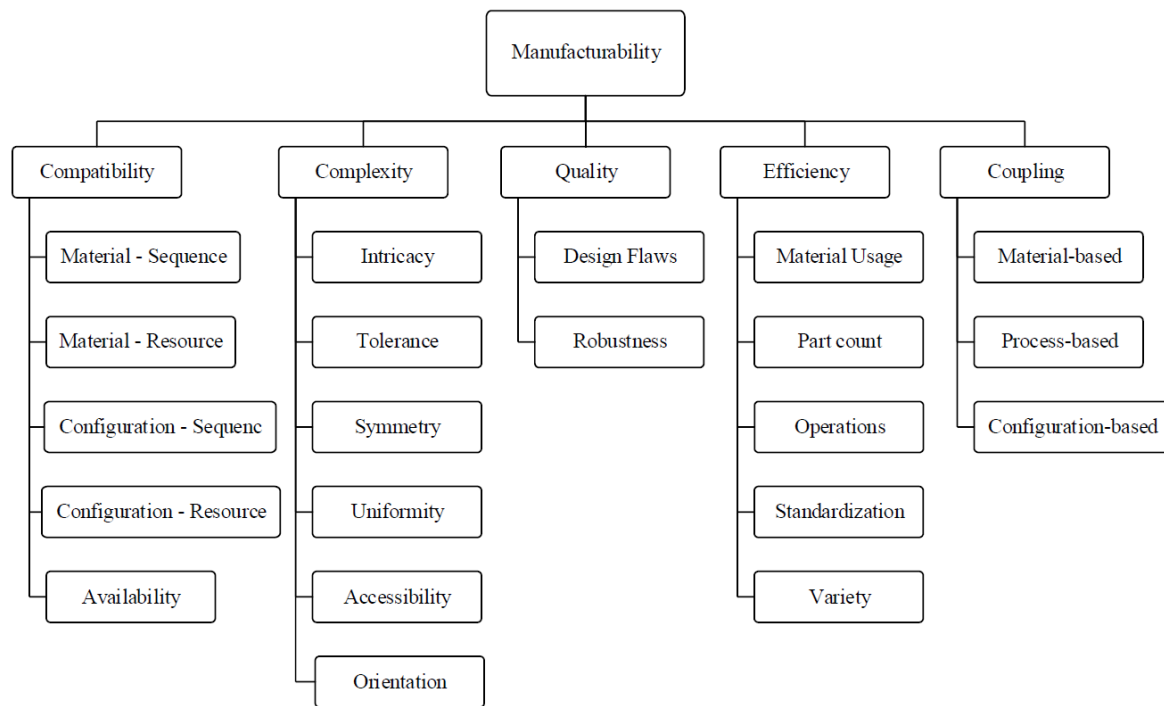


Figure 67 : A hierarchical model of manufacturability concepts (Jiang, 2016 July)

These criteria and subcriteria will help in the definition of Constructability criteria later on in this thesis.

The aim of Manufacturability is similar to Constructability as it focuses on the consideration of Implementation knowledge early in the design of products. The main difference between Manufacturability and Constructability comes from the context in which the product is built/manufactured: while in most of other industries the context of implementation is fixed and stabilized, in the construction industry it is always changing at each project depending on the context. As the context is changing, it may leads to new criteria to take into account when carrying Constructability analysis (environmental criteria, weather conditions, site conditions...). We can notice that in the list defined by Shankar in (Shankar & Jansson, A generalized methodology for evaluating manufacturability, 1993) no criteria is related to the context in which the product is manufactured neither the location where it is built (excepting maybe the criteria Accessibility). Definition of Design for Manufacturing from Sandberg neither mentions criteria related to the context (Sandberg, 2007).

### 2.3.2.2. Constructability and buildability

Buildability and Constructability are often terms used interchangeably (Kifokeris & Xenidis, 2016). The following definitions of Buildability can be found in the literature:

- “the extent to which the design of a building facilitates ease of construction, subject to the overall requirements for the completed building” (Wong, Lam, Chan, & Chan, 2006) (Lam, Wong, & Tiong, 2006) and (CIRIA (Construction Industry Research and Information Association), 1983)
- “The extent to which decisions, made during the whole building procurement process, ultimately facilitate the ease of construction and the quality of the completed project.” (Chen & McGeorge, 1994)

The latest definition of Buildability is given by the Building and Construction Authority of Singapore:

- “The extent to which the design of a building facilitates ease of construction as well as the extent to which the adoption of construction techniques and processes affects the productivity level of building works.” (Building and Construction Authority, 2014)

Efforts to make the distinction between Buildability and Constructability have been made in the 2000s to clarify these concepts and unify research efforts (Kifokeris & Xenidis, 2016), but there is not a global accepted distinction between these terms:

- As instance, for the Building and Construction Authority of Singapore (BCA), buildability is “*The extent to which the design of a building facilitates ease of construction as well as the extent to which the adoption of construction techniques and processes affects the productivity level of building works*”, while constructability “*focuses on the construction methods used during the construction phase. Through the Constructability Score, the builders’ contribution to raising site productivity can be increased by encouraging them to move away from traditionally labour-intensive construction methods and switching to more labour-efficient construction processes.*” (Building and Construction Authority, 2017). For the BCA, Buildability has a larger scope than Constructability which focuses only on automation and labour-efficiency while Buildability considers ease of implementation in the design phase.
- At the opposite, other authors considers that Constructability includes Buildability: Buildability focuses on the design phase of a construction product, whereas constructability integrates both design and management functions, Constructability is concerned with a wider scope than ‘buildability’: “*It deals with the project management systems that optimally use construction knowledge and experience to enhance efficient project delivery*” (Kifokeris & Xenidis, 2016), (Getuli, Giusti, & Capone, 2015), (The Institution of Professional Engineers New Zealand, 2008) and (Gambatese, Pocock, & Dunston, 2007).

As this last consideration matches more with our definition of Constructability we will keep the second comparison for the development of this thesis, but it is important to keep in mind that this is not a globally accepted definition.

To be more specific, and as explained in the figure below, whereas buildability only concerns ease of construction in technical terms, constructability also deals with (Kifokeris & Xenidis, 2016):

- **Indicative planning and operations performance evaluation** (Ireland, 2006) (POP):

Ireland analyses the effects of management on productivity (cost and time) and quality of construction products (and more particularly buildings). POP is not linked with the construction process directly but Ireland shows that it has impacts on the quality of construction products and needs to be taken into account in Constructability.

- **Value engineering** (Russell, Swiggum, Shapiro, & Alaydrus, 1994) (TQM, HVE and VE):

Russell sees construction knowledge as input data for Value Engineering (VE) in order to optimize costs of construction products. He also highlights interrelations between Constructability, Total Quality Management (TQM) and Value Engineering.

- **Contracting and finance in construction projects** (Haider T. , 2009) (C/B):

Haider explains impacts of “Cost Shifting” between different contracts on total cost of construction products and how to detect this practice. Constructability refers here not only on the “ease of implementation” of products, but more generally on required processes for the development of construction products and in this article on the contracting phase.

- **Knowledge Management** (Rezgui, Hopfe, & Vorakulpipat, 2010) (KM):

Knowledge Management (KM) is: “the process of creating, sharing, using and managing the knowledge and information of an organization”. In the construction industry this process is considered as part of constructability as a management activity. It highlights the difference with buildability as this activity is not directly linked with the production process but ensures the sharing of construction knowledge in all phases of projects.

- **Object-Oriented Analysis** (Alshawi & Underwood, 1996) (O/O):

The Object-Oriented approach consists in modeling (for example with diagrams) a system with:

- Characterization of the Objects constituting the system (i.e. its subsystems);
- Relationships between the defined objects (i.e. interfaces);
- What happens to the modeled objects (i.e. their functions);

The O/O method improves the construction process by allowing a better “reusability, stability, encapsulation, inheritance and modeling” of information, and by allowing to trace back construction issues to design choices resulting in a better consideration of construction knowledge in the design (Alshawi & Underwood, 1996). This activity does not concern directly ease of implementation but is still contributing to the improvement of the construction process and can be considered as part of the constructability corpus.

- **Productivity-oriented regression analysis** (Jarkas, 2011) (Malek, 2011) (P/O):

Productivity-oriented regression analysis concerns the evaluation of constructability on labor productivity and its quantification. In (Jarkas, 2011), Jarkas takes the example of formworks to illustrate P/O analysis and evaluate buildability factors impacts such as simplicity, standardization and element repetition.

- **Total Building Performance Framework** (Sui-Pheng, Junying, & Lim, 2008) (TBP):

In (Sui-Pheng, Junying, & Lim, 2008), Low analyses impacts of buildings performances on buildability criteria defined by the Building Authority of Singapore. Different solutions with different performances are evaluated regarded to their buildability score. Constructability analysis is more than buildability as performances of the product are considered in the analysis and not only ease of construction.

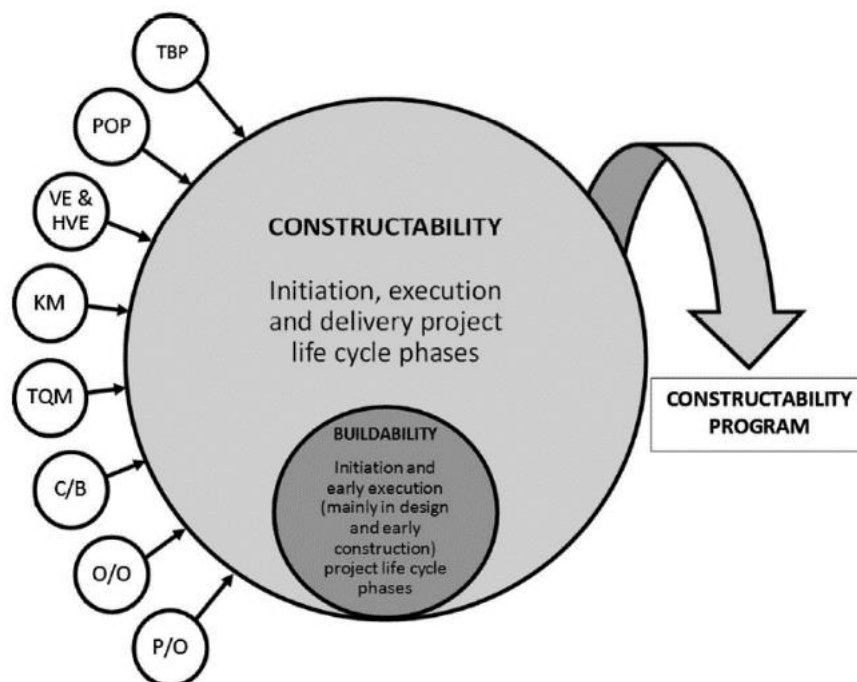


Figure 68 : Relationships and interconnections between constructability and buildability (Kifokeris & Xenidis, 2016). Signification of abbreviations are described in the text.

### 2.3.2.3. Constructability and Lean Construction

*Lean Construction* is the application of *Lean Production* developed in the manufacturing industry to the construction industry. Goals of lean construction concepts are to improve product quality and reduce costs (Yusuf & Adeleye, 2002) by eliminating wastes and unnecessary tasks. Compared with constructability, Lean production is focused on the production process whereas constructability also deals with the management of construction knowledge in all stages of construction products development. Compared with buildability, Lean construction does not necessarily insist on “ease of construction” but only on quality and costs, ease of construction being one consequence of Lean Construction objectives.

However, Lean construction is full of insights for the concept of Constructability and buildability, particularly to model the construction process: Koskela (Koskela, 2000), indicates that the construction process can be described by 3 different views:

- Transformation view: the construction process is modeled as “*a transformation of inputs into outputs*”;

Managing transformation consists in taking care on what has to be done: manage contracts and specify quality and safety requirements.

- Flow view: the construction process is modeled as “*a flow of material, composed of transformation, inspection, moving and waiting*” ;

Managing flows consists in managing the supply chain of materials and information in the construction process.

- Value Generation view: the construction process is modeled as “*a process where value for the customer is created through fulfillment of its requirements*”.

Managing value generation consists in assuring that tasks undertaken during the construction process actually add value to the under construction product.

Therefore, objectives of Lean Construction consist in optimizing these three views of the construction process. They can be summed up with the following schema:

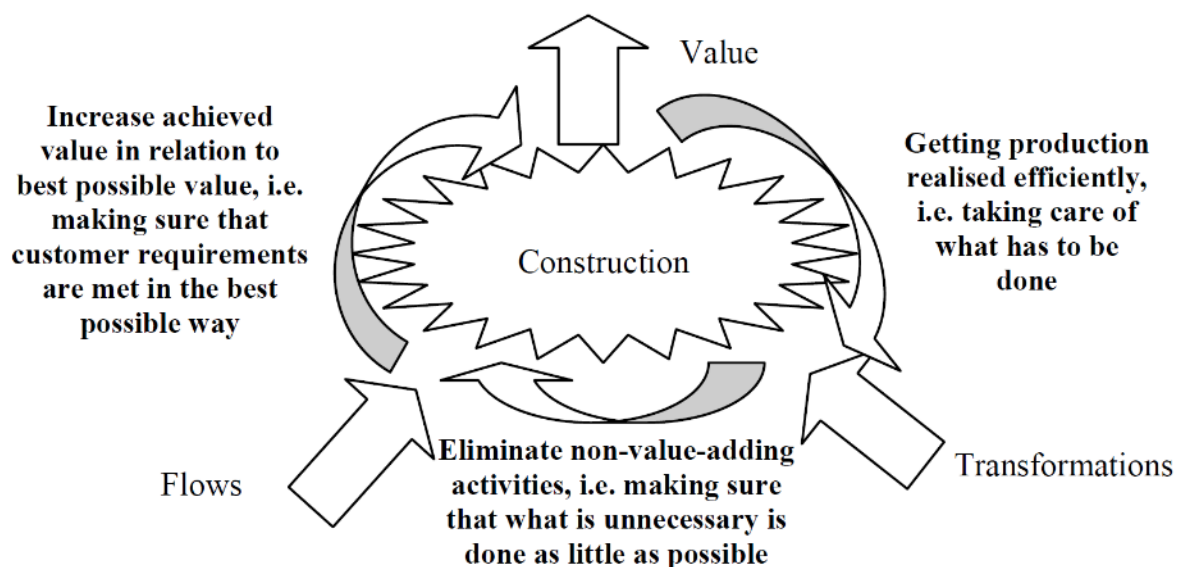


Figure 69 : The three parts of management in construction (Sardén & Stehn, 2005)

- Optimizing transformation is to decompose the construction tasks and to minimize costs, resources and time required to achieve them.



- Optimizing flows is to optimize the supply chain by avoiding non-adding value activities.
- Optimizing value is to express clients' needs and requirements as precisely and concretely as possible.

These concepts will be useful when establishing the methodology developed in this thesis in the third part.

Finally, Lean Construction has similar objectives than constructability: reduce costs and delays and improve quality but it focuses only on the production process. Lean Construction is focus on construction tasks, their rationalization and optimization whereas constructability concerns the integration of realization constraints early in the design of a construction system.

#### 2.3.2.4. Recapitulative table

The following table recapitulates the relations between the previous defined concepts and constructability:

	<b>Relations with Constructability</b>
<b>Manufacturability</b>	Manufacturability is the same concept than constructability in the manufacturing industry. The difference between both concepts comes from the consideration of environmental/contextual criteria in Constructability (site conditions, logistics, weather conditions...) which don't appear in Manufacturability.
<b>Buildability</b>	Buildability is the part of Constructability dedicated to the "ease of construction" while constructability concerns also management and design activities.
<b>Lean Construction</b>	Lean Construction is dedicated to the improvement of the construction process and tasks in terms of quality and costs: eliminate wastes, eliminate non-adding value activities, and fulfill clients' requirements. Somehow, Constructability and Lean Construction have the same objectives. Nevertheless, Constructability focus on the consideration of realization constraints during the realization phase and Lean Construction to the organization of labor on site in order to optimize it.

**Table 6: Constructability and Manufacturability, Buildability, Lean Construction**

Finally, manufacturability essentially applies to industrial systems more than construction systems. Comparing both corpuses we can highlight that manufacturability doesn't consider criteria related to the environment (e.g. weather) and to the location of the system which are essential elements for construction systems. Buildability for its part is dedicated to the "ease of construction" and not other aspects realization such as management activities. And Lean Construction is dedicated to the improvement of the construction process while Constructability intends to consider in design and planning phases constraints related to realization and management constraints during the realization phase.

### 2.3.3. The concept of Constructability and its evolutions

#### 2.3.3.1. Definition

Different definitions of Constructability exist; they have all in common the consideration of construction knowledge in the development of construction product (Gambatese, Pocock, & Dunston, 2007). However there are different interpretations of the definition amongst authors which have evolved over time:

- 1) The first definition of constructability was given by the CII in the US (Construction Industry Institute): *“The optimum knowledge and experience in conceptual planning/design/engineering/detail engineering/procurement/field operation/operation phases to achieve overall project objectives”* (CII, 1986);
- 2) *“Constructability was defined as a measure of the ease or expediency with which a facility can be constructed”* (Hugo, et al, 1990)
- 3) *“The application of a disciplined and systematic optimization of construction-related knowledge during the planning, design, procurement and construction stages by knowledgeable, experienced construction personnel who were part of a project team”* (CMC, 1991)
- 4) *“The process of doing everything possible to make construction easy, to improve quality, safety, and productivity, to shorten construction schedules and to reduce rejection and rework”* (Kerridge 1993)
- 5) *“Constructability involved construction-oriented input into planning, design and field operations of a construction project”* (Pepper, 1994)
- 6) *“Constructability programs was defined as the application of a disciplined, systematic optimization of the procurement, construction, test, and start-up phases by knowledgeable, experienced construction personnel who are part of a project team”* (Russel, et al, 1994)
- 7) *“Constructability was often portrayed as integrating construction knowledge, resources, technology, and experience into the engineering and design of a project”* (Anderson, et al, 1995)
- 8) *“Constructability of a design referred to the ease with which raw materials of the construction process (labor, production equipment and tools, an materials and installed equipment) can be brought together by a builder to complete the project in a timely and economic manner”* (Glavinich, 1995)
- 9) *“The integration of construction knowledge in the project delivery process and balancing the various project and environmental constraints to achieve the project goals and building performance at an optimum level”* (CII Australia, 1996)
- 10) *“... a planning process that required customer input in every phase of the capital project planning: front-end engineering, detailed design, procurement, contracting, construction, check-out, start-up, operation, maintenance, and business management, and communication among all project participants.”* (Geile, 1996)
- 11) *“The optimum use of construction knowledge and experience by the owner, engineer, contractor and construction manager in the conceptual planning, detailed engineering, procurement and field operations phases to achieve the overall project objectives.”* (Nima, et al, 1999)
- 12) *“The feasibility (or complexity) of a considered project to be performed by a specific technology based on the construction knowledge learned from past projects”* (Yu and Skibniewski, 1999)
- 13) *“Constructability programs aimed at integrating engineering, construction, and operation knowledge and experience to better achieve project objectives”* (Arditi, et al, 2002)
- 14) *“the capability of being constructed”* (ASCE, 1991)
- 15) *“a measure of the ease or expediency with which a facility can be constructed”* (Hugo, O'Connor, & Ward, 1990);
- 16) *“the implementation of construction knowledge, resources, technology and experience into engineering and design of a project”* (Anderson, Fisher, & Gupta, 1995)
- 17) *“A process that utilizes construction personnel with extensive construction knowledge early in the design stages of projects to ensure that the projects are buildable, while also being cost-effective and maintainable”* (AASHTO, 2000);
- 18) The Construction Institute (CI) of the American Society of Civil Engineers (ASCE) defines Constructability as: *“the integration of construction knowledge and experience in the planning, design,*

*procurement, construction, operation, maintenance, and decommissioning phases of projects consistent with overall project objectives.”*

19) IPENZ (now Engineers New Zealand) gives the following definition for Constructability: *“Constructability is a project management technique for reviewing construction processes from start to finish during the pre-construction phase. It will identify obstacles before a project is actually built to reduce or prevent error, delays and cost overruns”*. (IPENZ (Engineers New Zealand), April 2008)

The definition of Constructability has evolved from the *“capability of being constructed”* given by ASCE in 1991 to the last definition given by IPENZ in 2008 where constructability is mainly a *“project management technique [...] to prevent error, delays and cost overruns”*.

These definitions can be clustered in 5 groups:

<b>Consideration of construction knowledge in planning, design, field operation and procurement phases</b>	<b>Achieve project objectives</b>	<b>Ease and optimize construction</b>	<b>Project management technique</b>	<b>Consideration of customers' needs at all stages</b>
(1), (3), (5), (6), (7), (9), (11), (13), (16), (17), (18)	(8), (9), (11), (13)	(2), (4), (6), (8), (12), (14), (15), (17), (18)	(19)	(10)

**Table 7 : Constructability definitions clustering**

Most of the definitions focus on the consideration of construction knowledge and the ease and optimization of construction processes. Only 4 definitions integrate the achievement of project objectives, one definition that constructability is a project management technique and one definition that constructability concerns customers' requirements.

This last definition is the one we will keep for Constructability in the following chapters. Constructability concepts have been used in many different construction projects both in buildings and infrastructures (notably roads) (Sathyanarayanan, 2008).

#### **Improvement n°1:**

From these definitions, constructability partly answers to the **Issue n°5** defined in 2.2.3.5 to integrate constraints from the realization phase (construction knowledge) in upstream studies. However, constraints from planning, design, verification and commissioning phases are not integrated in the definition of Constructability. For this reason we will extend the concept of Constructability to Constructibility to consider also this constraint.

#### **2.3.3.2. Constructability Concepts and Principles**

Constructability principles, concepts and tools are implemented in all development phases of construction products from planning to realization. Some of these concepts are related to Knowledge Management and apply globally to companies rather than projects.

- Constructability Principles and Constructability Concepts

In (CII (Construction Industry Institute), 1996), 10 Constructability Principles (CP) are laid down and set out by Kifokeris in (Kifokeris & Xenidis, 2016). These 10 CP are the fundamentals of Constructability:

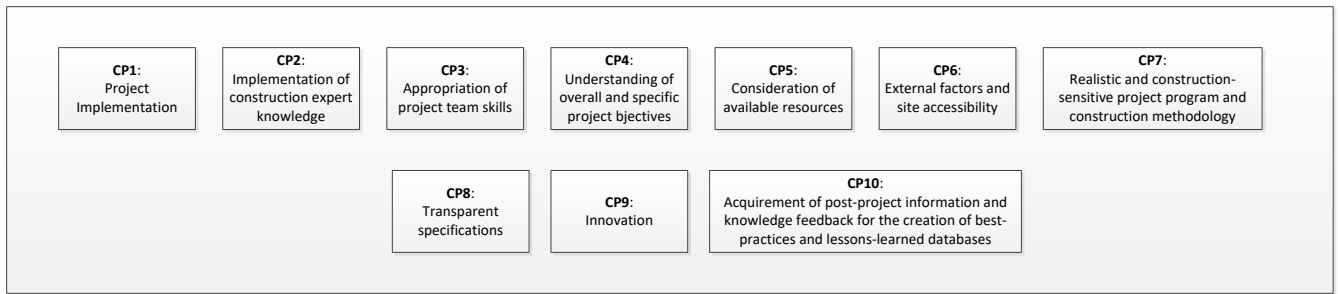


Figure 70: The 23 Constructability Principles (CP) (CII (Construction Industry Institute), 1996)

These principles are at the foundations of the 23 Constructability Concepts (CC) defined by Nima (Nima, 2001). All these concepts focus on the integration of construction knowledge in the different phases of construction projects in order to improve productivity and quality.

The CCs are discretized by project phases (Design, Realization and Delivery) as follows:

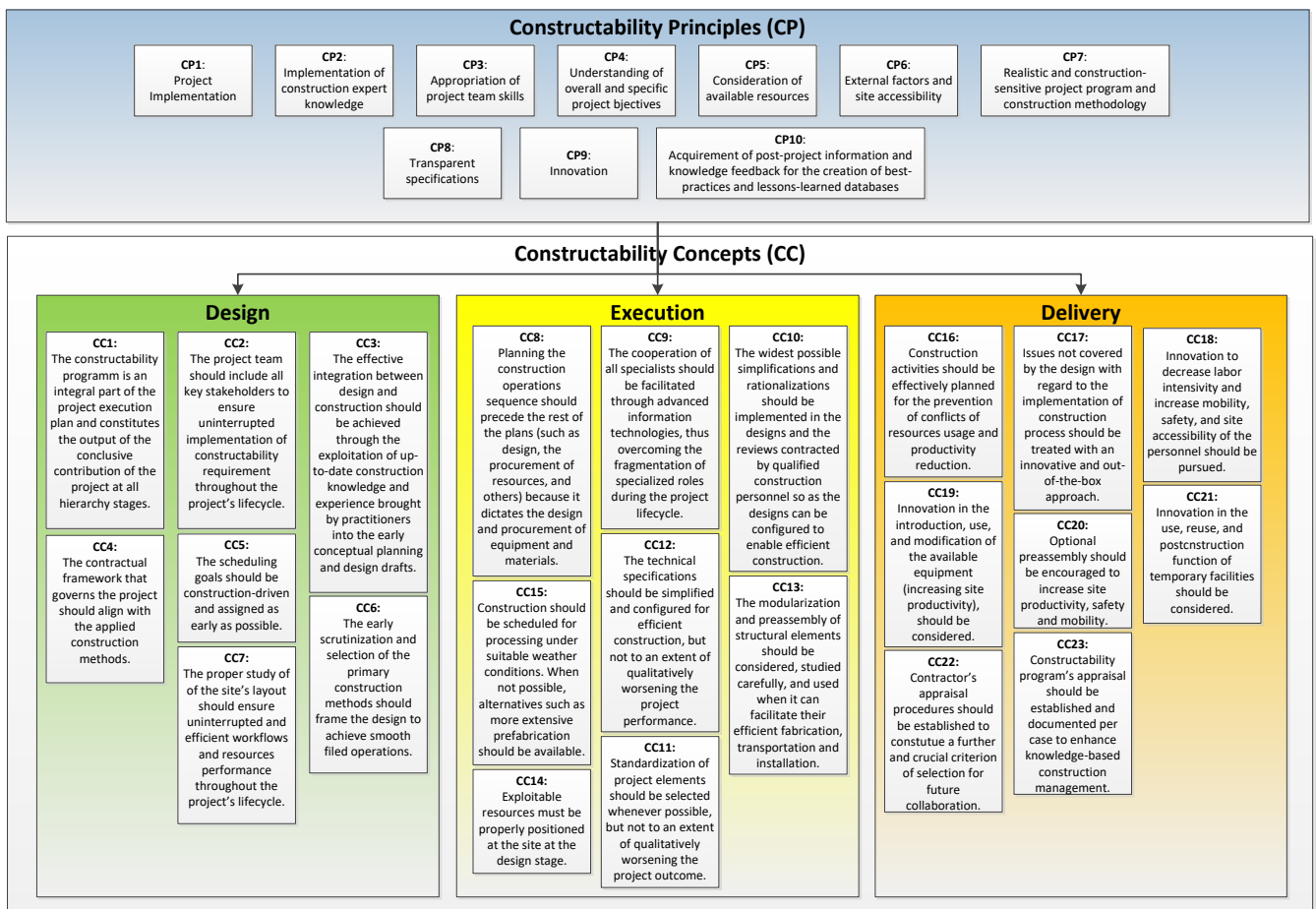


Figure 71 : Constructability Principles (CP) and Constructability Concepts (CC) adapted from (Nima, 2001) and (Kifokeris & Xenidis, 2016)

The above-mentioned Constructability Concepts are guidelines and methodological tools to set up constructability in projects. They have to be adapted to each project depending on their particular context. It is through CC that constructability is implemented in project management strategies.

In (Ahmed & Othman, 2011), Ahmed also defines Constructability concepts to consider in the development of construction products:

- Constructability Implementation

In (Kifokeris & Xenidis, 2016), Kifokeris defines a “mode-of-practice” to successfully integrate Constructability Principles and Concepts in the different phases of projects:

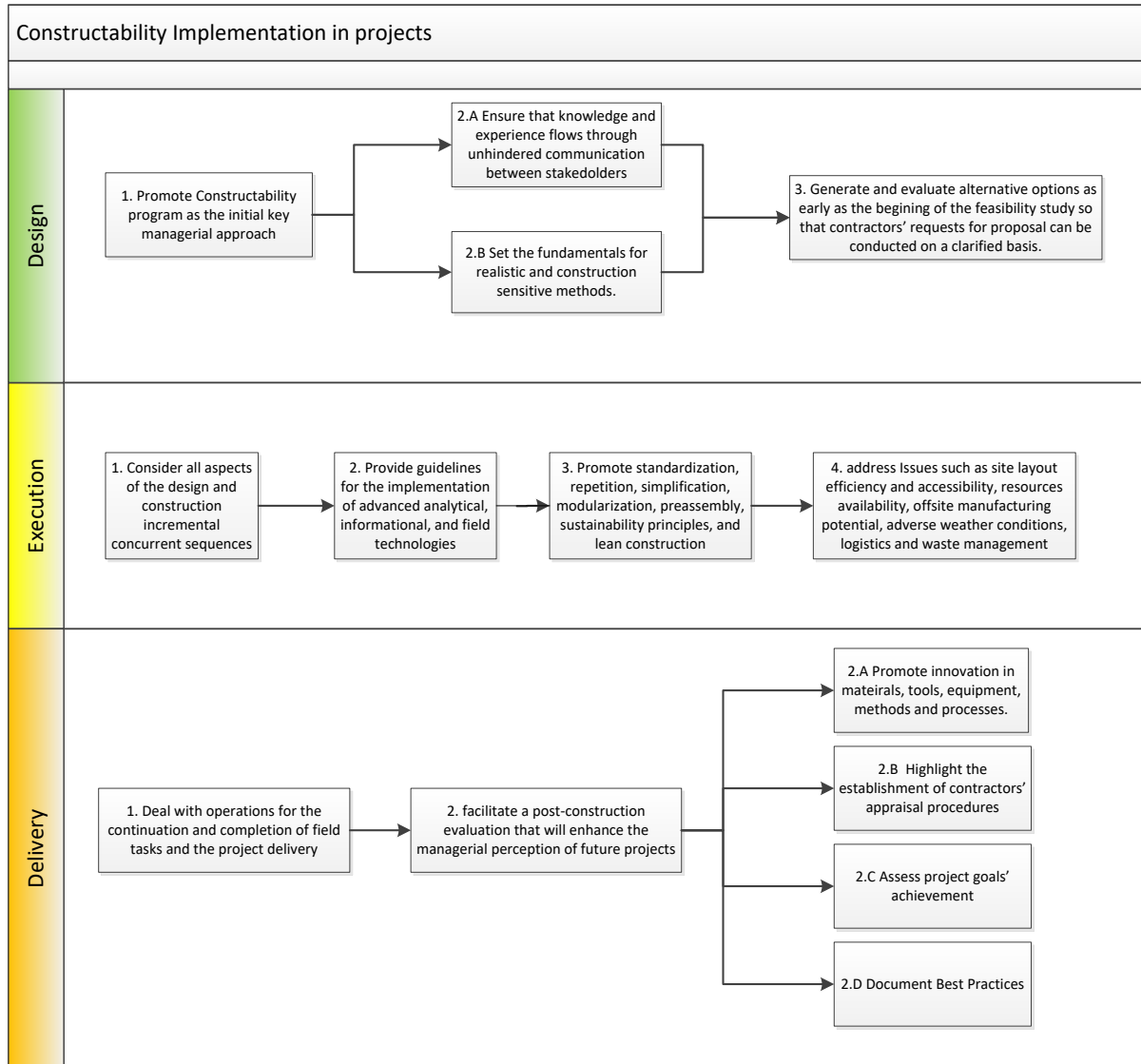


Figure 72 : Implementation of Constructability, adapted from (Kifokeris & Xenidis, 2016)

In (CII (Construction Industry Institute), 1996) a constructability implementation process is defined to ease the implementation of Constructability in projects:

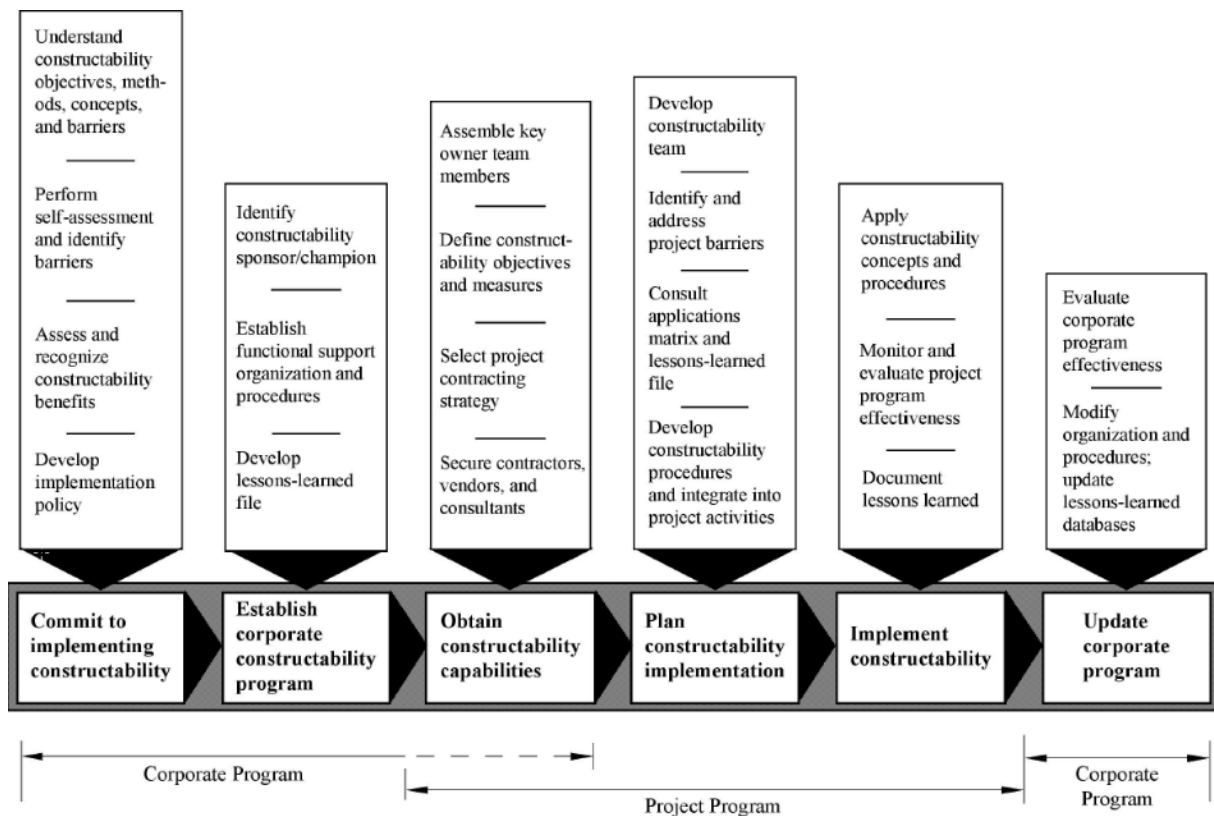


Figure 73 : The Constructability implementation process (CII (Construction Industry Institute), 1996)

The main differences between these two processes are that the Implementation process from the CII does not only include project programs but also company programs, project programs are separated in “Capabilities”, “Implementation plan” and “Implementation” while Kifokeris divides the process in project phases “design”, “execution” and “delivery”. Furthermore, Kifokeris includes communication between stakeholders and innovation in the constructability implementation process which is not the case in the CII process.

Both implementation processes are very general, and it is not clear when and where in the design, execution and delivery processes should constructability be taken into account, neither who should be responsible for it in project teams.

#### Issue n°8:

It is not clear when and how Constructability concepts and practices should be applied in the design process of a construction system. It is required to define more precisely the development workflow of construction systems and define exactly when and how they should be considered by project stakeholders, particularly in the workflow of the Functional Analysis method.

- Barriers to the implementation of constructability

Barriers to the implementation of constructability have been identified in (O'Connor & Miller, 1994), (Jergeas & Put, 2001), (Ahmed & Othman, 2011) and (Windapo & Ogunsanmi, 2014). These barriers can be classified into categories such as general, owner, designer and contractor barriers. It is important to highlight constructability barriers as they will irremediably come up when applying the method develop in this thesis. The most significant barriers are as follows:

- General barriers

General barriers concern complacency with actual management processes and procedures, low consideration of constructability benefits, lack of constructability experts in project teams, discontinuity in the consideration of constructability in key stakeholders of the project, lack of knowledge management in companies or/and projects, reluctance to innovation and changes, a rigid legislation, inappropriate procurement methods and the absence of constructability requirements in building codes.

- Owner barriers

Owner barriers include a lack of knowledge of constructability concepts and practices, misunderstanding of constructability impacts and stakes, reluctance to invest in early stages of projects, lack of commitment in the application of constructability, owner's will to separate design and construction activities, lack of team-building and partnering activities, no consideration of constructability in consultant/contractors selection, no clear project objectives, lack of consistency of requirements, limitation of lump-sum competitive contracting, reluctance to consider contractors and consultants innovations.

- Designer barriers

Design barriers include a lack of understanding of constructability concepts and practices, lack of construction knowledge, expertise and technologies in project teams, prioritize companies/personal objectives over project objectives, lack of management skills and resources, lack of training in constructability methods, software and tools, poor communication between actors in the design team and with external stakeholders, incomplete specifications (more particularly constructability specifications), nonstandardization of design, late consideration of constructability inputs.

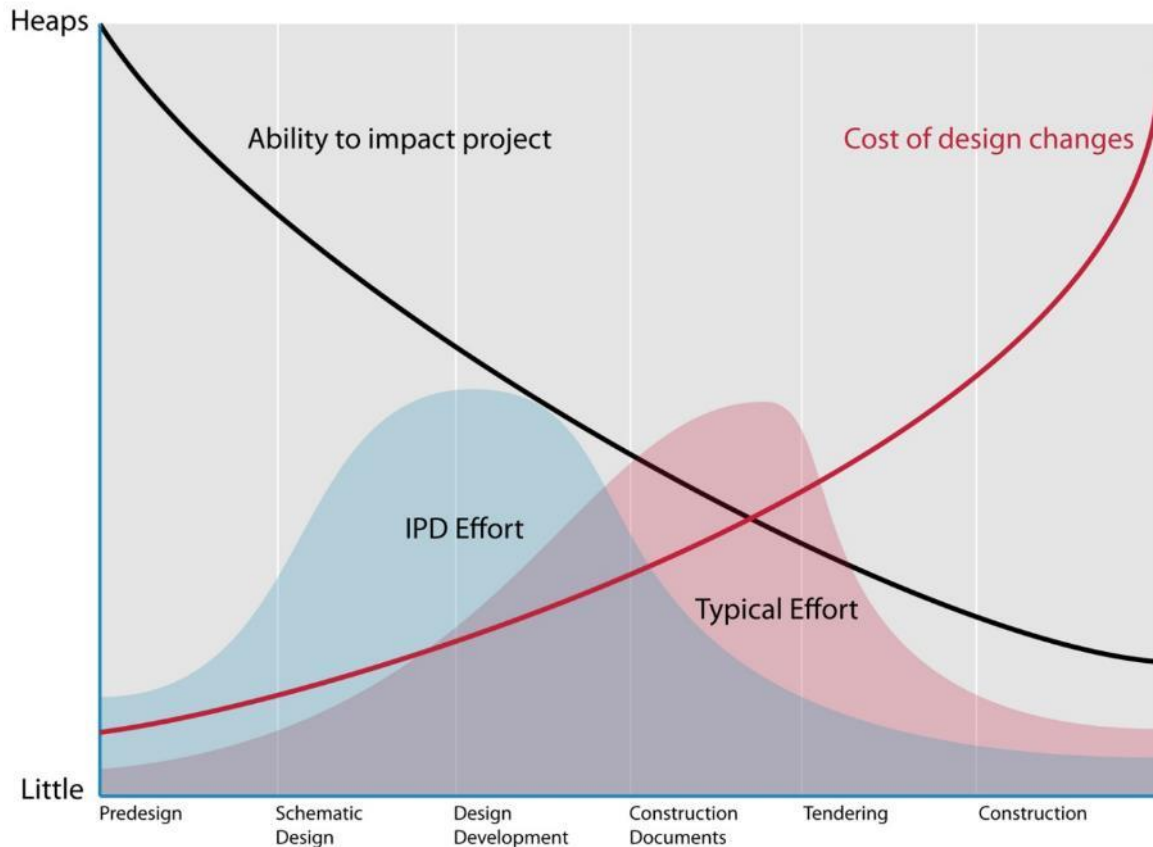
- Contractor barriers

Contractor barriers include reluctance of the personnel in the field to participate to pre-construction stages, no involvement in design phases, late communication of construction feedbacks, poor communication skills, poor construction knowledge and experience, absence of qualified and skilled labor, lack of management skills, absence of waste management, poor consideration of quality and no commitment in fulfilling clients' requirements.

We also consider that barriers to the implementation of constructability in design processes of construction products also come from a lack of methodology in the design. As the design process is usually chaotic with a lot of feedbacks loops and repetitions, is documents based and not structured it is more difficult to define precisely when, how and where constructability criteria, analysis and reviews should be incorporated.

- When to apply constructability concepts?

Constructability has to be applied all along the development process of a construction product (Gambatese, Pocock, & Dunston, 2007). MacLeamy (The American Institute of Architects, 2007) highlights that changes and modifications have not the same impacts depending on project phases, He illustrates this by the "MacLeamy" curve:



**Figure 74: Impacts of modifications depending on project phases (The American Institute of Architects, 2007). It shows that design changes are more costly in late stages of the project than early in the project development.**

In the IPD (Integrated Project Delivery) Guide (The American Institute of Architects, 2007), MacLeamy shows that changes and modifications are less costly and easier to consider in early phases of projects. Concerning constructability it means that constructability concepts should be applied as soon as possible in the development of construction products.

Nevertheless, even if it is clear that constructability concepts should be taken as soon as possible, all Constructability concepts can't be applied at the same time and should follow a logical order depending on the type of construction product (infrastructure, building...), their systemic level and projects phases. Nowadays, no methodology exists defining precisely when to apply Constructability concepts in the development process. In part 3, integration of constructability in Systems Engineering methods answers partly to this issue.

### **2.3.3.3. Constructability Criteria, a literature review**

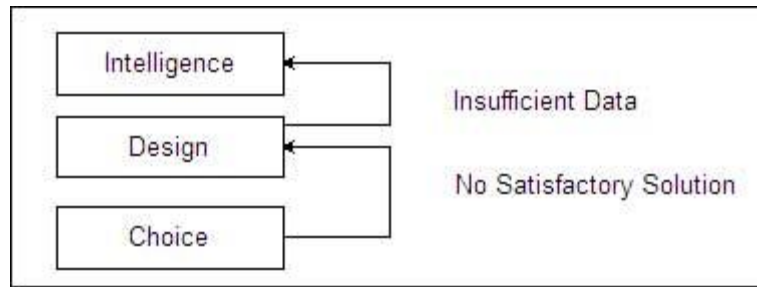
- Why constructability criteria?

Simon in (Simon, *The Sciences of the Artificial*, 1969) outlines that design activities are essentially problem solving activities and can be reduced to decision making. Even if Hatchuel in (Hatchuel, 2002) extends this idea by adding innovation and creativity to the process of Design, problem solving remains an important part of it.

Therefore, if constructability consists in incorporating construction knowledge into design activities, it means that decisions in the design process should take into account construction constraints and opportunities.

As decisions are made upon decision criteria it is crucial to define constructability criteria to take into account constructability in the decision making process (and hence design).





**Figure 75: the IDC (Intelligence Design Choice) model (Simon, The Sciences of the Artificial , 1969)**

- The intelligence phase consists in defining the problem/the opportunity, to gather information and facilitate access to information, analyze data, search for differences etc.
- The design phase consists in **defining decision criteria** and in modeling solutions to answer to problems identified at the intelligence phase.
- The choice phase consists in comparing the previously defined solutions by doing simulations, statistics, evaluations, optimizations etc.

Definition of Constructability criteria are at the core of the design process and allow the application of Constructability Concepts in the product development.

- What is a criterion?

From the definition of the Oxford Dictionary, a criterion is “*a standard on which a judgment or decision may be based, a characterizing mark or traits*”.

Therefore, if a criterion is a characterizing mark or traits, it implies that hypothesis have to be made on the subject of the defined criteria.

Finally defining criteria is a modeling activity or/and requires that the subject of the criteria to be modeled. Hence, defining Constructability criteria requires modeling or at least making hypothesis on the construction system.

Very often, there is a confusion between a criteria and a requirement. While criteria are elements which allow making decisions, a requirement is a characteristic a system has to follow. However, evaluation of criteria and notably constructability (and later Constructibility) criteria can lead to the definition of constructability/Constructibility requirements.

- Constructability criteria: a literature review

Many authors have defined Constructability Criteria:

- Pheng in (Pheng & Abeyegoonasekera, 1999) defines 16 buildability criteria in order to make a synergy between buildability and the ISO 9000 quality management system.
- Wong in (Wong W. , 2007) defines a list of criteria in order to measure buildability and constructability scores for the construction of Buildings in Hong Kong. 16 types of criteria for a total of 63 design attributes are defined from interviews with practitioners in Hong-Kong and literature reviews.
- IPENZ (Engineers New Zealand) in (IPENZ (Engineers New Zealand), April 2008) defines a matrix for Constructability review and analysis. The first part of this matrix is constituted of constructability criteria to consider for constructability reviews.
- Vergara and Jarpa in (Loyola Vergara & Goldsack Jarpa, 2010), has identified 22 Constructability criteria from the literature.
- Zhong in (Zhong & Wu, 2015) defines 4 constructability criteria applicable to steel structures.
- Singhaputtangkul in (Singhaputtangkul & Low, 2015) defines 6 Buildability Criteria from literature review to include them in a QFD (Quality Functional Deployment) matrix.

- Jiang in (Jiang, 2016 July) has defined 13 Constructability constraints (criteria). Criteria defined by Jiang are derived from manufacturability criteria transposed to the construction industry. Jiang has also modeled construction activities and resources to define Constructability criteria from manufacturability.

We have summarized in the table below 39 constructability criteria defined in the literature (Table 8):

Source/Constructability Criteria	Modeling a Decision Support Tool for Buildable and Sustainable Building Envelope Designs (Singhaputtangkul & Low, 2013)	Developing and implementing an Empirical System for scoring Buildability of designs in the Hong Kong Construction Industry (Wong 2007)	Constructability (PENZ (Engineers New Zealand) 2008)	Constructividad y Arquitectura (Loyola Vergara & Goldsack Jarpa, 2010)	Supporting automated constructability checking for formwork construction: an ontology (Jiang, 2016 July)	Economic sustainability, environmental sustainability and constructability indicators related to concrete- and steel-projects (Zhong & Wu, 2015)	Integrating buildability in ISO 9000 quality management systems: case study of a condominium project (Pheng & Abeyegoonasekera, 1999)
Health and safety of workers	X	X		X		X	X
Community disturbances	X		X	X			
Simplicity of design	X	X	X	X	X		
Design for simple assembly							X
Site specific factor		X					X
Below ground		X	X	X			X
Workforce				X			
Weather		X		X			
Innovations		X					
Coordination and rationalization of design information		X					
Flexibility		X	X			X	X
Tools plant and equipment		X	X				
Materials, fittings, products and subassemblies		X			X		X
Site layout, access and environment		X					X
Use of resources		X	X				
Time				X			
Installation sequence			X				X
Avoid damage to work by subsequent operations							X
Standardization			X				X
Preassembly			X				
Prefabrication			X				
Skills availability							X
Utility accessibility			X				
Storage				X			X
Modularity				X			
Construction sequence				X			
Ground conditions				X			
Communication				X			X
Contracting					X		
Tolerance					X		X
Repetitiveness					X		X
Operation					X		
Material - Sequence					X		
Material - Resource					X		
Configuration - sequence					X		
Configuration - resource					X		
Material - based coupling					X		
Configuration - based coupling					X		
Process - based coupling					X		

Table 8 : Constructability criteria, a literature review

1) Health and Safety of workers

The design should be arranged so as to facilitate safe working in foundations and earthworks, when materials and components are being handled and wherever traversing for access is necessary (Pheng & Abeyegoonasekera, 1999).

It refers to the consideration of the level of insecurity for the realization of the project (Loyola Vergara & Goldsack Jarpa, 2010).

Designers should be conscious of job-site safety which has strong moral and long-lasting economic effects for the project (Young III, 1998). Designs should facilitate a safe working environment, especially in foundation and earth works, when materials and components are being handled and wherever traversing for access is necessary (Adams, 1989).

#### 2) Community disturbances

In (Singhaputtangkul & Low, 2015), Singhaputtangkul takes into account community disturbances as a constructability criterion. Inconveniences (noise, vibrations, building cracks, aesthetic...) to surrounding communities around the site can lead to complaints from citizens and potentially interfere with the construction process (Kibert, 2012).

#### 3) Simplicity of design

Simplicity refers to a simple design, with a clear geometry, and simple installations and assembly systems (Loyola Vergara & Goldsack Jarpa, 2010).

Simplification of design details could lead to simpler construction on site, thus improving buildability (Griffith, 1984).

#### 4) Design for simple assembly

Designers should endeavor to produce the simplest possible details compatible with the overall requirements for the building to achieve efficient and defect-free works (Pheng & Abeyegoonasekera, 1999).

#### 5) Site specific factor

The investigation of site conditions and other circumstances likely to affect the course of the project should be thorough and complete to avoid the risk of subsequent costly delays and alterations after construction has commenced (Pheng & Abeyegoonasekera, 1999).

Buildability is significantly affected by the choice and type of site. Site conditions should be thoroughly investigated to avoid subsequent delays and alterations after construction has commenced (Adams, 1989).

#### 6) Below ground

Consideration should be given to minimize the amount of time taken by the work in the ground, particularly where the ground is poor, wet or hazardous (Pheng & Abeyegoonasekera, 1999).

Where works are to be undertaken below ground, careful considerations should be given to minimizing the time of underground construction (Adams, 1989), as well as the effect of works to the surroundings, and ensuring safety.

#### 7) Workforce

This criterion refers to the consideration of the workforce availability, skills availability, specialties and experiences, social conditions required or constraining construction of the product (Loyola Vergara & Goldsack Jarpa, 2010).

#### 8) Weather

It refers to the consideration of weather characteristics proper to the site and resulting difficulties for exterior working activities (Loyola Vergara & Goldsack Jarpa, 2010).

Design should facilitate the enclosure of building at the earliest possible stage to exclude hindrance and damage brought about by bad weather (Adams, 1989) and (Nima, 2001).

#### 9) Innovations

Innovative ideas could be applied in the sequencing of site activities, the use of temporary construction systems, and the use of hand tools and temporary facilities directly supportive of site methods etc. (Construction Industry

Institute Australia, 1996). Adopting innovative construction methods is conducive to reduce the use of labour on site and increase productivity (Low & Abeyegoonasekera, 2001).

#### 10) Coordination and rationalization of design information

To facilitate construction process on site, design should allow for easy communication with the contractor at the workplace (Adams, 1989). In addition, the use of dimensional coordination would allow practical building tolerances to be achieved both in terms of material tolerance and skill tolerance of craftsmen (Griffith, 1984).

#### 11) Flexibility

The design of the building assembly should recognize the tolerances which are normally attainable in site conditions, making allowances for differences between factory tolerances and those of normal site construction (Pheng & Abeyegoonasekera, 1999).

Flexibility is the consideration of the level of freedom given to the contractor to put forward different construction methods for the same result. Or to give the possibility to the contractor to choose the best option among different design choices to improve its construction process (Loyola Vergara & Goldsack Jarpa, 2010).

Designs specifying desired results, which allow contractors to select construction approaches and methods, e.g. formwork systems, shoring types and piling methods, can help improve buildability (Construction Industry Institute Australia, 1996). Similarly, adaptable design with interchangeable components provides room for changes to suit different circumstances (Wong F. , Lam, Chan, & Chan, 2006).

#### 12) Tools plant and equipment

The site layout should allow for the maximum use of mechanical plant, particularly for the movement of materials (Pheng & Abeyegoonasekera, 1999).

It refers to the consideration of specific characteristics of tools required to be used on site like technical working limits, level of availability, training requirements etc. (Loyola Vergara & Goldsack Jarpa, 2010)

Accessibility of personnel, materials and equipment during design and construction stages of project is essential for buildability performance (Adams, 1989) and (Construction Industry Institute Australia, 1996). Designers should optimize the use of plant and equipment taking their specific features and capacities into account. Attention should also be paid to site restrictions which affect layout of craneage (Construction Industry Institute Australia, 1996).

#### 13) Materials, fittings, products and subassemblies

Select robust and suitable products and materials which utilize normal site assembly methods and sequence, with subsequent operations as well as wear and tear in mind (Pheng & Abeyegoonasekera, 1999).

It refers to the consideration of components and raw materials required for the construction of the project, their local availability, materials handling, portability, toxicity, engines and tools requirements. (Loyola Vergara & Goldsack Jarpa, 2010)

Designers should use widely available and easily converted materials, which can be worked on quickly and economically for optimization of buildability. The products and materials to be used must be proven to be suitable for purposes of, with which manufacturers' recommendations should be complied (Adams, 1989).

Unifying the choice of materials can help achieve ease of construction because coordination problems were likely to arise from designs which involve many different types of materials. This however does not mean restrictions in specifying the range of material to be used. Besides, the dimension of building elements should be designed to minimize labour requirements and wastage of material by special cutting (Griffith, 1984).

#### 14) Site layout, access and environment

Describes the impacts on the space or logistical paths required for material or personnel to appropriately reach and install material at the work face (Hanlon & Sanvido, 1995).

The location of access to and around the site during construction should be carefully considered at the design stage (Pheng & Abeyegoonasekera, 1999).

It refers to the consideration of the degree of accessibility to the site for the transportation of raw materials, engines, manpower etc. (Loyola Vergara & Goldsack Jarpa, 2010).

It refers to the consideration of required space for construction activities and installations and their possible interferences inside the site perimeter (Loyola Vergara & Goldsack Jarpa, 2010).

#### 15) Use of resources

At the design stage, methods should be sought to improve buildability by designing for economical use of labour and widely available and versatile tools, plant and equipment (Griffith, 1984). Factors affecting the use of resources and skills e.g. the geographic location of the site, the market conditions or the socio-political situation, should be taken into considerations (Construction Industry Institute Australia, 1996). To suit the skills available locally, a realistic assessment of the levels of skills likely to be available from appropriately chosen contractors and specialists could be carried out (Adams, 1989). Careful examination and appraisal are also required for designs to minimize provision for special skills or high labor intensiveness (Construction Industry Institute Australia, 1996).

#### 16) Time

It refers to the time available for the realization of the project (Loyola Vergara & Goldsack Jarpa, 2010).

#### 17) Installation sequence

Designers should produce the simplest details compatible with the overall requirements for the building of and particular elements for performing efficient and defect-free works (Adams, 1989). Reducing the complexity of task sequence and simplifying interrelationship of trades is concerned with the sequence of construction work including handling of materials and the ways in which operations overlap and interrelate, as well as sequencing of different trades (Griffith, 1984)

#### 18) Plan to avoid damage to work subsequent operations

The design should enable work to be carried out in a workmanlike manner without risk of damage to adjacent finished elements and with minimum requirements for special protection (Pheng & Abeyegoonasekera, 1999).

#### 19) Standardization

Describes that the design or configuration of building objects are fixed with respect to accepted dimensions, criteria, materials, or parts (Fischer & Tatum, 1989).

The design of building elements and details should encourage appropriate repetition and standardization so as to reduce learning time, construction duration, costs and increased risks of error from construction of special projects (Pheng & Abeyegoonasekera, 1999).

Standardization refers to the consideration of normalized sizes and formats of components, sub-components and elements, the use of standardized products and the number of special pieces to assemble or build (Loyola Vergara & Goldsack Jarpa, 2010).

Standardization is one of the 3 key principles of Buildable Design Appraisal System which was defined to measure buildability of design in Singapore (Wong W. , 2007). Under the system, standardization refers to the repetition of grids, sizes of components and connection details. A repeated grid layout, for example will facilitate faster

construction either if formwork or precast components are used. Similarly, columns or external claddings of repeated sizes will reduce the number of changes either on-site or in the factory (Building and Construction Authority, 2017).

Designing for use of standardization and maximization and repetition helps contribute to good buildability. Repetition of simple work activities is highly productive because of reduced man-hours on any given task (Griffith, 1984). Meanwhile standardization improves productivity and quality, and reduces construction duration (Construction Industry Institute Australia, 1996).

It describes “the minimization of the number of materials, sizes, components, or sub-assemblies (Moore, 1996).”

#### 20) Preassembly

Preassembly refers to the number of components and sub-components possibly assembled outside the site or which require a simple process of assembly (Loyola Vergara & Goldsack Jarpa, 2010).

#### 21) Prefabrication

Prefabrication refers to the possible quantity of work near the site in a controlled environment (Loyola Vergara & Goldsack Jarpa, 2010).

By making use of precast components, substantial operation on site can be reduced, thereby improving site productivity (Building and Construction Authority, 2017). If prefabrication is to be used, designers’ considerations should focus on the economics repetition and standardization, simplifying the sequence of fixings and giving sufficient details for all the elements to fit together as intended (Ferguson, 1989). Furthermore, when standardization and prefabrication are used together, it would ultimately facilitate management (Gibb, 2001).

#### 22) Skills availability

Design must include a realistic assessment of the level of skills likely to be available from appropriately chosen contractors and specialists (Pheng & Abeyegoonasekera, 1999).

#### 23) Utility accessibility

It refers to the consideration of utilities availability and exterior services required for the realization of the project (Loyola Vergara & Goldsack Jarpa, 2010).

#### 24) Storage

Consideration should be given at the design stage to the location of material storage and unloading facilities (Pheng & Abeyegoonasekera, 1999).

#### 25) Modularity

Modularity refers to the consideration of unified dimensions and proportions of elements to build. It allows the repetition of materials used, measures realized and construction processes (Pheng & Abeyegoonasekera, 1999).

#### 26) Construction sequence

The construction method should encourage the most effective sequence of building operations (Pheng & Abeyegoonasekera, 1999).

It refers to the consideration of the logical order of the activities constituting the construction process and the possible interferences between them (Loyola Vergara & Goldsack Jarpa, 2010).

#### 27) Ground conditions

It refers to the consideration of ground characteristics and influence of topography, geology, soil pollution, preexisting elements etc. on construction activities (Loyola Vergara & Goldsack Jarpa, 2010).

### 28) Communication

Buildability is assisted by the thorough and clear presentation of information before the start of construction. Complete project information should be planned and coordinated to suit the construction process and to facilitate the best possible communication and understanding on site (Pheng & Abeyegoonasekera, 1999).

It refers to the consideration of the degree of clarity, fluidity, accuracy and validity of the information exchanged between stakeholders of the project. (Loyola Vergara & Goldsack Jarpa, 2010)

### 29) Contracting

It refers to the consideration of the level of conflicts potentially generated by the contracting system (Loyola Vergara & Goldsack Jarpa, 2010).

### 30) Tolerance

Permissible variation or deviation from a specified value, such as surface, deflections, location, or dimension of building objects (ACI, 2006).

It refers to the consideration of the level of tolerance of requirements and specifications (Loyola Vergara & Goldsack Jarpa, 2010).

Tolerance specifications, standardization and coordination are regarded as conducive toward developing achievable tolerance (Griffith, 1984). Tolerance compatibility is important for good buildability. Apart from sensible differentiation between factory tolerances and those of site construction, designers should allow for the problem of fit at the interfaces between different products (Adams, 1989).

### 31) Repetitiveness

It describes the repetition of the features of building objects, such as bay layout, dimension, and other design requirements (Jarkas, 2015).

### 32) Operation

It describes the impacts of the required features of a building object on the number of construction tasks/activities including handling, or the set-up time (Shankar, 1993).

### 33) Material - sequence

It describes the compatibility of a material system with the interdependencies between construction activities (Jiang, 2016 July).

### 34) Material – resource

It describes the compatibility of a material system with the resource requirements of a specific construction method (Jiang, 2016 July).

### 35) Configuration – sequence

It describes the compatibility of design configuration with the interdependencies between construction activities (Jiang, 2016 July).

### 36) Configuration – resource

It describes the compatibility of design configuration with the resource requirements of a specific construction method (Jiang, 2016 July).

### 37) Material – based coupling

It focuses on the coupling relationship between material parameter(s) and the requirements (Jiang, 2016 July).

### 38) Configuration – based coupling

It focuses on the coupling relationship between design configuration and the coupled requirements (Jiang, 2016 July).

### 39) Process – based coupling

It focuses on the coupling relationship between parameters of a production process and the requirements (Jiang, 2016 July).

- Comments on the Constructability criteria literature review

39 Constructability criteria have been identified in the literature. Surprisingly most of them have been defined without an explicit model of the construction process: what are the resources required to build a construction product? What are the constraints from construction methods and processes? To what system do Constructability Criteria apply?

These criteria are not the fruit of a methodological work but are mainly expert rules from interviews or literature reviews. Besides, some of the criteria only apply to a certain type of construction product (building, infrastructure...), activity (design, build etc.) or resource (human resources, equipment, raw materials...) and are sometimes related to each other. Some criteria can be applied to a very concrete element of the system like steel beams and other apply at the system level like “work below ground”.

Moreover, majority of the constructability criteria defined in the literature are related to the production process and site constraints, other criteria related to the overall development process of a construction product could have been integrated as they also constrain the planning and design of construction products.

Finally, there is a lack of methodology in the definition of constructability criteria to define to what element they apply, when to consider them in the development process and how to measure these criteria.

In comparison, criteria defined in the functional analysis method are the result of an intellectual process. Constructability is derived from Manufacturability used in the industry, a domain where production constraints are fixed and can be maintained from one project to another. At the opposite, in the construction industry, production constraints are changing depending on geographic characteristics of projects resulting in the consideration of different Constructability Criteria. Therefore, it is necessary to establish a method in order to define the appropriate criteria to consider at the appropriate development stage depending on projects characteristics.

Jiang in (Jiang, 2016 July), define Constructability criteria in relation with the construction process and resources required for the works:

Resources: Information, General conditions, Equipment, Materials, Space, Energy, Tools, Skills, Time.



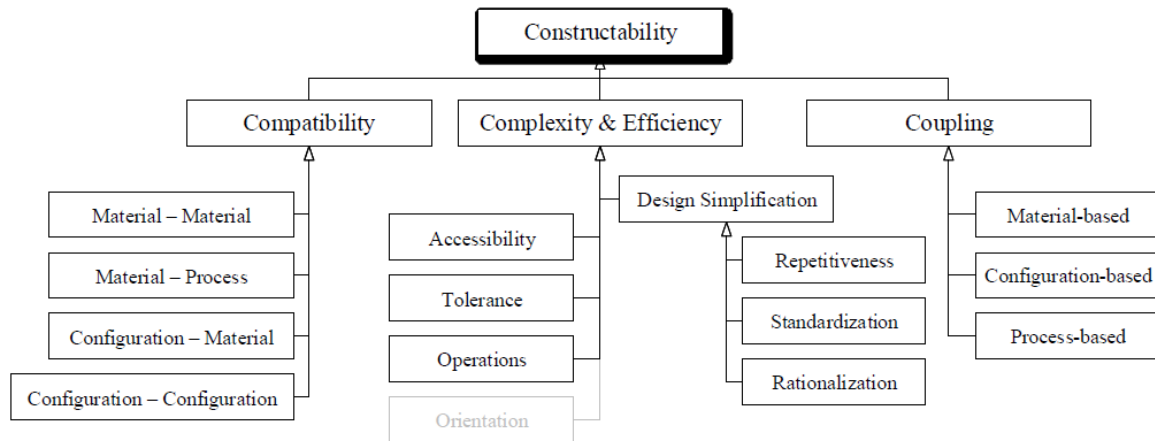


Figure 76 : Constructability criteria from (Jiang, 2016 July)

**Issue n°9:**

Currently, it is not explicit how Constructability criteria are defined and chosen at each step of the development process. A method or a rule is required to define the appropriate constructability criteria at the appropriate phase of the project.

Moreover, constructability criteria can lead to the definition of constructability requirements. These requirements have to be verified similarly to other requirements which apply to the System of Interest.

**Issue n°10:**

A tool might be necessary to model Constructability requirements in order to improve their management, their traceability and facilitate their verification. Particularly for complex projects where there is a numerous number of constructability requirements.

**2.3.3.4. Constructability tools**

In order to implement constructability into development activities and to carry constructability analysis tools have been developed. Some of them allow measuring the previously defined Constructability Criteria; some others allow implementing Constructability concepts in project activities or simply advertising about constructability.

- Constructability reviews

One of the main category of tool is “The Constructability review” (Fisher, 2000), (Gambatese, Pocock, & Dunston, 2007), (Ahmed & Othman, 2011) and others. A constructability review consists in analyzing if the design of a construction product is coherent with construction methods, techniques and technologies. Different types of Constructability review techniques have been developed and used (Ahmed & Othman, 2011):

- Peer Reviews: Design of a construction product is reviewed by experts (or peers) in order to provide complementary advises from another consultant/design firm on constructability of the product. Peer reviews can concern both management and technical aspects related to constructability.
- Feedback systems: Feedback systems concern the transfer and communication among design teams of lessons learned from past or present projects to improve their understanding of constructability issues.
- Brainstorming: Brainstorming about constructability is another way to carry out constructability reviews.

- Computer Models: Models allows capturing, recording and storing constructability concepts. They provide designers an easy access and a graphical retrieval of concepts and practices. Computer models will be detailed more in the next part about MBSE (Model Based Systems Engineering).
- Physical Models: A physical model is a small-scale physical mock-up of the future product. Constructability reviews are sometimes carried out with this type of tool but it appears to be increasingly rare.

Other Constructability tools exist and are used to carry constructability analysis, to implement constructability in design and management activities or to sensitize teams about constructability. In (Fisher, 2000), Fisher defines three categories of constructability tools: Policy process based tools, modeling tools and technological tools.

- Policy process based tools :

These tools are used in project management in order to set up constructability teams, tasks and reviews and mostly to communicate about constructability. They consist in methods, concepts and are document based. These tools are used to ensure that constructability will be taken into account in the different phases, to explain to team members what to do and to organize regular constructability meetings.

- Modeling tools:

Modeling tools allow implementing constructability. Two types of modeling tools are presented in (Fisher, 2000): process-based tools and computer based modeling tools.

- Technology based-tools:

Technology-based tools allow measuring Constructability criteria. Depending on constructability criteria taking into account and the types of information to measure, modeling tools can take different forms: graphical tools (CAD, Virtual Reality etc.) or non-graphical tools (databases, simulations, Artificial Intelligence etc.).

In (Fisher, 2000), Fisher describes the concept of Constructability and related tools in all phases of a construction process from planning to construction.

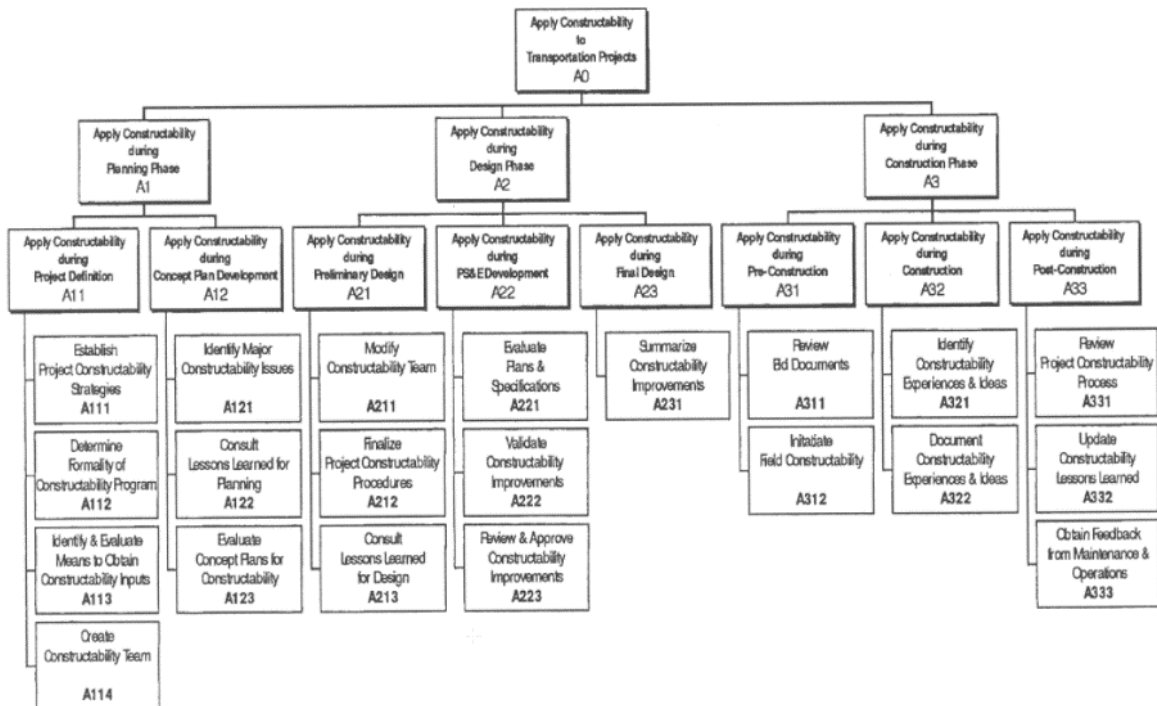


Figure 77: Constructability planning process framework (Fisher, 2000)

In Figure 77: Constructability planning process framework, Fisher describes how constructability tools can be integrated into the different development phases of a construction product from planning to construction.

In (Kifokeris & Xenidis, 2016), Kifokeris defines 5 types (cognitive tools, mathematical tools, methodological tools, programming tools, software tools), and 5 natures of Constructability tools per phase (Design, Execution and Delivery): quantitative project features and indices assessment (A), qualitative project feature and indices assessment (B), schedule cost-quality management and decision making (C), program review (D), Information and Knowledge feedback (E), acquired knowledge recording, management and dissemination (F). These tools allow the evaluation, assessment and improvement of Constructability Concepts define in (Nima, 2001) into projects:

Identified tool	Type					Nature												
	I	II	III	IV	V	A	B	C	D	E	F	A	B	C	D	E	F	
Technical reports (Mathes and Stevenson 1991)	X	—	X	—	—	—	—	—	—	—	—	X	X	—	—	—	—	—
Three-dimensional (3D), four-dimensional (4D), five-dimensional (5D) computer aided design (CAD), computer aided engineering (CAE), and computer aided manufacturing (CAM) (Tatum 1990)	—	—	—	X	X	—	—	—	—	—	—	X	X	—	—	—	—	—
Construction knowledge expert (COKE) (Fischer 1991)	X	—	X	X	X	—	—	—	—	X	—	—	—	—	X	—	—	—
Skill concept packages (SCoPs) (Moore 1993)	X	—	X	—	—	—	—	—	—	—	—	X	—	—	—	—	—	—
Brainstorming (Russell et al. 1994; Haider 2009)	X	—	X	—	—	—	—	—	X	—	—	—	—	X	—	—	—	X
Cost/benefit analysis (Russell et al. 1994; Haider 2009)	—	X	X	—	—	—	—	X	X	—	—	—	X	X	—	—	—	X
Model-based constructability analysis (MOCA) (Fischer et al. 1994)	X	—	X	X	X	—	—	—	—	—	—	X	—	—	—	—	—	—
S-curve function (Rwelamila and Savile 1994)	—	X	X	—	—	—	—	X	—	—	—	—	X	—	—	—	—	X
Geographic information systems (GIS) (Lee and Clover 1995)	X	X	X	—	X	—	—	—	X	—	—	—	—	X	—	—	—	X
Automated design aid (ADA) (Moore 1996)	X	—	X	X	—	—	—	—	—	—	—	X	—	—	—	—	—	—
Object-oriented analysis framework (OOAF) (Alshawi and Underwood 1996)	X	X	X	X	X	—	—	—	—	—	—	X	—	—	—	—	—	—
Building design appraisal system (BDAS) (Poh and Chen 1998)	—	—	X	—	—	—	—	—	—	—	—	X	—	—	—	—	—	—
Multimedia (Saad and Hancher 1998)	—	—	—	X	—	—	—	—	X	—	—	—	—	X	—	—	—	X
Constructability knowledge-intensive database system (Kartam et al. 1999)	X	—	X	—	X	—	—	—	—	X	—	—	—	X	—	—	—	X
Neuro-fuzzy analysis (Yu and Skibniewski 1999a, b)	—	X	X	X	—	—	—	—	—	X	X	—	—	X	—	—	—	X
Practices-to-excel and lessons-to-be-learned databases (Poon et al. 1999)	X	—	X	—	—	—	—	—	—	X	—	—	—	X	—	—	—	X
Best practices and lessons-learned databases (Poon et al. 1999)	X	—	X	—	—	—	—	—	X	—	—	—	—	X	—	—	—	X
4D TSCoAn (4D work planner time-space conflict analyzer) (Akinci et al. 2000)	—	—	X	X	X	—	—	—	—	—	—	X	—	—	—	—	—	—
Program evaluation and review technique (PERT) and critical path method (CPM) (Lu and AbouRizk 2000)	X	X	X	—	—	—	—	X	—	—	—	—	—	X	—	—	—	X
ISO 9000 quality management systems (Pheng and Abeyegoonasekera 2001)	X	—	X	—	—	—	—	X	—	—	—	—	X	—	—	—	—	X
Questionnaire surveys and interviews of professionals (Nima et al. 2001)	—	—	X	—	—	—	—	—	—	—	X	—	—	—	X	—	—	—
Fuzzy quality function deployment system (Yang et al. 2003)	X	X	X	—	—	—	—	—	—	—	—	X	—	—	—	—	—	—
Artificial neural networks (ANN) (Ballal and Sher 2003; Zin et al. 2004)	X	X	X	X	—	—	—	—	—	X	—	—	—	—	X	—	—	—
Conceptual product process matrix model (CPPMM) (Pulaski and Horman 2005)	X	X	X	—	—	—	—	—	—	X	—	—	—	—	X	—	—	X
Linear programming (Srouf et al. 2006)	—	X	X	X	X	—	—	X	—	—	—	—	X	—	—	—	X	—
Online cloud systems (Kuprenas et al. 2006)	—	—	X	X	X	—	—	—	X	—	—	—	X	—	—	—	—	X
Construction analysis for pavement rehabilitation strategies (CA4PRS) (Gambatese et al. 2007)	X	—	X	X	X	—	—	X	—	—	—	X	—	—	—	—	—	—
Implementation responsibility matrix (Gambatese et al. 2007)	X	X	X	X	—	—	—	X	—	—	—	—	X	—	—	—	—	X
Policy and objective statements (Gambatese et al. 2007)	—	—	X	—	—	—	—	—	—	X	—	—	—	—	—	—	—	X
Design process communication methodology (DPCM) (Senescu et al. 2011b)	X	—	X	X	X	—	—	—	—	X	—	—	—	—	—	—	—	X
3D, 4D, 5D structural building information modelling (S-BIM) (Lee et al. 2012)	—	X	X	X	X	—	—	—	—	X	X	—	—	—	—	—	—	X
Scheme design models (SDM) (Lam et al. 2012)	X	X	X	—	—	—	—	—	—	—	X	—	—	—	X	—	—	—
3D, 4D, 5D BIM (Abbasnejad and Moud 2013; Jan et al. 2013; Chong et al. 2014)	—	X	X	X	X	—	—	—	X	X	—	—	—	X	X	—	—	X
Decision support system for the selection of structural materials (DSSSSM) (Zhong 2013)	X	X	X	X	—	—	—	—	—	—	—	X	—	—	—	—	—	—
Utility functions (Kapilinski 2013)	—	X	X	—	—	—	—	X	—	—	—	—	X	—	—	—	—	—
BIM-based schedule-workspace conflict optimization system (BIM-SWACOS) (Moon et al. 2014)	—	X	X	—	X	—	—	—	—	—	—	X	—	—	—	—	—	—
BIM-enabled automated constructability review (Jiang 2016)	X	—	X	X	X	—	—	—	X	—	—	X	—	X	—	—	—	X

Note: I = cognitive; II = mathematical; III = methodological; IV = programming; V = software; A = quantitative project features' and indices' assessment; B = qualitative project features' and indices' assessment; C = schedule cost-quality management and decision making; D = program review; E = information and knowledge feedback; F = acquired knowledge recording, management, and dissemination.

Figure 78 : Constructability tools by type and by nature (Kifokeris & Xenidis, 2016)

We can notice from the literature review that a lot of tools exist to assess, evaluate and improve constructability but only few to model constructability criteria and requirements. Modeling requirements, their attributes and links between them is as much important as developing tools to measure, check and verify constructability requirements. In the next part we will develop a Systems Engineering tool which allows modeling constructability criteria and requirements and to link them with design models and mock-up.

However, we have not identified a tool which allows assessing different constructability criteria at different stages of construction projects from the definition of needs to the solution.

**Issue n°11:**

Nothing has been developed to evaluate several constructability criteria at the same time and related to different project phases and systemic levels. Develop a constructability tool to evaluate and make decisions related to constructability of construction systems at different phases and different systemic levels is required.

### 2.3.3.5. Constructability at the intersection between the product and production

In (Jiang, 2016 July), Jiang considers Constructability (purple block) at the intersection between the product (blue block) and the production system (yellow block) (see Figure 79 : Constructability at the intersection between the product and its production ). Constructability is not only a management process whose goal is to include construction knowledge into the design but the “bridge” between the product and its production system.

This new definition of the concept of constructability opens new opportunities of research to improve productivity and quality of construction products. Improve constructability can be achieved in two ways: align the product with its production system (design a “buildable” product) or/and improve the production system build construction products more efficiently and therefore allowing more complexity in the design and its functioning.

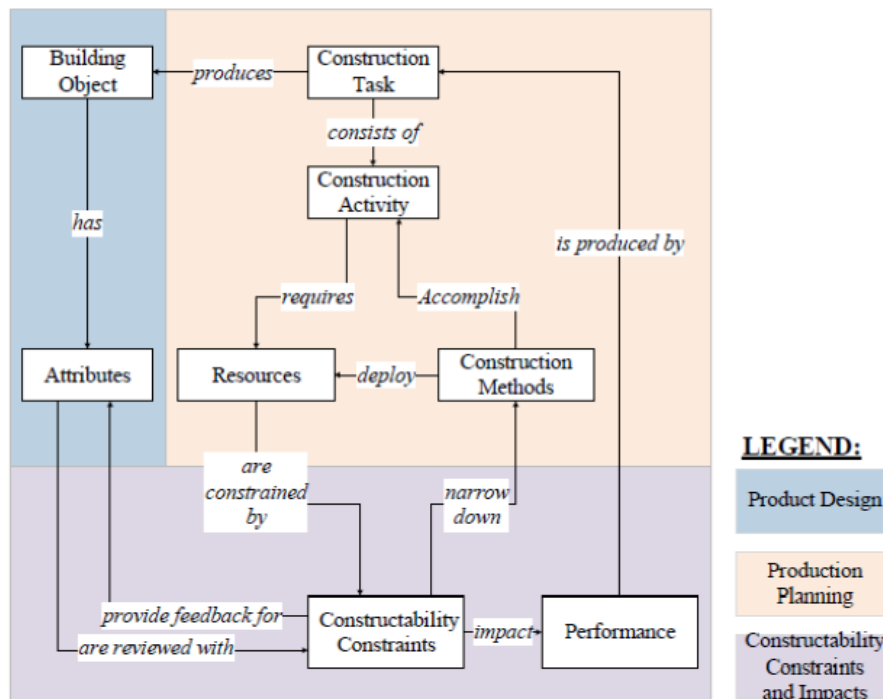


Figure 79 : Constructability at the intersection between the product and its production (Jiang, 2016 July). This figure highlights that constructability can be seen as the interface between the production and the product. It is through analyzing these interactions that constructability constraints (production side) and impacts (product side) are evaluated.

If construction products are modeled as a set of objects with attributes (as it is considered in Building Information Modeling (BIM)), therefore some attributes of BIM objects could be constructability criteria improving constructability reviews. Jiang considers that constructability criteria are constrained by available resources, narrow down construction methods and provide feedbacks for the definition of objects (Jiang, 2016 July).

In order to automatize constructability reviews, Jiang has established an ontology of both the product system and the production system (Figure 80 : An ontology based approach to reveal constructability links between product and production information ). s

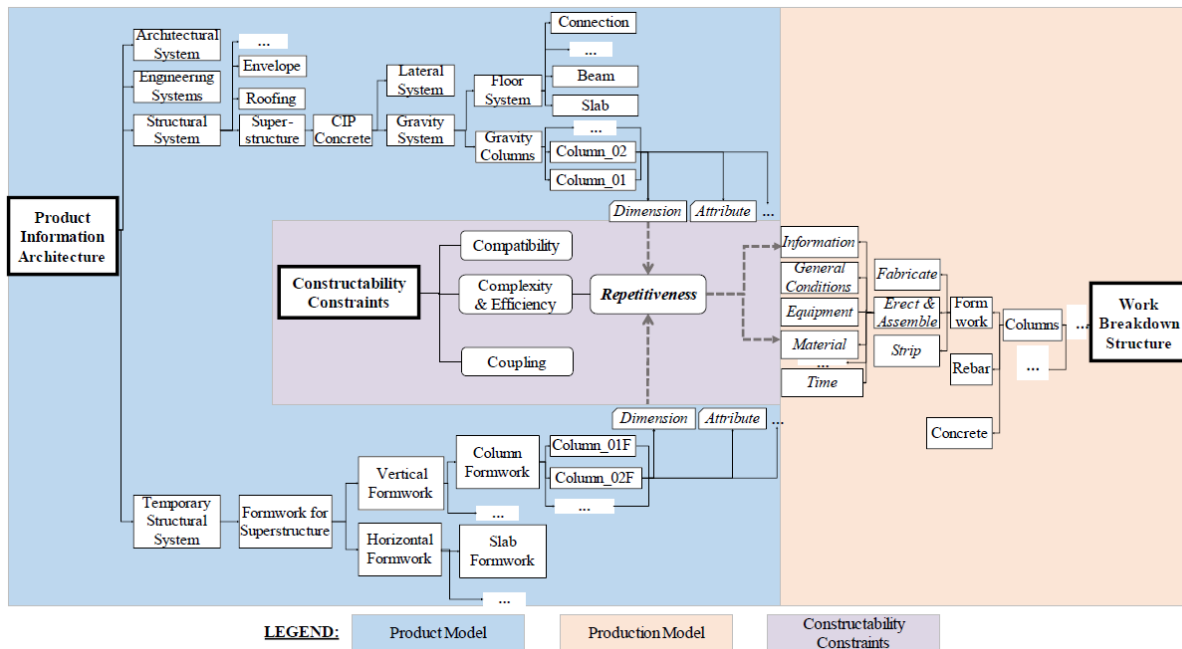


Figure 80 : An ontology based approach to reveal constructability links between product and production information (Jiang, 2016 July). This figure shows that analyzing interactions between the product and its production has allowed defining an ontology of constructability.

Getuli in (Getuli, Giusti, & Capone, 2015) considers constructability as the link between the product to build (technical aspects) and the management system allowing its execution (production system) (see Figure 81 : Constructability at the intersection between technic and management ). This approach is similar to the approach of Jiang but is more general as it includes not only the production system at the execution stage but more generally all management tasks allowing execution of the product.

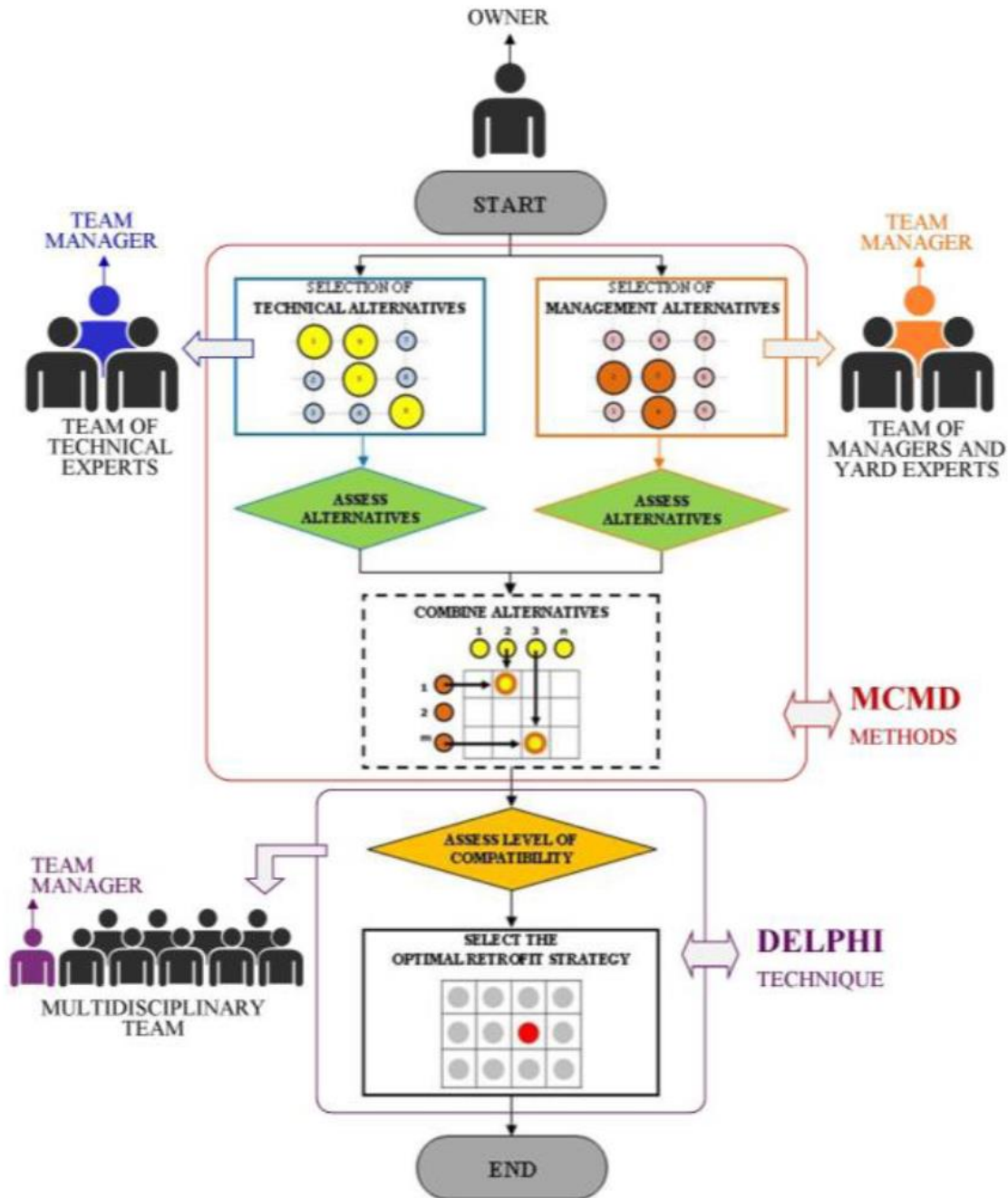


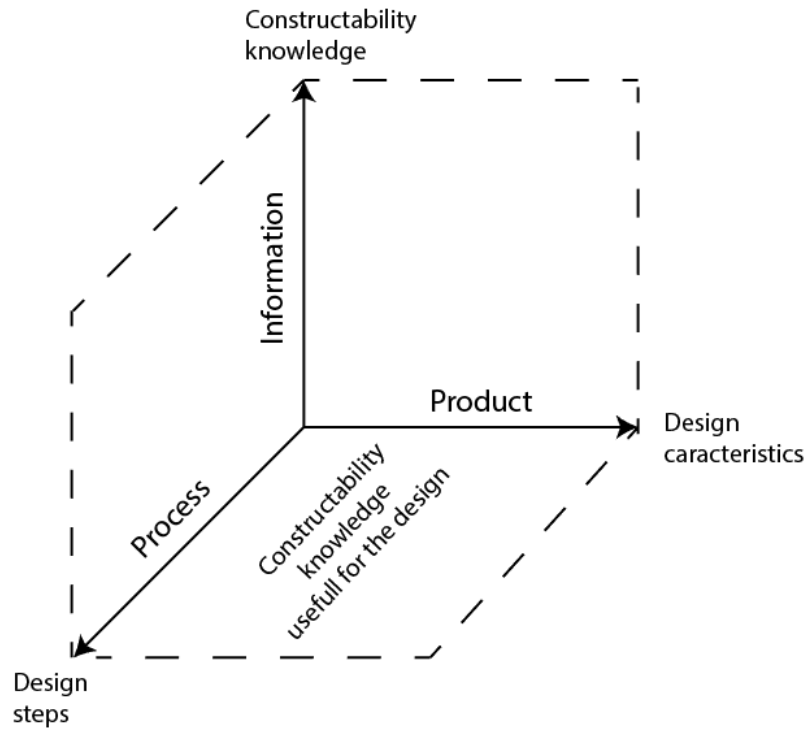
Figure 81 : Constructability at the intersection between technic and management (Getuli, Giusti, & Capone, 2015). This figure shows that to assess constructability of a system it is necessary both to evaluate technical aspects related to the product and management aspects related to the project. Improving constructability consists in finding the best trade-off between these two domains.

Getuli uses this new approach of constructability to define optimal strategies for the execution stage allowing designing the best compromise between technical/client's requirements and production requirements. A Multi-Criteria-Decision-Making (MCDM), a 3D model and the Delphi procedure are used to carry this constructability assessment.

Vergara and Jarpa in (Loyola Vergara & Goldsack Jarpa, 2010) have also defined constructability as the link between the product to build and the construction process. Constructability information can be ordered in three dimensions:

- The design process: when decisions should be made?

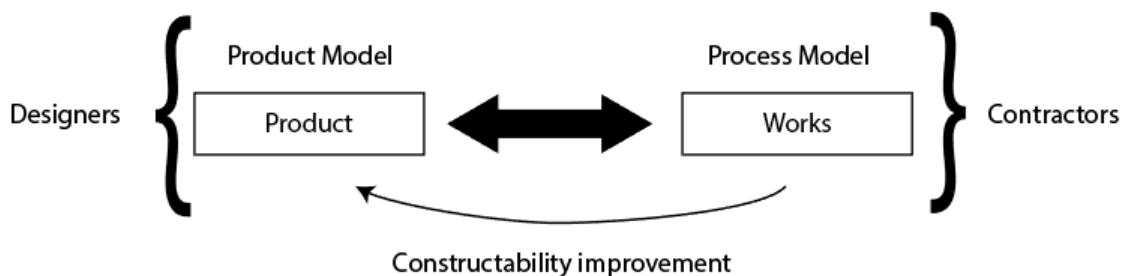
- The product: what is the purpose of the decision?
- Specific constructability knowledge: what should be considered to make the decision?



**Figure 82 : Three-dimensional model for the integration of constructability knowledge. Adapted from (Loyola Vergara & Goldsack Jarpa, 2010)**

Vergara and jarpa (Loyola Vergara & Goldsack Jarpa, 2010) add that consideration of constructability information depend on process steps and levels of detail of the product (system, subsystems, components etc.). This assumption strengthens the idea that constructability criteria depend on the level of development of the project and the level of detail of the product.

Operational implications of the previous theoretical approach are as instance to link product models (such as 3D mock-ups for example) to construction process models used to evaluate interferences between teams on site, lack of space to carry construction activity, materials flows etc. (Loyola Vergara & Goldsack Jarpa, 2010).



**Figure 83 : Model of the product and model of the construction process as an integration tool of constructability. Adapted from (Loyola Vergara & Goldsack Jarpa, 2010)**

Improve constructability would be achieved by a better integration of the product model and the project model. As instance, evaluating impact of a design choice on the construction process is a way to improve constructability.

Finally this approach allows a better understanding of the role of constructability knowledge in the development process of a construction product: constructability makes the link between the design of the product and the production process. The direct implication is that constructability knowledge should be organized depending on process steps in the project and level of details of the product.

It also allows a first organization of Constructability Criteria defined in the last section in the design process: Constructability Criteria are parameters allowing the consideration of production constraints for different process activities and different level of details of the product.

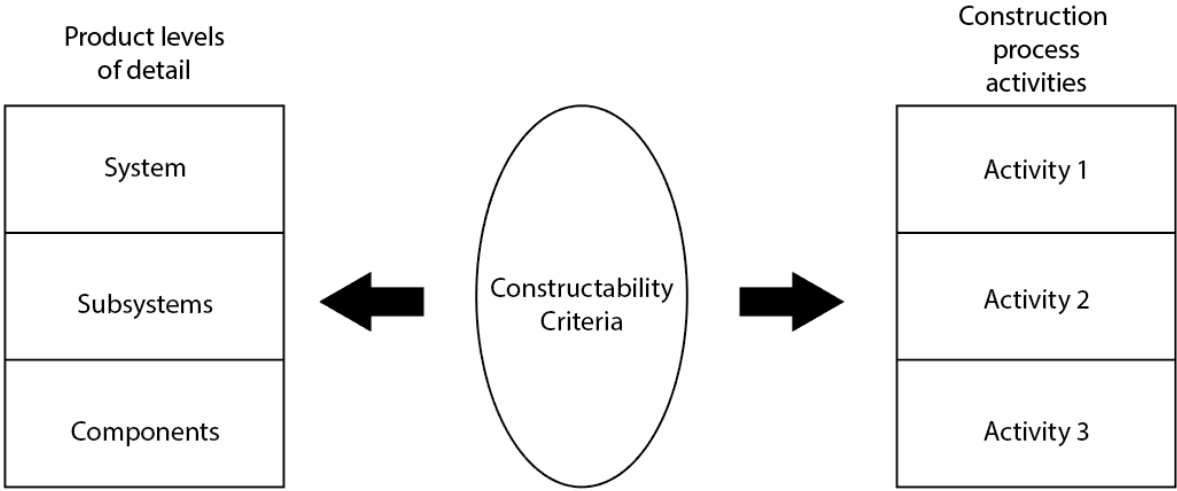


Figure 84 : Constructability criteria as parameters to align the product and the production process

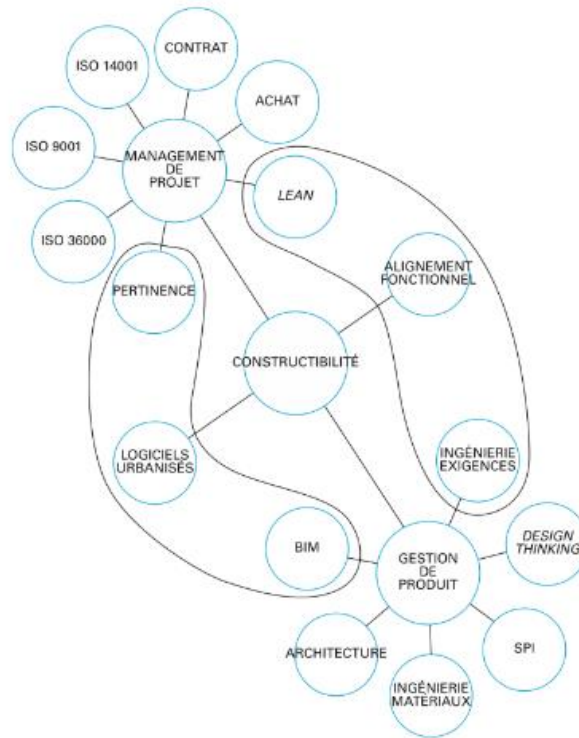
**2.3.3.6. From Constructability to Constructibility**

In France, a difference is made between *Constructability* and *Constructibility*: while constructability focuses on the consideration of construction knowledge in the construction process in all phases. Constructibility is:” *the capability at any moment to accept the subsequent consequences of choices made during the project*”. In other words, it does not only consider construction constraints but more generally all the constraints impacting the development process of a construction product from planning to design and production. To be more specific, constructability concerns only the relations between construction activities and design and management activities of the construction product. Constructibility not only considers construction activities but also the relations between planning and design activities and the design of the production product. As instance, the choice of a complex structure for a building will imply a lot of costly analysis and simulations at the design stage to verify requirements. This activity is not a construction activity but a design activity; nevertheless it requires resources and time. When choosing a complex structure (for aesthetical reasons for example) it is not only important to consider construction constraints such as logistics of materials or weather conditions but also the constraints due to planning and design of such a product.

In the next part we will go a step further, defining Constructibility as the link between the “System of Interest” (the product) and the “Enabling System” (the project), exploring what could be constructability criteria related to the design and planning stages.

Gobin in (Gobin, 2017), also considers formally Constructibility as the “bond” between project management and architecture of the product (Figure 85):





**Figure 85 : Constructibility as the link between project and product management (Gobin, 2017). This figure shows different elements of the product and the project and highlights that Constructibility is at the intersection between both.**

In the next part we will go further in detail about how to link project management with the product definition and architecture.

The IRC (Institut de Recherche en Constructibilité) (IRC, 2013) gives the following definition of constructability: *“Constructibility is to guaranty performance and avoid choices which would be difficult to accept from the beginning of projects. Constructibility corpus contains different scientific fields such as risk management, quality and performance management and improvement of productivity in the construction domain.”*

Therefore, Constructibility has a larger scope than Constructability as it does not only consider construction knowledge but all the domains which can potentially impact performances of the product or/and the project.

A first attempt to define a Constructibility matrix regrouping several constructability criteria all along the product lifecycle from planning to realization has been proposed by Gobin in (Gobin, La constructibilité - Une approche duale de la construction, 2017).

This matrix is organized as follows: lifecycle of the product is divided in three and placed in line:

- Planning is the phase where needs are analyzes, describes and specifies. It ends up by the redaction of the client’s program;
- Design is the phase where the product is defined, its functions and its composition. It ends up by the redaction of contracts for contractors companies;
- Production is the phase where the product is built/assembled.

In the columns, are represented the product and the project (composed of processes and procedures).

- **Process:** A process is a set of interrelated or interacting activities which transforms inputs into outputs (ISO 9000). It can be described with a flow map.

- **Procedure:** A procedure is specified way to carry out an activity or a process (ISO 9000). It is usually described by a text.

In other words, a process is **what we do** and a procedure is **how we do it**.

At the intersections between lifecycle phases and the product and project lines, constructability themes are indicated:

	<b>Product</b>	<b>Process</b>	<b>Procedures</b>
<b>Planning</b>	Conformation	Open data	Skills availability
<b>Design</b>	Simulation	Representation/viewing	Workability
<b>Production</b>	Interfaces	Lean Production/supply chain	Commissioning

In (Gobin, La constructibilité - Une approche duale de la construction, 2017), Gobin defines each one of the constructability categories described in the table:

- Conformation (product/planning):  
Configuration consists in verifying the coherence of the clients' program. In other terms that at least one solution exists to fulfill clients' specifications without taking unnecessary risks.

- Open data (process/planning):  
Open Data consists in verifying that all necessary data required for the project are available and will be available for the duration of the project.

- Skills availability (procedures/planning):  
Skills availability refers to the capability to evaluate availability of the required abilities to fulfill clients' specifications.

- Simulation (product/design):  
Simulations consist in verifying that the functioning of the product satisfies to the client's requirements.

- Representation/viewing (process/design) :  
Representation is the capability to represent the product considering underlying assumptions to answer the client's requirements.

- Workability (procedure/design) :  
Workability consists in verifying the feasibility of tasks required to carry out necessary works to build the product.

- Interfaces (product/production) :  
Verifications at the interfaces are required in order to avoid degradations due to the project breakdown related to the production phase.

- Lean production/supply chain (process/production) :  
Lean Production/supply chain is the capability to schedule tasks in a logic and efficient manner.

- Commissioning (procedures/production):  
Commissioning is the capability to evaluate if the functioning of the product matches with initials client's requirements.

Analyze Constructibility is to study relations between these domains or to study one of them not as an end in itself but as a part of a whole: the Constructibility corpus. By considering activities related to other phases of projects, Constructibility has a larger scope than constructability.

### 2.3.4. Conclusion: Constructability and design methodologies

Finally, over the past decades, the concept of constructability has evolved from a concept oriented on the construction phase only to the necessary link between products and projects in all phases of construction products development.

Several questions remain like how and when to integrate constructability criteria in the development process? To which systemic level do they apply? These questions rise the necessity of new methods to better organize and manage the development of construction products.

Integration of constructability in Functional Analysis would be an appropriate way to adapt FA methods to the construction industry and to give a methodological framework to introduce Constructability concepts and criteria in the development process of construction products. Nevertheless, simultaneously to the development of Functional Analysis methods presented in §2.1, another methodological corpus have been developed oriented to the management of complex systems: Systems Engineering. In some points, Systems Engineering is similar to Functional Analysis but is more oriented on the management of complexity. The next part will get more in detail about this methodological corpus and how to apply it to the construction industry.

#### Issue n°12:

Current definition of constructability considers only production/realization constraints and not all constraints related to all Enabling Systems such as planning and design constraints. It is necessary to push forward the Constructability concepts and practices to consider constraints from all Enabling Systems from planning to commissioning.

## 2.4. The management of complexity: Systems Engineering

In this part, we will present Systems Engineering (SE) methods and tools in order to implement constructability and functional analysis concepts and principles in the design and development processes of construction products. All aspects of SE are not presented but only those which are useful for purposes of this thesis.

### 2.4.1. History

Systems engineering clusters methods, concepts, best practices and tools developed since the Second World War mostly in the USA to design, build and operate complex systems like defense systems or aerospace systems. Such systems required managing a lot of information from different types and from different sources to be operational with a high performance level. In order to face these challenges, American engineers have developed methods to manage and integrate complex systems: Systems Engineering (SE) (Krob, 2009) and (Hall, 1962).

1937	British multidisciplinary team to analyze the air defense system
1939–1945	Bell Labs supported NIKE missile project development
1951–1980	SAGE air defense system defined and managed by Massachusetts Institute of Technology (MIT)
1954	Recommendation by the RAND Corporation to adopt the term “systems engineering”
1956	Invention of systems analysis by RAND Corporation
1962	Publication of <i>A Methodology for Systems Engineering</i> by Hall
1969	Modeling of urban systems at MIT by Jay Forrester
1990	National Council on Systems Engineering (NCOSE) established
1995	INCOSE emerged from NCOSE to incorporate international view
2008	ISO, IEC, IEEE, INCOSE, PSM, and others fully harmonize SE concepts on ISO/IEC/IEEE 15288:2008

Figure 86 : important dates in the development of SE, Systems Engineering Handbook (2015)

In 1995, INCOSE (International Council on Systems Engineering), a non-profit organization, has been founded “to develop and disseminate Systems Engineering the interdisciplinary principles and practices that enable the realization of successful systems” (International Council on Systems Engineering, 2015). In France, AFIS (Association Française d’Ingénierie Système) created in 1998 is an association to promote SE and encourage exchanges in this domain in France in all industries (Association Française d’Ingénierie Système).

Three norms describe Systems Engineering processes, activities and expected results:

- **IEEE 1220:** Standard for the application and Management of the Systems Engineering process.
- **EIA/ANSI 632:** Process for Engineering a system.
- **ISO 15288:** Systems and software Engineering – System lifecycle Processes.

---

1969	Mil-Std 499
1979	Army Field Manual 770-78
1994	Perry Memorandum urges military contractors to adopt commercial practices. EIA 632 IS (interim standard) and IEEE 1220 (trial version) issued instead of Mil-Std 499B
1998	EIA 632 released
1999	IEEE 1220 released
2002	ISO/IEC 15288 released, adopted by IEEE in 2003
2012	Guide to the Systems Engineering Body of Knowledge (SEBoK) released

---

**Figure 87 : Important dates in Systems Engineering standards, Systems Engineering Handbook (2015).**

2 handbooks also develop the application of Systems Engineering methods published by INCOSE (in English) and AFIS (in French):

- INCOSE Systems Engineering Handbook 4<sup>th</sup> edition.
- Découvrir et comprendre l’Ingénierie Système 3<sup>ème</sup> édition.

Based on these two handbooks as well as other publications we will summarize in this part Systems Engineering processes we will use in this thesis.

#### 2.4.2. Definition and objectives of Systems Engineering

Objectives of Systems Engineering are to allow designing, realizing and delivering complex systems under constraints of quality, cost, delay and people (QCDP constraints).

More precisely SE allows facing the main difficulties encountered in the development of complex systems (Krob, 2009):

- Needs to satisfy and expected properties of a system are refined during the design process and level off late in the development;
- People involved in the system development are facing a changing environment where everything is always questioned;
- Difficulties to integrate systems which involve very diverse disciplines (number of interfaces, technologies used, emerging effects...).

SE is an interdisciplinary and iterative approach to successfully enable the realization of complex systems:

- **Iterative:** Systems Engineering supports discovery, learning and continuous improvement.
- **Interdisciplinary:** all disciplines are considered in the development of the system of interest. Ideally, experts from different disciplines involved are coordinated by a Systems Engineer.

As systems are becoming more and more complex over time (as instance the number of interactions and functions are increasing) and innovations are becoming the norm, changes have to be evaluated and managed to evaluate their impacts. SE is an effective way to manage changes and complexity.

As well as Functional Analysis, Systems Engineering is based on System Thinking and is part of the “systemic paradigm” explained in part 2.2.1 of this thesis.

Studies carried by the Defense Acquisition University (DAU) highlight interests of SE in early stages of projects to avoid additional costs due to late changes:

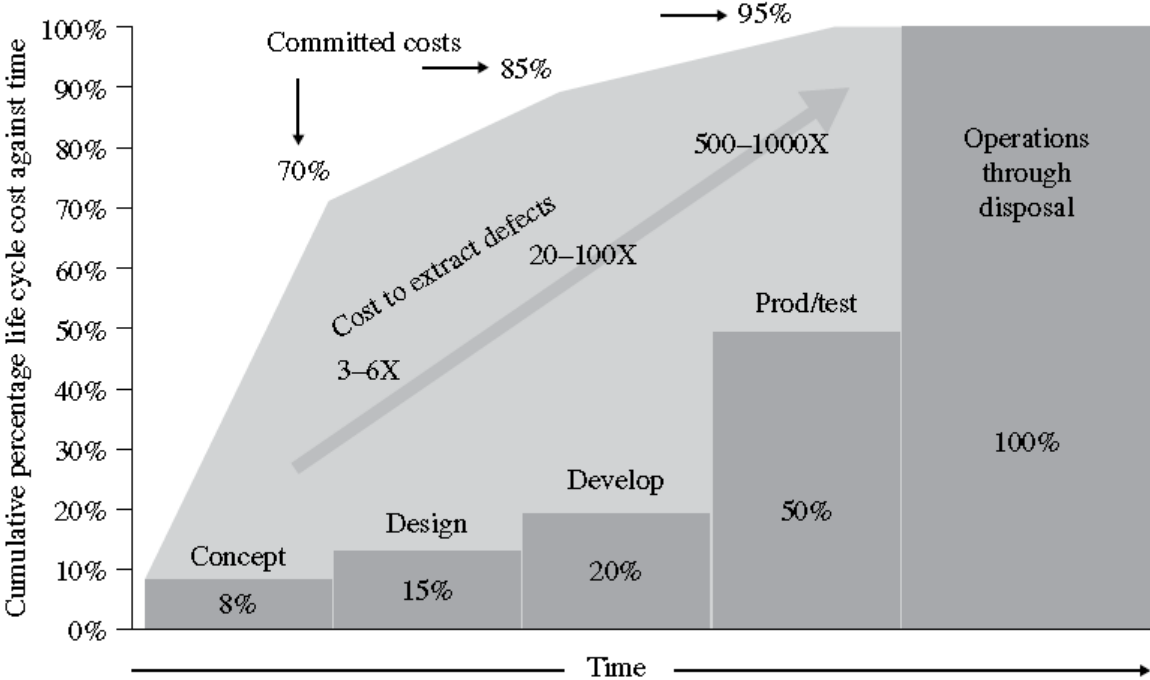
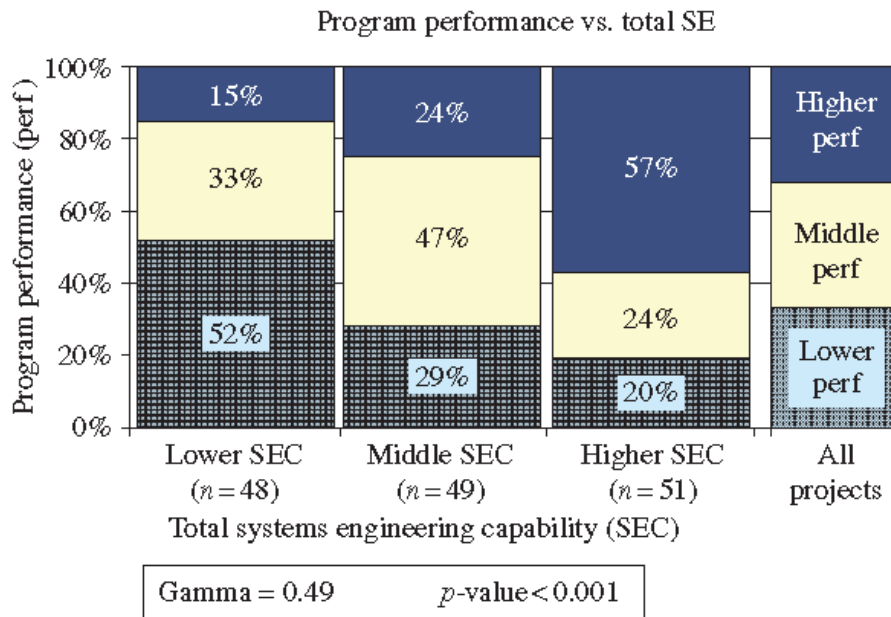


Figure 88 : Committed life cycle cost against time. Defense Acquisition University, 1993

Comparing **Erreur ! Source du renvoi introuvable.** and Figure 73 we can notice that there is the same objective to apply constructability concepts and principles and Systems Engineering methods as early as possible in the project development. This is a first argument to develop a method at the crossroad between Constructability and Systems Engineering.

Another study carried out by IEEE (Institute of Electrical and Electronic Engineers of Carnegie Mellon on 148 projects shows the interest of the application of Systems Engineering. The application of SE has been measured and compared to schedule, cost and client satisfaction levels in the evaluated projects. The results show that the highest score (in quantity and quality) of SE leads to better performance in terms of cost, schedule and quality:



**Figure 89 : Project performance Versus SE capability. Elm and Goldenson (2012). Systems Engineering Handbook (2015).**

Similar other studies carried out at the University of South Australia by Eric Honour show that the application of SE has a significant effect on project success. Its studies also show that the optimum level of SE costs should be around 14% of projects budget (Honour, 2013).

### 2.4.3. Lifecycle meta-models

One important contribution of SE is the definition of development metamodels for entire man-made systems from the system level to sub-systems and components. A metamodel is “*a model of a model, and metamodeling is the process of generating such metamodels. Thus metamodeling or meta-modeling is the analysis, construction and development of the frames, rules, constraints, models and theories applicable and useful for modeling a predefined class of problems. As its name implies, this concept applies the notions of meta- and modeling in software engineering and systems engineering. Metamodels are of many types and have diverse applications.*” (Mohanty, 2015).

Mainly three seminal metamodels have been developed, even if they have been developed mostly for software development they can be applied to any industrial systems (Estefan, 2008), (INCOSE, 2015): The waterfall model, the spiral model and the “Vee” model.

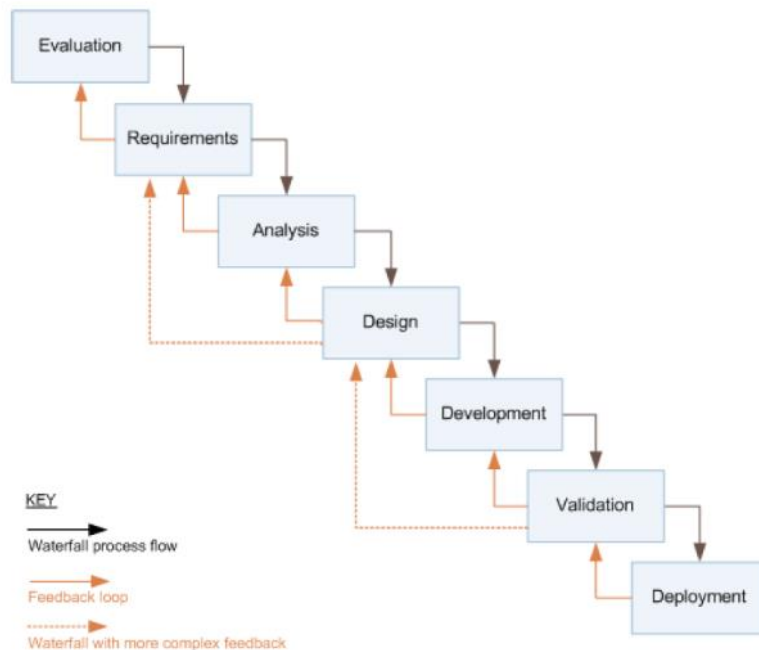
- Royce’s waterfall model (Royce, 1970):

The waterfall model is composed of several steps (Figure 90):

- i. Needs analysis/operational evaluation (Evaluation, Requirements, Analysis)
- ii. Design specifications (Design)
- iii. Production of the product (Development)
- iv. Test if the product functions correctly (Validation)
- v. Use the product (Operations)

In the waterfall metamodel, these steps are undertaken in a sequential manner similarly to Functional Analysis method. We can notice that the “functional analysis” step is not formalized in this metamodel but is part of the design step.

Ideally, feedback loops due to unforeseen difficulties only exist between successive steps, but very often it appears that feedback loops exist between non-successive steps (Royce, 1970).



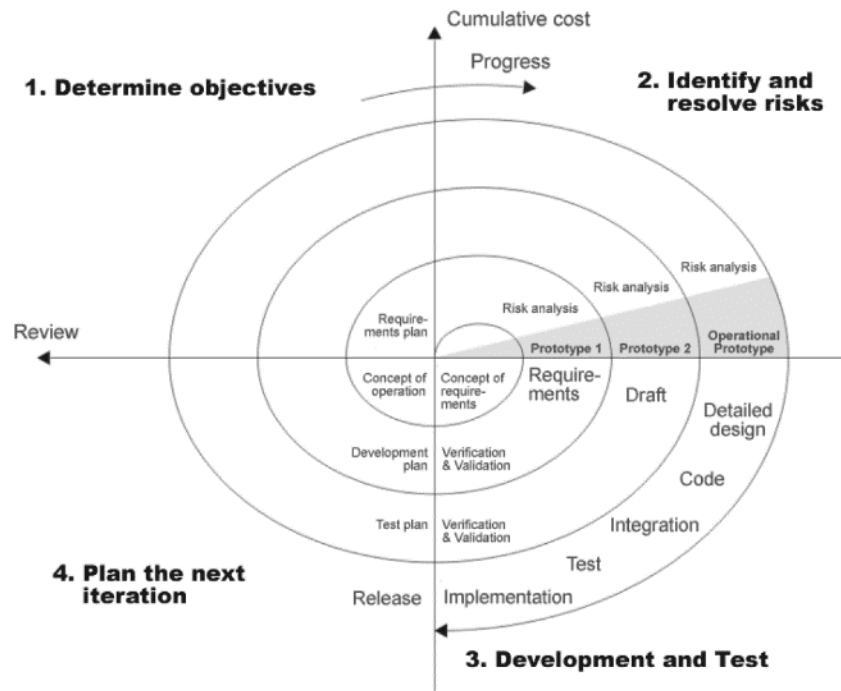
**Figure 90 : Adaptation of the Waterfall model by (Ruparelia, 2010). The figures represents the different steps of the waterfall model and feedback loops between the different steps.**

The waterfall model is the lifecycle model which is the simplest and the most used (even sometimes implicitly). It is the closest to the actual development model used in the construction industry where a stakeholder carries its part of the work as specified in its contract and gives it to the following stakeholder with only little consideration of risks incurred to other stakeholders. The Waterfall metamodel also implies a lot of feedbacks loops between the different phases, the more changes are made at the bottom of the cascade the more costly and time consuming it is to carry the modification. It is not surprising that this type of model has been initially developed in the construction industry and is very similar to development steps defined in the MOP law (Figure 24). It can be considered as the “Business as Usual” process.

For complex projects this lack of consideration can leads to redefine elements from previous phases implying costly and time consuming changes engaged late in the development process.

This process works very well for simple and small projects as it does not require important resources and is simple to understand.

- Spiral Model (Boehm, 1988):



**Figure 91 : The Spiral Metamodel applied to software development (Boehm, 1988). In this figure, the different steps of the spiral models are represented. The project starts in the center and steps are spread all along the spiral clockwise. The spiral is split in 4 macro steps: 1. Determine objectives, 2. Identify and resolve risks, 3. Development and test and 4. Plan the next iteration.**

The spiral model is an improvement of the waterfall model made by Boehm (Boehm, 1988), (Ruparelia, 2010):

- There is only one Design stage instead of two;
- Risks and issues are evaluated at an early stage by prototyping the product;

Each cycle in the spiral is composed of 4 parts:

1. Determine objectives;
2. Evaluate alternatives and identify involved risks;
3. Develop and test;
4. Plan the next iteration;

At each cycle in the spiral a prototype is built to verify requirements through testing. At this step development risks are evaluated. Two categories of risks are defined, performance risks and development risks. If performance risks predominate, a new cycle is engaged and the spiral development continues with the creation of a new prototype until performance related risks become low. On the other hand if development risks predominate and performance risks are low, the development process follows the waterfall model (Boehm, 1988).

The spiral model is very flexible and risks oriented. Risks (both performance and development) are identified early in the process allowing a better management of projects costs and delays.

An important particularity of this metamodel is the consideration of risks related to the development process. Consideration of such constraints is a first possibility to introduce constructability concepts and principles in the spiral metamodel.

Another important feature of the spiral model is the review process which takes place at the completion of each phase in the cycle. This review consists of analyzing the products produced during the last phase and to plan activities of the next phase.

Ruparelia also highlights that the spiral model (Ruparelia, 2010) *“attempts to contain project risks and costs at the outset. The main difficulty of the spiral is that it requires very adaptive project management, quite flexible contract*



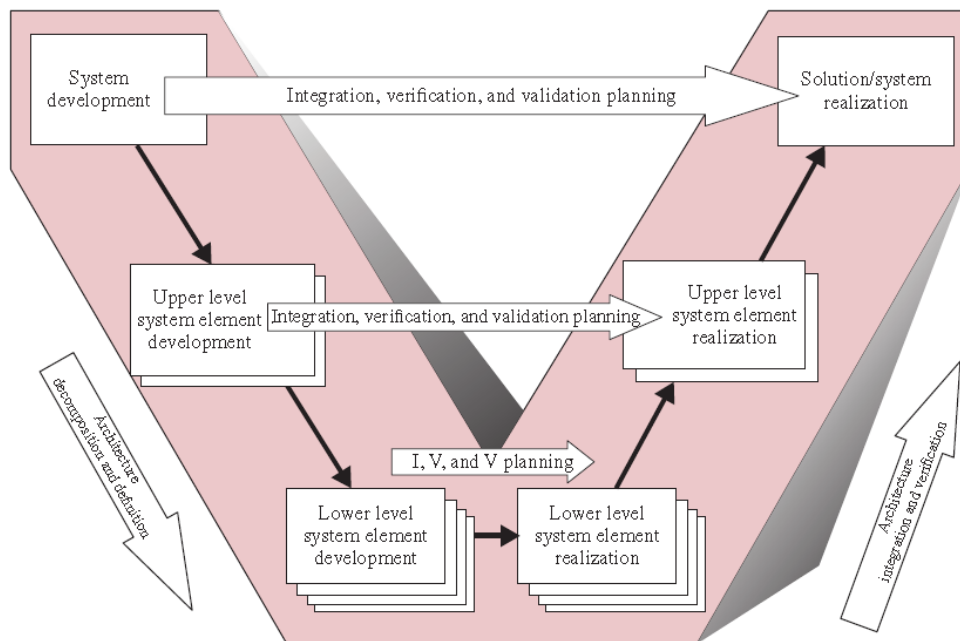
*mechanisms between the stakeholders and between each cycle of the spiral, and it relies heavily on the systems designers' ability to identify risks correctly for the forthcoming cycle.* ”

In the last step of each cycle in the spiral model a prototype is supposed to be produced. In the construction industry it's not possible to realize a prototype of the system: if one is building a bridge, a tunnel or a building he won't build it to test it and verify it works and then demolish it to build a new one... It is only possible to create models and/or mock-ups to verify and test requirements, models which are only a representation/abstraction of the reality. Moreover, non-integration of all stakeholders in the construction industry is an obstacle for the application of this metamodel. Indeed, evaluation of both development and performance risks requires the consideration of all stakeholders: clients, designers, contractors etc. which is not possible with actual types of organization and contracts in the construction industry.

Furthermore, the spiral model does not highlight the different systemic levels (system, subsystems, components...) of the product which is necessary for integration purposes and management of complexity. Most literature considers that the spiral model is best applied to small and simple system (International Council on Systems Engineering, 2015) but it is more flexible and adaptable and it allows a better “time to market”.

- The “Vee” Cycle (Forsberg & Mooz, 1992):

The Vee model is one of the most famous and used metamodel for manmade systems development (Figure 92).



**Figure 92 : The Vee model lifecycle development (Forsberg & Mooz, 1992). In the Vee model, the project start at the top left branch of the vee where System requirements are defined and constraints related to its integration, verification and validation are considered. Then subsystems are described similarly when going down in the left branch excepting that they also refine requirements from the upper level. In the right branch, it goes from the bottom to the top: components are realized, subsystem are assembled as the system is integrated.**

The Vee model is an adaptation of the Waterfall model. One of the main features of the Vee metamodel is the systemic approach of the product development: the product is considered as a system composed of subsystems, subsystems, components etc. which are successively developed in the process. Time and maturity of the project move from the left side to the right side of the diagram.

The left leg of the V shape represents the different systemic development levels of the product from the system level at the top of the leg to components at the bottom. At each systemic level, requirements the system will cover are defined. When requirements are defined, the way they will be verified and validated in the right leg of the Vee is also described. This process is consistent with the “SMART” (Specific, Measurable, Achievable, Realistic and Time-bounded) formalization of requirements (Doran & George, 1981).

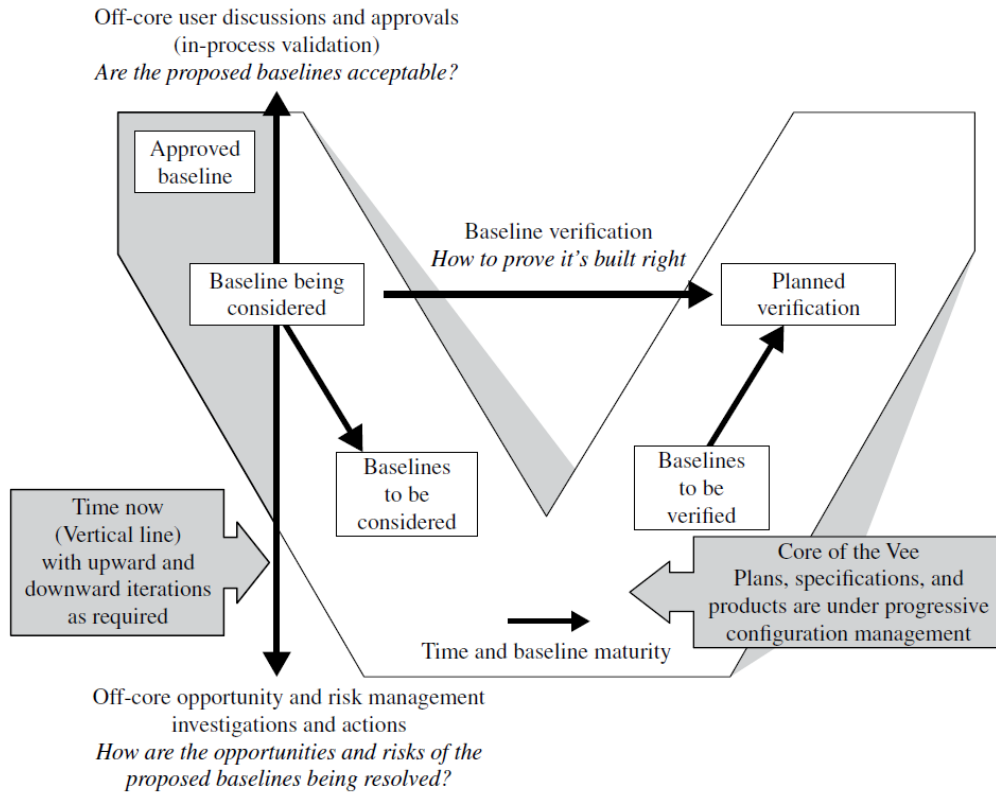


Figure 93 : Left side of the Vee model (International Council on Systems Engineering, 2015)

The right leg represents the integration, assembly and verification of system elements regarding requirements and design choices made in the left side of the Vee.

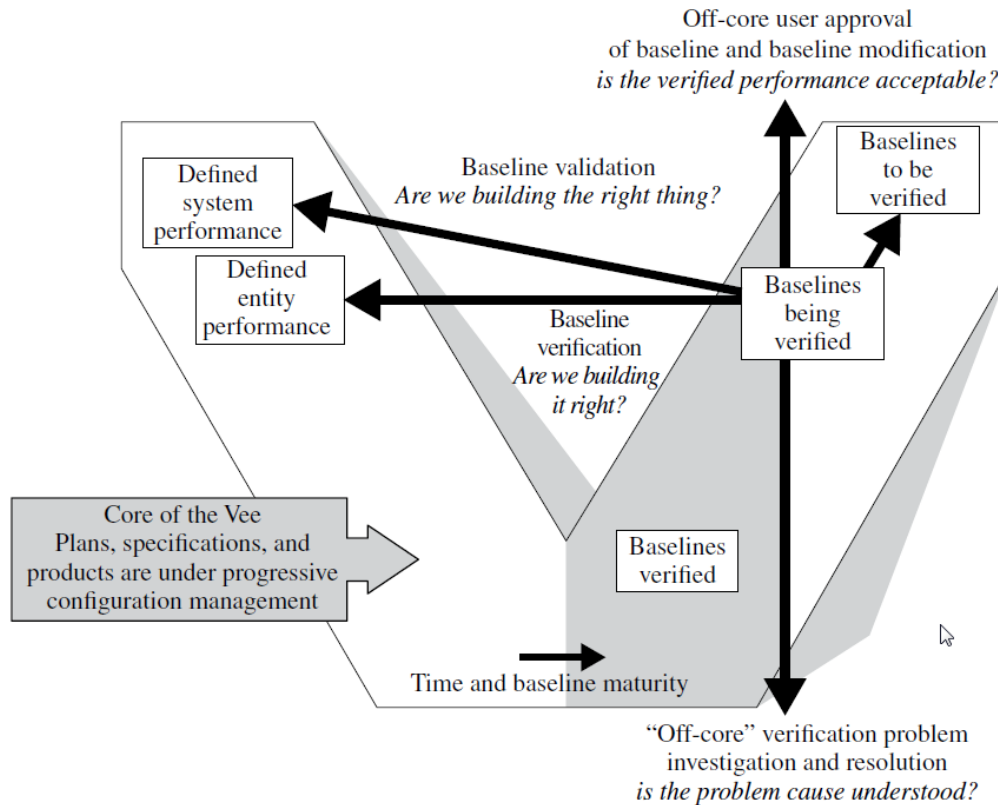


Figure 94 : The right side of the Vee model (International Council on Systems Engineering, 2015)

In the construction industry, one important particularity is that the right leg of the Vee is immediately the commissioning step: because every project is unique it's not possible to build a prototype of the product, non-conformities with requirements identified during verification steps in the right leg can hardly be resolved or have very important impacts on costs and delays if they are.

For this reason, more than in other industries, more efforts are required to evaluate risks implying non-conformities with requirements before the production phase, even and above all, risks related to the production process.

- Comparison of lifecycle development models

Main differences between lifecycle metamodels come from:

- Risks evaluation

**Waterfall:** The waterfall model is not particularly oriented on risks management.

**Spiral:** At the opposite, the spiral model focuses on risks evaluation. At each phase in the spiral cycle a risk analysis is carried (performance risks and development risks) before starting the next phase.

**Vee:** In the Vee model, risks related to the product are well evaluated as all requirements are verified during its development in the left leg of the Vee. Nevertheless, risks related to the development process itself (planning, design, construction...) are not taking into account in the Vee cycle.

- Requirements verification and testing

**Waterfall:** In the Waterfall model, requirements are verified only at the end of the development process in the "testing phase".

**Spiral:** In the spiral model, requirements are verified before the prototyping phase. They are then tested through the realization of prototypes at each phase of the spiral cycle.

**Vee:** Requirements verification and testing is at the core of the Vee metamodel process. It is for this reason that the Vee model is sometimes considered as rigid and as a resource consuming model: all requirements have to be verified, tested and validated from system requirements to components requirements.

- Consideration or not of requirements from the development process

**Waterfall:** Development requirements are not specifically taking into account.

**Spiral:** The spiral model is the only model which analyses requirements and risks related to the development process.

**Vee:** Only requirements related to the product are formally taken into account in the Vee model.

- Consideration or not of the systemic characteristics of the product

**Waterfall:** The product is not formally considered as system.

**Spiral:** It is the same for the spiral model, the product is not formally considered as a system.

**Vee:** The Vee model is the only one to consider the systemic characteristics of the product: the product is a system composed of subsystems. Requirements depend are related to a systemic level and one main challenge is the integration of the system.

Bruno Cuq: 0685335983

	<b>Waterfall model</b>	<b>Spiral model</b>	<b>Vee model</b>
<b>Advantages</b>	Well known easy to understand and simple metamodel;	Spiral Life Cycle Model is a very flexible model.	Due to the fact that in the V-Model defects are being repair short

	<p>Work well for small and simple projects;</p> <p>Cost effectiveness;</p>	<p>It allows a quick “time-to-market” delay.</p> <p>Estimates (i.e. budget, schedule, etc.) get more realistic as work progresses, because important issues are discovered earlier.</p> <p>Risks are better managed as the model is risk oriented.</p>	<p>time after they have been detected, it is cheaper to fix them;</p> <p>All the participants in development of a system have a responsibility for quality assurance and testing.</p> <p>One main advantage of the Vee-model is its focus on verification, validation and test activities of requirements.</p> <p>It is also an efficient and understandable way of representing projects evolution and phases.</p>
<b>Disadvantages</b>	<p>Test are undertaken only once at the end of the project;</p> <p>High amount of risk and uncertainty when used for complex projects;</p> <p>Inflexible method;</p> <p>Poor model for complex projects;</p>	<p>Evaluating the risks involved in the project can shoot up the cost and it may be higher than the cost for building the system.</p> <p>Risk analysis requires highly specific expertise.</p> <p>The spiral model doesn’t highlight the different systemic levels of the product and is not fit to management of complex projects.</p>	<p>The V-Model is very rigid and the least flexible, it means that if one of the requirements are changing, the tester should update the test documentation as a whole</p> <p>This model applicable mostly to big companies and projects because the model needs lot of resources</p> <p>The amount and the intensity of the test levels should be tailored according to the specific needs of the project</p>
<b>Application to the construction industry</b>	<p>Applicable for small and simple projects with few interactions, well know technologies and clear requirements.</p>	<p>Hardly applicable to the construction industry with actual organization and contracts.</p>	<p>As it’s not possible to build prototypes in the construction industry, the metamodel should integrate the consideration of development processes constraints.</p>

**Table 9 : Comparison of metamodels for construction projects**

**Improvement n°2:**

Definition of meta-models such as waterfalls, spiral or Vee meta-models in Systems Engineering answer to **Issue n°1**. Such metamodels offer a framework in which different Functional Analysis for different parts of the system at different systemic levels can be integrated.

#### 2.4.3.1. Systems Architecture

Systems Architecture (SA) is one of the main principles in System Engineering methods. It allows defining invariant parts of a system over time. It can be used as a “fulcrum” for the design of complex systems to manage its evolution, changes and modifications made during its development (Krob, 2014).

Systems Architecting is the main activity related to Systems Engineering. Krob highlights three problems where Systems Architecting can help in the development of complex systems:

- **The lack of systemic hindsight:** QCDP objectives of projects sometimes increase because analysis of the product at the system level is not undertaken, interactions between the system and its environment are not considered before entering the details, issues at the system level are not solved and will later cripple the project.
- **The complexity barrier:** the number of systems variables, of interfaces, technologies used, emerging effects, project management stakeholders, are sometimes extremely difficult to manage.
- **Interfaces management:** Most of integration problems come from interfaces management. Defining both external and internal interfaces is at the heart of Systems Architecting activities. The SA method consists in identifying, sharing and finally negotiating technical and human interfaces between stakeholders of the project.

In (Krob, 2009), Krob makes the comparison between Systems Architecture and “Architecture” in AEC industry as Architecture (both in SE and in the AEC industry) consists in defining invariant parts of a system (whereas it is a building or another system).

One of the most important principle of Systems Engineering and which is the purpose of System Architecture, is to separate the problem space from the solution space (Krob, 2009). The problem space consists in defining the system missions, why it has to be built. The system can be represented as a black box. Whereas the solution space consists in defining what the system does and how it is made up. The system can be represented as a white box: its components are defined and characterized.

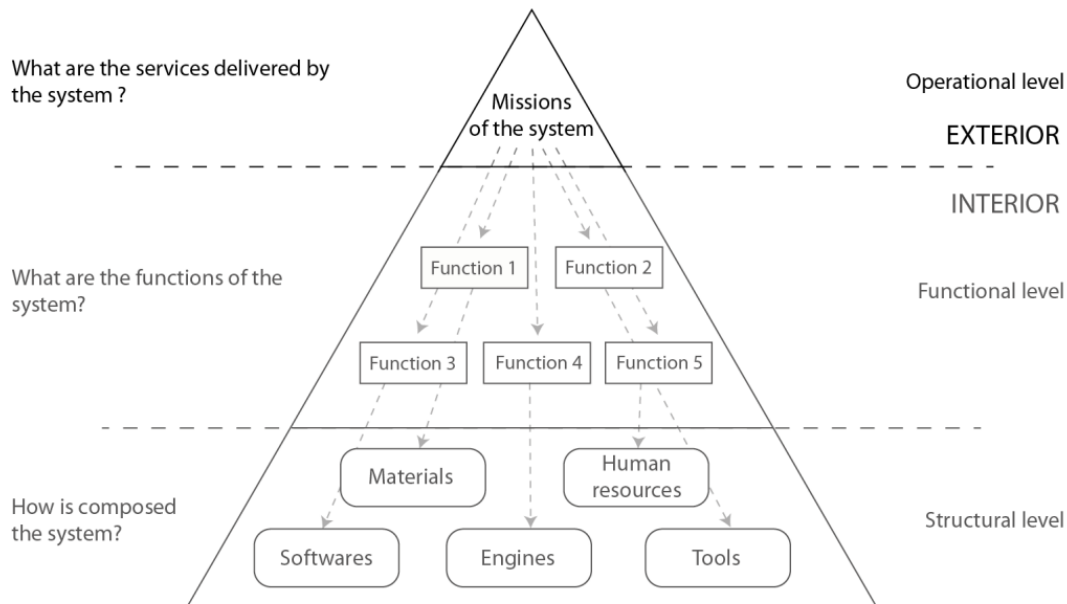
- **The System Environment:** The first step always consists in defining elements of the environment of the system, all external elements with which it will be in interaction are identified and characterized;
- **Operational view (external):** In this view, system missions (needs) are identified and analyzed; In this view we try to answer the question "why the system should be realized?", “what is its purpose?”.
- **Functional view (internal):** functions answering system missions are identified and characterized. Functions of the system are what the system actually does in space and time. It answers to the question: “what does the system do?” independently from how it is built or composed.
- **Organic/physical view (internal):** the organic view consists in defining what the system is composed of and how materials, software, humans components are organized, what is its geometry etc.; this view answers the question of "how the system is made up?"

Pollet (Pollet, 2007), distinguishes the domain of the needs and the domain of the problem. Needs concern the “why”, expectations of the client/user of the future system and the constraints related to the identified needs. Problems are related to the “what”, what the system should be able to do to answer the needs without defining the “how”. The solution is the concrete description of the system to perform functions, it concerns “how” the system is composed. Finally three domains can be identified:

- **External view** of the system:
  - Domain of the needs (operational view);
- **Internal view** of the system:
  - Domain of the problem (functional view);

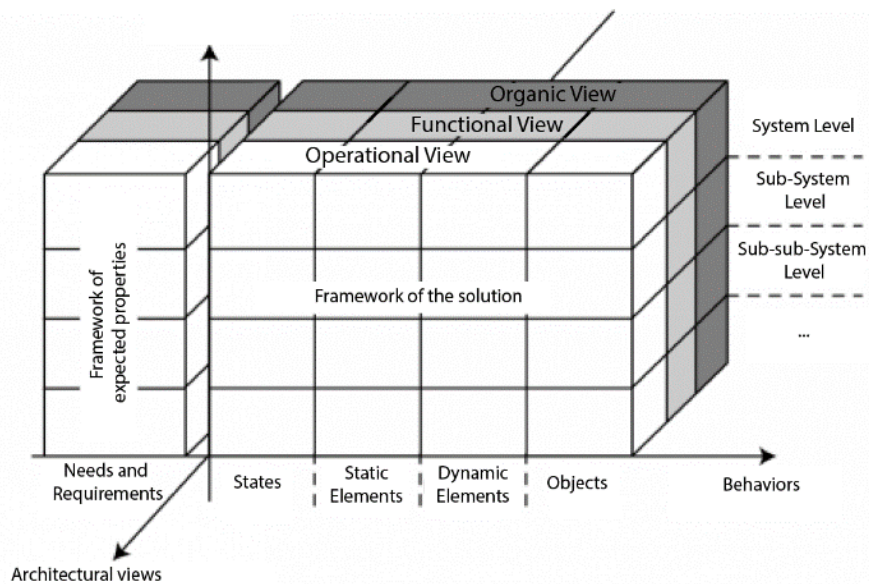
- Domain of the solution (organic view);

This decomposition is carried out at every systemic level from the system level to components.



**Figure 95: Universal framework for architectural analysis of real systems. Adapted from (Krob, 2009). This figure represents the 3 architectural views of a system at one systemic level.**

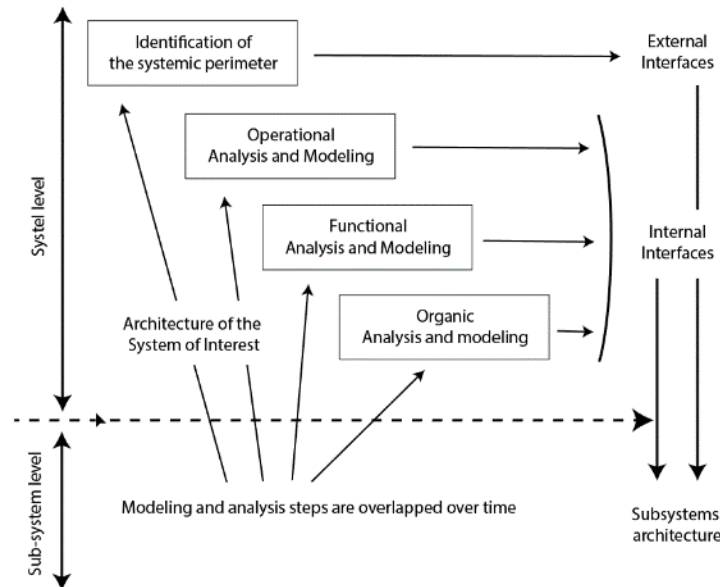
Furthermore, a system is characterized by a systemic hierarchy (system, sub-systems, sub-sub-systems etc.), the different Architectural views are similarly applicable to the different systemic levels of a system. Adding this systemic characteristic it is possible to summarize System Architecting by the “systemic cube” as presented in Figure 96.



**Figure 96 : The « systemic cube » for Systems Architecting. Adapted from (Krob, *Eléments de systémique. Architecture des systèmes.*, 2014).**

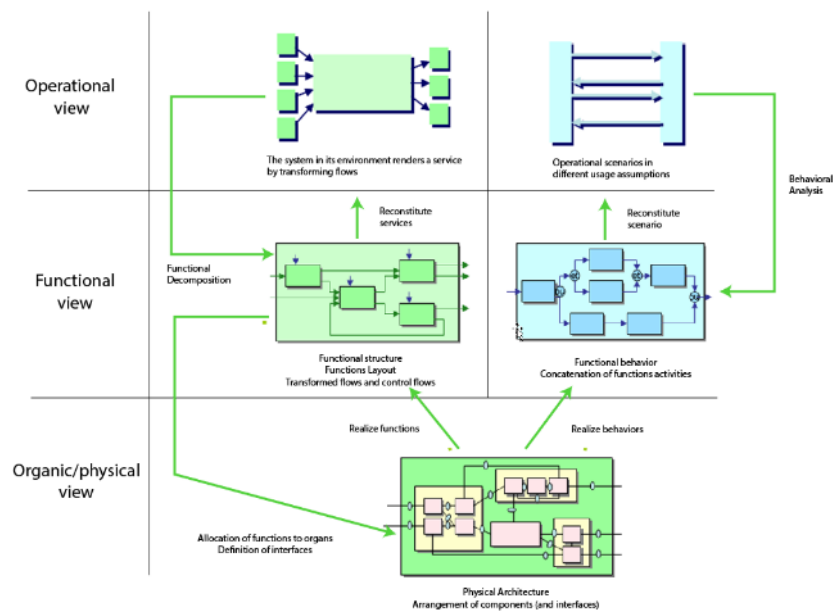
As presented in Figure 97, the process which consists in defining the architecture of a system is recursive : as instance it wouldn't be surprising (even if it has to be avoided) if new elements are added in the operational view whereas a system architect is establishing the organic view. It is even normal as definition of physical components

in the organic view as example can add new interfaces with elements from the environment and thus new constraints to represent in the operational view.



**Figure 97 : The (recursive) process of systemic analysis and modeling. Adapted from (Krob, Eléments d'architecture des systèmes complexes, 2009)**

In (Fiorèse & Meinadier, 2012), the same Architecting method is used. The only difference comes from the separation of the Operational and Functional views between static and dynamic elements as shown in Figure 98. For the operational view, static elements consists in modeling the system with its interactions with the environment, dynamic elements are the evolutions of the system missions over time. For the Functional view, static elements consists in modeling functions of the system and how they are related in terms of inputs and outputs, in the dynamic view is modeled how functions of the system are related over time.



**Figure 98 : Main views of an industrial system. Adapted from (Fiorèse & Meinadier, 2012). In this figure are also represented the 3 different architectural views of a system (in line) and behaviors of the system in columns.**

Other Architecting methods exist to analyze and model complex systems. SAGACE method is one of them; in this method we retrieve the same architecting principles (Operational, Functional and Organic) but 3 more views are

added: achronic (independent from time elements), synchronic (elements with a periodic evolution over time) and diachronic views (elements which evolve over time) (Feliot, 1997). In this thesis we consider that the Architecting method defines by Krob in (Krob, *Eléments de systématique. Architecture des systèmes.*, 2014) is enough in a first attempt to use Systems Engineering methods in the construction industry. In the next part we will adapt it and extend it to use it in the particular case of the construction industry.

**2.4.3.2. System Architecture and Functional Analysis**

Functional Analysis methods such as the APTE®/MISME method also define similar principles:

- The differentiation between the problem space and the solution space is similarly considered;
- Products are “architected” the same way but the different “views” don’t have the same names:

	<b>Systems Engineering</b>	<b>Functional Analysis</b>
<b>Needs</b>	Operational Analysis	External Functional Analysis
<b>Functions</b>	Functional Analysis	Internal Functional Analysis
<b>Organs</b>	Organic Analysis	Technical Analysis

**Table 10 : The correspondance between System Engineering and Functional Analysis**

The main difference between Systems Engineering and Functional Analysis methods comes from the integration of System Architecture with other methodological tools such as Requirements Engineering, Lifecycle development models, Model-Based Systems Engineering, Validation and Verification activities etc.

However, in Systems Architecture, all the steps and tasks to properly carry a Functional Analysis, i.e. define elements of the environment, needs, functions etc. is not developed and presented in the literature whereas it has been more documented in Functional Analysis presented in the beginning of this chapter.

**Issue n°13:**  
 Systems architecture gives concepts to architecture a system, however it is not mentioned how to integrate it in a project workflow and what are the steps to follow to architecture a system, which tools to use and task to carry.

**2.4.3.3. System Architecture and Lifecycle development models**

Systems Architecting can be theoretically integrated in lifecycle development models. As instance in the Vee-cycle model, at the top of the left branch, the system is “architected” at the system level according to the three different views in Systems Architecting (Operational, Functional and Organic). Eventually models are realized to simulate behaviors of the system and defined requirements are verified. Then, descending the left branch of the Vee-cycle, the same process is undertaken for sub-systems and sub-sub-systems until definition of the components.

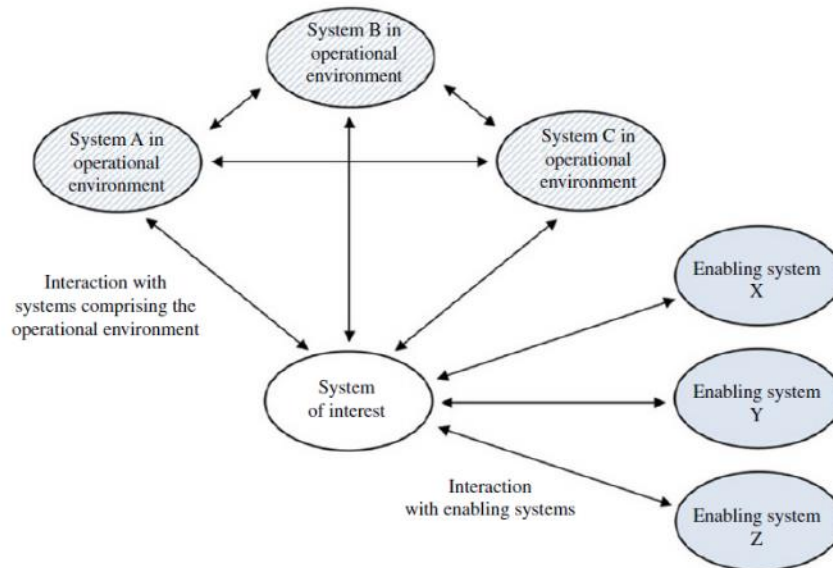
**2.4.4. Systems of Interest and Enabling Systems**

**2.4.4.1. Definition**

In Systems Engineering an important distinction is made between the “System of Interest” (SOI) and “Enabling Systems” (ES). We want to highlight here that this distinction SOI/ES is similar to the distinction made in recent developments of constructability between the product and the project presented in the last part.



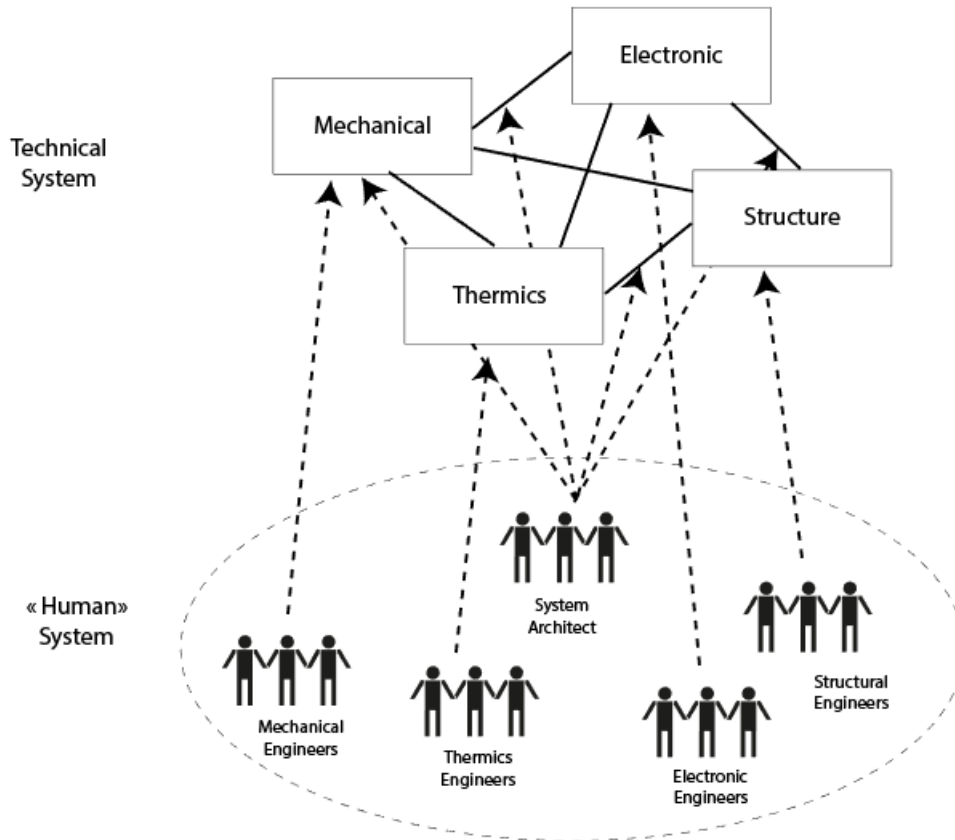
“Enabling Systems are systems that facilitate the life cycle activities of the SOI (System of Interest). The enabling systems provide services that are needed by the SOI during one or more life cycle stages, although the enabling systems are not a direct element of the operational environment. Examples of enabling systems include collaboration development systems, production systems, logistics, support systems etc.” (INCOSE, 2015)



**Figure 99: Systems of Interest, its operational environment and its Enabling Systems (ISO/IEC/IEEE, 2015).** In the center of this figure is represented the system to realize, it is the future product. Around it are the different “Enabling systems” which are necessary for its development and interacting with the “system to build” or “system of interest”. Are also represented interactions between Enabling systems themselves.

In the construction industry this distinction is fundamental as both the System of Interest (SOI) and Enabling Systems (SE) are changing at each system to develop. This differentiation will be at the core of the methodology we will develop in the third part of this thesis.

In (Krob, *Eléments d'architecture des systèmes complexes*, 2009), Krob also differentiates the industrial system (System of Interest) to build and the system facilitating its design and realization (Enabling System). These two systems are not independent and influence each other:



**Figure 100 : Human system and technical system involved in an industrial system project. Adapted from (Krob, *Éléments d'architecture des systèmes complexes*, 2009). This figure highlights that there are interactions between technical systems of the System of Interest and the « Human » system required for its development (planning, design, realization, and operation). It also shows that it is necessary to have a “system architect” in the human system to ensure integration of technical systems.**

We can highlight a difference in the definition of Enabling System in Krob or in the INCOSE Handbook: Krob only considers the Enabling System as the human system responsible for the design of the System of Interest whereas the INCOSE handbook also considers the production, logistics and support systems required for its development. In this thesis we will consider the definition of the INCOSE Handbook: the human system + production, logistics and support systems required for the development of the System of Interest.

However, links and interactions between the System of Interest and Enabling Systems have not been investigated extensively in the literature. Problematics such as what would be impacts on the product of changes in the project or how to assess if Enabling Systems are well fitted to develop the System of Interest are still required to be addressed.

**Issue n°14:**

Relations and interdependencies between the System of Interest and the Enabling Systems are not clear and defined precisely. A method to identify and analyze such interdependencies is lacking.

**2.4.4.2. The enabling system as a composition of projects**

In (Fiorèse & Meinadier, 2012), more precisions are given to define “Enabling Systems”: “*To organize, execute, and coordinate all activities from defining the purpose to the realization and delivery of the System of Interest, it is necessary to set up a system fitted with human and technical resources: the Enabling System. This system is organized in the form of one or several projects.*”

An important precision given by (Fiorèse & Meinadier, 2012) is the definition of enabling systems as a composition of one or more *projects* composed of human and technical resources.

The norm ISO 9000-2005 (ISO, 2005) gives the following definition of a project: “*a project is a unique process consisting of a set of activities coordinated and controlled with start and finishing dates, undertaken to achieve an objective conforming to specific requirements including constraints of time, cost and resources.*”

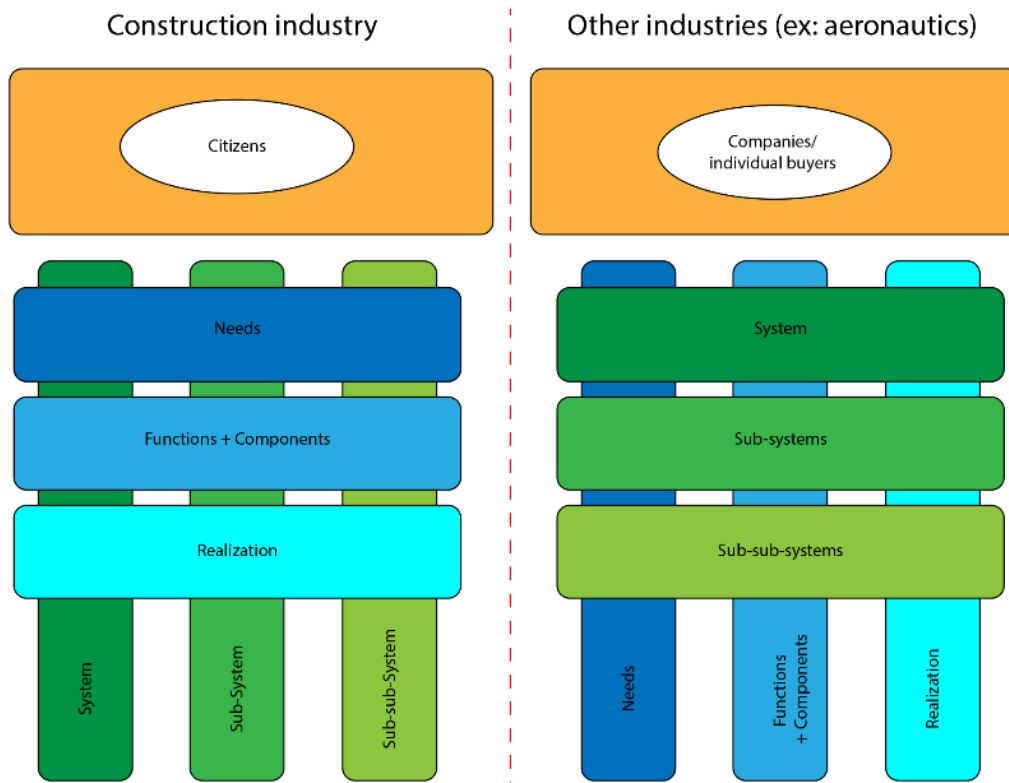
Sometimes the System of Interest is assimilated to the product and Enabling Systems to the project, this comparison is partly true with a slight twist: the System of Interest can be composed of several products and the Enabling System can be composed of several projects. Furthermore, the terms System of Interest and Enabling System add a *systemic* approach to the concepts of products and projects.

- The Enabling System in the construction industry

Contrarily to other industries, the construction industry is not integrated, whether the System of Interest which is in most cases *monofunctional* (answers to a single need) or the Enabling System which is divided between (see also organization of construction projects in France and abroad in the introduction):

- Needs analysis is dedicated to contracting authorities (transportation authority as instance for urban transportation systems) which is also responsible for the operation structure and the selection of the type of contract for the project;
- Design of the construction system is dedicated to the Project Manager/designer of the system;
- And realization of the construction system is dedicated to contractors;

This general organization may varies depending on the countries and the types of contract. In other industries, there is usually a single actor responsible for needs analysis, design of the system and its realization. Outfitters and subcontractors are solicited for the development of subsystems and components. In the construction industry, the client is usually a representative of the final user (municipalities, lessor etc.) and not the final user itself (citizens) while in other industries it is usually directly the client which order products. Finally, it is possible to represent such differences with the Figure 101: In the construction industry the project owner is responsible for “needs analysis” at all systemic levels from (taking the example of a metro system) size of doors to location of stations but don’t carry design neither realization of the system. At the opposite, in most of other industries, the project owner is responsible of needs, of the design and of realization/assembling of the system at the system levels and other subcontractors and outfitters have similar responsibilities but at their systemic levels (sub-systems, sub-sub-systems etc.). These differences inevitably have impacts on how the Enabling System is defined and about interactions between their elements in the different industries.



**Figure 101 : Comparison between organization of the construction industry and other industries**

In Figure 102, the enabling system of a construction system is presented (Sanvido, et al., 1988) with an IDEF-0 representation (Figure 102). Comparing it with the manufacturing process also represented with an IDEF-0 (Figure 103) by Sanvido (Sanvido, et al., 1988), we can identify the following differences: information related to the site are required for construction projects whereas they don't appear in the manufacturing industry. We can also notice that for the construction industry, development of the product is separated between planning, design and construction while in the manufacturing industry only one step is represented: "product development". Another difference which can be deduced from IDEF-0 schemes is the uniqueness of construction projects, meaning that for each construction project a new site has to be established. Comparing with other industries it means that each time a new product is developed a new factory has to be built at a different place.

These 3 differences are the same than the differences identified in chapter one of this thesis:

- Spatial characteristics of systems have to be considered in the "*Enabling System*" as well as in the "*System of Interest*";
- The construction industry is not integrated, the enabling system is separated between the planning, design and construction phase.
- Each construction project is unique, the system required for the realization of the product is different at each project.

The first difference concerns the consideration of spatial characteristics in the Enabling System and how they constraint its development.

The second difference leads us to enlarge the concept of constructability by considerate also constraints from planning and design stages. These activities have objectives, processes and require resources and therefore

constrain its development. Constructability criteria can be defined to consider these constraints as well as realization constraints.

The third difference leads to highlight the importance of considering constructability criteria when developing a construction product at all phases of development.

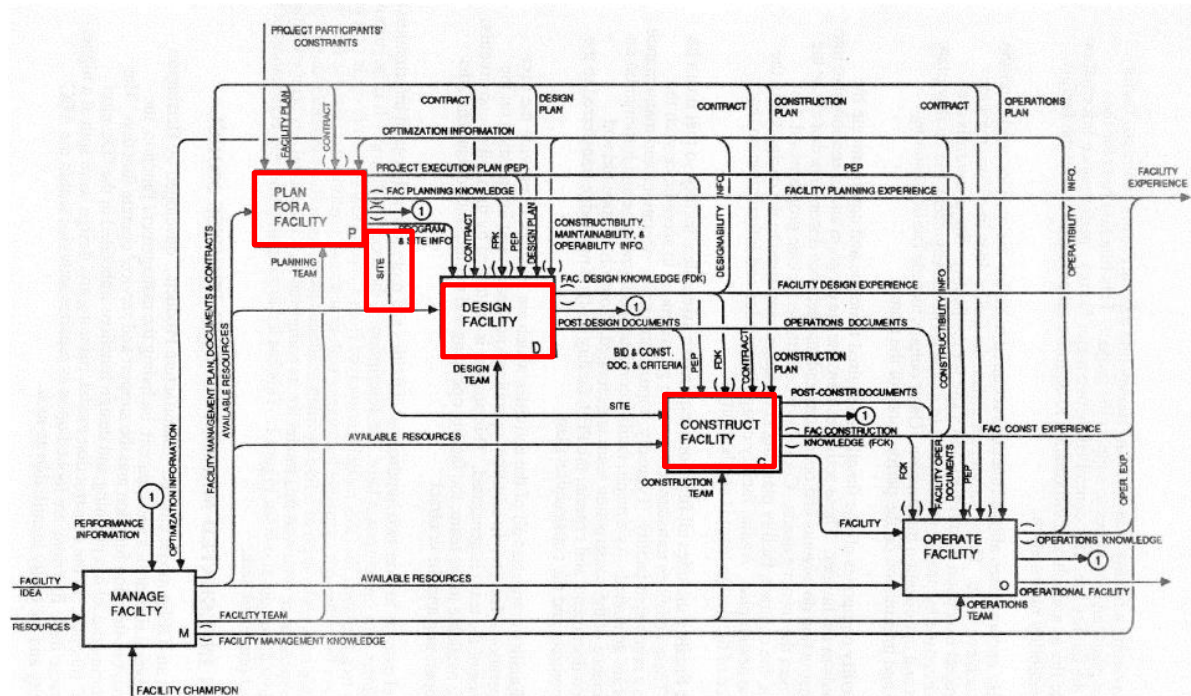


Figure 102 : IDEF-0 of the construction process (Sanvido, et al., 1988)

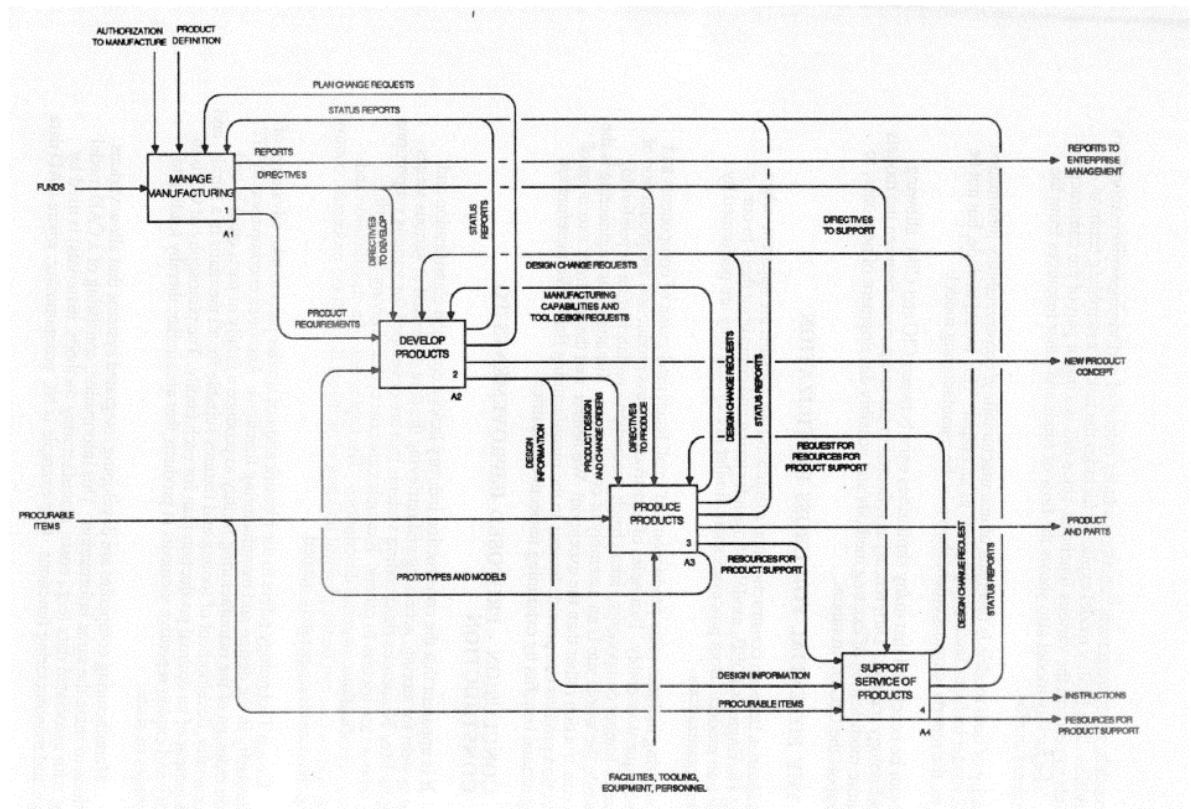


Figure 103 : IDEF-0 of the manufacturing process (Sanvido, et al., 1988)

#### 2.4.4.3. Apply Systems Architectures to Enabling Systems

In (Fiorèse & Meinadier, 2012) projects (which compose the Enabling System) are considered as systems and are analyzed as such:

As every artificial system, a project can be *engineered*. This activity is usually called *project engineering* or *project planning*: projects requirements are defined, objectives of the project are set (the *why?*), objectives are allocated to tasks which are the functions of the project (the *what?*), resources required to carry the previously defined tasks are estimated considering budget and time constraints (the *How?*).

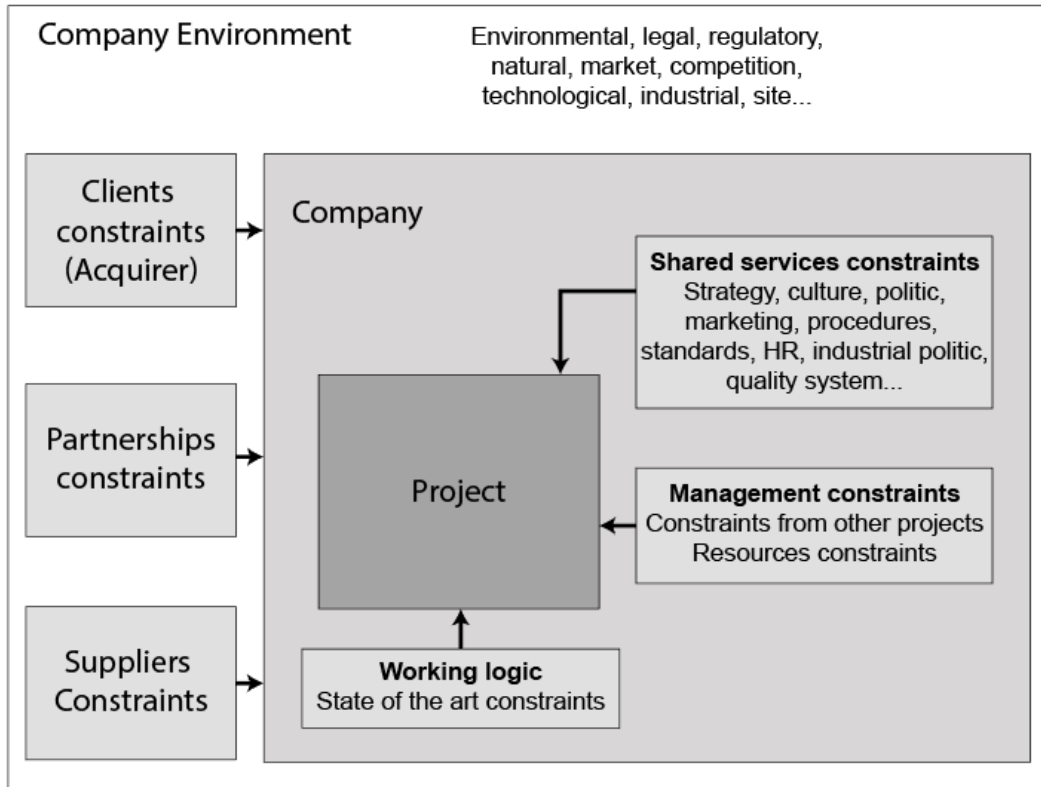
	<b>System of Interest</b>	<b>Enabling System</b>
<b>Operational View</b>	Needs	Objectives
<b>Functional View</b>	Functions	Activities
<b>Organic View</b>	Composition	Resources

Figure 104 : Systems Architecture for Systems of Interest and Enabling Systems

However, we can notice that the proposed architecture is not fully coherent with the actual organization of the construction domain: the proposed architecture supposes that one actor is responsible for the entire value chain. Whereas it might be the case in other industries, the construction industry is not an integrated industry, it implies that responsibilities are shared by the mean of contracts between stakeholders, contracts which are never perfects and can lead to divergence in stakeholders objectives and finally to over-costs, delays or defective works.

- Operational view: it answers to one or several objectives (why there is a project) and is subject to constraints; The operational view of a project consists to represent the project as a “black box” surrounded by elements of the environment with which it is in interaction. This environment is usually “complex” with a lot of interactions. Each element of the environment also has its own needs and constraints impacting the development of the project.

In Figure 105 an example of a project in its environment has been represented as an example. Examples of external elements (direct and indirect elements) are: the company or administration within the project is undertaken with all related constraints (HR, culture, working logics, procedures, management...), suppliers, partners, clients, law, nature, regulation, economic environment... (Fiorèse & Meinadier, 2012).



**Figure 105 : Example of an external (Operational) view of a project with its environment (objectives). Adapted from (Fiorèse & Meinadier, 2012). A project requires, working logic, has management constraints and is influenced by services constraints in the company. A company also have an environment and is constraint by its clients, suppliers and partners as well as a lot of other elements (law, competition rules, regulation, nature, market...).**

- Functional view: it is composed of coordinated activities (what the project does);

The functional view of a system consists to analyze what the system *does*. Considering a project, it can be modeled as a process where inputs (information, materials, energy) are processed into outputs which is the System of Interest. In the construction industry outputs of the project in the planning and design phases are “models” of the system to build in the realization phase. In other industries, planning and design phases can lead directly to the realization of the product (as instance in the software industry) or to the realization of prototypes. It means that in the construction industry, flows of inputs to outputs are based on information rather than energy or materials.

The process can be separated into two parts:

- *How* the process is undertaken which is the field of Systems Engineering. SE consists in defining how to do the transformations from inputs into outputs;
- *Who, When and What* is required for the project which is the field of Project Management. PM consists in defining, plan, organize and manage human resources and technical means required to carry the previously defined transformations considering budget and time.

On the functional plan, the project is seen as a set of tasks to carry in order to fulfill objectives defined in the operational view. The particularity of SE is to consider the structure and characteristics of the product to build (System of interest) in the organization of the project and the processes to undertake.

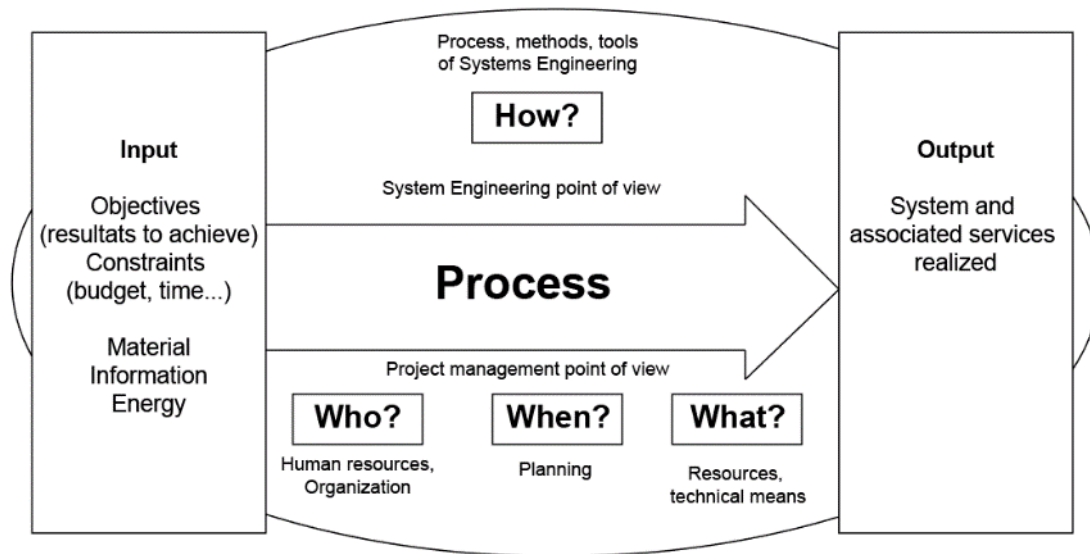


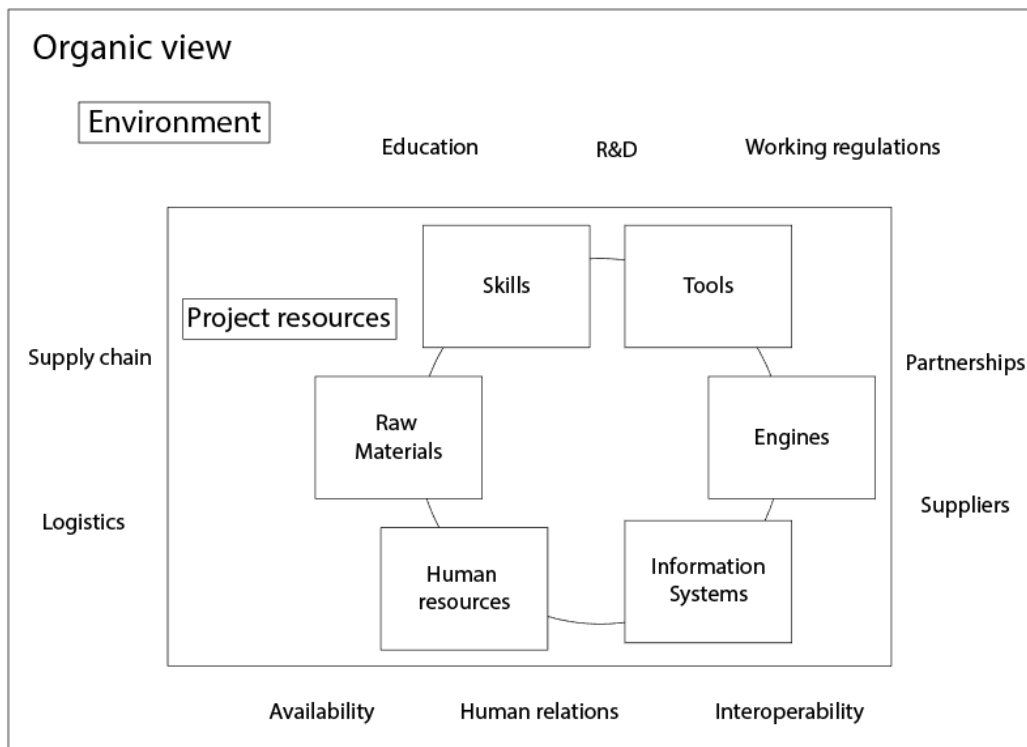
Figure 106 : The functional view of a project (activities). Adapted from (Fiorèse & Meinadier, 2012). This figure shows that the ‘functional view’ in the Enabling system is similar to a function in the System of Interest. The difference comes from the type of input and output and the purpose of the system which is here to develop the System of Interest (or one of its part).

- Organic view: it is composed of organization entities (what is the project);

On the organic plan, a project can be considered as an organization of “entities” realizing tasks. These entities are in interactions through organizational interfaces.

The organic view concerns resources required to undertake processes defined in the functional view. It can be human resources, engines, information systems (software, hardware), tools, raw materials, required skills etc. interactions between them and with their environment (education, human relations, availability, supply chain, interoperability...). Organic elements are assessed and integrated to evaluate feasibility of PM and SE strategies defined in the “functional view”.





**Figure 107 : The organic view of a project as a system (resources). Organic view of an Enabling System is constituted by the “concrete” elements required to carry processes defined in the “functional view”.**

- Project decomposition

Ideally the decomposition of projects should follow the decomposition of the system to build to avoid unnecessary interfaces. At a high systemic level, the project should be decomposed according to the subsystems of the System of interest.

Nevertheless, projects with multiple actors (which is often the case for complex projects) add another decomposition of the project: the decomposition by actors. Preferably, decomposition of the project in actors should also follow the subdivision of the system of interest.

In the construction industry (and particularly for large infrastructures) another decomposition is possible: spatial decomposition. How to decompose the project according to subdivisions of the System of Interest, actors involved in the project and spatial decomposition?

## 2.4.5. Requirements Engineering (RE)

### 2.4.5.1. Definition

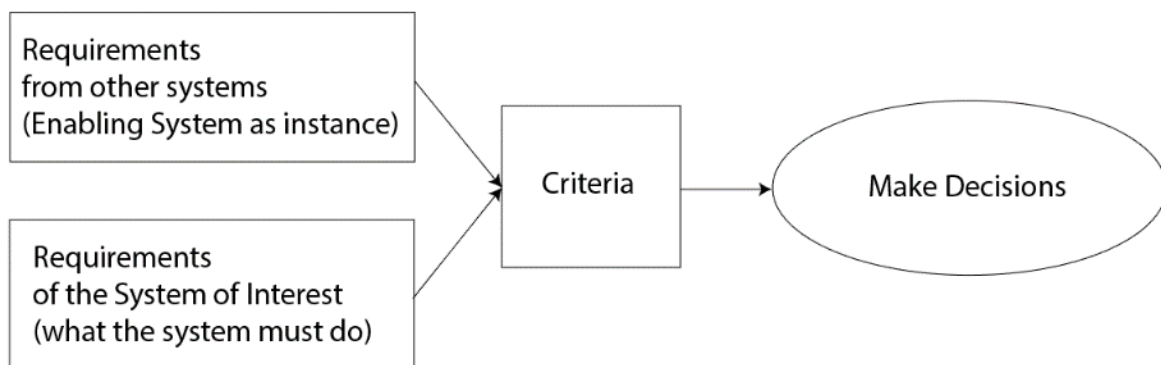
- Requirements and criteria

First of all precisions have to be made about the distinction between the terms “*criteria*” and “*requirements*”. These are sometimes similar and/or confused.

In the INCOSE Guide for Writing Requirements (INCOSE, 2015) the following definition of requirement is given: “*A requirement statement is the result of a formal transformation of one or more needs into an agreed-to obligation for an entity to perform some function or possess some quality (within specified constraints).*” Another definition is given by Weilkiens (Weilkiens, Systems Engineering with SysML/UML, Modeling, Analysis, Design, 2006): “*a requirement describes one or more properties or behaviors of a system that always have to be met*”. In other terms, a requirement is what the system *has to/must* do compulsorily.

Lebeaupin in (Lebeaupin, Rauzy, & Roussel, 2017) adds that “requirements are a communication tool: their goal is that the supplier understands what the customer wants”.

A criteria has been defined earlier in this chapter as “*a standard on which a judgment or decision may be based, a characterizing mark or traits*”. Therefore, a requirement is a criterion as it helps the designer to make decisions about the system and to make choices. But all criteria are not necessarily requirements of the system i.e. behaviors of the system but can also be from external systems. As instance, constructability criteria are not properties/behaviors of the System of Interest, however they are properties/behaviors of the Enabling System., in other words requirements of the Enabling System. Finally, criteria are requirements but not necessarily from the System of Interest.

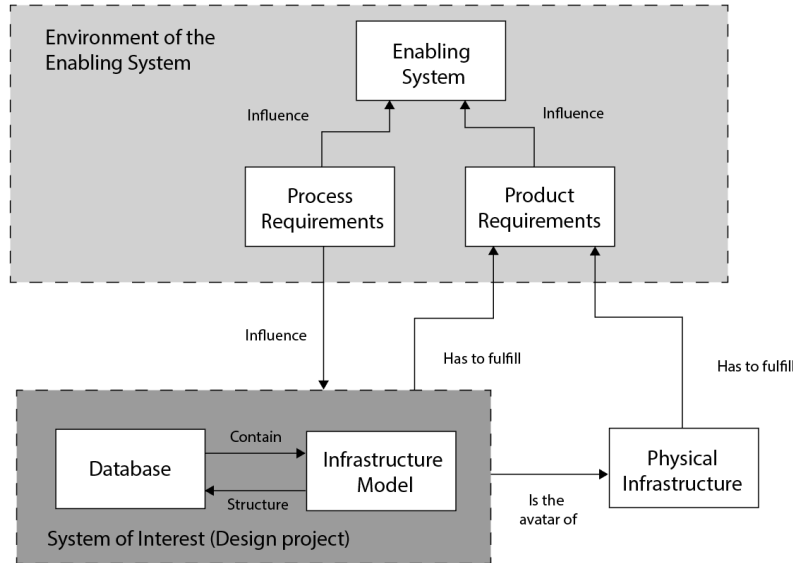


**Figure 108 : Requirements and criteria.** This figure highlights that criteria are defined in order to make decisions. Because in our case decisions are made amongst the different requirements coming both from the System of Interest and the Enabling System, criteria can be assimilated as requirements.

In chapter 3 we will present a Requirement Engineering tool we have developed as part of this thesis which allows to model requirements from different types of system and therefore to define criteria.

- Requirement Engineering (RE)

Requirement Engineering (RE) is a systematic approach consisting in rules and methods to specify and manage requirements throughout the entire system life cycle. It is “*the process of discovering that purpose, by identifying stakeholders and their needs, and documenting these in a form that is amenable to analysis, communication and subsequent implementation*” (Nuseibeh & Easterbrook, 2000). RE is a multi-disciplinary and human-centered process that involves stakeholders’ beliefs (epistemology), what is observable in the world (phenomenology) and what is agreed to be true (ontology) (Nuseibeh & Easterbrook, 2000). Initially, Requirement Engineering (RE) and Systems Engineering (SE) were two separated corpuses. First developments of Requirement engineering were in the software industry and then expanded to other industries. Nowadays, RE is at the heart of the SE approach (Badreau & Boulanger, 2014). Figure 109 highlights the two types of requirements usually considered in Requirement Engineering.



**Figure 109 : Process requirements and product requirements. Adapted from (Tolmer, 2016). This figure shows that there are two different types of requirements usually considered: requirements from the Enabling System and requirement from the system of interest.**

Activities related to RE processes are mainly divided into two groups (Badreau & Boulanger, 2014):

- **Requirements Modeling:** requirements are elicited, classified, prioritize, elucidated, analyzed, specified and validated;

Requirement modeling consist in defining requirements. Traditionally (and even more in the construction industry), requirements are text based and are “modeled” with Word®, PDF® or Excel® tools. Documents regrouping requirements are conventionally the “Program”, technical specification documents (CCTP in France which stands for Cahier des Clauses Techniques Particulières). These documents can easily exceed 1000 pages for large and complex projects. Which make them almost impossible to verify, check, trace or evaluate impacts of a change. Requirement modeling activity consist therefore in shifting from a paper-based method to a model-based method to write requirements, add attributes and model interdependences between them.

- **Requirements Management:** storing, changing and tracing requirements (traceability).

Requirement management on the other side is more oriented on project management but require Requirement modeling to be fully efficient. It consists in analyzing the amount of requirements remaining to model, to verify, to trace or to refine but also to evaluate the impact of changes in the project. It can also be the treatment of one or a group of requirements to a team or a specific person. Tools such as Doors®, Reqtify®, Visure®, Modern Requirements® etc.

Moreover, as far as textual requirements are concerned, the guide published by the Requirement Working Group of the International Council on Systems Engineering (International Council on Systems Engineering, 2015) states that they must be “necessary, appropriate, unambiguous, complete, singular, feasible, verifiable, correct and conforming” in order to avoid different interpretations, which may lead to rework, delays, cost overruns and less quality. These characteristics are similar to the “SMART” model for requirements which describe in the next part.

Requirements have to be characterized at least by an ID, a short text explaining the requirement content, an allocation, a verification test and a reference for traceability. Adding other attributes is also possible, such as risk and status (e.g., verified, validated). In the construction industry this method and this discipline is rarely (and almost never) applied for specification and tender documents.

#### 2.4.5.2. Objectives of Requirements Engineering

From the CHAOS report of the Standish Group the first factor of Project Impaired are Incomplete Requirements (Standish Group, 2014). This highlights the great importance of Requirement Engineering for projects success. The little comic of Scott Adams (Figure 110) illustrates very well this phenomenon, if requirements the future system/product has to fulfill are not clear it is even not worth to start the project. That is all the more true for complex systems.



Figure 110 : Importance of Requirement Engineering. Scott Adams 1997. It shows that without considering requirements, projects are most likely to fail.

In (Zave, 1997), Zave defines 14 objectives of Requirement Engineering (RE) split into 3 categories. Initially these objectives were related to software systems but they are easily applicable to all types of systems.

In chapter 3, we will present a tool we have developed as part of this thesis to apply Requirement Engineering for the construction industry and more precisely for metro projects.

- **Problem of investigating goals, functions, and constraints of systems**
  - Overcoming barriers to communication;

One objective of RE is to improve communication between stakeholders from different backgrounds by encouraging discussions about formalization of requirements. It allows a better understanding of clients' needs by the designer and ensuring that requirements are shared between all stakeholders.

- Generating strategies for converting vague goals (e.g., "user-friendliness," "security," "accuracy," "reliability") into specific properties or behavior;

Sometimes (often?) needs and goals of stakeholders are vague or/and inaccurate, formalization of goals into precise and verifiable requirements which can be checked by models.

- Understanding priorities and ranges of satisfaction

Not all requirements have the same level of priority, Requirement Engineering is a way to organize, prioritize and orientate the satisfaction of specific requirements.

- Generating strategies for allocating requirements among the system and the various agents of its environment

Requirements are allocated to elements of studied systems, this allow to share the work between the different specialties and to specify which element of the system will fulfill which requirement. The work to carry by designers is clearer. Interfaces are also better managed as requirements shared between different subsystems can be identified.

Requirements are not only allocated to elements of the System of Interest but also to elements of the Enabling system that will contribute to its verifying.

- Evaluate costs, risks and schedule

Most of the activities are to verify requirements by modeling systems. Therefore, Requirement Engineering allows managing costs, risks and schedule during the design phase.

- Ensuring completeness

Requirement Engineering allows evaluating the capability of the system to fulfill defined requirements, requirements which are under evaluation and requirements the system cannot answers.

- **Problems of specifying systems behavior**

- Integrating multiple views and representations

Formalization of requirements can diverge depending on points of view of the system. Refining requirements allows considering these multiple points of view and ease division of tasks to carry for their verification.

- Evaluating alternative strategies for satisfying requirements

Requirements can be of different types, when functional requirements are expressed it offers the possibility to evaluate different possibilities to satisfy them. Comparison of the different solutions by defining criteria (like indicated in the MISME method in part 2.2) allows optimization of the system.

- Obtaining complete, consistent, and unambiguous specifications

The definition of SMART requirements (Specific, Measurable, Achievable, Realistic, Time-Bound) allows defining unambiguous requirements. Furthermore, traceability and requirement management is allows ensuring completeness of the design.

- Checking that the specified system will satisfy the requirements

Without RE it is not possible to assess which requirement the specified system satisfies or not precisely.

- Obtaining specifications that are well-suited for design and implementation activities

Formalization of requirements allows better understanding of what has to be modeled and verified, it avoid unambiguous specifications which would be hardly understandable by designers. It can eventually leads to automation in their verification depending on the level of formalization (can the requirement be expressed by mathematical formula? If yes, can this mathematical expression be easily solved?).

- **Problems of managing evolution of systems and families of systems**

- Reusing requirements engineering during evolutionary phases

One of the main interest of RE is in future development phases when changes in the design happen. In the construction industry changes are no exception but the rule, clients' requirements as well as design requirements are always changing during the different development phases of the system.

- Reusing requirements engineering for developing similar systems

In some instances, parts or the totality of a requirement referential can be re-used or adapted. Even if this activity can save a lot of time and resources, it has to be carried very carefully as no project is the same particularly in the construction industry where constraints and clients' needs are always different.

- Reconstructing requirements

Another interest of RE is for maintenance and operation activities when it is necessary to understand why a system has been built and what are its functions. In this case establishing a referential of requirements can help.

#### **2.4.5.3. Define SMART requirements**

One of the main concept in Requirement Engineering is the formalization of requirements in a SMART way. SMART is the acronym of Specific, Measurable, Achievable/Attainable, Realistic and Time-Bound/Traceable (Mannion & Keepence, 1995):

**Specific** means that requirements are simple, clear and what is necessary is written to improve its understanding and avoid ambiguity. It also means that requirements have to be consistent, the same terms have to be used for all requirements when referring to the same objects. As instance, terms such as “clearly”, “obviously”, “several”, “some”, “many” etc. have to be avoided when writing requirements. Eventually, the use of pictures, figures or tables can help to precise and improve understanding of requirements by all stakeholders.

**Measurable** stands for the capability of a requirement to be verified and validated when the system is realized. It means, that at the same time as defining requirements it is necessary to define how they will be tested. If the requirement can't be tested it may mean that it is necessary to breakdown the requirement into sub-requirements which in turn are verifiable and testable. Two possibilities are possible when a requirement is not verifiable, whether no instrument exist to test the requirement whether no quantifiable criteria have been defined to verify the requirement. “*Measurability*” of requirement could be a constructability criteria to consider when defining requirements.

**Achievable/Attainable** means that the requirement is not beyond human being capacities. As instance a requirement such as “*the system shall be 100% reliable*” is not possible with the current knowledge.

**Realistic/Realizable** consists in considering past experiences and feedbacks to evaluate if the requirement have chances to be reached by the future system given available resources of the project. It is different than the last criteria by the fact that the requirement is attainable but would require important resources to be satisfied. Mannion (Mannion & Keepence, 1995) considers that this criteria is the most difficult to fulfill in creating SMART requirements. It is also at this stage that the “*desirability*” of a requirement is assessed: the level of desirability of a requirement can help to choose or not if a requirement which requires a lot of resources for the system has to be considered.

**Time-Bound/Traceable** is the capability to trace requirements in the project lifecycle from planning to realization and verification. More than the capability to specify how requirements are related between each others and how the system is compliant with which requirements, traceability also concerns stakeholders impacted by the defined requirements, when it has been created, their criticity, who has created the requirement and who is responsible for its verification.

#### **2.4.5.4. Requirements Engineering and Systems Engineering**

As stated in the part related to Systems Architecting, representation of a system is separated between two categories which structure the engineer framework (Krob, *Eléments de systémique. Architecture des systèmes.*, 2014):

- *Requirements* which are the logical conditions the system to realize must satisfy;
- *Specifications* which are non-ambiguous descriptions of the system to realize.

However, the delimitation between requirements and specifications is not always very clear and is mostly related to the engineering process of an industrial system as shown in Figure 111. The difference between specification and requirement is tight and somewhat difficult to perceive. A requirement is what the system should do (whereas

they are operational, functional or organic) in the needs space and specification is actually how the system has been designed in the solution space.

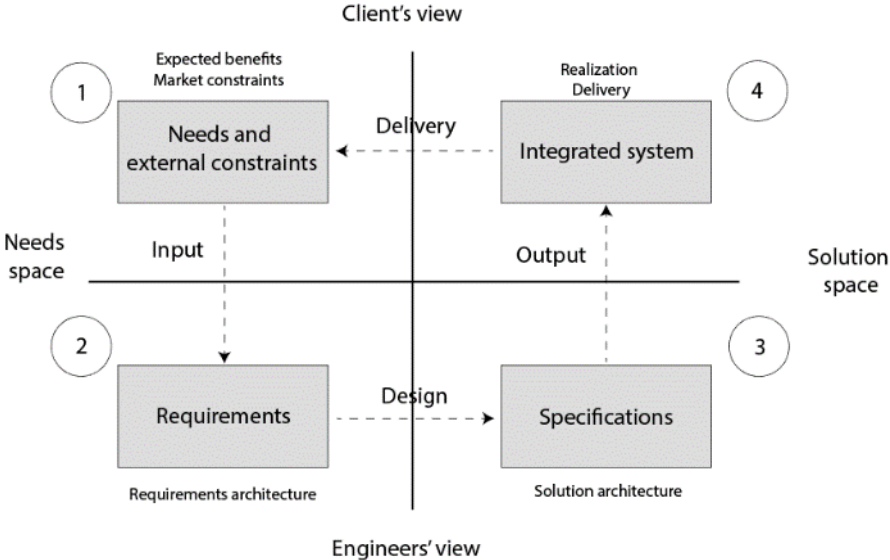


Figure 111 : Framework for System Architecture. Adapted from (Krob, *Eléments d'architecture des systèmes complexes*, 2009). This figure shows that Requirement Engineering is an important step in architecting a system in System Engineering (step 2).

Different types and classifications of requirement can be defined, Tolmer (Tolmer, 2016) highlights two types of classification: the type of system they belong to (System of Interest or Enabling System) or by architectural visions (Operational, Functional or Organic) (Figure 112). These classifications can help in structuring a requirement referential for the project.

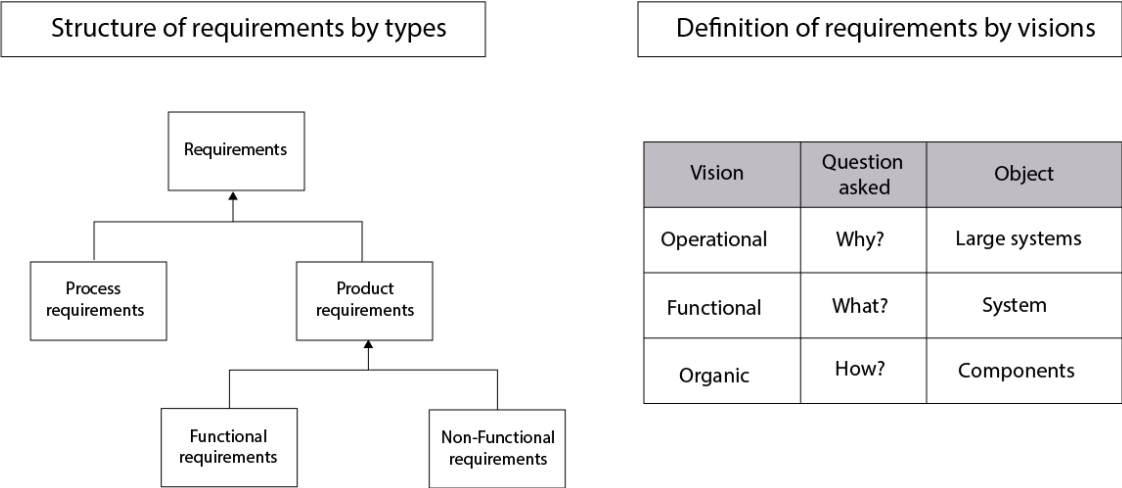


Figure 112 : Requirements typologies and structures. Adapted from (Tolmer, 2016).

Based on practitioners’ experiences in the aeronautic industry, Lebeaupin develops In (Lebeaupin, Rauzy, & Roussel, 2017) and (Lebeaupin, 2015) by studying Natural Languages and Formal Languages, ideas and methods to make text requirements less ambiguous and more easily “understandable” by machines. Notably:

- Use a formal language understandable by computers “hidden” under natural language words.

- An Requirements editor which helps engineers to right requirements in formal language by recognizing formal language when used;
- Use the same words in requirements modeling than in other types of models (see MBSE below) like state machine, or activity diagrams to enable easily links between them;

At Egis, Requirement Engineering tools have been used for different metro projects; could be mentioned as example: the Avenir Metro project (Sytral, 2017), the Doha Metro project (Egis, 2018) and line 18 of the Greater Paris project (Grand Paris, 2018). However each time it was used it was surprisingly only on other subsystems than civil engineering. It is difficult to assess why such methodologies and tools are not used for infrastructure and building parts. It may be because of the cultural background; these methods are uncommon in civil engineering and have almost never been used. The other possibility is that civil engineering subsystems are not considered as complex and doesn't need SE and RE. The last possibility would be that most of civil engineers and project managers in the construction industry are not aware of the existence of this type of methods and don't see why they would be useful. In any case, it is interesting to notice that even when these tools are used it is only when clients have specified it in their contracts; it is not a systematic approach.

#### **2.4.6. Model-Based System Engineering (MBSE)**

In its visions for 2025, INCOSE gives the following definition of MBSE (INCOSE, 2007): “Model based systems engineering (MBSE) is the formalized application of modeling to support system requirements, design, analysis, verification and validation activities beginning in the conceptual design phase and continuing throughout development and later life cycle phases.”

Transformation of an abstract need into a concrete solution requires many intellectual activities. It is necessary to use representations of both the problem and possible solutions with different levels of abstraction to grasp, conceptualize, design, estimate, simulate, verify, justify choices and communicate which is the role of modeling (Roques, SysML par l'exemple, un langage de modélisation pour systèmes complexes, 2009).

Formalisms presented in the Functional Analysis part such as SADT®, FAST, or MISME methodological tools like the “horned beast” and the “octopus diagram” are not standardized and are limited in their expressivity which makes them very difficult to integrate with other formalisms and tools and implies interoperability issues. Standardization is the main advantage of SysML, BPMN and other standardized diagrams we will present in this part.

Different types of models exist depending on what is required to be modeled. Some models have been developed especially to model the enabling system (MACTOR, BPMN, TOGAF...) and others for the system of interest (SysML, data dictionary...). Some of them like PPLM (Project Product Lifecycle Management) also allow modeling both enabling systems and the system of interest. In the following paragraphs we will develop these different models.

##### **2.4.6.1. Modeling the System of Interest**

SysML (System Modeling Language) is the main and most used standardized language to describe and model man-made complex systems. It has been developed by the OMG (Object Management Group) to offer a uniform modeling language to Systems Engineering (Weilkiens, Systems Engineering with SysML/UML, Modeling, Analysis, Design, 2006). SysML is an adaptation of UML 2 (Unified Modeling language) for industrial systems (Figure 113). UML has been developed for software development; SysML is an adaptation of this language to industrial systems notably by adding the possibility to model the following elements (Roques, 2009), (Weilkiens, Systems Engineering with SysML/UML, Modeling, Analysis, Design, 2006):

- Describe requirements and their traceability;



- Represent non-software elements (mechanical, hydraulic, wiring, sensors etc.)
- Represent physical equations;
- Represent flows (material, energy, information);
- Represent logical/physic, structure/dynamic allocations.

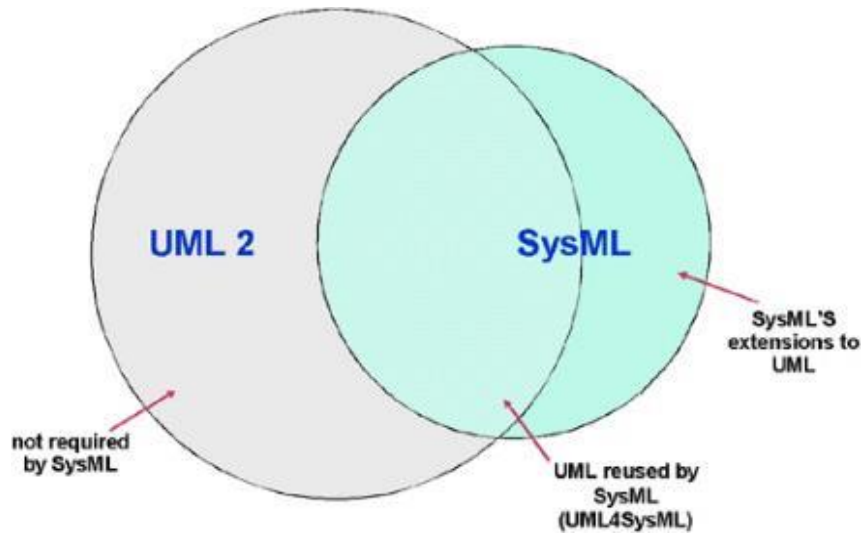


Figure 113 : SysML, an adaptation of UML 2 (OMG SysML, 2018). SysML is a language coming from UML which reuse some of its concepts in combination with new concepts developed specifically for System Engineering.

We can already notice that representation of “*physical space*” is not included in SysML diagrams while it is fundamental for construction systems. A proposition to adapt this language for construction projects by adding the representation of special relations will be developed in the 3<sup>rd</sup> chapter of this thesis.

SysML diagrams are composed of in 3 groups (Figure 114):

- **Behavior diagrams:** diagram of activity (represents the sequence of activities), diagram of sequence (represents information flows between subsystems), states diagram (represents the different states of the system and its transitions), use case diagrams (represents functional interrelations between the system and its environment).
- **Requirement diagram:** represent requirements the system has to fulfill and their relations.
- **Structure diagrams:** bloc diagram (represents composition, associations, and characteristics of systems), internal bloc diagram (represents the internal elements of the system), parametric diagram (represents equations that apply to the system), package diagram (represents the logical organization of the system and relations between packages).

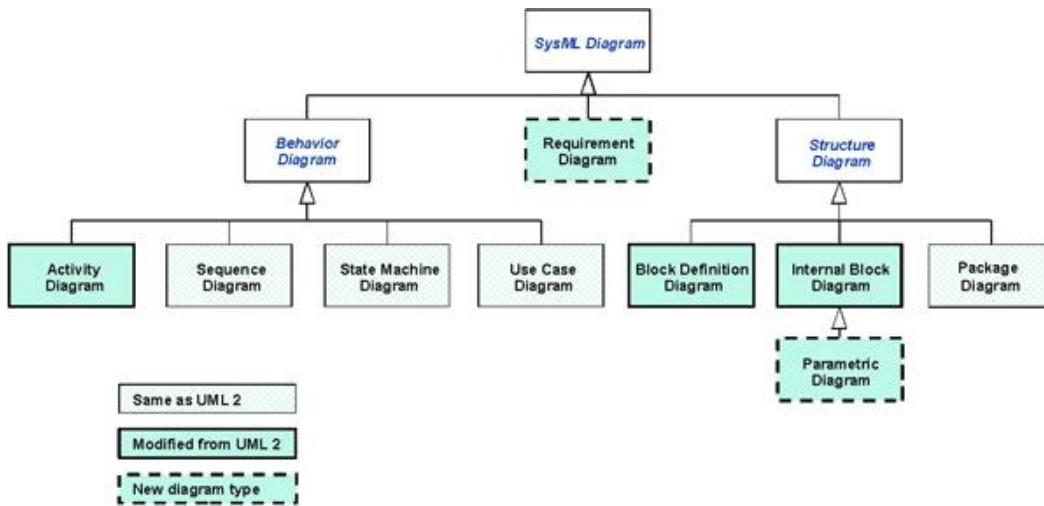


Figure 114 : The 9 SysML diagrams divided in Behavior diagrams and Structure diagrams (OMG SysML, 2018).

In (Krob, *Eléments d'architecture des systèmes complexes*, 2009), Krob considers that SysML has enough modeling capability to model any industrial system (Figure 115):

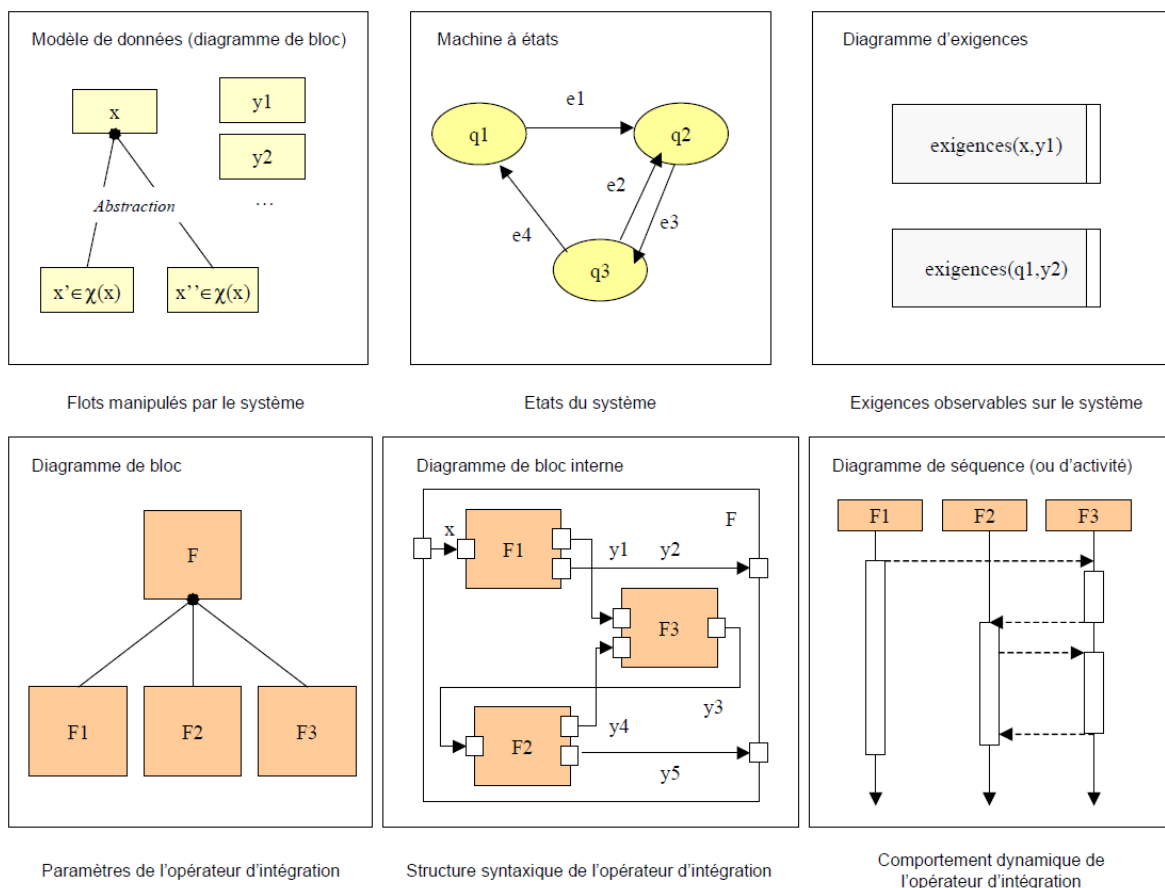


Figure 115 : The necessary and sufficient diagrams to represent an industrial system (Krob, *Eléments d'architecture des systèmes complexes*, 2009)

We do not fully agree with this assessment as SysML does not give the possibility to model space characteristics of systems like topological relations or geographic descriptions. It would be required to make some adaptations and modifications to SysML description to use for construction systems as we will explain in the next chapter.

Furthermore, adaptations of SysML and more generally of UML for specific domains are common and take the name of DSML (Domain Specific Modeling Language) (Kelly & Tolvanen, 2008).

**Improvement n°3:**

Requirement modeling based on SysML answers to **Issue n°10** which consists in modeling constructability requirements.

SysML standard language answers to **Issue n°2** defined in 2.2.3.5 by defining a standard language to represent elements of the system whereas it is functions, parts, flows, interconnections etc.

SysML based tools answer to **Issue n°3** defined in 2.2.3.5 by allowing to trace and represent how elements of the system are linked with the help of a computer tool. It enhances the management of design changes and modifications of the different system parts as well as requirements.

**2.4.6.2. Model the Enabling System**

Contrary to the “System of interest”, a unified model allowing modeling of the Enabling System doesn’t exist. Nevertheless, different types of models separately allow modeling Objectives, Activities and resources of the Enabling System. In this part we will detail some of them.

Like other requirements, requirements from the Enabling Systems have to be SMART (Specific, Measurable,

- Modeling objectives with their related stakeholders

One method to model stakeholders, their objectives and their relations is the MACTOR method (Méthode ACTeurs, Objectifs, Rapports de force), this method has been developed by Godet in France (Godet, 2007). Very often developing an industrial system (and even more for complex systems) implies numerous stakeholders with different and sometimes opposite objectives and construction systems are no exception.

In the MACTOR method, actors’ involvement, confrontations and their power relations are analyzed. It is composed of 5 steps as follows (Figure 116):

1. Knowledge about actors are referenced in data sheets in which actors are defined with its objectives, its forces, its weaknesses and its capacities;
2. Directs and indirects influences between actors are analyzed and their power relations are evaluated. Influences are modeled with the help of matrices: the MID (Matrice des Influences Directes) and MIDI (Matrice des Influences Directes et Indirectes) matrices.
3. Identify strategic stakes and associated objectives and position each actor against each objective. Positions of actors against objectives are modeled with a matrix: the MAO matrix (Matrice des positions d’acteurs/objectifs).
4. Identify convergences and divergences between actors;
5. Formulate strategic recommendations and key questions for the future.

The MACTOR method has been applied to several systems since its development in the 90’s mainly in France and Europe: actors related to costs containment of EDF (Electricité de France) nuclear plants, to mobility actors between different transportation modes for SNCF (Société Nationale des Chemins de Fer), for the future of rural spaces in France, and to evaluate divergences and convergences between member states of European governments for the organization of the intergovernmental conference in 1996 (Godet, 2007).

MACTOR is an efficient method to explore interrelations between actors and their objectives. Nevertheless, similarly to interactions between operational, functional and organic view of a system, interactions also exist between objectives of stakeholders, activities and resources required for the project. These interactions are not

modeled in the MACTOR method meanwhile activities and resources required can also influence objectives of stakeholders.

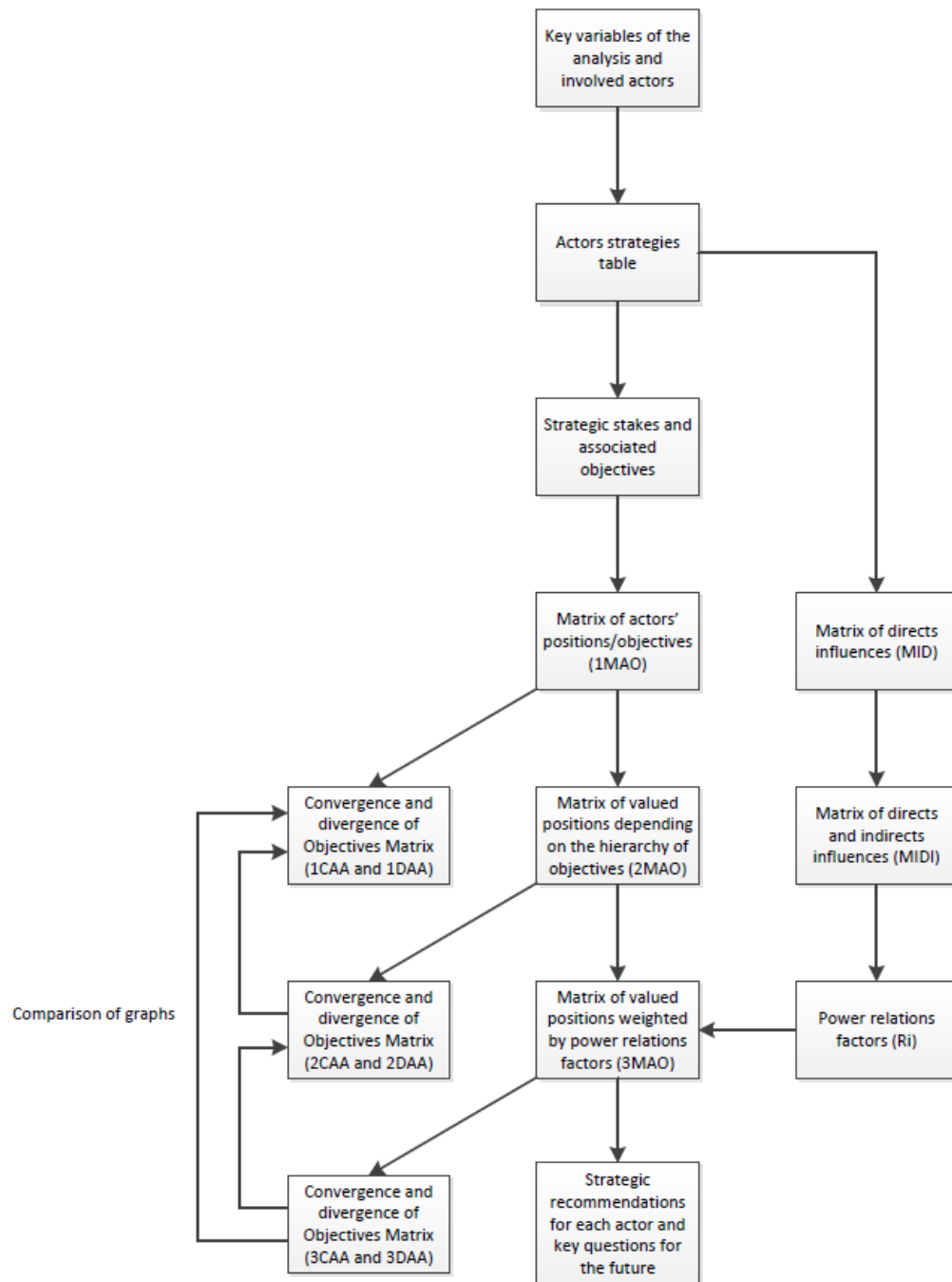


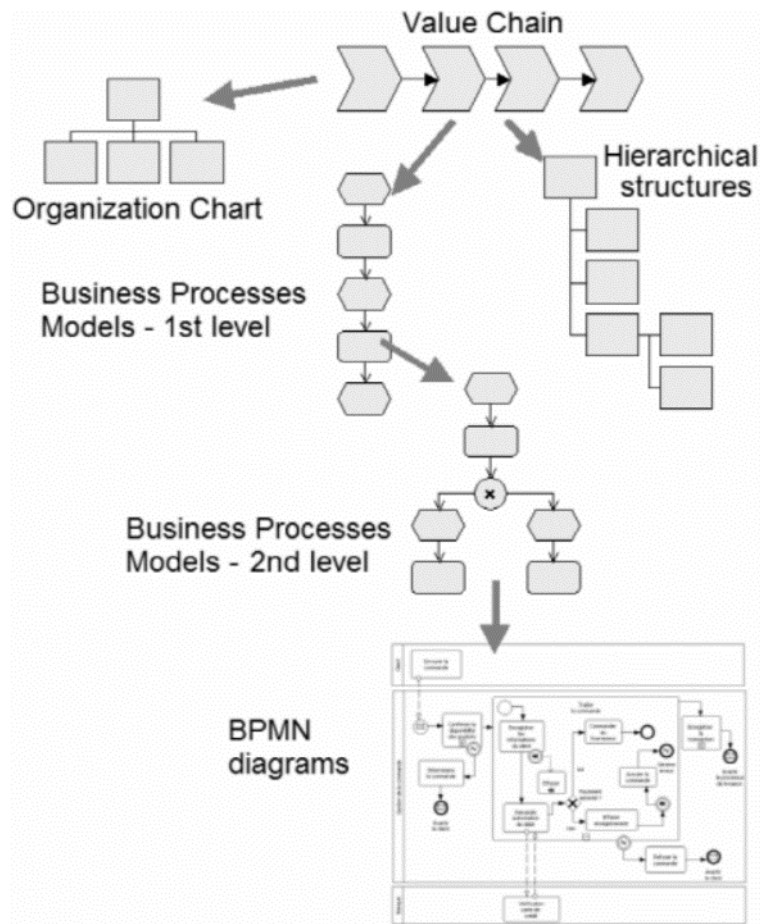
Figure 116 : The steps composing the MACTOR process to evaluate stakeholders' interactions and their impact on the system development. Adapted from (Godet, 2007)

- Modeling activities

Models exist allowing modeling activities of the “Enabling System”. One of them is BPM (Business Process Model), it aims to model elements that drive businesses from finance and resource usage to production and activities localization (Briol, 2008) with the help of different types of diagrams. In (Briol, 2008), 4 types of diagrams are described in BPM. These 4 diagrams are supposed to represent the value chain of a company.

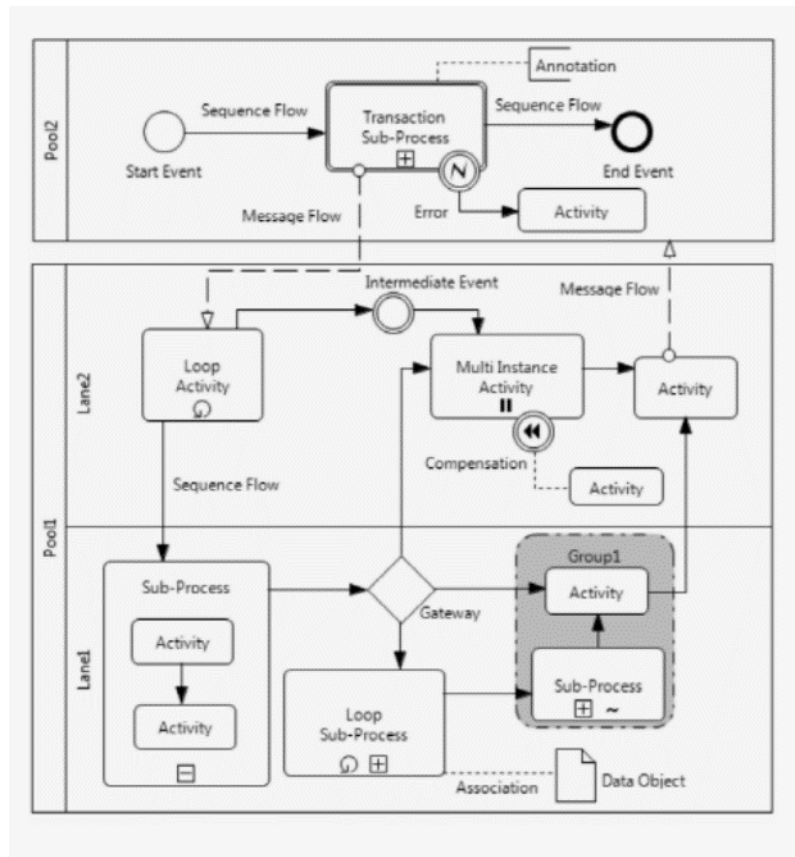
- The Business Process diagram describes the logical and chronological sequences of activities;
- The Value Chain diagram depicts a macroscopic view of the value creation within the organization;
- The Organization chart represents the hierarchical organizational structure;
- The Business Rules sheets define the applied rules and policies within the organization.

These 4 diagrams are represented in Figure 117 :



**Figure 117 : The BPMN diagrams and processes to model companies' organization and businesses. (Briol, 2008). The value chain can be described with the Organization chart, the Hierarchical structures and Business processes. BPMN diagrams are used to model the business processes at different systemic levels.**

Like SysML, BPMN models use a formalized language to describe processes: BPMN (Business Process Model Notation). Graphical elements of BPMN constituting BPD (Business Process Diagrams) diagrams are summed up in Figure 118:



**Figure 118 : Graphical objects used in a BPD (Briol, 2008). This figure described the representation language used in BPMN diagrams.**

The most used diagram is the Business Process diagram. This type of diagram is used to model activities in an organization, inputs and outputs of modeled activities and its participants.

- Modeling project resources

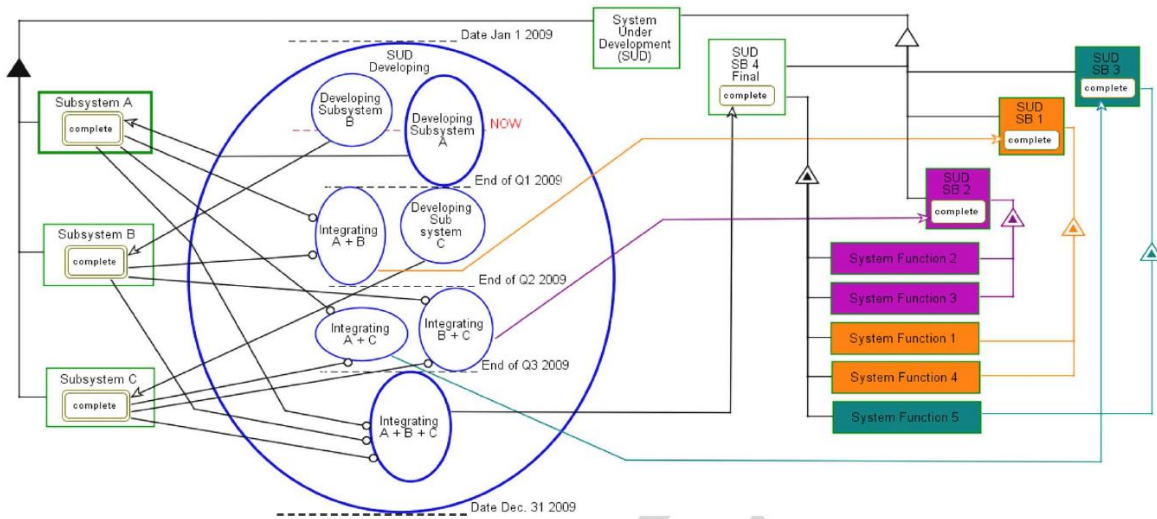
As far as our researches have led us, there is no language like BPMN or SysML dedicated especially for resource management. However, block diagrams in SysML used to describe composition of systems could be used to model components and resources of the Enabling system as well as interactions between them.

#### **2.4.6.3. Modeling both the system of interest and the enabling system**

Some authors have developed modeling tools to model both the Enabling System and the System of Interest.

- The PPLM approach (Sharon & Dori)

Sharon and Dori in (Sharon & Dori, 2012) and Dori in (Dori, 2008) have developed a Model-based approach which integrates both modeling of the product architecture (System of Interest) and the project architecture (Enabling System) (Figure 119). Their model enables expression of functions, structure and behavior of the product and expression of tasks, resources, deliverables and tools required for the project. The PPLM (Product-Project Lifecycle Management) method developed in their researches is based on a language called OPM (Object Process Methodology). Compared to SysML, this language integrates Project and Management ontologies. One singularity of OPM is that a single type of diagram is used to model product and project characteristics. Each diagram is composed of several diagrams which are obtained by zooming or unfolding in diagrams.

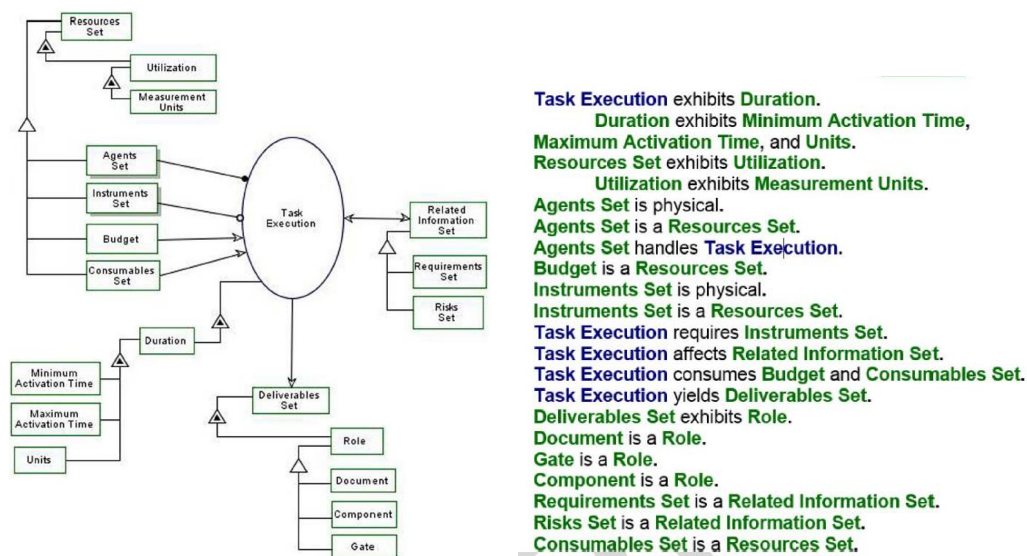


**Figure 119 :** Example of PPLM model of an SUD developing process (Sharon & Dori, 2012). This figure shows the System of Interest with its different subsystems (green sidebars on the left) and their functions (pink, orange and green sidebars on the right) as well as activities required for the development of the System of Interest (blue sidebars in the center) and interactions between the System of Interest and the Enabling System.

In their researches, Dori and Sharon highlight that “A framework and a process for integrating perspectives of a developed complex system with its corresponding project processes are clearly missing. [...] Relationships and interactions between architecture of products, their development projects, and the organizational teams involved, should be aligned in order for a company to become successful” (Sharon & Dori, 2012). Sharon and Dori also say that the development of complex systems is usually unique, it is all the more the case for construction systems.

- Project elements

In the PPLM method, projects elements are as Deliverables: documents (requirements documents, drawings, testing documents...), Gates (key milestones) and components (engines, payload, software...). Resources are decomposed in inputs (Budget and Consumable sets) and enablers (Human agents and Instrument). And resources utilization is modeled with activities which can be decomposed in tasks with their related activation time, duration and risks.



**Figure 120 :** OPM model of a generic project construct with its OPD (Sharon & Dori, 2012)

Compared to the Enabling System architecture defines previously, “Objectives” of the project are not modeled in the PPLM approach and deliverables and gates have been added in the architecture. We can also notice that required spaces to carry activities and tasks of the project are not mentioned in the PPLM approach whereas we will see in the next chapter that spaces required to carry tasks can interfere with spaces required for the system functioning.

- Product elements

Product elements are composed of functionalities and components of the system with their different hierarchical system levels. The notion of “needs” the product answers is not mentioned in the PPLM approach contrary to the architecture usually used in Systems Engineering.

The PPLM approach is similar to what we want to develop by introducing Constructibility in Functional Analysis and Systems Engineering methods. The model developed by Dori allows improving traceability, more reliable project plans and clarifying relationships between the project and the product.

- Architecture of the Manufacturing System (Benkamoun, Elmaraghy, Huyet & Kouiss)

Benkamoun, Elmaraghy, Huyet and Kouiss (Benkamoun, Elmaraghy, Huyet, & Kouiss, 2014) have developed an architecture framework which integrates architecture of the product and the manufacturing system (Figure 121). In their researches, they highlight that modeling the manufacturing system (its components and its functions) is a “key-enabler” for re-use in a changeable context. In other word being able to model the manufacturing system in one context allows re-using it in a different context by identifying changing elements. It is also interesting to note that the need to model the manufacturing system has risen from the fact that changes in production contexts is changing faster and faster. In the construction industry, the production context is always different. This another argument for modeling the Enabling System in the construction industry.

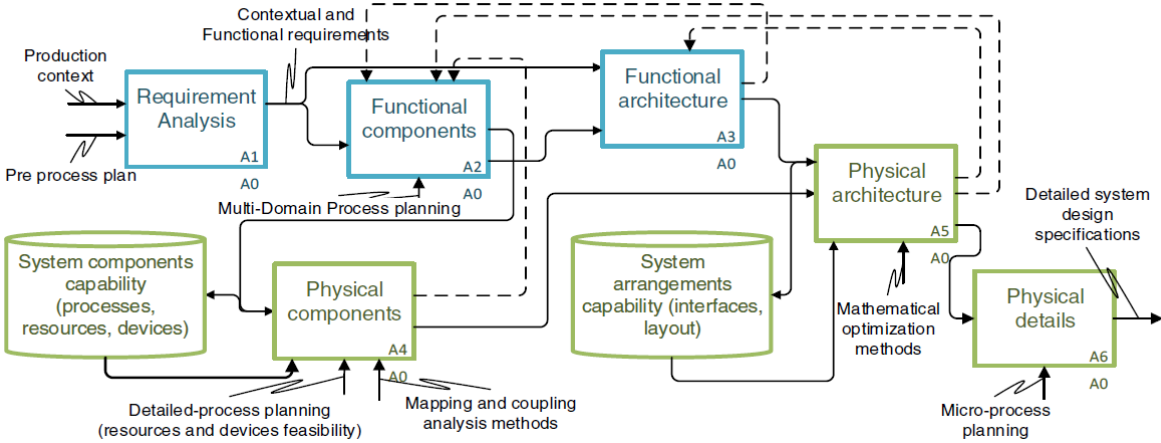
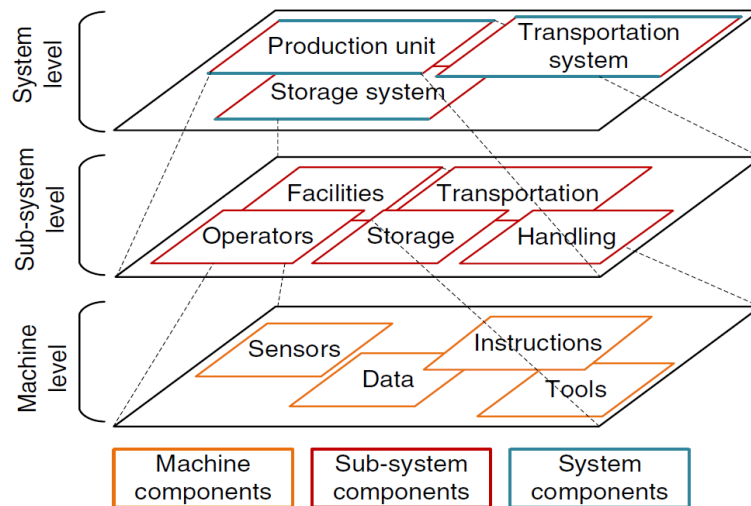


Figure 121 : IDEF0 – Manufacturing system design process with supporting system capabilities taxonomies (Benkamoun, Elmaraghy, Huyet, & Kouiss, 2014). This figure highlights the interactions between the System of Interest (in green) and some activities of the Enabling System (in Blue).

In their researches, Benkamoun & al. have defined three levels of hierarchy to architecture the Manufacturing system:





**Figure 122 : Physical hierarchical levels illustration (Benkamoun, Elmaraghy, Huyet, & Kouiss, 2014).** In this figure, different systemic levels of the Enabling System are represented. From the system level where production unit, transport systems and storage systems are modeled to the “machine” level where sensors, data, instructions, tools are modeled. It highlights that it is possible to model different elements of the Enabling system at different systemic levels and interactions between them.

Here again, space required for producing systems is not mentioned in the framework set up for manufacturing systems.

A taxonomy of manufacturing components is also presented composed of 5 classes (System layout, System control, Production unit, Storage system, Transportation system) and 18 sub-classes.

Contrarily to the framework previously defined only manufacturing processes are integrated in the framework and not design and planning activities.

#### **Improvement n°3:**

SysML and other standardized languages are useful to model both the System of Interest and Enabling Systems. It answers to the **Issue n°2** and **Issue n°3** by allowing a common representation of system elements and store, share, connect important amount of information and to modify, carry simulations and evaluate change impacts more efficiently.

Nevertheless, it is still required to assess if actual Model-based tools (such as SysML based-tools) are well adapted for the construction industry. The fact that development responsibilities are shared between different actors (client, design company and contractors) and the importance of spatial and geospatial characteristics which are not well represented in actual modeling languages used in SE are still to be addressed to evaluate the applicability of such tools in the construction industry.

#### **Issue n°15:**

The SysML modelling language and related tools have been developed for other industries than the construction industry. It is necessary to adapt SysML-based tools to the construction industry by integrating spatial considerations of systems and the specific organization of the sector.

## **2.4.7. Systems Engineering in the construction industry**

### **2.4.7.1. Application of SE concepts and principles in the construction industry**

In the INCOSE handbook, the construction industry and more precisely infrastructures are mentioned as a sector which can potentially benefits from the application of SE: “*Within infrastructure many of the engineering*

disciplines (e.g., civil, structural, mechanical, chemical, process, electrical) have well-established, traditional practices and are guided by industry codes and standards. SE practices are more developed in the high-technology subsystems” (INCOSE, 2015). The main benefit from its application lies in its capability to ease integration of complex systems; “The benefits of SE to the infrastructure domain lies in the structured approach to delivering and operating a multidisciplinary, integrated and configurable system and needs to align with the associated project management practices.” (INCOSE, 2015)

Emes (Emes & Marjanovic-Halburd, 2012) and Whyte (Whyte, 2016) highlight that Systems Engineering principles, concepts and guidelines are not being used and studied very widely neither in construction projects and researches.

Whyte in (Whyte, 2016) gives a state of the art of the most recent researches related to the application of Systems Engineering in the construction industry. She differentiates two types of researches related to Systems Engineering in the construction industry: the development and application of Systems Engineering in the construction industry (Table 11), and consequences of the use of SE on governance and policy of infrastructures projects (Table 12).

**Table 11 : Key research paper on engineering systems integration in civil infrastructures (Whyte, 2016)**

<b>Authors</b>	<b>Contribution</b>	<b>Focus, methods and cases</b>
(Baudains, et al., 2014)	Approaches to examining ‘hidden’ connectivity by treating the building as a complex adaptive system.	Buildings review
(Akanmu, Anumba, & Messner, 2012)	Cyber-physical integration through bi-directional coordination of virtual models and physical construction so changes in one are reflected in the other.	Buildings/virtual models: systems architecture and application scenario
(Geyer, 2012)	Parametric systems modelling approach to sustainable building design, complementing IFC and XML standards that address information by seeking to represent multidisciplinary dependencies for performance-oriented planning, exploring the possible variations physical–technical interdependencies.	Buildings: MBSE using SysML modelling as a basis for integrating design.
(Shen, et al., 2010)	Focus on integration of two or more construction software systems to communicate share or exchange information, and then to inter-operate in order to achieve a common objective. This is considered from the perspective of data and frameworks interoperability.	Software: Review of research on construction software integration.
(Tao, Zophy, & Wiegmann, 2000)	Asset management model and systems integration approach to integrate asset management of components at different stages of their development life cycles. Business, system requirements, logical design, physical design, development and implementation considered to ensure interoperability and effective asset management.	Data: Developed asset management model and operational scenario tool.
(Zhu & Mostafavi, 2015)	Prospective identification of vulnerability to uncertainty through analysis of construction projects as networks. Uncertain events impact through perturbation of nodes (humans,	Resilience: Dynamic network analysis and Monte Carlo

	information, resource, tasks) and their links, changing topological structure with negative effects on project efficiency. Extent of variation is used to indicate vulnerability across different scenarios.	simulation; worked example of a tunneling project.
--	--	--

**Table 12 : Key papers on systems integration policy and governance in civil infrastructure (Whyte, 2016)**

<b>Authors</b>	<b>Contribution</b>	<b>Focus, methods and cases</b>
(Bouch, et al., 2015)	User-infrastructure interdependencies: research on new infrastructure business models (called iBUILD) including local business opportunities deriving from high-speed rail, proposing novel business models as ‘enabler’ in “complex multiply-conflicting future city agendas”.	Policy: MBSE, cor9 modeling from infrastructure 2013 as a key policy documents
(Davies, Gann, & Douglas, 2009)	Drawing on innovation the strong tradition of work on complex projects that has examined the business of systems integration.	Innovation studies, case studies: Heathrow Terminal 5; London 2012 Olympics
(Lundrigan, Gil, & Puranam, 2014)	Argues that megaprojects are organizations that are composed of other organizations (i.e. meta organizations) and have two structures: a “core” that shares control over goals and high-level design choices and a “periphery” that is the supply-chain that delivers but lacks authority to change high-level goals and design choices.	Complex projects: London 2012 Olympics
(Miller J. , 1997)	Optimization of project delivery and finance organizations at project and system levels based on analysis of more than 3000 infrastructures projects in the US and Hong Kong; detailed case of multimodal transportation facility.	Finance: Large set of projects; USA transportation case
(Naderpajouh, 2014) (Hastak, 2014)	Modelled emergent dynamics and risks in institutionally complex projects (understood as systems of systems) that involve international organizations, public and community groups. Methodology proposed and applied to cases of social opposition in infrastructure: Stuttgart 21; dams: Belo Monte Dam (Brazil), Bujugali Dam (Uganda); and pipelines: Keystone (N. America), Nabucco (Central Asia and Europe).	Policy: Mathematical model of risk based on theory bargaining games. Examples focus on hydroelectric projects
(Winch, 1998)	Innovations systems and questions about identification and role of the “systems integrator” in construction.	Innovation studies: construction as a complex systems industry

(Matar, Osman, Georgy, Abou-Zeid, & El-Said, 2015)	SysML model for sustainability in infrastructure involving 1) Natural systems that make up an environment SoS, the atmosphere, lithospheric system (material, resources); hydrosphere; biosphere and energy; 2) construction product SoS, architectural, structural, mechanical, electrical; 3) Business management, design management, project planning and management, construction and facilities management.	Infrastructure: MBSE using SysML modelling
--	--	--

The main topics studied in integration of Systems Engineering in the construction industry are: review techniques, software interoperability, MBSE, Asset Management and resilience of construction systems. However, particularities and adaptations of Systems Engineering for the construction industry has not been studied in the State of the art described by Whyte and is one objective of this thesis.

Whyte (Whyte, 2016) also presents 8 tools used to implement Systems Engineering methodologies (General Theory of Systems Integration (GTSI), DSM (Design Structure Matrices), STAMP (System Theoretic Accident Model), SysML (System Modeling Language), Systems Dynamics, Network Analysis, Montecarlo Simulation and Scenario Planning). She also indicates that only 5 of them have been used in civil infrastructures: SysML, Systems dynamics, Network Analysis, Montecarlo Simulation and Scenario Planning. In the next chapter, two of these tools, a SysML based tool to model requirements for infrastructures and a DSM matrix integrating Constructibility criteria will be presented more in detail.

From an operational perspective, Systems Engineering has been used successfully in several construction projects such as: the Øresund bridge between Malmö and Copenhagen (INCOSE Infrastructure Working Group, 2012) and the Heathrow Terminal 5 and London Olympics (Brady & Davies, 2014).

Aslaken in (Aslaken, Knight Merz, & Leonards, 2005), highlights that the application of Systems Engineering in the construction industry is more complicated because projects are very often (and almost always) separated between different stakeholders with different contracts between the concept (planning), design, construction and operation phases. The main consequence being that each actor is more inclined to promote its own objectives instead of the project success. As instance in France, design companies are remunerated by a percentage of the project works, it implies that the more a project is costly the more the design company earns money. From its own perspective, a design company would better design a costly project whereas it is of course at the opposite of the contracting authority objectives. Aslaken also says that new forms of contracts like “alliancing” where all stakeholders are together from the very beginning to the end of the project and where “pain and gain” are shared between all would potentially resolve the situation and would enable a better application of Systems Engineering.

- Obstacles for the application of Systems Engineering in the construction industry

In (Van den Houdt & Dr Vrancken, 2009) Van den Houdt identifies 9 categories of factors which explain difficulties of implementation of SE in the Dutch construction industry. These 9 categories are spread in two groups: Management and organizational factors and Project context:

- Management and organizational factors

Management and organizational factors are composed of 7 categories: **strategy** (clarity of mission, vision and objective of SE, support from higher management, level of agreement and understanding of SE), **Structure** (clarity of roles and responsibilities, association between SE and Project Management principles, Representation of supporting processes in the project management team, coordination between interdisciplinary organization), **Culture** (support from project management teams, level of support for SE from individual employees, Acknowledgement of the learning process by employees), **People** (Availability of SE manager, Skills and

competences of SE managers, Individual experience with SE), **Resources** (Resources availability for the application of SE, Resources availability for SE development, level of managerial support provided by SE managers, availability and quality of SE tools in the organization, availability and quality of SE document and training, Knowledge Management tools, Alignment between KM tools between disciplines, projects and stakeholders, Awareness and usability of the knowledge management tools), **Results** (benefits of applying SE, perceivable benefits of applying SE, level of evaluation and feedback from SE in projects) and **Interfaces** (Continuous identification of interfaces, Up-to-date formulation of interfaces in accessible environment, Regular and scheduled interface meetings including all stakeholders).

- Project context factors

Project context factors are composed of 2 categories: **Project** (Level of freedom in project arrangements, Project team composition, Job happiness and internal pressure, Project task (size / complexity), Contract arrangements) and **Context** (Overall SE skills and competencies of client (experience and expertise), Overall SE skills and expertise of subcontractors / suppliers, Applicable industry standards and legislation, Relationship with client (trust)).

From the evaluation of these factors in 4 case studies in the Royal BAM group, Van Den Houdt has identified 6 key problems area for the implementation of Systems Engineering in the construction industry.

**The client knowledge about SE:** when the client is not used to SE processes and concepts he sometimes provides an incomplete set of requirements or defines directly organic requirements instead of functional requirements. It implies a lack of freedom to the contractor. The large amount of regulations laws is also mentioned as a factor which alters freedom of the contractor.

**Standardization:** the absence of standardization in the construction sector is mentioned as a brake to the implementation of SE. Notably because it implies more efforts for the realization of V&V processes and tools interoperability. The involvement of a large number of stakeholders (like subcontractors and suppliers). This key problem is another reason for the development of standards in the construction industry and is another argument to support the development of BIM (Building Information Modelling).

**Limited knowledge sharing and updating within the organization:** no time is usually allocated to SE managers to gather and update knowledge. SE managers also don't have the time for feedbacks and analysis evaluations. The usability of knowledge required for SE processes is outdated implying low involvement of employees.

**SE expertise not involved:** there is lack of SE managers in the construction industry. Most of project managers and teams usually even don't know the existence of the scientific methodological corpus. When used, SE can also be applied in a wrong way amplifying a negative reputation of such methods.

**Poor management of interfaces within the SE lifecycle:** works done in silos in project team is a big obstacle for the application and development of SE within a project. The different interpretations of interfaces between designers and contractors is also negatively impacting the application of SE. Early exchanges between these two stakeholders would have a positive impact. This is exactly the objective of constructability. The development of SE as a separate process has a negative effect and causes resistance among employees (change management).

**Insufficient perceivable benefits:** most of the employees don't see the benefits of SE. More education and teaching is required within civil engineering organizations to promote and show benefits of the application of SE principles and concepts.

- Adaptation of the Vee Model

Another conceptual tool of Systems Engineering which has been adapted to the construction industry is the "vee model":

Notably, the Infrastructure Working Group of INCOSE proposed another form of the Vee model (Figure 123):

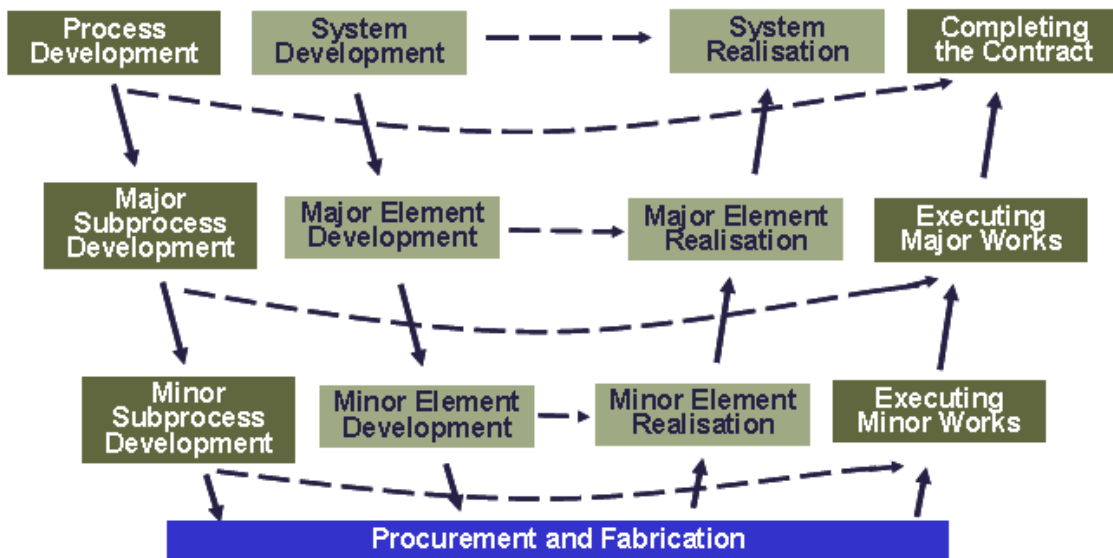


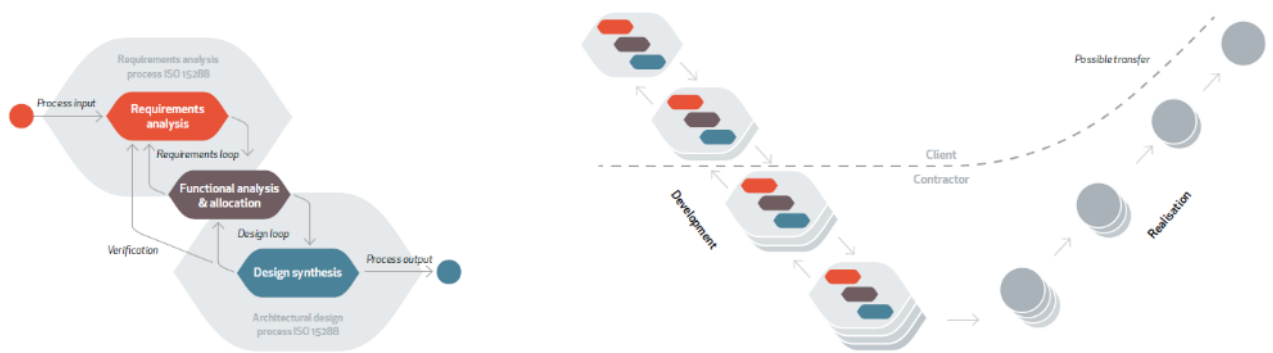
Figure 123 ; Adaptation of the Vee model for Infrastructures (INCOSE Infrastructure Working Group, 2012). Particularity of this Vee cycle metamodel is the representation of the processes and subprocesses required to develop elements of the system in both branches of the Vee cycle.

The Vee model developed by the Infrastructure Working group of INCOSE has the particularity to be duplicated:

- In the left branch between elements from the system to develop and elements from processes.
- In the right branch between elements to realize and assemble and the execution of the works necessary for its realization.

The bottom of the Vee concerns procurement and fabrication phases.

In the Netherlands, another adaptation of the Vee model for infrastructures have been defined (Prorail, Rijkswaterstaat Ministerie van infrastructure en Milieu, Vereniging Van Waterbouwers, Bouwend Nederland, Uneto Vni, NLingénieurs, 2009). In this model, each phase of the Vee (which corresponds to one systemic level) is decomposed in 3 steps: Requirements analysis, Functional Analysis and allocation and Design synthesis. Feedback loops between these 3 steps allow verification of the model. It is not far from the three architecting views (Operational, Functional and Organic) defined by Krob (Krob, 2009) at each systemic level. Operational analysis is replaced by Requirements Engineering and Organic analysis by Design synthesis. It is also the only representation which integrates at the same time the Vee Model and the three architectural views of Systems Engineering.



**Figure 124 : The Vee model in the Dutch infrastructure industry (Prorail, Rijkswaterstaat Ministerie van Infrastructuur en Milieu, Vereniging Van Waterbouwers, Bouwend Nederland, Uneto Vni, NLIingénieurs, 2009). In this Vee cycle metamodel developed by the Dutch, there is no specific representation of the Enabling System however, the requirement engineering phase, functional analysis phase and design phase are represented at different systemic levels.**

#### **2.4.7.2. Systems Engineering and Building Information Modeling (BIM)**

In (buildingSMART, 2017), the International organization for the development of BIM standards, it is stated that it is essential from an Asset management perspective for infrastructures to “understand why an asset exists, what functions it performs, what technical specification does it satisfies and how it is constructed”. Meaning that information delivered to operators after the system is built should follow the System Architecture defined in this chapter (needs, functions, components).

In the construction industry, actual developments of models and “MBSE” take the name of “BIM” (Castaing & Tolmer, 2015) which stands for Building Information Modeling. We can find the following definitions of BIM in the literature “With BIM technology, an accurate virtual model of a building is constructed digitally” or “we define BIM as a modeling technology and associated set of processes to produce, communicate, and analyze building models” (Eastman, Teicholz, Sacks, & Liston, 2008). Similar to MBSE, one main objective of BIM in the construction industry is to shift from a paper-based to a model-centered working method.

BIM models are characterized by (Eastman, Teicholz, Sacks, & Liston, 2008):

- Building components with data attributes and parametric rules;
- Components that include data that describe how they behave as needed for analyses and work processes;
- Consistent and non-redundant data;
- Coordinated data such that all views of a model are represented in a coordinated way.

We can already notice that in the previous description of BIM models, functions of the system or needs it is supposed to answer are not integrated in the modeling scope where it is in other MBSE approaches as SysML.

BuildingSmart International, the worldwide organization in charge of the development of open international standards defines the 3 standards of BIM: data model standards (IFC), Data dictionary standards (IFD) and processes definition standards (IDM) (Figure 125).

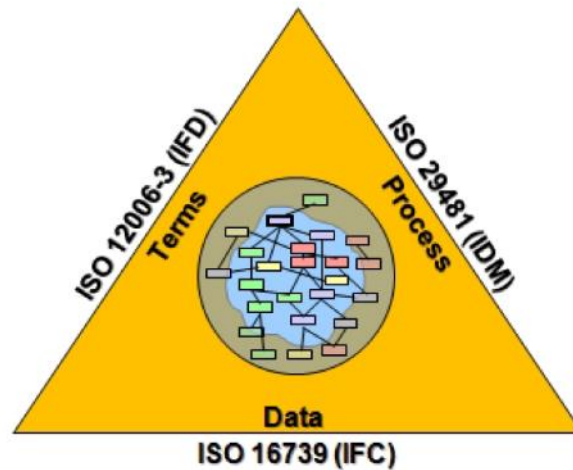


Figure 125 : The 3 pillars of BIM open and standardized (Building Smart International, 2018)

Considering this definition and past descriptions of model-based methods described in SE, BIM only allows the description of the organic view of Systems Engineering. Functional and operational views are not described by BIM modeling tools and standards at the moment. Objects are first defined by their geometry and not their function(s). Even if attributes can be added to BIM objects it does not constitute a functional model of the system: hierarchy of functions and their relationships are not represented. This is problematic as if an object is changed, or if a function is changed, there is no possibility to evaluate with accuracy impacts on the functions of a construction system and even less to the needs it answers. A functional and operational BIM model of the construction system would be necessary to match with SE methods.

In the following paragraph, we will present some of the BIM concepts and we will evaluate how they can be linked with MBSE and Systems Engineering methods.

Tolmer in (Tolmer, 2016) uses Systems Engineering principles to structure information through the definition of Conceptual Data Model, Information Delivery Manuals and “BIM uses”. The definition of Data Dictionary can also benefit from Systems Engineering principles.

- Conceptual Data Model (CDM) and Systems Engineering

A Conceptual Data Model (CDM) is a representation of the structure of an information system from a data point of view and also defines relations between data (Zoghiami, 2013). It is an abstract and/or logical representation of data in a domain or an information system, (Arthaud, 2007).

In (Tolmer, 2016), Tolmer highlights that abstraction is one of three main axes in modeling is abstraction (the two others being discourse and formalism). Abstraction is at the core of CDM and allows managing complexity.

Abstraction is also a fundamental concept of Systems Engineering. More precisely, architecting a system by defining its Operational, Functional and Organic elements is to realize an abstraction of the system. Therefore, architecting activities in Systems Engineering is one way to realize a CDM of the system in order to manage its complexity.

- IDM (Information Delivery Manual), IFC (Industry Foundation Class) and Systems Engineering and IFD (Data Dictionary Standards)

IDM describe information exchanged and how they are shared between stakeholders in construction projects. It allows defining in detail availability and quality of exchanged information. IDM describe information utilization steps all along the project (Tolmer, 2016). An IDM is composed of a BPMN representing flows of information



between stakeholders and a Data Dictionary which details properties of BIM objects. Information exchanged between stakeholders being the BIM objects properties.

buildingSMART Data Dictionnary (bSDD) objective is to standardize objects and their attributes (buildingSMART International, 2018) i.e. the definition of IFC. Its purpose is to allow all stakeholders of the construction to speak the same language and that *“a door in Iceland means the same thing than a door in India”*. Benefits of bSDD are to improve interoperability between software used in the construction industry and hence improve quality by using reusable shared object libraries, provide definition of objects with their properties to all software editors worldwide, allow automatic rule checking, avoid miscommunication and data duplication, extend property sets for the verification of specific requirements and add new classification requirements (buildingSMART International, 2018).

BPMN considered as a “functional view” of the enabling system as activities of the project are represented with flows of information. Activities are represented without neither defining how they should be carried out neither the required resources to carry these activities which would be the organic view.

Initially, IDM is an initiative of BuildingSmart® International to define IFC (Industry Foundation Class) more realistically (BuildingSmart International Alliance for Interoperability, 2007). IFC is a standardized format to describe BIM objects in order to enhance interoperability between BIM software (Arthaud, 2007). IFC is the standard used to model construction systems. Finally, to define IFC (i.e. modeling the system of Interest) properly and realistically, it has been necessary to model activities of the Enabling system in order to associate appropriate properties and attributes to BIM objects.

However, in the definition of IFC only the organic view of the construction system is considered i.e. what systems are composed of, as if a construction system doesn't have functions whereas we have shown in this thesis the contrary. IFC models don't allow neither operational neither functional views of construction systems. Current developments of IFC don't describe environment of the system. Therefore, operational and functional requirements cannot be verified with IFC at the moment: objects representing functions and needs of the system do not exist. The development of new types of IFC would be necessary to carry this type of analysis.

One reason may be that the development of BIM has started from modeling low abstraction level objects in 3D and interactions between them. However, modeling needs cover broader needs than only 3D objects, as instance for a metro system: operation models, socio-economic models, traffic model and many more. One important contribution of Systems Engineering is the necessary integration of these different models of different level of abstractions to evaluate more easily impacts of top-down and bottom-up changes and modifications in projects (which are the norm in the construction industry). Therefore, Systems Engineering principles allow to improve interoperability between tools: architecture of systems, the decomposition of the system in subsystems allow to define which modeling tool must be used at which step.

- BIM uses and Systems Engineering

Another interesting contribution of Systems Engineering for BIM is the definition of “BIM uses”. In MINnD (Modélisation des INformations iNtéropérables pour les Infrastructures Durables) a French research group on the application of BIM in infrastructures, Systems Engineering has been identified as a method to define “BIM uses” especially for infrastructures (MINnD, 2016).

In the BIM Project Execution Planning Guide from Penn State University, the following definition of BIM use is given: *“BIM Use is a unique task or procedure on a project which can benefit from the integration of BIM into that process”* (Pennsylvania State University, 2010).

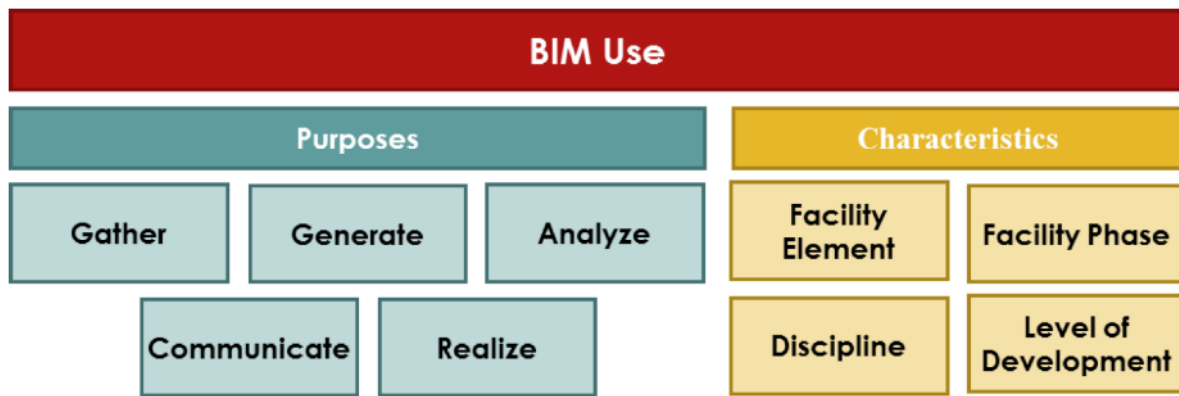


Figure 126 : The components of a BIM use (Kreider & Messner, 2013)

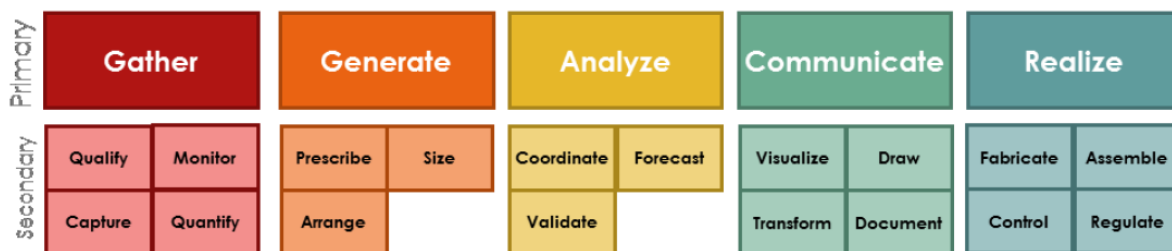


Figure 127 : The BIM use Purposes and secondary purposes (Kreider & Messner, 2013)

In Figure 126 different categories of BIM uses have been defined for different purposes: BIM and modelling activities can be used for *Gather*, *Generate*, *Analyze*, *Communicate* and *Realize*. Each of these purposes have been divided in sub-classes (Figure 127).

- Gather (capture, quantify, monitor, qualify): these types of BIM uses concern the collect and gather of information about a facility.
- Generate (prescribe, arrange, size): create information about the utility (location, needs, scale)
- Analyze (coordinate, forecast, validate): model, simulate and verify characteristics of the facility;
- Communicate (visualize, transform, draw, document): Exchange information between stakeholders;
- Realize (fabricate, assemble, control, regulate): control that the built system answer to defined requirements

Contribution of Systems Engineering and more precisely of Requirements Engineering consists in considering MBSE (and therefore BIM) as a way to better verify and validate requirements of the system. As instance modelling and management of requirements is not considered in the categories of BIM uses (see §2.4.1.6 for more information about Requirement Engineering and management) described explicitly in BIM Project Execution Planning Guide from Penn State University whereas it is a fundamental modeling activity in MBSE.

From another perspective, MBSE has also a lot to learn from BIM and its utilization. As instance, information gathering activities are not mentioned in MBSE while they are an important part of BIM.

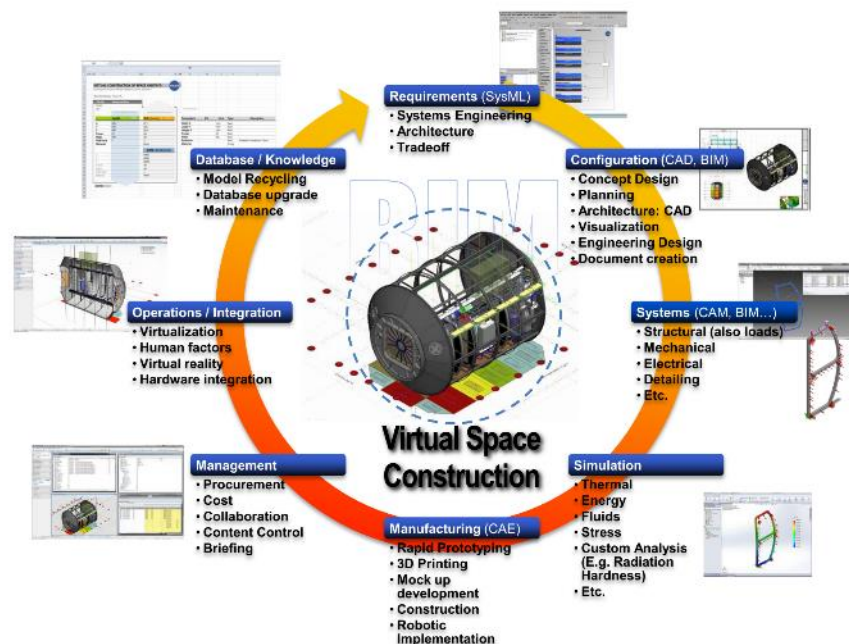
- Combined use of BIM (Building Information Modelling) and MBSE (Model-Based Systems Engineering)

Several authors have developed tools which combine the use of BIM models and SysML models for different purposes.

On the other hand, BIM authoring platforms can effectively model geometric and spatial requirements. Modelling other views of the system, such as the requirement diagrams, allows working simultaneously on both the geometric and metadata levels. Geyer in (Geyer, 2012) has developed an interactive Parametric System Modeling (PSM) diagram where requirements are modelled in SysML and integrated in a BIM model developed in Revit. In such an integration the objects are both in the BIM model and in the SysML model; changes in one model are updated in the other one supporting the design review process. Valdes et al (Valdes, Gentry, Eastman, & Forrest, 2016) also proposed a system-based and knowledge-aided modelling framework that integrated a BIM authoring platform with a system modelling one. Their aim was to create a formal link between domain-specific knowledge and geometry in order to ensure the compliance of design proposals against design requirements.

Matar in (Matar, Osman, Georgy, Abou-Zeid, & El-Said, 2015) uses Systems Engineering in order to build more sustainable infrastructures. Because sustainability implies more integrated systems with their environment, it implies also more interactions and therefore more complexity. The combined use of Systems Engineering and BIM is a way to manage more efficiently this new complexity. Matar, distinguishes 3 system models; the environment, the construction product and the production system. The distinction between the construction product and the production system is close to the concept of constructability presented before in this thesis. In this example, SysML is used to define parts of the different systems (with a block diagram), activities undertaken as well as flow of resources which highlight that the Enabling System can also be modeled with SysML in some extent. Matar also says that the use of a BIM database coupled with SysML would allow “*dynamic and systems level evaluation*”.

In (Polit-Casillas & Howe, 2013), Polit-Casillas uses a combination of BIM tools to model geometry of a space habitat to a SysML base tool allowing to model requirements related to geometry of the space habitat in order to better manage complexity of the design. He also considers potential links with other types of software like CAE (Computer Aided Engineering) or CAM (Computer Aided Manufacturing) (Figure 128). Polit says that the combination of BIM and SysML would be of great interest not only for the construction industry but as well in the aerospace sector to model links between geometrical information and other types of information (such as requirements).



**Figure 128 : Lifecycle of aerospace hardware development potentially covered by a virtual space construction process (Polit-Casillas & Howe, 2013). In this approach, a combined use of SysML to model requirements and a BIM model have been used for different modelling purposes.**

**Improvement n°3:**

The combined use of SysML-based tools and BIM models answer to **Issue n°4**. By allowing to trace requirements with elements of BIM models, it is possible to check more easily (or at least to trace) if objects modeled in BIM models fulfil defined requirements. In other words, to check if the solution developed is consistent with functions defined in the Functional Analysis (and more generally to requirements).

The SysML-based tool we have developed as part of this thesis presented in the next chapter is also a combined use of SysML and BIM models.

**Issue n°16:**

Currently, spatial elements are not considered or even stated in Systems Engineering methods. As space is central in for construction systems it is necessary to define how space should be integrated in SE in particular in architectural views.

**Lessons learn**

Analysis of the literature shows that only few has been done on the application and adaptation of Systems Engineering in the construction industry and that no connections have been made between the Systems Engineering corpus and the Constructability corpus. Functional Analysis has been used and applied in the construction industry but mostly when the infrastructure/building is under operation for risks analysis and not much for the design of new products. It shows that joining these 3 methodological corpuses is potentially rich for its application in the construction domain.

In this part we have presented the main methodologies to carry Functional Analysis and tools with a focus on the MISME/APTE® method. The MISME method has the advantage of giving an operational method to carry Functional Analysis in projects to identify, define and characterize needs and functions of a system. However, this method needs to be adapted to be used in complex construction projects which has led to the definition of 7 objectives to improve and adapt Functional Analysis.

To fulfil these objectives, two methodological corpuses have been investigated, constructability which defines, principles, concepts and criteria to better consider the production/construction constraints in design and planning phases. And Systems Engineering which offers tools and methods to better manage complexity of projects. These methodologies have different objectives which are both useful and even essential to apply Functional Analysis to the construction industry: management of complexity and consideration of production constraints. Analysis of these methodological corpuses has allowed to fulfil 4 of the 7 objectives identified (objectives 1, 2, 3 and partly 5). Other objectives will be reached by extending actual methods in the following part.

Moreover, Systems Engineering and Constructability would also benefit from the enrichment of Functional Analysis. In the next part, we will focus on the definition of an integrated methodology using concepts, principles and tools from Functional Analysis, Systems Engineering and Constructability.

Finally, a total of **16 issues** have been identified in the 3 methodological corpuses to develop an integrated and adapted method for the construction industry. In green are objectives reached and in orange, objectives partly reached by the analysis of SE and Constructability:

**Table 13 : Issues identified in the State of the Art**

Issues	Description
<b>Issues answered by Constructability and Systems Engineering</b>	

Issue n°1	The first issue identified in the application of Functional Analysis is the need of a “meta-model” in which the method will be applied in order to give the systemic framework in which different the different Functional Analysis steps are carried from planning at the system level to realization of components.
Issue n°2	The second issue consists in the lack of a common language to describe system elements in Functional Analysis: functions, parts of the system, how elements of the system are in interaction. This common standard would allows improving communication between stakeholders but is also better “understandable” by computers in order to automatize verification of functions or to manage functions of the system during its development.
Issue n°3	In the MISME method functions and functional requirements are described with documents, i.e. with a paper-based method. In complex projects where numerous functions are defined, it becomes very hard to ensure that the future system fulfill all defined functions. For these kind of projects which is sometimes the case for buildings and almost always for infrastructures, it is necessary to shift from a paper-based approach to a model-based approach.
Issue n°10	A tool might be necessary to model Constructability requirements in order to improve their management, their traceability and facilitate their verification. Particularly for complex projects where there is a numerous number of constructability requirements.
<b>Issues partially answered in Systems Engineering and Constructibility</b>	
Issue n°5	The current Functional Analysis method doesn't explicitly consider constraints from Enabling systems at the different stages of development. There is a need to improve Functional Analysis methods to better integrate constraints and objectives from Enabling Systems required for the product development from planning to design, realization, verification and commissioning phases.
<b>Issues to investigate in the next part</b>	
Issue n°4	It is required to verify if solutions developed answer to functional requirements, particularly for complex systems with numerous elements and functions. The current paper-based Functional Analysis method doesn't allow such verification in an efficient and easy way.
Issue n°6	Define what are “ <i>spatial characteristics</i> ” of construction systems and identify how and when they should be considered in Functional Analysis methods and its different steps.
Issue n°7	The seventh issue consists in defining how the method can be applied at different systemic levels, how to define interactions between different systemic levels and to identify the redundant information between system elements at different systemic levels (if there are).
Issue n°8	It is not clear when and how Constructability concepts and practices should be applied in the design process of a construction system. It is required to define more precisely

	the development workflow of construction systems and define exactly when and how they should be considered by project stakeholders, particularly in the workflow of the Functional Analysis method.
Issue n°9	Currently, it is not explicit how Constructability criteria are defined and chosen at each step of the development process. A method or a rule is required to define the appropriate constructability criteria at the appropriate phase of the project.
Issue n°11	Nothing has been developed to evaluate several constructability criteria at the same time and related to different project phases and systemic levels. Develop a constructability tool to evaluate and make decisions related to constructability of construction systems at different phases and different systemic levels is required.
Issue n°12	Current definition of constructability considers only production/realization constraints and not all constraints related to all Enabling Systems such as planning and design constraints. It is necessary to push forward the Constructability concepts and practices to consider constraints from all Enabling Systems from planning to commissioning.
Issue n°13	Systems architecture gives concepts to architecture a system, however it is not mentioned how to integrate it in a project workflow and what are the steps to follow to architecture a system, which tools to use and task to carry.
Issue n°14	Relations and interdependencies between the System of Interest and the Enabling Systems are not clear and defined precisely. A method to identify and analyze such interdependencies is lacking.
Issue n°15	The SysML modelling language and related tools have been developed for other industries than the construction industry. It is necessary to adapt SysML-based tools to the construction industry by integrating spatial considerations of systems and the specific organization of the sector.
Issue n°16	Currently, spatial elements are not considered or even stated in Systems Engineering methods. As space is central in for construction systems it is necessary to define how space should be integrated in SE in particular in architectural views.

It has also been identified that the concept of constructability requires to be extended to consider not only constraints from the “production/execution” phase but also constraints from other parts of the Enabling System: planning, design, verification and commissioning phases. How, why and when to define and use constructability criteria is also not clear in the constructability corpus, the application of Functional Analysis methods could in this objective.

The Issue n°6 (consideration of spatial characteristics of systems in Functional Analysis), has not been investigated neither in Systems Engineering neither in Constructability corpuses. In the next parts, further methodological elements will be presented to better manage spatial complexity of systems which is at the heart of construction products problematics.

<b>Design methodologies</b>	<b>Advantages</b>	<b>Disadvantages</b>
-----------------------------	-------------------	----------------------

<b>Functional Analysis</b>	Optimization of products, re-engineering, operating reliability, easy to use.	Not adapted for complex projects. Is not an innovation oriented method.
<b>Systems Engineering</b>	Allows managing complexity of products development.	Requires more resources. Is not an innovation oriented method.

**Table 14: Comparison of Functional Analysis and System Engineering methodologies**

### **3. Enrichment of Functional Analysis to the construction industry through Systems Engineering and Constructibility integration**

---





## Résumé de la partie en français

Dans cette partie nous présentons la méthode d'Analyse Fonctionnelle enrichie par la Constructibilité et l'Ingénierie système. 2 outils sont aussi présentés permettant de mettre en œuvre la méthode : la matrice de Constructibilité inspirée des matrices QFD présentées précédemment et d'un outil de modélisation des exigences, Exegis.

Néanmoins, avant de pouvoir intégrer l'Ingénierie Système il est nécessaire de l'adapter au domaine de la construction. Pour cela nous présentons comment intégrer la dimension spatiale dans ces méthodes. Notamment, nous montrons que l'espace peut, et doit, être pris en compte à toutes les étapes d'analyse : dans les 3 vues d'architecture système (Opérationnelle, Fonctionnelle et Organique) et à tous les niveaux systémiques. Cette prise en compte doit pouvoir se retrouver dans les outils d'implémentation et donc dans le langage SysML par exemple, nous proposons ainsi différentes manières de prendre en compte l'espace dans ces langages, certaines étant inspirées de la littérature. Nous montrons aussi que l'espace doit être pris en compte dans les éléments du système pour faire et que ces espaces peuvent être en conflit avec des espaces du système à faire voire peuvent impacter de nouveaux espaces.

D'autre part, nous adaptons aussi la *Constructability* en définissant un nouveau terme, la *Constructibility* qui consiste à analyser les interactions entre le Système à faire et le Système pour faire. Cette approche tirée de l'Ingénierie Système renforce les concepts de la *Constructability* en prenant en compte non seulement les contraintes liées à la réalisation du système (ce qui englobe donc la *Constructability*) mais aussi l'ensemble des contraintes liées au développement du système depuis les étapes de planification, conception, réalisation, tests, vérifications et exploitation. Cette approche holistique permet de mieux appréhender les conséquences des choix effectués sur l'ensemble du projet, du produit et de ses parties prenantes. Cette nouvelle approche a permis de mettre en place une méthode pour identifier et définir des critères de Constructibilité.

Finalement, nous présentons comment ces nouveaux éléments, adaptés pour nos besoins, peuvent venir enrichir l'Analyse Fonctionnelle. Nous proposons ainsi une nouvelle méthode adaptée aux besoins de produits complexes du domaine de la construction. Comme évoqué, la matrice de constructibilité permet d'analyser les interactions entre le Système à faire et le Système pour faire de manière efficace même si il reste beaucoup à faire sur la quantification des critères de constructibilité. Exegis, un outil de modélisation des exigences, permet de prendre en compte l'ensemble des exigences du projet quelles sont du système à faire ou pour faire. Dans le cadre de son développement nous avons rendu possible de faire des liens entre les exigences modélisées et les objets modélisés dans les maquettes numériques BIM (Building Information Modelling). Ces développements étant une première étape pour l'intégration des éléments spatiaux dans SysML et les outils de modélisation de l'Ingénierie Système.

In the last chapter we have presented Functional Analysis methods. In order to adapt Functional Analysis to the construction industry we have identified and presented two other methodological: Constructability which allows considering “realization constraints” early in the development process and Systems Engineering which allows better managing complexity of projects. 16 Issues have been identified: 7 Issues related directly to FA to apply it more efficiently to construction projects, 3 of them are directly answered by the analysis of the state of the art of other corpuses (mainly issues which are not directly related to particularities of the construction industry and required to be integrated in the method, the 4 others will be developed in this part. 11 Issues have been defined in the 2 other corpuses to integrate them in FA and to adapt to the construction industry. 1 of them is reached in the state of the art and the 10 others are developed in this part.

Essentially, to adapt previous methodologies to the construction industry, we integrate the two particularities of construction systems presented in the first chapter: construction systems are “localized” which means that the consideration of space must be integrated in the method, secondly that all construction projects are unique which requires précising the interactions between the system of interest and the enabling system leading to the consideration of constructability in Systems Engineering.

The “16 Issues” to Functional Analysis identified in the last chapter shapes the structure of part 3:

- **3.1. Adaptation of System Engineering and Constructability methods for the construction industry** (Issues 6, 9, 11, 13 and 14);
- **3.2 Enrichment of Functional Analysis by the integration of Constructability and Systems Engineering methods** (Issues 1, 2, 3, 5, 7, 8 and 12);
- **3.3 Development of tools at the crossroad of Functional Analysis, Systems Engineering and Constructability** (Issues 4 and 16);

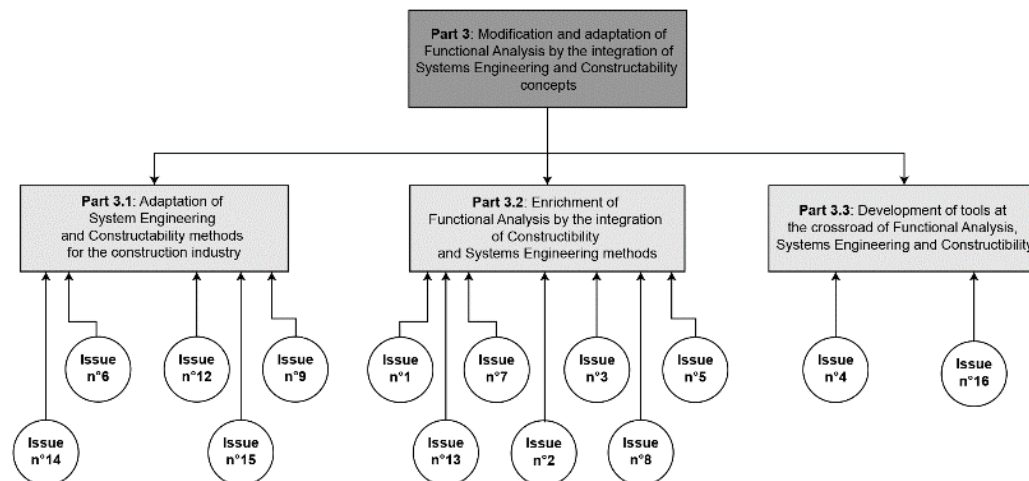


Figure 129 : plan of the 3rd part. This diagram also shows in which part do issues identified in part 3 are treated.

### 3.1. Adaptation of System Engineering and Constructability methods for integration in Functional Analysis

#### 3.1.1. Integrate spatial characteristics of construction systems in Functional Analysis and Systems Engineering

##### 3.1.1.1. Spatial characteristics of systems

First of all, it is presented in this part what would be to “characterize a system over space”. Perception of spatial dimension of systems and consideration of the different levels of organization is crucial to understand the functioning of construction systems.

To characterize systems over space we have identified 5 elements (form, location, metadata, topology, interactions):

- The form of the system defined by its geometrical characteristics in the 3 dimensions (x,y,z). Representation of systems is not always carried in 3D and can be represented by 1D (points, lines) or 2D elements (surfaces, networks) which is an abstraction of the system to highlight particular properties.
- Spatial allocation: systems are allocated spaces whereas it is the geographic space or an “abstract” space of the project. As instance different coordinates systems exist to locate a system on earth: RGF93 (Réseau Géodésique Français 1993), NTF (Nouvelle Triangulation Française), ETRS89 (European terrestrial Reference system 1989), WGS84 (World Geodetic System 1984) etc.
- Topologic information to define spatial relations between the system and its environment;

The most formal way to describe spatial relations between elements is the “distance”. But in some cases, it is not possible or desirable to describe relations of the system with its environment with distance and a more qualitative description is required, this is why topologic information are useful to describe a system over space. Topology answers to questions like “what is near what?” or “what is connected to what?”

There are 6 possible spatial relations between two systems (Borrmann, et al., 2009) as illustrated in Figure 130: System A is disjoint from system B (1), System A equals system B (2), System A contains System B (3), System A is within system B (4), System A touches system B (5), System A overlaps system B (6).

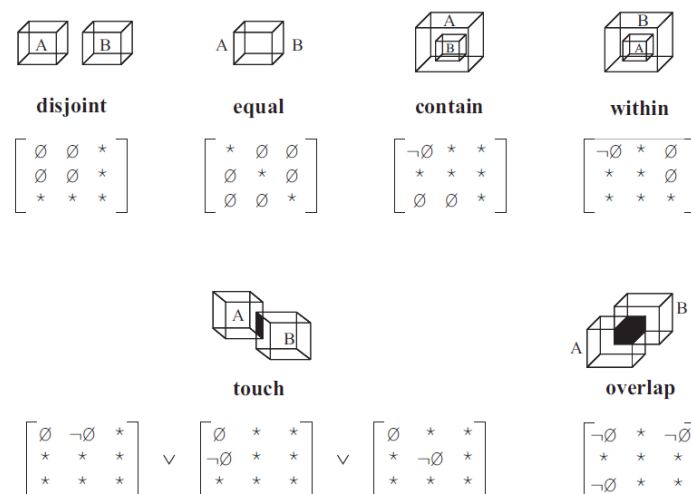


Figure 130 : the 6 topological spatial relations between two systems (Borrmann, et al., 2009).

- Spatial interactions between the system and its environment;

Previous description allows describing what the system “*is*” over space and description of physical relations between the system and its environment. But, a system also has a dynamic behavior over space and has a dynamic behavior with elements from the environment. It is through space that human-human relations, human-environment interactions occur (Dursun, 2012) and more generally that societies are organized and created (Lefebvre, 1974). To define these interactions Brunet (Brunet, 1987), defines “chorèmes” as the elemental structures to organize space in geography. Chorèmes are divided in 7 types of spatial interactions:

- **Mesh:** this process consists in connecting different points of a territory;
- **Criss-cross:** this process consists in dividing a territory to facilitate its control or its surveillance;
- **Attract or repulse:** A system can have an attraction or repulsive effect (intended or not) on elements of other systems;
- **Contact:** Functions of spatial systems can be to separate, make a barrier, limit space or to carry a specialized activity like to allow the passage of people or goods between two systems over space;
- **Tropism:** systems can grow or regress by aggregation or segregation of other systems;
- **Territorial dynamic:** spatial systems can expand or retract by the effect of other systems;
- **Hierarchy:** Systems can have a hierarchical function to give more importance or more power to systems over others.

However, chorèmes are nothing less than functions of geographical systems allocated to space. These processes are represented with 4 types of spatial representation (point, line, surface, network) as shown in Figure 131. This list is not intended to be exhaustive but gives an idea of possible functions of a spatial system. Brunet (Brunet, 1987) highlights that chorèmes can be used to represent spatial processes at any scale. More spatial processes can eventually be added leading to the definition of new chorèmes.

The 28 chorèmes proposed by Brunet are one possible way to describe spatial relations, interactions and phenomenon. Representation of chorèmes are in 2D but could be extended to the modeling of space in 3D leading to new chorèmes. Modeling spatial phenomenon by the use chorèmes has been strongly criticized (Lacoste, 1995) as they limit their expression. However, the intention of chorèmes is to model and modeling consists by nature to do an abstraction of the reality to highlight particular characteristics of a system. It is therefore not surprising that all geographical phenomenon are not included in the 28 chorèmes described by Brunet but it is always possible to combine them or to create new ones to express more geographical phenomenon.

The most important lesson that emerges from chorèmes is that description of a system and its relations with the environment over space not only consists in describing its geometry and its topology but also all the geographical interactions between spatial systems. These interactions can be considered as “*functions*” of geographical systems. Representations of these interactions over space are proposed by the means of chorèmes. Chorèmes not only represent interactions but also integrate geometrical (point, line, area and network) and topological information, it could be required to represent separately interactions between systems and their functions.

	POINT	LIGNE	AIRE	RESEAU
maillage				
	chef lieu	limite administrative	État, région	centres, limites et polygones
quadrillage				
	tête de réseau carrefour	voies de communication	aire de desserte irrigation, drainage	réseau
attraction				
	points attirés satellites	lignes d'isotropie orbites	aire d'attraction	liaisons préférentielles
contact				
	point de passage	rupture, interface	aires en contact	base tête de port
tropisme				
	flux directionnel	ligne de partage	surfaces de tendance	dissymétries
dynamique territoriale				
	évolutions ponctuelles	axes de propagation	aires d'extension	tissu du changement
hiérarchie				
	semis urbain	relation de dépendance limites administratives	sous-ensemble	réseau maillé

Figure 131 : The 28 chorèmes to model spatial interactions (Brunet, 1987).

We insist on the distinction between descriptions of systems over space, and its allocation to geographical/project space:

- Metadata characterizing the space: its functions, its composition...;

Metadata describing the system (i.e. its functions, its composition, its typology) are already defined and described in regular Systemic analysis however, it is important to highlight that a spatial description of systems is not enough and is “perpendicular” to operational, functional and organic analysis.

- Description of the system over space consists in defining its geometry (surface, volume, height, length etc.) whereas it is a need, a function or a component of the system;

Allocation of the system to space consists in defining its geographical/project location and its relation with other systems over space (i.e. its topology);

Both descriptions of systems elements have to be covered in the different architectural views.

We also have made the difference between the project space and the geographical space. The project space is an abstract space where spatial functioning and geometry can be modelled without considering interactions with the geographical space in which it will be implemented in reality. Geographical space is the space where the system will be realized in the real world.

**Improvement n°4:**

Characterizing systems over space consists in describing their geometry, their location in a referential and relations with other spaces (topology and dynamic interactions).

**3.1.1.2. Integration of spatial characteristics in architectural views of Systems Engineering**

The purpose of construction systems is to adapt space to carry human related activities. Therefore, most of engineers and architects works and activities in the AEC industry are somehow related to “space”: defining functional spaces, geometry, structure calculations, comfort calculations (acoustic, lighting, flows etc.), strength of materials etc. All these activities are related to how systems elements are organized over space, their form, their geometry, distances between objects (topology). Complexity arises when different disciplines are involved for the design of the same system. This effect arises in construction projects when the system to design has to answer to different needs, to carry different functions over space, or has a complex geometry and has several (spatial) interactions which increases the number of specialties involved. Therefore, the methodology we are developing and the introduction of space in this methodology aims to help designers and architects to manage complexity of the development of such systems from high level of abstraction to the definition of very concrete elements.

If the particularity of construction products comes from the consideration of space in its development, adaptation of Systems Engineering for infrastructures and buildings should be from the integration of space in the methodology. The question is how and where to integrate space in Systems Engineering methodologies? All the more that neither the INCOSE handbook neither the AFIS handbook describe how is considered space in Systems Engineering methodologies. Only in the CESAME guide (CESAM, 2017), space is briefly mentioned as “*space and time are always required to specify any functional behavior (that takes place “functionally somewhere” at a certain time)*”. However, the same guide also mention that “functional space” can be described with interaction diagrams and Functional Decomposition which is not enough in our point of view to model all spatial phenomenon. Voiron in (Voiron, et al., 2005) highlights that in most of systemic analysis, space is not considered whereas it is fundamental for the description of spatial systems as space has an important impact on their dynamic.

First and foremost, the definition of systems over space is something already considered in current construction projects at all systemic levels: from the definition of Master plans for city planning to digital mock-ups for buildings or infrastructures. The work carried in this part is to link Systems Engineering methods with spatial description of systems to incorporate this dimension in the method we are establishing. Dursun in (Dursun, 2012) says that space is simultaneously a very concrete concept which can be described by length, width, scale, geometry, topology etc. and at the same time a very abstract and complex concept very difficult to formalize such as social relations. These last aspects are more difficult to measure, more abstract and somehow “invisible”.

The concept of space in the different steps of development of construction products has been studied by Mauger (Mauger, 2015) in the case of buildings. In architecture programming, three types of space are considered: *functional space*, *planned space* and *designed space*. Functional space refers to the space required by the client, planned space is the space quantified by the “programmer” by considering flows of people, resources and activities/works which will be carried in the building. The *designed space* is the space designed by architects and engineers in the project proposals.

Mauger in his thesis considers space only physical characteristics of space: “*As a result, only physical properties are included in the concept of space while the (functional) logic behind the space is layout is postponed to the*

concept of activity”. Hence, space is only considers for its geometrical and topological properties. Mauger locates space at a “low level” of abstraction in terms of needs and requirements (Figure 132).

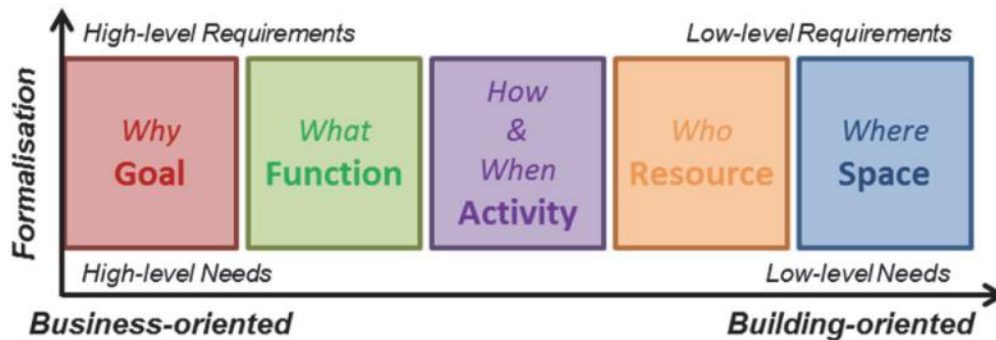


Figure 132 : Relations between space, goals, functions, activities and resources (Mauger, 2015)

However, when considering logic spatial interactions between systems, space appears also at high level of abstraction. Needs and functions of a system can also be allocated to space(s) and these space(s) are not necessarily the same than geometrical and topological description of the system.

- Operational view and space

To be more specific, let’s take the example of a metro infrastructure. Goals and needs of a metro system is to improve mobility and or accessibility in a several parts of a city. It is therefore required to model where people *are* and *where* they are willing to go to answer to their needs. Spaces impacted to describe and model are areas of the city. Yet, geometry of the infrastructure would be a link between these spaces. As instance, in the studies of the 5<sup>th</sup> line of the Lyon metro, an analysis of mobility needs in the 5<sup>th</sup> district has been carried and is illustrated on a map, i.e. over space (Figure 133).

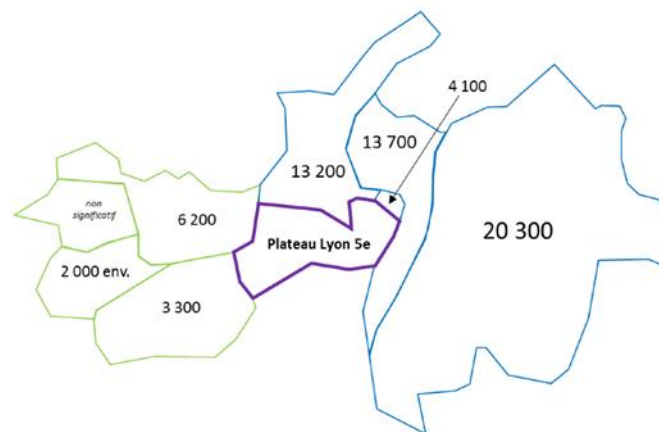


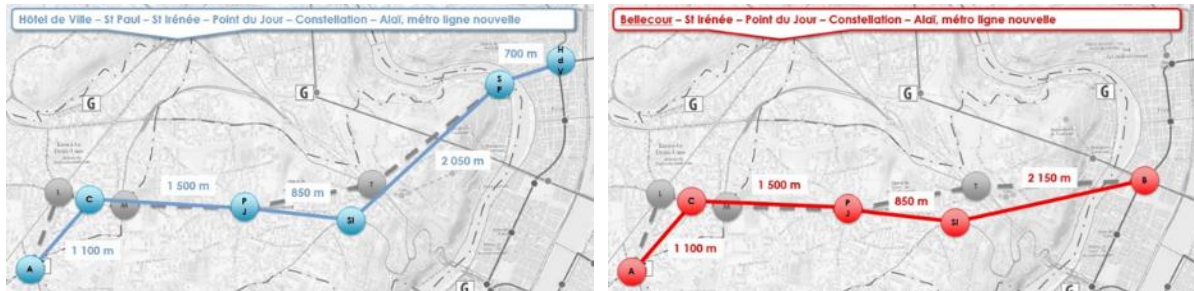
Figure 133 : Mobility needs analysis in the 5th district of Lyon

Let take another example with a land developer, its objective (“need”) is to make business by selling offices or residential buildings. The price of the land is related to many spatial characteristics which are not only related to the geometrical characteristics of a building like: the presence of green spaces, accessibility of the location, social characteristics of the district etc. All these elements can be described over space and are not related to geometrical characteristics of buildings. .

- Functional view and space



At the functional level it is also possible to consider space, i.e. to define what the system *does* over space. As instance for a metro system, two essential functions (what the system does) is to “transport people” and “access to the system”. These functions are intimately linked to space. The function to transport people has a makes sense only if a depart point, a destination point and several other points over space are reached. In the same way, the function “access to the system” has no sense if it is not described over space: location and catchment areas of access points. In the example below an example is given where the two functions “transport people” and “access to the system” are represented over space (Figure 134):

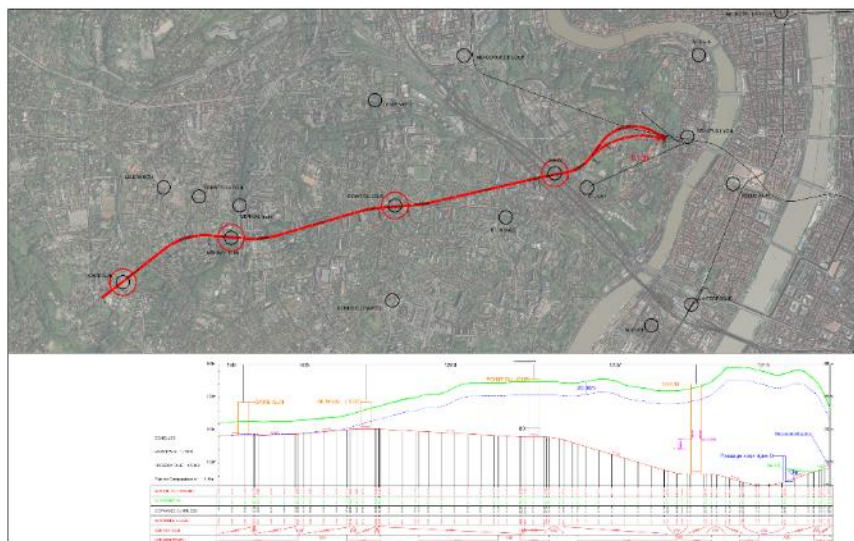


**Figure 134 : Functions « transport people » and « access to the system » of the 5th metro line of Lyon for the two selected scenario.**

Finally, space and time compose the 4 dimensions (3 dimensions of space plus time) constituting phenomenon perceived by humans. Any system can be described over these 4 dimensions whatever the considered abstraction level is. Space is the expanse where phenomenon unfold. The question of space in Systems Engineering and Functional Analysis is a question of allocation: needs, functions and elements constituting the system are allocated to spaces.

- Organic view and space

At the organic level, the system is decomposed in concrete elements which will enable to realize previously defined functions (the “how”). As instance, in the case of the 5<sup>th</sup> metro line of Lyon, it will be necessary to define a space which will allows to transport people (function defined previously), in our case this will be an underground tunnel. This tunnel can be described over space in the geographical referential of the city of Lyon (Figure 135).



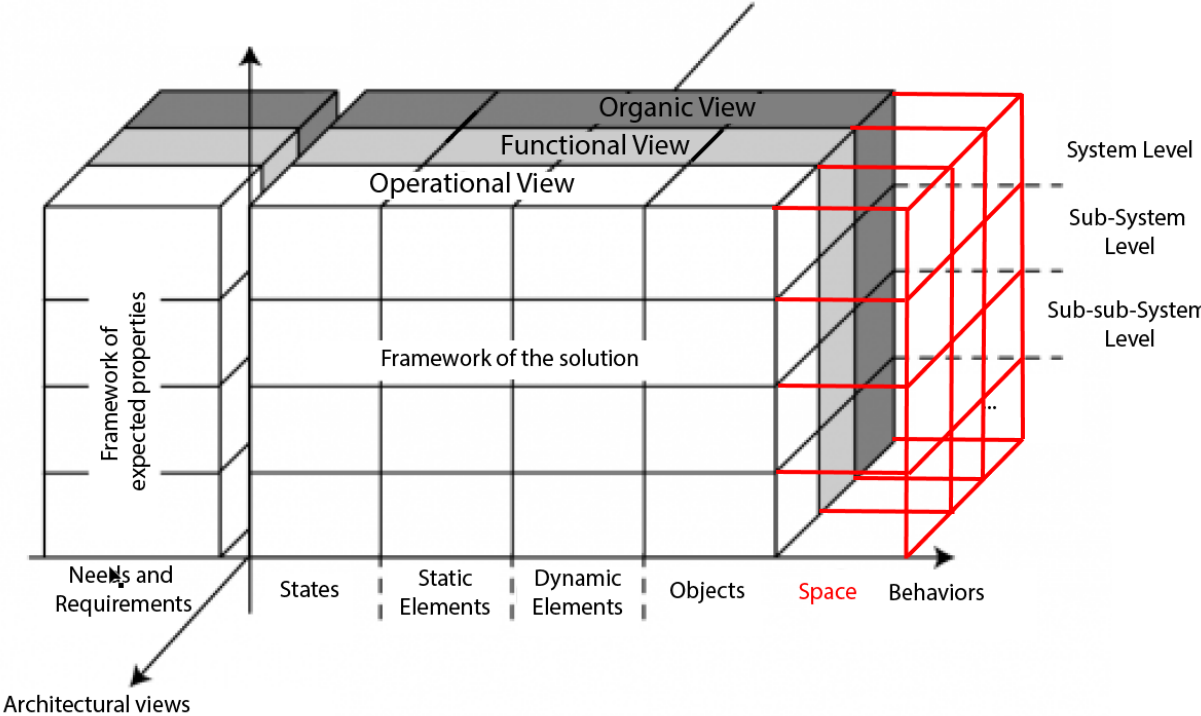
**Figure 135 : Organic description (alinement) of the tunnel of the 5th metro line of Lyon at the system level**

Similarly, stations of the metro system which are the components of the system allowing to access the system have been represented spatially in Figure 135.

There are two implications of this example, needs, functions and components of a construction system can be expressed at a high abstraction level over space and more importantly, spaces involved in the dynamic of the system are not the same depending on the considered view (operational, functional or organic). Operational, Functional or Organic spaces sometimes overlap but are different. Moreover, we can highlight that the more we get into concrete modeling of the system the more it is the physical space which is interacting with the system. In the example presented above, Operational requirements are more related to the human space: mobility between administrative districts in Lyon while in the organic view it is important to represent the topography and the anthropic built spaces.

Space is not related to a systemic hierarchy, whatever the considered systemic level (system, sub-system, sub-sub-system etc.) a system always exists “over” space. As instance, tunnels and stations presented in (Figure 135) could be much more detailed over space at another level of detail.

Hence, the cube framework presented by Krob in (Krob, 2014) can be adapted by adding space as a new “behavior” of the system to analyze. This behavior is essential to the application of SE in the construction industry but we don’t exclude it could be useful for other systems the only difference being that “needs” of other systems are not related to space (Figure 136).



**Figure 136: The addition of “space” in the “systemic cube”. Adapted from (Krob, 2014). Space is added as a “behavior” of the system as it is perpendicular to systemic levels and architectural views.**

Usually, interactions between the system and its environment were carried out only “before” the operational analysis as stated in Figure 97 and Figure 148. The consideration of space in the three architectural views is not neutral in the method. Because impacted spaces are not necessarily the same between the different views, it means that eventually new interactions with external elements can interfere with the future system. New interactions can come from the fact that different spaces are impacted in the different views or, in the same space different the System can interfere with other properties of space. These interactions need to be identified and characterized between each architecture analysis (Operational, Functional and Organic). Compared to the classic Functional Analysis method, and as stated before and in the adapted cube in Figure 136 spatial analysis should be carried in all phases of the Functional Analysis method (Operational, Functional, Organic) (Figure 137).

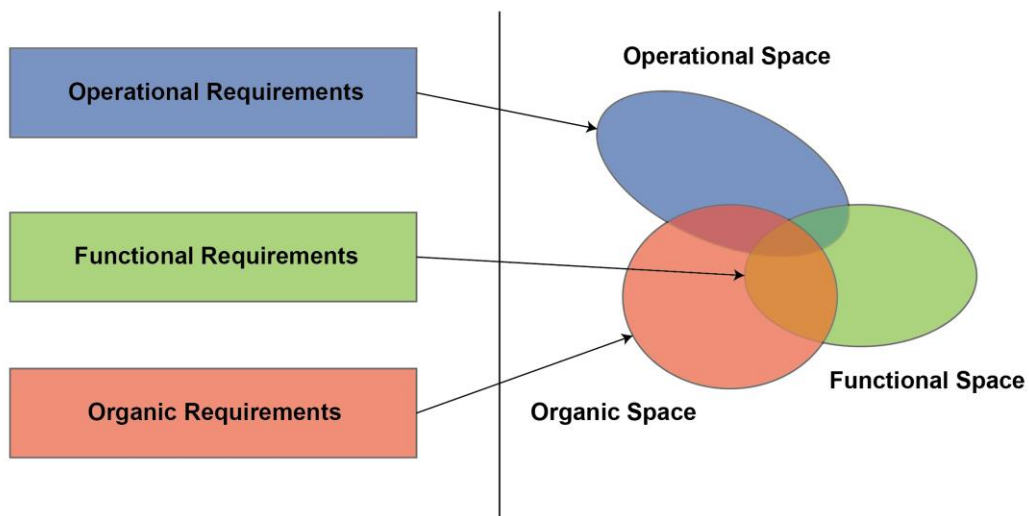


Figure 137 : Operational, Functional and Organic requirements with their allocated spaces

### 3.1.1.2.1. Integrate spatial characteristics in the operational analysis

As explained in the last section define spatial characteristics of systems consists in defining their location (in a referential), their geometry (form) and their spatial relations with other systems (topology).

Needs construction systems answer are to adapt “geographical spaces” to carry activities. The territorial diagnosis is a methodological tool to assess the relevance of the scope of action, the relevance of the project and to define needs of a territory (Piveteau, et al., 2002). It can be applied at different geographical scales from a district to a big agglomeration (Lardon, et al., 2005).

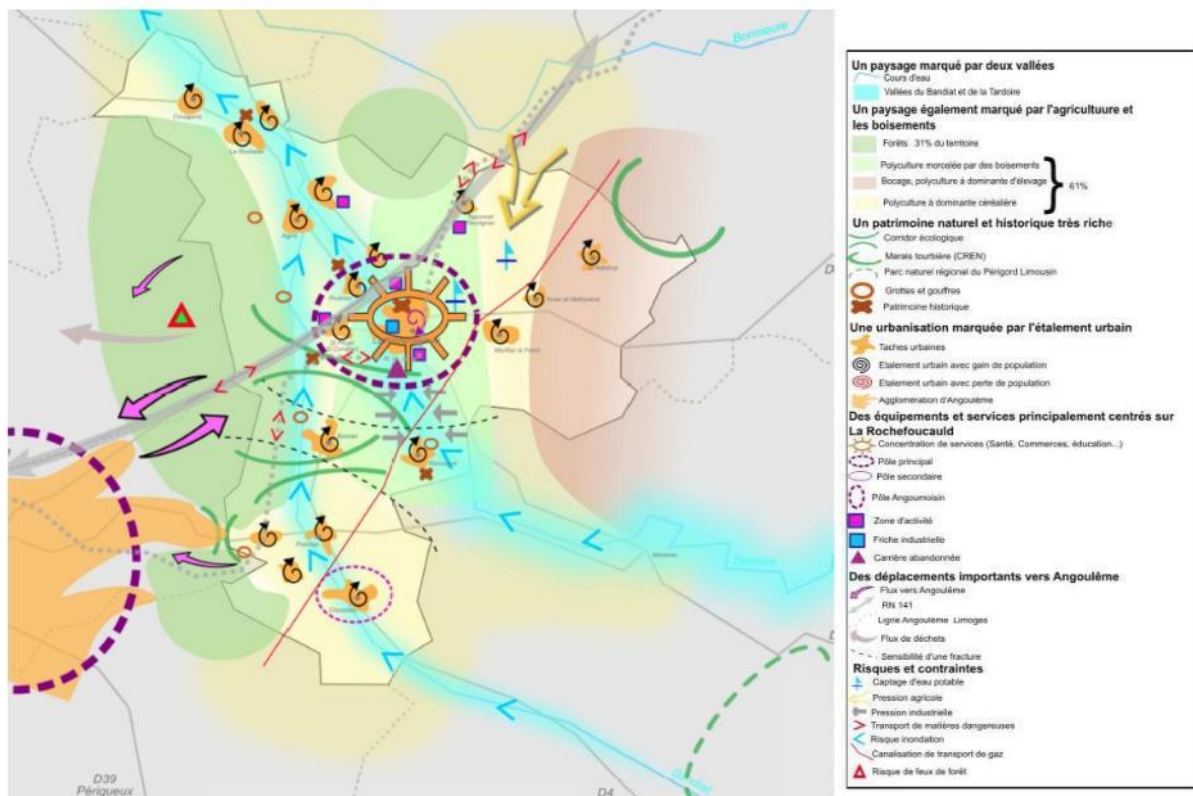


Figure 138 : Example of a territorial diagnosis represented on a 2D map in La Rochefoucauld, France (DREAL, 2017)

Objectives of the territorial diagnosis are the same than an Operational analysis for industrial systems the only difference being their geographical allocation on a territory. Another main difference between construction and other industrial systems is that identification and definition of the needs are established by administrations for public buildings and infrastructures or private owners for other types of construction products. In any case it is not the same actor responsible for the design and realization of the system than the actor responsible for the definition of the needs.

Piveteau and Lardon (Lardon, et al., 2005) defines the 7 steps to realize a territorial diagnosis (Figure 140):

1. Choose sources of information (photos, pictures...) and constitute a model from this initial knowledge of the territory: identify elemental spatial interactions (mesh, criss-cross, attract etc.) defined by chorèmes;
2. Analyze “cold” data (statistics and maps) and characterize dynamic structures of the territory. Represent territorial dynamics with chorèmes and classify them by themes (demography, agriculture etc.);
3. Analyze “lukewarm” data (pictures, photos) as well as regulatory documents (PLU (Plan Local d’Urbanisme) or SCOT (Schéma de Cohérence Territorial) in France) and characterize territorial dynamics with chorèmes;
4. Analyze “warm” data (surveys and interviews with actors) and represent territorial dynamics with chorèmes;
5. Confront spatial analysis to highlight territorial key issues. Identify areas where point of view between actors differ. Translate them with the help of chorèmes;
6. Elaborate scenario to answer actors’ needs and translate them with chorèmes;
7. Restitution of the diagnosis and present the different visions of the territory from the different actors and its possible evolutions.

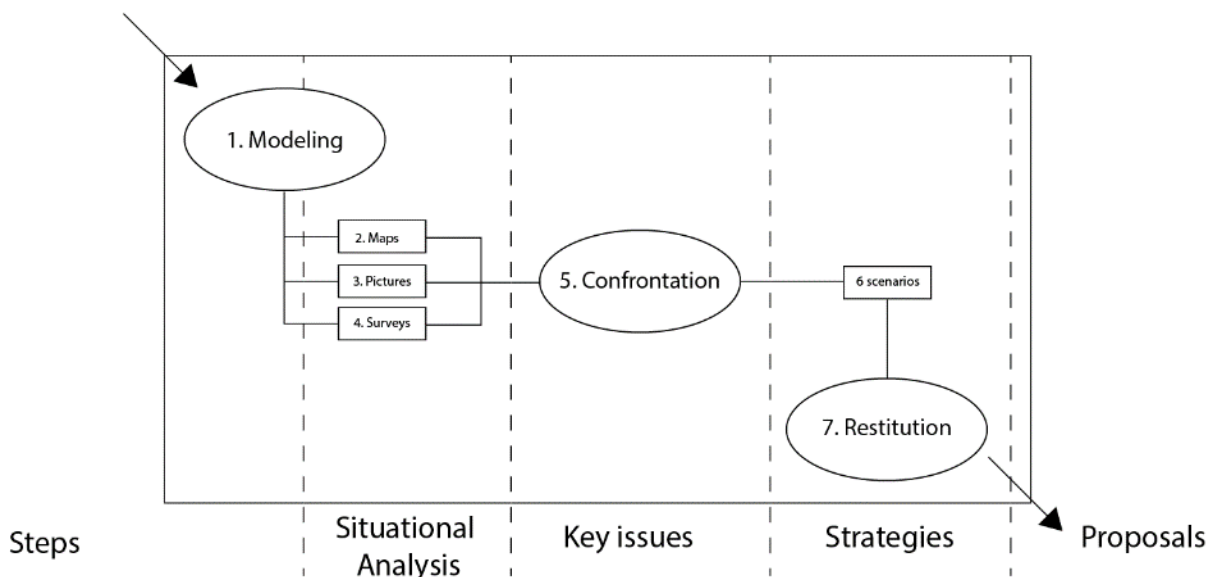


Figure 139 : The 7 steps of a territorial diagnosis. Adapted from (Lardon, et al., 2005)

The territorial diagnosis is composed of 4 registers (Figure 140): themes of analysis (demography, land use, natural environment...), scales, interactions between systems and temporal dynamics.

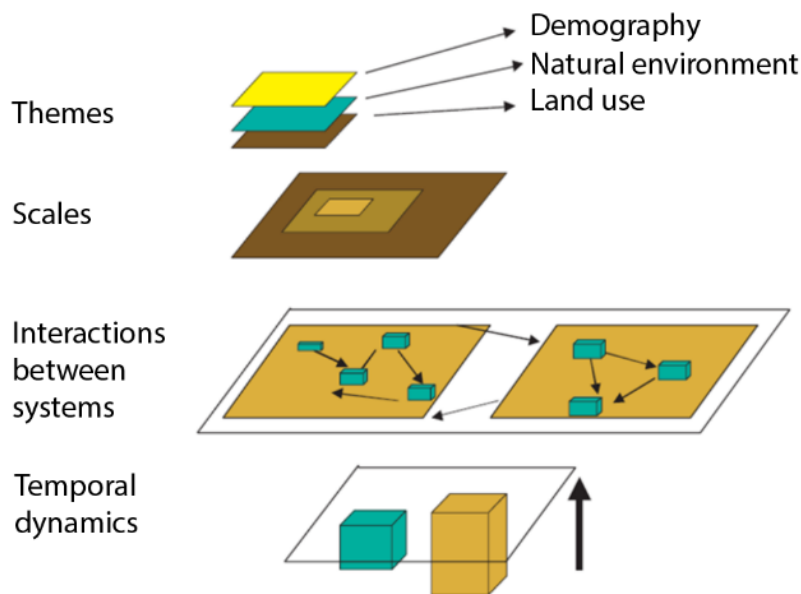


Figure 140 : The 4 elements constituting of a territorial diagnosis (Piveteau, et al., 2002)

This process leads to some comment:

- Firstly criteria to decide which source of information to choose are not defined whereas choosing wrong information at the first step could have disastrous impacts on the territorial diagnosis. It will lead us to the definition of Constructibility criteria (see section 3.4.2): the collecting information process is part of the Enabling System and this example illustrates perfectly that it can affect the System of Interest (here needs it will answer).
- The different stakeholders in a territory can have different and even opposite objectives, the territorial diagnosis does not give a methodological approach to manage interplay of actors. The MACTOR method described in chapter 2 could be used to carry this type of analysis. Constructibility criteria related to the convergence of objectives could also be defined.
- As explained before, chorèmes represent interactions between systems over space. Interactions between systems can eventually be described in other types of diagrams separately from their geographic allocation in order to better understand their interrelations.
- Defining key issues for stakeholders is essential in the method but not enough: impacts of the solutions which can potentially answer to actors' key issues also have to be analyzed whereas they are on other actors or on the environment.
- The territorial diagnosis allows two different functions: definition of key issues of stakeholders and interactions between them and allocation of space of these issues and interactions with the help of chorèmes.

To sum up, the territorial diagnosis allows identifying needs of stakeholders on a territory. In this analysis three things are carried: identification of needs and their allocation to geographical space as well as interactions between needs the system will answer and other systems. This diagnostic is coherent with the method defined earlier, it can be carried at any geographical scale from a building to a large agglomeration.

The only drawback of this method is the representation of spaces in 2D. This problem is not only a representation problem as it could lead to the non-consideration of some interactions with underground/aboveground elements and the non-consideration of these spaces to answer to potential needs of the territory and its stakeholders.

### Improvement n°6:

Territorial diagnosis is one possible methodological tool to carry a spatial analysis of a construction system at the operational level.

#### 3.1.1.2.2. Integrate spatial characteristics in the functional view

In the functional view we refer to internal functions of the system. The nature of the analysis is the same than the operational view, the only difference being that the system is not anymore considered as a “black box” but as a “white box”. It means that the internal spatial organization of the system will be analyzed. In the functional view is analyzed what the system “does” over time but also and more importantly in our case over space, geographical characteristics and geometry of functions are defined as well as topology between functions of the system.

Hence, in the functional view the internal organization of functions is considered:

- External functions are refined in several internal functions which are also defined over space and allocated to spaces;
- Interface functions are defined: how to separate activities or to link them as instance.

Example of a functional diagram is given in Figure 141 with a multimedia building:

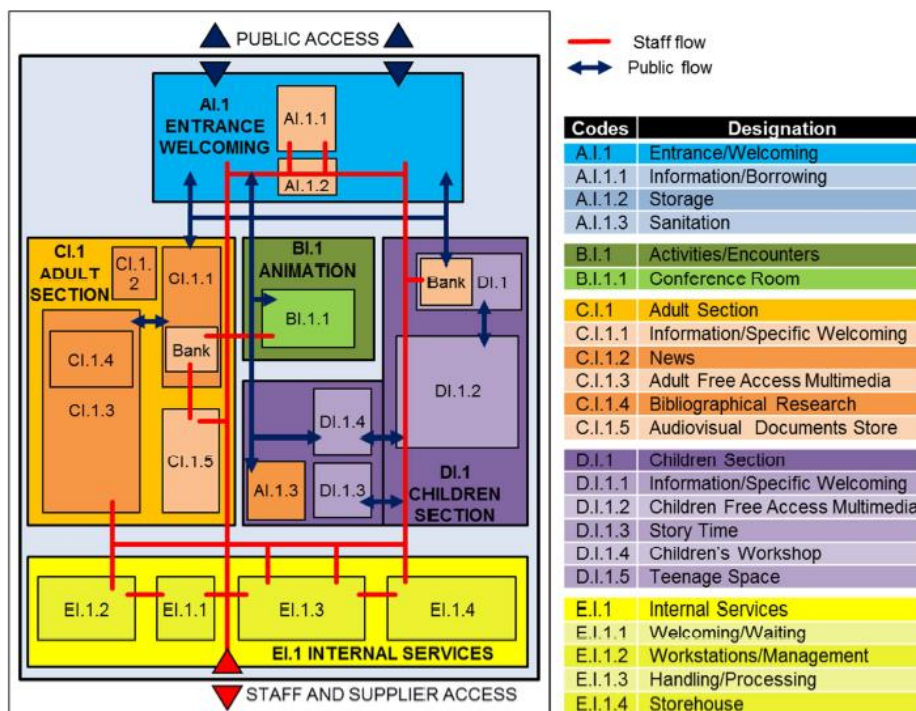


Figure 141 : Example of a functional diagram based on a multimedia brief (Mauger & Kubicki, January 2013)

In this example we can notice that activities are not only allocated to spaces as it would be the case in the operational view, but the diagram also represents how activities are separated and linked over space, i.e. allocation of internal functions over space. We can highlight that “geographical” characteristics of functions are not mentioned, however they are described in a particular referential: the building referential. It shows that when carrying internal analysis of systems (whereas it is functional or organic), the referential might change from a geographic analysis to a building/infrastructure referential. It is not surprising that the referential has changed as interactions between the system and the environment are only carried in the operational view. However, it is

essential to allocate functions of the system over space in a particular referential at least to identify spatial interactions between functions, even if it is not a geographic referential.

The functional diagram presented has some drawbacks considering the methodology defined in Figure 148: the functional diagram only represents 2D spaces while spaces are defined in 3D, and maybe more importantly, interactions with other spatial elements external from the system are not represented. This last drawback is of importance, as instance, external accesses to the building are not mentioned neither utility networks or near buildings which can largely affect positioning of the different functions over space and interactions with external elements.

**Improvement n°7:**

The Functional Diagram is a methodological tool to carry spatial analysis of a construction system at the functional level. However, it should be improved by considering interactions with the environment.

*3.1.1.2.3. Integrate spatial characteristics in the organic view*

Organic elements of a system, i.e. its composition can be described over space by its form (geometry), its location (in a particular referential which can be geographic or not) and topological characteristics with other systems elements. Initially, consideration of space in Systems Engineering was only considered at the organic level of abstraction while we have just seen that operational and functional views can also be studied over space. In the Organic view, systems are represented as they are physically.

As well as other views, the same method can be applied for organic elements of the system: description of organic elements over space: which concerns its form at the organic level. And in a second step its allocation to project/geographical space.

Form of the system concerns its geometrical properties, its volume, its length, its height etc. When the geometry is defined, the system is then allocated to space whereas it is space of the project or the geographical space and physical interactions with other systems/subsystems can be analyzed (clash detection).

Hence, when analyzing how a solution in the organic view answers to a function in the functional view consists it is necessary to compare how spatial characteristics of the solution (its geometry, location and topology) answer to functions of the system.

Tools such as CAD tools (in 2D or 3D) can be used to model organic elements of systems.

Note: in the examples given above (functional diagrams and territorial diagnosis), developed tools were only in 2D. However, reality of phenomenon are in 3D, therefore their representation in 2D is necessarily a simplification of the reality. This simplification is mainly related to a technological limitation (territorial diagnosis and functional diagrams have been developed when 3D models have intentionally or not been developed). However, carrying operational or functional analysis in 2D necessarily implies ignoring vertical aspects of urban and building dynamics and to miss opportunities to answer needs and functions by vertical systems.

*3.1.1.2.4. Integration of spatial characteristics of systems in MBSE*

MBSE (Model-Based Systems Engineering) allows implementing in practice Systems Engineering methods. If space has to be considered in the 3 architectural views (Operational, Functional and Organic) let see what are the possibilities offered by MBSE to model space.

SysML does not give enough modeling capability to model spatial characteristics of systems and need to be adapted.

- Perceptory

Perceptory (Université de Laval, 2018), allows identifying quickly in an UML (and SysML) diagram geometry and dimensionality of objects: not only the geometrical properties of UML objects are described but also if its environment is in 1, 2 or 3 dimensions (Figure 142).

	Univers 2D	Univers 3D
0D (forme ponctuelle)		
1D (forme linéaire)		
2D (forme polygonale)		
3D (forme volumique)		
Forme compliquée		
Toutes formes confondues		
Forme inconnue		

Géométrie alternative		Les objets représentés possèdent une ou l'autre des géométries proposées
Géométrie multiple		Les objets représentés possèdent autant de géométries qu'il y'a de pictogrammes
Géométrie complexe		Objets composés en même temps de toutes les géométries proposées

Figure 142 : Perceptory icons (Université de Laval, 2018)

Even if Perceptory is a first attempt to introduce spatial characteristics of systems in UML diagrams, it does not allow describing neither topological relations between objects neither dynamic behaviors of systems over space (like chorèmes).

One proposition possibility would be to model spatial elements of systems at the organic level (i.e. its geometry, location and topology) is to model geometry types as proposed in Perceptory and to model topological relations with the help of links between blocks. By defining different types of links (8) all the 8 possible topological relations between two systems would be able to be modeled.

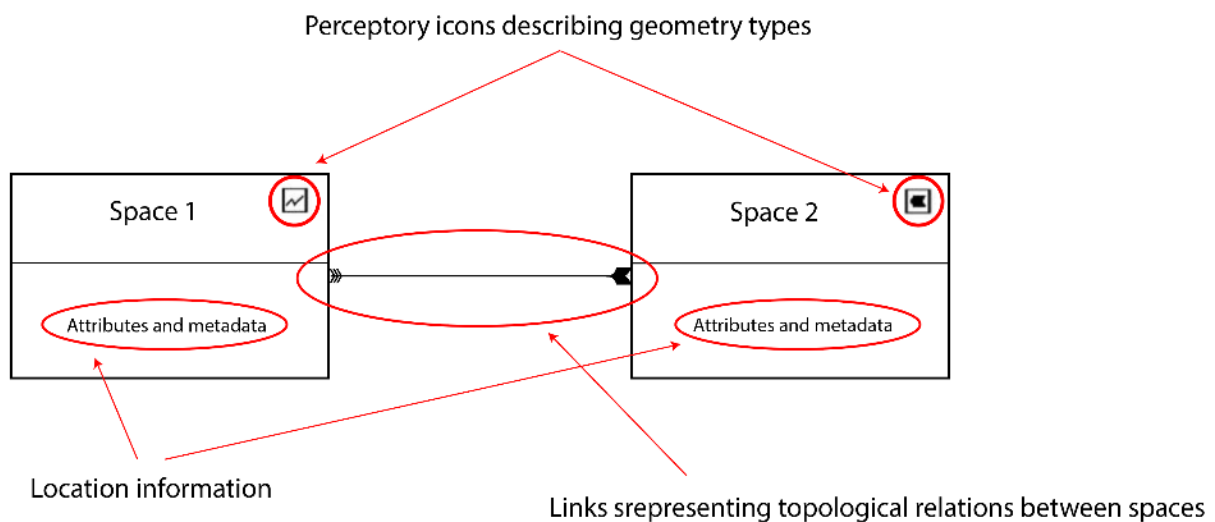


Figure 143 : Proposition to model geometric, location and topological information of spaces

In this example, topological links can be modeled but other spatial interactions between systems remain to be integrated in SysML models. Chorèmes are a good source of inspiration to model spatial interactions but they don't represent interactions in the 3 dimensions and they are not standardized to be introduced in SysML diagrams. Another possibility would be to model interactions between spaces which are not geometry/topology/location by other types of diagrams in SysML like activity diagrams or Internal Block diagrams which allow to model flows and interactions between system elements. Such diagrams could be then linked directly to 3D implementation models or GIS (Geographic Information Systems) modeling tools to be represented. In (Barbedienne, 2017),



Barbedienne also suggests to enrich the SysML language to integrate spatial and geometrical information. GERTRUDE (Geometrical Extension Related to a TTRS Reference for a Unified Design) the SysML extension developed by Barbedienne notably contains geometrical representation (topology in TTRS), the capability to add new geometries and a face-based geometrical modeling dedicated to thermal simulation.

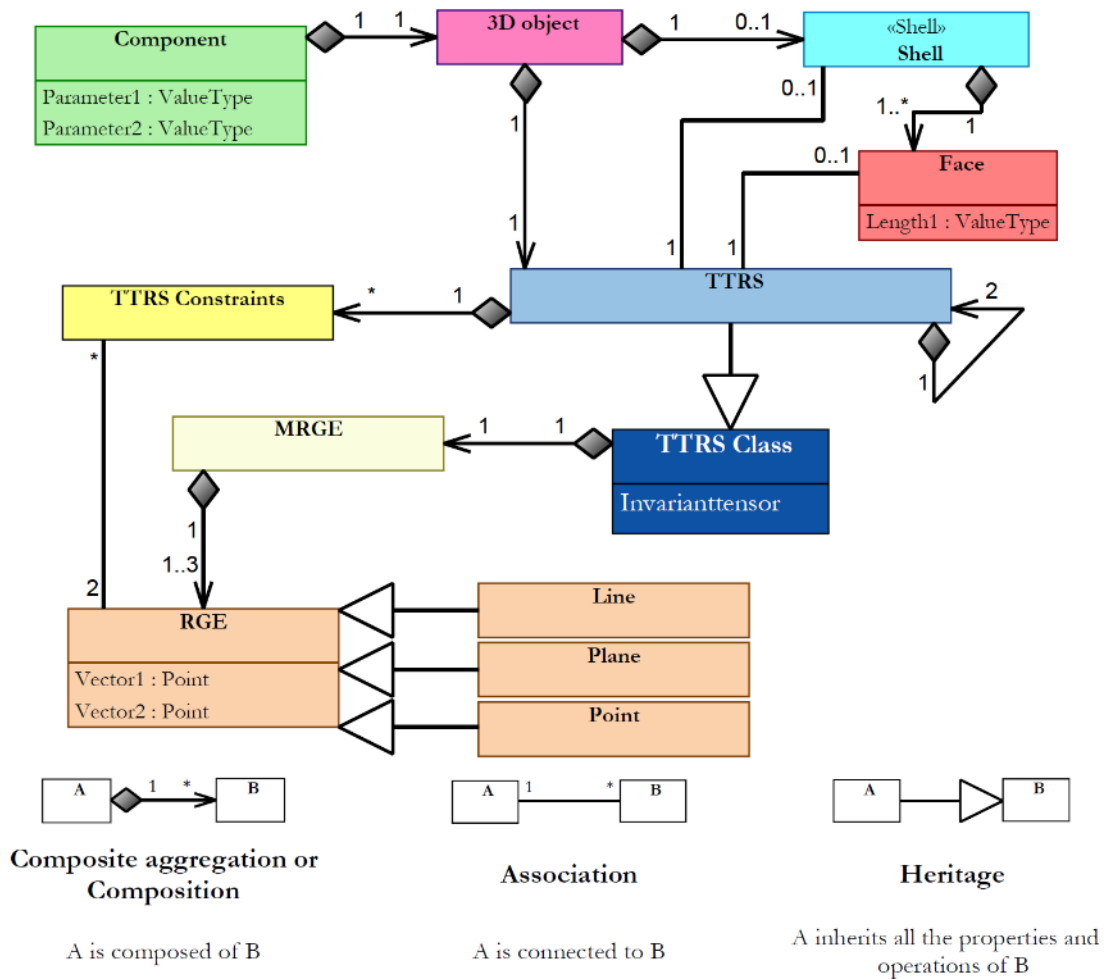


Figure 144 : Metamodel of the GERTRUDE extension of SysML developed by Barbedienne (Barbedienne, 2017)

In the industry, several authors have investigated this possibility: (Albers & Zingel, 2011) proposes to extend SysML to model geometry of physical flows between component, (Bohnke, Reichwein, & Rudolph, 2009) proposes an UML profile for geometrical properties but without their assembly constraint (Barbedienne highlights that this profile is useful for complex detailed geometries but not for conceptual design when geometry is not clearly specified), finally (Warniez, Penas, Plateaux, & Barbedienne, 2014) proposes a geometrical SysML extension including simplified geometrical volumes however this extension doesn't allows modeling positions between elements (topology) neither to add new geometries.

Different types of other system elements (eventually modeled in other diagrams) could be then allocated to spaces modeled in (Figure 143): needs, functions or components of a system.

#### Improvement n°8:

In order to model spatial characteristics of construction systems in SysML based tools, we propose to introduce specific new fields dedicated to spatial characteristics: geometry, location, and topology. Needs, functions and components of construction systems can then be allocated to spaces modeled in such diagrams.

- RailTopoModel (RTM)

In the rail sector, a metamodel has been developed considering spatial characteristics of systems: RailTopoMode. Objectives of the metamodel are multiple and somehow join objectives of the construction industry notably (International Railway Solution, 2016):

- The model provides a topological representation of the iron network which is fully connected and can be visualized schematically;
- The model supports multiple referencing systems:
  - o Linear referencing;
  - o Geographic reference systems;
  - o Screen coordinates;
- The model defines and locates “point”, “linear” and “areal” entities

These 3 particularities of RailTopoModel are exactly the concepts we would like to integrate in SysML in order to model construction products by considering its spatial characteristics: topology (yellow), referencing (green) and geometry (blue) (Figure 145).

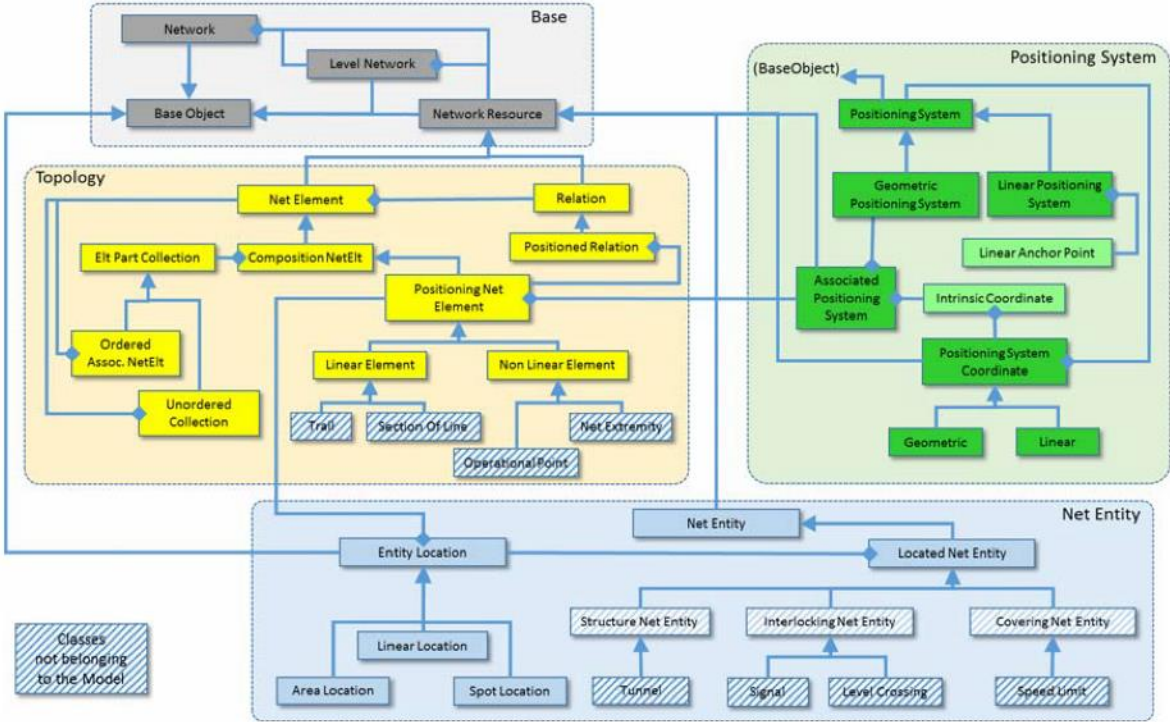


Figure 145 : RTM class diagram (International Railway Solution, 2016)

However, even if a standard exchange format in XML already exists (railML, rail Marke-up Language) no tool has been developed to implement RailTopoModel and to effectively model a railway network with RTM.

- IFC space:

In IFC (Industry Foundation Classes) defined by buildingSMART it is also possible to describe spaces with IFC space: “A space represents an area or volume bounded actually or theoretically. Spaces are areas or volumes that provide for certain functions within a building.

A space is (if specified) associated to a building storey (or in case of exterior spaces to a site). A space may span over several connected spaces. Therefore a space group provides for a collection of spaces included in a storey. A space can also be decomposed in parts, where each part defines a partial space.” (buildingSMART, 2008).

A space is different than an object as it does not necessarily refers to something which is “built” or “realized”. IFC space included definition of geometry of the space as well as its referencing in a specific referential. However, topology is not included in this description.

Therefore IFC space allow to define over space something else than only physical objects like an exterior space, a storey or a room.

In (Mauger, 2015), Mauger highlights that description of space in IFC focuses on physical aspects of space. “A space represents an area or volume bounded actually or theoretically. Spaces are areas or volumes that provide for certain functions within a building”. Mauger also considers that the logic behind spaces is postponed to the concept of activity.

### 3.1.1.2.5. Spatial characteristics in Functional Analysis methodological tools

Further in the development of the thesis, we propose to use SysML diagrams to carry Functional Analysis. However, if for a reason or another it is necessary to use “initial” tools of FA, it is also possible to represent spatial characteristics of construction systems using these tools:

To integrate these spatial elements, we propose to adapt the “fundamental expression of the needs” diagram by adding description of its elements over space (topology, geometry, localization) of beneficiaries of the system and of other systems impacted.

For each need, it is possible to integrate the 3 spatial characteristics (geometry, topology and location) in the fundamental expression of the need diagram (Figure 146):

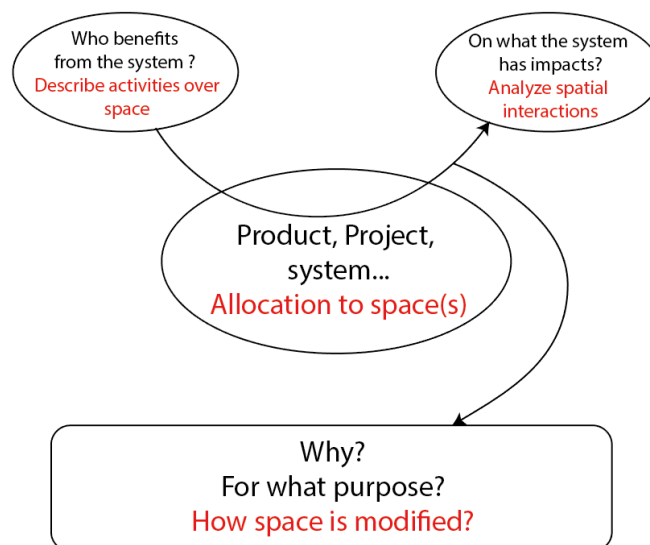


Figure 146 : the addition of « space » in the fundamental expression of the need(s) scheme

In the case the system will answer different needs, it is important to ensure the spatial coherence of the system.

The next step in the MISME method used to define needs is to define external functions (service and constraint functions). Both elements from the environment and functions can be described over space. Spatial characteristics

can be represented with the table used for description of External Elements and External Functions of the system (Table 15).

- Elements from the environment can be described by their localization, their geometry and their topology with the system. Eventually existing spatial interactions between elements of the environment can also be described.
- Functions can be described over space by the type of interaction, its direction and its magnitude. Functions are then allocated to geographical space and/or space of the project.

EE1	MF1	EE2
<b>Description of spatial characteristics of EE1:</b> <ul style="list-style-type: none"> <li>• <b>Geometry</b></li> <li>• <b>Localization</b></li> <li>• <b>Topology with the system</b></li> </ul>	<b>Description of spatial interactions with the system</b> (attraction, contact, hierarchy, connect etc.). Direction of the interaction and its magnitude (nominal criteria).	<b>Description of spatial characteristics of EE2:</b> <ul style="list-style-type: none"> <li>• <b>Geometry</b></li> <li>• <b>Localization</b></li> <li>• <b>Topology with the system</b></li> </ul>
...	...	...

**Table 15 : Characterization of functions and external elements by integrating spatial characteristics**

Moreover, at this stage Internal Functions and the Organic Composition of the system (the solution) are not defined yet, only External Elements enabling or constraining functions of the system are identified. In construction systems, new External Elements from the environment will be identified and will impact the system when Internal Functions and the Composition of the system will be defined. In effect, in construction systems, needs, functions and components can be allocated to spaces and often different spaces. These different spaces can imply new interactions with the environment and the identification of new External Elements. Therefore, we have defined a typology of External Elements interacting with the system:

**Functional External Elements:** these elements of the environment enable the operation of Main Functions and Constraint Functions defined during the External Functional Analysis;

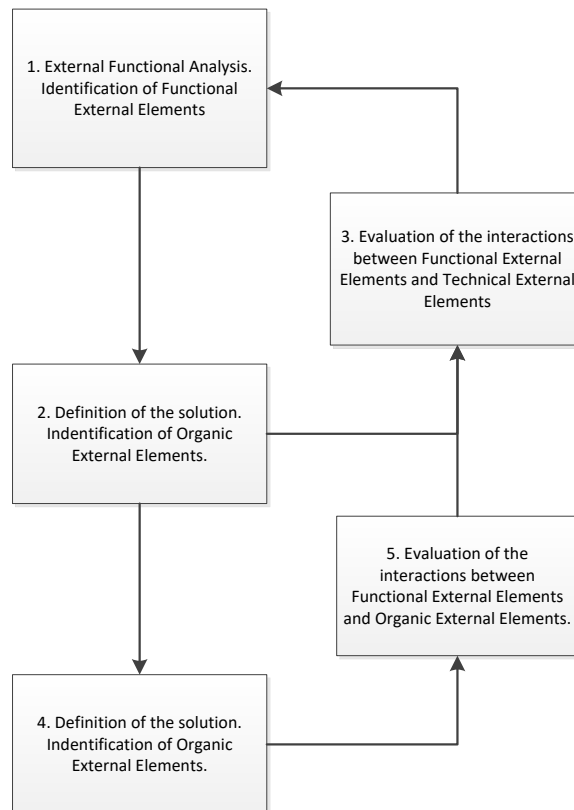
**Technical External Elements:** these elements of the environment enable the operation of Technical/Internal Functions of the system defined in the Internal Functional Analysis;

**Organic External Elements:** these elements of the environment interact with the Organic Composition of the system defined during Organic Analysis.

Eventually, elements of the environment interacting with the system at different levels also have interactions between each other implying a recursive loop in the ability of the system to operate.

This definition of External Elements typology is usually not part of the APTE method but is a first enrichment we make in the methodology. Later in the thesis we will see that the “enabling system” also has interactions with the environment of the system complexifying even more the development of the system.

These recursive loops in the interactions between a system and its environment are not always happening but is part of the definition of a complex system.



**Figure 147 : Interactions between the environment and the System of Interest. This diagram shows the feedback loops between the different steps of the Functional Analysis process from analysis of the needs to analysis of the solution.**

Note: Another way to consider space in the development of construction systems is to consider space as an opportunity. If free spaces are available to develop new construction systems, the question is not anymore how to find the appropriate space to answer needs, functions and components of the system but to evaluate what could be the best way to take advantage of this opportunity. I.e. to which needs/functions/composition the targeted space is the most suitable for. This other way to consider space is not contradictory with the last one as needs/functions/components are still allocated to different spaces however the methodology is different.

**Improvement n°5:**

Spatial characteristics of systems have to be considered in the three architectural views in Systems Engineering (Operational, Functional and Organic). I.e. in Needs Analysis, Internal Functional Analysis and Composition of the system in Functional Analysis. The method has been enriched by the integration of spatial characteristics and identification of external elements of the system.

**3.1.1.3. V&V and Functional Analysis**

Another concept added in Systems Engineering is the “V&V” (Verification and Validation) concept. In Functional Analysis nothing is mentioned about how functions and more generally requirements will be verified and validated or what V&V implies in the MISME method.

Verification consists in making sure that things are getting done accordingly to what has been defined, while validation consists in making sure that results have been reached (ISO, 2015). Verification activities are carried both in the left branch and in the right branch while validation activities can only be carried in the right branch of the vee when results the product should reach can be measured.

However, the V&V process is fundamental, particularly when defining functions of the system. The V&V concepts consists in firstly defining all requirements will be verified and validated and secondly to consider requirements

related to these verification and validation tasks. The second part of the concept is not very far from the concept of Constructibility (and notably horizontal Constructibility).

Enrich Functional Analysis by the V&V concepts means that it is necessary when defining needs, functions and organs to define at the same time how they will be verified and validated and to define Constructibility requirements related to these activities.

In the construction industry and in the left branch of the Vee, operational, functional and organic requirements are verified by the mean of survey, simulations, maps and virtual mock-ups. Requirements related to these verifications are part of the horizontal Constructibility.

In the right branch of the vee, verification activities mostly concern tests and trials applied on the product realized. Tests can be carried on site or in a laboratory.

As instance, in France, the LOTI (Loi d'Orientation des Transports Intérieurs) enforce Transport Authorities to carry an ex-post verification of socio-economic analysis carried at the system level and which characterized needs a transport infrastructure should answer (Cerema, 2015). This example highlights that verification and validation activities concern all systemic levels from the global system in the LOTI to verification of requirements at a low level of abstraction such as concrete as instance.

These activities necessarily have impacts on the product to develop and construction systems are no exception, requirements related to these activities are part of the Enabling System and can be classified as Constructibility requirements.

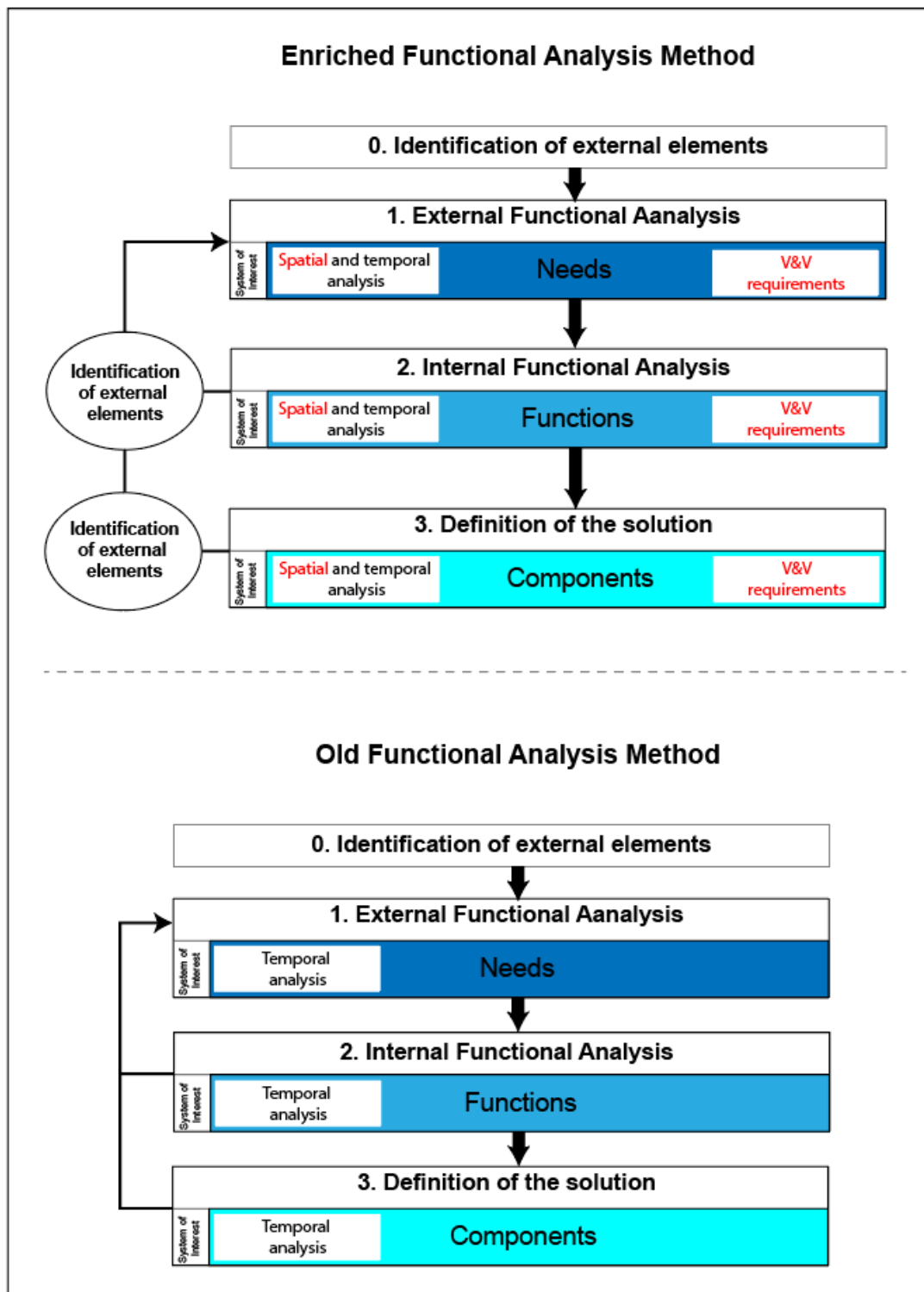


Figure 148 : Integration of space in the Functional Analysis method. This figure shows new elements added to Functional Analysis in red. The integration of space in each view can lead to the identification of new spaces impacted by the system and therefore new elements from the environment to consider.

**Improvement n°18:**

The V&V concept can and has to be applied for all defined requirements (i.e. operational, functional and organic requirements). V&V activities also lead to the definition of Constructibility requirements related to these activities: they have to be considered when designing the system, needs, functions and components.

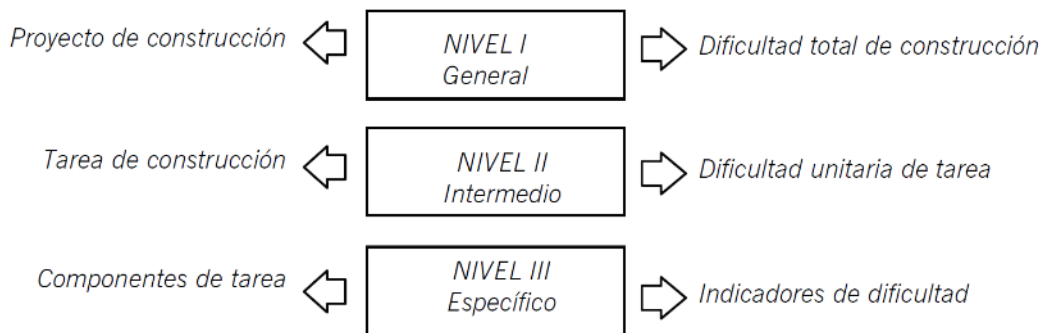
### 3.1.2. Improvement of the Constructibility concept

One of the main contribution of the thesis is the shift from Constructability to Constructibility. The main idea of Constructibility is to consider constraints from all elements of the Enabling Systems when developing the System of Interest by analyzing and evaluating interactions between both systems. This part is composed of three sub-parts: firstly we define the concept of Constructibility, in a second part how to carry Constructibility analysis and finally integration of space in Constructibility.

#### 3.1.2.1. Consideration of constructability at all development phases

Several authors have started to explore interactions between the System of Interest and the Enabling System from the system level to lower systemic levels (subsystems, components...):

Loyola Vergara in (Loyola Vergara, et al., 2010), defines three levels of constructability analysis: project level, task level and component level. Even if these levels does not correspond with the levels defines in Systems Engineering it is an attempt to define different levels of constructability in a project (Figure 149).



**Figure 149 :** The three levels of constructability in (Loyola Vergara, et al., 2010). This diagram highlights that there are interactions between the project and the product both at high and low systemic levels and that constructibility intends to study both of them.

Pulaski et al. (Pulaski, et al., 2005) also have defined different constructability levels depending on the systemic level of the product (system, subsystem etc.) and the development stage of the project (conceptual design, schematic design etc.) (Figure 150). This approach is close to the definition of Constructibility as the interaction between the System of Interest and the Enabling System.

		Process Model				
		Design				Pre-Construction
		Conceptual Design	Schematic Design	Design Development	Construction Documents	Shop Drawings/ Submittals
Product Model (Level of Detail of Constructability Input)	Building/Site					
	System	System				
	Sub-System		Sub-System			
	Components			Components		
	Elements				Elements	Elements

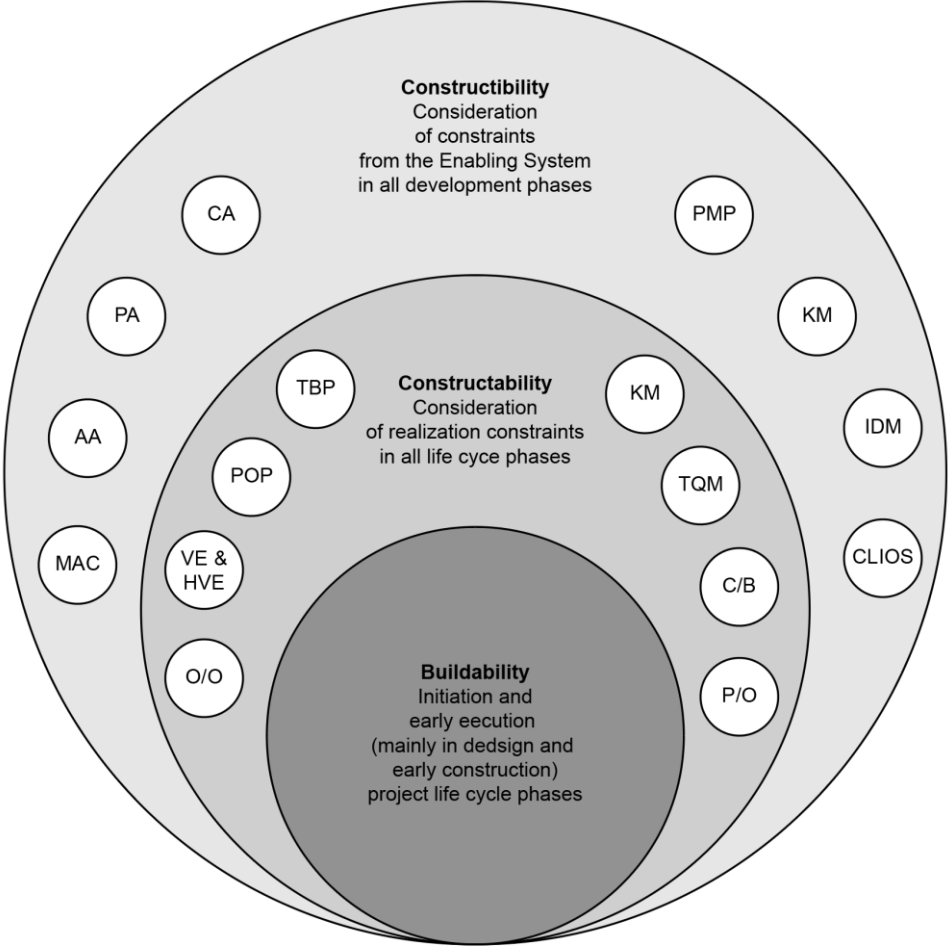
**Figure 150:** The conceptual Product/Process matrix model (Pulaski, et al., 2005). This figure highlights interactions between the product model and the process model at different systemic levels from system to components. It goes a bit further than the last figure by specifying the different activities carried in the Enabling system (e.g. conceptual design, construction documents).



In (Getuli, Giusti, & Capone, 2015), Getuli distinguishes two families of strategies regarding the management of complexity of construction products: Technical strategies referring to performances of the product (in the cited example seismic performance) and the Management strategies referring to “the way in which a technical strategy is implemented”. It highlights that improving constructability can be achieved in two different ways: improve the product and keep the same “Enabling System” or improve the project in order to be able to develop the product and keep the same “System of Interest”.

These different approaches have all in common the analysis of interactions between the project (Enabling Systems) and the product (System of Interest) at different systemic levels. Implicitly it means that constructability is not only related to constraints related to the realization phase but also to other types of constraints related to development processes of the construction product all along its life cycle. The aim of this thesis is to explicitly analyze these interactions: shift from constructability to Constructibility. In the following paragraphs, we will detail how interactions between the System of Interest and the Enabling System can be considered.

While the difference between Constructability and Buildability was the consideration of construction/realization constraints in design and planning phases, Constructibility aims to consider the constraints from all elements related to the development of the construction product (Enabling System) which can affect the System of Interest. Such elements concern inevitably realization constraints as already mentioned by Constructability but also other types of elements such as design and planning activities (Figure 151).



**Figure 151 : From Buildability to Constructibility. In the last chapter a similar figure has been used to highlight the differences between Buildability and Constructability. Here, we show the difference between Constructability and Constructibility and new elements added.**

Figure 151 highlights the difference between Constructibility, Constructability and Buildability. New concepts developed in Constructability (TBP, POP, VE&HVE, O/O, KM, TQM, C/B, P/O) are described in the State of the Art. In Figure 151 some concepts related to Constructibility are mentioned (SE & SM, CLIOS, AA, CA, PPLM, IDM, FI), these concepts are not new in the fact that already exist and are already studied in construction projects. However, what is new is the consideration that these concepts have interactions with the System of Interest, to explicitly consider them and integrate them in the development methodology of construction projects (such as Functional Analysis in this thesis). The list is not exhaustive but gives a sample of new concepts potentially integrated in Constructibility:

**SE & SM** (Systems Engineering and Systems Management): In (Sage & Rouse, 1999), Sage and Rouse analyze interactions between Systems Engineering and how a System should be architected and Project Management and the role of Systems Engineers in projects. In (Demirkesen & Ozorhon, 2017), Demirkesen and Ozorhon also analyze interactions between integration management and clients satisfaction, i.e. requirements the construction system should answers.

**CLIOS** (Complex, Large Scale, Integrated, Open Systems): Sussman in (Sussman, 2009) analyzes interactions between the Institutional sphere and physical elements of construction (and more precisely infrastructure) projects. The CLIOS method is taken as an example for the evaluation of interactions between the System of Interest and the Enabling System (i.e. constructibility analysis) further in the thesis.

**AA** (Acceptability Analysis): Celik, Kamali and Arayici analyze social costs of projects in (Celik, Kamali, & Arayici, 2017). Realize a construction project has inevitably consequences on its surroundings during its realization phase obviously but also during its operational phase: disturbances (noise, air pollution) but also social impacts such as the arriving of new populations or at the opposite the departure/replacement of populations (as instance when a social building is built or a new transport infrastructure between two districts. These phenomenon can lead to acceptability issues of the project.

**CA** (Contract Analysis): Impacts of contracting issues on construction projects (and more precisely on oil & gas projects) have been analyzed by Ventroux in (Ventroux, 2016). Contracting strategies can have important impacts on risks faced by construction projects, notably on interfaces of the System of Interest (so called technical interfaces). Similarly, contractual interfaces can create artificial interfaces in the project (interfaces related to the Enabling System and not to the System of Interest) and impact the System of Interest.

**PPLM** (Project Product Management Lifecycle): PPLM (Sharon & Dori, 2012) is a modeling environment to model interactions between the project (Enabling System) and the product (System of Interest) (also mentioned in the State of the Art).

**KM** (Knowledge Management): while Knowledge Management in Constructability was mainly focused on realization knowledge, it takes a larger scope in Constructibility by also considering knowledge from design and planning activities.

**IDM** (Information Delivery Manual): Information Delivery Manual have been described in part 2. IDM consists in describing exchanges between project stakeholders. Tolmer in (Tolmer, 2016) highlights that IDM should consider both requirements from the System of Interest and the Enabling System (Tolmer refers to the Enabling System as the elements required in the project only at the design and planning phase). Interactions between the SoI and the ES are analyzed and considered which can lead to improvement of the Constructibility of the construction product.

**FI** (Finance): Project finance is another element from the Enabling System which can eventually have an impact on the System of Interest. As instance, Chirkunova, Kireeva, Kornilova and Pschenichnikova in (Chirkunova,

Kireeva, Kornilova, & Pschenichnikova, 2016) have analyzed the impact of project finance on innovation for construction products and Steffen in (Steffen, 2017) impacts of finance in renewable energy projects.

Further in this thesis Constructibility criteria defined thanks to the analysis of interactions between the System of Interest and the Enabling System allowing Constructibility analysis will be presented.

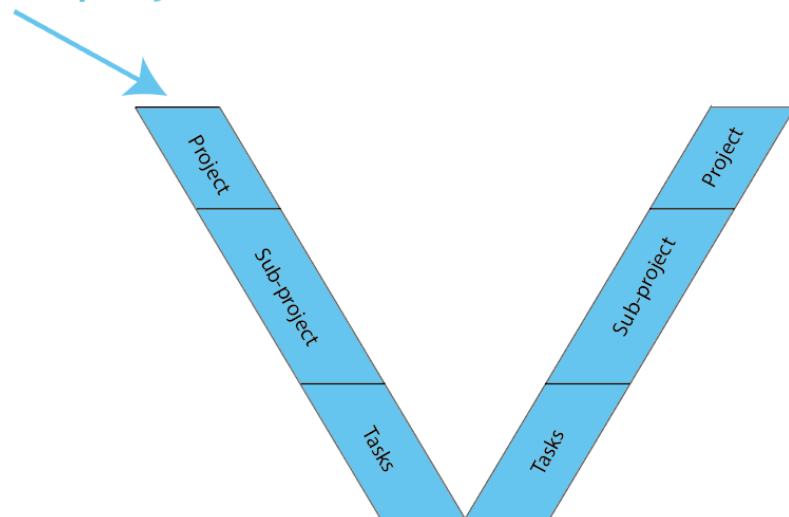
#### **Improvement n°9:**

The shift between Constructability to Constructibility allows considering constraints from the entire development cycle of a construction systems from planning to realization and verification. These constraints were previously not evaluated when evaluating constructability of a system. The aim being to make choices which can be more easily assumed by decision makers by analyzing the capability of Enabling Systems to develop the future product at all phases.

- The double Vee cycle

In chapter 2 we have presented a meta-model of Systems Engineering which allows representing the development of the System of Interest from the system level to the component level as well as assembling and verifying activities for the entire lifecycle of the product: the Vee cycle. This metamodel is usually used for the System of Interest and can also be used to model the Enabling System. The different systemic levels represent the different project levels: the “project” level can be considered as the “system”, “sub-projects” are analogue to “sub-systems” and “tasks” to “sub-sub-systems” levels etc required to develop the System of Interest (Figure 152). We can highlight that contrary to the Vee model for Systems of Interest the right branch of the Vee in the case of the Enabling System represents the Project, Sub-projects and Tasks required to validate, realize and assemble the System of Interest. Links between the left branch and the right branch of the Vee model for the Enabling System concern the anticipation of Objectives, Activities and required Resources in the right leg of the Vee, i.e. validation, assembling and realization activities.

## Enabling System (projects)

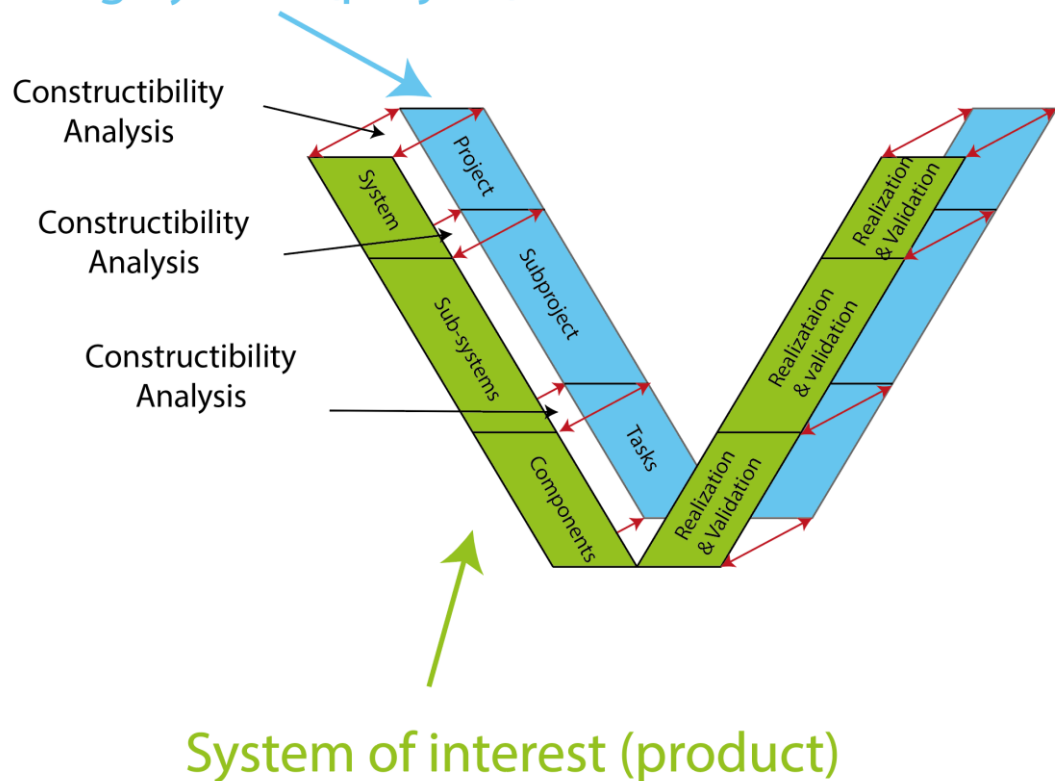


**Figure 152 : The Vee cycle metamodel applied to the Enabling system. This figure shows that simultaneously to the development of the product and its different systemic levels, elements of the Enabling System can also be modeled with a Vee metamodel.**

Therefore, it is possible to define a meta-model which allows representing the System of Interest as well as the Enabling System and the interactions between both: the Vee cycle in green represents the System of Interest and the Vee cycle in blue the Enabling system allowing its development (Figure 153). Constructibility analysis consists

in analyzing interactions between both systems to better evaluate and anticipate risks and better manage complexity of both the System of Interest and the Enabling system.

## Enabling System (project)



**Figure 153 : The double Vee cycle. This figure highlights that Constructibility consists in analyzing interactions between the System of interest (in green) and the Enabling System (in blue) in all development steps in the different systemic levels.**

- Horizontal and Vertical Constructibility

In general terms, we can consider that two types of processes can be identified in the Enabling System. In the left branch of the Vee model, activities concern planning, modeling, simulating and verifying. It is mostly information which are processed during these activities and to acquire and process these information.

In the right branch of V, activities concern realizing, assembling, testing and logistic activities. Energy and materials are essential resources of these processes. In these activities, spatial interactions are strong between subsystems of the Enabling System, its surrounding environment and with elements of the System of Interest.

Therefore, it is important to evaluate Constructibility not only of processes which are required during the realization process in the right branch but also Constructibility of all processes including processes in the left branch.

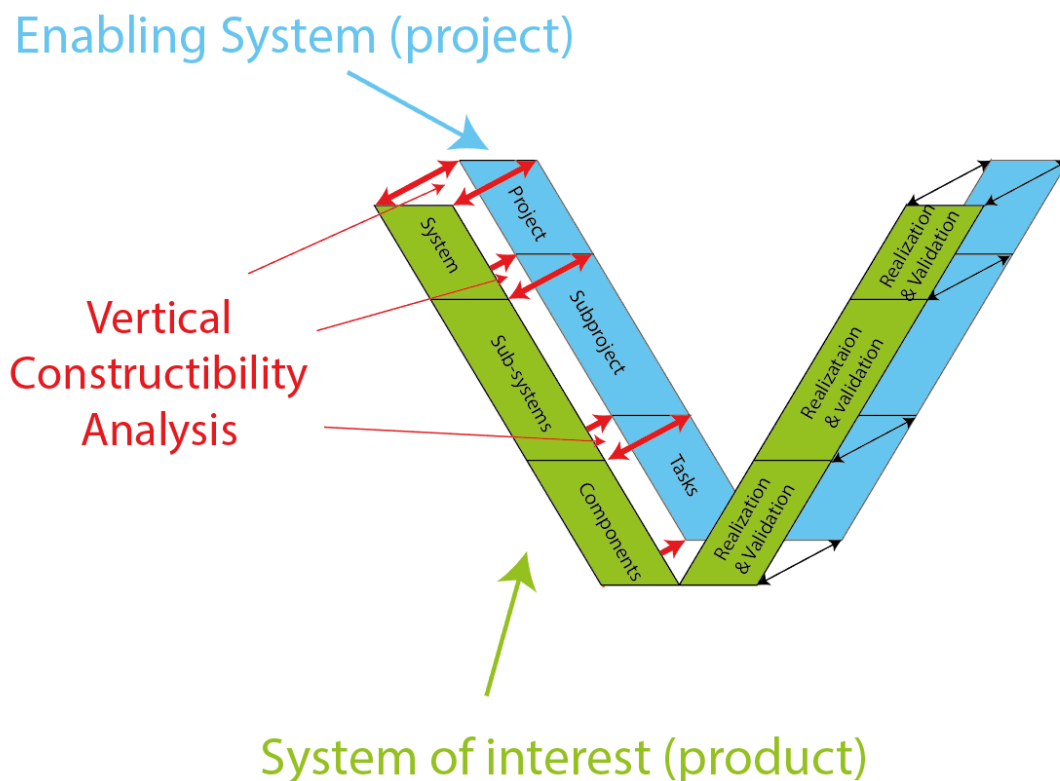
In the left branch of the V, two Constructibility analyses are possibly undertaken:

- Analyze Constructibility of design and planning processes: **Vertical Constructibility** analysis;

Vertical Constructibility analysis consists in evaluating the capability of the enabling system to carry the necessary activities required to plan and design the future system. These activities have objectives, constraints and require resources, it is composed of processes and methods. The analysis of Vertical Constructibility leads to the definition of Constructibility requirements which have to be traced and verified.

Most of the activities in the left branch of the Vee concern gathering of data, creation of information, creation of the requirement referential, ensuring quality of information, modeling, simulation, verification of requirements. These activities require tools, computational power, sensors for data gathering, engines to carry drillings, human resources to manage and execute the tasks etc. all these elements are part of the enabling system and vertical Constructibility analysis consists in analyzing capability of this Enabling System to develop the System of Interest.

BIM processes (BIM uses, BIM Execution Plan etc.) as example are part of the Enabling System, evaluation of constraints related to such processes and the definition of requirements related to BIM processes are part of the so called “Vertical Constructibility” analysis.

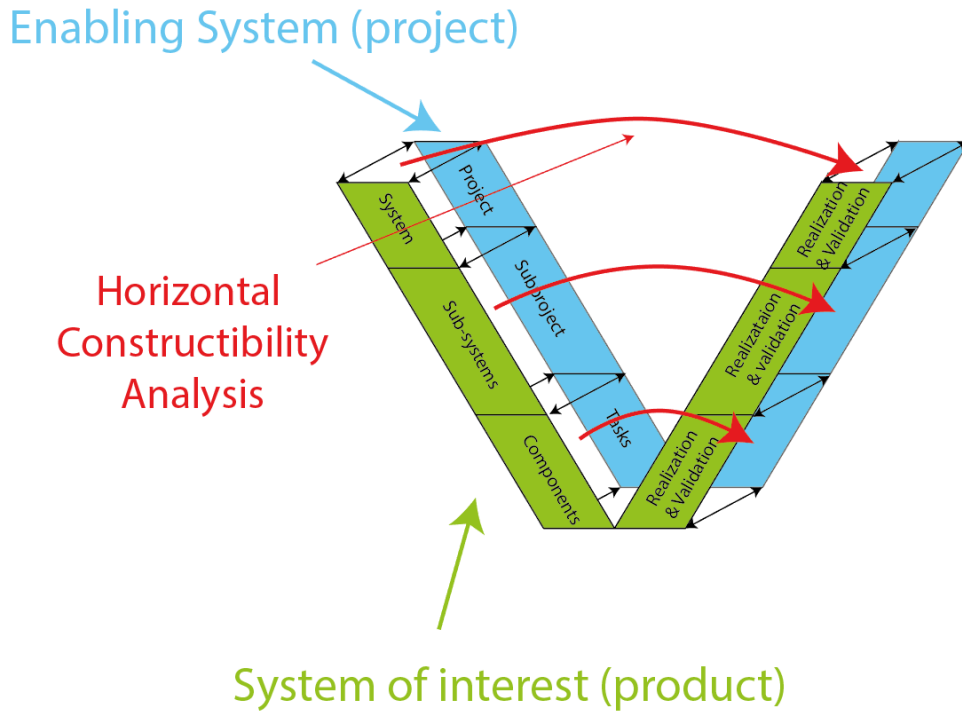


**Figure 154 : Vertical Constructibility analysis in the double V-cycle. Vertical constructibility (in red) consists in analyzing interactions between activities in the left branch of the Vee cycle and the System of Interest. In vertical constructibility activities consist in developing an avatar of the product (also called a model) which represent as much as possible to the product developed in the right branch.**

- Analyze Constructibility of verifying and assembling activities: **Horizontal Constructibility** analysis :

In opposition with Vertical Constructibility Analysis, Horizontal Constructibility Analysis consists in analyzing the right branch of the Vee meta-model. In the right branch, elements of the system are realized, materials and components are forwarded, stored, assembled and verified. These activities also have objectives and require resources at different system levels. Requirements related to these constraints have to be defined and traced similarly to other types of Constructibility requirements. Initially, Constructibility criteria defined in the last chapter were mainly related to horizontal Constructibility. However, it was mainly focus on a low and concrete systemic level. Horizontal Constructibility requirements at a high systemic level also require to be considered.

How these verification will be carried? What should be measured and how? Who should do it? Etc. Are questions which are part of a Constructibility analysis at a high systemic level when defining needs the future system will answer. This example shows that an Horizontal Constructibility analysis does not only concern low abstraction levels and concrete components, verification activities conditions notably are part of a Constructibility analysis.



**Figure 155 : Horizontal Constructibility analysis and the double V cycle.** This figure shows that Horizontal constructibility consists in considering requirements related to elements of the Enabling System in the right branch of the vee (such as logistic, assembling, verification) when modeling the System of Interest in the left branch of the vee.

Assembling and logistic activities have the particularity to involve materials resources in their processes (as well as energy and information) and therefore space. The space used for logistic and assembling activities is often concurrent with spaces allocated to organic or functional views. It is therefore required to ensure the use of the same space by Enabling systems or the System of Interest is not contradictory.

Moreover, we want to highlight that the definition and the distinction between vertical and horizontal Constructibility helps to structure the requirement referential related to the Enabling Systems.

**Improvement n°10:**

The double Vee cycle allows to apply appropriate Constructibility constraints at the appropriate development phase. It also highlights that Constructibility analysis required to be carried at all systemic levels.

**Improvement n°11:**

The distinction between horizontal and vertical Constructibility highlights that requirements (Constructibility requirements) related to tests and verifications of the future system have to be considered at the same time than tests and verifications activities are defined during the development process.

- Constructibility Principles and Concepts

In the last chapter, we have presented 10 Constructibility Principles (CP) and 23 Constructibility Concepts (CC). The shift from Constructability to Constructibility and the consideration of interactions between the SoI and the ES for the entire lifecycle leads to the definition of new CP and adaptation of others related to the new elements bring by Constructibility compared to Constructability.

From the 10 constructability Principles, 4 are adapted (CP2, CP5, CP6 and CP9) and we have defined 4 new Constructibility Principles (CP11, CP12, CP13 and CP14):

- Adaptation of previous Constructability Principles:

CP2: Implementation of construction expert knowledge

Constructibility leads to modify this CP to the following: “Implementation of planning, design and construction expert knowledge” at all phases of projects from the system level to the lower systemic level. It means that not only construction knowledge require being introduced at the system level but also design and planning knowledge at lower systemic levels the objective being to make choices at the realization phase considering needs and functions of the system globally.

CP5: Consideration of available resources

While previously resources were referring to materials and eventually energy to supply the construction site, in Constructibility, resources refer also to all the inputs required to carry planning, design, realization, verification and commissioning activities. As instance: tools, human resources, human knowledge, engines, software etc.

CP6: External Factors and site accessibility

In Constructibility, external factors concern not only external factors which potentially affect the site but also all the factors which potentially affect all activities related to the development of the project from planning, design, realization and verification phases.

CP9: Innovation

Previously, innovation was considered as an objective of constructability: it would be necessary to develop innovative methods/tools/concepts to improve constructability. We don't have the same interpretation of innovation in Constructibility: innovate is not an objective per se, it is first necessary to identify potential improvements or a problem to resolve (in the System of Interest or in Enabling Systems) and only then to innovate to solve the issue or improve the system.

Only then, Constructibility is necessary to evaluate impacts of the innovation on other systems and particularly Enabling Systems. Innovations on the System of Interest have inevitably impacts on the Enabling Systems and it is necessary to carry a Constructibility analysis to identify them and adapt Enabling Systems in consequence. Similarly, innovations on Enabling Systems will necessarily have impacts on the System of Interest (needs, functions, components of the system), these impacts also have to be evaluated to decide if the innovation is suitable or not.

- New Constructibility Principles:

CP11: Consideration of the interactions between Enabling Systems and System of Interest

One of the main Principle of Constructibility compared to Constructability is the consideration of constraints from all Enabling Systems i.e. all the systems required to develop the System of Interest.

CP12: Consideration of constraints from planning and design activities

The Constructibility Principle n°12 is a direct implication of the previous Constructibility Principle: Planning and design phases also have objectives, activities and resources. Similarly to realization activities they imply constraints on the development of the System of Interest.

CP13: Choices related to the System of Interest have to be assumed by the analysis of Enabling Systems

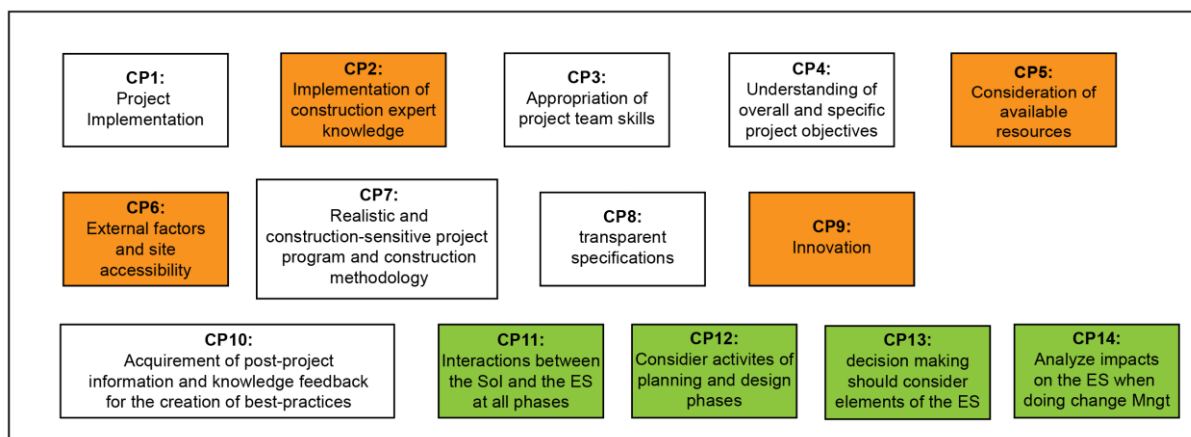
Another main principle of Constructibility is to be able to assume choices which are made at all development phases by considering constraints from the Enabling System. Answering to a new need, adding a function, develop a new component or change it has inevitably impacts on the systems require to develop the future product. Such changes and modifications have to be assess to evaluate impacts on Enabling Systems.

#### CP14: Modification and change management

The direct implication of the previous CP is the development of tool which allow better managing complexity of interrelations between the Enabling Systems or/and parts of the System of Interest. Requirement Engineering and Management notably allow to do so even if their application in the construction industry remains to be established. It consists in the application of such methodologies at the planning and design phases to model and manage requirements. It allows a better management of changes and modifications and evaluation of related impacts (which is very often in the construction industry). How defined requirements are formalized and essentially verified is also an important aspect of this principle.

Most importantly, previous CP defined in constructability referred only to “Horizontal Constructibility” as they refer essentially to the consideration of realization and assembling constraints in the design, execution and delivery phases. The introduction of “Horizontal Constructibility” leads to the application of previously defined CP and CC to planning and design activities which were not the case in the previous definition of Constructability.

In Figure 156 the 14 Constructibility Principles are represented, in orange are adapted Constructability Principles to Constructibility and in green the new Constructibility Principles previously defined.



**Figure 156 : Adapted Constructability Principles and new Constructibility Principles. In orange are adapted Constructability Principles and in Green new Constructibility Principles developed in the thesis.**

#### ***3.1.2.2. Constructibility Analysis: Analyze interactions between the System of Interest and the Enabling System***

Analysis of interactions between the Enabling System and the System of Interest will carried through the definition of *Constructibility criteria*. Analyze and evaluation of Constructibility criteria can be carried through the application of different methods, the CLIOS method being one of them (Figure 157).

Criteria are used to make decisions: criterion is “*a standard on which a judgment or decision may be based*” from the Merriam-Webster dictionary. Therefore Constructibility criteria are used to help decisions makers assessing the Constructibility of the System of Interest considering all elements of the Enabling System.

In the last chapter, we have identified 39 different constructability criteria of different types in the literature. These criteria are defined thanks to expert knowledge and are therefore dependent of a particular context: the individual experience of each expert. However, there is no method in the literature to define properly these criteria. In this part we propose a methodology to define appropriate Constructibility criteria for each project and each context. We also propose a set of criteria defined thanks to this method based on invariants of construction projects (Enabling Systems). It is important to keep in mind that these criteria are necessarily subjective and related to the context of each project. Application of the method for each project can lead to the definition of other or different criteria. The Table 16 is a first typology of the different Constructibility criteria related to the decomposition of



the Enabling System in Objectives, Activities and Resources and to the different systemic levels of the Enabling System (System, sub-system, sub-sub-system etc. which correspond to project, sub-project and tasks levels).

	<b>Objectives</b>	<b>Activities</b>	<b>Resources</b>
<b>Operational view</b>	CC*	CC	CC
<b>Functional view</b>	CC	CC	CC
<b>Organic view</b>	CC	CC	CC

**Table 16 : Constructibility Criteria in all phases of a construction project. CC (Constructibility Criteria) can be defined in the 3 views of Systems Engineering related to Objectives, Activities and Resources.**

\*Constructability Criteria

To achieve this objective, we propose to consider the “Enabling System” as a system and to apply exactly the same principles than the “System of interest” to define its *objectives*, *activities* and *resources*. Defining the three views of *Operational*, *Functional* and *Organic* analysis requires an enabling system and can be decomposed in *Objectives*, *Activities* and *Resources*. In the Functional Analysis method and more precisely in the MISME method, is explained how functional criteria are defined: 1. Definition of external elements of the system 2. Definition of functions 3. Definition of functional criteria. The same method can be applied to define constructability criteria by considering Enabling Systems instead of System of interests.

Defined criteria can also be refined in more precise criteria when precisions are given on Objectives, Activities or resources (on what the decision is about) and on how the criteria will be measured.

- Analyze interactions between objectives of the Enabling System and the System of Interest

Interactions between Objectives of the Enabling system and the System of Interest differ depending on the system level and elements of the System of Interest considered (Needs, Functions and Components).

A good example of the analysis of interactions between components of the System of Interest and Objectives of the Enabling System is the CLIOS method (Complex, Large Scale, Integrated, Open Systems) developed by Sussman (Sussman, 2009), (Mostashari, June 2005), (Dr. Dodder, et al., 2009). The CLIOS method intends to analyze interactions between complex socio-technical systems and the institutional sphere in charge of their development (Figure 157). The institutional sphere is part of the Enabling System and the different institutions have different objectives which can affect the development of components of the System of Interest (its subsystems).

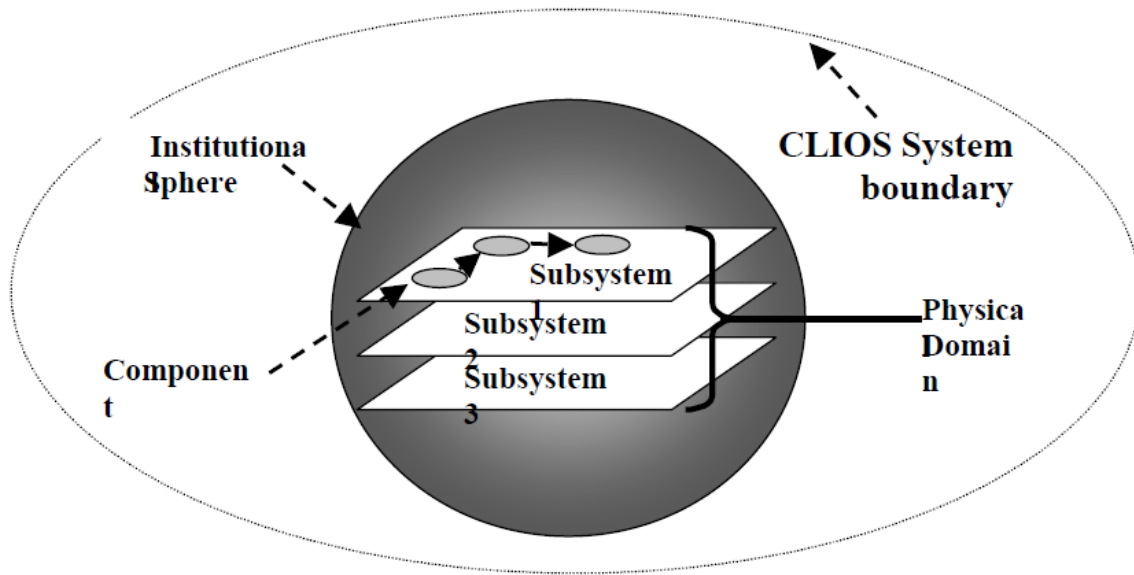


Figure 157 : A CLIOS System consists of a physical domain (made up of subsystems), embedded in an institutional sphere (Mostashari, 2005). This figure highlights that physical elements of a system in megaprojects and more particularly in construction projects are in interaction with the Institutional sphere.

By linking the development of large socio-technical systems with the Institutional sphere, Sussman (Sussman, 2009) proposes to intervene and make changes on the under development socio-technical system or directly on the institutional sphere depending on the problems to solve: “The CLIOS Process is structured not only to support analysis, but guide users in their efforts to change, affect or otherwise intervene in the system, in order to address the problem (or CCI) that motivated the analysis in the first place. Strategic alternatives are essentially the changes we consider to improve the performance of the CLIOS System [...] Strategic alternatives may be developed for both the physical domain and the institutional sphere. Usually, strategic alternatives that influence the physical domain need to be complemented by changes in the institutional sphere that would make the implementation of the alternative possible”.

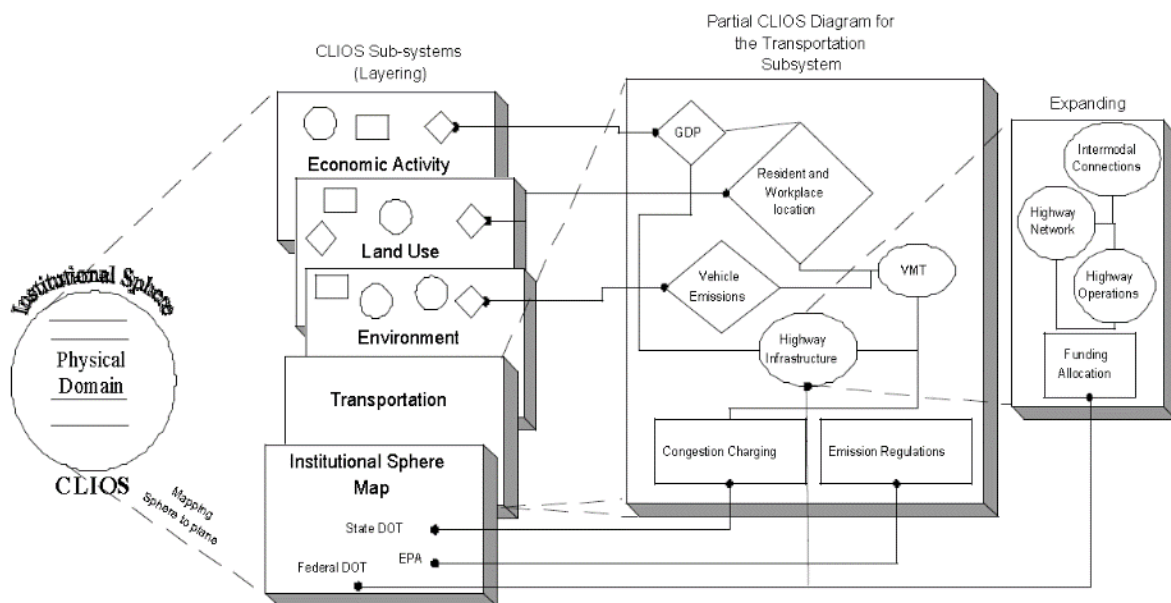


Figure 158: Example of the application of the CLIO process on a transportation system.

This is exactly the type of consideration we want to bring when shifting from constructability to Constructibility: not consider only production constraints but also all the other types of constraints related to the enabling system

of construction products from planning to design and realization and identify how they impact constitution of the System of Interest. It is interesting to see that the CLIOS method intends to evaluate interactions between physical systems and the institutional sphere which shows that such interactions can be analyzed at high systemic levels.

In the CLIOS method, Sussman highlights that improving development of the System of Interest can be undertaken in two different ways: by modifying the Institutional sphere (the Enabling System) and/or to modify the “physical subsystems” i.e. components of the System of Interest. It means that improving Constructibility of a system can always be carried in two ways: modify the System of Interest in order to better adapt it to the Enabling System already in place, or at the opposite improve the Enabling System in order to develop more complex products.

The CLIOS method consists in analyzing interactions between Objectives of the Enabling System and Components of the System of Interest. In our vision of Constructibility, we don’t only analyze interactions between Objectives and Components but more generally, interactions between Needs, Functions and Components of the System of Interest with the Enabling System. Other similar methods would be required to investigate other types of interactions with the System of Interest such as Objectives <-> Functions interactions or Objectives <-> Needs interactions.

To define objectives of the Enabling System, it is possible to use both the fundamental expression of the needs diagram and the interaction diagram (a Use Case diagram from SysML has been used instead in Figure 159). The interaction diagram is normally used to determine external functions of systems. When used to analyze the Enabling System it represents its objectives: “main functions” of the Enabling System, what it is intended for. External elements of the Enabling System are represented and the Enabling System is in the center (Figure 159), Main Functions of the Enabling System therefore represent its Objectives. Each objective can be evaluated relatively to elements of the System of Interest to evaluate, the link between the Objective defined and the element of the System of Interest constitutes a Constructibility criteria.

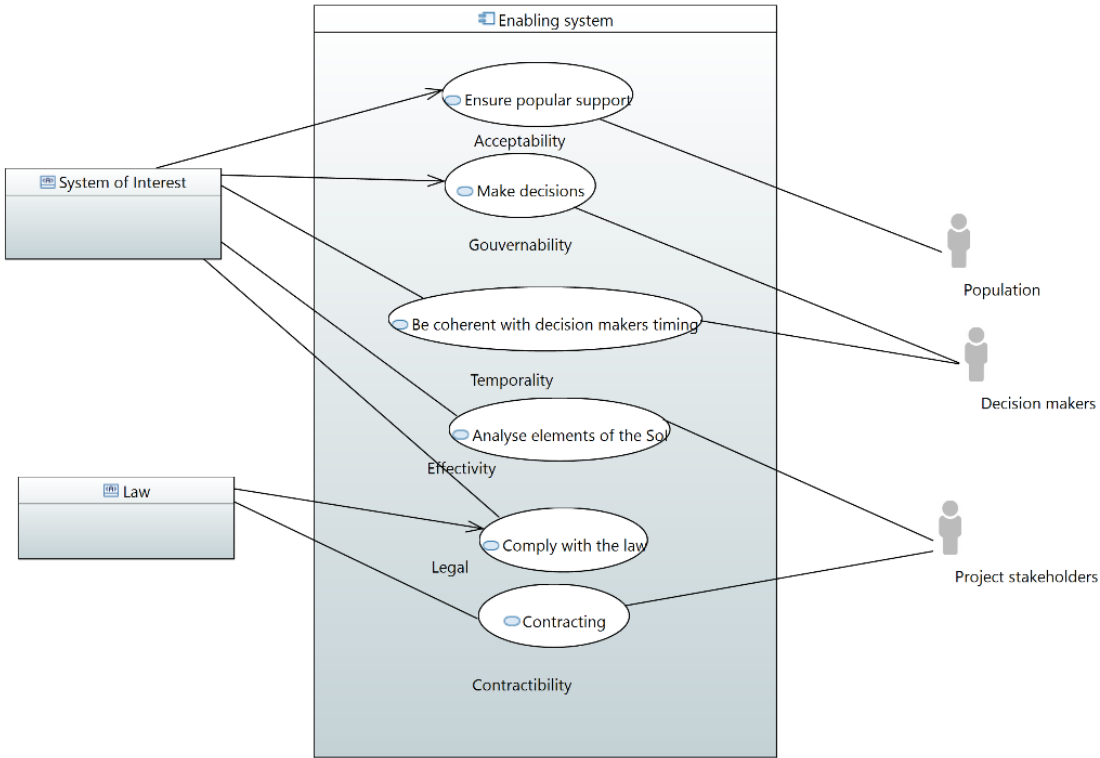


Figure 159 : Example of objectives of an Enabling System analysis represented with a Use Case Diagram (SysML)

Similarly than in the MISME method, external elements to the Enabling System are identified and “Service Objectives” and “Constraint Objectives” are defined. In the State of the Art, 3 types of performance have been defined, Effectivity, Pertinence and Efficiency, these performance have been associated to elements the 3 views constituting the Enabling System: Effectivity makes the link between Objectives of the Enabling System and the definition of the System of Interest. The Enabling System is effective if elements of the System of Interest are described with the appropriate level of precision and detail. Pertinence makes the link between the System of Interest and Activities of the Enabling System. A pertinent activity allows reaching Objectives. Efficiency makes the link between the System of Interest and the amount of Resources of the Enabling System used to carry the activity. An efficient Enabling System requires few resources to carry an Activity. These 3 performance have been identified as the first “*Constructibility criteria*”.

In this example, 6 objectives have been defined for the enabling system:

Objective 1: The first objective of the Enabling System to analyze elements of the System of Interest whereas it is Needs, Functions or Components. This objective can lead to the definition of external functions, internal functions, spatial and time description, organic elements etc. of the system of interest as instance.

- **Effectivity:** The link between the System of Interest and the Enabling System to define and analyze elements of the SoI can be formalized as “Effectivity”, i.e. the capability of the Enabling System to analyze elements of the System of Interest (Needs/functions/Components) over space and time with a defined level of precision and detail.

Objective 2: Another objective of the Enabling System is to make decisions. Eventually, different actors with different objectives can impact the project and influence the decision making process. How decisions are made, complexity of the procedures, actors’ interactions can all have impacts on the System of Interest.

- **Governability:** the System of Interest to develop, the needs it will answer, its functions and even its components directly influences the number and types of decision makers involved in the Enabling System. It is therefore possible to modify the system of interest to avoid issues related to decision making or to modify the Enabling System to improve its capability to make decisions. The Constructibility criteria related to the capability of the Enabling System to make decision has been called Governability.

Objective 3: Ensure that elements of the System of Interest will answer have coherent deadlines. Whereas it is needs, functions or components have the system, the enabling system should ensure that they are “timely” coherent. As example in the Operational View, If one need has to be fulfill in the next 2 years and another one in the next 30 years, the possibility to develop two different systems is worth asking. This phenomenon is frequent in the construction industry as depending on the needs the system will answer, the timing is not necessarily the same which often leads to the realization of two different systems and therefore under optimization.

- **Temporality:** Both the System of Interest and the Enabling System can influence time coherence of the System to develop. It is possible to choose or modify elements of the System of Interest in order to make them timely coherent. Or at the opposite to modify the Enabling System to be timely coherent. As example, politic elections often punctuate public projects while the private sector have other imperatives, a metro system answers to needs for the next 30 years whereas the timing horizon of a heat network is for the next 5 five years.

Objective 4: Very often different stakeholders are implied in construction projects. An objective of the Enabling System is to find a contractual agreement between them which defines missions of the different stakeholders in the project and relation between them. These relations are formalized by contracts and are regulated by laws which can change depending on the country and the type of System of Interest.

- **Contractibility:** the Constructibility criteria related to the formalization of relations between project stakeholders takes the name of contractibility. It intends to evaluate if the existing types of contracts fits well with needs, functions and elements of the System of Interest. Here again, it is possible to change the System of Interest to adapt it to the current existing contracts, or conversely to develop new types of contracts which better fit with the System of Interest.

Objective 5: Laws, norms, decrees etc. regulate what systems can do or not. Consequently one objective of the Enabling System is traditionally to respect applicable laws. When developing a System it is compulsory to respect such laws which change depending on the country and the type of system to develop. Laws can affect both the System of Interest and the Enabling System.

- **Legal:** The Constructibility criteria which allows evaluating if the System of interest to develop has been called “legal”. It is possible to modify the System of Interest in order to respect laws or at the contrary to modify laws, which are elements of the Enabling System, to develop the product.

Objective 6: The last objective defined is related to the acceptance of the System by populations. Construction systems in urban environments are inevitably interacting with dwellers and future citizens. Non-consideration of such interactions can impact both the System of Interest and the Enabling System.

- **Acceptability:** Acceptability has been chosen as the Constructibility criteria related to acceptance of the System of Interest by populations. It is possible to modify the System to develop in order to make it more acceptable for the population and therefore modify the System of Interest or to improve communication with population and better explain interest of the project as instance and modify the Enabling System.

Such criteria can be applied on components of the System of Interest as carried in the CLIOS method, or to any other elements of the System of Interest (needs and Functions).

The method developed by Giezen in (Giezen, 2012) is another example of how to improve Constructibility of a project in the planning phase. In his works, Giezen develops concepts to better manage complexity and uncertainty for decision-making and planning notably by adding adaptability (Figure 160) and strategic capacity.

**Adaptive capacity:** *“Adaptive capacity categorizes the types of adaptations or non-adaptations that are made to the organization and scope of mega projects and relates them to changes in a project and its context.”* (Giezen M. , 2012)

**Strategic capacity:** *“Strategic capacity focuses on the strategic organization of the decision-making process and looks at issues such as ambiguity, redundancy, and resilience.”* (Giezen M. , 2012)

This type of work typically intends to modify and adapt the Enabling System to improve its capacity to cope with complexity of projects.

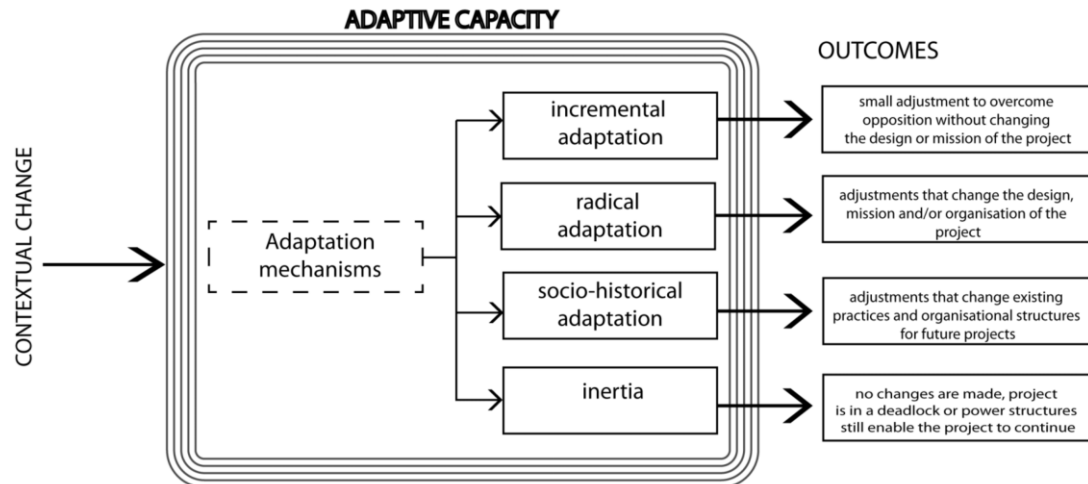


Figure 160 : Conceptual scheme of « Adaptive Capacity » (Giezen M. , 2012). It regroups the different adaptation mechanisms to carry to be able to face to contextual changes in a project governance.

- Analyze interactions between Activities of the Enabling System and elements of the System of Interest

Other elements of the Enabling System are Activities. In this part we will analyze possible interactions between Activities of the Enabling System and elements of the System of interest (Needs, Functions and Components).

To fulfill objectives of the enabling system, activities require to be carried. In turn, these activities will constraint the development of the system of interest. Activities carried by the enabling system would be the counterpart of internal functions in the MISME method. They can be formalized and modeled with an Internal Function Diagram as instance. Another way to model activities is to use BPMN (Business Process Model and Notation). Both modeling methods have different interests: modeling activities with an Internal Function Diagram allows modeling links between Objectives of the enabling System and activities, modeling activities with BPMN allows modeling sequencing of activities as well as its inputs and outputs.

In (Piatt, 2012), Piatt defines 6 criteria to improve processes. Evaluate processes against these criteria allows assessing Activities of the Enabling System and Constructibility of the System of Interest related to these Activities . These criteria apply to any process whereas they are technical, commercial or support-processes and therefore also when analyzing needs, functions or components of systems.

- **Complexity:** the number of resource types (information, energy or material) is a source of error makes it difficult control and inspect. As far as it is possible processes should remain simple with few inputs and outputs.
- **Robustness:** processes have to be robust to external events. Environmental possible conditions should be taken into account when defining processes to anticipate unexpected events.
- **Documentation:** processes have to be documented (at least with a paper based method and preferably with models like BPMN). Documentation allow improving processes over time and simulate scenarios, it also enhances communication of the process and avoid misunderstandings between actors. Furthermore, documentation and standardization is the first step to automation and later Artificial Intelligence.
- **Control:** Processes have to be controlled and managed to ensure their quality and completeness. Controlling processes is also a way to improve them by identifying recurring problems and ways of improvement.

- **Error-proofed:** good processes incorporate alerts and error-proofing techniques to avoid mistakes by people executing it
- **Communication:** participants should be aware of the process in order to improve self-management and better understanding of expectations.

We add Pertinence, Repeatability and Standardization to the criteria defined by Piatt as they seem important to consider when evaluating Constructibility of a system:

- **Pertinence:** pertinence makes the link between the System of Interest and activities required to fulfill Objectives of the Enabling System. An activity is pertinent if it allows reaching Objectives of the Enabling System.
- **Repeatability and standardization:** Establishing a process is time consuming and requires resource. Therefore a repeatable process is easier to achieve as difficulties are better expected and managed and tasks are carried quicker.
- Analyze interactions between Resources of the Enabling System and elements of the System of Interest

Activities or processes involved in needs analysis require resources. Resources are component of the Enabling System, it is equivalent to the organic view for the System of Interest. One possible way to model composition of the enabling system would be to use block diagrams in SysML for example.

Two types of resources can be identified: processor resources required to enable the process like human resources, tools, engines etc. and processed resources which can be considered as inputs of the process: natural resources, information, materials, energy etc. In the left branch of the Vee, it is mostly information resources which are required as inputs and processors are human resources and computer tools. Some criteria apply to processors resources, to processed resources and other to both types of resources:

- **Efficiency:** Efficiency makes the link between Resources required to carry activities of the Enabling System and the System of Interest. The Enabling System is Efficient if it allows carrying Activities with few resources.
- **Availability** (processors and processed): availability concerns the “scarcity” of the resource. When a resource is required for a process, evaluating its rarity is crucial for its effective operation.
- **Accessibility** (processors and processed): some resources may be difficult to access whereas they are human resources, information or materials. As instance, information about mobility needs can be difficult to assess or a material difficult to find.
- **Workability** (processed): workability concerns the capability of the resource to be used in processes required to achieve project objectives. As instance, the format of gathered data can influence this criteria as well as the capability of a material to be deformed (if require in the process which is rarely the case in needs analysis processes).
- **Knowledge** (processors and processed): knowledge about required resource is important to avoid unexpected behaviors and events during the process development. A well-known resource will be used more efficiently.
- **Reliability** (processors and processed): reliability on resource behavior and characteristics is fundamental for proper functioning of processes. As instance, if wrong information about mobility needs are collected the built system will answer to a need that even does not exist or has not been well evaluated. The system could not be fit to answer needs of the population or worth could be totally useless. Reliability on processors is also of great importance, to avoid uncertainty on processes results.

- **Ambivalence** (processors and processed): ambivalence of processors and processed resources can be useful to ease the functioning of processes. An ambivalent resource can be used for different purposes and help to standardize processes.
- **Financiability** (processed): Financiability concerns the capability of the construction product to be financed. Depending on the cost of the System of Interest (or forecast cost) and many other factors related to the Enabling System such as political stability, investment capability of actors, funds raising capability of actors or their capability to issue mortgage bonds as example, financiability of the system can vary. As instance, it is possible to influence the System of Interest by giving financing or tax facilities as it is sometimes the case to promote the use of green energy.

Constructibility criteria related to Objectives, Activities and Resources are applicable both on Vertical Constructibility, i.e. the Enabling System intended to design the System of Interest and on Horizontal Constructibility, i.e. the Enabling System intended to realize, assemble, verify and validate the System of interest.

To implement the decision making process and to carry Constructibility analysis, a Constructibility matrix can be used with the different Constructibility criteria defined above. The Constructibility matrix will be developed in detail further in the thesis.

Constructibility criteria defined in this part are largely debatable, they are general criteria to consider to evaluate the capability of the Enabling System to develop the System of Interest and eventually to give ways of improvement for the future. New criteria can eventually be defined and current criteria defined here could be modified or adjusted depending on the projects. Most importantly, the method used to define Constructibility criteria by defining objectives, activities and resources required should allow a better definition and structure of criteria. Eventually, criteria can be refined when detailing both the System of Interest and the Enabling System.

#### **Improvement n°13:**

Analyze the Enabling System with a Functional Analysis approach allows defining a method to define Constructibility criteria at the development phase of the construction system.

- Formalization and quantification of Constructibility criteria

As Constructibility is defined as the link between the System of Interest and the Enabling System, improving constructability can be divided in two objectives:

- Improve *the efficacy* of the Enabling System (its capability to realize a product whatever its complexity);
- Improve *the feasibility* of the System of Interest (develop products which are easy to realize with the existing Enabling System);

Efficacy of the Enabling System is its capability to reach objectives of the project and feasibility of the System of Interest is its capability to be developed with varying degrees of difficulty.

**Therefore constructability criteria can be characterized by a ratio  $C = \frac{A}{B}$**

“A” is the efficacy of the project and “B” is the feasibility of the product. Constructability is therefore a trade-off between the efficacy of the project and the feasibility of the product.

As an example, it is possible to standardize components of a product improving its feasibility or to improve the enabling system by developing a machine able to realize different components. The constructability result is the same but impacts are either on the product or the project. These solutions are two different ways to improve constructability.



**Improve constructability consists in having the higher value of the ratio  $C = \frac{A}{B}$ , either by increasing A (improve efficacy of the project) or decreasing B (improve feasibility of the product).**

- Improve the efficacy of the enabling system

One way to improve constructability is to improve the efficacy of the enabling system. Improve efficacy consists in developing new methods and tools to improve either means required to develop the system of interest either improve complexity management.

- Improve the feasibility of the System of Interest

Another possibility is to improve the feasibility of the System of Interest in order to facilitate its development. Improving feasibility consists in adapting the System of Interest to the Enabling system. It facilitates the development of the Product without changing the Enabling System.

It can consist in modifying elements of the System of Interest such as Needs, Functions or Components at different systemic levels in order to facilitate its development. Inevitably, a change in the System of Interest is not neutral and change/modification analysis should be carried when making such decision.

- Improve feasibility of the product or efficacy of the project?

As we have just explained two ways are possible to improve constructability, improve efficacy of the project or feasibility of the product. How to choose which direction to take when designing a new product?

First, we need to keep in mind that the reason a product is under development is to answer needs of stakeholders. When analyzing constructability it is necessary to evaluate impacts of choices made on components, functions and needs of the product and objectives, activities and resources of the project. Therefore, the idea is to improve feasibility of the product or to improve efficacy of the project avoiding as much as possible changes on the product (organs, functions, needs) and the project (Objectives, Activities, resources) architectures.

Even if the proposed formula is very simple at the moment (a ratio A/B) it is a first mathematical formalization of Constructibility criteria. Further researches would be required to investigate more in detail this possibility.

Finally, carrying constructability analysis consists in analyzing impacts on the product and project architectures of a solution which allows and facilitates the product development while answering to stakeholders' needs.

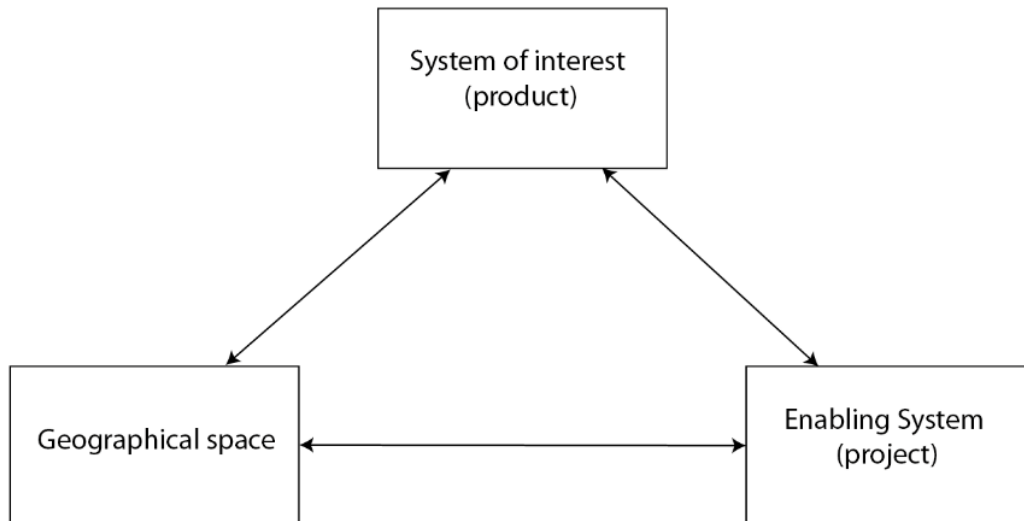
#### **Improvement n°14:**

Even if Constructibility criteria are not always formally defined and measurable, this improvement offers one possible approach for future definition of Constructibility criteria as a ratio between measurements of elements from the System of Interest and the Enabling System.

#### ***3.1.2.3. Consideration of space in the Enabling System in the construction industry***

As mentioned all systems operate over time and space. It is true for the System of Interest as well as for the Enabling System. The CESAM guided also mentions that similarly to the System of Interest the Enabling System have to be modeled over space “*Since space and time are always both required to specify any constructional reality (that take place somewhere at a certain time)*” (CESAM, 2017).

As mentioned in the previous section, the particularity of construction projects comes from consideration of geographical space in its development. Geographical space with all its subsystems (physical but also political, social etc.) has impacts both on the System of Interest and the Enabling System:



**Figure 161 : Particularity of the construction industry: Geographical Space, the System of Interest and the Enabling System. It highlights that not only the System of Interest is related to space but also the Enabling System.**

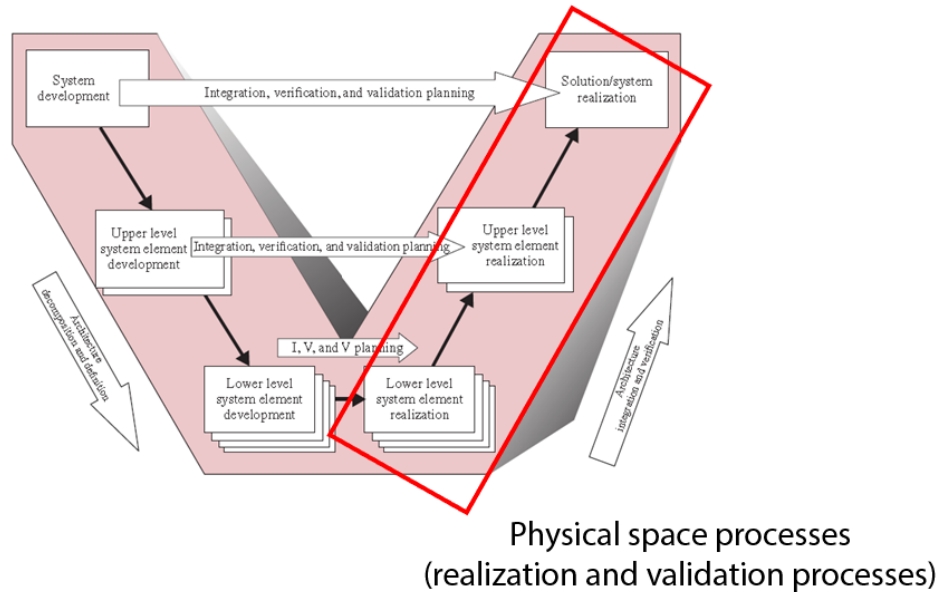
Therefore, when conducting a constructability analysis it is necessary to focus on impacts of the geographical space on the System of Interest and the Enabling System as this is what makes every construction projects unique and complex.

To be more specific, geographical space is a resource from the point of view of the product and a constraint in the project domain: purpose of a construction product is to adapt the geographical space and it is therefore considered as a resource, whereas in the project domain the aim is to develop and build the product and geographical space can be considered as a constraint.

In the development of construction systems it happens that the same space is required for the System of Interest and the Enabling system. Sometimes, spatial clashes also happened between two subsystems of the System of Interest or two subsystems of the Enabling system. These spatial conflicts are important to assess in order to avoid inadequate functioning of both systems.

One question arises: when does the Enabling System requires space? It depends of the processes and required resources to achieve defined objectives of projects. As instance, activities of planning and designing mostly consist in realizing models of the future system to evaluate its future characteristics. These activities mostly require information which have low physical space interactions.

At the contrary, realization activities which consist in adapting space have high physical space interactions. Validation of physical space based systems like construction systems also require physical space and may interact with other physical space processes.



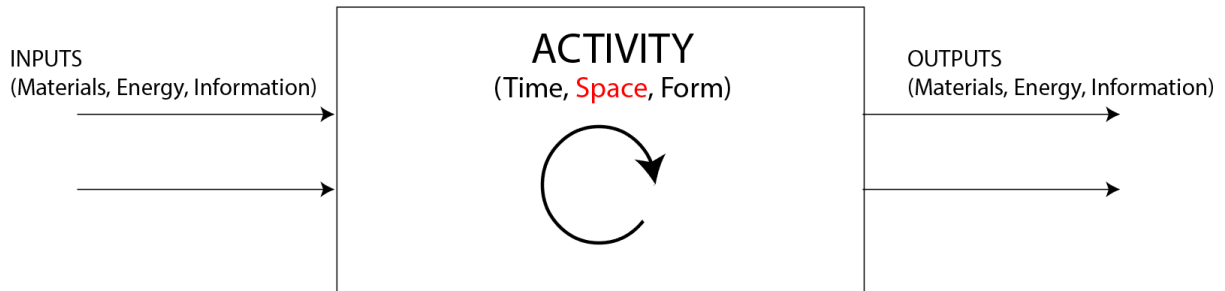
**Figure 162 : Physical space processes in the V-cycle development meta-model. Adapted from (Forsberg & Mooz, 1992)**

Consideration of space in the enabling system is of great importance for several reasons when studying Constructibility of a construction product.

- The space required is at least juxtaposed with the future space “used” by the building. Moreover, very often, the required space is bigger than the space required for the future for logistic purposes;
- Required characteristics of space are not the same for the “Enabling System” and the “System of interest”. As instance, accessibility of the space by engines and trucks is not the same than the accessibility requirements for pedestrians or cars of future inhabitants. But also: slopes, bearing capability of the soil, weather etc. are not necessarily the same;
- If the enabling system has spatial characteristics it also has spatial interactions: noise, accessibility, visual pollution, dust etc. which have to be considered when developing the product.

These spatial characteristics will lead to the definition of Constructibility criteria specific to the construction industry. Nevertheless, not all activities required for the development of construction products require space, or more precisely geographical space. As instance, design activities can be carried out “anywhere”. It is important to precise what are the types of activities which require geographical space and why.

Actually, it depends of the types of transformation of the activity. As stated by Le Moigne in the State of the Art (Le Moigne, 2006), any transformation is a change of Materials Energy or Information over Time, Form or *Space*. When an activity concerns the adaptation of spatial characteristics of an object (whereas it is Materials, Energy or Information) the question of interferences between spaces required for the functioning of the future construction product and spaces required for the activity to develop is worth asking (Figure 163).



**Figure 163 : Space and activities of the enabling system.**

Consideration of space in activities to carry concern mostly the realization phase but not only, as instance collect information useful for design or planning activities can have spatial requirements: geotechnical surveys, household surveys etc. have interactions with different subsystems of geographical subsystems.

Spatial characteristics of the enabling system can lead to constructability criteria such as: weather conditions, logistic surfaces availability, accessibility of the site, geological conditions etc. These criteria are not covered by manufacturability as geographical space is not a problematic in the manufacturing industry (systems are built in factories where the conditions are stable).

Sometimes, spaces required by the enabling system cannot be mutualized with the under development System of Interest and are opportunities to add new functions to the system.

**Improvement n°12:**

Not only the System of interest has spatial characteristics but also some elements from the Enabling Systems. As the allocated spaces are different but often overlap, it is necessary to consider spatial characteristics of Enabling Systems and interactions between these spaces and spaces of the System of Interest.

### **3.2. Enrichment of Functional Analysis by the integration of Constructibility and Systems Engineering**

#### **3.2.1. Functional Analysis and Systems Architecture**

##### *3.2.1.1. Embodiment of Functional Analysis at different systemic levels*

One main difference between Systems Engineering and Functional Analysis is the consideration of different systemic levels in SE, while in Functional Analysis this “systemic” approach is not explicit.

In the Functional Analysis method, little is said about the links between a functional analysis carried at the system level or a FA carried at the subsystem level (and subsystem levels etc.). It is not problematic for products with few components which are not complex (like a computer mouse or Hoover which are classical examples considered in FA). However, when the number of systemic level grows as well as its number different functional analysis are potentially carried at different systemic levels and the question of the relations between FA at different systemic levels appears. As most of construction systems are complex systems (or the ones we are studying) it is necessary to establish such links.

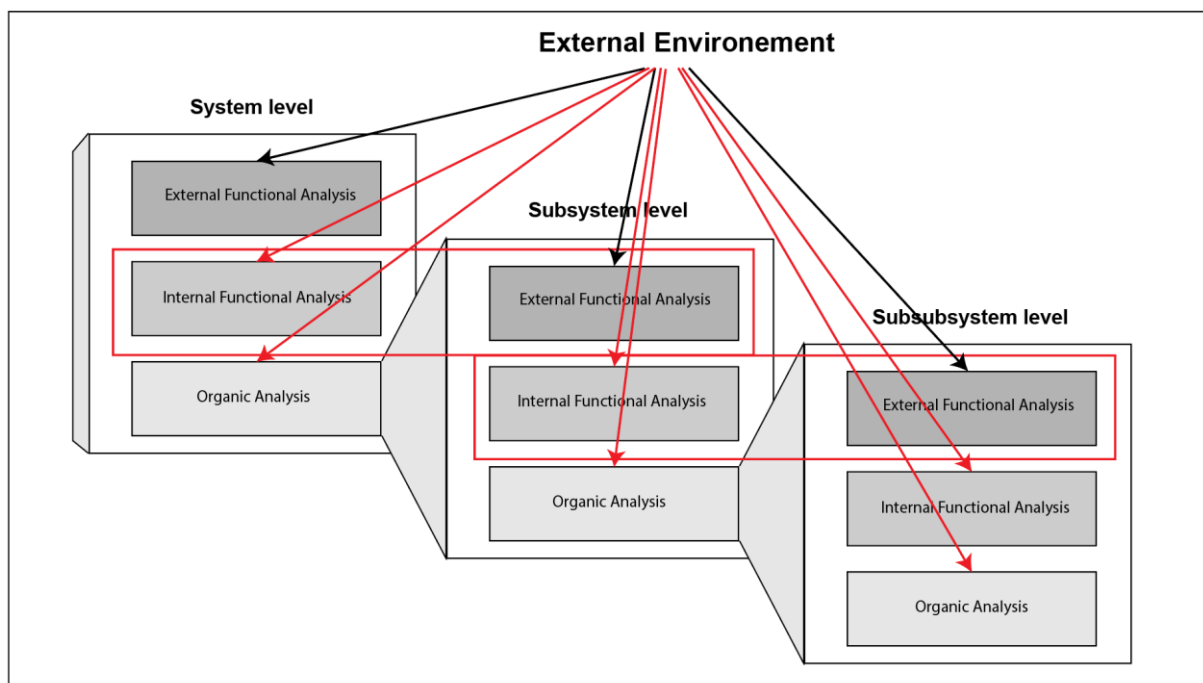
Therefore, we consider that Functional Analysis is a repeatable process at different systemic levels. As instance for a metro system, it can be applied at the system level globally for the entire metro system but also at the subsystem level as instance the Rolling Stock, stations, Automation system etc.

At the system level, Main Functions and Constraint Functions are defined and allow to characterize needs the system will answer. At this step, the system can be considered as a “black box”. In Internal Analysis, Main and Constraint functions are refined in “Technical Functions” (Internal Functional Analysis) which are then allocated to components of the system (Organic Analysis). Components of the system in their turn can be considered as systems.

Subsystems of the system are therefore defined in the organic Analysis at the system level. Other subsystems and external elements constitute the environment of the subsystem. Its Main Functions and Constraints are Internal Functions defined at the System level + eventual Constraints functions from its environment which have not been identified at the system level.

In their turn, Main Functions and Constraints Functions of the subsystem are refined in Technical Functions which will be future Main Functions of subsystems and the Organic Analysis will allows defining the different subsystems.

This “systemic pattern” is theoretically repeatable until the lowest systemic level ensuring integration of system elements in a global system which answers to clients/users’ needs (Figure 164).



**Figure 164 : Functional Analysis Embodiment in different systemic levels. Sidebars in red highlight that Internal Functional Analysis in one systemic level is the External Functional Analysis in the lower systemic level. As mentioned earlier due to the consideration of space in all views of SE, the external environment is interacting in Operational, Functional and Organic views.**

**Improvement n°15:**

Construction systems are often complex systems composed of a great number of subsystems and subsystems. It is therefore worth considering that multiple Functional Analysis will be carried during its developments. To ensure integration of the system this improvement offers one possibility to link different Functional Analysis at different systemic levels.

**3.2.1.2. Construction phases and System Architecture**

Construction phases are usually divided in 3 steps in the development process: Planning, Design and Realization phases. To which steps/systemic levels these phases are related to? Is the planning phase corresponds to

Operational Analysis, the Design phase to Functional Analysis and Organic analysis to the realization phase? Or, contrarily, Planning would corresponds to the System level, Design to the subsystem level and realization to the sub-subsystem level?

The question is worth asking for being able to adapt the actual way of working to another one by the introduction of Functional Analysis, Systems Engineering and Constructibility concepts. The hypothesis we make is that the phases in construction projects (planning, design and realization) correspond to systemic levels (system, sub-system, sub-subsystem) rather than architectural views (operational, functional, organic). This hypothesis is not neutral as it means that at each phase of construction projects the three architectural analysis (operational, functional and organic) have to be carried for a good system integration.

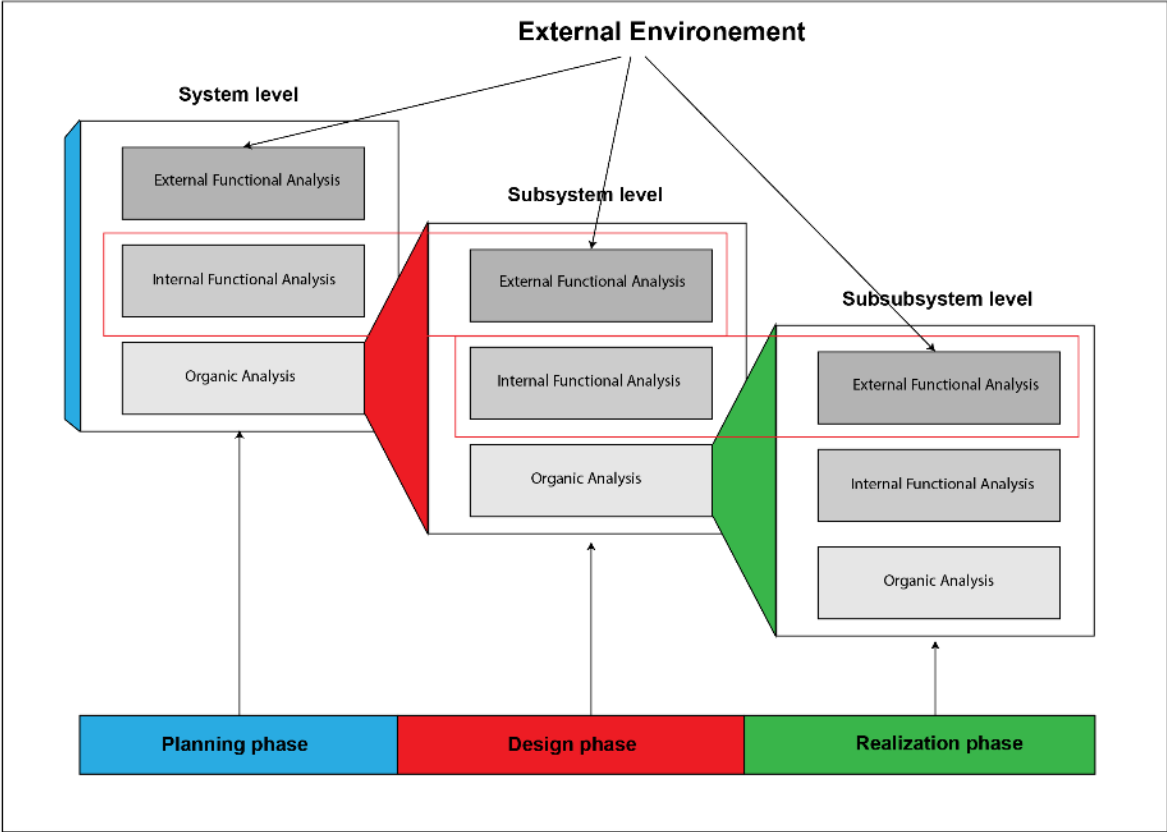


Figure 165 : Systemic levels and phases of construction projects

3.2.2. SysML and Functional Analysis

3.2.2.1. MBSE (Model-Based Systems Engineering) and Functional Analysis

The tool used to implement the SysML language (MBSE) is the open source tool Papyrus® developed by Eclipse. As explained in chapter 2, MBSE objective is to apply Systems Engineering principles by using digital models. MBSE associates capacities of digital technologies with design principles of System Engineering (and by extension to Functional Analysis as we will see). It offers the possibility to link automatically different visions of the system and to carry analysis that would be too complex for human brains: as instance changes/modifications analysis, ensuring completeness of the design, manage a great number of interfaces, greatly improve analysis capability. MBSE is therefore useful for large and complex systems with a great number of requirements and properties. In the following part we explore the capability of a SysML tool to apply Functional Analysis principles as explained in the MISME method.

In other way, MBSE only offers digital tools to implement digitally Systems Engineering methods it doesn't say how to use the tools and what functionalities they should incorporate. MBSE is therefore complementary with architecting methods in SE and Functional Analysis (MISME).

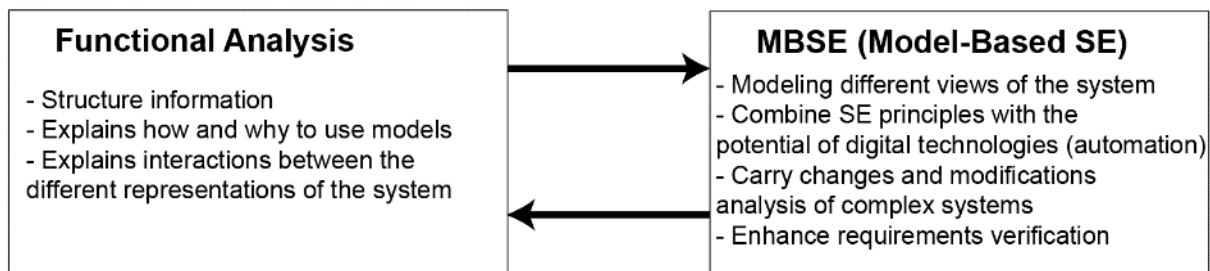


Figure 166 : Complementarity between Functional Analysis and MBSE

### 3.2.2.1.1. MBSE and characterization of elements from the environment

In Functional Analysis the first step consists in analyzing and characterizing elements from the environment of the system. Interactions between the system and the environment can be described with “Context diagrams”. In SysML an IBD (Internal block diagram) can be used to model elements of the environment and characterize them. An Internal Block diagram is used to model a system (or a subsystem) its parts and its interfaces. Kossiakof gives the following definition of a context diagram (Kossiakof, et al., 2011): “System Context Diagrams... represent all external entities that may interact with a system... Such a diagram pictures the system at the center, with no details of its interior structure, surrounded by all its interacting systems, environments and activities. The objective of the system context diagram is to focus attention on external factors and events that should be considered in developing a complete set of systems requirements and constraints.” This definition well corresponds with an Environmental analysis in the MISME method in Functional Analysis.

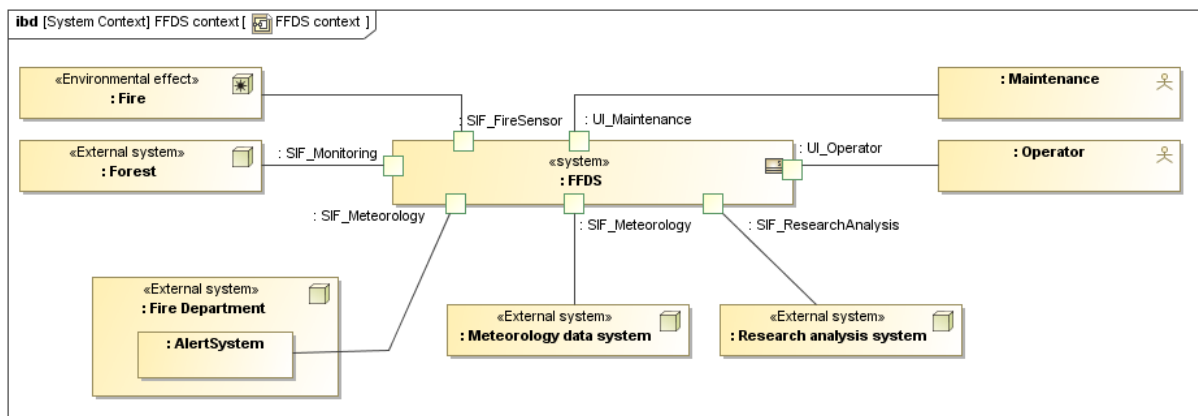


Figure 167 : Example of a context diagram with an Internal Block Diagram (Weilkiens, 2012)

To be fully compatible with EFA (External Functional Analysis), elements from the environment and interactions with the system have to be characterized; it should be possible to add attributes to the “block” representing external elements.

Eventually, the context diagram can be used as an *Interaction Diagram* in the MISME method. However the context diagram only allows “connecting” one external element from the environment with the system. In the MISME method this type of interaction would represent only Constraint functions, Main function would be represented by the interconnection between two elements from the environment and the system. In other words, in MBSE it is not possible to distinguish Constraint Functions and Main functions.

### 3.2.2.1.2. MBSE and External Functional Analysis

The operational view consists in analyzing needs the system answers in Systems Engineering. It has the same objectives than the External Functional Analysis (EFA) in the Functional Analysis corpus. The only difference being that EFA adds methodological tools to analyze needs and external functions with their attributes (the “fundamental need expression” scheme and the interaction diagram as instance). But there is not a standardized way to describe needs in terms of computer science in Functional Analysis. However, in SysML (System Modelling Language), a language used in MBSE (Model Based Systems Engineering), the Use case diagram allows to describe needs in a standardized way. Barbier (Barbier, 2005) says that the use of Use Case diagrams is similar to needs analysis in Functional Analysis.

Therefore we propose to use the concepts and principles described in the EFA and to use the Use Case diagram in SysML to describe needs and external functions in a standardized way. It implies some modifications and explanations on how to use the Use Case Diagram. Attributes must be added to model Service and Constraint functions the system will answer in Use cases diagrams as indicated in the EFA such as: risks related to the modification, disappearing or increase of Service and Constraint Function but also the three types of criteria defined to characterize functions (nominal, RAMS and society). Furthermore, in the EFA method, a Service function links two elements from the environment with the system while Constraint functions link one element from the environment with the system. This distinction is not integrated in current Use Case diagrams in SysML: it is not possible to link two external (or more) elements from the environment with the system, only one element at a time can be linked.

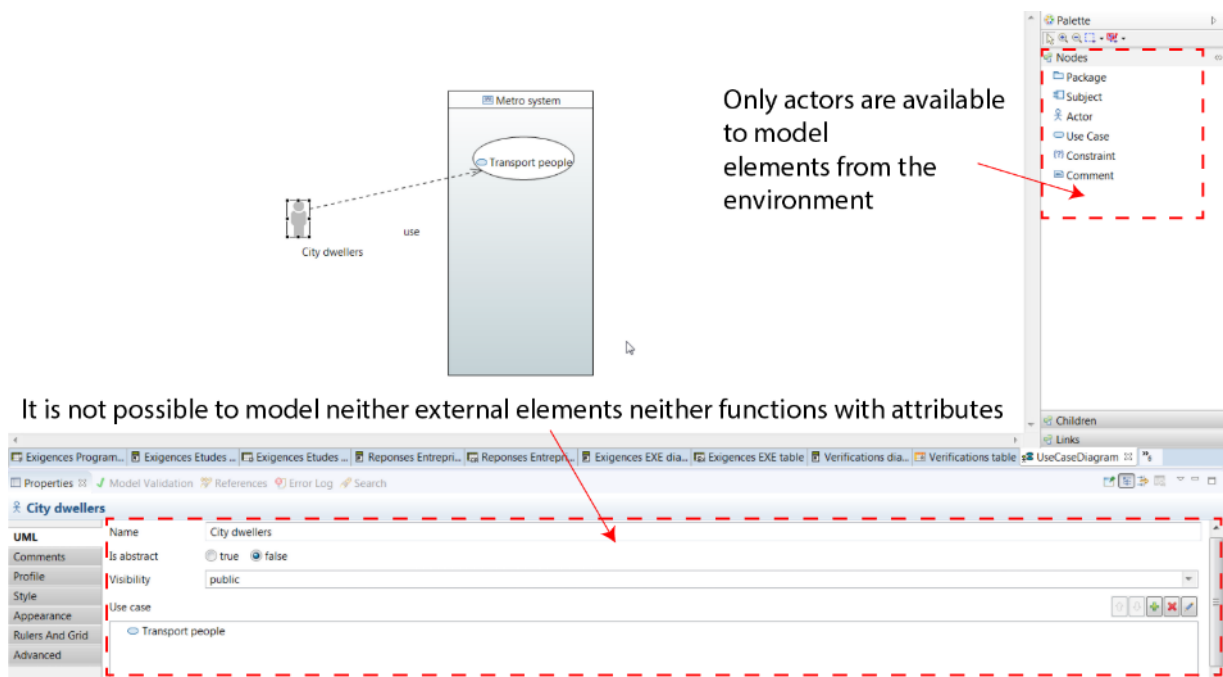


Figure 168 : Example of a Use Case diagram in SysML (implemented in Papyrus)

In Figure 168, a simple example of a Use Case diagram is presented. We can highlight that elements from the environment can be modeled only with “actors” while in construction systems external elements from the environment can also be physical elements (city, geology, buildings etc.). Neither the term “actor” neither its representation are adequate with modeling of other types of external elements. Moreover, with the current version of SysML it is not possible to characterized elements from the environment with attributes which would be required to be coherent with the EFA method.

### 3.2.2.1.3. MBSE and Internal Functional Analysis



Description and modeling of Internal Functions of the system is probably the most developed part in SysML. Many diagrams and representations allow modeling “*what the system does*”: sequence diagrams, activity diagrams and state diagrams notably. These types of diagrams express well how the system can evolve over time but we can already notice that is not easy to evaluate what the system does over space with these types of diagrams (which is problematic in the construction industry).

Different diagrams allow modeling internal functions of the system. The sequence diagram as instance allows describing how functions are sequenced over time.

#### 3.2.2.1.4. MBSE and Organic description of the system

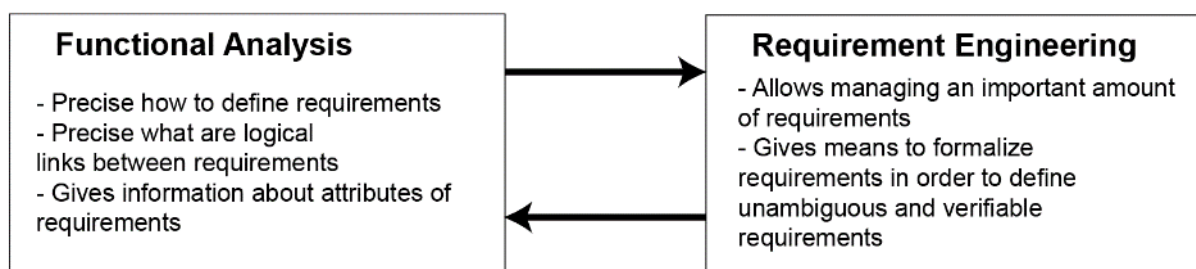
Organic description of a system is also very easy with SysML, particularly Bdd (Block Diagrams) and Ibd (Internal Block Diagrams) allow defining the composition of the system and its organic characteristics. Interfaces between subsystems and components are easily modeled with flows in an Internal Block Diagrams and it is possible to add attributes to the defined blocks to define any organic characteristics of systems.

#### **Improvement n°16:**

In the previous part, it has been notified that SysML is a powerful standardized language to carry a Functional Analysis for industrial systems. In this improvement we insist on which diagram can be used at which phase of the Functional Analysis to practically use it in the methodology in the Operational, Functional and Organic phases.

#### 3.2.2.2. Requirement Engineering and Functional Analysis

Requirement Engineering offers the possibility to model and manage requirements. Nevertheless, RE does not give how requirements should be defined neither how about relations between requirements. Functional Analysis (and as Instance the MISME method) precisely gives an operational method to define needs, functions and solutions, however nothing is said about formalization, modeling and management of requirements in FA. These two methods are therefore complementary. In §3.5 of this chapter we will present a Requirement Engineering tool we have developed as part of this thesis (Exegis).



**Figure 169 : Complementarity between Functional Analysis and Requirement Engineering**

- Functional Analysis: a method to define requirements and relations between them

Functional Analysis gives methods to define needs, functions and solution the system will answer: what are the steps to define them, what are the links between them and how to define their attributes (see the MISME method in chapter 2). It avoids defining unnecessary requirements, traceability between functional and organic requirements, and criteria defined in functional analysis are the attributes possibly given to requirements.

- Formalization of needs, functions and solutions

However in FA methods nothing is said about formalization of needs, functions and solutions into verifiable and traceable requirements. Requirement Engineering gives methodological concepts to formalize needs, functions and solutions into unambiguous, verifiable and traceable requirements: requirements have to be SMART (Specific,

Measurable, Achievable, Realistic, Time-Bound), they have a unique ID, they have to be allocated to elements of the System of Interest or the Enabling System (see chapter 2 on Requirement Engineering).

- Manage an important amount of requirements

When studying relatively simple systems like a Hoover, a computer mouse etc. (example which are given in the MISME method) the number of requirements remains low and is still manageable by humans. However, when studying complex systems like a metro system or a nuclear plant the number of requirements explodes and can reach tens of thousands of requirements which becomes completely unmanageable by human brains. Requirement management offers the possibility to properly manage all types of requirements whatever their number. Requirement management also allows evaluating impacts of changes and modifications made on requirements or/and to the designed system. Changes are easily traceable when the number of requirements remains low but for complex systems with a lot of internal and external interactions it is almost impossible. By defining links between requirements (as instance in an MBSE tool) it is possible more easily to evaluate the number of impacted requirements by tracing back to which requirements the modified requirement/system element is linked.

- Requirement Engineering, MBSE and Functional Analysis

Requirement modeling is an important part of the development of MBSE (Model-Based Systems Engineering), it allows modeling requirements in a formalized way and to allocate them to other models in order to facilitate their verification. As instance, requirements can be stored in tables or in diagrams when using MBSE tools. Dashboards can be developed to evaluate the number of requirements which are verified by the designed system, the number of requirements which still require to be refined, the number of requirements which have been allocated to system elements or not. Such functionalities have been developed in Exegis an MBSE tool developed at Egis as part of this thesis.

#### **Improvement n°17:**

Requirement Engineering and Requirement Management are efficient ways to manage requirements coming from Functional Analysis for complex systems when a lot of information have to be processed. Requirements to manage derive from the different steps of Functional Analysis from Needs to Internal Functions and components.

### **3.2.3. Integration of Constructibility in Functional Analysis**

#### ***3.2.3.1. Constructibility concepts in the Functional Analysis method***

For all 3 defined architectural views of the System of Interest (Operational, Functional and Organic) Activities are necessary for modeling, simulations, analysis, assembling, verifying etc. These Activities require resources and have objectives, therefore Constructibility criteria can also be categorized depending on which architectural views of the System of Interest they belong to.

Previously, Constructibility concepts and principles have been defined. In this part, we will show where and how these principles can be considered in Functional Analysis.

As shown in Figure 170, for any construction project, the 1<sup>st</sup> step always consists in defining needs the system, then the 2<sup>nd</sup> step concerns the definition of Internal Functions and finally the 3<sup>rd</sup> step to define components of the system. At each step a constructibility analysis is carried and elements of the Enabling Systems are analyzed and evaluated. Constructibility Principles (and by extension Constructibility Concepts) can be allocated to the different steps of Functional Analysis which allows defining when to consider and apply which Constructibility Principle. The 14 Constructibility Principles (CP) (10 *Constructibility* Principles + 4 *Constructibility* Principles) are allocated to the Operational, Functional and Organic views (Figure 170).

We can notice that some Constructibility Principles are general and apply at all steps and phases of Functional Analysis such as CP 9, 10 and 11. Others are specific to some phases (CP 2, 6 and 7 are only applicable in the Organic phase, CP4 at the operational phase).

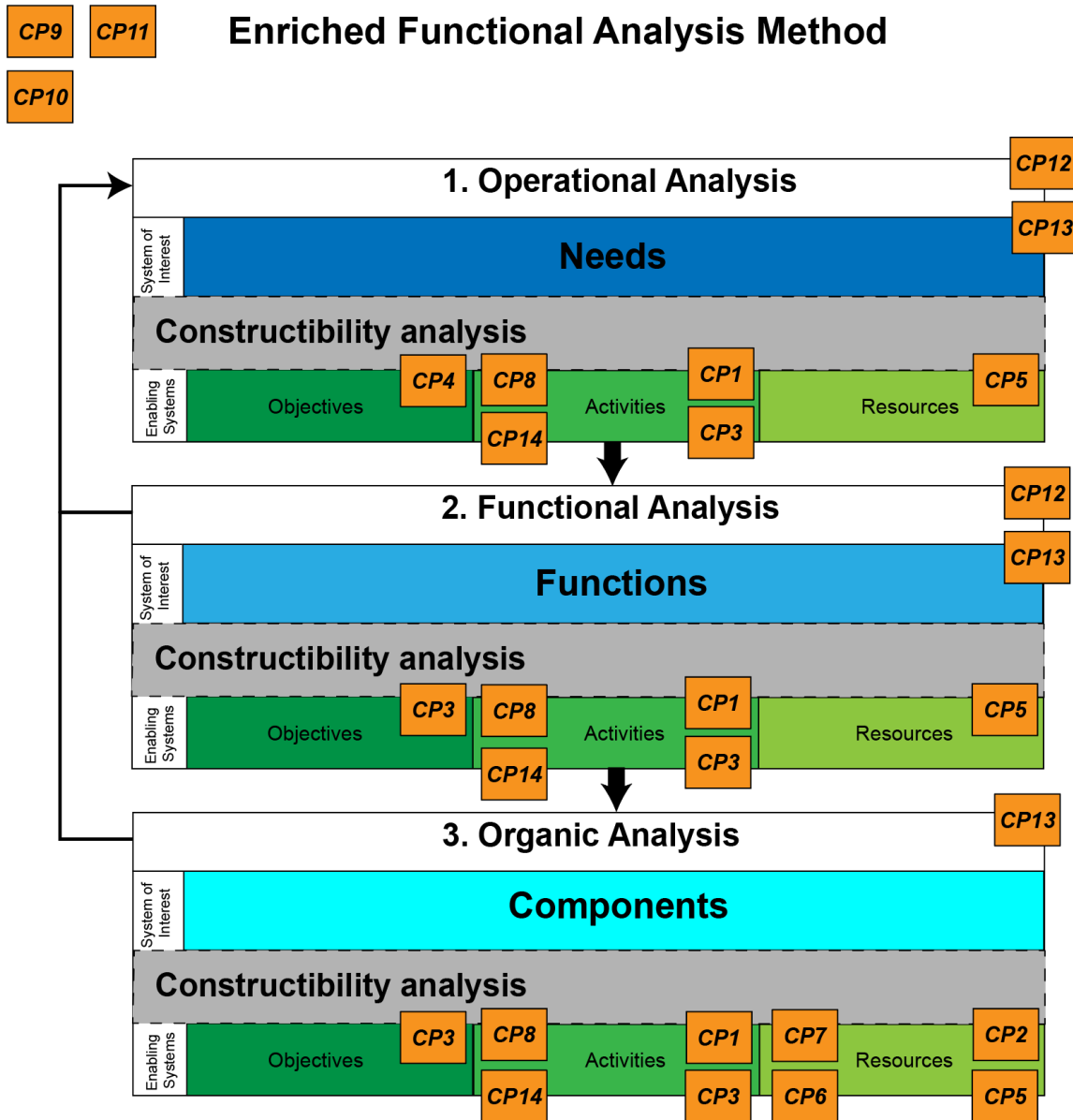


Figure 170 : Constructibility in the different Architectural views. Constructibility Principles (in orange) presented in this thesis are represented in the different steps of the Enriched Functional Analysis method.

### 3.2.3.2. Constructibility in Functional Analysis methodological tools

#### 3.2.3.2.1. Constructibility in the operational view

Analyze needs the system will answer can be considered as a project on itself. As a project, objectives can be defined, activities will be carried and resources will be required. These considerations will constrain analysis of the needs and can be considered when needs are being defining in order to ensure that the Enabling System will be in capability to define properly the needs or if “new” and innovative Enabling Systems are required.

As the construction industry is not integrated, stakeholders in charge of defining needs the system will answer and stakeholders in charge of analyzing these are usually not the same they are not necessarily aware of difficulties encountered when carrying needs analysis.

To introduce these new considerations when analyzing needs of construction systems, we propose to add Constructibility criteria to Service and Constraint Functions criteria (Table 17). These Constructibility criteria are of three types: *Objectives*, *Activities* and *Resources*.

- **Objectives:** are their actors susceptible to analyze needs related to this function? Are objectives of these stakeholders coherent with needs of the beneficiaries of the system? These criteria are related to actors' interrelations and ask questions of governance.
- **Activities:** Constructibility criteria related to activities are criteria related to the activities carried to analyze needs. What are the possible existing processes to analyze Service and Constraint functions? With which degree of accuracy?
- **Resources:** Constructibility criteria related to resources are criteria related to the required resources to carry activities required to analyze the needs. Availability, accessibility, usability of resources are examples of Constructibility criteria. When analyzing the needs of a construction project it is mostly information resources which are required.

		Characteristics													
N°	Designation	K	Nominal Criteria		O&M Criteria		Societal Criteria		Constructibility criteria						
			L*	F*	L	F	L	F	Objectives		Activities		Resources		
										L	F	L	F	L	F

**Table 17 : Functional formalization table including Constructibility criteria**

L: level of the function

F: flexibility

The first step of the operational analysis consists in analyzing environment of the system, external elements are identified, defined and characterized. To carry this analysis, information about the environment are required to be gathered. Then, this analysis allows defining potential future needs of the system (i.e. Main Functions and Constraint Functions) related to this environmental analysis (which can be carried by doing a territorial diagnosis as instance as shown before in this chapter). Needs are then characterized with criteria, performance and tolerance levels which leads to the definition of operational requirements (see Table 17 as an example of operational specification table). The operational specification table will be replaced by a requirement engineering tool which allows better modelling Main and Constraint functions with their associated criteria. Notably by improving traceability and impact analysis.

At this stage, a Constructibility analysis is carried, objectives, activities and resources are defined and analyzed in relation with previous similar analysis carried for similar needs, Constructibility requirements can be formalized in requirements diagrams. It is necessary at this stage to compare the environment of previous carried Constructibility Analysis to identify potential changes and evaluate impacts of such changes. This step is crucial in construction projects as each project is unique and has necessarily some differences with other similar projects. This analysis allows assessing Constructibility of needs previously identified (both horizontal and vertical Constructibility) and to a first decision on which needs are kept for further analysis (they only have been identified at this stage).

Then, needs are evaluated and analyzed over space and time, which allows assessing with more details importance of the different needs (notably by a quantified analysis). Finally, this last step allows deciding which needs will be chosen for the future system and are formalized by modeling Operational Requirements (with Table 17 or with a requirement diagram as presented later, interactions between Constructibility requirements and Operational requirements are necessary for future modification/change/impact analysis). The entire process has been formalized with a BPMN (Figure 171).

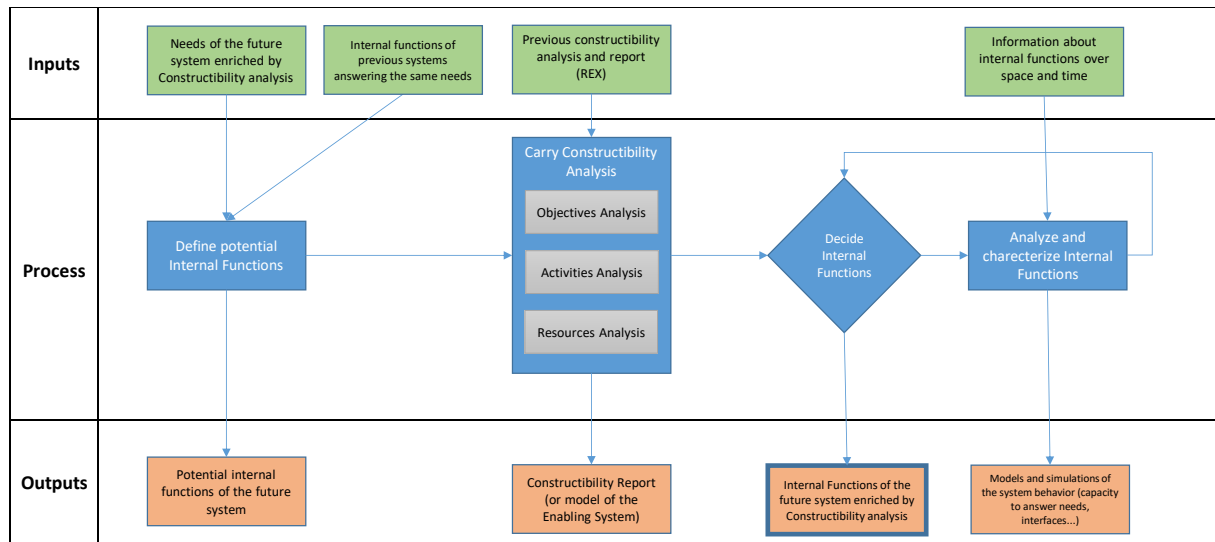


Figure 171 : Constructibility in the Operational view

### 3.2.3.2.2. Constructibility in the functional view

In the functional view, we enter into the internal analyze of the system. internal functions of the system are described, i.e. “what” the system will do to answer the “why”. “What” the system will do is influenced by both horizontal and vertical Constructibility: the activities required to model the system in the left branch of the vee and activities required to verify and validate internal functions in the right branch.

To define internal functions, a functional tree diagram or a FAST diagram can be used in Functional Analysis. The use of SysML and notably Activity diagrams is another way to define internal functions. Concurrently to the definition of Internal Functions, a Constructibility analysis should be carried to evaluate capacities of the Enabling System to develop Internal Functions. Therefore, similarly to the operational view, the Enabling System can be seen as a “system” itself and analyzed as such with its Objectives, Activities and Resources in both branches of the Vee meta-model.

In methodological terms, the definition of internal functions is a recursive process: considering needs previously defined in the Operational view and considering Internal Functions of other systems which answer to the same or similar needs (Return on Experience) potential internal functions are identified. Here again, as each project is unique it is necessarily to evaluate with attention differences between other similar systems and the current one and to carry modifications in internal functions relating to these differences.

Then, a constructibility analysis is carried by analyzing Objectives, Activities and Resources necessary to model, simulate, verify and validate internal Functions. Differences between previous Enabling Systems used are evaluated and potential changes are made to fit better with the current construction system to develop. Constructibility requirements are eventually formalized in a Constructibility report or a requirement diagram.

Finally, chosen Internal Functions are analyzed and characterized by models and simulations. Interfaces between Internal Functions (over time and space) are also analyzed particularly for construction systems. The SPEC method and QFD matrices (presented in the State of the Art) are example of tools to analyze if Internal Functions have the

capability to answer to needs and constraints in the Operational view. Depending on this Internal Function analysis Internal Functions are chosen. Eventually, Functional requirements can be modeled with requirement diagrams or a Functional tree as example. Interactions between Constructibility requirements and Functional requirements are modeled in order to improve change/modification and impact analysis. The presented process for the definition of Internal Functions has been modeled in a BPMN in Figure 172.

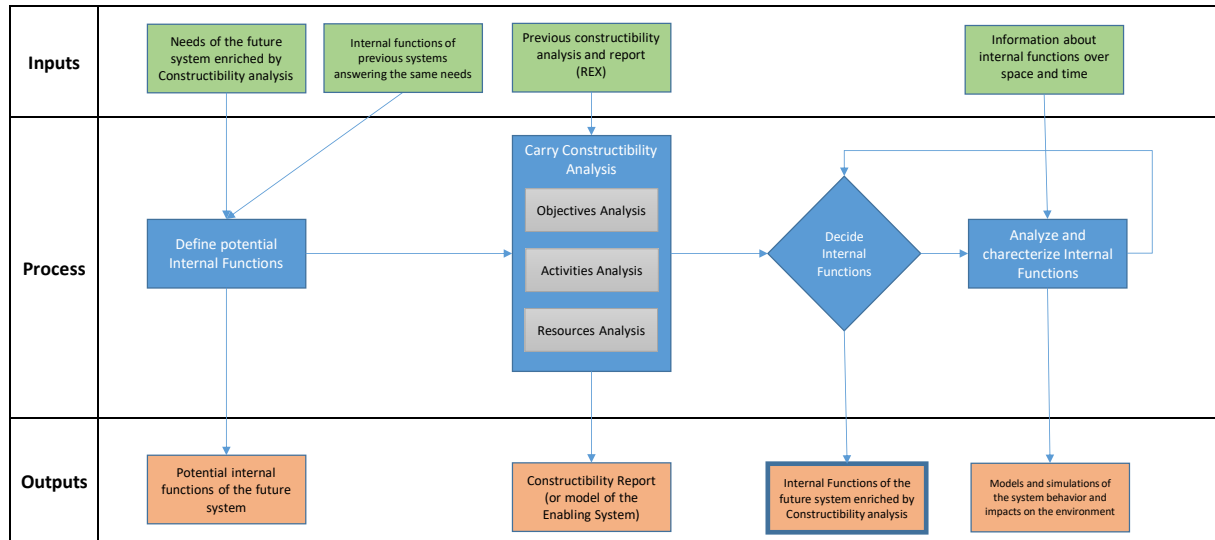


Figure 172 : Constructibility in the functional view

### 3.2.3.2.3. Constructibility in the organic view

The Organic view also concerns interior of the system. In the Organic view, components of the system which will fulfil Internal Functions of the system are defined and characterized: the “how”. Similarly to other views, organic elements are modeled in the left branch and realized, assembled, forwarded etc. in the right branch. Both vertical and horizontal Constructibility can be analyzed.

The first step consists in evaluating potential components which could answer previously defined internal functions. Eventually, if no components exist to realize the internal functions new components could be invented.

Then, a Constructibility analysis is carried on pre-selected components: Objectives, Activities and Resources are evaluated thanks to previous constructibility reports and feedbacks. It is important to evaluate modifications between constructibility analysis of similar other components and the current system to develop. As all construction systems are unique it is important to assess changes between previous constructibility analysis and constructibility of the current components. From this Constructibility analysis, constructibility requirements are defined and can eventually be formalized and modeled in a requirement modeling tool.

Consequently to the Constructibility analysis, components are selected. They are then designed, modeled and simulated to analyze their behavior, check their capability to answer Internal Functions of the system and interfaces between components. This last step is recursive and can lead to the redesign of new/other components if preselected ones don’t answer to Internal Functions with previously defined levels of performance.

The Organic Analysis process has been modeled with a BPMN flow chart (Figure 173).

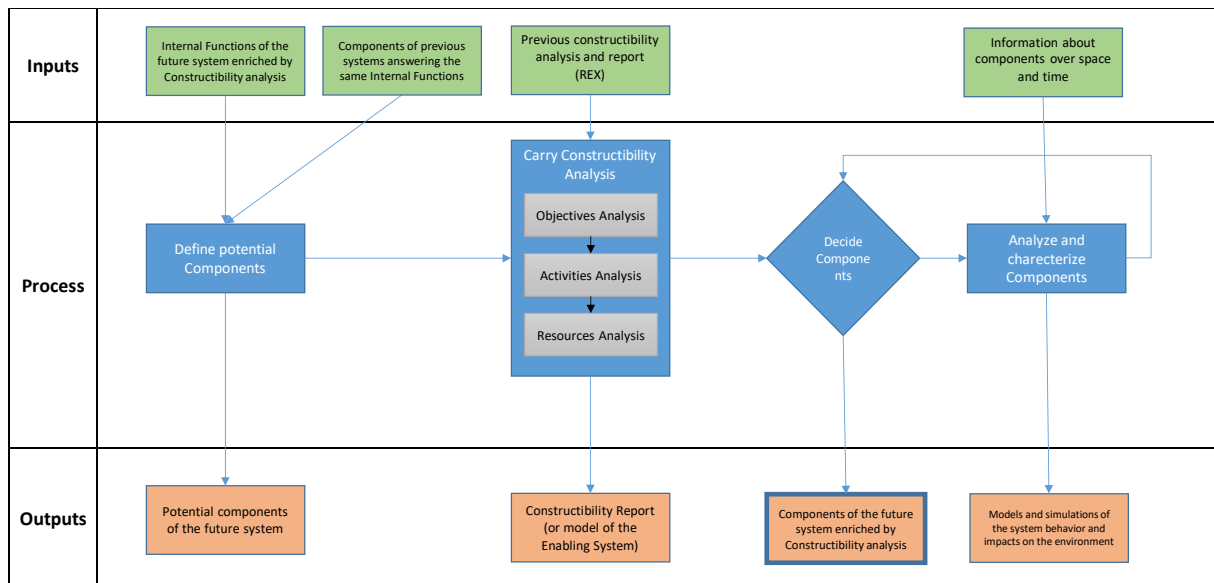


Figure 173 : Constructibility in the organic view

#### Improvement n°19:

Constructibility principles and concepts (including Constructability) have been integrated in the different Functional Analysis steps in the method. It allows indicating when and how Constructibility analysis should be integrated when carrying a Functional Analysis for a construction system.

Finally, the entire process from the Operational Analysis to the Organic Analysis is a recursive process. As example, if Internal Functions can't answer to the needs and constraints defined in the Operational Analysis, needs and constraints could be reanalyzed and eventually modified consequently. Similarly, if components can't answer to Internal Functions (whereas it is because of the components themselves don't have the capability to fulfill Internal Functions or because the Enabling System doesn't have the capability to develop components), Internal Functions can be modified or changed. As changes and modifications are the rule in construction projects, modeling the different interactions between Operational, Functional and Organic elements and with their appropriate Enabling System elements is of great important to ease and better assess impacts of such modifications.

For this reason, we have developed modeling tools as part of this thesis to model different types of interactions:

- A requirement modelling tool (Exegis) which allows modelling requirements (Operational, Functional, Organic and Constructibility requirements) and to link them with implementation models such as BIM models;
- Constructibility matrices which allow resuming in a simple way constructibility of the system in the different views to ease decision making related to constructibility and to identify ways of constructibility improvements.

### 3.3. Development of tools at the crossroad of Functional Analysis, Systems Engineering and Constructibility

#### 3.3.1. Development of a tool to link SysML requirements and BIM models

##### 3.3.1.1. An MBSE Tool dedicated for the construction industry: Exegis

In order to implement MBSE and Systems Engineering principles in construction projects and more precisely metro projects, Egis has established a partnership with the CEA and developed a tool called « Exegis ». Initially, the tool has been developed to model and manage only requirements of metro projects and has shifted to a full

MBSE tools during its development. It is not surprising that the development of the tool firstly started from a requirement point of view, it is usually the first step to enter MBSE as it has been the case in other industries.

Notably, we have developed solutions to link requirements defined in Exegis and elements of implementation models like Mock-ups (and especially IFC models) as a Proof of Concept.

The tool is based on the language SysML. The presentation of the tool is split in two parts: a first part presents how we have adapted SysML to model requirements in the construction industry and a second part is related to establishing the links between requirements and IFC models.

Development of Exegis has been realized specifically for « designers » and « project management » companies. Modeling needs of clients and contractors may differ from actual developments.

In the proposed methodology Exegis is useful to model all types of requirements whereas they are Operational, Functional, Organic or Constructibility requirements.

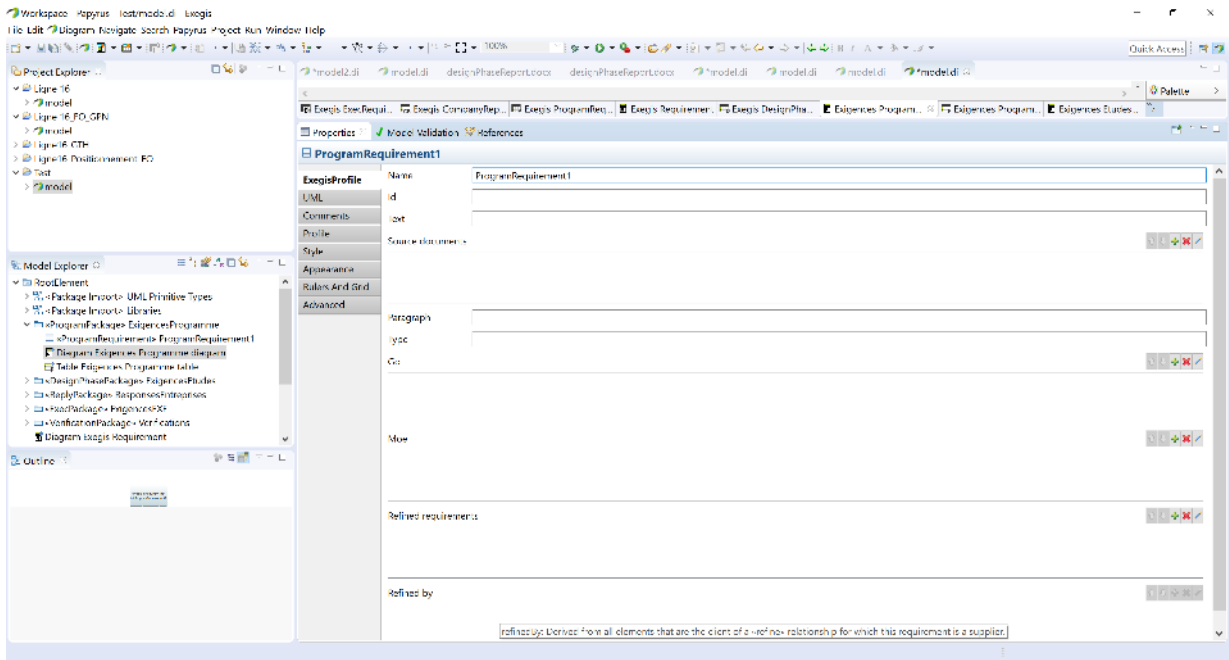
#### *3.3.1.1.1. Modeling and manage requirements*

The general process of requirement modeling consists in refining Program requirements established by the client to Design Requirements which are in turn refined in Execution requirements. To be more specific, program requirements are the requirements defined by the client, Design requirements are the requirements defined by the design team and Execution requirements are requirements of the contractor. It is important to highlight that these categories of requirements are not related to architectural views but more to systemic levels of requirements. Program requirements are system requirements, Design requirements are sub-system requirements and Execution requirements are sub-sub-system requirements. At each systemic levels, i.e. for each category of requirement it is theoretically possible to define Operational, Functional and Organic requirements.

- Modeling program requirements

The first step consists in modeling program requirements. Usually clients have modeled their requirements in PDF or Word formats. The first step in the short term is to translate these requirements in SysML (Figure 174). This step is tedious and repetitive as it consists basically to copy and synthetize requirements from word documents to the SysML tool (Exegis). Most importantly, requirements have to be SMART (Specific, Measurable, Assignable, Realistic, Time-related). Several attributes have been set-up for Program requirements:





**Figure 174 : Program Requirements model (Exegis).** This figure shows how to model a “Program” requirements with exegis, i.e. requirements expressed by the client with its different attributes (at least an ID, a text detailing the requirement and relations with other requirements).

- Modeling Design requirements

The second type of requirement defined in Exegis is Design requirement. This type of requirement refines Program requirements defined by the client. Different attributes have been added (Figure 175): notably the possibility to link documents to the requirements like pictures, schemes, tables or any other features which can make Design requirements more explicit. Documents are accessible directly in the tool. Construction projects are usually breakdown into different phases (exploratory studies, preliminary studies, detail design etc.) therefore phase of the project has been added as an attribute of Design requirements. Flexibility of the requirement can also be added, some requirements are not compulsory and can eventually be negotiated with other stakeholders during the design phase (whereas it is with the client or contractors). Finally, the last attributes related to Design requirements is the “refined requirements” attribute which indicates which requirements this requirement refines and “Refined by” which indicates which are the requirements refining the requirement.

These two last attributes are particularly useful for project management to evaluate the percentage of program requirements refined and if Design requirements don’t refine a program requirement. This last possibility implies that maybe the requirement is not necessary or if this requirement refines a requirement which is not in the program (such as norms or technical rules). They are also useful for change and modification management in order to evaluate potential impacts of the change in one or more Design requirements.

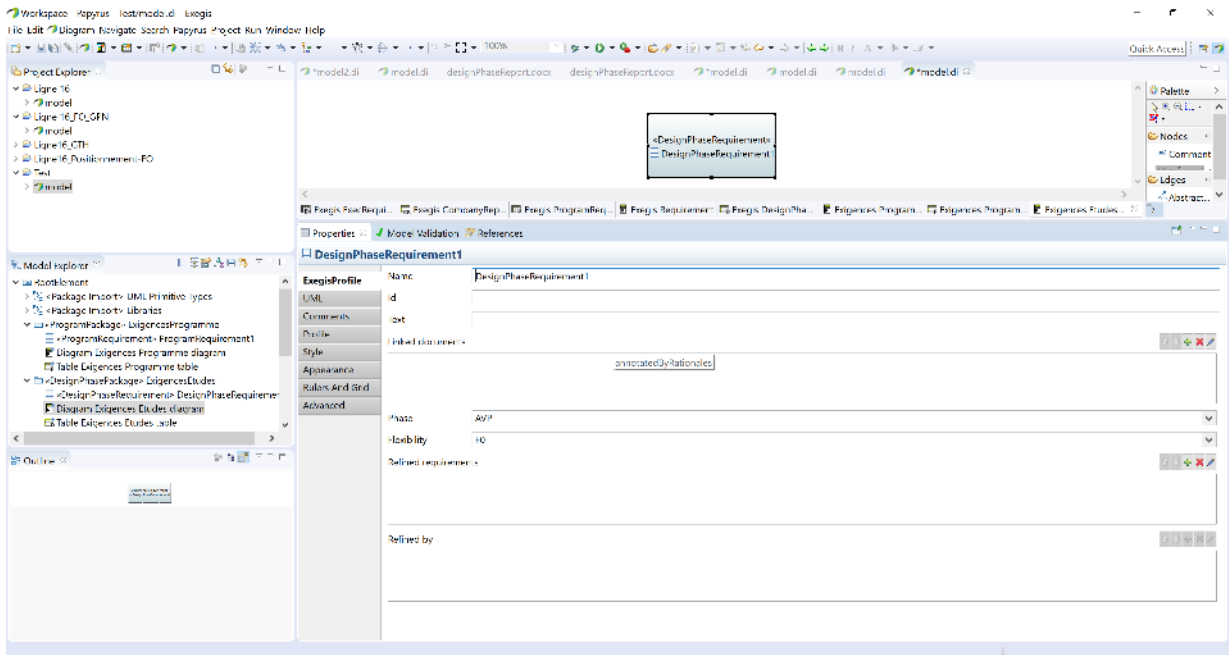


Figure 175 : Example of a Design requirement with its attributes in Exegis (i.g. ID, text links with other requirements, state (satisfied or not satisfied). i.e. requirements defined by the consultant/designer.

- Modeling Execution requirements

Execution requirements can be modeled in the tool. However, as Exegis has been developed by Egis a design company the focus was not on the modeling of these requirements. Execution requirements refined Design requirements at the component level. It is usually contractors who define Execution requirements and designers are responsible of the compliance between Execution requirements and Design requirements. Hence, a table called “company replies”, allows contractors assessing if they are compliant with Design requirements and conversely designer assessing if contractors are compliant or not with Design requirements.

In order to allow companies which don't use SysML based tools (which is the case in most cases), it is possible to export the table in an excel format and reimport it in Exegis with companies responses as presented in (Figure 176).

Identifiant de l'exigence		Nom de l'exigence	Description de l'exigence	Conformité	Commentaire sur la conformité	Type de vérification
L18_MRV_CCTPp2.1_00 05	L18_MRV_CCTPp2.1_0005		Le matériel roulant de la ligne 18 est un métro automatique sans conducteur (niveau d'automatisation GoA4 selon la norme NF EN 62290-1) composé de 3 voitures et exploité en unité simple en mode nominal.	Conforme		
L18_MRV_CCTPp2.1_00 06	L18_MRV_CCTPp2.1_0006		Le matériel roulant doit circuler sur l'ensemble de la ligne 18 du Grand Paris, composé de : - Sections sous-terrains : tunnel monotube de diamètre utile 7,80 m et d'entraxe entre voie de 3,2m avec cheminement d'évacuation latéral - Sections aériennes : viaduc avec un entraxe entre voies de 5,30m et un cheminement d'évacuation central - Gares aériennes et sous-terrains avec accès depuis l'extérieur des voies - Tranchées couvertes et couvertes, réalisant la transition entre la partie sous-terrain et aérienne Il doit aussi circuler sur l'ensemble du site du centre d'exploitation de la ligne 18 (SMR et SMI).	Conforme		
L18_MRV_CCTPp2.1_00 07	L18_MRV_CCTPp2.1_0007		Si le secours d'un train par un autre train est nécessaire, le convoi ainsi formé doit pouvoir parcourir l'ensemble de la ligne.			
L18_MRV_CCTPp2.1_00 08	L18_MRV_CCTPp2.1_0008		Chaque voiture est équipée de 2 bogies à roulement fer et écartement UIC (1435mm).			

Figure 176 : Company replies table. This table allows contractors to assess if they are compliant with requirements defined by the designer and in what extent.

- Verifications of requirements

There are two distinctive ways to verify requirements, firstly digitally by modeling the system and simulating its functioning to verify that requirements are met, this type of verification is carried in the left branch of the Vee

cycle. The other type of verification occurs in the right branch of Vee where requirements are verified concretely in “real life” by measurements and tests. Validation of the system for its part is only carried during its operational phase when it is used by users. In Exegis, the two types of verifications can be traced and allocated to requirements. Verification processes can be modeled in Exegis and it is possible to allocate requirements to these verification processes. It is also possible to mention if requirements have been allocated to a verification process, if they have passed the verification process or if they fail.

In Figure 177, an example of the Exegis tool shows the number of requirements which have passed the verification tests, which have failed to pass the test, errors and inconclusive requirements. It is possible to know which are the requirements in each type of verification. This reporting allows managing verification of requirements more efficiently.

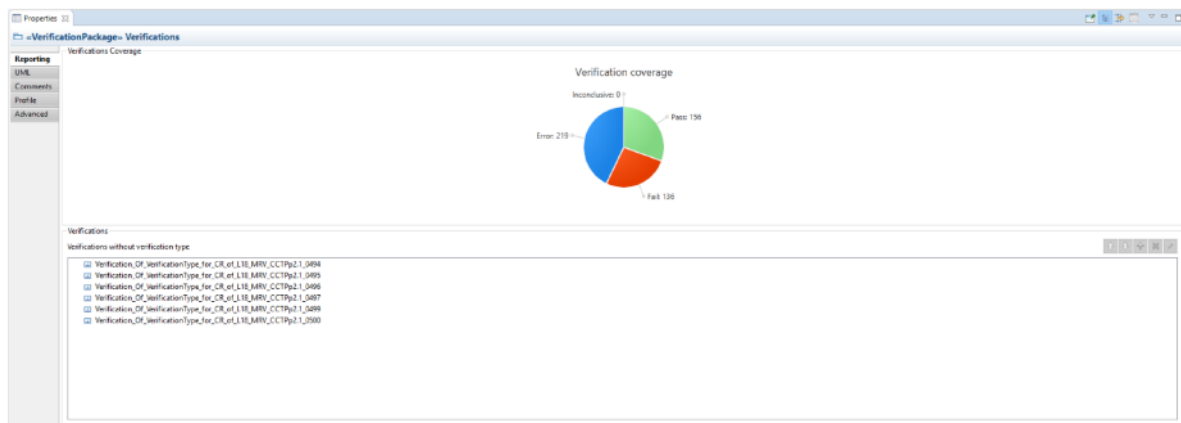


Figure 177 : Example of a verification board. This figure allows summing up the proportion of requirements verified, which have failed the test and which are not verified yet.

Figure 178 shows a reporting tool which allows tracing requirements which are refined by another requirement, which don't refine any requirement which are not refined by any requirement. It allows the project manager to have an overview of the progress of the design and its quality. However, it is important to highlight that this reporting tool is only a traceability tool: it is not because a requirement is refining another one that it refines it well.

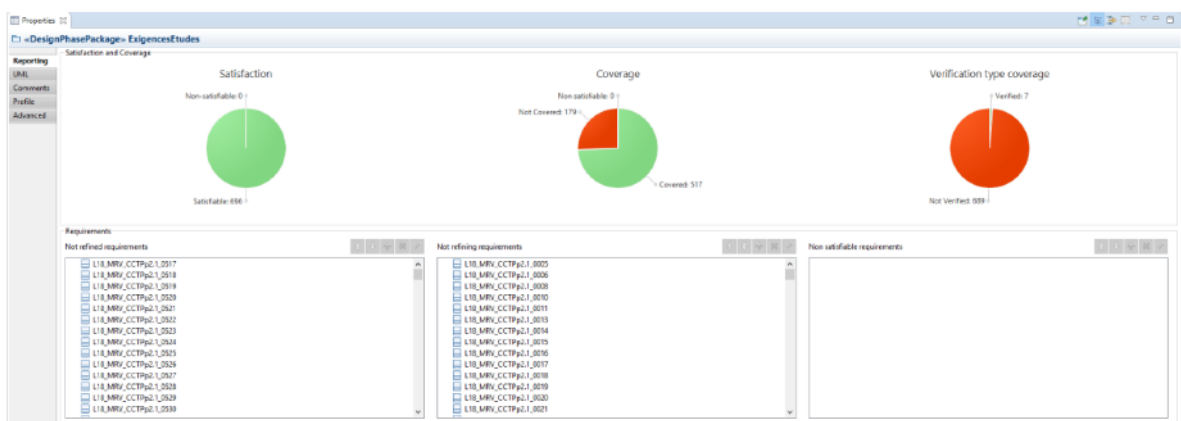


Figure 178 : Example of traceability board. This traceability board allows summing up the proportion of requirements refined by the designer.

- Report creation

Another function developed in Exegis consists in directly export reports from SysML models in a word format. Indeed, most of stakeholders in the construction industry are still working with a paper-based method and it is

usually compulsory to deliver deliverables and exchange information with other stakeholders. Diagrams are automatically exported in the word file as images, packages created in Exegis compose the different paragraphs of the document and requirements are described in a table with their source and their flexibility level.

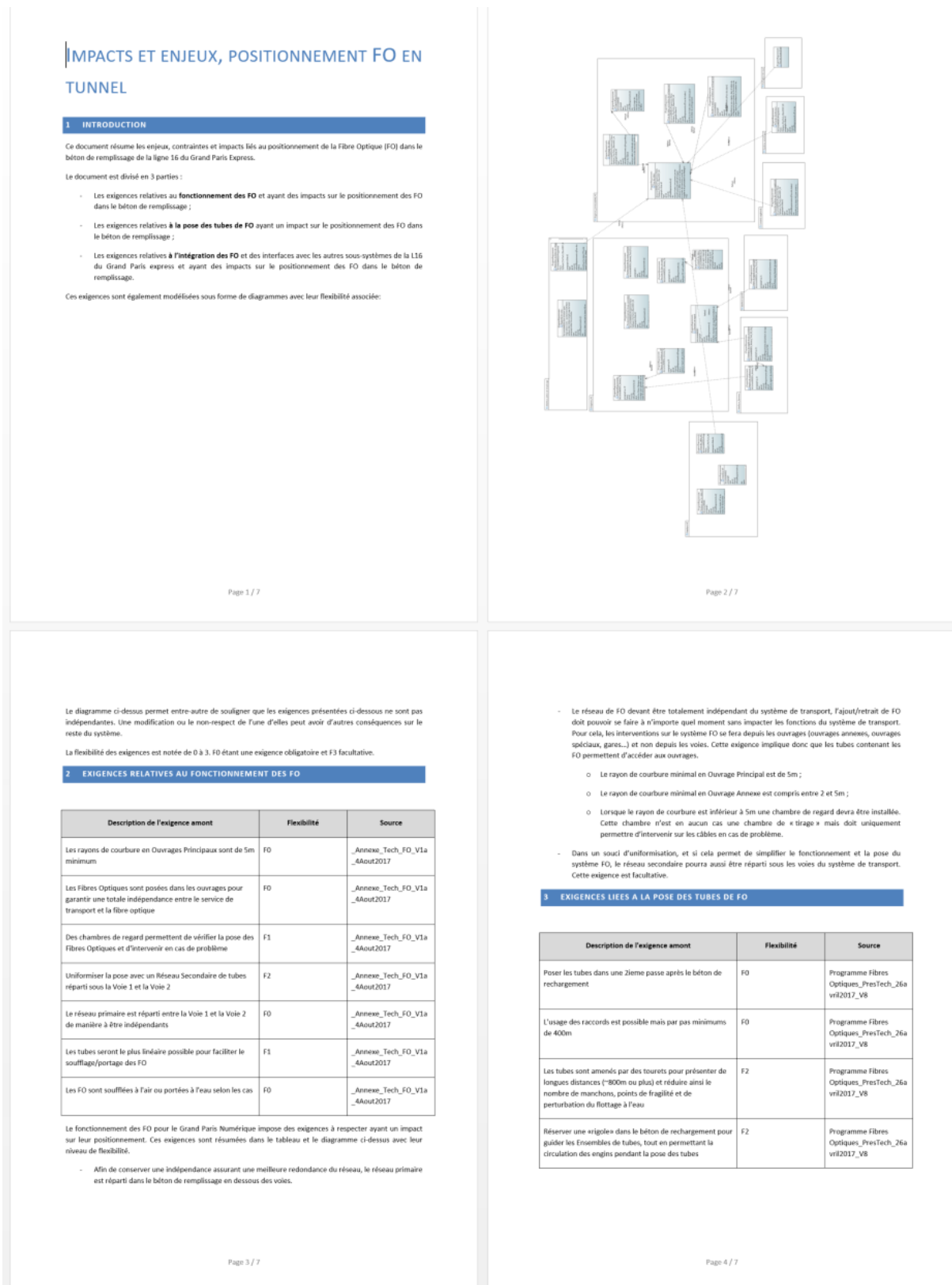


Figure 179 : Example of a report created with Exegis applied to the optical fiber subsystem of the line 16 of the Greater Paris metro project. Diagrams and table of requirement are automatically produced in a word format by Exegis.

Note: it is not possible with Exegis to import requirements from an unstructured word file. However it is possible to import requirements from an excel file.

- Change management functionalities

**Improvement n°20:**

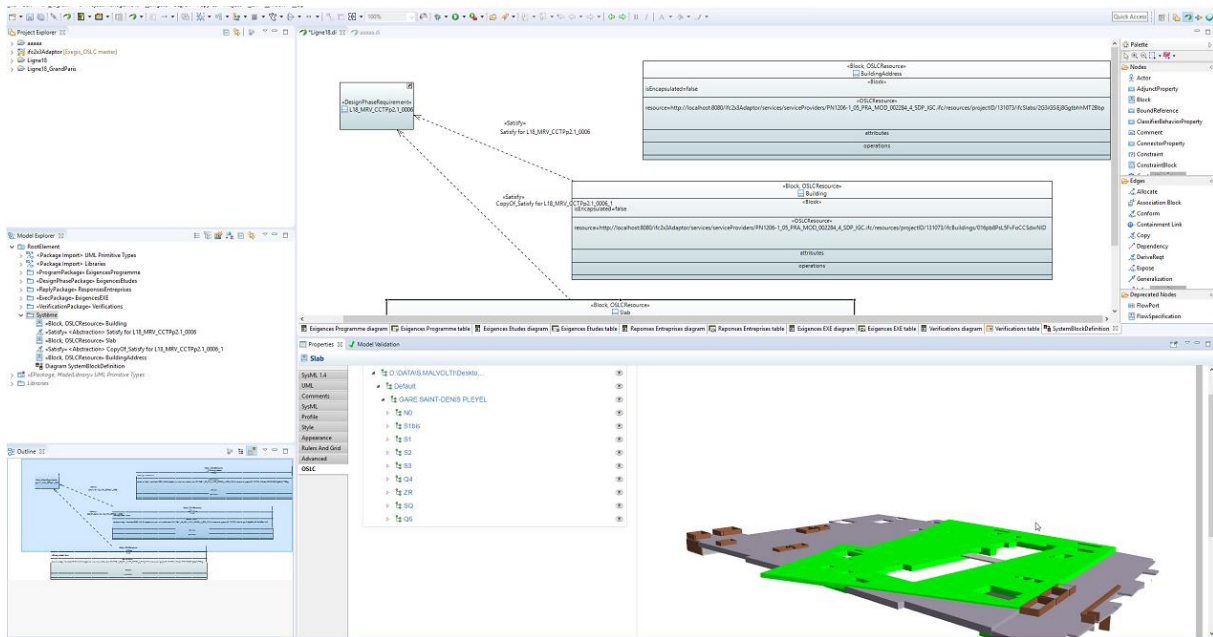
The SysML tool developed as part of this thesis allows to shift from a paper-based working method to a model-based working method. The tool is dedicated to design teams and consider particularities of the construction industry by the modeling of client requirements, design requirements and contractors' requirements. It allows integrating different types of documents related to requirements to populate their justification.

*3.3.1.1.2. Link requirements with BIM implementation models*

The tool developed in partnership between Egis and the CEA Tech allows linking SysML requirements and elements of the BIM model. As shown in Figure 180 requirements modeled in Exegis are allocated to BIM objects and the BIM model can be opened directly in Exegis to better manage allocations. To allow the integration of BIM models and Exegis the OSLC (Open Services for Lifecycle Collaboration) technology has been used (OSLC, 2018). OSLC allows simplifying the integration of heterogeneous software tools for Lifecycle Management.

This functionality is particularly interesting for evaluation of modifications, impact analysis and requirement verifications. The possibility to link requirements with elements of the BIM model notably allows tracing if all requirements are associated to an element of the infrastructure and therefore to easily evaluate if requirement have been consider or not in the design. The tool developed doesn't allow yet verifying if requirements are satisfied by the implemented model which will be the next development step. To be more specific if a requirement indicates that a platform should have a length of 120m it is only possible at the moment to check that the requirement is correctly allocated to the platform but not that the platform actually have a length of 120m.

An arising problem which is another avenue for research is how to import data from the BIM model in Exegis and how to synchronize data from the BIM model and data in Exegis. Indeed, requirements are stored in Exegis and connected with the BIM model online, how should modifications on the BIM model should be visualized in Exegis? Some of the information included in BIM models are not standardized in IFC and are therefore non-interpretable and non-interoperable.



**Figure 180 : Example of links between SysML requirements modeled in Exegis and BIM models**

Moreover, objects modeled in the BIM model only represent an “organic view” of the system (its components, walls, floors, stairs etc.) but not the “Functional view” neither an “Operational view” of the system. These views are not implemented in the BIM model whereas requirements at the Functional and Operational level exist and require to be verified and satisfied. They are even the most important requirements as a client is paying for functions more than components. Modeling Functional and Operational space is another avenue for research for the future of BIM and the development of IFC. Another possibility and avenue for research would be the possibility to modify directly the BIM model from Exegis by using the OSLC technology (strong integration). This type of integration would mean that the system is modeled twice: in the SysML tool and in the BIM modeling tool which implies other synchronization issues.

**Improvement n°21:**

Links between SysML tool (Exegis) and BIM models allow allocating requirements to spatial elements in the implementation model in order to verify that the design is compliant with requirements. However, at this stage only “organic” requirements can be checked in the BIM model as no functional spaces have been implemented in the BIM model.

**3.3.2. Development of a tool to assess Constructibility of a construction system at different phases**

**3.3.2.1. Constructibility matrices**

In this part we present two different tools which have been developed to implement Constructibility into the development of construction systems:

The first tool is the constructibility matrix, it allows considering and evaluating impacts of the enabling system on the system of interest by the definition of Constructibility criteria and essentially to help decision makers to make the appropriate design choices related to the System of Interest and by considering constraints from the Enabling System.

The second tool is a requirement-engineering tool with SysML (System Modeling Language). The tool has been developed in partnership with the CEA (Commissariat aux Energies renouvelables et Alternatives) and Egis to model requirements the System should fulfill. This tool allows modeling Constructibility requirements and linking

them to models such as BIM models in order to facilitate their consideration in the design, their verification or their allocation to system elements.

3.3.2.1.1. Design Structure Matrices (DSM) and Domain Mapping Matrices (DMM)

- Design Structure Matrices (DSM)

Design Structure Matrices (DSM) and Domain Mapping Matrices (DMM) are tools which are part of the Systems Engineering corpus (Eppinger, et al., 2012). DSM are used to model and analysis interfaces between elements of systems' architectures. As they don't cross different domains of systems' architectures DSM are square matrices. As instance DSM can represent components <-> components interfaces (Figure 181) or processes <-> processes interfaces.

In the matrix, relations between two elements can be highlighted in binary format (0 when there isn't relations and 1 otherwise) or with a symbol (a cross for example) only to indicate presence or not of a interrelation, with colors to allow qualifying strength of interrelations qualitatively or with numbers to allow qualifying strength of interrelations quantitatively.

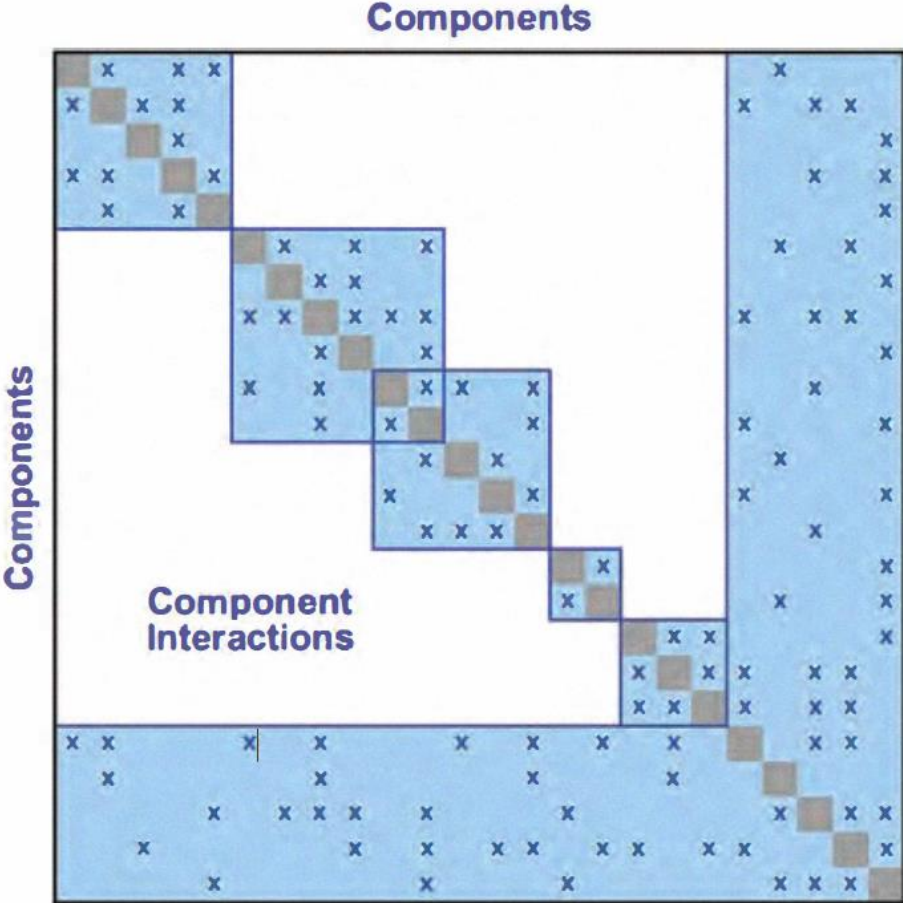


Figure 181 : Example of a DSM components <-> components matrix (Eppinger, et al., 2012). Crosses at intersections between components indicate interfaces between them.

DSM matrices are essentially interesting to optimize a system in a specific domain but not to cross different domains. They have not to be forgotten when analyzing specifically views of the System of Interest and/or the Enabling. However, aim of Constructibility matrices is to evaluate interactions between different domains: the Enabling System and the System of Interest which is not the purpose of DSM matrices.

- Domain Mapping Matrices (DMM)

Domain Mapping Matrices (DMM) allow modeling interactions between different domains which is exactly what we are intending to do when modeling interactions between the domain of the product (the System of Interest) and the domain of the project (the Enabling System). As instance, the example given in (Eppinger, et al., 2012) consists in modeling interactions between a sunroof product of a BMW and processes required for its development (Figure 182).

Since the 2000s numerous developments have been made on DMM notably (Eppinger, et al., 2001), (Browning, 2001) who worked on the interactions between three different domains: product components, organizational units and process activities. Linking product components and process activities is not far from the definition of Constructibility given in this chapter. Even if our approach is broader than only product components (we consider also product needs and product functions) and process activities (we consider also process objectives and process resources), it consolidates the proposed method.

One particularity of DMM matrices is that they are rectangular matrices, Eppinger in (Eppinger, et al., 2012) highlights that this type of matrices is very similar to QFD matrices and Suh matrices we have presented in chapter 2. Thus, there is all the more reason to use this type of matrix to evaluate Constructibility of construction systems.

In the DMM example below (Figure 182), it is interesting to notice that the author linked functions of the system, components of the system and activities required for its development, i.e. the product model with the process model.

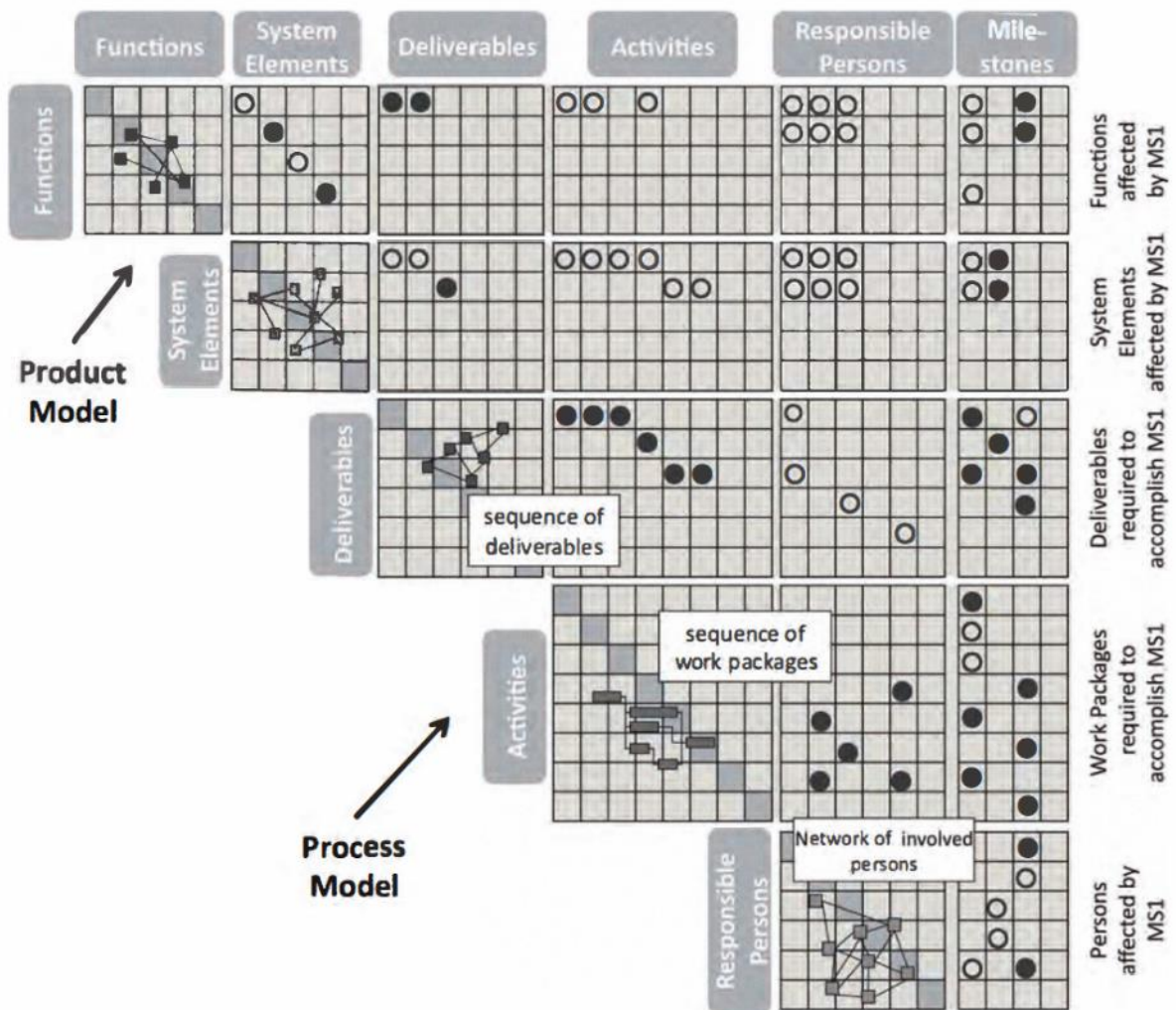


Figure 182 : Example of a DMM matrix applied to the modeling of independencies between a sunroof product and its development process (Eppinger, et al., 2012). Intereactions and relations between elements of the process and the



product are modeled through circles, squares, bars and links between them at intersections of rows and columns of the matrix.

- DSM and DMM analysis

One of the main analyzing activities with DSM and DMM matrices is clustering. Clustering consists in reorganizing columns and rows for different objectives as: components produced by the same supplier, sharing multiple interfaces, or having complex interactions (Eppinger, et al., 2012). The goals are to minimize interactions outside clusters and minimize the size of the cluster.

In our case clustering activities consist in regrouping issues which arise in the Enabling System to treat them and improve Constructibility of the System of Interest: low Constructibility elements are clustered in the same group/area in the matrix depending if they are related to objectives/activities/resources of the Enabling System and Needs/functions/organs of the System of Interest. Therefore depending on their category different actions can be undertaken to improve Constructibility of the cluster. As instance, if different functions have “objectives” Constructibility issues, they will be regrouped in a specific cluster, a team could be dedicated to analysis of the cluster and to improve the Constructibility by specific actions depending on the type of cluster.

**Number of clusters:** neither having too many clusters neither having a unique cluster is an objective when carrying a DSM/DMM analysis. The objective is to have a number of cluster easily manageable by a human operator and which enables to make partitioning choices both in the System of Interest and in the Enabling System.

**Cluster size:** Similarly to the number of cluster, there is no specific rule related to cluster size excepting that the cluster should be all the matrix and not to be empty. Objective of the clustering activity is to regroup Constructibility issues and treat them. Therefore the size of the cluster should be big enough to represent an issue to treat and small enough to be manageable. It remains to define what would be a “manageable cluster”.

Finally, Eppinger (Eppinger, et al., 2012) highlights that the MDM development is a promising avenue for modeling complex systems. This is precisely in this direction that we orient our researches in order to improve Constructibility of construction systems.

#### *3.3.2.1.2. The Constructibility matrix*

Objective of the Constructibility matrix is to evaluate Constructibility of the System of Interest with a particular Enabling System. For each architecture view of the System of Interest (Operational, functional or Organic view) a constructability matrix can be defined. For each view is assessed feasibility of the system in terms of Objectives, Processes and resources. The Constructibility matrix is largely inspired by DSM, MDM, HOQ and Suh matrices but adapted to our problematic which consists in assessing Constructibility of a construction system.

To do so, the different views of the System of Interest are in lines (Needs, Functions, Composition) and the different views of the Enabling System in columns (Objectives, Activities, Resources). Intersections between the System of Interest and the Enabling system represent Constructibility criteria.

Eventually, the matrix is not diagonal meaning that elements from the enabling system (in columns) can be used for the development of different elements of the System of Interest. This effect must be sought as it allows mutualizing the different processes to use and eventually required resources. Research of optimization would lead to reduce the number of columns (i.e. the number of objectives, processes, resources) and to have a non-diagonal matrix.

Because there is no reason that objectives, processes and resources required for the Enabling System would be the same between Operational, Functional and Organic analysis we propose to separate them in order to build a block diagonal matrix (Figure 183):

	Objectives						Activities						Resources									
	Effectivity	Governability	Contractibility	Acceptability	Legal	Temporality	Pertinence	Complexity	Robustness	Documentation	Communication	Control	Error proofed	Knowledge	Repeatability	Efficiency	Availability	Accessibility	Workability	Reliability	Ambivalence	Financiability
Need 1																						
Need ...																						
Need n																						
Function 1																						
Function ...																						
Function n																						
Component 1																						
Component ...																						
Component n																						

**Figure 183 : The Constructibility matrix. In rows are represented elements from the product (System of Interest), its needs, functions and components and in columns elements of the project (Enabling System) with previously defined Constructibility criteria.**

The Constructibility matrix is not necessarily a square matrix as mutualization in the enabling system can lead to reduce the number of columns, or at the opposite that several objectives/processes/resources may be required for one element of the System of Interest leading to more columns than lines.

Moreover, as mentioned when we have developed the Constructibility concepts, it exists two different types of Constructibility analysis: Vertical Constructibility which consists in analyzing Objectives/Activities/Resources in the left branch of the vee cycle and Horizontal Constructibility analysis which consists in analyzing Objectives/Activities/Resources in the right branch of the vee cycle. At the moment, the constructibility matrix regroups both type of Constructibility analysis in the same cells which can be confusing as they don't refer to the same elements. We are aware of this problem, eventually different Constructibility matrices could be used to differentiate both types of analysis or further research could be carried to integrate more clearly the different types of Constructibility analysis in the same matrix.

The constructability matrix is making the link between the System of Interest represented in lines and the Enabling System represented in columns, therefore Constructibility criteria are represented at their crossroads. In other words, each cells of the matrix represents a constructability criteria.

**Improvement n°22:**

The Constructibility matrix allows consideration, evaluation and verification of different Constructibility criteria at all views of the system (Operational, Functional and Organic). Eventually, a more accurate measurement of Constructibility criteria (notably quantified criteria) would allow a deeper use of DSM matrix principles.

In the last part, 39 Constructability criteria have been defined in the literature, all these 39 Constructability criteria corresponds to at least one criteria we have defined in this thesis and in the Constructibility matrix (Figure 184):

	Objectives					Activities					Resources											
	Effectivity	Governability	Contractibility	Acceptability	Legal	Temporality	Pertinence	Complexity	Robustness	Documentation	Communication	Control	Error proofed	Knowledge	Repeatability	Efficiency	Availability	Accessibility	Workability	Reliability	Ambivalence	Financiability
<b>Operational View</b>			Contracting						Coordination and rationalisation of information	Coordination and rationalisation of information		Skills availability										
			Contracting						Coordination and rationalisation of information	Communication		Skills availability										
<b>Functional View</b>			Contracting					Simplicity of the design	Coordination and rationalisation of information	Coordination and rationalisation of information		Skills availability										
									Coordination and rationalisation of information	Communication		Skills availability										
<b>Organic View</b>									Coordination and rationalisation of information	Coordination and rationalisation of information		Skills availability										
			Contracting	Community disturbances					Coordination and rationalisation of information	Communication		Skills availability										
								Simplicity of the design	Coordination and rationalisation of information	Communication		Skills availability										
								Construction sequence				Skills availability										
								Operation				Skills availability										
												Skills availability										
												Skills availability										
												Skills availability										
												Skills availability										
												Skills availability										

Figure 184 : Constructability criteria from the literature in the Constructability matrix

Position of Constructability criteria in the Constructability matrix leads to some comments: some of the constructability criteria are positioned in the matrix in the Operational, Functional and organic views. It means that these criteria don't depend on the nature of the System of Interest elements analyzed, they depend on the Enabling System elements and can have potential impacts on the System of Interest (as instance, coordination and rationalization of information, skills availability, contracting don't depend on a specific element of the System of Interest). These criteria can be considered as "sub-criteria" of global criteria defined in the thesis as they are more precise on a specific element of the Enabling System.

Other Constructability criteria are positioned in Objectives, Activities and Resources at the same time. It means that these criteria may be specific to a particular element of the System of Interest and have implications on different elements of the Enabling System (Modularity as example is linked to Ambivalence and Repeatability). At the contrary to previous types of Constructability criteria, these criteria could be considered as more general criteria than the ones chosen in the Constructability matrix.

Most of the previously defined Constructability criteria are positioned in the Organic view. This is not surprising as Constructability concerns mostly the consideration of constraints from the realization phase early in the development which is represented in Systems Engineering by the Organic view.

3.3.2.1.3. The constructability cube

The Constructability matrix only allows analyzing constructability at one systemic level. When adding the different systemic levels of the system it is possible to represent the framework as a cube (Figure 185): the z axis represents the different systemic levels from the system level to components, the y axis represents views of the Enabling System and the x axis represents views of the System of Interest.

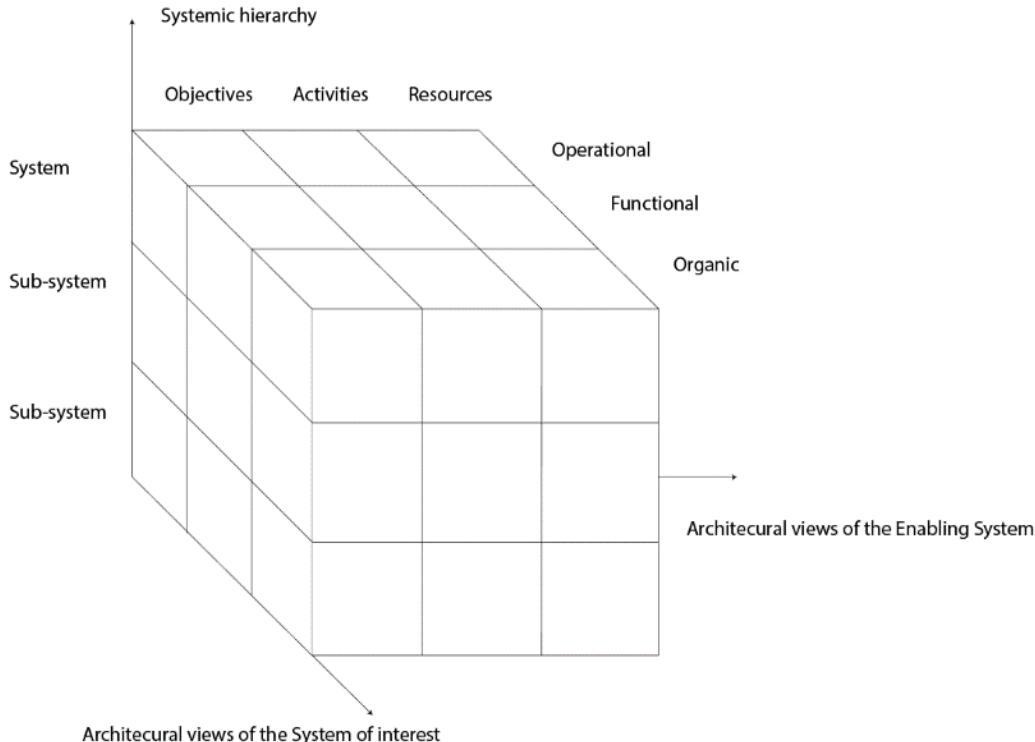
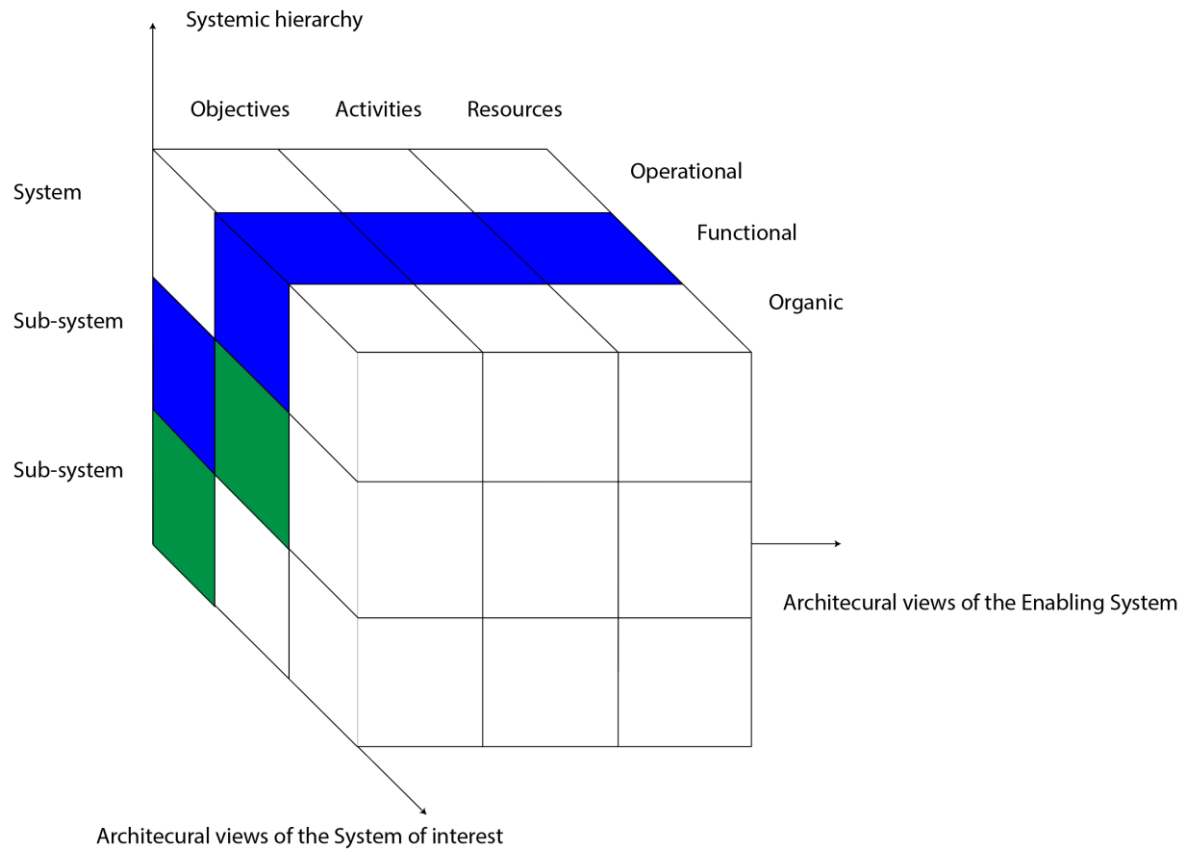


Figure 185 : The theoretical Constructability cube. More than the Constructability matrix, the constructability cube allows representing the different systemic levels of a construction system.

Some boxes in the Constructability cube are redundant as the Functional view at one systemic level corresponds to the Operational view at the lower systemic level as shown in Figure 165. Therefore following boxes are similar in the cube (in blue and in red) (Figure 186):



**Figure 186 : The Constructibility cube. Similar boxes between systemic levels in the Constructibility cube are represented in different colors (blue and green here).**

In the case studies developed in this thesis, only Constructibility matrix have been used. Indeed, analyze all systemic levels from the System level to the Sub-systems level would have required much more than the time available for a thesis dissertation. It means that interactions between systemic levels haven't been studied as part of this thesis. More researches and time would be necessary to apply the Constructibility cube in constructions projects. Organization of construction projects in France is also partly responsible for the non-utilization of the Constructibility cube metamodel, as actors may change between studies systemic levels it implies losses of information and cuts in the information chain.

### **Conclusion of part 3**

In this chapter, particularities of construction systems have been integrated in Systems Engineering and notably the consideration of space in all views of SE. Consideration of space have led to the definition of spatial characteristics of systems in Operational, Functional and Organic elements and to the consideration of spatial interactions of the system in the three views. Constructability has been extended to Constructibility to consider constraints from all elements of the Enabling System. This shift has led to the definition of new Constructibility Concepts and Principles and the definition of new Constructibility criteria. Adapted concepts and principles of both Systems Engineering and Constructibility have been integrated in the Functional Analysis method in order to enrich it for an application on complex construction systems. Notably, the integration of Validation & Verification concepts and the SysML modeling language has been integrated in the enriched Functional Analysis method. It has been identified that the SysML language requires to be adapted to describe spatial characteristics of systems (topology, geometry and location) and indications have been made in this way.

To implement the method, 2 tools have been developed to implement the enriched Functional Analysis for its application to the construction industry. A Requirement modelling tool based on the SysML language which allows linking different types of requirements (Operational, Function, Organic or Constructibility requirements) to BIM models. This tool allows tracing and verifying requirements more easily and with a better efficacy. More importantly, it allows to allocate requirements to spaces modeled in BIM models. However, at the moment only organic requirements can be traced on BIM modeled, which raises the question of how to represent functional and operational spaces in BIM models? And how to represent abstract view of construction systems (i.e. functional and operational spaces) in SysML?

The second tool developed is the Constructibility matrix, a tool which allows analyzing Constructibility of construction systems in its different views (Operational, Functional and Organic) and in terms of Objectives, Activities and Resources to model interactions between the System of Interest and the Enabling System. This tool is based on the use of DSM and MDM matrices which allows the application of clustering concepts, to identify hard Constructibility constraints and finally to improve Constructibility of the construction system.

In the next part, the enriched Functional Analysis method with its implementation tools will be applied on two case studies: application of the multifunctional metro concept of the 5th metro line of Lyon and on the broadband system of the line 16 of the Greater Paris project.

In Figure 187, enrichments of the Functional Analysis method and application of developed tools have been highlighted in comparison with the basic Functional Analysis method (new tools, consideration of space, V&V, Constructibility analysis). In Figure 188, each view is detailed with a flow chart (BPMN) detailing the different steps to carry the Enriched Functional Analysis method in the different views (Operational, Functional and Organic).

In the last part, 16 issues have been identified for the integration of Systems Engineer, Constructability and Functional Analysis and their application to the construction industry. To face these issues 23 Improvements have been made to the enriched Functional Analysis method.

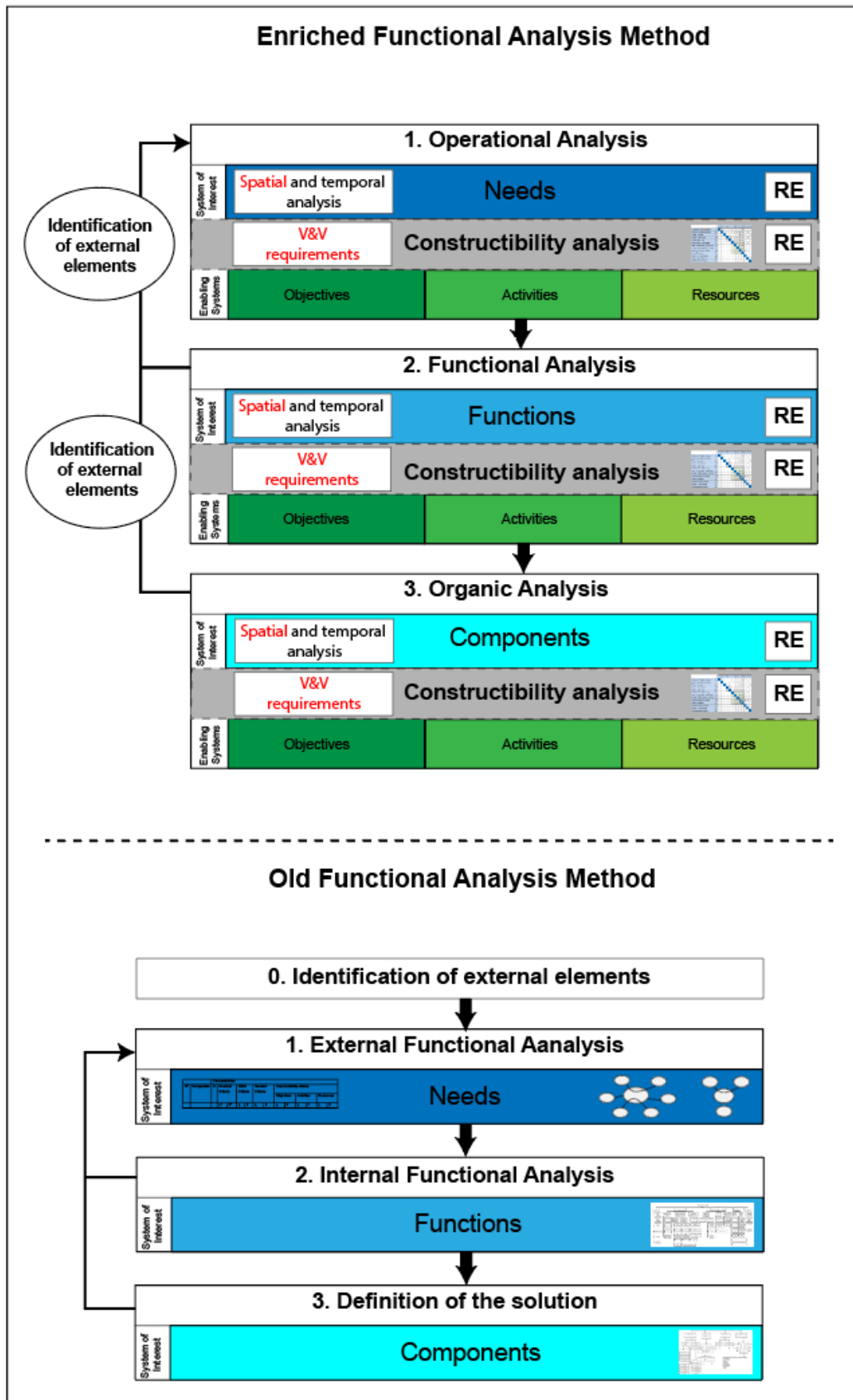


Figure 187 : Comparison between the enriched Functional Analysis Method and the Old Functional Analysis method. Compared with the classic Functional Analysis method, The enriched FA method adds the consideration of spatial characteristics of systems, V&V requirements, Constructibility analysis, the use of new tools such as Requirement Engineering tools and Constructibility matrices.

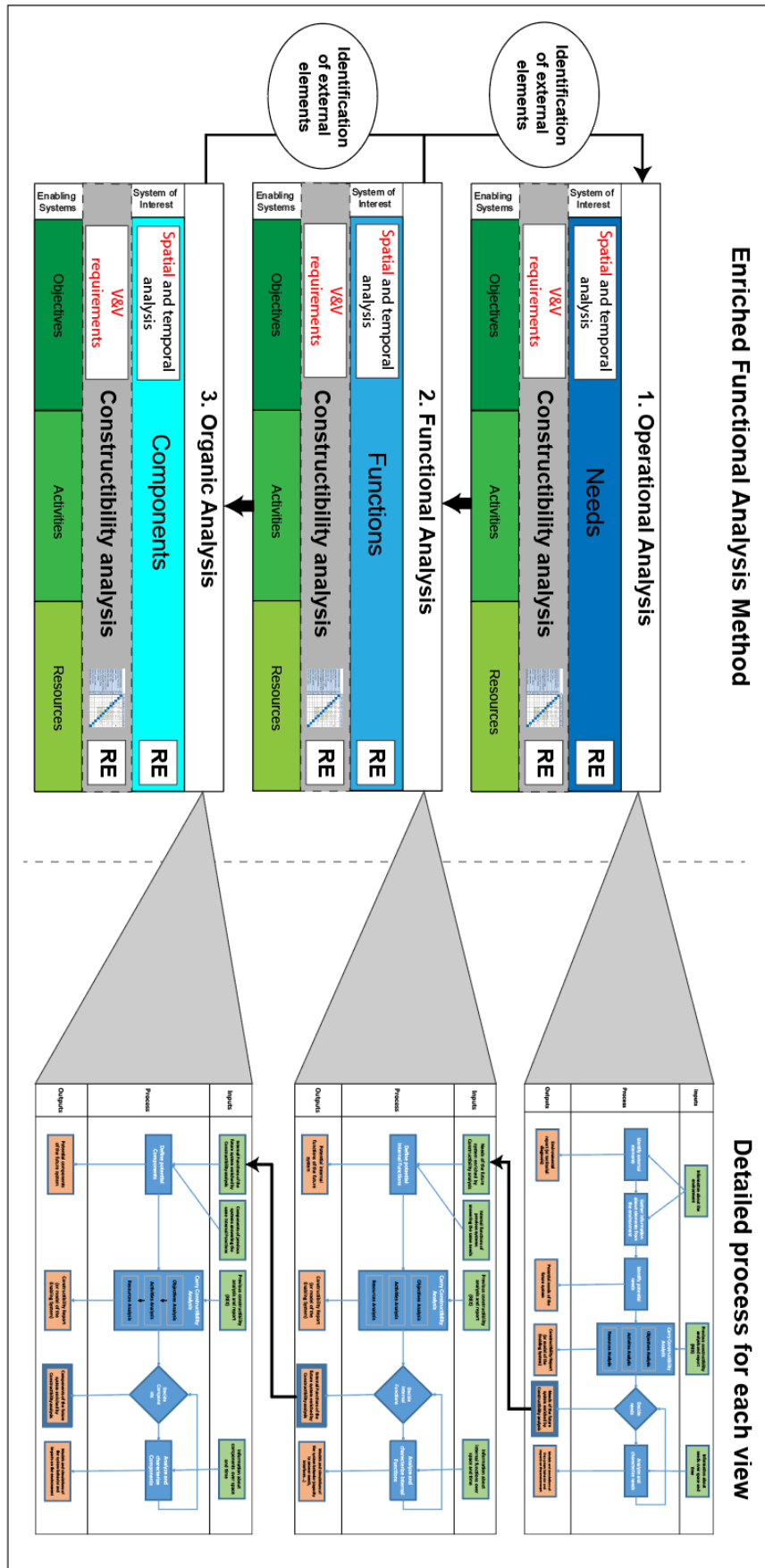


Figure 188 : The Enriched Functional Analysis Method and its detailed processes. This figure details the precise workflow to follow and the different steps in each view.





## **4. Application of the method on case studies**

---



## Résumé de la partie en français

Dans cette dernière partie, après une rapide description des 2 cas d'étude, nous appliquons la méthode d'Analyse Fonctionnelle Enrichie sur 2 projets tous 2 en lien avec le concept de métro multifonctionnel développé au cours de la thèse chez Egis. Le premier cas d'étude porte sur les Etudes de Faisabilité de la 5<sup>ème</sup> ligne de Lyon aux cours desquelles nous avons étudié les possibilités de mutualisation avec d'autres besoins de la ville. Le deuxième cas d'étude porte sur l'intégration d'une nouvelle fonction dans la ligne 16 du Grand Paris Express, l'ajout de plus de 105 fibres optiques permettant d'irriguer l'île de France en internet haut débit des zones non encore raccordées. 2 niveaux systémiques sont donc étudiés au niveau « système » pour la 5<sup>ème</sup> ligne de Lyon et au niveau sous-système pour la fibre optique de la ligne 16 du Grand Paris numérique.

Sur l'ensemble des cas d'étude nous avons utilisé la méthode d'Analyse Fonctionnelle Enrichie, on notera l'utilisation d'éléments spatiaux dans les différentes vues. Au niveau Opérationnel pour la 5<sup>ème</sup> ligne de Lyon où des cartes ont été utilisées pour analyser le besoin. Et au niveau organique pour la ligne 16 du Grand Paris où certaines exigences ont été vérifiées grâce à des maquettes numériques. Des diagrammes d'exigences ont aussi été utilisés pour modéliser les exigences issues du Système à faire et du Système pour faire pour le programme fibre optique de la ligne 16 du Grand Paris.

Les matrices de Constructibilité et les critères de Constructibilité associés ont pu être appliqués sur les 2 cas d'étude. Ces matrices mettent en évidence les liens entre le Système à faire et le Système pour faire dans ces 2 cas. Ils révèlent notamment certaines difficultés pour le développement du concept de métro multifonctionnel. Les problèmes de gouvernance et la gestion des fonctions urbaines en silo est un frein majeur pour le développement de systèmes multifonctionnels. Des problèmes législatifs peuvent aussi survenir comme ce fut le cas pour la géothermie. La disponibilité des informations précises sur l'état actuel des réseaux urbains est aussi un problème que nous avons rencontré du fait des problèmes de gouvernance. La « contractabilité » des systèmes multifonctionnels est une autre difficulté que nous avons identifiée, par exemple les questions de logistique urbaines gérées en grande partie par le secteur privé posent la problématique de la forme contractuelle à donner pour intégrer ces nouveaux acteurs potentiels.

Pour la ligne 16 du Grand Paris, la matrice de constructibilité met en évidence que les difficultés liées aux interactions entre le système pour faire et le système à faire à ce niveau systémique sont surtout liées à la vue organique : la pose des tubes contenant les fibres optiques dans le radier du tunnel comporte quelques difficultés et n'est pas anodine sur le planning et les moyens à mobiliser selon la conception et le mode constructif choisis. Le financement des « surcoûts » liés au développement du Grand Paris Numérique dus aux choix de conception précédemment évoqués pose question (financiabilité) ainsi que sur la facilité à réaliser le système (workability).

Finalement, nous montrons par l'application sur ces 2 cas d'étude que l'utilisation la méthode d'Analyse Fonctionnelle Enrichie a permis d'améliorer l'application de l'Analyse Fonctionnelle pour le développement de systèmes du secteur de la construction en prenant en compte les éléments spatiaux et les interactions avec le système pour faire.

In order to test and illustrate and validate the method defined in the last chapter, we have applied it to two case studies at two different systemic levels: the 5<sup>th</sup> metro line of Lyon at the system level, and integration of the broadband network in line 16<sup>th</sup> of the Greater Paris project at the subsystem level. The interest is to show that the method can be applied both at the system and the subsystem level. Both case study deals with metro systems as the thesis has been carried as part of an industrial contract between Egis Rail, a company specialized in transport infrastructure systems and ESTP (Ecole Spéciale des Travaux Publics et de l'Industrie) a Civil Engineering university based in Paris. They have been chosen depending on ongoing project opportunities at Egis Rail.

The main question case studies will answer is to assess if the introduction of spatial considerations and Constructibility allows, facilitates and improves the application of Functional Analysis to construction products (by the integration of Systems Engineering and Constructibility concepts). In order to evaluate the method, we have defined the following validation conditions:

- Is it relevant to introduce spatial considerations in the different views at different systemic levels when applying Systems Engineering/Functional Analysis to construction projects?
- Is it relevant to introduce Constructibility criteria in the different views at different systemic levels when applying Systems Engineering/Functional Analysis to construction projects?

Not all “Improvements” defined in the last part will be applied in case studies due to a lack of time or resources. In Figure 189 Improvements used in case studies are represented in red and Improvements which have not been applied in grey. Further researches would be required to apply or investigate more Improvements which have not been used.

Improvements applied in Case study 1 (5<sup>th</sup> metro line of Lyon) are:

- Improvement n°4: characterization of spatial characteristics of systems;
- Improvement n°5: integration of spatial characteristics of systems in architectural views;
- Improvement n°9: shift from constructability to Constructibility;
- Improvement n°10: the double vee cycle;
- Improvement n°12: spatial interactions between the System of Interest and the Enabling System;
- Improvement n°16: the use of SysML in Functional Analysis methods;
- Improvement n°19: Constructibility in the different steps of Functional Analysis
- Improvement n°20: shift from paper based method to model based method
- Improvement n°22; Constructibility matrix for Constructibility assessment

Improvements applied in Case study 2 (broadband network of the Greater Paris line 16) are:

- Improvement n°4: characterization of spatial characteristics of systems;
- Improvement n°5: integration of spatial characteristics of systems in architectural views;
- Improvement n°7: functional diagram;
- Improvement n°9: shift from constructability to Constructibility;
- Improvement n°10: the double vee cycle;
- Improvement n°11: use both horizontal and vertical Constructibility
- Improvement n°12: spatial interactions between the System of Interest and the Enabling System;

- Improvement n°16: the use of SysML in Functional Analysis methods;
- Improvement n°17: requirement engineering and requirement management;
- Improvement n°19: Constructibility in the different steps of Functional Analysis;
- Improvement n°20: shift from paper based method to model based method;
- Improvement n°22; Constructibility matrix for Constructibility assessment;

Improvements which are not applied:

Improvement n°6: the territorial diagnosis methodology detailed in Improvement n°6 has not been strictly applied at the system level. Only the mobility part of the territorial diagnosis has been carried. Territorial diagnosis related to other needs than mobility (energy, water, logistic etc.) would be necessary to properly evaluate such needs. Instead, only interviews with urban professional at Grand Lyon have been carried (which is only one part of the territorial diagnosis). More time, resources and contacts at Grand Lyon would be necessary to have access to the appropriate information required to realize a territorial diagnosis.

Improvement n°8: Improvement n°8 concerns the adaptation of the SysML modelling language to integrate spatial characteristics to enable the description of spatial characteristics of systems (topology, geometry, referential). This improvement has not been implemented in a SysML tool and would require more researches to evaluate the pertinence of such a modification. This improvement is more a proposition and for this reason has not been used in case studies.

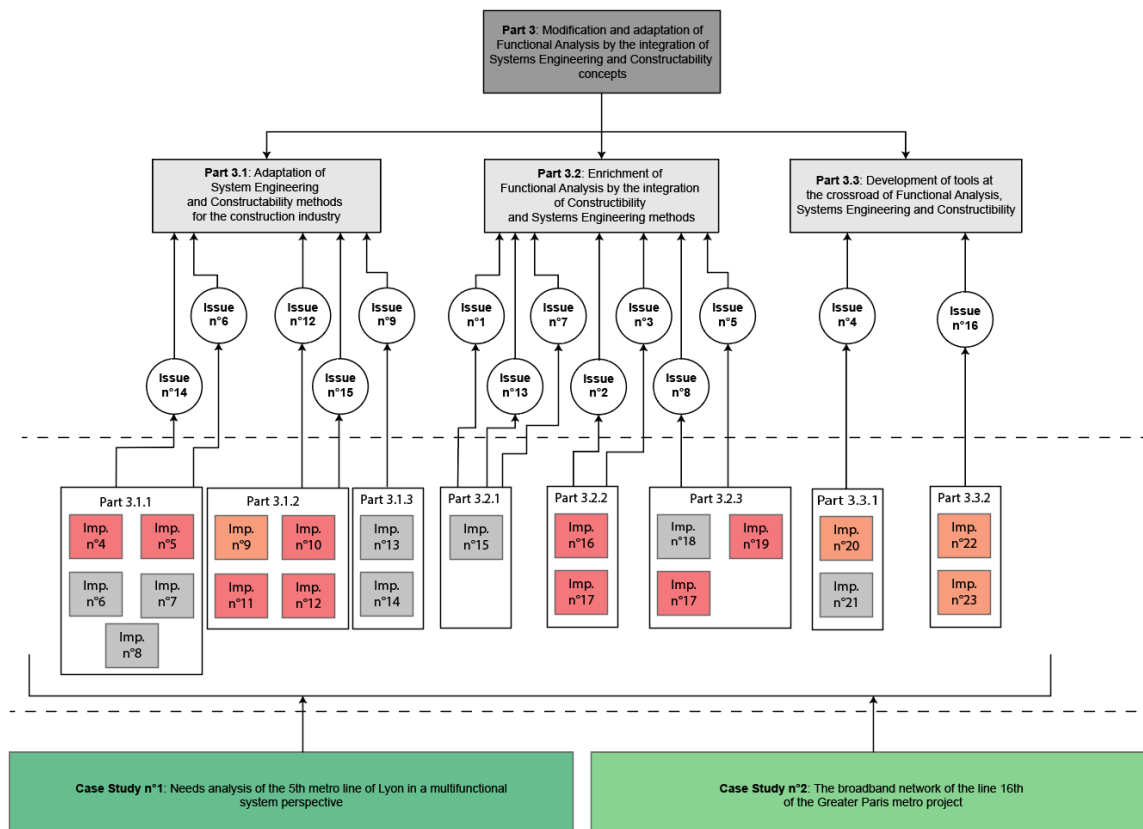
Improvement n°13: Improvement n°13 is a method to define Constructibility criteria it has allowed defining Constructibility criteria at different levels. Eventually, application of this method can lead to the definition of new Constructibility criteria. However, in case studies developed in this part only Constructibility criteria defined in the last part have been applied.

Improvement n°14: this improvement is a first attempt to formalize mathematically Constructibility criteria as the link between the System of Interest and the Enabling System. In case studies, Constructibility criteria are not formalized mathematically and they are evaluated with a range of colors. Further researches would be required to formalize Constructibility criteria mathematically as well as how to measure them.

Improvement n°15: In Case Studies developed only one Systemic level is studied at a time. Links between different systemic levels and how they could be integrated have not been evaluated. Further researches would be necessary to evaluate the links between different systemic levels in the construction industry. This work is particularly difficult as studies at different levels are carried by different actors in the value chain.

Improvement n°18: Mostly vertical Constructibility has been applied in case studies. In the second case study, horizontal Constructibility is applied notably to evaluate how some functions will be tested.

Improvement n°21: link SysML models with implementation models, has not been applied in case study n°1 as numeric models have not been undertaken at the system level for identified functions; Only a mobility model has been used and we didn't have the time and resources to develop links between eventual Use case diagrams/requirement diagrams realized for mobility needs and the numeric model. In case study n°2 an implementation model of the infrastructure required for the broadband network has been realized but too late to be considered as part of our analysis. However, other applications of improvement 21 on other elements of the system has proved that it is technically possible to link SysML elements with implementation models such as BIM models.



**Figure 189 : Use of improvements in Case studies. Improvements in orange have been developed specifically in this thesis and integrated in the method. Improvements in red have are coming from other researches and integrated in the Enriched Function Analysis method.**

Another objective of the thesis and of the application of the method is to manage complexity of the development of multifunctional metro systems. Therefore case studies have been selected also depending on projects where new functions were implemented or where the client is willing to add new functions to the metro system: in the 5<sup>th</sup> metro line of Lyon the Sytral (the Transport Authority in Lyon, France) agreed to analyze if other needs could be identified to evaluate opportunities of mutualization with the metro system at the system level. In the line 16 of the Greater Paris project, it has been chosen by the French government to add optical fiber in the project, integration of this new function (transport information) is studied as a case study to apply the method. Nevertheless, we want to insist on the fact that the method can be applied at any systemic level, for different types of construction products (buildings or infrastructures) and for mono or multi-functional systems.

#### 4.1. Presentation of case studies

##### 4.1.1. At the system level: the 5th line of Lyon

Studies for the planning of the 5<sup>th</sup> metro line of Lyon to link the western districts of the city to the city center was an electoral promise of the mayor of Lyon Gerrard Collomb during the municipal elections held in France in 2014. Therefore, the political component of this study cannot be ignored as the 5<sup>th</sup> district of Lyon which the 5<sup>th</sup> metro line is intending to connect is a district regularly at stake for municipal elections in Lyon (Lyon Capitale, 2014), (L'express, 2014), (Rue89Lyon, 2018).

The Sytral (Syndicat des Transports de l'Agglomération Lyonnaise) is the Authority responsible for transportation and mobility planning in the agglomeration of Lyon. It is the Sytral which is responsible of the studies for the 5<sup>th</sup> line of Lyon. Egis has been awarded for the feasibility studies on behalf of the Sytral as a consultant company.

Objective of the study is to evaluate the feasibility of a new “Mass Rapid Transit system” from Lyon city center to different suburbs in the Western part of Lyon (Trion, Point du jour, Ménéval, Alai) and to end at “Alai train station”. This study is linked with another project called “Anneau des Sciences” which is a road project to circumvent Lyon (Figure 190). The future MRT urban transport system will connect the future road project to Lyon city center. The feasibility study will investigate the analysis of several scenarios with different alignment options and different access points (stations) (Sytral, 2016).



Figure 190 : Future connected areas of the 5th metro line of Lyon from Lyon city center and “Gare d’Alai”.

The feasibility study is separated in three phases (Sytral, 2016):

- A diagnosis phase where input data are consolidated and capitalized and missing data are identified. A diagnosis of the territory will have to be undertaken in the western part of Lyon comprising the description of the urban space (density, typology of activities, urban transformations, public buildings and attracting points). A transport diagnosis comprising an analysis of planning documents (PDU (Plan Urban de Déplacement) and PLU (Plan Local d’Urbanisme)). A socio-economic analysis. A transport offer diagnosis and its future capability. A topographic diagnosis. A diagnosis of underground networks. A diagnosis of existing buildings and infrastructures. A geological and geotechnical diagnosis.
- A first phase will identify the corridor of the future metro line. This first phase will comprise geometrical possibilities of alignments, identification of specific points, the number and localization of stations, operation modes of the line (extension of an existing metro line or a new line), traffic forecasts of the future system as well as impacts on the actual transport network in Lyon, evaluation of investment costs as well as a multi-criteria analysis of the different scenarios.
- A second phase where selected scenarios in the phase one are consolidated by analyzing more in detail Civil Engineering considerations, geotechnical constraints, Rolling Stock operation, performance of the system, cost and operation investments, detail singular points of each scenario and a risk analysis.

It is interesting to notice that like in System Engineering method, the 3 phases in the feasibility study correspond more or less to the three views in SE (Operational, Functional and Organic). However with some major differences: as instance, performance of the system are defined at the functional level in SE whereas they are in the last phase here.

#### 4.1.2. At the subsystem level: Optical fiber in the line 16 of the Greater Paris Project

Integration of an optical fiber network in the line 16 (Figure 191) and more generally in all new lines of the Greater Paris project has been decided in the law n°2010-597 on the Greater Paris project voted at the parliament June, 3<sup>rd</sup> 2010: “Les infrastructures du Réseau du Grand Paris intègrent des dispositifs destinés à permettre le déploiement de réseaux très haut débit” (infrastructures of the Greater Paris network will integrate systems which allow the deployment of a broadband network).

One could argue that optical fiber is a usual system integrated in a metro system. Indeed, a broadband system is usually used in metro systems to transport, transfer and exchange information for the metro operation. However,



it is used only for the metro system itself and not to transport information for other stakeholders from outside the system (such as telecom operators, public administrations, the private sector etc.). This difference implies major changes in the requirements which apply to the broadband system: it has to be accessible from outside the system at any moment of the day (7d/7 and 24h/24), the amount of information to transport is radically different (from 3 to 5 optical fibers in the case of a classic broadband metro system to more than 100 optical fibers in the case studied here), operation and maintenance have to be independent from the transport system operation, accesses to the system also has to be independent and a higher level of quality and security is also required.

Objectives of this integration are specified as follows: improve the coverage of the broadband network in the region “Ile de France” around Paris, offer new services for inhabitants as part of the “numeric city”, benefit from the construction of a metro infrastructure to mutualize it with a broadband network and decrease the required investment of a broadband network alone, increase the synergy between research, health, education, economic and cultural clusters located around Paris by improving sharing of information thanks to the broadband network.



Figure 191 : The line 16 of the Greater Paris project (in dark blue) (Société du Grand Paris) from Noisy-Champs to Saint-Denis in the east of Paris.

At this stage of the analysis, studies have already been made at the system level by SGP (Société du Grand Paris) the authority responsible for the development of the Greater Paris project. Notably, evaluation of the needs related to the broad band network, as well as performance specifications:

- Irrigate more than 300 points over the “Ile de France” territory;
- Offer an information transport capability which can afford almost an unlimited increase of the amount of transported data;
- Be able to adapt to any architectural network with marginal investments;
- Offer a high level of availability, quality of service, security and resilience to answer to the needs of critical infrastructures;
- Be operational 24h/24 7d/7 independently from the transport system.

The work to carry in our stage and in the team I was involved was to integrate the broadband network in the metro infrastructure and design its dedicated infrastructure when required. The definition of specifications of the broadband network itself was carried by another design team in the project (Figure 192).

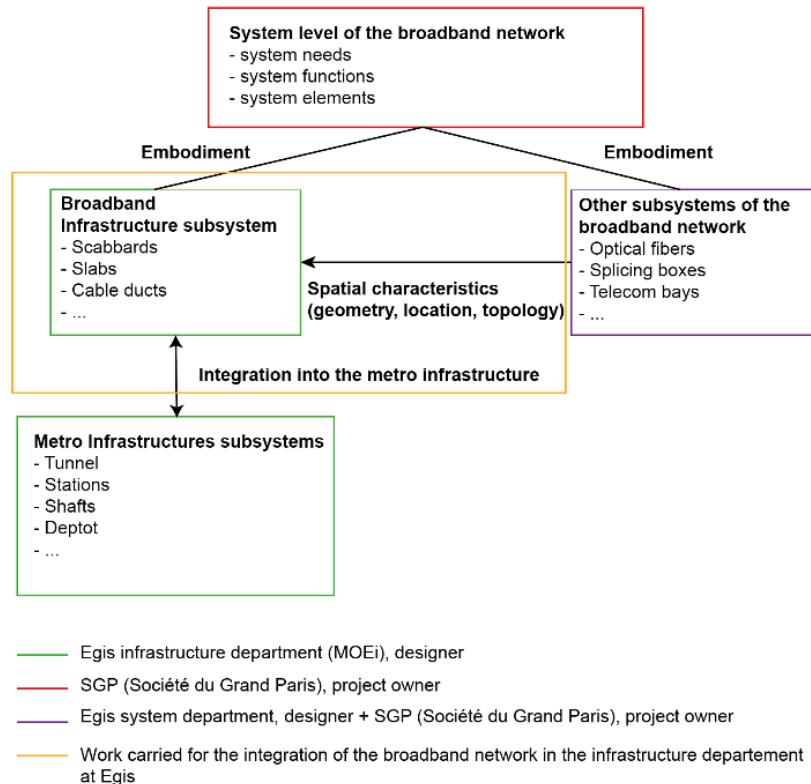


Figure 192 : Organization of the work for the integration of the broadband network. This diagram shows that the design of the metro system has been separated into two distinct project teams with two distinct contracts. A project related to the design of the infrastructure of the line 16 and a project team dedicated to the design of equipments of the Greater Paris project. The project team I was integrated as part of this thesis was the integration of the Fiber optic network in the infrastructure of the line 16 (orange sidebar).

The general architecture of the broadband network system was also given by SGP (Société du Grand Paris) (Figure 193):

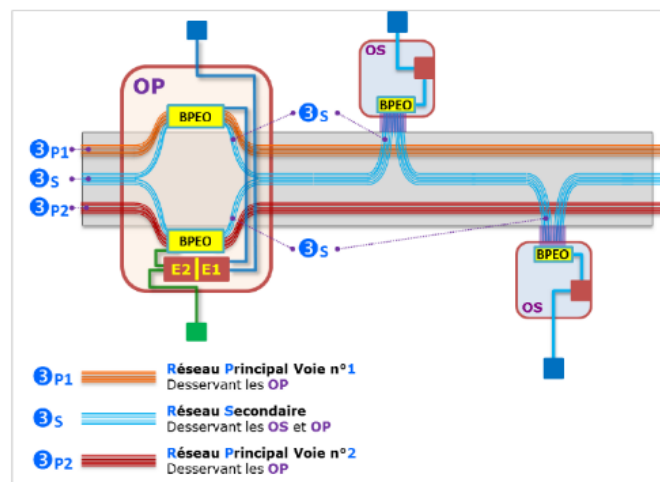


Figure 193 : Architecture of the Broadband network in the Greater Paris project and its different “spatial elements”.

#### 4.2. Case Study n°1: Application of the method at the system level: the 5<sup>th</sup> metro line of Lyon

In this part, we will use the contributions defined in the last chapter on the case study of the 5<sup>th</sup> metro line of Lyon. Notably, Constructibility criteria, the Constructibility matrix, use case diagrams, the double-vee meta-model and spatial considerations in needs and functional analysis.

Studies for the 5<sup>th</sup> metro line of Lyon are carried at the system level. We will show in this part that the different activities carried during the studies can be “translated” into activities defined in System Engineering and Constructibility methods. The objective is to give a methodological framework to this type of studies (Figure 194).

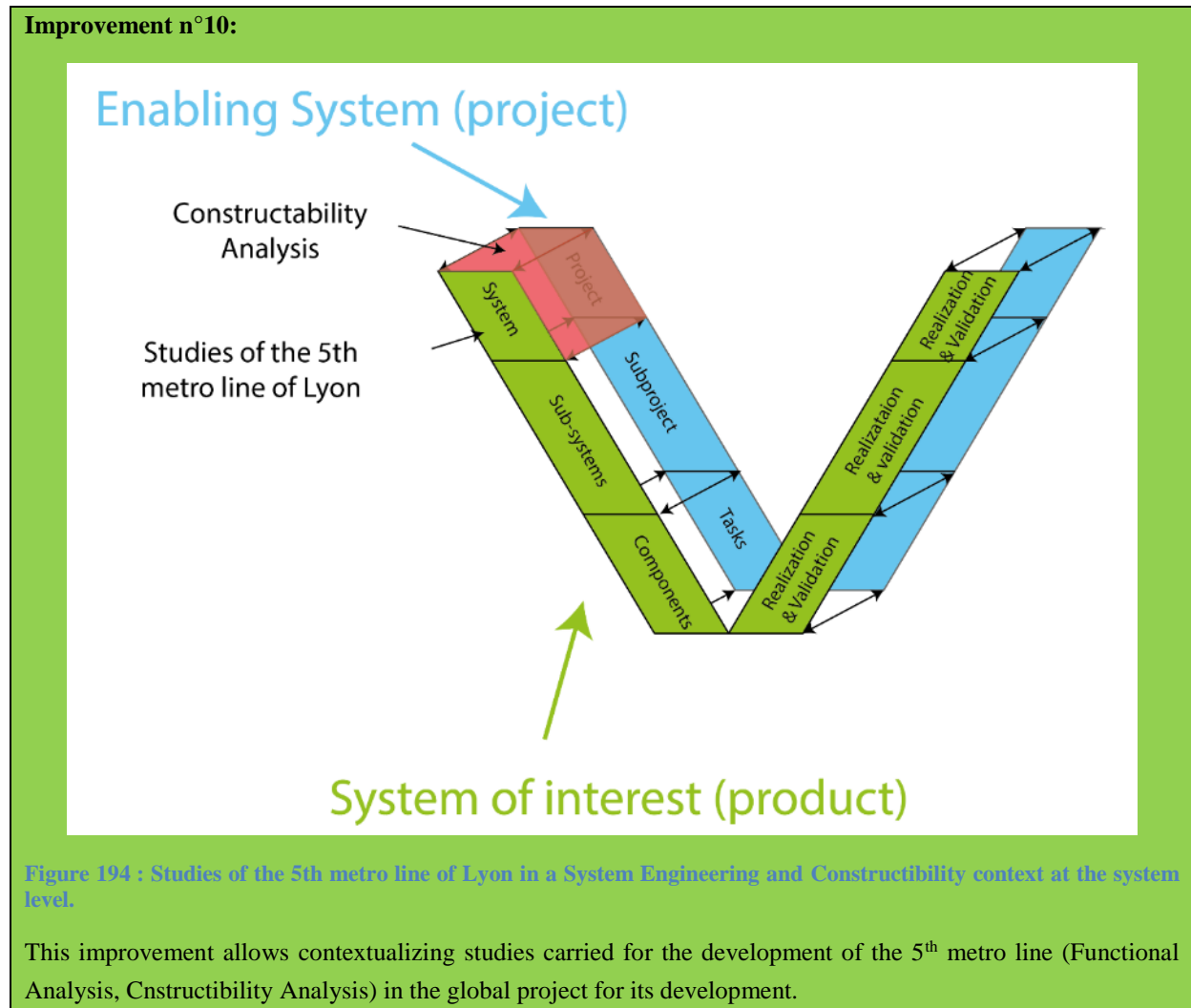


Figure 194 : Studies of the 5<sup>th</sup> metro line of Lyon in a System Engineering and Constructibility context at the system level.

This improvement allows contextualizing studies carried for the development of the 5<sup>th</sup> metro line (Functional Analysis, Constructibility Analysis) in the global project for its development.

In further studies (not presented here), subsystems will be analyzed and defined similarly (rolling stock, civil engineering, telecom, CBTC (communication based train control) etc.) until the definition of the lower parts of the metro system.

This case study is composed of two parts, in a first part, at the operational level we analyze how to carry Operational analysis (needs analysis) for a multifunctional urban system (multifunctional metro system in our case). We show how to apply Systems Engineering and Constructibility methods in order to analyze and define needs the system will answer. A focus is made on mobility need as it is the need which has been analyzed more in detail in the studies.

In a second part, we keep only the mobility needs and show how to apply Functional Analysis and Organic Analysis to a metro system at the system level. At this stage no decisions has been made to investigate more concretely other needs the system could answer (such as energy, logistic, water or waste management). Therefore, Functional Analysis and Organic Analysis have not been carried for other needs than Mobility during studies made by Egis.

As part of the studies for the 5<sup>th</sup> metro line of Lyon, we have analyzed other urban needs the metro system could answer in order to develop a “Multifunctional metro system” (Figure 196). The metro infrastructure is considered as an opportunity not only to answer to mobility needs but also to other urban needs. The other needs analyzed as

part of this study were: Energy (Electric, Heat, Cold), Water (drinkable water, sewage, flood), Logistic (merchandises, materials), wastes (bio-wastes, industrial wastes, household wastes). Needs have been identified by interviewing professionals of each need at the “Grand Lyon”. Grand Lyon is a French Territorial Authority which regroups abilities of the Lyon agglomeration and the Rhône department. Officially, it is notably responsible for: water and sewage networks planning, transport and mobility planning (this ability is actually delegated to the Sytral (Syndicat des Transports de l’Agglomération Lyonnaise)), renewable energies, realization and operation of cold and heat networks, concession and distribution of electricity and gas, management of aquatic environments, realization and operation of telecom broadband networks, waste management, territorial and urban planning (Figure 195). The Grand Lyon has also other abilities which don’t have direct impacts on needs considered in this studies (disabled people, social and cultural events, education etc.) (Grand Lyon, 2018).

**Improvement n°16 and 20:**

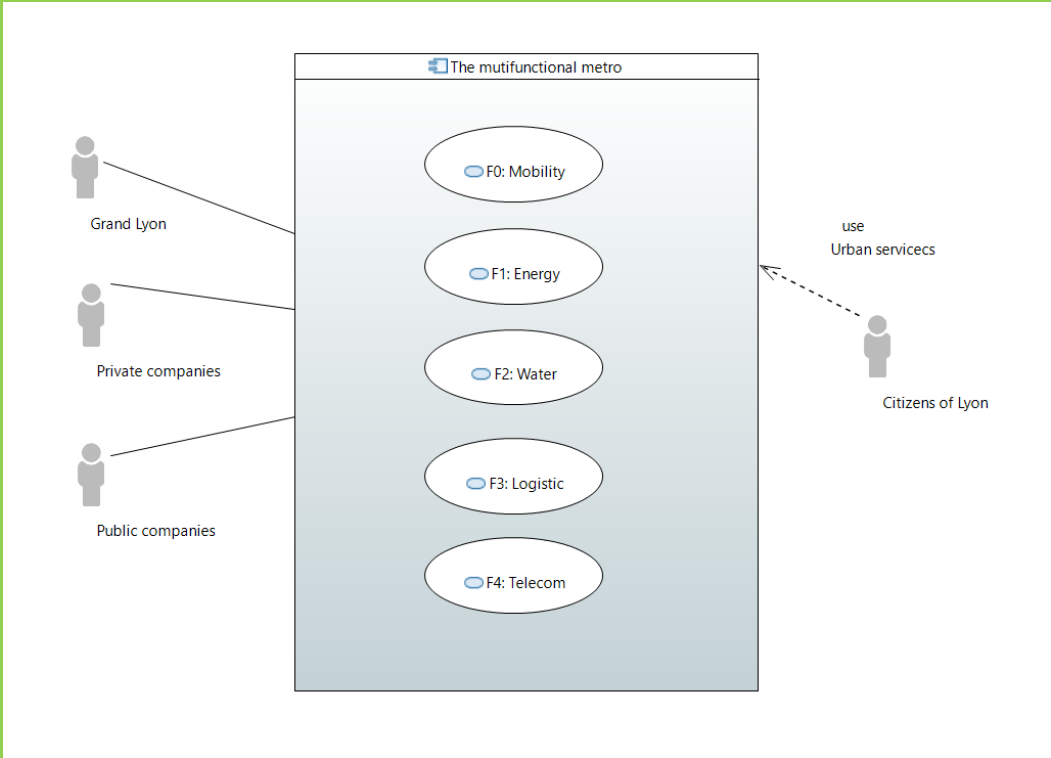
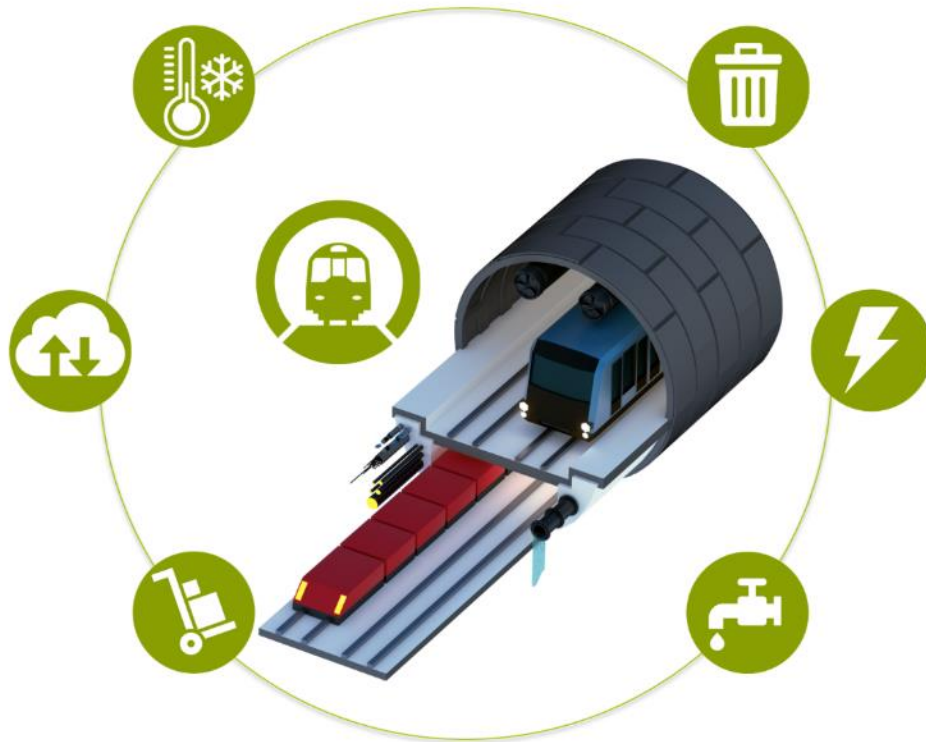


Figure 195 : Use Case diagram of Functionalities of the multifunctional metro concept. In the middle are the different needs identified for potential integration in the future system. On both sides stakeholders are represented: citizens of Lyon, the Grand Lyon which is the local authorities responsible for urban functions in Lyon, private and public companies.



**Figure 196 : Illustration of the multifunctional metro concept applied in the 5<sup>th</sup> metro line of Lyon.**

Compared with other multifunctional projects such as utility galleries, the advantage of the multifunctional metro is that there is an identified stakeholder in charge of the project: usually the transport authority. The lack of leadership was identified in (Clé de sol, 2005) as a significant barrier to the development of multifunctional projects, a barrier that doesn't exist in our case. However, this advantage is double-edged: if the transport authority is willing to integrate new functions in the metro project it is an advantage for multifunctional infrastructures in the other case it can be almost impossible to integrate new functions.

In a TOD (Transport Oriented Development) perspective, it is not surprising that a transport authority would be an important stakeholder for the development of other networks such as energy, water or goods in order to jointly develop the city as well as the transport system.

**Improvement n°19: Constructibility in the different steps of Functional Analysis**

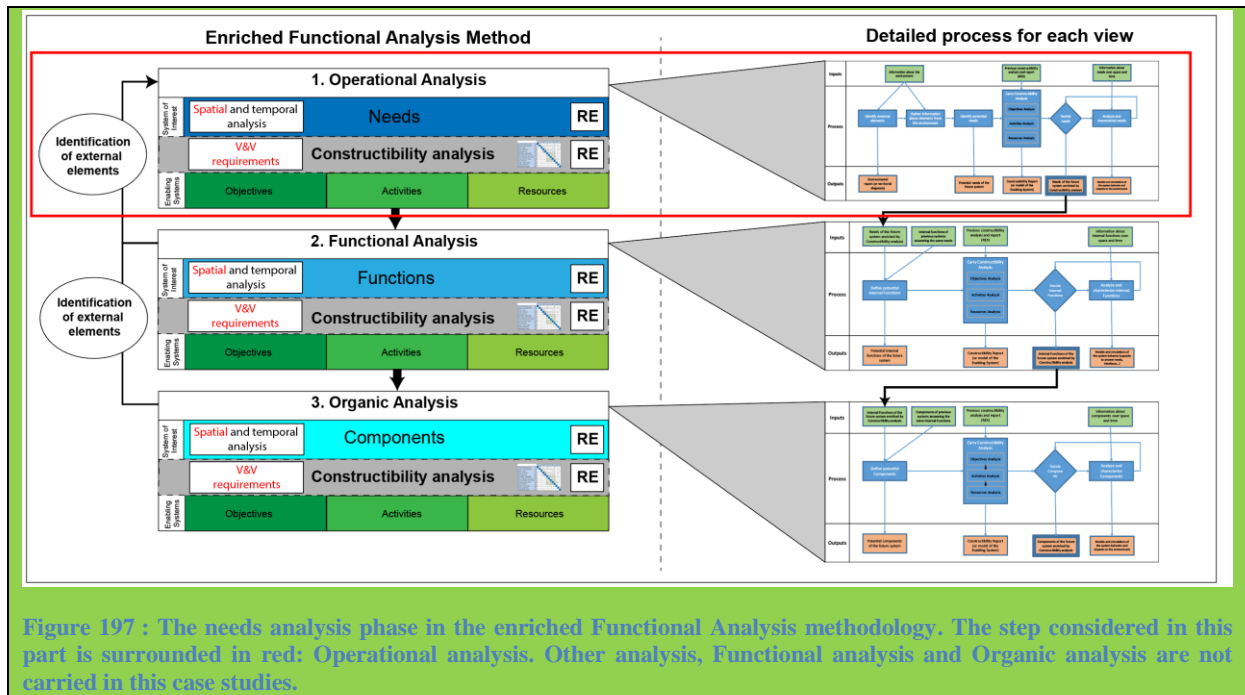


Figure 197 : The needs analysis phase in the enriched Functional Analysis methodology. The step considered in this part is surrounded in red: Operational analysis. Other analysis, Functional analysis and Organic analysis are not carried in this case studies.

For each need analyzed, the working flow described in Figure 198 is applied, starting by the identification of external elements and the current state of the urban environment related to the appropriate need, then the identification or not of the existence of the need in the specific case analyzed (the 5<sup>th</sup> metro line of Lyon and its future surroundings) and the Constructibility analysis of the need at the operational view. Further steps, (decide needs and analyze impacts of the need on the current system and its impacts on its environment) have not been carried as part of the project and would require decisions from the Sytral to continue.

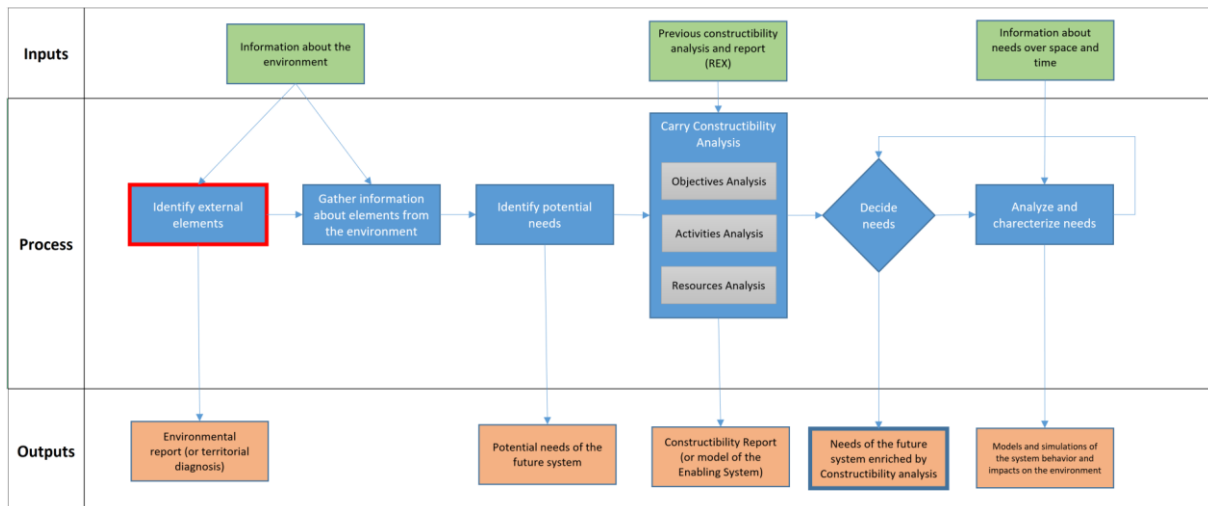


Figure 198 : Identify External elements for energy needs. This diagram details the different steps undertaken to analyse potential needs the system will answer.

#### 4.2.1. Energy needs analysis

The first step in the Enriched Functional Analysis Method consists in identifying stakeholders of the system related to energy needs (Figure 198).

In Figure 199, are represented in a Use case diagram in SysML, the potentially identified Main Functions to integrate in the 5<sup>th</sup> metro line of Lyon:

## Improvement n°16 and 20:

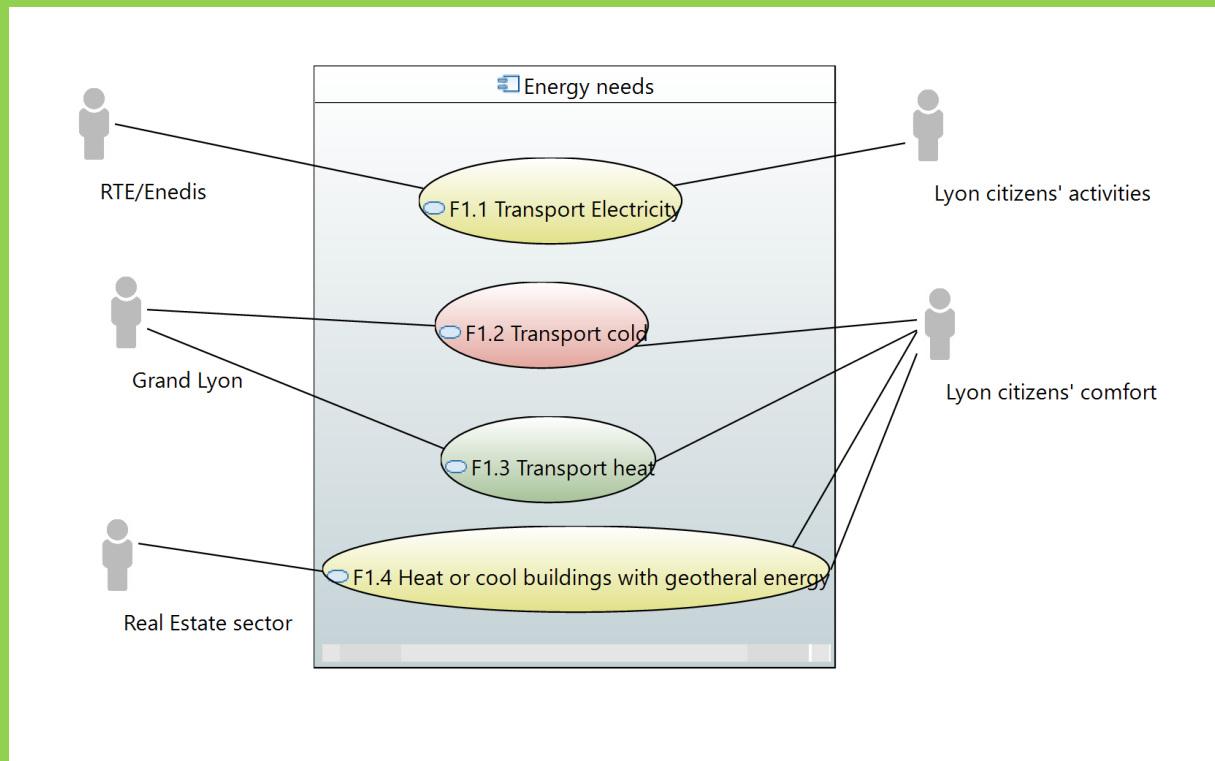


Figure 199 : Use case diagram representing energy needs potentially mutualized with the metro infrastructure. In the middle are represented Main Functions the system will potentially answer related to the energy sector. On both sides stakeholders interacting with the system are represented. In green, needs which have been identified and would benefit from an integration in the 5<sup>th</sup> metro line through interviews with the Grand Lyon. In yellow, needs on which we don't have information or which have not been identified as a priority by the Grand Lyon. In red, needs which are not existing from the Grand Lyon perspective.

The use of SysML in Functional Analysis has two interests: replace Functional Analysis tools (it replaces the interaction diagram) by a model-based tool which allows modelling interactions with other views and trace them numerically and using a formalized language similar to all practitioners of Systems Engineering all over the world.

Then discussions with the Sytral are engaged to evaluate potential interactions with activities of the Sytral and potential confidentiality issues.

Once energy stakeholders have been identified and selected with the Sytral we have contacted the most appropriate expert in the organization/company to evaluate needs. This last step was one of the most difficult as most of these people are very busy and particularly difficult to reach. Then, stakeholders are interviewed to assess with them the potential existence of energy needs in the western part of Lyon. Following these interviews we have formalized energy needs, a constructability analysis is carried to evaluate difficulties related to the definition of the needs and potential risks related to needs analysis due to this process. Finally, conclusions are sent to the Sytral and a decision is made to investigate with more precision the mutualization opportunity.

Energy needs have been analyzed by interviewing the director of the “*Mission Energie*” at Grand Lyon. From a general perspective, the energy sector is subject to 3 main changes: decarbonize and lower energy consumption, operate the energetic system at local scale with the development of Smart grids and micro-grids and the division between production and energy supply functions imposed by the European legislation (production and supply of energy is managed by the private sector while energy transportation is dedicated to the public sector in France (RTE and Enedis)). These 3 main changes have important impacts on the development of energy systems and have to be considered when evaluating the opportunity to mutualize energy functions in the metro system.

Historically, energy networks have been oversized to anticipate evolution of energy needs. It means that where energy networks are already existing there is no need to improve them. However, improving its resilience as instance by creating new links in the network is a potential need to answer. Nowadays, the trend reversed, we try to reduce energy consumption, new infrastructures are required only to improve the network and connect renewable energy sources.

Currently, only heat and cold networks are really managed by the *Mission Energie* of the Grand Lyon. For Electricity and gas systems the Grand Lyon has a concession contract with RTE (Réseau de Transport d'Electricité) and Enedis since 1950 which manage, operate and plan these networks. It highlights governance issues in the energy sector in France which is already a major issue to improve energy systems between them. Only few cities in France like Grenoble or Strasbourg manage their electrical and gas networks by themselves.

- Energy needs analysis in the western part of Lyon near the 5<sup>th</sup> metro line

The next step consists in identifying potential min functions related to energy needs.

- Electrical network needs

In terms of needs, historically in Lyon electric networks have been oversized to anticipate evolutions of energy supply needs. Furthermore, as stated before, there is a downward trend in energy consumption in Lyon. Therefore, there is no need to develop more the electrical network in the western part of Lyon in terms of energy needs. However, it is an opportunity to improve resilience of the network by adding a new branch to the network.

In this last perspective, it could be interesting to highlight that the electrical issue which happened in Gare Montparnasse in Paris in the summer 2018 which blocked all the train traffic during several days could be avoided in the future if a high voltage electrical network would be integrated in the line 15 of the Greater Paris metro project. Because of governance issues and lack of incentive from the different stakeholders it probably won't be the case. However, like in Lyon, electrical networks in Paris are already well developed, it shows that in developed countries the need might arise more to improve resilience of networks than to supply new urban areas. The development of multifunctional metro systems is therefore an excellent opportunity in this way.

Because, the Grand Lyon has only little knowledge and little decision power on the electric network it has not been possible to investigate more this possibility. It would be required to discuss it with RTE (Réseau de Transport d'Electricité) in Lyon to evaluate how they consider this opportunity.

The only available information nowadays are in the RTE website where the high voltage network of France is geographically represented on a map (Figure 200):



#### Improvement n°4:

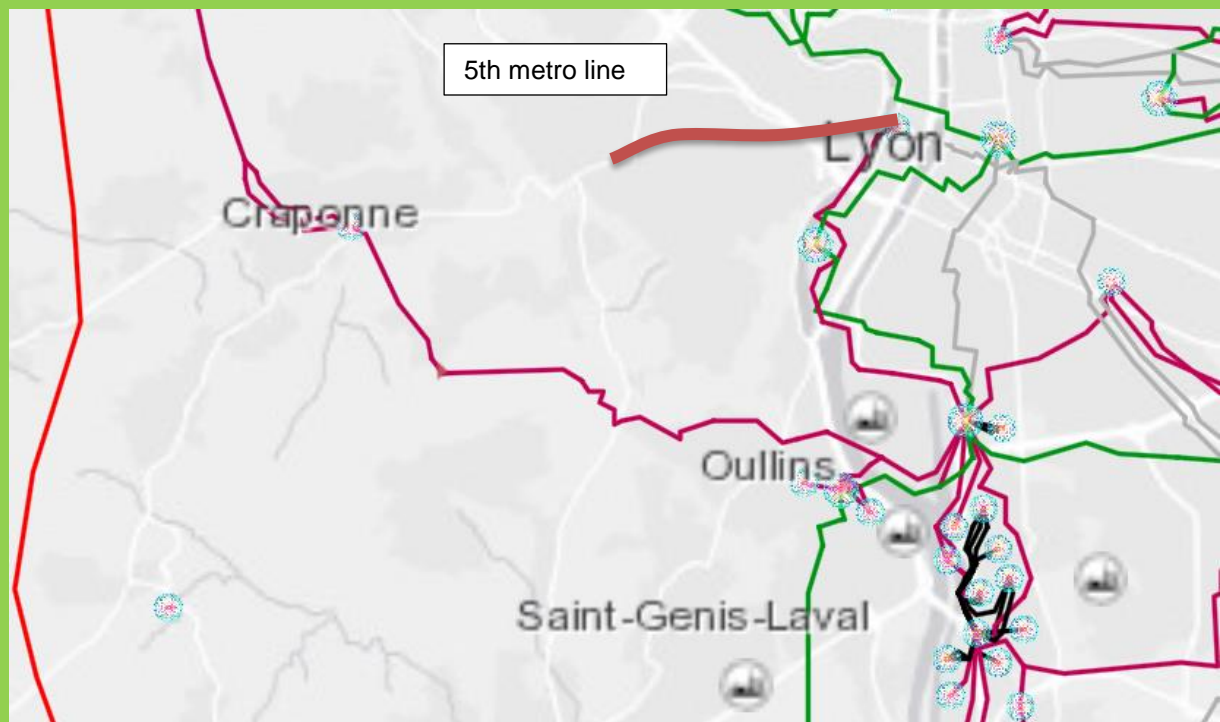


Figure 200 : High voltage electrical network in the region of Lyon, France (RTE, 2018). In dark red is the future metro line, in ref the 400kV network, in green the 225kV network and in purple the 63kV network.

From this map some interesting information can be analyzed: there is no high voltage connection linking the RTE network and the western part of Lyon. From this statement, it would be possible to imagine that a new link would be beneficiary for citizens to secure energy supply by integrating it in the future metro line. It would be necessary to contact RTE in order to evaluate this possibility with them which was not possible as part of this study because of governance issues.

It is also interesting to highlight that the map in Figure 200 has been used to analyze potential electrical connection needs. In other words, needs the system could answer have been analyzed thanks to a spatial analysis. It shows here again, that *spatial* analysis are not dedicated to *organic analysis* but also at the *operational* level where needs are defined.

The integration of a High Voltage Electrical network in a metro system has been done previously in the extension of the metro line B in Lyon (Figure 201) in 2013. Notably, all the technical constraints related to the integration of the cables have been carried by RTE, it has been proved that such impacts are negligible for the metro operation. More than the cables integrated in the tunnel, a room is also integrated in the station to connect the cables from the RTE network to cables in the metro tunnel, to transform electric power (transformer) and ensure security in case of transformer problem (the room is filled with sand).



Figure 201 : The High Voltage Electrical network integrated in the metro infrastructure. This picture shows an example of mutualization between a metro tunnel and an energy tunnel.

- Heat network needs

Heat needs have also been analyzed as part of this study. Heat needs evaluation and heat network developments are the responsibility of the *Mission Energie* of the *Grand Lyon*. Therefore, it has been easier to evaluate potential mutualization of the heat network and the metro infrastructure.

An interview with the director of the *Mission Energie* has led to the conclusion that there is a need to expand the heat network to the western part of Lyon and in the 5<sup>th</sup> district. In (Figure 202), future developments of the heat network in the city of Lyon are represented. It shows that there is no heat network currently in development or already built in the west of Lyon which confirms what has been said during the interview.

#### Improvement n°4:

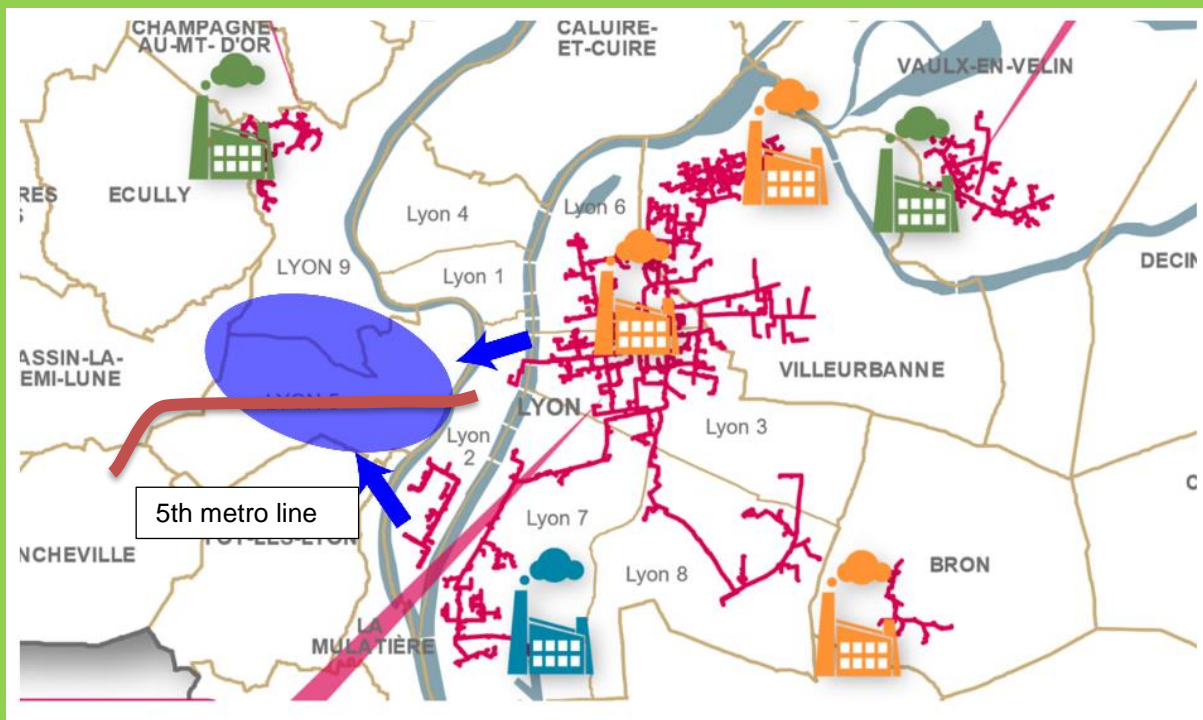


Figure 202 : The heat network and its future developments in Lyon, France (Grand Lyon, 2017). In red is the 5<sup>th</sup> metro line of Lyon. In blue the zone where the heat network would be potentially extended in the future and in pink the current heat network in Lyon.

In this map, needs related to the extension of the heat network have been represented: its form which a zone (in blue) and links with the actual heat network, a topology, needs are located west of the city center and in a referential, the districts of Lyon agglomeration.

- Cold network

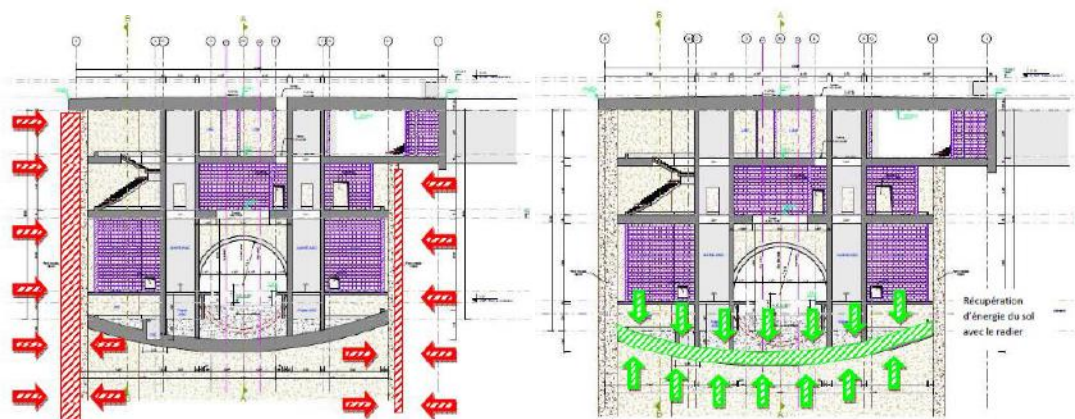
A cold network already exists in Lyon or is under construction. Notably in the Part-Dieu district in the city center a cold network is existing (Lambert, 2015) and is under extension (Lyon Part-Dieu, 2017). However, from the interview with the *Mission Energie* there is no plan to expand it or to build a new one in the 5<sup>th</sup> district of Lyon.

- Gas network

Like the electrical network, the gas network system is not managed and plan by the *Mission Energie*. Therefore, we were not able to get the information about gas transportation or storing. In any case, we have not investigate this function extensively, as risks related gas transportation and storing seem are very high in terms of security. Due to security requirements, it is not sure that a mutualization of infrastructure would have led to a lower cost for each stakeholder.

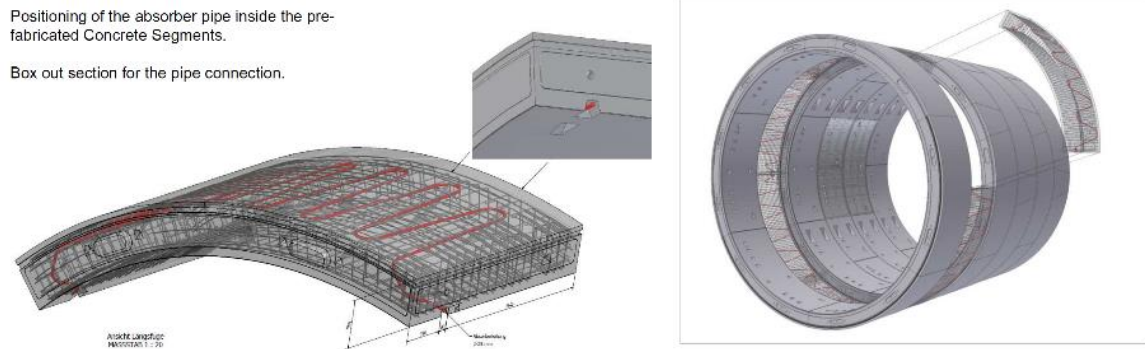
- Geothermal energy

Mutualization of geothermal systems with metro systems are more and more common nowadays. As instance, the future line B of the metro of Rennes, France is planning to integrate geothermal energy systems in 4 stations will be equipped of geothermal systems allowing to heat or cool housing above the underground metro infrastructure. In Paris, the same principle is used in the station Mairie d'Aubervilliers (line 12) and stations Porte de Clichy and Marie de Saint-Ouen (line 14).



**Figure 203 : Geothermal systems in inverts and diaphragm walls of Rennes metro line B (Egis, 2014). It gives an example of mutualization between a geothermal system and metro station.**

Integration of geothermal systems in tunnels has also been tested in tunnels in Germany (Stuttgart, U6 Stuttgart Fasanenhof) and Austria (Jenbach, Northern approach of the Brenner Base Tunnel) (Rehau, 2011) (Figure 204). However, activated tunnel length in case studies don't exceed 60m which is not representative in comparison with usual tunnels length and impacts on the Enabling Systems are not clear (notably impacts on segments realization and installation processes).



**Figure 204 : Geothermal system in tunnel segments (Rehau, 2011). It gives an example of mutualization between a geothermal system and da tunnel.**

However, the *Mission Energie* of the Grand Lyon is not responsible or don't have the objective to develop geothermal energy. The *Mission Energie* told us to contact real estate actors, or urban planning entities to evaluate geothermal energy opportunities in the 5<sup>th</sup> district.

- Constructibility analysis of the integration of Energy needs

Constructibility analysis consists in analyzing interactions between the System of interest and Enabling Systems. Previously, in the needs analysis, it has been highlighted that sometimes even if energy needs exist, the future system won't necessarily answer to them because of interactions with the Enabling System. These difficulties can come from objectives, activities or resources of the ES.

- Objectives of the Enabling System

#### **Improvement n°9:**

6 Constructibility criteria have been defined in the last chapter related to **Objectives of Enabling Systems** at the Operational Level and required to be analyzed: Effectivity, Governability, Contractibility, Acceptability, Legal, Temporality.

**Effectivity:** the Sytral objective is to evaluate potentialities of mutualization of energy needs with the metro system. To achieve this objective, we have carried interviews with energy specialists at the Grand Lyon. This method is necessary but not sufficient, more analysis would be required to define more precisely energy needs over the Lyon territory, starting with interviews with other energy professionals (RTE, Enedis, EDF etc.).

**Governability:** mobility needs and energy needs are not planned and managed by the same institutions in Lyon for different reasons, and the purpose of these thesis is not to assess the different governance systems. However, it is our objective to assess in a project if the System of Interest and/or the Enabling System are adapted to each other to prevent future dysfunctions. In this case, transportation systems and mobility in Lyon are planned and managed by the Sytral and Energy needs by the *Mission Energie*, RTE, Enedis, property developer, and urban and local planners. Some of these stakeholders are under the authority of the Grand Lyon (Sytral, urban planners and the *Mission Energie*) and other are independents (RTE, Enedis, property developers and local planners). Geothermal energy for its part is usually managed by local planning authorities which are not under the responsibility of the Grand Lyon.

**Contractibility:** In this case study, the contract type has not been defined yet. However, in most cases urban transportation systems are delivered with a classic "MOP" contract. It means that the client would certainly be the Sytral and that Sytral will be the owner of the future infrastructure and will be responsible for it. This "contracting" choice (or no-choice) largely impacts the integration of energy needs in the future system. Indeed, it means that it

would be the Sytral that will be responsible in case of dysfunction of the system meanwhile it is not their mission to provide energy to citizens.

That being said, in the case of the line B of the Lyon metro, a high voltage electrical cable has been integrated in the metro tunnel by RTE. In this case, it is indicated that in case of dysfunction of the high voltage electrical cable, RTE is responsible for any dysfunction impacts on the transportation system. It shows that when stakeholders have goodwill it is possible to adapt the contracting structure and find a consensus. This example and past experiences on the integration of high voltage electrical networks makes it easier in terms of contracting issues even if this type of contract is not perfect for multifunctional system.

Anyway, the integration of several needs into a single infrastructure should leads to the definition of new types of contract. In the “Clé de sol” report (Clé de sol, 2005), the use of PPP (Public Private Partnerships) is recommended for utility (multifunctional) galleries. Should it be applied for this multifunctional metro systems? If the answer is yes, it will be a major change in such projects as PPP are not popular in Urban Transport systems such as metro.

**Legal:** The integration of energy needs in a metro system also brings new legal challenges. If it is the Transport Authority (TA) which is the beneficiary of the project, can a TA legally sell energy to another stakeholder than EDF (Electricité de France)? This issue actually raised during the integration of a geothermal system in the metro of Rennes. Until the MAPAM (Loi de modernisation de l’action publique territoriale et d’affirmation des métropoles) law, the city council of Rennes was not allowed to sell energy to a third party which was problematic to sell geothermal energy to future consumers (housing and office buildings). Another legal issue related to geothermal energy is that it is not clear to whom the energy belongs to. Indeed, geothermal energy is using the calorific potential of soils, however it is not clear which part of the soil the energy is extracted and therefore to whom it belongs to and if it is legal to use this kind of energy. There is a legal uncertainty around this issue.

**Acceptability:** by offering more services to inhabitants with less impacts, acceptability of the project is improved.

**Temporality:** Energy needs and transportation needs have different temporal scales. While transportation needs are evaluated over the next 30 or 50 years, energy needs are usually evaluated no more than 10 to 20 years. It implies that it is very difficult to integrate early energy needs in a transport system as energy needs have not been identified. A similar problem occurs for geothermal energy as development projects are not known at the beginning of a metro project, it is therefore difficult to forecast geothermal energy projects.

- Activities of the Enabling System

#### **Improvement n°9:**

9 Constructibility criteria have been defined in the last chapter related to **Activities of Enabling Systems** at the Operational level and required to be analyzed: Complexity, Robustness, Documentation, Control, Error-proofed, Communication, Knowledge, and Repeatability.

Assessing Constructibility of activities related to identification, definition and characterization of energy needs consists in evaluating the process with the criteria defined in Improvement n°9:

**Pertinence:** considering that the objective of the Sytral is only to identify opportunities of mutualization and not necessarily to define with a high degree of precision needs the future system will answer. Therefore, interviews with experts seems pertinent in a first step to identify mutualization opportunities.

**Complexity:** the activity of interviewing energy experts is “simple”, inputs are experts’ statements and outputs are opportunities of energy needs mutualization.

**Robustness:** the process is robust as only few inputs are considered there are low risks of external events which can potentially affect the process. The main risk lies in the subjectivity of the expert interviewed and of imprecision of the transferred information and eventual over or miss understanding between experts and interviewers.

Moreover, governance issues imply that the *Mission Energie* of the Grand Lyon has only limited knowledge on some energy needs (as electrical needs and geothermal energy needs) which results in less robust results for such needs.

**Documentation:** The process is documented and represented with a flow chart in Figure 197 but it has not been modeled with a standard modeling language (as BPMN).

**Control:** the process is controlled by feedbacks with actors interviewed to avoid misinterpretations and misunderstandings. Another source of information would be beneficial to evaluate needs with more precision and avoid biased to due misunderstanding with experts and/or experts' mistakes.

**Error-proofed:** The only way to alert about errors related to energy needs consists in regular feedbacks between the Sytral and the *Mission Energie* and other energy related stakeholders. Considering the lack of communication between these stakeholders the process used to analyze needs is not sufficiently error-proofed.

**Communication:** As mentioned before, communication between energy stakeholders themselves and with the Sytral is not effective. Transport specialists at the Sytral are not aware of energy needs in Lyon and similarly, Energy experts don't have information about transport projects in Lyon.

**Knowledge:** The required knowledge for this process concerns essentially the course of a metro project in order to intervene at the appropriate phase to integrate energy needs. Similarly, the course of energy projects would be required to integrate energy needs in a metro project. This last aspect was missing in this case study.

**Repeatability:** Repeatability of the process depends on the urban organization of the city. In Lyon we had the chance that the Grand Lyon is responsible of most of urban needs which was very helpful in identifying energy stakeholders and contacting them.

- Resources of the Enabling System

#### **Improvement n°9:**

6 Constructibility criteria have been defined in the last chapter related to **Resources of Enabling Systems** at the Operational level and required to be analyzed: Efficiency, Availability, Accessibility, Workability, Reliability, Ambivalence.

**Efficiency:** In our case, the efficiency objective was to evaluate mutualization opportunities with limited time spent by the project manager and myself. In this way the process was very efficient as with limited resources we have been able to identify opportunities of mutualization.

**Availability:** Activities undertaken to analyze energy needs required to be financed and the question of who finances what arises. In the case of Lyon, because of the existing governance it depends of which type of energy is intended to be integrated: electricity is managed and planned by Enedis and RTE, heat and cold by the *Mission Energie* and geothermal energy is managed independently. However, as the project is not a "pure" energy project and because even if the future system integrates energy needs it will be before all a transport system it is not as clear as it seems. Indeed, decisions in the 5<sup>th</sup> line of Lyon will be taken by Sytral and not Energy stakeholders which means that other stakeholders will take the risk to finance studies while they don't take the final decisions. For this reason, all or at least part of the finance could come from a more general institution in charge of urban issues like the Grand Lyon.

Human resources are required to evaluate energy needs, at least to make the link and transfer information between the different stakeholders but also to make decisions and to carry previously defined process. In our case, we didn't have human resource availability issues as it has been carried as part of this thesis.

To model and simulate needs the system will answer (here what would be energy needs in 2030 as instance, including position of energy sources, energy consumption per inhabitants, types of energy to use etc.), we assume that this kind of information is available but not easily accessible due to governance issues.

**Accessibility:** the most important resources to consider in needs analysis are information and knowledge. Accessibility to the appropriate information is not easy and people with the knowledge about energy needs are rare. Experts at the Grand Lyon is a good source of information about energy needs but they are usually hard to access.

**Workability:** this criteria is related to the type of data gathered, their format, and the capability to use them for analysis, modeling or simulation. When data were available for energy needs analysis their format were mostly maps in pdf and textual reports of interviews which were not accurate and easy to manipulate for further modeling activities.

**Reliability:** We are confident in the reliability of knowledge experts about energy needs at the Grand Lyon, at least in their domain of responsibility.

**Ambivalence:** Energy needs analysis in the 5<sup>th</sup> district of Lyon can eventually be used for other purposes than mutualization opportunities identification.

**Financiability:** Financiability concerns the capability of the activities to be financed. Renewable energy systems such as geothermal energy or Heat energy coming from incineration plants can benefit of finances from ADEME in France (Agence de l'Environnement et de la Maitrise de l'Energie) which can greatly helps at least to carry analysis related to the integration such systems (ADEME, 2018). Other financing possibilities can be offered by the E.U. like FEDER funds which objectives in France are to foster innovation, reduce CO<sub>2</sub> emissions and promote actions which support adaptation to climate change (L'Europe s'engage en France, 2016).

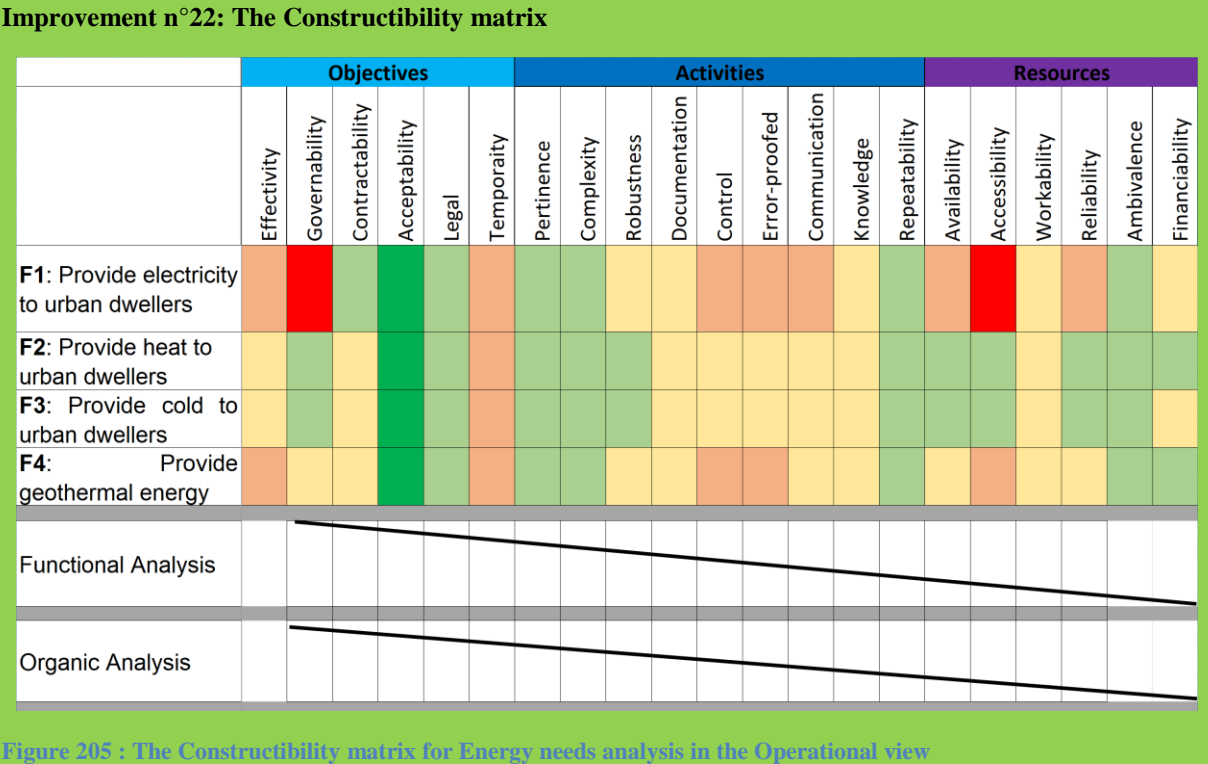


Figure 205 : The Constructibility matrix for Energy needs analysis in the Operational view

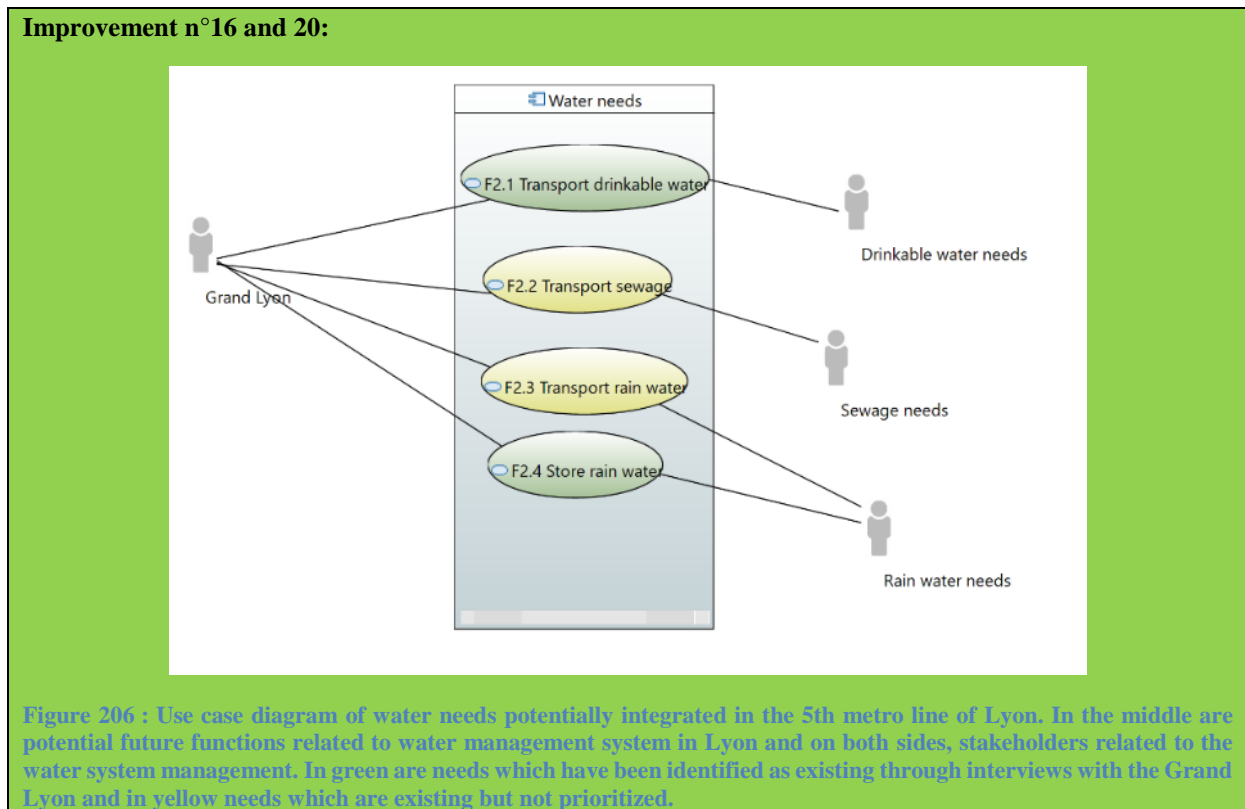
In (Figure 205), the Constructibility matrix sums up the evaluation of Constructibility criteria for Energy needs. It highlights that the current Enabling System is not well adapted for the integration of energy needs in the 5<sup>th</sup> metro line of Lyon whereas needs have been identified.

#### 4.2.2. Water needs analysis

- Water needs analysis in the western part of Lyon near the 5<sup>th</sup> metro line

Similarly to energy needs, we have analyzed opportunities to integrate functions related to water management in the 5<sup>th</sup> metro line of Lyon. This study has been carried by interviewing responsible of water management at the Grand Lyon. The interviews have led to the definition of 4 functions: transport drinkable water, transport sewage, transport rain water and store rain water.

The functions have been represented with a Use Case diagram as shown in (Figure 206):



Once stakeholders have been identified, it is necessary to gather information about their needs and constraints.

- Sewage system

Interviews with the Grand Lyon and the “General plan for sewage management in Lyon” (Grand Lyon, 2015) have highlighted mainly 3 needs in the 5th district related to sewage management: Control intrusion of rain water in the sewage network, reduce storm water overflows from storm water retention tanks and develop a distinct water network to disconnect rain water from sewage.

However constraints for its integration have dampened the Grand Lyon to eventually integrate it in the future metro line: notably because the metro tunnel is not linear and the sewage system is gravity-fed which would implies a great number of water pumps. However, this argument is not relevant for us as at this stage we are only in the needs analysis stage and we don’t exclude to develop a particular technology which would facilitate the integration of such a function.



## Improvement n°4:

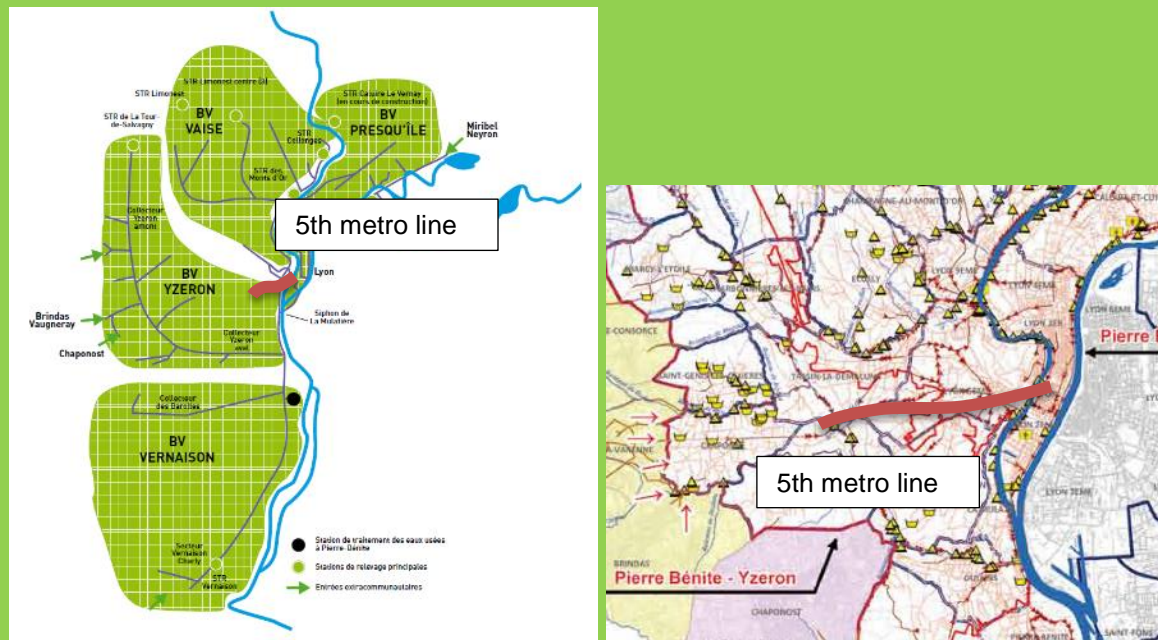


Figure 207 : The sewage system (on the left) and drinkable water system (on the right) in Lyon and the 5<sup>th</sup> metro line (adapted from (Grand Lyon, 2015)). The 5<sup>th</sup> metro line is represented in dark red.

- Drinkable water system

Globally, the drinkable water network is well developed in Lyon. There is not a significant demand to extend the network in Lyon and its surroundings, the main reason being that the water network is dimensioned to supply heavy industrial plants which are now out of service. Drinkable water needs in Lyon and its surroundings are decreasing due to the decrease of industrial activities and the evolution of per capita consumption. These assumptions are confirmed in the “*Shéma Général d’Assainissement du Grand Lyon*” as shown in Figure 208.

En équivalents habitants	2014	2030
Population raccordée (GL + extérieur)	482 000 EH	526 850 EH
Charges des industriels et % de charge totale	42 325 EH, soit 8 %	42 325 EH
Total	524 325 EH	569 175 EH

Figure 208 : Water consumption comparison between 2014 and 2030 (Grand Lyon, 2015)

Despite this, the new metro line has been identified as an opportunity to improve resilience of the drinkable water network in case of a problem in another branch of the network. Indeed, the drinkable water network is very sensitive to the external environment: site works, car crash etc. but also for security reasons: biological attacks is a risk and integrate the network in a tunnel such as a metro tunnel makes it harder to reach.

- Flood management system

Another need identified by the Grand Lyon is to store rain water. In fact, overflows regularly appear in the sewage network during storms and there is a need to store rain water in water tanks to avoid such overflows: 30 storm tanks overflow more than 20 times per year which represents 6.4% of the total volume. Moreover, currently rain

water is managed with the sewage network, the need has been identified to separate management of rain waters and sewage water.

The development of a new underground metro infrastructure is an opportunity to use free spaces or to create new ones mutualize with the metro infrastructure to create storm water tanks. Another potential opportunity would be to use the descending metro tunnel at each side of the line to integrate water pipes (and take advantage of the gravity) to transport rain or sewage water.

This concept of using the metro infrastructure and available spaces as water tanks is not new: in the Osmose concept developed by RATP in 2010 the idea was already included for the development of stations of the Greater Paris project (Figure 209) (RATP, 2010).

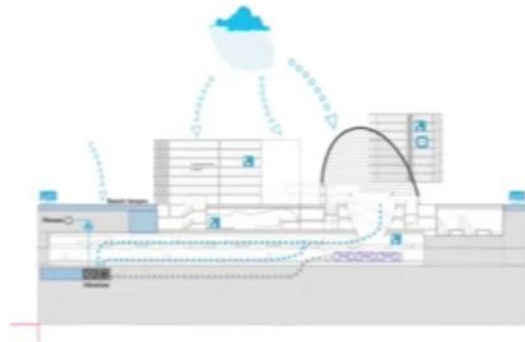


Figure 209 : water tanks in metro station in the « Osmose » concept (RATP, 2010). Example of the integration of a water management system in a metro station.

- Constructibility analysis of the integration of Energy needs
  - Objectives of the Enabling System

#### Improvement n°9:

6 Constructibility criteria have been defined in the last chapter related to **Objectives of Enabling Systems** at the Operational Level and required to be analyzed: Effectivity, Governability, Contractibility, Acceptability, Legal, Temporality.

**Effectivity:** At this stage the main objective of the Enabling System is to analyze needs the System of Interest will answer. Effectivity of the Enabling System consists in defining its capability to define needs with a defined level of precision. In our case, only interviews with experts have been carried to evaluate the needs, it is not the most effective way to analyze needs with a high degree of precision (it is however an efficient way as presented above). More studies would be necessary to analyze needs with a better accuracy: gather, analyze data and model needs, surveys, public debate etc.

**Governability:** water management is fully under the responsibility of the Grand Lyon in the concerned area (Figure 210). Therefore, no governance issue has been identified for water needs, whereas it is drinkable water, sewage or flood management.

#### Improvement n°4:



Figure 210 : Governance of the water system in Lyon. In dark red is represented the 5th metro line of Lyon.

**Contractibility:** Contracting issues are less problematic than for energy needs as water management is fully managed by the Grand Lyon and the Sytral is a subsidiary of Grand Lyon. However, the Grand Lyon does not operate the system by himself, water management operations and maintenance are currently carried by private companies. Would it be necessary that the future metro operator be able to operate also the water system? Or should it be two different specialized companies which implies the definition of specific contracts. Some contracting issues remain for the integration of water needs in a metro system.

**Acceptability:** Overflows of the sewage network has bad impacts on the population. The possibility offers by the construction of the new metro line to reduce these impacts clearly increases acceptability of the project.

**Legal:** Integration of water needs in the metro system is consistent with the “Lois sur l’eau” in France notably on the protection of natural aquatic systems, the reinforcement of local management of the water system and the consideration of climate change in water management.

**Temporality:** Temporality of water projects is usually shorter than temporality of metro projects. Therefore it was not easy for water specialists at the Grand Lyon to imagine water needs at the horizon of the metro project of the 5<sup>th</sup> metro line of Lyon.

- Activities of the Enabling System

#### Improvement n°9:

9 Constructibility criteria have been defined in the last chapter related to **Activities of Enabling Systems** at the Operational level and required to be analyzed: Pertinence, Complexity, Robustness, Documentation, Control, Error-proofed, Communication, Knowledge, and Repeatability.

**Pertinence:** Pertinence of the Enabling System consists in evaluating if activities undertaken allow achieving objectives defined previously. Considering needs of the Sytral (identify mutualization opportunities) interviews with experts are pertinent. It is not necessary to carry more activities or more complex activities as it would not be pertinent considering objectives defined by the Sytral.

**Complexity:** the process chosen to identify water needs is simple: inputs consist in interviews with experts and outputs are the identification of mutualization opportunities. Conclusion of the study is transmitted to the Sytral which chose or not to investigate more the mutualization opportunity. The simplicity of the process is double-edged: needs related to the water system are not evaluated quantitatively which is not enough to develop models.

**Robustness:** external events which can affect the identification and characterization needs process can come from a divergence of actors objectives or actors' interactions. It is also dependent on information given by experts, the process is sensible to the reliability of experts' judgement.

**Documentation:** the process is documented with a flow chart. However we have not modeled the process.

**Control:** the process is controlled by feedbacks with experts when the needs analysis is carried. Feedbacks are then taken into account and modifications are discussed and made in the analysis.

**Error-proofed:** Other activities could be carried to ensure that needs are correctly considered: public debates, surveys, data gathering with sensors, interviews with operational companies which manage the system. However, adding new sources of information increases the complexity of the process (the number of inputs increases) and makes it less robust as it could be influenced by more external events.

**Repeatability:** Technically speaking, the process is easily repeatable, we have repeated it for the analysis of all new functions to integrate in the multifunctional metro for the 5<sup>th</sup> metro line of Lyon. Repeatability comes here from the simplicity of the process, it is clear that a process involving more inputs and/or more outputs would have been inevitably less repeatable except if it is very well integrated in working methodologies and if the process is very well mastered. From an institution point of view, it depends on how administrations are organized, on relations between administrations and interactions between actors.

**Communication:** Communication between stakeholders of the Grand Lyon is not very efficient, people at the water department were not aware of the existence of the 5<sup>th</sup> metro line project to the west part of Lyon. However, communication is easier than other potential needs as the water system is managed entirely by the Grand Lyon.

**Knowledge:** No cutting-edge expertise was required to analyze information gathered for water needs analysis in this process.

- Resources of the Enabling System

#### **Improvement n°9:**

6 Constructibility criteria have been defined in the last chapter related to **Resources of Enabling Systems** at the Operational level and required to be analyzed: Efficiency, Availability, Accessibility, Workability, Knowledge, Reliability, Ambivalence.

**Efficiency:** In our case, the efficiency objective was to evaluate mutualization opportunities with limited time spent by the project manager and myself. In this way the process was very efficient as with limited resources we have been able to identify opportunities of mutualization.

**Availability:** Finance of water needs evaluation is easier than energy needs as the water system is under the responsibility of the Grand Lyon. However, lack of communication and the separation of Grand Lyon departments in silos could be a problem as everyone could have the feeling of paying for the other: the water department won't want to pay for a project they have no decision power and the Sytral (transport department) won't pay for studies related to water needs while its not their mission.

There are two difficulties related to the time required for the consideration of water needs. Firstly, usually the time between the identification and definition of the needs and completion of the project is between 2 or 3 years while

it is more than 10 years for a classic metro project. Secondly, time is required to evaluate needs, availability of human resources to carry this activity is not

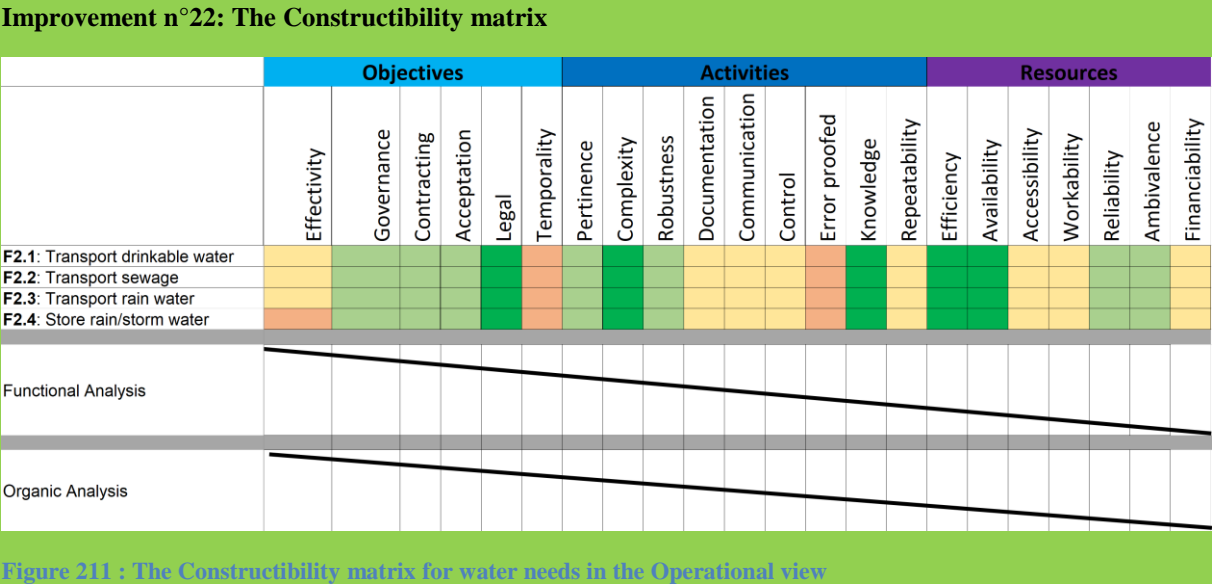
**Accessibility:** data related to the water system or related to water management are not available on the opendata website of the Grand Lyon. The Grand Lyon certainly has data about the water system notably on their location and their specification, however it is not clear how data management information are shared between private companies responsible for water management and the Grand Lyon. Data from INSEE (Institut National de la Statistique et des Etudes Economiques) on demographic and job evolution with their location in Lyon are available on the INSEE website, it allows assessing evolution of water needs both for private consumers and industrials.

**Workability:** At this stage, the only information available for water needs analysis are interviews with the Grand Lyon. These information help to identify opportunities of mutualization however, they are not enough to develop a model of the water system. Workability of such information is not optimal, it is hard to define precisely water needs only with experts' statements.

**Reliability:** Experts at the Grand Lyon are probably the people who know the best future needs related to the water system in the western part of Lyon. Information gathered by interviewing experts are highly reliable.

**Ambivalence:** Water needs analysis related to the possibility of integration with the 5<sup>th</sup> metro line in western districts of Lyon can be easily be re-used for other purpose: the water system management itself but also health studies, pollution studies etc.

**Financiability:** financiability of the integration of water needs is unclear. Investment capability of the Grand Lyon on water management is unknown and it is not certain that the Grand Lyon is willing to invest for the improvement of the system. However, needs identified related to storm water management has been identified as a top priority by the water department, there is a chance that funds could be unlocked for water systems in a near future.



The Constructibility matrix for water needs are the same for all water related functions. The main reason being that in the perimeter of the project all water responsibilities are undertaken by the Grand Lyon.

**4.2.3. Logistic needs analysis**

Logistic needs, concern the storing and transportation of goods and merchandises. Different types of merchandises could be transported or stored which would have different impacts on the development of the future system. In Ile de France, around Paris, a similar study has been carried as part of the public debate for the Greater Paris metro

project (DRIEA , 2010). In this study, logistic needs around Paris have been analysed to evaluate the opportunity to use the Greater Paris to transport merchandises. To do so, different types of merchandises have been identified: mass distribution goods, specialized distribution (pharmaceutical products, press, construction materials, chemical products, drinks) and postal and courier services. Each merchandise having its particular requirements, risks and impacts. Current logistic systems in the region of Paris have been described with maps:

**Improvement n°4:**

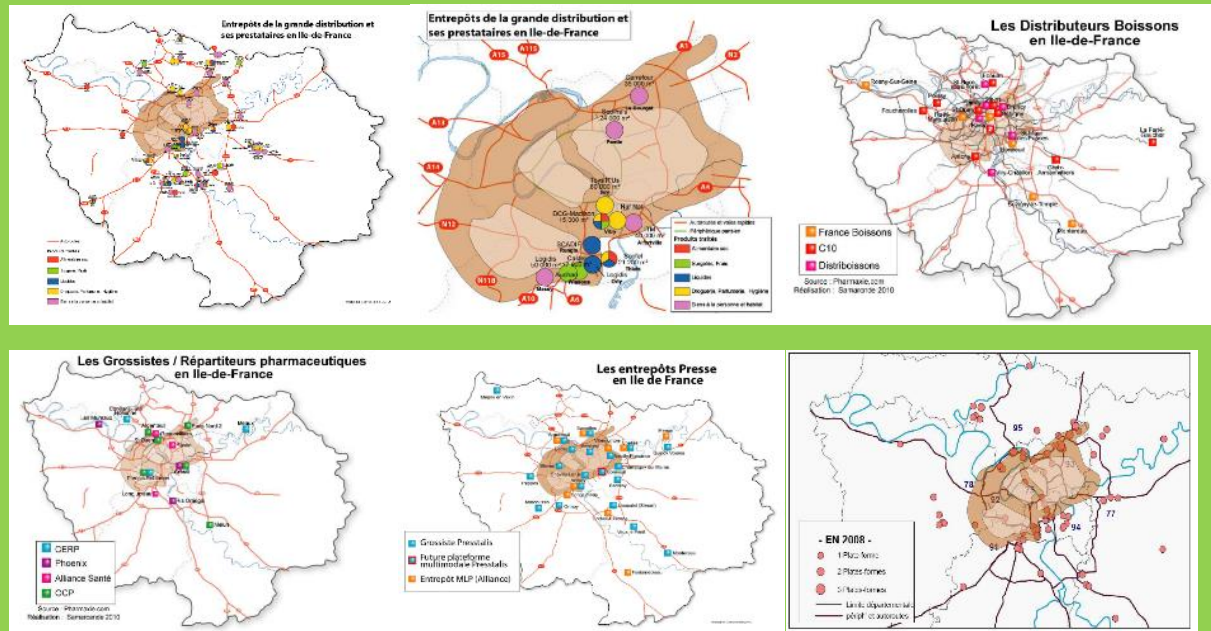


Figure 212 : Example of a logistic system analysis in Ile de France by type of merchandise (DRIEA , 2010). Different types of current merchandise flows in île de France have been studied and represented on maps. From up left to bottom right: mass market retailing flows and storage, beverage flows, pharmaceutical products flows and their storage, construction materials and their storage.

A similar study has been carried in London in 2007 to evaluate logistic needs and opportunities to extend it with the rail network (Transport for London, 2007):

**Improvement n°4:**

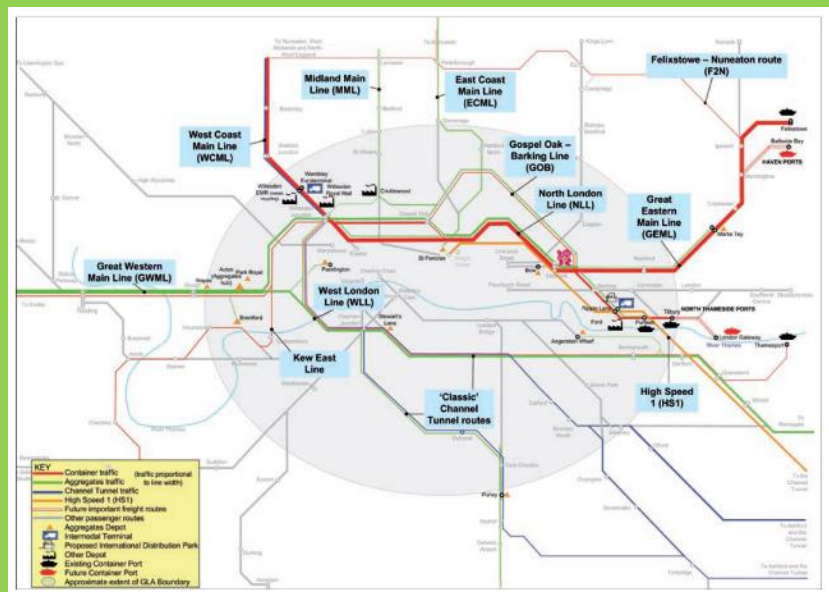


Figure 213 : Location of key freight flows in London – schematic (Transport for London, 2007). This map shows the current and future different types of freight flows in the Greater London area: container traffic and aggregates traffic and depot, depots in general as well as main passenger routes. Objective of this study undertaken by the municipality of London was to evaluate potentialities to use passenger routes for freight.

The direction of the 5<sup>th</sup> metro line from outside the city (western suburbs) and the city centre is particularly adapted to logistic needs. Particularly, the proximity with the A6 highway and the future “Anneau des sciences” an underground highway project in the west part of Lyon is adapted to multimodal platforms.

Logistic needs in the west part of Lyon are represented by the Use Case diagram in **Erreur ! Source du renvoi introuvable.**

**Improvement n°16 and 20:**

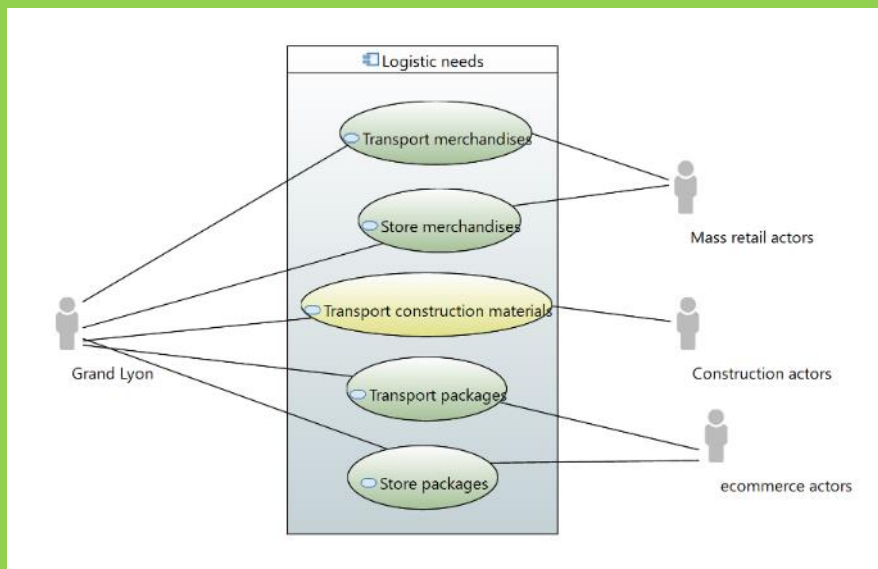


Figure 214: Use case diagram of logistic needs. In the middle are needs related to the logistic system in Lyon, in green main functions which have been identified by the Grand Lyon as potentially interesting to integrate in the future 5<sup>th</sup> metro line. In yellow needs which have been identified but are not a priority to integrate in the future metro line. On both sides of the diagram are represented actors in interaction with the logistic system in Lyon.

Once stakeholders and external elements have been identified, the next step consists in gathering information about their potential needs and constraints (**Erreur ! Source du renvoi introuvable.**).

- Transport commodities:

In Lyon, interviews carried with the Grand Lyon has demonstrated that logistic needs related are at stake: ecommerce is booming and the demand to transport related merchandises follows the same trend with always shorter delivery deadlines. There is currently a tension on the logistic the current transport system for logistic is mainly based on trucks utilization which is polluting (noise, CO<sub>2</sub> emissions, fine particles etc.), it immobilizes parking lots for trucks, and is a factor of traffic congestion (traffic jams, low reliability) (Augereau, 2009).

- Store commodities:

Another current trend observed in Lyon and in its western suburbs is the creation of local supermarkets which have no storage areas and which are delivered by trucks every day and even several times per day. It is mainly due to the real estate market which is rising in Lyon and is still cheap outside which implies that storage areas are delocalized outside the city and which increases the number of trucks inside to deliver merchandises.

For those reasons, the development of a metro infrastructure has been identified as a great opportunity to face these challenges by offering spaces to store merchandises and an efficient and sustainable transport system. A similar

study than those carried in the Paris region (Figure 212) or in London (Figure 213) is currently under way in Lyon integrating needs related to ecommerce.

Integration of logistic needs in a metro system have been studied in different projects notably the CargoCap project in Switzerland which consists in automatic vehicles transporting merchandises in dedicated tunnels (Figure 214):



**Figure 214 : Cargocap example of an underground logistic system to transport freight (CargoCap, 2007).**

A study carried by the RATP (Régie Autonome des Transports Parisiens), Interface Transport, Jonction and Mines Paris Tech in 2012, highlights that if logistic needs are integrated early in the design of the system it is totally possible to develop an infrastructure which enables transportation of people and goods (PREDIT, Ministère de l'Ecologie du Développement durable et de l'Energie, 2012). In the same report, a detailed functional analysis is proposed for the integration of fret in an urban transportation system (including metro systems).

Finally, storing and transporting merchandises have both been identified as potential needs to integrate in the future system. The next step consists in carrying a Constructibility analysis to evaluate constraints for their integration (**Erreur ! Source du renvoi introuvable.**).

- Constructibility analysis of logistic needs
  - Objectives of the Enabling System

#### **Improvement n°9:**

6 Constructibility criteria have been defined in the last chapter related to **Objectives of Enabling Systems** at the Operational Level and required to be analyzed: Effectivity, Governability, Contractibility, Acceptability, Legal, Temporality.

**Effectivity:** Objectives is to assess logistic needs in the west part of Lyon. Interviews with experts of the Grand Lyon allows having a brief idea of logistic needs however a more precise study would be required to analyze



precisely merchandise movements in Lyon quantitatively, by types of goods and with more precision on their location.

**Governability:** The main issue concerning logistic needs is that it is ruled by private companies and not public administrations. In other words, even if the need exists, neither the Grand Lyon nor the Sytral has the responsibility of managing and planning movements of goods and merchandises in Lyon. However it is their mission to improve living conditions of Inhabitants of Lyon, to improve the economic attractiveness of the city and to manage parking spaces, therefore the congestion and pollution mainly due to the use of trucks is their concern. More precisely, public administrations have various levers on logistic: municipalities have the right to manage parking lots and give the right or not to park to a certain type of vehicle for a certain period of time. The Grand Lyon has control over traffic flows and can constraint tonnage of trucks and their gauging and on building permit for companies or factories to force them to use different modes of transport for their merchandises and notably sustainable transport modes.

However, there is an importance difference with other urban services, moving goods and merchandises is not a public mission. Transporting goods in a more sustainable way could be seen as a new service offered by the Grand Lyon or the Sytral. However, involvement of the private sector seems to be the best way to develop logistic infrastructures as they are the first impacted and beneficiaries of a new logistic infrastructure.

**Contractibility:** Potential involvement of new stakeholders such as private logistic companies asks the question of the type of contract to use for this type of project. New types of contract or adaptation of PPP (Public Private Partnership) as instance could be imagined to better define the role of private logistic companies and public administrations such as the Sytral and the Grand Lyon for the development of logistic infrastructures.

**Acceptability:** Shifting the transport of merchandises from road at the surface to a dedicated infrastructure and to be more specific the suppression of externalities due to the use of trucks (congestion, noise, air pollution etc.) in the city center is beneficial for inhabitants.

**Legal:** the law is more and more severe concerning truck traffic in city centers in France and more globally in European cities. In Figure 215 are represented cities where city tolls (in red) or legal restrictions (in yellow) on the circulation of polluting vehicles are currently under application in Europe. In Lyon, the circulation of polluting vehicles will be prohibited in 2020 and more precisely trucks built before 2009 for petrol trucks and before 2014 for diesel trucks.

#### Improvement n°4:

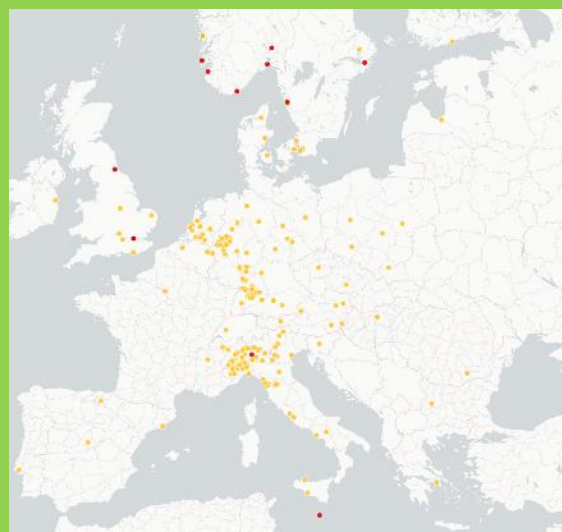


Figure 215 : European cities where restrictions on polluting vehicles are applied (Le Monde, 2017). This map shows that the legal context on traffic regulation in city is changing and will potentially impact the logistic system. More

specifically there is a trend in western Europe to regulate the traffic of polluted trucks in city centers. In Yellow are represented cities where traffic is regulated for trucks, in red where it exists a city toll.

This legal evolution is positive for the development of multifunctional systems integrating logistic needs. It means that new ways to move goods in city centers will have to be developed, metro infrastructures can be part of the solution.

**Temporality:** With the exception of isolated cases, logistic projects are usually short term and flexible projects. This another constraint for a transport system integrating goods transportation as it means that they logistic needs have to be forecast for the next 30 years with a lot of incertitude on the type of merchandises to move and their quantity.

- Activities of the Enabling System

#### **Improvement n°9:**

9 Constructibility criteria have been defined in the last chapter related to **Activities of Enabling Systems** at the Operational level and required to be analyzed: Pertinence, Complexity, Robustness, Documentation, Control, Error-proofed, Communication, Knowledge, and Repeatability.

**Pertinence:** The Sytral objective is only to evaluate if the opportunity to mutualize logistic needs with the future metro system exists. Considering this objective interviews with the Grand Lyon are relevant for this purpose. More design efforts would have been over quality.

**Complexity:** the process chosen to identify logistic needs is simple: inputs consist in interviews with experts and outputs are the identification of mutualization opportunities. Conclusion of the study is transmitted to the Sytral which chose or not to investigate more the mutualization opportunity. The simplicity of the process is double-edged: needs related to the logistic system are not evaluated quantitatively which is not enough to develop models.

**Robustness:** external events which can affect the identification and characterization needs process can come from a divergence of actors objectives or actors' interactions. It is also dependent on information given by experts, the process is sensible to the reliability of experts' judgement.

**Documentation:** the process is documented with a flow chart (see figure **Erreur ! Source du renvoi introuvable.**). However we have not modeled the process.

**Control:** the process is controlled by feedbacks with experts when the needs analysis is carried. Feedbacks are then taken into account and modifications are discussed and made in the analysis.

Error-proofed: No alerts has been planned to prevent potential errors related to needs evaluation.

**Communication:** Communication between stakeholders of the Grand Lyon is not very efficient, people at the water department were not aware of the existence of the 5<sup>th</sup> metro line project to the west part of Lyon. We have done regular feedbacks to the Grand Lyon and the Sytral during the needs analysis process.

**Knowledge:** No cutting-edge expertise was required to analyze information gathered for water needs analysis in this process.

**Repeatability:** Technically speaking, the process is easily repeatable, we have repeated it for the analysis of all new functions to integrate in the multifunctional metro for the 5<sup>th</sup> metro line of Lyon. Repeatability comes here from the simplicity of the process, it is clear that a process involving more inputs and/or more outputs would have been inevitably less repeatable except if it is very well integrated in working methodologies and if the process is very well mastered. From an institution point of view, it depends on how administrations are organized, on relations between administrations and interactions between actors.

- Resources of the Enabling System

### Improvement n°9:

6 Constructibility criteria have been defined in the last chapter related to **Resources of Enabling Systems** at the Operational level and required to be analyzed: Efficiency, Availability, Accessibility, Workability, Reliability, Ambivalence.

**Efficiency:** Only few resources have been used to analyze needs, the project manager of the 5<sup>th</sup> line of Lyon, interviews with experts at the Grand Lyon and myself. The process applied to identify opportunities of mutualization can be considered as efficient.

**Availability:** resources required to analyze logistic needs are mostly information about flows of merchandises. These information are hardly accessible as private companies are not necessarily willing to communicate about their flows of merchandises. More researches would be required to better estimate logistic needs. The only information available at the moment are experts' sayings from the Grand Lyon.

**Accessibility:** The logistic business is constituted by a lot of small and even familial companies, it is very difficult to have access to all information about logistic flows. Even though, due to confidentiality issues, we were not authorized by the Sytral to contact logistic companies.

**Workability:** Information gathered are mostly experts' sayings which are transcribed in audio recordings and reports. Without quantified data, workability of information gathered remains low.

**Reliability:** Experts met at the Grand Lyon about logistic needs are reliable, it consists in general trends observed globally in the Lyon area and feedbacks directly from citizens. However, their vision is necessarily partial as the mission of the Grand Lyon is not to transport commodities, it would be necessary to interview other actors such as logistic professionals to have more reliable information.

**Ambivalence:** information gathered about logistic needs could be used for other studies (pollution studies, traffic studies etc.).

**Financiability:** the logistic business is spread in several "little" companies which makes difficult for the private sector to finance integration of logistic needs. Moreover, because logistic is not currently a public mission it is hard to secure public funds. Another possibility would be the involvement of large private companies as major retailers (Amazon, Carrefour etc.) to finance the project.

### Improvement n°22: The Constructibility matrix

	Objectives						Activities							Resources							
	Effectivity	Governability	Contractability	Acceptability	Legal	Temporality	Pertinence	Complexity	Robustness	Documentation	Communication	Control	Error proofed	Repeatability	Efficiency	Availability	Accessibility	Workability	Reliability	Ambivalence	Financiability
F3.1: Transport commodities	Orange	Red	Red	Green	Light Green	Orange	Light Green	Green	Light Green	Yellow	Orange	Yellow	Light Green	Yellow	Green	Yellow	Orange	Yellow	Light Green	Light Green	Orange
F3.2: Store commodities	Orange	Red	Red	Green	Light Green	Orange	Light Green	Green	Light Green	Yellow	Orange	Yellow	Light Green	Yellow	Green	Yellow	Orange	Yellow	Light Green	Light Green	Orange
Functional Analysis																					
Organic Analysis																					

Figure 216 : Constructibility matrix related to logistic needs in the operational view

#### 4.2.4. Telecom needs analysis

Mutualisation of telecom needs has also been evaluated as part of the studies for the 5<sup>th</sup> metro line of Lyon. The first step consists in identifying stakeholders and External Elements to the system (**Erreur ! Source du renvoi introuvable.**).

3 new functions notably have been evaluated (**Erreur ! Source du renvoi introuvable.**): Transport citizens' data, transport companies, telecom operators and administrations data and store data.

#### Improvement n°16 and 20:

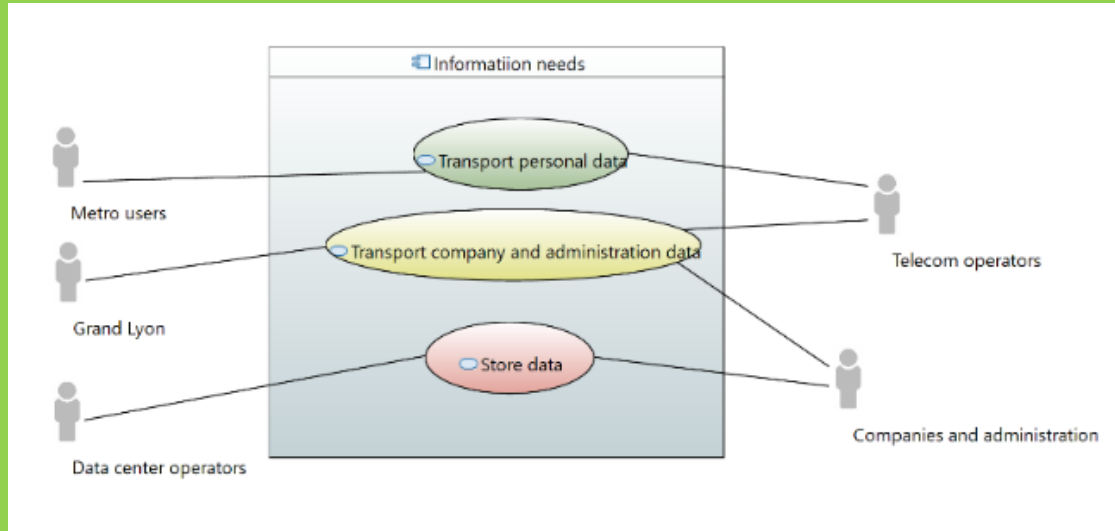


Figure 218: Use Case diagram of telecom needs. In green are needs which have been identified by the Grand Lyon for further integration in the future 5<sup>th</sup> metro line of Lyon, in yellow needs which have been identified but which are not urgent and in red needs which are not existing from the Grand Lyon point of view.

Once stakeholders and external elements have been identified, it is necessary to gather information about potential telecom needs the system could answer (**Erreur ! Source du renvoi introuvable.**).

- Telecom needs analysis
  - Transport information

Surprisingly, transport information was not a need expressed by the Grand Lyon while it is a common need integrated in a metro system (examples are Paris, New York, several cities in Australia etc.). However, because the cost related to the integration of optical fiber in a metro system for urban needs is very low compared to build an underground space under roads, the Grand Lyon is still interested. Moreover, using the metro infrastructure to integrate telecom infrastructure to transport information is already something occurring in the Lyon metro nowadays: the Grand Lyon has a contract with the Sytral to install optical fiber wires, the Sytral is responsible for the maintenance of the wires and owns the cables. The Grand Lyon can “rent” them to operators and retrieve the earnings. Investments and maintenance tasks are reimbursed by the Grand Lyon to the Sytral. Mutualization of optical fiber cables in the Lyon metro is a good example for the integration of new functions in a metro system.

The tendency is even on a downward trend as copper cables are progressively replaced by optical fibers. Nevertheless, when looking to Figure 217, the western part of Lyon is not fully connected with optical fiber (only 25% to 50% of households in Tassin-la-demi-lune, the district the future metro line will arrive) which highlights that the need to improve the broadband network is exists.

This function of transporting information has been divided in 2 sub functions: transport data for citizens and transport data for companies and administration. Each function don't have the same requirements of RAMS (Reliability, Availability, Maintainability and Security) neither the same performance requirement.

### Improvement n°4:

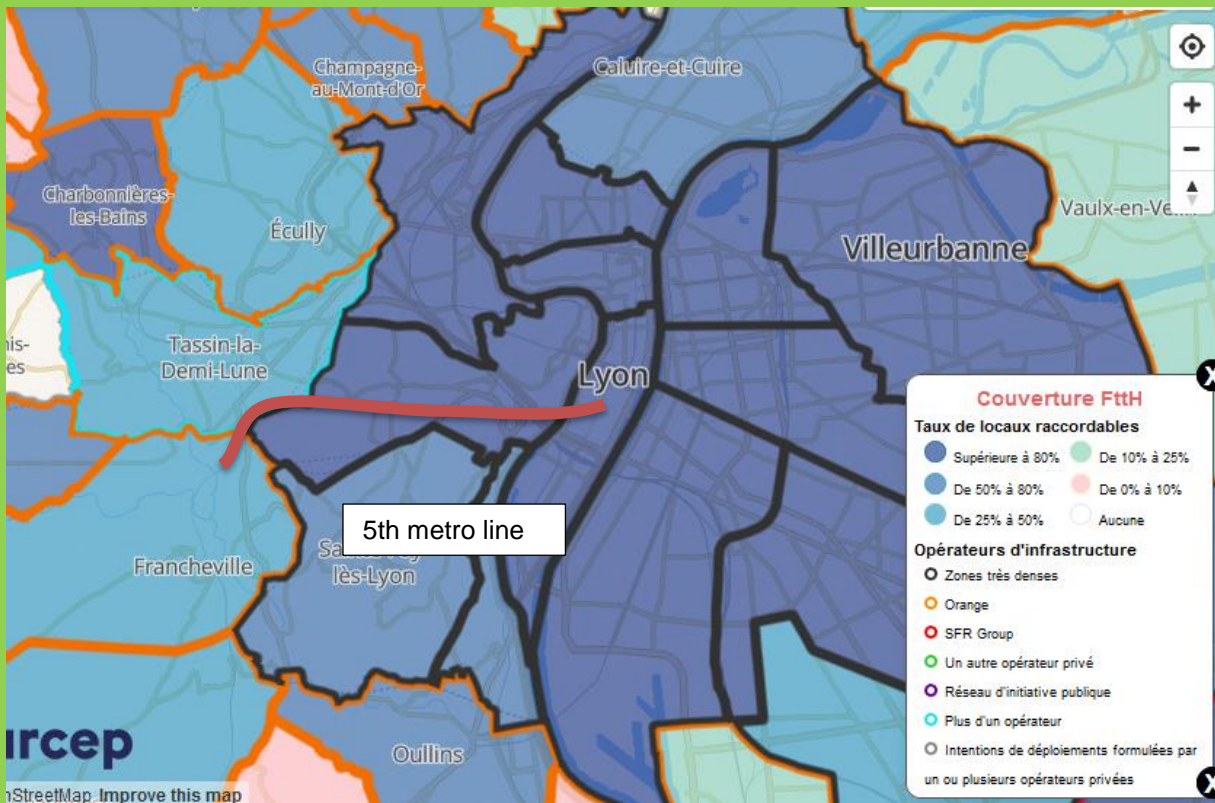
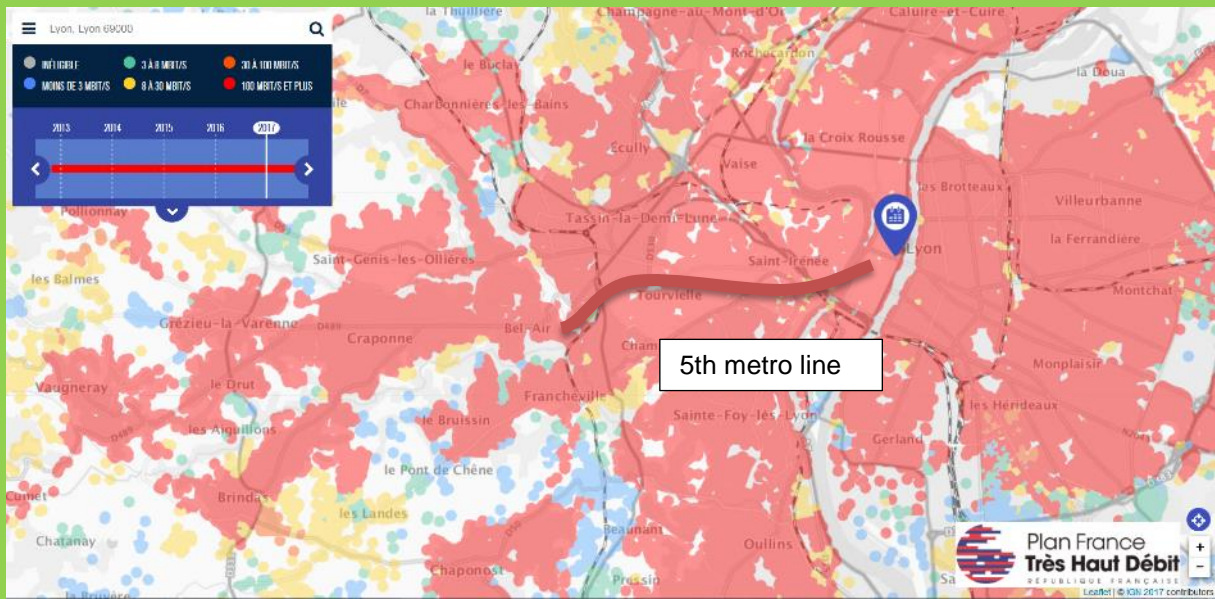
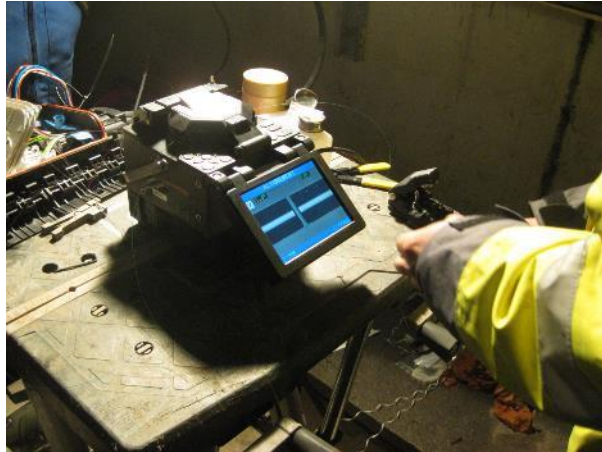


Figure 217 : The broadband services in Lyon and its suburbs (arcep, 2018) (Plan France Très Haut Débit, 2018). In both figures the future 5<sup>th</sup> metro line of Lyon is represented in dark red. In both figures is represented the connection of areas to the high speed broadband network in Lyon.



**Figure 218 : Example of the installation of Optical Fiber inside a metro infrastructure by an operator**

- Store information

Storing information with high levels of RAMS (Reliability, Availability, maintainability and Security) implies strict requirements: notably redundancy in energy supply, redundancy in data delivery, be isolated from external events as much as possible (floods, intrusion). Integration of data centers in a metro infrastructure can easily answers to such requirements: the energy supply of metro systems is usually already redundant, metro systems are already equipped with a broadband network which could be mutualized for Data centers needs. Moreover, the integration of data centers is also an opportunity to use the heat created to heat stations or buildings at the surface. Integration of Data Centers in a metro system is an opportunity selected by the Greater Paris (Société du Grand Paris, 2014) and they are even used to heat urban agriculture systems (Figure 219).

Store data (data center) at the contrary has not been identified as a need by the Grand Lyon to store its own data. The Grand Lyon is not responsible for data storing or don't want to take this responsibility. Contrarily, the Greater Paris has a totally different strategy and uses free spaces available in stations, shafts and depots to develop data centers (Société du Grand Paris, 2018), (Société du Grand Paris, 2014).

However, the Grand Lyon has no mission to store data, except for its own needs which are not significant. It would be necessary to interview other actors specialized in the Data Center business to better evaluate this opportunity.

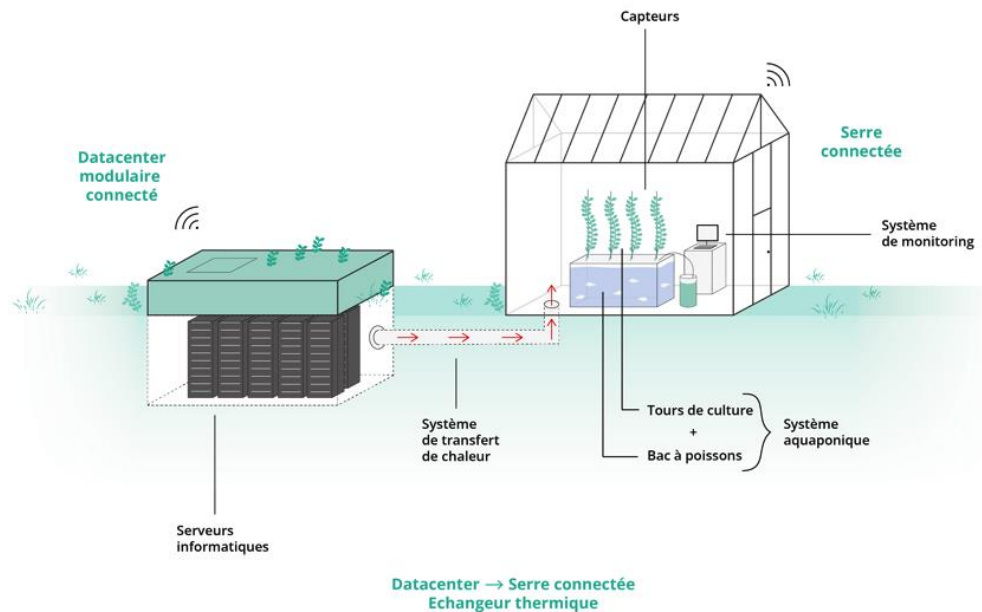


Figure 219 : Scheme of the use of a Data Center in the Greater Paris project for urban agriculture (Société du Grand Paris, 2018)

Finally, transport information for companies and administrations has been the only need identified which could potentially be integrated in the future metro system. Then, it is necessary to evaluate constraints related to integration of this need (Constructibility analysis) (**Erreur ! Source du renvoi introuvable.**).

- Constructibility analysis of information needs
  - Objectives of the Enabling System

#### Improvement n°9:

6 Constructibility criteria have been defined in the last chapter related to **Objectives of Enabling Systems** at the Operational Level and required to be analyzed: Effectivity, Governability, Contractibility, Acceptability, Legal, Temporality.

**Effectivity:** Comparison between interviews with experts from the Grand Lyon and optical fiber coverage available on internet are contradictory. Experts say that there is no need to extend more optical fiber infrastructure while the district open data available on internet say that only 25 to 50% of households are connected with optical fiber. It shows that in this case the study carried is not effective and would require more analysis to evaluate realistically telecom needs in the west part of Lyon.

**Governability:** The Grand Lyon only has a facilitation role for the development of telecom infrastructures in Lyon, but they do not operate the system neither build new telecom infrastructures which is done by telecom operators such as Orange, SFR, Free or Bouygues in France. However, the Grand Lyon has the capability to install telecom infrastructures in a metro system as it is the case currently in the Lyon metro.

**Contractibility:** From the interviews carried in the Grand Lyon and the Sytral, the current contract between both stakeholder for the integration and operation of an Optical fiber network in the metro system works well. A similar contract could be intended if the decision to integrate telecom needs is made.

**Acceptability:** Provide broadband network for households is usually welcome by the population, no particular acceptability issue has been identified.

**Legal:** No legal constraint have been identified, the law “n° 2016-1321” voted in 2016 (Legifrance, 2016) is even favorable for the development of the broadband network in French cities.

**Temporality:** An important brake to the development of the mutualization between the development of a metro project and optical fiber is the temporality of projects. While a project of optical fiber infrastructure lasts 2 years approximatively, a metro project can lasts between 10 and 30 years. Most of telecom operators and telecom infrastructure owners can hardly evaluate their needs at this horizon.

- Activities of the Enabling System

#### **Improvement n°9:**

9 Constructibility criteria have been defined in the last chapter related to **Activities of Enabling Systems** at the Operational level and required to be analyzed: Pertinence, Complexity, Robustness, Documentation, Control, Error-proofed, Communication, Knowledge, and Repeatability.

**Pertinence:** The difference between optical fiber availability and experts sayings may come from a governance question: as telecom infrastructures are mainly developed by telecom operators the Grand Lyon is maybe not aware of the current state and future needs related to the telecom network. Therefore, pertinence of the process raises question.

**Complexity:** the process chosen to identify information needs is simple: inputs consist in interviews with experts and outputs are the identification of mutualization opportunities. Conclusion of the study is transmitted to the Sytral which chose or not to investigate more the mutualization opportunity. The simplicity of the process is double-edged: needs related to the telecom system are not evaluated quantitatively which is not enough to develop models.

**Robustness:** external events which can affect the identification and characterization needs process can come from a divergence of actors objectives or actors’ interactions. It is also dependent on information given by experts, the process is sensible to the reliability of experts’ judgement. This last statement highlights the importance to have different sources of information, preferably from actors from the private, public sectors and eventually directly citizens when possible.

**Documentation:** the process is documented with a flow chart (see figure **Erreur ! Source du renvoi introuvable.**). However we have not modeled the process.

**Control:** the process is controlled by feedbacks with experts when the needs analysis is carried. Feedbacks are then taken into account and modifications are discussed and made in the analysis.

**Error-proofed:** No alerts has been planned to prevent potential errors related to needs evaluation.

**Communication:** Communication between stakeholders of the Grand Lyon is not very efficient, people at the water department were not aware of the existence of the 5<sup>th</sup> metro line project to the west part of Lyon. We have done regular feedbacks to the Grand Lyon and the Sytral during the needs analysis process.

**Knowledge:** No cutting-edge expertise was required to analyze information gathered for water needs analysis in this process.

**Repeatability:** Technically speaking, the process is easily repeatable, we have repeated it for the analysis of all new functions to integrate in the multifunctional metro for the 5<sup>th</sup> metro line of Lyon. Repeatability comes here from the simplicity of the process, it is clear that a process involving more inputs and/or more outputs would have been inevitably less repeatable except if it is very well integrated in working methodologies and if the process is very well mastered. From an institutional point of view, it depends on how administrations are organized, on relations between administrations and interactions between actors.



- Resources of the Enabling System

### Improvement n°9:

6 Constructibility criteria have been defined in the last chapter related to **Resources of Enabling Systems** at the Operational level and required to be analyzed: Efficiency, Availability, Accessibility, Workability, Reliability, Ambivalence.

Resources required to carry a needs analysis related information/telecom needs in this process are human resources and information.

**Efficiency:** Only few resources have been used to analyze needs, the project manager of the 5<sup>th</sup> line of Lyon, interviews with experts at the Grand Lyon and myself. The process applied to identify opportunities of mutualization can be considered as efficient.

**Availability:** Information about telecom needs are available publicly on internet (Figure 217). More information are available from telecom operators but they have not been reached as part of these studies.

**Accessibility:** Basic information about coverage in optical fiber and 4G are easily accessible as they are available on internet.

**Workability:** Workability of information gathered from interviews from the Grand Lyon is low. Opendata available on internet can be downloaded and analyzed through a GIS tool and are of better workability.

**Reliability:** Reliability of experts sayings about telecom needs and interviews carried at the Grand Lyon is high, however they may be incomplete are subjective. Information gathered in internet are from arcep which is the regulating authority for telecommunication and mails. Reliability of such information is high.

**Ambivalence:** Information gathered and analysis carried can be used for other studies.

**Financiability:** The Grand Lyon is eager to integrate few optical fibers in the metro system even if they are not certain that the need exist. Like they did previously in the Lyon metro, the Grand Lyon will finance the system and the Sytral will be in charge of its operation.

### Improvement n°22: The Constructibility matrix

	Objectives							Activities							Resources						
	Effectivity	Governability	Contractability	Acceptability	Legal	Temporality	Pertinence	Complexity	Robustness	Documentation	Communication	Control	Error proofed	Repeatability	Efficiency	Availability	Accessibility	Workability	Reliability	Ambivalence	Financiability
F4.1: Transport Information	Red	Yellow	Green	Green	Green	Orange	Green	Green	Yellow	Orange	Yellow	Orange	Yellow	Green	Green	Yellow	Yellow	Yellow	Green	Green	Green
F4.2: Store information	Red	Orange	Orange	Green	Green	Orange	Green	Green	Yellow	Orange	Yellow	Orange	Yellow	Green	Green	Yellow	Yellow	Yellow	Green	Green	Green
Functional Analysis																					
Organic Analysis																					

Figure 220 : Constructibility matrix related to telecom needs in the Operational view

#### 4.2.5. Wastes needs analysis

- Wastes needs analysis

Wastes management is another need studied as part of the 5th metro line of Lyon. The first step consists in identifying stakeholders related to this need (**Erreur ! Source du renvoi introuvable.**).

## Improvement n°16 and 20:

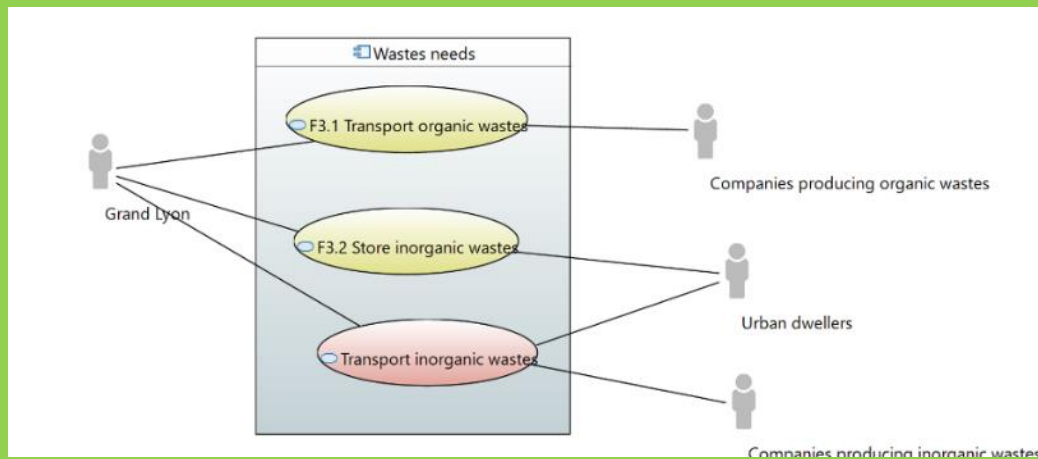


Figure 224: Use case diagram of wastes needs. In yellow needs which have been identified but which are not urgent, in red needs which don't exist from the Grand Lyon point of view.

Once stakeholders and external elements have been identified, it is necessary to gather information about needs and constraints of stakeholders related to waste management needs.

- Transport wastes

Even if the wastes management system currently under operation in Lyon works well and that globally the quantity of waste to transport is decreasing (Grand Lyon, 2018), the need to transport wastes from the city center to the periphery in 2030 has been identified by the Grand Lyon. In other words, it is more a change in the direction of the flows (center <-> periphery) than a global increasing trend which has been identified (here again it shows that needs can be allocated to spaces). The reason being that most of the wastes are created in the center while wastes treatment plants (landfills and incinerators) are located outside the city or because they certainly will in the future).

The construction of a new metro line from the inner city of Lyon and its periphery is therefore a good opportunity to answer this need. Currently, only districts of La Duchères and Rillieux-la-Pape have replaced the door-to-door collection system with underground silos (around 5m<sup>3</sup> per silo). This system suffers from several incivilities: people park on the platform which hinders emptying the containers, other don't put their garbages in the silos but aside of them, the more the collect point is far from users the more these types of problems arise. These phenomenons should be considered when integrating waste needs in a metro system.

Interviews with the Grand Lyon have shown an interest to transport organic wastes with the metro line, as a new law in France will force organizations and companies producing more than 10t of organic wastes per year to treat them. This activity cannot be done inside the city and they will have to be evacuated (for instance thanks to the new metro infrastructure). This need is considered as uncertain as the law is not yet applicable.

As instance, pneumatic systems could be a solution to transport wastes. This solution functions and is already installed in several cities, however one main drawback of this system is its high investment cost. For this reason this solution is almost always excluded from discussions when analyzing waste management solutions. However, its integration in a metro system could lower significantly its realization cost as most of the infrastructure would be integrated in the metro system.

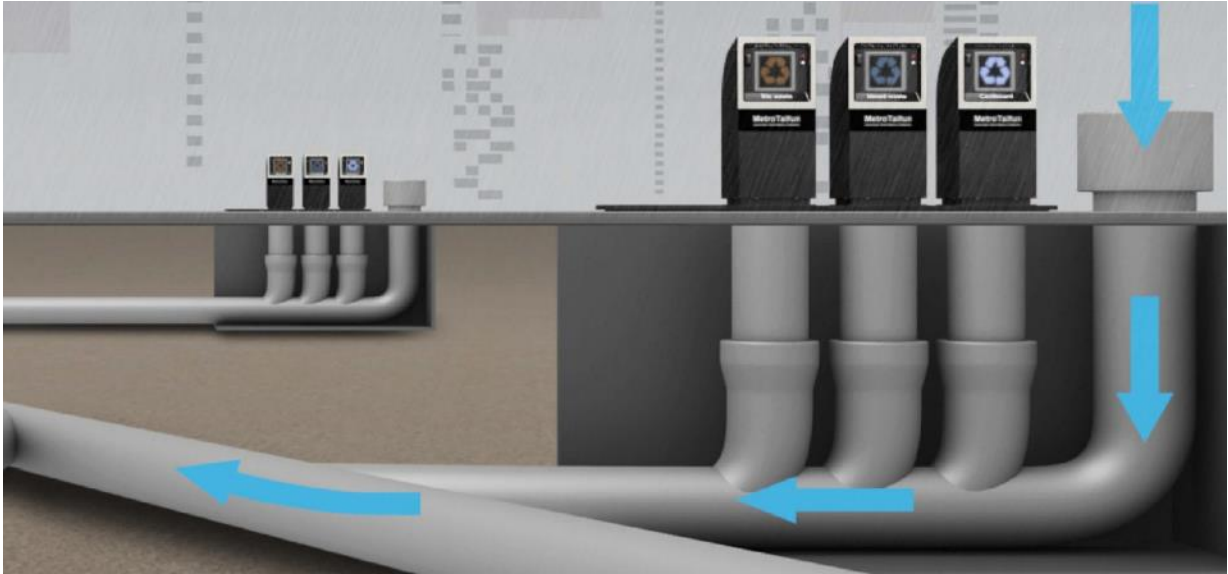


Figure 221 : Example of a pneumatic waste management system (MariMatic, 2014)

- Store and treat wastes

The other need related to wastes management identified is to store wastes i.e. to create landfills and/or incinerators. In fact, the creation of a new landfill inside the city at the surface is impossible due to reluctance of urban citizens. As we can see in Figure 223 and Figure 222, no landfill neither incinerators exist in the west part of Lyon. The need identified would be to integrate a landfill in the metro infrastructure as instance with the future depot. A depot is already a logistic area accessible for trucks and could be easily transformed into a logistic hub even for wastes.

#### Improvement n°4:



Figure 222 : Location of incinerators in Lyon (in red) (Google Map, 2018). The future 5<sup>th</sup> metro line of Lyon is represented in dark red.

## Improvement n°4:

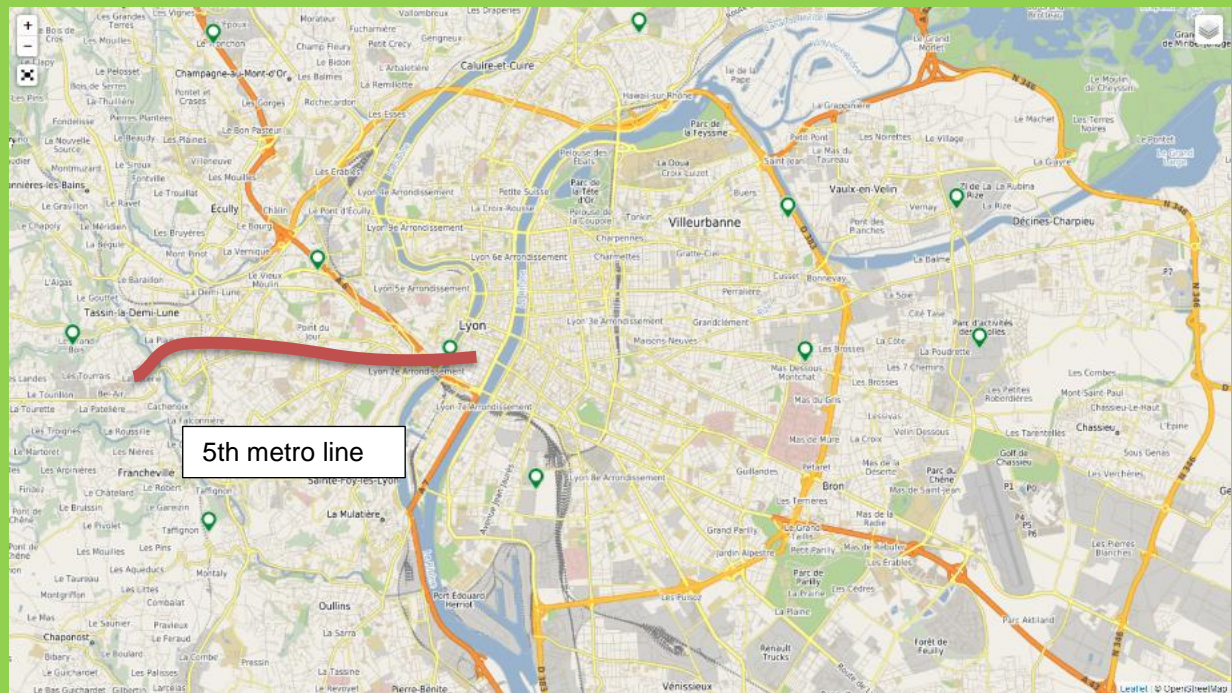


Figure 223 : Location of landfills in Lyon (in green) (Google Map, 2018). The future 5<sup>th</sup> metro line of Lyon is represented in dark red.

Finally, the needs selected for future integration in the system is “storing wastes”, “transport inorganic wastes” and transport “organic wastes”.

- Constructibility analysis of waste needs

After having identify potential waste needs to integrate, it is necessary to evaluate Constructibility constraints for their integration in the system (**Erreur ! Source du renvoi introuvable.**).

- Objectives of the Enabling System

## Improvement n°9:

6 Constructibility criteria have been defined in the last chapter related to **Objectives of Enabling Systems** at the Operational Level and required to be analyzed: Effectivity, Governability, Contractibility, Acceptability, Legal, Temporality.

**Effectivity:** Interviews carried at the Grand Lyon has allowed identifying needs related to waste management in 2030. However, the needs have not been quantified and are still vague. It would be required to carry more analysis maybe with other stakeholders as waste operators in Lyon and develop a method to quantify future needs to have a more precise idea of future needs related to waste management.

**Governance:** Waste management in the area of the 5<sup>th</sup> metro line is under the responsibility of the Grand Lyon (Figure 224), governance issues are therefore less problematic than some other urban functions (like logistic). However, the organization in silos and the lack of communication between urban departments is still a problem for the integration of waste problematics in a transport system.

## Improvement n°4:

### Les syndicats de traitement des ordures ménagères sur l'agglomération lyonnaise

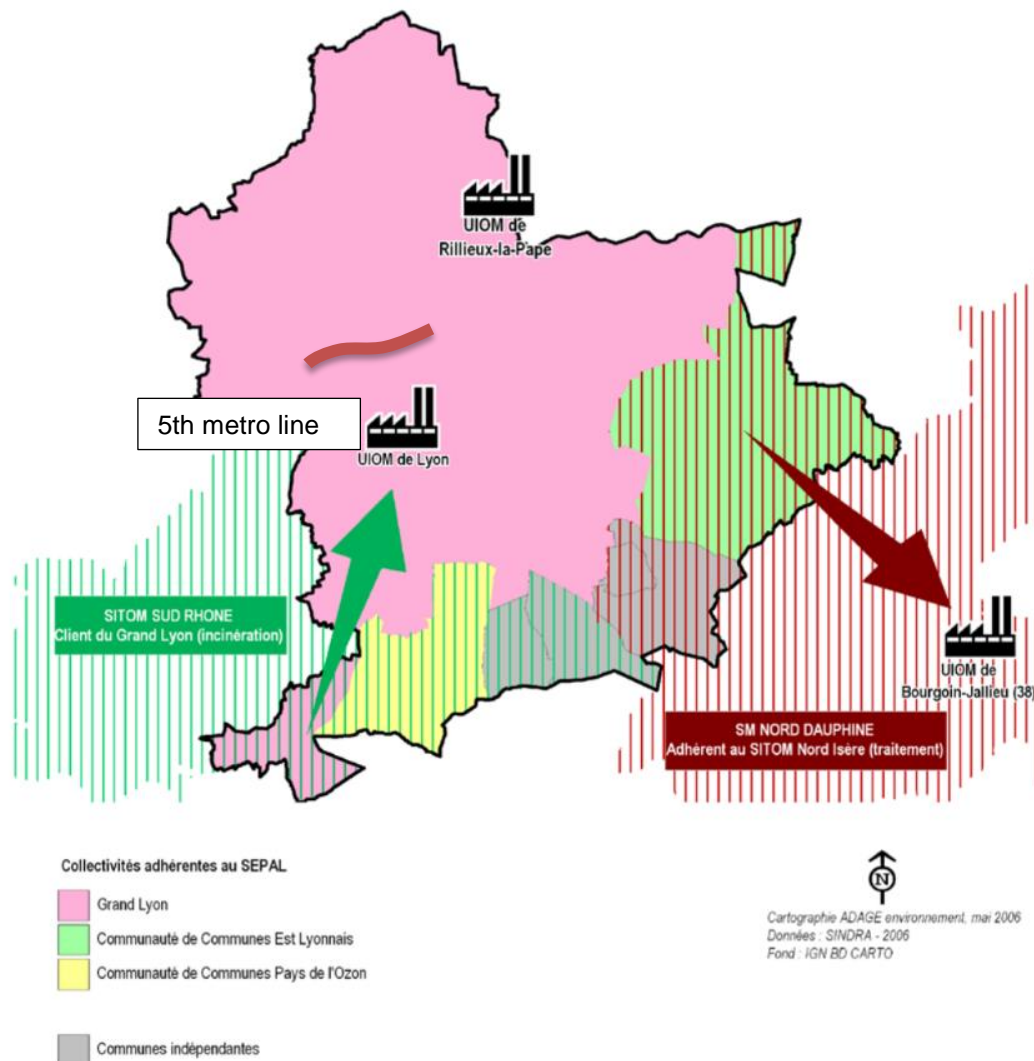


Figure 224 : Governance of the waste management system in Lyon and its surroundings and interactions between them (Grand Lyon, 2018). In dark red is represented the future 5<sup>th</sup> metro line.

**Contractibility:** In Lyon the waste management system is fully under the responsibility of the Grand Lyon. Therefore it should be easier to find a consensus between stakeholders involved and the rules to follow as the Sytral is also part of the Grand Lyon. Furthermore the waste system is operated internally by the Grand Lyon itself, it is therefore simpler as there is no another stakeholder which interferes in the project of mutualization.

**Acceptability:** Acceptability could be more problematic as wastes have usually a bad image and some externalities which are not desirable for metro users or and inhabitants (smells, hygiene, air pollution etc.).

**Legal:** The law evolution is favorable to mutualization as new laws will potentially impose to transport and recycle wastes in a sustainable way.

**Temporality:** Most of waste projects are not scheduled at the same temporality scale than transport projects like metro systems.

- Activities of the Enabling System

**Improvement n°9:**

9 Constructibility criteria have been defined in the last chapter related to **Activities of Enabling Systems** at the Operational level and required to be analyzed: Pertinence, Complexity, Robustness, Documentation, Control, Error-proofed, Communication, Knowledge, and Repeatability.

**Pertinence:** The Grand Lyon is the only responsible for waste management in the Lyon agglomeration. It is therefore pertinent to interview this stakeholder on waste management needs. The level of detail of the needs analysis process is also pertinent as requirement of the Sytral was only to identify mutualization opportunities and not a precise and quantified needs analysis.

**Complexity:** the process chosen to define waste needs is simple: inputs consist in interviews with experts and outputs are the identification of mutualization opportunities. Conclusion of the study is transmitted to the Sytral which chose or not to investigate more the mutualization opportunity. The simplicity of the process is double-edged: needs related to the waste management system are not evaluated quantitatively which is not enough to develop models.

**Robustness:** external events which can affect the identification and characterization needs process can come from a divergence of actors objectives or actors' interactions. It is also dependent on information given by experts, the process is sensible to the reliability of experts' judgement. This last statement highlights the importance to have different sources of information, preferably from actors from the private, public sectors and eventually directly citizens when possible.

**Documentation:** the process is documented with a flow chart. However we have not modeled the needs analysis process.

**Control:** the process is controlled by feedbacks with experts when the needs analysis is carried. Feedbacks are then taken into account and modifications are discussed and made in the analysis.

**Error-proofed:** No alerts has been planned to prevent potential errors related to needs evaluation.

**Communication:** Communication between stakeholders of the Grand Lyon is not very efficient, people at the water department were not aware of the existence of the 5<sup>th</sup> metro line project to the west part of Lyon. We have done regular feedbacks to the Grand Lyon and the Sytral during the needs analysis process. However, communication is greatly improved by the fact that the Grand Lyon is almost the only actor managing the waste system.

**Knowledge:** No cutting-edge expertise was required to analyze information gathered for water needs analysis in this process.

**Repeatability:** Technically speaking, the process is easily repeatable, we have repeated it for the analysis of all new functions to integrate in the multifunctional metro for the 5<sup>th</sup> metro line of Lyon. Repeatability comes here from the simplicity of the process, it is clear that a process involving more inputs and/or more outputs would have been inevitably less repeatable except if it is very well integrated in working methodologies and if the process is very well mastered. From an institutional point of view, it depends on how administrations are organized, on relations between administrations and interactions between actors.

- Resources of the Enabling System

**Improvement n°9:**

6 Constructibility criteria have been defined in the last chapter related to **Resources of Enabling Systems** at the Operational level and required to be analyzed: Efficiency, Availability, Accessibility, Workability, Reliability, Ambivalence.

Only few resources have been used to analyze needs, the project manager of the 5<sup>th</sup> line of Lyon, interviews with experts at the Grand Lyon and myself. The process applied to identify opportunities of mutualization can be considered as efficient.

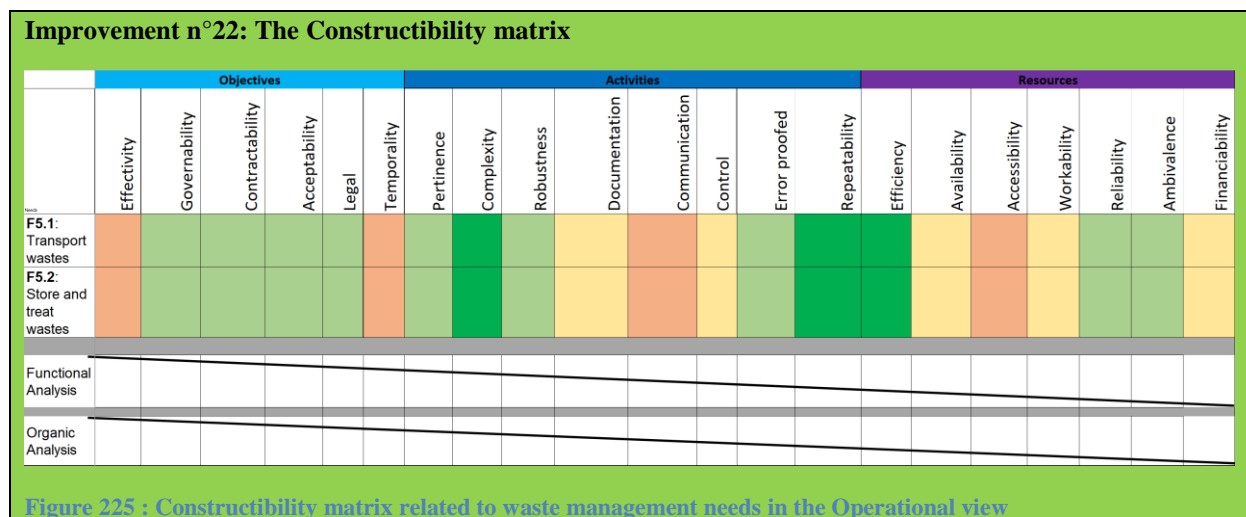
**Availability:** Information about waste needs are available from experts of the Grand Lyon and from professionals working in the management system (also from the Grand Lyon). We have not been able to assess availability of all information related to wastes needs (flows, types, origin, destination etc.).

**Accessibility:** Information about the waste management system are accessible through professionals and experts at the Grand Lyon. No information have been found don internet or through the open data portal of the Grand Lyon. Accessibility of waste information can be considered as medium.

**Workability:** Workability of information gathered from interviews from the Grand Lyon is low: it consists of documents and maps in pdf.

**Reliability:** Reliability of experts sayings about wastes needs and interviews carried at the Grand Lyon is high, the Grand Lyon is managed all the waste system and is the main stakeholder in operation.

**Ambivalence:** Information gathered and analysis carried can be used for other studies.



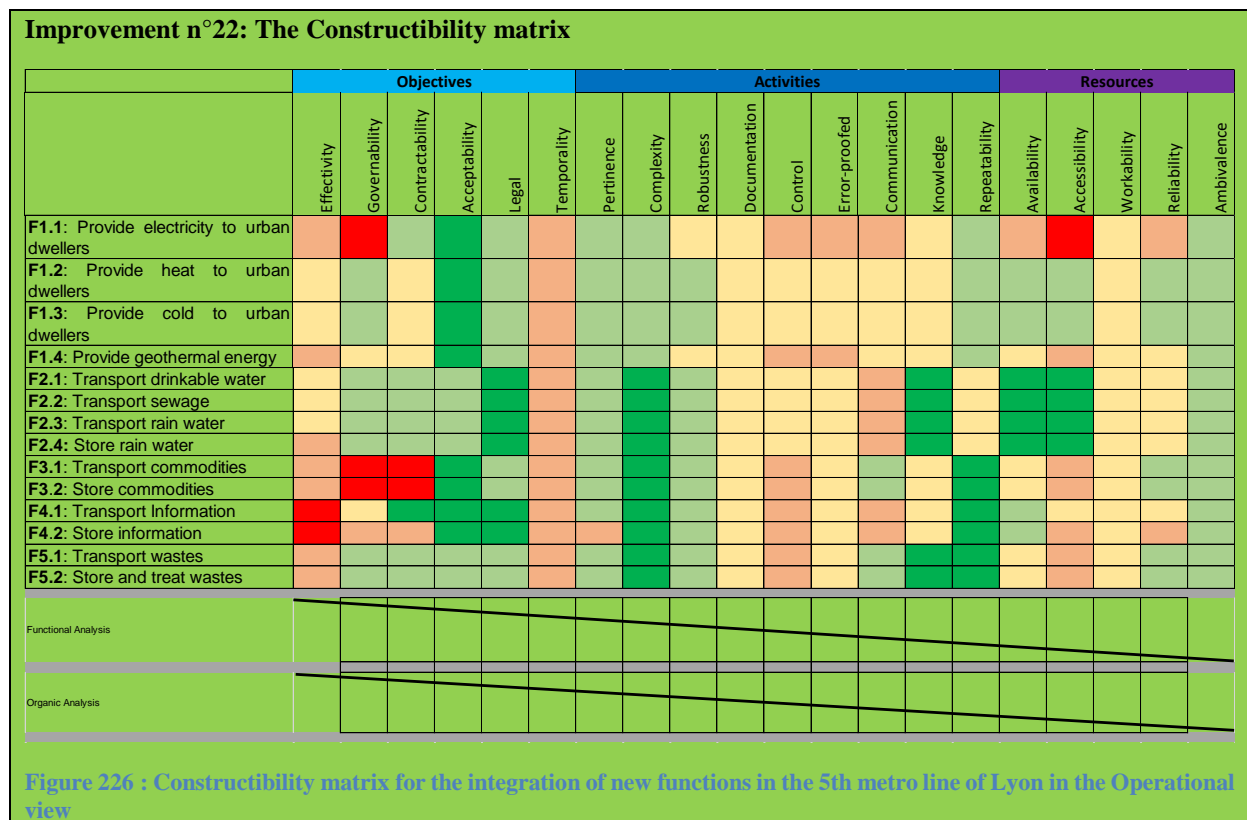
### Conclusion

The Constructibility analysis carried for the integration of new functions in the 5<sup>th</sup> metro line of the Lyon metro has greatly enriched the “classic” Functional Analysis. More than the identification of potential External Functions, the Constructibility analysis has allowed identifying the different constraints from the Enabling System which entail limitations for its development notably (Figure 226):

- A governance problem (i.e. a decision making problem): organization of cities in silos greatly hinders possibilities of mutualization, the fact that each department is responsible for a specific urban function implies that decisions are made related to each function independently of the others. In our case study, even if interesting mutualization opportunities have been identified, it is not certain that the Sytral will be eager to integrate them in further studies for the 5<sup>th</sup> metro line, the main reason being that it is not the mission of the Sytral to improve the energy or water sector and they have no decision power neither responsibility on them.
- The choice of a “simple” process to identify mutualization opportunities have advantages: it is easily repeatable and it is not sensitive to external events. However, this process is not the most effective as needs are not defined very precisely. More studies would be required to define properly the needs. The

choice of this process is also due to the low accessibility of resources, so-called data, related to urban functions. Even if some of them are available in the OpenData website of the Grand Lyon or in the INSEE website most of them are still not available (sometimes for very good reasons) for everyone. The use and application of a more complex process would have allowed a better identification and characterization of needs, however, it would have implied more modeling and engineering knowledge complexifying the process and making it less flexible. We find here again that improving the System of Interest (in this case needs the system will answer) has inevitably impacts on the Enabling System which have to be considered.

Finally, only when the Constructibility analysis has been carried it is possible to decide which need will be investigated deeper in detail and then integrated in the system. We have identified that “provide heat”, “transport information”, “transport merchandises”, “store water”, “transport water” are potential interesting needs to integrate in the future metro system. In the next step (not carried in the thesis), it will be necessary to quantify and analyze more in detail these needs over space and time to assess if it is worth to integrate them in the system. Only then the final decision could be made on their integration or not in the system.



Spatial analysis have allowed identifying and analyzing potential functions to integrate, when available maps and location data have been used. It shows that even at the Operational level, space needs to be integrated in the analysis. Space does not help to analyze, it is fundamental in the development of construction systems.

In this example, only the Constructibility analysis of the operational view (needs) has been carried. It shows that even at this stage and for this type of activity a Constructibility analysis is worth doing (and not only at the realization stage for organic elements like it is usually done). During our interviews with the Grand Lyon as well as interviews with professionals of the different studied sectors (notably, Alstom, Sogaris, Dalkia, Veolia, Keolis, Vinci Energie).



### 4.3. Case Study n°2: Application of the method at the sub-system level: the broadband network of the line 16 of the Greater Paris project

In this case study, only one subsystem of the optical network is analyzed: the necessary system to integrate the optical network system over space with the metro system, i.e. the infrastructure (Figure 227).

Tool n°1:

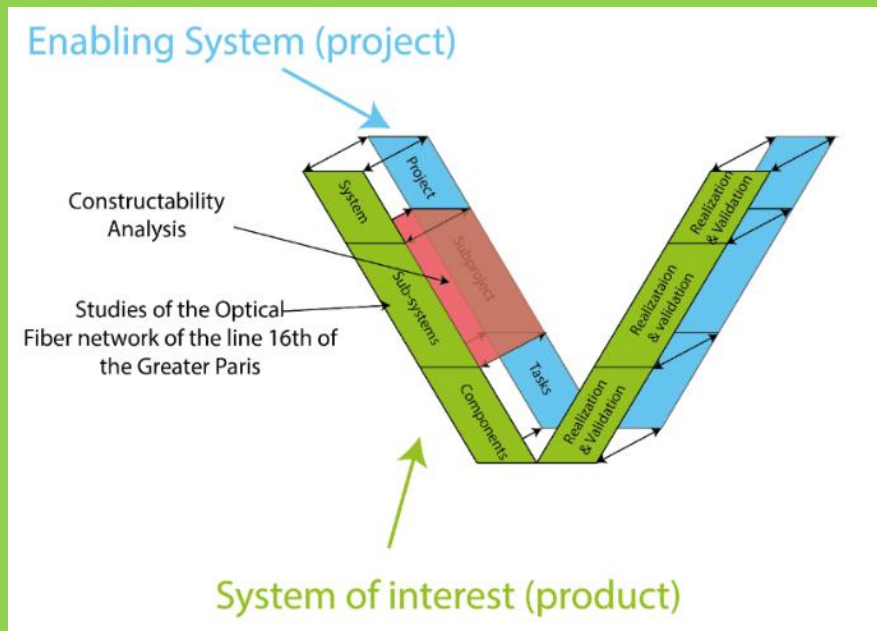


Figure 227 : Studies of the “construction subsystem” of the broadband system for the line 16 of the Greater Paris project in a System Engineering and Constructibility context

Compared with the other Case Study, the three architectural views are analyzed (Operational, Functional and Organic) and constraints related to Enabling Systems are evaluated in each of these architectural views. Operational, Functional and Organic requirements are sum up in the following paragraphs, they have been described much more in detail by the Société du Grand Paris in the “*Programme du Grand Paris Numérique*” but without making the distinction between types of requirement, without being formalized in SysML and without considering interactions with the Enabling System.

Constructibility analysis have led to the definition of Constructibility requirements which have been formalized in Exegis, the SysML tool developed at Egis to manage and model requirements Figure 237, Figure 253, Figure 240.

#### 4.3.1. Operational View analysis

##### 4.3.1.1. Needs analysis

The first view to analyze is the Operational View, in this view needs the broadband network of the Greater Paris line 16 are identified, described and analyzed (Figure 228).

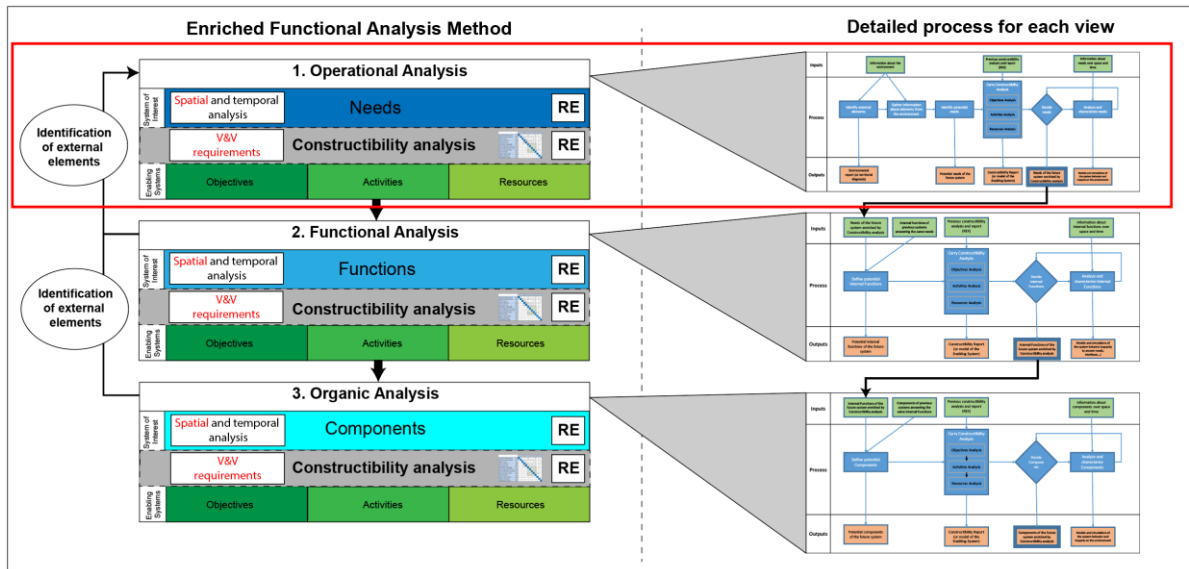


Figure 228 : Operational Analysis for the broadband system of the Greater Paris line 16. In the red sidebar is also detailed the working flow to carry the Operational analysis.

Needs the Optical Fiber network has to fulfil at the sub-system level are the functions of the broadband network system defined at the system level by the SGP (Société du Grand Paris). Operational requirements are written by Société du Grand Paris in a document classified as confidential, only interpretations of this document are used in this thesis.

More precisely in this part we will analyze a subsystem of the broadband network: its infrastructure/construction subsystem.

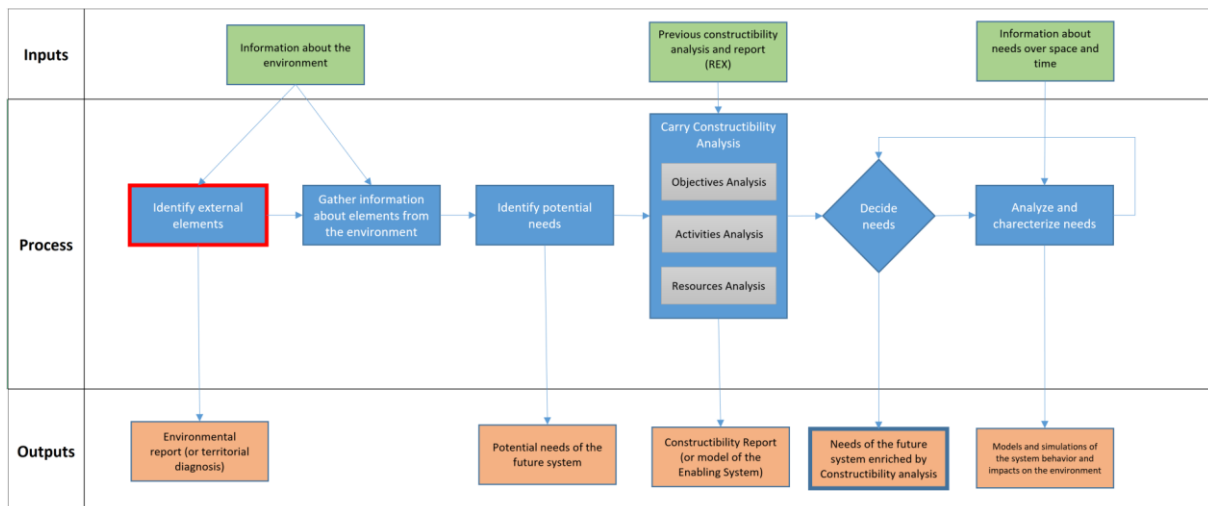


Figure 229 : The working flow undertaken to carry the Operational Analysis

Therefore, needs the construction subsystem has to answer have been modeled with a Use Case diagram (Figure 230):

## Improvement n°16 and 20:

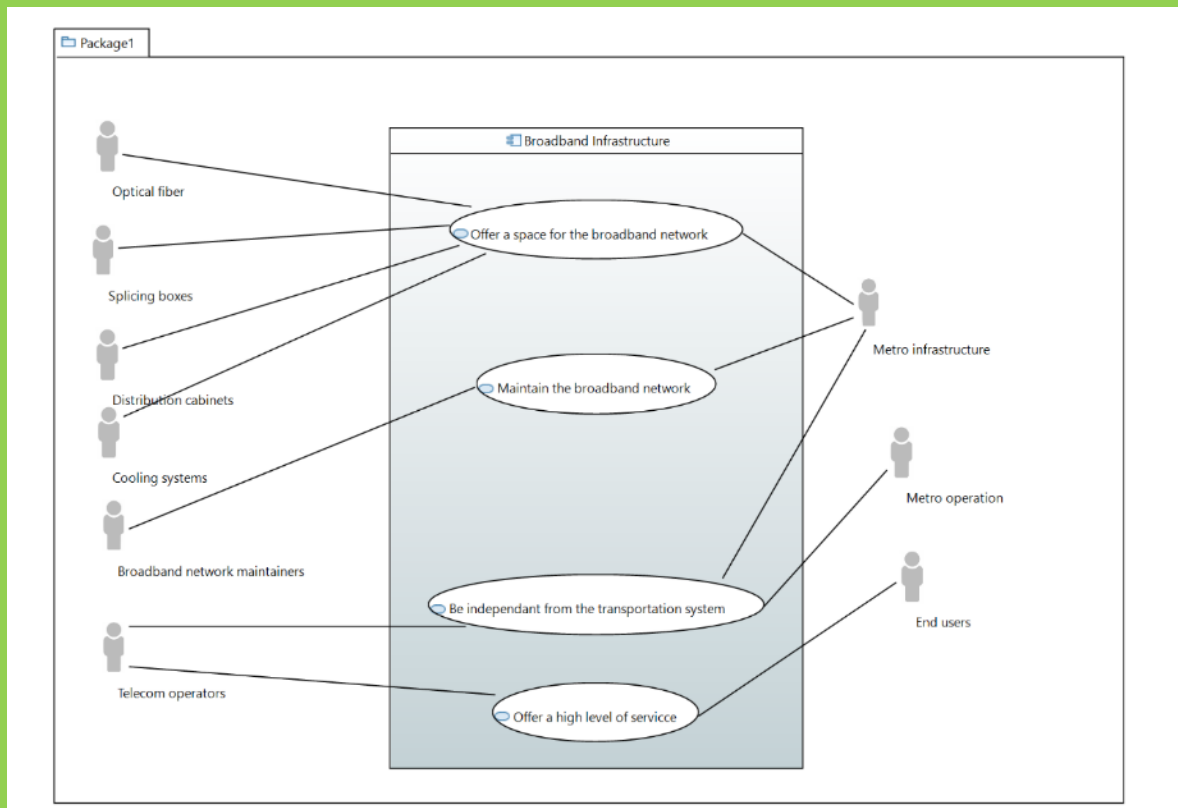


Figure 230 : Needs of the infrastructure broadband network modeled with a Use case diagram. In the middle are main functions of the future system and on both sides are represented stakeholders in interaction with the future system.

All Operational requirements have been modeled with Use Case diagrams in SysML in the requirement engineering tool developed as part of this thesis: Exegis.

Needs the construction subsystem will answer to support the broadband network are to offer space for the broadband network, offer space for maintaining the broadband network, offer space to operate the broadband network, separate spaces dedicated to the broadband network from spaces dedicated to the transport system an allow a high level of service for the broadband network.

To define needs properly over space and time, it is necessary to gather information. In the following part main functions and sub-functions expressing needs the broadband infrastructure answer are described and modeled with Exegis (a SysML tool) (Figure 237).

- **MF1:** Provide space for the broadband network system

Offer a space for physical subsystems of the broadband network has been the first need identified. It is only at the subsystem level when the construction part becomes a subsystem that this need arises. More precisely, at the system level, the system is considered as a block box and no difference is made between the subsystems, there is not a “construction” subsystems in interfaces between other subsystems but only a system with functions.

This first need is ambiguous as it means that spatial characteristics of the broadband system have already been defined: their geometry, their position in a referential and their topology with eventual other elements of the system. This description was indeed defined by “Programme Fibre optique du Grand Paris Numérique” which details the required spaces for the different elements of the broadband network:

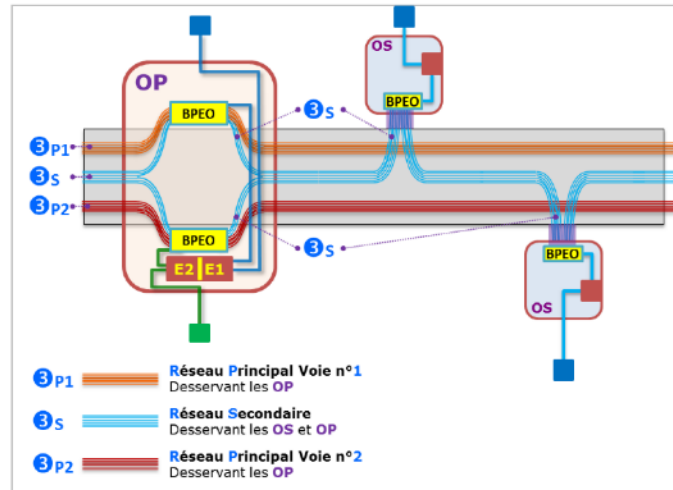


Figure 231 : the broadband network system of the Greater Paris project. Are represented the main elements of the broadband network required: slicing rooms, optical fiber paths (secondary and primary networks), technical rooms, the tunnel, stations and shafts of the metro infrastructure.

In Figure 231 are represented spaces related to some subsystems of the broadband network developed in the Greater Paris project: the optical fiber subsystem (in red, orange and blue lines), the splicing subsystem (yellow boxes), telecom bays subsystem (red boxes), connections with external operators subsystem (navy blue and green lines). Are not represented in this scheme maintenance and operation subsystems such as reels, cooling systems and required spaces for maintenance and accessibility of the system.

One need the infrastructure subsystem is answering is to offer a space for the subsystems of the broadband network describe above:

- Provide space for optical fiber subsystem

The optical fiber subsystem which function is to transport information is spited into two systems, the primary network is located under the invert and connect stations and shafts equipped with data centers and the secondary network connects all stations and shafts. Both networks are located under the invert in the tunnel (topology) and go from the tunnel to the splicing space, the telecom bays room when they arrive in shafts and stations and finally to the exterior (localization) (Figure 231). It means that one need the infrastructure will have to carry is to fulfill a “space” for optical fibers considering previous topological and localization information. In terms of geometry, optical fibers are defined as follows (Figure 232): optical fibers have a diameter between 25mm and 13mm, a minimum curvature of 5m, 105 optical fibers will have to be integrated and they are located in the metro tunnel, shafts and stations.



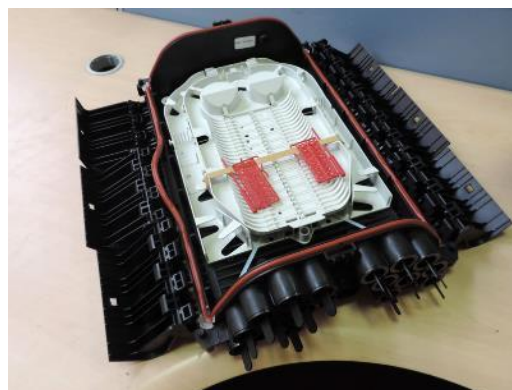
**Figure 232 : Example of an optical fiber cable**

The infrastructure subsystem dedicated for optical fiber wires will have to allow integrating 105 of optical fibers between 25 mm to 13 mm with a minimum curvature of 5 m located below the invert in the tunnel, from the tunnel to the stations or shafts and then from stations and shafts to the exterior. It is important to notice that we haven't describe yet in this part functions (functional view) of the infrastructure subsystem neither its organic elements (organic view).

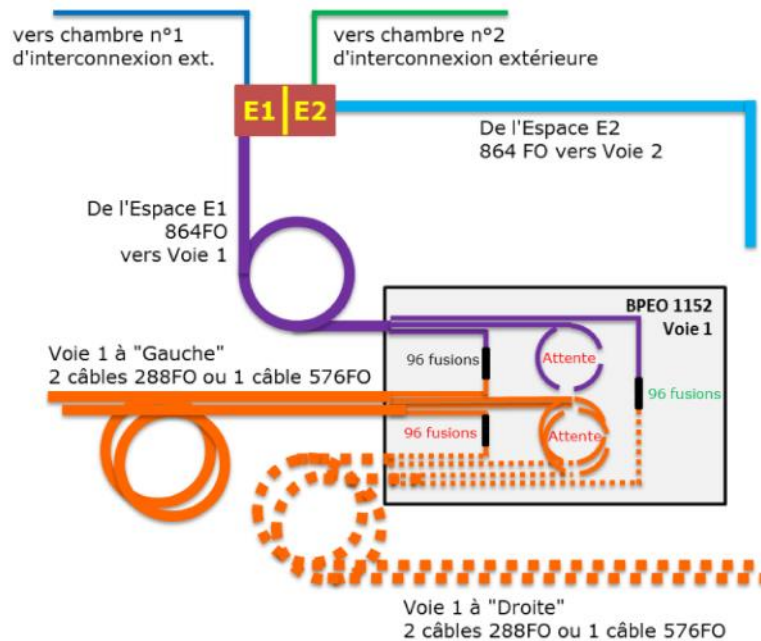
For redundancy requirements, the primary network is separated in two spatially separated networks

- Provide a space for splicing subsystems

Splicing systems are used to connect optical fibers between them. 30 splicing boxes are required for Primary network and 15 splicing boxes are required for the secondary network. Splicing boxes are used to connect optical fibers coming from the exterior and optical fibers in the tunnel. Therefore Splicing boxes are localized between the tunnel and accesses to the exterior (shafts and stations). More precisely, splicing boxes are localized between the tunnel and the technical rooms containing telecom bays used by telecom operators. Space is also required to operate the system: operation of splicing boxes consist in welding optical fibers between them, this operation is undertaken by a technician which means that splicing boxes need to be accessible by a human, a space with a table is required as well as lighting and power supply. Similarly to optical fibers it is possible to describe spatial needs over space: the volume required for splicing boxes operation is  $6 \times 2 \times 2 = 24 \text{ m}^3$  for splicing spaces of the primary network and  $3 \times 2 \times 2 = 12 \text{ m}^3$  for splicing boxes operation of the secondary network. These spaces are located in all elements of the infrastructure where links with the surface are forecast: stations and shafts which contain data centers for the primary network and in all shafts for the secondary network.

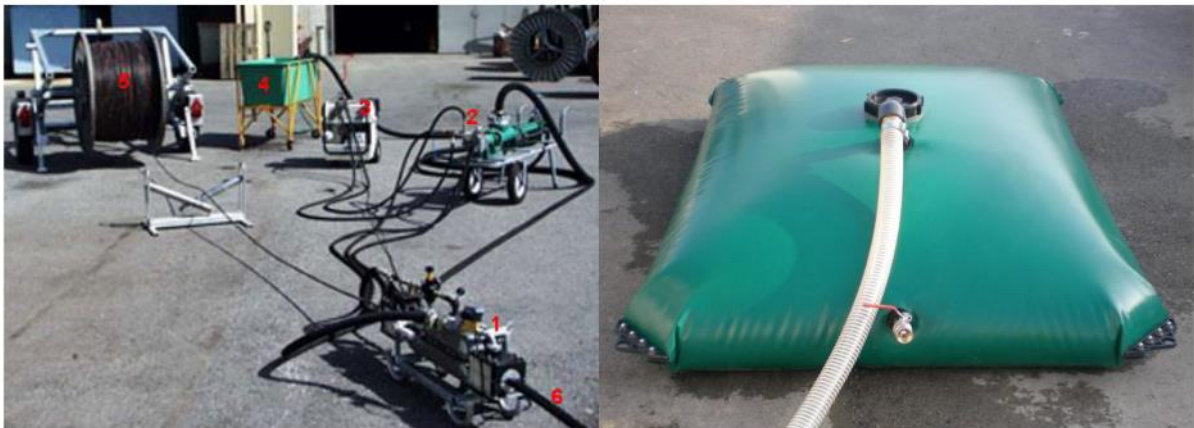


**Figure 233 : Photo of a splicing box**



**Figure 234 : Spaces required in splicing rooms**

Regularly during the lifecycle of the broadband system, optical fibers will be added to the network which requires to “carry” optical fibers in the tubes for a distance between 2 and 4 km (which are potential distances reached between some metro infrastructure elements). Only a water carrying method can reach such distances. It implies that water supply evacuation should be available in splicing spaces and enough space to install the water carrying machine.



**Figure 235 : Photo of a water cable carrying system. In the left the engine require to “blow” the cable into the tube. In the right the water tank required to inject water in the tube.**

- Provide a space for distribution cabinet subsystem over space

Telecom bays regroup active elements of a broadband network. In the case of the Greater Paris project they consist in future active equipment of the future operator of the network, evolutions of these equipment into NFV (Network Function Virtualization) and SDN (Software Defined Networks). Other operator of the broadband network to “activate” their optical fibers. Active equipment of mobile operators. Active equipment of web services providers.



**Figure 236 : Example of a distribution cabinet**

Spaces required (also called technical rooms) for distribution cabinets have the following specifications: a surface between 50 and 100m<sup>2</sup> in stations and 20m<sup>2</sup> in shafts.

Active equipment in distribution cabinets required to be cooled. The cooling system is not described in this thesis whereas its integration in the metro infrastructure is also required (and it has been carried during the studies at Egis).

- Provide space to connect the broadband network of the Greater Paris to external networks

Each room will have the capability to pass through 30 cables for the primary network and 15 cables for the secondary network and their associated slicing boxes to connect cables. The room will have to be able to support circulation of heavy vehicles such as emergency vehicles at the surface. Interconnection rooms will be located at proximity of each station or shaft where the broadband network gets out.

- **MF2:** Be independent from the transport system

Accesses to the broadband system have to be independent from operation spaces and public areas and have to be secured. An operator with its maintenance tools has to be able to access the technical rooms dedicated to the broadband networks where distribution cabinets are.

Splicing rooms also have to be accessible by an operator with its maintenance tools without passing by a public area or operation areas of the metro system.

These requirements are necessary to provide an independent access h24/h24 without interfering with operation of the metro system.

#### *4.3.1.2. Constructibility analysis*

Before deciding if needs will be integrated or not in the system, it is necessary to carry a constructibility analysis to evaluate constraints for its development related to previously defined needs.

- Objectives of the Enabling System

**Improvement n°9:**

6 Constructibility criteria have been defined in the last chapter related to **Objectives of Enabling Systems** at the Operational Level and required to be analyzed: Effectivity, Governability, Contractibility, Acceptability, Legal, Temporality.

**Effectivity:** All spaces dedicated to the broadband network have been integrated in the metro infrastructure (stations, shafts, tunnels) and their dimensions have to answer to defined requirements. The Enabling System was effective in the sense that all requirements related to the System of Interest have been taken into account in the design of the metro infrastructure.

**Governability:** Requirements related to the broadband network were defined partially by Société du Grand Paris, Egis team responsible for systems requirements and Egis teams responsible for infrastructure requirements. Even if, at the end, it is the Société du Grand Paris which takes the decisions, there was sometimes conflict between Egis teams for the definition of technical requirements due to this sharing in an unclear decision making system.

**Contractibility:** No particular issue has been identified related to contractibility, only two stakeholders are involved Egis and the Société du Grand Paris.

**Legal:** Integration of the broadband system requirements in the metro infrastructure is incorporated in the law about the Greater Paris project.

**Acceptability:** integration of the broadband network requirements was hardly accepted by project stakeholders, mainly because the program arrived late in the studies implying a lot of changes and modifications and also because people are not used to integrate broadband networks in a metro system. Integrating a new function such as transport information for external operators is unusual in a metro project, such changes and innovations are not always welcome by design teams.

**Temporality:** Delays in the definition of the broadband network requirements from Société du Grand Paris have greatly impacted the project, some spaces have had to be modified due to the integration of broadband requirements and some others have just can't be integrated. Moreover, needs related to flows of information and therefore in optical fibers to install are vague and uncertain, at the beginning only 3 optical fibers are set up while the infrastructure is designed to welcome a total of more than 100 optical cables in 2050.

- Activities of the Enabling System

#### **Improvement n°9:**

9 Constructibility criteria have been defined in the last chapter related to **Activities of Enabling Systems** at the Operational level and required to be analyzed: Complexity, Robustness, Documentation, Control, Error-proofed, Communication, Knowledge, and Repeatability.

**Pertinence:** all spaces related to the broadband requirements have been modeled in Autocad. Considering the complexity of spaces to model it was not necessary to model them in 3D. The pertinence of activities undertaken to consider broadband requirements is considered as satisfactory.

**Complexity:** The difficulty in the activities to undertake to model spatial requirements related to the broadband network was essentially coming from the dissemination of requirements in different documents sources from the program of the SGP to reports from meetings. It implied a lot of different sources of information and high complexity in the process.

**Robustness:** External elements which can potentially impact the design activities are delayed related to the definition, clarification, explanation of the client (SGP) requirements and/or interfaces with other project teams which would not be studied due to a lack of availability of other engineers. The activity was lacking a project manager who would be in charge of managing internal interfaces in the project to better evaluate and analyze



interfaces. Therefore, the activity was not very robust and was influenced by lack of communications between design stakeholders internally in the project.

**Documentation:** The process to consider spatial requirements from the broadband network was not documented and has not been documented. It was the first time the company undertook such a study.

**Control:** Regular feedback meetings were undertaken with the client and engineers at Egis to control the evolution of the consideration of requirements related to the broadband network

**Error-proofed:** Modeling of requirements in a requirement engineering tool has allowed to check if all requirements have been considering in the design. Even if some requirements have not been integrated in the design (mostly because of a lack of communication, as explained below) at least it was possible to assess which requirements were concerned.

**Communication:** There was low communication between engineers in charge of the integration of the broadband network in the design and other engineers in the project. Modifications of the metro infrastructure related to the integration of broadband requirements were not always considered are too late to be taken into account. This lack of communication have led to gaps in the design.

**Knowledge:** the required knowledge to undertake the activity is not complex. It concerns only the consideration of spatial requirements.

**Repeatability:** The process is hardly repeatable as the requirement gathering was made from a lot of sources from documents written by the client to meeting reports and phone calls. A more structured flow of information between stakeholders would have allowed a better repeatability.

- Resources of the Enabling System

#### **Improvement n°9:**

6 Constructibility criteria have been defined in the last chapter related to **Resources of Enabling Systems** at the Operational level and required to be analyzed: Efficiency, Availability, Accessibility, Workability, Reliability, Ambivalence.

**Efficiency:** 2 engineers at half time and several meetings with the client for a duration of 6 months have been required for the integration of requirements related to the broadband network. Considering the number of requirements to consider and complexity of their integration, we can consider that the level of efficiency was satisfactory compared with the integration of similar subsystems in the project.

**Availability:** All the required information to design the broadband system and notably needs from the client were available through documents or by contacting the client. The level of availability of information was satisfactory.

**Accessibility:** The client was easily accessible to share its needs and requirements. Several feedbacks with the client have allowed better considering its needs. Information had a great level of accessibility.

**Workability:** Workability of information shared with the client was very low, needs and requirements were not formalized, and it was mostly through written documents and schemes which has led to misinterpretation in several occasions.

**Reliability:** Reliability of the client information was high. Having a direct and regular contact with the Société du Grand Paris have improved reliability of information shared.

**Ambivalence:** Requirements gathered from the client can be reused in other projects to advise other clients on usual requirements related to the integration of a broadband network, to compare its own requirements with requirements of SGP and to reuse parts of design when requirements are similar.

**Financiability:** define and implement needs related to the construction subsystem of the broadband network was part of the contract between Egis and the SGP, it was clear for each part that Egis was responsible for the implementation of the broadband network and financing of its design. No financiability issues have been identified.

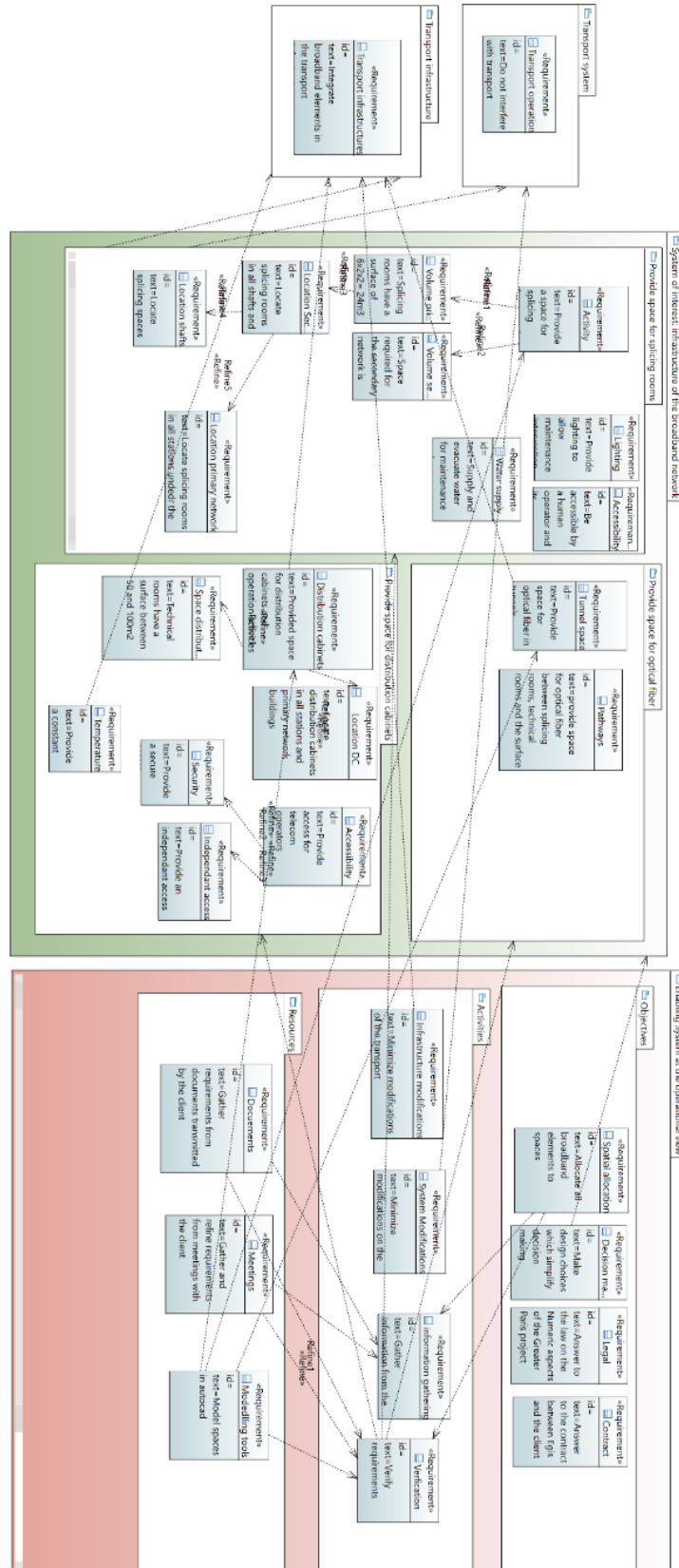


Figure 237 : Interactions between requirements of the System of Interest and the Enabling System. In the green space are requirements related to the System of Interest (what the future system should be and do). In the red space are requirements related to the Enabling System (how the system should be designed and built). Interactions between requirements have also been modeled.

### Improvement n°22: The Constructibility matrix

	Objectives					Activities						Resources										
	Effectivity	Governability	Contractibility	Acceptability	Legal	Temporality	Pertinence	Complexity	Robustness	Documentation	Communication	Control	Error proofed	Knowledge	Repeatability	Efficiency	Availability	Accessibility	Workability	Reliability	Ambivalence	Financiability
F1: Provide space for the broadband network system	Green	Yellow	Green	Orange	Green	Orange	Green	Green	Orange	Orange	Green	Green	Green	Green	Green	Green	Green	Green	Yellow	Green	Green	Green
F2: Be independant from the transport system	Green	Yellow	Green	Orange	Green	Orange	Green	Green	Orange	Orange	Green	Green	Green	Green	Green	Green	Green	Green	Yellow	Green	Green	Green
Functional Analysis	[Line graph showing a downward trend from left to right]																					
Organic Analysis	[Line graph showing a downward trend from left to right]																					

Figure 238 : The constructibility matrix related to the Operational view of the construction subsystem of the broadband network

Results of the Constructibility analysis allow deciding if it is worth to analyze further in detail previously mentioned needs in the infrastructure.

Finally, after having considered the constraints related to the analysis of needs the broadband infrastructure, it has been necessary to “derogate” to some Operational requirements: in some cases spaces were not available in stations and shafts to host broadband system elements. For different reasons it has been chosen not to answer Operational requirements: because it would be too costly to enlarge stations or/and shafts for the broadband network or because it would require to re-design totally the station or/and shaft to integrate requirements related to the broadband system. We can highlight that needs haven’t been answered for different reasons: in some cases it was because there was simply no space available, which would be related to “effectivity” in the other cases, space is available however it would be required to re-design the station which would require too much design efforts (complexity, availability, financiability criteria).

In some of these cases, broadband needs are simply not answered and the system is not integrated, in other cases it has been possible to integrate the broadband system in a “degraded” mode (needs were answered only partially, as instance a lower space was dedicated to the broadband network than what was mentioned in Operational requirements).

#### 4.3.2. Functional View and the enabling system

Functions of the system consists in defining what the system “does” over time and over space. In this case the system considered is the “infrastructure” subsystem of the broadband system. We will analyze what the infrastructure subsystem “does”. In the case of the broadband system, functions of its infrastructure subsystem are under “classic” performance of functions of a metro infrastructure. Therefore, the functional analysis didn’t require a lot of efforts. We remind that we refer in the functional view of internal functions of the infrastructure subsystem, internal functions are concretization of principal functions of the system defined in the operational view (Figure 239).

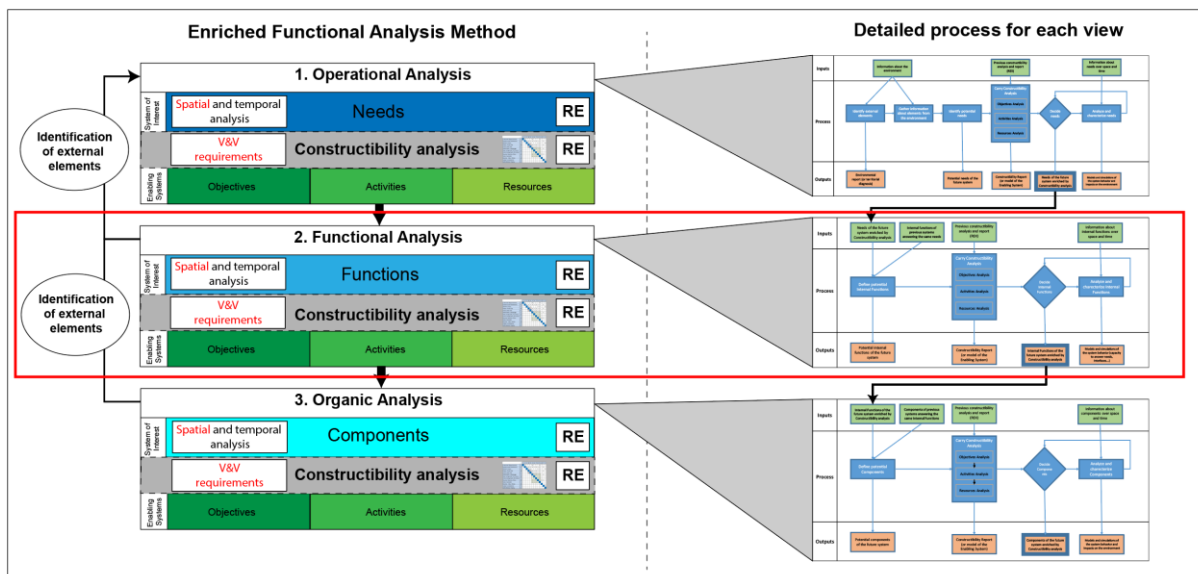


Figure 239 : Functional Analysis for the broadband network of the line 16 of the Greater Paris. In the red sidebar the working flow to carry the Functional Analysis is also detailed.

#### 4.3.2.1. Functional analysis

The first step of the Functional Analysis view is to identify potential Internal Functions which can potentially answer to previously identified needs.

- F1: Offer space for broadband elements
  - F1.1: Support the weight of broadband network elements

The first function is to support the weight of broadband elements (optical fiber, slicing boxes, servers, reels). Weight of these elements are negligible compared to other elements of the metro system, a weight of 500 kN/m<sup>2</sup> has been considered which is the minimum weight considered for floors for the infrastructure elements. This value is much higher than the maximum weight of broadband elements.

- F1.2: Support its own weight

Infrastructure elements have to support their own weight which has been considered in structural models of the infrastructure.

- F2: Be independent from the transport system
  - F2.1: Resist to high temperature

Most of the broadband elements and more precisely rooms containing these elements have fire resistance requirements. Fire resistance requirement is to be fire resistant for 1h in optical fibers pathways and technical rooms. Such a requirement is classic for a metro infrastructure and common infrastructure components can fulfill this requirement (most of metro infrastructure elements are 2h fire resistant). Nos specific analysis has been carried to model this function.

- F2.2: Resist to rolling stock crashes

The infrastructure protecting cables in the tunnel will have to resist to eventual rolling stock crashes. To ensure this function optical cables have been located in the invert of the tunnel. No more modeling activities have been carried to evaluate if the concrete of the invert can resist to a rolling stock crash.

- F2.3: Absorb noise vibrations

To isolate technical rooms and slicing rooms from public areas and areas dedicated to the operation of the metro system it is required to absorb noise vibrations related to operation of the broadband network. Noise impacts of the broadband network have not been identified as problematic and no particular noise modeling activities have been carried.

- F2.4: Hinder visibility

To isolate technical rooms and slicing rooms from public areas and areas dedicated to the operation of the metro system it is required to hinder visibility of broadband elements. It implies that walls won't be transparent and will block visibility.

Note: these functions are not dissimilar with functions of buildings defined by Gobin in (Gobin, La constructibilité - Une approche duale de la Construction, 2017) with the difference that spaces dedicated to broadband elements are welcoming non-human systems.

#### 4.3.2.2. Constructibility analysis

- Objectives of the Enabling System

#### **Improvement n°9:**

6 Constructibility criteria have been defined in the last chapter related to **Objectives of Enabling Systems** at the Operational Level and required to be analyzed: Effectivity, Governability, Contractibility, Acceptability, Legal, Temporality.

**Effectivity**: As functions realized by the infrastructure for the broadband system can be considered as “classic” and even negligible compared with other components the metro infrastructure will have to support. Therefore functional modeling activities have been reduced to the strict minimum and effectivity is evaluated as low.

**Governability**: Infrastructure elements required for the broadband system are usually shared with other subsystems of the metro infrastructure (shafts, stations, tunnels etc.). Most of the structural modeling activities have been carried by infrastructure teams at Egis. In most cases, broadband elements are not dimensioning for the infrastructure, the fact that structural calculations were carried internally drastically reduced governance issues.

**Contractibility**: Contractibility level is high, as studies are all carried internally in Egis teams.

**Legal**: No legal barriers have been identified.

**Acceptability**: Most acceptability issues came from the delays related to the integration of broadband requirements which has led to recalculate structural elements. Except that no acceptability issues concerning functional requirements have been identified.

**Temporality**: Delays in the definition of the broadband network requirements from Société du Grand Paris have impacted the project, some analysis have not been carried due to this delay. However, given the relative impact of functional requirements of the infrastructure of the broadband network it had low impacts on the satisfaction of defined requirements.

- Activities of the Enabling System

#### **Improvement n°9:**

9 Constructibility criteria have been defined in the last chapter related to **Activities of Enabling Systems** at the Operational level and required to be analyzed: Complexity, Robustness, Documentation, Control, Error-proofed, Communication, Knowledge, and Repeatability.

**Pertinence:** Given the performance level of functional requirements related to the broadband infrastructure, activities undertaken to define and verify them are pertinent.

**Complexity:** Potential modeling activities can be complex depending on the type of structure to design. In our case the activity only consisted in verifying that characteristics of structures supporting the broadband elements are higher or equal to requirements related to broadband functional requirements. Which was always the case. Therefore, the activity was quite simple to carry with few inputs and outputs.

**Robustness:** Activities undertaken to define and verify functional requirements are robust with only few interactions with external elements.

**Documentation:** The activity was not documented.

**Control:**

Vertical Constructibility:

No control were undertaken during the activity.

Horizontal Constructibility:

Tests have been planned to check that the required space for optical fibers in tubes is available: a mandrelling test is overtaken to verify that tubes are not blocked, hindered, ovalized or too much arched. A leak test is also performed before and after concrete of the invert is cast.

**Error-proofed:** Modeling of requirements in a requirement engineering tool has allowed to check if all requirements have been considering in the design. Even if some requirements have not been integrated in the design (mostly because of a lack of communication, as explained below) at least it was possible to assess which requirements were concerned.

**Communication:** There was low communication between engineers in charge of the integration of the broadband network in the design and other engineers in the project. Modifications of the metro infrastructure related to the integration of broadband requirements were not always considered are too late to be taken into account. This lack of communication have led to gaps in the design.

**Control:** All functional requirements have been defined and verified for each infrastructure elements of the broadband system. Thanks to formalization of requirements in SysML and links with 3D models it was possible to trace easily for each broadband infrastructure elements if they fulfil functional requirements.

**Error-proofed:** No alert is scheduled in case requirements are not met.

**Communication:** Communication on the verification of functional requirements the broadband system were communicated through emails or by voice. This communication process is not very effective as it is not traceable easily and the information can be easily lost.

**Knowledge:** the required knowledge to undertake the activity is not complex. It only consisted in comparing numbers to evaluate if functional requirements are met (which was always the case).

**Repeatability:** The process is easily repeatable.

- Resources of the Enabling System

**Improvement n°9:**

6 Constructibility criteria have been defined in the last chapter related to **Resources of Enabling Systems** at the Operational level and required to be analyzed: Efficiency, Availability, Accessibility, Workability, Reliability, Ambivalence, Financiability.

**Efficiency:** 2 engineers at half time and several meetings with the client for a duration of 6 months have been required for the integration of requirements related to the broadband network. Considering the number of requirements to consider and complexity of their integration, we can consider that the level of efficiency was satisfactory compared with the integration of similar subsystems in the project.

**Availability:** 2 types of resources were required to define and verify requirements: human resources and information. All the required information to define and verify functional requirements related to the broadband infrastructure were available from the client and industrials. Information about the transport infrastructure and transport system were available in documents written by Egis teams internally. Human resources were also available.

**Accessibility:** Accessibility of information was not a problem as well as human resources.

**Workability:** Similarly to other information exchanges with the client, workability of information shared with the client, industrials and internal teams was very low, with a low level of formalization, information were shared mostly through written documents and schemes which has led to misinterpretation in several occasions.

**Reliability:** Reliability of the client information was high. Having a direct and regular contact with the Société du Grand Paris have improved reliability of information shared. They have been checked in comparison with information from industrials which confirmed requirements related to the broadband infrastructure.

**Ambivalence:** Functional requirements gathered can be reused for similar projects which are undertaken in same context than line 16 of the Greater Paris.

The constructability analysis shows that activities to undertake were very simple and basic. It is mainly due to the low performance required for the broadband infrastructure. It shows that “simplifying” the System of Interest has direct impacts on the Enabling System (here basic requirements imply “easy” activities).

In some cases, the position of some broadband elements have been changed in order to avoid to model new structural elements which have not been studied yet. This situation shows that changing the System of Interest (here position of broadband elements) can influence and simplify the Enabling System.

**Financiability:** As most of the functional requirements related to the construction subsystem are mutualized with the metro infrastructure only verifications were carried. This activity was easily financeable and was part of the contract between Egis and SGP. No financiability issue has been identified.



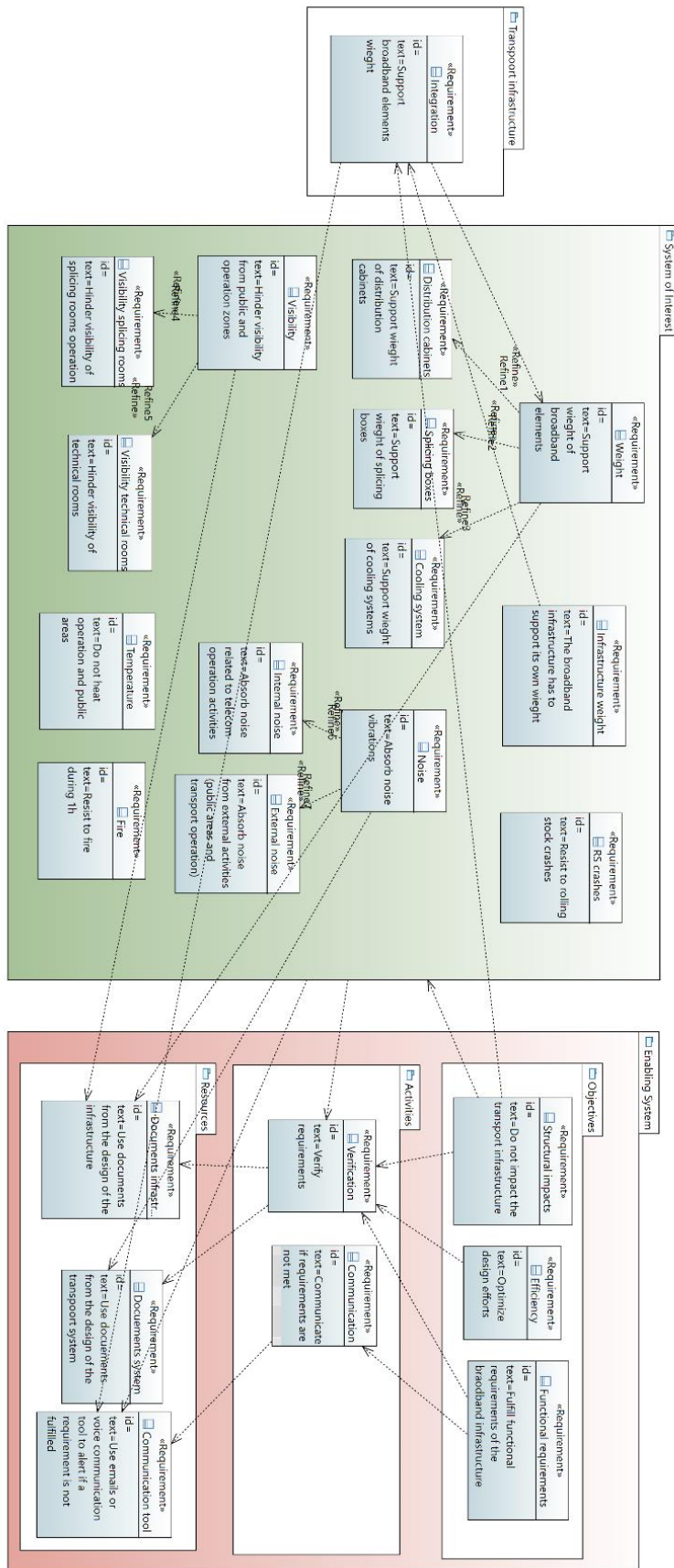


Figure 240 : Interactions between requirements of the System of Interest and the Enabling System in the functional analysis view. In green are represented requirements related to the system of Interest (what the system has to do) and in red requirements related to the Enabling System (what is required to develop the system) and interactions between both.

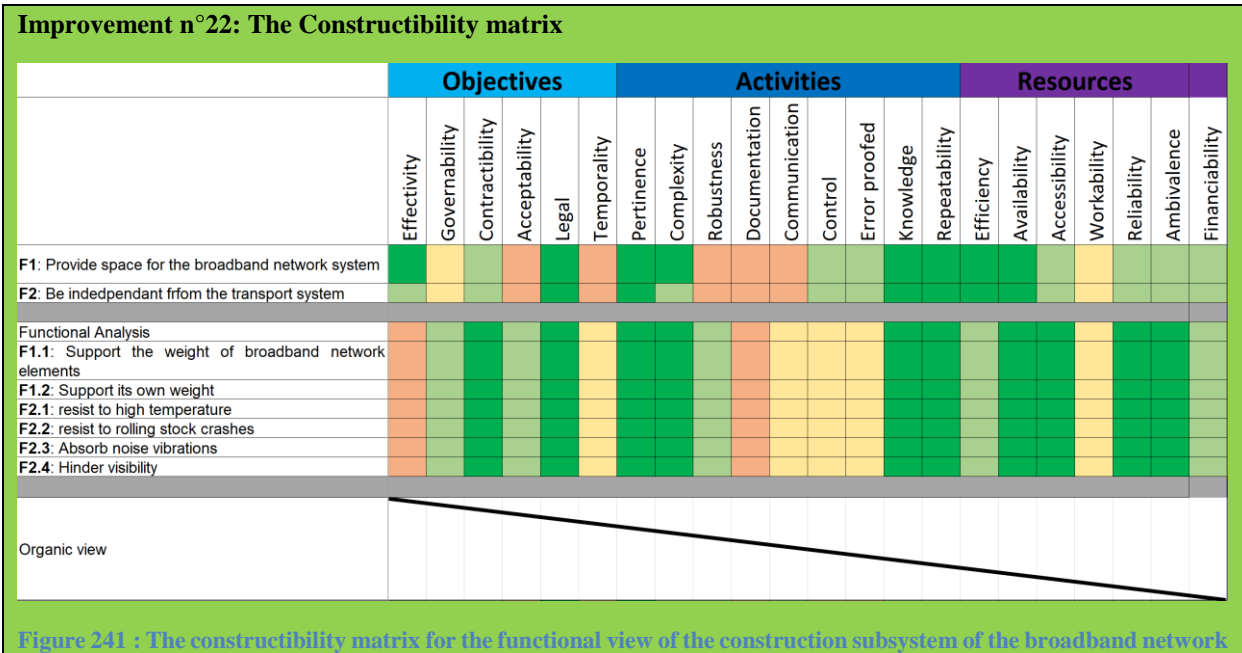


Figure 241 : The constructibility matrix for the functional view of the construction subsystem of the broadband network

### 4.3.3. Organic analysis and the enabling system

#### 4.3.3.1. Organic analysis

In the organic analysis, infrastructure components of the broadband network are described concretely, notably their dimensions and compositions. In the following paragraphs, some organic requirements are defined as well as Constructibility requirements related to this view (Figure 242).

Note: not all requirements have been defined as part of the thesis as the objective is to show interactions between the System of Interest and the Enabling System more than described exhaustively all organic requirements.

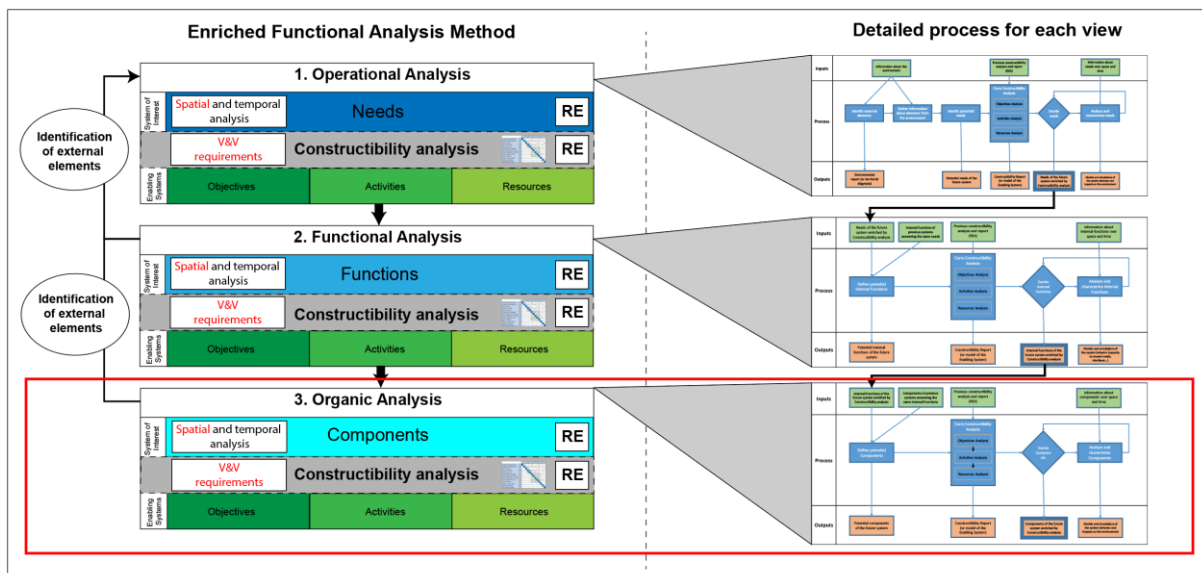
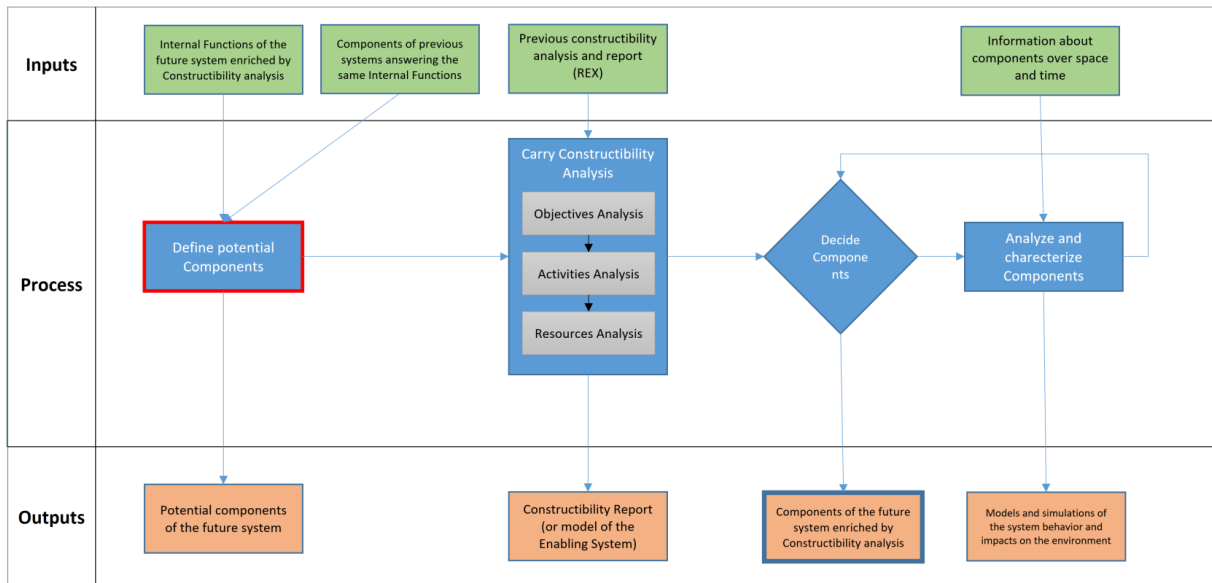


Figure 242 : Organic Analysis for the broadband network of the Greater Paris line 16

The first step consists in identifying potential components which will answer to Internal Functions of the broadband system (Figure 243).



**Figure 243 :** This diagram represents the workflow used to carry the Organic analysis for the broadband network of the Greater Paris project.

- Tubes in tunnels

To protect and guide optical fibers in tunnel, the choice of tubes has been made. Each Optical fiber cable has its own tube as we will see later for Constructibility reasons. Diameter of each tube is 40% to 80% higher than the diameter of cables: between 22mm and 32mm. Tubes are standard HDPE based (High Density Polyethylene) like PE80 and should be certified AFNOR NF 330. Tubes can be assembled on site or pre-assembled off site. They have to resist a pressure minimal of 10bars, have friction coefficient inferior or equal to 0.1, to be finned inside and pre-lubrifed. Tubes will be equipped of waterproof caps to avoid inflows of water, materials, dust and fire. The minimum curvature radius of tubes is 5m when entering in stations and 2m in other cases (with a tolerance of 1m). Minimum length of tubes is 400m without connectors.



**Figure 244 :** Example of HDPE tubes/tubes

Set of tubes are bonded with a high level of flexibility and adaptability to ease their setting (Figure 245). Set of tubes are set as far as possible from other types of network in the invert of the tunnel to avoid interactions particularly during installation (Figure 246).

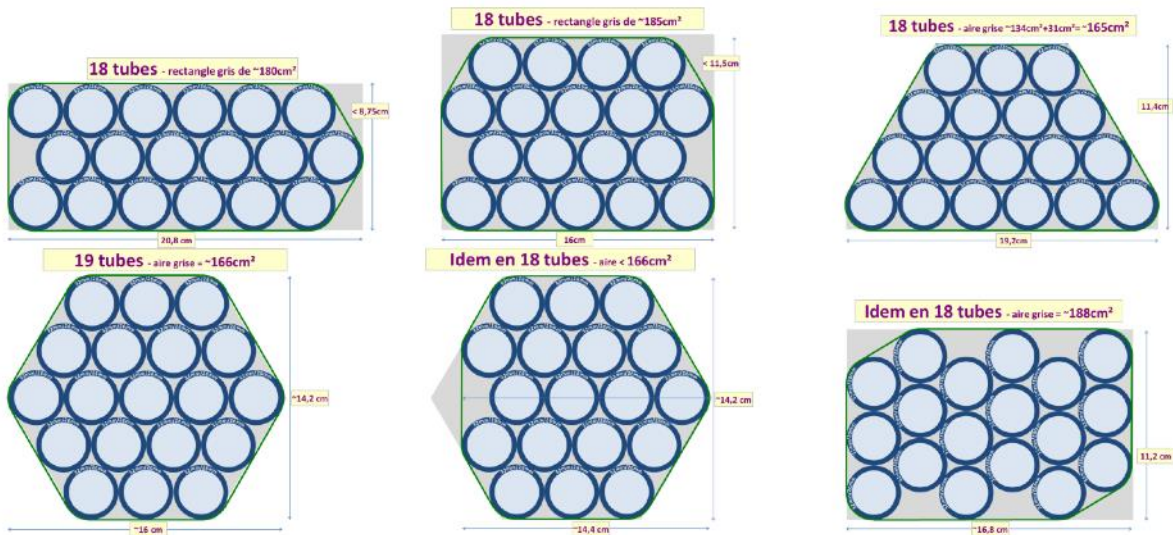


Figure 245 : Example of assembled tubes

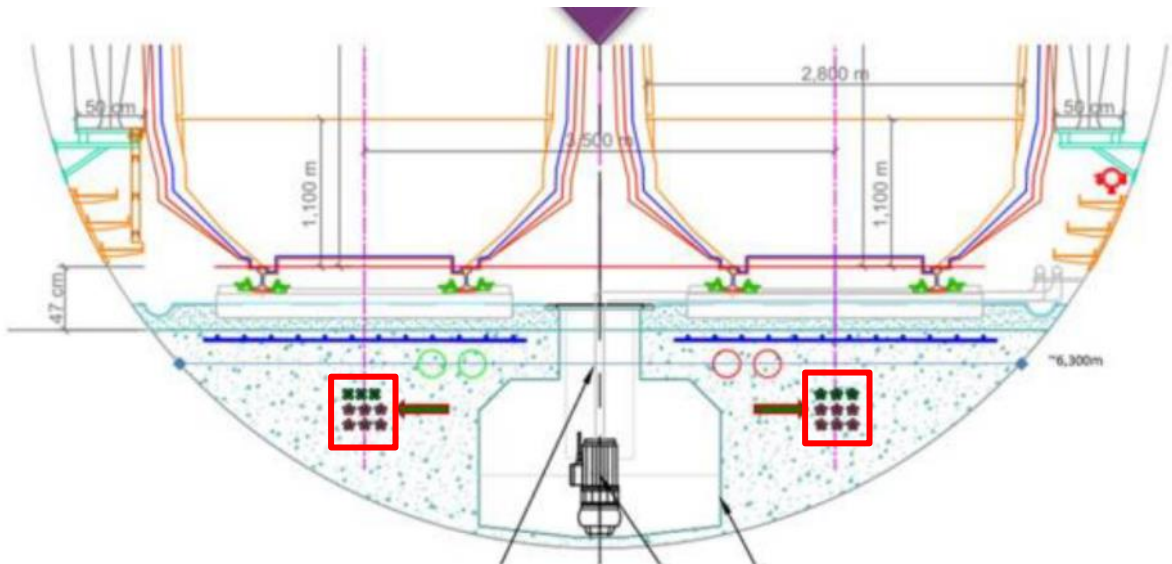
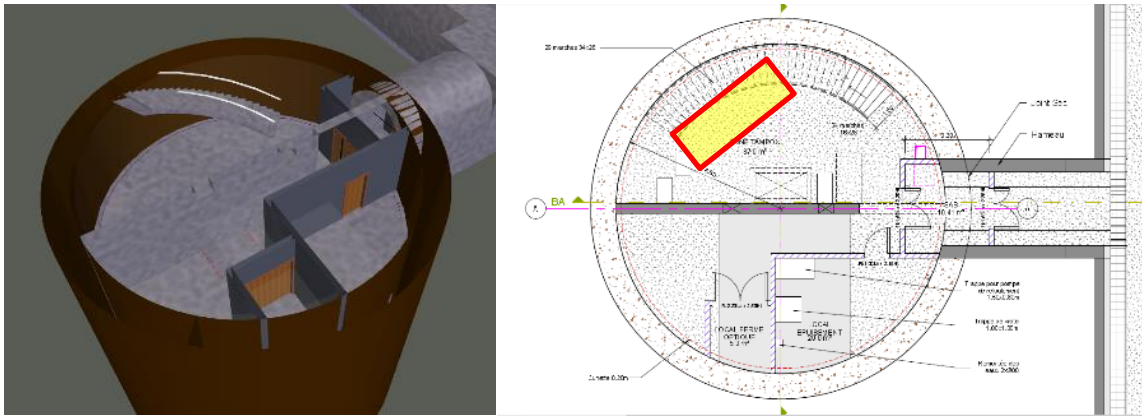


Figure 246 : Example of the position of tube sets in the invert of the tunnel. Tubes dedicated to optical fibers are located in red squares in the invert.

- Splicing rooms in shafts and stations

Splicing rooms are mutualized with other spaces required for the metro infrastructure: under platforms and at the bottom of shafts (Figure 247). Therefore, splicing rooms take the Characteristics of rooms they are integrated in. Organic requirements related to splicing rooms are reduce to the minimum: Splicing boxes can be stored in cabinets or on hooks hung on walls. If the two splicing rooms required for both branch of the primary network are nearby, it is required to separate them by a partition resisting to fire for 1h.



**Figure 247 : Example of a shaft integrating a space dedicated to slicing boxes. On the left the shaft is represented in 3D using Navisworks® and on the right in 2D using Autocad®. The space dedicated to splicing boxes is represented in yellow.**

- Path ways from shafts/stations to technical rooms and the surface

Each path way has a diameter of 2 dm<sup>2</sup> in order to channel 30 cables with a diameter of 25mm in stations and a diameter of 1 dm<sup>2</sup> in shafts in order to channel 15 cables with a diameter of 25mm. Path ways don't require to be protected (CTP).



**Figure 248 : Example of non CTP path ways**

- Technical rooms in stations and in shafts

Technical rooms have been integrated and mutualized in stations and in some shafts where space was available. Therefore, most of the organic elements of the technical rooms (i.e. its walls, floors etc.) are mutualized with other organic elements constituting the metro infrastructure and are therefore designed directly in the metro studies.

The only elements which have to be designed are partitions of the technical rooms. These partitions have no structural functions in stations and shafts and have not required structural studies. However they have to be fireproof for 1h, hinder visibility, absorb noise vibrations and do not spread heat on other metro spaces. These last requirements are functional requirements of the technical room as mentioned in the last paragraph, the only defined organic requirements concern geometry of partitions which have been defined in plans such as Figure 249.



#### 4.3.3.2. Constructibility analysis

- Objectives of the Enabling System

##### **Improvement n°9:**

6 Constructibility criteria have been defined in the last chapter related to **Objectives of Enabling Systems** at the Operational Level and required to be analyzed: Effectivity, Governability, Contractibility, Acceptability, Legal, Temporality.

**Effectivity:** A lot of time was spent to evaluate Constructibility of organic elements. Effectivity can be considered as high as all Constructibility requirements have been considered. However, as we will see further it was not efficient.

**Governability:** There was a classic governability issue related to the construction industry in this view. Organic description of the broadband infrastructure elements have been carried by Egis teams while Egis is not responsible for the realization of the infrastructure. However, definition of organic elements has inevitably impacts on how they will be realized (i.e. its Constructibility). In other words, we (Egis) have defined organic elements which constraints the future Enabling System responsible for its realization without coping with the consequences.

**Contractibility:** The previous governance issue has inevitably impacts on contractibility of the broadband system. It is written in the contract that the company responsible for the realization of tubes is responsible for their functioning or more precisely that 100% of tubes tests presented in the last part have to be passed (i.e. that no tubes are blocked, clogged or have leaks). However, the company which realizes the tubes is not the company which has designed or specified them and they would be responsible for all the damages if tests do not succeed. Here again it is as if the design of the tubes has no impacts on their Constructibility and more precisely here their fabrication and assembling.

**Legal:** No legal issue identified.

**Acceptability:** No acceptability issue identified.

**Temporality:** Integration of the broadband infrastructure elements have inevitably impacts on the planning of the project, particularly the integration of tubes in the concrete.

- Activities of the Enabling System

##### **Improvement n°9:**

9 Constructibility criteria have been defined in the last chapter related to **Activities of Enabling Systems** at the Operational level and required to be analyzed: Complexity, Robustness, Documentation, Control, Error-proofed, Communication, Knowledge, and Repeatability.

**Pertinence:** Given the performance level of functional requirements related to the broadband infrastructure, activities undertaken to define and verify them are pertinent.

##### **Complexity:**

Most of the complexity related to Constructibility comes from the integration of tubes in the invert of the tunnel:

##### Horizontal Constructibility:

The solution used to set up cables in tubes for distances between 2 and 4km is to carry cables by applying a water pressure on it. This Constructibility requirement has led to use of one tube for one cable, to the definition of the diameter of the tubes, their ductility, friction coefficient and the minimum pressure they have to withstand. It is interesting to highlight that a Constructibility requirement (the use of water pressure) has a lot of impacts on the

design of the tubes. The other solution would have been to blow cables in tubes with air pressure, however there is a risk that distances to cover may not be reached.

Tube assembling is another challenge faced during the design of the system, pre-assemble tubes outside the site is expensive and offers less flexibility during installation (but simplifies the design as all tube sets would have been the same), therefore it has been chosen to assemble them on site. Moreover, the only factory offering to pre-assemble tubes was located in Germany implying complexities and cost related to transportation of the tubes and over costs related to lack of competition.

More importantly, how tubes are installed was at stake during the studies: the first possibility would be to set up steel columns in the tunnel manually, to place tubes on it and then to cast the concrete constituting the concrete. This solution requires a lot of workforce to install the steel columns and to place the tubes and is therefore very expensive. The other solution is to cast a first layer of concrete on which trucks equipped with reels bring to the tunnel from shafts can drive on. Then trucks scroll tubes in slots realized in the concrete very rapidly (Figure 251). This last solution is very effective however it implies that the concrete constituting the invert is cast in two times (a first time to allow trucks driving in the tunnel and a second time to finish the invert) without considering consequences on the other subsystems placed in the invert. Impacts of this last solution on subsequent operation and on the planning is too high and it is the first solution which has been chosen. Here again, it is utopian to consider that such choices have no impact on the design of the tubes, as instance it has at least a consequence on how tubes are connected while the client’s requirement is to limit the quantity of connectors between tubes as much as possible.

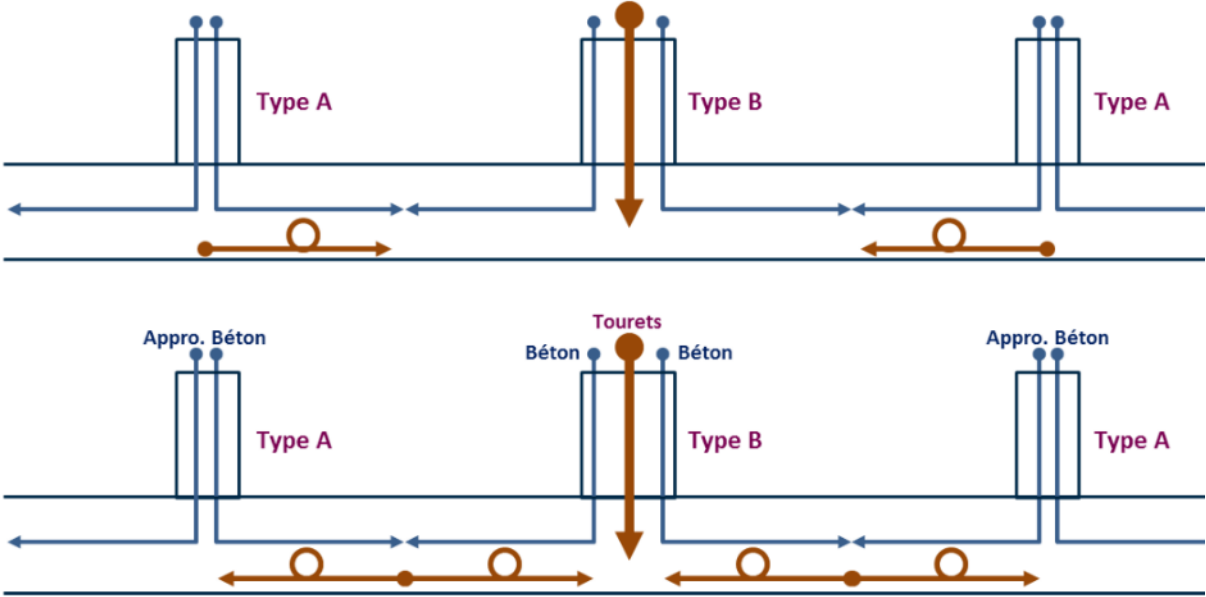


Figure 251 : Tube installation sequence on site. In black are represented shafts, stations and the tunnel. In blue is represented concrete supply and in red how reels will be supplied to the tunnel.

This problematic was the Constructibility issue the most studied during the studies. However other issues have to be resolved such as how distribution cabinets will be transported in technical rooms.

Vertical Constructibility:

Vertical Constructibility is even more complex as it is necessary to evaluate all the potential interactions between tubes integrated in invert of the tunnel and implications on other networks and elements also placed in the invert. It is also necessary to evaluate planning impacts and impacted on the design of the broadband system itself. A lot



of inputs has to be processed to define organic requirements of the tubes some from the installation process and other from the functioning of the broadband system.

This Constructibility criteria is similar to Constructability criteria *Installation Sequence* and *Impact on subsequent operation* defined in the literature.

**Robustness:** Robustness of the previously described process to set up tubes in the tunnel has a lot interactions with other systems installed (electric cables, mine water systems, stray current systems etc.), it can't be considered as robust as all interactions have not been studied particularly during installation of the tubes.

**Documentation:** The activity was documented in documents written and transmitted to the realization companies. The documentation level can be considered as low.

**Control:** All functional requirements have been defined and verified for each infrastructure elements of the broadband system. Thanks to formalization of requirements in SysML and links with 3D models it was possible to trace easily for each broadband infrastructure elements if they fulfil functional requirements.

**Error-proofed:** No alert is scheduled in case requirements are not met.

**Communication:** All functional requirements related to the broadband infrastructure have been transmitted to structural engineers.

**Knowledge:** the required knowledge to undertake the activity is not complex. It only consisted in comparing numbers to evaluate if functional requirements are met (which was always the case)..

**Repeatability:** The process is easily repeatable.

- Resources of the Enabling System

#### **Improvement n°9:**

6 Constructibility criteria have been defined in the last chapter related to **Resources of Enabling Systems** at the Operational level and required to be analyzed: Efficiency, Availability, Accessibility, Workability, Reliability, Ambivalence.

#### **Efficiency:**

##### Horizontal Constructibility:

Efficiency evaluation in term of horizontal Constructibility depends on the organic elements. As instance because most of the organic elements of the broadband infrastructure such as splicing rooms or technical rooms are mutualized with the metro infrastructure the efficiency level is very high: almost no resources are required compared to a broadband infrastructure "alone" to realize the infrastructure as it is shared with the metro. In these cases efficiency is high. Contrarily, other organic elements are only partly shared with the metro infrastructure such as tubes in the invert which will require materials, engines and a lot of workforce to be realized.

##### Vertical Constructibility:

Vertical Constructibility was efficient, only 2 engineers at half time have been involved in the design of the broadband infrastructure which is few compared to other infrastructure subsystems.

Two Constructability criteria from the literature also allows assessing these elements: *Storage* and *Workforce*.

#### **Availability:**

##### Horizontal Constructibility:

Availability of required resources (workforce, engines, materials) to realize the broadband system was hard to assess as these information are mostly held by contractors.

Vertical Constructibility:

All the required information to design the broadband system and notably needs from the client were available through documents or by contacting the client. The level of availability of information was satisfactory.

In the literature, a Constructability criteria was defined to carry similar analysis: Resource availability.

**Accessibility:**

Horizontal Constructibility: As mentioned before, the choice of assembling tubes in place and not pre-assembled them was partly led by transportation constraints. However this analysis has been carried only on tubes and not other elements of the broadband infrastructure.

Two Constructability criteria in the literature allow assessing Accessibility: *Site layout access and environment* and *Logistic*.

**Workability:**

Vertical Constructibility:

Workability of information shared with the client was very low, needs and requirements were not formalized, and it was mostly through written documents and schemes which has led to misinterpretation in several occasions.

Horizontal Constructibility:

Generally speaking horizontal workability of organic elements is satisfactory. Excepting for installation of tubes which depends on the process used. Set up optical fiber tubes with trucks in the tunnel is much more workable than the installation of steel bars by human workforce.

Two Constructability criteria in the literature allow assessing similar elements: *Preassembly* and *Workforce*.

**Reliability:** Reliability of the client information was high. Having a direct and regular contact with the Société du Grand Paris have improved reliability of information shared.

**Ambivalence:** Requirements gathered from the client can be reused in other projects to advise other clients on usual requirements related to the integration of a broadband network, to compare its own requirements with requirements of SGP and to reuse parts of design when requirements are similar.

**Financiability:**

Vertical Constructibility:

Integration of the construction subsystem of the broadband network in the metro infrastructure was part of the contract between Egis and SGP. No financiability issue have been identified for the vertical Constructibility analysis.

Horizontal Constructibility:

However, the horizontal Constructibility is more problematic, particularly for the tubes integration in the invert of the tunnel. The current adopted solution risks to be very costly, to overshoot the budget dedicated to the broadband network and to modify the economic equilibrium of the system. A similar problem arise for splicing rooms and technical rooms in infrastructures elements (stations, shafts) which can't integrate spaces related to the broadband network: change the configuration of a station or a shaft may be way too costly to be considered. Improving financiability would require to change the System of Interest: modify the size of technical rooms/splicing rooms, set up the tubes in cable-trays instead that in the invert as example. It is interesting to highlight that improving

financiability can be done in two ways: modify the System of Interest as presented or to find new ways to finance the broadband network and change the Enabling System.

**Improvement n°22: The Constructibility matrix**

Functional Analysis elements	Constructibility Criteria																					
	Effectivity	Governability	Contractibility	Acceptability	Legal	Temporality	Pertinence	Complexity	Robustness	Documentation	Communication	Control	Error proofed	Knowledge	Repeatability	Efficiency	Availability	Accessibility	Workability	Reliability	Ambivalence	Financiability
F1: Provide space for the broadband network system	Green	Yellow	Green	Orange	Green	Orange	Green	Green	Orange	Orange	Orange	Green	Green	Green	Green	Green	Green	Green	Yellow	Green	Green	Green
F2: Be independant from the transport system	Green	Green	Green	Green	Green	Green	Green	Green	Green	Green	Green	Green	Green	Green	Green	Green	Green	Green	Green	Green	Green	Green
F1.1: Support the weight of broadband network elements	Green	Green	Green	Green	Green	Green	Green	Green	Green	Green	Green	Green	Green	Green	Green	Green	Green	Green	Green	Green	Green	Green
F1.2: Support its own weight	Green	Green	Green	Green	Green	Green	Green	Green	Green	Green	Green	Green	Green	Green	Green	Green	Green	Green	Green	Green	Green	Green
F2.1: resist to high temperature	Green	Green	Green	Green	Green	Green	Green	Green	Green	Green	Green	Green	Green	Green	Green	Green	Green	Green	Green	Green	Green	Green
F2.2: resist to rolling stock crashes	Green	Green	Green	Green	Green	Green	Green	Green	Green	Green	Green	Green	Green	Green	Green	Green	Green	Green	Green	Green	Green	Green
F2.3: Absorb noise vibrations	Green	Green	Green	Green	Green	Green	Green	Green	Green	Green	Green	Green	Green	Green	Green	Green	Green	Green	Green	Green	Green	Green
F2.4: Hinder visibility	Green	Green	Green	Green	Green	Green	Green	Green	Green	Green	Green	Green	Green	Green	Green	Green	Green	Green	Green	Green	Green	Green
Tubes	Green	Green	Green	Green	Green	Green	Green	Green	Green	Green	Green	Green	Green	Green	Green	Green	Green	Green	Green	Green	Green	Green
Splicing rooms	Green	Green	Green	Green	Green	Green	Green	Green	Green	Green	Green	Green	Green	Green	Green	Green	Green	Green	Green	Green	Green	Green
Technical rooms	Green	Green	Green	Green	Green	Green	Green	Green	Green	Green	Green	Green	Green	Green	Green	Green	Green	Green	Green	Green	Green	Green
Pathways	Green	Green	Green	Green	Green	Green	Green	Green	Green	Green	Green	Green	Green	Green	Green	Green	Green	Green	Green	Green	Green	Green
Connecting rooms	Green	Green	Green	Green	Green	Green	Green	Green	Green	Green	Green	Green	Green	Green	Green	Green	Green	Green	Green	Green	Green	Green

Figure 252 : Constructibility matrix of the broadband network of line 16 in the 3 architectural views: Operational, Functional and Organic and with the 22 Constructibility criteria.

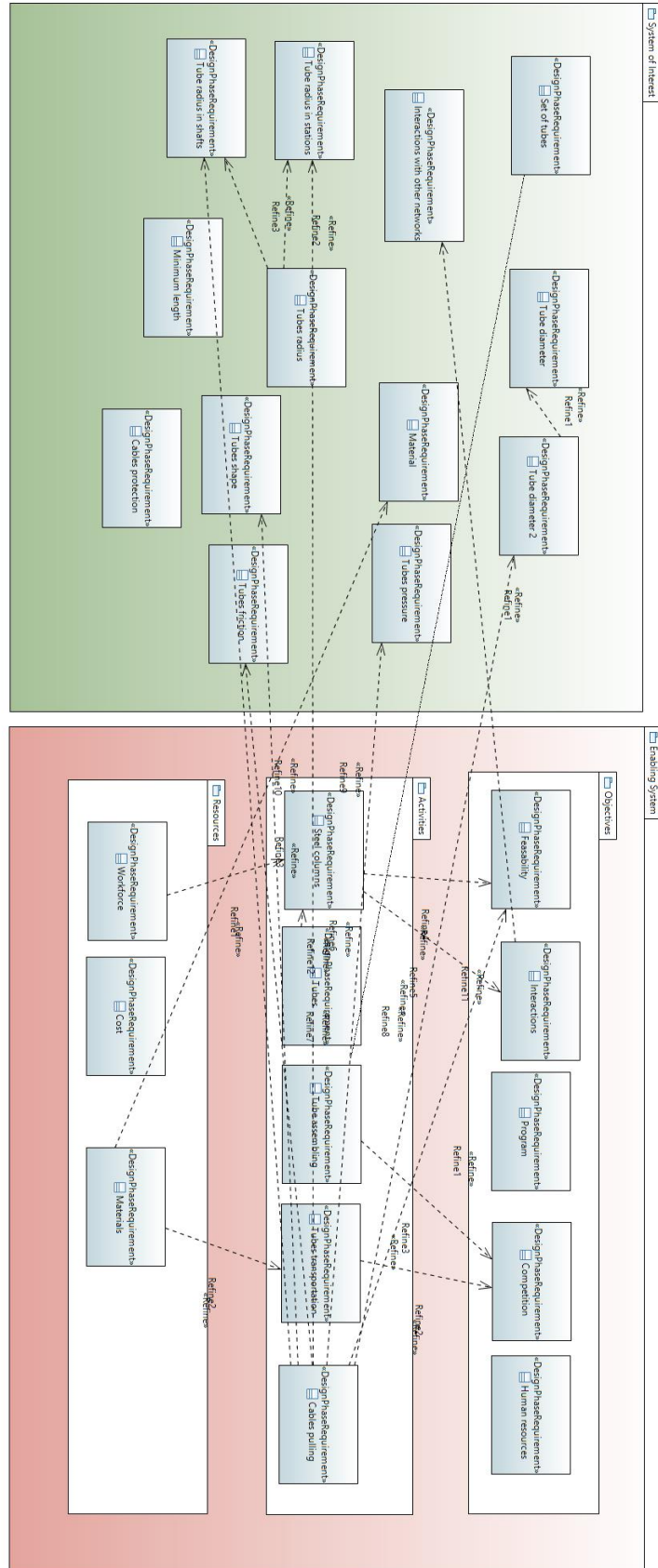


Figure 253 : Requirement diagram related to the tube system in Exegis. In green are represented requirements related to the System (what the system has to do) and in red requirements related to the Enabling system (how the system has to be developed) and interactions between them.

Both requirements from the Enabling System and the System of Interest related to tubes of the broadband network have been modeled in Exegis (Figure 253). Links and refinements between requirements of both system shows that there are interactions between them.

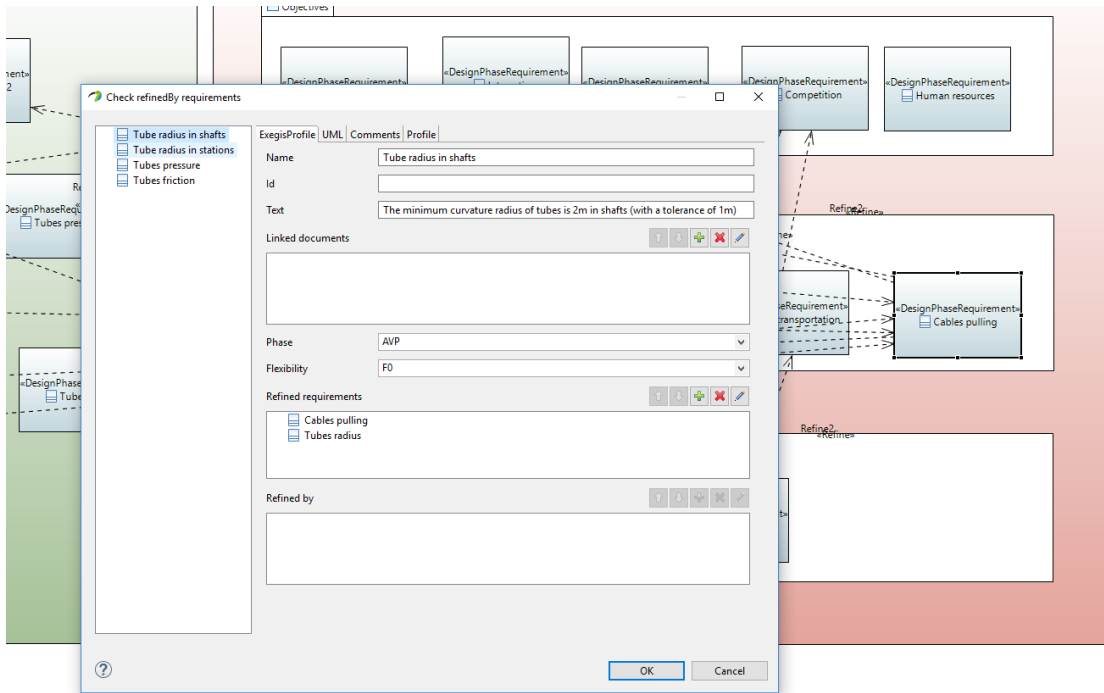
	id	name	text	/refinedRequireme...	phase	flexibility	/refinedBy	/annotatedByRati...
System of Interest	N/A	System of Interest	N/A	N/A	N/A	N/A	N/A	N/A
Tube diameter		Tube diameter	Diameter of the tubes are 40 to ...		AVP	F0	Tube diameter 2	
Tube diameter 2		Tube diameter 2	Diameter of tubes are between ...	Tube diameter	AVP	F0	Cables pulling	
Material		Material	Tubes are standar HDPE (PE80) ...	Materials	AVP	F0		
Tubes pressure		Tubes pressure	Tubes have to resist a minimal ...	Cables pulling	AVP	F0		
Tubes friction		Tubes friction	Tubes friction coefficient will b...	Cables pulling	AVP	F0		
Tubes shape		Tubes shape	Tubes will be finned inside and...		AVP	F0	Cables pulling	
Cables protection		Cables protection	Tubes will be equiped of water...		AVP	F0		
Tube radius in stations		Tube radius in stations	The minimum curvature radius...	Cables pulling Tubes radius	AVP	F0		
Tube radius in shafts		Tube radius in shafts	The minimum curvature radius...	Cables pulling Tubes radius	AVP	F0		
Minimum length		Minimum length	The minimum length of tubes L...		AVP	F0		
Set of tubes		Set of tubes	Set of tubes are bonded with a...		AVP	F0		
Tubes radius		Tubes radius	Tubes radius have to be lower L...		AVP	F0	Tube radius in stations Tube radius in shafts	
Interactions with other ne...		Interactions with other networks	Tubes will be distant of at least ...	Interactions	AVP	F0		
Enabling System	N/A	Enabling System	N/A	N/A	N/A	N/A	N/A	N/A
Objectives	N/A	Objectives	N/A	N/A	N/A	N/A	N/A	N/A
Feasibility		Feasibility	Ensure feasibility of the tubes		AVP	F0	Cables pulling Steel columns	
Interactions		Interactions	Limit interactions with other su...		AVP	F0	Steel columns Interactions with other networks	
Program		Program	Answer to clients requirements		AVP	F0		
Competition		Competition			AVP	F0	Tube transportation Tube assembling	
Human resources		Human resources			AVP	F0		
Activities	N/A	Activities	N/A	N/A	N/A	N/A	N/A	N/A
Steel columns		Steel columns	Set up steel columns in the tun...	Feasibility Interactions	AVP	F0	Tubes Workforce	
Tubes		Tubes	Set tubes on steel columns	Steel columns	AVP	F0		
Tube assembling		Tube assembling	Assemble tubes on site	Competition	AVP	F0		
Tubes transportation		Tubes transportation		Competition Feasibility Tube diameter 2 Tubes shape	AVP	F0	Materials Tube radius in shafts Tube radius in stations Tubes pressure Tubes friction	
Cables pulling		Cables pulling			AVP	F0		
Resources	N/A	Resources	N/A	N/A	N/A	N/A	N/A	N/A
Workforce		Workforce	Optimize workforce	Steel columns	AVP	F0		
Cost		Cost			AVP	F0		
Materials		Materials	Use easilly accessible materials	Tube transportation	AVP	F0	Material	

Figure 254 : Requirement table related to the tube system in Exegis with all their attributes.

Requirements are also (automatically) modeled in a table where refinements, texts, ID, flexibility of requirements are easily modifiable and summed up (Figure 254). Both diagrams and tables are useful to have a global vision of the requirements which apply on the system. During studies carried for line 16 of the Greater Paris project it has notably been useful as a check list when designing the broadband system and integrating it with other subsystems.

More importantly, Exegis allows carrying simple impact analysis when modifying a requirement (Figure 255). As instance, at one point of the project it has been necessary to evaluate impacts of switching between water pressure and air pressure to set up cables in the tubes. The impact analysis tools we have developed in Exegis has allowed evaluating impacts on other requirements very easily and almost instantly.

Changes and modifications are the rule in construction systems as all projects are unique. Therefore the use of such tool is of great help for their design.



**Figure 255 : Example of an impact analysis in Exegis. It allows very quickly to see first degree interactions between different requirements.**

### ***Conclusion***

In this Case Study, the three architectural views have been analyzed at the subsystem level (Operational, Functional and Organic). It has allowed applying Constructibility analysis at a different system level and on all architectural views. A “classic” Functional Analysis method would have allowed identifying External functions, Internal functions and description of the solution. In this case, Functional Analysis has been enriched by Constructibility analysis in the three usual steps of FA (which corresponds to the three architectural views in SE).

The Constructibility Analysis have allowed identifying constraints to the development of the construction system of the Broadband network for the line 16 of the Greater Paris project. Notably (Figure 252): workability, financiability and complexity of Optical Fiber tubes in the Organic view.

In the presented Case Studies we haven’t show modelling of links between requirements from the different views: between Operational, Functional and Organic views as we wanted to highlight the links between the System of Interest and the Enabling System in each view. However, it is important not to forget that these links also exist and are of great importance. Operational requirements are refined by Functional requirements which are themselves refined by Organic requirements. A modification of a requirements in one of these three views, as instance because of a change in the Enabling System in one of the three views, inevitably has consequences on requirements in other views. These impacts also have to be assessed when adding or modifying a requirements.

- In the Operational view

Acceptability issues have been identified mostly inside the project as requirements from the client arrived late in the project when the design of the infrastructure was already completed which have implied last minute modifications. Communication between the different project teams (teams in charge of the structure, of the synthesis, of the design of broadband elements) was not efficient, a lot of go and backs between different members of teams were necessary to the consideration of all requirements related to the broadband network and the related interfaces. The process was not documented and it was a paper based method implying a lot of losses of information

when exchanged between project stakeholders and to trace modifications. The numerous interactions between the broadband network and other elements of the metro infrastructure were not very well managed due to communication issues which have impacted robustness of the process.

- In the Functional view

In the functional view, the Enabling System was not effective as limited verifications have been undertaken to verify or/and to model that the elements dedicated to the broadband network satisfied functional requirements.

- In the Organic view

Most of the Constructibility issues concerned the Organic view and particularly the integration of tubes in the invert (and to a lesser extent on splicing and technical rooms). Tubes in the invert are in interaction with a lot of other elements of the metro infrastructure implying high complexity for its integration. Moreover, the workability of the process intended to set up the tubes in the invert is not highly “workable” as it requires a lot of working force and materials handling. This last elements has greatly increased the cost of the realization of the broadband network which has led to financing issues.

We have highlighted that particularly in this part we find back some of the Constructability criteria defined in the literature. It shows that at some point, Consstructibility and Constructability merge in the Organic analysis and that Constructibility consider the analysis of more elements from the Enabling System.

This analysis shows ways of improvement to better design and integrate broadband elements for line 16 of the Greater Paris or/and for future projects as a REX (Return of Experience).

The requirements diagram and the use of SysML (which can be considered as a Resource (tool) in the Enabling System) have been greatly useful to make tradeoff between the System of Interest and the Enabling System by evaluating impacts on both systems easily. It has also allowed to check that all requirements related to the broadband network have been met in the design of the infrastructure. In this way, the tool improves effectivity and efficiency of the Enabling System (few resources are required and requirements are met).

## **5. General conclusion**

---





## 5.1. Contributions of the thesis

In the introduction we have identified 2 issues for the adaptation of Functional Analysis to the construction industry: integration of space in the method and consideration of constraints from the Enabling System. To take into account complexity of construction systems, Systems Engineering methods have also been studied and integrated in the chosen Functional Analysis method, notably in terms of Systems Architecture, Verification and Validation concepts, metamodels, formalization language and tool (SysML). In this thesis we have made different propositions for the adaptation of Systems Engineering. Notably, in the Enriched Functional Analysis method spatial characteristics of systems are integrated in the three architectural views (Operational, Functional and Organic). Propositions to adapt SysML for the construction industry by integrating spatial elements are also mentioned. An architecture of the Enabling System is proposed (Objectives, Activities and Resources) and constraints from the Enabling System are integrated at different stages of development from the system level to components.

Consideration of space in the method has been applied in the two case studies at different systemic levels: application of the multifunctional metro concept for the 5<sup>th</sup> metro line of Lyon at the system level and on the broadband network of the line 16 of the Greater Paris at the subsystem level. Even if we haven't been able to gather all spatial data related to both case studies, either because they don't exist or because we didn't have access to it, we have showed that space can be considered at different systemic levels and in different architectural views (Operational, Functional and Organic) and that these data are fundamental for analyzing construction systems. A SysML tool has been developed in cooperation with CEA Tech which allows to "map" requirements to spatial elements of systems and notably BIM objects. However, works with the CEA Tech have shown that only physical space are represented in current BIM models while some requirements are allocated to functional space and even Operational space. It is coherent with our approach that space has to be considered in the three architectural views and not only at the organic level as it is currently the case in most BIM models. The concept of IFC space notably which allows creating spaces instead of objects could help in this approach but more researches are required to better integrate space between the different views and the different systemic levels (which also asks the question of interoperability between space modeling tools like GIS and BIM tools). There is also certainly more to do about the different aspects of space (e.g. cultural, social, political, economic), how they interact with the development of construction products and how to consider these aspects in the different architectural views of Systems Engineering at different systemic levels.

One characteristic of geographical space is its uniqueness, all spaces on earth are unique even more at the earth surface where human beings live and adapt their environment to carry activities. As construction systems consist in adapting space to carry human or related activities, the direct implication is that each construction project is unique. The challenge faced by the construction industry is therefore to realize different products by keeping as much as possible the same development system (Enabling System) to improve productivity. We assume that this could be possible by considering and analyzing development constraints all along the product lifecycle from planning, realization and maintenance: i.e. carry Constructibility analysis and by identifying differences and similarities between environment of Enabling System elements to improve Constructibility from System level to components. In the thesis we propose a shift from *Constructability* which aims to consider realization constraints in all development phases to *Constructibility* which aims to consider all constraints related to the Enabling System globally (architected in Objectives, Activities and Resources) in the different phases of development. In a general perspective, Constructibility consists in the evaluation of interactions between the System of Interest and the Enabling System. This shift has led to the definition of new Constructibility criteria and more importantly a methodological background to define them. A tool has been developed to ease the Constructibility analysis: the Constructibility matrix, an adaptation of DSM (Design Structure Matrix) and MDM (Multidomain Design Matrix). The Constructibility matrix crosses architectural views of the System of Interest and architectural views of the

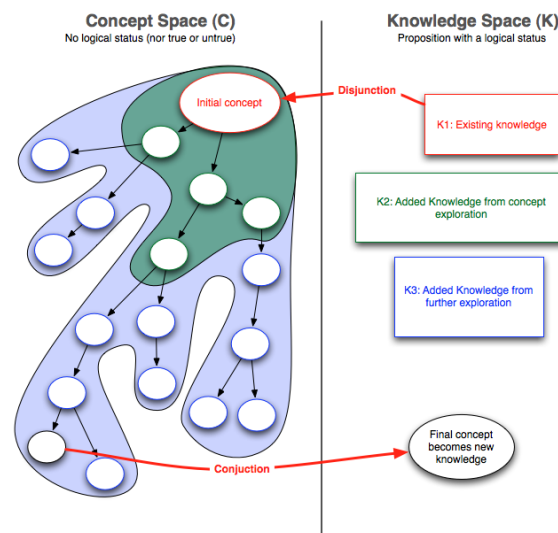
Enabling System allowing to assess interactions between both. The matrix has been used in both case studies to evaluate their Constructibility at different phases and different systemic levels. The matrix could be improved by the integration of Horizontal and Vertical Constructibility which are currently not distinguished and more importantly a lot is still to do about measurement of Constructibility criteria and their refinement.

Application of the Enriched Functional Analysis method by the integration of Constructibility on the “multifunctional metro concepts” has allowed identifying challenges for the development of multipurpose infrastructures both at the at the System level in the case of the 5<sup>th</sup> metro line of Lyon and at the Sub-system level for the broadband infrastructure of line 16 of the Greater Paris project. This example shows that the application of new methods and tools can lead to the identification of new challenges faced by complex construction systems which are more integrated and offer more services for populations.

Application of the “standard” Functional Analysis method would not have allowed highlighting and identifying of such challenges. This is through analysis of spatial elements of the studied systems and interactions with Enabling Systems in the different steps that they have been identified.

## 5.2. Avenues for research

Even if in this thesis we have proposed a methodology integrating different scientific corpuses to adapt one of them (Functional Analysis) to the construction industry, other methods exist with other objectives. As instance, the C-K theory (Concept and Knowledge theory) developed at Ecole des Mines in France by Hatchuel, Le Masson and Weil (Hatchuel, Le Masson, & Weil, 2011) intends to develop innovative products. Its application on construction products and on complex products more generally rises questions. The development of a “unified” methodology, or more probably how to use them concurrently and simultaneously, adapted for the construction industry integrating the different potential objectives (mastering complexity, innovate, decrease costs etc.) is still to be defined and would require more efforts of research.



**Figure 256 : the C-K theory (Hatchuel, Le Masson, & Weil, 2011). On the left is represented the Concept space (C) where concepts trees are developed. And in the right the Knowledge space (K). In red are represented interactions between both.**

Similarly, System of Systems concepts that we have presented in the State of the art have not been applied in this thesis whereas several authors have identified their potential application on infrastructures and construction systems. Integration of SoS concepts in the methodology developed in this thesis and particularly integration of space and Constructibility would certainly be a promising avenue for research (Zhu, Whyte, & Mostafavi, 2017). Implications of the consideration of infrastructures as Systems of Systems are still not clear and desirable

considering that SoS may be more costly as stated by Maier (Maier, 1998). Impacts of the application of SoS concepts on infrastructures, in the decision making process, in design strategies, policies, resilience, interoperability of urban systems are still to assess.

More integration between Project Management disciplines and the Enriched Functional Analysis method presented in the thesis would also be beneficial. Project Management is fully part of the so called Enabling System. Such analysis would allow improving interoperability between tools used in Project Management and tools used for Systems Engineering. As instance, Lean Construction concepts have not been studied extensively in the thesis while its aim is to improve efficacy of the Enabling System. Links between Constructability and Lean Construction are obvious at the realization phase, application of such concepts as well as new management techniques (Agile techniques notably) in other parts of the Enabling System such as Design and Planning phases would require more researches, particularly on the impact on the System of Interest to develop (INCOSE, PMI & MIT, 2012). Interoperability between modelling tools of the System of Interest (such as tools based on SysML) and modelling tools of the Enabling System (e.g. Work Breakdown Structure, schedul) is also an interesting avenue for research as started by Dori (Dori, 2008).

The concept of multifunctional metro and more generally multipurpose infrastructures have several advantages which have been presented in the introduction. Development of such integrated systems is very promising for the future of infrastructures but requires appropriate methods and tools to manage their complexity. The development of the Enrich Functional Analysis method allows managing complexity of the development of such infrastructures. The Constructibility analysis has allowed identifying challenges for their development notably: Governance and Contracting issues. Researches related to changes or adaptations on current governance, decision making processes, communication between decision makers, aversion to risks in the construction industry and new types of contract between stakeholders would be necessary to improve Constructibility of Multipurpose infrastructures. The Constructibility analysis have highlighted that the development of multifunctional infrastructures is less a technical challenge than a decision-making challenge. Eventually further researches could be undertaken to identify new functions and new needs construction products and infrastructures could answer. As example, in Lyon the HCL (Lyon Hospitals (Hospices Civils de Lyon)) were interested by integrating pneumatic tubes in the metro tunnel to link the different hospitals reachable by metro to transport blood samples and medical tests with a high level of security and reliability. This example shows that sometimes unexpected needs can be identified if appropriate stakeholders are considered in the development of new infrastructures and buildings. Even if it necessarily increases complexity of the development process of construction systems (mastering complexity being the objective of the method developed in this thesis and of Systems Engineering) it is highly profitable for citizens and urban dwellers.

Another important particularity which has not been considered when developing the present methodology is the current contractual and legal organization of the construction industry. In France, construction projects are governed by the MOP (Maitrise d'Ouvrage Publique) law, the Enriched Functional Analysis method is not always possible in this context as stakeholders have only limited information about other stakeholders' objectives, activities and resources. Impacts of this legal and contracting organization is partly considered in Constructibility criteria (legal, contracting criteria), however impacts of this organization is very impacting for the potential application of the methodology in construction projects. As instance, how to evaluate Constructibility in the organic view if contractors are not involved very early in the development process? Whereas it's them which have the knowledge to assess Constructibility in this view. Even if some new types of contracts are emerging which integrate all stakeholders from the beginning of the project, they are still the exception (Australian Government, 2015).

## Figures

---

Figure 1: population rurale et urbaine dans le monde, 1950-2050 (United Nations, 2014).....	12
Figure 2 : Forecasts of investments in infrastructures for the 2013-2030 period (McKinsey Global Institute, 2013) .....	13
Figure 3 : « La ville compacte » (Locuratolo, 2014). This scheme highlights the complexity induced by compact cities. ....	14
Figure 4 : Map of the metro in Tokyo. The map of the Tokyo metro illustrates complexity of its management and operation in dense cities such as Tokyo. ....	15
Figure 5: The Khaju bridge by night. The Khaju bridge is an example of a multifunctional bridge built in 1650 by the Persians. ....	16
Figure 6: Utility Gallery, Geneva, Switzerland. The utility gallery is a multifunctional structure which welcomes all types of urban utilities (electricity, water, optical fiber, gas). ....	17
Figure 7: The Wadi Hanifah, Riyadh, Saudi Arabia. This treatment plant has been designed also to restore natural habitat and for agriculture irrigation. ....	17
Figure 8: Tunnel and stations with multiple functions, Egis, 2016. This conceptual scheme of the multifunctional metro illustrates the different possibilities to integrate new functions into metro systems. ....	18
Figure 9 : Companies' public annual reports; IHS Herold Global Projects Database, November 19, 2013; press releases. This figure shows that in average construction projects suffer overcosts of 80% and delays of 20 months. ....	21
Figure 10 : Illustration of non-quality issues in the construction industry and the different point of views of different stakeholders of the same product. ....	22
Figure 11 : Comparison between productivity of the construction industry and other industries (McKinsey Global Institute, 2013). This graph shows that compared to other industries, productivity of the construction sector has decreased in the US and in Germany.....	23
Figure 12 : Example of a spatial mobility analysis at the territorial level (Leurent). This figure shows representation of forecast mobility needs over space at the territorial level. ....	26
Figure 13 : Example of comfort analysis for a transport system at the human level (Fruin, 1971). This figure represents different level of spatial comfort at the human level.....	27
Figure 14 : Geography as the domain related to the analysis of interactions between Physical and Human science (Pattison, 1964).....	28
Figure 15 : The construction industry: modify Human space by modifying physical space .....	28
Figure 16 : In other industries, space is only considered as a constraint in comparison with the construction industry .....	29
Figure 17 : Territory decomposition in systems (Cunha, 1988). This diagram represents one possible systemic analysis of a territory .....	30
Figure 18 : Territory decomposition in systems (Le Moine, 2014). This diagram represents another systemic way to describe a territory .....	30
Figure 19 : Impacts of space on uniqueness of construction systems. This figure shows that because each space is unique and because purpose of the construction industry is to adapt space, each construction system is unique. ....	32
Figure 20 : Uniqueness of construction systems and implications on the Enabling System. This uniqueness implies that the Enabling system is necessarily unique for each project. ....	32
Figure 21 : Construction project stakeholders classification (Winch G. , 2010). Another particularity of the construction sector is the numerous and different type of stakeholders and that they change at each project. ....	33
Figure 22 : Interactions between different stakeholders in construction projects. This scheme illustrates conflicts between construction stakeholders because of a lack of communication and coordination.....	34

Figure 23 : Separation of tasks and lack of communication in construction projects. Internally, construction stakeholders manage their activity in silos with low consideration of other actors' problematics. ....	35
Figure 24 : Steps of a construction project as defined in the MOP law (Legifrance, 1985). The MOP law in France implies a "cascade" working flow between different steps.....	36
Figure 25 : FIDIC contracts and how to use them (FIDIC, 2018). FIDIC contracts are example of the different types of contracts existing for construction systems abroad. ....	38
Figure 26 : Egis breakdown activities between sectors (Egis, 2018).....	40
Figure 27 : Egis activities in the world (Egis, 2018).....	40
Figure 28 : Thesis organization. 16 issues are identified in the second part (state of the art) for the application of Functional Analysis, Systems Engineering to the construction sector and the integration of Constructability. In the third part 23 improvements are explained to develop an Enriched Functional Analysis method applicable to complex construction projects. In the fourth part, the Enriched method is applied on two case studies. ....	41
Figure 29: State of the art structure. The state of the art is divided in three parts: Functional Analysis, Constructability and Systems Engineering. It also shows that objective of the thesis is the integration of Constructability and Systems Engineering elements in Functional Analysis for complex construction systems. ....	46
Figure 30 : Systems Thinking, Systems science and Systems Engineering, (INCOSE, 2015). This diagram shows how Systems thinking and Systems science influence Systems Engineering methodologies and approaches. Functional Analysis as well has been very much influenced by System thinking theories. ....	47
Figure 31 : Levels of complexity. Adapted from (Berrard, 2010). This table shows different level of complexity of systems and how definition of system complexity has evolved over the years. ....	49
Figure 32 : Complexity levels of metro systems. This figure shows that complexity of a system depends of its frontier/limit and what is considered in or outside the system. This is even more true if the system is not limited to its functioning under operation but also to all the required subsystems for its development. ....	52
Figure 33 : System of Systems definition (SE LAB Kaist, 2018). This figure sums up the different properties of a System of Systems. ....	54
Figure 34 : Megaproject system-of-systems conceptualization (Zhu, Whyte, & Mostafavi, 2017). This diagram shows the different systemic levels of a construction/infrastructure project. It shows that it can be considered as a System of Systems. However, does it also apply on a construction product?.....	55
Figure 35 : The triadic decomposition of any function. Adapted from (Le Moigne, 2006). Any processing function of a system can be decomposed in the three dimensions: time, space and form. These last elements (spafe and form) will be of great importance for the application of Functional Analysis in the construction sector. ....	57
Figure 36 : Systems as black boxes. Adapted from (Le Moigne, 2006). Any system can be seen as a black box surrounded by an environment with which it is interacting and processing inputs from this environment to outputs. ....	57
Figure 37 : Functional Analysis Principle (Peyras, 2003). Most of Functional Analysis methods follow the same process: it starts with the definition of needs and by considering the system as a black box. Then the system is analyzed internally as a whyte box, internal functions and subsystems are defined. A feedback loop allows optimizing the couple needs/solution. Finally the product is realized when the couple needs vs solution is considered as satisfactory.....	59
Figure 38 : SADT Activity and Data diagrams. In this method the system is represented as a box. Arrows from the left side of the box are inputs of the process and arrows on the right side output of the process. Arrows at the top are control activities of the process eventually constraining its progress and arrows at the bottom mechanisms required for the process which also potentially impact its progress. ....	60
Figure 39 : The different systemic levels in SADT diagrams. In the SADT method, the different systemic levels are represented through different levels. A0 represents the highest level, then the system is decomposed in	

A1...An schemes where the lower systemic levels are described. Subsystems are also represented as boxes similarly to the system level. ....	61
Figure 40 : The basic FAST Model (Bytheway, Society of American Value Engineers, 1964). In this figure an example of a system decomposed in functions with the FAST method is represented. Going from the left to the right are represented the different functional levels, higher order functions are on the left side and they are decomposed in lower order functions the more we go on the right side. Going from the left to the right answers to the question “How?”, from the right to the left to the question “Why?” and from the top to the bottom to the question “When?”. ....	62
Figure 41 : GRAFCET example applied to an elevator. This figure gives an example of the application of the GRAFCET method. It starts at the state (0), then going from top to the bottom logical equations (E1.(P2+P3, E2.(P1+P3), E3.(P1+P2)) indicate the following state of the system (1, 4, 7). Then other logical equations make evolve the system in other states until it ends up to the last state (3) where it comes back to the initial state (0) when the last logical equation (a) is true. ....	63
Figure 42 : QFD matrices scheme (Azam Haron & Mohd Khairudin, 2012). This figure details the QFD method. On the left side are the Customers’ requirements in rows. On the top the technical characteristics of the system, the roof represents interfaces between technical characteristics, on the right customers’ evaluation of the capacity of the system to answer their requirements and at the bottom the importance of the different technical characteristics of the system ponderated by customers’ requirements which leads to the prioritization of quality improvement to the system. ....	64
Figure 43 : example of a QFD matrix in the construction industry (apartments buildings) (Dikmen, Birgonul, & Kiziltas, 2005) .....	65
Figure 44 : Linked QFD matrices (Loenen & Mroczkowski, 2010). In this figure, different QFD matrices are used in combination to consider the different development phases of a construction system. It starts with the customers’ requirements through technical and product characteristics and ends up with the manufacturing operations. ....	66
Figure 45 : The « fundamental expression of the need » in the MISME method, adapted from (Tassinari, 2006). This scheme allows formalizing needs the system will fulfill. ....	69
Figure 46 : Context diagram, MISME method. The context diagram allows identifying and formalizing Main Functions and Constraint functions of the system. The system is seen as a black box and functions are interactions with the environment. A main function links two or more elements of the environment with the system and a constraint function only inks one element of the environment with the system. ....	71
Figure 47 : Example of an onion diagram. The onion diagram represents how stakeholders interact with the system under development. The further a stakeholder is far from the center the less it interacts with it. ....	72
Figure 48 : Example of a Functional Tree. A functional tree allows representing the hierarchical links between functions of a system. ....	73
Figure 49 : Example of a Product Breakdown Structure. A product breakdown structure diagram allows representing the different systemic levels of a system: its sub-systems, sub-sub-systems, components. ....	73
Figure 50 : example of an Internal Function Diagram (Azarian & Pollet, 2016). An internal function diagram allows representing links between internal functions, subsystems and main functions of the system. ....	74
Figure 51 : The 3 steps of Functional Analysis from the APTE®/MISME method. This diagram sums up the different phases of a standard Functional Analysis with its dedicated tools. It starts with the identification of external elements of the system, then the definition of needs the system will fulfill by using both the interaction diagram and the fundamental expression of the needs diagram. Then internal functions are defined, hierarchical relations between functions can be formalized through a functional tree and an internal function diagram. Then components (subsystems, subsystems) are defined as technical solutions to carry functions of the system. The hierarchical relations between components can be formalized through a product breakdown structure. Feedback loops between the different step of the analysis allows optimizing the couple needs/solutions of the future	

system. This diagram will be improved all along the thesis by adding new elements developed for the application of FA for complex constructions systems in part 3. ....	77
Figure 52 : Performance defined by (Gibert, 1980). This figure shows the three different ways to define performance and how they are related between eachother: Pertinence, Efficacy and Efficiency. ....	80
Figure 53 : Adaptation of the performance concept by integrating processes (Allaire, 2012). ....	80
Figure 54 : Product performance adapted from (Gibert, 1980). Objectives and Mean have been replaced respectively by Needs and Functions. ....	81
Figure 55 : Optimization of Technical Alternatives (Cariaga, El-Diraby, & Hesham, 2007). Points in the figure represent different possible solutions and the efficiency frontier the optimum performance of the system. ....	83
Figure 56 : Functional Analysis, QFD and DEA used in conjunction (Cariaga, El-Diraby, & Hesham, 2007). This figure details the step to follow to evaluate the capacity of a system to answer functional requirements through Functional Analysis, QFD matrices and DEA. ....	83
Figure 57 : Use of the SPEC method in the development of a system. Adapted from (Yannou & Limayem, 2000) .....	84
Figure 58 : Objectives of the SPEC method. Adapted from (Yannou & Limayem, 2000).....	84
Figure 59 : Satisfaction model in the STEP method. Adapted from (Yannou & Limayem, 2000). F1...Fn are functions of the system, C1..Cn Functional criteria. ....	85
Figure 60 : Dashboard summarizing capacities of solutions to answer functions. (Yannou & Limayem, 2000) .	85
Figure 61 : The dashboard allowing a detailed representation of the capability of solutions to answer functional criteria. (Yannou & Limayem, 2000) .....	86
Figure 62 : Uses of Functional Analysis in the construction industry in different domains, adapted from (Gonzva, 2017) .....	87
Figure 63 : The 8 functions of buildings (Gobin, 2017).....	88
Figure 64 : Constructability benefits divided into quantitative and qualitative types (Russell, Swiggum, Shapiro, & Alaydrus, 1994).....	90
Figure 65 : The gap between earned value of the product and cost of projects in France (adapted from (IRC, 2013)). Curve A represents expenditures of the project and curve B commitments progressively locked by stakeholders. ....	91
Figure 66 : Origin of non-quality costs (adapted from (IRC, 2013)).....	91
Figure 67 : A hierarchical model of manufacturability concepts (Jiang, 2016 July) .....	92
Figure 68 : Relationships and interconnections between constructability and buildability (Kifokeris & Xenidis, 2016). Signification of abbreviations are described in the text. ....	94
Figure 69 : The three parts of management in construction (Sardén & Stehn, 2005) .....	95
Figure 70: The 23 Constructability Principles (CP) (CII (Construction Industry Institute), 1996) .....	99
Figure 71 : Constructability Principles (CP) and Constructability Concepts (CC) adapted from (Nima, 2001) and (Kifokeris & Xenidis, 2016).....	99
Figure 72 : Implementation of Constructability, adapted from (Kifokeris & Xenidis, 2016) .....	100
Figure 73 : The Constructability implementation process (CII (Construction Industry Institute), 1996).....	101
Figure 74: Impacts of modifications depending on project phases (The American Institute of Architects, 2007). It shows that design changes are more costly in late stages of the project than early in the project development.	103
Figure 75: the IDC (Intelligence Design Choice) model (Simon, The Sciences of the Artificial , 1969) .....	104
Figure 76 : Constructability criteria from (Jiang, 2016 July).....	112
Figure 77: Constructability planning process framework (Fisher, 2000) .....	113
Figure 78 : Constructability tools by type and by nature (Kifokeris & Xenidis, 2016) .....	114
Figure 79 : Constructability at the intersection between the product and its production (Jiang, 2016 July). This figure highlights that constructability can be seen as the interface between the production and the product. It is	



through analyzing these interactions that constructability constraints (production side) and impacts (product side) are evaluated.....	115
Figure 80 : An ontology based approach to reveal constructability links between product and production information (Jiang, 2016 July). This figure shows that analyzing interactions between the product and its production has allowed defining an ontology of constructability.....	116
Figure 81 : Constructability at the intersection between technic and management (Getuli, Giusti, & Capone, 2015). This figure shows that to assess constructability of a system it is necessary both to evaluate technical aspects related to the product and management aspects related to the project. Improving constructibility consists in finding the best trade-off between these two domains. ....	117
Figure 82 : Three-dimensional model for the integration of constructability knowledge. Adapted from (Loyola Vergara & Goldsack Jarpa, 2010) .....	118
Figure 83 : Model of the product and model of the construction process as an integration tool of constructability. Adapted from (Loyola Vergara & Goldsack Jarpa, 2010).....	118
Figure 84 : Constructability criteria as parameters to align the product and the production process.....	119
Figure 85 : Constructibility as the link between project and product management (Gobin, 2017). This figure shows different elements of the product and the project and highlights that Constructibility is at the intersection between both.....	120
Figure 86 : important dates in the development of SE, Systems Engineering Handbook (2015).....	122
Figure 87 : Important dates in Systems Engineering standards, Systems Engineering Handbook (2015).....	123
Figure 88 : Committed life cycle cost against time. Defense Acquisition University, 1993 .....	124
Figure 89 : Project performance Versus SE capability. Elm and Goldenson (2012). Systems Engineering Handbook (2015). ....	125
Figure 90 : Adaptation of the Waterfall model by (Ruparelia, 2010). The figures represents the different steps of the waterfall model and feedback loops between the different steps. ....	126
Figure 91 : The Spiral Metamodel applied to software development (Boehm, 1988). In this figure, the different steps of the spiral models are represented. The project starts in the center and steps are spread all along the spiral clockwise. The spiral is split in 4 macro steps: 1. Determine objectives, 2. Identify and resolve risks, 3. Development and test and 4. Plan the next iteration. ....	127
Figure 92 : The Vee model lifecycle development (Forsberg & Moorz, 1992). In the Vee model, the project start at the top left branch of the vee where System requirements are defined and constraints related to its integration, verification and validation are considered. Then subsystems are described similarly when going down in the left branch excepting that they also refine requirements from the upper level. In the right branch, it goes from the bottom to the top: components are realized, subsystem are assembled an the system is integrated. ....	128
Figure 93 : Left side of the Vee model (International Council on Systems Engineering, 2015).....	129
Figure 94 : The right side of the Vee model (International Council on Systems Engineering, 2015).....	129
Figure 95: Universal framework for architectural analysis of real systems. Adapted from (Krob, 2009). This figure represents the 3 architectural views of a system at one systemic level.....	133
Figure 96 : The « systemic cube » for Systems Architecting. Adapted from (Krob, Eléments de systémique. Architecture des systèmes., 2014). ....	133
Figure 97 : The (recursive) process of systemic analysis and modeling. Adapted from (Krob, Eléments d'architecture des systèmes complexes, 2009).....	134
Figure 98 : Main views of an industrial system. Adapted from (Fiorèse & Meinadier, 2012). In this figure are also represented the 3 different architectural views of a system (in line) and behaviors of the system in columns. ....	134
Figure 99: Systems of Interest, its operational environment and its Enabling Systems (ISO/IEC/IEEE, 2015). In the center of this figure is represented the system to realize, it is the future product. Around it are the different	

“Enabling systems” which are necessary for its development and interacting with the “system to build” or “system of interest”. Are also represented interactions between Enabling systems themselves. ....	136
Figure 100 : Human system and technical system involved in an industrial system project. Adapted from (Krob, <i>Eléments d'architecture des systèmes complexes</i> , 2009). This figure highlights that there are interactions between technical systems of the System of Interest and the « Human » system required for its development (planning, design, realization, and operation). It also shows that it is necessary to have a “system architect” in the human system to ensure integration of technical systems. ....	137
Figure 101 : Comparison between organization of the construction industry and other industries .....	139
Figure 102 : IDEF-0 of the construction process (Sanvido, et al., 1988) .....	140
Figure 103 : IDEF-0 of the manufacturing process (Sanvido, et al., 1988) .....	140
Figure 104 : Systems Architecture for Systems of Interest and Enabling Systems .....	141
Figure 105 : Example of an external (Operational) view of a project with its environment (objectives). Adapted from (Fiorèse & Meinadier, 2012). A project requires, working logic, has management constraints and is influenced by services constraints in the company. A company also have an environment and is constraint by its clients, suppliers and partners as well as a lot of other elements (law, competition rules, regulation, nature, market...). .....	142
Figure 106 : The functional view of a project (activities). Adapted from (Fiorèse & Meinadier, 2012). This figure shows that the ‘functional view’ in the Enabling system is similar to a function in the System of Interest. The difference comes from the type of input and output and the purpose of the system which is here to develop the System of Interest (or one of its part). .....	143
Figure 107 : The organic view of a project as a system (resources). Organic view of an Enabling System is constituted by the “concrete” elements required to carry processes defined in the “functional view”.....	144
Figure 108 : Requirements and criteria. This figure highlights that criteria are defined in order to make decisions. Because in our case decisions are made amongst the different requirements coming both from the System of Interest and the Enabling System, criteria can be assimilated as requirements. ....	145
Figure 109 : Process requirements and product requirements. Adapted from (Tolmer, 2016). This figure shows that there are two different types of requirements usually considered: requirements from the Enabling System and requirement from the system of interest. ....	146
Figure 110 : Importance of Requirement Engineering. Scott Adams 1997. It shows that without considering requirements, projects are most likely to fail. ....	147
Figure 111 : Framework for System Architecture. Adapted from (Krob, <i>Eléments d'architecture des systèmes complexes</i> , 2009). This figure shows that Requirement Engineering is an important step in architecting a system in System Engineering (step 2). ....	150
Figure 112 : Requirements typologies and structures. Adapted from (Tolmer, 2016). ....	150
Figure 113 : SysML, an adaptation of UML 2 (OMG SysML, 2018). SysML is a language coming from UML which reuse some of its concepts in combination with new concepts developed specifically for System Engineering. ....	152
Figure 114 : The 9 SysML diagrams divided in Behavior diagrams and Structure diagrams (OMG SysML, 2018). .....	153
Figure 115 : The necessary and sufficient diagrams to represent an industrial system (Krob, <i>Eléments d'architecture des systèmes complexes</i> , 2009).....	153
Figure 116 : The steps composing the MACTOR process to evaluate stakeholders’ interactions and their impact on the system development. Adapted from (Godet, 2007) .....	155
Figure 117 : The BPMN diagrams and processes to model companies’ organization and businesses. (Briol, 2008). The value chain can be described with the Organization chart, the Hierarchical structures and Business processes. BPMN diagrams are used to model the business processes at different systemic levels. ....	156

Figure 118 : Graphical objects used in a BPD (Briol, 2008). This figure described the representation language used in BPMN diagrams. ....	157
Figure 119 : Example of PPLM model of an SUD developing process (Sharon & Dori, 2012). This figure shows the System of Interest with its different subsystems (green sidebars on the left) and their functions (pink, orange and green sidebars on the right) as well as activities required for the development of the System of Interest (blue sidebars in the center) and interactions between the System of Interest and the Enabling System. ....	158
Figure 120 : OPM model of a generic project construct with its OPD (Sharon & Dori, 2012) .....	158
Figure 121 : IDEF0 – Manufacturing system design process with supporting system capabilities taxonomies (Benkamoun, Elmaraghy, Huyet, & Kouiss, 2014). This figure highlights the interactions between the System of Interest (in green) and some activities of the Enabling System (in Blue).....	159
Figure 122 : Physical hierarchical levels illustration (Benkamoun, Elmaraghy, Huyet, & Kouiss, 2014). In this figure, different systemic levels of the Enabling System are represented. From the system level where production unit, transport systems and storage systems are modeled to the “machine” level where sensors, data, instructions, tools are modeled. It highlights that it is possible to model different elements of the Enabling system at different systemic levels and interactions between them. ....	160
Figure 123 ; Adaptation of the Vee model for Infrastructures (INCOSE Infrastructure Working Group, 2012). Particularity of this Vee cycle metamodel is the representation of the processes and subprocesses required to develop elements of the system in both branches of the Vee cycle. ....	165
Figure 124 : The Vee model in the Dutch infrastructure industry (Prorail, Rijkswaterstaat Ministrie van infrastructure en Milieu, Vereniging Van Waterbouwers, Bouwend Nederland, Uneto Vni, NIngénieurs, 2009). In this Vee cycle metamodel developed by the Dutch, there is no specific representation of the Enabling System however, the requirement engineering phase, functional analysis phase and design phase are represented at different systemic levels. ....	166
Figure 125 : The 3 pillars of BIM open and standardized (Building Smart International, 2018) .....	167
Figure 126 : The components of a BIM use (Kreider & Messner, 2013) .....	169
Figure 127 : The BIM use Purposes and secondary purposes (Kreider & Messner, 2013) .....	169
Figure 128 : Lifecycle of aerospace hardware development potentially covered by a virtual space construction process (Polit-Casillas & Howe, 2013). In this approach, a combined use of SysML to model requirements and a BIM model have been used for different modelling purposes. ....	170
Figure 129 : plan of the 3rd part. This diagram also shows in which part do issues identified in part 3 are treated. ....	178
Figure 130 : the 6 topological spatial relations between two systems (Borrmann, et al., 2009).....	179
Figure 131 : The 28 chorèmes to model spatial interactions (Brunet, 1987). ....	181
Figure 132 : Relations between space, goals, functions, activities and resources (Mauger, 2015).....	183
Figure 133 : Mobility needs analysis in the 5th district of Lyon.....	183
Figure 134 : Functions « transport people » and « access to the system » of the 5th metro line of Lyon for the two selected scenario. ....	184
Figure 135 : Organic description (alinement) of the tunnel of the 5th metro line of Lyon at the system level ..	184
Figure 136: The addition of “ <i>space</i> ” in the “systemic cube”. Adapted from (Krob, 2014). Space is added as a “behavior” of the system as it is perpendicular to systemic levels and architectural views.....	185
Figure 137 : Operational, Functional and Organic requirements with their allocated spaces .....	186
Figure 138 : Example of a territorial diagnosis represented on a 2D map in La Rochefoucaud, France (DREAL, 2017) .....	186
Figure 139 : The 7 steps of a territorial diagnosis. Adapted from (Lardon, et al., 2005) .....	187
Figure 140 : The 4 elements constituting of a territorial diagnosis (Piveteau, et al., 2002).....	188
Figure 141 : Example of a functional diagram based on a multimedia brief (Mauger & Kubicki, january 2013) .....	189

Figure 142 : Perceptory icons (Université de Laval, 2018) .....	191
Figure 143 : Proposition to model geometric, location and topological information of spaces .....	191
Figure 144 : Metamodel of the GERTRUDe extension of SysML developed by Barbedienne (Barbedienne, 2017) .....	192
Figure 145 : RTM class diagram (International Railway Solution, 2016).....	193
Figure 146 : the addition of « <i>space</i> » in the fundamental expression of the need(s) scheme .....	194
Figure 147 : Interactions between the environment and the System of Interest. This diagram shows the feedback loops between the different steps of the Functional Analysis process from analysis of the needs to analysis of the solution. ....	196
Figure 148 : Integration of space in the Functional Analysis method. This figure shows new elements added to Functional Analysis in red. The integration of space in each view can lead to the identification of new spaces impacted by the system and therefore new elements from the environment to consider.....	198
Figure 149 : The three levels of constructability in (Loyola Vergara, et al., 2010). This diagram highlights that there are interactions between the project and the product both at high and low systemic levels and that constructability intends to study both of them. ....	199
Figure 150: The conceptual Product/Process matrix model (Pulaski, et al., 2005). This figure highlights interactions between the product model and the process model at different systemic levels from system to components. It goes a bit further than the last figure by specifying the different activities carried in the Enabling system (e.g. conceptual design, construction documents). ....	199
Figure 151 : From Buildability to Constructability. In the last chapter a similar figure has been used to highlight the differences between Buildability and Constructability. Here, we show the different between Constructability and Constructability and new elements added.....	200
Figure 152 : The Vee cycle metamodel applied to the Enabling system. This figure shows that simultaneously to the development of the product and its different systemic levels, elements of the Enabling System can also be modeled with a Vee metamodel. ....	202
Figure 153 : The double Vee cycle. This figure highlights that Constructability consists in analyzing interactions between the System of interest (in green) and the Enabling System (in blue) in all development steps in the different systemic levels.....	203
Figure 154 : Vertical Constructability analysis in the double V-cycle. Vertical constructability (in red) consists in analyzing interactions between activities in the left branch of the Vee cycle and the System of Interest. In vertical constructability activities consist in developing an avatar of the product (also called a model) which represent as much as possible to the product developed in the right branch. ....	204
Figure 155 : Horizontal Constructability analysis and the double V cycle. This figure shows that Horizontal constructability consists in considering requirements related to elements of the Enabling System in the right branch of the vee (such as logistic, assembling, verification) when modeling the System of Interest in the left branch of the vee. ....	205
Figure 156 : Adapted Constructability Principles and new Constructability Principles. In orange are adapted Constructability Principles and in Green new Constructability Principles developed in the thesis. ....	207
Figure 157 : A CLIOS System consists of a physical domain (made up of subsystems), embedded in an institutional sphere (Mostashari, 2005). This figure highlights that physical elements of a system in megaprojects and more particularly in construction projects are in interaction with the Institutional sphere. ....	209
Figure 158: Example of the application of the CLIO process on a transportation system. ....	209
Figure 159 : Example of objectives of an Enabling System analysis represented with a Use Case Diagram (SysML).....	210
Figure 160 : Conceptual scheme of « <i>Adaptative Capacity</i> » (Giezen M. , 2012). It regroups the different adaptation mechanisms to carry to be able to face to contextual changes in a project governance. ....	213

Figure 161 : Particularity of the construction industry: Geographical Space, the System of Interest and the Enabling System. It highlights that not only the System of Interest is related to space but also the Enabling System. ....	217
Figure 162 : Physical space processes in the V-cycle development meta-model. Adapted from (Forsberg & Mooz, 1992) .....	218
Figure 163 : Space and activities of the enabling system. ....	219
Figure 164 : Functional Analysis Embodiment in different systemic levels. Sidebars in red highlight that Internal Functional Analysis in one systemic level is the External Functional Analysis in the lower systemic level. As mentioned earlier due to the consideration of space in all views of SE, the external environment is interacting in Operational, Functional and Organic views. ....	220
Figure 165 : Systemic levels and phases of construction projects .....	221
Figure 166 : Complementarity between Functional Analysis and MBSE .....	222
Figure 167 : Example of a context diagram with an Internal Block Diagram (Weilkiens, 2012).....	222
Figure 168 : Example of a Use Case diagram in SysML (implemented in Papyrus).....	223
Figure 169 : Complementarity between Functional Analysis and Requirement Engineering.....	224
Figure 170 : Constructibility in the different Architectural views. Constructibility Principles (in orange) presented in this thesis are represented in the different steps of the Enriched Functional Analysis method.....	226
Figure 171 : Constructibility in the Operational view.....	228
Figure 172 : Constructibility in the functional view .....	229
Figure 173 : Constructibility in the organic view.....	230
Figure 174 : Program Requirements model (Exegis). This figure shows how to model a “Program” requirements with exegis, i.e. requirements expressed by the client with its different attributes (at least an ID, a text detailing the requirement and relations with other requirements).....	232
Figure 175 : Example of a Design requirement with its attributes in Exegis (i.g. ID, text links with other requirements, state (satisfied or not satisfied). i.e. requirements defined by the consultant/designer. ....	233
Figure 176 : Company replies table. This table allows contractors to assess if they are compliant with requirements defined by the designer and in what extent.....	233
Figure 177 : Example of a verification board. This figure allows summing up the proportion of requirements verified, which have failed the test and which are not verified yet.....	234
Figure 178 : Example of traceability board. This traceability board allows summing up the proportion of requirements refined by the designer.....	234
Figure 179 : Example of a report created with Exegis applied to the optical fiber subsystem of the line 16 of the Greater Paris metro project. Diagrams and table of requirement are automatically produced in a word format by Exegis. ....	235
Figure 180 : Example of links between SysML requirements modeled in Exegis and BIM models .....	237
Figure 181 : Example of a DSM components <-> components matrix (Eppinger, et al., 2012). Crosses at intersections between components indicate interfaces between them. ....	238
Figure 182 : Example of a DMM matrix applied to the modeling of independencies between a sunroof product and its development process (Eppinger, et al., 2012). Intereactions and relations between elements of the process and the product are modeled through circles, squares, bars and links between them at intersections of rows and columns of the matrix. ....	239
Figure 183 : The Constructibility matrix. In rows are represented elements from the product (System of Interest), its needs, functions and components and in columns elements of the project (Enabling System) with previously defined Constructibility criteria. ....	241
Figure 184 : Constructibility criteria from the literature in the Constructibility matrix .....	242

Figure 185 : The theoretical Constructibility cube. More than the Constructibility matrix, the constructibility cube allows representing the different systemic levels of a construction system. ....	243
Figure 186 : The Constructibility cube. Similar boxes between systemic levels in the Constructibility cube are represented in different colors (blue and green here).....	244
Figure 187 : Comparison between the enriched Functional Analysis Method and the Old Functional Analysis method. Compared with the classic Functional Analysis method, The enriched FA method adds the consideration of spatial characteristics of systems, V&V requirements, Constructibility analysis, the use of new tools such as Requirement Engineering tools and Constructibility matrices.....	246
Figure 188 : The Enriched Functional Analysis Method and its detailed processes. This figure details the precise workflow to follow and the different steps in each view.....	247
Figure 189 : Use of improvements in Case studies. Improvements in orange have been developed specifically in this thesis and integrated in the method. Improvements in red have are coming from other researches and integrated in the Enriched Function Analysis method. ....	254
Figure 190 : Future connected areas of the 5th metro line of Lyon from Lyon city center and “Gare d’Alaïr” .	255
Figure 191 : The line 16 of the Greater Paris project (in dark blue) (Société du Grand Paris) from Noisy-Champs to Saint-Denis in the east of Paris. ....	256
Figure 192 : Organization of the work for the integration of the broadband network. This diagram shows that the design of the metro system has been separated into two distinct project teams with two distinct contracts. A project related to the design of the infrastructure of the line 16 and a project team dedicated to the design of equipments of the Greater Paris project. The project team I was integrated as part of this thesis was the integration of the Fiber optic network in the infrastructure of the line 16 (orange sidebar). ....	257
Figure 193 : Architecture of the Broaodband network in the Greater Paris project and its different “spatial elements”. ....	257
Figure 194 : Studies of the 5th metro line of Lyon in a System Engineering and Constructibility context at the system level. ....	258
Figure 195 : Use Case diagram of Functionalities of the multifunctional metro concept. In the middle are the different needs identified for potential integration in the future system. On both sides stakeholders are represented: citizens of Lyon, the Grand Lyon which is the local authorities responsible for urban functions in Lyon, private and public companies. ....	259
Figure 196 : Illustration of the multifunctional metro concept applied in the 5 <sup>th</sup> metro line of Lyon. ....	260
Figure 197 : The needs analysis phase in the enriched Functional Analysis methodology. The step considered in this part is surrounded in red: Operational analysis. Other analysis, Functional analysis and Organic analysis are not carried in this case studies. ....	261
Figure 198 : Identify External elements for energy needs. This diagram details the different steps undertaken to analyse potential needs the system will answer. ....	261
Figure 199 : Use case diagram representing energy needs potentially mutualized with the metro infrastructure. In the middle are represented Main Functions the system will potentially answer related to the energy sector. On both sides stakeholders interacting with the system are represented. In green, needs which have been identified and would benefit from an integration in the 5 <sup>th</sup> metro line through interviews with the Grand Lyon. In yellow, needs on which we don’t have information or which have not been identified as a priority by the Grand Lyon. In red, needs which are not existing from the Grand Lyon perspective. ....	262
Figure 200 : High voltage electrical network in the region of Lyon, France (RTE, 2018). In dark red is the future metro line, in ref the 400kV network, in green the 225kV network and in purple the 63kV network. ....	264
Figure 201 : The High Voltage Electrical network integrated in the metro infrastructure. This picture shows an example of mutualization between a metro tunnel and an energy tunnel. ....	265

Figure 202 : The heat network and its future developments in Lyon, France (Grand Lyon, 2017). In red is the 5 <sup>th</sup> metro line of Lyon. In blue the zone where the heat network would be potentially extended in the future and in pink the current heat network in Lyon. ....	265
Figure 203 : Geothermal systems in inverts and diaphragm walls of Rennes metro line B (Egis, 2014). It gives an example of mutualization between a geothermal system and metro station. ....	266
Figure 204 : Geothermal system in tunnel segments (Rehau, 2011). It gives an example of mutualization between a geothermal system and da tunnel. ....	267
Figure 205 : The Constructibility matrix for Energy needs analysis in the Operational view .....	270
Figure 206 : Use case diagram of water needs potentially integrated in the 5th metro line of Lyon. In the middle are potential future functions related to water management system in Lyon and on both sides, stakeholders related to the water system management. In green are needs which have been identified as existing through interviews with the Grand Lyon and in yellow needs which are existing but not prioritized. ....	271
Figure 207 : The sewage system (on the left) and drinkable water system (on the right) in Lyon and the 5 <sup>th</sup> metro line (adapted from (Grand Lyon, 2015)). The 5 <sup>th</sup> metro line is represented in dark red. ....	272
Figure 208 : Water consumption comparison between 2014 and 2030 (Grand Lyon, 2015). ....	272
Figure 209 : water tanks in metro station in the « Osmose » concept (RATP, 2010). Example of the integration of a water management system in a metro station. ....	273
Figure 210 : Governance of the water system in Lyon. In dark red is represented the 5th metro line of Lyon...	274
Figure 211 : The Constructibility matrix for water needs in the Operational view .....	276
Figure 212 : Example of a logistic system analysis in Ile de France by type of merchandise (DRIEA , 2010). Different types of current merchandise flows in île de France have been studied and represented on maps. From up left to bottom right: mass market retailing flows and storage, beverage flows, pharmaceutical products flows and their storage, construction materials and their storage. ....	277
Figure 213 : Location of key freight flows in London – schematic (Transport for London, 2007). This map shows the current and future different types of freight flows in the Greater London area: container traffic and aggregates traffic and depot, depots in general as well as main passenger routes. Objective of this study undertaken by the municipality of London was to evaluate potentialities to use passenger routes for freight. ....	278
Figure 214 : Cargocap example of an underground logistic system to transport freight (CargoCap, 2007). ....	279
Figure 215 : European cities where restrictions on polluting vehicles are applied (Le Monde, 2017). This map shows that the legal context on traffic regulation in city is changing and will potentially impact the logistic system. More specifically there is a trend in western Europe to regulate the traffic of polluted trucks in city centers. In Yellow are represented cities where traffic is regulated for trucks, in red where it exists a city toll. ....	280
Figure 216 : Constructibility matrix related to logistic needs in the operational view .....	282
Figure 217 : The broadband services in Lyon and its suburbs (arcep, 2018) (Plan France Très Haut Débit, 2018). In both figures the future 5 <sup>th</sup> metro line of Lyon is represented in dark red. In both figures is represented the connection of areas to the high speed broadband network in Lyon. ....	284
Figure 218 : Example of the installation of Optical Fiber inside a metro infrastructure by an operator .....	285
Figure 219 : Scheme of the use of a Data Center in the Greater Paris project for urban agriculture (Société du Grand Paris, 2018) .....	286
Figure 220 : Constructibility matrix related to telecom needs in the Operational view .....	288
Figure 221 : Example of a pneumatic waste management system (MariMatic, 2014). ....	290
Figure 222 : Location of incinerators in Lyon (in red) (Google Map, 2018). The future 5 <sup>th</sup> metro line of Lyon is represented in dark red. ....	290
Figure 223 : Location of landfills in Lyon (in green) (Google Map, 2018). The future 5 <sup>th</sup> metro line of Lyon is represented in dark red. ....	291

Figure 224 : Governance of the waste management system in Lyon and its surroundings and interactions between them (Grand Lyon, 2018). In dark red is represented the future 5 <sup>th</sup> metro line. ....	292
Figure 225 : Constructibility matrix related to waste management needs in the Operational view .....	294
Figure 226 : Constructibility matrix for the integration of new functions in the 5th metro line of Lyon in the Operational view .....	295
Figure 227 : Studies of the “construction subsystem” of the broadband system for the line 16 of the Greater Paris project in a System Engineering and Constructibility context .....	296
Figure 228 : Operational Analysis for the broadband system of the Greater Paris line 16. In the red sidebar is also detailed the working flow to carry the Operational analysis. ....	297
Figure 229 : The working flow undertaken to carry the Operational Analysis .....	297
Figure 230 : Needs of the infrastructure broadband network modeled with a Use case diagram. In the middle are main functions of the future system and on both sides are represented stakeholders in interaction with the future system. ....	298
Figure 231 : the broadband network system of the Greater Paris project. Are represented the main elements of the broadband network required: slicing rooms, optical fiber paths (secondary and primary networks), technical rooms, the tunnel, stations and shafts of the metro infrastructure. ....	299
Figure 232 : Example of an optical fiber cable .....	300
Figure 233 : Photo of a slicing box .....	300
Figure 234 : Spaces required in splicing rooms .....	301
Figure 235 : Photo of a water cable carrying system. In the left the engine require to “blow” the cable into the tube. In the right the water tank required to inject water in the tube. ....	301
Figure 236 : Example of a distribution cabinet .....	302
Figure 237 : Interactions between requirements of the System of Interest and the Enabling System. In the green space are requirements related to the System of Interest (what the future system should be and do). In the red space are requirements related to the Enabling System (how the system should be designed and built). Interactions between requirements have also been modeled. ....	306
Figure 238 : The constructibility matrix related to the Operational view of the construction subsystem of the broadband network .....	307
Figure 239 : Functional Analysis for the broadband network of the line 16 of the Greater Paris. In the red sidebar the working flow to carry the Functional Analysis is also detailed. ....	308
Figure 240 : Interactions between requirements of the System of Interest and the Enabling System in the functional analysis view. In green are represented requirements related to the system of Interest (what the system has to do) and in red requirements related to the Enabling System (what is required to develop the system) and interactions between both. ....	312
Figure 241 : The constructibility matrix for the functional view of the construction subsystem of the broadband network .....	313
Figure 242 : Organic Analysis for the broadband network of the Greater Paris line 16. ....	313
Figure 243 : This diagram represents the workflow used to carry the Organic analysis for the broadband network of the Greater Paris project. ....	314
Figure 244 : Example of HDPE tubes/tubes .....	314
Figure 245 : Example of assembled tubes .....	315
Figure 246 : Example of the position of tube sets in the invert of the tunnel. Tubes dedicated to optical fibers are located in red squares in the invert. ....	315
Figure 247 : Example of a shaft integrating a space dedicated to slicing boxes. On the left the shaft is represented in 3D using Navisworks® and on the right in 2D using Autocad®. The space dedicated to splicing boxes is represented in yellow. ....	316



Figure 248 : Example of non CTP path ways .....	316
Figure 249 : Example of the integration of a technical room in the line 16 of the Greater Paris project. The technical room is represented in yellow in the upper scheme and telecom cabinets in blue in the lower scheme. ....	317
Figure 250 : Examples of connecting rooms used for the broadband system in 3D and 2D.....	317
Figure 251 : Tube installation sequence on site. In black are represented shafts, stations and the tunnel. In blue is represented concrete supply and in red how reels will be supplied to the tunnel. ....	319
Figure 253 : Constructibility matrix of the broadband network of line 16 in the 3 architectural views: Operational, Functional and Organic and with the 22 Constructibility criteria.....	322
Figure 254 : Requirement diagram related to the tube system in Exegis. In green are represented requirements related to the System (what the system has to do) and in red requirements related to the Enabling system (how the system has to be developed) and interactions between them.....	323
Figure 255 : Requirement table related to the tube system in Exegis with all their attributes. ....	324
Figure 256 : Example of an impact analysis in Exegis. It allows very quickly to see first degree interactions between different requirements.....	325
Figure 257 : the C-K theory (Hatchuel, Le Masson, & Weil, 2011). On the left is represented the Concept space (C) where concepts trees are developed. And in the right the Knowledge space (K). In red are represented interactions between both.....	330

## Bibliography

---

- AASHTO. (2000). *Constructability review best practice guides*. Washington D.C.: Association of State Highway and Transportation Officials.
- Abbasnejad, B. (2013). *Poor Quality Cost in Construction: Literature review*. Chalmers University of Technology.
- Adams, S. (1989). *Practical buildability*. London: Butterworths.
- ADEME. (2014). Enquêtes Ménages et Déplacement (EMD). *Méthodes et outils transverses - Cahier Technique Mobilité*, 31 - 34.
- ADEME. (2018). *Le Fonds Chaleur, Une mesure majeure en faveur du développement des Énergies Renouvelables*. ADEME.
- AFIS. (2012). *Guide bonnes pratiques en ingénierie des exigences*. Cépaduès.
- AFNOR. (2009). *FD X50-153 Analyse de la valeur - Recommandations pour sa mise en oeuvre*. AFNOR Editions .
- Ahmed, A., & Othman, E. (2011). Constructability for reducing construction waste and improving building performance. *Built Environment Journal*, 31-54.
- Akanmu, A., Anumba, C., & Messner, J. (2012). *Scenarios for cyber=physical systems integration in construction*. ITcon 18: 240=260.
- Akintoye, A. (2006). Design and build: A survey of construction contractors' views. *Construction Management and Economics*, 155-163.
- Albers, A., & Zingel, C. (2011). *interdisciplinary Systems Modeling Using the Contact & Channel-mode for SysML*.
- Albert, P., & Chan an Ada, P. (2004). Key performance indicators for measuring construction success. *Benchmarking: an International Journal*, 11(2), 221.
- Allaire, D. (2012). Développement d'une approche systémique de la gestion patrimoniale d'un parc immobilier d'envergure nationale pour améliorer sa performance énergétique. 634.
- Alshawi, M., & Underwood, J. (1996). Applying object-oriented analysis to the integration of design and construction. *Automation in Construction*, 105 - 121.
- American Heritage Dictionary. (2018). <https://www.dictionary.com/browse/geography>.
- Anderson, S., Fisher, D., & Gupta, V. (1995). *Total constructibility management: A process-oriented framework*. Project Management Journal.
- APTE. (2018, 05 01). *méthode APTE®*. Retrieved from <http://methode-apte.com/>
- arcep. (2018). *La carte des villes couvertes en fibre optique*. Retrieved from <https://www.ariase.com/fr/haut-debit/couverture-fibre-optique.html>
- Arthaud, G. (2007). *Apports de modèles de comparaison structurelle et sémantique à la synchronisation de la maquette numérique de construction. Application aux ponts*.
- ASCE. (1991). *Constructability and constructability programs: White paper*. Journal Construction, Engineering and Management. Construction and Management committee.
- Aslaken, E., Knight Merz, S., & Leonards, S. (2005). *Systems Engineering and the Construction Industry*. Requirements and construction.
- Association Française d'Ingénierie Système. (n.d.). Retrieved from <https://www.afis.fr/pages/accueil.aspx>
- Augereau, V. (2009). *Du transport de marchandises en ville à la logistique urbaine, quels rôles pour un opérateur de transports publics urbains. L'exemple de la RATP*. Université Paris-Est: Laboratoire Ville Mobilité et Transport.
- Australian Government. (2015). *National Alliance Contracting Guidelines*. Department of Infrastructure and Regional Development.

- Azam Haron, N., & Mohd Khairudin. (2012). *The application of Quality Function Deployment (QFD) in the Design Phase of Industrialized Building System (IBS) Apartement construction project*. European International Journal of Science and Technology.
- Azarian, A., & Pollet, Y. (2016). *Analyse fonctionnelle des systèmes*. Presses des MINES.
- Baccarini, D. (1996). The Concept of project complexity - a review. *International Journal of Project Management*, 201 - 204.
- Badreau, S., & Boulanger, J. (2014). *Ingénierie des exigences - Méthodes et bonnes pratiques pour construire et maintenir un référentiel*. Dunod.
- Barbedienne, R. (2017). *Gestion des interactions pour l'évaluation en phase de préconception, des architectures 3D de systèmes sous contraintes multi-physique, application à la thermique*. Université Paris-Saclay.
- Barbier, F. (2005). *UML 2 et MDE Ingénierie des Modèles avec étude de cas*. DUNOD.
- Bar-Yam, Y. (2000). *General Features of Complex Systems*. New England Complex Systems Institute, Cambridge, MA, USA: KNOWLEDGE MANAGEMENT, ORGANIZATIONAL INTELLIGENCE AND LEARNING, AND COMPLEXITY- Vol. I -.
- Baudains, P., Bishop, S., Duffour, P., Marjanovic=Halburd, L., Psarra, S., & Spataru, C. (2014). *A systems paradigm for integrated building design*. Intelligent Buildings International.
- Benkamoun, N., Elmaraghy, W., Huyet, A.-L., & Kouiss, K. (2014). Variety Management in Manufacturing. Proceedings of the 47th CIRP Conference on Manufacturing. *Architecture Framework for Manufacturing System Design*, (pp. 88 - 93). Elsevier.
- Berrard, C. (2010). *Le processus de décision dans les systèmes complexes : une analyse d'une intervention systémique*. Université Paris-Dauphine.
- Bertelsen, S. (2003). Proceedings for the 11th Annual Conference of the International Group for Lean Construction. *Construction as a complex System*.
- Boehm, B. (1988). A Spiral Model of Software Development and Enhancement. *Computer*, 61 - 72.
- Bohnke, D., Reichwein, A., & Rudolph, S. (2009). *Design language for airplane geometries using the unified modeling language*.
- Bonnel, P. (2001). *Prévision de la demande de transport*. Lyon: Laboratoire d'Economie des Transports ENTP, Université Lumière Lyon 2.
- Boothroyd, G., Dewhurst, P., & Knight, W. (2002). *Product Design for Manufacture Assembly 2nd Edition*. Marcel Dekker, Inc.: New York - Basel.
- Borrmann, A., & Ernst, R. (2009). Topological analysis of 3D BuildingModels using a SpatialQuery Language. *Computation in Engineering*.
- Borrmann, A., & Norbert, P. (2009). Geometrical and topological approaches in Building Information Modeling. *Computation in Engineering*.
- Borza, J. (2011). General Dynamics Land Systems. *FAST diagrams: the Foundation for Creative Effective Function Models* (pp. 1-10). Detroit: Value Innovation.
- Bouch, C., Rogers, C., Dawson, R., Baker, C., Quinn, A., & Walsh, C. (2015). *A Systems=Based approach to the Identification of User/Infrastructure Interdependencies as a Precursor to Identifying Opportunities to Improve Infrastructure Project Value/cost Ratios*. International Institute of Applied Systems Analysis (IIASA), Scgloss Laxenburg, Vienna, Austria; UCL STEaPP: London, UK: International Symposium for Newt Generation Infrastructure Conference Proceedings.
- Brady, T., & Davies, A. (2014). *Managing structural and dynamic complexity: a tale of two projects*. Project Management Journal 45(4), 21-38.
- Briol, P. (2008). *BPMN, the Business Process Modeling Notation Pocket Handbook*. Ingénierie des Processus.net.

- Browning, T. (2001). *Applying the Design Structure Matrix to System Decomposition and Integration Problems: A Review and New Directions*. IEEE Transactions on Engineering Management.
- Brunet, R. (1987). *La carte, mode d'emplois*. Paris: Fayard-Reclus.
- Building and Construction Authority. (2014). *Code of practice on Buildability*. Singapore: BCA.
- Building and Construction Authority. (2017). *Code of Practice on Buildability*. Singapore.
- Building Smart International. (2018, 02 02). Retrieved from <http://www.buildingsmart-tech.org/buildingSMART>.
- buildingSMART. (2008). *IFC space*. Retrieved 06 08, 2018, from <http://www.buildingsmart-tech.org/ifc/IFC2x3/TC1/html/ifcproductextension/lexical/ifcspace.htm>
- buildingSMART. (2017). *Infrastructure Asset Managers BIM requirements*.
- buildingSMART International. (2018, 03 29). *Data Dictionary*. Retrieved from buildingSMART International home of openBIM: <https://www.buildingsmart.org/standards/standards-tools-services/data-dictionary/>
- BuildingSmart International Alliance for Interoperability. (2007). *Information Delivery Manual Guide to Components and Development Method*.
- Bytheway, C. (1964). Society of American Value Engineers. *Functional Analysis Systems Technique*.
- Bytheway, C. (2007). *FAST Creativity & Innovation, Rapidly Improving Processes, Product Development and Solving Complex Problems*. J. Ross.
- Cantarelli, C., Flyvbjerg, B., Molin, B., & van Wee, B. (2010). *Overruns in Large-Scale Transportation Infrastructure Projects: Explanations and Their Theoretical Embeddedness*. European Journal of Transport and Infrastructure Research.
- Capital. (2013). *TGV Tours-Bordeaux: les folies du plus grand chantier d'Europe*. Retrieved from <https://www.capital.fr/economie-politique/tgv-tours-bordeaux-les-folies-du-plus-grand-chantier-d-europe-839593>
- CargoCap. (2007). *Freight transportation in congested urban areas*. Retrieved 07 18, 2018, from <http://www.cargocap.com/content/the-cargocap-system>
- Cariaga, I., El-Diraby, T., & Hesham, O. (2007). *Integrating Value Analysis and Quality Functional Deployment for Evaluating Design Alternatives*. Journal of Construction Engineering and Management, ASCE.
- Castaing, C., & Tolmer, C.-E. (2015). *gestion et modélisation des informations pour les projets d'infrastructures: vers l'ingénierie système, la gestion d'exigences et l'Ingénierie Dirigée par les Modèles (IDM)*. Génie Logiciel n°114.
- Cavalcante, E., Cacho, N., Lopes, F., & Batista, T. (2017). *Challenges to the Development of Smart City Systems: A System-of-Systems View*. Natal: Association for computer machinery.
- Celik, T., Kamali, S., & Arayici, Y. (2017). *Social cost in construction projects*. Environmental impact Assessment Review.
- Cerema. (2015). *Evaluation a posteriori des transports collectifs en site propre - Note méthodologique*. Direction technique territoires et ville.
- CESAM. (2017). *CESAMS Systems Architecting Method, A Pocket Guide*.
- Chen, S., & McGeorge, W. (1994). A systems approach to managing buildability. *Austrian Institute of Building Papers*, 5.
- Chirkunova, E., Kireeva, E., Kornilova, A., & Pschenichnikova, J. (2016). *Research of Instruments for Financing of Innovation and Investment Construction Projects*. Samara State University of Architecture and Civil Engineering, Molodovgvardeskaya: Procedia Engineering.
- CII (Construction Industry Institute). (1996). *Constructability Implementation Guide, CII*. Austin, TX: University of Texas at Austin.
- Cilliers, P. (1998). *Complexity & Postmodernism*. London and New York: Routledge.

- CIRIA (Construction Industry Research and Information Association). (1983). *Buildability: an assessment*. Baltimore: CIRIA publications.
- Clé de sol. (2005). *Guide pratique des galeries multiréseaux*. Techni.Cités.
- Clementini, E., & Di Felice, P. (1997). Approximate topological relations. *International Journal of Approximate Reasoning*.
- Construction Industry Institute Australia. (1996). *Construction manual*. Adelaide: CII Australia.
- Cunha, A. (1988). *Systèmes et territoire: valeurs, concepts et indicateurs pour un autre développement*. L'Espace Géographique.
- CUNHA, A. (1998). Systèmes et territoire : valeurs, concepts et indicateurs pour un autre développement. *Espace géographique*, 3(17), 181-198.
- D. Breyse, H. N. (2009). *Identification des risques pour les projets de construction: revue des pratiques internationales et propositions*.
- D.A.R. Dolage, P. C. (2013). Productivity in the construction industry - a critical review of research. *Engineer*, 6(4), 12.
- David, R., & Alla, H. (1997). *Du grafset aux réseaux de Petri*. Hermès - Lavoisier.
- Davies, A., Gann, D., & Douglas, T. (2009). *Innovation in Megaprojects: Systems Integration at London Heathrow Terminal 5*. *California Management Review*, 51(2): 101=125.
- Demirkesen, S., & Ozorhon, B. (2017). *Impact of integration management on construction management performance*. *International Journal of Project Management*.
- Deru, M., & Torcellini, P. (2005). *Performance Metrics Research Project - Final Report*. NREL (National Renewable Energy Laboratory), Golden, Colorado, USA.
- Di Méo, G. (1998). De l'espace aux territoires : éléments pour une archéologie des concepts fondamentaux de la géographie. *L'information géographique*, 62(3), 99-110.
- Dikmen, I., Birgonul, T., & Kiziltas, S. (2004). *Strategic use of quality functional deployment (QFD) in the construction industry*. *Building and Environment*.
- Dikmen, I., Birgonul, T., & Kiziltas, S. (2005). *Strategic use of quality function deployment (QFD) in the construction industry*. *Building and environment*.
- Doran, & George. (1981). There's a S.M.A.R.T. way to describe way to write management's goals and objectives. *Management Review*.
- Dori, D. (2008). *Towards a Unified Product and Project Lifecycle Model (PPLM) for Systems Engineering*. Haifa, Israel : Proceedings of the 9th Biennial ASME Conference on Engineering Systems Design and Analysis .
- Dr. Dodder, R., Pr. Sussman, J., Dr. B. McConnell, J., Dr. Mostashari, A., & Dr. Sgouridis, S. (2009). *The "CLIOS Process" A User's Guide*. Boston: MIT.
- DREAL. (2017). *La méthode de Diagnostic Partagé Territorial : Un outil d'analyse au service de la connaissance et du dialogue avec les collectivités*. [http://www.nouvelle-aquitaine.developpement-durable.gouv.fr/etudes-analyses-territoriales-r816.html?page=rubrique&id\\_rubrique=816&id\\_article=1496&masquable=OK](http://www.nouvelle-aquitaine.developpement-durable.gouv.fr/etudes-analyses-territoriales-r816.html?page=rubrique&id_rubrique=816&id_article=1496&masquable=OK).
- DRIEA . (2010). *Etude de Benchmarking pour le projet de fret dans le cadre de la préparation du débat public sur le Grand Paris*. Île de France.
- Dursun, P. (2012). *Dialogue on space: Spatial codes and language of space*. İstanbul Technical University, Faculty of Architecture, İstanbul, TURKEY: ITU A|Z.
- Eastman, C., Teicholz, P., Sacks, R., & Liston, K. (2008). *BIM Handbook*. Wiley.
- Egenhofer, M., & Franzosa, R. (1991). Point set topological spatial relations. *International Journal of Geographical Information Systems*.
- Egis. (2014). *Geothermal systems in inverts and diaphragm walls of Rennes metro line B*. Internal Documents Egis.

- Egis. (2018). *About Egis, Key Figures*. Retrieved from <https://www.egis-group.com/group/about-egis/key-figures>
- Egis. (2018, 03 05). *Métro de Doha au Qatar: Egis en groupement avec Louis Berger, remporter un contrat de Management de projet*. Retrieved from <http://www.egis.fr/action/actualites/metro-de-doha-au-qatar-egis-en-groupement-avec-louis-berger-remporte-un-contrat-de>
- Eisner, H., Marciniak, J., & McMillan, R. (1991). *Computer aided System of Systems Engineering*. IEEE SMC.
- Emes, M., & Marjanovic-Halburd, L. (2012). *Systems for construction: lessons for the construction industry from experiences in spacecraft systems engineering*. Intelligent Buildings International.
- Engie and Global Cities Institute. (2015). *Cities and sustainable infrastructure* .
- Eppinger, S., & Browning, T. (2012). *Design Structure Matrix Methods and Applications*. Cambridge, Massachusetts: The MIT Press.
- Eppinger, S., & Salminen, V. (2001). *Patterns of Product Development Interactions*. Glasgow, Scotland: International Conference on Engineering Design.
- Estefan, J. (2008). *Survey of Model-Based Systems Engineering (MBSE) Methodologies*. Pasadena, California: California Institute of Technology.
- Eusgeld, I., Nan, C., & Dietz, S. (2011). *"System-of-Systems" approach for interdependant critical infrastructures*. Zurich: Elsevier.
- EY and Urban Land Institute. (2013). *Infrastructure 2013, Global Priorities, Global Insights*.
- Feliot, C. (1997). *Modélisation des systèmes complexes: intégration et formalisation de modèles*. Lille: Université de Lille.
- Ferguson, I. (1989). *Buildability in practice*. London: Mitchell.
- FIDIC. (2018, 08 30). *Which FIDIC Contract should I use?* Retrieved from International Federation of Consulting Engineers: <http://fidic.org/bookshop/about-bookshop/which-fidic-contract-should-i-use>
- Fiorèse, S., & Meinadier, J.-P. (2012). *Découvrir et comprendre l'ingénierie système*. Paris: Cépaduès.
- Fischer, M., & Tatum, C. (1989). *Partially automating the design-construction interface: constructibility design rules for reinforced concrete structures*. Stanford Univ., Stanford CA: Working paper n°4, Center for Integrated Facility Engineering (CIFE).
- Fisher, D. (2000). *An Overview of Constructibility tools*. Albuquerque: Departement of Civil Engineering, University of New Mexico.
- Flyvbjerg, B. (2007). *Policy and planning for large-infrastructure projects: problems, causes, cures*. Environment and Planning B: Planning and Design.
- Forsberg, K., & Mooz, H. (1992). The relationship of Systems Engineering to the Project Cycle. *Engineering Management Journal*, 36 - 43.
- Frisullo, E. (2017, juin 13). *Lyon: Le projet de ligne de métro jusqu'à Tassin enfin à l'étude*. (20 minutes) Retrieved from <http://www.20minutes.fr/lyon/2085775-20170613-lyon-projet-ligne-metro-jusqu-tassin-enfin-etude>
- Fruin, J. (1971). *Designing for pedestrians: A level-of-service concept*. The port of New York Authority.
- Fung, R., Xu, b., & Wang, D. (2000). *A new Approach to Qualify Function Deployment planning with financial consideration*.
- Gambatese, J., Pocock, J., & Dunston, P. (2007). *Constructability: Concepts and practice*. ASCE and American Society of Civil Engineers.
- Ganah, A. (2003). The use of computer visualization in communicating constructability information in UK. *Journal of Engineering Design and Technology*, 151-167.

- Geller, A. L. (2003). Smart Growth: A Prescription for livable cities. *American Journal of Public Health*, 9, 6.
- Géoconfluence. (2009, March). Retrieved from <http://geoconfluences.ens-lyon.fr/glossaire/gouvernance-territoriale>
- Getuli, V., Giusti, T., & Capone, P. (2015). *A Decision Support System (DSS) for constructibility assesment in seismic retrofit of complex buildings*. Firenze: Università degli Studi di Firenze.
- Getuli, V., Giusti, T., & Capone, T. (2015). International Symposium on Autmotion and Robotics in Construction. *A Decision Support System (DSS) for constructability assesment in seismic retrofit of complex buildings*. Taipei.
- Geyer, P. (2012). *Systems Modelling for sustainable building design*. Advanced Engineering Informatics.
- Gibb, A. (2001). Standardization and preassembly - distinguishing myth from reality using case study research. *Construction Management and Economics*, 307-315.
- Gibert, P. (1980). *Le contrôle de gestion dans les organisations publiques*. Paris: Editions d'Organisation.
- Giezen, M. (2012). *Keeping it simple ? A case study into the advantages and disadvantages of reducing complexity in mega project planning*. International Journal of Project Management.
- Giezen, M. (2012). *Navigating mega projects through complexity and uncertainty: strategic and adaptative capacity in planning and decision-making*. Amsterdam Institute for Social Science Research: PhD thesis.
- Gobin, C. (2013). *Enrichissement de l'analyse fonctionnelle, les apports de la construction*. DIRSII.
- Gobin, C. (2013). *L'usage comme valeur référence de la construction*. Master EGF/BTP ESTP.
- Gobin, C. (2017). *Conformation programmatique - principes d'une étape clé de l'efficience du bâti*. Techniques de l'ingénieur.
- Gobin, C. (2017). La constructibilité - Une approche duale de la construction. *Techniques de l'Ingénieur*.
- Gobin, C. (2017). *La constructibilité - Une approche duale de la Construction*. Paris: Techniques de l'Ingénieur.
- Godet, M. (2007). *Manuel de prospective stratégique*. Dunod.
- Gonzva, M. (2017). *Résilience des systèmes de transport guidé en milieu urbain : approche quantitative des perturbations et stratégies de gestion*. Université Paris-Est, Lab'Urba.
- Gonzva, M., Mireia, B., & Barroca, B. (2015). *Mobilisation de l'analyse fonctionnelle pour l'étude de la résilience des quartiers et des systèmes de transport guidé face au risque d'inondaction*. Techniques Sciences Méthodes.
- Grand Lyon. (2015). *Schéma général d'assainissement du Grand Lyon*.
- Grand Lyon. (2017, November). *Répartition des réseaux de chaleur publics sur le territoire*. Retrieved 05 14, 2018
- Grand Lyon. (2018). *métropole du Grand Lyon*. Retrieved 05 12, 2018, from <https://www.grandlyon.com/>
- Grand Lyon. (2018). *Schéma de COhérence Territorial*. <https://www.scot-agglolyon.fr/les-documents-du-scot/>.
- Grand Paris. (2018, 03 05). *Ligne 18*. Retrieved from <https://www.societedugrandparis.fr/gpe/ligne/ligne-18>
- Griffith, A. (1984). *Buildability: The effect of design and management on construction (a case study)*. Edinburgh: Edinburgh: Heriot-Watt University, Dept of building.

- Haider, T. (2009). Financial management of construction contracts (constructability and its relation with TQM, cost shifting Risk and Cost/benefit). *International Research Journal of Finance and Economy*, 42-51.
- Haider, T. (2009). Financial Mangement of Construction Contracts (Constructability and its relation with TQM, Cost shifting Risk and Cost/Benefit). *International Research Journal of Finance and Economics*.
- Hall, A. D. (1962). *A methodology for systems engineering*. Princeton, N.J. : Van Nostrand.
- Hammer, J. (2015, 07 23). *How Berlin's Futuristic Airport Became a \$6 Billion Embarrassment*. (BloombergBusinessweek) Retrieved 02 2017, 23, from <https://www.bloomberg.com/news/features/2015-07-23/how-berlin-s-futuristic-airport-became-a-6-billion-embarrassment>
- Haroglu, H., Glass, J., & Thorp, T. (2010). *Contractors influence within the design process of design-build projects*. Oxfordshire, U.K.: Challenges opportunities solutions structure engineering construction, Taylor & Francis Group.
- Hastak, M. (2014). *Quantitative analysis of policies for governance of emergent dynamics in complex construction projects*. *Construction Management and Economics* 32(12): 1222=1237.
- Hatchuel, A. (1996). *Théories et modèles de conception, Cours d'ingénierie de la conception*. Paris: Ecole des Mines de Paris.
- Hatchuel, A. (2002). Towards Design Theory and expandable rationality: the unfinished program of Herbert Simon. *Journal of Management and Governance*.
- Hatchuel, A., Le Masson, P., & Weil, B. (2011). Teaching innovative design reasoning: How concept-knowledge theory can help overcome fixation effects. *Artificial intelligence for engineering design analysis and manufacturing*, 77-92.
- Haugthon, G., & Hunter, C. (1994). *Sustainable Cities*. London: Routledge.
- Henderson, V. (2001). *Marshall's scale economies*.
- Higgings, A. (2018, 05 11). *Resilient Construction for a Changing Climate*. Retrieved from Connect & Construct: <https://connect.bim360.autodesk.com/climate-change-resilient-construction>
- Honour, E. (2013). *Systems Engineering Return on Investment Ph.D. Thesis*. University of South Wales, Defense and Systems Institute.
- Houet, T., Hubert-Moy, L., Corgne, S., & Marchand, J.-P. (2008). *Approche systémique du fonctionnement d'un territoire agricole bocager*. (Belin, Ed.) L'espace Géographique.
- Hugo, F., O'Connor, J., & Ward, W. (1990). *Highway constructability guide*. Austin TX: Center for Transportation Research, University of Texas at Austin.
- IMF. (2014). Is it the right time for an infrastructure push. In *The time is right for an infrastructure push* (p. 40).
- INCOSE. (2004). *INCOSE SE Vision 2020*.
- INCOSE. (2007). *INCOSE SE Vision 2020*.
- INCOSE. (2015). *Guide for Writing Requirements*. San Diego, California: Requirement Working Group.
- INCOSE. (2015). *Systems Engineering Handbook*. Wiley.
- INCOSE. (2015). *Systems Engineering Handbook 4th edition*. Wiley.
- INCOSE Infrastructure Working Group. (2012). *Guide for the application of Systems Engineering in Large Infrastructure Projects*. INCOSE.
- INCOSE, PMI & MIT. (2012). *The guide to Lean Enablers for Managing Engineering Programs*.
- INSEE. (2016, 10 13). *Productivité*. Retrieved 23 02, 2017, from <https://www.insee.fr/fr/metadonnees/definition/c1452>



- International Council on Systems Engineering. (2015). *Systems Engineering Handbook 4th Edition*. WILEY.
- International Railway Solution. (2016). *RailTopoModel - Railway infrastructure topological model*.
- IPENZ (Engineers New Zealand). (April 2008). *Constructability*. IPENZ.
- IRC. (2013). *Constructibilité*. Cahier Pratique, Le Moniteur des Travaux Publics et du Bâtiment.
- Ireland, V. (2006). The role of managerial actions in the cost, time and quality performance of high-rise commercial buildings. *Construction Management and Economics*, 59 - 87.
- ISO. (2005). *ISO 9000-2005*. International Organization for Standardization.
- ISO. (2015). *ISO 9001:2015 Systèmes de management de la qualité -- Exigences*. Organisation Internationale de Normalisation.
- ISO/IEC/IEEE. (2015). *15288:2015 Systems and software engineering -- System life cycle processes*. International Organization for Standardization.
- Jacot, J., & Micaelli, J. (1996). *La performance économique en entreprise*. Hermès.
- Jacquot, J.-C. (2010). *L'analyse fonctionnelle pour les débutants*. Case France.
- James, P., Holden, M., Lewin, M., Nelson, L., Oackley, C., Truter, A., & Wilmoth, D. (2013). Managing metropolises by negotiating urban growth. In *Institutional and Social Innovation for Sustainable Urban Development*. Routledge.
- Jarkas, A. (2011). Buildability factors that influence micro-level formwork labour productivity of beams in building floors. *Journal of Construction in Developing Countries*, 1-18.
- Jergeas, G., & Put, J. (2001). Benefits of constructability on construction projects. *Journal of Construction Engineering and Management*, 281-290.
- Jiang, L. (2016 July). Supporting automated constructability checking for formwork construction: an ontology. *Journal of Information Technology in Construction*, 23.
- Kaliba, C., Muya, M., & Mumba, K. (2008). *Cost escalation and schedule delays in road construction projects in Zambia*. International Journal of Project Management.
- Kazman, R., Nielsen, C., & Shmid, K. (December 2013). *Understanding patterns for System-of-Systems integration*. Software Engineering Institute.
- Keirstead, J., Jennings, M., & Sivakumar, A. (2012). *A review of urban energy system models: Approaches, challenges and opportunities*. London: Renewable and Sustainable Energy Reviews.
- Kelly, S., & Tolvanen, J.-P. (2008). *Domain-Specific Modeling: Enabling Full Code Generation*. New Jersey: John Wiley & Sons.
- Kibert, C. (2012). *Sustainable Construction*. Hoboken, New Jersey: John Wiley & Sons.
- Kifokeris, D., & Xenidis, Y. (2016). *Constructability: Outline of Past, Present, and Future Research*. (ASCE, Ed.) Journal of Construction Engineering and Management.
- Koskela, L. (2000). *An exploration towards a production theory and its application to construction*. Espoo: VTT Building Technology.
- Kossiakof, A., Sweet, W., Seymour, S., & Biemer, S. (2011). *Systems Engineering Principles and Practice, second edition*. Wiley.
- Kreider, R., & Messner, J. (2013). *The Uses of BIM: Classifying and selecting BIM uses*. Pen State Computer Integrated Construction.
- Krob, D. (2009). *Éléments d'architecture des systèmes complexes*. 20.
- Krob, D. (2014). *Éléments de systémique*. Architecture des systèmes. Paris: OpenEdition books - Collège de France.
- Kubicki, S. (2006). *Assister la coordination flexible de l'activité de construction de bâtiments. Une approche par les modèles pour la proposition d'outils de visualisation du contexte de coopération*. Université Henri Poincaré, Nancy I.

- Kubicki, S. (2006). *Assister la coordination flexible de l'activité de construction de bâtiments. Une approche par les modèles pour la proposition d'outils de visualisation du contexte de coopération*. Université Henri Poincaré, Nancy I.
- Lacoste, Y. (1995). Les géographes, la Science et l'illusion. *Hérodote revue de géographie et de géopolitique*(76).
- Lakhoua, M. (2012). *Using structured analysis for the control of real-time systems*. Journal of Engineering and Technology Research .
- Lam, P., & Wong, F. (2011). A comparative study of buildability perspectives between clients, consultants and contractors. *Construction Innovation*, 305-320.
- Lam, P., Wong, F., & Chan, A. (2006). Contributions of designers to improving buildability and constructability. *Design Studies*, 457 - 479.
- Lam, P., Wong, F., & Chan, A. (2006). Contributions of designers to improving buildability and constructability.
- Lam, P., Wong, F., & Tiong, R. (2006). An Empirical Study of the relationship between Buildability and Productivity in Singapore- lessons learn from Hong Kong SAR. *The CRIOCM 2006 International Symposium on "Advancement of Construction Mangement and Real Estate"*, 10.
- Lambert, R. (2015, Octobre 12). *À Lyon-Villeurbanne, un réseau de chaleur et de froid bon élève*. Retrieved 05 26, 2018, from DHCnews.com: <https://www.dhcnews.com/lyon-villeurbanne-reseau-de-chaleur-et-de-froid/>
- Lardon, S., & Piveteau, V. (2005). *Méthodologie de diagnostic pour le projet de territoire: une approche par les modèles spatiaux*. Géocarrefour.
- Larousse. (2018, 06 08). *Dictionnaire de français*. Retrieved from Larousse: <https://www.larousse.fr/dictionnaires/francais/espace/31013>
- Laugier, R. (2012). *L'étalement urbain en France, synthèse documentaire*. Centre de Ressources Documentaires Aménagement Logement Nature .
- Le Corbusier. (1933). *Charte d'Athènes*. Athens: Congrès International d'Architecture Moderne.
- Le Masson, P., & Mehamon, C. (2015). *Armand Hatchuel et Benoit Weil la théorie C-K, un fondement formel aux théories de l'innovation*. Paris: HAL archives-ouvertes.fr.
- Le Masson, P., Chris, M., Hatchuel, A., & Weil, B. (2016). la théorie C-K, un fondement formel aux théories de l'innovation. *Les grands auteurs du management de l'innovation et de la créativité In Quarto - Editions Management et Société*, pp. 588-613.
- Le Masson, P., Weil, B., & Hatchuel, A. (2014). *Théories, méthodes et organisations de la conception*. Paris: Presse des Mines.
- Le Moigne, J. (2006). *Théorie du système général*. Les classiques du réseau, Intelligence de la complexité.
- Le Moigne, J.-L. (2006). *La théorie du Système Général*. Les classiques du réseau Intelligence de la Complexité.
- Le Moine, A. (2014). *Comprendre et Observer les teerritoires l'indispensable apport ded la systémique*. Université de Franche-Comté.
- Le Monde. (2017). *Pollution à Paris : interdiction des véhicules les plus polluants à partir du 1er juillet*. Retrieved 07 18, 2018, from [https://abonnes.lemonde.fr/pollution/article/2017/06/30/pollution-a-paris-interdiction-des-vehicules-les-plus-polluants-a-partir-du-1er-juillet\\_5153778\\_1652666.html](https://abonnes.lemonde.fr/pollution/article/2017/06/30/pollution-a-paris-interdiction-des-vehicules-les-plus-polluants-a-partir-du-1er-juillet_5153778_1652666.html)
- Lebeau-pin, B. (2015). *A Language for Writing System Specifications in an Aeronautical Context*. Chatenay-Malabry, France: Ecole Centrale Paris.
- Lebeau-pin, B., Rauzy, A., & Roussel, J.-M. (2017). *A Language Proposition for System Requirements*. SYSCONA.

- Lebeauvin, B., Rauzy, A., & Roussel, J.-M. (2017). *A Language Proposition for Systems Engineering*. Cachan, France: ENS Cachan.
- Lefebvre, H. (1974). *La production de l'espace*. Economica.
- Legifrance. (1985). *Loi n° 85-704 du 12 juillet 1985 relative à la maîtrise d'ouvrage publique et à ses rapports avec la maîtrise d'oeuvre privée*. Retrieved from <https://www.legifrance.gouv.fr/affichTexte.do?cidTexte=JORFTEXT000000693683>
- Legifrance. (2016). *loi sur la circulation ddes données et du savoir*. Retrieved 20 07, 2018, from [https://www.legifrance.gouv.fr/affichTexte.do;jsessionid=2EEDDC53AA4334B2F421EFAD13113A7B.tpdila23v\\_1?cidTexte=JORFTEXT000033202746&dateTexte=&oldAction=rechJO&catégorieLien=id&idJO=JORFCONT000033202743](https://www.legifrance.gouv.fr/affichTexte.do;jsessionid=2EEDDC53AA4334B2F421EFAD13113A7B.tpdila23v_1?cidTexte=JORFTEXT000033202746&dateTexte=&oldAction=rechJO&catégorieLien=id&idJO=JORFCONT000033202743)
- Legifrance. (July 18th 2017). *Loi n° 85-704 du 12 juillet 1985 relative à la maîtrise d'ouvrage publique et à ses rapports avec la maîtrise d'oeuvre privée*. Retrieved from <https://www.legifrance.gouv.fr/affichTexte.do?cidTexte=JORFTEXT000000693683>
- Lehmann, S. (2010). Green Urbanism: Formulating a Series of Holistic Principles. *SAPIENS*, 3(2), 11.
- Leicht, L. &. (n.d.). Supporting automated constructability checking for formwork construction: an ontology. *ITcon Vol. 21 (2016)*, 456.
- L'Espace Géographique. (2013). Retrieved from [lesdefinitions.fr/espace-geographique](http://lesdefinitions.fr/espace-geographique)
- Leurent, F. (n.d.). *La modélisation de la demande de transport, distribution spatiale*. Ecole Nationale des Ponts et Chaussées.
- L'Europe s'engage en France. (2016). *Le FEDER, qu'est-ce que c'est ?* <http://www.europe-en-france.gouv.fr/Centre-de-ressources/Actualites/Le-FEDER-qu-est-ce-que-c-est>.
- L'express. (2014, 02 18). *Municipales à Lyon: la guerre des métros*. Retrieved 04 22, 2018, from [https://www.lexpress.fr/actualite/politique/municipales-a-lyon-la-guerre-des-metros\\_1423352.html](https://www.lexpress.fr/actualite/politique/municipales-a-lyon-la-guerre-des-metros_1423352.html)
- Locuratolo, V. (2014). *La ville Compacte*.
- Loenen, B., & Mroczkowski, M. (2010). *QFD for the building and construction industry*. International Journal of Design Sciences and Technology.
- Low, S., & Abeyegoonasekera, B. (2001). Integrating buildability in ISO 9000 quality management systems: a case study of a condominium project. *Building and Environment*, 299 - 312.
- Low, S.-P., Liu, J., & Lim, J. (2008). Implications of thermal and building integrity performance on buildability of a worker dormitories project. *Structural survey*, 142-164.
- Loyola Vergara, M., & Goldsack Jarpa, L. (2010). *Constructividad y Arquitectura*. Santiago: Universidad de Chile Facultad de Arquitectura y Urbanismo.
- Lundrigan, C., Gil, N., & Puranam, P. (2014). *The (under) performance of MegaProjects: A meta-organizational perspective*. The University of Manchester.
- Lyon Capitale. (2014, 02 06). *Carte : le nouveau métro que Collomb voudrait créer*. Retrieved 22 04, 2018, from <https://www.lyoncapitale.fr/politique/carte-le-nouveau-metro-que-collomb-voudrait-creer/>
- Lyon Part-Dieu. (2017). *Travaux de production de froid urbain*. Retrieved 26 05, 2018, from [Carte des chantiers: https://www.lyon-partdieu.com/chantiers/travaux-de-production-de-froid-urbain/](http://Carte des chantiers: https://www.lyon-partdieu.com/chantiers/travaux-de-production-de-froid-urbain/)
- Maier, M. (1998). *Architecting Principles for Systems-of-Systems*. Chantilly VA: The Aerospace Corporation.
- Malek, M. (2011). Model Development of Constructability. *Management and Engineering*, 1-9.
- Mannion, M., & Keepence, B. (1995). *SMART Requirements*. Edinburgh, United Kingdom: Software Engineering Research Group Napier University Department of Mechanical, Manufacturing and Software Engineering.

- marche-public.fr. (2018, 08 30). Retrieved from Marchés de conception-réalisation:  
<http://www.marche-public.fr/Marches-publics/Definitions/Entrees/Marches-conception-realisation.htm>
- MariMatic. (2014). *Pneumatic Waste Collection System for MSW and Recyclables*.
- Matar, M., Osman, H., Georgy, M., Abou-Zeid, A., & El-Said, M. (2015). *A systems engineering approach for realizing sustainability in infrastructure projects*. Housing and Building National Research Center Journal .
- Mauger, C. (2015). *Framework for integration of Services in Product requirements Definition Applied to Public Buildings*. Ecole Nationale des Arts et Métiers.
- Mauger, C., & Kubicki, S. (january 2013). *A Conceptual Model for Building Requirements processing*. Service Science & innovation Department, Public Research Centre Henri Tudor.
- McKinsey. (2015). *The construction productivity imperatives*. McKinsey Productivity Science Center.
- McKinsey Global Institute. (2013). *Infrastructure productivity: how to save \$1 trillion a year*.
- MEO, G. D. (1998). De l'espace aux territoires : éléments pour une archéologie des concepts fondamentaux de la géographie. *L'information géographique*, 62(3), 99-110.
- Micaëlli, J.-P., Deniaud, I., & Bonjour, E. (2012). *Conception routinière ou innovante: quels apports de l'ingénierie Système*. Génie logiciel.
- Miller, J. (1965). Living Systems. *The organizations in behavioral science*, 103-111.
- Miller, J. (1997). *Engineering Systems integration for civil infrastructure projects*. Journal of Management in Engineering.
- MINnD. (2016). *Cas d'usage MINnD*. Retrieved from <http://www.minnd.fr/le-projet-minnd/cas-dusages/>
- Mohanty, S. (2015). *Nanoelectronic Mixed-Signal System Design, Chapter 12 Metamodel-Based Fast AMS-SoC Design Methodologies*. McGraw-Hill.
- MOINE, A. (2006). Le territoire comme un système complexe : un concept opératoire pour l'aménagement et la géographie. *L'espace géographique*, 35, 115-132.
- Molwus, J. (2014). *Stakeholder Management in Construction Projects: A lifecycle based framework*. Herriot Watt University, Edinburgh.
- Morize, X. (2018). *Gestion patrimoniale des équipements en transports publics urbains*. Université Paris-Est, Laboratoire Ville Mobilité et Transport (LVMT).
- Mostaphari, A. (2005). *Stakeholder-Assisted Modeling and policy Design for Engineering Systems*.
- Mostashari, A. (2005). *Stakeholder-Assisted Modeling and Policy Design for Engineering Systems*. MIT.
- Mostashari, A. (June 2005). *Stakeholder-Assisted Modeling and policy Design for Engineering Systems*. (M. Libraries, Ed.) Massachusetts institute of Technology (MIT).
- Mostashari, A. (June 2005). *Stakeholder-Assisted Modeling and Policy Design for Engineering Systems*. Boston.
- Naderpajouh, N. (2014). *Interactional analysis of policies for governance of emergent dynamics complex construction projects*. Purdue.
- Nielson, Y., & Erdogan, B. (2005). Constructability of the North Saskatchewan River Bridge. *Proceedings of the Annual conference on Transportation Association of Canada*. Ottawa: Transportation Association of Canada.
- Nima, M. (2001). *Constructability factors in the Malaysian construction industry*. Selangor: PhD Thesis.
- Nuseibeh, B., & Easterbrook, S. (2000). Requirements Engineering: A Roadmap. *Proceedings of the conference on the future of Software engineering*, 35-46.
- O'Connor, T., & Miller, S. (1994). Barriers to constructability implementation. *Journal of performance of Constructed Facilities*, 110-129.
- OECD. (2007). *Infrastructure to 2030, Mapping policy for electricity, water and transport*.

- Olander, S. (2007). *Stakeholder impact analysis in construction project management*. Construction Management and Economics.
- OMGSysML. (2018, 02 11). *WHats is SysML?* Retrieved from <http://www.omgsysml.org/what-is-sysml.htm>
- Orstavik, F., Dainty, A., & Abbott, C. (2015). *Construction Innovation*. Hoboken, New Jersey: Wiley-Blackwell.
- OSLC. (2018, 08 31). *Home page*. Retrieved from Open Services for Lifecycle Collaboration: <https://open-services.net/>
- Pattison, W. (1964). *The four traditions of geography*. National Council for Geographic Education. Pennsylvania State University. (2010). *BIM Project Execution Planning Guide*. Philadelphia: The Computer Integrated Construction Research Program.
- Peyras, L. (2003). *Diagnostic et analyse de risques liés au vieillissement des barrages*. Université de Clermont-Ferrand 2.
- Pheng, L., & Abeyegoonasekera, B. (1999). Integrating buildability in ISO 9000 quality management systems: case study of a condominium project. *Building and Environment*, 14.
- Philip, B. (2009). *Cost of Quality in the construction Industry*. California Polytechnic State University.
- Piatt, J. (2012). *Six easy criteria for targeting a good process*. Retrieved 03 02, 2018, from Industry Week: <http://www.industryweek.com/continuous-improvement/six-easy-criteria-targeting-good-process>
- Piveteau, V., & Lardon, S. (2002). *Chorèmes et diagnostic de territoire: une expérience de formation*. Mappemonde 68.
- Plan France Très Haut Débit. (2018). Retrieved 07 19, 2018, from <https://observatoire.francethd.fr/>
- Polit-Casillas, R., & Howe, S. (2013). *Virtual Construction of Space Habitats: connecting Building Information Models (BIM) and SysML*. San Diego CA: AIAA SPACE 2013 conference and Exposition.
- Pollet, Y. (2007). *La démarche d'Ingénierie Système*. Conservatoire National des Arts et Métiers - Chaire d'intégration des systèmes.
- Prager, J.-C., & Quinet, E. (2013). *Les effets des infrastructures sur la répartition spatiale des populations et des emplois*. Commissariat Général à la stratégie et à la prospective.
- PREDIT, Ministère de l'Ecologie du Développement durable et de l'Energie. (2012). *Intégration des Mixités Opérationnelles Transport: Etats deds Possibles*. Rapport final.
- Prorail, Rijkswterstaat Ministrie van infrastructure en Milieu, Vereniging Van Waterbouwers, Bouwend Nederland, Uneto Vni, NLingénieurs. (2009). *Guideline for Systems Engineering within the civil engineering sector*.
- Pulaski, M., & Horman, M. (2005). *Organizing Constructability knowledge for Design* (Vol. 131). Journal of Construction Engineering and management.
- Rahmani, F., Khalfan, M., Maqsood, T., Noor, M., & Alshabri, N. (2013). How can trust facilitate the implementation of Early Contractor Involvement (ECI)? *Proceedings of the 19th CIB World Building Congress*, (pp. 74-85). Queensland University of Technology, Queensland AUstralia.
- RATP. (2010). *RATP - Station OSMOSE*. (RATP) Retrieved from <https://vimeo.com/11971353>
- Rehau. (2011). *Geothermal Tunnel Lining*. International Tunnelling Awards 2011.
- Rezgui, Y., Hopfe, C., & Vorakulpipat, C. (2010). Generations of knowledge management in the architecture, engineering and construction industry: An Evolutionary perspective. *Advanced Engineering Informatics*, 219 - 228.
- Ritchey, T. (2006). Problem Structuring using computer-aided morphological analysis. *Journal of the Operational Research Society*, 57.

- Roques, P. (2009). *SysML par l'exemple, un langage de modélisation pour systèmes complexes*. Eyrolles.
- Ross, D. (1977). *Structured Analysis (SA): A language for communicating ideas*. IEEE Transactions on Software Engineering.
- Royce, W. (1970). *Managing Development of Large Software Systems*.
- RTE. (2018). *Carte du réseau RTE*. Retrieved 05 14, 2018, from [https://rte-france.maps.arcgis.com/apps/Embed/index.html?webmap=02d413bcbe184384ba424fc40f9b8ce8&extent=-11.8692,40.3171,16.4975,52.9519&home=true&zoom=true&scale=true&legend=true&disable\\_scroll=false&theme=light](https://rte-france.maps.arcgis.com/apps/Embed/index.html?webmap=02d413bcbe184384ba424fc40f9b8ce8&extent=-11.8692,40.3171,16.4975,52.9519&home=true&zoom=true&scale=true&legend=true&disable_scroll=false&theme=light)
- Rue89Lyon. (2018, 02 16). *Un métro E pour relier Tassin à Lyon : il faudra dépenser un milliard d'euros*. Retrieved 04 22, 2018, from Rue89Lyon: <https://www.rue89lyon.fr/2018/02/16/metro-e-relier-tassin-a-lyon-il-faudra-depenser-un-milliard-euro/>
- Ruparelia, N. (2010). Software Development Lifecycle Models. *ACM SIGSOFT Software Engineering Notes*, 8.
- Russell, J., Swiggum, K., Shapiro, J., & Alaydrus, A. (1994). Constructability related to TQM, Value Engineering and Cost/Benefits. *Journal of Performance of Constructed Facilities*.
- Sage, A., & Rouse, W. (1999). *Handbook of Systems Engineering and Management*. John Wiley & Sons.
- Sandberg, M. (2007). *Design for manufacturing: Methods and applications using knowledge engineering*. Lulea University of Technology Department of Applied Physics and Mechanical Engineering: Division of Functional product Development.
- Sanvido, V., & Medeiros, D. (1988). *The cross fertilization of construction and manufacturing through computer integration*. The Pennsylvania State University.
- Sardén, Y., & Stehn, L. (2005). *Managing transformation, flow and value generation: a solid timber frame housing case*. Lulea University of Technology, Division of Structural engineering - Timber structures, Lulea Sweden.
- Sathyanarayanan, R. (2008). *Constructability review process - A summary of Literature*. Departement of Civil, Construction and Environmental Engineering, Oregon State University.
- Savanovic, P. (2007). Using methodical design for culture change in the Dutch building design practice: 'learning by doing' workshops. *Design Principles & Practices: An International Journal*, 71-82.
- Savanovic, P. (2009). *Integral design method in the context of sustainable building design*. Eindhoven: Duncan Harkness.
- Schneuwly, D., & Caloz, R. (2013). *Les concepts spatiaux fondamentaux*. Geographic Information Technology Training Alliance.
- SE LAB Kaist. (2018). *System of Systems*. Retrieved from <http://se.kaist.ac.kr/>
- Senescu, R., & Haymaker, J. (2011). *Design process communication methodology: Improving the efficiency and effectiveness of collaboration, sharing and understanding*. Technical rep. No TR197: Center for Integrated Facility Engineering, Stanford Univ., Stanford CA.
- Senescu, R., & Haymaker, J. (2011). *Design process communication methodology: Improving the efficiency and effectiveness of collaboration, sharing and understanding*. Stanford Univ., Stanford CA: Center for Integrated Facility Engineering.
- Serre, D. (2005). *Evaluation de la performance des digues de protection contre les inondations: modélisation de critères de décision dans un système d'information géographique*. Université Marne-la-vallée.

- Shankar. (1993). *A generalized methodology for Manufacturability Evaluation*. Texas A&M University: College Station.
- Shankar, & Jansson. (1993). A generalized methodology for evaluating manufacturability. *Concurrent Engineering*, 248 - 263.
- Sharon, A., & Dori, D. (2012). *A Project-product Model-based approach to Planning Work Breakdown Structures of Complex Systems Projects*. IEEE Systems Journal.
- Shen, W., Hao, Q., Mak, H., Neelamkavil, J., Xie, H., Dickinson, J., . . . Xue, H. (2010). *Systems integration and collaboration in architecture, engineering, construction, and facilities management: A review*. *Advanced Engineering Informatics* 24(2): 196=207.
- Shenhar, A. (1995). *A new System Engineering Taxonomy*. Incoase International Symposium.
- Simon, H. (1962). *The Architecture of Complexity* . Proceedings of the American Philosophical Society, Vol. 106, No. 6. .
- Simon, H. (1969). *The Sciences of the Artificial* . Cambridge, MA USA: MIT Press.
- Singhaputtangkul, N., & Low, S. (2015). Modeling a Decision Support Tool for Buildable and Sustainable Building Envelope Designs. *Buildings*, 521 - 535.
- Société du Grand Paris. (2014). *Appel à manifestations d'Intérêt sur la dimension numérique du Grand Paris Express*. SGP.
- Société du Grand Paris. (2018, 05 15). *Créer l'autoroute digitale qui soutiendra le développement du Grand Paris*. Retrieved 07 12, 2018, from <https://www.societedugrandparis.fr/sgp/engagements/numerique-189>
- Société du Grand Paris. (2018). *Data Center Agricole*. Retrieved 07 17, 2018, from <http://www.innovation.societedugrandparis.fr/data-center-agricole/>
- Société du Grand Paris. (n.d.). *Ligne 16 du Grand Paris Express*. Retrieved 04 22, 2018, from <https://www.societedugrandparis.fr/#lignes/1600>
- Standish Group. (2014). *CHAOS report*. Project SMART.
- Steffen, B. (2017). *The importance of project finance for renewable energy projects*. Energy Politics Group, Department of Humanities, Social and Political Sciences, ETH Zurich, Zurich, Switzerland: Energy Economics.
- Sterman, J. (1992). *System Dynamics modeling for project Management*. Cambridge MA: Sloan School of Management MIT.
- Sterman, J. (2000). *Business dynamics: systems thinking and modeling for complex world*. Irwin-McGraw-Hill.
- Strange, W., & Rosenthal, S. (2004). Evidence on the nature and source of agglomeration economies. *Handbook of Urban and Regional Economics vol 4*.
- Stransky, V. (2013). Repenser les modes de transport. In *Constructif* (p. 2).
- Suh, N. (2005). *Complexity: Theory and Applications*. Oxford University Press.
- Sui-Pheng, L., Junying, L., & Lim, J. (2008). Implications of thermal and building integrity performance on buildability of a worker dormitories project. *Structural survey*, 142-164.
- Sussman, J. (2009). *The "CLIOS" Process*. MIT.
- Sytral. (2016). *Ligne vers Alai, Cahier des Clauses Particulières (CCP)*.
- Sytral. (2017). *Dossier de presse: Le projet "Avenir Metro"*. Lyon.
- Tabarly, S. (2009, February 2). *Quelles échelles de gouvernance pour quels territoires métropolitains ? L'exemple de la région métropolitaine lyonnaise* . Retrieved from <http://geoconfluences.ens-lyon.fr/geoconfluences/doc/territ/FranceMut/FranceMutDoc13.htm>
- Tao, Z., Zophy, F., & Wiegmann, J. (2000). *Asset Management model and systems integration approach*. *Transportation Research Record*: 191=199.
- Tassinari, R. (2003). *Pratique de l'Analyse fonctionnelle*. Dunod.

- Tassinari, R. (2006). *Pratique de l'analyse fonctionnelle - 4ème édition*. Dunod.
- Tatum, C. (1993). *Structure characteristics of knowledge from construction experience*. Stanford Univ., Stanford VA: Technical rep. No. 81 Center for Integrated Facility Engineering.
- The American Institute of Architects. (2007). *Integrated Project Delivery: A Guide*. AIA.
- The Institution of Professional Engineers New Zealand. (2008). *Constructability*. IPENZ Engineers New Zealand.
- The Manila Times. (2017). *PPP suffers delays amid lack of continuity policy*. Retrieved from <https://www.manilatimes.net/ppp-suffers-delays-amid-lack-continuity-policy/310328/>
- Tolmer, C.-E. (2016). *Contribution à la définition d'un modèle d'ingénierie concourante pour la mise en oeuvre des projets d'infrastructures linéaires urbaines : Prise en compte des interactions entre enjeux, acteurs, échelles et objets*. Université Paris-Est.
- Toubin, M. (2014). Université Paris-Diderot.
- Transport for London. (2007). *Rail Freight Strategy*. Mayor of London.
- Transport Works. (n.d.). *Agglomeration effects, how transport can brings, workers and households closer together to increase productivity*. Retrieved 02 23, 2017, from <http://www.transportworks.org/evidence-base/agglomeration-effects>
- Tsai, T., & Yang, M. (2010). Risk assessment of design-bid-build and design-build building projects. *Journal on Operational Research of Japan*, 20-39.
- United Nations. (2014). *World Urbanization Prospects*.
- Université de Laval. (2018). *Perceptory*. Retrieved 02 22, 2018, from <http://perceptory.scg.ulaval.ca/>
- Valdes, F., Gentry, R., Eastman, C., & Forrest, S. (2016). *Applying Systems Modeling Approaches to Building Construction*. 33rd International Symposium on Automation and Robotics in Construction (ISARC 2016).
- Van den Houdt, S., & Dr Vrancken, J. (2009). *Rolling out Systems Engineering in the Dutch Civil Construction Industry*. Delft University of Technology.
- Van Loenen, B., & Mroczkowski, M. (2010). *QFD for the building and construction industry* (Vol. 17). International Journal of Design Sciences and Technology.
- Velasquez, E. (2013). L'avenir des villes denses. In *Constructif* (p. 6).
- Venables, A. (2007). *Evaluating urban transport improvements: cost benefit analysis in the presence of agglomeration and income taxation*. Journal of Transport Economics and Policy.
- Ventroux, J. (2016). *Aide à la maîtrise des risques liés à la contractualisation et l'exécution d'un projet complexe pétrolier*. Université Paris-Saclay Centrale Supélec.
- Veyret, Y., & Vigneau, J.-P. (2002). *Géographie physique, milieux et environnement dans le système terre*. Armand Colin.
- Voiron, C., & Chery, J.-P. (2005). *Espace géographique, spatialisation et modélisation en Dynamique des Systèmes*. 6ème Congrès Européen des Sciences des Systèmes.
- Voiron, C., & Chery, J.-P. (2005). *Espace géographique, spatialisation et modélisation en Dynamique des Systèmes*. 6ème Congrès Européen des Sciences des Systèmes.
- W. Halpin, D. (2010). *Construction Management*. John Wiley & Sons.
- Warniez, A., Penas, O., Plateaux, R., & Barbedienne, R. (2014). *SysML geometrical profile for integration of mechatronic systems*. IEEE/ASME International Conference on Advanced Intelligent Mechatronics, Besançon.
- Weilkiens, T. (2006). *Systems Engineering with SysML/UML, Modeling, Analysis, Design*. Morgan Kaufman.
- Weilkiens, T. (2007). *Systems Engineering with SysML/UML*. the MK/OMG Press.



- Weilkiens, T. (2012). *How to model an extended system context with SysML*. Retrieved from <https://model-based-systems-engineering.com/2012/08/06/how-to-model-an-extended-system-context-with-sysml/>
- Whyte, J. (2016). *The future of systems integration within civil infrastructure: A review and directions for research*. INCOSE, Imperial College London, Departement of Civil and Environmental Engineering.
- Winch, G. (1998). *Zephyrs of creative destruction*. *Building Research & Information*26(4): 268-279.
- Winch, G. (2010). *Managing Construction projects: an information processing approach*. Wiley-Blackwell, West Sussex, UK.
- Windapo, A., & Ogunsanmi, O. (2014). Evaluation of the barriers to the use of appropriate constructability practices on construction projects. *Journal of Construction Management and Innovation*, 734 - 754.
- Wong, F., Lam, P., Chan, A., & Chan, E. (2006). A review of buildability performance in Hong Kong and strategies for improvement. *Surveying and Built Environment Vol 17(2)*, 12.
- Wong, F., Lam, P., Chan, E., & Wong, F. (2006). Factors affecting buildability of building designs. *Canadian Journal of Civil Engineering*, 795 - 806.
- Wong, F., Lam, P., Chan, E., & Wong, F. (2006). Factors affecting buildability of building designs. 33.
- Wong, W. (2007). *Developing and implementing an Empirical System for scoring Buildability of designs in the Hong Kong Construction Industry*. Hong Kong: The Hong Kong Polytechnic University Department of Building and Real Estate.
- World Bank. (2009, Avril 23). *Les difficultés de financement des projets d'infrastructure compromettent la réalisation des objectifs de développement*. (World Bank Group) Retrieved 02 23, 2017, from <http://web.worldbank.org/WBSITE/EXTERNAL/ACCUEILEXTN/NEWSFRENCH/0,,contentMDK:22155998~menuPK:51200699~pagePK:34370~piPK:34424~theSitePK:1074931,00.html>
- World Bank. (2009). *Systèmes de villes, l'urbanisation au service de la croissance et de la lutte contre la pauvreté*. Stratégie de la Banque Mondiale pour les villes et les collectivités territoriales.
- World Bank. (2015). *Transformation through Infrastructure : World Bank Group Infrastructure*. World Bank Group.
- Yannou, B., & Limayem, F. (2000). *La méthode SPEC: une modélisation détaillée du cahier des charges fonctionnel pour un suivi de projet et une maîtrise des risques*. Paris: Laboratoire Productique et Logistique.
- Young III, J. (1998). Constructability in design firm. *Cost Engineering*, 33-35.
- Yusuf, Y., & Adeleye, E. (2002). A comparative study of lean and agile manufacturing with a related survey of contentn practices in the UK. *International Journal of Production Research*, 40(17).
- Zave, P. (1997). *Classification of research efforts in Requirements Engineering*. AT&T Laboratory Murray Hill, New Jersey 07974, USA: AT&T inc.
- Zhang, X. Q. (2015). *The trends, promises and challenges of urbanisation in the world*.
- Zhong, Y., & Wu, P. (2015). Economic sustainability, environmental sustainability and constructability indicators related to concrete- and steel-projects. *Journal of Cleaner Production*, 748 - 756.
- Zhu, J., & Mostafavi, A. (2014). *Toward a new paradigm for management of complex engineering projects: A system-of-systems framework*. Texas A&M University.
- Zhu, J., & Mostafavi, A. (2015). *Ex=ante assessment of vulnerability to uncertainty in complex construction project organizations*. Vancouver, British Columbia, Canada: 5th International/11th Construction Specialty Conference.

- Zhu, J., Whyte, J., & Mostafavi, A. (2017). *Towards Systems integration theory in Megaprojects: a System-of-Systems framework*. Heraklion, Greece: Proceedings of the Joint Conference on Computing in Construction (JC3).
- Zidane, Y., Johansen, A., & Ekambaram, A. (2012). *Megaprojects - Challenges and lessons learned*. Procedia - Social and Behavioral Sciences.
- Zoghalmi, A. (2013). *Modélisation et conception de systèmes d'information géographique gérant l'imprécision*. Université Paris Diderot.
- Zwingelstein, G. (1996). *La maintenance basée sur la fiabilité*. Diagnostic et Maintenance: Hermès.

