



**HAL**  
open science

# Johnson-type homomorphisms for surfaces and the universal perturbative invariant of 3-manifolds

Anderson Vera

► **To cite this version:**

Anderson Vera. Johnson-type homomorphisms for surfaces and the universal perturbative invariant of 3-manifolds. Geometric Topology [math.GT]. Université de Strasbourg, 2019. English. NNT : . tel-02145110v2

**HAL Id: tel-02145110**

**<https://theses.hal.science/tel-02145110v2>**

Submitted on 30 Jun 2019 (v2), last revised 16 Oct 2019 (v3)

**HAL** is a multi-disciplinary open access archive for the deposit and dissemination of scientific research documents, whether they are published or not. The documents may come from teaching and research institutions in France or abroad, or from public or private research centers.

L'archive ouverte pluridisciplinaire **HAL**, est destinée au dépôt et à la diffusion de documents scientifiques de niveau recherche, publiés ou non, émanant des établissements d'enseignement et de recherche français ou étrangers, des laboratoires publics ou privés.

# Thèse

INSTITUT DE  
RECHERCHE  
MATHÉMATIQUE  
AVANCÉE

UMR 7501

Strasbourg

présentée pour obtenir le grade de docteur de  
l'Université de Strasbourg  
Spécialité MATHÉMATIQUES

**Anderson Arley Vera Arboleda**

**Homomorphismes de type Johnson pour les  
surfaces et invariant perturbatif universel des  
variétés de dimension trois**

Soutenue le 28 juin 2019  
devant la commission d'examen

Gwénaél Massuyeau, directeur de thèse  
Christine Vespa, co-directrice de thèse  
Jean-Baptiste Meilhan, rapporteur  
Jun Murakami, rapporteur  
Benjamin Enriquez, examinateur  
Christian Kassel, examinateur  
Gregor Masbaum, examinateur

[www-irma.u-strasbg.fr](http://www-irma.u-strasbg.fr)



**Université**

**de Strasbourg**

ÉCOLE DOCTORALE MSII ED 269

IRMA, UMR 7501

**THÈSE** présentée par :

**Anderson Arley VERA ARBOLEDA**

soutenue le : 28 juin 2019

pour obtenir le grade de : **Docteur de l'Université de Strasbourg**

Discipline/ Spécialité : Mathématiques fondamentales

**Homomorphismes de type Johnson pour les surfaces et invariant perturbatif universel des variétés de dimension trois**

**THÈSE dirigée par :**

**M. MASSUYEAU Gwénaél**  
**Mme VESPA Christine**

Professeur, Université de Bourgogne  
Maître de Conférences (HDR), Université de Strasbourg

**RAPPORTEURS :**

**M. MEILHAN Jean-Baptiste**  
**M. MURAKAMI Jun**

Maître de Conférences (HDR), Université Grenoble Alpes  
Professeur, Waseda University

**AUTRES MEMBRES DU JURY :**

**M. ENRIQUEZ Benjamin**  
**M. KASSEL Christian**  
**M. MASBAUM Gregor**

Professeur, Université de Strasbourg  
Directeur de Recherche émérite, Université de Strasbourg  
Directeur de Recherche, Institute de Mathématiques de Jussieu-Paris Rive Gauche

Johnson-type homomorphisms for surfaces and the universal  
perturbative invariant of 3-manifolds

Anderson Vera



# Contents

<b>Introduction</b>	<b>v</b>
1 Introduction (en Français) . . . . .	v
1.1 Théorie de Johnson-Morita . . . . .	ix
1.2 Homomorphismes du type Johnson et le foncteur LMO . . . . .	xiii
1.3 Organisation de la thèse . . . . .	xvii
2 Introduction (in English) . . . . .	xvii
2.1 Johnson-Morita theory . . . . .	xxi
2.2 Johnson-type homomorphisms and the LMO functor . . . . .	xxv
2.3 Contents of this manuscript . . . . .	xxix
<b>1 Johnson-Levine homomorphisms and the tree reduction of the LMO functor</b>	<b>1</b>
1 Introduction . . . . .	1
2 Johnson homomorphisms . . . . .	3
2.1 Mapping class group . . . . .	3
2.2 Homology cobordisms and bottom-top tangles . . . . .	4
2.3 Johnson homomorphisms for homology cobordisms . . . . .	6
2.4 Milnor invariants and the Milnor-Johnson correspondence . . . . .	6
2.5 Diagrammatic version of the Johnson homomorphisms . . . . .	8
3 Lagrangian version of the Johnson homomorphisms . . . . .	9
3.1 Preliminaries . . . . .	9
3.2 The Lagrangian mapping class group . . . . .	10
3.3 The monoid of Lagrangian homology cobordisms . . . . .	13
4 Properties of the Johnson-Levine homomorphisms . . . . .	15
4.1 Surjectivity of the Johnson-Levine homomorphisms . . . . .	15
4.2 Invariance under the $Y_k$ -equivalence relation . . . . .	16
4.3 Comparison of the Johnson and Johnson-Levine filtrations . . . . .	18
4.4 Proof of Proposition 4.7 . . . . .	20
5 The LMO functor and the Johnson-Levine homomorphisms . . . . .	23
5.1 Jacobi diagrams . . . . .	23
5.2 The LMO functor . . . . .	24
5.3 Diagrammatic version of the Johnson-Levine homomorphisms . . . . .	25
5.4 Relating the LMO functor and the Johnson-Levine homomorphisms . . . . .	26
<b>2 Alternative versions of the Johnson homomorphisms and the LMO functor</b>	<b>29</b>
1 Introduction . . . . .	29
2 Spaces of Jacobi diagrams and their operations . . . . .	34
2.1 Generalities . . . . .	34
2.2 Operations on Jacobi diagrams . . . . .	35
3 The Kontsevich integral and the LMO functor . . . . .	38
3.1 Kontsevich Integral . . . . .	38
3.2 The LMO functor . . . . .	40
4 Johnson-type filtrations . . . . .	47

---

4.1	Preliminaries . . . . .	47
4.2	Alternative Torelli group . . . . .	48
4.3	Alternative Johnson filtration . . . . .	50
5	Johnson-type homomorphisms . . . . .	53
5.1	Preliminaries . . . . .	54
5.2	Alternative Johnson homomorphisms . . . . .	56
5.3	Alternative Johnson homomorphism on $\mathcal{L}$ . . . . .	59
5.4	Diagrammatic versions of the Johnson-type homomorphisms . . . . .	65
6	Alternative Johnson homomorphisms and the LMO functor . . . . .	68
6.1	The filtration on Lagrangian cobordisms induced by the alternative degree . . . . .	68
6.2	First alternative Johnson homomorphism and the LMO functor . . . . .	71
6.3	Higher alternative Johnson homomorphisms and the LMO functor . . . . .	75
	<b>Bibliography</b>	<b>83</b>

---

# Introduction

## 1 Introduction (en Français)

Cette thèse s'inscrit dans le cadre de la *topologie quantique*, un domaine au carrefour de l'algèbre, la topologie et la physique mathématique qui a ses origines dans les années 1980. La topologie quantique s'intéresse à deux familles d'objets : *objets de nature topologique* et *invariants de ces objets*. Commençons par une description brève et intuitive des objets de nature topologique auxquels on s'intéresse : en dimension un, on s'intéresse aux nœuds, aux entrelacs, etc. ; en dimension deux, on s'intéresse aux surfaces et ses groupes de « symétrie » ; et en dimension trois, on s'intéresse aux variétés de dimension trois. En fait, nœuds (ou entrelacs) et « symétries » de surfaces peuvent être vus comme variétés de dimension trois.

**Théorie des nœuds.** On considère des objets de dimension un plongés dans un espace de dimension trois. Par exemple les nœuds, les entrelacs, les enchevêtrements, etc. Voir la Figure 1.1 pour quelques exemples.

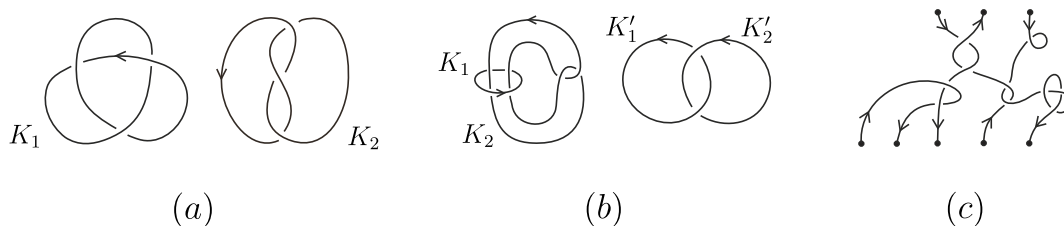


Figure 1.1: (a) Nœuds, (b) entrelacs et (c) enchevêtrement.

Deux objets noués sont dit *équivalents* si l'un peut être déformé (en étirant, emmêlant, démmêlant mais sans couper) dans l'autre. Par exemple les deux nœuds  $K_1$  et  $K_2$  dans la Figure 1.1 (a) sont équivalents. On peut passer du nœud  $K_1$  au nœud  $K_2$  comme on montre dans la Figure 1.2.

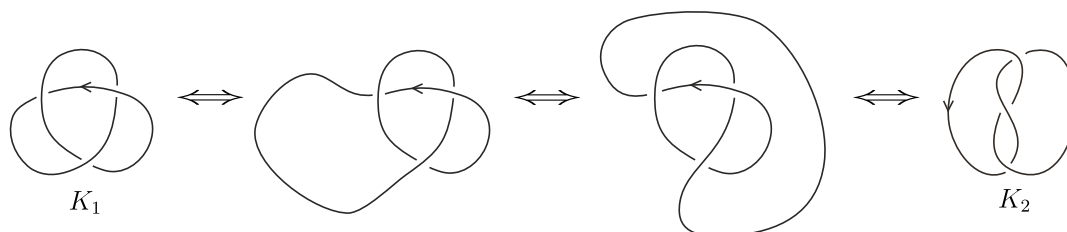
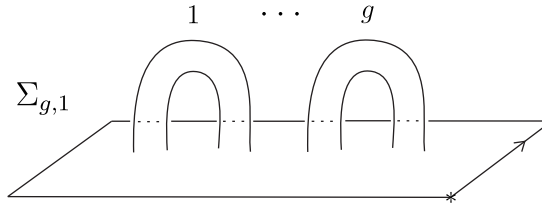


Figure 1.2: Équivalence entre  $K_1$  et  $K_2$ .

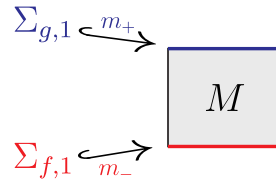
**Groupe d'homéotopie des surfaces.** On considère une surface  $\Sigma_{g,1}$  compacte connexe orientée de genre  $g$  avec une seule composante de bord. Voir la Figure 1.3.

La classification des surfaces compactes connexes est bien connue. Ainsi l'objet auquel on s'intéresse est le groupe des « symétries » de la surface. Plus précisément, il s'agit du groupe des classes d'isotopie des homéomorphismes  $h : \Sigma_{g,1} \rightarrow \Sigma_{g,1}$  qui préservent l'orientation et fixent le bord  $\partial\Sigma_{g,1}$ . Dans la suite, ce groupe sera noté  $\mathcal{M}_{g,1}$ .

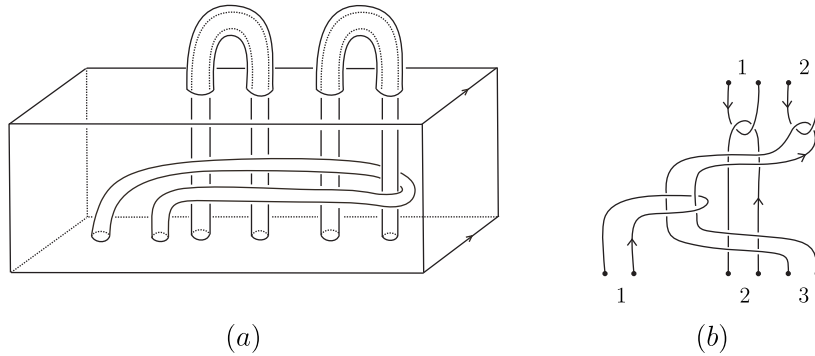


Figure 1.3: Surface  $\Sigma_{g,1}$ .

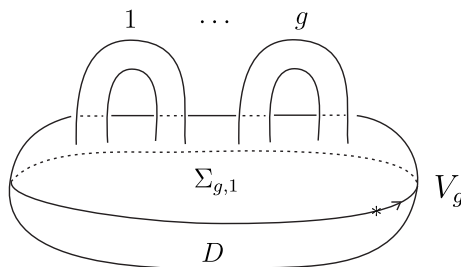
**Variétés de dimension 3.** On s'intéresse aux variétés de dimension 3 compactes connexes et orientées avec ou sans bord. En particulier on s'intéresse aux *cobordismes* de  $\Sigma_{g,1}$  à  $\Sigma_{f,1}$  : ce sont des 3-variétés  $M$  dont le bord se décompose comme l'union d'une copie de la surface  $\Sigma_{g,1}$  (en haut), une copie de la surface  $\Sigma_{f,1}$  (en bas) et le cylindre  $\mathbb{S}^1 \times [-1, 1]$  (bord latéral). Ainsi, on a des plongements  $m_+ : \Sigma_{g,1} \rightarrow \partial M \subseteq M$  et  $m_- : \Sigma_{f,1} \rightarrow \partial M \subseteq M$ . Schématiquement :



Par exemple dans la Figure 1.4 (a), on considère un cobordisme de  $\Sigma_{2,1}$  à  $\Sigma_{3,1}$ .

Figure 1.4: (a) Cobordisme de  $\Sigma_{2,1}$  à  $\Sigma_{3,1}$  (b) présentation par enchevêtrement bas-haut du cobordisme montré à gauche.

Un autre exemple de variété de dimension 3 est le *corps en anses de genre g* : il s'agit de la variété de dimension trois obtenue à partir d'une boule fermée de dimension 3 en collant  $g$  anses (d'indice 1)  $[0, 1] \times D^2$  sur son bord. On note  $V_g$  cette variété. Remarquons que le bord de  $V_g$  peut être décomposé comme l'union de la surface  $\Sigma_{g,1}$  avec un disque  $D$ , voir Figure 1.5.

Figure 1.5: Corps en anses  $V_g$  et décomposition  $\partial V_g = \Sigma_{g,1} \cup D$ .

Dorénavant, on utilise le terme de « 3-variété » à la place de « variété de dimension trois compacte »

connexe et orientée ».

Les trois familles d'objets topologiques mentionnées ci-dessus sont étroitement liées :

1. Toute 3-variété sans bord peut être obtenue comme une *chirurgie* le long d'un entrelacs dans  $\mathbb{S}^3$ . Un tel entrelacs s'appelle *présentation chirurgicale* de la 3-variété.
2. Toute 3-variété sans bord peut être obtenue comme la réunion de deux corps en anses  $V_g$  recollés via  $ih$  où  $h$ , *l'élément du recollement*, est un élément du groupe d'homéotopie du bord en commun et  $i : \partial V_g \rightarrow \partial V_g$  est l'involution qui échange les méridiens et longitudes (préférées) de  $\partial V_g$ . Une telle décomposition s'appelle un *scindement de Heegaard* de la 3-variété. Il est intéressant de noter que certaines propriétés topologiques de la 3-variété obtenue à partir d'un scindement de Heegaard se reflètent dans les propriétés algébriques de l'élément de recollement et réciproquement. Par exemple, une 3-variété avec un scindement de Heegaard dont l'élément de recollement agit trivialement en homologie, est une *sphère d'homologie*, c'est-à-dire une 3-variété avec les mêmes groupes d'homologie que  $\mathbb{S}^3$ .
3. Tout cobordisme de  $\Sigma_{g,1}$  à  $\Sigma_{f,1}$  peut être représenté (après chirurgies) comme un objet noué dans le cube  $[-1, 1]^3$ . Une telle présentation s'appelle *présentation par enchevêtrement bas-haut* (« bottom-top tangle presentation »). Par exemple, l'enchevêtrement de la Figure 1.4 (b) est une présentation par enchevêtrement bas-haut du cobordisme de  $\Sigma_{2,1}$  à  $\Sigma_{3,1}$  montré dans la Figure 1.4 (a).
4. Tout élément  $h$  du groupe  $\mathcal{M}_{g,1}$  permet de définir un cobordisme de  $\Sigma_{g,1}$  à  $\Sigma_{g,1}$  comme suit. On considère le cylindre  $\Sigma_{g,1} \times [-1, 1]$  avec les plongements  $m_{\pm} : \Sigma_{g,1} \rightarrow \partial(\Sigma_{g,1} \times [-1, 1])$  donnés par  $m_+(x) = (h(x), 1)$  et  $m_-(x) = (x, -1)$ . Ce cobordisme s'appelle *le cylindre d'application associé à  $h$*  et on le note par  $c(h)$ .

Les liens décrits entre ces objets permettent d'interpréter un problème dans une famille particulière (par exemple les 3-variétés) en termes d'une autre famille (par exemple les nœuds ou les groupes d'homéotopie). C'est une manière très fructueuse d'aborder l'étude de ces familles d'objets et nous l'utiliserons tout au long de ce travail.

Une des questions fondamentales en topologie est la suivante : comment distinguer deux objets de même nature (deux nœuds, deux 3-variétés ou deux éléments de  $\mathcal{M}_{g,1}$ ) ? Par exemple, la Figure 1.2 montre que les deux nœuds  $K_1$  et  $K_2$  de la Figure 1.1 (a) sont équivalents et elle montre aussi une façon de déformer l'un dans l'autre. Cependant, supposons que nous ayons les deux entrelacs de la Figure 1.1 (b) et que nous voulions savoir s'ils sont équivalents ou non. Nous pouvons commencer par essayer de déformer l'un dans l'autre. À supposer que nous n'y arrivons pas, cela ne veut pour autant dire qu'il n'est pas possible de le faire. Nous avons donc besoin d'une autre façon d'aborder le problème. Une alternative est la construction d'*invariants*, c'est-à-dire de « quantités » (nombres, polynômes, groupes parmi d'autres) qui sont égales pour des objets équivalents. Un exemple d'un invariant pour les entrelacs orientés est le *nombre d'enlacement* qui admet la définition suivante : soit  $K$  un entrelacs orienté et considérons une projection régulière de  $K$  dans un plan. Soient  $K_i$  et  $K_j$  deux composantes de  $K$ . Le nombre d'enlacement  $\text{Lk}(K_i, K_j)$  entre  $K_i$  et  $K_j$  est défini par

$$\text{Lk}(K_i, K_j) = \frac{1}{2} \sum_c \text{sgn}(c),$$

où  $c$  parcourt l'ensemble de croisements entre  $K_i$  et  $K_j$  et  $\text{sgn}(c)$  désigne le *signe* du croisement  $c$  défini selon la règle donnée dans la Figure 1.6.

Par exemple, pour l'entrelacs  $K_1 \cup K_2$  de la Figure 1.1 (b), nous avons  $\text{Lk}(K_1, K_2) = 0$  tandis que pour l'entrelacs  $K'_1 \cup K'_2$  dans la même figure, nous avons  $\text{Lk}(K'_1, K'_2) = -1$ . On peut donc dire que les entrelacs  $K_1 \cup K_2$  et  $K'_1 \cup K'_2$  ne sont pas équivalents.

Jusque dans les années 1980, la topologie algébrique était la principale source de construction des invariants des entrelacs et 3-variétés. Un grand événement est survenu en 1984 avec la découverte



Figure 1.6: Croisement positif et négatif.

par Jones d'un nouvel invariant des entrelacs qui est actuellement connu sous le nom de *polynôme de Jones* [35]. Un des faits remarquables de cet invariant est que, dans sa construction originale, il n'est pas fait appel à la topologie algébrique et il y a des idées qui viennent de la mécanique statistique. En 1989, Witten donne une interprétation physique de cet invariant [67]. Cette interprétation lui a permis de proposer, de façon heuristique, la définition de nouveaux invariants des 3-variétés. Ces deux moments historiques sont généralement considérés comme les origines de la topologie quantique. Les idées de Jones et Witten ont été, et continuent d'être, une grande source d'inspiration pour la recherche en topologie. Ces découvertes ont ouvert la voie à de multiples connexions entre la topologie en basse dimension et d'autres domaines des mathématiques et de la physique.

Une première définition rigoureuse des invariants des 3-variétés inspiré par ces nouvelles idées a été obtenue par Reshetikhin et Turaev à l'aide des représentations des groupes quantiques [59], approche qui est connue comme *non-perturbative*. Cela a abouti à l'avènement de nombreux nouveaux invariants, appelés *invariants quantiques*, puisque la méthode de Reshetikhin et Turaev permet de construire un invariant à partir de la quantification d'une algèbre de Lie semi-simple. De cette façon, nous avons au moins autant d'invariants que d'algèbres de Lie semi-simples. Par conséquent, les invariants quantiques ne sont pas seulement des outils intéressants pour essayer de distinguer deux objets topologiques différents, mais ils deviennent par eux-mêmes un objet d'étude à part entière. Par exemple, une question fondamentale est : est-il possible d'organiser/hierarchiser ces invariants d'une certaine manière ? Il s'avère que c'est le cas avec la théorie des *invariants de type fini (Vassiliev-Goussarov)* dans le cas des entrelacs [65, 17, 6] et avec la théorie des *invariants de type fini (Ohtsuki-Goussarov-Habiro)* dans le cas des 3-variétés [55, 26, 18].

Un succès important a été obtenu avec l'introduction de l'*intégrale de Kontsevich* pour les entrelacs [36, 1] et de l'*invariant perturbatif universel de Le-Murakami-Ohtsuki* (invariant LMO) pour les 3-variétés [38], ici le mot "*perturbatif*" fait allusion aux méthodes perturbatives de la physique. L'importance de ces invariants réside dans le fait qu'ils sont *universels* par rapport aux invariants de type fini à valeurs dans  $\mathbb{Q}$ . Grosso modo, cette propriété dit que chaque invariant de type fini à valeurs dans  $\mathbb{Q}$  (en particulier chaque invariant de Reshetikhin-Turaev convenablement « développé ») est complètement déterminé par l'intégrale de Kontsevich dans le cas des entrelacs ou par l'invariant LMO dans le cas des 3-sphères d'homologie.

À l'origine, l'invariant LMO a été construit pour les variétés fermées. Bar-Natan, Garoufalidis, Rozansky et Thurston en ont donné une nouvelle construction en utilisant un type d'intégrale gaussienne au niveau diagrammatique [4, 5]. Leur définition n'est valable que pour les sphères d'homologie. Mais il s'agit du contexte le plus intéressant pour l'invariant LMO.

L'invariant LMO a été généralisé aux variétés à bord sous la forme d'une TQFT (*Topological Quantum Field Theory*), appelée *foncteur LMO*, par Cheptea, Habiro et Massuyeau [9] (d'autres généralisations de l'invariant LMO pour les variétés à bord avaient été obtenues auparavant dans [8, 53]). Le foncteur  $\text{LMO} \tilde{Z} : \mathcal{LCob}_q \rightarrow {}^t\mathcal{A}$  part d'une catégorie de cobordismes de surfaces à bord  $\mathcal{LCob}_q$  et prend ses valeurs dans une catégorie de *diagrammes de Jacobi*  ${}^t\mathcal{A}$ . Voir la Figure 1.13 pour quelques exemples de diagrammes de Jacobi.

La construction du foncteur LMO est sophistiquée : elle utilise des présentations chirurgicales des cobordismes, une version combinatoire de l'intégrale de Kontsevich, qui dépend du choix d'un *associateur de Drinfeld*, et afin de lever l'ambiguïté dans la présentation chirurgicale, il est nécessaire

de faire plusieurs opérations combinatoires dans l'espace de diagrammes de Jacobi. Ainsi, une question importante se pose :

- Quelle est l'information topologique codée par le foncteur LMO ? En particulier, est-il possible de donner des interprétations du foncteur LMO en termes d'invariants classiques ?

Le but principal de cette thèse est d'apporter des éléments de réponse à cette question. Pour l'aborder nous utilisons l'interaction décrite ci-dessus entre les cobordismes, les groupes d'homéotopie et les objets noués. En particulier, ceci nous amène à faire une étude détaillée de quelques suites décroissantes de sous-groupes du groupe  $\mathcal{M}_{g,1}$ , que nous appelons *filtrations de type Johnson*, et des homomorphismes définis sur chacun des termes de chaque filtration que nous appelons *homomorphismes de type Johnson*. Ainsi, les deux principaux protagonistes de cette thèse sont « le foncteur LMO » et « les homomorphismes de type Johnson ». Une partie de nos résultats principaux peut être résumée en disant que certaines réductions du foncteur LMO peuvent être interprétées à l'aide des *homomorphismes de type Johnson*.

Dans la suite, nous donnons une description plus précise de nos résultats.

## 1.1 Théorie de Johnson-Morita

Notons simplement  $\Sigma := \Sigma_{g,1}$  et  $\mathcal{M} := \mathcal{M}_{g,1}$ . Une façon naturelle d'étudier le groupe  $\mathcal{M}$  est d'analyser la façon dont il agit sur d'autres objets. Par exemple, on peut considérer l'action sur le premier groupe d'homologie  $H = H_1(\Sigma; \mathbb{Z})$  de  $\Sigma$ . Cette action donne lieu à la *représentation symplectique* :

$$\sigma : \mathcal{M} \longrightarrow \mathrm{Sp}(H, \omega),$$

où  $\omega : H \otimes H \rightarrow \mathbb{Z}$  est la forme d'intersection de  $\Sigma$  et  $\mathrm{Sp}(H, \omega)$  est le groupe d'automorphismes de  $H$  qui préservent  $\omega$ . L'homomorphisme  $\sigma$  est surjectif mais il est loin d'être injectif. Son noyau est connu sous le nom de *groupe Torelli* de  $\Sigma$  et est noté  $\mathcal{I}$ . Ainsi, nous avons la suite exacte courte

$$1 \longrightarrow \mathcal{I} \xrightarrow{\subset} \mathcal{M} \xrightarrow{\sigma} \mathrm{Sp}(H, \omega) \longrightarrow 1. \quad (1.1)$$

Nous voyons ainsi que, pour comprendre la structure algébrique de  $\mathcal{M}$ , le groupe de Torelli  $\mathcal{I}$  mérite une étude particulière car, d'une certaine manière, c'est la partie de  $\mathcal{M}$  qui va au-delà de l'algèbre linéaire (au moins en ce qui concerne la représentation symplectique).

L'action de  $\mathcal{M}$  sur le groupe fondamental  $\pi := \pi_1(\Sigma, *)$ , où  $*$   $\in \partial\Sigma$  est un point fixé, s'avère plus intéressante, puisqu'on obtient un homomorphisme injectif

$$\rho : \mathcal{M} \longrightarrow \mathrm{Aut}(\pi),$$

qui est connu comme la *représentation de Dehn-Nielsen-Baer* et dont l'image est le sous-groupe des automorphismes de  $\pi$  qui fixent la classe d'homotopie du bord de  $\Sigma$ .

**Filtrations de type Johnson.** On peut considérer des approximations pas à pas de la représentation  $\rho$ , c'est-à-dire, considérer l'action de  $\mathcal{M}$  sur les quotients nilpotents de  $\pi$  :

$$\rho_m : \mathcal{M} \longrightarrow \mathrm{Aut}(\pi/\Gamma_{m+1}\pi),$$

où  $\Gamma_1\pi := \pi$  et  $\Gamma_{m+1}\pi := [\pi, \Gamma_m\pi]$  pour  $m \geq 1$  est la *suite centrale descendante* de  $\pi$ . C'est l'approche suivie par Johnson [32] et Morita [51]. Cette approche permet de définir la *filtration de Johnson* :

$$\mathcal{M} \supseteq \mathcal{I} = J_1\mathcal{M} \supseteq J_2\mathcal{M} \supseteq J_3\mathcal{M} \supseteq \dots \quad (1.2)$$

où  $J_m\mathcal{M} := \ker(\rho_m)$ . En particulier,  $\rho_1 = \sigma$  et  $J_1\mathcal{M} = \mathcal{I}$ .

En considérant l'interaction entre le groupe d'homéotopie et les 3-variétés mentionnée ci-dessus, il est naturel de considérer la surface  $\Sigma$  comme une partie du bord d'un corps en anses  $V := V_g$ ,

voir Figure 1.4. Notons  $\iota : \Sigma \hookrightarrow V$  l'inclusion induite et soient  $B = H_1(V; \mathbb{Z})$  et  $\pi' = \pi_1(V, \iota(*))$ . Notons  $A$  le sous-groupe  $\ker(H \xrightarrow{\iota_*} B)$  de  $H$  et  $\mathbb{A}$  le sous-groupe  $\ker(\pi \xrightarrow{\iota_\#} \pi')$  de  $\pi$ , où  $\iota_*$  et  $\iota_\#$  sont respectivement les applications induites par  $\iota$  en homologie et en homotopie. Le *groupe d'homéotopie lagrangien* de  $\Sigma$  est le groupe

$$\mathcal{L} = \{f \in \mathcal{M} \mid f_*(A) \subseteq A\}.$$

En considérant une suite décroissante  $(K_m)_{m \geq 1}$  de sous-groupes distingués de  $\pi$  (différente de la suite centrale descendante), Habiro et Massuyeau [28] ont introduit une filtration du groupe d'homéotopie lagrangien  $\mathcal{L}$  :

$$\mathcal{L} \supseteq \mathcal{I}^a = J_1^a \mathcal{M} \supseteq J_2^a \mathcal{M} \supseteq J_3^a \mathcal{M} \supseteq \dots \quad (1.3)$$

que nous appelons ici la *filtration de Johnson alternative*. Nous appelons le premier terme  $\mathcal{I}^a := J_1^a \mathcal{M}$  de cette filtration le *groupe de Torelli alternatif*. On remarque que  $\mathcal{I}^a$  est un sous-groupe distingué dans  $\mathcal{L}$ , mais il n'est pas distingué dans  $\mathcal{M}$ . Grosso modo, le groupe  $K_m$  est le sous-groupe de  $\pi$  engendré par les commutateurs de poids  $m$ , où les éléments de  $\mathbb{A}$  sont considérés comme de poids 2. Par exemple  $K_1 = \pi$ ,  $K_2 = \mathbb{A} \cdot \Gamma_2 \pi$ ,  $K_3 = [\mathbb{A}, \pi] \cdot \Gamma_3 \pi$ , etc. La filtration de Johnson alternative sera notre objet d'étude principal dans la section 4 du chapitre 2.

Par ailleurs, Levine [43, 46] avait défini une filtration différente de  $\mathcal{L}$  en considérant la suite centrale descendante de  $\pi'$  :

$$\mathcal{L} \supseteq \mathcal{I}^L = J_1^L \mathcal{M} \supseteq J_2^L \mathcal{M} \supseteq J_3^L \mathcal{M} \supseteq \dots \quad (1.4)$$

et dont le premier terme est le *groupe de Torelli lagrangien*<sup>1</sup>  $\mathcal{I}^L = \{f \in \mathcal{L} \mid f_*|_A = \text{Id}_A\}$ .

Nous appelons cette filtration la *filtration de Johnson-Levine*. Remarquons que, à nouveau,  $\mathcal{I}^L$  est distingué dans  $\mathcal{L}$  mais pas dans  $\mathcal{M}$ .

Par *filtration de type Johnson*, nous entendons la filtration de Johnson, la filtration de Johnson alternative ou la filtration de Johnson-Levine.

Contrairement à la filtration de Johnson, la filtration de Johnson alternative et celle de Johnson-Levine prennent en compte un corps en anses bordé par la surface. Par ailleurs, l'intersection de tous les termes dans la filtration de Johnson alternative est triviale comme dans le cas de la filtration de Johnson, mais ce n'est pas le cas pour la filtration de Johnson-Levine. Le deuxième but principal de cette thèse est l'étude de la filtration de Johnson alternative (qui n'a jamais été étudiée) et de son rapport avec les deux autres filtrations. La Proposition 4.9 et la Proposition 4.13 donnent le résultat suivant.

**Théorème 1.** *La filtration de Johnson alternative satisfait les propriétés suivantes.*

- (i)  $\bigcap_{m \geq 1} J_m^a \mathcal{M} = \{\text{Id}_\Sigma\}$ .
- (ii) Pour tout  $k \geq 1$  le groupe  $J_k^a \mathcal{M}$  est résiduellement nilpotent, i.e.

$$\bigcap_m \Gamma_m J_k^a \mathcal{M} = \{\text{Id}_\Sigma\}.$$

D'autre part, pour tout  $m \geq 1$ , on a

$$(iii) \quad J_{2m}^a \mathcal{M} \subseteq J_m \mathcal{M}, \quad (iv) \quad J_m \mathcal{M} \subseteq J_{m-1}^a \mathcal{M}, \quad (v) \quad J_m^a \mathcal{M} \subseteq J_{m+1}^L \mathcal{M},$$

où  $J_0^a \mathcal{M} = \mathcal{L}$ . En particulier, la filtration de Johnson et la filtration de Johnson alternative sont cofinales.

**Homomorphismes de type Johnson.** Chacun des termes de chaque filtration de type Johnson est muni d'un homomorphisme dont le noyau est le terme suivant de la filtration. Nous les appelons *homomorphismes de type Johnson*. Les homomorphismes de Johnson sont des outils importants pour comprendre la structure du groupe de Torelli et la topologie des 3-sphères d'homologie [34, 49, 50, 52].

<sup>1</sup>Dans [66] nous utilisons la notation  $\mathcal{I}\mathcal{L}$  au lieu de  $\mathcal{I}^L$ , et nous utilisons la terminologie *groupe lagrangien fort* au lieu de groupe de Torelli lagrangien.

Commençons par définir les espaces d'arrivée de ces homomorphismes. Pour un groupe abélien  $G$ , on note par  $\mathfrak{Lie}(G) = \bigoplus_{m \geq 1} \mathfrak{Lie}_m(G)$  l'algèbre de Lie graduée librement engendrée par  $G$  en degré 1.

Le  $m$ -ième homomorphisme de Johnson  $\tau_m$  est défini sur  $J_m \mathcal{M}$  et il prend ses valeurs dans le groupe  $\text{Der}_m(\mathfrak{Lie}(H))$  des dérivations de  $\mathfrak{Lie}(H)$  de degré  $m$ . Considérons l'élément  $\Omega \in \mathfrak{Lie}_2(H)$  déterminé par la forme d'intersection  $\omega : H \otimes H \rightarrow \mathbb{Z}$ . Une dérivation *symplectique* de  $\mathfrak{Lie}(H)$  est une dérivation  $d$  telle que  $d(\Omega) = 0$ . Morita montre dans [51] que pour  $h \in J_m \mathcal{M}$ , la dérivation  $\tau_m(h)$  est symplectique. Le groupe des dérivations symplectiques de  $\mathfrak{Lie}(H)$  de degré  $m$  peut être canoniquement identifié avec le noyau  $D_m(H)$  du crochet de Lie  $[\cdot, \cdot] : H \otimes \mathfrak{Lie}_{m+1}(H) \rightarrow \mathfrak{Lie}_{m+2}(H)$ . Ainsi, pour  $m \geq 1$  nous avons les homomorphismes

$$\tau_m : J_m \mathcal{M} \longrightarrow D_m(H).$$

Le  $m$ -ième homomorphisme de Johnson-Levine  $\tau_m^L : J_m^L \mathcal{M} \rightarrow D_m(B)$  est défini sur  $J_m^L \mathcal{M}$  et il prend ses valeurs dans le noyau  $D_m(B)$  du crochet de Lie  $[\cdot, \cdot] : B \otimes \mathfrak{Lie}_{m+1}(B) \rightarrow \mathfrak{Lie}_{m+2}(B)$ , voir [43, 46].

Pour les *homomorphismes de Johnson alternatifs* [28], on considère l'algèbre de Lie graduée  $\mathfrak{Lie}(B; A)$  librement engendrée par  $B$  en degré 1 et par  $A$  en degré 2. Le  $m$ -ième homomorphisme de Johnson alternatif  $\tau_m^a : J_m^a \mathcal{M} \rightarrow \text{Der}_m(\mathfrak{Lie}(B; A))$  est défini sur  $J_m^a \mathcal{M}$  et il prend ses valeurs dans le groupe  $\text{Der}_m(\mathfrak{Lie}(B; A))$  des dérivations de  $\mathfrak{Lie}(B; A)$  de degré  $m$ . Comme dans le cas de  $\mathfrak{Lie}(H)$ , nous définissons une notion de *dérivation symplectique* de  $\mathfrak{Lie}(B; A)$  en utilisant l'élément  $\Omega' \in \mathfrak{Lie}_3(B; A)$  défini par la forme d'intersection du corps en anses  $V$ . Le Théorème 5.9 et la Proposition 5.11 impliquent le résultat suivant.

**Théorème 2.** *Soient  $m \geq 1$  et  $h \in J_m^a \mathcal{M}$ . Alors*

- (i) *Le morphisme  $\tau_m^a(h)$  définit une dérivation symplectique de  $\mathfrak{Lie}(B; A)$  de degré  $m$ .*
- (ii) *Le morphisme  $\tau_{m+1}^L(h)$  est déterminé par le morphisme  $\tau_m^a(h)$ .*

La propriété (ii) du Théorème 2 exprime la commutativité du diagramme

$$\begin{array}{ccc} J_m^a \mathcal{M} & \xrightarrow{\subset} & J_{m+1}^L \mathcal{M} \\ \tau_m^a \downarrow & & \downarrow \tau_{m+1}^L \\ D_m(B; A) & \xrightarrow{\iota_*} & D_{m+1}(B), \end{array}$$

pour tout  $m \geq 1$ , où l'inclusion  $J_m^a \mathcal{M} \subseteq J_{m+1}^L \mathcal{M}$  est donnée par le Théorème 1 (v). L'homomorphisme  $\iota_* : D_m(B; A) \rightarrow D_{m+1}(B)$  est induit par l'application  $\iota_* : H \rightarrow B$ . La propriété (i) du Théorème 2 permet de définir une *version diagrammatique* des homomorphismes de Johnson alternatifs. Nous pouvons ainsi étudier leurs relations avec le foncteur LMO.

Avant de poursuivre avec une description de nos résultats dans ce contexte, énonçons d'autres résultats dans le contexte des homomorphismes de type Johnson. Dans [28], Habiro et Massuyeau considèrent un homomorphisme de groupes

$$\tau_0^a : \mathcal{L} \rightarrow \text{Aut}(\mathfrak{Lie}(B; A)),$$

que nous appelons ici le *0-ième homomorphisme de Johnson alternatif*, et dont le noyau est le groupe de Torelli alternatif  $\mathcal{I}^a$ . Dans la section 5.3 du chapitre 2 nous montrons le résultat suivant.

**Théorème 3.** *L'homomorphisme  $\tau_0^a : \mathcal{L} \rightarrow \text{Aut}(\mathfrak{Lie}(B; A))$  peut être décrit de manière équivalente comme un homomorphisme de groupes  $\tau_0^a : \mathcal{L} \rightarrow \text{Aut}(B) \times \text{Hom}(A, \Lambda^2 B)$  pour une certaine action de  $\text{Aut}(B)$  sur  $\text{Hom}(A, \Lambda^2 B)$ . Le noyau de  $\tau_0^a$  est le deuxième terme  $J_2^L \mathcal{M}$  de la filtration de Johnson-Levine. En particulier, nous avons  $\mathcal{I}^a = J_1^a \mathcal{M} = J_2^L \mathcal{M}$ .*

De plus, nous décrivons explicitement l'image  $\mathcal{G} := \tau_0^a(\mathcal{L})$ . Nous obtenons ainsi la suite exacte courte :

$$1 \longrightarrow \mathcal{I}^a \xrightarrow{\subset} \mathcal{L} \xrightarrow{\tau_0^a} \mathcal{G} \longrightarrow 1. \quad (1.5)$$

Cette suite exacte courte a un rôle similaire, dans le contexte des homomorphismes de Johnson alternatifs, à celui de la suite exacte courte (1.1) dans le contexte des homomorphismes de Johnson. En effet, dans [28], les auteurs montrent que les homomorphismes de Johnson alternatifs satisfont une propriété d'équivariance par rapport à l'homomorphisme  $\tau_0^a$ , qui est l'analogue de la propriété de Sp-équivariance satisfaite par les homomorphismes de Johnson. Par conséquent, la suite exacte courte (1.5) peut se révéler importante pour une étude ultérieure de la filtration de Johnson alternative.

**Cobordismes d'homologie.** La filtration de Johnson et la filtration de Johnson-Levine, ainsi que les homomorphismes respectifs se généralisent naturellement au monoïde de *cobordismes d'homologie* de  $\Sigma = \Sigma_{g,1}$ , voir [16]. Un *cobordisme d'homologie* [26, 19] de  $\Sigma$  est la classe d'équivalence d'un couple  $M = (M, m)$ , où  $M$  est un cobordisme de  $\Sigma$  à  $\Sigma$ , et l'homéomorphisme  $m : \partial(\Sigma \times [-1, 1]) \rightarrow \partial M$  est tel que les restrictions *en bas* et *en haut*  $m_{\pm}(\cdot) := m(\cdot, \pm 1) : \Sigma \rightarrow M$  induisent des isomorphismes en homologie. Ici, deux couples  $(M, m)$  et  $(M', m')$  sont *équivalents* s'il existe un homéomorphisme  $\varphi : M \rightarrow M'$  tel que  $\varphi \circ m = m'$ .

La *composée*  $(M, m) \circ (M', m')$  de deux cobordismes d'homologie  $(M, m)$  et  $(M', m')$  de  $\Sigma$  est la classe d'équivalence du couple  $(\widetilde{M}, m_- \cup m'_+)$ , où  $\widetilde{M}$  est obtenue à partir de  $M$  et  $M'$  en les collant via l'application  $m_+ \circ (m'_-)^{-1}$ . Cette loi de composition est associative et elle a comme objet identité la classe d'équivalence du cobordisme trivial  $(\Sigma \times [-1, 1], \text{Id})$ . Notons  $\mathcal{C} = \mathcal{C}_{g,1}$  le monoïde des cobordismes d'homologie de  $\Sigma = \Sigma_{g,1}$ .

Comme nous l'avons évoqué précédemment, un élément  $h \in \mathcal{M}$  définit un cobordisme  $c(h)$  de  $\Sigma$  à  $\Sigma$ , et de plus  $c(h) \in \mathcal{C}$ . Nous avons ainsi un morphisme (injectif) de monoïdes  $c : \mathcal{M} \rightarrow \mathcal{C}$  qui s'appelle *application cylindre*. De cette façon, nous pouvons considérer le monoïde  $\mathcal{C}$  comme un généralisation du groupe d'homéotopie  $\mathcal{M}$ .

La représentation de Dehn-Nielsen-Baer  $\rho : \mathcal{M} \rightarrow \text{Aut}(\pi)$  ne peut pas être étendue à tout le monoïde  $\mathcal{C}$ . Cependant, grâce à un théorème de Stallings [63], les homomorphismes  $\rho_k : \mathcal{M} \rightarrow \text{Aut}(\pi/\Gamma_{k+1}\pi)$  peuvent être étendus à  $\mathcal{C}$  :

$$\rho_k : \mathcal{C} \longrightarrow \text{Aut}(\pi/\Gamma_{k+1}\pi)$$

est l'homomorphisme qui envoie  $(M, m) \in \mathcal{C}$  sur l'automorphisme  $m_{-,*}^{-1} \circ m_{+,*}$ , voir [16]. Ainsi, la *filtration de Johnson* de  $\mathcal{C}$  est la suite décroissante de sous-monoïdes :

$$\mathcal{C} \supseteq \mathcal{IC} = J_1\mathcal{C} \supseteq J_2\mathcal{C} \supseteq J_3\mathcal{C} \supseteq \dots \quad (1.6)$$

où  $J_k\mathcal{C} := \ker(\rho_k)$ . Le premier terme  $\mathcal{IC} = J_1\mathcal{C}$  de cette filtration s'appelle *le monoïde de cylindres d'homologie*. Nous avons aussi les *homomorphismes de Johnson* :

$$\tau_m : J_m\mathcal{C} \longrightarrow D_m(H). \quad (1.7)$$

Le monoïde des *cobordismes d'homologie lagrangiens*  $\mathcal{LC}$  et *fortement lagrangiens*<sup>2</sup>  $\mathcal{IC}^L$  sont définis par

$$\mathcal{LC} = \{(M, m) \in \mathcal{C} \mid \rho_1(M)(A) \subseteq A\} = \{(M, m) \in \mathcal{C} \mid m_{+,*}(A) \subseteq m_{-,*}(A)\},$$

et

$$\mathcal{IC}^L = \{(M, m) \in \mathcal{LC} \mid \rho_1(M)|_A = \text{Id}_A\} = \{(M, m) \in \mathcal{LC} \mid m_{+,*}|_A = m_{-,*}|_A\}.$$

En utilisant l'application cylindre, nous obtenons  $c(\mathcal{I}) \subseteq \mathcal{IC}$ ,  $c(\mathcal{I}^L) \subseteq \mathcal{IC}^L$  et  $c(\mathcal{L}) \subseteq \mathcal{LC}$ .

De façon analogue, nous pouvons définir la *filtration de Johnson-Levine* de  $\mathcal{C}$  :

$$\mathcal{C} \supseteq \mathcal{LC} \supseteq \mathcal{IC}^L = J_1^L\mathcal{C} \supseteq J_2^L\mathcal{C} \supseteq J_3^L\mathcal{C} \supseteq \dots \quad (1.8)$$

ainsi que les *homomorphismes de Johnson-Levine* :

$$\tau_m^L : J_m^L\mathcal{C} \longrightarrow D_m(B). \quad (1.9)$$

<sup>2</sup>Dans [66] nous utilisons la notation  $\mathcal{ILC}$  au lieu de  $\mathcal{IC}^L$ .

Levine a comparé les filtrations de Johnson et Johnson-Levine en petits degrés pour ce qui concerne le groupe d'homéotopie. Il a montré dans [46] que pour  $m = 1$  et  $m = 2$  on a  $J_m^L \mathcal{M} = J_m \mathcal{M} \cdot (\mathcal{H} \cap \mathcal{I}^L)$ , où le sous-groupe  $\mathcal{H} = \{h \in \mathcal{M} \mid h_{\#}(\mathbb{A}) \subseteq \mathbb{A}\}$  peut être identifié au groupe d'homéotopie du corps en anses  $V$ . Levine a posé la question de la comparaison en tout degré. Dans le cas des cobordismes d'homologie, nous avons une comparaison en tout degré à certaines relations chirurgicales près. Celles-ci, notées  $Y_k$  pour  $k \geq 1$ , ont été introduites indépendamment par Goussarov dans [18, 19] et par Habiro dans [26] en lien avec la théorie des invariants de type fini. Plus précisément, nous avons le résultat suivant.

**Théorème 4.** *Pour tous  $k, l \geq 1$ , on a*

$$\frac{J_k^L \mathcal{C}}{Y_{k+l}} = \frac{J_k \mathcal{C}}{Y_{k+l}} \cdot q_{k+l}(\mathcal{H}\mathcal{C} \cap \mathcal{I}\mathcal{C}^L),$$

où  $q_{k+l} : \mathcal{C} \rightarrow \mathcal{C}/Y_{k+l}$  désigne la projection canonique et  $\cdot$  est le produit dans  $\mathcal{C}/Y_{k+l}$ .

Ici, le sous-monoïde  $\mathcal{H}\mathcal{C}$  est l'analogie du groupe  $\mathcal{H}$  dans le contexte des cobordismes d'homologie. Plus précisément  $\mathcal{H}\mathcal{C}$  est le sous-monoïde des cobordismes  $(M, m) \in \mathcal{C}$  tels que  $M \circ V = V$  comme cobordismes, où nous considérons  $V$  comme un cobordisme de la surface  $\Sigma$  au disque  $D$  et  $\circ$  est défini comme dans le cas de  $\mathcal{C}$ . Le Théorème 4 est un des points-clés pour montrer le lien entre les homomorphismes de Johnson-Levine et le foncteur LMO.

## 1.2 Homomorphismes du type Johnson et le foncteur LMO

Donnons une brève description du foncteur  $\text{LMO} \tilde{Z} : \mathcal{L}Cob_q \rightarrow {}^{ts}\mathcal{A}$ . Les objets de la catégorie de départ sont des mots non associatifs dans le symbole  $\bullet$ . Soient  $u$  et  $v$  deux mots non associatifs formés du symbole  $\bullet$ , de longueurs  $g$  et  $f$  respectivement. Un élément de  $\mathcal{L}Cob_q(u, v)$  est un cobordisme de  $\Sigma_{g,1}$  à  $\Sigma_{f,1}$  qui satisfait en plus quelques conditions homologiques (propriété lagrangienne [8]). En particulier, si on munit les éléments de  $\mathcal{L}\mathcal{C} = \mathcal{L}\mathcal{C}_{g,1}$  avec le mot non associatif  $u_g = (\bullet \cdots (\bullet(\bullet)) \cdots)$  de longueur  $g$  en haut et en bas, nous avons  $\mathcal{L}\mathcal{C}_{g,1} \subseteq \mathcal{L}Cob_q(u_g, u_g)$ .

Nous passons maintenant à la définition de la catégorie d'arrivée  ${}^{ts}\mathcal{A}$  du foncteur LMO. Un *diagramme de Jacobi* est un graphe fini univalent tel que les sommets trivalents sont *orientés*, c'est-à-dire que les arêtes incidentes sont ordonnées cycliquement. Soit  $C$  un ensemble fini, on dit qu'un diagramme de Jacobi est *C-colorié* si les sommets univalents sont coloriés par le  $\mathbb{Q}$ -espace vectoriel engendré par  $C$ . Le *degré interne* d'un diagramme de Jacobi est le nombre de sommets trivalents, noté *i-deg*. Le diagramme de Jacobi connexe de *i-deg* = 0 est appelé *strut*. On renvoie à la Figure 1.7 pour quelques exemples.

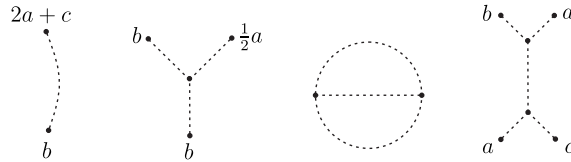


Figure 1.7: Diagrammes de Jacobi  $C$ -coloriés de *i-deg* 0, 1, 2 et 2, respectivement. Ici  $C = \{a, b, c\}$ .

L'espace de diagrammes de Jacobi  $C$ -coloriés est alors défini par

$$\mathcal{A}(C) := \frac{\text{Vect}_{\mathbb{Q}}\{\text{Diagrammes de Jacobi } C\text{-coloriés}\}}{\text{AS, IHX, } \mathbb{Q}\text{-multilinéarité}},$$

où les relations AS, IHX et multilinéarité sont décrites dans la Figure 1.8.

Pour un entier non négatif  $g$ , on note  $[g]^*$  l'ensemble  $\{1^*, \dots, g^*\}$ , où  $*$  est un symbole décoratif comme par exemple  $+$ ,  $-$  ou  $*$  lui-même. Les objets de la catégorie  ${}^{ts}\mathcal{A}$  sont les entiers naturels. L'ensemble des morphismes de  $g$  à  $f$  est le sous-espace  ${}^{ts}\mathcal{A}(g, f)$  des diagrammes dans  $\mathcal{A}([g]^+ \sqcup [f]^-)$



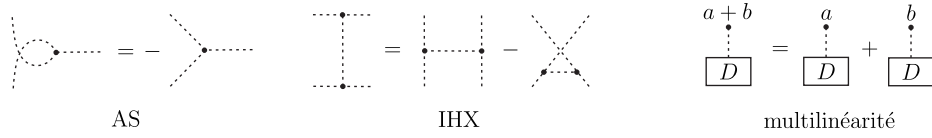
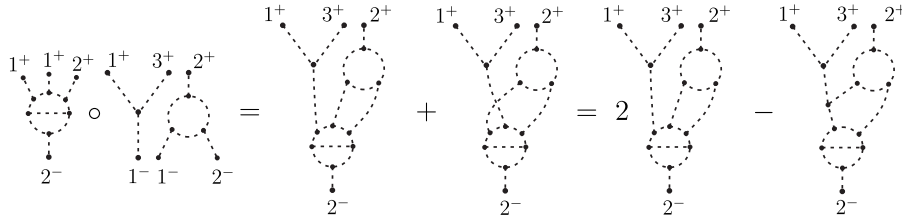


Figure 1.8: Relations dans  $\mathcal{A}(C)$ .

sans struts dont les deux extrémités sont coloriées par des éléments de l'ensemble  $[g]^+$ . Pour  $D \in {}^{ts}\mathcal{A}(g, f)$  et  $E \in {}^{ts}\mathcal{A}(h, g)$ , la composée  $D \circ E$  est l'élément dans  ${}^{ts}\mathcal{A}(h, f)$  défini comme la somme de diagrammes de Jacobi obtenus en considérant toutes les façons possibles de coller les sommets univalents  $[g]^+$ -coloriés de  $D$  sur les sommets univalents  $[g]^-$ -coloriés de  $E$ . Par exemple :



Le morphisme identité de  ${}^{ts}\mathcal{A}(g, g)$  est

$$\text{Id}_g := \exp_{\square} \left( \sum_{i=1}^g \begin{array}{c} i^+ \\ \vdots \\ i^- \end{array} \right).$$

La catégorie  ${}^{ts}\mathcal{A}$  est appelée catégorie de *diagrammes de Jacobi de type "top-substantial"*.

Voyons maintenant l'idée de la définition de  $\tilde{Z}$ . On fixe un système de méridiens et de parallèles  $\{\alpha_i, \beta_i\}$  de  $\Sigma_{g,1}$  comme dans la Figure 1.9.

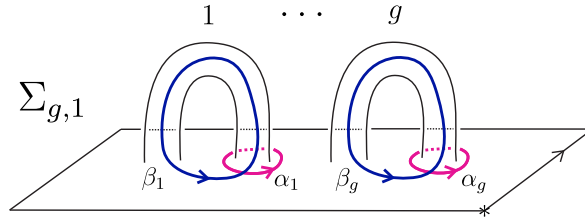


Figure 1.9: Système de méridiens et de parallèles  $\{\alpha_i, \beta_i\}$ .

Soit  $(M, m)$  un cobordisme lagrangien, disons  $(M, m) \in \mathcal{LC}_{g,1}$ . On attache  $g$  anses (d'indice 2)  $D^2 \times [0, 1]$  sur la surface du bas de  $M$  en envoyant les âmes des anses sur les courbes  $m_-(\alpha_i)$ . De façon similaire, on attache  $g$  anses (d'indice 2) sur la surface du haut de  $M$  en envoyant les âmes des anses sur les courbes  $m_+(\beta_i)$ . Ainsi, on obtient une 3-variété  $B$  dont le bord est homéomorphe au bord du cube  $[-1, 1]^3$  et les co-âmes des anses définissent un objet noué  $\gamma'$  dans  $B$ , voir la Figure 1.10. Le couple  $(B, \gamma')$  est appelé *présentation par enchevêtrement bas-haut* de  $M$ .

Ensuite, on considère une présentation chirurgicale du couple  $(B, \gamma')$ , c'est-à-dire, un entrelacs framé  $L \subseteq \text{int}([-1, 1]^3)$  et un objet noué  $\gamma \subseteq [-1, 1]^3 \setminus L$ , tel que la chirurgie le long de  $L$  transforme le couple  $([-1, 1]^3, \gamma)$  en le couple  $(B, \gamma')$ , voir la Figure 1.11.

Puis nous considérons l'intégrale de Kontsevich du couple  $([-1, 1]^3, L \cup \gamma)$  pour obtenir une série de diagrammes de Jacobi d'un certain type. Pour lever l'ambiguïté de la présentation chirurgicale, il est nécessaire d'effectuer des opérations combinatoires sur les diagrammes. Finalement, nous allons obtenir une série de diagrammes de Jacobi  $\tilde{Z}(M)$  dans  ${}^{ts}\mathcal{A}(g, g)$ , voir la Figure 1.12.

Les homomorphismes de type Johnson peuvent être décrits en termes de diagrammes de Jacobi où, parmi tous les graphes, seuls les arbres sont autorisés. Par conséquent, il est naturel de s'interroger sur la relation entre la version diagrammatique des homomorphismes de type Johnson et la réduction arborée du foncteur LMO. Cheptea, Habiro et Massuyeau montrent dans [8] que les homomorphismes

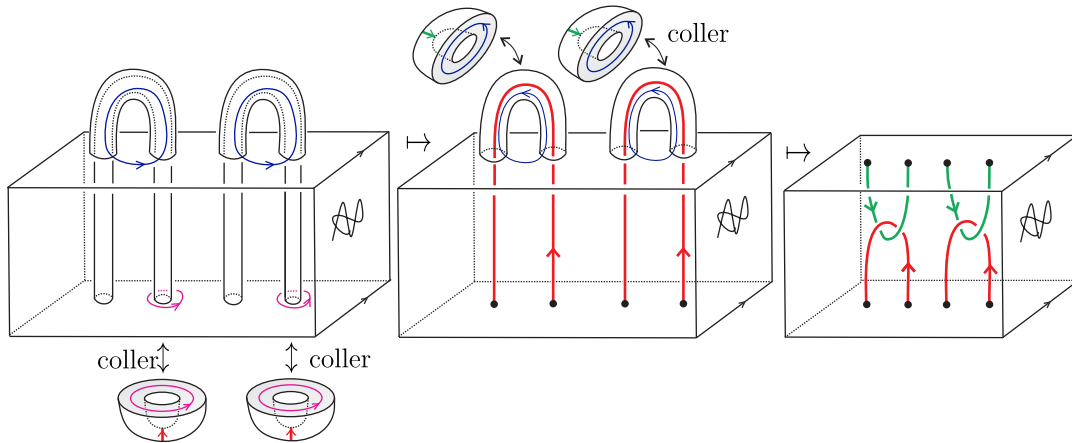


Figure 1.10: Passage de  $(M, m)$  à  $(B, \gamma')$ .

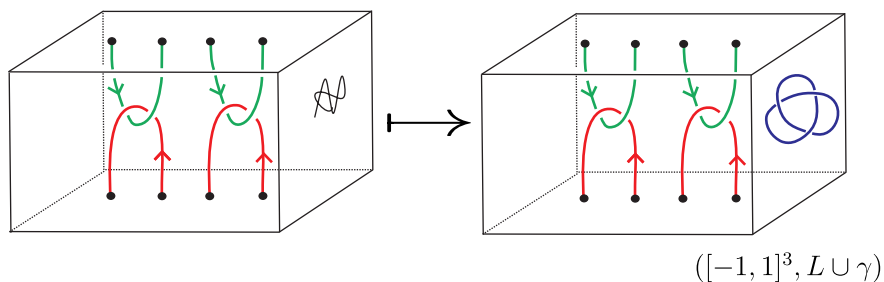


Figure 1.11: Passage de  $(B, \gamma')$  à  $([-1, 1]^3, L \cup \gamma)$ .

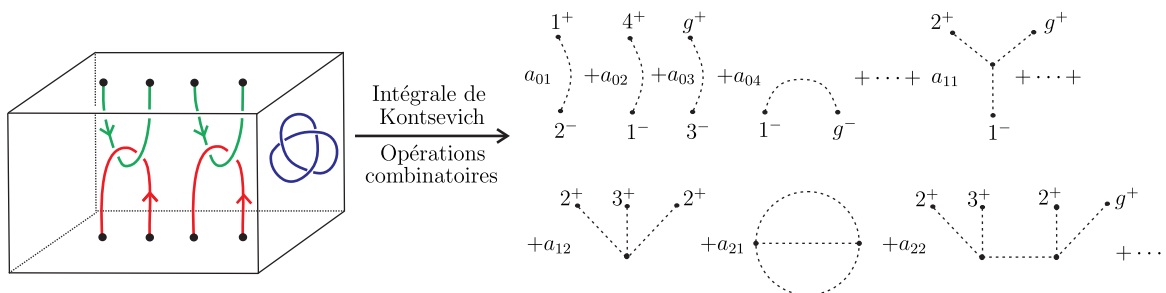


Figure 1.12: Passage de  $([-1, 1]^3, L \cup \gamma)$  à  $\tilde{Z}(M) \in {}^{ts}\mathcal{A}(g, g)$ .

de Johnson peuvent être lus dans la réduction arborée du foncteur LMO. Nous montrons le résultat suivant.

**Théorème 5.** *Les homomorphismes de Johnson-Levine peuvent être lus dans la réduction arborée du foncteur LMO.*

Plus précisément, pour  $M \in J_m^L \mathcal{C}$  nous montrons que les termes du type arbre, de degré interne  $m$  et avec sommets univalents uniquement coloriés par l'ensemble  $[g]^+$  de  $\tilde{Z}(M)$  coïncident avec la version diagrammatique de  $\tau_m^L(M)$ , après les changements  $i^- \mapsto a_i$  et  $i^+ \mapsto b_i$ , où  $\{a_i, b_i\}$  est une base symplectique de  $H_1(\Sigma)$  telle que  $\{a_i\}$  est une base de  $A = \ker(H_1(\Sigma) \xrightarrow{\iota^*} B)$  et  $B = H_1(V)$ .

Les homomorphismes de Johnson alternatifs motivent la définition du *degré alternatif*, noté  $\mathfrak{a}\text{-deg}$ , pour les diagrammes Jacobi connexes du type arbre. Si  $T$  est un diagramme de Jacobi connexe du type arbre colorié par  $B \oplus A$ , alors

$$\mathfrak{a}\text{-deg}(T) = 2|T_A| + |T_B| - 3,$$

où  $|T_A|$  (respectivement  $|T_B|$ ) désigne le nombre de sommets univalents de  $T$  coloriés par  $A$  (respectivement par  $B$ ). Voir la Figure 1.13 (a) et (b) pour quelques exemples.

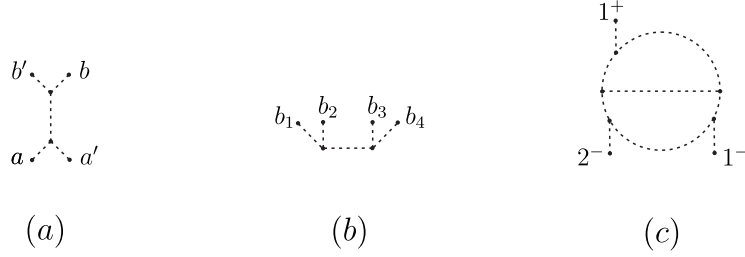


Figure 1.13: Diagrammes de Jacobi du type arbre de  $\mathbf{a}\text{-deg} = 3$  dans (a) et de  $\mathbf{a}\text{-deg} = 1$  dans (b) et (c) diagramme de Jacobi avec boucle. Ici  $a, a' \in A$  et  $b, b', b_1, \dots, b_4 \in B$ .

Le tableau suivant met en regard degré alternatif et degré interne pour les diagrammes de Jacobi les plus simples. Nous colorions un sommet univalent avec le signe  $+$  si la couleur correspondante appartient à  $B$  et avec  $-$  si la couleur correspondante appartient à  $A$ .

i-deg \ a-deg	0	1	2	3
0				
1				
2				
3				
4				
5				

Notons par  $\mathcal{T}_m^{Y,\mathbf{a}}(B \oplus A)$  l'espace engendré par les diagrammes de Jacobi connexes du type arbre, coloriés par  $B \oplus A$ , avec au moins un sommet trivalent et de  $\mathbf{a}\text{-degré}$  égal à  $m$ . Pour un cobordisme lagrangien  $M$  notons  $\tilde{Z}^t(M)$  la réduction de  $\tilde{Z}(M)$  modulo les *diagrammes de Jacobi avec boucles*, c'est-à-dire, les diagrammes avec une composante connexe non contractile. Voir la Figure 1.13 (c) pour un exemple. Ainsi,  $\tilde{Z}^t(M)$  est uniquement composé de diagrammes de Jacobi du type arbre. La première étape pour relier les homomorphismes de Johnson alternatifs avec le foncteur LMO est donnée par le Théorème 6.5 qui énonce le résultat suivant.

**Théorème 6.** *Le degré alternatif induit une filtration  $\{\mathcal{F}_m^{\mathbf{a}}\mathcal{C}\}_{m \geq 1}$  de  $\mathcal{C}$  par des sous-monoïdes. De plus, considérons l'application*

$$\tilde{Z}_m^{Y,\mathbf{a}} : \mathcal{F}_m^{\mathbf{a}}\mathcal{C} \longrightarrow \mathcal{T}_m^{Y,\mathbf{a}}(B \oplus A),$$

où  $\tilde{Z}_m^{Y,\mathbf{a}}(M)$  est défini comme les diagrammes de Jacobi dans  $\tilde{Z}^t(M)$  avec au moins un sommet trivalent et de  $\mathbf{a}\text{-deg} = m$ , pour  $M \in \mathcal{F}_m^{\mathbf{a}}\mathcal{C}$ . Alors,  $\tilde{Z}_m^{Y,\mathbf{a}}$  est un morphisme de monoïdes.

Dans le Théorème 6.14 et le Théorème 6.16 nous montrons le résultat suivant.

**Théorème 7.** *Les homomorphismes de Johnson alternatifs peuvent être lus dans la réduction arborée du foncteur LMO.*

Plus précisément, nous montrons que pour  $h \in J_m^{\mathfrak{a}}\mathcal{M}$  avec  $m \geq 2$ , la valeur  $\tilde{Z}_m^{Y,\mathfrak{a}}(c(h))$  coïncide avec la version diagrammatique de  $\tau_m^{\mathfrak{a}}(h)$ . Pour  $h \in J_1^{\mathfrak{a}}\mathcal{M}$ , nous montrons que  $\tau_1^{\mathfrak{a}}(h)$  est donné par  $\tilde{Z}_1^{Y,\mathfrak{a}}(c(h))$  et par les diagrammes de Jacobi sans sommets trivalents de  $\mathfrak{a}$ -deg= 1 dans  $\tilde{Z}(c(h))$ . Les techniques utilisées dans la preuve du Théorème 7 dans le cas  $m = 1$  (Théorème 6.14) et  $m \geq 2$  (Théorème 6.16) sont différentes. Pour  $m = 1$ , nous devons faire des calculs explicites du foncteur LMO et une comparaison entre le premier homomorphisme de Johnson alternatif et le premier homomorphisme de Johnson. Pour  $m \geq 2$ , le point clé est le fait que le foncteur LMO définit un *développement symplectique alternatif* de  $\pi$ . Pour montrer cela, nous utilisons un résultat de Massuyeau [47] qui montre que le foncteur LMO définit un développement symplectique de  $\pi$ .

Le Théorème 6 et le Théorème 7 fournissent une nouvelle grille de lecture de la réduction arborée du foncteur LMO par le degré alternatif. Remarquons que le Théorème 6 est valide dans le contexte des cobordismes d’homologie, ainsi que les résultats que nous utilisons dans la preuve du Théorème 7. Cela suggère que les homomorphismes de Johnson alternatifs et le Théorème 7 pourraient être généralisés aux cobordismes d’homologie, mais nous n’avons pas encore exploré cette question.

### 1.3 Organisation de la thèse

Le présent mémoire se compose des deux prépublications suivantes :

1. *Johnson-Levine homomorphisms and the tree reduction of the LMO functor.*  
arXiv : 1712.00073, 2017.
2. *Alternative versions of the Johnson homomorphisms and the LMO functor.*  
arXiv : 1902.10012, 2019.

Chacune de ces deux parties peut être lue indépendamment et chacune a une introduction plus détaillée. En particulier les théorèmes 4 et 5 sont démontrés dans la première partie et les théorèmes 1, 2 ,3, 6 et 7 le sont dans la deuxième partie.

## 2 Introduction (in English)

This thesis lies in the framework of *quantum topology*, a domain at the crossroads of algebra, topology and mathematical physics that has its origins in the 1980s. Quantum topology is mainly concerned with two types of objects: *objects of topological nature* and *invariants of these objects*. Let us start with a brief and intuitive description of the objects of topological nature we are interested in. In dimension one, we are interested in knots, links, and other similar knotted objects. In dimension two, we are interested in surfaces and their “symmetry groups”. In dimension three, we are interested in 3-dimensional manifolds. In fact, knots (or links) and the “symmetries” of surfaces can be seen as 3-dimensional manifolds.

**Knot theory.** We consider one dimensional objects embedded in a three dimensional space. For instance *knots*, *links*, *tangles*, etc. See Figure 2.1 for some examples.

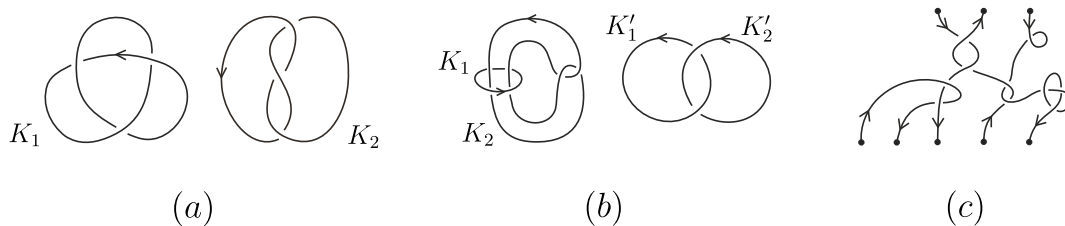


Figure 2.1: (a) Knots, (b) links and (c) a tangle.

Two knotted objects are said to be *equivalent* if one can be deformed (by stretching, entangling, detangling but without cutting) into the other. For instance, the knots  $K_1$  and  $K_2$  in Figure 2.1 (a) are equivalent. We can deform  $K_1$  into  $K_2$  as shown in Figure 2.2.

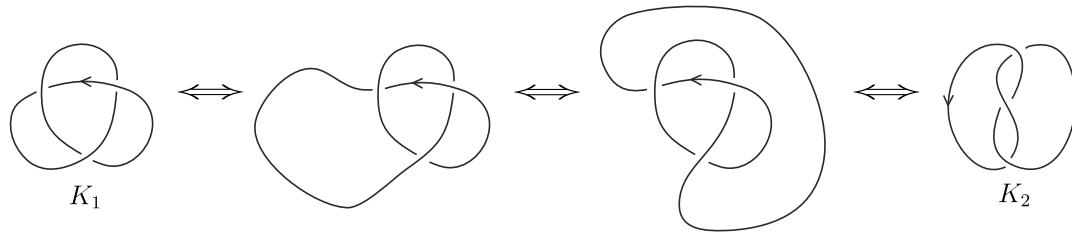


Figure 2.2: Equivalence between  $K_1$  and  $K_2$ .

**Mapping class group.** Let  $\Sigma_{g,1}$  be a compact connected oriented surface of genus  $g$  with one boundary component. See Figure 2.3.

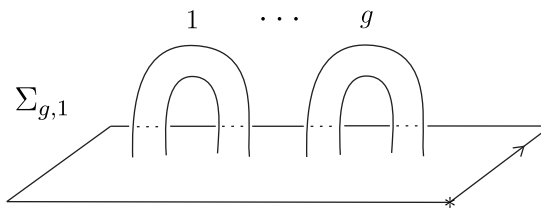
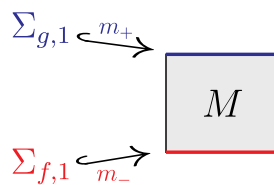


Figure 2.3: Surface  $\Sigma_{g,1}$ .

The classification of compact surfaces is well known. Therefore, the object we are interested in is the “symmetry group” of the surface. More precisely, the group of isotopy classes of orientation-preserving homeomorphisms  $h : \Sigma_{g,1} \rightarrow \Sigma_{g,1}$  that fix  $\partial\Sigma_{g,1}$ . From now on, this group will be denoted by  $\mathcal{M}_{g,1}$ .

**3-manifolds.** We are interested in compact oriented connected 3-manifolds (possibly with boundary). In particular we are interested in *cobordisms* from  $\Sigma_{g,1}$  to  $\Sigma_{f,1}$ , that is, 3-manifolds  $M$  whose boundary decomposes as the union of a copy of  $\Sigma_{g,1}$  (on top), a copy of  $\Sigma_{f,1}$  (on bottom) and the cylinder  $\mathbb{S}^1 \times [-1, 1]$  (lateral boundary). Hence, we have embeddings  $m_+ : \Sigma_{g,1} \rightarrow \partial M \subseteq M$  and  $m_- : \Sigma_{f,1} \rightarrow \partial M \subseteq M$ . Schematically:



For instance, Figure 2.4 (a) shows a *cobordism* from  $\Sigma_{2,1}$  to  $\Sigma_{3,1}$ .

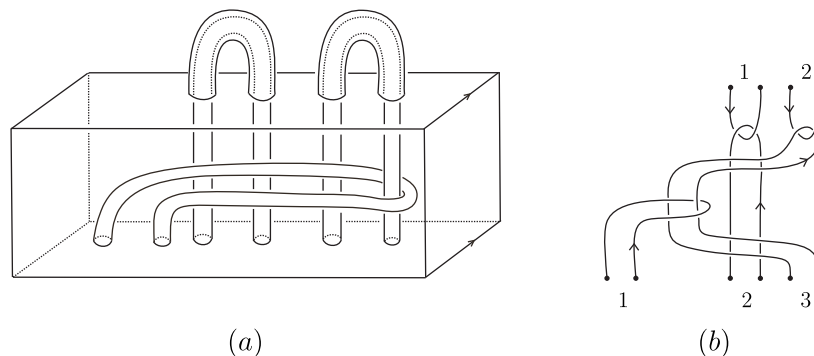


Figure 2.4: (a) Cobordism from  $\Sigma_{2,1}$  to  $\Sigma_{3,1}$  (b) bottom-top tangle presentation of the cobordism on the left.

Another example of 3-manifold is the *genus  $g$  handlebody*, that is, the 3-manifold obtained from a closed 3-ball by gluing  $g$  1-handles  $[0, 1] \times D^2$  on its boundary. The obtained 3-manifold is denoted by  $V_g$ . Notice that the boundary of  $V_g$  decomposes as the union of the surface  $\Sigma_{g,1}$  together with a disk  $D$ , see Figure 2.5.

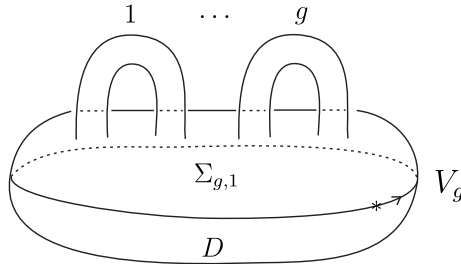


Figure 2.5: Handlebody  $V_g$  and decomposition  $\partial V_g = \Sigma_{g,1} \cup D$ .

From now on, by “3-manifold” we mean “compact oriented connected 3-manifold”.

The three families of topological objects described above are closely related:

1. Every 3-manifold without boundary can be obtained as a *surgery* along a link in  $\mathbb{S}^3$ . Such a link is called *surgery presentation* of the 3-manifold.
2. Let  $i : \partial V_g \rightarrow \partial V_g$  be the involution which exchanges the meridians and (preferred) longitudes of  $\partial V_g$ . Every 3-manifold without boundary can be obtained by gluing two copies of the handlebody  $V_g$  by using a homeomorphism  $ih$ , where  $h$  (*the gluing element*) is an element in the mapping class group of  $\partial V_g$ . Such a decomposition is called a *Heegaard splitting* of the 3-manifold. It is interesting to notice that some topological properties of the 3-manifold obtained from a Heegaard splitting are reflected in the algebraic properties of the gluing element and reciprocally. For instance, a 3-manifold with a Heegaard splitting whose gluing element acts trivially in homology, is a *homology sphere* (3-manifold with the same homology groups as  $\mathbb{S}^3$ ).
3. Every cobordism from  $\Sigma_{g,1}$  to  $\Sigma_{f,1}$  can be represented (after surgery) as a knotted object in  $[-1, 1]^3$ . Such a presentation is called *bottom-top tangle presentation*. For example, the tangle in Figure 2.4 (b) is a bottom-top tangle presentation of the cobordism from  $\Sigma_{2,1}$  to  $\Sigma_{3,1}$  shown in Figure 2.4 (a).
4. Every element  $h$  in the group  $\mathcal{M}_{g,1}$  allows to define a cobordism from  $\Sigma_{g,1}$  to  $\Sigma_{g,1}$  as follows. Consider the cylinder  $\Sigma_{g,1} \times [-1, 1]$  with embeddings  $m_{\pm} : \Sigma_{g,1} \rightarrow \partial(\Sigma_{g,1} \times [-1, 1])$  given by  $m_+(x) = (h(x), 1)$  and  $m_-(x) = (x, -1)$ . This cobordism is called the *mapping cylinder* of  $h$  and it is denoted by  $c(h)$ .

The above relations between these objects make it possible to interpret a problem in a particular family of objects (for instance 3-manifolds) in terms of another family (for instance knots or mapping class groups). It is a very fruitful way to approach the study of these families of objects and we will use it throughout this work.

A fundamental question that arises in topology is: how to distinguish two objects of the same nature (two knots, two 3-manifolds or two elements in  $\mathcal{M}_{g,1}$ )? For example, Figure 2.2 shows that the two knots  $K_1$  and  $K_2$  in Figure 2.1 (a) are equivalent by describing a way of deforming one into the other. However, suppose we consider the two links from Figure 2.1 (b). We would like to know if they are equivalent or not. We can start by trying to deform one into the other. Assuming we do not succeed, it does not mean that it can not be done. Hence, we need another way to approach the problem. One possible approach to this task is the construction of *invariants*, that is, “quantities” (numbers, polynomials, groups among others) which are equal for equivalent objects. For example, an invariant for oriented links is the *linking number* which admits the following definition. Let  $K$  be an

oriented link and consider a regular projection of  $K$  onto a plane. Let  $K_i$  and  $K_j$  be two connected components of  $K$ . The *linking number*  $\text{Lk}(K_i, K_j)$  between  $K_i$  and  $K_j$  is defined by

$$\text{Lk}(K_i, K_j) = \frac{1}{2} \sum_c \text{sgn}(c),$$

where  $c$  runs over the set of crossing between  $K_i$  and  $K_j$  in the regular projection and  $\text{sgn}(c)$  is the *sign* of the crossing  $c$  defined according to the rule given in Figure 2.6. Consider for example the



Figure 2.6: Positive and negative crossing.

link  $K_1 \cup K_2$  from Figure 2.1 (b). We have  $\text{Lk}(K_1, K_2) = 0$  while for the link  $K'_1 \cup K'_2$  in the same figure, we have  $\text{Lk}(K'_1, K'_2) = -1$ . Thus, we can conclude that the links  $K_1 \cup K_2$  and  $K'_1 \cup K'_2$  are not equivalent.

Until the 1980s, algebraic topology was the main source for the construction of invariants for links and 3-manifolds. An important event occurred in 1984 with Jones' discovery of a new invariant of links, which is currently known as the *Jones Polynomial* [35]. Some of the remarkable facts about this invariant is that, in its original construction, algebraic topology is not used and that there are ideas that come from statistical mechanics. In 1989, Witten gave a physical interpretation of this invariant [67]. This interpretation allowed him to propose, in a heuristic way, the definition of new invariants of 3-manifolds. These two historical moments are generally considered as the origins of quantum topology. The ideas of Jones and Witten have been, and continue to be, a great source of inspiration for research in topology. These discoveries paved the way for multiple connections between low-dimensional topology and other areas of mathematics and physics.

A rigorous definition of the 3-manifold invariants inspired by these new ideas was obtained by Reshetikhin and Turaev by using quantum groups and their representations [59]. This approach is sometimes called the *non-perturbative approach*. This led to the advent of many new invariants, called *quantum invariants*, since the method of Reshetikhin and Turaev allows to construct an invariant from the quantization of a semi-simple Lie algebra. Therefore, we have at least as many invariants as semi-simple Lie algebras. This way, quantum invariants are not only interesting tools for trying to distinguish two different topological objects, but they become a subject of study in their own right. For instance, a fundamental question is: is it possible to organize (or hierarchize) these invariants in a certain way? It turns out that this is possible thanks to the theory of *finite-type invariants* (*Vassiliev-Goussarov*) in the case of links [65, 17, 6] and to the theory *finite-type invariants* (*Ohtsuki-Goussarov-Habiro*) in the case of 3-manifolds [55, 26, 18].

An important success was obtained with the introduction of the *Kontsevich integral* for links [36, 1] and the *universal perturbative invariant of Le-Murakami-Ohtsuki* (LMO invariant) for 3-manifolds [38]. Here the word “*perturbative*” refers to the perturbative methods in physics. The importance of these invariants lies in the fact that they are *universal* with respect to  $\mathbb{Q}$ -valued finite-type invariants. Roughly speaking, this property says that each  $\mathbb{Q}$ -valued finite-type invariant (in particular each suitably “developed” Reshetikhin-Turaev invariant) is completely determined by the Kontsevich integral in the case of links or by the LMO invariant in the case of homology 3-spheres.

Originally, the LMO invariant was defined for closed 3-manifolds. Bar-Natan, Garoufalidis, Rozansky and Thurston gave a new construction using a kind of diagrammatic Gaussian integral [4, 5]. Their definition is only valid for homology spheres. But this is the most interesting context for the LMO invariant.

The LMO invariant was generalized to 3-manifolds with boundary in the form of a *Topological Quantum Field Theory* (TQFT), called *LMO functor*, by Cheptea, Habiro and Massuyeau [9] (other generalizations of the LMO invariant for 3-manifolds with boundary have been previously obtained in [8, 53]). The source category  $\mathcal{LCob}_q$  of the LMO functor  $\tilde{Z} : \mathcal{LCob}_q \rightarrow {}^{ts}\mathcal{A}$  is the category of *Lagrangian cobordisms* (cobordisms satisfying a homological condition) between bordered surfaces. The target of the LMO functor is the category  ${}^{ts}\mathcal{A}$  of *top-substantial Jacobi diagrams* (uni-trivalent graphs up to certain relations). See Figure 2.13 for some examples of Jacobi diagrams.

The construction of the LMO functor is quite sophisticated: it uses surgery presentations of cobordisms, a combinatorial version of the Kontsevich integral (which depends on the choice of a *Drinfeld associator*) and in order to remove the ambiguity in the surgery presentation, it is necessary to perform several combinatorial operations in the space of Jacobi diagrams. Thus, an important question arises:

- Which topological information is encoded by the LMO functor? In particular, is it possible to give interpretations of the LMO functor in terms of classical invariants?

The main purpose of this thesis is to provide some partial answers to this question. To approach it we use the interaction described above between cobordisms, mapping class groups and knotted objects. In particular, this leads us to a detailed study of some decreasing sequences of subgroups of the group  $\mathcal{M}_{g,1}$ , which we call here *Johnson-type filtrations*, and homomorphisms defined on each of the terms of the filtrations which we call *Johnson-type homomorphisms*. Thus, the two main protagonists of this dissertation are “the LMO functor” and “the Johnson-type homomorphisms”. Part of our main results can be summarized by saying that certain reductions of the LMO functor can be interpreted by means of the *Johnson-type homomorphisms*.

Below, we give a more detailed description of our results.

## 2.1 Johnson-Morita theory

To simplify we denote by  $\Sigma := \Sigma_{g,1}$  and  $\mathcal{M} := \mathcal{M}_{g,1}$ . A natural way to study  $\mathcal{M}$  is to analyse the way it acts on other objects. For instance, we can consider the action on the first homology group  $H := H_1(\Sigma; \mathbb{Z})$  of  $\Sigma$ . This action gives rise to the so-called *symplectic representation*

$$\sigma : \mathcal{M} \longrightarrow \mathrm{Sp}(H, \omega),$$

where  $\omega : H \otimes H \rightarrow \mathbb{Z}$  is the intersection form of  $\Sigma$  and  $\mathrm{Sp}(H, \omega)$  is the group of automorphisms of  $H$  preserving  $\omega$ . The homomorphism  $\sigma$  is surjective but it is far from being injective. Its kernel is known as the *Torelli group* of  $\Sigma$ , denoted by  $\mathcal{I}$ . Hence we have the short exact sequence

$$1 \longrightarrow \mathcal{I} \xrightarrow{\subset} \mathcal{M} \xrightarrow{\sigma} \mathrm{Sp}(H, \omega) \longrightarrow 1. \quad (2.1)$$

We can see that, in order to understand the algebraic structure of  $\mathcal{M}$ , the Torelli group  $\mathcal{I}$  deserves significant attention because, in a certain way, it is the part of  $\mathcal{M}$  that is beyond linear algebra (at least with respect to the symplectic representation).

More interestingly, we can consider the action of  $\mathcal{M}$  on the fundamental group  $\pi := \pi_1(\Sigma, *)$  for a fixed point  $* \in \partial\Sigma$ . This way we obtain an injective homomorphism

$$\rho : \mathcal{M} \longrightarrow \mathrm{Aut}(\pi),$$

which is known as the *Dehn-Nielsen-Baer representation* and whose image is the subgroup of automorphisms of  $\pi$  that fix the homotopy class of the boundary of  $\Sigma$ .

**Johnson-type filtrations.** As stepwise approximations of the representation  $\rho$ , we can consider the action of  $\mathcal{M}$  on the nilpotent quotients of  $\pi$ :

$$\rho_m : \mathcal{M} \longrightarrow \mathrm{Aut}(\pi/\Gamma_{m+1}\pi),$$



where  $\Gamma_1\pi := \pi$  and  $\Gamma_{m+1}\pi := [\pi, \Gamma_m\pi]$  for  $m \geq 1$ , define the *lower central series* of  $\pi$ . This is the approach pursued by Johnson [32] and Morita [51]. This approach allows to define the *Johnson filtration*

$$\mathcal{M} \supseteq \mathcal{I} = J_1\mathcal{M} \supseteq J_2\mathcal{M} \supseteq J_3\mathcal{M} \supseteq \dots \quad (2.2)$$

where  $J_m\mathcal{M} := \ker(\rho_m)$ . In particular,  $\rho_1 = \sigma$  and  $J_1\mathcal{M} = \mathcal{I}$ .

Recall the deep interaction between the mapping class group and the study of 3-manifolds mentioned above. In this setting, it is natural to consider the surface  $\Sigma$  as being part of the boundary of the handlebody  $V := V_g$ , see Figure 2.4. Let  $\iota : \Sigma \hookrightarrow V$  denote the induced inclusion and let  $B := H_1(V; \mathbb{Z})$  and  $\pi' := \pi_1(V, \iota(*))$ . Let  $A$  and  $\mathbb{A}$  be the subgroups  $\ker(H \xrightarrow{\iota_*} B)$  and  $\ker(\pi \xrightarrow{\iota_\#} \pi')$ , where  $\iota_*$  and  $\iota_\#$  are the induced maps by  $\iota$  in homology and homotopy, respectively. The *Lagrangian mapping class group* of  $\Sigma$  is the group

$$\mathcal{L} = \{f \in \mathcal{M} \mid f_*(A) \subseteq A\}.$$

By considering a descending series  $(K_m)_{m \geq 1}$  of normal subgroups of  $\pi$  (different from the lower central series) Habiro and Massuyeau introduced in [28] a filtration of the Lagrangian mapping class group  $\mathcal{L}$ :

$$\mathcal{L} \supseteq \mathcal{I}^a = J_1^a\mathcal{M} \supseteq J_2^a\mathcal{M} \supseteq J_3^a\mathcal{M} \supseteq \dots \quad (2.3)$$

that we call here the *alternative Johnson filtration*. We call the first term  $\mathcal{I}^a := J_1^a\mathcal{M}$  of this filtration the *alternative Torelli group*. Notice that  $\mathcal{I}^a$  is a normal subgroup of  $\mathcal{L}$  but it is not normal in  $\mathcal{M}$ . Roughly speaking, the group  $K_m$  consists of commutators of  $\pi$  of *weight*  $m$ , where the elements of  $\mathbb{A}$  are considered to have weight 2. For instance  $K_1 = \pi$ ,  $K_2 = \mathbb{A} \cdot \Gamma_2\pi$ ,  $K_3 = [\mathbb{A}, \pi] \cdot \Gamma_3\pi$  and so on. The alternative Johnson filtration will be our main object of study in Section 4 of Chapter 2.

Besides, in [43, 46] Levine defined a different filtration of  $\mathcal{L}$  by considering the lower central series of  $\pi'$ , and whose first term is the *Lagrangian Torelli group*<sup>3</sup>  $\mathcal{I}^L = \{f \in \mathcal{L} \mid f_*|_A = \text{Id}_A\}$ :

$$\mathcal{L} \supseteq \mathcal{I}^L = J_1^L\mathcal{M} \supseteq J_2^L\mathcal{M} \supseteq J_3^L\mathcal{M} \supseteq \dots \quad (2.4)$$

we call this filtration the *Johnson-Levine filtration*. The group  $\mathcal{I}^L$  is normal in  $\mathcal{L}$  but not in  $\mathcal{M}$ .

We refer to the Johnson filtration, the alternative Johnson filtration and the Johnson-Levine filtration as *Johnson-type filtrations*.

Notice that, unlike the Johnson filtration, the alternative Johnson filtration and the Johnson-Levine filtration take into account a handlebody bounded by the surface. Besides, the intersection of all terms in the alternative Johnson filtration is the identity of  $\mathcal{M}$  as in the case of the Johnson filtration. But this is not the case for the Johnson-Levine filtration. The second main purpose of this dissertation is the study of the alternative Johnson filtration (which has not been studied previously) and its relation with the other two filtrations. Proposition 4.9 and Proposition 4.13 give the following result.

**Theorem 1.** *The alternative Johnson filtration satisfies the following properties.*

- (i)  $\bigcap_{m \geq 1} J_m^a\mathcal{M} = \{\text{Id}_\Sigma\}$ .
- (ii) For all  $k \geq 1$  the group  $J_k^a\mathcal{M}$  is residually nilpotent, that is,

$$\bigcap_m \Gamma_m J_k^a\mathcal{M} = \{\text{Id}_\Sigma\}.$$

Besides, for every  $m \geq 1$ , we have

$$(iii) \quad J_{2m}^a\mathcal{M} \subseteq J_m\mathcal{M}, \quad (iv) \quad J_m\mathcal{M} \subseteq J_{m-1}^a\mathcal{M}, \quad (v) \quad J_m^a\mathcal{M} \subseteq J_{m+1}^L\mathcal{M},$$

<sup>3</sup>In [66] we use the notation  $\mathcal{IL}$  instead of  $\mathcal{I}^L$  and we use the term *strongly Lagrangian mapping class group* instead of Lagrangian Torelli group.

where  $J_0^{\mathfrak{a}}\mathcal{M} = \mathcal{L}$ . In particular, the Johnson filtration and the alternative Johnson filtration are cofinal.

**Johnson-type homomorphisms.** Each term of the Johnson-type filtrations comes with a homomorphism whose kernel is the next subgroup in the filtration. We refer to these homomorphisms as *Johnson-type homomorphisms*. The *Johnson homomorphisms* are important tools to understand the structure of the Torelli group and the topology of homology 3-spheres [34, 49, 50, 52]. Let us review the target spaces of these homomorphisms. For an abelian group  $G$ , we denote by  $\mathfrak{L}\mathfrak{ie}(G) = \bigoplus_{m \geq 1} \mathfrak{L}\mathfrak{ie}_m(G)$  the graded Lie algebra freely generated by  $G$  in degree 1.

The  $m$ -th *Johnson homomorphism*  $\tau_m$  is defined on  $J_m\mathcal{M}$  and it takes values in the group  $\text{Der}_m(\mathfrak{L}\mathfrak{ie}(H))$  of degree  $m$  derivations of  $\mathfrak{L}\mathfrak{ie}(H)$ . Consider the element  $\Omega \in \mathfrak{L}\mathfrak{ie}_2(H)$  determined by the intersection form  $\omega : H \otimes H \rightarrow \mathbb{Z}$ . A *symplectic derivation*  $d$  of  $\mathfrak{L}\mathfrak{ie}(H)$  is a derivation satisfying  $d(\Omega) = 0$ . Morita shows in [51] that for  $h \in J_m\mathcal{M}$ , the derivation  $\tau_m(h)$  is symplectic. The group of symplectic degree  $m$  derivations of  $\mathfrak{L}\mathfrak{ie}(H)$  can be canonically identified with the kernel  $D_m(H)$  of the Lie bracket  $[\cdot, \cdot] : H \otimes \mathfrak{L}\mathfrak{ie}_{m+1}(H) \rightarrow \mathfrak{L}\mathfrak{ie}_{m+2}(H)$ . This way, for  $m \geq 1$  we have homomorphisms

$$\tau_m : J_m\mathcal{M} \longrightarrow D_m(H).$$

The  $m$ -th *Johnson-Levine homomorphism*  $\tau_m^L : J_m^L\mathcal{M} \rightarrow D_m(B)$  is defined on  $J_m^L\mathcal{M}$  and it takes values in the kernel  $D_m(B)$  of the Lie bracket  $[\cdot, \cdot] : B \otimes \mathfrak{L}\mathfrak{ie}_{m+1}(B) \rightarrow \mathfrak{L}\mathfrak{ie}_{m+2}(B)$ , see [43, 46].

For the *alternative Johnson homomorphisms* [28], consider the graded Lie algebra  $\mathfrak{L}\mathfrak{ie}(B; A)$  freely generated by  $B$  in degree 1 and  $A$  in degree 2. The  $m$ -th *alternative Johnson homomorphism*  $\tau_m^{\mathfrak{a}} : J_m^{\mathfrak{a}}\mathcal{M} \rightarrow \text{Der}_m(\mathfrak{L}\mathfrak{ie}(B; A))$  is defined on  $J_m^{\mathfrak{a}}\mathcal{M}$  and it takes values in the group  $\text{Der}_m(\mathfrak{L}\mathfrak{ie}(B; A))$  of degree  $m$  derivations of  $\mathfrak{L}\mathfrak{ie}(B; A)$ . Similarly to the case of  $\mathfrak{L}\mathfrak{ie}(H)$ , we define a notion of *symplectic derivation* of  $\mathfrak{L}\mathfrak{ie}(B; A)$  by considering the element  $\Omega' \in \mathfrak{L}\mathfrak{ie}_3(B; A)$  defined by the intersection form of the handlebody  $V$ . Theorem 5.9 and Proposition 5.11 give the following result.

**Theorem 2.** *Let  $m \geq 1$  and  $h \in J_m^{\mathfrak{a}}\mathcal{M}$ . Then*

- (i) *The morphism  $\tau_m^{\mathfrak{a}}(h)$  defines a degree  $m$  symplectic derivation of  $\mathfrak{L}\mathfrak{ie}(B; A)$ .*
- (ii) *The morphism  $\tau_{m+1}^L(h)$  is determined by the morphism  $\tau_m^{\mathfrak{a}}(h)$ .*

Property (ii) in Theorem 2 can be expressed more precisely by the commutativity of the diagram

$$\begin{array}{ccc} J_m^{\mathfrak{a}}\mathcal{M} & \xrightarrow{\subset} & J_{m+1}^L\mathcal{M} \\ \tau_m^{\mathfrak{a}} \downarrow & & \downarrow \tau_{m+1}^L \\ D_m(B; A) & \xrightarrow{\iota_*} & D_{m+1}(B), \end{array}$$

for  $m \geq 1$ , where the inclusion  $J_m^{\mathfrak{a}}\mathcal{M} \subseteq J_{m+1}^L\mathcal{M}$  is assured by Theorem 1 (v). The homomorphism  $\iota_* : D_m(B; A) \rightarrow D_{m+1}(B)$  is induced by the map  $\iota_* : H \rightarrow B$ . Property (i) in Theorem 2 allows to define a *diagrammatic version* of the alternative Johnson homomorphisms so that we are able to study their relation to the *LMO functor*.

Before we proceed with a description of our results in this setting, let us state another result in the context of the alternative Johnson homomorphisms. In [28], Habiro and Massuyeau consider a group homomorphism  $\tau_0^{\mathfrak{a}} : \mathcal{L} \rightarrow \text{Aut}(\mathfrak{L}\mathfrak{ie}(B; A))$ , to which we refer as the *0-th alternative Johnson homomorphism*, and whose kernel is the alternative Torelli group  $\mathcal{I}^{\mathfrak{a}}$ . In subsection 5.3 of Chapter 2 we prove the following.

**Theorem 3.** *The homomorphism  $\tau_0^{\mathfrak{a}} : \mathcal{L} \rightarrow \text{Aut}(\mathfrak{L}\mathfrak{ie}(B; A))$  can be equivalently described as a group homomorphism  $\tau_0^{\mathfrak{a}} : \mathcal{L} \rightarrow \text{Aut}(B) \times \text{Hom}(A, \Lambda^2 B)$  for a certain action of  $\text{Aut}(B)$  on  $\text{Hom}(A, \Lambda^2 B)$ . The kernel of  $\tau_0^{\mathfrak{a}}$  is the second term  $J_2^L\mathcal{M}$  of the Johnson-Levine filtration. In particular we have  $\mathcal{I}^{\mathfrak{a}} = J_1^{\mathfrak{a}}\mathcal{M} = J_2^L\mathcal{M}$ .*

Moreover, we explicitly describe the image  $\mathcal{G} := \tau_0^{\mathfrak{a}}(\mathcal{L})$  and then we obtain the short exact sequence

$$1 \longrightarrow \mathcal{I}^{\mathfrak{a}} \xrightarrow{\subset} \mathcal{L} \xrightarrow{\tau_0^{\mathfrak{a}}} \mathcal{G} \longrightarrow 1. \quad (2.5)$$

This short exact sequence has a similar role, in the context of the alternative Johnson homomorphisms, to that of the short exact sequence (2.1) in the context of the Johnson homomorphisms. This is because in [28] the authors prove that the alternative Johnson homomorphisms satisfy an equivariant property with respect to the homomorphism  $\tau_0^a$ , which is the analogue of the Sp-equivariant property of the Johnson homomorphisms. Hence the short exact sequence (2.5) can be important for a further development of the study of the alternative Johnson filtration.

**Homology cobordisms.** The Johnson filtration and the Johnson-Levine filtration as well as the respective Johnson-type homomorphisms generalize in a natural way to the monoid of *homology cobordisms* of  $\Sigma$ , see [16]. A *homology cobordism* [26, 19] is a homeomorphism class of pairs  $(M, m)$ , where  $M$  is a cobordism from  $\Sigma$  to  $\Sigma$  and  $m : \partial(\Sigma \times [-1, 1]) \rightarrow \partial M$  is an orientation-preserving homeomorphism such that the *top* and *bottom* restrictions  $m_{\pm}(\cdot) := m(\cdot, \pm 1) : \Sigma \rightarrow M$  induce isomorphisms in homology. Here, two pairs  $(M, m)$  and  $(M', m')$  are said to be *equivalent* if there is a homeomorphism  $\phi : M \rightarrow M'$  such that  $\phi \circ m = m'$ .

The *composition*  $(M, m) \circ (M', m')$  of two homology cobordisms  $(M, m)$  and  $(M', m')$  of  $\Sigma$  is the equivalence class of the pair  $(\bar{M}, m_- \cup m'_+)$ , where the 3-manifold  $\bar{M}$  is obtained by gluing the two 3-manifolds  $M$  and  $M'$  by using the map  $m_+ \circ (m'_-)^{-1}$ . This composition is associative and has as identity element the equivalence class of the trivial cobordism  $(\Sigma \times [-1, 1], \text{Id})$ . Let us denote by  $\mathcal{C}$  (or by  $\mathcal{C}_{g,1}$  if there is ambiguity) the monoid of homology cobordisms of  $\Sigma$ .

As we previously mentioned, an element  $h \in \mathcal{M}$  defines a cobordism  $c(h)$  from  $\Sigma$  to  $\Sigma$ . Moreover  $c(h)$  is a homology cobordism, that is  $c(h) \in \mathcal{C}$ . Therefore, we have an (injective) monoid homomorphism  $c : \mathcal{M} \rightarrow \mathcal{C}$  which is called the *mapping cylinder construction*. This way, we can consider the monoid  $\mathcal{C}$  as a generalization of the mapping class group  $\mathcal{M}$ .

The Dehn-Nielsen-Baer representation  $\rho : \mathcal{M} \rightarrow \text{Aut}(\pi)$  can not be extended to the whole monoid  $\mathcal{C}$ . However, by a theorem of Stallings [63], the homomorphisms  $\rho_k : \mathcal{M} \rightarrow \text{Aut}(\pi/\Gamma_{k+1}\pi)$  can be extended to  $\mathcal{C}$ :

$$\rho_k : \mathcal{C} \longrightarrow \text{Aut}(\pi/\Gamma_{k+1}\pi)$$

is the homomorphism which sends  $(M, m) \in \mathcal{C}$  to the automorphism  $m_{-,*}^{-1} \circ m_{+,*}$ , see [16]. Hence, the *Johnson filtration* of  $\mathcal{C}$  is the descending chain of submonoids

$$\mathcal{C} \supseteq \mathcal{IC} = J_1\mathcal{C} \supseteq J_2\mathcal{C} \supseteq J_3\mathcal{C} \supseteq \dots \quad (2.6)$$

where  $J_k\mathcal{C} := \ker(\rho_k)$ . The first term  $\mathcal{IC} = J_1\mathcal{C}$  in this filtration is called the *monoid of homology cylinders*. We also have the *Johnson homomorphisms* for homology cobordisms

$$\tau_m : J_m\mathcal{C} \longrightarrow D_m(H). \quad (2.7)$$

The monoid of *Lagrangian homology cobordisms*  $\mathcal{LC}$  is defined as

$$\mathcal{LC} = \{(M, m) \in \mathcal{C} \mid \rho_1(M)(A) \subseteq A\} = \{(M, m) \in \mathcal{C} \mid m_{+,*}(A) \subseteq m_{-,*}(A)\},$$

and the monoid of *strongly Lagrangian homology cobordisms*<sup>4</sup>  $\mathcal{IC}^L$  is defined as

$$\mathcal{IC}^L = \{(M, m) \in \mathcal{LC} \mid \rho_1(M)|_A = \text{Id}_A\} = \{(M, m) \in \mathcal{LC} \mid m_{+,*}|_A = m_{-,*}|_A\}.$$

Using the mapping cylinder construction we obtain  $c(\mathcal{I}) \subseteq \mathcal{IC}$ ,  $c(\mathcal{I}^L) \subseteq \mathcal{IC}^L$  and  $c(\mathcal{L}) \subseteq \mathcal{LC}$ .

Similarly, we can define the *Johnson-Levine filtration* of  $\mathcal{C}$ :

$$\mathcal{C} \supseteq \mathcal{LC} \supseteq \mathcal{IC}^L = J_1^L\mathcal{C} \supseteq J_2^L\mathcal{C} \supseteq J_3^L\mathcal{C} \supseteq \dots \quad (2.8)$$

as well as the *Johnson-Levine homomorphisms*:

$$\tau_m^L : J_m^L\mathcal{C} \longrightarrow D_m(B). \quad (2.9)$$

<sup>4</sup>In [66] we use the notation  $\mathcal{ILC}$  instead of  $\mathcal{IC}^L$ .

Levine compared the Johnson and Johnson-Levine filtrations in lower degree for the mapping class group. He proved in [46] that for  $m = 1$  and  $m = 2$ , we have  $J_m^L \mathcal{M} = J_m \mathcal{M} \cdot (\mathcal{H} \cap \mathcal{I}^L)$ , where the subgroup  $\mathcal{H} = \{h \in \mathcal{M} \mid h_{\#}(\mathbb{A}) \subseteq \mathbb{A}\}$  can be identified with the mapping class group of the handlebody  $V$ . Levine asked about the comparison in any degree. In the case of homology cobordisms we have a comparison in any degree up to some surgery relations. These relations, denoted by  $Y_k$  for  $k \geq 1$ , were introduced independently by Goussarov in [18, 19] and by Habiro in [26] in connection with the theory of finite-type invariants. More precisely, we have the following result.

**Theorem 4.** *For every  $k, l \geq 1$ , we have*

$$\frac{J_k^L \mathcal{C}}{Y_{k+l}} = \frac{J_k \mathcal{C}}{Y_{k+l}} \cdot q_{k+l}(\mathcal{HC} \cap \mathcal{IC}^L),$$

where  $q_{k+l} : \mathcal{C} \rightarrow \mathcal{C}/Y_{k+l}$  is the canonical projection and  $\cdot$  denotes the product in  $\mathcal{C}/Y_{k+l}$ .

Here, the submonoid  $\mathcal{HC}$  is the analogue of the group  $\mathcal{H}$  in the context of homology cobordisms. More precisely  $\mathcal{HC}$  is the submonoid of  $(M, m) \in \mathcal{C}$  such that  $M \circ V = V$  as cobordisms, where we consider  $V$  as a cobordism from the surface  $\Sigma$  to the disc  $D$  and  $\circ$  is defined as in the case of  $\mathcal{C}$ . Theorem 4 is one of the key points to understand the relation between the Johnson-Levine homomorphisms and the LMO functor.

## 2.2 Johnson-type homomorphisms and the LMO functor

Let us give a brief description of the LMO functor  $\tilde{Z} : \mathcal{LCob}_q \rightarrow {}^{ts}\mathcal{A}$ . The objects of the source category are non-associative words in the symbol  $\bullet$ . Let  $u$  and  $v$  be two non-associative words in the symbol  $\bullet$  of lengths  $g$  and  $f$ , respectively. An element of  $\mathcal{LCob}_q(u, v)$  is a cobordism of  $\Sigma_{g,1}$  to  $\Sigma_{f,1}$  which satisfies in addition certain homological condition (Lagrangian property [8]). In particular, if we equip the elements of  $\mathcal{LC} = \mathcal{LC}_{g,1}$  on the top and bottom with the non-associative word  $u_g = (\bullet \cdots (\bullet(\bullet\bullet)) \cdots)$  of length  $g$ , we have  $\mathcal{LC}_{g,1} \subseteq \mathcal{LCob}_q(u_g, u_g)$ .

We now turn to the definition of the target category  ${}^{ts}\mathcal{A}$  of the LMO functor. A *Jacobi diagram* is a finite univalent graph such that the trivalent vertices are *oriented*, that is, the incident edges are ordered cyclically. Let  $C$  be a finite set, we say that a Jacobi diagram is  *$C$ -colored* if the univalent vertices are colored by the  $\mathbb{Q}$ -vector space generated by  $C$ . The *internal degree* of a Jacobi diagram is the number of trivalent vertices, denoted *i-deg*. A connected Jacobi diagram of *i-deg* = 0 is called a *strut*. We refer to Figure 2.7 for some examples.

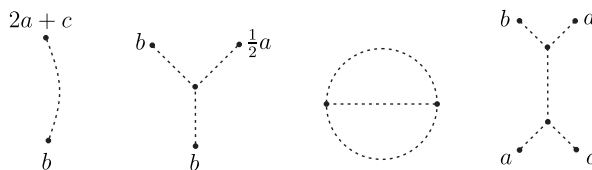


Figure 2.7:  $C$ -colored Jacobi diagrams of *i-deg* 0, 1, 2 and 2, respectively. Here  $C = \{a, b, c\}$ .

The space of  $C$ -colored Jacobi diagrams is defined by

$$\mathcal{A}(C) := \frac{\text{Vect}_{\mathbb{Q}}\{C\text{-colored Jacobi diagrams}\}}{\text{AS, IHX, } \mathbb{Q}\text{-multilinearity}},$$

where the relations AS, IHX and multilinearity are described in Figure 2.8.

For a non-negative integer  $g$ , denote by  $[g]^*$  the set  $\{1^*, \dots, g^*\}$ , where  $*$  is a decorative symbol like  $+$ ,  $-$  or  $*$  itself. The objects of the category  ${}^{ts}\mathcal{A}$  are the non-negative integers. The set of morphisms from  $g$  to  $f$  is the subspace  ${}^{ts}\mathcal{A}(g, f)$  of diagrams in  $\mathcal{A}([g]^+ \sqcup [f]^-)$  without struts whose both ends are colored by elements of  $[g]^+$ . If  $D \in {}^{ts}\mathcal{A}(g, f)$  and  $E \in {}^{ts}\mathcal{A}(h, g)$  the composition  $D \circ E$  is the

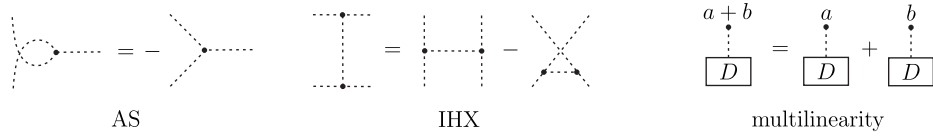
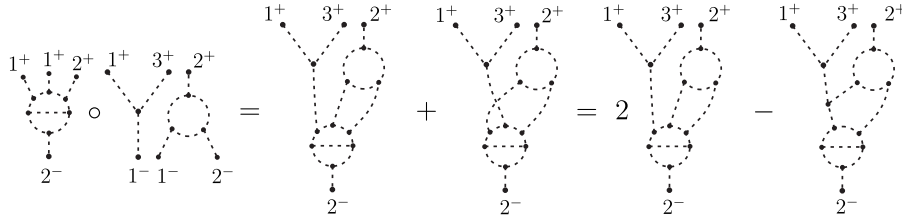


Figure 2.8: Relations in  $\mathcal{A}(C)$ .

element in  ${}^{ts}\mathcal{A}(h, f)$  given by the sum of Jacobi diagrams obtained by considering all the possible ways of gluing the  $[g]^+$ -colored legs of  $D$  with the  $[g]^-$ -colored legs of  $E$ . For example



The identity morphism in  ${}^{ts}\mathcal{A}(g, g)$  is given by

$$\text{Id}_g := \exp_{\square} \left( \sum_{i=1}^g \begin{array}{c} \cdot i^+ \\ \vdots \\ \cdot i^- \end{array} \right).$$

The category  ${}^{ts}\mathcal{A}$  is called the category of *top-substantial Jacobi diagrams*.

Let us now turn to a brief sketch of the definition of  $\tilde{Z}$ . We fix a system of meridians and parallels  $\{\alpha_i, \beta_i\}$  of  $\Sigma_{g,1}$  as in Figure 2.9.

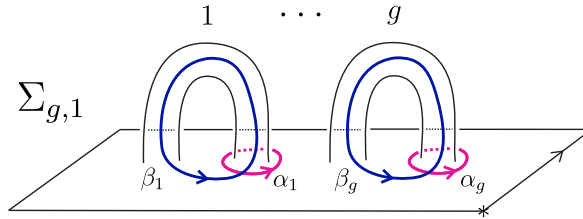


Figure 2.9: System of meridians and parallels  $\{\alpha_i, \beta_i\}$ .

Let  $(M, m)$  be a Lagrangian cobordism, for instance  $(M, m) \in \mathcal{LC}_{g,1}$ . Let us attach  $g$  2-handles  $D^2 \times [0, 1]$  on the bottom surface of  $M$  by sending the cores of the 2-handles to the curves  $m_-(\alpha_i)$ . In the same way, attach  $g$  2-handles on the top surface of  $M$  by sending the cores to the curves  $m_+(\beta_i)$ . This way, we obtain a compact connected oriented 3-manifold  $B$  and an orientation-preserving homeomorphism  $b : \partial([-1, 1]^3) \rightarrow \partial B$ . The pair  $B = (B, b)$  together with the cocores of the 2-handles, determine a tangle  $\gamma'$  in  $B$ , see Figure 2.10. The pair  $(B, \gamma')$  is called *bottom-top tangle presentation* of  $(M, m)$ .

Next, take a *surgery presentation* of  $(B, \gamma')$ , that is, a framed link  $L \subseteq \text{int}([-1, 1]^3)$  and a tangle  $\gamma$  in  $[-1, 1]^3 \setminus L$  such that surgery along  $L$  carries  $([-1, 1]^3, \gamma)$  to  $(B, \gamma')$ , see Figure 2.11.

Then, we consider the Kontsevich integral of the pair  $([-1, 1]^3, L \cup \gamma)$ , which gives a series of a kind of Jacobi diagrams. To get rid of the ambiguity in the surgery presentation, it is necessary to use some combinatorial operations on the space of diagrams. Finally, we obtain a series of Jacobi diagrams  $\tilde{Z}(M)$  in  ${}^{ts}\mathcal{A}(g, g)$ , see Figure 2.12.

Johnson-type homomorphisms can be described in terms of Jacobi diagrams where, among all the graphs, only trees are allowed. Therefore, it is natural to wonder about the relationship between the diagrammatic version of Johnson-type homomorphisms and the tree reduction of the LMO functor. Cheptea, Habiro and Massuyeau proved in [8] that Johnson homomorphisms can be read in the tree reduction of the LMO functor. We show the following result.

**Theorem 5.** *Johnson-Levine homomorphisms can be read in the tree reduction of the LMO functor.*

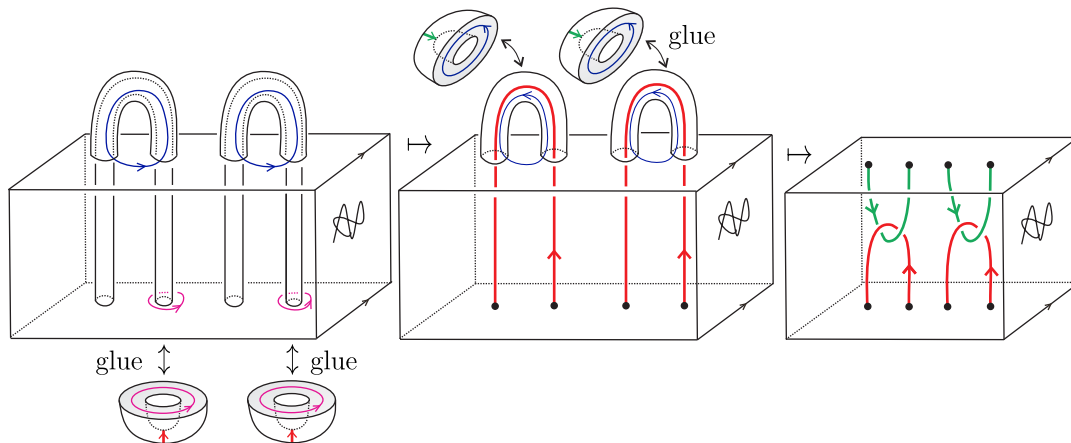


Figure 2.10: From  $(M, m)$  to  $(B, \gamma')$ .

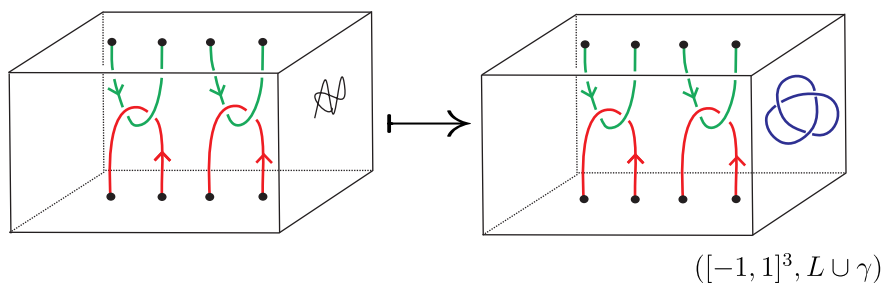


Figure 2.11: From  $(B, \gamma')$  to  $([-1, 1]^3, L \cup \gamma)$ .

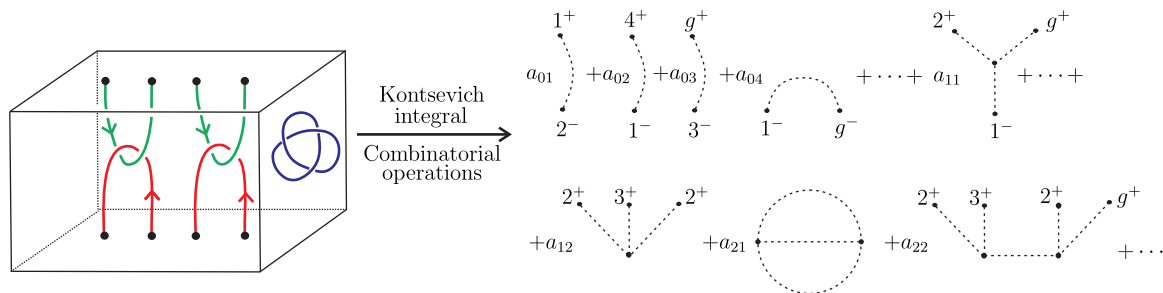


Figure 2.12: From  $([-1, 1]^3, L \cup \gamma)$  to  $\tilde{Z}(M) \in {}^{ts}\mathcal{A}(g, g)$ .

More precisely, we show that for  $M \in J_m^L \mathcal{C}$  the tree-type terms of internal degree  $m$  and with univalent vertices only colored by the set  $[g]^+$  in  $\tilde{Z}(M)$  coincide with the diagrammatic version of  $\tau_m^L(M)$ , after the replacements  $i^- \mapsto a_i$  and  $i^+ \mapsto b_i$ , where  $\{a_i, b_i\}$  is a symplectic basis of  $H_1(\Sigma)$  such that  $\{a_i\}$  is a basis of  $A = \ker(H_1(\Sigma) \xrightarrow{L^*} B)$  and  $B = H_1(V)$ .

The alternative Johnson homomorphisms motivate the definition of the *alternative degree*, denoted  $\mathfrak{a}\text{-deg}$ , for connected tree-like Jacobi diagrams. If  $T$  is a tree-like Jacobi diagram colored by  $B \oplus A$ , then

$$\mathfrak{a}\text{-deg}(T) = 2|T_A| + |T_B| - 3,$$

where  $|T_A|$  (respectively  $|T_B|$ ) denotes the number of univalent vertices of  $T$  colored by  $A$  (respectively by  $B$ ). See Figure 2.13 (a) and (b) for some examples.

The following table compares alternative degree and internal degree for the simplest Jacobi diagrams. We color a univalent vertex with the sign  $+$  if the corresponding color belongs to  $B$  and with  $-$  if the corresponding color belongs to  $A$ .

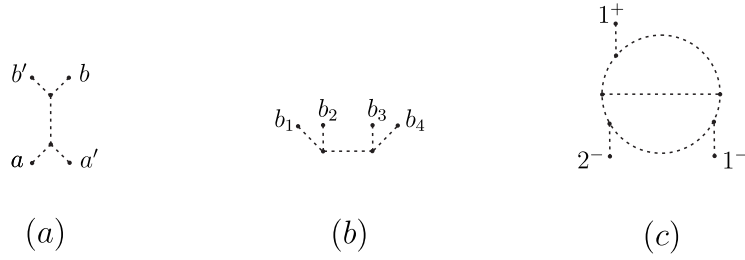


Figure 2.13: Tree-like Jacobi diagrams of  $\mathfrak{a}\text{-deg} = 3$  in (a) and of  $\mathfrak{a}\text{-deg} = 1$  in (b) and (c) looped Jacobi diagram. Here  $a, a' \in A$  and  $b, b', b_1, \dots, b_4 \in B$ .

$\mathfrak{a}\text{-deg} \backslash \text{i-deg}$	0	1	2	3
0				
1				
2				
3				
4				
5				

Denote by  $\mathcal{T}_m^{Y,\mathfrak{a}}(B \oplus A)$  the space generated by tree-like Jacobi diagrams colored by  $B \oplus A$  with at least one trivalent vertex and with  $\mathfrak{a}\text{-deg} = m$ . For a Lagrangian cobordism  $M$  let  $\tilde{Z}^t(M)$  denote the reduction of  $\tilde{Z}(M)$  modulo looped diagrams, that is, diagrams with a non-contractible connected component. See Figure 2.13 (c) for an example of a looped diagram. This way,  $\tilde{Z}^t(M)$  consists only of tree-like Jacobi diagrams. The first step to relate the alternative Johnson homomorphisms with the LMO functor is given in Theorem 6.5 where we prove the following.

**Theorem 6.** *The alternative degree induces a filtration  $\{\mathcal{F}_m^{\mathfrak{a}}\mathcal{C}\}_{m \geq 1}$  of  $\mathcal{C}$  by submonoids. Consider the map*

$$\tilde{Z}_m^{Y,\mathfrak{a}} : \mathcal{F}_m^{\mathfrak{a}}\mathcal{C} \longrightarrow \mathcal{T}_m^{Y,\mathfrak{a}}(B \oplus A),$$

where  $\tilde{Z}_m^{Y,\mathfrak{a}}(M)$  (for  $M \in \mathcal{F}_m^{\mathfrak{a}}\mathcal{C}$ ) is defined as the terms in  $\tilde{Z}^t(M)$  with at least one trivalent vertex and of  $\mathfrak{a}\text{-deg} = m$ . Then  $\tilde{Z}_m^{Y,\mathfrak{a}}$  is a monoid homomorphism.

In Theorem 6.14 and Theorem 6.16 we prove the following.

**Theorem 7.** *The alternative Johnson homomorphisms can be read in the tree-reduction of the LMO functor.*

More precisely, we prove that for  $h \in J_m^{\mathfrak{a}}\mathcal{M}$  with  $m \geq 2$ , the value  $\tilde{Z}_m^{Y,\mathfrak{a}}(c(h))$  coincides with the diagrammatic version of  $\tau_m^{\mathfrak{a}}(h)$ . For  $h \in J_1^{\mathfrak{a}}\mathcal{M}$ , we show that  $\tau_1^{\mathfrak{a}}(h)$  is given by  $\tilde{Z}_1^{Y,\mathfrak{a}}(c(h))$  together with the diagrams without trivalent vertices in  $\tilde{Z}(c(h))$  of  $\mathfrak{a}\text{-deg} = 1$ . The strategies for the proof in the case  $m = 1$  (Theorem 6.14) and  $m \geq 2$  (Theorem 6.16) are different. For  $m = 1$  we need to

do some explicit computations of the LMO functor and a comparison between the first alternative Johnson homomorphism and the first Johnson homomorphism. For  $m \geq 2$ , the key point is the fact that the LMO functor defines an *alternative symplectic expansion* of  $\pi$ . To show this, we use a result of Massuyeau [47] where he proves that the LMO functor defines a symplectic expansion of  $\pi$ .

Theorem 6 and Theorem 7 provide a new reading grid of the tree reduction of the LMO functor by the alternative degree. Notice that Theorem 6 holds in the context of homology cobordisms, as do the results that we use to prove Theorem 7. This suggests that the alternative Johnson homomorphisms and Theorem 7 could be generalized to the setting of homology cobordisms, but we have not explored this issue so far.

### 2.3 Contents of this manuscript

This dissertation consists of the following two prepublications:

1. *Johnson-Levine homomorphisms and the tree reduction of the LMO functor.*  
arXiv : 1712.00073, 2017.
2. *Alternative versions of the Johnson homomorphisms and the LMO functor.*  
arXiv : 1902.10012, 2019.

Each one of these two parts can be read independently and each one has a more detailed introduction. In particular, theorems 4 and 5 are proved in the first part and theorems 1, 2, 3, 6 and 7 are proved in the second part.

---





# Chapter 1

## Johnson-Levine homomorphisms and the tree reduction of the LMO functor

**Abstract.** Let  $\mathcal{M}$  denote the mapping class group of  $\Sigma$ , a compact connected oriented surface with one boundary component. The action of  $\mathcal{M}$  on the nilpotent quotients of  $\pi_1(\Sigma)$  allows to define the so-called Johnson filtration and the Johnson homomorphisms. J. Levine introduced a new filtration of  $\mathcal{M}$ , called the *Lagrangian filtration*. He also introduced a version of the Johnson homomorphisms for this new filtration. The first term of the Lagrangian filtration is the *Lagrangian mapping class group*, whose definition involves a handlebody bounded by  $\Sigma$ , and which contains the Torelli group. These constructions extend in a natural way to the monoid of homology cobordisms. Besides, D. Chepcea, K. Habiro and G. Massuyeau constructed a functorial extension of the LMO invariant, called the LMO functor, which takes values in a category of diagrams. In this paper we give a topological interpretation of the *upper part* of the tree reduction of the LMO functor in terms of the homomorphisms defined by J. Levine for the Lagrangian mapping class group. We also compare the Johnson filtration with the filtration introduced by J. Levine.

### 1 Introduction

Let  $\Sigma$  be a compact connected oriented surface with one boundary component and let  $\mathcal{M}$  denote the mapping class group of  $\Sigma$ . The interaction between the study of 3-manifolds and that of the mapping class group is well known. In some sense, the algebraic structure of  $\mathcal{M}$  and of its subgroups is reflected in the topology of 3-manifolds. For instance, the subgroup of homeomorphisms acting trivially in homology, known as the *Torelli group* and denoted by  $\mathcal{I}$ , is tied to homology 3-spheres. In this direction, D. Johnson [32] and S. Morita [51] studied the mapping class group by using its action on the nilpotent quotients of the fundamental group of  $\Sigma$ . This action allows to define the Johnson filtration of  $\mathcal{M}$ ; the  $k$ -th term  $J_k\mathcal{M}$  of this filtration consists of the elements in  $\mathcal{M}$  acting trivially on the  $k$ -th nilpotent quotient of  $\pi_1(\Sigma)$ . On the Johnson filtration it is possible to define the Johnson homomorphisms which play an important role in the structure of the Torelli group. For instance, the first Johnson homomorphism appears in the computation of the abelianization of  $\mathcal{I}$  [34]. S. Morita also discovered the strong relation between the structure of the Torelli group and some properties of the Casson invariant of homology 3-spheres [49, 50, 52]. The Johnson homomorphisms take values in a Lie subalgebra of the derivation Lie algebra of a free Lie algebra constructed from the first homology group of  $\Sigma$ ; this Lie subalgebra admits a diagrammatic description in terms of *tree-like Jacobi diagrams*.

The Johnson filtration and the Johnson homomorphisms generalize in a natural way to the monoid of *homology cobordisms*  $\mathcal{C}$  of  $\Sigma$ , that is, homeomorphism classes of pairs  $(M, m)$ , where  $M$  is a compact oriented 3-manifold and  $m : \partial(\Sigma \times [-1, 1]) \rightarrow \partial M$  is an orientation-preserving homeomorphism such that the *top* and *bottom* restrictions of  $m$  induce isomorphisms in homology [16]. In particular, the mapping class group of  $\Sigma$  embeds into the monoid of homology cobordisms by associating to

each  $h \in \mathcal{M}$  the cobordism  $(\Sigma \times [-1, 1], m^h)$  where  $m^h$  is the orientation-preserving homeomorphism defined on the top surface  $\Sigma \times \{1\}$  by  $h$  and the identity elsewhere. Under this embedding, the Torelli group is mapped into the monoid of homology cobordisms  $(M, m)$  such that the top and bottom restrictions of  $m$  induce the *same* isomorphisms in homology. This class of cobordisms is denoted by  $\mathcal{IC}$  and they are called *homology cylinders*.

On the other hand, T. Le, J. Murakami and T. Ohtsuki defined in [38] a universal finite type invariant for homology 3-spheres called the *LMO invariant*. This invariant was extended by D. Cheptea, K. Habiro and G. Massuyeau in [8] to a functor  $\tilde{Z} : \mathcal{LCob}_q \rightarrow {}^{ts}\mathcal{A}$ , called the *LMO functor*, from a category of cobordisms (with a homological condition) between bordered surfaces to a category of Jacobi diagrams. In particular, the monoid of homology cylinders  $\mathcal{IC}$  is a subset of morphisms in  $\mathcal{LCob}_q$ . The construction of the LMO functor is sophisticated: it uses the *Kontsevich integral*, which requires the choice of a *Drinfeld associator*, and it also uses several combinatorial operations in the space of Jacobi diagrams. In consequence, it is not clear which topological information is encoded by the LMO functor.

In [24], N. Habegger and G. Masbaum gave a topological interpretation of the tree reduction of the Kontsevich integral in terms of Milnor invariants. Following the same spirit, D. Cheptea, K. Habiro and G. Massuyeau gave in [8] a topological interpretation of the leading term of the tree reduction of the LMO functor in terms of the first non-vanishing Johnson homomorphism. This was improved by G. Massuyeau in [47], where he gave an interpretation of the full tree reduction of the LMO functor on  $\mathcal{IC}$ .

In [43, 46], J. Levine introduced a different filtration of the mapping class group as follows. Let  $V$  be a handlebody of genus  $g$  and fix a disk  $D$  on the boundary of  $V$  so that  $\partial V = \Sigma \cup D$ , where  $D$  and  $\Sigma$  are glued along their boundaries. Denote by  $\iota$  the inclusion of  $\Sigma$  into  $\partial V \subseteq V$ . Let us denote by  $A$  and  $\mathbb{A}$  the subgroups  $\ker(H_1(\Sigma) \xrightarrow{\iota_*} H_1(V))$  and  $\ker(\pi_1(\Sigma) \xrightarrow{\iota_\#} \pi_1(V))$ , respectively (we use the subscripts  $*$  and  $\#$  to indicate the induced maps in homology and homotopy, respectively). The *Lagrangian mapping class group* of  $\Sigma$ , denoted by  $\mathcal{L}$ , consists of the elements in  $\mathcal{M}$  preserving the subgroup  $A$ . The *strongly Lagrangian mapping class group* of  $\Sigma$ , denoted by  $\mathcal{IL}$ , consists of the elements in  $\mathcal{L}$  which are the identity on  $A$ . The  $k$ -th term  $J_k^L \mathcal{M}$  of the *Lagrangian filtration* of  $\mathcal{M}$ , which we shall call here the *Johnson-Levine filtration*, consists of the elements  $h$  in  $\mathcal{IL}$  such that  $\iota_\# h_\#(\mathbb{A})$  is contained in the  $(k+1)$ -st term of the lower central series of  $\pi_1(V)$ .

J. Levine also defined a version of the Johnson homomorphisms for this filtration, that we shall call here the *Johnson-Levine homomorphisms*, which take values in an abelian group that can be described in terms of  $H_1(V)$ . This abelian group also admits a diagrammatic description in terms of tree-like Jacobi diagrams. One of J. Levine's main motivations was to understand the relation between the Johnson-Levine homomorphisms and finite type invariants of homology spheres. The first Johnson-Levine homomorphism comes up in the computation of the abelianization of  $\mathcal{IL}$ , found by T. Sakasai in [61]. It also appears in the work of N. Broaddus, B. Farb and A. Putman [7] to compute the distortion of  $\mathcal{IL}$  as a subgroup of  $\mathcal{M}$ .

The Johnson-Levine filtration and the Johnson-Levine homomorphisms generalize in a natural way to the monoid of homology cobordisms. Thus, it is natural to wonder about the relation of these homomorphisms with the LMO functor. The aim of this paper is to make explicit this relation. The main result is a topological interpretation of the leading term in the *upper part* of the tree reduction of the LMO functor in terms of the first non-vanishing Johnson-Levine homomorphism. This sheds some new light on the topological information encoded by the LMO functor. One key point in the proof of this result is to compare the Johnson filtration and the Johnson-Levine filtration. This comparison was already carried out by J. Levine in degrees 1 and 2 for the mapping class group in [46]. In this direction, a second main result of this paper is a comparison of the two filtrations in all degrees for homology cobordisms up to some surgery equivalence relations. These equivalence relations were introduced independently by M. Goussarov in [18, 19] and by K. Habiro in [26] in connection with the theory of finite type invariants.

The organization of the paper is as follows. In Section 2 we review the definitions of the Johnson filtration and Johnson homomorphisms in the mapping class group case, as well as in the case of

homology cobordisms. We also explain the bottom-top tangle presentation of homology cobordisms, which is a way to present homology cobordisms by using a kind of knotted objects. Finally, in this section, we review the Milnor-Johnson correspondence which relates the Milnor invariants with the Johnson homomorphisms. Section 3 deals with the Johnson-Levine filtration and Johnson-Levine homomorphisms in the mapping class group case, as well as in the case of homology cobordisms. Section 4 provides a detailed exposition of important properties of the Johnson-Levine homomorphisms, and a comparison of the Johnson filtration with the Johnson-Levine filtration. Finally, Section 5 is devoted to the topological interpretation of the upper part of the tree reduction of the LMO functor.

**Notation.** For a group  $G$ , the *lower central series* is the descending chain of subgroups  $\{\Gamma_k G\}_{k \geq 1}$  defined by  $\Gamma_1 G := G$  and  $\Gamma_{k+1} G := [G, \Gamma_k G]$ . If  $x \in G$  we denote the *nilpotent* class of  $x$  in  $G/\Gamma_k G$  interchangeably by  $\{x\}_k$  or  $x\Gamma_k G$ . If  $f : (X, x) \rightarrow (Y, y)$  is a continuous map between two pointed topological spaces  $(X, x)$  and  $(Y, y)$ , we denote by  $f_{\#} : \pi_1(X, x) \rightarrow \pi_1(Y, y)$  and  $f_* : H_1(X; \mathbb{Z}) \rightarrow H_1(Y; \mathbb{Z})$  the induced maps in homotopy and homology, respectively. Finally, when we draw framed knotted objects we use the blackboard framing convention.

**Acknowledgements.** I am deeply grateful to my advisor Gwénaél Massuyeau for his encouragement, helpful advice and careful reading.

## 2 Johnson homomorphisms

For every non-negative integer  $g$  denote by  $\Sigma$  (or by  $\Sigma_{g,1}$  if there is ambiguity) a compact connected oriented surface of genus  $g$  with one boundary component. Let us fix a base point  $*$   $\in \partial\Sigma$  and set  $\pi := \pi_1(\Sigma, *)$  and  $H := H_1(\Sigma; \mathbb{Z})$ .

### 2.1 Mapping class group

Denote by  $\mathcal{M}$  (or by  $\mathcal{M}_{g,1}$  if there is ambiguity) the *mapping class group* of  $\Sigma$ , that is, the group of isotopy classes of orientation-preserving diffeomorphisms of  $\Sigma$  fixing  $\partial\Sigma$  point-wise. The isotopy class of  $h$  in  $\mathcal{M}$  is still denoted by  $h$ . The *Dehn-Nielsen-Baer representation* is the injective group homomorphism

$$\rho : \mathcal{M} \longrightarrow \text{Aut}(\pi),$$

that maps the isotopy class  $h \in \mathcal{M}$  to the induced map in homotopy  $h_{\#} \in \text{Aut}(\pi)$ .

Consider the lower central series  $\{\Gamma_k \pi\}_{k \geq 1}$  of  $\pi$ . The *nilpotent version* of the Dehn-Nielsen-Baer representation,  $\rho_k : \mathcal{M} \rightarrow \text{Aut}(\pi/\Gamma_{k+1}\pi)$ , is defined as the composition

$$\mathcal{M} \xrightarrow{\rho} \text{Aut}(\pi) \longrightarrow \text{Aut}(\pi/\Gamma_{k+1}\pi). \quad (2.1)$$

The *Johnson filtration* is the descending chain of subgroups  $\{J_k \mathcal{M}\}_{k \geq 1}$  of  $\mathcal{M}$  where  $J_k \mathcal{M}$  is the kernel of  $\rho_k$ . In particular,  $J_1 \mathcal{M}$  is the set of elements in  $\mathcal{M}$  acting trivially in homology. This subgroup is denoted by  $\mathcal{I}$  (or  $\mathcal{I}_{g,1}$ ) and it is called the *Torelli group*.

Associated to the Johnson filtration, there is a family of group homomorphisms called the *Johnson homomorphisms*. These homomorphisms are of great importance in the study of the structure of the mapping class group and its subgroups. They were introduced by D. Johnson in [30, 32] and extensively studied by S. Morita in [50, 51]. We refer to [62] for a survey on this subject.

For every positive integer  $k$ , the  $k$ -th *Johnson homomorphism*

$$\tau_k : J_k \mathcal{M} \longrightarrow \text{Hom}(H, \Gamma_{k+1}\pi/\Gamma_{k+2}\pi) \cong H^* \otimes \Gamma_{k+1}\pi/\Gamma_{k+2}\pi \cong H \otimes \mathfrak{L}_{k+1}(H), \quad (2.2)$$

is defined by sending the isotopy class  $h \in J_k \mathcal{M}$  to the map

$$\{x\}_2 \longmapsto \rho_{k+1}(h)(\{x\})\{x\}_{k+1}^{-1} \in \frac{\Gamma_{k+1}\pi}{\Gamma_{k+2}\pi},$$

for all  $x \in \pi$ . The second isomorphism in (2.2) is given by the identification  $H \xrightarrow{\sim} H^*$  that maps  $x$  to  $\omega(x, \cdot)$  where  $\omega : H \otimes H \rightarrow \mathbb{Z}$  is the *intersection form*, together with the identification of  $\Gamma_{k+1}\pi/\Gamma_{k+2}\pi$  with the term of degree  $k+1$  in the *free Lie algebra*

$$\mathfrak{L}(H) = \bigoplus_{k \geq 1} \mathfrak{L}_k(H)$$

generated by the  $\mathbb{Z}$ -module  $H$ . Moreover, S. Morita proved in [51, Corollary 3.2] that the  $k$ -th Johnson homomorphism takes values in the kernel  $D_k(H)$  of the Lie bracket  $[\cdot, \cdot] : H \otimes \mathfrak{L}_{k+1}(H) \rightarrow \mathfrak{L}_{k+2}(H)$ .

## 2.2 Homology cobordisms and bottom-top tangles

In this subsection we recall from [8] the definition of the monoid of homology cobordisms and their presentation by bottom-top tangles, that is, a presentation by a special kind of knotted objects. The bottom-top tangle presentation is also used in the definition of the LMO functor as we will see in Section 5.

The notion of homology cobordism was introduced independently by M. Goussarov in [19] and by K. Habiro in [26] in connection with the theory of finite type invariants. A *homology cobordism* of  $\Sigma$  is the equivalence class of a pair  $M = (M, m)$ , where  $M$  is a compact connected oriented 3-manifold and  $m : \partial(\Sigma \times [-1, 1]) \rightarrow \partial M$  is an orientation-preserving homeomorphism, such that the *bottom* and *top* inclusions  $m_{\pm}(\cdot) := m(\cdot, \pm 1) : \Sigma \rightarrow M$  induce isomorphisms in homology. Two pairs  $(M, m)$  and  $(M', m')$  are *equivalent* if there exists an orientation-preserving homeomorphism  $\varphi : M \rightarrow M'$  such that  $\varphi \circ m = m'$ .

The *composition*  $(M, m) \circ (M', m')$  of two homology cobordisms  $(M, m)$  and  $(M', m')$  of  $\Sigma$  is the equivalence class of the pair  $(\bar{M}, m_- \cup m'_+)$ , where  $\bar{M}$  is obtained by gluing the two 3-manifolds  $M$  and  $M'$  by using the map  $m_+ \circ (m'_-)^{-1}$ . This composition is associative and has as identity element the equivalence class of the trivial cobordism  $(\Sigma \times [-1, 1], \text{Id})$ . Let us denote by  $\mathcal{C}$  (or by  $\mathcal{C}_{g,1}$  if there is ambiguity) the *monoid of homology cobordisms* of  $\Sigma$ .

**Example 2.1.** The mapping class group  $\mathcal{M}$  can be embedded into  $\mathcal{C}$  by associating to any  $h \in \mathcal{M}$  the equivalence class of the pair  $(\Sigma \times [-1, 1], m^h)$ , where  $m^h : \partial(\Sigma \times [-1, 1]) \rightarrow \partial(\Sigma \times [-1, 1])$  is the orientation-preserving homeomorphism defined by  $m^h(x, 1) = (h(x), 1)$  and  $m^h(x, t) = (x, t)$  for  $t \neq 1$ . The submonoid obtained in this way is precisely the group of invertible elements of  $\mathcal{C}$ , see [27, Proposition 2.4].

Let us now turn to the definition of bottom-top tangles. Consider the square  $[-1, 1]^2$ . For all  $g \geq 1$ , fix  $g$  pairs of different points  $(p_1, q_1), \dots, (p_g, q_g)$  in  $[-1, 1]^2$  distributed uniformly along the horizontal axis  $\{(x, 0) \mid x \in [-1, 1]\}$ , see Figure 2.1(a). A *bottom-top tangle* of type  $(g, g)$  is an equivalence class of pairs  $(B, \gamma)$ , where  $B = (B, b)$  consists of a compact connected oriented 3-manifold  $B$  and an orientation-preserving homeomorphism  $b : \partial([-1, 1]^3) \rightarrow \partial B$ ; and  $\gamma = (\gamma^+, \gamma^-)$  is a framed oriented tangle with  $g$  top components  $\gamma_1^+, \dots, \gamma_g^+$  and  $g$  bottom components  $\gamma_1^-, \dots, \gamma_g^-$  such that

- each  $\gamma_j^+$  runs from  $p_j \times 1$  to  $q_j \times 1$ ,
- each  $\gamma_j^-$  runs from  $q_j \times (-1)$  to  $p_j \times (-1)$ .

Two such pairs  $(B, \gamma)$  and  $(B', \gamma')$  are *equivalent* if there is an orientation-preserving homeomorphism  $\varphi : B \rightarrow B'$  such that  $\varphi \circ b = b'$  and  $\varphi(\gamma) = \gamma'$ . See Figure 2.1(b) for an example.

Let  $(M, m)$  be a homology cobordism of  $\Sigma_{g,1}$ . We associate a bottom-top tangle of type  $(g, g)$  to  $(M, m)$  as follows. Let us fix a system of meridians and parallels  $\{\alpha_1, \dots, \alpha_g, \beta_1, \dots, \beta_g\}$  of  $\Sigma_{g,1}$  as in Figure 2.2.

Then attach  $g$  2-handles on the bottom surface of  $M$  by sending the cores of the 2-handles to the curves  $m_-(\alpha_i)$ . In the same way, attach  $g$  2-handles on the top surface of  $M$  by sending the cores to the curves  $m_+(\beta_i)$ . This way we obtain a compact connected oriented 3-manifold  $B$  and an orientation-preserving homeomorphism  $b : \partial([-1, 1]^3) \rightarrow \partial B$ . The pair  $B = (B, b)$  together with the cocores

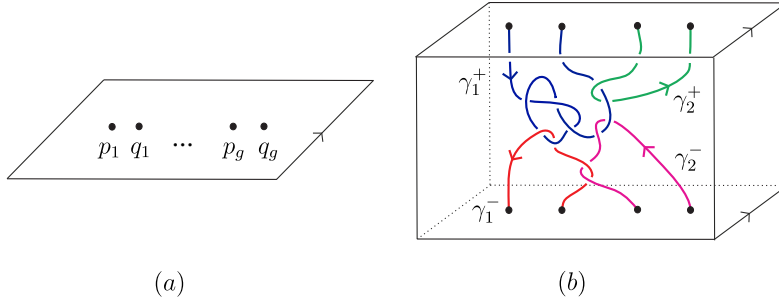


Figure 2.1: (b) bottom-top tangle of type  $(2, 2)$  in  $[-1, 1]^3$ .

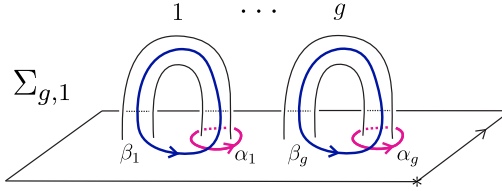


Figure 2.2: System of meridians and parallels.

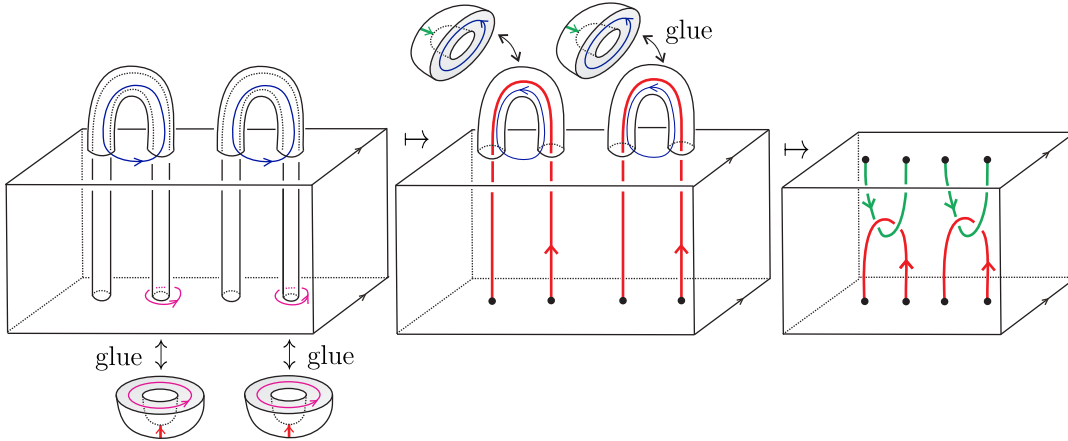


Figure 2.3: From homology cobordisms to bottom-top tangles.

of the 2-handles, determine a bottom-top tangle  $(B, \gamma)$  of type  $(g, g)$ . We call  $(B, \gamma)$  the *bottom-top tangle presentation* of  $(M, m)$ . See Figure 2.3 for an example.

We emphasize that the bottom-top tangle presentation of homology cobordisms depends on the choice of a system of meridians and parallels of  $\Sigma$ . From now on, when we say “the bottom-top tangle presentation” of a homology cobordism we mean the bottom-top tangle presentation associated to the choice of meridians and parallels of  $\Sigma$  as in Figure 2.2.

We are mainly interested in bottom-top tangles in homology cubes. A *homology cube* is a homology cobordism of  $\Sigma_{0,1}$ . In particular, if  $(B, b)$  is such a cobordism we have  $H_*(B; \mathbb{Z}) \cong H_*([-1, 1]^3; \mathbb{Z})$ .

**Definition 2.2.** Let  $(B, \gamma)$  be a bottom-top tangle of type  $(g, g)$  with  $B$  a homology cube. Let us label its connected components by  $\{1^+, \dots, g^+\} \cup \{1^-, \dots, g^-\} =: [g]^+ \cup [g]^-$ , where the label  $k^\pm$  is assigned to the component  $\gamma_k^\pm$ . The *linking matrix* of  $(B, \gamma)$  is the matrix, with rows and columns indexed by  $[g]^+ \cup [g]^-$ , defined by

$$\text{Lk}_B(\gamma) := \text{Lk}_{\hat{B}}(\hat{\gamma}), \quad (2.3)$$

where  $\hat{B}$  is the homology sphere  $B \cup_b (\mathbb{S}^3 \setminus [-1, 1]^3)$  and  $\hat{\gamma}$  is the framed oriented link in  $\hat{B}$  whose component  $\hat{\gamma}_j^\pm$  is obtained from  $\gamma_j^\pm$  by connecting  $p_j \times (\pm 1)$  with  $q_j \times (\pm 1)$  with a small arc, and  $\text{Lk}_{\hat{B}}(\hat{\gamma})$  denotes the usual linking matrix of  $\hat{\gamma}$  in the homology sphere  $\hat{B}$ .

Let  $(M, m) \in \mathcal{C}$  and let  $(B, \gamma)$  be its bottom-top tangle presentation. If  $B$  is a homology cube, we define the linking matrix  $\text{Lk}(M)$  of  $(M, m)$  as the linking matrix of its bottom-top tangle presentation.

### 2.3 Johnson homomorphisms for homology cobordisms

The Johnson filtration and the Johnson homomorphisms of  $\mathcal{M}$  extend in a natural way to the monoid of homology cobordisms, see [16]. Given  $M = (M, m)$  in  $\mathcal{C}$ , since  $m_+$  and  $m_-$  induce isomorphisms in homology in all degrees, by Stallings' theorem [63, Theorem 3.4], the maps  $m_{\pm,*} : \pi/\Gamma_k\pi \rightarrow \pi_1(M, *)/\Gamma_k\pi_1(M, *)$  are isomorphisms for all  $k \geq 2$ . Hence, the nilpotent version of the Dehn-Nielsen-Baer representation of the mapping class group can be extended to  $\mathcal{C}$ . For every positive integer  $k$  define

$$\rho_k : \mathcal{C} \longrightarrow \text{Aut}(\pi/\Gamma_{k+1}\pi), \quad (2.4)$$

by sending  $(M, m) \in \mathcal{C}$  to the automorphism  $m_{-,*}^{-1} \circ m_{+,*}$ .

The *Johnson filtration*  $\{J_k\mathcal{C}\}_{k \geq 1}$  of  $\mathcal{C}$  is the descending chain of submonoids

$$\mathcal{C} \supseteq J_1\mathcal{C} \supseteq J_2\mathcal{C} \supseteq \cdots \supseteq J_k\mathcal{C} \supseteq J_{k+1}\mathcal{C} \supseteq \cdots$$

where  $J_k\mathcal{C} := \ker(\rho_k)$  for all  $k \geq 1$ . The submonoid  $J_1\mathcal{C}$  is denoted by  $\mathcal{IC}$  and it is called the *monoid of homology cylinders*. Notice that under the embedding described in Example 2.1, the Torelli group  $\mathcal{I}$  is mapped into  $\mathcal{IC}$ . Let  $M = (M, m) \in \mathcal{C}_{g,1}$  and  $(B, \gamma)$  be its bottom-tangle presentation. We have that  $M$  belongs to  $\mathcal{IC}$  if and only if  $B$  is a homology cube and  $\text{Lk}(M) = \begin{pmatrix} 0 & \text{Id}_g \\ \text{Id}_g & 0 \end{pmatrix}$ , see Lemma 3.7.

For  $k \geq 1$  the  $k$ -th *Johnson homomorphism* for homology cobordisms

$$\tau_k : J_k\mathcal{C} \longrightarrow H \otimes \mathfrak{L}_{k+1}(H), \quad (2.5)$$

is defined as in the mapping class group case. In this case we also have that  $\tau_k$  takes values in  $D_k(H)$ . We refer to [16] for further details.

It was shown by S. Morita that the Johnson homomorphism  $\tau_k : J_k\mathcal{M} \rightarrow D_k(H)$  is not surjective in general (see [51, Section 6]). The situation changes if we enlarge the mapping class group to the monoid of homology cobordisms. S. Garoufalidis and J. Levine proved in [16, Theorem 3, Proposition 2.5] the following.

**Theorem 2.3** (S. Garoufalidis, J. Levine). *For every positive integer  $k$ , the  $k$ -th Johnson homomorphism  $\tau_k : J_k\mathcal{C} \rightarrow D_k(H)$  is surjective.*

Their proof uses obstruction theory and surgery techniques. N. Habegger gave in [21] a different proof of this theorem based on the surjectivity of Milnor invariants. We shall recall his proof in the next subsection, since it will be useful to us later.

### 2.4 Milnor invariants and the Milnor-Johnson correspondence

In this subsection we recall the Milnor invariants for string links and the Milnor-Johnson correspondence, which relates the Johnson homomorphisms with the Milnor invariants. We refer to [22, 23] for more details about Milnor invariants and to [21, 8] for more details about the Milnor-Johnson correspondence.

#### String links and Milnor invariants

We start by introducing the definition of a string link in a homology cube. Denote by  $D_l$  the surface  $\Sigma_{0,1}$  together with  $l$  fixed different points  $p_1, \dots, p_l$  distributed uniformly along the horizontal axis  $\{(x, 0) \mid x \in [-1, 1]\}$ , see Figure 2.4(a). A *string link on  $l$  strands* is an equivalence class of pairs  $(B, \sigma)$ , where  $B = (B, b)$  is a homology cube and  $\sigma = (\sigma^1, \dots, \sigma^l) : [-1, 1]^l \rightarrow B$  is an oriented framed embedding such that  $\sigma^i(\pm 1) = b(p_i, \pm 1)$ , see Figure 2.4(b). Two pairs  $(B, \sigma)$  and  $(B', \sigma')$  are *equivalent* if there exists an equivalence of homology cobordisms sending  $\sigma$  to  $\sigma'$ .

The *linking matrix* of a string link  $(B, \sigma)$  on  $l$  strands is the matrix, with rows and columns indexed by the components of  $\sigma$ , defined by

$$\text{Lk}_B(\sigma) := \text{Lk}_{\hat{B}}(\hat{\sigma}),$$

where  $\hat{B}$  is the homology sphere  $B \cup_b (\mathbb{S}^3 \setminus [-1, 1]^3)$  and  $\hat{\sigma}$  is the *braid closure* of  $\sigma$ , see Figure 2.4(c).

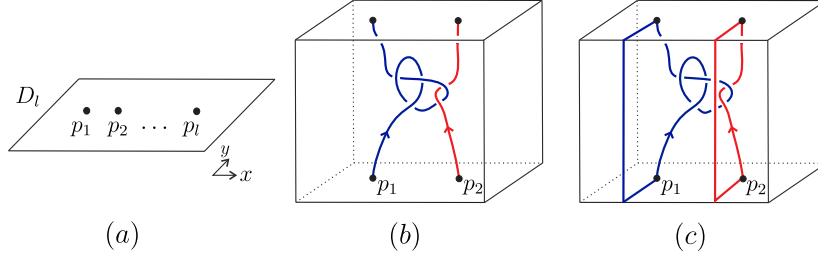


Figure 2.4: (a)  $D_l$ , (b) a string link  $\sigma$  on 2 strands in  $[-1, 1]^2 \times [-1, 1]$  and (c) braid closure of  $\sigma$ .

By using the composition of homology cobordisms we can compose string links on  $l$  strands. The equivalence class of  $([-1, 1]^3, \text{Id}_l)$ , where  $\text{Id}_l$  is the trivial string link, is the identity for this composition. Denote this monoid by  $\mathcal{S}_l$ .

We now turn to the definition of the Milnor invariants. Let  $N(\{p_1, \dots, p_l\})$  be a tubular neighborhood of the fixed points in  $D_l$ . Let  $D_l^\circ$  denote  $D_l \setminus \text{int}(N(p_1, \dots, p_l))$  and denote by  $F_l$  the fundamental group  $\pi_1(D_l^\circ, *)$  where  $*$   $\in \partial D_l$ . We identify  $F_l$  with the free group on  $\{u_1, \dots, u_l\}$ , where  $u_i$  is the homotopy class of a loop encircling the  $i$ -th hole of  $D_l^\circ$  in the counterclockwise sense. Let  $(B, \sigma)$  be a string link on  $l$  strands. Set  $S := B \setminus \text{int}(N(\sigma))$ , where  $N(\sigma)$  is a tubular neighborhood of  $\sigma$ . The homeomorphism  $b : \partial([-1, 1]^3) \rightarrow \partial B$  and the framing of  $\sigma$  determine an orientation-preserving homeomorphism  $s : \partial(D_l^\circ \times [-1, 1]) \rightarrow \partial S$ . Denote by  $s_\pm : D_l^\circ \times \{\pm 1\} \rightarrow \partial S$  the top and bottom restrictions of  $s$ . Since  $B$  is a homology cube, the induced maps in homology  $s_{\pm,*} : H_*(D_l^\circ; \mathbb{Z}) \rightarrow H_*(S; \mathbb{Z})$  are isomorphisms. It follows from Stallings' theorem [63, Theorem 3.4] that  $s_{\pm,*}$  induce isomorphisms on the nilpotent quotients of the fundamental groups. Thus we can define for every positive integer  $k$ , the  $k$ -th *Artin representation* as the monoid homomorphism

$$A_k : \mathcal{S}_l \longrightarrow \text{Aut} \left( \frac{F_l}{\Gamma_{k+1} F_l} \right), \quad (2.6)$$

that sends  $(B, \sigma)$  to the automorphism  $s_{-,*}^{-1} \circ s_{+,*}$ . The *Milnor filtration* of  $\mathcal{S}_l$  is the descending chain of submonoids

$$\mathcal{S}_l = \mathcal{S}_l[1] \supseteq \mathcal{S}_l[2] \supseteq \dots \supseteq \mathcal{S}_l[k] \supseteq \mathcal{S}_l[k+1] \supseteq \dots$$

where  $\mathcal{S}_l[k] := \ker(A_k)$ . Notice that  $\mathcal{S}_l[2]$  is the submonoid of string links with trivial linking matrix.

Let  $(B, \sigma) \in \mathcal{S}_l[k]$  and let  $\lambda_i$  be the  $i$ -th longitude determined by the framing of the component  $\sigma^i$ . Since  $(B, \sigma) \in \mathcal{S}_l[k]$ , the homotopy class of the loop determined by  $\lambda_i$  becomes trivial in  $\pi_1(S)/\Gamma_k \pi_1(S)$ . Therefore we can define the monoid homomorphism

$$\mu_k : \mathcal{S}_l[k] \longrightarrow \frac{F_l}{\Gamma_2 F_l} \otimes \frac{\Gamma_k F_l}{\Gamma_{k+1} F_l}$$

by the formula

$$\mu_k(B, \sigma) = \sum_{i=1}^l u_i \otimes s_{-,*}^{-1}(\lambda_i). \quad (2.7)$$

Let us identify  $F_l/\Gamma_2 F_l$  with  $\tilde{H} := H_1(D_l^\circ; \mathbb{Z})$  and  $(\Gamma_k F_l)/(\Gamma_{k+1} F_l)$  with the  $k$ -th term  $\mathfrak{L}_k(\tilde{H})$  of the free Lie algebra generated by  $\tilde{H}$ . The fact that the Artin representation fixes the homotopy class of  $\partial D_l$  implies that  $\mu_k$  takes values in the kernel  $D_{k-1}(\tilde{H})$  of the Lie bracket  $[\cdot, \cdot] : \tilde{H} \otimes \mathfrak{L}_k(\tilde{H}) \rightarrow \mathfrak{L}_{k+1}(\tilde{H})$ . From the above discussion, for all  $k \geq 2$  we can write

$$\mu_k : \mathcal{S}_l[k] \longrightarrow D_{k-1}(\tilde{H}). \quad (2.8)$$



The monoid homomorphism  $\mu_k$  is called the  $k$ -th *Milnor map*. Notice that  $\ker(\mu_k) = \mathcal{S}_l[k+1]$ . In [23, Section 1] N. Habegger and X. Lin proved that for all  $k \geq 1$  the  $k$ -th Milnor map  $\mu_k$  is surjective. The idea of their proof was adapted from the work of K. Orr in [57], where he studied which Milnor invariants are realizable. There is a more geometric approach to the realizability of Milnor invariants developed by T. Cochran in [12, 13], which we will need and sketch briefly in subsection 4.4.

### The Milnor-Johnson correspondence

In [21], N. Habegger defined a bijection between homology cylinders and string links with trivial linking matrix. We follow the construction in [8] which can be described schematically as follows:

$$\text{homology cylinder} \rightsquigarrow \text{bottom-top tangle} \rightsquigarrow \text{string link.} \quad (2.9)$$

More precisely, let  $(M, m)$  be a homology cylinder over  $\Sigma_{g,1}$  and consider its bottom-top tangle presentation. Next, from a bottom-top tangle of type  $(g, g)$  we can obtain a string on  $2g$  strands by the method illustrated in Figure 2.5.

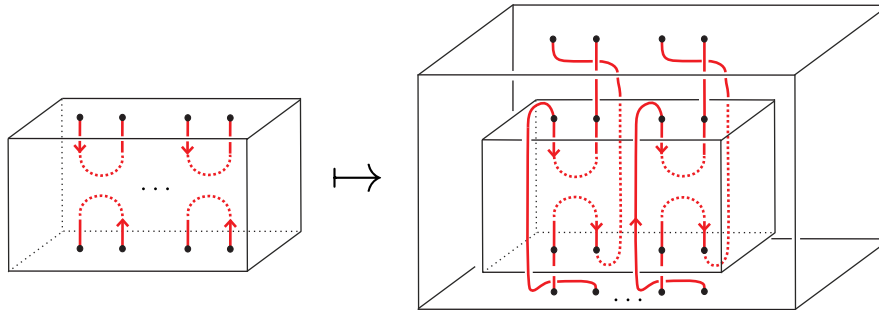


Figure 2.5: From bottom-top tangles to string links.

In this way we transform a homology cylinder  $(M, m) \in \mathcal{IC}_{g,1}$  into a string link  $\text{MJ}(M) \in \mathcal{S}_{2g}$ . N. Habegger proved in [21] that MJ defines a bijection between  $\mathcal{IC}_{g,1}$  and the submonoid  $\mathcal{S}_{2g}[2]$  of string links with trivial linking matrix. Moreover, for all  $k \geq 1$  the following diagram is commutative (see [8, Claim 8.16]).

$$\begin{array}{ccc} J_k \mathcal{C}_{g,1} & \xrightarrow[\cong]{\text{MJ}} & \mathcal{S}_{2g}[k+1] \\ \tau_k \downarrow & & \downarrow \mu_{k+1} \\ D_k(H) & \xrightarrow[\cong]{} & D_k(\tilde{H}), \end{array} \quad (2.10)$$

where the bottom isomorphism is induced by the identification  $\pi \cong F_{2g}$  described as follows. Consider a free basis  $\{\alpha_1, \dots, \alpha_g, \beta_1, \dots, \beta_g\}$  of  $\pi$  induced by basing at  $*$  the system of meridians and parallels in Figure 2.2. Identify  $\alpha_i$  with  $u_{2i-1}^{-1}$  and  $\beta_i$  with  $u_{2i}$ .

In this way, from the surjectivity of  $\mu_{k+1}$  and diagram (2.10), it follows that  $\tau_k : J_k \mathcal{C} \rightarrow D_k(H)$  is surjective. This is the proof of Theorem 2.3 by N. Habegger [21].

### 2.5 Diagrammatic version of the Johnson homomorphisms

In order to relate the Kontsevich integral with the Milnor invariants, N. Habegger and G. Masbaum gave in [24] a diagrammatic version of the Milnor map. This was also done for Johnson homomorphisms by S. Garoufalidis and J. Levine in [16]. Let us recall this description.

By a *tree-like Jacobi diagram* we mean a finite contractible univalent graph such that the trivalent vertices are *oriented*, that is, each set of incident edges to a trivalent vertex is endowed with a cyclic order. The *internal degree* of such a diagram is the number of trivalent vertices; we denote it by *i*-deg. Let  $C$  be a finite set. We say that a tree-like Jacobi diagram  $T$  is  $C$ -colored if there is a map from the set of univalent vertices (*legs*) of  $T$  to the free abelian group generated by  $C$ . We use dashed lines

to represent tree-like Jacobi diagrams and, when we draw them, we assume that the orientation of trivalent vertices is counterclockwise.

Consider the abelian group

$$\mathcal{T}(C) := \frac{\mathbb{Z}\{\text{C-colored tree-like Jacobi diagrams}\}}{\text{AS, IHX, } \mathbb{Z}\text{-multilinearity}},$$

where the relations AS, IHX are local and the multilinearity relation applies to the  $C$ -colored legs, see Figure 2.6.

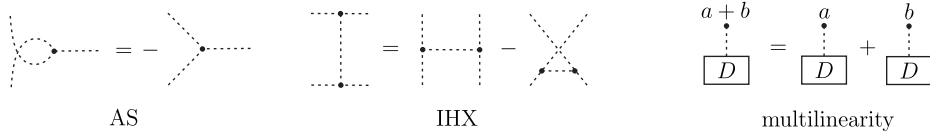


Figure 2.6: Relations in  $\mathcal{T}(C)$ . Here  $a, b \in \mathbb{Z} \cdot C$ .

Notice that  $\mathcal{T}(C)$  is graded by the internal degree: for  $k \geq 1$ ,  $\mathcal{T}_k(C)$  is the subspace of  $\mathcal{T}(C)$  generated by tree-like Jacobi diagrams of i-deg =  $k$ . We can define  $\mathcal{T}(G)$  for any finitely generated free abelian group  $G$  by  $\mathcal{T}(G) = \mathcal{T}(C)$  where  $C$  is any set of free generators of  $G$ .

Consider the abelian group  $H = H_1(\Sigma_{g,1}; \mathbb{Z})$ . We have seen that the  $k$ -th Johnson homomorphism takes values in  $D_k(H) \subseteq H \otimes \mathfrak{L}_{k+1}(H)$ . Observe that a *rooted* tree of i-deg =  $k$  with  $H$ -colored legs determines a Lie commutator in  $\mathfrak{L}_{k+1}(H)$ . Let us consider the map

$$\eta_k^{\mathbb{Z}} : \mathcal{T}_k(H) \longrightarrow D_k(H), \quad T \longmapsto \sum_v \text{color}(v) \otimes (T \text{ rooted at } v), \quad (2.11)$$

where the sum ranges over the set of univalent vertices of  $T$ , and the rooted trees are identified with Lie commutators. For instance,

$$\begin{aligned} \eta_2^{\mathbb{Z}} \left( \begin{array}{c} d \quad c \\ \diagdown \quad \diagup \\ \quad \quad \quad \\ \diagup \quad \diagdown \\ a \quad b \end{array} \right) &= a \otimes \begin{array}{c} d \quad c \\ \diagdown \quad \diagup \\ \quad \quad \quad \\ \diagup \quad \diagdown \\ \quad \quad \quad \end{array} + b \otimes \begin{array}{c} d \quad c \\ \diagdown \quad \diagup \\ \quad \quad \quad \\ \diagup \quad \diagdown \\ \quad \quad \quad \end{array} + c \otimes \begin{array}{c} b \quad a \\ \diagdown \quad \diagup \\ \quad \quad \quad \\ \diagup \quad \diagdown \\ \quad \quad \quad \end{array} + d \otimes \begin{array}{c} b \quad a \\ \diagdown \quad \diagup \\ \quad \quad \quad \\ \diagup \quad \diagdown \\ \quad \quad \quad \end{array} \\ &= a \otimes [[d, c], b] + b \otimes [a, [d, c]] + c \otimes [[b, a], d] + d \otimes [c, [b, a]]. \end{aligned}$$

Consider the rational version of  $\eta_k^{\mathbb{Z}}$ :

$$\eta_k : \mathcal{T}_k(H) \otimes \mathbb{Q} \longrightarrow D_k(H) \otimes \mathbb{Q}. \quad (2.12)$$

This map is an isomorphism, see [44, Corollary 3.2]. In this way, for  $M \in J_k \mathcal{C}_{g,1}$  we define the *diagrammatic version* of the  $k$ -th Johnson homomorphism by

$$\eta_k^{-1}(\tau_k(M)) \in \mathcal{T}_k(H) \otimes \mathbb{Q}.$$

### 3 Lagrangian version of the Johnson homomorphisms

In [43, 46], J. Levine introduced a different filtration of the mapping class group by considering a handlebody bounded by  $\Sigma$ . The induced inclusion determines a Lagrangian subgroup of the first homology group of the surface. This Lagrangian subgroup, together with the lower central series of the fundamental group of the handlebody, allow to define the new filtration.

#### 3.1 Preliminaries

Let  $V$  (or  $V_g$  if there is ambiguity) be a handlebody of genus  $g$ . Fix a disk  $D$  on the boundary of  $V$  such that  $\partial V = \Sigma \cup D$ , where  $D$  and  $\Sigma$  are glued along their boundaries. Denote by  $\iota$  the inclusion

of  $\Sigma$  into  $\partial V \subseteq V$ , see Figure 3.1. Set  $H' := H_1(V; \mathbb{Z})$  and  $\pi' := \pi_1(V, \iota(*))$ . Denote by  $A$  the kernel of the induced map  $\iota_* : H \rightarrow H'$  in homology and by  $\mathbb{A}$  the kernel of the induced map  $\iota_{\#} : \pi \rightarrow \pi'$  in homotopy. Notice that  $A$  is a *Lagrangian* subgroup of  $H$  with respect to the intersection form  $\omega : H \otimes H \rightarrow \mathbb{Z}$ .

Let us denote by  $\text{ab} : \pi \rightarrow H$  and  $\text{ab}' : \pi' \rightarrow H'$  the abelianization maps. The equality  $\iota_* \circ \text{ab} = \text{ab}' \circ \iota_{\#}$  implies that  $\text{ab}^{-1}(A) = \mathbb{A} \cdot \Gamma_2\pi$ . Thus, we have

$$A \xleftarrow[\text{ab}]{\cong} (\mathbb{A} \cdot \Gamma_2\pi) / \Gamma_2\pi \cong \mathbb{A} / (\Gamma_2\pi \cap \mathbb{A}).$$

By Hopf's formula, we obtain  $(\Gamma_2\pi \cap \mathbb{A}) / [\pi, \mathbb{A}] \cong H_2(\pi / \mathbb{A}) \cong H_2(\pi')$ , and since  $\pi'$  is a free group,  $H_2(\pi') = 0$ . Hence  $\Gamma_2\pi \cap \mathbb{A} = [\pi, \mathbb{A}]$ . To sum up, we have the short exact sequence

$$1 \longrightarrow [\pi, \mathbb{A}] \longrightarrow \mathbb{A} \xrightarrow{\text{ab}} A \longrightarrow 1. \quad (3.1)$$

Finally, let us recall the symplectic representation. Since the elements in  $\mathcal{M}$  are orientation-preserving, their induced maps on  $H$  preserve the intersection form. Therefore we have a map

$$\mathcal{M} \longrightarrow \text{Sp}(H) = \{f \in \text{Aut}(H) \mid \forall x, y \in H, \omega(f(x), f(y)) = \omega(x, y)\},$$

that sends  $h \in \mathcal{M}$  to the induced map  $h_*$  on  $H$ . We will often need to consider bases to perform some computations. On this purpose, we fix a free basis  $\{\alpha_1, \dots, \alpha_g, \beta_1, \dots, \beta_g\}$  of  $\pi$  induced by basing at  $*$  the fixed system of meridians and parallels in Figure 2.2. We also fix the symplectic basis  $\{a_1, \dots, a_g, b_1, \dots, b_g\}$  of  $H$ , induced by  $\{\alpha_1, \dots, \alpha_g, \beta_1, \dots, \beta_g\}$ . Here we assume that the curves  $\iota(\alpha_i)$ 's bound disks in  $V$ , see Figure 3.1. This way,  $\{a_1, \dots, a_g\}$  is a basis for  $A$ , and  $\{b_1 + A, \dots, b_g + A\}$  is a basis for  $H/A$ .

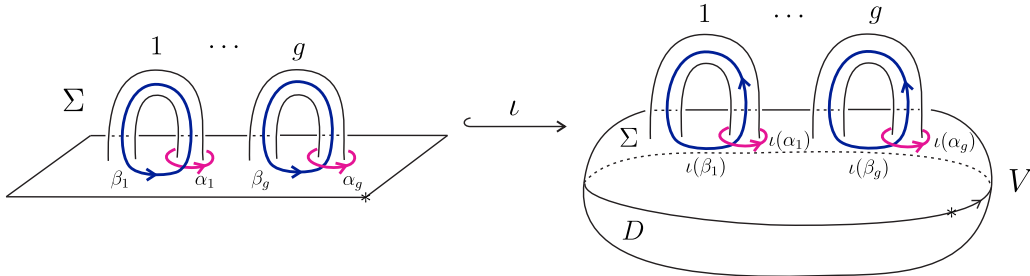


Figure 3.1: The inclusion  $\Sigma \hookrightarrow V$ .

We use the above symplectic basis of  $H$  to identify  $\text{Sp}(H)$  with the group  $\text{Sp}(2g, \mathbb{Z})$  of  $(2g) \times (2g)$  matrices  $\Lambda$  with integer entries such that  $\Lambda^T J \Lambda = J$ , where  $J$  is the standard invertible skew-symmetric matrix  $\begin{pmatrix} 0 & \text{Id}_g \\ -\text{Id}_g & 0 \end{pmatrix}$ . Denote this identification by  $\psi : \text{Sp}(H) \rightarrow \text{Sp}(2g, \mathbb{Z})$ .

### 3.2 The Lagrangian mapping class group

Let us define two important subgroups of the mapping class group associated to the Lagrangian subgroup  $A$ . Set

$$\mathcal{L} := \{f \in \mathcal{M} \mid f_*(A) \subseteq A\} \quad \text{and} \quad \mathcal{IL} := \{f \in \mathcal{L} \mid f_*|_A = \text{Id}_A\}. \quad (3.2)$$

The subgroup  $\mathcal{L}$  is called the *Lagrangian mapping class group* of  $\Sigma$ , and  $\mathcal{IL}$  is called the *strongly Lagrangian mapping class group* of  $\Sigma$ .

**Example 3.1.** The Torelli group  $\mathcal{I}$  is contained in  $\mathcal{IL}$ . Also, any Dehn twist along a meridian  $\alpha_i$  (see Figure 2.2) belongs to  $\mathcal{IL}$ . This shows that  $\mathcal{I}$  is strictly contained in  $\mathcal{IL}$ .

**Example 3.2.** Let  $g \geq 2$ . Consider the orientation-preserving homeomorphism  $h : \Sigma \rightarrow \Sigma$  that interchanges the first and second handle in Figure 2.2. This homeomorphism can be extended to the handlebody  $V$  (this extension is known in the literature as *interchanging two knobs*, see [64, Section 3] for a detailed description). We have that  $h$  belongs to  $\mathcal{L}$  but not to  $\mathcal{IL}$ , hence  $\mathcal{IL}$  is strictly contained in  $\mathcal{L}$ .

Let us give some equivalent formulations of the strongly Lagrangian mapping class group. If  $h$  belongs to  $\mathcal{L}$ , then it induces a well defined isomorphism  $\hat{h}_* : H/A \rightarrow H/A$  by sending  $x + A$  to  $h_*(x) + A$ . By means of the isomorphism  $H/A \xrightarrow{\iota_*} H'$ , we have an isomorphism  $h'_* : H' \rightarrow H'$  defined by  $h'_* := \iota_* \circ \hat{h}_* \circ \iota_*^{-1}$ .

**Lemma 3.3.** *Let  $h$  be an element in  $\mathcal{L}$ . The following assertions are equivalent:*

- (i)  $h$  belongs to  $\mathcal{IL}$ .
- (ii) The induced isomorphism  $h'_* : H' \rightarrow H'$  is the identity.
- (iii)  $\iota_* \circ h_* = \iota_*$ .

*Proof.* We use the symplectic basis  $\{a_1, \dots, a_g, b_1, \dots, b_g\}$  and the identification  $\psi : \mathrm{Sp}(H) \rightarrow \mathrm{Sp}(2g, \mathbb{Z})$  described in subsection 3.1. Let  $h \in \mathcal{L}$ , then there exist integers  $\lambda_{kj}, \delta_{kj}$  and  $\epsilon_{kj}$  such that for  $1 \leq j \leq g$ ,

$$h_*(a_j) = \sum_{k=1}^g \lambda_{kj} a_k \quad \text{and} \quad h_*(b_j) = \sum_{k=1}^g \delta_{kj} a_k + \sum_{k=1}^g \epsilon_{kj} b_k. \quad (3.3)$$

Hence  $\psi(h_*) = \begin{pmatrix} P & Q \\ 0 & R \end{pmatrix}$ , where  $P = (\lambda_{ij})$ ,  $Q = (\delta_{ij})$  and  $R = (\epsilon_{ij})$ . The symplectic condition on  $h_*$  becomes

$$P^T R = \mathrm{Id}_g \quad \text{and} \quad Q^T R = R^T Q. \quad (3.4)$$

Recall that  $\{a_1, \dots, a_g\}$  is a basis for  $A$ , and  $\{b_1 + A, \dots, b_g + A\}$  is a basis for  $H/A$ . The matrices of  $h_*|_A : A \rightarrow A$  and  $\hat{h}_* : H/A \rightarrow H/A$  in these bases are  $P$  and  $R$  respectively. The first condition in (3.4) implies that  $P = \mathrm{Id}_g$  if and only if  $R = \mathrm{Id}_g$ . Therefore we have the equivalence (i)  $\Leftrightarrow$  (ii). Now, from the definition of  $h'_*$  it follows that  $h'_* = \mathrm{Id}_{H'}$  if and only if  $\iota_* \circ \hat{h}_* = \iota_*$  on  $H/A$  if and only if  $\iota_* \circ h_* = \iota_*$  on  $H$ . Hence we have (ii)  $\Leftrightarrow$  (iii).  $\square$

We now describe the filtration introduced by J. Levine in [43, 46].

**Definition 3.4.** The *Lagrangian filtration* or *Johnson-Levine filtration*  $\{J_k^L \mathcal{M}\}_{k \geq 1}$  of  $\mathcal{M}$  is defined as

$$J_k^L \mathcal{M} := \{h \in \mathcal{M} \mid \iota_{\#} h_{\#}(\mathbb{A}) \subseteq \Gamma_{k+1} \pi', h_*|_A = \mathrm{Id}_A\}.$$

Notice that the condition  $\iota_{\#} h_{\#}(\mathbb{A}) \subseteq \Gamma_{k+1} \pi'$  implies that  $h_*(A) \subseteq A$ . Besides, J. Levine also defined and studied in [43, 46] a version of the Johnson homomorphisms for the above filtration. In order to define them, let us first identify  $H/A$  with  $A^*$  by sending  $x + A \in H/A$  to  $\omega(x, \cdot) \in A^*$ . We also identify  $H/A$  with  $H'$  via the isomorphism  $\iota_*$ .

**Proposition 3.5.** (*J. Levine*) *For every non-negative integer  $k$ , the  $k$ -th term  $J_k^L \mathcal{M}$  of the Johnson-Levine filtration is a subgroup of  $\mathcal{M}$ . Let*

$$\tau_k^L : J_k^L \mathcal{M} \rightarrow \mathrm{Hom}(A, \Gamma_{k+1} \pi' / \Gamma_{k+2} \pi') \cong A^* \otimes \Gamma_{k+1} \pi' / \Gamma_{k+2} \pi' \cong H' \otimes \mathfrak{L}_{k+1}(H'), \quad (3.5)$$

*be the map that sends  $h \in J_k^L \mathcal{M}$  to the map  $a \in A \mapsto \{\iota_{\#} h_{\#}(\alpha)\}_{k+2}$ , where  $\alpha \in \mathbb{A}$  is such that  $\mathrm{ab}(\alpha) = a$ . Then  $\tau_k^L$  is a group homomorphism which we shall call the  $k$ -th Johnson-Levine homomorphism.*

For the sake of completeness let us see the proof.

*Proof.* The argument is by induction on  $k$ . From Definition 3.4, it follows that  $J_1^L \mathcal{M} = \mathcal{I}\mathcal{L}$  which is indeed a subgroup of  $\mathcal{M}$ . Now suppose that  $J_k^L \mathcal{M}$  is a subgroup. Let us verify that  $\tau_k^L$  is well defined and it is a group homomorphism. Let  $h \in J_k^L \mathcal{M}$ ,  $a \in A$  and  $\alpha_1, \alpha_2 \in \mathbb{A}$  such that  $\text{ab}(\alpha_1) = \text{ab}(\alpha_2) = a$ . The short exact sequence (3.1) implies  $\alpha_1 \alpha_2^{-1} = [x_1, y_1] \cdots [x_n, y_n]$  with  $x_1, \dots, x_n \in \pi$  and  $y_1, \dots, y_n \in \mathbb{A}$ . Since for every  $j$ , we have that  $[\iota_{\#} h_{\#}(x_j), \iota_{\#} h_{\#}(y_j)]$  is in  $[\pi', \Gamma_{k+1} \pi'] = \Gamma_{k+2} \pi'$ , then  $\iota_{\#} h_{\#}(\alpha_1 \alpha_2^{-1})$  belongs to  $\Gamma_{k+2} \pi'$ , so  $\tau_k^L(h)$  is well defined as a map from  $A$  to  $\Gamma_{k+1} \pi' / \Gamma_{k+2} \pi'$ .

Clearly  $\tau_k^L(h)$  belongs to  $\text{Hom}(A, \Gamma_{k+1} \pi' / \Gamma_{k+2} \pi')$ . Let us see that  $\tau_k^L$  is a group homomorphism. Let  $h, \tilde{h} \in J_k^L \mathcal{M}$ ,  $a \in A$  and  $\alpha \in \mathbb{A}$  with  $\text{ab}(\alpha) = a$ . The splittable short exact sequence

$$1 \longrightarrow \mathbb{A} \longrightarrow \pi \xrightarrow{\iota_{\#}} \pi' \longrightarrow 1, \quad (3.6)$$

and the fact that  $\tilde{h} \in J_k^L \mathcal{M}$ , allow us to write  $\tilde{h}_{\#}(\alpha) = \beta y$  with  $\beta \in \mathbb{A}$  and  $y \in \Gamma_{k+1} \pi$ . Notice that  $a = \tilde{h}_*(a) = \text{ab}(\tilde{h}_{\#}(\alpha)) = \text{ab}(\beta y) = \text{ab}(\beta)$ .

On the other hand, suppose that  $y$  is a group commutator of length  $k+1$ , say in the elements  $y_1, \dots, y_{k+1} \in \pi$  (if  $y$  is a product of such commutators, the reasoning is similar). Then  $\iota_{\#}(h_{\#}(y))$  and  $\iota_{\#}(y)$  are commutators of length  $k+1$  in the elements  $\iota_{\#}(h_{\#}(y_1)), \dots, \iota_{\#}(h_{\#}(y_{k+1}))$  and  $\iota_{\#}(y_1), \dots, \iota_{\#}(y_{k+1})$  respectively. Notice that  $y$ ,  $\iota_{\#}(y)$  and  $\iota_{\#}(h_{\#}(y))$  have the same *commutator structure*, that is, they have the same bracketing structure.

Under the identification  $\Gamma_{k+1} \pi' / \Gamma_{k+2} \pi' \cong \mathfrak{L}_{k+1}(H')$ , the elements  $\iota_{\#}(h_{\#}(y)) \Gamma_{k+2} \pi'$  and  $\iota_{\#}(y) \Gamma_{k+2} \pi'$  correspond to Lie commutators, with the same structure as  $y$ , in the elements  $\text{ab}'(\iota_{\#}(h_{\#}(y_1))), \dots, \text{ab}'(\iota_{\#}(h_{\#}(y_{k+1})))$  and  $\text{ab}'(\iota_{\#}(y_1)), \dots, \text{ab}'(\iota_{\#}(y_{k+1}))$  respectively. The identity  $\iota_* \circ \text{ab} = \text{ab}' \circ \iota_{\#}$  and Lemma 3.3(iii) imply that

$$\text{ab}'(\iota_{\#} h_{\#}(y_j)) = \iota_* h_*(\text{ab}(y_j)) = \iota_*(\text{ab}(y_j)) = \text{ab}'(\iota_{\#}(y_j)),$$

thus  $\iota_{\#} h_{\#}(y) \Gamma_{k+2} \pi' = \iota_{\#}(y) \Gamma_{k+2} \pi'$ . From the above discussion, it follows that

$$\begin{aligned} \tau_k^L(h \circ \tilde{h})(a) &= \iota_{\#}(h_{\#}(\tilde{h}_{\#}(\alpha))) \Gamma_{k+2} \pi' \\ &= \iota_{\#}(h_{\#}(\beta)) \Gamma_{k+2} \pi' + \iota_{\#}(h_{\#}(y)) \Gamma_{k+2} \pi' \\ &= \tau_k^L(h)(\text{ab}(\beta)) + \iota_{\#}(h_{\#}(y)) \Gamma_{k+2} \pi' \\ &= \tau_k^L(h)(a) + \iota_{\#}(y) \Gamma_{k+2} \pi' \\ &= \tau_k^L(h)(a) + \tau_k^L(\tilde{h})(a), \end{aligned} \quad (3.7)$$

which shows that  $\tau_k^L$  is a group homomorphism. From the definition of  $\tau_k^L$  it follows that  $\ker(\tau_k^L) = J_{k+1}^L \mathcal{M}$ , and so  $J_{k+1}^L \mathcal{M}$  is a subgroup of  $\mathcal{M}$ . This completes the proof.  $\square$

A similar argument to the one used to show that  $\tau_k$  takes values in  $D_k(H)$  [51, Remark 3.3], works to show that  $\tau_k^L$  takes values in

$$D_k(H') := \ker([\ , \ ] : H' \otimes \mathfrak{L}_{k+1}(H') \longrightarrow \mathfrak{L}_{k+2}(H')). \quad (3.8)$$

This was already remarked by J. Levine [43, Proposition 4.3]. Let us recall the argument. Consider the bases fixed in subsection 3.1. Then, for  $h \in J_k^L \mathcal{M}$  the  $k$ -th Johnson-Levine homomorphism can be written

$$\tau_k^L(h) = - \sum_{j=1}^g \iota_*(b_j) \otimes \{\iota_{\#}(h_{\#}(\alpha_j))\}_{k+2} = - \sum_{j=1}^g \iota_*(h_*(b_j)) \otimes \{\iota_{\#}(h_{\#}(\alpha_j))\}_{k+2}, \quad (3.9)$$

where the second equality follows from Lemma 3.3(iii).

The Lie bracket  $[\ , \ ] : H' \otimes \mathfrak{L}_{k+1}(H') \longrightarrow \mathfrak{L}_{k+2}(H')$  corresponds to the commutator map

$$\Psi : \frac{\pi'}{\Gamma_2 \pi'} \otimes \frac{\Gamma_{k+1} \pi'}{\Gamma_{k+2} \pi'} \longrightarrow \frac{\Gamma_{k+2} \pi'}{\Gamma_{k+3} \pi'}, \quad (3.10)$$

that sends  $\{x'\}_2 \otimes \{y'\}_{k+2}$  to  $[x', y']\Gamma_{k+3}\pi'$ . Thus

$$\begin{aligned}\Psi(\tau_k^L(h)) &= \sum_{j=1}^g \Psi\left(\iota_*(h_*(-b_j)) \otimes \iota_{\#}(h_{\#}(\alpha_j))\Gamma_{k+2}\pi'\right) \\ &= \sum_{j=1}^g \Psi\left(\{\iota_{\#}h_{\#}(\beta_j^{-1})\}_2 \otimes \{\iota_{\#}h_{\#}(\alpha_j)\}_{k+2}\right) \\ &= \iota_{\#}h_{\#}\left(\prod_{j=1}^g [\beta_j^{-1}, \alpha_j]\right)\Gamma_{k+3}\pi' \\ &= \Gamma_{k+3}\pi',\end{aligned}$$

where the last equality holds because  $\prod_{j=1}^g [\beta_j^{-1}, \alpha_j]$  represents the inverse of the homotopy class of  $\partial\Sigma$  (see Figure 3.1), and this element is fixed by  $h_{\#}$ . Hence  $\tau_k^L(h) \in D_k(H')$ . To sum up, we have a descending chain of subgroups

$$\mathcal{M} \supseteq \mathcal{L} \supseteq \mathcal{IL} = J_1^L \mathcal{M} \supseteq J_2^L \mathcal{M} \supseteq \cdots \quad (3.11)$$

and a family of group homomorphisms

$$\tau_k^L : J_k^L \mathcal{M} \rightarrow D_k(H'). \quad (3.12)$$

**Remark 3.6.** Let  $\mathcal{H}$  (or  $\mathcal{H}_{g,1}$ ) be the subgroup of  $\mathcal{M}$  consisting of the elements that can be extended to the handlebody  $V$ . The subgroup  $\mathcal{H}$  is called the *handlebody group* and is contained in  $\mathcal{L}$ . By virtue of Dehn's lemma  $\mathcal{H} = \{h \in \mathcal{M} \mid h_{\#}(\mathbb{A}) \subseteq \mathbb{A}\}$ , see [20, Theorem 10.1]. J. Levine showed in [43, Proposition 4.1] that

$$\bigcap_{k \geq 1} J_k^L \mathcal{M} = \mathcal{H} \cap \mathcal{IL}.$$

The inclusion  $\mathcal{H} \cap \mathcal{IL} \subseteq \bigcap_{k \geq 1} J_k^L \mathcal{M}$  is clear. Now, let  $h \in \bigcap_{k \geq 1} J_k^L \mathcal{M}$  and  $\alpha \in \mathbb{A}$ , thus  $\iota_{\#}h_{\#}(\alpha) \in \Gamma_{k+1}\pi'$  for all  $k \geq 1$ . Since  $\pi'$  is residually nilpotent we have  $\iota_{\#}h_{\#}(\alpha) = 1$ , that is,  $h_{\#}(\alpha) \in \mathbb{A}$ . Hence  $\bigcap_{k \geq 1} J_k^L \mathcal{M} \subseteq \mathcal{H} \cap \mathcal{IL}$ .

### 3.3 The monoid of Lagrangian homology cobordisms

The Johnson-Levine filtration can be defined similarly on the monoid  $\mathcal{C}$  of homology cobordisms. Let us start by defining the analogues to the Lagrangian and strongly Lagrangian mapping class groups.

The monoid of *Lagrangian homology cobordisms* is defined as

$$\mathcal{LC} := \{(M, m) \in \mathcal{C} \mid \rho_1(M)(A) \subseteq A\} = \{(M, m) \in \mathcal{C} \mid m_{+,*}(A) \subseteq m_{-,*}(A)\}, \quad (3.13)$$

and the monoid of *strongly Lagrangian homology cobordisms* is defined as

$$\mathcal{ILC} := \{(M, m) \in \mathcal{LC} \mid \rho_1(M)|_A = \text{Id}_A\} = \{(M, m) \in \mathcal{LC} \mid m_{+,*}|_A = m_{-,*}|_A\}. \quad (3.14)$$

Notice that we have the inclusions  $\mathcal{IC} \subseteq \mathcal{ILC} \subseteq \mathcal{LC}$ . Let us see how these monoids are characterized in terms of the linking matrix.

**Lemma 3.7.** *Let  $M \in \mathcal{C}_{g,1}$  and let  $(B, \gamma)$  be its bottom-top tangle presentation. Then*

$$(i) \ M \text{ belongs to } \mathcal{LC}_{g,1} \text{ if and only if } B \text{ is a homology cube and } \text{Lk}(M) = \begin{pmatrix} 0 & \Lambda \\ \Lambda^T & \Delta \end{pmatrix},$$

$$(ii) \ M \text{ belongs to } \mathcal{ILC}_{g,1} \text{ if and only if } B \text{ is a homology cube and } \text{Lk}(M) = \begin{pmatrix} 0 & \text{Id}_g \\ \text{Id}_g & \Delta \end{pmatrix},$$

$$(iii) \ M \text{ belongs to } \mathcal{IC}_{g,1} \text{ if and only if } B \text{ is a homology cube and } \text{Lk}(M) = \begin{pmatrix} 0 & \text{Id}_g \\ \text{Id}_g & 0 \end{pmatrix},$$

where  $\Lambda$  and  $\Delta$  are  $g \times g$  matrices and  $\Delta$  is symmetric.

*Proof.* The proof is similar to the proof of [8, Lemma 2.12]. Consider the bases fixed in subsection 3.1. A Mayer-Vietoris argument shows that  $H_1(B; \mathbb{Z})$  is isomorphic to the quotient of  $H_1(M; \mathbb{Z})$  by the subgroup spanned by  $S = \{m_{+,*}(b_1), \dots, m_{+,*}(b_g), m_{+,*}(a_1), \dots, m_{+,*}(a_g)\}$ . Hence  $B$  is a homology cube if and only if  $S$  is a basis for  $H_1(M; \mathbb{Z})$ .

If  $S$  is a basis for  $H_1(M; \mathbb{Z})$ , then for  $1 \leq j \leq g$ ,

$$m_{+,*}(a_j) = \sum_{k=1}^g \chi_{kj} m_{+,*}(b_k) + \lambda_{kj} m_{-,*}(a_k) \quad \text{and} \quad m_{-,*}(b_j) = \sum_{k=1}^g \epsilon_{kj} m_{+,*}(b_k) + \delta_{kj} m_{-,*}(a_k), \quad (3.15)$$

where the  $\chi$ 's,  $\lambda$ 's,  $\epsilon$ 's and  $\delta$ 's are integer coefficients. We observe that  $m_-(\beta_k)$  and  $m_-(\alpha_k)$  are the oriented longitude and oriented meridian of  $\gamma_k^-$ , respectively. Similarly  $m_+(\alpha_k)$  and  $m_+(\beta_k)$  are the oriented longitude and oriented meridian of  $\gamma_k^+$ , respectively, see Figure 2.3. Now, the columns of  $\text{Lk}(B, \gamma)$  express how the oriented longitudes  $m_+(\alpha_1), \dots, m_+(\alpha_k), m_-(\beta_1), \dots, m_-(\beta_g)$  expand in the basis  $S$ . So we have  $\chi_{ij} = \chi_{ji}$ ,  $\lambda_{ij} = \epsilon_{ji}$ ,  $\delta_{ij} = \delta_{ji}$  and  $\text{Lk}(M) = \begin{pmatrix} X & \Lambda^T \\ \Lambda & \Delta \end{pmatrix}$ , where  $X = (\chi_{ij})$ ,  $\Lambda = (\lambda_{ij})$  and  $\Delta = (\delta_{ij})$ .

If  $M \in \mathcal{LC}_{g,1}$ , then  $m_{+,*}(A) \subseteq m_{-,*}(A)$  so  $S$  is a basis for  $H_1(M; \mathbb{Z})$  and all the coefficients  $\chi_{ij}$  in equation (3.15) are zero. Thus  $B$  is a homology cube and  $X = 0$ . Conversely, if  $B$  is a homology cube and  $X = 0$ , then  $M \in \mathcal{LC}_{g,1}$ . Therefore we have (i).

Now assuming that  $B$  is a homology cube, we have that  $M \in \mathcal{ILC}$  if and only if  $X = 0$  and  $\Lambda = \text{Id}_g$ , thus we have (ii). Similarly,  $M \in \mathcal{IC}$  if and only if  $X = \Delta = 0$  and  $\Lambda = \text{Id}_g$ , so we have (iii).  $\square$

Using Lemma 3.7 let us now see that the inclusions  $\mathcal{IC} \subseteq \mathcal{ILC}$  and  $\mathcal{ILC} \subseteq \mathcal{LC}$  are strict.

**Example 3.8.** Let  $g \geq 2$ . Consider the identity cobordism  $M = \Sigma_{g,1} \times [-1, 1]$  and embed two framed Hopf links  $L_1$  and  $L_2$  as in Figure 3.2(a). Perform surgery along  $L_1$  and  $L_2$ . The resulting cobordism  $M_{L_1 \cup L_2}$  belongs to  $\mathcal{LC}$  but not to  $\mathcal{ILC}$ . This follows from Lemma 3.7: in Figure 3.2(b) we show the bottom-top tangle presentation of  $M_{L_1 \cup L_2}$ , which allows to compute its linking matrix.

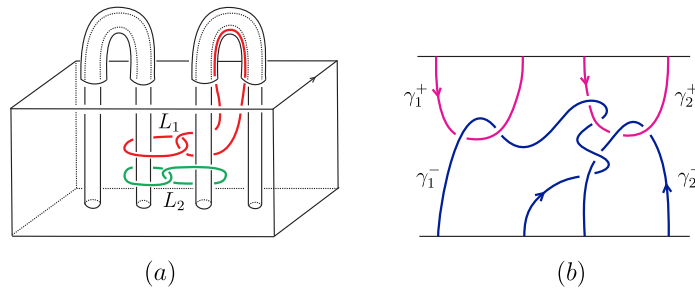


Figure 3.2: (a) Embedding of  $L_1$  and  $L_2$  in  $M$  and (b) bottom-top tangle presentation of  $M_{L_1 \cup L_2}$ .

**Example 3.9.** Let  $g \geq 2$ . Consider  $M = \Sigma_{g,1} \times [-1, 1]$  and embed a framed Hopf link  $L$  as in Figure 3.3(a). The resulting cobordism  $M_L$ , obtained after surgery along  $L$ , belongs to  $\mathcal{ILC}$  but not to  $\mathcal{IC}$ . In Figure 3.3(b) we show the bottom-top tangle presentation of  $M_L$ , which allows to compute its linking matrix.

**Definition 3.10.** The *Lagrangian filtration* or *Johnson-Levine filtration* of  $\mathcal{C}$  is the descending chain of submonoids  $\{J_k^L \mathcal{C}\}_{k \geq 1}$  defined as

$$J_k^L \mathcal{C} := \{(M, m) \in \mathcal{ILC} \mid \forall \alpha \in \mathbb{A}, \iota_{k+1} \rho_k(M)(\{\alpha\}_{k+1}) = 1 \in \pi' / \Gamma_{k+1} \pi'\},$$

where  $\iota_{k+1} : \pi / \Gamma_{k+1} \pi \rightarrow \pi' / \Gamma_{k+1} \pi'$  is induced by  $\iota_{\#} : \pi \rightarrow \pi'$ .

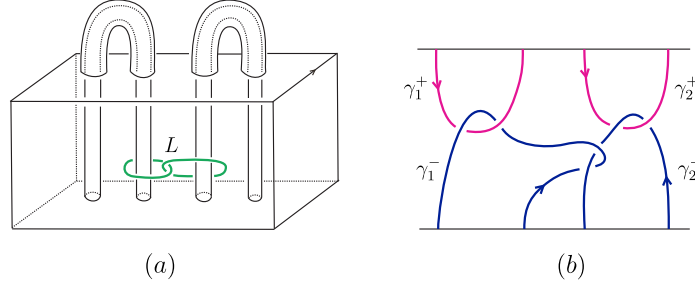


Figure 3.3: (a) Embedding of  $L$  in  $M$  and (b) bottom-top tangle presentation of  $M_L$ .

Notice that  $J_1^L \mathcal{C} = \mathcal{I} \mathcal{L} \mathcal{C}$ . To summarize, we have a descending chain of submonoids

$$\mathcal{C} \supseteq \mathcal{L} \mathcal{C} \supseteq \mathcal{I} \mathcal{L} \mathcal{C} = J_1^L \mathcal{C} \supseteq J_2^L \mathcal{C} \supseteq \dots \quad (3.16)$$

**Definition 3.11.** Let  $k \geq 1$ . The  $k$ -th *Johnson-Levine homomorphism*

$$\tau_k^L : J_k^L \mathcal{C} \rightarrow \text{Hom}(A, \Gamma_{k+1} \pi' / \Gamma_{k+2} \pi') \cong A^* \otimes \mathfrak{L}_{k+1}(H') \cong H' \otimes \mathfrak{L}_{k+1}(H'), \quad (3.17)$$

is the map that sends  $(M, m) \in J_k^L \mathcal{C}$  to the map  $a \in A \mapsto \{\iota_{k+2} \rho_{k+1}(M)(\{\alpha\})\}_{k+2}$ , where  $\alpha \in \mathbb{A}$  is such that  $ab(\alpha) = a$ .

Notice that  $\ker(\tau_k^L) = J_{k+1}^L \mathcal{C}$ . The same arguments as those used in the case of the mapping class group, work to show that  $J_k^L \mathcal{C}$  is a submonoid of  $\mathcal{C}$  and that  $\tau_k^L$  is well defined, it is a monoid homomorphism, and that it takes values in  $D_k(H')$ .

## 4 Properties of the Johnson-Levine homomorphisms

In this section we study some properties of the Johnson-Levine homomorphisms and we compare the Johnson-Levine filtration to the Johnson filtration.

### 4.1 Surjectivity of the Johnson-Levine homomorphisms

Let us start by the compatibility between the Johnson and Johnson-Levine homomorphisms. The surjective homomorphism  $\iota_* : H \rightarrow H'$  induces surjective homomorphisms  $\mathfrak{L}_k(H) \rightarrow \mathfrak{L}_k(H')$  which are compatible with the Lie bracket.

**Lemma 4.1.** *The map  $\iota_* : D_k(H) \rightarrow D_k(H')$  induced by  $\iota_* : H \rightarrow H'$  is surjective.*

*Proof.* The result follows from the existence of a group section  $s : H' \rightarrow H$  of the surjective homomorphism  $\iota_* : H \rightarrow H'$  and the commutative diagram

$$\begin{array}{ccc} H \otimes \mathfrak{L}_{k+1}(H) & \xrightarrow{[\cdot, \cdot]} & \mathfrak{L}_{k+2}(H) \\ \iota_* \otimes \iota_* \downarrow & & \downarrow \iota_* \\ H' \otimes \mathfrak{L}_{k+1}(H') & \xrightarrow{[\cdot, \cdot]} & \mathfrak{L}_{k+2}(H'). \end{array} \quad (4.1)$$

More precisely, denote by  $\Psi$  and  $\Psi'$  the Lie brackets  $[\cdot, \cdot] : H \otimes \mathfrak{L}_{k+1}(H) \rightarrow \mathfrak{L}_{k+2}(H)$  and  $[\cdot, \cdot] : H' \otimes \mathfrak{L}_{k+1}(H') \rightarrow \mathfrak{L}_{k+2}(H')$ , respectively. Let  $y \in D_k(H') \subseteq H' \otimes \mathfrak{L}_{k+1}(H')$ . The group section  $s$  allows us to lift  $y$  to  $s(y) \in H \otimes \mathfrak{L}_{k+1}(H)$  such that  $\iota_*(s(y)) = y$ . We deduce  $\Psi(s(y)) = s\Psi'(y) = 0$ , hence  $s(y) \in D_k(H)$ .  $\square$

As pointed out by J. Levine in [46, Section 4], in the mapping class group case, the Johnson homomorphisms and the Johnson-Levine homomorphisms are compatible. This also holds for the monoid of homology cobordisms.



**Proposition 4.2.** *For every positive integer  $k$ , the diagram*

$$\begin{array}{ccc} J_k\mathcal{C} & \xrightarrow{\subset} & J_k^L\mathcal{C} \\ \tau_k \downarrow & & \downarrow \tau_k^L \\ D_k(H) & \xrightarrow{\iota_*} & D_k(H') \end{array} \quad (4.2)$$

*is commutative.*

*Proof.* From the definitions, it is clear that  $J_k\mathcal{C} \subseteq J_k^L\mathcal{C}$  for all  $k \geq 1$ . Consider the free basis  $\{\alpha_1, \dots, \alpha_g, \beta_1, \dots, \beta_g\}$  of  $\pi$  and the symplectic basis  $\{a_1, \dots, a_g, b_1, \dots, b_g\}$  of  $H$  fixed in subsection 3.1. Let  $M = (M, m) \in J_k\mathcal{C} \subseteq J_k^L\mathcal{C}$ . In these bases, the  $k$ -th Johnson homomorphism is given by the formula

$$\tau_k(M) = \sum_{j=1}^g a_j \otimes \left( \rho_{k+1}(M)(\{\beta_j\}) \cdot \{\beta_j^{-1}\}_{k+2} \right) - \sum_{j=1}^g b_j \otimes \left( \rho_{k+1}(M)(\{\alpha_j\}) \cdot \{\alpha_j^{-1}\}_{k+2} \right). \quad (4.3)$$

Similarly, the  $k$ -th Johnson-Levine homomorphism is given by the formula

$$\tau_k^L(M) = - \sum_{j=1}^g \iota_*(b_j) \otimes (\iota_{k+2}\rho_{k+1}(M)(\{\alpha_j\})). \quad (4.4)$$

Thus by applying  $\iota_* : D_k(H) \rightarrow D_k(H')$  to equation (4.3) we obtain  $\iota_*\tau_k(M) = \tau_k^L(M)$ .  $\square$

From Proposition 4.2 and Theorem 2.3 we obtain the following corollary.

**Corollary 4.3.** *For every positive integer  $k$ , we have*

$$\ker(D_k(H) \xrightarrow{\iota_*} D_k(H')) = \tau_k(J_k\mathcal{C} \cap J_{k+1}^L\mathcal{C}). \quad (4.5)$$

According to Lemma 4.1, Proposition 4.2 and Theorem 2.3, we have the following.

**Corollary 4.4** (J. Levine [43] Theorem 8). *For all  $k \geq 1$ , the Johnson-Levine homomorphism  $\tau_k^L : J_k^L\mathcal{C} \rightarrow D_k(H')$  is surjective.*

The proof of J. Levine does not use Theorem 2.3, instead, it uses the Oda embedding [54] and the surjectivity of Milnor invariants. More precisely, by choosing an embedding of the disk  $D_g^o$  with  $g$  holes into  $\Sigma$ , we obtain the so-called *Oda embedding*  $\mathcal{O} : \mathcal{S}_g \rightarrow \mathcal{C}_{g,1}$ , see [43, Section 3.2]. This embedding relates the Milnor filtration with the Johnson filtration and it is compatible with the Milnor maps and the Johnson-Levine homomorphisms. These properties of the Oda embedding imply the surjectivity of the Johnson-Levine homomorphisms, for further details see [43, Theorem 8].

## 4.2 Invariance under the $Y_k$ -equivalence relation

In order to compare the Johnson filtration and the Johnson-Levine filtration, from our approach, we need to take some quotients of  $J_k\mathcal{C}$  and  $J_k^L\mathcal{C}$  by some equivalence relations to obtain a group structure compatible with the Johnson and Johnson-Levine homomorphisms. There are at least two ways to obtain a group from the monoid of homology cobordisms. One way is to consider homology cobordisms up to 4-dimensional homology bordism, see [43, 16]. Another way is to consider homology cobordisms up to  $Y_k$ -equivalence. We follow the latter approach. The notion of  $Y_k$ -equivalence was introduced independently by M. Goussarov in [19, 18] and by K. Habiro in [26] in their study of finite type invariants. Here, we follow the terminology of [26].

Let  $G$  be a graph that can be decomposed into two subgraphs, say  $G = G' \cup G^o$ , where  $G'$  is a univalent graph and  $G^o$  is a union of looped edges of  $G$  such that each univalent vertex of  $G'$  is attached to a looped edge in  $G^o$ . Moreover, we suppose that there are no free looped edges, *i.e.* every looped edge is connected to  $G'$ . The subgraph  $G'$  is called the *shape* of  $G$ . Let us consider a

pair  $(M, \gamma)$ , where  $M$  is a compact oriented 3-manifold (possibly with boundary) and  $\gamma$  is a framed oriented tangle (possibly empty) in  $M$  such that  $\partial\gamma$  (if any) are fixed points in  $\partial M$ . A *graph clasper* in  $(M, \gamma)$  is an embedding  $\mathbb{G} \hookrightarrow \text{int}(M \setminus \gamma)$  of a thickening  $\mathbb{G}$  of  $G$ , see Figure 4.1. We still denote the image of the embedding by  $G$ . In particular, if the shape of  $G$  is simply connected, we call it a *tree clasper*. The *degree* of a graph clasper is the number of trivalent vertices of its shape. If  $G$  has degree 1 we call it a *Y-clasper*. From now on, we assume that the degree of graph claspers is greater than or equal to 1.

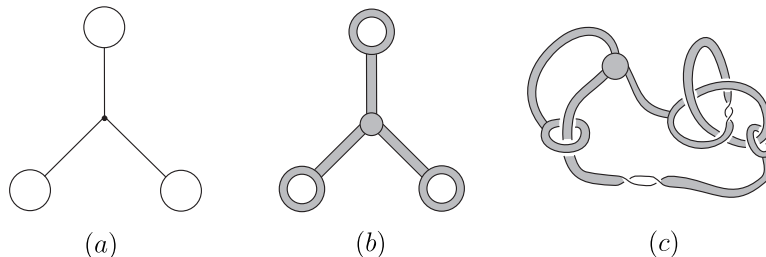


Figure 4.1: (a) Graph  $G$ . (b) Thickening  $\mathbb{G}$ . (c) Embedding  $\mathbb{G} \hookrightarrow M$ .

A graph clasper  $G$  in  $(M, \gamma)$  carries surgery instructions for modifying this pair as follows. Suppose that  $G$  has degree 1. Consider a regular neighborhood  $N(G)$  of  $G$  in  $\text{int}(M \setminus \gamma)$ . Perform surgery in  $N(G)$  along the framed six-component link  $L$  illustrated in Figure 4.2.

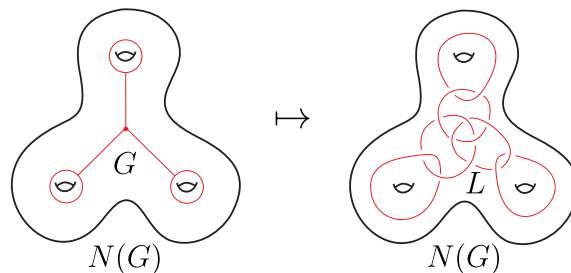


Figure 4.2: Framed link associated to a  $Y$ -clasper.

Denote the result by  $N(G)_L$ . We obtain a new pair  $(M_G, \gamma_G)$  by setting

$$M_G := (M \setminus N(G)) \cup N(G)_L,$$

and  $\gamma_G$  is equal to the trace of  $\gamma$  under the surgery. If  $G$  is of degree  $> 1$  we apply the *fission rule*, illustrated in Figure 4.3, until obtaining a disjoint union of  $Y$ -claspers. Then  $(M_G, \gamma_G)$  is defined by performing surgery as before along each  $Y$ -clasper. We say that  $(M_G, \gamma_G)$  is obtained from  $(M, \gamma)$  by a  $Y_k$ -surgery, where  $k$  is the degree of  $G$ .

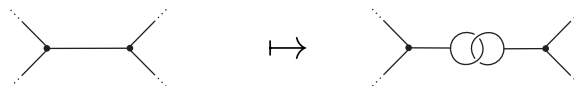


Figure 4.3: Fission rule.

The  $Y_k$ -equivalence is the equivalence relation among pairs  $(M, \gamma)$  generated by  $Y_k$ -surgeries and orientation-preserving homeomorphisms. For  $l \geq k$ ,  $Y_l$ -equivalence implies  $Y_k$ -equivalence (this follows from Move 2 and Move 9 in [26, Section 2.4]).

Let us restrict to the monoid of homology cobordisms. K. Habiro proved in [26, Theorem 5.4] that  $\mathcal{IC}/Y_r$  is a group. His proof is done in the setting of string links but the arguments are the same for  $\mathcal{IC}$ , see also [19, Theorem 9.2]. From the short exact sequence

$$1 \longrightarrow \mathcal{IC}/Y_r \xrightarrow{\subset} \mathcal{C}/Y_r \xrightarrow{\rho_1} \text{Sp}(H) \longrightarrow 1,$$

it follows that  $\mathcal{C}/Y_r$  is also a group. From [48, Lemma 6.1] it follows that the homomorphism  $\rho_{k+1} : \mathcal{C} \rightarrow \text{Aut}(\pi/\Gamma_{k+2}\pi)$  is invariant under  $Y_{k+1}$ -equivalence. Therefore, the Johnson homomorphism  $\tau_k$  and the Johnson-Levine homomorphism  $\tau_k^L$  are invariant under  $Y_{k+l}$ -equivalence for all  $l \geq 1$ .

**Lemma 4.5.** *For  $r \geq k \geq 1$ , the group  $\mathcal{C}/Y_r$  contains  $J_k\mathcal{C}/Y_r$  and  $J_k^L\mathcal{C}/Y_r$  as subgroups.*

*Proof.* It is enough to show that  $J_k\mathcal{C}/Y_r$  and  $J_k^L\mathcal{C}/Y_r$  are closed under inverses. Let  $\{M\} \in J_k\mathcal{C}/Y_r$ , then there exists  $\{N\} \in \mathcal{C}/Y_r$  such that  $\{N\}\{M\} = \{\Sigma \times [-1, 1]\}$  in  $\mathcal{C}/Y_r$ . By the invariance of  $\rho_k$  under  $Y_r$ -equivalence, we have

$$\text{Id}_{\pi/\Gamma_{k+1}\pi} = \rho_k(N) \circ \rho_k(M) = \rho_k(N),$$

hence  $\{N\} \in J_k\mathcal{C}/Y_r$ .

Now, let us show by induction on  $k$  that  $J_k^L\mathcal{C}/Y_r$  is closed under inverses. Suppose that  $k = 1$  and let  $\{M\} \in J_1^L\mathcal{C}/Y_r$ . Consider  $\{N\} \in \mathcal{C}/Y_r$  such that  $\{N\}\{M\} = \{\Sigma \times [-1, 1]\}$  in  $\mathcal{C}/Y_r$ . By the invariance of  $\rho_1$  under  $Y_r$ -equivalence, we have  $\text{Id}_H = \rho_1(N) \circ \rho_1(M)$ . Let  $a \in A$ , thus  $\rho_1(N)(a) = \rho_1(N)(\rho_1(M)(a)) = a$ . Therefore  $\{N\} \in J_1^L\mathcal{C}/Y_r$ . Next, suppose that  $k \geq 2$  and let  $\{M\} \in J_k^L\mathcal{C}/Y_r$ . Since  $J_k^L\mathcal{C} \subseteq J_{k-1}^L\mathcal{C}$ , by induction there exists  $\{N\} \in J_{k-1}^L\mathcal{C}/Y_r$  such that  $\{N\}\{M\} = \{\Sigma \times [-1, 1]\}$  in  $J_{k-1}^L\mathcal{C}/Y_r$ . On the other hand  $\tau_{k-1}^L(M) = 0$ , so we have

$$\tau_{k-1}^L(N) = \tau_{k-1}^L(N) + \tau_{k-1}^L(M) = 0.$$

Hence  $\{N\} \in J_k^L\mathcal{C}/Y_r$ . □

### 4.3 Comparison of the Johnson and Johnson-Levine filtrations

Consider the handlebody  $V$  as in subsection 3.1, seeing it as a cobordism from  $\Sigma$  to  $\Sigma_{0,1} = D$ , the fixed disk on  $\partial V$ , see Figure 4.4.

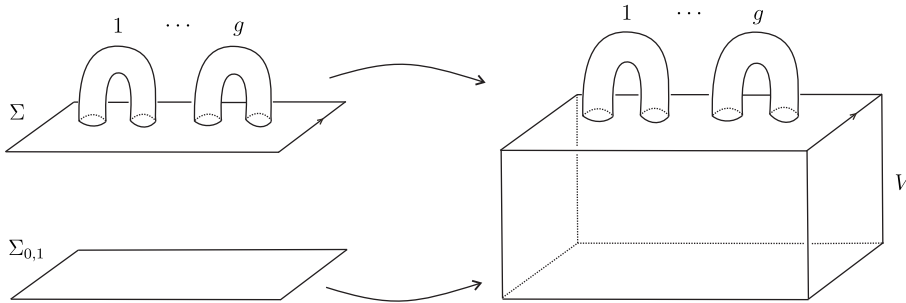


Figure 4.4: The handlebody  $V$  as a cobordism from  $\Sigma$  to  $\Sigma_{0,1}$ .

Denote by  $\mathcal{HC}$  the submonoid of  $\mathcal{C}$  consisting of the cobordisms  $(M, m)$  such that  $M \cup_{m_-} V$  is equal to  $V$  as cobordisms. Notice that  $\mathcal{HC} \cap \mathcal{M}$  is the handlebody group  $\mathcal{H}$  defined in Remark 3.6.

**Lemma 4.6.** *We have the inclusion  $\mathcal{HC} \cap \mathcal{ILC} \subseteq \bigcap_{k \geq 1} J_k^L\mathcal{C}$ .*

*Proof.* Consider the system of meridians and parallels  $\{\alpha_1, \dots, \alpha_g, \beta_1, \dots, \beta_g\}$  of  $\Sigma$  and denote in the same way an induced system of generators of  $\pi$ . Notice that  $\mathbb{A} = \ker(\pi_1(\Sigma) \xrightarrow{L\#} \pi_1(V))$  is the normal closure of  $\{\alpha_1, \dots, \alpha_g\}$ . Let  $(M, m) \in \mathcal{HC} \cap \mathcal{ILC}$ . It is enough to show that, for all  $1 \leq i \leq g$  and for all  $k \geq 1$ , we have  $\rho_k(M)(\{\alpha_i\}) \in (\mathbb{A} \cdot \Gamma_{k+1}\pi)/\Gamma_{k+1}\pi$ . Indeed, since  $M \cup_{m_-} V \cong V$ , the curve  $m_+(\alpha_i)$  bounds a disk  $D^i$  in  $M \cup_{m_-} V$ . Now, some of the curves  $m_-(\beta_j)$  intersect  $D^i$  in a transversal way. Hence  $m_{+,\#}(\alpha_i)$  can be written as a product of homotopy classes of meridians associated to those curves  $m_-(\beta_j)$  intersecting  $D^i$ . Since all the meridians are conjugates, we conclude that  $m_{+,\#}(\alpha_i)$  can be written as a product of conjugates of the homotopy classes of the curves  $m_-(\alpha_j)$ . Hence  $\rho_k(M)(\{\alpha_i\})$  belongs to  $(\mathbb{A} \cdot \Gamma_{k+1}\pi)/\Gamma_{k+1}\pi$ . Therefore  $M$  belongs to  $\bigcap_{k \geq 1} J_k^L\mathcal{C}$ . □

The other inclusion does not hold. To see this, consider any homology sphere  $P$  not homeomorphic to  $S^3$ . The connected sum  $M = (\Sigma \times [-1, 1]) \# P$  is a homology cobordism, which by construction, belongs to  $\bigcap_{k \geq 1} J_k^L \mathcal{C}$  and does not belong to  $\mathcal{HC}$ . This contrasts with the mapping class group case where the respective equality holds, see Remark 3.6.

**Proposition 4.7.** *For all  $k \geq 1$ , we have  $\ker(D_k(H) \rightarrow D_k(H')) = \tau_k(\mathcal{HC} \cap J_k \mathcal{C})$ .*

We postpone the proof of this proposition to subsection 4.4.

**Lemma 4.8.** *For all  $k, l \geq 1$ , we have*

$$\tau_k(\mathcal{HC} \cap J_k \mathcal{C}) = \tau_k\left(J_k \mathcal{C} \cap J_{k+1}^L \mathcal{C}\right), \quad (4.6)$$

and

$$\frac{J_k \mathcal{C} \cap J_{k+1}^L \mathcal{C}}{Y_{k+1+l}} = \frac{J_{k+1} \mathcal{C}}{Y_{k+1+l}} \cdot q_{k+1+l}(\mathcal{HC} \cap J_k \mathcal{C}) \quad (4.7)$$

in  $\mathcal{C}/Y_{k+1+l}$ , where  $q_{k+1+l} : \mathcal{C} \rightarrow \mathcal{C}/Y_{k+1+l}$  is the canonical projection.

*Proof.* Equality (4.6) follows from Proposition 4.7 and Corollary 4.3. Let us show equality (4.7). The inclusion “ $\supseteq$ ” follows from Lemma 4.6. Let  $M \in J_k \mathcal{C} \cap J_{k+1}^L \mathcal{C}$ , thus by (4.6),  $\tau_k(M) = \tau_k(U)$  for some element  $U \in \mathcal{HC} \cap J_k \mathcal{C}$ . But we can consider the inverse of  $\{U\}$  in  $\mathcal{C}/Y_{k+1+l}$ , then  $\{M\}\{U\}^{-1} \in \ker(J_k \mathcal{C}/Y_{k+1+l} \xrightarrow{\tau_k} D_k(H))$ . Thus  $\{M\} = \{X\}\{U\}$  with  $X \in \ker(\tau_k) = J_{k+1} \mathcal{C}$ .  $\square$

In [46, Proposition 6.1], J. Levine showed that  $J_k^L \mathcal{M} = J_k \mathcal{M} \cdot (\mathcal{H} \cap \mathcal{IL})$  for  $k = 1, 2$  and he asked if this holds for all  $k$ . In the case of homology cobordisms we have the following result.

**Theorem 4.9.** *For all  $k, l \geq 1$ ,*

$$\frac{J_k^L \mathcal{C}}{Y_{k+l}} = \frac{J_k \mathcal{C}}{Y_{k+l}} \cdot q_{k+l}(\mathcal{HC} \cap \mathcal{ILC}), \quad (4.8)$$

where  $q_{k+l} : \mathcal{C} \rightarrow \mathcal{C}/Y_{k+l}$  is the canonical projection.

*Proof.* By Lemma 4.6,  $(J_k \mathcal{C}/Y_{k+l}) \cdot q_{k+l}(\mathcal{HC} \cap \mathcal{ILC})$  is contained in  $J_k^L \mathcal{C}/Y_{k+l}$ . Let us show the other inclusion by induction on  $k$ . The argument for the case  $k = 1$  is similar to the one used by J. Levine in [46, Proposition 6.1]. Indeed, let  $M \in \mathcal{ILC}/Y_{1+l}$  with  $\rho_1(M) \in \mathrm{Sp}(H)$ . Identify  $\mathrm{Sp}(H)$  with  $\mathrm{Sp}(2g, \mathbb{Z})$  as in subsection 3.1. Now, every matrix  $\begin{pmatrix} \mathrm{Id}_g & \Lambda \\ 0 & \mathrm{Id}_g \end{pmatrix}$  in  $\mathrm{Sp}(H)$  can be realized as the image by  $\rho_1$  of an element in  $\mathcal{H} \cap \mathcal{IL}$ , see [46, Lemma 6.3]. Let  $P \in \mathcal{H} \cap \mathcal{IL}$  that realizes the matrix  $\rho_1(M)$  and consider the inverse  $\{P\}^{-1}$  of  $\{P\}$  in  $\mathcal{C}/Y_{1+l}$  (this is actually the class of the inverse of  $P$  in  $\mathcal{M}$ ). Hence  $\{M\}\{P\}^{-1}$  acts trivially in homology, that is,  $\{M\}\{P\}^{-1} = \{N\} \in \mathcal{IC} = J_1 \mathcal{C}$ . Therefore

$$\{M\} = \{N\}\{P\} \in \frac{J_1 \mathcal{C}}{Y_{1+l}} \cdot q_{1+l}(\mathcal{HC} \cap \mathcal{ILC}).$$

Suppose that the inclusion “ $\subseteq$ ” in (4.8) is true for  $k$ . Thus we have

$$\frac{J_{k+1}^L \mathcal{C}}{Y_{k+1+l}} \subseteq \frac{J_k^L \mathcal{C}}{Y_{k+1+l}} \subseteq \frac{J_k \mathcal{C}}{Y_{k+1+l}} \cdot q_{k+1+l}(\mathcal{HC} \cap \mathcal{ILC}). \quad (4.9)$$

Let  $M \in J_{k+1}^L \mathcal{C}$ . By the above inclusion we can write  $\{M\} = \{N\}\{P\}$  with  $N \in J_k \mathcal{C}$  and  $P \in \mathcal{HC} \cap \mathcal{ILC}$ . Notice that  $\tau_k^L(P) = 0$  by Lemma 4.6. Since  $\tau_k^L$  is invariant under  $Y_{k+1+l}$ -surgery (see subsection 4.2), we have

$$0 = \tau_k^L(M) = \tau_k^L(N) + \tau_k^L(P) = \tau_k^L(N),$$

therefore  $N \in \ker(\tau_k^L) = J_{k+1}^L \mathcal{C}$ . Hence  $N \in J_k \mathcal{C} \cap J_{k+1}^L \mathcal{C}$ .

From equality (4.7) in Lemma 4.8, it follows that  $\{N\} \in (J_{k+1} \mathcal{C}/Y_{k+1+l}) \cdot q_{k+1+l}(\mathcal{HC} \cap J_k \mathcal{C})$ . Hence

$$\begin{aligned} \{M\} = \{N\}\{P\} &\in \left( \frac{J_{k+1} \mathcal{C}}{Y_{k+1+l}} \cdot q_{k+1+l}(\mathcal{HC} \cap J_k \mathcal{C}) \right) \cdot q_{k+1+l}(\mathcal{HC} \cap \mathcal{ILC}) \\ &\subseteq \frac{J_{k+1} \mathcal{C}}{Y_{k+1+l}} \cdot q_{k+1+l}(\mathcal{HC} \cap \mathcal{ILC}), \end{aligned}$$

which completes the proof.  $\square$

#### 4.4 Proof of Proposition 4.7

Let us start by reviewing some preliminaries, we follow [45]. Consider the free quasi-Lie algebra

$$\mathfrak{L}^q(H) = \bigoplus_{k \geq 1} \mathfrak{L}_k^q(H)$$

generated by the  $\mathbb{Z}$ -module  $H$ , that is, instead of the relation  $[x, x] = 0$  in  $\mathfrak{L}(H)$  we have the antisymmetry relation  $[x, y] + [y, x] = 0$ . Let  $D_k^q(H)$  denote the kernel of the quasi-Lie bracket map  $[\cdot, \cdot] : H \otimes \mathfrak{L}_{k+1}^q(H) \rightarrow \mathfrak{L}_{k+2}^q(H)$ . There is a canonical map  $\mathfrak{L}^q(H) \rightarrow \mathfrak{L}(H)$ , which induces a homomorphism  $D^q(H) = \bigoplus_{k \geq 1} D_k^q(H) \rightarrow D(H) = \bigoplus_{k \geq 1} D_k(H)$ .

We can define a homomorphism

$$\eta_k^q : \mathcal{T}_k(H) \longrightarrow D_k^q(H) \quad (4.10)$$

in the same way that we defined the homomorphism  $\eta_k^{\mathbb{Z}} : \mathcal{T}_k(H) \rightarrow D_k(H)$  in subsection 2.5: the composition of  $\eta_k^q$  with the canonical map  $D_k^q(H) \rightarrow D_k(H)$  is exactly  $\eta_k^{\mathbb{Z}}$ . Recall that we denote by  $\eta_k : \mathcal{T}_k(H) \otimes \mathbb{Q} \rightarrow D_k(H) \otimes \mathbb{Q}$  the rationalization of  $\eta_k^{\mathbb{Z}}$ . J. Levine carried in [45] a detailed study of the homomorphism  $\eta_k^q$ . In particular, he obtained ([45, Corollary 2.3]) for all  $j \geq 1$  the following short exact sequences

$$0 \longrightarrow H \otimes \mathfrak{L}_j(H) \otimes \mathbb{Z}/2 \xrightarrow{s} D_{2j-1}^q(H) \longrightarrow D_{2j-1}(H) \longrightarrow 0 \quad (4.11)$$

where  $s(h \otimes u \otimes 1) = h \otimes [u, u]$  for  $h \in H$  and  $u \in \mathfrak{L}_j(H)$ , and

$$0 \longrightarrow D_{2j}^q(H) \longrightarrow D_{2j}(H) \xrightarrow{p} \mathfrak{L}_{j+1}(H) \otimes \mathbb{Z}/2 \longrightarrow 0. \quad (4.12)$$

To describe the map  $p$  in (4.12) let us first recall from [45, Remark 2.4] some elements of  $D_{2j}(H)$  which do not come from  $D_{2j}^q(H)$ . Let  $u \in \mathfrak{L}_{j+1}(H)$  and denote by  $\text{tr}(u)$  the associated rooted tree. Let  $\text{tr}(u) \odot \text{tr}(u)$  be the Jacobi diagram obtained by joining the roots of two copies of  $\text{tr}(u)$ . The element  $\eta_{2j}(\frac{1}{2}\text{tr}(u) \odot \text{tr}(u))$  belongs to  $D_{2j}(H)$  and does not belong to  $D_{2j}^q(H)$ . The map  $p$  sends  $\eta_{2j}(\frac{1}{2}\text{tr}(u) \odot \text{tr}(u))$  to  $u \otimes 1$ .

J. Levine also proved [44, Theorem 1] that the map  $\eta_k^q$  is surjective and that  $(k+2)\ker(\eta_k^q) = 0$ . (These results imply, in particular, that  $\eta_k$  is an isomorphism, as we recalled at the end of subsection 2.5). From the exact sequences (4.11) and (4.12) together with the surjectivity of  $\eta_k^q$  we deduce the following.

**Corollary 4.10.** *For all  $j \geq 1$ ,*

- (i)  $D_{2j-1}(H)$  is generated by the elements  $\eta_{2j-1}^{\mathbb{Z}}(v)$  with  $v \in \mathcal{T}_{2j-1}(H)$ .
- (ii)  $D_{2j}(H)$  is generated by the elements  $\eta_{2j}^{\mathbb{Z}}(v)$  with  $v \in \mathcal{T}_{2j}(H)$  and  $\eta_{2j}(\frac{1}{2}\text{tr}(u) \odot \text{tr}(u))$  with  $u \in \mathfrak{L}_{j+1}(H)$ .

**Lemma 4.11.** *Let  $S = \{a_1, \dots, a_g, b_1, \dots, b_g\}$  be the fixed symplectic basis of  $H$ . For all  $j \geq 1$ ,*

- (i)  $\ker(D_{2j-1}(H) \rightarrow D_{2j-1}(H'))$  is generated by the elements  $\eta_{2j-1}^{\mathbb{Z}}(v)$  with  $v$  a tree-like Jacobi diagram with legs colored by  $S$  and at least one leg colored by some  $a_i$ .
- (ii)  $\ker(D_{2j}(H) \rightarrow D_{2j}(H'))$  is generated by the elements  $\eta_{2j}^{\mathbb{Z}}(v)$  with  $v$  a tree-like Jacobi diagram with legs colored by  $S$ , with at least one leg colored by some  $a_i$ ; and the elements  $\eta_{2j}(\frac{1}{2}\text{tr}(u) \odot \text{tr}(u))$  with  $u \in \mathfrak{L}_{j+1}(H)$  a Lie commutator which has at least one  $a_i$  as one of its components.

*Proof.* Let  $k \geq 1$  and let  $x \in \ker(D_k(H) \rightarrow D_k(H'))$ . By Corollary 4.10, we have

$$x = \sum_i \eta_k^{\mathbb{Z}}(v_i) + \sum_l \eta_k \left( \frac{1}{2}\text{tr}(u_l) \odot \text{tr}(u_l) \right) \quad (4.13)$$

with  $v_i \in \mathcal{T}_k(H)$ , and  $u_l \in \mathfrak{L}_{j+1}(H)$  if  $k = 2j$ . Notice that if  $k$  is odd, the second sum in equation (4.13) does not appear. By the linearity relation we can suppose that all the  $v_i$ 's have legs colored by  $S$  and

that all the  $u_i$ 's are Lie commutators on  $S$ . Let  $y = \sum_i v_i + \sum_l \frac{1}{2} \text{tr}(u_l) \odot \text{tr}(u_l) \in \mathcal{T}_k(H) \otimes \mathbb{Q}$  and consider the commutative diagram

$$\begin{array}{ccc} \mathcal{T}_k(H) \otimes \mathbb{Q} & \xrightarrow[\cong]{\eta_k} & D_k(H) \otimes \mathbb{Q} \\ \varphi \downarrow & & \downarrow \varphi' \\ \mathcal{T}_k(H') \otimes \mathbb{Q} & \xrightarrow[\eta_k]{\cong} & D_k(H') \otimes \mathbb{Q} \end{array} \quad (4.14)$$

where  $\varphi$  and  $\varphi'$  are induced by the homomorphism  $\iota_* : H \rightarrow H'$ . We have that  $\varphi' \eta_k(y) = 0$ , so  $\eta_k \varphi(y) = 0$ . Since  $\eta_k$  is an isomorphism,  $\varphi(y) = 0$ . Let us write

$$y = \sum_i v_i + \sum_l \frac{1}{2} \text{tr}(u_l) \odot \text{tr}(u_l) = y' + y'',$$

such that all the diagrams appearing in  $y'$  have at least one leg colored by some  $a_i$ , and all the diagrams appearing in  $y''$  have legs colored only by  $\{b_1, \dots, b_g\}$ . Hence

$$0 = \varphi(y) = \varphi(y') + \varphi(y'') = \varphi(y'').$$

Now,  $\varphi(y'') = y''$  because all terms of  $y''$  only have legs colored by  $\{b_1, \dots, b_g\}$ . Thus  $y'' = 0$ , so  $y = y'$ . In other words, the diagrams appearing in  $y$  whose legs are colored only by  $\{b_1, \dots, b_g\}$  can be grouped and they cancel out by IHX and antisymmetry relations.  $\square$

Let us now turn to the proof of Proposition 4.7. Recall that we want to show that

$$\ker(D_k(H) \xrightarrow{\iota_*} D_k(H')) = \tau_k(\mathcal{HC} \cap J_k \mathcal{C}).$$

Let us first see the inclusion “ $\supseteq$ ”. Since  $\mathcal{HC} \cap \mathcal{ILC} \subseteq \bigcap J_k^L \mathcal{C}$  (Lemma 4.6), we have that  $\tau_k^L(\mathcal{HC} \cap \mathcal{ILC}) = 0$  for all  $k \geq 1$ . Therefore, if  $M \in \mathcal{HC} \cap J_k \mathcal{C} \subseteq \mathcal{HC} \cap \mathcal{ILC}$ , then  $\tau_k^L(M) = 0$ , so by Proposition 4.2 we have that  $\iota_*(\tau_k(M)) = \tau_k^L(M) = 0$ , that is,  $\tau_k(M) \in \ker(D_k(H) \xrightarrow{\iota_*} D_k(H'))$ .

We now show the inclusion “ $\subseteq$ ”. According to Lemma 4.11, it is enough to prove for all  $j \geq 1$  that

- (i)  $\eta_{2j-1}^{\mathbb{Z}}(v) \in \tau_{2j-1}(\mathcal{HC} \cap J_{2j-1} \mathcal{C})$  for  $v$  as in Lemma 4.11(i), and
- (ii)  $\eta_{2j}^{\mathbb{Z}}(v) \in \tau_{2j}(\mathcal{HC} \cap J_{2j} \mathcal{C})$  and  $\eta_{2j}^{\mathbb{Z}}(\frac{1}{2} \text{tr}(u) \odot \text{tr}(u)) \in \tau_{2j}(\mathcal{HC} \cap J_{2j} \mathcal{C})$  for  $v$  and  $u$  as in Lemma 4.11(ii).

Let  $\mathcal{S}_{2g}^{\text{odd}}$  be the submonoid of string links  $\sigma$  on  $2g$  strands in homology cubes, with trivial linking matrix and satisfying the property that if we forget all the odd components of  $\sigma$ , the obtained string link is trivial. The Milnor-Johnson correspondence, described in subsection 2.4, sends  $\mathcal{HC} \cap \mathcal{IC}$  to  $\mathcal{S}_{2g}^{\text{odd}}$ . Hence by diagram (2.10), proving (i) and (ii) above is equivalent to show

- (iii)  $v \in \eta_k^{-1} \mu_{k+1}(\mathcal{S}_{2g}^{\text{odd}} \cap \mathcal{S}_{2g}[k+1])$  for  $k$  odd and  $v$  as in Lemma 4.11(i), and
- (iv)  $v, \frac{1}{2} \text{tr}(u) \odot \text{tr}(u) \in \eta_k^{-1} \mu_{k+1}(\mathcal{S}_{2g}^{\text{odd}} \cap \mathcal{S}_{2g}[k+1])$  for  $k$  even and  $v$  and  $u$  as in Lemma 4.11(ii).

This can be done by using a string link version of Cochran's realization theorems for Milnor invariants [12, Theorem 7.2] and [13, Theorem 3.3]: here we develop [24, Remark 8.2]. This process is called *antidifferentiation* and it is very close to surgery along tree claspers, see [26, Section 7]. We sketch this process below.

Let  $S$  be as in Lemma 4.11. Suppose that  $k = 2j$ . Consider  $u \in \mathfrak{L}_{j+1}(H)$  a Lie commutator which has at least one  $a_i$  as one of its components. From the rooted tree  $\text{tr}(u)$  we are going to recursively construct a string link  $L(\frac{1}{2}u)$  which realizes the diagram  $\frac{1}{2} \text{tr}(u) \odot \text{tr}(u)$ .

**Starting step.** Suppose that  $u = [u_1, u_2]$ . Consider the oriented Whitehead link and label its components by  $u_1$  and  $u_2$  respectively, see Figure 4.5(a).

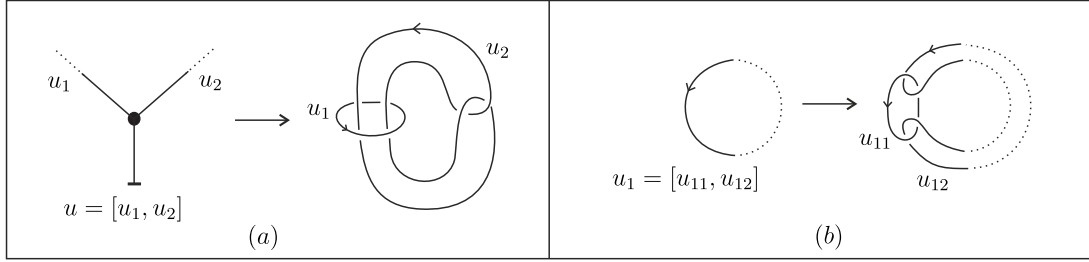


Figure 4.5: (a) Starting step and (b) recursive step.

**Recursive step.** Suppose for example that  $u_1 \in \mathcal{L}_{\geq 2}(H)$ , say  $u_1 = [u_{11}, u_{12}]$ . Perform a 0-twisted Bing doubling to the component labeled by  $u_1$  and label the two new components  $u_{11}$  and  $u_{12}$  respectively. See Figure 4.5(b).

**Banding step.** After finishing the above process we obtain a  $(j + 1)$ -component link whose components are labeled with elements of  $S$ . Now, if two components have the same label, we perform an *interior band sum* between the two components, see [12, Section 7] for more details. If necessary, add trivial components to the resulting link in order to obtain a  $2g$ -component link with components, each one, labeled by a unique element of  $S$ . Denote this link by  $l(\frac{1}{2}u)$ . Since  $u$  is a Lie commutator with at least one  $a_i$  as one of its components, the construction implies that the link  $l(\frac{1}{2}u)$  becomes the trivial  $g$ -component link if we forget all the components with labels  $a_1, \dots, a_g$ .

**Final step.** Open the link  $l(\frac{1}{2}u)$  to obtain a string link  $l'(\frac{1}{2}u)$  on  $2g$ -strands, each one labeled by a unique element of  $S$ , satisfying the property that if we forget all the components with labels  $a_1, \dots, a_g$  then it becomes the trivial  $g$ -component string link. Now, by conjugating with the generators  $\sigma_1, \dots, \sigma_{2g-1}$  of the braid group on  $2g$ -strands, we arrange the components of  $l'(\frac{1}{2}u)$  in a such way that the  $(2i)$ -th component is labeled by  $b_i$  and the  $(2i - 1)$ -st component is labeled by  $a_i$ , for  $i = 1, \dots, g$ . Denote the resulting string link by  $L(\frac{1}{2}u)$ . We have that  $L(\frac{1}{2}u) \in \mathcal{S}_{2g}^{\text{odd}} \cap \mathcal{S}_{2g}[k + 1]$  and  $\mu_{k+1}(L(\frac{1}{2}u)) = \mu_{k+1}(l'(\frac{1}{2}u)) = \pm \eta_k(\frac{1}{2}\text{tr}(u) \odot \text{tr}(u))$ , see [14, Corollary 7] or [24, Remark 8.2], the sign depending on the clasp of the Whitehead link in the starting step.

**Example 4.12.** Let us illustrate the above process in a particular case. Suppose that  $g = 2$  and  $u = [[a_1, b_1], a_1]$ . We show in Figure 4.6(i) the starting step, in Figure 4.6(ii) the recursive step. In Figure 4.6(iii) we perform an interior band sum and add trivial components. Finally in Figure 4.7 we show one associated string link and the arrangement of its components.

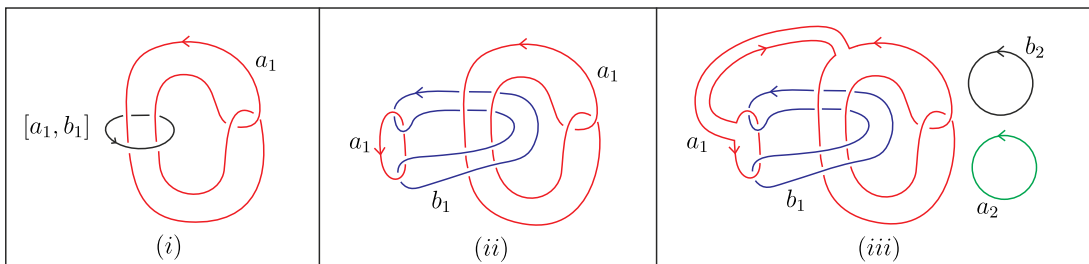


Figure 4.6: (i) Starting step, (ii) recursive step and (iii) link  $l(\frac{1}{2}u)$  for  $u = [[a_1, b_1], a_1]$ .

Now if  $v$  is a tree-like Jacobi diagram as in Lemma 4.11, of  $i\text{-deg} \geq 2$  (the case  $i\text{-deg} = 1$  is realized by a string link version of the Borromean rings), then chose any *internal edge* of  $v$  (edge connecting two trivalent vertices) and cut it in half to obtain two rooted trivalent trees. Let  $u_1$  and  $u_2$  be the Lie commutators associated to these rooted trees. Notice that  $v = \text{tr}(u_1) \odot \text{tr}(u_2)$ . Consider the oriented Hopf link and label its components by  $u_1$  and  $u_2$  respectively, see Figure 4.8.

Then continue the antidifferentiation process by performing the recursive step, banding step and final step. At the end we obtain a string link  $L(v) \in \mathcal{S}_{2g}^{\text{odd}} \cap \mathcal{S}_{2g}[k + 1]$  such that  $\mu_{k+1}(L(v)) = \pm \eta_k^{\mathbb{Z}}(v)$ , see

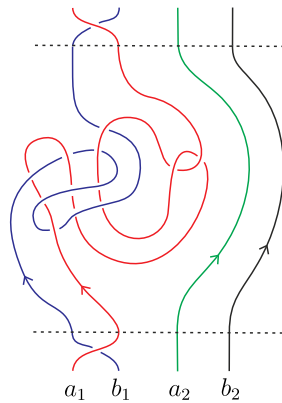


Figure 4.7: String link  $L(\frac{1}{2}u)$  for  $u = [[a_1, b_1], a_1]$ .

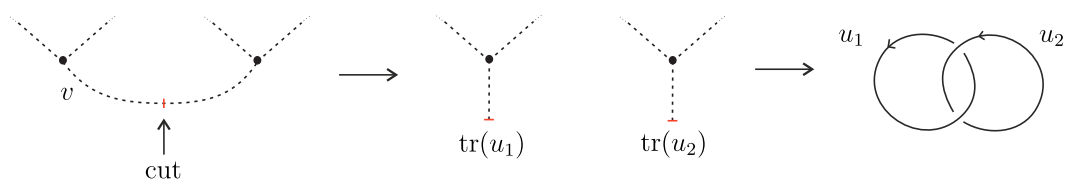


Figure 4.8: Starting the antidifferentiation process to realize  $v$ .

[14, Corollary 7] or [24, Remark 8.2], the sign depending on the clasp of the Hopf link that we started with to realize  $v$ .

## 5 The LMO functor and the Johnson-Levine homomorphisms

This section is devoted to the relation between the Johnson-Levine homomorphisms and the LMO functor. We refer to [56, 4, 5] for an introduction to the LMO invariant and to [8] for its functorial extension.

### 5.1 Jacobi diagrams

In subsection 2.5 we reviewed the notion of tree-like Jacobi diagram. In this subsection we consider more general Jacobi diagrams.

A *Jacobi diagram* is a finite univalent graph such that the trivalent vertices are *oriented*, that is, its incident edges are endowed with a cyclic order. Let  $C$  be a finite set. We call a Jacobi diagram  $C$ -*colored* if its univalent vertices (or *legs*) are colored with elements of the  $\mathbb{Q}$ -vector space spanned by  $C$ . The *internal degree* of a Jacobi diagram is the number of trivalent vertices, we denote it by  $i\text{-deg}$ . The connected Jacobi diagram of  $i\text{-deg} = 0$  is called a *strut*. As for tree-like Jacobi diagrams, we use dashed lines to represent Jacobi diagrams and, when we draw them, we assume that the orientation of trivalent vertices is counterclockwise. See Figure 5.1 for some examples.

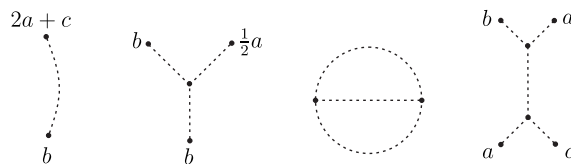


Figure 5.1:  $C$ -colored Jacobi diagrams of  $i\text{-deg}$  0, 1, 2 and 2, respectively. Here  $C = \{a, b, c\}$

The space of  $C$ -colored Jacobi diagrams is defined as

$$\mathcal{A}(C) := \frac{\text{Vect}_{\mathbb{Q}}\{C\text{-colored Jacobi diagrams}\}}{\text{AS, IHX, } \mathbb{Q}\text{-multilinearity}},$$



where the relations AS, IHX are local and the multilinearity relation applies to the  $C$ -colored legs, see Figure 2.6 in subsection 2.5.

The vector space  $\mathcal{A}(C)$  is graded by the internal degree, thus we can consider the degree completion which we still denote by  $\mathcal{A}(C)$ , in other words, we also consider formal series of Jacobi diagrams. There is a product in  $\mathcal{A}(C)$  given by disjoint union, and a coproduct defined by  $\Delta(D) := \sum D' \otimes D''$  where the sum ranges over pairs of subdiagrams  $D', D''$  of  $D$  such that  $D' \sqcup D'' = D$ . With these structures,  $\mathcal{A}(C)$  is a complete Hopf algebra. Its primitive part is the subspace  $\mathcal{A}^c(C)$  spanned by connected Jacobi diagrams. We denote by  $\mathcal{A}^Y(C)$  the subspace of Jacobi diagrams such that all of their connected components have at least one trivalent vertex. A Jacobi diagram in  $\mathcal{A}(C)$  is *looped* if it has a non-contractible component, for instance the third diagram in Figure 5.1 is looped. The subspace generated by looped diagrams is an ideal. We denote by  $\mathcal{A}^{Y,t}(C)$  the quotient of  $\mathcal{A}^Y(C)$  by this ideal.

For  $k \geq 1$  denote by  $\mathcal{A}_k^{Y,t,c}(C)$  the subspace of  $\mathcal{A}^{Y,t}(C)$  generated by connected diagrams of i-deg =  $k$ . If  $G$  is a finitely generated free abelian group, we define the space  $\mathcal{A}(G)$  of  $G$ -colored Jacobi diagrams by  $\mathcal{A}(G) = \mathcal{A}(C)$  where  $C$  is any set of free generators of  $G$ . In particular for the abelian group  $H = H_1(\Sigma_{g,1}; \mathbb{Z})$  we have

$$\mathcal{A}_k^{Y,t,c}(H) = \mathcal{T}_k(H) \otimes \mathbb{Q},$$

where  $\mathcal{T}(H) = \bigoplus_{k \geq 1} \mathcal{T}_k(H)$  is the group of tree-like Jacobi diagrams defined in subsection 2.5.

## 5.2 The LMO functor

Let us start by the definition of the target category  ${}^{ts}\mathcal{A}$  of the LMO functor. For a non-negative integer  $g$ , denote by  $[g]^*$  the set  $\{1^*, \dots, g^*\}$ , where  $*$  is a symbol like  $+$ ,  $-$  or  $*$  itself. The objects of the category  ${}^{ts}\mathcal{A}$  are non-negative integers. The set of morphisms from  $g$  to  $f$  is the subspace  ${}^{ts}\mathcal{A}(g, f)$  of diagrams in  $\mathcal{A}([g]^+ \sqcup [f]^-)$  without struts whose both ends are colored by elements of  $[g]^+$ . If  $D \in {}^{ts}\mathcal{A}(g, f)$  and  $E \in {}^{ts}\mathcal{A}(h, g)$  the composition  $D \circ E$  is the element in  ${}^{ts}\mathcal{A}(h, f)$  given by the sum of Jacobi diagrams obtained by considering all the possible ways of gluing the  $[g]^+$ -colored legs of  $D$  with the  $[g]^-$ -colored legs of  $E$ . Schematically

$$D \circ E := \sum \begin{array}{c} \text{..... } [h]^+ \\ \boxed{E} \\ \text{.....} \\ \boxed{\text{glue}} \\ \text{.....} \\ \boxed{D} \\ \text{..... } [f]^- \end{array}.$$

For example,

where the last equality follows from the IHX relation. The identity morphism in  ${}^{ts}\mathcal{A}(g, g)$  is given by

$$\text{Id}_g := \exp_{\sqcup} \left( \sum_{i=1}^g \begin{array}{c} \cdot i^+ \\ \vdots \\ \cdot i^- \end{array} \right).$$

The category  ${}^{ts}\mathcal{A}$  is called the category of *top-substantial Jacobi diagrams*.

Now, let us define the source category  $\mathcal{L}Cob$  of the LMO functor, which is called the category of *Lagrangian cobordisms*. The objects of  $\mathcal{L}Cob$  are non-negative integers. For all  $g \geq 1$ , let us fix the handlebody  $V_g$  and the inclusion  $\iota : \Sigma_{g,1} \hookrightarrow V_g$  as in subsection 3.1. A cobordism  $(M, m)$  over  $\Sigma_{g,1}$  belongs to  $\mathcal{L}Cob(g, g)$  if it satisfies  $H_1(M) = m_{-,*}(A_g) + m_{+,*}(H_1(\Sigma_{g,1}; \mathbb{Z}))$  and  $m_{+,*}(A_g) \subseteq m_{-,*}(A_g)$ . Recall that  $A_g$  denotes the kernel of  $H_1(\Sigma_{g,1}; \mathbb{Z}) \xrightarrow{\iota_*} H_1(V_g; \mathbb{Z})$ . In particular we have that the monoid

of Lagrangian homology cobordisms  $\mathcal{LC}_{g,1}$  is contained in  $\mathcal{LCob}(g, g)$ . More generally, the set  $\mathcal{LCob}(g, f)$  is defined in a similar way by considering cobordisms from  $\Sigma_{g,1}$  to  $\Sigma_{f,1}$ .

For the definition of the LMO functor we need to use the *Kontsevich integral*, because of this, it is necessary to change the objects of  $\mathcal{LCob}$  to obtain the category  $\mathcal{LCob}_q$ : instead of non-negative integers, the objects of  $\mathcal{LCob}_q$  are non-associative words in the single letter  $\bullet$ . We refer to [8] for more details.

Roughly speaking, the LMO functor  $\tilde{Z} : \mathcal{LCob}_q \rightarrow {}^{ts}\mathcal{A}$  is defined as follows. Let  $M$  be a Lagrangian cobordism (for example  $M \in \mathcal{LC}_{g,1}$ ) and consider its bottom-top tangle presentation  $(B, \gamma')$ . Next, take a *surgeries presentation* of  $(B, \gamma')$ , that is, a framed link  $L \subseteq \text{int}([-1, 1]^3)$  and a bottom-top tangle  $\gamma$  in  $[-1, 1]^3$  such that surgery along  $L$  carries  $([-1, 1]^3, \gamma)$  to  $(B, \gamma')$ . Then take the *Kontsevich integral* of the pair  $([-1, 1]^3, L \cup \gamma)$ , which gives a series of a kind of Jacobi diagrams. To get rid of the ambiguity in the surgery presentation, it is necessary to use some combinatorial operations on the space of diagrams. Among these operations, the so-called *Aarhus integral* (see [4, 5]), which is a kind of formal Gaussian integration on the space of diagrams. In this way we arrive to  ${}^{ts}\mathcal{A}$ . Finally, to obtain the functoriality, it is necessary to do a normalization.

We emphasize that the definition of the Kontsevich integral requires the choice of a *Drinfeld associator*, and the bottom-top tangle presentation requires the choice of a system of meridians and parallels. Thus the LMO functor also depends on these choices.

**Example 5.1.** In [8, Section 5.3] the value of the LMO functor was calculated in low degrees for the generators of  $\mathcal{LCob}$ , when the chosen Drinfeld associator is even. For instance, for the Lagrangian cobordisms  $\psi_{1,1}$  with bottom-top tangle presentation given in Figure 5.2, we have

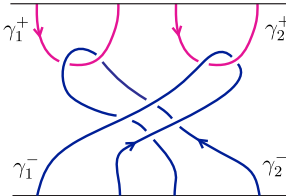
$$\tilde{Z}(\psi_{1,1}) = \exp_{\sqcup} \left( \begin{array}{c} \cdot 1^+ \\ \vdots \\ \cdot 2^- \end{array} + \begin{array}{c} \cdot 2^+ \\ \vdots \\ \cdot 1^- \end{array} \right) \sqcup \exp_{\sqcup} \left( -\frac{1}{2} \begin{array}{c} \cdot 1^+ \\ \vdots \\ \cdot 2^- \end{array} \cdots \begin{array}{c} \cdot 2^+ \\ \vdots \\ \cdot 1^- \end{array} + (\text{i-deg} > 2) \right).$$


Figure 5.2: Bottom-top tangle presentation of  $\psi_{1,1}$ .

For a matrix  $\Lambda = (l_{ij})$  with entries indexed by a finite set  $C$ , we define the element  $[\Lambda]$  in  $\mathcal{A}(C)$  by

$$[\Lambda] := \exp_{\sqcup} \left( \sum_{i,j \in C} l_{ij} \begin{array}{c} \cdot j \\ \vdots \\ \cdot i \end{array} \right).$$

It was proved in [8, Lemma 4.12] that the LMO functor takes group-like values, and that if  $w$  and  $u$  are non-associative words in  $\bullet$  of lengths  $g$  and  $f$  respectively, then for  $M \in \mathcal{LCob}_g(w, u)$ ,  $\tilde{Z}(M)$  splits as  $\tilde{Z}(M) = \tilde{Z}^s(M) \sqcup \tilde{Z}^Y(M)$ , where  $\tilde{Z}^Y(M)$  belongs to  $\mathcal{A}^Y([g]^+ \sqcup [f]^-)$  and  $\tilde{Z}^s(M)$  only contains struts. Moreover  $\tilde{Z}^s(M)$  is given by

$$\tilde{Z}^s(M) = \left[ \frac{\text{Lk}(M)}{2} \right], \quad (5.1)$$

where  $\text{Lk}(M)$  has been defined in subsection 2.2, see for instance Example 5.1. The colors  $1^+, \dots, g^+$  and  $1^-, \dots, f^-$  in the series of Jacobi diagrams  $\tilde{Z}(M)$  refer to the curves  $m_+(\beta_1), \dots, m_+(\beta_g)$  and  $m_-(\alpha_1), \dots, m_-(\alpha_f)$  on the top and bottom surfaces of  $M$  respectively.

### 5.3 Diagrammatic version of the Johnson-Levine homomorphisms

In subsection 2.5 we recalled the diagrammatic version of the Johnson homomorphisms. The same idea applies to the Johnson-Levine homomorphisms. We have seen in Section 3 that the  $k$ -th Johnson-

Levine homomorphism takes values in  $D_k(H')$ . Let us consider the space  $\mathcal{A}_k^{Y,t,c}(H') = \mathcal{T}_k(H') \otimes \mathbb{Q}$  of connected tree-like Jacobi diagrams of i-deg =  $k$  with  $H'$ -colored legs. We have the isomorphism

$$\eta_k : \mathcal{A}_k^{Y,t,c}(H') \longrightarrow D_k(H') \otimes \mathbb{Q}, \quad T \longmapsto \sum \text{color}(v) \otimes (T \text{ rooted at } v), \quad (5.2)$$

as in subsection 2.5. Define the *diagrammatic version* of the  $k$ -th Johnson-Levine homomorphism by

$$\eta_k^{-1}(\tau_k^L(M)) \in \mathcal{A}_k^{Y,t,c}(H').$$

Moreover, if we consider the symplectic basis  $\{a_1, \dots, a_g, b_1, \dots, b_g\}$  of  $H$  fixed in subsection 3.1, we have that

$$\eta_k^{-1}(\tau_k^L(M))|_{\iota_*(b_j) \mapsto j^+} \in \mathcal{A}_k^{Y,t,c}(\lfloor g \rfloor^+),$$

where the expression  $\iota_*(b_j) \mapsto j^+$  means to replace the color  $\iota_*(b_j)$  by the color  $j^+$  for  $j = 1, \dots, g$ . We still denote the diagrammatic version by  $\tau_k^L$ .

#### 5.4 Relating the LMO functor and the Johnson-Levine homomorphisms

We have seen that for  $M \in J_k^L \mathcal{C}$ , the homomorphism  $\tau_k^L(M)$  can be seen as taking values in the space  $\mathcal{A}_k^{Y,t,c}(\lfloor g \rfloor^+)$  of connected tree-like Jacobi diagrams with  $\lfloor g \rfloor^+$ -colored legs of i-deg =  $k$ . While the value  $\tilde{Z}(M)$  of the LMO functor takes values in  ${}^{ts}\mathcal{A}(g, g)$ . Now,  $\mathcal{A}_k^{Y,t,c}(\lfloor g \rfloor^+)$  is contained in  ${}^{ts}\mathcal{A}(g, g)$ . In this subsection we show an explicit relation between the Johnson-Levine homomorphisms and the LMO functor. Let us first start by the strut part of the LMO functor. Consider the monoid homomorphism

$$\vartheta : \mathcal{LC} \longrightarrow \text{Hom}(A, A), \quad M \longmapsto \rho_1(M)|_A. \quad (5.3)$$

Notice that  $\mathcal{ILC} = \ker(\vartheta)$ . We have the following.

**Proposition 5.2.** *For  $(M, m) \in \mathcal{LC}$ , the homomorphism  $\vartheta(M)$  is essentially the strut part  $\tilde{Z}^s(M)$  of the LMO functor not considering struts whose both ends are colored by  $\lfloor g \rfloor^-$ .*

*Proof.* Consider the same bases of  $H$ ,  $A$  and  $H_1(M; \mathbb{Z})$  as in the proof of Lemma 3.7. In these bases the matrix of  $\vartheta(M)$  is given by  $\Lambda = (\lambda_{ij})$ , where  $\lambda_{ij}$  are integer coefficients as in equation (3.15). Besides,  $\tilde{Z}^s(M) = \left[ \frac{\text{Lk}(M)}{2} \right]$  and we have seen in the proof of Lemma 3.7 that  $\text{Lk}(M) = \begin{pmatrix} 0 & \Lambda^T \\ \Lambda & \Delta \end{pmatrix}$ . In other words, the homomorphism (5.3) is tantamount to the strut part of the LMO functor not considering struts whose both ends are colored by  $\lfloor g \rfloor^-$ .  $\square$

We now turn to the trivalent part of the LMO functor. For  $M \in \mathcal{LC}$  denote by  $\tilde{Z}^{Y,t,+}(M)$  the element in  $\mathcal{A}^{Y,t}(\lfloor g \rfloor^+)$  obtained from  $\tilde{Z}^Y(M)$  by sending all terms with loops or with  $i^-$ -colored legs to 0. Let us consider the filtration of  $\mathcal{C}$  induced by  $\tilde{Z}^{Y,t,+}$ . Specifically, we set

$$\mathcal{F}_k \mathcal{C} := \{(M, m) \in \mathcal{ILC} \mid \tilde{Z}^{Y,t,+}(M) = \emptyset + (\text{terms of i-deg} \geq k)\}.$$

We call  $\{\mathcal{F}_k \mathcal{C}\}_{k \geq 1}$  the *upper tree filtration* of  $\mathcal{C}$ .

**Proposition 5.3.** *Let  $M, N \in \mathcal{F}_k \mathcal{C}$  and write  $\tilde{Z}^{Y,t,+}(M) = \emptyset + D_k + (\text{i-deg} > k)$  and  $\tilde{Z}^{Y,t,+}(N) = \emptyset + D'_k + (\text{i-deg} > k)$ , where  $D_k$  and  $D'_k$  are linear combinations of connected Jacobi diagrams in  $\mathcal{A}^{Y,t}(\lfloor g \rfloor^+)$  of i-deg =  $k$ . Then*

$$\tilde{Z}^{Y,t,+}(M \circ N) = \emptyset + (D_k + D'_k) + (\text{i-deg} > k). \quad (5.4)$$

*Proof.* For simplicity of notation, we write  $D(\cdot)$  instead of  $\tilde{Z}^{Y,t,+}(\cdot)$  and  $\hat{D}(\cdot)$  instead of  $\tilde{Z}^Y(\cdot)$ . Suppose that

$$\text{Lk}(M) = \begin{pmatrix} 0 & \text{Id}_g \\ \text{Id}_g & \Delta \end{pmatrix}.$$

It follows from Lemma 4.5 in [8] that

$$\hat{D}(M \circ N) = \left\langle \left( \hat{D}(M)_{|j^+ \mapsto j^* + j^+ + \Delta \cdot j^-} \right), \left( [\Delta/2]_{|j^- \mapsto j^*} \right) \sqcup \left( \hat{D}(N)_{|j^- \mapsto j^* + j^-} \right) \right\rangle_{[g]^*}, \quad (5.5)$$

where  $\Delta \cdot j^- = \sum_{p=1}^g l_{pj} p^-$  with  $\Delta = (l_{pq})$ , and for  $E, F \in {}^{ts}\mathcal{A}([g]^* \sqcup C)$ , the element  $\langle E, F \rangle_{[g]^*} \in {}^{ts}\mathcal{A}(C)$  is defined as the linear combination of Jacobi diagrams obtained from  $E$  and  $F$  by considering all possible ways of gluing all the  $[g]^*$ -colored legs of  $E$  with all the  $[g]^*$ -colored legs of  $F$ , see [4, 5] for details about this operation.

It is possible for  $\hat{D}(M)$  and  $\hat{D}(N)$  to have diagrams of  $i\text{-deg} < k$  but with some  $[g]^-$ -colored legs or with loops, thus we need to check that this kind of diagrams do not contribute any terms of  $i\text{-deg} \leq k$  to

$$(\hat{D}(M \circ N))_{|j^-, \text{ loops} \mapsto 0} = D(M \circ N).$$

The diagrams with loops remain with loops after the pairing (5.5), so they do not contribute any term to  $D(M \circ N)$ . Let  $E$  be a diagram of  $i\text{-deg} < k$  without loops and having  $[g]^-$ -colored legs, suppose that  $E$  appears in  $\hat{D}(M)$ , hence all terms in  $E' := E_{|j^+ \mapsto j^* + j^+ + \Delta \cdot j^-}$  still has  $[g]^-$ -colored legs. Therefore all the diagrams obtained from  $E'$  after the pairing (5.5) still have  $[g]^-$ -colored legs, so they do not appear in  $D(M \circ N)$ . Now suppose that  $E$  appears in  $\hat{D}(N)$ . In this case  $E'' := E_{|j^- \mapsto j^* + j^-}$  can be written as  $E'' = E_1 + E_2$ , where  $E_1$  is a linear combination of diagrams with  $[g]^-$ -colored legs and  $E_2$  is a linear combination of diagrams without  $[g]^-$ -colored legs. The diagrams of  $E_1$  do not contribute to  $D(M \circ N)$  as in the previous case. The diagrams obtained from  $E_2$  after the pairing (5.5) could only contribute diagrams of  $i\text{-deg} > k$  to  $D(M \circ N)$ . Summarizing, we have shown that  $D(M \circ N) = \emptyset + (i\text{-deg} \geq k)$ . It remains to show that the terms of  $i\text{-deg} = k$  are exactly those given by  $D_k + D'_k$ . This can be easily checked by using formula (5.5).  $\square$

The above proposition shows that  $\mathcal{F}_k \mathcal{C}$  is a monoid and that we can define homomorphisms

$$\tilde{Z}_k^{Y,t,+} : \mathcal{F}_k \mathcal{C} \longrightarrow \mathcal{A}_k^{Y,t,c}([g]^+),$$

for all  $k \geq 1$ , where  $\tilde{Z}_k^{Y,t,+}(M)$  denotes the terms of  $i\text{-deg} = k$  in  $\tilde{Z}^{Y,t,+}(M)$  for  $M \in J_k^L \mathcal{C}$ . The following theorem shows that the upper tree filtration coincides with the Johnson-Levine filtration, and makes explicit the relation between the LMO functor and the Johnson-Levine homomorphisms.

**Theorem 5.4.** *For all  $k \geq 1$ ,*

$$\mathcal{F}_k \mathcal{C} = J_k^L \mathcal{C}. \quad (5.6)$$

Moreover, if  $M \in J_k^L \mathcal{C}$  then

$$\tilde{Z}_k^{Y,t,+}(M) = \emptyset - \tau_k^L(M) + (i\text{-deg} > k). \quad (5.7)$$

*Proof.* Notice that if equality (5.7) holds then  $\mathcal{F}_{k+1} \mathcal{C} = J_{k+1}^L \mathcal{C}$ . From the definitions,  $\mathcal{F}_1 \mathcal{C} = \mathcal{ILC} = J_1^L \mathcal{C}$ . Therefore, it is enough to show that equality (5.6) implies equality (5.7) for all  $k \geq 1$ .

Let  $M \in J_k^L \mathcal{C} = \mathcal{F}_k \mathcal{C}$ . Theorem 4.9 allows us to write

$$\{M\}_{Y_{k+1}} = \{N\}_{Y_{k+1}} \{P\}_{Y_{k+1}},$$

with  $N \in J_k \mathcal{C}$  and  $P \in \mathcal{HC} \cap \mathcal{ILC}$ . From Lemma 4.6 it follows that  $\tau_k^L(P) = 0$ . Hence by the invariance of  $\tau_k^L$  under  $Y_{k+1}$ -surgery (see subsection 4.2), we have

$$\tau_k^L(M) = \tau_k^L(N) + \tau_k^L(P) = \tau_k^L(N).$$

By Proposition 4.2, we conclude that  $\tau_k^L(M)$  is equal to the reduction of  $\tau_k(N)$  under the map  $\iota_* : D_k(H) \rightarrow D_k(H')$ .

Besides, by the invariance under  $Y_{k+1}$ -surgery of the  $i\text{-deg} = k$  part of the LMO functor and Proposition 5.3, we have

$$\tilde{Z}_k^{Y,t,+}(M) = \tilde{Z}_k^{Y,t,+}(N) + \tilde{Z}_k^{Y,t,+}(P).$$

The monoid  $\mathcal{HC}$  is contained in the category of *special Lagrangian cobordisms* introduced in [8]. For every cobordism  $Q$  of this kind, it was proved in [8, Corollary 5.4] that  $(\tilde{Z}(Q))|_{j \rightarrow 0} = \emptyset$ . Now  $P \in \mathcal{HC} \cap \mathcal{ILC}$ , so we have  $\tilde{Z}_k^{Y,t,+}(P) = 0$ . It follows from Theorem 8.19 in [8] that  $\tilde{Z}_k^{Y,t,+}(N)$  is the reduction of  $-\tau_k(N)$  under the map  $\iota_* : D_k(H) \rightarrow D_k(H')$ , and so it is for  $\tilde{Z}_k^{Y,t,+}(M)$ . Hence the theorem follows.  $\square$

As an immediate consequence of the above theorem we have the following corollary.

**Corollary 5.5.** *For  $M \in J_k^L \mathcal{C}$ , the upper tree reduction of the LMO functor of internal degree  $k$ ,  $\tilde{Z}_k^{Y,t,+}(M)$ , is independent of the choice of a Drinfeld associator. Moreover,*

$$(\tilde{Z}_k^{Y,t,+}(M))|_{j \rightarrow \iota_*(b_j)} \in \mathcal{T}_k(H') \otimes \mathbb{Q}$$

*is also independent of the choice of the system of meridians and parallels used in the definition of the LMO functor.*

## Chapter 2

# Alternative versions of the Johnson homomorphisms and the LMO functor

**Abstract.** Let  $\Sigma$  be a compact connected oriented surface with one boundary component and let  $\mathcal{M}$  denote the mapping class group of  $\Sigma$ . By considering the action of  $\mathcal{M}$  on the fundamental group of  $\Sigma$  it is possible to define different filtrations of  $\mathcal{M}$  together with some homomorphisms on each term of the filtration. The aim of this paper is twofold. Firstly we study a filtration of  $\mathcal{M}$  introduced recently by Habiro and Massuyeau, whose definition involves a handlebody bounded by  $\Sigma$ . We shall call it the “*alternative Johnson filtration*”, and the corresponding homomorphisms are referred to as “*alternative Johnson homomorphisms*”. We provide a comparison between the alternative Johnson filtration and two previously known filtrations: the original Johnson filtration and the Johnson-Levine filtration. Secondly, we study the relationship between the alternative Johnson homomorphisms and the functorial extension of the Le-Murakami-Ohtsuki invariant of 3-manifolds. We prove that these homomorphisms can be read in the tree reduction of the LMO functor. In particular, this provides a new reading grid for the tree reduction of the LMO functor.

## 1 Introduction

Let  $\Sigma$  be a compact connected oriented surface with one boundary component and let  $\mathcal{M}$  denote the *mapping class group* of  $\Sigma$ , that is, the group of isotopy classes of orientation-preserving self-homeomorphisms of  $\Sigma$  fixing the boundary pointwise. The group  $\mathcal{M}$  is not only an important object in the study of the topology of surfaces but also plays an important role in the study of 3-manifolds, Teichmüller spaces, topological quantum field theories, among other branches of mathematics.

A natural way to study  $\mathcal{M}$  is to analyse the way it acts on other objects. For instance, we can consider the action on the first homology group  $H := H_1(\Sigma; \mathbb{Z})$  of  $\Sigma$ . This action gives rise to the so-called *symplectic representation*

$$\sigma : \mathcal{M} \longrightarrow \mathrm{Sp}(H, \omega),$$

where  $\omega : H \otimes H \rightarrow \mathbb{Z}$  is the intersection form of  $\Sigma$  and  $\mathrm{Sp}(H, \omega)$  is the group of automorphisms of  $H$  preserving  $\omega$ . The homomorphism  $\sigma$  is surjective but it is far from being injective. Its kernel is known as the *Torelli group* of  $\Sigma$ , denoted by  $\mathcal{I}$ . Hence we have the short exact sequence

$$1 \longrightarrow \mathcal{I} \xrightarrow{\subset} \mathcal{M} \xrightarrow{\sigma} \mathrm{Sp}(H, \omega) \longrightarrow 1. \quad (1.1)$$

We can see that, in order to understand the algebraic structure of  $\mathcal{M}$ , the Torelli group  $\mathcal{I}$  deserves significant attention because, in a certain way, it is the part of  $\mathcal{M}$  that is beyond linear algebra (at least with respect to the symplectic representation).

More interestingly, we can consider the action of  $\mathcal{M}$  on the fundamental group  $\pi := \pi_1(\Sigma, *)$  for a fixed point  $* \in \partial\Sigma$ . This way we obtain an injective homomorphism

$$\rho : \mathcal{M} \longrightarrow \mathrm{Aut}(\pi),$$

which is known as the *Dehn-Nielsen-Baer representation* and whose image is the subgroup of automorphisms of  $\pi$  that fix the homotopy class of the boundary of  $\Sigma$ .

**Johnson-type filtrations.** As stepwise approximations of  $\rho$ , we can consider the action of  $\mathcal{M}$  on the nilpotent quotients of  $\pi$

$$\rho_m : \mathcal{M} \longrightarrow \text{Aut}(\pi/\Gamma_{m+1}\pi),$$

where  $\Gamma_1\pi := \pi$  and  $\Gamma_{m+1}\pi := [\pi, \Gamma_m\pi]$  for  $m \geq 1$ , define the *lower central series* of  $\pi$ . This is the approach pursued by D. Johnson [32] and S. Morita [51]. This approach allows to define the *Johnson filtration*

$$\mathcal{M} \supseteq \mathcal{I} = J_1\mathcal{M} \supseteq J_2\mathcal{M} \supseteq J_3\mathcal{M} \supseteq \cdots \quad (1.2)$$

where  $J_m\mathcal{M} := \ker(\rho_m)$ .

Now, there is a deep interaction between the study of 3-manifolds and that of the mapping class group. For instance through *Heegaard splittings*, that is, by gluing two handlebodies via an element of the mapping class group of their common boundary. Thus, if we are interested in this interaction, it is natural to consider the surface  $\Sigma$  as the boundary of a handlebody  $V$ . Let  $\iota : \Sigma \hookrightarrow V$  denote the induced inclusion and let  $B := H_1(V; \mathbb{Z})$  and  $\pi' := \pi_1(V, \iota(*))$ . Let  $A$  and  $\mathbb{A}$  be the subgroups  $\ker(H \xrightarrow{\iota_*} B)$  and  $\ker(\pi \xrightarrow{\iota_\#} \pi')$ , where  $\iota_*$  and  $\iota_\#$  are the induced maps by  $\iota$  in homology and homotopy, respectively. The *Lagrangian mapping class group* of  $\Sigma$  is the group

$$\mathcal{L} = \{f \in \mathcal{M} \mid f_*(A) \subseteq A\}.$$

By considering a descending series  $(K_m)_{m \geq 1}$  of normal subgroups of  $\pi$  (different from the lower central series) K. Habiro and G. Massuyeau introduced in [28] a filtration of the Lagrangian mapping class group  $\mathcal{L}$ :

$$\mathcal{L} \supseteq \mathcal{I}^a = J_1^a\mathcal{M} \supseteq J_2^a\mathcal{M} \supseteq J_3^a\mathcal{M} \supseteq \cdots \quad (1.3)$$

that we call the *alternative Johnson filtration*. We call the first term  $\mathcal{I}^a := J_1^a\mathcal{M}$  of this filtration the *alternative Torelli group*. Notice that  $\mathcal{I}^a$  is a normal subgroup of  $\mathcal{L}$  but it is not normal in  $\mathcal{M}$ . Roughly speaking, the group  $K_m$  consists of commutators of  $\pi$  of *weight*  $m$ , where the elements of  $\mathbb{A}$  are considered to have weight 2, for instance  $K_1 = \pi$ ,  $K_2 = \mathbb{A} \cdot \Gamma_2\pi$ ,  $K_3 = [\mathbb{A}, \pi] \cdot \Gamma_3\pi$  and so on. The alternative Johnson filtration will be our main object of study in Section 4.

Besides, in [43, 46] J. Levine defined a different filtration of  $\mathcal{L}$  by considering the lower central series of  $\pi'$ , and whose first term is the *Lagrangian Torelli group*  $\mathcal{I}^L = \{f \in \mathcal{L} \mid f_*|_A = \text{Id}_A\}$ :

$$\mathcal{L} \supseteq \mathcal{I}^L = J_1^L\mathcal{M} \supseteq J_2^L\mathcal{M} \supseteq J_3^L\mathcal{M} \supseteq \cdots \quad (1.4)$$

we call this filtration the *Johnson-Levine filtration*. The group  $\mathcal{I}^L$  is normal in  $\mathcal{L}$  but not in  $\mathcal{M}$ .

We refer to the Johnson filtration, the alternative Johnson filtration and the Johnson-Levine filtration as *Johnson-type filtrations*. Notice that unlike the Johnson filtration the alternative Johnson filtration takes into account a handlebody. Besides, the intersection of all terms in the alternative Johnson filtration is the identity of  $\mathcal{M}$  as in the case of the Johnson filtration. But this is not the case for the Johnson-Levine filtration. One of the main purposes of this paper is the study of the alternative Johnson filtration and its relation with the other two filtrations. Proposition 4.9 and Proposition 4.13 give the following result.

**Theorem A.** *The alternative Johnson filtration satisfies the following properties.*

- (i)  $\bigcap_{m \geq 1} J_m^a\mathcal{M} = \{\text{Id}_\Sigma\}$ .
- (ii) For all  $k \geq 1$  the group  $J_k^a\mathcal{M}$  is residually nilpotent, that is,  $\bigcap_m \Gamma_m J_k^a\mathcal{M} = \{\text{Id}_\Sigma\}$ .

Besides, for every  $m \geq 1$ , we have

$$(iii) \quad J_{2m}^a\mathcal{M} \subseteq J_m\mathcal{M}, \quad (iv) \quad J_m\mathcal{M} \subseteq J_{m-1}^a\mathcal{M}, \quad (v) \quad J_m^a\mathcal{M} \subseteq J_{m+1}^L\mathcal{M},$$

where  $J_0^a \mathcal{M} = \mathcal{L}$ . In particular, the Johnson filtration and the alternative Johnson filtration are cofinal.

**Johnson-type homomorphisms.** Each term of the Johnson-type filtrations comes with a homomorphism whose kernel is the next subgroup in the filtration. We refer to these homomorphisms as *Johnson-type homomorphisms*. The *Johnson homomorphisms* are important tools to understand the structure of the Torelli group and the topology of homology 3-spheres [34, 49, 50, 52]. Let us review the target spaces of these homomorphisms. For an abelian group  $G$ , we denote by  $\mathfrak{Lie}(G) = \bigoplus_{m \geq 1} \mathfrak{Lie}_m(G)$  the graded Lie algebra freely generated by  $G$  in degree 1.

The  $m$ -th *Johnson homomorphism*  $\tau_m$  is defined on  $J_m \mathcal{M}$  and it takes values in the group  $\text{Der}_m(\mathfrak{Lie}(H))$  of degree  $m$  derivations of  $\mathfrak{Lie}(H)$ . Consider the element  $\Omega \in \mathfrak{Lie}_2(H)$  determined by the intersection form  $\omega : H \otimes H \rightarrow \mathbb{Z}$ . A *symplectic derivation*  $d$  of  $\mathfrak{Lie}(H)$  is a derivation satisfying  $d(\Omega) = 0$ . S. Morita shows in [51] that for  $h \in J_m \mathcal{M}$ , the morphism  $\tau_m(h)$  defines a symplectic derivation of  $\mathfrak{Lie}(H)$ . The group of symplectic degree  $m$  derivations of  $\mathfrak{Lie}(H)$  can be canonically identified with the kernel  $D_m(H)$  of the Lie bracket  $[\cdot, \cdot] : H \otimes \mathfrak{Lie}_{m+1}(H) \rightarrow \mathfrak{Lie}_{m+2}(H)$ . This way, for  $m \geq 1$  we have homomorphisms

$$\tau_m : J_m \mathcal{M} \longrightarrow D_m(H).$$

The  $m$ -th *Johnson-Levine homomorphism*  $\tau_m^L : J_m^L \mathcal{M} \rightarrow D_m(B)$  is defined on  $J_m^L \mathcal{M}$  and it takes values in the kernel  $D_m(B)$  of the Lie bracket  $[\cdot, \cdot] : B \otimes \mathfrak{Lie}_{m+1}(B) \rightarrow \mathfrak{Lie}_{m+2}(B)$ .

For the *alternative Johnson homomorphisms* [28], consider the graded Lie algebra  $\mathfrak{Lie}(B; A)$  freely generated by  $B$  in degree 1 and  $A$  in degree 2. The  $m$ -th *alternative Johnson homomorphism*  $\tau_m^a : J_m^a \mathcal{M} \rightarrow \text{Der}_m(\mathfrak{Lie}(B; A))$  is defined on  $J_m^a \mathcal{M}$  and it takes values in the group  $\text{Der}_m(\mathfrak{Lie}(B; A))$  of degree  $m$  derivations of  $\mathfrak{Lie}(B; A)$ . Similarly to the case of  $\mathfrak{Lie}(H)$ , we define a notion of *symplectic derivation* of  $\mathfrak{Lie}(B; A)$  by considering the element  $\Omega' \in \mathfrak{Lie}_3(B; A)$  defined by the intersection form of the handlebody  $V$ . Theorem 5.9 and Proposition 5.11 give the following result.

**Theorem B.** *Let  $m \geq 1$  and  $h \in J_m^a \mathcal{M}$ . Then*

- (i) *The morphism  $\tau_m^a(h)$  defines a degree  $m$  symplectic derivation of  $\mathfrak{Lie}(B; A)$ .*
- (ii) *The morphism  $\tau_{m+1}^L(h)$  is determined by the morphism  $\tau_m^a(h)$ .*

Property (ii) in Theorem B can be expressed more precisely by the commutativity of the diagram

$$\begin{array}{ccc} J_m^a \mathcal{M} & \xrightarrow{\subseteq} & J_{m+1}^L \mathcal{M} \\ \tau_m^a \downarrow & & \downarrow \tau_{m+1}^L \\ D_m(B; A) & \xrightarrow{\iota_*} & D_{m+1}(B), \end{array}$$

for  $m \geq 1$ , where the inclusion  $J_m^a \mathcal{M} \subseteq J_{m+1}^L \mathcal{M}$  is assured by Theorem A (v). The homomorphism  $\iota_* : D_m(B; A) \rightarrow D_{m+1}(B)$  is induced by the map  $\iota_* : H \rightarrow B$ . Property (i) in Theorem B allows to define a *diagrammatic version* of the alternative Johnson homomorphisms so that we are able to study their relation to the *LMO functor*. This is the second main purpose of this paper. Before we proceed with a description of our results in this setting, let us state another result in the context of the alternative Johnson homomorphisms. In [28], K. Habiro and G. Massuyeau consider a group homomorphism  $\tau_0^a : \mathcal{L} \rightarrow \text{Aut}(\mathfrak{Lie}(B; A))$ , which we call the *0-th alternative Johnson homomorphism*, and whose kernel is the alternative Torelli group  $\mathcal{I}^a$ . In subsection 5.3 we prove the following.

**Theorem C.** *The homomorphism  $\tau_0^a : \mathcal{L} \rightarrow \text{Aut}(\mathfrak{Lie}(B; A))$  can be equivalently described as a group homomorphism  $\tau_0^a : \mathcal{L} \rightarrow \text{Aut}(B) \times \text{Hom}(A, \Lambda^2 B)$  for a certain action of  $\text{Aut}(B)$  on  $\text{Hom}(A, \Lambda^2 B)$ . The kernel of  $\tau_0^a$  is the second term  $J_2^L \mathcal{M}$  of the Johnson-Levine filtration. In particular we have  $\mathcal{I}^a = J_1^a \mathcal{M} = J_2^L \mathcal{M}$ .*

Moreover, we explicitly describe the image  $\mathcal{G} := \tau_0^a(\mathcal{L})$  and then we obtain the short exact sequence

$$1 \longrightarrow \mathcal{I}^a \xrightarrow{\subseteq} \mathcal{L} \xrightarrow{\tau_0^a} \mathcal{G} \longrightarrow 1. \quad (1.5)$$



This short exact sequence has a similar role, in the context of the alternative Johnson homomorphisms, to that of the short exact sequence (1.1) in the context of the Johnson homomorphisms. This is because in [28] the authors prove that the alternative Johnson homomorphisms satisfy an equivariant property with respect to the homomorphism  $\tau_0^{\mathfrak{a}}$ , which is the analogue of the Sp-equivariant property of the Johnson homomorphisms. Hence the short exact sequence (1.5) can be important for a further development of the study of the alternative Johnson filtration.

**Relation with the LMO functor.** After the discovery of the Jones polynomial and the advent of many new invariants, the so-called *quantum invariants*, of links and 3-manifolds, it became necessary to “organize” these invariants. The theory of *finite-type (Vassiliev-Goussarov) invariants* in the case of links and the theory of *finite-type (Goussarov-Habiro) invariants* in the case of 3-manifolds, provide an efficient way to do this task. An important success was achieved with the introduction of the *Kontsevich integral* for links [36, 1] and the *Le-Murakami-Ohtsuki invariant* for 3-manifolds [38], because they are *universal* among rational finite-type invariants. Roughly speaking, this property says that every  $\mathbb{Q}$ -valued finite-type invariant is determined by the Kontsevich integral in the case of links or by the LMO invariant in the case of homology 3-spheres.

The LMO invariant was extended to a TQFT (Topological quantum field theory) in [53, 9, 8]. We follow the work of D. Cheptea, K. Habiro and G. Massuyeau in [8], where they extend the LMO invariant to a functor  $\tilde{Z} : \mathcal{LCob}_q \rightarrow {}^t\mathcal{A}$ , called the *LMO functor*, from the category of *Lagrangian cobordisms* (cobordisms satisfying a homological condition) between bordered surfaces to a category of *Jacobi diagrams* (uni-trivalent graphs up to some relations). See Figure 1.1 for some examples of Jacobi diagrams. There is still a lack of understanding of the topological information encoded by the LMO functor. One reason for this is that the construction of the LMO functor takes several steps and also uses several combinatorial operations on the space of Jacobi diagrams. This motivates the search of topological interpretations of some reductions of the LMO functor through known invariants, some results in this direction were obtained in [8, 47, 66]. The second main purpose of this paper is to give a topological interpretation of the tree reduction of the LMO functor through the alternative Johnson homomorphisms.

A *homology cobordism* of  $\Sigma$  is a homeomorphism class of pairs  $(M, m)$  where  $M$  is a compact oriented 3-manifold and  $m : \partial(\Sigma \times [-1, 1]) \rightarrow \partial M$  is an orientation-preserving homeomorphism such that the *top* and *bottom* restrictions  $m_{\pm}|_{\Sigma \times \{\pm 1\}} : \Sigma \times \{\pm 1\} \rightarrow M$  of  $m$  induce isomorphisms in homology. Denote by  $\mathcal{C}$  the monoid of homology cobordisms of  $\Sigma$  (or  $\mathcal{C}_{g,1}$  where  $g$  is the genus of  $\Sigma$ ). In particular, if  $h \in \mathcal{M}$ , we can consider the homology cobordism  $c(h) := (\Sigma \times [-1, 1], m^h)$  where  $m^h$  is such that  $m_+^h = h$  and  $m_-^h = \text{Id}_{\Sigma}$ . Moreover,  $h \in \mathcal{L}$  if and only if the cobordism  $c(h)$  is a Lagrangian cobordism. Thus  $c(h)$  belongs to the source category of the LMO functor and therefore we can compute  $\tilde{Z}(c(h))$ .

The alternative Johnson homomorphisms motivate the definition of the *alternative degree*, denoted  $\mathfrak{a}\text{-deg}$ , for connected tree-like Jacobi diagrams. If  $T$  is a tree-like Jacobi diagram colored by  $B \oplus A$ , then

$$\mathfrak{a}\text{-deg}(T) = 2|T_A| + |T_B| - 3,$$

where  $|T_A|$  (respectively  $|T_B|$ ) denotes the number of univalent vertices of  $T$  colored by  $A$  (respectively by  $B$ ). See Figure 1.1 (a) and (b) for some examples.

Denote by  $\mathcal{T}_m^{Y,\mathfrak{a}}(B \oplus A)$  the space generated by tree-like Jacobi diagrams colored by  $B \oplus A$  with at least one trivalent vertex and with  $\mathfrak{a}\text{-deg} = m$ . For a Lagrangian cobordism  $M$  let  $\tilde{Z}^t(M)$  denote the reduction of  $\tilde{Z}(M)$  modulo *looped* diagrams, that is, diagrams with a non-contractible connected component. See Figure 1.1 (c) for an example of a looped diagram. This way,  $\tilde{Z}^t(M)$  consists only of tree-like Jacobi diagrams. The first step to relate the alternative Johnson homomorphisms with the LMO functor is given in Theorem 6.5 where we prove the following.

**Theorem D.** *The alternative degree induces a filtration  $\{\mathcal{F}_m^{\mathfrak{a}}\}_{m \geq 1}$  of  $\mathcal{C}$  by submonoids. Consider the map*

$$\tilde{Z}_m^{Y,\mathfrak{a}} : \mathcal{F}_m^{\mathfrak{a}} \mathcal{C} \longrightarrow \mathcal{T}_m^{Y,\mathfrak{a}}(B \oplus A),$$

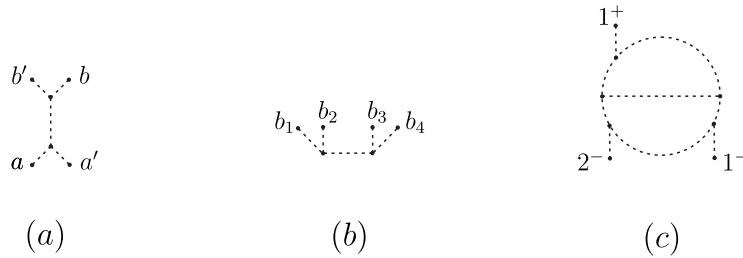


Figure 1.1: Tree-like Jacobi diagrams of  $\mathbf{a}\text{-deg} = 3$  in (a) and of  $\mathbf{a}\text{-deg} = 1$  in (b). (c) Looped Jacobi diagram. Here  $a, a' \in A$  and  $b, b', b_1, \dots, b_4 \in B$ .

where  $\tilde{Z}_m^{Y,\mathbf{a}}(M)$  is defined as the Jacobi diagrams with at least one trivalent vertex and of  $\mathbf{a}\text{-deg} = m$  in  $\tilde{Z}^t(M)$  for  $M \in \mathcal{F}_m^{\mathbf{a}}\mathcal{C}$ . Then  $\tilde{Z}_m^{Y,\mathbf{a}}$  is a monoid homomorphism.

In Theorem 6.14 and Theorem 6.16 we prove the following.

**Theorem E.** The alternative Johnson homomorphisms can be read in the tree-reduction of the LMO functor.

More precisely, we prove that for  $h \in J_m^{\mathbf{a}}\mathcal{M}$  with  $m \geq 2$ , the value  $\tilde{Z}_m^{Y,\mathbf{a}}(c(h))$  coincides (up to a sign) with the diagrammatic version of  $\tau_m^{\mathbf{a}}(h)$ . For  $h \in J_1^{\mathbf{a}}\mathcal{M}$ , we show that  $\tau_1^{\mathbf{a}}(h)$  is given by  $\tilde{Z}_1^{Y,\mathbf{a}}(c(h))$  together with the diagrams without trivalent vertices in  $\tilde{Z}(c(h))$  of  $\mathbf{a}\text{-deg} = 1$ . The techniques for the proof of Theorem E in the case  $m = 1$  (Theorem 6.14) and  $m \geq 2$  (Theorem 6.16) are different. For  $m = 1$  we need to do some explicit computations of the LMO functor and a comparison between the first alternative Johnson homomorphism and the first Johnson homomorphism. For  $m \geq 2$ , the key point is the fact that the LMO functor defines an *alternative symplectic expansion* of  $\pi$ . To show this, we use a result of Massuyeau [47] where he proves that the LMO functor defines a symplectic expansion of  $\pi$ .

Theorem D and Theorem E provide a new reading grid of the tree reduction of the LMO functor by the alternative degree. Theorem E follows the same spirit of a result of D. Cheptea, K. Habiro and G. Massuyeau in [8] and of the author in [66] where they prove that the Johnson homomorphisms and the Johnson-Levine homomorphisms, respectively, can be read in the tree-reduction of the LMO functor.

Notice that Theorem D holds in the context of homology cobordisms, as do the results that we use to prove Theorem E. This suggests that the alternative Johnson homomorphisms and Theorem E could be generalized to the setting of homology cobordisms, but we have not explored this issue so far.

The organization of the paper is as follows. In Section 2 we review the definition of several spaces of Jacobi diagrams and some operations on them as well as some explicit computations. Section 3 deals with the Kontsevich integral and the LMO functor, in particular we do some explicit computations that are needed in the following sections. Section 4 and Section 5 provide a detailed exposition of the alternative Johnson filtration and the alternative Johnson homomorphisms, in particular we prove Theorem A, B and C. Finally, Section 6 is devoted to the topological interpretation of the LMO functor through the alternative Johnson homomorphisms, in particular we prove Theorem D and E.

**Reading guide.** The reader more interested in the mapping class group could skip Section 2 and Section 3 and go directly to Section 4 and Section 5 (skipping subsection 5.4) referring to the previous sections only when needed. The reader familiar with the LMO functor and more interested in the topological interpretation of its tree reduction through the alternative Johnson homomorphisms can go directly to Section 3. Then go to subsection 4.3 and subsection 5.2 to the necessary definitions to read Section 6.

**Notations and conventions.** All subscripts appearing in this work are non-negative integers. When we write  $m \geq 0$  or  $m \geq 1$  we always mean that  $m$  is an integer. We use the blackboard framing convention on all drawings of knotted objects. We usually abbreviate simple closed curve as scc. By a Dehn twist we mean a left-handed Dehn twist.

**Acknowledgements.** I am deeply grateful to my advisor Gwénaél Massuyeau for his encouragement, helpful advice and careful reading. I thank sincerely Takuya Sakasai for helpful and stimulating discussions, in particular for explaining to me Remark 4.15.

## 2 Spaces of Jacobi diagrams and their operations

In this section we review several spaces of diagrams which are the target spaces of the Kontsevich integral, LMO functor and Johnson-type homomorphisms. We refer to [1, 56] for a detailed discussion on the subject. Throughout this section let  $X$  denote a compact oriented 1-manifold (possibly empty) whose connected components are ordered and let  $C$  denote a finite set (possibly empty).

### 2.1 Generalities

A *vertex-oriented univalent graph* is a finite graph whose vertices are univalent (*legs*) or trivalent, and such that for each trivalent vertex the set of half-edges incident to it is cyclically ordered.

A *Jacobi diagram* on  $(X, C)$  is a vertex-oriented univalent graph whose legs are either embedded in the interior of  $X$  or are colored by the  $\mathbb{Q}$ -vector space generated by  $C$ . Two Jacobi diagrams are considered to be the same if there is an orientation-preserving homeomorphism between them respecting the order of the connected components, the vertex orientation of the trivalent vertices and the colorings of the legs. For drawings of Jacobi diagrams we use solid lines to represent  $X$ , dashed lines to represent the univalent graph and we assume that the orientation of trivalent vertices is counterclockwise. See Figure 2.1 for some examples.

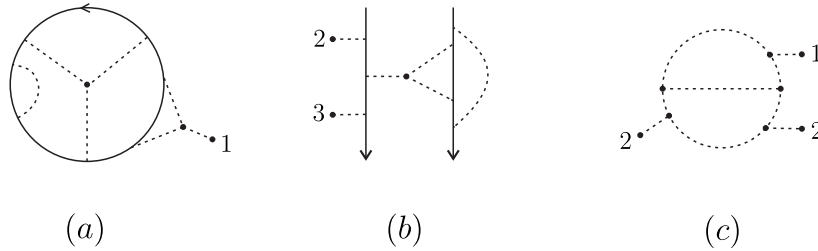


Figure 2.1: Jacobi diagrams with  $X = \circlearrowleft$  in (a),  $X = \downarrow\downarrow$  in (b) and  $X = \emptyset$  in (c). Here  $C = \{1, 2, 3\}$ .

The *space of Jacobi diagrams on  $(X, C)$*  is the  $\mathbb{Q}$ -vector space:

$$\mathcal{A}(X, C) = \frac{\text{Vect}_{\mathbb{Q}}\{\text{Jacobi diagrams on } (X, C)\}}{\text{STU, AS, IHX, } \mathbb{Q}\text{-multilinearity}},$$

where the relations STU, AS, IHX are local and the multilinearity relation applies to the colored legs. See Figure 2.2.

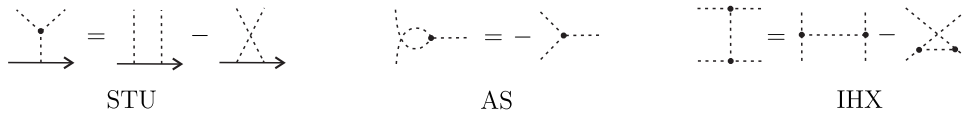


Figure 2.2: Relations on Jacobi diagrams.

If  $X$  is not empty, it is well known that, for diagrams  $D \in \mathcal{A}(X, C)$  such that every connected component of  $D$  has at least one leg attached to  $X$ , the STU relation implies the AS and IHX relations, see [1, Theorem 6]. We can also define the space  $\mathcal{A}(X, G)$  for any finitely generated free abelian group  $G$  as  $\mathcal{A}(X, G) = \mathcal{A}(X, C)$ , where  $C$  is any finite set of free generators of  $G$ . If  $X$  or  $C$  is empty we drop it from the notation. For  $D \in \mathcal{A}(X, C)$  we define the *internal degree*, the *external degree* and *total degree*; denoted  $\text{i-deg}(D)$ ,  $\text{e-deg}(D)$  and  $\text{deg}(D)$  respectively, as

$$\text{i-deg}(D) := \text{number of trivalent vertices of } D,$$

$$\begin{aligned} \text{e-deg}(D) &:= \text{number of legs of } D, \\ \text{deg}(D) &:= \frac{1}{2}(\text{i-deg}(D) + \text{e-deg}(D)). \end{aligned}$$

This way, the space  $\mathcal{A}(X, C)$  is graded with the total degree. We still denote by  $\mathcal{A}(X, C)$  its degree completion.

**Example 2.1.** A connected Jacobi diagram in  $\mathcal{A}(C)$  without trivalent vertices is called a *strut*. See Figure 2.3 (a). For a matrix  $\Lambda = (l_{ij})$  with entries indexed by a finite set  $C$ , we define the element  $[\Lambda]$  in  $\mathcal{A}(C)$  by

$$[\Lambda] := \left[ \sum_{i,j \in C} l_{ij} \begin{array}{c} \cdot \\ \vdots \\ j \\ \vdots \\ i \end{array} \right] = \exp_{\sqcup} \left( \sum_{i,j \in C} l_{ij} \begin{array}{c} \cdot \\ \vdots \\ j \\ \vdots \\ i \end{array} \right).$$

**Example 2.2.** For a positive integer  $n$ , denote by  $[n]^*$  the set  $\{1^*, \dots, n^*\}$ , where  $*$  is one of the symbols  $+$ ,  $-$  or  $*$  itself. For instance the morphisms in the target category of the LMO functor are subspaces of the spaces  $\mathcal{A}([g]^+ \sqcup [f]^-)$  for  $g$  and  $f$  positive integers. See Figure 2.3 (b).

**Example 2.3.** A Jacobi diagram in  $\mathcal{A}(C)$  is *looped* if it has a non-contractible component, see Figure 2.3 (b). The space of *tree-like Jacobi diagrams* colored by  $C$ , denoted by  $\mathcal{A}^t(C)$ , is the quotient of  $\mathcal{A}(C)$  by the subspace generated by looped diagrams. The space of *connected tree-like Jacobi diagrams* colored by  $C$ , denoted by  $\mathcal{A}^{t,c}(C)$ , is the subspace of  $\mathcal{A}^t(C)$  spanned by connected Jacobi diagrams in  $\mathcal{A}^t(C)$ . For instance the spaces  $\mathcal{A}^{t,c}(G)$ , for  $G$  some particular abelian groups, are the target of the diagrammatic versions of the Johnson-type homomorphisms. See Figure 2.3 (c) for an example of a connected tree-like Jacobi diagram.

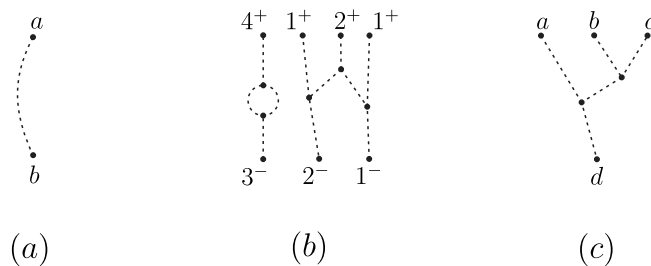


Figure 2.3: (a) Strut, (b) Jacobi diagram in  $\mathcal{A}([4]^+ \sqcup [3]^-)$ , (c) Tree-like Jacobi diagram. Here  $a, b, c, d \in C$  where  $C$  is any finite set.

## 2.2 Operations on Jacobi diagrams

Let us recall some operations on the spaces of Jacobi diagrams.

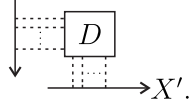
**Hopf algebra structure.** There is a product in  $\mathcal{A}(C)$  given by disjoint union, with unit the empty diagram, and a coproduct defined by  $\Delta(D) = \sum D' \otimes D''$  where the sum ranges over pairs of subdiagrams  $D', D''$  of  $D$  such that  $D' \sqcup D'' = D$ . For instance:

$$\Delta \left( \begin{array}{c} 4^+ \quad 1^+ \quad 2^+ \quad 1^+ \\ \cdot \\ \vdots \\ \cdot \\ \cdot \\ \vdots \\ 3^- \quad 2^- \quad 1^- \end{array} \right) = \emptyset \otimes \begin{array}{c} 4^+ \quad 1^+ \quad 2^+ \quad 1^+ \\ \cdot \\ \vdots \\ \cdot \\ \cdot \\ \vdots \\ 3^- \quad 2^- \quad 1^- \end{array} + \begin{array}{c} 4^+ \quad 1^+ \quad 2^+ \quad 1^+ \\ \cdot \\ \vdots \\ \cdot \\ \cdot \\ \vdots \\ 3^- \quad 2^- \quad 1^- \end{array} \otimes \emptyset + \begin{array}{c} 4^+ \quad 1^+ \quad 2^+ \quad 1^+ \\ \cdot \\ \vdots \\ \cdot \\ \cdot \\ \vdots \\ 3^- \quad 2^- \quad 1^- \end{array} \otimes \begin{array}{c} 1^+ \quad 2^+ \quad 1^+ \\ \cdot \\ \vdots \\ \cdot \\ \cdot \\ \vdots \\ 2^- \quad 1^- \end{array} + \begin{array}{c} 1^+ \quad 2^+ \quad 1^+ \\ \cdot \\ \vdots \\ \cdot \\ \cdot \\ \vdots \\ 2^- \quad 1^- \end{array} \otimes \begin{array}{c} 4^+ \\ \cdot \\ \vdots \\ \cdot \\ \cdot \\ \vdots \\ 3^- \end{array}.$$

With these structures  $\mathcal{A}(C)$  is a co-commutative Hopf algebra with counit the linear map  $\epsilon : \mathcal{A}(C) \rightarrow \mathbb{Q}$  defined by  $\epsilon(\emptyset) = 1$  and  $\epsilon(D) = 0$  for  $D \in \mathcal{A}(C) \setminus \{\emptyset\}$  and with antipode the linear map  $S : \mathcal{A}(C) \rightarrow \mathcal{A}(C)$  defined by  $S(D) = (-1)^{k_D} D$  where  $k_D$  denotes the number of connected components

of  $D \in \mathcal{A}(C)$ . It follows from the definition of the coproduct that the primitive part of  $\mathcal{A}(C)$  is the subspace  $\mathcal{A}^c(C)$  spanned by connected Jacobi diagrams.

**Doubling and orientation-reversal operations.** Suppose that we can decompose the 1-manifold  $X$  as  $X = \downarrow \sqcup X' = \downarrow X'$ , here  $X'$  can be empty. Then given a Jacobi diagram  $D$  on  $\downarrow X'$  it is possible to obtain new Jacobi diagrams  $\Delta(D)$  on  $\downarrow \sqcup X' = \downarrow \downarrow X'$  and  $S(D)$  on  $\uparrow X'$ . Let us represent the Jacobi diagram  $D$  as



Then  $\Delta(D)$  is defined in Figure 2.4, where we use the *box notation* to denote the sum over all the possible ways of gluing the legs of  $D$  attached to the grey box to the two intervals involved in the grey box, in particular if there are  $k$  legs attached to the grey box, there will be  $2^k$  terms in the sum.

$$\Delta(D) = \boxed{\downarrow} \downarrow \downarrow D = \downarrow \downarrow D + \downarrow \downarrow D + \cdots + \downarrow \downarrow D \rightarrow X'$$

Figure 2.4: Definition of the doubling map and box notation.

Besides, the Jacobi diagram  $S(D)$  is given in Figure 2.5.

$$S(D) = (-1)^k \uparrow \downarrow D \rightarrow X'$$

Figure 2.5: Definition of orientation-reversal map. Here we suppose that there are  $k$  legs attached to the chosen interval.

To sum up, we have maps

$$\Delta : \mathcal{A}(\downarrow X') \longrightarrow \mathcal{A}(\downarrow \downarrow X') \quad \text{and} \quad S : \mathcal{A}(\downarrow X') \longrightarrow \mathcal{A}(\uparrow X'), \quad (2.1)$$

called *doubling map* and *orientation reversal map*, respectively. Observe that even if we use the same notation for the doubling map and the coproduct, the respective meaning can be deduced from the context.

**Symmetrization map.** Let us recall the diagrammatic version of the Poincaré-Birkhoff-Witt isomorphism. We follow [1, 10] in our exposition. Let  $D$  be a Jacobi diagram on  $(X, C \sqcup \{s\})$ , we could glue all the  $s$ -colored legs of  $D$  to an interval  $\uparrow_s$  (labelled by  $s$ ) in order to obtain a Jacobi diagram on  $(X \uparrow_s, C)$ , *i.e.* there would not be any  $s$ -colored leg left. But there are many ways of doing this gluing, so we consider the arithmetic mean of all the possible ways of gluing the  $s$ -colored legs of  $D$  to the interval  $\uparrow_s$ . This way we obtain a well defined vector space isomorphism

$$\chi_s : \mathcal{A}(X, C \sqcup \{s\}) \longrightarrow \mathcal{A}(X \uparrow_s, C), \quad (2.2)$$

called *symmetrization map*. It is not difficult to show that the map (2.2) is well defined, but it is more laborious to show that it is bijective, see [1, Theorem 8]. If  $S = \{s_1, \dots, s_l\}$ , it is possible to define, in a similar way, a vector space isomorphism

$$\chi_S : \mathcal{A}(X, C \sqcup S) \longrightarrow \mathcal{A}(X \uparrow_S, C),$$

where  $\uparrow_S = \uparrow_{s_1} \cdots \uparrow_{s_l}$ . More precisely,  $\chi_S = \chi_{s_l} \circ \cdots \circ \chi_{s_1}$ .

**Example 2.4.** Fix  $r \in S$ . Denote by  $\mathcal{H}(r)$  the subspace of  $\mathcal{A}(S)$  generated by Jacobi diagrams with at least one component that is looped or that possesses at least two  $r$ -colored legs. Similarly, denote by  $\mathcal{H}(\uparrow_r)$  the subspace of  $\mathcal{A}(\uparrow_S)$  generated by Jacobi diagrams with at least one dashed component that is looped or that possesses at least two legs attached to  $\uparrow_r$ . Bar-Natan shows in [2, Theorem 1] that  $\chi(\mathcal{H}(r)) = \mathcal{H}(\uparrow_r)$ .



### 3 The Kontsevich integral and the LMO functor

In this section we review the combinatorial definition of the Kontsevich integral from [56, 39]. We also recall the construction of the LMO functor following [8]. We focus on particular examples, which will play an important role in the next sections, rather than in a detailed exposition on the subject.

#### 3.1 Kontsevich Integral

Let us start by recalling some basic notions. Consider the cube  $[-1, 1]^3 \subseteq \mathbb{R}^3$  with coordinates  $(x, y, z)$ . A *framed tangle* in  $[-1, 1]^3$  is a compact oriented framed 1-manifold  $T$  properly embedded in  $[-1, 1]^3$  such that the boundary  $\partial T$  (the *endpoints* of  $T$ ) is uniformly distributed along  $\{0\} \times [-1, 1] \times \{\pm 1\}$  and the framing on the endpoints of  $T$  is the vector  $(0, 1, 0)$ . We draw diagrams of framed tangles using the blackboard framing convention. Let  $T$  be a framed tangle. Denote by  $\partial_t T$  the endpoints of  $T$  lying in  $\{0\} \times [-1, 1] \times \{+1\}$ , we call  $\partial_t T$  the *top boundary* of  $T$ . Similarly,  $\partial_b T$  of  $T$  denotes the *bottom boundary*.

We can associate words  $w_t(T)$  and  $w_b(T)$  on  $\{+, -\}$  to  $\partial_t T$  and  $\partial_b T$  as follows. To an endpoint of  $T$  we associate  $+$  if the orientation of  $T$  goes downwards at that endpoint, and  $-$  if the orientation of  $T$  goes upwards at that endpoint. The words  $w_t(T)$  and  $w_b(T)$  are obtained by reading the corresponding signs in the positive direction of the  $y$  coordinate. See Figure (3.1) (a) for an example of a tangle with its corresponding words.

We consider *non-associative words* on  $\{+, -\}$ , that is, words on  $\{+, -\}$  together with a parenthesization (formally an element of the *free magma* generated by  $\{+, -\}$ ). For instance  $((+-)+)$  and  $(+(-+))$  are the two possible non-associative words obtained from the word  $+ - +$ . From now on we omit the outer parentheses. A *q-tangle* is a framed tangle whose top and bottom words are endowed with a parenthesization. See Figure (3.1) (b) and (c) for two different parenthesizations of the same framed tangle.

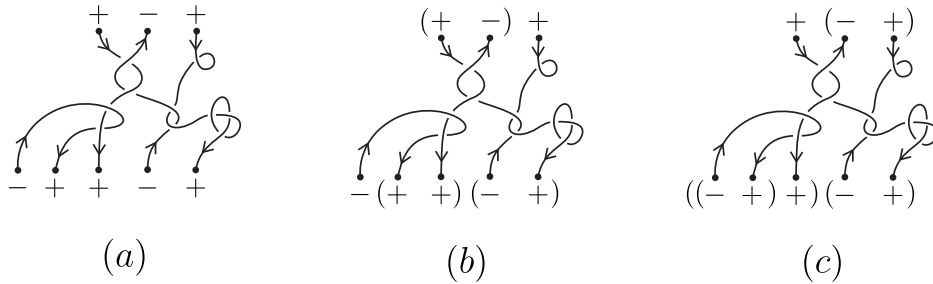


Figure 3.1: A framed tangle and two different  $q$ -tangles obtained from it.

To define the Kontsevich integral it is necessary to fix a particular element  $\Phi \in \mathcal{A}(\downarrow\downarrow\downarrow)$  called an *associator*. The element  $\Phi$  is an exponential series of Jacobi diagrams satisfying several conditions, among these, one “pentagon” and two “hexagon” equations; see [56, (6.11)–(6.13)]. From now on we fix an *even Drinfeld associator*  $\Phi$ , see [3, Corollary 4.2] for the definition and existence. In low degree we have:

$$\Phi = 1 + \frac{1}{24} \downarrow\downarrow\downarrow + \text{deg} \geq 4 \quad \text{and} \quad \Phi^{-1} = 1 - \frac{1}{24} \downarrow\downarrow\downarrow + \text{deg} \geq 4.$$

Here 1 means  $\downarrow\downarrow\downarrow$ . The Kontsevich integral is defined so that:

$$\begin{aligned} Z(T_1 \circ T_2) &= Z(T_1) \circ Z(T_2), \\ Z(T_1 \otimes T_2) &= Z(T_1) \otimes Z(T_2); \end{aligned} \tag{3.1}$$

where the composites  $T_1 \circ T_2$  and  $Z(T_1) \circ Z(T_2)$  and the tensor products  $T_1 \otimes T_2$  and  $Z(T_1) \otimes Z(T_2)$  are defined by vertical and horizontal juxtaposition of  $q$ -tangles and Jacobi diagrams, respectively. Now

every  $q$ -tangle can be expressed as the composition of tensor products of some *elementary  $q$ -tangles*, so it is enough to define the Kontsevich integral on these  $q$ -tangles. Set

$$\nu = \left( \begin{array}{c} \downarrow \\ \boxed{S_2\Phi} \\ \downarrow \end{array} \right)^{-1} = \downarrow + \frac{1}{48} \begin{array}{c} \downarrow \\ \circlearrowleft \\ \downarrow \end{array} + (\text{deg} \geq 4),$$

where  $S_2$  is the orientation-reversal map applied to the second interval. The Kontsevich integral is defined on the elementary  $q$ -tangles as follows:

$$Z \left( \begin{array}{c} (+ \quad +) \\ \swarrow \quad \searrow \\ (+ \quad +) \end{array} \right) = \left[ \frac{1}{2} \begin{array}{c} \downarrow \quad \downarrow \\ \swarrow \quad \searrow \\ \downarrow \quad \downarrow \end{array} \right] = \boxed{\exp\left(\frac{1}{2} \downarrow \downarrow \downarrow\right)} = \begin{array}{c} \downarrow \quad \downarrow \\ \swarrow \quad \searrow \\ \downarrow \quad \downarrow \end{array} + \frac{1}{2} \begin{array}{c} \downarrow \quad \downarrow \\ \swarrow \quad \searrow \\ \downarrow \quad \downarrow \end{array} + \frac{1}{8} \begin{array}{c} \downarrow \quad \downarrow \\ \swarrow \quad \searrow \\ \downarrow \quad \downarrow \end{array} + (\text{deg} \geq 3),$$

$$Z \left( \begin{array}{c} (+ \quad +) \\ \swarrow \quad \searrow \\ (+ \quad +) \end{array} \right) = \left[ \frac{1}{2} \begin{array}{c} \downarrow \quad \downarrow \\ \swarrow \quad \searrow \\ \downarrow \quad \downarrow \end{array} \right] = \boxed{\exp\left(-\frac{1}{2} \downarrow \downarrow \downarrow\right)} = \begin{array}{c} \downarrow \quad \downarrow \\ \swarrow \quad \searrow \\ \downarrow \quad \downarrow \end{array} - \frac{1}{2} \begin{array}{c} \downarrow \quad \downarrow \\ \swarrow \quad \searrow \\ \downarrow \quad \downarrow \end{array} + \frac{1}{8} \begin{array}{c} \downarrow \quad \downarrow \\ \swarrow \quad \searrow \\ \downarrow \quad \downarrow \end{array} + (\text{deg} \geq 3),$$

$$Z \left( \begin{array}{c} \curvearrowright \\ (+ \quad -) \end{array} \right) = \begin{array}{c} \curvearrowright \\ \nu \end{array} = \begin{array}{c} \curvearrowright \\ \downarrow \end{array} + \frac{1}{48} \begin{array}{c} \curvearrowright \\ \circlearrowleft \\ \downarrow \end{array} + (\text{deg} \geq 4), \quad Z \left( \begin{array}{c} (+ \quad -) \\ \curvearrowright \end{array} \right) = \begin{array}{c} \curvearrowright \end{array},$$

$$Z \left( \begin{array}{c} + \quad (++) \\ \downarrow \quad \downarrow \\ (+) \quad (+) \end{array} \right) = \Phi, \quad Z \left( \begin{array}{c} (+) \quad (+) \\ \downarrow \quad \downarrow \\ + \quad (+) \end{array} \right) = \Phi^{-1};$$

and for elementary  $q$ -tangles of the form

$$\begin{array}{c} \bullet \quad \bullet \\ \parallel \\ \bullet \quad \bullet \end{array} \quad \text{and} \quad \begin{array}{c} \bullet \quad \bullet \\ \parallel \\ \bullet \quad \bullet \end{array},$$

where the thick lines represent a trivial tangle and the black dots some non-associative words on  $\{+, -\}$ , the Kontsevich integral is defined by using the doubling and orientation reversal maps, see subsection 2.2, for instance

$$Z \left( \begin{array}{c} + \quad (-+ -) \\ \downarrow \quad \downarrow \quad \downarrow \\ (+) \quad (+) \end{array} \right) = S_4 S_2 \Delta_3 \Phi = 1 - \frac{1}{24} \begin{array}{c} \downarrow \quad \downarrow \\ \swarrow \quad \searrow \\ \downarrow \quad \downarrow \end{array} + \frac{1}{24} \begin{array}{c} \downarrow \quad \downarrow \\ \swarrow \quad \searrow \\ \downarrow \quad \downarrow \end{array} + (\text{deg} \geq 4).$$

Here the subscripts indicate the interval to which the operation is applied. It is known that  $Z$  is well defined and is an isotopy invariant of  $q$ -tangles, see [40, 41]. For a  $q$ -tangle  $T$ , we denote by  $Z^t(T)$  the reduction of  $Z(T)$  modulo looped diagrams, see Example 2.3.

**Example 3.1.**

$$Z \left( \begin{array}{c} (+) \quad (-) \\ \downarrow \quad \downarrow \\ (+) \quad (-) \end{array} \right) = Z \left( \begin{array}{c} (+) \quad (-) \\ \downarrow \quad \downarrow \\ (+) \quad (-) \end{array} \right) = \begin{array}{c} \boxed{S_3 S_2 \Delta_3 \Phi^{-1}} \\ \boxed{S_2 S_1 \Phi} \\ \boxed{S_2 S_1 \Phi^{-1}} \\ \boxed{S_3 S_2 \Delta_3 \Phi} \end{array} = \begin{array}{c} \downarrow \quad \uparrow \quad \uparrow \\ \downarrow \quad \downarrow \quad \uparrow \quad \uparrow \\ \downarrow \quad \uparrow \quad \uparrow \\ \downarrow \quad \uparrow \quad \uparrow \end{array} + (\text{deg} \geq 3).$$





**Example 3.5.** Denote by  $\mathcal{M}_{g,1}$  the *mapping class group* of  $\Sigma_{g,1}$ , i.e. the group of isotopy classes of orientation-preserving homeomorphisms of  $\Sigma_{g,1}$  that fix the boundary  $\partial\Sigma_{g,1}$  pointwise. This group can be embedded into  $\mathcal{C}_{g,1}$  by associating to any  $h \in \mathcal{M}_{g,1}$  the homology cobordism, called *mapping cylinder*,  $c(h) = (\Sigma_{g,1} \times [-1, 1], m^h)$ , where  $m^h : \partial(\Sigma_{g,1} \times [-1, 1]) \rightarrow \partial(\Sigma_{g,1} \times [-1, 1])$  is the orientation-preserving homeomorphism defined by  $m^h(x, 1) = (h(x), 1)$  and  $m^h(x, t) = (x, t)$  for  $t \neq 1$ . This way we have an injective map  $c : \mathcal{M}_{g,1} \rightarrow \mathcal{C}_{g,1}$ . The submonoid  $c(\mathcal{M}_{g,1})$  is precisely the group of invertible elements of  $\mathcal{C}_{g,1}$ , see [27, Proposition 2.4].

There is a more general notion of cobordism. For  $g, f \geq 0$  let  $C_f^g$  denote the compact oriented 3-manifold obtained from  $[-1, 1]^3$  by adding  $g$  (respectively  $f$ ) 1-handles along  $[-1, 1] \times [-1, 1] \times \{+1\}$  (respectively along  $[-1, 1] \times [-1, 1] \times \{-1\}$ ), uniformly in the  $y$  direction. A *cobordism* from  $\Sigma_{g,1}$  to  $\Sigma_{f,1}$  is the homeomorphism class relative to the boundary of a pair  $(M, m)$ , where  $M$  is a compact connected oriented 3-manifold and  $m : \partial C_f^g \rightarrow \partial M$  is an orientation-preserving homeomorphism.

Given a homology cobordism  $(M, m)$  of  $\Sigma_{g,1}$ ; or more generally a cobordism from  $\Sigma_{g,1}$  to  $\Sigma_{f,1}$ . We can associate a particular kind of tangle whose components split in  $f$  bottom components and  $g$  top components (they are called *bottom-top tangles* in [8]). The association is defined as follows. First fix a system of meridians and parallels  $\{\alpha_i, \beta_i\}$  on  $\Sigma_{g,1}$  for each non-negative integer  $g$  as shown in Figure 3.2.

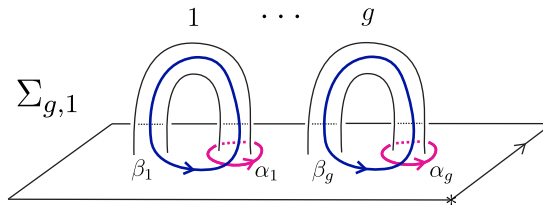


Figure 3.2: System of meridians and parallels  $\{\alpha_i, \beta_i\}$  on  $\Sigma_{g,1}$ .

Then attach  $g$  2-handles (or  $f$  in the case of a cobordism from  $\Sigma_{g,1}$  to  $\Sigma_{f,1}$ ) on the bottom surface of  $M$  by sending the cores of the 2-handles to the curves  $m_-(\alpha_i)$ . In the same way, attach  $g$  2-handles on the top surface of  $M$  by sending the cores to the curves  $m_+(\beta_i)$ . This way we obtain a compact connected oriented 3-manifold  $B$  and an orientation-preserving homeomorphism  $b : \partial([-1, 1]^3) \rightarrow \partial B$ . The pair  $B = (B, b)$  together with the cocores of the 2-handles, determine a tangle  $\gamma$  in  $B$ . We call the homeomorphism class relative to the boundary of the pair  $(B, \gamma)$ , still denoted in the same way, the *bottom-top tangle presentation* of  $(M, m)$ . Following the positive direction of the  $y$  coordinate, we label the bottom components of  $\gamma$  with  $1^-, \dots, f^-$  and the top components with  $1^+, \dots, g^+$ , respectively. This procedure is sketched in Example 3.6.

**Example 3.6.** In Figure 3.3 we illustrate the procedure to obtain the bottom-top tangle presentation of the trivial cobordism  $\Sigma_{g,1} \times [-1, 1]$ .

**Lagrangian Cobordisms.** Let us now roughly describe the source category  $\mathcal{LCob}$  of the LMO functor. For each non-negative integer  $g$ , let  $H_g = H_1(\Sigma_{g,1}; \mathbb{Z})$  be the first homology group of  $\Sigma_{g,1}$  with integer coefficients, and  $\omega : H_g \otimes H_g \rightarrow \mathbb{Z}$  the intersection form. Denote by  $A_g$  the subgroup of  $H_g$  generated by the homology classes of the meridians  $\{\alpha_i\}$ . This is a Lagrangian subgroup of  $H_g$  with respect to the intersection form. Let  $V_g$  be a handlebody of genus  $g$  obtained from  $\Sigma_{g,1}$  by attaching  $g$  2-handles by sending the cores of the 2-handles to the meridians  $\alpha_i$ 's, in particular the curves  $\alpha_i$  bound pairwise disjoint disks in  $V_g$ . We also see  $V_g$  as a cobordism from  $\Sigma_{g,1}$  to  $\Sigma_{0,1}$ , see Figure 3.4. Thus we can also see  $A_g$  as  $A_g = \ker(H_g \rightarrow H_1(V_g; \mathbb{Z}))$ .

**Definition 3.7.** [8, Definitions 2.4 and 2.6] A cobordism  $(M, m)$  from  $\Sigma_{g,1}$  to  $\Sigma_{f,1}$  is said to be *Lagrangian* if it satisfies:

- $H_1(M; \mathbb{Z}) = m_{-,*}(A_f) + m_{+,*}(H_g)$ ,
- $m_{+,*}(A_g) \subseteq m_{-,*}(A_f)$  in  $H_1(M; \mathbb{Z})$ .

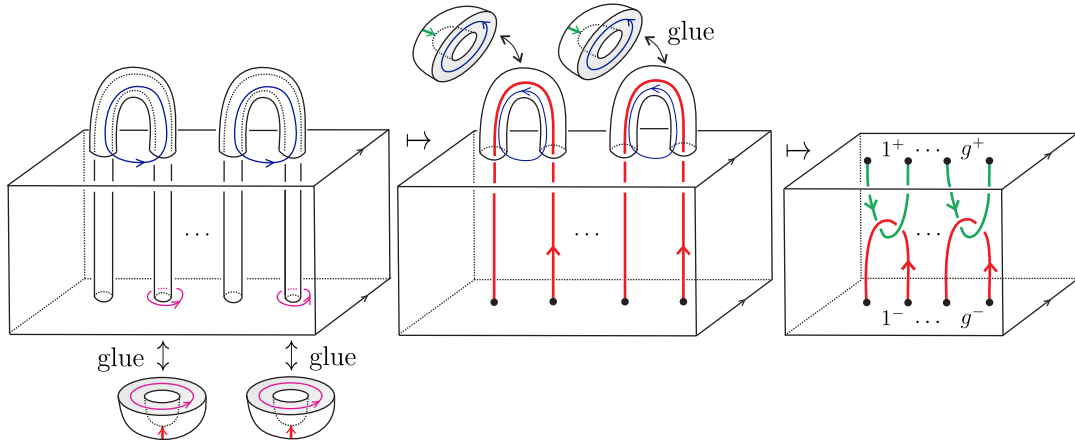


Figure 3.3: Obtaining the bottom-top tangle presentation of the trivial cobordism  $\Sigma_{g,1} \times [-1, 1]$ .

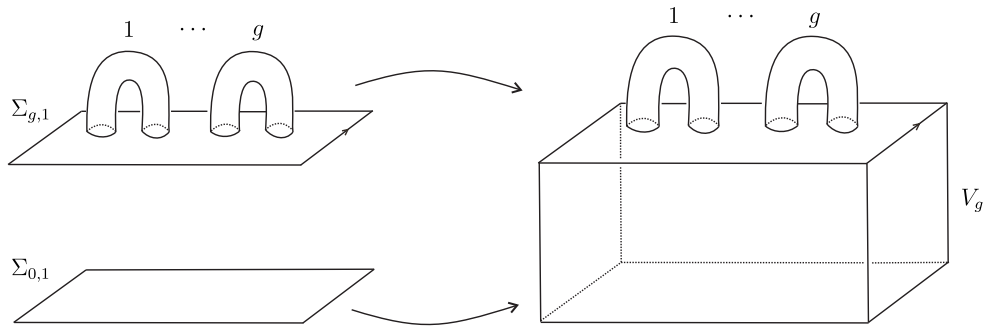


Figure 3.4: Handlebody  $V_g$  as a cobordism from  $\Sigma_{g,1}$  to  $\Sigma_{0,1}$ .

Moreover,  $(M, m)$  is said to be *special Lagrangian* if it additionally satisfies  $V_f \circ M = V_g$  as cobordisms.

Let  $M$  be a Lagrangian cobordism and  $(B, \gamma)$  its bottom-top tangle presentation. It follows, from a Mayer-Vietoris argument, that  $B$  is a *homology cube*, *i.e.*  $B$  has the same homology groups as the standard cube  $[-1, 1]^3$ , see [8, Lemma 2.12]. Notice that the definition of  $q$ -tangle in  $[-1, 1]^3$  given in subsection 3.1 extends naturally to  $q$ -tangles in homology cubes.

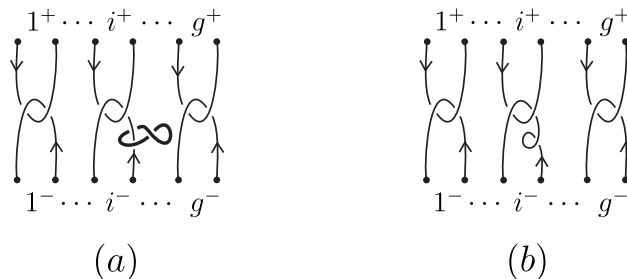
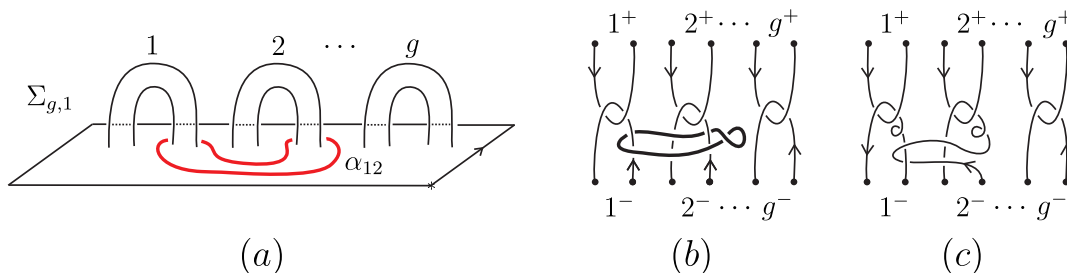
Let us now define the category  $\mathcal{LCob}$ . The objects of  $\mathcal{LCob}$  are the non-negative integers and the set of morphisms  $\mathcal{LCob}(g, f)$  from  $g$  to  $f$  are Lagrangian cobordisms from  $\Sigma_{g,1}$  to  $\Sigma_{f,1}$ . Denote by  ${}^s\mathcal{LCob}(g, f)$  the morphisms from  $g$  to  $f$  which are special Lagrangian.

**Example 3.8.** Let  $h \in \mathcal{M}_{g,1}$ . Then the mapping cylinder  $c(h)$  is Lagrangian if and only if  $h(A_g) \subseteq A_g$ . Moreover,  $c(h)$  is special Lagrangian if and only if  $h$  can be extended to a self-homeomorphism of the handlebody  $V_g$ .

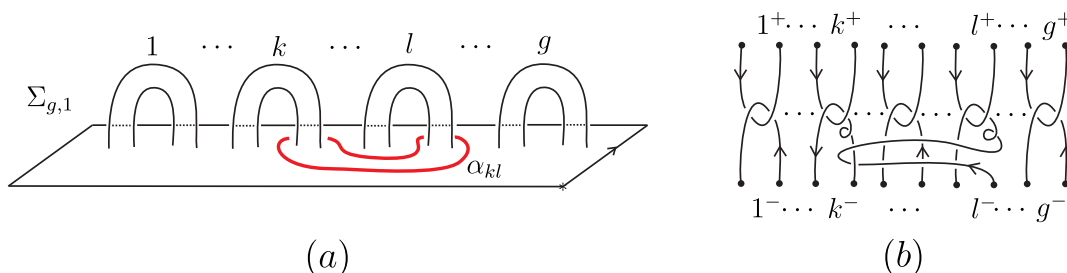
Let us consider some particular cases of the mapping cylinders described in Example 3.8. Let  $\gamma$  be a simple closed curve on  $\Sigma_{g,1}$  and denote by  $t_\gamma$  the (left) Dehn twist along  $\gamma$ . Recall that the mapping cylinder  $c(t_\gamma)$  can be obtained from the trivial cobordism  $\Sigma_{g,1} \times [-1, 1]$  by performing a surgery along a  $(-1)$ -framed knot in a neighbourhood of a push-off of the curve  $\gamma$  in  $\Sigma_{g,1} \times [-1, 1]$ , see for instance [56, Lemma 8.5]. In particular we can obtain the bottom-top tangle presentation of  $c(t_\gamma)$  from that of  $\Sigma_{g,1} \times [-1, 1]$ , see Examples 3.9, 3.10 and 3.11.

**Example 3.9.** Let  $t_{\alpha_i}$  be the Dehn twist along a meridian curve  $\alpha_i$ . Then  $c(t_{\alpha_i}) \in {}^s\mathcal{LCob}(g, g)$ . Figure 3.5 (a) shows the bottom-top tangle presentation of the trivial cobordism  $\Sigma_{g,1} \times [-1, 1]$  (in thin line) together with a  $(-1)$ -framed knot (in thick line) such that the surgery along this knot gives the bottom-top tangle presentation of  $c(t_{\alpha_i})$  showed in Figure 3.5 (b).

**Example 3.10.** Let  $\alpha_{12}$  be the curve shown in Figure 3.6 (a) and let  $t_{\alpha_{12}}$  be the Dehn twist along  $\alpha_{12}$ . We have  $c(t_{\alpha_{12}}) \in {}^s\mathcal{LCob}(g, g)$ . As in Example 3.9, Figure 3.6 (c) shows the bottom-top tangle presentation of  $c(t_{\alpha_{12}})$  obtained by surgery along the thick component in Figure 3.6 (b).

Figure 3.5: Bottom-top tangle presentation of  $c(t_{\alpha_i})$ .Figure 3.6: (a) Curve  $\alpha_{12}$  and (c) bottom-top tangle presentation of  $c(t_{\alpha_{12}})$ .

**Example 3.11.** Example 3.10 can be generalized. Consider two integers  $k$  and  $l$  with  $1 \leq k < l \leq g$ . Let  $\alpha_{kl}$  be the simple closed curve which turns around the  $k$ -th handle and the  $l$ -th handle as shown in Figure 3.7 (a). Consider the Dehn twist  $t_{\alpha_{kl}}$  along  $\alpha_{kl}$ . We have  $c(t_{\alpha_{kl}}) \in {}^s\mathcal{L}ob(g, g)$ . Figure 3.7 (b) shows the bottom-top tangle presentation of  $c(t_{\alpha_{kl}})$ .

Figure 3.7: (a) Curve  $\alpha_{kl}$  and (b) bottom-top tangle presentation of  $c(t_{\alpha_{kl}})$ .

**Example 3.12.** Let  $N_i$  be the cobordism from  $\Sigma_{g,1}$  to  $\Sigma_{g+1,1}$  with the bottom-top tangle presentation shown in Figure 3.8. Then  $N_i$  is a special Lagrangian cobordism. The label  $r$  on the first (from left to right) bottom component stands for *root*. This is because from these cobordisms we will obtain, via the LMO functor, rooted trees with root  $r$  that we will interpret as Lie commutators. See subsection 6.3.

**Top-substantial Jacobi diagrams.** Let us now describe the target category  ${}^{ts}\mathcal{A}$  of the LMO functor. The objects of the category  ${}^{ts}\mathcal{A}$  are the non-negative integers. The set of morphisms from  $g$  to  $f$  is the subspace  ${}^{ts}\mathcal{A}(g, f)$  of diagrams in  $\mathcal{A}([g]^+ \sqcup [f]^-)$  (see Example 2.2) without struts whose both ends are colored by elements of  $[g]^+$ . These kind of Jacobi diagrams are called *top-substantial*. If  $D \in {}^{ts}\mathcal{A}(g, f)$  and  $E \in {}^{ts}\mathcal{A}(h, g)$  the composition

$$D \circ E = \left\langle D_{|j^+ \mapsto j^*}, E_{|j^- \mapsto j^*} \right\rangle_{[g]^*}$$

is the element in  ${}^{ts}\mathcal{A}(h, f)$  given by the sum of Jacobi diagrams obtained by considering all the possible ways of gluing the  $[g]^+$ -colored legs of  $D$  with the  $[g]^-$ -colored legs of  $E$ . A schematic description is shown in Figure 3.9 (a). The identity morphism in  ${}^{ts}\mathcal{A}(g, g)$  is shown in Figure 3.9 (b).

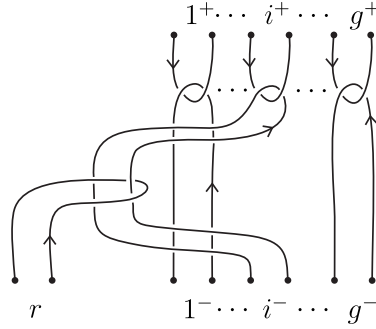


Figure 3.8: Bottom-top tangle presentation of  $N_i \in {}^s\mathcal{LCob}(g, g+1)$ .

$$\begin{array}{ccc}
 \langle D_{|j^+ \rightarrow j^*}, E_{|j^- \rightarrow j^*} \rangle_{[g]^*} = D \circ E = \sum & \begin{array}{c} \cdots \cdots [h]^+ \\ \boxed{E} \\ \cdots \cdots \\ \boxed{\text{glue}} \\ \cdots \cdots \\ \boxed{D} \\ \cdots \cdots [f]^- \end{array} & \text{Id}_g = \exp_{\square} \left( \sum_{i=1}^g \begin{array}{c} \bullet i^+ \\ \vdots \\ \bullet i^- \end{array} \right). \\
 (a) & & (b)
 \end{array}$$

Figure 3.9: (a) Composition in  ${}^{ts}\mathcal{A}$  and (b) identity morphism in  ${}^{ts}\mathcal{A}(g, g)$ .

**Sketch of the construction of the LMO functor.** The definition of the LMO functor uses the Kontsevich integral which is defined for  $q$ -tangles. Because of this, it is necessary to modify the objects of  $\mathcal{LCob}$  to obtain the category  $\mathcal{LCob}_q$ : instead of non-negative integers, the objects of  $\mathcal{LCob}_q$  are non-associative words in the single letter  $\bullet$  and if  $u$  and  $v$  are non-associative words in  $\bullet$  of length  $g$  and  $f$  respectively, a morphism from  $u$  to  $v$  is a Lagrangian cobordism from  $\Sigma_{g,1}$  to  $\Sigma_{f,1}$ .

Roughly speaking, the LMO functor  $\tilde{Z} : \mathcal{LCob}_q \rightarrow {}^{ts}\mathcal{A}$  is defined as follows. Let  $M \in \mathcal{LCob}_q(u, v)$ , where  $u$  and  $v$  are two non-associative words in  $\bullet$ . Let  $(B, \gamma')$  be the bottom-top tangle presentation of  $M$ . By performing the change  $\bullet \mapsto (+-)$  in  $u$  and  $v$  we obtain words  $w_t(\gamma')$  and  $w_b(\gamma')$  on  $\{+, -\}$  together with some parenthesizations. Hence  $\gamma'$  is a  $q$ -tangle in the homology cube  $B$ . Next, take a *surgeries presentation* of  $(B, \gamma')$ , that is, a framed link  $L \subseteq \text{int}([-1, 1]^3)$  and a tangle  $\gamma$  in  $[-1, 1]^3 \setminus L$  such that surgery along  $L$  carries  $([-1, 1]^3, \gamma)$  to  $(B, \gamma')$ . Set  $w_t(\gamma) = w_t(\gamma')$  and  $w_b(\gamma) = w_b(\gamma')$ . Hence  $L \cup \gamma$  is a  $q$ -tangle in  $[-1, 1]^3$ . Now, consider the Kontsevich integral of  $L \cup \gamma$ , which gives a series of a kind of Jacobi diagrams. To get rid of the ambiguity in the surgery presentation, it is necessary to use some combinatorial operations on the space of diagrams. Among these operations there is the so-called *Aarhus integral* (see [4, 5]), which is a kind of formal Gaussian integration on the space of diagrams. We then arrive to  ${}^{ts}\mathcal{A}$ . Finally, to obtain the functoriality, it is necessary to do a normalization.

Recall that the definition of the Kontsevich integral requires the choice of a *Drinfeld associator*, and the bottom-top tangle presentation requires the choice of a system of meridians and parallels. Thus, the LMO functor also depends on these choices.

We are especially interested in the LMO functor for special Lagrangian cobordisms. For these kind of cobordisms the LMO functor can be computed from the Kontsevich integral and the symmetrization map as is assured by a result of Cheptea, Habiro and Massuyeau. We state the result for our particular case.

**Convention 3.13.** From now on, we endow Lagrangian cobordisms with the right-handed non-associative word  $(\bullet \cdots (\bullet(\bullet)) \cdots)$  in the letter  $\bullet$  unless we say otherwise. This way we will always be in the context of the category  $\mathcal{LCob}_q$ .

**Lemma 3.14.** [8, Lemma 5.5] *Let  $M \in \mathcal{LCob}_q(u, v)$ , where  $u$  and  $v$  are non-associative words in the letter  $\bullet$  of length  $g$  and  $f$ , respectively. Suppose that the bottom-top tangle presentation of  $M$  is as in*

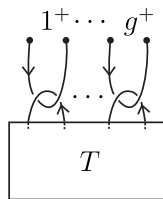
Figure 3.10: Bottom-top tangle presentation of  $M$ .

Figure 3.10, where  $T$  is a tangle in  $[-1, 1]^3$ . Endow  $T$  with the non-associative words  $w_t(T) = u_{/\bullet \rightarrow (+-)}$  and  $w_b(T) = v_{/\bullet \rightarrow (+-)}$ . Then the value of the LMO functor  $\tilde{Z}(M)$  can be computed from the value of the Kontsevich integral  $Z(T)$  as shown in Figure 3.11.

$$\tilde{Z}(M) = \chi^{-1} \left( \begin{array}{c} \left[ \begin{array}{c} 1^+ \\ \vdots \\ \end{array} \right] \quad \left[ \begin{array}{c} g^+ \\ \vdots \\ \end{array} \right] \\ \vdots \\ \left[ \begin{array}{c} \vdots \\ \vdots \\ \end{array} \right] \\ \hline Z(T) \end{array} \right)$$

Figure 3.11: Value of  $\tilde{Z}(M)$  in terms of  $Z(T)$ .

Let  $(M, m)$  be a homology cobordism and  $(B, \gamma)$  its bottom-top tangle presentation. Define the *linking matrix* of  $(M, m)$ , denoted  $\text{Lk}(M)$ , as the linking matrix of the link  $\hat{\gamma}$  in  $B$  obtained from  $\gamma$  by identifying the two endpoints on each of the top and bottom components of  $\gamma$ .

For any Lagrangian cobordism  $M$ , denote by  $\tilde{Z}^s(M)$  the strut part of  $\tilde{Z}(M)$ , that is, the reduction of  $\tilde{Z}(M)$  modulo diagrams with at least one trivalent vertex. Denote by  $\tilde{Z}^Y(M)$  the reduction of  $\tilde{Z}(M)$  modulo struts. Denote by  $\tilde{Z}^t(M)$  the reduction of  $\tilde{Z}(M)$  modulo looped diagrams. Finally denote by  $\tilde{Z}^{Y,t}(M)$  the reduction of  $\tilde{Z}^t(M)$  modulo struts.

**Lemma 3.15.** [8, Lemma 4.12] Let  $M \in \mathcal{LCob}_g(u, v)$  where  $u$  and  $v$  are non-associative words in the letter  $\bullet$ . Then  $\tilde{Z}(M)$  is group-like. Moreover  $\tilde{Z}(M) = \tilde{Z}^s(M) \sqcup \tilde{Z}^Y(M)$  and

$$\tilde{Z}^s(M) = \left[ \frac{\text{Lk}(M)}{2} \right]. \quad (3.2)$$

The colors  $1^+, \dots, g^+$  and  $1^-, \dots, f^-$  in the series of Jacobi diagrams  $\tilde{Z}(M)$  refer to the curves  $m_+(\beta_1), \dots, m_+(\beta_g)$  and  $m_-(\alpha_1), \dots, m_-(\alpha_f)$  on the top and bottom surfaces of  $M$  respectively.

**Example 3.16.** Let us consider the special Lagrangian cobordism  $c(t_{\alpha_i})$ , from Example 3.9, equipped with non-associative words as in Convention 3.13. By Lemma 3.14 and the functoriality of  $Z$  (see Equation (3.1)), to compute  $\tilde{Z}^t(c(t_{\alpha_i}))$  in low degrees we need to first compute

$$Z^t \left( \mathcal{J}_1^{\rightarrow} \right)$$

in low degrees, which we already computed in Example 3.2. Therefore

$$\tilde{Z}^t(c(t_{\alpha_i})) = \chi_{[g]^-}^{-1} \left( \begin{array}{c} \left[ \begin{array}{c} 1^+ \\ \vdots \\ \end{array} \right] \quad \left[ \begin{array}{c} i^+ \\ \vdots \\ \end{array} \right] \quad \left[ \begin{array}{c} g^+ \\ \vdots \\ \end{array} \right] \\ \vdots \\ \left[ \begin{array}{c} \vdots \\ \vdots \\ \end{array} \right] \\ \hline \begin{array}{c} \text{---} \\ \uparrow \\ \boxed{Z^t(\mathcal{J}_1^{\rightarrow})} \\ \downarrow \\ \text{---} \\ 1^- \quad i^- \quad g^- \end{array} \end{array} \right).$$

From Example 2.9, we conclude



of length  $g - 1$ . Denote by  $P_{\bullet, \bullet, w}$  the  $q$ -cobordism  $((\bullet\bullet)w) \rightarrow (\bullet(\bullet w))$  whose underlying cobordism is the identity  $\mathcal{L}Cob(g + 1, g + 1)$ . Thus we can decompose  $N_1$  as  $N_1 = P_{\bullet, \bullet, w} \circ (T \otimes \text{Id}_w)$ , where  $\text{Id}_w$  is the identity cobordism equipped with  $w$  on the top and bottom, and  $T$  is the special Lagrangian cobordism whose bottom-top tangle presentation is shown in Figure 3.12.



Figure 3.12: Bottom top-tangle presentation of  $T$ .

Hence,  $\tilde{Z}^t(N_1) = \tilde{Z}^t(P_{\bullet, \bullet, w}) \circ (\tilde{Z}^t(T) \otimes \text{Id}_{g-1})$ . Now, by the functoriality of  $\tilde{Z}$  we have

$$\left(\tilde{Z}^t(P_{\bullet, \bullet, w})|_{r \rightarrow 0}\right) = \emptyset \otimes \text{Id}_g \quad \text{and} \quad \left(\tilde{Z}^t(P_{\bullet, \bullet, w})|_{1^- \rightarrow 0}\right) = \text{Id}_1 \otimes \emptyset \otimes \text{Id}_{g-1},$$

therefore

$$\left(\tilde{Z}^Y(P_{\bullet, \bullet, w})|_{r \rightarrow 0}\right) = \emptyset \quad \text{and} \quad \left(\tilde{Z}^Y(P_{\bullet, \bullet, w})|_{1^- \rightarrow 0}\right) = \emptyset.$$

This way, each one of the connected diagrams appearing in  $\tilde{Z}^Y(P_{\bullet, \bullet, w})$  has at least one  $r$ -colored leg and at least one  $1^-$ -colored leg. Hence, each one of the connected diagrams in  $\tilde{Z}^t(N_1)$  coming from  $\tilde{Z}^Y(P_{\bullet, \bullet, w})$  has at least one  $r$ -colored leg and at least one  $1^-$ -colored leg.

We are interested in the low degree terms of  $\tilde{Z}^t(N_1) \bmod \mathcal{H}(r)$ . By Lemma 3.14, we need to compute the low degree terms of

$$Z^t \left( \begin{array}{c} (-+) \\ \uparrow \\ \text{tangle} \\ \downarrow \\ (+-) \quad (-+) \end{array} \right) \bmod \mathcal{H}(\sphericalangle_r)$$

which we already computed in Example 3.4. Whence we obtain

$$\tilde{Z}^t(T) \bmod \mathcal{H}(r) = \exp_{\sqcup} \left( \begin{array}{c} 1^+ \\ \vdots \\ 1^- \end{array} + \begin{array}{c} 1^- \\ \vdots \\ r \end{array} \right) \sqcup \exp_{\sqcup} \left( \frac{1}{2} \begin{array}{c} 1^+ \quad 1^- \\ \vdots \\ r \end{array} + (\text{i-deg} \geq 2) \right).$$

We conclude that each of the terms with  $\text{i-deg} = 1$  in  $\tilde{Z}^t(N_1) \bmod \mathcal{H}(r)$  has one  $r$ -colored and one  $1^-$ -colored leg. In a similar way, it can be shown for  $1 \leq i \leq g$  that each of the terms with  $\text{i-deg} = 1$  in  $\tilde{Z}^t(N_i) \bmod \mathcal{H}(r)$  has one  $r$ -colored leg and one  $i^-$ -colored leg.

## 4 Johnson-type filtrations

As in subsection 3.2, we denote by  $\Sigma_{g,1}$  a compact connected oriented surface of genus  $g$  with one boundary component. Let  $\mathcal{M}_{g,1}$  denote the mapping class group of  $\Sigma_{g,1}$ . We will often omit the subscripts  $g$  and  $1$  of our notation unless there is ambiguity, then we will usually write  $\Sigma$  and  $\mathcal{M}$  instead of  $\Sigma_{g,1}$  and  $\mathcal{M}_{g,1}$ .

### 4.1 Preliminaries

Let us fix a base point  $* \in \partial\Sigma$  and set  $\pi = \pi_1(\Sigma, *)$  and  $H = H_1(\Sigma, \mathbb{Z})$ , finally denote by  $\text{ab} : \pi \rightarrow H$  the abelianization map. Notice that the intersection form  $\omega : H \otimes H \rightarrow \mathbb{Z}$  is a symplectic form on  $H$ .



The elements of  $\mathcal{M}$  preserve  $\partial\Sigma$ , in particular they preserve  $*$ , therefore we have a well defined group homomorphism:

$$\rho : \mathcal{M} \longrightarrow \text{Aut}(\pi), \quad (4.1)$$

which sends  $h \in \mathcal{M}$  to the induced map  $h_{\#}$  on  $\pi$ . It is well known that the map  $\rho$  is injective and it is called the *Dehn-Nielsen-Baer representation* of  $\mathcal{M}$ . On the other hand, since the elements of  $\mathcal{M}$  are orientation-preserving, their induced maps on  $H$  preserve the intersection form. This way we have a well defined surjective group homomorphism:

$$\sigma : \mathcal{M} \longrightarrow \text{Sp}(H) = \{f \in \text{Aut}(H) \mid \forall x, y \in H, \omega(f(x), f(y)) = \omega(x, y)\}, \quad (4.2)$$

that sends  $h \in \mathcal{M}$  to the induced map  $h_*$  on  $H$ . The map  $\sigma$  is called the *symplectic representation* of  $\mathcal{M}$  and it is far from being injective, its kernel is known as the *Torelli group* of  $\Sigma$ , which is denoted by  $\mathcal{I}$  (or  $\mathcal{I}_{g,1}$ ), so

$$\mathcal{I} = \mathcal{I}_{g,1} = \ker(\sigma) = \{h \in \mathcal{M} \mid h_* = \text{Id}_H\}. \quad (4.3)$$

## 4.2 Alternative Torelli group

Let  $V$  (or  $V_g$ ) be a handlebody of genus  $g$ . Consider a disk  $D$  on  $\partial V$  such that  $\partial V = \Sigma \cup D$ , where  $D$  and  $\Sigma$  are glued along their boundaries. Let  $\iota : \Sigma \hookrightarrow V$  be the inclusion of  $\Sigma$  into  $\partial V \subseteq V$ , see Figure 4.1.

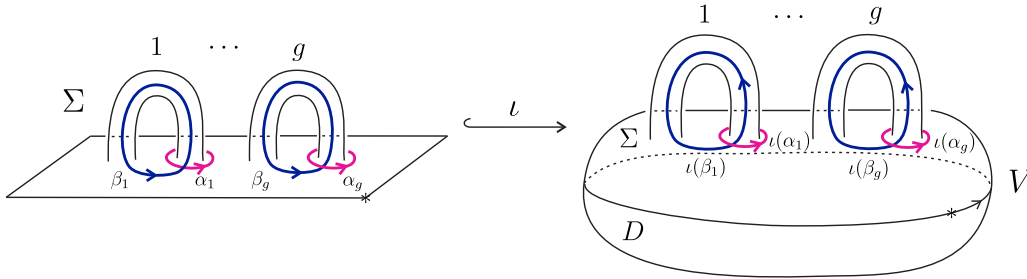


Figure 4.1: The inclusion  $\Sigma \hookrightarrow V$ .

Figure 4.1 also shows the fixed system of meridians and parallels of  $\Sigma$  used in subsection 3.2. Moreover we suppose that the images  $\iota(\alpha_i)$  of the meridians  $\alpha_i$ , under the embedding  $\iota$ , bound pairwise disjoint disks in  $V$ . Set  $H' = H_1(V; \mathbb{Z})$  and  $\pi' = \pi_1(V, \iota(*))$  and denote by  $\text{ab}' : \pi' \rightarrow H'$  the abelianization map. Consider the following subgroups of  $\pi$  and  $H$  that arise when looking at the induced maps by  $\iota$  in homotopy and in homology:

$$A = \ker(\iota_* : H \rightarrow H') \quad \text{and} \quad \mathbb{A} = \ker(\iota_{\#} : \pi \rightarrow \pi'). \quad (4.4)$$

We also consider the following subgroup of  $\pi$ :

$$K_2 = \ker(\pi \xrightarrow{\iota_{\#}} \pi' \xrightarrow{\text{ab}'} H') = \mathbb{A} \cdot \Gamma_2 \pi. \quad (4.5)$$

The subgroup  $A \leq H$  is a Lagrangian subgroup of  $H$  with respect to the intersection form on  $H$  and it is the group that appears in the definition of Lagrangian cobordisms in the previous section. We may think of  $K_2$  as the subgroup of  $\pi$  generated by commutators of *weight 2*, where the elements of  $\pi$  are considered to have weight 1 and the elements of  $\mathbb{A}$  are considered to have weight 2. The subgroups  $A$ ,  $\mathbb{A}$  and  $K_2$  allow us to define some important subgroups of the mapping class group  $\mathcal{M}$ .

**Definition 4.1.** The *Lagrangian mapping class group* of  $\Sigma$ , denoted by  $\mathcal{L}$  (or  $\mathcal{L}_{g,1}$ ) is defined as follows:

$$\mathcal{L} = \mathcal{L}_{g,1} = \{f \in \mathcal{M}_{g,1} \mid f_*(A) \subseteq A\}. \quad (4.6)$$

We are mainly interested in three particular subgroups of  $\mathcal{L}$ , one of these is the Torelli group, see equation (4.3).

**Definition 4.2.** The *Lagrangian Torelli group* of  $\Sigma$ , denoted by  $\mathcal{I}^L$  (or  $\mathcal{I}_{g,1}^L$ ), is defined as follows:

$$\mathcal{I}^L = \mathcal{I}_{g,1}^L = \{h \in \mathcal{L} \mid h_*|_A = \text{Id}_A\}. \quad (4.7)$$

The groups  $\mathcal{L}$  and  $\mathcal{I}^L$  appear in the works [43, 46] of J. Levine in connection with the theory of finite-type invariants of homology 3-spheres. From an algebraic point of view these groups were studied by S. Hirose in [29], where he found a generating system for  $\mathcal{L}$  and by T. Sakasai in [61], where he computed  $H_1(\mathcal{L}; \mathbb{Z})$  and  $H_1(\mathcal{I}^L; \mathbb{Z})$ .

**Definition 4.3.** The *alternative Torelli group* of  $\Sigma$ , denoted by  $\mathcal{I}^a$  (or  $\mathcal{I}_{g,1}^a$ ), is defined as follows:

$$\mathcal{I}^a = \mathcal{I}_{g,1}^a = \left\{ h \in \mathcal{L} \left| \begin{array}{l} \text{for } x \in \pi : \quad h_{\#}(x)x^{-1} \in K_2 \\ \text{and for } y \in K_2 : \\ h_{\#}(y)y^{-1} \in \Gamma_3\pi \cdot [\pi, \mathbb{A}] =: K_3 \end{array} \right. \right\}. \quad (4.8)$$

Notice that the definition of  $\mathcal{I}^a$  involves the group  $K_3 = \Gamma_3\pi \cdot [\pi, \mathbb{A}] = [[\pi, \pi], \pi] \cdot [\pi, \mathbb{A}]$ , which we see as the subgroup of  $\pi$  generated by commutators of weight 3. Like the Lagrangian Torelli group, the group  $\mathcal{I}^a$  appears in [43, 46, 15] in connection with the theory of finite-type invariants but with a different definition: the second term of the Johnson-Levine filtration. Definition 4.3 comes from [28], see Proposition 5.16 for the equivalence of the two definitions. J. Levine shows in [43, Proposition 4.1] that  $\mathcal{I}^a$  is generated by Dehn twists along simple closed curves (scc) whose homology class belongs to  $A$ . Equivalently,  $\mathcal{I}^a$  is generated by Dehn twists along scc's which bound a surface in the handlebody  $V$ . This is the definition of  $\mathcal{I}^a$  given in [46, 15].

From the above definitions it follows that  $\mathcal{I} \subseteq \mathcal{I}^L \subseteq \mathcal{L}$  and  $\mathcal{I}^a \subseteq \mathcal{I}^L \subseteq \mathcal{L}$ . But  $\mathcal{I}^a \not\subseteq \mathcal{I}$  and  $\mathcal{I} \not\subseteq \mathcal{I}^a$ . We shall call here the groups  $\mathcal{I}$ ,  $\mathcal{I}^L$  and  $\mathcal{I}^a$  *Torelli-type groups*. In contrast with  $\mathcal{I}$ , the groups  $\mathcal{I}^L$  and  $\mathcal{I}^a$  are not normal in  $\mathcal{M}$ , but they are normal in  $\mathcal{L}$ .

**Example 4.4.** The Dehn twists  $t_{\alpha_i}$  and  $t_{\alpha_{kl}}$  from Examples 3.9 and 3.11 are elements of the alternative Torelli group which do not belong to the Torelli group.

**Example 4.5.** Consider the parallel  $\beta_1$  and the curve  $\gamma$  as shown in Figure 4.2. These curves form a *bounding pair*. Consider the Dehn twists  $t_{\beta_1}$  and  $t_{\gamma}$  along these curves. It can be shown that the homeomorphism  $t_{\gamma}t_{\beta_1}^{-1}$  belongs to  $\mathcal{I} \cap \mathcal{I}^a$ .

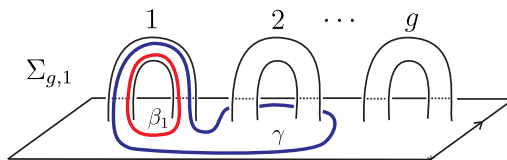


Figure 4.2: Curves  $\beta_1$  and  $\gamma$ .

More generally we have the following lattice of subgroups:

$$\begin{array}{ccccc} & & \mathcal{I}^a & & \\ & \nearrow & & \searrow & \\ \mathcal{I} \cap \mathcal{I}^a & & & & \mathcal{I}^L \hookrightarrow \mathcal{L} \\ & \searrow & & \nearrow & \\ & & \mathcal{I} & & \end{array}$$

where all the inclusions are proper. Besides, J. Levine proved in [42, Theorem 2] that

$$\mathcal{I} \cap \mathcal{I}^a = \mathcal{K} \cdot [\mathcal{I}, \mathcal{I}^a], \quad (4.9)$$

where  $\mathcal{K}$  is the *Johnson kernel*. D. Johnson proved in [33] that  $\mathcal{K}$  is generated by BSCC maps (bounding scc's), that is, Dehn twists along scc's which are null-homologous in  $\Sigma$ .

### 4.3 Alternative Johnson filtration

This subsection is devoted to the study of a filtration of the alternative Torelli group introduced in [28] which we shall call here the *alternative Johnson filtration*. We compare this filtration with the *Johnson filtration* and the *Johnson-Levine filtration*. Let us start by recalling some terminology.

An *N-series*  $(G_m)_{m \geq 1}$  of a group  $G$  is a decreasing sequence

$$G = G_1 \geq G_2 \geq \cdots \geq G_m \geq G_{m+1} \geq \cdots$$

of subgroups of  $G$  such that  $[G_i, G_j] \subseteq G_{i+j}$  for  $i, j \geq 1$ . We are interested in *N-series* of the group  $\pi = \pi(\Sigma, *)$ . A first example of an *N-series* of  $\pi$  is the lower central series  $(\Gamma_k \pi)_{k \geq 1}$ . We consider an *N-series* of  $\pi$  in which the subgroup  $\mathbb{A}$  plays a special role.

Set  $K_1 = \pi$  and  $K_2 = \mathbb{A} \cdot \Gamma_2 \pi$  as defined in Equation (4.5). Let  $(K_m)_{m \geq 1}$  be the smallest *N-series* of  $\pi$  starting with these  $K_1$  and  $K_2$ , that is, if  $(G_i)_{m \geq 1}$  is any *N-series* of  $\pi$  with  $G_1 = K_1$  and  $G_2 = K_2$  then  $K_m \subseteq G_m$  for every  $m \geq 1$ . More precisely, for every  $m \geq 3$  we have

$$K_m = [K_{m-1}, K_1] \cdot [K_{m-2}, K_2]. \quad (4.10)$$

In particular  $K_3 = \Gamma_3 \pi \cdot [\pi, \mathbb{A}]$  is the group that we used in the definition of the alternative Torelli group, see (4.8). We can think of  $K_m$  as the subgroup of  $\pi$  generated by commutators of weight  $m$ , where the elements of  $\pi$  have weight 1 and the elements of  $\mathbb{A}$  have weight 2. By induction on  $m \geq 1$  we have

$$\Gamma_m \pi \subseteq K_m \subseteq \Gamma_{\lceil m/2 \rceil} \pi, \quad (4.11)$$

where  $\lceil m/2 \rceil$  denotes the least integer greater than or equal to  $m/2$ .

Restricting the Dehn-Nielsen-Baer representation (4.1) to the Lagrangian mapping class group we get an action of  $\mathcal{L}$  on  $K_1 = \pi$ . We denote the action of  $h \in \mathcal{L}$  on  $x \in \pi$  by  ${}^h x$ . Hence  ${}^h x = \rho(h)(x) = h_{\#}(x)$ .

**Lemma 4.6.** *For every  $h \in \mathcal{L}$  we have  ${}^h(K_2) = K_2$ .*

*Proof.* It is enough to show  ${}^h(K_2) \subseteq K_2$  for every  $h \in \mathcal{L}$ . Let  $h \in \mathcal{L}$  and  $x \in K_2 = \ker(\text{ab}'\iota_{\#})$ . Hence  $0 = \text{ab}'\iota_{\#}(x) = \iota_*(\text{ab}(x))$ , so  $\text{ab}(x) \in A$  and then  $h_*(\text{ab}(x)) \in A$ . Therefore

$$\text{ab}'\iota_{\#}h_{\#}(x) = \iota_*(\text{ab}(h_{\#}(x))) = \iota_*(h_*(\text{ab}(x))) = 0,$$

that is,  $h_{\#}(x) \in K_2$ . □

It follows from Equality (4.10) and Lemma 4.6, by induction, that  ${}^h(K_m) = K_m$  for every  $m \geq 1$  and  $h \in \mathcal{L}$ . From the general setting in [28, Section 3.4 and Section 10.2] we have a decreasing sequence

$$\mathcal{L} = J_0^{\mathfrak{a}} \mathcal{M} \supseteq J_1^{\mathfrak{a}} \mathcal{M} \supseteq J_2^{\mathfrak{a}} \mathcal{M} \supseteq \cdots \supseteq J_m^{\mathfrak{a}} \mathcal{M} \supseteq J_{m+1}^{\mathfrak{a}} \mathcal{M} \supseteq \cdots \quad (4.12)$$

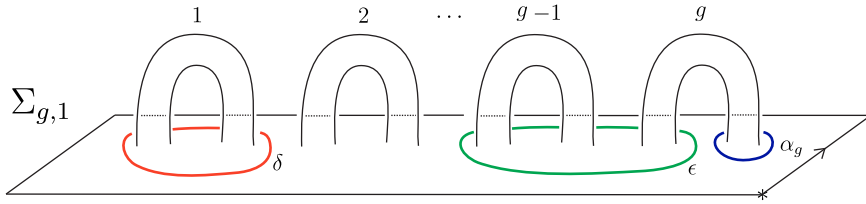
of subgroups of  $\mathcal{M}$  satisfying:

$$[J_l^{\mathfrak{a}} \mathcal{M}, J_m^{\mathfrak{a}} \mathcal{M}] \subseteq J_{l+m}^{\mathfrak{a}} \mathcal{M} \quad \text{for all } l, m \geq 0. \quad (4.13)$$

In our case, the  $m$ -th term in this decreasing sequence is given by

$$J_m^{\mathfrak{a}} \mathcal{M} = J_m^{\mathfrak{a}} \mathcal{M}_{g,1} = \left\{ h \in \mathcal{L} \left| \begin{array}{l} \text{for } x \in \pi : \quad h_{\#}(x)x^{-1} \in K_{1+m} \\ \text{and for } y \in K_2 : \\ \quad h_{\#}(y)y^{-1} \in K_{2+m} \end{array} \right. \right\}. \quad (4.14)$$

**Definition 4.7.** The *alternative Johnson filtration* of  $\mathcal{M}$  is the descending chain  $\{J_m^{\mathfrak{a}} \mathcal{M}\}_{m \geq 0}$  of subgroups of  $\mathcal{M}$ .

Figure 4.3: Curves  $\delta, \epsilon$  and  $\alpha_g$ .

**Example 4.8.** Consider the curves  $\delta, \epsilon$  and the meridian  $\alpha_g$  as show in Figure 4.3. It can be show that  $t_\delta$  and  $t_\epsilon t_{\alpha_g}^{-1}$  belong to  $J_2^a \mathcal{M}$ . We will show this explicitly in Examples 5.7 and 5.8. In particular  $t_\delta$  and  $t_\epsilon t_{\alpha_g}^{-1}$  belong to  $\mathcal{I} \cap \mathcal{I}^a$ .

**Proposition 4.9.** *The alternative Johnson filtration satisfies the following properties.*

- (i)  $\bigcap_{m \geq 0} J_m^a \mathcal{M} = \{\text{Id}_\Sigma\}$ .
- (ii) For all  $k \geq 1$  the group  $J_k^a \mathcal{M}$  is residually nilpotent, that is,  $\bigcap_m \Gamma_m J_k^a \mathcal{M} = \{\text{Id}_\Sigma\}$ .

*Proof.* In order to prove (i), recall that  $K_m \subseteq \Gamma_{\lceil m/2 \rceil} \pi$  for  $m \geq 1$ . Consider  $h \in \mathcal{L}$  such that  $h \in J_m^a \mathcal{M}$  for all  $m \geq 0$ . Let  $x \in \pi$ , thus

$$\forall m \geq 1, h_\#(x)x^{-1} \in K_{m+1} \subseteq \Gamma_{\lceil (m+1)/2 \rceil} \pi.$$

Therefore  $h_\#(x)x^{-1} \in \Gamma_k \pi$  for all  $k \geq 1$ . Since  $\pi$  is residually nilpotent, we have that  $h_\# = \rho(h) = \text{Id}_\pi$ . In view of the injectivity of the Dehn-Nielsen-Baer representation  $\rho$  we conclude that  $h = \text{Id}_\Sigma$ , so we have (i). Now, let us see (ii). Fix  $k \geq 1$ , from (4.13) it follows, by induction on  $m$ , that  $\Gamma_m J_k^a \mathcal{M} \subseteq J_m^a \mathcal{M}$  for all  $m \geq 1$ . Therefore by (i) we obtain  $\bigcap_{m \geq 1} \Gamma_m J_k^a \mathcal{M} = \{\text{Id}_\Sigma\}$ .  $\square$

The Johnson filtration satisfies similar properties to those stated in the above proposition. Let us briefly recall the Johnson filtration and the Johnson-Levine filtration in order to compare them with each other.

**Johnson filtration.** The lower central series of  $\pi$  is preserved by the Dehn-Nielsen-Baer representation  $\rho$ , so for every  $k \geq 1$  there is a group homomorphism

$$\rho_k : \mathcal{M} \longrightarrow \text{Aut}(\pi/\Gamma_{k+1}\pi), \quad (4.15)$$

defined as the composition

$$\mathcal{M} \xrightarrow{\rho} \text{Aut}(\pi) \longrightarrow \text{Aut}(\pi/\Gamma_{k+1}\pi).$$

Notice that  $\ker(\rho_1)$  is the Torelli group  $\mathcal{I}$ . The *Johnson filtration* of  $\mathcal{M}$  is the descending chain of subgroups

$$\mathcal{M} \supseteq \mathcal{I} = J_1 \mathcal{M} \supseteq J_2 \mathcal{M} \supseteq J_3 \mathcal{M} \supseteq \cdots \quad (4.16)$$

defined by  $J_k \mathcal{M} := \ker(\rho_k)$  for  $k \geq 1$ . Equivalently for  $k \geq 1$ ,

$$J_k \mathcal{M} = \{h \in \mathcal{M} \mid \text{for all } x \in \pi : h_\#(x)x^{-1} \in \Gamma_{k+1}\pi\}. \quad (4.17)$$

**Proposition 4.10.** [50, Corollary 3.3] *The Johnson filtration satisfies the following properties.*

- (i)  $[J_k \mathcal{M}, J_m \mathcal{M}] \subseteq J_{k+m} \mathcal{M}$  for all  $k, m \geq 1$ .
- (ii)  $\bigcap_{k \geq 1} J_k \mathcal{M} = \{\text{Id}_\Sigma\}$ .
- (iii) For all  $k \geq 1$  the group  $J_k \mathcal{M}$  is residually nilpotent.

**Johnson-Levine filtration.** J. Levine introduced in [43, 46] a different filtration of the mapping class group by means of the embedding  $\iota : \Sigma \hookrightarrow V$ , see Figure 4.1, and the lower central series of  $\pi' = \pi_1(V, \iota(*))$ .

The *Johnson-Levine filtration* of  $\mathcal{M}$  is the descending chain of subgroups

$$\mathcal{I}^L = J_1^L \mathcal{M} \supseteq J_2^L \mathcal{M} \supseteq J_3^L \mathcal{M} \supseteq \cdots \quad (4.18)$$

defined by

$$J_k^L \mathcal{M} := \{h \in \mathcal{I}^L \mid \iota_{\#} h_{\#}(\mathbb{A}) \subseteq \Gamma_{k+1} \pi'\} \quad (4.19)$$

for  $k \geq 1$ .

Let  $\mathcal{H}$  be the subgroup of  $\mathcal{M}$  consisting of the elements that can be extended to the handlebody  $V$ . In Example 3.8 we used these kind of homeomorphisms to give examples of special Lagrangian cobordisms. It is well known that

$$\mathcal{H} = \{h \in \mathcal{M} \mid h_{\#}(\mathbb{A}) \subseteq \mathbb{A}\}, \quad (4.20)$$

see [20, Theorem 10.1]. The group  $\mathcal{H}$  is called the *handlebody group* because it is isomorphic to the mapping class group of  $V$ .

**Proposition 4.11.** (Levine [43, 46]) *The Johnson-Levine filtration satisfies the following properties.*

- (i) For  $k \geq 1$ ,  $J_k^L \mathcal{M}$  is a subgroup of  $\mathcal{M}$ .
- (ii)  $\bigcap_{k \geq 1} J_k^L \mathcal{M} = \mathcal{H} \cap \mathcal{I}^L$ .
- (iii)  $J_k \mathcal{M} \subseteq J_k^L \mathcal{M}$  for every  $k \geq 1$ .
- (iv)  $J_2^L \mathcal{M}$  is generated by simple closed curves which bound in  $V$ , equivalently by scc's whose homology class belongs to  $A$ .
- (v)  $\mathcal{I}^L = \mathcal{I} \cdot (\mathcal{H} \cap \mathcal{I}^L)$  and  $J_2^L \mathcal{M} = J_2 \mathcal{M} \cdot (\mathcal{H} \cap \mathcal{I}^L)$ .

We refer to the alternative Johnson filtration, the Johnson filtration and the Johnson-Levine filtration as *Johnson-type filtrations*.

**Comparison between Johnson-type filtrations.** Proposition 4.11 gives a first comparison between the three filtrations. Let us give a more general comparison.

**Lemma 4.12.** *For every  $m \geq 1$  there exists a normal subgroup  $N_m$  of  $\mathbb{A}$  such that  $K_m = \Gamma_m \pi \cdot N_m$ .*

*Proof.* The argument is by strong induction on  $m$ . Taking  $N_1 = \{1\}$  and  $N_2 = \mathbb{A}$ , clearly we have  $K_1 = \Gamma_1 \pi \cdot N_1$  and  $K_2 = \Gamma_2 \pi \cdot N_2$ . Suppose  $m \geq 3$  and let  $N_{m-2}, N_{m-1}$  be normal subgroups of  $\mathbb{A}$  such that  $K_{m-1} = \Gamma_{m-1} \pi \cdot N_{m-1}$  and  $K_{m-2} = \Gamma_{m-2} \pi \cdot N_{m-2}$ . Thus

$$\begin{aligned} K_m &= [K_{m-1}, K_1] \cdot [K_{m-2}, K_2] \\ &= [\Gamma_{m-1} \pi \cdot N_{m-1}, \pi] \cdot [\Gamma_{m-2} \pi \cdot N_{m-2}, K_2] \\ &= [\Gamma_{m-1} \pi, \pi] \cdot [N_{m-1}, \pi] \cdot [\Gamma_{m-2} \pi, \Gamma_2 \pi \cdot \mathbb{A}] \cdot [N_{m-2}, K_2] \\ &= \Gamma_m \pi \cdot [N_{m-1}, \pi] \cdot [\Gamma_{m-2} \pi, \Gamma_2 \pi] \cdot [\Gamma_{m-2} \pi, \mathbb{A}] \cdot [N_{m-2}, K_2] \\ &= \Gamma_m \pi \cdot N_m, \end{aligned}$$

where  $N_m = [N_{m-1}, \pi] \cdot [\Gamma_{m-2} \pi, \mathbb{A}] \cdot [N_{m-2}, K_2]$  is a normal subgroup of  $\mathbb{A}$ . □

**Proposition 4.13.** *For every  $m \geq 1$ , we have*

- (i)  $J_{2m}^a \mathcal{M} \subseteq J_m \mathcal{M}$ .
- (ii)  $J_m \mathcal{M} \subseteq J_{m-1}^a \mathcal{M}$ .

(iii)  $J_m^a \mathcal{M} \subseteq J_{m+1}^L \mathcal{M}$ .

In particular the Johnson filtration and the alternative Johnson filtration are cofinal.

*Proof.* Let  $m \geq 1$ . Let  $h \in J_{2m}^a \mathcal{M}$ , then for every  $x \in \pi$  we have

$$h_{\#}(x)x^{-1} \in K_{2m+1} \subseteq \Gamma_{\lceil(2m+1)/2\rceil} \pi = \Gamma_{m+1} \pi,$$

that is,  $h \in J_m \mathcal{M}$  so (i) holds. Let  $h \in J_m \mathcal{M}$ , then for every  $x \in \pi$  we have

$$h_{\#}(x)x^{-1} \in \Gamma_{m+1} \pi \subseteq K_{m+1}.$$

In particular,  $h_{\#}(x)x^{-1} \in K_m$  for every  $x \in \pi$  and  $h_{\#}(y)y^{-1} \in K_{m+1}$  for every  $y \in K_2$ . That is,  $h \in J_{m-1}^a \mathcal{M}$ , hence (ii). Finally for (iii) we use Lemma 4.12 to write  $K_{m+2} = \Gamma_{m+2} \pi \cdot N$  with  $N$  a normal subgroup of  $\mathbb{A}$ . Let  $h \in J_m^a \mathcal{M}$ . It follows that for every  $\alpha \in \mathbb{A} \subseteq K_2$ ,  $h_{\#}(\alpha)\alpha^{-1} \in K_{m+2}$ . Write  $h_{\#}(\alpha)\alpha^{-1} = xn$  with  $x \in \Gamma_{m+2} \pi$  and  $n \in N$ . Therefore

$$\iota_{\#}(h_{\#}(\alpha)) = \iota_{\#}(h_{\#}(\alpha)\alpha^{-1}) = \iota_{\#}(x)\iota_{\#}(n) = \iota_{\#}(x) \in \Gamma_{m+2} \pi',$$

whence  $\iota_{\#}h_{\#}(\mathbb{A}) \subseteq \Gamma_{m+2} \pi'$ . Hence  $h \in J_{m+1}^L \mathcal{M}$ .  $\square$

**Remark 4.14.** We expect that the subscripts of the relations on Proposition 4.13 are the best possible.

**Remark 4.15.** D. Johnson proved in [31] that the Torelli group  $\mathcal{I}_{g,1}$  is finitely generated for  $g \geq 3$ . This result together with the short exact sequence

$$1 \longrightarrow \mathcal{I} \longrightarrow \mathcal{I}^L \xrightarrow{\sigma} \sigma(\mathcal{I}^L) \longrightarrow 0,$$

where  $\sigma$  is the symplectic representation, imply that the Lagrangian Torelli group  $\mathcal{I}_{g,1}^L$  is finitely generated for  $g \geq 3$ . Notice that

$$\sigma(\mathcal{I}^L) = \sigma(\mathcal{I}^a) = \left\{ \begin{pmatrix} \text{Id}_g & \Delta \\ 0 & \text{Id}_g \end{pmatrix} \in \text{Sp}(2g, \mathbb{Z}) \mid \Delta \text{ is symmetric} \right\},$$

see Lemma 6.6 and Equation (6.10). Hence  $\sigma(\mathcal{I}^L)$  and  $\sigma(\mathcal{I}^a)$  are finitely generated. Recently T. Church, M. Ershov and A. Putnam proved in [11] several results concerning the finite generation of the Johnson filtration. In particular they proved [11, Theorem A] that the Johnson kernel  $\mathcal{K}_{g,1}$  is finitely generated for  $g \geq 4$ . This result together with the short exact sequences

$$1 \longrightarrow \mathcal{K} \longrightarrow \mathcal{I} \cap \mathcal{I}^a \xrightarrow{\tau_1} \tau_1(\mathcal{I} \cap \mathcal{I}^a) \longrightarrow 0 \quad \text{and} \quad 1 \longrightarrow \mathcal{I} \cap \mathcal{I}^a \longrightarrow \mathcal{I}^a \xrightarrow{\sigma} \sigma(\mathcal{I}^a) \longrightarrow 0,$$

where  $\tau_1$  is the first Johnson homomorphism, imply that the alternative Torelli group  $\mathcal{I}_{g,1}^a$  is finitely generated for  $g \geq 4$ . Besides, it follows from the general result [11, Theorem B] that  $J_m^a \mathcal{M}_{g,1}$  is finitely generated for  $m \geq 2$  and  $g \geq 2m + 1$ .

## 5 Johnson-type homomorphisms

Throughout this section we use the same notations and conventions from Section 4. The aim of this section is the study of a sequence of group homomorphisms  $\{\tau_m^a\}_{m \geq 0}$  introduced in [28], which are defined on each term of the alternative Johnson filtration and taking values in some abelian groups. These abelian groups can be described by means of the first homology group  $H$  of the surface  $\Sigma$ , the first homology group  $B := H'$  of the handlebody  $V$  and the subgroup  $A = \ker(\iota_*)$ .

## 5.1 Preliminaries

Since  $[J_l^a \mathcal{M}, J_m^a \mathcal{M}] \subseteq J_{l+m}^a \mathcal{M}$  for all  $l, m \geq 0$ , the quotient group  $J_m^a \mathcal{M} / J_{m+1}^a \mathcal{M}$  is an abelian group for  $m \geq 1$  and we can endow

$$\mathrm{Gr}(J_\bullet^a \mathcal{M}) = \bigoplus_{m \geq 1} \frac{J_m^a \mathcal{M}}{J_{m+1}^a \mathcal{M}} \quad (5.1)$$

with a structure of graded Lie algebra with Lie bracket induced by the commutator operation. K. Habiro and G. Massuyeau show in [28] that the Lie algebra (5.1) embeds into a Lie algebra of derivations. To achieve this, they define group homomorphisms on each term of the alternative Johnson filtration, even on the 0-th term  $J_0^a \mathcal{M}$  which is the Lagrangian mapping class group  $\mathcal{L}$ . We shall call these homomorphisms the *alternative Johnson homomorphisms*. In order to define them, let us start with some preliminaries.

**Free Lie algebra associated to the  $N$ -series  $(K_m)_{m \geq 1}$ .** In the definition of the alternative Johnson filtration we use the  $N$ -series  $(K_m)_{m \geq 1}$  defined in Equation (4.10). The graded Lie algebra associated to this  $N$ -series is given by

$$\mathrm{Gr}(K_\bullet) = \bigoplus_{m \geq 1} \frac{K_m}{K_{m+1}} = \frac{K_1}{K_2} \oplus \frac{K_2}{K_3} \oplus \cdots \quad (5.2)$$

It follows from [37, Proposition 1] that this graded Lie algebra is freely generated in degree 1 and 2, see also [28, Lemma 10.9]. More precisely, by Hopf's formula we have  $(\Gamma_2 \pi \cap \mathbb{A}) / [\pi, \mathbb{A}] \cong H_2(\pi / \mathbb{A}) \cong H_2(\pi')$  and  $H_2(\pi') = 0$  because  $\pi'$  is a free group. Hence  $[\pi, \mathbb{A}] = \Gamma_2 \pi \cap \mathbb{A}$ . Consider the injective homomorphism  $j : A \rightarrow K_2 / K_3$  given by the composition

$$A \xrightarrow[\mathrm{ab}]{\cong} (\mathbb{A} \cdot \Gamma_2 \pi) / \Gamma_2 \pi \cong \mathbb{A} / (\Gamma_2 \pi \cap \mathbb{A}) = \mathbb{A} / [\pi, \mathbb{A}] \hookrightarrow \frac{K_2}{K_3}. \quad (5.3)$$

Identify  $B = H'$  with  $K_1 / K_2$ . Denote by  $\mathfrak{L}\mathfrak{ic}(B; A)$  the graded free Lie algebra (over  $\mathbb{Z}$ ) generated by  $B$  in degree 1 and  $A$  in degree 2:

$$\mathfrak{L}\mathfrak{ic}(B; A) = \bigoplus_{m \geq 1} \mathfrak{L}\mathfrak{ic}_m(B; A) = B \oplus (\Lambda^2 B \oplus A) \oplus \cdots \quad (5.4)$$

Therefore we have

$$\mathrm{Gr}(K_\bullet) \cong \mathfrak{L}\mathfrak{ic}(B; A). \quad (5.5)$$

**Positive symplectic derivations of  $\mathfrak{L}\mathfrak{ic}(B; A)$ .** Recall that a derivation of  $\mathfrak{L}\mathfrak{ic}(B; A)$  is a linear map  $d : \mathfrak{L}\mathfrak{ic}(B; A) \rightarrow \mathfrak{L}\mathfrak{ic}(B; A)$  such that  $d([x, y]) = [d(x), y] + [x, d(y)]$  for every  $x, y \in \mathfrak{L}\mathfrak{ic}(B; A)$ . The set  $\mathrm{Der}(\mathfrak{L}\mathfrak{ic}(B; A))$  of derivations of  $\mathfrak{L}\mathfrak{ic}(B; A)$  is a Lie algebra with Lie bracket  $[d, d'] = dd' - d'd$ .

From the long exact sequence associated to the pair  $(V, \partial V)$  we obtain the short exact sequence

$$0 \longrightarrow H_2(V, \partial V; \mathbb{Z}) \xrightarrow{\delta_*} H \xrightarrow{\iota_*} B \longrightarrow 0, \quad (5.6)$$

whence  $H_2(V, \partial V; \mathbb{Z}) \cong A$ . Besides, by Poincaré-Lefschetz duality there is a canonical isomorphism  $H_2(V, \partial V; \mathbb{Z}) \cong H^1(V; \mathbb{Z})$  which allows to define the intersection form of the handlebody

$$\omega' : B \times H_2(V, \partial V; \mathbb{Z}) \longrightarrow \mathbb{Z}. \quad (5.7)$$

Consider the identifications  $B \cong A^*$  given by the isomorphism  $H/A \xrightarrow{\iota_*} B$  and by sending  $x + A \in H/A$  to  $\omega(x, \cdot) \in A^*$ ; and  $A \cong B^*$  given by the isomorphism  $H_2(V, \partial V; \mathbb{Z}) \cong A$  and by sending  $a \in A$  to  $\omega'(\cdot, a) \in B^*$ . This way, the intersection form  $\omega'$  determines an element  $\Omega' \in \mathfrak{L}\mathfrak{ic}_3(B; A)$ . The intersection form  $\omega : H \otimes H \rightarrow \mathbb{Z}$  determines an element  $\Omega \in \mathfrak{L}\mathfrak{ic}_2(H) \subseteq \mathfrak{L}\mathfrak{ic}(H)$ , where  $\mathfrak{L}\mathfrak{ic}(H)$  is the graded Lie algebra freely generated by  $H$  in degree 1. The relation between the intersection form  $\omega$  of  $\Sigma$  and  $\omega'$  of  $V$  is given by the commutativity of the diagram:

$$\begin{array}{ccc} B \times H_2(V, \partial V) & \xrightarrow{\omega'} & \mathbb{Z} \\ \uparrow \iota_* \cong & \cong \downarrow \delta_* & \nearrow \omega \\ H/A \times A & & \end{array}$$

**Definition 5.1.** Let  $d$  be a derivation of  $\mathfrak{Lie}(B; A)$ .

- (i) We say  $d$  is a *positive* derivation if  $d(B) \subseteq \mathfrak{Lie}_{\geq 2}(B; A)$  and  $d(A) \subseteq \mathfrak{Lie}_{\geq 3}(B; A)$ .
- (ii) Let  $m \geq 1$ . We say that  $d$  is a derivation of *degree*  $m$  if  $d(B) \subseteq \mathfrak{Lie}_{m+1}(B; A)$  and  $d(A) \subseteq \mathfrak{Lie}_{m+2}(B; A)$ .
- (iii) We say that  $d$  is a *symplectic* derivation if  $d(\Omega') = 0$ .

Denote by  $\text{Der}^{+\omega}(\mathfrak{Lie}(B; A))$  the set of positive symplectic derivations of  $\mathfrak{Lie}(B; A)$ . This set is a Lie subalgebra of  $\text{Der}(\mathfrak{Lie}(B; A))$ . Let  $m \geq 1$ , denote by  $\text{Der}_m(\mathfrak{Lie}(B; A))$  the subgroup of derivations of  $\mathfrak{Lie}(B; A)$  of degree  $m$ . Notice that a derivation  $d$  of  $\mathfrak{Lie}(B; A)$  of degree  $m$  is a family  $d = (d_i)_{i \geq 1}$  of group homomorphisms

$$d_i : \mathfrak{Lie}_i(B; A) \longrightarrow \mathfrak{Lie}_{i+m}(B; A),$$

satisfying  $d_{i+j}[x, y] = [d_i(x), y] + [x, d_j(y)]$  for  $x \in \mathfrak{Lie}_i(B; A)$  and  $y \in \mathfrak{Lie}_j(B; A)$ . Set

$$D_m(\mathfrak{Lie}(B; A)) = \text{Hom}_{\mathbb{Z}}(B, \mathfrak{Lie}_{m+1}(B; A)) \oplus \text{Hom}_{\mathbb{Z}}(A, \mathfrak{Lie}_{m+2}(B; A)). \quad (5.8)$$

The following is a classical result, see for instance [60, Lemma 0.7].

**Proposition 5.2.** *For every  $m \geq 1$ , there is a bijection*

$$\text{Der}_m(\mathfrak{Lie}(B; A)) \xrightarrow{\Psi} D_m(\mathfrak{Lie}(B; A)),$$

defined by  $\Psi(d) = d|_B + d|_A$  for  $d \in \text{Der}_m(\mathfrak{Lie}(B; A))$ .

By using the identifications  $B \cong A^*$  and  $A \cong B^*$ , we have

$$\begin{aligned} D_m(\mathfrak{Lie}(B; A)) &\cong (B^* \otimes \mathfrak{Lie}_{m+1}(B; A)) \oplus (A^* \otimes \mathfrak{Lie}_{m+2}(B; A)) \\ &\cong (A \otimes \mathfrak{Lie}_{m+1}(B; A)) \oplus (B \otimes \mathfrak{Lie}_{m+2}(B; A)). \end{aligned} \quad (5.9)$$

Hence we can see the map  $\Psi$  from Proposition 5.2 as taking values in the space on the left-hand side of Equation (5.9). For  $m \geq 1$ , consider the Lie bracket map

$$\Xi_m : (A \otimes \mathfrak{Lie}_{m+1}(B; A)) \oplus (B \otimes \mathfrak{Lie}_{m+2}(B; A)) \longrightarrow \mathfrak{Lie}_{m+3}(B; A). \quad (5.10)$$

Set  $D_m(B; A) := \ker(\Xi_m)$ . Denote by  $\text{Der}_m^+(\mathfrak{Lie}(B; A))$  (respectively by  $\text{Der}_m^{+\omega}(\mathfrak{Lie}(B; A))$ ) the subgroup of positive (respectively positive symplectic) derivations of  $\mathfrak{Lie}(B; A)$  of degree  $m$ .

**Proposition 5.3.** *Let  $d \in \text{Der}_m^+(\mathfrak{Lie}(B; A))$ . Then  $\Xi_m \Psi(d) = 0$  if and only if  $d(\Omega') = 0$ . That is*

$$\text{Der}_m^{+\omega}(\mathfrak{Lie}(B; A)) \cong D_m(B; A).$$

*Proof.* Consider the symplectic basis  $\{a_i, b_i\}$  induced by the systems of meridians and parallels  $\{\alpha_i, \beta_i\}$  on  $\Sigma$  shown in Figure 3.2 and identify  $\iota_*(b_i) \in B$  with  $b_i \in H$ . Then, in this basis, the element  $\Omega'$  is given by

$$\Omega' = \sum_{i=1}^g [a_i, b_i] \in \mathfrak{Lie}_3(B; A). \quad (5.11)$$

Using the identification (5.9) we obtain

$$\Psi(d) = \sum_{i=1}^g b_i^* \otimes d(b_i) + \sum_{i=1}^g a_i^* \otimes d(a_i) = \sum_{i=1}^g a_i \otimes d(b_i) - \sum_{i=1}^g b_i \otimes d(a_i). \quad (5.12)$$

Hence

$$\Xi_m \Psi(d) = \sum_{i=1}^g [a_i, d(b_i)] - \sum_{i=1}^g [b_i, d(a_i)] = d \left( \sum_{i=1}^g [a_i, b_i] \right) = d(\Omega') = 0. \quad (5.13)$$

□



## 5.2 Alternative Johnson homomorphisms

Let  $m$  be a positive integer and consider the space  $D_m(\mathfrak{L}\mathfrak{ic}(B; A))$  defined in (5.8).

**Definition 5.4.** The  $m$ -th *alternative Johnson homomorphism* is the group homomorphism

$$\tau_m^{\mathfrak{a}} : J_m^{\mathfrak{a}}\mathcal{M} \longrightarrow D_m(\mathfrak{L}\mathfrak{ic}(B; A)), \quad (5.14)$$

that maps  $h \in J_m^{\mathfrak{a}}\mathcal{M}$  to  $\tau_m^{\mathfrak{a}}(h) = (\tau_m^{\mathfrak{a}}(h)_1, \tau_m^{\mathfrak{a}}(h)_2)$ , where

$$\tau_m^{\mathfrak{a}}(h)_1(xK_2) = h_{\#}(x)x^{-1}K_{m+2} \quad \text{and} \quad \tau_m^{\mathfrak{a}}(h)_2(a) = h_{\#}(y)y^{-1}K_{m+3}$$

for all  $x \in \pi, a \in A$ , here  $y \in \mathbb{A} \subseteq K_2$  is any lift of  $a$ , see (5.3).

We refer to [28, Proposition 6.2] for a proof of the homomorphism property. From the definition of the alternative Johnson homomorphisms it follows that for  $m \geq 1$

$$\ker(\tau_m^{\mathfrak{a}}) = J_{m+1}^{\mathfrak{a}}\mathcal{M}. \quad (5.15)$$

Consider the bases as in Proposition 5.3 of  $H$  and  $B$  and keep the notation  $\{\alpha_i, \beta_i\}$  for a free basis of  $\pi$ . Using the identification (5.9) we have that the  $m$ -th alternative Johnson homomorphism of  $h \in J_m^{\mathfrak{a}}\mathcal{M}$  is given by

$$\begin{aligned} \tau_m^{\mathfrak{a}}(h) &= \sum_{i=1}^g a_i \otimes (\tau_m^{\mathfrak{a}}(h)_1(\beta_i K_2)) - \sum_{i=1}^g b_i \otimes (\tau_m^{\mathfrak{a}}(h)_2(a_i)) \\ &= \sum_{i=1}^g a_i \otimes (h_{\#}(\beta_i)\beta_i^{-1}K_{m+2}) - \sum_{i=1}^g b_i \otimes (h_{\#}(\alpha_i)\alpha_i^{-1}K_{m+3}). \end{aligned} \quad (5.16)$$

**Example 5.5.** Consider the Dehn twist  $h = t_{\alpha_i}$  from Example 4.4, we know that  $h \in J_1^{\mathfrak{a}}\mathcal{M} = \mathcal{I}^{\mathfrak{a}}$ . Let us compute its first alternative Johnson homomorphism. We have  $h_{\#}(\alpha_j) = \alpha_j$  for  $1 \leq j \leq g$ ,  $h_{\#}(\beta_j) = \beta_j$  for  $1 \leq j \leq g$  with  $j \neq i$  and  $h_{\#}(\beta_i) = \alpha_i^{-1}\beta_i$ . Hence

$$\tau_1^{\mathfrak{a}}(t_{\alpha_i}) = -a_i \otimes a_i.$$

**Example 5.6.** Consider the Dehn twist  $h = t_{\alpha_{12}}$  from Examples 4.4 and 3.10, which is an element of  $\mathcal{I}^{\mathfrak{a}}$ . The homotopy class of the curve  $\alpha_{12}$  is represented by  $\lambda = \alpha_2\alpha_1 \in K_2$ . We have  $h_{\#}(\alpha_j) = \alpha_j$  and  $h_{\#}(\beta_j) = \beta_j$  for  $3 \leq j \leq g$  and  $h_{\#}(\alpha_1) = \lambda^{-1}\alpha_1\lambda$ ,  $h_{\#}(\alpha_2) = \lambda^{-1}\alpha_2\lambda$ ,  $h_{\#}(\beta_1) = \lambda^{-1}\beta_1$  and  $h_{\#}(\beta_2) = \lambda^{-1}\beta_2$ . Hence

$$\tau_1^{\mathfrak{a}}(t_{\alpha_{12}}) = -(a_1 \otimes a_1) - (a_2 \otimes a_2) - (a_1 \otimes a_2) - (a_2 \otimes a_1).$$

Similarly for the Dehn twist  $t_{\alpha_{kl}}$  from Example 3.11 we have

$$\tau_1^{\mathfrak{a}}(t_{\alpha_{kl}}) = -(a_k \otimes a_k) - (a_l \otimes a_l) - (a_k \otimes a_l) - (a_l \otimes a_k).$$

**Example 5.7.** Consider the Dehn twist  $h = t_{\delta}$ , from Example 4.8. We have that  $t_{\delta} \in \mathcal{I}^{\mathfrak{a}}$ . The homotopy class of the curve  $\delta$  is represented by the commutator  $\lambda = [\alpha_1, \beta_1^{-1}] \in K_3$ . We have  $h_{\#}(\alpha_j) = \alpha_j$  and  $h_{\#}(\beta_j) = \beta_j$  for  $2 \leq j \leq g$  and  $h_{\#}(\alpha_1) = \lambda^{-1}\alpha_1\lambda$  and  $h_{\#}(\beta_1) = \lambda^{-1}\beta_1\lambda$ . Hence

$$\tau_1^{\mathfrak{a}}(t_{\delta}) = 0.$$

In particular  $t_{\delta} \in J_2^{\mathfrak{a}}\mathcal{M}$ .

**Example 5.8.** Let  $h = t_{\epsilon}t_{\alpha_g}^{-1}$  from Example 4.8. The homotopy class of the curve  $\epsilon$  is represented by  $\lambda = \beta_g^{-1}\alpha_g^{-1}\beta_g[\alpha_{g-1}, \beta_{g-1}]$ . We have  $h_{\#}(\alpha_i) = \alpha_i$  and  $h_{\#}(\beta_i) = \beta_i$  for  $1 \leq i \leq g-2$ , and  $h_{\#}(\alpha_g) = \alpha_g$ ,  $h_{\#}(\alpha_{g-1}) = \lambda^{-1}\alpha_{g-1}\lambda$ ,  $h_{\#}(\beta_{g-1}) = \lambda^{-1}\beta_{g-1}\lambda$  and  $h_{\#}(\beta_g) = \alpha_g\beta_g\lambda$ . By a direct calculation we obtain

$$\tau_1^{\mathfrak{a}}(t_{\epsilon}t_{\alpha_g}^{-1}) = 0.$$

In particular  $t_{\epsilon}t_{\alpha_g}^{-1} \in J_2^{\mathfrak{a}}\mathcal{M}$ .

Notice that in Examples 5.5 and 5.6, we have  $\Xi_1 \tau_1^{\mathfrak{a}}(t_{\alpha_i}) = 0$  and  $\Xi_1 \tau_1^{\mathfrak{a}}(t_{\alpha_{12}}) = 0$ . This is a more general fact.

**Theorem 5.9.** *Let  $m \geq 1$ . For  $h \in J_m^{\mathfrak{a}} \mathcal{M}$  we have  $\Xi_m \tau_m^{\mathfrak{a}}(h) = 0$ , that is*

$$\tau_m^{\mathfrak{a}}(h) \in D_m(B; A) \cong \text{Der}_m^{+, \omega}(\mathfrak{L}\mathfrak{ic}(B; A)).$$

*In other words,  $\tau_m^{\mathfrak{a}}(h)$  is a positive symplectic derivation of  $\mathfrak{L}\mathfrak{ic}(B; A)$ .*

*Proof.* The proof is similar to the proof of [51, Corollary 3.2]. Consider the free basis  $\{\alpha_i, \beta_i\}$  of  $\pi$  induced by the system of meridians and parallels in Figure 3.2. Let  $h \in J_m^{\mathfrak{a}} \mathcal{M}$ . Since  $h$  preserves the boundary  $\partial\Sigma$  of  $\Sigma$ , then  $h_{\#}$  fixes the inverse of the homotopy class  $[\partial\Sigma]$  of  $\Sigma$ . So  $h_{\#}([\partial\Sigma]^{-1}) = [\partial\Sigma]^{-1}$ , that is,

$$h_{\#} \left( \prod_{i=1}^g [\beta_i^{-1}, \alpha_i] \right) = \prod_{i=1}^g [\beta_i^{-1}, \alpha_i]. \quad (5.17)$$

For  $1 \leq i \leq g$  we have

$$\beta_i^{-1} h_{\#}(\beta_i) = \delta_i \in K_{1+m} \quad \text{and} \quad h_{\#}(\alpha_i) \alpha_i^{-1} = \gamma_i \in K_{2+m}.$$

Whence  $h_{\#}(\beta_i^{-1}) = \delta_i^{-1} \beta_i^{-1}$ . Hence

$$\begin{aligned} [h_{\#}(\beta_i^{-1}), h_{\#}(\alpha_i)] &= [\delta_i^{-1} \beta_i^{-1}, \gamma_i \alpha_i] \\ &= \delta_i^{-1} \beta_i^{-1} \gamma_i \alpha_i \beta_i \delta_i \alpha_i^{-1} \gamma_i^{-1} \\ &= \left( \delta_i^{-1} [\beta_i^{-1}, \gamma_i] \delta_i \right) \left( \delta_i^{-1} \gamma_i [\beta_i^{-1}, \alpha_i] \gamma_i^{-1} \delta_i \right) [\delta_i^{-1}, \gamma_i] \left( \gamma_i [\delta_i^{-1}, \alpha_i] \gamma_i^{-1} \right). \end{aligned}$$

It follows from equation (5.17) that

$$\prod_{i=1}^g [\beta_i^{-1}, \alpha_i] = \prod_{i=1}^g \left( \delta_i^{-1} [\beta_i^{-1}, \gamma_i] \delta_i \right) \left( \delta_i^{-1} \gamma_i [\beta_i^{-1}, \alpha_i] \gamma_i^{-1} \delta_i \right) [\delta_i^{-1}, \gamma_i] \left( \gamma_i [\delta_i^{-1}, \alpha_i] \gamma_i^{-1} \right). \quad (5.18)$$

Now  $[\beta_i^{-1}, \gamma_i] \in K_{3+m}$ ,  $[\delta_i^{-1}, \gamma_i] \in K_{3+2m} \subseteq K_{m+4}$  and  $[\delta_i^{-1}, \alpha_i] \in K_{3+m}$ . Therefore, by considering Equation (5.18) modulo  $K_{m+4}$  we obtain

$$\begin{aligned} \prod_{i=1}^g [\beta_i^{-1}, \alpha_i] &\equiv \prod_{i=1}^g \left( \delta_i^{-1} [\beta_i^{-1}, \gamma_i] \delta_i \right) \left( \delta_i^{-1} \gamma_i [\beta_i^{-1}, \alpha_i] \gamma_i^{-1} \delta_i \right) [\delta_i^{-1}, \gamma_i] \left( \gamma_i [\delta_i^{-1}, \alpha_i] \gamma_i^{-1} \right) \\ &\equiv \left( \prod_{i=1}^g [\beta_i^{-1}, \alpha_i] \right) \left( \prod_{i=1}^g [\beta_i^{-1}, \gamma_i] [\delta_i^{-1}, \alpha_i] \right). \end{aligned}$$

Thus

$$\prod_{i=1}^g [\beta_i^{-1}, \gamma_i] [\delta_i^{-1}, \alpha_i] \in K_{m+4}. \quad (5.19)$$

From (5.19), identification (5.9) and (5.16) we have

$$\begin{aligned} 0 &= \Xi_m \left( \sum_{i=1}^g (-b_i) \otimes (\gamma_i K_{m+3}) + \sum_{i=1}^g a_i \otimes (\delta_i K_{m+2}) \right) \\ &= \sum_{i=1}^g [a_i, h_{\#}(\beta_i) \beta_i^{-1} K_{m+2}] - \sum_{i=1}^g [b_i, h_{\#}(\alpha_i) \alpha_i^{-1} K_{m+3}] \\ &= \Xi_m \tau_m^{\mathfrak{a}}(h). \end{aligned} \quad (5.20)$$

In the second equality of (5.20) we use  $\delta_i K_{m+2} = \beta_i \delta_i \beta_i^{-1} K_{m+2} = h_{\#}(\beta_i) \beta_i^{-1} K_{m+2}$ .  $\square$

Let us briefly recall the Johnson homomorphisms and the Johnson-Levine homomorphisms.

**Johnson homomorphisms.** To define the Johnson filtration we use the lower central series  $(\Gamma_m \pi)_{m \geq 1}$  of  $\pi$ . The associated graded Lie algebra of this filtration is

$$\mathrm{Gr}(\Gamma_\bullet \pi) = \bigoplus_{m \geq 1} \frac{\Gamma_m \pi}{\Gamma_{m+1} \pi} \cong \bigoplus_{m \geq 1} \mathfrak{L}\mathfrak{ie}_m(H) = \mathfrak{L}\mathfrak{ie}(H), \quad (5.21)$$

where  $\mathfrak{L}\mathfrak{ie}(H)$  is the graded free Lie algebra on  $H$ . The  $m$ -th *Johnson homomorphism*

$$\tau_m : J_m \mathcal{M} \longrightarrow \mathrm{Hom}(H, \Gamma_{m+1} \pi / \Gamma_{m+2} \pi) \cong H^* \otimes \Gamma_{m+1} \pi / \Gamma_{m+2} \pi \cong H \otimes \mathfrak{L}\mathfrak{ie}_{m+1}(H), \quad (5.22)$$

sends the isotopy class  $h \in J_m \mathcal{M}$  to the map  $x \mapsto h_\#(\tilde{x})\tilde{x}^{-1}\Gamma_{m+2}\pi$  for all  $x \in H$ , where  $\tilde{x} \in \pi$  is any lift of  $x$ . The second isomorphism in (5.22) is given by the identification  $H \xrightarrow{\sim} H^*$  that maps  $x$  to  $\omega(x, \cdot)$ . These homomorphisms were introduced by D. Johnson in [30, 32] and extensively studied by S. Morita in [50, 51]. In particular S. Morita proved in [51, Corollary 3.2] that the  $m$ -th Johnson homomorphism takes values in the kernel  $D_m(H)$  of the Lie bracket  $[\cdot, \cdot] : H \otimes \mathfrak{L}\mathfrak{ie}_{m+1}(H) \rightarrow \mathfrak{L}\mathfrak{ie}_{m+2}(H)$ . Compare this with Theorem 5.9. From the definition it follows that  $\ker(\tau_m) = J_{m+1} \mathcal{M}$ .

**Johnson-Levine homomorphisms.** J. Levine defined and studied in [43, 46] a version of the Johnson homomorphisms for the Johnson-Levine filtration. Identify  $H/A$  with  $A^*$  by sending  $x + A \in H/A$  to  $\omega(x, \cdot) \in A^*$  and  $H/A$  with  $H'$  via the isomorphism  $\iota_*$ . The  $m$ -th *Johnson-Levine homomorphism*

$$\tau_m^L : J_m^L \mathcal{M} \rightarrow \mathrm{Hom}(A, \Gamma_{m+1} \pi' / \Gamma_{m+2} \pi') \cong A^* \otimes \Gamma_{m+1} \pi' / \Gamma_{m+2} \pi' \cong H' \otimes \mathfrak{L}\mathfrak{ie}_{m+1}(H'),$$

is the group homomorphism that sends  $h \in J_m^L \mathcal{M}$  to the map  $a \in A \mapsto \iota_\# h_\#(\alpha) \Gamma_{m+2} \pi'$ , where  $\alpha \in \mathbb{A}$  is any lift of  $a$ . Notice that here we consider the graded free Lie algebra  $\mathfrak{L}\mathfrak{ie}(H')$  generated by  $H'$ . J. Levine showed in [43, Proposition 4.3] that  $\tau_m^L$  takes values in the kernel  $D_m(H')$  of the Lie bracket  $[\cdot, \cdot] : H' \otimes \mathfrak{L}\mathfrak{ie}_{m+1}(H') \rightarrow \mathfrak{L}\mathfrak{ie}_{m+2}(H')$ . Compare this with Theorem 5.9. From the definition it follows that  $\ker(\tau_m^L) = J_{m+1}^L \mathcal{M}$ .

We refer to the alternative Johnson homomorphisms, the Johnson-Levine homomorphisms and the Johnson homomorphisms as *Johnson-type homomorphisms*.

**Alternative Johnson homomorphisms and Johnson-Levine homomorphisms.** In view of Proposition 4.13, for  $m \geq 1$  we have  $J_m^a \mathcal{M} \subseteq J_{m+1}^L \mathcal{M}$ . We show that for  $J_m^a \mathcal{M}$  the  $m$ -th alternative Johnson homomorphism determines the  $(m+1)$ -st Johnson-Levine homomorphism. Recall that  $B = H'$ .

**Lemma 5.10.** *For  $m \geq 1$ , there is a well defined homomorphism*

$$\iota_* : D_m(B; A) \longrightarrow D_{m+1}(H').$$

*Proof.* It follows from Lemma 4.12 that for  $m \geq 1$  the map  $\iota_\# : \pi \rightarrow \pi'$  induces a well-defined homomorphism

$$\iota_* : \mathfrak{L}\mathfrak{ie}_{m+2}(B; A) \cong \frac{K_{m+2}}{K_{m+3}} \longrightarrow \frac{\Gamma_{m+2} \pi'}{\Gamma_{m+3} \pi'} \cong \mathfrak{L}\mathfrak{ie}_{m+2}(H'),$$

which sends  $xK_{m+3}$  to  $\iota_\#(x)\Gamma_{m+3}\pi'$  for all  $x \in K_{m+2}$ . This map is compatible with the Lie bracket, in particular, the following diagram is commutative

$$\begin{array}{ccc} (A \otimes \mathfrak{L}\mathfrak{ie}_{m+1}(B; A)) \oplus (B \otimes \mathfrak{L}\mathfrak{ie}_{m+2}(B; A)) & \xrightarrow{[\cdot, \cdot]} & \mathfrak{L}\mathfrak{ie}_{m+3}(B; A) \\ \downarrow \iota_* \otimes \iota_* & & \downarrow \iota_* \\ H' \otimes \mathfrak{L}\mathfrak{ie}_{m+2}(H') & \xrightarrow{[\cdot, \cdot]} & \mathfrak{L}\mathfrak{ie}_{m+3}(H'). \end{array}$$

Whence, we have a well-defined homomorphism  $\iota_* : D_m(B; A) \rightarrow D_{m+1}(H')$ .  $\square$

**Proposition 5.11.** *For  $m \geq 1$ , the diagram*

$$\begin{array}{ccc} J_m^{\mathfrak{a}}\mathcal{M} & \xrightarrow{\subset} & J_{m+1}^L\mathcal{M} \\ \tau_m^{\mathfrak{a}} \downarrow & & \downarrow \tau_{m+1}^L \\ D_m(B; A) & \xrightarrow{\iota_*} & D_{m+1}(H') \end{array}$$

is commutative. In other words, for  $J_m^{\mathfrak{a}}\mathcal{M}$ , the homomorphism  $\tau_{m+1}^L$  is determined by the homomorphism  $\tau_m^{\mathfrak{a}}$ .

*Proof.* Let  $h \in J_m^{\mathfrak{a}}\mathcal{M}$ . By considering the free basis  $\{\alpha_i, \beta_i\}$  of  $\pi$  and the induced symplectic basis  $\{a_i, b_i\}$  of  $H$ , the  $(m+1)$ -st Johnson-Levine homomorphism on  $h$  is given by

$$\tau_{m+1}^L(h) = - \sum_{i=1}^g \iota_*(b_i) \otimes (\iota_{\#} h_{\#}(\alpha_i) \Gamma_{m+3} \pi'). \quad (5.23)$$

Applying  $\iota_* : D_m(B; A) \rightarrow D_{m+1}(H')$  to Equation (5.16) we obtain exactly the left-hand side of (5.23), that is,  $\iota_* \tau_m^{\mathfrak{a}}(h) = \tau_{m+1}^L(h)$ .  $\square$

**Remark 5.12.** In general it is not easy to compare the alternative Johnson homomorphisms and the Johnson homomorphisms. In Lemma 6.9 we carry out the comparison between  $\tau_1^{\mathfrak{a}}(\psi)$  and  $\tau_1(\psi)$  for  $\psi \in \mathcal{I} \cap \mathcal{I}^{\mathfrak{a}}$ .

### 5.3 Alternative Johnson homomorphism on $\mathcal{L}$

In [28], K. Habiro and G. Massuyeau defined, in a general context, a group homomorphism on  $\mathcal{L}$ . In this subsection we study in detail this homomorphism, which we shall call here the *0-th alternative Johnson homomorphism*.

An *automorphism*  $\phi$  of  $\mathfrak{L}\mathfrak{ie}(B; A)$  is a family  $\phi = (\phi_i)_{i \geq 1}$  of group isomorphisms  $\phi_i : \mathfrak{L}\mathfrak{ie}_i(B; A) \rightarrow \mathfrak{L}\mathfrak{ie}_i(B; A)$ , such that  $\phi_{i+j}([x, y]) = [\phi_i(x), \phi_j(y)]$  for  $x \in \mathfrak{L}\mathfrak{ie}_i(B; A)$  and  $y \in \mathfrak{L}\mathfrak{ie}_j(B; A)$ . Let us denote by  $\text{Aut}(\mathfrak{L}\mathfrak{ie}(B; A))$  the group of automorphisms of  $\mathfrak{L}\mathfrak{ie}(B; A)$ .

Recall that for the  $N$ -series  $(K_i)_{i \geq 1}$  defined in (4.10), we have from Lemma 4.6 that for  $h \in \mathcal{L}$ ,  ${}^h(K_i) \subseteq K_i$  for  $i \geq 1$ . Here  ${}^h x = h_{\#}(x)$  for  $x \in K_i$ .

**Definition 5.13.** The *0-th alternative Johnson homomorphism* is the group homomorphism

$$\tau_0^{\mathfrak{a}} : \mathcal{L} \longrightarrow \text{Aut}(\mathfrak{L}\mathfrak{ie}(B; A)) \quad (5.24)$$

which sends  $h \in \mathcal{L}$  to the family  $\tau_0^{\mathfrak{a}}(h) = (\tau_0^{\mathfrak{a}}(h)_i)_{i \geq 1}$  where

$$\tau_0^{\mathfrak{a}}(h)_i : \mathfrak{L}\mathfrak{ie}_i(B; A) \cong \frac{K_i}{K_{i+1}} \longrightarrow \frac{K_i}{K_{i+1}} \cong \mathfrak{L}\mathfrak{ie}_i(B; A)$$

is defined by  $\tau_0^{\mathfrak{a}}(h)_i(xK_{i+1}) = h_{\#}(x)K_{i+1}$  for  $x \in K_i$ .

From the definition it follows that  $\ker(\tau_0^{\mathfrak{a}}) = J_1^{\mathfrak{a}}\mathcal{M} = \mathcal{I}^{\mathfrak{a}}$ . We refer to [28, Proposition 6.1] for a proof of the homomorphism property with the above definition. We will see an equivalent definition of  $\tau_0^{\mathfrak{a}}$  in (5.31) and we prove the homomorphism property with the equivalent definition in Proposition 5.16.

Let us see how  $\tau_0^{\mathfrak{a}}$  is related to the other alternative Johnson homomorphisms. First, for  $m \geq 1$  there is an action of  $\mathcal{L}$  on  $J_m^{\mathfrak{a}}\mathcal{M}$  by conjugation, that is, for  $h \in \mathcal{L}$ , and  $f \in J_m^{\mathfrak{a}}\mathcal{M}$ , we set  ${}^h f = h f h^{-1} \in J_m^{\mathfrak{a}}\mathcal{M}$ . On the other hand, there is an action of  $\text{Aut}(\mathfrak{L}\mathfrak{ie}(B; A))$  on the group  $\text{Der}_m(\mathfrak{L}\mathfrak{ie}(B; A))$  of derivations of degree  $m$  of  $\mathfrak{L}\mathfrak{ie}(B; A)$ . Let  $\phi \in \text{Aut}(\mathfrak{L}\mathfrak{ie}(B; A))$  and  $d \in \text{Der}_m(\mathfrak{L}\mathfrak{ie}(B; A))$ , set

$$\phi d = \phi d \phi^{-1}. \quad (5.25)$$

More precisely,  $(\phi d)_i(x) = \phi_{m+i} d_i \phi_i^{-1}(x)$  for  $x \in \mathfrak{L}\mathfrak{ie}_i(B; A)$  and  $i \geq 1$ . The following is an instance of a part of [28, Theorem 6.4].

**Proposition 5.14.** *Let  $m \geq 1$  and  $h \in \mathcal{L}$ . The  $m$ -th alternative Johnson homomorphism  $\tau_m^a : J_m^a \mathcal{M} \rightarrow \text{Der}_m(B; A)$  satisfies the following equivariant property: for every  $f \in J_m^a \mathcal{M}$  we have*

$$\tau_m^a(hf) = \tau_0^a(h)\tau_m^a(f).$$

**Understanding the image of  $\tau_0^a$ .** Recall that  $\mathfrak{Lie}(B; A)$  is the free Lie algebra generated by  $B$  in degree 1 and  $A$  in degree 2. For  $h \in \mathcal{L}$  the automorphism  $\tau_0^a(h) : \mathfrak{Lie}(B; A) \rightarrow \mathfrak{Lie}(B; A)$  is completely determined by its parts of degree 1 and degree 2:

$$\tau_0^a(h)_1 : \mathfrak{Lie}_1(B; A) \rightarrow \mathfrak{Lie}_1(B; A) \quad \text{and} \quad \tau_0^a(h)_2 : \mathfrak{Lie}_2(B; A) \rightarrow \mathfrak{Lie}_2(B; A), \quad (5.26)$$

but  $\mathfrak{Lie}_1(B; A) = B$  and  $\mathfrak{Lie}_2(B; A) = \Lambda^2 B \oplus A$ . Consider the subgroup  $\mathcal{P}$  of  $\text{Aut}(B) \times \text{Aut}(\mathfrak{Lie}_2(B; A))$  defined by

$$\mathcal{P} = \{(u, v) \in \text{Aut}(B) \times \text{Aut}(\mathfrak{Lie}_2(B; A)) \mid v([x, y]) = [u(x), u(y)] \quad \forall x, y \in B\}.$$

Besides, consider the set

$$\mathcal{D} = \left\{ (u, v) \in \text{Aut}(B) \times \text{Hom}(A, \mathfrak{Lie}_2(B; A)) \mid \begin{array}{l} \text{the map } [x, y] + a \mapsto [u(x), u(y)] + v(a) \\ \text{is an automorphism of } [B, B] \oplus A = \mathfrak{Lie}_2(B; A) \end{array} \right\}.$$

For  $(u, v) \in \mathcal{D}$ , define  $\tilde{v} : \mathfrak{Lie}_2(B, A) \rightarrow \mathfrak{Lie}_2(B, A)$  on the summands by

$$\tilde{v}([x, y]) = [u(x), u(y)] \quad \text{and} \quad \tilde{v}(a) = v(a),$$

for  $x, y \in B$  and  $a \in A$ .

**Lemma 5.15.** *There is a bijective correspondence  $\Phi : \mathcal{P} \rightarrow \mathcal{D}$ , which sends  $(u, v) \in \mathcal{P}$  to  $(u, v|_A)$ . This way,  $\mathcal{D}$  inherits a group structure from  $\mathcal{P}$ , so that the product in  $\mathcal{D}$  is given by*

$$(u_1, v_1)(u_2, v_2) = \Phi((u_1, \tilde{v}_1)(u_2, \tilde{v}_2)) = \Phi(u_1 u_2, \tilde{v}_1 \tilde{v}_2) = (u_1 u_2, (\tilde{v}_1 \tilde{v}_2)|_A) \quad (5.27)$$

for  $(u_1, v_1), (u_2, v_2) \in \mathcal{D}$ .

*Proof.* The inverse of  $\Phi$  is defined by  $\Phi^{-1}(u, v) = (u, \tilde{v})$  for  $(u, v) \in \mathcal{D}$ . □

If  $h \in \mathcal{L}$  we have  $(\tau_0^a(h)_1, (\tau_0^a(h)_2)|_A) \in \mathcal{D}$ . Hence we can see the 0-th alternative Johnson homomorphism  $\tau_0^a$  as taking values in  $\mathcal{D}$ .

We can still improve the target of  $\tau_0^a$ . First, recall that if  $h \in \mathcal{L}$ , the induced map  $h_* : H \rightarrow H$  is symplectic, see (4.2). Denote by  $\hat{h}_* : H/A \rightarrow H/A$  the homomorphism induced by  $h_*$ . Hence  $\tau_0^a(h)_1 = \iota_* \hat{h}_* \iota_*^{-1} : H' \rightarrow H'$ . The symplectic condition on  $h_*$  implies that there is some information of  $(\tau_0^a(h)_2)|_A$  which is already encoded in  $\tau_0^a(h)_1$ . More precisely, we have

$$(\tau_0^a(h)_2)|_A = \iota_* (\tau_0^a(h)_2)|_A + h_{*|A} \in \text{Hom}(A, \Lambda^2 B \oplus A) = \text{Hom}(A, \mathfrak{Lie}_2(B; A)), \quad (5.28)$$

where  $\iota_* : \Lambda^2 B \oplus A \rightarrow \Lambda^2 B$  denotes the projection on  $\Lambda^2 B$ . For the moment we have that  $\tau_0^a(h)$  is completely determined by the pair

$$\left( \tau_0^a(h)_1, \iota_* (\tau_0^a(h)_2)|_A \right) \in \text{Aut}(B) \times \text{Hom}(A, \Lambda^2 B),$$

because  $h_{*|A}$  and  $\tau_0^a(h)_1 = \iota_* \hat{h}_* \iota_*^{-1}$  determine each other by the symplectic condition on  $h_*$ . The set  $\text{Aut}(B) \times \text{Hom}(A, \Lambda^2 B)$  inherits the group structure (5.27) from  $\mathcal{D}$ , which can be described explicitly as follows. Let  $h \in \text{Aut}(B)$ . Using the identification  $H' = B \cong A^*$ , described in subsection 5.1, we obtain  $h'' \in \text{Aut}(A^*)$ . Denote by  $h'$  the automorphism of  $A$  such that  $(h')^* = h''$ . Let  $\mu \in \text{Hom}(A, \Lambda^2 B)$ . We consider the following actions of  $\text{Aut}(B)$  on  $\text{Hom}(A, \Lambda^2 B)$

$$\begin{aligned} \text{right action:} \quad & \mu \cdot h := \mu \circ h' \in \text{Hom}(A, \Lambda^2 B), \\ \text{left action:} \quad & h \cdot \mu := \Lambda^2 h \circ \mu \in \text{Hom}(A, \Lambda^2 B). \end{aligned} \quad (5.29)$$

We have that the product in  $\text{Aut}(B) \times \text{Hom}(A, \Lambda^2 B)$  inherited from (5.27) is given by

$$(h, \mu)(f, \nu) = (hf, h \cdot \nu + \mu \cdot f) \quad (5.30)$$

for  $h, f \in \text{Aut}(B)$  and  $\mu, \nu \in \text{Hom}(A, \Lambda^2 B)$ .

Let  $\text{Aut}(B) \hat{\times} \text{Hom}(A, \Lambda^2 B)$  denote the set  $\text{Aut}(B) \times \text{Hom}(A, \Lambda^2 B)$  with the product given in (5.30). Hence we can see the 0-th Johnson homomorphism (5.24) as the map

$$\tau_0^{\mathfrak{a}} : \mathcal{L} \longrightarrow \text{Aut}(B) \hat{\times} \text{Hom}(A, \Lambda^2 B), \quad (5.31)$$

which sends  $h \in \mathcal{L}$  to the pair  $(\tau_0^{\mathfrak{a}}(h)_1, \iota_*(\tau_0^{\mathfrak{a}}(h)_2)|_A)$ . Moreover, the homomorphism  $\iota_*(\tau_0^{\mathfrak{a}}(h)_2)|_A$  takes  $a \in A$  to  $\iota_{\#} h_{\#}(\alpha) \Gamma_3 \pi'$  where  $\alpha \in \mathbb{A}$  is any lift of  $a$ , and we identify  $\Gamma_2 \pi' / \Gamma_3 \pi'$  with  $\Lambda^2 H' = \Lambda^2 B$ . In this context we can show the homomorphism property of  $\tau_0^{\mathfrak{a}}$ .

**Proposition 5.16.** *The map  $\tau_0^{\mathfrak{a}} : \mathcal{L} \rightarrow \text{Aut}(B) \hat{\times} \text{Hom}(A, \Lambda^2 B)$  is a group homomorphism and its kernel is the second term  $J_2^L \mathcal{M}$  of the Johnson-Levine filtration. In particular we have  $\mathcal{I}^{\mathfrak{a}} = J_1^{\mathfrak{a}} \mathcal{M} = J_2^L \mathcal{M}$ .*

*Proof.* Let  $h, f \in \mathcal{L}$ . Clearly we have  $\tau_0^{\mathfrak{a}}(hf)_1 = \tau_0^{\mathfrak{a}}(h)_1 \tau_0^{\mathfrak{a}}(f)_1$ . Identify  $\Gamma_2 \pi' / \Gamma_3 \pi'$  with  $\Lambda^2 B$ . Set  $\mu = \iota_*(\tau_0^{\mathfrak{a}}(h)_2)|_A$ ,  $\nu = \iota_*(\tau_0^{\mathfrak{a}}(f)_2)|_A$  and  $\kappa = \iota_*(\tau_0^{\mathfrak{a}}(hf)_2)|_A$ . Let us see that

$$\kappa = \tau_0^{\mathfrak{a}}(h)_1 \cdot \nu + \mu \cdot \tau_0^{\mathfrak{a}}(f)_1.$$

Let  $a \in A$  and  $\alpha \in \mathbb{A}$  with  $\text{ab}(\alpha) = a$ . By Lemma 4.6 we can write  $f_{\#}(\alpha) = \beta y$  with  $\beta \in \mathbb{A}$  and  $y \in \Gamma_2 \pi$ . We have

$$\text{ab}(\beta) = \text{ab}(\beta y) = \text{ab}(f_{\#}(\alpha)) = f_*(\text{ab}(\alpha)) = f_*(a).$$

Hence

$$\begin{aligned} \kappa &= \iota_{\#}(h_{\#}(f_{\#}(\alpha))) \Gamma_3 \pi' \\ &= \iota_{\#}(h_{\#}(\beta)) \Gamma_3 \pi' + \iota_{\#}(h_{\#}(y)) \Gamma_3 \pi' \\ &= \mu(\text{ab}(\beta)) + \iota_{\#}(h_{\#}(y)) \Gamma_3 \pi' \\ &= \mu(f_*(a)) + \Lambda^2 h(\nu(a)) \\ &= (\mu \cdot \tau_0^{\mathfrak{a}}(f)_1)(a) + (\tau_0(h)_1 \cdot \nu)(a) \\ &= (\tau_0(h)_1 \cdot \nu)(a) + (\mu \cdot \tau_0^{\mathfrak{a}}(f)_1)(a). \end{aligned}$$

Whence  $\kappa = \tau_0^{\mathfrak{a}}(h)_1 \cdot \nu + \mu \cdot \tau_0^{\mathfrak{a}}(f)_1$ . Thus  $\tau_0^{\mathfrak{a}} : \mathcal{L} \rightarrow \text{Aut}(B) \hat{\times} \text{Hom}(A, \Lambda^2 B)$  is a group homomorphism. Now, let  $h \in \ker(\tau_0^{\mathfrak{a}})$ , thus  $\tau_0(h)_1 = \text{Id}_{H'}$ . From the symplectic condition we have  $h_{*|_A} = \text{Id}_A$ , so  $h \in \mathcal{I}^L$ . Let  $\alpha \in \mathbb{A}$ , hence

$$\iota_{\#} h_{\#}(\alpha) \Gamma_3 \pi' = \iota_*(\tau_0^{\mathfrak{a}}(h)_2)(\text{ab}(\alpha)) = \Gamma_3 \pi',$$

that is,  $\iota_{\#} h_{\#}(\alpha) \in \Gamma_3 \pi'$  for all  $\alpha \in \mathbb{A}$ , so that  $h \in J_2^L \mathcal{M}$ .  $\square$

The next proposition follows from the definition (5.31) of  $\tau_0^{\mathfrak{a}}$  and shows that for the elements of  $\mathcal{I}^L$ , the 0-th alternative Johnson homomorphism determines the first Johnson-Levine homomorphism.

**Proposition 5.17.** *Let  $q : \text{Aut}(B) \hat{\times} \text{Hom}(A, \Lambda^2 B) \rightarrow \text{Hom}(A, \Lambda^2 B)$  denote the cartesian projection (which is not a group homomorphism). Then, the diagram*

$$\begin{array}{ccc} \mathcal{I}^L & \xrightarrow{\subset} & \mathcal{L} \\ \tau_1^L \downarrow & & \downarrow \tau_0^{\mathfrak{a}} \\ \text{Hom}(A, \Lambda^2 B) & \xleftarrow{q} & \text{Aut}(B) \hat{\times} \text{Hom}(A, \Lambda^2 B) \end{array}$$

*is commutative.*

**Remark 5.18.** There is a right split short exact sequence

$$0 \longrightarrow \text{Hom}(A, \Lambda^2 B) \xrightarrow{j} \text{Aut}(B) \hat{\times} \text{Hom}(A, \Lambda^2 B) \xrightarrow{p} \text{Aut}(B) \longrightarrow 1,$$

$\xleftarrow[s]{\quad}$

where  $j(\mu) = (\text{Id}_B, \mu)$ ,  $p(h, \mu) = h$  and  $s(h) = (h, 0)$  for  $\mu \in \text{Hom}(A, \Lambda^2 B)$  and  $h \in \text{Aut}(B)$ . Therefore, the group  $\text{Aut}(B) \hat{\times} \text{Hom}(A, \Lambda^2 B)$  is isomorphic to the semidirect product  $\text{Aut}(B) \ltimes \text{Hom}(A, \Lambda^2 B)$ , where the action of  $\text{Aut}(B)$  on  $\text{Hom}(A, \Lambda^2 B)$  is given by  $h * \mu = h \cdot \mu \cdot h^{-1}$  for  $h \in \text{Aut}(B)$  and  $\mu \in \text{Hom}(A, \Lambda^2 B)$ . Here the  $\cdot$  means the left and right actions defined in (5.29). The explicit isomorphism

$$\Theta : \text{Aut}(B) \hat{\times} \text{Hom}(A, \Lambda^2 B) \longrightarrow \text{Aut}(B) \ltimes \text{Hom}(A, \Lambda^2 B),$$

is given by  $\Theta(h, \mu) = (h, \mu \cdot h^{-1})$  for  $h \in \text{Aut}(B)$  and  $\mu \in \text{Hom}(A, \Lambda^2 B)$ .

We can do yet another refinement of the target of  $\tau_0^a$ . Considering the Definition 5.13 we have that  $\tau_0^a(h)_3(\Omega') = \Omega'$  for  $h \in \mathcal{L}$ , where  $\Omega' \in \mathfrak{Lie}_3(B; A)$  is determined by the intersection form (5.7).

Notice that a pair  $(h, \kappa) \in \text{Aut}(B) \times \text{Hom}(A, \mathfrak{Lie}_2(B; A))$  uniquely determines a morphism of Lie algebras  $(h, \kappa) : \mathfrak{Lie}(B; A) \rightarrow \mathfrak{Lie}(B; A)$ .

**Lemma 5.19.** *Let  $h \in \text{Aut}(B)$  and let  $h' : A \rightarrow A \subseteq \mathfrak{Lie}_2(B; A)$  be the automorphism of  $A$  determined by  $h$ . Then  $(h, h')(\Omega') = \Omega'$ .*

*Proof.* Consider the bases of  $H$  and  $B$  as in Proposition 5.3 and identify  $\iota_*(b_i)$  with  $b_i$ . Hence  $\Omega'$  is given as in Equation (5.11). If  $R = (\epsilon_{kj})$  is the matrix of  $h$  in the basis  $\{\iota_*(b_i)\}$  and  $P = (\lambda_{ij})$  is the the matrix of  $h'$  in the basis  $\{a_i\}$ , then  $P^T R = \text{Id}_g$ . Thus

$$\begin{aligned} (h, h')(\Omega') &= \sum_{j=1}^g [h'(a_j), h(b_j)] = \sum_{j=1}^g \left[ \sum_{i=1}^g \lambda_{ij} a_i, \sum_{k=1}^g \epsilon_{kj} b_k \right] = \sum_{i=1}^g \sum_{k=1}^g \sum_{j=1}^g \lambda_{ij} \epsilon_{kj} [a_i, b_k] \\ &= \sum_{j=1}^g [a_j, b_j] = \Omega'. \end{aligned}$$

□

Let  $(h, \mu) \in \text{Aut}(B) \hat{\times} \text{Hom}(A, \Lambda^2 B)$ . Let  $(h_i)_{i \geq 1}$  be the associated automorphism of  $\mathfrak{Lie}(B; A)$ . Explicitly we have  $h_1 = h$  and  $h_2 = \mu + h'$  where  $h' \in \text{Aut}(A)$  is determined by  $h$ .

**Lemma 5.20.** *The condition  $h_3(\Omega') = \Omega'$  holds if and only if  $(h, \mu)(\Omega') = 0$ .*

*Proof.* We use bases as in Lemma 5.19. We have

$$\begin{aligned} h_3(\Omega') &= \sum_{j=1}^g [h_2(a_j), h_1(b_j)] = \sum_{j=1}^g [\mu(a_j), h(b_j)] + \sum_{j=1}^g [h'(a_j), h(b_j)] \\ &= (h, \mu)(\Omega') + (h, h')(\Omega') = (h, \mu)(\Omega') + \Omega'. \end{aligned}$$

Last equality comes from Lemma 5.19. Whence the desired result. □

Notice that a pair  $(h, \mu) \in \text{Aut}(B) \hat{\times} \text{Hom}(A, \Lambda^2 B)$ , determines an element  $\mu_h \in B \otimes \Lambda^2 B$  through the identification

$$\text{Hom}(A, \Lambda^2 B) \cong A^* \otimes \Lambda^2 B \cong B \otimes \Lambda^2 B \xrightarrow{h \otimes \text{Id}_{\Lambda^2 B}} B \otimes \Lambda^2 B,$$

Thus  $\mu_h := (h \otimes \text{Id}_{\Lambda^2 B})(\mu)$ . Set

$$\mathcal{G} := \left\{ (h, \mu) \in \text{Aut}(B) \hat{\times} \text{Hom}(A, \Lambda^2 B) \mid \Xi_3(\mu_h) = 0 \right\}, \quad (5.32)$$

where  $\Xi_3 : B \otimes \mathfrak{Lie}_2(B) \rightarrow \mathfrak{Lie}_3(B)$  is the Lie bracket. Using bases as in Lemma 5.19 we have

$$\mathcal{G} = \left\{ (h, \mu) \in \text{Aut}(B) \hat{\times} \text{Hom}(A, \Lambda^2 B) \mid \Xi_3 \left( \sum_{j=1}^g h(b_j) \otimes \mu(a_j) \right) = 0 \right\}. \quad (5.33)$$

**Proposition 5.21.** *The set  $\mathcal{G}$  is a subgroup of  $\text{Aut}(B) \hat{\times} \text{Hom}(A, \Lambda^2 B)$ .*

*Proof.* The result can be deduced from Lemma 5.20 or from the description of  $\mathcal{G}$  given in (5.33) as follows. Let  $(h, \mu), (f, \nu) \in \mathcal{G}$ . Let us see that  $(h, \mu)(f, \nu) = (hf, h \cdot \nu + \mu \cdot f)$  and  $(h, \mu)^{-1} = (h^{-1}, -h^{-1} \cdot \mu \cdot h^{-1})$  belong to  $\mathcal{G}$ . We have

$$\begin{aligned} \Xi_3\left(\sum_{j=1}^g hf(b_j) \otimes (h \cdot \nu + \mu \cdot f)(a_j)\right) &= \sum_{j=1}^g \left[ hf(b_j), \Lambda^2 h(\nu(a_j)) + \mu f'(a_j) \right] \\ &= \mathfrak{L}\mathfrak{ie}_3(h)\left(\sum_{j=1}^g [f(b_j), \nu(a_j)]\right) \\ &\quad + \sum_{j=1}^g [h(f(b_j)), \mu(f'(a_j))] \\ &= \sum_{j=1}^g [h(b_j), \mu(a_j)] \\ &= 0, \end{aligned}$$

where  $\mathfrak{L}\mathfrak{ie}_3(h) : \mathfrak{L}\mathfrak{ie}_3(B) \rightarrow \mathfrak{L}\mathfrak{ie}_3(B)$  is the isomorphism induced by  $h$ . The equality

$$\sum_{j=1}^g [h(f(b_j)), \mu(f'(a_j))] = \sum_{j=1}^g [h(b_j), \mu(a_j)]$$

is deduced in a similar way as we did in the proof of Lemma 5.19. Therefore  $(h, \mu)(f, \nu) \in \mathcal{G}$ . On the other hand

$$\begin{aligned} \Xi_3\left(\sum_{j=1}^g h^{-1}(b_j) \otimes (-h^{-1} \cdot \mu \cdot h^{-1})(a_j)\right) &= \sum_{j=1}^g \left[ h^{-1}(b_j), -\Lambda^2 h^{-1}(\mu(h^{-1})'(a_j)) \right] \\ &= -\mathfrak{L}\mathfrak{ie}_3(h^{-1})\left(\sum_{j=1}^g [h(h^{-1}(b_j)), \mu(h^{-1})'(a_j)]\right) \\ &= -\mathfrak{L}\mathfrak{ie}_3(h^{-1})\left(\sum_{j=1}^g [h(b_j), \mu(a_j)]\right) \\ &= 0. \end{aligned}$$

Hence  $(h, \mu)^{-1} \in \mathcal{G}$ . □

**Lemma 5.22.** *The 0-th alternative Johnson homomorphism defined in (5.31) takes its values in  $\mathcal{G}$ .*

*Proof.* Let  $h \in \mathcal{L}$ . Set  $\mu = \iota_*(\tau_0^{\mathfrak{a}}(h)_2)|_A$ . Hence

$$\begin{aligned} \Xi_3\left(\sum_{j=1}^g \tau_0^{\mathfrak{a}}(h)_1(b_j) \otimes \mu(a_j)\right) &= -\sum_{j=1}^g \Xi_3\left(\iota_* h_*(-b_j) \otimes \iota_{\#} h_{\#}(\alpha_j) \Gamma_3 \pi'\right) \\ &= -\sum_{j=1}^g \Xi_3\left(\iota_{\#} h_{\#}(\beta_j^{-1}) \Gamma_2 \pi' \otimes \iota_{\#} h_{\#}(\alpha_j) \Gamma_3 \pi'\right) \\ &= \left(\iota_{\#} h_{\#}\left(\prod_{j=1}^g [\beta_j^{-1}, \alpha_j]\right) \Gamma_4 \pi'\right)^{-1} \\ &= \Gamma_4 \pi' \\ &= 0 \in \mathfrak{L}\mathfrak{ie}_3(B). \end{aligned}$$

□



To sum up, we can write

$$\tau_0^{\mathfrak{a}} : \mathcal{L} \longrightarrow \mathcal{G}. \quad (5.34)$$

**Theorem 5.23.** *The 0-th alternative Johnson homomorphism  $\tau_0^{\mathfrak{a}} : \mathcal{L} \rightarrow \mathcal{G}$  is surjective.*

*Proof.* Notice that the diagram

$$\begin{array}{ccc} \mathcal{I} & \xrightarrow{\subset} & \mathcal{I}^L \\ \tau_1 \downarrow & & \downarrow \tau_1^L \\ D_1(H) & \xrightarrow{\iota_*} & D_1(H') \end{array}$$

is commutative, this can be shown by writing  $\tau_1$  and  $\tau_1^L$  by using a symplectic basis as we did for  $\tau_{m+1}^L$  in Equation 5.23, see [46, Section 4] for more details. The map  $\iota_* : D_1(H) \rightarrow D_1(H')$  is induced by  $\iota_* : H \rightarrow H'$ . It is easy to show that  $\iota_* : D_1(H) \rightarrow D_1(H')$  is surjective and it is well known that the first Johnson homomorphism  $\tau_1$  is surjective [30, Theorem 1]. Hence  $\tau_1^L$  is surjective. Using the symplectic basis  $\{a_i, b_i\}$  to identify  $\mathrm{Sp}(H)$  with  $\mathrm{Sp}(2g, \mathbb{Z})$  we have that the image of  $\mathcal{L}$  under the symplectic representation (4.2) is

$$\sigma(\mathcal{L}) = \left\{ \begin{pmatrix} P & Q \\ 0 & (P^T)^{-1} \end{pmatrix} \in \mathrm{Sp}(2g, \mathbb{Z}) \mid P^{-1}Q \text{ is symmetric} \right\}. \quad (5.35)$$

Let  $(f, \mu) \in \mathcal{G}$ . From (5.35), it follows that there is  $h \in \mathcal{L}$  such that  $\tau_0^{\mathfrak{a}}(h)_1 = f$ . Let  $\nu = \iota_* (\tau_0^{\mathfrak{a}}(h)_2)|_A \in \mathrm{Hom}(A, \Lambda^2 B)$ . Hence  $\tau_0^{\mathfrak{a}}(h) = (f, \nu) \in \mathcal{G}$ .

Consider the element

$$\mu' = f^{-1} \cdot (\mu - \nu) \in \mathrm{Hom}(A, \Lambda^2 H').$$

Recall that  $B = H'$ . Let us see that  $\mu' \in D_1(H')$ . Indeed, if  $\Xi : H' \otimes \mathfrak{Lie}_2(H') \rightarrow \mathfrak{Lie}_3(H')$  denotes the Lie bracket, we have

$$\begin{aligned} \Xi(\mu') &= -\Xi\left(\sum_{j=1}^g b_j \otimes (f^{-1} \cdot (\mu - \nu))(a_j)\right) \\ &= -\sum_{j=1}^g [b_j, \Lambda^2 f^{-1} \mu(a_j)] + \sum_{j=1}^g [b_j, \Lambda^2 f^{-1} \nu(a_j)] \\ &\quad - \sum_{j=1}^g [f^{-1}(f(b_j)), \Lambda^2 f^{-1} \mu(a_j)] + \sum_{j=1}^g [f^{-1}(f(b_j)), \Lambda^2 f^{-1} \nu(a_j)] \\ &= -\mathfrak{Lie}_3(f^{-1})\left(\sum_{j=1}^g [f(b_j), \mu(a_j)]\right) + \mathfrak{Lie}_3(f^{-1})\left(\sum_{j=1}^g [f(b_j), \nu(a_j)]\right) \\ &= 0. \end{aligned}$$

Whence  $\mu' \in D_1(H')$ . By the surjectivity of  $\tau_1^L$  and Proposition 5.17, there exists  $g \in \mathcal{I}^L$  such that  $\tau_0^{\mathfrak{a}}(g) = (\mathrm{Id}_{H'}, \mu')$ . Therefore

$$\begin{aligned} \tau_0^{\mathfrak{a}}(hg) &= \tau_0^{\mathfrak{a}}(h)\tau_0^{\mathfrak{a}}(g) = (f, \nu)(\mathrm{Id}_{H'}, \mu') = (f, \nu)(\mathrm{Id}_{H'}, f^{-1} \cdot (\mu - \nu)) \\ &= (f, f \cdot (f^{-1} \cdot (\mu - \nu)) + \nu) = (f, \mu). \end{aligned}$$

Hence we have the surjectivity of  $\tau_0^{\mathfrak{a}} : \mathcal{L} \rightarrow \mathcal{G}$ . □

**Corollary 5.24.** *We have the following short exact sequence*

$$1 \longrightarrow \mathcal{I}^{\mathfrak{a}} \xrightarrow{\subset} \mathcal{L} \xrightarrow{\tau_0^{\mathfrak{a}}} \mathcal{G} \longrightarrow 1.$$

## 5.4 Diagrammatic versions of the Johnson-type homomorphisms

In subsection 5.2 we have seen that for  $m \geq 1$ , the  $m$ -th Johnson homomorphism, the  $m$ -th Johnson-Levine homomorphism and the  $m$ -th alternative Johnson homomorphism take values in the abelian groups  $D_m(H)$ ,  $D_m(H') = D_m(B)$  and  $D_m(B; A)$ , respectively. These spaces were defined as

$$\begin{aligned} D_m(H) &= \ker(H \otimes \mathfrak{L}ie_{m+1}(H) \xrightarrow{[\cdot, \cdot]} \mathfrak{L}ie_{m+2}(H)), \\ D_m(H') &= \ker(H' \otimes \mathfrak{L}ie_{m+1}(H') \xrightarrow{[\cdot, \cdot]} \mathfrak{L}ie_{m+2}(H')) \quad \text{and} \\ D_m(B; A) &= \ker((A \otimes \mathfrak{L}ie_{m+1}(B; A)) \oplus (B \otimes \mathfrak{L}ie_{m+2}(B; A)) \xrightarrow{[\cdot, \cdot]} \mathfrak{L}ie_{m+3}(B; A)). \end{aligned}$$

The rational versions  $D_m(H) \otimes \mathbb{Q}$ ,  $D_m(H') \otimes \mathbb{Q}$  and  $D_m(B; A) \otimes \mathbb{Q}$  can be interpreted as subspaces of the spaces of connected tree-like Jacobi diagrams  $\mathcal{A}^{t,c}(H)$ ,  $\mathcal{A}^{t,c}(H')$  and  $\mathcal{A}^{t,c}(B \oplus A)$ , respectively. See Example 2.3 for the definitions. Recall that these spaces are graded by the internal degree. Notice that as spaces  $\mathcal{A}^{t,c}(H) = \mathcal{A}^{t,c}(B \oplus A)$  but we would like to give a special role to  $A$  in the latter space, which will be reflected in a different grading of the space  $\mathcal{A}^{t,c}(B \oplus A)$ . Let us start by recalling this interpretation.

For a connected tree-like Jacobi diagram  $T$  in  $\mathcal{A}^{t,c}(H) = \mathcal{A}^{t,c}(B \oplus A)$  or in  $\mathcal{A}^{t,c}(H')$ , set

$$\eta(T) = \sum_v \text{color}(v) \otimes (T \text{ rooted at } v), \quad (5.36)$$

where the sum ranges over the set of legs (univalent vertices) of  $T$  and we interpret a rooted tree as a Lie commutator.

**Example 5.25.** Consider the tree

$$T_0 = \begin{array}{c} \begin{array}{c} b' \quad b \\ \diagdown \quad \diagup \\ \cdot \\ \diagup \quad \diagdown \\ a \quad a' \end{array} \end{array}$$

where  $a, a' \in A$  and  $b, b' \in B$ . Hence,

$$\begin{aligned} \begin{array}{c} \begin{array}{c} b' \quad b \\ \diagdown \quad \diagup \\ \cdot \\ \diagup \quad \diagdown \\ a \quad a' \end{array} \end{array} &\xrightarrow{\eta} a \otimes \begin{array}{c} \begin{array}{c} b' \quad b \\ \diagdown \quad \diagup \\ \cdot \\ \diagup \quad \diagdown \\ a' \end{array} \end{array} + a' \otimes \begin{array}{c} \begin{array}{c} b' \quad b \\ \diagdown \quad \diagup \\ \cdot \\ \diagup \quad \diagdown \\ a \end{array} \end{array} + b \otimes \begin{array}{c} \begin{array}{c} a' \quad a \\ \diagdown \quad \diagup \\ \cdot \\ \diagup \quad \diagdown \\ b' \end{array} \end{array} + b' \otimes \begin{array}{c} \begin{array}{c} a' \quad a \\ \diagdown \quad \diagup \\ \cdot \\ \diagup \quad \diagdown \\ b \end{array} \end{array} \\ &= a \otimes [[b', b], a'] + a' \otimes [a, [b', b]] + b \otimes [[a', a], b'] + b' \otimes [b, [a', a]]. \end{aligned}$$

We have that  $\eta(T_0) \in H \otimes \mathfrak{L}ie_3(H)$  and  $\eta(T_0) \in (A \otimes \mathfrak{L}ie_4(B; A)) \oplus (B \otimes \mathfrak{L}ie_5(B; A))$ . Moreover, by the Jacobi identity, if we apply the Lie bracket  $\Xi$  to  $\eta(T_0)$  we obtain  $\Xi\eta(T_0) = 0$ . Therefore  $\eta(T_0) \in D_2(H)$  and  $\eta(T_0) \in D_3(B; A)$ .

Denote by  $\mathcal{A}_m^{t,c}(H)$  the subspace of  $\mathcal{A}^{t,c}(H)$  generated by diagrams of internal degree  $m$ . So if  $T \in \mathcal{A}_m^{t,c}(H)$ , then  $T$  has  $m + 2$  legs and therefore by rooting  $T$  at one of its legs we obtain a rooted tree with  $m + 1$  leaves. To sum up,  $\eta(T) \in H \otimes \mathfrak{L}ie_{m+1}(H)$ . Moreover if we apply the Lie bracket  $\Xi : H \otimes \mathfrak{L}ie_{m+1}(H) \rightarrow \mathfrak{L}ie_{m+2}(H)$  to  $\eta(T)$ , we obtain  $\Xi\eta(T) = 0$ . This way  $\eta(T) \in D_m(H)$ , see [44, Lemma 3.1] for the proof in the general case. The following result is well known.

**Theorem 5.26.** For  $m \geq 1$  the map

$$\eta : \mathcal{A}_m^{t,c}(H) \longrightarrow D_m(H) \otimes \mathbb{Q}, \quad (5.37)$$

defined as in Equation (5.36), is an isomorphism of  $\mathbb{Q}$ -vector spaces.

i-deg \ a-deg	0	1	2	3
0				
1				
2				
3				
4				
5				

Table 2.1:

We refer to [44, Corollary 3.2] or [25, Theorem 1] for a proof of Theorem 5.26.

In particular we have an isomorphism of graded  $\mathbb{Q}$ -vector spaces

$$\eta : \bigoplus_{m \geq 1} \mathcal{A}_m^{t,c}(H) \longrightarrow \bigoplus_{m \geq 1} D_m(H) \otimes \mathbb{Q}. \quad (5.38)$$

The same statements hold replacing  $H$  by  $H'$ . We define a degree for connected tree-like Jacobi diagrams, which we call *alternative degree* and denote by  $\mathfrak{a}\text{-deg}$ , such that if  $T \in \mathcal{A}^{t,c}(B \oplus A)$  is such that  $\mathfrak{a}\text{-deg}(T) = m$  then  $\eta(T) \in D_m(B; A) \otimes \mathbb{Q}$ . In Example 5.25,  $\eta(T_0) \in D_3(B; A)$ , so we want  $\mathfrak{a}\text{-deg}(T_0) = 3$ .

**Definition 5.27.** Let  $T$  be a connected tree-like Jacobi diagram with legs colored by  $B \oplus A$ . The *alternative degree* of  $T$ , denoted  $\mathfrak{a}\text{-deg}(T)$ , is defined as

$$\mathfrak{a}\text{-deg}(T) = 2\#\{A\text{-colored legs of } T\} + \#\{B\text{-colored legs of } T\} - 3.$$

Here  $\#S$  denotes the cardinal of the set  $S$ .

In Table 2.1 we show some examples of tree-like Jacobi diagrams organized by their internal degree in the columns and by the alternative degree in the rows. The legs colored by  $+$  (respectively by  $-$ ) in the diagrams represent legs colored by elements of  $B$  (respectively of  $A$ ). Notice that a strut diagram  $D$  whose both legs are colored by elements of  $B$  is such that  $\mathfrak{a}\text{-deg}(D) = -1$ .

For  $m \geq 1$ , let  $\mathcal{T}_m^{\mathfrak{a}}(B \oplus A)$  denote the subspace of  $\mathcal{A}^{t,c}(B \oplus A)$  generated by diagrams of alternative degree  $m$ .

**Proposition 5.28.** For  $m \geq 1$  the map  $\eta$  defined in (5.36) induces an isomorphism

$$\eta : \mathcal{T}_m^{\mathfrak{a}}(B \oplus A) \longrightarrow D_m(B; A) \otimes \mathbb{Q} \quad (5.39)$$

of  $\mathbb{Q}$ -vector spaces.





Notice that the given definition of  $\mathcal{IC}^a$  is motivated by the definition of  $J_2^L \mathcal{M}$ . There is an equivalent definition motivated by the definition of  $\mathcal{I}^a$ , see Proposition 5.16.

**Example 6.3.** If  $c : \mathcal{M} \rightarrow \mathcal{C}$  is the mapping cylinder monoid homomorphism, then  $c(\mathcal{L}) \subseteq \mathcal{LC}$ ,  $c(\mathcal{I}) \subseteq \mathcal{IC}$ ,  $c(\mathcal{I}^L) \subseteq \mathcal{IC}^L$  and  $c(\mathcal{I}^a) \subseteq \mathcal{IC}^a$ .

Recall that for  $M$  a Lagrangian cobordism,  $\tilde{Z}^{Y,t}(M)$  denotes the reduction of the value  $\tilde{Z}(M)$  modulo struts and looped diagrams.

**Definition 6.4.** The *alternative tree filtration*  $\{\mathcal{F}_m^a \mathcal{C}\}_{m \geq 1}$  of  $\mathcal{C}$  is defined by

$$\mathcal{F}_m^a \mathcal{C} = \{(M, m) \in \mathcal{IC}^a \mid \tilde{Z}^{Y,t}(M) = \emptyset + (\text{terms of } \mathbf{a}\text{-deg} \geq m)\}.$$

Let  $\mathcal{T}_m^{Y,a}([g]^+ \sqcup [g]^-)$  denote the subspace of  $\mathcal{A}^{Y,t}([g]^+ \sqcup [g]^-)$  generated by diagrams of  $\mathbf{a}\text{-deg} = m$ .

**Theorem 6.5.** For  $m \geq 1$ , the set  $\mathcal{F}_m^a \mathcal{C}$  is a submonoid of  $\mathcal{C}$ . Consider the map

$$\tilde{Z}_m^{Y,a} : \mathcal{F}_m^a \mathcal{C} \longrightarrow \mathcal{T}_m^{Y,a}([g]^+ \sqcup [g]^-),$$

where  $\tilde{Z}_m^{Y,a}(M)$  is defined as the terms of  $\mathbf{a}\text{-deg} = m$  in  $\tilde{Z}^{Y,t}(M)$  for  $M \in \mathcal{F}_m^a \mathcal{C}$ . Then  $\tilde{Z}_m^{Y,a}$  is a monoid homomorphism.

*Proof.* Let  $M, N \in \mathcal{F}_m^a \mathcal{C}$  and write  $\tilde{Z}^{Y,t}(M) = \emptyset + D_M + (\mathbf{a}\text{-deg} > m)$  and  $\tilde{Z}^{Y,t}(N) = \emptyset + D_N + (\mathbf{a}\text{-deg} > m)$ , where  $D_M$  and  $D_N$  are linear combinations of connected Jacobi diagrams in  $\mathcal{A}^{Y,t}([g]^+ \sqcup [g]^-)$  of  $\mathbf{a}\text{-deg} = m$ . We have to show that  $M \circ N \in \mathcal{F}_m^a \mathcal{C}$  and that

$$\tilde{Z}^{Y,t}(M \circ N) = \emptyset + (D_M + D_N) + (\mathbf{a}\text{-deg} > m). \quad (6.4)$$

Suppose that  $\text{Lk}(M) = \begin{pmatrix} 0 & \text{Id}_g \\ \text{Id}_g & \Lambda \end{pmatrix}$  and  $\text{Lk}(N) = \begin{pmatrix} 0 & \text{Id}_g \\ \text{Id}_g & \Delta \end{pmatrix}$ , where  $\Lambda = (m_{ij})$  and  $\Delta = (n_{ij})$  are symmetric  $g \times g$  matrices. We have

$$\tilde{Z}(M \circ N) = \tilde{Z}(M) \circ \tilde{Z}(N) = \left\langle \tilde{Z}(M)_{|j^+ \mapsto j^*}, \tilde{Z}(N)_{|j^- \mapsto j^*} \right\rangle_{[g]^*}. \quad (6.5)$$

By Lemma 3.15 we can write

$$\begin{aligned} \tilde{Z}(M \circ N) = \left\langle \left[ \sum_i \begin{array}{c} \cdot \\ \vdots \\ i^* \\ \vdots \\ i^- \\ \cdot \end{array} + \frac{1}{2} \sum_{i,j} m_{ij} \begin{array}{c} \cdot \\ \vdots \\ i^- \quad \cdot \\ \vdots \\ j^- \\ \cdot \end{array} \right] \sqcup \tilde{Z}^Y(M)_{|j^+ \mapsto j^*}, \right. \\ \left. \left[ \sum_i \begin{array}{c} \cdot \\ \vdots \\ i^+ \\ \vdots \\ i^* \\ \cdot \end{array} + \frac{1}{2} \sum_{i,j} n_{ij} \begin{array}{c} \cdot \\ \vdots \\ i^* \quad \cdot \\ \vdots \\ j^* \\ \cdot \end{array} \right] \sqcup \tilde{Z}^Y(N)_{|j^- \mapsto j^*} \right\rangle_{[g]^*}. \end{aligned} \quad (6.6)$$

Recall that the square brackets denote an exponential. Let us write

$$\tilde{Z}^{Y,t}(M \circ N) = \emptyset + E + (\mathbf{a}\text{-deg} > m),$$

where  $E$  is a linear combination of connected Jacobi diagrams in  $\mathcal{A}^{Y,t}([g]^+ \sqcup [g]^-)$  with  $\mathbf{a}\text{-deg} \leq m$ . We want to show that  $E$  only has diagrams with  $\mathbf{a}\text{-deg} = m$  and moreover that  $E = D_M + D_N$ . Since  $\tilde{Z}^{Y,t}(M \circ N)$  is obtained by considering the reduction of  $\tilde{Z}(M \circ N)$  modulo struts and looped diagrams, we need to carefully analyse the pairing (6.6).

- It is possible for  $\tilde{Z}^Y(M)$  or  $\tilde{Z}^Y(N)$  to have diagrams with loops. A diagram in  $\tilde{Z}(M \circ N)$  coming from the pairing of a diagram with loops, in  $\tilde{Z}^Y(M)$  or in  $\tilde{Z}^Y(N)$ , with any other diagram will still have loops. Hence the diagrams with loops in  $\tilde{Z}^Y(M)$  or in  $\tilde{Z}^Y(N)$  do not contribute any term to  $\tilde{Z}^{Y,t}(M \circ N)$ .

- The diagrams of type

$$m_{ij} \begin{array}{c} \text{---} \\ \cdot \\ \text{---} \\ i^- \quad j^- \end{array}$$

do not contribute any connected term to  $\tilde{Z}^{Y,t}(M \circ N)$ . Therefore, the diagrams (which are no struts) with the lowest alternative degree contributed by the diagrams

$$\left[ \sum_i \begin{array}{c} \cdot \\ \text{---} \\ \cdot \\ i^- \end{array} + \frac{1}{2} \sum_{i,j} m_{ij} \begin{array}{c} \text{---} \\ \cdot \\ \text{---} \\ i^- \quad j^- \end{array} \right] \quad (6.7)$$

after the pairing (6.6) are exactly the diagrams appearing in  $D_N$ .

- The diagrams of type

$$n_{ij} \begin{array}{c} \text{---} \\ \cdot \\ \text{---} \\ i^* \quad j^* \end{array}$$

(6.8)

can contribute looped diagrams to  $\tilde{Z}^Y(M \circ N)$  when we consider their pairing with *connected* diagrams in  $\tilde{Z}^{Y,t}(M)$ , so at the end they do not appear in  $\tilde{Z}^{Y,t}(M \circ N)$ . Or they can also contribute connected diagrams to  $\tilde{Z}^Y(M \circ N)$  after their pairing with *disconnected* diagrams  $T$  of  $\tilde{Z}^t(M)$ , where at least one of the connected components of  $T$  has at least one trivalent vertex. In Figure 6.1 we illustrate this situation with three examples of such a  $T$ .

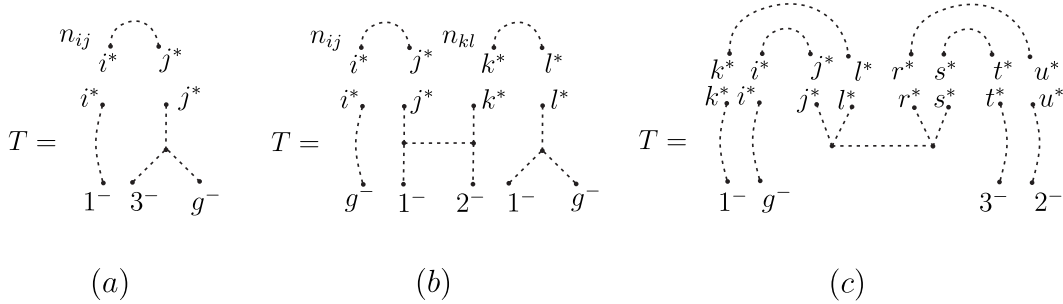


Figure 6.1:

Let us see that in this case, the obtained connected tree-like Jacobi diagrams are of  $\mathfrak{a}\text{-deg} > m$ . Let  $T$  be a disconnected diagram in  $\tilde{Z}^t(M)$ . Then the connected components of  $T$  can be struts or diagrams with at least one trivalent vertex. If there are diagrams in  $T$  whose all legs are colored by elements of  $[g]^-$ , then it is not possible to obtain a connected diagram from  $T$  after the pairing (6.6), hence we can suppose that there is not this type of diagrams in  $T$ . Also note that if all the legs of all the connected components of  $T$  are colored by elements of  $[g]^+$ , then after the pairing (6.6) with the struts of type (6.8), we will obtain looped diagrams. This way we can suppose that there is at least one connected component of  $T$  which has one leg colored by an element of  $[g]^-$ , and moreover that all the struts appearing in  $T$  have one leg colored by  $[g]^+$  and the other by  $[g]^-$ . Let  $T_1$  be a connected component of  $T$  with at least one trivalent vertex, then  $\mathfrak{a}\text{-deg}(T_1) \geq m$ . Now,  $T_1$  has legs colored by  $[g]^+$  and when we do the pairing with the struts of the type (6.8), we connect such legs either with struts which have legs colored by  $[g]^-$  or with other trees appearing in  $T$ . In either case, we strictly increase the alternative degree of  $T_1$ . To sum up, the connected tree-like Jacobi diagrams which can appear in this case are of  $\mathfrak{a}\text{-deg} > m$ .

Therefore, the diagrams (which are not struts) with the lowest alternative degree contributed by the diagrams

$$\left[ \sum_i \begin{array}{c} \cdot \\ \text{---} \\ \cdot \\ i^+ \end{array} + \frac{1}{2} \sum_{i,j} n_{ij} \begin{array}{c} \text{---} \\ \cdot \\ \text{---} \\ i^* \quad j^* \end{array} \right] \quad (6.9)$$

after the pairing (6.6), are exactly the diagrams appearing in  $D_M$ .

- Let  $S$  be a diagram appearing in  $\tilde{Z}^t(N)$  and  $T$  be a diagram appearing in  $\tilde{Z}^t(M)$ . If all the legs of every connected component of  $S$  are colored by  $[g]^+$ , then  $S$  does not intervene in the pairing (6.6), except with the empty diagram. Similarly when all the legs of every connected component of  $T$  are colored by  $[g]^-$ . Hence we can suppose that there is at least a connected component of  $S$  (respectively in  $T$ ) with at least one trivalent vertex and with at least one  $[g]^-$ -colored leg (respectively one  $[g]^+$ -colored leg). As in the previous case, the connected diagrams without loops obtained from the pairing of  $S$  and  $T$  strictly increase the alternative degree. The alternative degree only remains stable when we do the pairing with diagrams coming from

$$\left[ \sum_i \begin{array}{c} \cdot \\ \vdots \\ i^+ \\ \vdots \\ i^* \end{array} \right] \quad \text{or} \quad \left[ \sum_i \begin{array}{c} \cdot \\ \vdots \\ i^* \\ \vdots \\ i^- \end{array} \right].$$

In conclusion, the lower alternative degree terms appearing in  $\tilde{Z}^{Y,t}(M \circ N)$  are exactly  $D_M + D_N$ , that is,  $E = D_M + D_N$ .

□

## 6.2 First alternative Johnson homomorphism and the LMO functor

From Definition 5.29, the diagrammatic version of the first alternative Johnson homomorphism of an element in  $\mathcal{I}^a$  is given by a linear combination of the diagrams shown in Figure 6.2. Recall that by a  $-$  (respectively by a  $+$ ) we mean that the color of the leg belongs to  $A$  (respectively to  $B$ ).

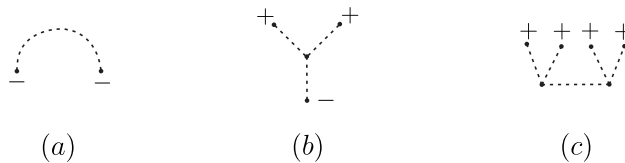


Figure 6.2: Tree-like Jacobi diagrams of  $\mathbf{a}$ -deg = 1.

Besides, the diagrammatic version of the first Johnson homomorphism of an element in  $\mathcal{I}$  is given by a linear combination of the diagrams shown in Figure 6.3 and the diagrammatic version of the second Johnson-Levine homomorphism is given by a linear combination of diagrams of type (c) in Figure 6.2.

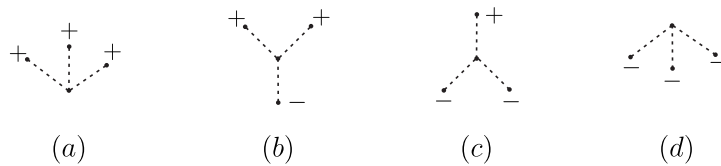


Figure 6.3: Tree-like Jacobi diagrams of  $i$ -deg = 1.

Let us start by identifying the elements in  $\mathcal{I}^a$  whose first alternative Johnson homomorphism only contains diagrams of the type (a) in Figure 6.2. Let  $\mathcal{N}$  be the subgroup of  $\mathcal{I}^a$  generated by the Dehn twists  $t_{\alpha_i}$  and  $t_{\alpha_{kl}}$  with  $1 \leq i \leq g$  and  $1 \leq k < l \leq g$ . Here  $\alpha_i$  denotes the  $i$ -th meridional curve as in Figure 3.2; and  $\alpha_{kl}$  is as shown in Figure 3.7 (a).

Using the symplectic basis  $\{a_i, b_i\}$  to identify  $\text{Sp}(H)$  with  $\text{Sp}(2g, \mathbb{Z})$  we have that the image of  $\mathcal{N}$  under the symplectic representation (4.2) is

$$\sigma(\mathcal{N}) = \left\{ \left( \begin{array}{cc} \text{Id}_g & \Delta \\ 0 & \text{Id}_g \end{array} \right) \in \text{Sp}(2g, \mathbb{Z}) \mid \Delta \text{ is symmetric} \right\}. \quad (6.10)$$

Equality (6.10) is precisely [46, Lemma 6.3]. It also follows from the computations made in Examples 5.5 and 5.6. Notice that  $\mathcal{N}$  is contained in the handlebody group  $\mathcal{H}$  defined in (4.20).



**Lemma 6.6.** *We have the equality  $\mathcal{I}^a = \mathcal{N} \cdot (\mathcal{I} \cap \mathcal{I}^a)$ .*

*Proof.* Let  $h \in \mathcal{I}^a$ . In the symplectic basis  $\{a_i, b_i\}$ , the matrix of  $\sigma(h) = h_*$  is  $\begin{pmatrix} \text{Id}_g & \Delta \\ 0 & \text{Id}_g \end{pmatrix}$  with  $\Delta$  a symmetric matrix. From (6.10) there exists  $f \in \mathcal{N}$  such that the matrix of  $\sigma(f) = f_*$  is  $\begin{pmatrix} \text{Id}_g & -\Delta \\ 0 & \text{Id}_g \end{pmatrix}$ . Therefore  $f \circ h \in \mathcal{I}$ . Let  $\psi = f \circ h$ , we also have  $\psi = f \circ h \in \mathcal{I}^a$ . Thus  $h = f^{-1} \circ \psi \in \mathcal{N} \cdot (\mathcal{I} \cap \mathcal{I}^a)$ .  $\square$

We have already computed in Examples 5.5 and 5.6 the first alternative Johnson homomorphism for the generators of  $\mathcal{N}$ . These computations imply the following.

**Proposition 6.7.** *For  $h \in \mathcal{N}$  the first alternative Johnson homomorphism  $\tau_1^a(h)$  can be computed from the action of  $h$  in homology and reciprocally. More precisely, if the matrix of  $\sigma(h) = h_* : H \rightarrow H$  in the symplectic basis  $\{a_i, b_i\}$  is  $\begin{pmatrix} \text{Id}_g & \Delta \\ 0 & \text{Id}_g \end{pmatrix}$  with  $\Delta = (n_{ij})$  a symmetric matrix, then*

$$\tau_1^a(h) = \sum_{1 \leq i, j \leq g} n_{ij} a_i \otimes a_j.$$

*Proof.* By Examples 5.5 and 5.6, the result holds for the generators  $t_{\alpha_i}$  and  $t_{\alpha_{kl}}$  of  $\mathcal{N}$ . The general result follows from the homomorphism property of  $\tau_1^a$  and the equality

$$\begin{pmatrix} \text{Id}_g & \Delta \\ 0 & \text{Id}_g \end{pmatrix} \begin{pmatrix} \text{Id}_g & \Delta' \\ 0 & \text{Id}_g \end{pmatrix} = \begin{pmatrix} \text{Id}_g & \Delta + \Delta' \\ 0 & \text{Id}_g \end{pmatrix},$$

for all matrices  $\Delta$  and  $\Delta'$  of size  $g \times g$ .  $\square$

**Proposition 6.8.** *For  $h \in \mathcal{N}$  we have*

$$\log \left( \tilde{Z}^s(c(h)) \right) = \left( \sum_{i=1}^g \begin{matrix} \cdot \\ \vdots \\ \cdot \end{matrix} \begin{matrix} i^+ \\ \vdots \\ i^- \end{matrix} \right) - \left( \eta^{-1} \tau_1^a(h) \right)_{|a_i \mapsto i^-}.$$

*Proof.* From Examples 3.16, 3.17, 3.18 and Examples 5.30 and 5.31, we already have the result for the generators of  $\mathcal{N}$ . By Lemma 3.15, we know that the strut part in the LMO functor is encoded in the linking matrix. Thus we need to know how the strut part, or equivalently the linking matrix, behaves with respect to the composition of cobordisms, this was done in [8, Lemma 4.5]. For  $M, N \in \mathcal{IC}^L$  with  $\text{Lk}(M) = \begin{pmatrix} 0 & \text{Id}_g \\ \text{Id}_g & \Delta \end{pmatrix}$  and  $\text{Lk}(N) = \begin{pmatrix} 0 & \text{Id}_g \\ \text{Id}_g & \Delta' \end{pmatrix}$  we have

$$\text{Lk}(M \circ N) = \begin{pmatrix} 0 & \text{Id}_g \\ \text{Id}_g & \Delta + \Delta' \end{pmatrix}. \quad (6.11)$$

Whence we have the desired result from the homomorphism property of  $\tau_1^a$  and  $\eta^{-1}$ . (Equality (6.11) can also be deduced from the description of the composition of cobordisms in terms of their bottom-top tangle presentations).  $\square$

At this point, we understand the first alternative Johnson homomorphism for the elements of  $\mathcal{N}$  and moreover we know that the diagrammatic version only contains diagrams of type (a) in Figure 6.2. By Lemma 6.6, in order to understand  $\tau_1^a$  for all  $\mathcal{I}^a$  we need to understand it for the elements of  $\mathcal{I} \cap \mathcal{I}^a$ . Recall that  $B = H'$ .

Consider the projection

$$p : (A \otimes \mathfrak{L}\mathfrak{ic}_2(B; A)) \oplus (B \otimes \mathfrak{L}\mathfrak{ic}_3(B; A)) \longrightarrow (A \otimes \Lambda^2 B) \oplus \left( B \otimes \frac{\mathfrak{L}\mathfrak{ic}_3(B; A)}{\mathfrak{L}\mathfrak{ic}_3(B)} \right), \quad (6.12)$$

defined as  $\text{Id}_A \otimes \iota_*$  on the first direct summand and by sending  $b \otimes z \in B \otimes \mathfrak{L}\mathfrak{ic}_3(B; A)$  to  $b \otimes (z \mathfrak{L}\mathfrak{ic}_3(B))$ . Let  $\psi \in \mathcal{I} \cap \mathcal{I}^a$ . Then,  $\tau_1^a(\psi) \in (A \otimes \mathfrak{L}\mathfrak{ic}_2(B; A)) \oplus (B \otimes \mathfrak{L}\mathfrak{ic}_3(B; A))$ . Thus, we can apply  $p$  to  $\tau_1^a(\psi)$ . Diagrammatically, when we apply  $p$  we kill the diagrams in  $\eta^{-1}(\tau_1^a(\psi))$  of type (c) in Figure 6.2. Besides, by Proposition 5.11, we have that  $\iota_*(\tau_1^a(\psi)) = \tau_2^L(\psi)$ . Here the map  $\iota_*$  is the map appearing

in Proposition 5.11. Diagrammatically we are killing all the diagrams in  $\eta^{-1}(\tau_1^{\mathfrak{a}}(\psi))$  with at least one leg colored by an element of  $A$ . This way, we have

$$\tau_1^{\mathfrak{a}}(\psi) = p(\tau_1^{\mathfrak{a}}(\psi)) + \iota_*(\tau_1^{\mathfrak{a}}(\psi)) = p(\tau_1^{\mathfrak{a}}(\psi)) + \tau_2^L(\psi). \quad (6.13)$$

On the other hand we can also consider the first Johnson homomorphism  $\tau_1(\psi)$  of  $\psi$ . Hence, the diagrammatic version of  $\tau_1(\psi)$  is a linear of the diagrams shown in Figure 6.3. We want to compare  $\tau_1(\psi)$  and  $\tau_1^{\mathfrak{a}}(\psi)$ . Thus, we need to kill the diagrams of type (a), (c) and (d) in Figure 6.3 from  $\eta^{-1}\tau_1(\psi)$ . For this, consider the projection

$$q : (B \otimes \Lambda^2 H) \oplus (A \otimes \Lambda^2 H) \longrightarrow \left( B \otimes \frac{\Lambda^2 H}{\langle \Lambda^2 A + \Lambda^2 B \rangle} \right) \oplus (A \otimes \Lambda^2 H'), \quad (6.14)$$

which in the first direct summand is given by the  $\text{Id}_B$  tensored with the projection, and in the second direct summand is given by  $\text{Id}_A \otimes \Lambda^2 \iota_*$ , where  $\Lambda^2 \iota_* : \Lambda^2 H \rightarrow \Lambda^2 H'$  is induced by  $\iota_* : H \rightarrow H'$ .

**Lemma 6.9.** *Via the canonical isomorphism*

$$\frac{\mathfrak{L}\mathfrak{I}\mathfrak{e}_3(B; A)}{\mathfrak{L}\mathfrak{I}\mathfrak{e}_3(B)} \cong A \wedge B \cong \frac{\Lambda^2 H}{\langle \Lambda^2 A + \Lambda^2 B \rangle},$$

we have  $p(\tau_1^{\mathfrak{a}}(\psi)) = q(\tau_1(\psi))$  for every  $\psi \in \mathcal{I} \cap \mathcal{I}^{\mathfrak{a}}$ .

*Proof.* Let  $\psi \in \mathcal{I} \cap \mathcal{I}^{\mathfrak{a}}$ . From equation (5.16) we can write

$$\tau_1^{\mathfrak{a}}(\psi) = \sum_{i=1}^g a_i \otimes (\psi_{\#}(\beta_i)\beta_i^{-1}K_3) - \sum_{i=1}^g b_i \otimes (\psi_{\#}(\alpha_i)\alpha_i^{-1}K_4), \quad (6.15)$$

besides

$$\tau_1(\psi) = \sum_{i=1}^g a_i \otimes (\psi_{\#}(\beta_i)\beta_i^{-1}\Gamma_3\pi) - \sum_{i=1}^g b_i \otimes (\psi_{\#}(\alpha_i)\alpha_i^{-1}\Gamma_3\pi). \quad (6.16)$$

By applying  $p$  to (6.15) and  $q$  to (6.16) we obtain

$$p\tau_1^{\mathfrak{a}}(\psi) = \sum_{i=1}^g a_i \otimes (\iota_{\#}(\psi_{\#}(\beta_i)\beta_i^{-1})\Gamma_3\pi') - \sum_{i=1}^g b_i \otimes ((\psi_{\#}(\alpha_i)\alpha_i^{-1}K_4) \bmod \mathfrak{L}\mathfrak{I}\mathfrak{e}_3(B)),$$

and

$$q\tau_1(\psi) = \sum_{i=1}^g a_i \otimes (\iota_{\#}(\psi_{\#}(\beta_i)\beta_i^{-1})\Gamma_3\pi') - \sum_{i=1}^g b_i \otimes ((\psi_{\#}(\alpha_i)\alpha_i^{-1}\Gamma_3\pi) \bmod (\Lambda^2 A + \Lambda^2 B)).$$

Thus we need to show that

$$(\psi_{\#}(\alpha_i)\alpha_i^{-1}K_4) \bmod \mathfrak{L}\mathfrak{I}\mathfrak{e}_3(B)$$

and

$$(\psi_{\#}(\alpha_i)\alpha_i^{-1}\Gamma_3\pi) \bmod (\Lambda^2 A + \Lambda^2 B)$$

define the same element in  $A \wedge B$ . By Lemma 4.12, we can write  $\psi_{\#}(\alpha_i)\alpha_i^{-1} = y_i n_i$  with  $y_i \in \Gamma_3\pi \subseteq K_3$  and  $n_i \in \mathbb{A}$ . Since  $\psi_{\#}(\alpha_i)\alpha_i^{-1} \in \Gamma_2\pi$ , then  $n_i \in \Gamma_2\pi \cap \mathbb{A} = [\pi, \mathbb{A}] \subseteq K_3$ . Therefore

$$\psi_{\#}(\alpha_i)\alpha_i^{-1}\Gamma_3\pi = n_i\Gamma_3\pi = \sum_{k<l} \lambda_{kl}^i (a_k \wedge a_l) + \sum_{k<l} \epsilon_{kl}^i (b_k \wedge b_l) + \sum_{k,l} \delta_{kl}^i (a_k \wedge b_l) \in \Lambda^2 H,$$

where  $\lambda_{kl}^i, \epsilon_{kl}^i, \delta_{kl}^i \in \mathbb{Z}$ . Thus

$$(\psi_{\#}(\alpha_i)\alpha_i^{-1}\Gamma_3\pi) \bmod (\Lambda^2 A + \Lambda^2 B) = \sum_{k,l} \delta_{kl}^i (a_k \wedge b_l) \in A \wedge B.$$

On the other hand  $\psi(\alpha_i)\alpha_i^{-1}K_4 = y_iK_4 + n_iK_4$ , but  $y_i \in \Gamma_3\pi$ , hence  $y_iK_4 \in \mathfrak{L}\mathfrak{ic}_3(B)$ . Therefore we also have

$$\begin{aligned} (\psi_{\#}(\alpha_i)\alpha_i^{-1}K_4) \bmod \mathfrak{L}\mathfrak{ic}_3(B) &= (y_iK_4) \bmod \mathfrak{L}\mathfrak{ic}_3(B) + (n_iK_4) \bmod \mathfrak{L}\mathfrak{ic}_3(B) \\ &= \sum_{k,l} \delta_{kl}^i (a_k \wedge b_l) \in A \wedge B. \end{aligned}$$

□

**The first alternative Johnson homomorphism and the LMO functor.** In order to relate  $\tau_1^{\mathfrak{a}}$  with the LMO functor we need particular cases of the two theorems that say how the Johnson homomorphisms and the Johnson-Levine homomorphisms are related to the LMO functor. For  $h \in \mathcal{L}$  denote by  $\tilde{Z}^{Y,t,+}(c(h))$  the element in  $\mathcal{A}^{Y,t}(\lfloor g \rfloor^+)$  obtained from  $\tilde{Z}^Y(c(h))$  by sending all terms with loops or with  $i^-$ -colored legs to 0.

**Theorem 6.10.** [47, Corollary 5.11] *Let  $m \geq 1$ . If  $h \in J_m\mathcal{M}$  then*

$$\tilde{Z}^{Y,t}(c(h)) = \emptyset - \left( \eta^{-1}\tau_m(c(h)) \right)_{|a_j \mapsto j^-, b_j \mapsto j^+} + (\mathfrak{i}\text{-deg} > m).$$

**Theorem 6.11.** [66, Theorem 5.4] *Let  $m \geq 1$ . If  $h \in J_m^L\mathcal{M}$  then*

$$\tilde{Z}^{Y,t,+}(c(h)) = \emptyset - \left( \eta^{-1}\tau_m^L(c(h)) \right)_{|b_j \mapsto j^+} + (\mathfrak{i}\text{-deg} > m).$$

**Remark 6.12.** We state Theorems 6.10 and 6.11 in the context of the mapping class group, but the original versions are stated in the context of homology cobordisms.

**Lemma 6.13.** *Let  $h \in \mathcal{N} \subseteq J_1^{\mathfrak{a}}\mathcal{M}$ . Then*

$$\tilde{Z}^{Y,t}(c(h)) = \emptyset + (\mathfrak{a}\text{-deg} > 1),$$

*equivalently,  $\tilde{Z}_1^{Y,\mathfrak{a}}(c(h)) = 0$ .*

*Proof.* The diagrams with  $\mathfrak{a}\text{-deg} = 1$  have  $\mathfrak{i}\text{-deg}$  between 0 and 2 included. In Examples 3.16, 3.17 and 3.18 we have seen that for the generators  $h \in \mathcal{N}$  there are no diagrams of  $\mathfrak{a}\text{-deg} = 1$  and  $\mathfrak{i}\text{-deg} = 1$  in  $\tilde{Z}^{Y,t}(c(h))$ . Now, the diagrams of  $\mathfrak{a}\text{-deg} = 1$  and  $\mathfrak{i}\text{-deg} = 2$  are of type (c) in Figure 6.2. Since  $\mathcal{N}$  is included in the handlebody group, this kind of diagrams do not appear in  $\tilde{Z}^{Y,t}$ , see [8, Corollary 5.4]. Therefore we have the stated result for the generators of  $\mathcal{N}$  and the general statement follows by Theorem 6.5. □

**Theorem 6.14.** *Let  $f \in J_1^{\mathfrak{a}}\mathcal{M}$ . Then*

$$\log \left( \tilde{Z}^t(c(f)) \right) = \left( \sum_{i=1}^g \begin{array}{c} \vdots \\ i^+ \\ \vdots \\ i^- \\ \vdots \end{array} \right) - \left( \eta^{-1}\tau_1^{\mathfrak{a}}(f) \right)_{|a_j \mapsto j^-, b_j \mapsto j^+} + (\mathfrak{a}\text{-deg} > 1).$$

*In particular  $\tilde{Z}_1^{Y,\mathfrak{a}}(c(f)) = - \left( \eta^{-1}\tau_1^{\mathfrak{a}}(f) \right)_{|a_j \mapsto j^-, b_j \mapsto j^+}^Y$ , where  $\left( \eta^{-1}\tau_1^{\mathfrak{a}}(f) \right)^Y$  is the reduction of  $\eta^{-1}\tau_1^{\mathfrak{a}}(f)$  modulo struts.*

*Proof.* Let  $f \in J_1^{\mathfrak{a}}\mathcal{M}$ . By Lemma 6.6 we can write  $f = h\psi$  with  $h \in \mathcal{N}$  and  $\psi \in \mathcal{I} \cap \mathcal{I}^{\mathfrak{a}}$ . From (6.13) and Lemma 6.9 we have

$$\tau_1^{\mathfrak{a}}(f) = \tau_1^{\mathfrak{a}}(h) + \tau_1^{\mathfrak{a}}(\psi) = \tau_1^{\mathfrak{a}}(h) + p(\tau_1^{\mathfrak{a}}(\psi)) + \tau_2^L(\psi) = \tau_1^{\mathfrak{a}}(h) + q(\tau_1(\psi)) + \tau_2^L(\psi).$$

Therefore

$$\eta^{-1}\tau_1^{\mathfrak{a}}(f) = \eta^{-1}\tau_1^{\mathfrak{a}}(h) + \eta^{-1}q(\tau_1(\psi)) + \eta^{-1}\tau_2^L(\psi). \quad (6.17)$$

Notice that  $\eta^{-1}\tau_1^{\mathfrak{a}}(h)$  corresponds to the diagrams of  $\mathfrak{i}\text{-deg} = 0$ ,  $\eta^{-1}p(\tau_1^{\mathfrak{a}}(\psi))$  corresponds to the diagrams of  $\mathfrak{i}\text{-deg} = 1$  and  $\eta^{-1}\tau_2^L(\psi)$  corresponds to the diagrams of  $\mathfrak{i}\text{-deg} = 2$  appearing in  $\eta^{-1}\tau_1^{\mathfrak{a}}(f)$ . By Lemma 3.15 and Proposition 6.8 we have

$$\begin{aligned}
\log \left( \tilde{Z}^s(c(f)) \right) - \left( \sum_{i=1}^g \begin{array}{c} \vdots \\ i^+ \\ \vdots \\ i^- \end{array} \right) &= \log \left( \tilde{Z}^s(c(h)) \right) - \left( \sum_{i=1}^g \begin{array}{c} \vdots \\ i^+ \\ \vdots \\ i^- \end{array} \right) \\
&= - \left( \eta^{-1} \tau_1^{\mathfrak{a}}(h) \right)_{|a_i \mapsto i^-} \\
&= - \left( \eta^{-1} \tau_1^{\mathfrak{a}}(f) \right)_{|a_i \mapsto i^-}^s,
\end{aligned}$$

where  $(\eta^{-1} \tau_1^{\mathfrak{a}}(f))^s$  is the reduction of  $\eta^{-1} \tau_1^{\mathfrak{a}}(f)$  modulo diagrams with  $\mathfrak{i}\text{-deg} \geq 1$ .

On the other hand, by Theorem 6.10

$$\begin{aligned}
- \left( \eta^{-1} q(\tau_1(\psi)) \right)_{|a_j \mapsto j^-, b_j \mapsto j^+} &= - \left( \left( \eta^{-1} \tau_1(\psi) \right)_{|a_j \mapsto j^-, b_j \mapsto j^+} \right)_{\mathfrak{a}\text{-deg}=1} \\
&= \left( \tilde{Z}^{Y,t}(c(\psi)) \right)_{\mathfrak{a}\text{-deg}=1, \mathfrak{i}\text{-deg}=1},
\end{aligned} \tag{6.18}$$

and by Theorem 6.11

$$- \left( \eta^{-1} \tau_2^L(\psi) \right)_{b_j \mapsto j^+} = \left( \tilde{Z}^{Y,t,+}(c(\psi)) \right)_{|\mathfrak{i}\text{-deg}=2} = \left( \tilde{Z}^{Y,t}(c(\psi)) \right)_{|\mathfrak{a}\text{-deg}=1, \mathfrak{i}\text{-deg}=2}. \tag{6.19}$$

Therefore

$$\begin{aligned}
\tilde{Z}_1^{Y,\mathfrak{a}}(c(f)) &= \tilde{Z}_1^{Y,\mathfrak{a}}(c(h)) + \tilde{Z}_1^{Y,\mathfrak{a}}(c(\psi)) \\
&= \left( \tilde{Z}^{Y,t}(c(\psi)) \right)_{\mathfrak{a}\text{-deg}=1, \mathfrak{i}\text{-deg}=1} + \left( \tilde{Z}^{Y,t}(c(\psi)) \right)_{|\mathfrak{a}\text{-deg}=1, \mathfrak{i}\text{-deg}=2} \\
&= - \left( \eta^{-1} q(\tau_1(\psi)) \right)_{|a_j \mapsto j^-, b_j \mapsto j^+} - \left( \eta^{-1} \tau_2^L(\psi) \right)_{b_j \mapsto j^+} \\
&= - \left( \eta^{-1} (p\tau_1^{\mathfrak{a}}(\psi) + \tau_2^L(\psi)) \right)_{|a_j \mapsto j^-, b_j \mapsto j^+} \\
&= - \left( \eta^{-1} \tau_1^{\mathfrak{a}}(\psi) \right)_{|a_j \mapsto j^-, b_j \mapsto j^+} \\
&= - \left( \eta^{-1} \tau_1^{\mathfrak{a}}(f) \right)_{|a_j \mapsto j^-, b_j \mapsto j^+}^Y
\end{aligned}$$

In the first equality we use Theorem 6.5, in the second we use Lemma 6.13, in the third we use (6.18) and (6.19), in the fourth we use Lemma 6.9 and the homomorphism property of  $\eta^{-1}$ , and in the fifth we use (6.13). Finally in the sixth equality we use (6.17).  $\square$

**Remark 6.15.** Theorems 6.10 and 6.11 are valid in the context of homology cobordisms. This suggests that the first alternative Johnson homomorphism could be defined on  $\mathcal{IC}^{\mathfrak{a}}$  and that the statement of Theorem 6.14 could be generalized to  $\mathcal{IC}^{\mathfrak{a}}$ . It is very likely possible to read the 0-th alternative Johnson homomorphism  $\tau_0^{\mathfrak{a}}(h)$  for  $h \in \mathcal{L}$  in the  $\mathfrak{a}\text{-deg} = 0$  part of  $\tilde{Z}^t(c(h))$ .

### 6.3 Higher alternative Johnson homomorphisms and the LMO functor

The aim of this subsection is to prove an analogue of Theorem 6.14 for  $\tau_m^{\mathfrak{a}}$  with  $m \geq 2$ . That is, we want to prove the following.

**Theorem 6.16.** *Let  $m \geq 2$ . If  $f \in J_m^{\mathfrak{a}}\mathcal{M}$ , then*

$$\tilde{Z}^{Y,t}(c(f)) = \emptyset - \left( \eta^{-1} \tau_m^{\mathfrak{a}}(f) \right)_{|a_j \mapsto j^-, b_j \mapsto j^+} + (\mathfrak{a}\text{-deg} > m).$$

Or equivalently  $\tilde{Z}_m^{Y,\mathfrak{a}}(c(f)) = - \left( \eta^{-1} \tau_m^{\mathfrak{a}}(f) \right)_{|a_j \mapsto j^-, b_j \mapsto j^+}$ .

An immediate consequence of the above theorem is the following.

**Corollary 6.17.** For  $f \in J_m^{\mathfrak{a}}\mathcal{M}$  the value

$$\widetilde{Z}_m^{Y,\mathfrak{a}}(c(f))_{j^+ \mapsto b_j, j^- \mapsto a_j} \in \mathcal{T}_m^{\mathfrak{a}}(B \oplus A)$$

is independent of the choice of a Drinfeld associator.

One of the key points in the proof of Theorem 6.16 is to show that the LMO functor defines an *alternative symplectic expansion* of  $\pi$ . We use several results and definitions from [47] and [28].

**Alternative symplectic expansions.** Let  $H_{\mathbb{Q}}$  be the  $\mathbb{Q}$ -module  $H_1(\Sigma, \mathbb{Q}) = H \otimes \mathbb{Q}$ . Denote by  $T(H_{\mathbb{Q}})$  the free associative  $\mathbb{Q}$ -algebra generated by  $H_{\mathbb{Q}}$  in degree 1, that is,  $T(H_{\mathbb{Q}})$  is the tensor algebra of  $H_{\mathbb{Q}}$  and let  $\widehat{T}(H_{\mathbb{Q}})$  denote its degree completion. Let  $A_{\mathbb{Q}} = A \otimes \mathbb{Q}$  and  $B_{\mathbb{Q}} = B \otimes \mathbb{Q}$ . Let  $T(B_{\mathbb{Q}}; A_{\mathbb{Q}})$  be the free associative  $\mathbb{Q}$ -algebra generated by  $B_{\mathbb{Q}}$  in degree 1 and  $A_{\mathbb{Q}}$  in degree 2. We call the induced degree in  $T(B_{\mathbb{Q}}, A_{\mathbb{Q}})$  the *alternative degree*. Hence

$$T(B_{\mathbb{Q}}; A_{\mathbb{Q}}) = \mathbb{Q} \oplus B_{\mathbb{Q}} \oplus (A_{\mathbb{Q}} \oplus (B_{\mathbb{Q}} \otimes B_{\mathbb{Q}})) \oplus ((A_{\mathbb{Q}} \otimes B_{\mathbb{Q}}) \oplus (B_{\mathbb{Q}} \otimes A_{\mathbb{Q}}) \oplus (B_{\mathbb{Q}} \otimes B_{\mathbb{Q}} \otimes B_{\mathbb{Q}})) \oplus \cdots$$

Denote by  $\widehat{T}(B_{\mathbb{Q}}; A_{\mathbb{Q}})$  the completion of  $T(B_{\mathbb{Q}}; A_{\mathbb{Q}})$  with respect to the alternative degree. Notice that  $\widehat{T}(H_{\mathbb{Q}})$  and  $\widehat{T}(B_{\mathbb{Q}}; A_{\mathbb{Q}})$  are complete Hopf algebras.

**Definition 6.18.** An *expansion* of  $\pi$  is a multiplicative map  $\theta : \pi \rightarrow \widehat{T}(H_{\mathbb{Q}})$  such that  $\theta(x) = 1 + \{x\} + (\mathfrak{a}\text{-deg} > 1)$  for all  $x \in \pi$ . Here  $\{x\}$  denotes  $x\Gamma_2\pi \otimes 1 \in H_{\mathbb{Q}}$ . Moreover, we say that an expansion  $\theta$  is *group-like* if it takes values in the group of group-like elements of  $\widehat{T}(H_{\mathbb{Q}})$ .

**Definition 6.19.** An *alternative expansion* of  $\pi$  relative to  $\mathbb{A}$  is a multiplicative map  $\theta : \pi \rightarrow \widehat{T}(B_{\mathbb{Q}}, A_{\mathbb{Q}})$  which takes values in the group of group-like elements of  $\widehat{T}(B_{\mathbb{Q}}, A_{\mathbb{Q}})$  and such that:

- $\theta(x) = 1 + \{x\} + (\mathfrak{a}\text{-deg} > 1)$  for all  $x \in \pi$  and
- $\theta(\alpha) = 1 + \{\alpha\} + (\mathfrak{a}\text{-deg} > 2)$  for all  $\alpha \in \mathbb{A}$ .

Here  $\{x\}$  denotes  $xK_2 \otimes 1 \in B_{\mathbb{Q}}$  for  $x \in \pi$ , and  $\{\alpha\}$  denotes  $\alpha K_3 \otimes 1 \in (A_{\mathbb{Q}} \oplus (B_{\mathbb{Q}} \otimes B_{\mathbb{Q}}))$  for  $\alpha \in \mathbb{A}$ .

**Remark 6.20.** Definition 6.19 implies that for  $i \geq 1$  and  $x \in K_i$ ,  $\theta(x) = 1 + (xK_{i+1}) \otimes 1 + (\mathfrak{a}\text{-deg} > i)$ . Hence an alternative expansion of  $\pi$  relative to  $\mathbb{A}$  is an *expansion of the  $N$ -series*  $(K_i)_{i \geq 1}$  in the sense of [28, Section 12].

Notice that  $T(H_{\mathbb{Q}}) = T(B_{\mathbb{Q}}; A_{\mathbb{Q}})$  as  $\mathbb{Q}$ -algebras as soon as we have chosen a section of  $\iota_* : H \rightarrow H'$  with isotropic image and identified  $B = H'$  to the image of this section. Thus if  $\theta$  is an alternative expansion of  $\pi$  relative to  $\mathbb{A}$ , then, in particular,  $\theta$  is a group-like expansion of  $\pi$ . We denote this group-like expansion by  $\theta'$ .

**Example 6.21.** Consider the free basis  $\{\alpha_i, \beta_i\}$  of  $\pi$  defined by the system of meridians and parallels of Figure 3.9 and let  $\{a_i, b_i\}$  be the induced symplectic basis of  $H$ . We identify  $H' = B$  with the subgroup of  $H$  generated by  $\{b_1, \dots, b_g\}$ . Define  $\theta : \pi \rightarrow \widehat{T}(B; A)$  by  $\theta(\alpha_i) = \exp(a_i)$  and  $\theta(\beta_i) = \exp(b_i)$ . Then  $\theta$  is an alternative expansion of  $\pi$  relative to  $\mathbb{A}$ .

Recall that the intersection form  $\omega : H \otimes H \rightarrow \mathbb{Z}$  determines an element  $\Omega' \in \mathfrak{L}\mathfrak{e}_3(B; A)$ , see Equation (5.11).

**Definition 6.22.** [47, Definition 2.15] An expansion  $\theta$  of  $\pi$  is said to be *symplectic* if it is group-like and  $\theta([\partial\Sigma]) = \exp(-\Omega')$ .

**Definition 6.23.** An alternative expansion  $\theta$  of  $\pi$  relative to  $\mathbb{A}$  is said to be *symplectic* if  $\theta([\partial\Sigma]) = \exp(-\Omega')$ .

In [47, Lemma 2.16] Massuyeau shows that symplectic expansions exist by “deforming” the expansion of Example 6.21. It can be verified that the constructed symplectic expansion in that lemma is actually an alternative symplectic expansion of  $\pi$  relative to  $\mathbb{A}$ . We will see that the LMO functor also gives an example of an alternative symplectic expansion of  $\pi$  relative to  $\mathbb{A}$ .

**Completions of the group algebra  $\mathbb{Q}[\pi]$ .** Let  $\mathbb{Q}[\pi]$  be the group  $\mathbb{Q}$ -algebra of  $\pi$ . We have considered two  $N$ -series of  $\pi$ ; the lower central series  $\Gamma_+ = (\Gamma_m \pi)_{m \geq 1}$  and the  $N$ -series  $K_+ = (K_m)_{m \geq 1}$  defined in (4.10). Each one of these defines a *filtration* of  $\mathbb{Q}[\pi]$ , that is, a decreasing sequence  $\mathbb{Q}[\pi] = F_0 \supseteq F_1 \supseteq F_2 \supseteq \dots$  of additive subgroups of  $\mathbb{Q}[\pi]$  indexed by non-negative integers such that  $F_m F_n \subseteq F_{m+n}$  for  $m, n \geq 0$ . Let  $I$  be the augmentation ideal of  $\mathbb{Q}[\pi]$ . For  $m \geq 1$  it is well known that

$$I^m = \langle (x_1 - 1) \cdots (x_p - 1) \mid p \geq 1, x_i \in \Gamma_{m_i} \pi \text{ and } m_1 + \cdots + m_p \geq m \rangle,$$

where the angle brackets stand for the generated subspace of  $\mathbb{Q}[\pi]$ . For  $m \geq 1$ , set

$$R_m = \langle (x_1 - 1) \cdots (x_p - 1) \mid p \geq 1, x_i \in K_{m_i} \text{ and } m_1 + \cdots + m_p \geq m \rangle.$$

This way we have the filtrations  $\{I^m\}_{m \geq 0}$  and  $\{R_m\}_{m \geq 0}$  of  $\mathbb{Q}[\pi]$  where we set  $I^0 = R_0 = \mathbb{Q}[\pi]$ . These filtrations define inverse systems  $\{\mathbb{Q}[\pi]/I^m\}_m$  and  $\{\mathbb{Q}[\pi]/R_m\}_m$ .

Consider the  $I$ -adic and  $R$ -adic completions of  $\mathbb{Q}[\pi]$ , that is, the inverse limits

$$\widehat{\mathbb{Q}[\Gamma_+]} = \varprojlim_m (\mathbb{Q}[\pi]/I^m) \quad \text{and} \quad \widehat{\mathbb{Q}[K_+]} = \varprojlim_m (\mathbb{Q}[\pi]/R_m).$$

Notice that  $\widehat{\mathbb{Q}[\Gamma_+]}$  and  $\widehat{\mathbb{Q}[K_+]}$  are filtered complete Hopf algebras, with filtrations  $\{\widehat{I}^m\}_{m \geq 0}$  and  $\{\widehat{R}_m\}_{m \geq 0}$  defined by

$$\widehat{I}^m = \varprojlim_l (I^m/I^l) \quad \text{and} \quad \widehat{R}_m = \varprojlim_l (R_m/R_l),$$

for  $m \geq 0$ . From now on, let  $\theta : \pi \rightarrow \widehat{T}(B_{\mathbb{Q}}; A_{\mathbb{Q}})$  be an alternative expansion of  $\pi$  relative to  $\mathbb{A}$  and denote by  $\theta' : \pi \rightarrow \widehat{T}(H_{\mathbb{Q}})$  the associated group-like expansion of  $\pi$ . The Quillen's description [58] of the associated graded of the filtered ring  $\mathbb{Q}[\pi]$  with respect to  $\{I^m\}_m$ , can be generalized [28, Theorem 11.2] to describe the associated graded of  $\mathbb{Q}[\pi]$  with respect to  $\{R_m\}_m$ . Moreover, we have the following.

**Proposition 6.24.** [28, Proposition 12.2][47, Proposition 2.10] *The maps  $\theta$  and  $\theta'$  extend uniquely to complete Hopf algebra isomorphisms*

$$\widehat{\theta} : \widehat{\mathbb{Q}[K_+]} \longrightarrow \widehat{T}(B_{\mathbb{Q}}; A_{\mathbb{Q}}) \quad \text{and} \quad \widehat{\theta}' : \widehat{\mathbb{Q}[\Gamma_+]} \longrightarrow \widehat{T}(H_{\mathbb{Q}}),$$

which are the identity at the graded level.

Since  $\Gamma_m \pi \subseteq K_m \subseteq \Gamma_{\lceil m/2 \rceil} \pi$  for  $m \geq 1$ , see (4.10), then  $I^m \subseteq R_m$  and  $R_m \subseteq I^{\lceil m/2 \rceil}$ . Hence, the identity automorphism of  $\pi$  induces a morphism of inverse systems

$$\{u_m : \mathbb{Q}[\pi]/I^m \longrightarrow \mathbb{Q}[\pi]/R_m\}$$

which induces an isomorphism

$$U : \widehat{\mathbb{Q}[\Gamma_+]} \longrightarrow \widehat{\mathbb{Q}[K_+]}$$

of complete Hopf algebras. The following two results are straightforward.

**Proposition 6.25.** *The diagram*

$$\begin{array}{ccc} \widehat{\mathbb{Q}[\Gamma_+]} & \xrightarrow[\cong]{U} & \widehat{\mathbb{Q}[K_+]} \\ \widehat{\theta}' \downarrow \cong & & \cong \downarrow \widehat{\theta} \\ \widehat{T}(H) & \xlongequal{\quad} & \widehat{T}(B; A) \end{array}$$

is commutative.

For a complete Hopf algebra  $F$  denote by  $\text{Aut}(F)$  the group of automorphisms of  $F$ .

**Corollary 6.26.** *The diagram*

$$\begin{array}{ccc} \text{Aut}(\widehat{\mathbb{Q}[\Gamma_+]}) & \xrightarrow{U(\_)U^{-1}} & \text{Aut}(\widehat{\mathbb{Q}[K_+]}) \\ \hat{\theta}'(\_) \hat{\theta}'^{-1} \downarrow & & \downarrow \hat{\theta}(\_) \hat{\theta}^{-1} \\ \text{Aut}(\widehat{T}(H)) & \xlongequal{\quad\quad\quad} & \text{Aut}(\widehat{T}(B; A)) \end{array}$$

is commutative.

Recall that we can restrict the Dehn-Nielsen representation (4.1) to the Lagrangian mapping class group  $\mathcal{L}$ . Now, if  $h \in \mathcal{L}$ , we have  $\rho(h)(\Gamma_m\pi) = h_{\#}(\Gamma_m\pi) \subseteq \Gamma_m\pi$  and  $\rho(h)(K_m) = h_{\#}(K_m) \subseteq K_m$ , see Lemma 4.6. This way, we obtain representations

$$\hat{\rho}' : \mathcal{L} \longrightarrow \text{Aut}(\widehat{\mathbb{Q}[\Gamma_+]})$$

and

$$\hat{\rho} : \mathcal{L} \longrightarrow \text{Aut}(\widehat{\mathbb{Q}[K_+]}) .$$

Notice that for  $h \in \mathcal{L}$ , the diagram

$$\begin{array}{ccc} \widehat{\mathbb{Q}[\Gamma_+]} & \xrightarrow{U} & \widehat{\mathbb{Q}[K_+]} \\ \hat{\rho}'(h) \downarrow & & \downarrow \hat{\rho}(h) \\ \widehat{\mathbb{Q}[\Gamma_+]} & \xrightarrow{U} & \widehat{\mathbb{Q}[K_+]} \end{array} \quad (6.20)$$

is commutative. Besides, using Proposition 6.24, we define

$$\rho^{\hat{\theta}'} : \mathcal{L} \longrightarrow \text{Aut}(\widehat{T}(H_{\mathbb{Q}})) \quad \text{and} \quad \rho^{\hat{\theta}} : \mathcal{L} \longrightarrow \text{Aut}(\widehat{T}(B_{\mathbb{Q}}; A_{\mathbb{Q}})),$$

by  $\rho^{\hat{\theta}'}(h) = \hat{\theta}'\hat{\rho}'(h)\hat{\theta}'^{-1}$  and  $\rho^{\hat{\theta}}(h) = \hat{\theta}\hat{\rho}(h)\hat{\theta}^{-1}$  for  $h \in \mathcal{L}$ .

**Proposition 6.27.** *The diagram*

$$\begin{array}{ccc} \mathcal{L} & \xrightarrow{\rho^{\hat{\theta}'}} & \text{Aut}(\widehat{T}(H_{\mathbb{Q}})) \\ \rho^{\hat{\theta}} \downarrow & \searrow & \text{Aut}(\widehat{T}(B_{\mathbb{Q}}; A_{\mathbb{Q}})) \end{array} \quad (6.21)$$

is commutative.

*Proof.* Let  $h \in \mathcal{L}$ , then

$$\begin{aligned} \rho^{\hat{\theta}}(h) &= \hat{\theta}\hat{\rho}(h)\hat{\theta}^{-1} \\ &= \hat{\theta}U\hat{\rho}'(h)U^{-1}\hat{\theta}^{-1} \\ &= \hat{\theta}'\hat{\rho}'(h)\hat{\theta}'^{-1} \\ &= \rho^{\hat{\theta}'}(h). \end{aligned}$$

In the second equality we use (6.20), and in the third equality we use Proposition 6.25.  $\square$

From Proposition 4.11 we have  $J_2^{\mathfrak{a}}\mathcal{M} \subseteq J_1\mathcal{M} = \mathcal{I}$ . Hence, by considering the restriction of  $\rho^{\hat{\theta}'}$  to  $\mathcal{I}$  and the restriction of  $\rho^{\hat{\theta}}$  to  $J_2^{\mathfrak{a}}\mathcal{M}$  and using Proposition 6.27 we obtain the following.

**Corollary 6.28.** *The diagram*

$$\begin{array}{ccc} J_2^a \mathcal{M} & \xrightarrow{\subset} & \mathcal{I} \\ \rho^{\hat{\theta}} \downarrow & & \downarrow \rho^{\hat{\theta}'} \\ \text{Aut}(\widehat{T}(B_{\mathbb{Q}}, A_{\mathbb{Q}})) & \xlongequal{\quad} & \text{Aut}(\widehat{T}(H_{\mathbb{Q}})) \end{array}$$

is commutative.

Notice that the maps  $\rho^{\hat{\theta}'}$  and  $\rho^{\hat{\theta}}$  can be defined on  $\mathcal{M}$  and  $\mathcal{L}$ , respectively. Hence, Corollary 6.28 still holds when replacing  $\mathcal{I}$  by  $\mathcal{M}$  and  $J_2^a \mathcal{M}$  by  $\mathcal{L}$ , but we are interested in taking the logarithm on the images of  $\rho^{\hat{\theta}'}$  and  $\rho^{\hat{\theta}}$  and we can do this only if we restrict to the Torelli-type groups  $\mathcal{I}$  and  $\mathcal{I}^a$ , see [28, Lemma 12.5]. The following is an instance of one of the main results in [28].

**Theorem 6.29.** [47, Theorem 3.5][28, Theorem 12.6, Remark 12.8] *Consider the filtration-preserving maps*

$$\varrho^{\theta} : \mathcal{I}^a \longrightarrow \widehat{\text{Der}}^+(\mathfrak{L}\mathfrak{ic}(B_{\mathbb{Q}}; A_{\mathbb{Q}})) \quad \text{and} \quad \varrho^{\theta'} : \mathcal{I} \longrightarrow \widehat{\text{Der}}^+(\mathfrak{L}\mathfrak{ic}(H_{\mathbb{Q}})),$$

defined by  $\varrho^{\theta}(h) = \log(\rho^{\hat{\theta}}(h))$  and  $\varrho^{\theta'}(f) = \log(\rho^{\hat{\theta}'}(f))$  for  $h \in \mathcal{I}^a$  and  $f \in \mathcal{I}$ . Then,  $\varrho^{\theta}$  determines all the alternative Johnson homomorphisms and  $\varrho^{\theta'}$  determines all the Johnson homomorphisms. That is, for  $m \geq 1$ ,  $h \in J_m^a \mathcal{M}$  and  $f \in J_m \mathcal{M}$ , we have

$$\tau_m^a(h) = (\varrho^{\theta}(h)|_{B \oplus A})_m \in D_m(\mathfrak{L}\mathfrak{ic}(B_{\mathbb{Q}}, A_{\mathbb{Q}})), \quad (6.22)$$

and

$$\tau_m(f) = (\varrho^{\theta'}(f)|_H)_m \in \text{Hom}(H, \mathfrak{L}\mathfrak{ic}_{m+1}(H_{\mathbb{Q}})), \quad (6.23)$$

where  $D_m(\mathfrak{L}\mathfrak{ic}(B_{\mathbb{Q}}, A_{\mathbb{Q}}))$  is defined by considering the rational version of Equation (5.8). The subscripts  $m$  in the right-hand side of the above equations denote the terms of degree  $m$  in  $\varrho^{\theta}(h)|_{B \oplus A}$  and  $\varrho^{\theta'}(f)|_H$ , respectively.

**Remark 6.30.** Notice that in the left-hand sides of (6.22) and (6.23) we are actually considering the rationalization of the Johnson-type homomorphisms, but there is no loss of information by doing this.

Furthermore, if  $\theta$  is symplectic, then the maps  $\varrho^{\theta}$  and  $\varrho^{\theta'}$  take values in the completions

$$\widehat{\text{Der}}^{+, \omega}(\mathfrak{L}\mathfrak{ic}(B_{\mathbb{Q}}; A_{\mathbb{Q}})) \quad \text{and} \quad \widehat{\text{Der}}^{+, \omega}(\mathfrak{L}\mathfrak{ic}(H_{\mathbb{Q}}))$$

of positive symplectic derivations of  $\mathfrak{L}\mathfrak{ic}(B_{\mathbb{Q}}; A_{\mathbb{Q}})$  and  $\mathfrak{L}\mathfrak{ic}(H_{\mathbb{Q}})$ , respectively. Now

$$\widehat{\text{Der}}^{+, \omega}(\mathfrak{L}\mathfrak{ic}(B_{\mathbb{Q}}; A_{\mathbb{Q}})) \cong \prod_m D_m(B_{\mathbb{Q}}; A_{\mathbb{Q}}) \cong \mathcal{T}^a(B \oplus A),$$

where the first isomorphism is given by Proposition 5.2 and the second by Proposition 5.28. Similarly

$$\widehat{\text{Der}}^{+, \omega}(\mathfrak{L}\mathfrak{ic}(H_{\mathbb{Q}})) \cong \prod_m D_m(H_{\mathbb{Q}}) \cong \mathcal{A}^{t,c}(H),$$

where the second isomorphism is given by Theorem 5.26. This way, with the hypothesis that  $\theta$  is symplectic, Theorem 6.29 can be restated by saying that for  $m \geq 1$  the diagrams

$$\begin{array}{ccc} J_m^a \mathcal{M} & \xrightarrow{\subset} & \mathcal{I}^a \\ \eta^{-1} \tau_m^a \downarrow & & \downarrow \eta^{-1} \varrho^{\theta} \\ \mathcal{T}_m^a(B \oplus A) & \longleftarrow & \mathcal{T}^a(B \oplus A) \end{array} \quad \text{and} \quad \begin{array}{ccc} J_m \mathcal{M} & \xrightarrow{\subset} & \mathcal{I} \\ \eta^{-1} \tau_m \downarrow & & \downarrow \eta^{-1} \varrho^{\theta'} \\ \mathcal{A}_m^{t,c}(H) & \longleftarrow & \mathcal{A}^{t,c}(H) \end{array} \quad (6.24)$$



are commutative. In the same way, if  $\theta$  is symplectic, Corollary 6.28 can be restated by saying that the diagram

$$\begin{array}{ccc} J_2^a \mathcal{M} & \xrightarrow{\subset} & \mathcal{I} \\ \eta^{-1} \rho^\theta \downarrow & & \downarrow \eta^{-1} \rho^{\theta'} \\ \mathcal{T}^a(B \oplus A) & \equiv & \mathcal{A}^{t,c}(H) \end{array} \quad (6.25)$$

is commutative.

**The LMO functor defines a symplectic alternative expansion.** We want to apply diagrams (6.24) and (6.25) with a particular symplectic alternative expansion of  $\pi$  relative to  $\mathbb{A}$ . In [47, Section 5], G. Massuyeau constructed a symplectic expansion of  $\pi$  from the LMO functor. It turns out that this expansion is a symplectic alternative expansion of  $\pi$  relative to  $\mathbb{A}$ . Let us recall this construction.

Fix two points  $p, q \in \text{int}(\Sigma)$ . A *bottom knot* in  $\Sigma \times [-1, 1]$  is the isotopy class (relative to the boundary) of a connected framed oriented tangle starting at  $q \times \{-1\}$  and ending at  $p \times \{-1\}$ , see Figure 6.4 (a) for an example. Let  $\mathcal{B}$  denote the set of bottom knots in  $\Sigma \times [-1, 1]$ . There is a monoid structure in  $\mathcal{B}$ . If  $K, L \in \mathcal{B}$ , then  $K \cdot L$  is the bottom knot obtained from  $K$  and  $L$  by joining  $K$  and  $L$  as shown in Figure 6.4 (b).

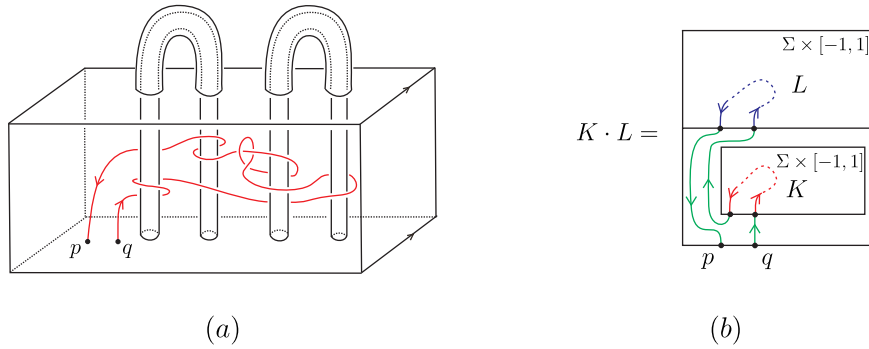


Figure 6.4: (a) Bottom knot in  $\Sigma \times [-1, 1]$  and (b) monoid structure in  $\mathcal{B}$ .

Two bottom knots  $K, K' \in \mathcal{B}$  are said to be *homotopic*, denoted  $K \simeq K'$ , if  $K'$  can be obtained from  $K$  by framing changes and a finite number of crossing changes. This relation is compatible with the monoid structure, that is, if  $K, K', L, L' \in \mathcal{B}$  are such that  $K \simeq K'$  and  $L \simeq L'$ , then  $K \cdot L \simeq K' \cdot L'$ . There is a canonical monoid morphism

$$\ell : \mathcal{B}/\simeq \longrightarrow \pi, \quad (6.26)$$

which assigns to the homotopy class of  $K \in \mathcal{B}$  the based loop in  $\Sigma \times [-1, 1]$  as shown in Figure 6.5. Then identify  $\pi$  with  $\pi_1(\Sigma \times [-1, 1], *)$ , see [47, Lemma 5.3].

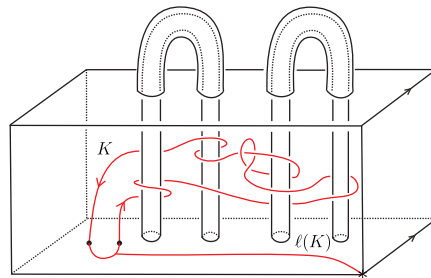


Figure 6.5: The based loop  $\ell(K)$ .

Now, a bottom knot  $K \in \mathcal{B}$  gives rise to an element in  $\mathcal{LCob}(g, g+1)$  by “digging” along  $K$ , more precisely, let  $(M_K, m)$  be the cobordism obtained from  $\Sigma \times [-1, 1]$  by removing a tubular neighborhood

of  $K$  and define the parametrization  $m$  on the first handle of the bottom surface of  $M_K$  by using the framing of  $K$  and as the identity elsewhere. We continue to denote the cobordism  $(M_K, m)$  by  $K$  and we endow its top and bottom with the right-handed non-associative words as in Convention 3.13.

This way we have  $K \in \mathcal{LCob}_q(g, g+1)$  and we can apply the LMO functor to it, to obtain  $\tilde{Z}(K) \in {}^{ts}\mathcal{A}(g, g+1) \subseteq \mathcal{A}([g]^+ \sqcup [g+1]^-)$ . Change the colors in  $\tilde{Z}(K)$  as follows

$$1^- \mapsto r \quad \text{and} \quad i^- \mapsto (i-1)^-, \quad \forall i = 2, \dots, g+1;$$

so that, the variable  $r$  refers to the bottom knot. Thus  $\tilde{Z}(K) \in \mathcal{A}([g]^+ \sqcup [g]^- \sqcup \{r\})$ .

**Example 6.31.** In Example 3.12 we considered a cobordism  $N_i \in {}^s\mathcal{LCob}(g, g+1)$ , for  $i = 1, \dots, g$ , with bottom-top tangle presentation shown in Figure 3.8. Analyzing carefully Figure 3.8 we see that the cobordism  $N_i$  corresponds to the bottom knot, also denoted  $N_i$ , in  $\Sigma \times [-1, 1]$  such that  $\ell(N_i)$  is the homotopy class of the meridian  $\alpha_i$  in  $\Sigma$ .

Recall the space  $\mathcal{H}(r)$  defined in Example 2.4. Hence,  $\tilde{Z}(K) \bmod \mathcal{H}(r)$  is an exponential series of tree-like Jacobi diagrams with at most one  $r$ -colored leg and which only depends on the homotopy class of  $K$ , see [47, Lemma 5.5]. Moreover, the series consisting of the terms without  $r$ -colored legs in  $\tilde{Z}(K) \bmod \mathcal{H}(r)$  is exactly the identity morphism in  ${}^{ts}\mathcal{A}(g, g)$ . To sum up

$$S^{\tilde{Z}}(K) := \log_{\sqcup} \left( \tilde{Z}(K) \bmod \mathcal{H}(r) \right) - \left( \sum_{i=1}^g \begin{array}{c} \vdots^{i^+} \\ \vdots \\ \vdots^{i^-} \end{array} \right)$$

is a series of connected tree-like Jacobi diagrams with legs colored by  $[g]^+ \sqcup [g]^- \sqcup \{r\}$  and with exactly one  $r$ -colored leg. Hence, by considering the  $r$ -colored leg as a root, we can see  $S^{\tilde{Z}}(K)$  as an element in  $\widehat{\mathfrak{Lie}}(B_{\mathbb{Q}}, A_{\mathbb{Q}})$  after the replacement of colors  $i^+ \mapsto b_i$  and  $i^- \mapsto a_i$  for  $i = 1, \dots, g$ . The map

$$\theta^{\tilde{Z}} : \pi \longrightarrow \widehat{T}(B_{\mathbb{Q}}; A_{\mathbb{Q}}), \quad (6.27)$$

defined by  $\theta^{\tilde{Z}}(\ell(K)) = \exp_{\otimes}(S^{\tilde{Z}}(K))$  is a symplectic expansion of  $\pi$ , see [47, Proposition 5.6].

**Proposition 6.32.** *The symplectic expansion  $\theta^{\tilde{Z}} : \pi \rightarrow \widehat{T}(B_{\mathbb{Q}}; A_{\mathbb{Q}})$  satisfies*

$$\theta^{\tilde{Z}}(\alpha) = 1 + \{\alpha\} + (\mathfrak{a}\text{-deg} > 2)$$

for all  $\alpha \in \mathbb{A}$ . Therefore  $\theta^{\tilde{Z}}$  is a symplectic alternative expansion of  $\pi$  relative to  $\mathbb{A}$ .

*Proof.* By [47, Proposition 5.6] we know that for every  $\alpha \in \mathbb{A}$ ,

$$\theta^{\tilde{Z}}(\alpha) = 1 + \{\alpha\} + (\text{deg} > 1).$$

First, notice that a tree of  $i\text{-deg} > 1$  with one leg colored by  $r$  (the root) and the other legs colored by elements of  $B \oplus A$  gives rise to a Lie commutator in  $\mathfrak{Lie}(B_{\mathbb{Q}}, A_{\mathbb{Q}})$  of  $\mathfrak{a}\text{-deg} > 2$ . Therefore, we only need to calculate the terms of  $i\text{-deg} = 1$  in  $S^{\tilde{Z}}(K)$  for bottom knots  $K$  such that  $\ell(K) \in \mathbb{A}$ .

Now  $\mathbb{A}$  is the normal closure of the subgroup  $\langle \alpha_i \mid i = 1, \dots, g \rangle$  of  $\pi$  generated by the homotopy classes of the meridians and by Example 6.31, the cobordism  $N_i$  is such that  $\ell(N_i)$  is the homotopy class of  $\alpha_i$ . Therefore, by the homomorphism property of  $\tilde{Z}_{i\text{-deg}=1}$ , it is enough to calculate the terms of  $i\text{-deg} = 1$  in  $\tilde{Z}(N_i) \bmod \mathcal{H}(r)$  and see whether they give rise to Lie commutators in  $\mathfrak{Lie}(B_{\mathbb{Q}}, A_{\mathbb{Q}})$  of  $\mathfrak{a}\text{-deg} = 1$ . In Example 3.19 we see that each of the terms with  $i\text{-deg} = 1$  in  $\tilde{Z}(N_i) \bmod \mathcal{H}(r)$  has one  $r$ -colored leg and one  $i^-$ -colored leg, thus the associated commutator has  $\mathfrak{a}\text{-deg} > 2$  which completes the proof.  $\square$

**Proof of Theorem 6.16.** Let  $\theta$  denote the symplectic alternative expansion of  $\pi$  relative to  $\mathbb{A}$  defined by the LMO functor and denote by  $\theta'$  the associated symplectic expansion of  $\pi$ . In [47, Theorem 5.13] G. Massuyeau proved that the diagram

$$\begin{array}{ccc}
 \mathcal{I} & \xrightarrow{c} & \mathcal{L}Cob_q(g, g) \\
 \eta^{-1}\varrho^{\theta'} \downarrow & & \swarrow -\log \tilde{Z}^{Y,t} \\
 \mathcal{A}^{t,c}(H) & & 
 \end{array} \tag{6.28}$$

is commutative, where  $c$  denotes the cylinder map and for  $h \in \mathcal{I}$  we endow the top and bottom of  $c(h)$  with the right-handed non-associative words as in Convention 3.13. In order to see  $\log(\tilde{Z}(c(h)))$  as an element of  $\mathcal{A}^{t,c}(H)$  we consider the change of colors  $i^+ \mapsto b_i$  and  $i^- \mapsto a_i$  for  $i = 1, \dots, g$ . We obtain the desired result by putting together the commutative diagrams (6.24), (6.25) and (6.28).  $\square$

**Remark 6.33.** In fact [47, Theorem 5.13] is more general than the commutativity of diagram (6.28); it says that for every homology cylinder  $M \in \mathcal{IC}$  we have  $\eta^{-1}\varrho^{\theta'}(M) = -\log(\tilde{Z}^{Y,t}(M))$ . Besides, Theorem 6.5 is proved in the setting of homology cobordisms. This suggests that our results could be generalized to the setting of homology cobordisms. More precisely, we expect that the alternative Johnson filtration and the alternative Johnson homomorphisms extend to homology cobordisms and that the diagrammatic version of such alternative Johnson homomorphisms can be read in the tree reduction of the LMO functor.

# Bibliography

- [1] Dror Bar-Natan. On the Vassiliev knot invariants. *Topology*, 34(2):423–472, 1995.
- [2] Dror Bar-Natan. Vassiliev homotopy string link invariants. *J. Knot Theory Ramifications*, 4(1):13–32, 1995.
- [3] Dror Bar-Natan. On associators and the Grothendieck-Teichmüller group. I. *Selecta Math. (N.S.)*, 4(2):183–212, 1998.
- [4] Dror Bar-Natan, Stavros Garoufalidis, Lev Rozansky, and Dylan P. Thurston. The Aarhus integral of rational homology 3-spheres. I. A highly non trivial flat connection on  $S^3$ . *Selecta Math. (N.S.)*, 8(3):315–339, 2002.
- [5] Dror Bar-Natan, Stavros Garoufalidis, Lev Rozansky, and Dylan P. Thurston. The Aarhus integral of rational homology 3-spheres. II. Invariance and universality. *Selecta Math. (N.S.)*, 8(3):341–371, 2002.
- [6] Joan S. Birman and Xiao-Song Lin. Knot polynomials and Vassiliev’s invariants. *Invent. Math.*, 111(2):225–270, 1993.
- [7] Nathan Broaddus, Benson Farb, and Andrew Putman. Irreducible Sp-representations and subgroup distortion in the mapping class group. *Comment. Math. Helv.*, 86(3):537–556, 2011.
- [8] Dorin Cheptea, Kazuo Habiro, and Gwénaél Massuyeau. A functorial LMO invariant for Lagrangian cobordisms. *Geom. Topol.*, 12(2):1091–1170, 2008.
- [9] Dorin Cheptea and Thang T. Q. Le. A TQFT associated to the LMO invariant of three-dimensional manifolds. *Comm. Math. Phys.*, 272(3):601–634, 2007.
- [10] S. Chmutov, S. Duzhin, and J. Mostovoy. *Introduction to Vassiliev knot invariants*. Cambridge University Press, Cambridge, 2012.
- [11] Thomas Church, Mikhail Ershov, and Andrew Putman. On finite generation of the Johnson filtrations. *arXiv:1711.04779*, 2017.
- [12] Tim D. Cochran. Derivatives of links: Milnor’s concordance invariants and Massey’s products. *Mem. Amer. Math. Soc.*, 84(427):x+73, 1990.
- [13] Tim D. Cochran.  $k$ -cobordism for links in  $S^3$ . *Trans. Amer. Math. Soc.*, 327(2):641–654, 1991.
- [14] J. Conant, R. Schneiderman, and P. Teichner. Milnor invariants and twisted Whitney towers. *J. Topol.*, 7(1):187–224, 2014.
- [15] Stavros Garoufalidis and Jerome Levine. Finite type 3-manifold invariants, the mapping class group and blinks. *J. Differential Geom.*, 47(2):257–320, 1997.
- [16] Stavros Garoufalidis and Jerome Levine. Tree-level invariants of three-manifolds, Massey products and the Johnson homomorphism. In *Graphs and patterns in mathematics and theoretical physics*, volume 73 of *Proc. Sympos. Pure Math.*, pages 173–203. Amer. Math. Soc., Providence, RI, 2005.

- [17] M. Goussarov. On  $n$ -equivalence of knots and invariants of finite degree. In *Topology of manifolds and varieties*, volume 18 of *Adv. Soviet Math.*, pages 173–192. Amer. Math. Soc., Providence, RI, 1994.
  - [18] M. N. Goussarov. Variations of knotted graphs. The geometric technique of  $n$ -equivalence. *Algebra i Analiz*, 12(4):79–125, 2000.
  - [19] Mikhail Goussarov. Finite type invariants and  $n$ -equivalence of 3-manifolds. *C. R. Acad. Sci. Paris Sér. I Math.*, 329(6):517–522, 1999.
  - [20] H. B. Griffiths. Automorphisms of a 3-dimensional handlebody. *Abh. Math. Sem. Univ. Hamburg*, 26:191–210, 1963/1964.
  - [21] Nathan Habegger. Milnor, Johnson, and tree level perturbative invariants. *Preprint*, 2000.
  - [22] Nathan Habegger and Xiao-Song Lin. The classification of links up to link-homotopy. *J. Amer. Math. Soc.*, 3(2):389–419, 1990.
  - [23] Nathan Habegger and Xiao-Song Lin. On link concordance and Milnor’s  $\mu$  invariants. *Bull. London Math. Soc.*, 30(4):419–428, 1998.
  - [24] Nathan Habegger and Gregor Masbaum. The Kontsevich integral and Milnor’s invariants. *Topology*, 39(6):1253–1289, 2000.
  - [25] Nathan Habegger and Wolfgang Pitsch. Tree level Lie algebra structures of perturbative invariants. *J. Knot Theory Ramifications*, 12(3):333–345, 2003.
  - [26] Kazuo Habiro. Claspers and finite type invariants of links. *Geom. Topol.*, 4:1–83, 2000.
  - [27] Kazuo Habiro and Gwénaél Massuyeau. From mapping class groups to monoids of homology cobordisms: a survey. In *Handbook of Teichmüller theory. Volume III*, volume 17 of *IRMA Lect. Math. Theor. Phys.*, pages 465–529. Eur. Math. Soc., Zürich, 2012.
  - [28] Kazuo Habiro and Gwénaél Massuyeau. Generalized Johnson homomorphisms for extended  $N$ -series. *J. Algebra*, 510:205–258, 2018.
  - [29] Susumu Hirose. The action of the handlebody group on the first homology group of the surface. *Kyungpook Math. J.*, 46(3):399–408, 2006.
  - [30] Dennis Johnson. An abelian quotient of the mapping class group  $\mathcal{I}_g$ . *Math. Ann.*, 249(3):225–242, 1980.
  - [31] Dennis Johnson. The structure of the Torelli group. I. A finite set of generators for  $\mathcal{I}$ . *Ann. of Math. (2)*, 118(3):423–442, 1983.
  - [32] Dennis Johnson. A survey of the Torelli group. In *Low-dimensional topology (San Francisco, Calif., 1981)*, volume 20 of *Contemp. Math.*, pages 165–179. Amer. Math. Soc., Providence, RI, 1983.
  - [33] Dennis Johnson. The structure of the Torelli group. II. A characterization of the group generated by twists on bounding curves. *Topology*, 24(2):113–126, 1985.
  - [34] Dennis Johnson. The structure of the Torelli group. III. The abelianization of  $\mathcal{T}$ . *Topology*, 24(2):127–144, 1985.
  - [35] Vaughan F. R. Jones. A polynomial invariant for knots via von Neumann algebras. *Bull. Amer. Math. Soc. (N.S.)*, 12(1):103–111, 1985.
  - [36] Maxim Kontsevich. Vassiliev’s knot invariants. In *I. M. Gelfand Seminar*, volume 16 of *Adv. Soviet Math.*, pages 137–150. Amer. Math. Soc., Providence, RI, 1993.
-

- 
- [37] John P. Labute. On the descending central series of groups with a single defining relation. *J. Algebra*, 14:16–23, 1970.
- [38] Thang T. Q. Le, Jun Murakami, and Tomotada Ohtsuki. On a universal perturbative invariant of 3-manifolds. *Topology*, 37(3):539–574, 1998.
- [39] Tu Quoc Thang. Le. The LMO invariant. Lecture notes from: “*Ecole d’Eté de Mathématiques: Invariants de noeuds et de variétés de dimension trois*”, Institut Fourier, 1999.
- [40] Tu Quoc Thang Le and Jun Murakami. Representation of the category of tangles by Kontsevich’s iterated integral. *Comm. Math. Phys.*, 168(3):535–562, 1995.
- [41] Tu Quoc Thang Le and Jun Murakami. The universal Vassiliev-Kontsevich invariant for framed oriented links. *Compositio Math.*, 102(1):41–64, 1996.
- [42] Jerome Levine. Pure braids, a new subgroup of the mapping class group and finite-type invariants of 3-manifolds. In *Tel Aviv Topology Conference: Rothenberg Festschrift (1998)*, volume 231 of *Contemp. Math.*, pages 137–157. Amer. Math. Soc., Providence, RI, 1999.
- [43] Jerome Levine. Homology cylinders: an enlargement of the mapping class group. *Algebr. Geom. Topol.*, 1:243–270, 2001.
- [44] Jerome Levine. Addendum and correction to: “Homology cylinders: an enlargement of the mapping class group” [*Algebr. Geom. Topol.* **1** (2001), 243–270; MR1823501 (2002m:57020)]. *Algebr. Geom. Topol.*, 2:1197–1204, 2002.
- [45] Jerome Levine. Labeled binary planar trees and quasi-Lie algebras. *Algebr. Geom. Topol.*, 6:935–948, 2006.
- [46] Jerome Levine. The Lagrangian filtration of the mapping class group and finite-type invariants of homology spheres. *Math. Proc. Cambridge Philos. Soc.*, 141(2):303–315, 2006.
- [47] Gwénaél Massuyeau. Infinitesimal Morita homomorphisms and the tree-level of the LMO invariant. *Bull. Soc. Math. France*, 140(1):101–161, 2012.
- [48] Gwénaél Massuyeau and Jean-Baptiste Meilhan. Equivalence relations for homology cylinders and the core of the Casson invariant. *Trans. Amer. Math. Soc.*, 365(10):5431–5502, 2013.
- [49] Shigeyuki Morita. Casson’s invariant for homology 3-spheres and characteristic classes of surface bundles. I. *Topology*, 28(3):305–323, 1989.
- [50] Shigeyuki Morita. On the structure of the Torelli group and the Casson invariant. *Topology*, 30(4):603–621, 1991.
- [51] Shigeyuki Morita. Abelian quotients of subgroups of the mapping class group of surfaces. *Duke Math. J.*, 70(3):699–726, 1993.
- [52] Shigeyuki Morita. Casson invariant, signature defect of framed manifolds and the secondary characteristic classes of surface bundles. *J. Differential Geom.*, 47(3):560–599, 1997.
- [53] J. Murakami and T. Ohtsuki. Topological quantum field theory for the universal quantum invariant. *Comm. Math. Phys.*, 188(3):501–520, 1997.
- [54] Takayuki Oda. A lower bound for the graded modules associated with the relative weight filtration on the teichmuller group. *Preprint*, 1992.
- [55] Tomotada Ohtsuki. Finite type invariants of integral homology 3-spheres. *J. Knot Theory Ramifications*, 5(1):101–115, 1996.
-

- [56] Tomotada Ohtsuki. *Quantum invariants*, volume 29 of *Series on Knots and Everything*. World Scientific Publishing Co., Inc., River Edge, NJ, 2002. A study of knots, 3-manifolds, and their sets.
  - [57] Kent E. Orr. Homotopy invariants of links. *Invent. Math.*, 95(2):379–394, 1989.
  - [58] Daniel G. Quillen. On the associated graded ring of a group ring. *J. Algebra*, 10:411–418, 1968.
  - [59] N. Reshetikhin and V. G. Turaev. Invariants of 3-manifolds via link polynomials and quantum groups. *Invent. Math.*, 103(3):547–597, 1991.
  - [60] Christophe Reutenauer. *Free Lie algebras*, volume 7 of *London Mathematical Society Monographs. New Series*. The Clarendon Press, Oxford University Press, New York, 1993. Oxford Science Publications.
  - [61] Takuya Sakasai. Lagrangian mapping class groups from a group homological point of view. *Algebr. Geom. Topol.*, 12(1):267–291, 2012.
  - [62] Takao Satoh. On the Johnson homomorphisms of the mapping class groups of surfaces. In *Handbook of group actions. Vol. I*, volume 31 of *Adv. Lect. Math. (ALM)*, pages 373–407. Int. Press, Somerville, MA, 2015.
  - [63] John Stallings. Homology and central series of groups. *J. Algebra*, 2:170–181, 1965.
  - [64] Shin’ichi Suzuki. On homeomorphisms of a 3-dimensional handlebody. *Canad. J. Math.*, 29(1):111–124, 1977.
  - [65] V. A. Vassiliev. Cohomology of knot spaces. In *Theory of singularities and its applications*, volume 1 of *Adv. Soviet Math.*, pages 23–69. Amer. Math. Soc., Providence, RI, 1990.
  - [66] Anderson Vera. Johnson-Levine homomorphisms and the tree reduction of the LMO functor. *arXiv:1712.00073*, 2017.
  - [67] Edward Witten. Quantum field theory and the Jones polynomial. *Comm. Math. Phys.*, 121(3):351–399, 1989.
-

# Homomorphismes de type Johnson pour les surfaces et invariant perturbatif universel des variétés de dimension trois

Soit  $\Sigma$  une surface compacte connexe orientée avec une seule composante du bord. Notons par  $\mathcal{M}$  le groupe d'homéotopie de  $\Sigma$ . En considérant l'action de  $\mathcal{M}$  sur le groupe fondamental de  $\Sigma$ , il est possible de définir différentes filtrations de  $\mathcal{M}$  ainsi que des homomorphismes sur chaque terme de ces filtrations. Le but de cette thèse es double. En premier lieu, nous étudions deux filtrations de  $\mathcal{M}$  : la « filtration de Johnson-Levine » introduite par Levine et la « filtration de Johnson alternative » introduite récemment par Habiro et Massuyeau. Les définitions de ces deux filtrations prennent en compte un corps en anses bordé par la surface. Nous nous référons à ces filtrations comme « filtrations de type Johnson » et les homomorphismes correspondants sont appelés « homomorphismes de type Johnson » par leur analogie avec la filtration de Johnson originale et les homomorphismes de Johnson usuels. Nous donnons une comparaison de la filtration de Johnson avec la filtration de Johnson-Levine au niveau du monoïde des cobordismes d'homologie de  $\Sigma$ . Nous donnons également une comparaison entre la filtration de Johnson alternative, la filtration Johnson-Levine et la filtration de Johnson au niveau du groupe d'homéotopie. Deuxièmement, nous étudions la relation entre les « homomorphismes de type Johnson » et l'extension fonctorielle de l'invariant perturbatif universel des variétés de dimension trois (l'invariant de Le-Murakami-Ohtsuki ou invariant LMO). Cette extension fonctorielle s'appelle le foncteur LMO et il prend ses valeurs dans une catégorie de diagrammes. Nous démontrons que les « homomorphismes de type Johnson » peuvent être lus dans la réduction arborée du foncteur LMO. En particulier, cela fournit une nouvelle grille de lecture de la réduction arborée du foncteur LMO.

Mots-Clés : variétés de dimension trois, cobordismes d'homologie, groupe d'homéotopie, homomorphismes de Johnson, homomorphismes de Johnson-Levine, homomorphismes de Johnson alternatifs, invariant LMO, foncteur LMO.

Let  $\Sigma$  be a compact oriented surface with one boundary component and let  $\mathcal{M}$  denote the mapping class group of  $\Sigma$ . By considering the action of  $\mathcal{M}$  on the fundamental group of  $\Sigma$  it is possible to define different filtrations of  $\mathcal{M}$  together with some homomorphisms on each term of the filtrations. The aim of this thesis is twofold. First, we study two filtrations of  $\mathcal{M}$  : the « Johnson-Levine filtration » introduced by Levine and « the alternative Johnson filtration » introduced recently by Habiro and Massuyeau. The definition of both filtrations involve a handlebody bounded by  $\Sigma$ . We refer to these filtrations as « Johnson-type filtrations » and the corresponding homomorphisms are referred to as « Johnson-type homomorphisms » by their analogy with the original Johnson filtration and the usual Johnson homomorphisms. We provide a comparison of the Johnson filtration with the Johnson-Levine filtration at the level of the monoid of homology cobordisms of  $\Sigma$ . We also provide a comparison of the alternative Johnson filtration with the Johnson-Levine filtration and the Johnson filtration at the level of the mapping class group. Secondly, we study the relationship between the « Johnson-type homomorphisms » and the functorial extension of the universal perturbative invariant of 3-manifolds (the Le-Murakami-Ohtsuki invariant or LMO invariant). This functorial extension is called the LMO functor and it takes values in a category of diagrams. We prove that the « Johnson-type homomorphisms » can be read in the tree reduction of the LMO functor. In particular, this provides a new reading grid of the tree reduction of the LMO functor.

Keywords : 3-manifolds, homology cobordisms, mapping class group, Johnson homomorphisms, Johnson-Levine homomorphisms, alternative Johnson homomorphisms, LMO invariant, LMO functor.



Soit  $\Sigma$  une surface compacte connexe orientée avec une seule composante du bord. Notons par  $\mathcal{M}$  le groupe d'homéotopie de  $\Sigma$ . En considérant l'action de  $\mathcal{M}$  sur le groupe fondamental de  $\Sigma$ , il est possible de définir différentes filtrations de  $\mathcal{M}$  ainsi que des homomorphismes sur chaque terme de ces filtrations. Le but de cette thèse es double. En premier lieu, nous étudions deux filtrations de  $\mathcal{M}$  : la "filtration de Johnson-Levine" introduite par Levine et la "filtration de Johnson alternative" introduite récemment par Habiro et Massuyeau. Les définitions de ces deux filtrations prennent en compte un corps en anses bordé par la surface. Nous nous référons à ces filtrations comme "filtrations de type Johnson" et les homomorphismes correspondants sont appelés "homomorphismes de type Johnson" par leur analogie avec la filtration de Johnson originale et les homomorphismes de Johnson usuels. Nous donnons une comparaison de la filtration de Johnson avec la filtration de Johnson-Levine au niveau du monoïde des cobordismes d'homologie de  $\Sigma$ . Nous donnons également une comparaison entre la filtration de Johnson alternative, la filtration Johnson-Levine et la filtration de Johnson au niveau du groupe d'homéotopie. Deuxièmement, nous étudions la relation entre les "homomorphismes de type Johnson" et l'extension fonctorielle de l'invariant perturbatif universel des variétés de dimension trois (l'invariant de Le-Murakami-Ohtsuki ou invariant LMO). Cette extension fonctorielle s'appelle le foncteur LMO et il prend ses valeurs dans une catégorie de diagrammes. Nous démontrons que les "homomorphismes de type Johnson" peuvent être lus dans la réduction arborée du foncteur LMO. En particulier, cela fournit une nouvelle grille de lecture de la réduction arborée du foncteur LMO.

**INSTITUT DE RECHERCHE MATHÉMATIQUE AVANCÉE**  
 UMR 7501  
 Université de Strasbourg et CNRS  
 7 Rue René Descartes  
 67 084 STRASBOURG CEDEX

Tél. 03 68 85 01 29  
 Fax 03 68 85 03 28  
[www-irma.u-strasbg.fr](http://www-irma.u-strasbg.fr)  
[irma@math.unistra.fr](mailto:irma@math.unistra.fr)



Université  
de Strasbourg



IRMA 2019/005  
<https://tel.archives-ouvertes.fr/tel-02145110>

ISSN 0755-3390