



HAL
open science

The development of the fire diffusion law by modelling the level of danger and its evolution over time. : comparison with experimental data in Lebanese forests

Nizar Hamadeh

► To cite this version:

Nizar Hamadeh. The development of the fire diffusion law by modelling the level of danger and its evolution over time. : comparison with experimental data in Lebanese forests. Applications [stat.AP]. Université d'Angers, 2017. English. NNT : 2017ANGE0060 . tel-02145748

HAL Id: tel-02145748

<https://theses.hal.science/tel-02145748>

Submitted on 3 Jun 2019

HAL is a multi-disciplinary open access archive for the deposit and dissemination of scientific research documents, whether they are published or not. The documents may come from teaching and research institutions in France or abroad, or from public or private research centers.

L'archive ouverte pluridisciplinaire **HAL**, est destinée au dépôt et à la diffusion de documents scientifiques de niveau recherche, publiés ou non, émanant des établissements d'enseignement et de recherche français ou étrangers, des laboratoires publics ou privés.

Thèse de Doctorat

Nizar HAMADEH

*Mémoire présenté en vue de l'obtention du
grade de Docteur de l'Université d'Angers
sous le sceau de l'Université Bretagne Loire*

École doctorale : *Sciences et technologies de l'information et mathématiques – ED STIM*

Discipline : *Informatique et applications*

Spécialité : *Informatique*

Soutenu le : *2 Mai 2017*

Le développement de la loi de diffusion des incendies en modélisant le niveau de danger et son évolution dans le temps. Comparaison avec des données expérimentales dans les forêts libanaises

JURY

Rapporteurs : **Marc BUI**, Professeur, Laboratoire LAISC, Université Paris-Sud 11
Mohammad HAJJAR, Professeur, Doyen de l'Institut Université de Technologie-Liban

Examineurs : **Marie Françoise COUREL**, Professeur, Directeur d'études émérite-EPHE
Soufian BEN AMOR, HDR, Université de Versailles Saint Quentin en Yvelines

Invité(s) : **Ali KAROUNI**, Professeur Assistant, Institut Université de Technologie-Liban

Directeur de Thèse : **Pierre CHAUVET**, Professeur, Université Catholique de l'Ouest-Angers

Co-directeur de Thèse : **Bassam DAYA**, Professeur, Institut Université de Technologie-Liban

L'auteur du présent document vous autorise à le partager, reproduire, distribuer et communiquer selon les conditions suivantes :



- Vous devez le citer en l'attribuant de la manière indiquée par l'auteur (mais pas d'une manière qui suggérerait qu'il approuve votre utilisation de l'œuvre).
- Vous n'avez pas le droit d'utiliser ce document à des fins commerciales.
- Vous n'avez pas le droit de le modifier, de le transformer ou de l'adapter.

Consulter la licence creative commons complète en français :

<http://creativecommons.org/licences/by-nc-nd/2.0/fr/>

Acknowledgment

There are many people who helped me reach this place in my life. I can never thank all of them adequately. However, I would like to mention the people who were milestones in my life and those who specifically helped me as I developed this dissertation.

Firstly, I would like to express my gratitude to my supervisors Professors Bassam Daya and Pierre Chauvet, whose rigorous and attentive criticism have been of an immense value during all stages of writing. Their wide knowledge and expertise in the subject have influenced both the methodology and the content of my research and helped me to shape and sharpen my arguments and findings. Their patience, support and encouragement have been a great help to my work.

I gratefully thank Dr. Ali Karouni for his support, encouragement and personal attention which have provided good and smooth basis for my Ph.D. tenure. I really appreciate the big efforts he paid during the period of my work.

My special thanks go to the Association of Forests Development and Conservation, Lebanese Agriculture Research Institute and the Lebanese Internal Security Forces for dedicating their valuable experiences and providing me with the needed data for this thesis.

Special thanks are due to my mother, sister and brothers who supported me with their continuous love and patience. Also many thanks for my wife who encouraged me not only in my dissertation but in everything in my life.

Finally, I am, in particular, greatly indebted to my father Prof. Akram Hamade, whose enthusiasm, encouragement and support helped to make this dissertation possible. This work is dedicated to him and to his unconditional and infinite love for me.

Résumé

Les incendies de forêt sont l'un des phénomènes les plus complexes auxquels sont confrontées nos sociétés. Le Liban, faisant partie du Moyen-Orient, est en train de perdre dramatiquement ses forêts vertes principalement en raison de graves incendies. Cette thèse étudie le phénomène des incendies de forêt. Elle propose des nouveaux modèles et méthodologies pour remédier à la crise des incendies de forêts, en particulier au Liban et en Méditerranée. Elle est divisée en deux parties principales: nouvelles approches de la prévision des incendies de forêt et développement d'un nouveau modèle de diffusion du feu plus fidèle du cas réel.

La première partie est subdivisée en 3 chapitres. Le premier chapitre présente une étude analytique des modèles météorologiques les plus utilisés qui permettent de prédire les incendies de forêt. Dans le deuxième chapitre, nous appliquons cinq méthodes de techniques d'exploration de données: Réseaux de neurones, arbre de décision, floue logique, analyse discriminante linéaire et méthode SVM. Nous cherchons à trouver la technique la plus précise pour la prévision des incendies de forêt. Dans le troisième chapitre, nous utilisons différentes techniques d'analyse de données corrélatives (Régression, Pearson, Spearman et Kendall-tau) pour évaluer la corrélation entre l'occurrence d'incendie et les données météorologiques (température, point de rosée, température du sol, humidité, précipitation et vitesse du vent). Cela permet de trouver les paramètres les plus influents qui influencent l'occurrence de l'incendie, ce qui nous amène à développer un nouveau Indice Libanais de Risques d'Incendie (IL). L'indice proposé est ensuite validé à partir des données météorologiques pour les années 2015-2016.

La deuxième partie est subdivisée en 3 chapitres. Le premier chapitre passe en revue les caractéristiques du comportement de feu et sa morphologie; il se concentre sur la validité des modèles mathématique et informatique de comportement de feu. Le deuxième chapitre montre l'importance des automates cellulaires, en expliquant les principaux types et examine certaines applications dans différents domaines. Dans le troisième chapitre, nous utilisons des automates cellulaires pour élaborer un nouveau modèle de comportement pour prédire la propagation de l'incendie, sur des bases elliptiques, dans des paysages homogènes et hétérogènes. La méthodologie proposée intègre les paramètres de la vitesse du vent, du carburant et de la topographie. Notre modèle développé est ensuite utilisé pour simuler les incendies de forêt qui ont balayé la forêt du village d'Aandqet, au nord du Liban. Les résultats de simulation obtenus sont comparés avec les résultats rapportés de l'incident réel et avec des simulations qu'on a

effectuées sur le modèle de Karafyllidis et le modèle de Karafyllidis modifié par Gazmeh. Ces comparaisons ont prouvé l'ambiguë du modèle proposé.

Dans cette thèse, la crise des feux de forêt a été étudiée et de nouveaux modèles ont été développés dans les deux phases: pré-feu et post-feu. Ces modèles peuvent être utilisés comme outils préventifs efficaces dans la gestion des incendies de forêt .

Mots-clés: Prévion des incendies de forêt, L'exploration de données, Analyse des données, Automates cellulaires, Diffusion des incendies.

Abstract

Wildland fires are one of the most complex phenomena facing our societies. Lebanon, a part of Middle East, is losing its green forests dramatically mainly due to severe fires. This dissertation studies the phenomenon of forest fires. It proposes new models and methodologies to tackle the crisis of forest fires particularly in Lebanon and Mediterranean. It is divided into two main parts: New Approaches in Forest Fire Prediction and Forest Fire modeling.

The first part is sub-divided into 3 chapters. First chapter presents an analytical study of the most widely used metrological models that can predict forest fires. In the second chapter we apply five data mining techniques methods: Neural Networks, Decision Tree, Fuzzy Logic, Linear Discriminate Analysis and Support Vector Machine. We aim to find the most accurate technique in forecasting forest fires. In the third chapter, we use different correlative data analysis techniques (Regression, Pearson, Spearman and Kendall-tau) to evaluate the correlation between fire occurrence and meteorological data (Temperature, Dew point, Soil temperature, Humidity, Precipitation and Wind speed). This allows to find the most influential parameters that affect the occurrence of fire, which lead us to develop a new Lebanese fire danger Index (LI). The proposed index is then validated using meteorological data for the years 2015-2016.

The second part is sub-divided into 3 chapters. The first chapter reviews the fire behavior characteristics and its morphology; and focuses on the validity of mathematical and computer fire behavior models. The second chapter manifests the importance of cellular automata, explains the main types of cellular automata and reviews some applications in various domains. In the third chapter, we use cellular automata to develop a new behavior model for predicting the spread of fire, on elliptical basis, in both homogeneous and heterogeneous landscapes .The proposed methodology incorporates the parameters of wind speed, fuel and topography. The developed model is then used to simulate the wildfire that swept through the forest of Aandqet village, North Lebanon. Obtained simulation results are compared with reported results of the real incident and with simulations done on Karafyllidis model and Gazmeh-Modified Karafyllidis model. These comparisons have proven the outperformance of the proposed model.

In this dissertation, the crisis of forest fires has been studied and new models have been developed in both phases: pre-fire and post-fire. These models can be used as efficient preventive tools in forest fire management.

Keywords: Forest fire prediction, Data mining, Data analysis, Cellular automata, Fire diffusion

Table of Contents

PART 1: INTRODUCTION ----- 6

CHAPTER 1: FOREST FIRES-A GLOBAL DANGER TO COMBAT -----7

1.1. Problem statement -----7

1.2. Causes of forest fires ----- 11

1.2.1. Human-induced fires ----- 11

1.2.2. Nature-made fires ----- 12

1.2.3. Consequences of forest fires ----- 12

1.2.4. Biodiversity elimination----- 12

1.2.5. Global warming ----- 12

1.2.6. Economical losses----- 12

1.2.7. Soil erosion ----- 12

1.2.8. Human health ----- 13

1.3. Vegetation Cover in Lebanon ----- 13

1.4. Current policy in Lebanon ----- 15

1.5. The obstacles that led to the failure of this policy----- 17

1.6. Proposed actions for policy makers ----- 17

1.7. Thesis objectives ----- 18

1.7.1. Pre-forest fire ----- 18

1.7.2. Post-forest fire ----- 18

1.8. Thesis structure ----- 18

REFERENCES OF CHAPTER 1 ----- 19

PART 2: NEW APPROACHES IN FOREST FIRE PREDICTION -----20

CHAPTER 2: ANALYTICAL REVIEW ON THE MOST WIDELY USED METROLOGICAL MODELS----- 24

2.1. Introduction ----- 24

2.2. Literature review on widely used weather fire indices----- 26

2.1.1. Angstrom index ----- 27

2.1.2. Nesterov Index ----- 27

2.1.3. Modified Nesterov Index ----- 28

2.1.4. Baumgartner Index ----- 28

2.1.5. KeetchByram Drought Index ----- 29

2.1.6. Canadian Forest Fire Weather Index (FWI) ----- 30

2.1.7.	McArthur Forest Fire Danger Index (FFDI) -----	32
2.1.8.	Simple Fire Danger Index (F) -----	33
2.1.9.	Modified Keetch-Byram Drought Index. -----	33
2.1.10.	Fire danger index (FD) -----	34
2.3.	<i>Comparative study between classical models</i> -----	34
2.3.1.	Meteorological parameters and places of studies -----	35
2.3.2.	Validity and accuracy of models -----	36
2.4.	<i>Recent initiative studies on fire prediction</i> -----	39
CONCLUSION -----		40
REFERENCES OF CHAPTER 2 -----		41
CHAPTER 3: COMPARATIVE STUDY OF DIFFERENT DATA MINING TECHNIQUES IN PREDICTING FOREST FIRE IN LEBANON AND MEDITERRANEAN -----		45
3.1.	<i>Introduction</i> -----	45
3.2.	<i>Data Mining and its fields</i> -----	46
3.2.1.	Accounting and finance fields -----	46
3.2.2.	Medical fields-----	47
3.2.3.	Geo-science fields -----	47
3.2.4.	Telecommunication fields -----	47
3.2.5.	Education fields-----	48
3.3.	<i>Place of study and data</i> -----	48
3.4.	<i>Methodology and data classification preliminaries</i> -----	49
3.5.	<i>Artificial Neural Networks (ANN)</i> -----	50
3.5.1.	Neural network validations in predicting forest Fires -----	51
3.5.2.	Application of Neural Networks -----	51
3.6.	<i>Decision Tree</i> -----	55
3.6.1.	Decision Tree validations in predicting forest Fire -----	56
3.6.2.	Application of Decision Tree-----	56
3.7.	<i>Fuzzy Logic</i> -----	58
3.7.1.	Fuzzy logic validations in predicting forest Fires -----	60
3.7.2.	Applying Fuzzy Logic -----	61
3.8.	<i>Linear Discriminate analysis (LDA)</i> -----	65
3.8.1.	LDA validations in predicting forest Fire -----	66
3.8.2.	Application of LDA -----	66
3.9.	<i>Support Vector Machine</i> -----	68
3.9.1.	SVM validations in predicting forest Fire -----	70
3.9.2.	Application of SVM predictor algorithms-----	71
3.10.	<i>Comparative study between different data mining techniques applications</i> -----	72

CONCLUSION	73
REFERENCES OF CHAPTER 3	73
CHAPTER 4: A PROPOSAL OF NEW WEATHER INDEX FOR LEBANON AND THE MEDITERRANEAN: ASSESSMENT VERSUS PREVALENT METEOROLOGICAL INDICES	77
4.1. Introduction	78
4.2. Place of study and data	79
4.3. Data analysis to identify the influential parameters	80
4.3.1. Temperature	81
4.3.2. Relative Humidity	82
4.3.3. Dew Point temperature	82
4.3.4. Soil Temperature	83
4.3.5. Wind Speed	84
4.3.6. Precipitation	84
4.4. Pearson, Spearman and Kendall correlative data analysis	85
4.4.1. Pearson correlative data analysis	85
4.4.2. Spearman correlative data analysis	87
4.4.3. Kendall's tau correlative data analysis	88
4.5. Finding the relationships among affective parameters to derive Lebanese Index (LI)	89
4.6. Validation of Lebanon Index	91
4.7. Assessment of Lebanon Index versus prevalent meteorological indices	93
CONCLUSION	96
REFERENCES OF CHAPTER 4	97
PART 3: FOREST FIRE DIFFUSION	99
CHAPTER 5: OVERVIEW ON WIDELY USED FIRE BEHAVIOR MODELS	99
5.1. Introduction	101
5.2. Fire behavior foundations	102
5.2.1. Fire types	102
5.2.2. Fire morphology	104
5.3. Parameters that affect the behavior of wildfire	106
5.3.1. Weather	107
5.3.2. Topography	108
5.3.3. Fuel	109
5.4. Fire behavior classical models	110

5.4.1.	Fon’s model -----	110
5.4.2.	George Byram model -----	111
5.4.3.	Mcarthur model -----	111
5.4.4.	Rothermel model -----	111
5.4.5.	Albini Model -----	112
5.4.6.	Anderson Model -----	113
5.4.7.	Van Wanger model -----	113
5.4.8.	Weber model -----	114
5.5.	Computer models and simulators -----	115
5.5.1.	Canadian Forest Fire Danger Rating System (CFFDRS) -----	115
5.5.2.	National Fire Danger Rating System (NFDRS) -----	116
5.5.3.	Behave plus -----	117
5.5.4.	Fire Area Simulator (FARSITE) -----	118
5.5.5.	Phoenix -----	119
5.5.6.	Bushfire -----	119
5.5.7.	PYROCARD -----	119
5.5.8.	HFire -----	120
5.5.9.	Firementor -----	121
5.6.	Simulators validity and characteristics -----	121
5.7.	New generation in wildfire prediction -----	125
5.7.1.	Percolation theory and fire behavior application -----	126
CONCLUSION -----		128
REFERENCES OF CHAPTER 5 -----		129
CHAPTER 6: CELLULAR AUTOMATA -----		129
6.1.	Background -----	134
6.2.	Elementary cellular automata (1D) -----	135
6.2.1.	ECA Transition rule -----	135
6.3.	2-D CA concepts -----	136
6.3.1.	Von Neumann’s neighborhood -----	138
6.3.2.	Moore’s neighborhood -----	139
6.3.3.	Hexagonal Cellular automata -----	140
6.3.4.	Probabilistic cellular automata -----	140
6.4.	Cellular automata applications -----	141
6.4.1.	Image Processing -----	141
6.4.2.	Cryptography -----	142
6.4.3.	Physical Evolution -----	142
6.4.4.	Social Science -----	143
CONCLUSION -----		145

REFERENCES OF CHAPTER 6	146
CHAPTER7: A NEW METHODOLOGY FOR SPATIAL SIMULATION OF FOREST FIRE BEHAVIOR USING CELLULAR AUTOMATA	149
7.1. Introduction	149
7.2. Place of study	152
7.3. CA Structure for fire fronts simulation	153
7.4. Karafyllidis CA models for fire spreading	154
7.4.1. Karafyllidis linear Model	154
7.4.2. Improved Karafyllidis Non- linear Model	155
7.4.3. The proposed CA-Model	156
7.4.4. Hypothetical Simulation of Proposed Model	162
7.5. Attributes affecting fire behavior	162
7.5.1. Wind speed and direction	163
7.5.2. Vegetation	163
7.5.3. Topography	165
7.6. Transition Rule for Heterogeneous Forests	166
7.7. The Case Study and Simulation Results	166
7.8. Real Case Simulations on Karafyllidis, Modified Karafyllidis Models versus Proposed Model	170
CONCLUSION	171
REFERENCES OF CHAPTER 7	173
GENERAL CONCLUSION	176
LIST OF FIGURES	178
LIST OF TABLES	180
PUBLICATIONS	182

Part 1: Introduction

Résumé

Les crises naturelles tels que les tremblements de terre, les tornades, les inondations et les incendies de forêt ne causent pas seulement une détérioration du terrain, mais menacent aussi la vie des êtres humains, directement ou indirectement. L'incendie de forêt est l'une des catastrophes naturelles les plus complexes auxquelles est confrontée notre communauté. Les études statistiques mondiales ont montré que la fréquence des incendies augmente jour après jour en conduisant à des résultats catastrophiques sur la vie humaine et la biodiversité. Ces conséquences ont attiré l'attention des gouvernements, des donateurs et des organisations non-gouvernementales pour mettre en œuvre de nouvelles stratégies et donc trouver des solutions pour cette crise. La prévention des incendies est considérée comme l'une des techniques les plus importantes qui aident à la réduction des conséquences dangereuses d'incendie. Pour ces raisons, les scientifiques ont travaillé dur pour trouver des stratégies et des politiques efficaces qui aident à la prédiction de l'incidence du feu et le traitement de sa diffusion afin de limiter les dégâts et réduire son danger sur nos sociétés.

Abstract

Natural crises such as earthquakes, tornados, floods and forest fires do not only cause damage to the shape of the land but also threaten human beings lives. Forest fire is one of the most complicated natural disasters facing our community. The global statistical studies showed that fire occurrence is increasing day after day leading to catastrophic results on human life and biodiversity. Such consequences have attracted the attention of governments, donors and non-governmental organizations to implement new strategies and thus find solutions for this crisis. Fire prevention is considered one of the most important techniques that help in the reduction of fire dangerous consequences. For these reasons, scientists have been working hard to find effective strategies and policies that help in the prediction of fire incidence and its diffusion behavior in order to limit the damage and reduce danger in our societies.

Chapter 1: Forest Fires-A Global Danger to Combat

1.1. Problem statement

Global warming has been one of the most critical phenomena we are witnessing. It is the result of the increase of the average temperature of the atmosphere that makes the earth getting hotter and leads to plant and earth droughts. It is proven by scientists that air temperature has risen by a little than 1 degree Celsius or 1.3 degrees Fahrenheit [1].

Global warming, due to unbalanced conditions, causes long summer days which increase drought time and makes fuel more combustible. This increases the probability of fire occurrence because warmer and drier conditions are conducive to widespread beetle and other insect infestations, resulting in broad ranges of dead combustible trees. In addition, decrease in fuel moisture content makes it easier to enter into thermos chemical decomposition at elevated temperatures in the absence of oxygen and the continual increase in carbon dioxide (pyrolysis).

Consequently, forest fire problem is not restricted to one country; but it is a global environmental problem that threatens vegetation cover and human life as well. Global statistical studies show that 12,908,461 ha, of forests were burned between the years 2003-2012 [2]. These scaring statistical studies urge to ring the bell of global danger.

Wildfires phenomena occur at the intersection of hot weather and dry fuel. Forest fires pose a serious threat to countries in the Mediterranean basin, often razing large areas of lands every year. Climate change, agriculture, urban developments are eroding biodiversity.

Lebanon is a part of Mediterranean; it is considered the gate to the East and West with an area of 10452 km². Also it is considered a national heritage, a fascinating landscape, and a recreation zone. Its location has made it a major destination for tourists from all over the world. Besides, it is rich in caves and in its mountains which are covered with different kinds of trees. Cedars and Pine trees are known in Lebanon since ancient times. Yet Lebanon has been facing a critical threat of losing its green fields.

Lebanon is divided into five regional administrative districts: Beirut, North Lebanon, South Lebanon, Beqaa and Nabatiyeh. The Lebanese weather is generally mild, in winter; it is cold and wet; while in summer season it is hot and dry. During the last several decades, green and forest areas have been in a continual decline in the country. More

than 70 forest fire incidents occur in Lebanon yearly [3]. Forest fire has caused the loss of many green acres in the past years. According to the statistical studies of Association for Forests, Development and Conservation (AFDC), less than 13% of Lebanon are forested now [4].

After holding several meetings with internal security forces and the associations that are concerned with environmental protection, two major factors are found to cause fire: the absence of environmental education in our society and the continual increase in temperature due to global warming.

Economically, Lebanese Republic depends on the environmental tourism as a main factor to increase the Lebanese treasury savings. Then the Lebanese Republic loses millions of dollars yearly caused by occurring forest fires. The predictions show that the deforestation will invade Lebanon in 2035 to change the geomorphology of Lebanese lands and destroy the whole biodiversity.



Fig. 1: Lebanese forest area map

The forested area in Lebanon is planted by various types: Pine, Cedar, Juniper, Oak, Beech, and Cypress [5]. These types are distributed in different regions which made of Lebanon a rich land in forest types. But these types lost hundreds of hectares in the last five years. The statistics of Lebanese Ministry of Environment are shown in Table 1.

Forest type	2009 (ha)	2010 (ha)	2011 (ha)	2012 (ha)	2013 (ha)	2014 (ha)
Oak	38000	36080	34900	34609	34287	33907
Pine	13058	12110	11303	10908	10703	10403
Juniper	11700	11200	10900	10303	10101	9780
Cedar	1650	1592	1380	1150	1090	980
Beech	1200	1119	932	908	809	704
Cypress	180	159	146	132	103	91
Total Forested Area	65788	62260	59561	58010	57093	55865

Table 1: The degradation of forest types during the years 2009-2014

The major problem of forest fires in Lebanon is the climate change. Consequently, as the climate becomes hotter and drier in summer seasons, fire risk occurrence probability increases. Fig. 2 views the effect of climate change on the number of forest fires in Lebanon.

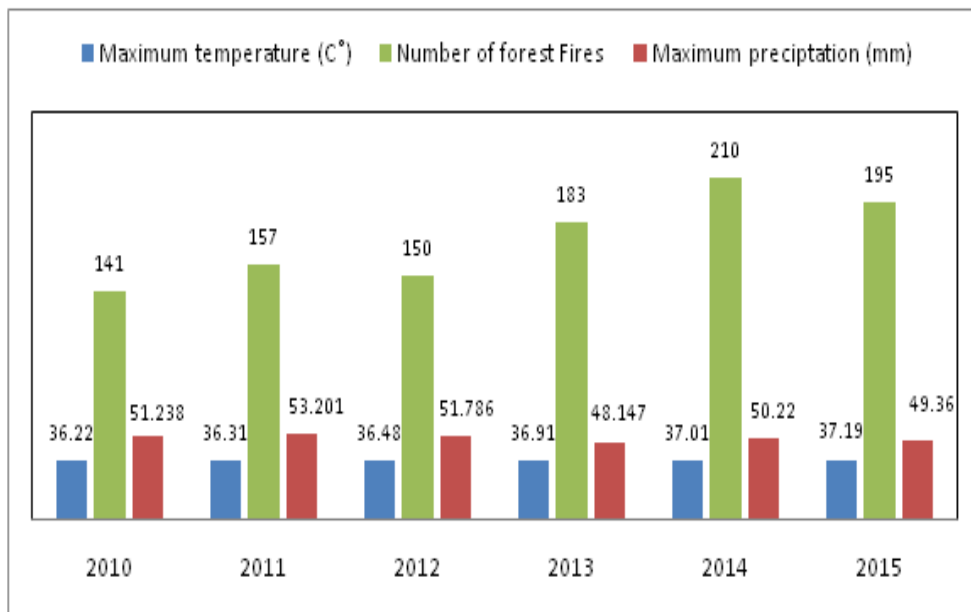

Fig. 2: Effect of Lebanese climate change on forest fire

Fig. 2 clearly shows the unceasing increase of the maximum temperature between the years of 2010-2015. In addition the continual decrease of maximum precipitation can lead to drought.

Dry season starts in the summer period from June till the end of September. During this period, no rain is recorded and a state of high pressure dominates the whole country, with a general tendency toward Northeast. In summer period, the occidental winds known by Khamsin from the Arabian Desert, brings with it dry and very hot air waves. When

temperature is high and precipitation is low in summer, forest fires very likely occur in Lebanon.

As we viewed, green areas declined dramatically during the last years in Lebanon; this fact imposes an urgent intervention of governmental policies and support of nongovernmental organizations. Forest fire prediction proves to contribute to the prevention of fire occurrence or, in worst cases, to reduction of fire catastrophic impacts on human lives, properties and green forestry. Lebanon lacks the minimum needed policy measures and management capacities to address a number of forest protection measures relative to fire management, including monitoring, prediction, readiness, prevention, suppression and restoration. This decline pushed the council of ministers to adopt the national executive and technical forest fire prevention with the corporation of AFDC, through decision number 118/2007 on June 11, 2007 [6]. This policy is based on 5 strategies: collecting data, risk modification, readiness, response to fire and recovery [7], [8]. But this strategy haven't adequately implemented, since Lebanon lacks logistical and material support. Moreover, this policy didn't take into account the prediction method of pre and post fire.

North Lebanon is one of the most affected places by forest fires. It is well known that fire control is difficult due to the high vegetation density. Besides it is a very hot zone in summer season; it is rich in high rates of genetic and diverse ecosystem represented by changes in types and structures as well as differences in living standards caused by discrepancies in livelihoods [9]. Documented records of fire occurrences show a continual increase in fire incidents; this fact imposes to conduct a new scientific research to tackle such intricate problem.

The lack of monitoring, the lack of documentation and the absence of reliable assessments of the damage and the effects obstruct decision-making in some cases. The reports of the Internal Security Forces indicated that 585 ha were burned in 2004, 440 ha in 2005 (resulting from 117 fires) and approximately 874 ha resulting from 144 fires during July war 2006.

Therefore the problem of forest fires in Lebanon is very complex and should not be addressed on the level of sectors only. It concerns all the perspectives related to forest management, prevention, suppression, and spreading fire management.

Actually many studies were done in order to manage fire occurrence in North Lebanon, but they didn't succeed to manage the phenomenon. Documented records of fire

occurrences show a continual increase in fire incidents; this fact imposes to conduct a new scientific research to tackle such intricate problem.

What we need today is to intensify efforts of governmental and non-governmental organizations, to find new scientific strategies to tackle the forest fire crises. Moreover Lebanese ministry should encourage and fund forest fire research in order to keep the Cedar tree, symbol on its flag, in its place.

1.2. Causes of forest fires

Forest fire is an exothermic reaction that requires an oxidizing agent to burn the fuel. This combustion reaction requires three main factors (Fuel, Oxygen and ignition) to occur. Fuel and oxygen factors are known as oxidizing agents in the atmosphere, while the ignition factor can be done by human or nature.

1.2.1. Human-induced fires

In Lebanon more than 75% of forest fires are caused by human activities for the following reasons [3]:

- ✓ The burning of herbs and shrubs: This often happens when some farmers collect dry weeds and small shrubs in piles, and then dispose them by burning. Volatile sparks issued by the burning act are unable to be controlled which results in devouring fire to different parts of forests.
- ✓ Oblivion and neglect: These are recurring reasons caused by the carelessness of the passers-by in nature by throwing cigarette butts which may cause massive fire occurrences.
- ✓ Camping: Hikers leave behind embers of burning coal used during their stay in camps or picnic without being fully amortized, it will re-ignite to make a new fire.
- ✓ Fireworks: This is uncontrollable in Lebanon because the Lebanese citizens celebrate in using fireworks in their celebrations without taking into consideration the dangers on health and nature at the same time.
- ✓ Voltage power lines: These are installed above Lebanese forested areas regardless of any consideration of the electromagnetic emission of the electric current which may cause the occurrence of fire in any green area.

1.2.2. Nature-made fires

Natural causes are considered to be a prime reason for forest fires. Here we mention some of them that are related to this research.

- ✓ Climate change: This is considered as a major cause of fire severity [10].
- ✓ Increase in temperature: This leads to drought which makes forests a fertile place for fire occurrence.
- ✓ Thunder and lightning: they do rarely cause fire ignition in Lebanon.
- ✓ Wind speed: Windy weather increases the diffusion of forest fire because of the increase in the amount of oxygen in air, and thus rapid combustion occurs.

1.2.3. Consequences of forest fires

Forest fire critical consequences are not only seen in our natural environment but they embrace the destiny of the human race. Fire occurrence is a real threat not only to Lebanon but also to the whole world. It is to be considered an international crisis facing man regardless of his nationality, color, or race.

1.2.4. Biodiversity elimination

Forest fires have caused the loss of biodiversity in Lebanon. Because of fire, hundreds of natural species and different varieties of wild plants and butterflies were eliminated. In addition, forest fires have led to the formation of a layer of sand that does not absorb rain and thus have caused erosion of rivers and canals.

1.2.5. Global warming

Forest fires release two billion tons of carbon dioxide, which leads to the increase in global warming. Thus the loss of hectares of green trees reduces the absorption of carbon dioxide in air. It could not be denied that forests help in climate mitigation and contribute to the absorption of sun rays in adjusting the temperature around.

1.2.6. Economical losses

The time needed for pine and cedar tree to flower is twenty five years. Each hectare of burned trees causes the loss of hundreds of dollars from the national treasury. This loss affects the national economy twice: the loss of trees and the cost of reforestation. In addition, forest fires leave its negative impact on agricultural areas and eco-touristic settings.

1.2.7. Soil erosion

Soil erosion is a serious agricultural and environmental problem that causes devastating results in landslides during rainfall period. Forests play an important role in preserving the soil by the roots of trees and thus help in the prevention of soil erosion in sustaining a stability and persistence of the soil. Whereas, the combustion of trees leads to the erosion and the loss of agricultural areas.

1.2.8. Human health

Forest fires release polluting particulate matter, carbon monoxide and oxides of nitrogen, sulphur dioxide and organic compounds. These pollutants have potentially detrimental health effects because they can penetrate deep into the evaporating system which led to asthma, cardiovascular and lung diseases. In addition Epidemiological studies showed that the forest fire gases increase the rate of cancer diseases during the rapid movement of particular matters in atmosphere [11].

1.3. Vegetation Cover in Lebanon

Lebanon geographical position and the great diversity of climatic conditions create a unique biodiversity in a very limited place. There are 9119 species of known species in Lebanon, almost equally divided between animals (4,486 species) and plants (4,633 species) according to the United Nations program.

Lebanon covers important components of the Mediterranean vegetation: Atlas Pistache, Bishop Pine, Black Oak and Cedar; which are relicts from the ancient forests that dominated the Mediterranean Basin two million years ago and represent the past and present climax of the country.

Lebanon Cedar has been exploited since the rise of civilization in the Fertile Crescent. While, Lebanon is known for its green forests which occupy 13%. More than 65% of the total canopy coverage is considered dense with the highest concentrations found in North Lebanon (30%) and Mount Lebanon (37%), followed by South Lebanon (9%) and Nabatieh (6%). Oak forests occupy the largest forests' surface areas (52.42%) while Cypress (0.15%) Cedar (0.83%) and Fir (1.76%) occupy the lowest cover areas [12]. In addition, mixed forests recorded 17.98% whilst the Pine forests 14.91% and the Juniper 8.74%. [13]

A fuel type has an important effect on fire occurrence and the direction of fire. In a collaborative framework between the Institute of Environmental Studies at the University of Balamand and Forestation Project in Lebanon in 2013: The Prometheus fuel type classification system, which is considered to be better adapted to the Mediterranean ecosystem, was adopted.

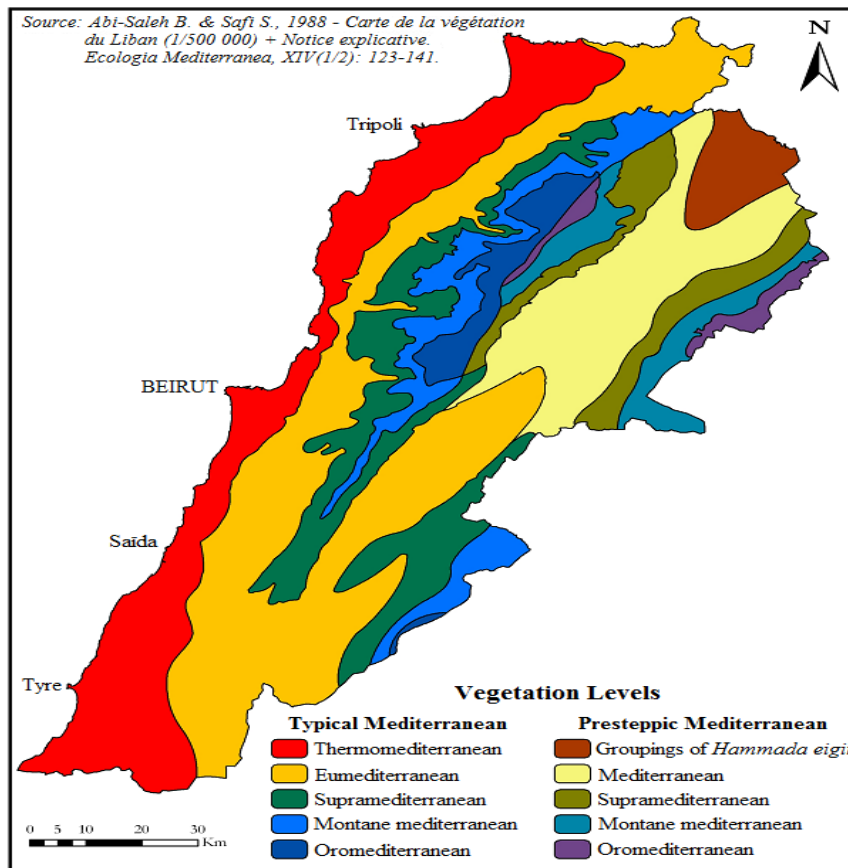

Fig. 3: Vegetation levels in Lebanon

This map complies, to a great extent, with National vegetation classification that stands out by as an evolving posteriori classification.

Vegetation levels In Lebanon	Dominant fuel types	Combustibility
Thermo-Mediterranean (0-500 m)	Grass	Extremely High
Eu-Mediterranean (500-1000m)	Grassland, shrubs, Oak, conifers.	Very high
Supra-Mediterranean (1000-1500m)	Grass and small shrubs	high
Montane-Mediterranean (1500-2000 m)	High shrubs, cedars, pines.	Medium
Oro- Mediterranean (>2000)	Cedars	Low

Table 2: Different vegetation levels and their description

After analyzing Fig. 3 and Table 2, it is clearly shown that Lebanon western chain has the most combustible vegetation types. Lebanon western chain is famous for its mountains of temperate climate in summer and bitter cold in winter. In addition a large and excellent precipitation varies from one season to another.



Fig. 4: Vegetation covers in Lebanon

1.4. Current policy in Lebanon

Further to AFDC, about 1,500 hectares of Lebanese woodland are affected by fires every year. Severe fires often lead to serious consequences. A shift is required towards more pandemic, inter-sectoral approaches to forest fire management in aspect, implementation, recovering and monitoring. The joined efforts between concerned ministries, donors and NGOs lead to the proposal of a forest fire fighting strategy and a reforestation plan in 2009. The forest fire management strategy has been adopted by the Council of Ministers, but unfortunately lacks necessary funds and resources for valid implementation. Regrettably, institutions of public sector do not have an allocated budget for risk reduction, as Lebanon is under large deficit and deficits are going higher; hence crisis risk reduction is not a governmental priority. Particular initiatives could work in this regard but couldn't solely fill the void. AFDC has launched a project to plant one million trees as a part of the strategy of both Ministry of Environment and Ministry of Agriculture to increase Lebanon's green areas from 13 to 20%, supported by the private sector. In the last decade, the Civil Defense and through the cooperation of Active NGOs (AFDC and others) and the CNRS-Remote Sensing conducted various projects for mapping forest fires risk potentiality and building relevant geo-database. The UNDP also supported a national media campaign that aims to raise awareness on forest fires and the significance of taking actions to reduce risks through the Disaster Risk Management Unit. The campaign is a joint partnership with the Ministry of Interior, Ministry of Agriculture, and Ministry of Environment, AFDC, USAID and others.

The Civil defense in corporation with CIMA Research Foundation, founded by the Italian Civil Protection Department, provides municipalities, farmers and related Ministries with a set of tools for fire hazard mapping, fire danger early warning system and diffusion model useful to manage a fire risk. RISICO model has been implemented in Lebanon since 2011 enabling local civil defense to issue a daily bulletin for the prediction and prevention of forest and rural fires. The system RISICO is being updated using near-real time satellite imagery based data in cooperation with the CNRS-Remote Sensing Center [12].

The RISICO provides Italian Civil Protection Department (DPC) with daily wildland fire risk forecast maps of the entire Italian territory since 2003. The RISICO system comprises a complex software architecture relying on a framework able to conduct geo-spatial and temporal information like real time weather observations and satellite data. Semi-physical models are implemented within the model taking into account the variability of the fuel moisture content. This factor is the most influential on the ignition of a fire. Relying on this parameter and benefiting from parameters of topography, vegetation and wind, the model generates the rate of spread and linear intensity of a potential fire caused by accidental or intentional ignition. The model outputs are represented in a GIS environment. Some improvements have been made to the model's structure and functionality in 2007. In order to validate the RISICO system, a data set of more than 11000 wildland fires that took place in Italy in the years 2007-2008 has been considered. The system effectiveness relevant to the capability of identifying the correct danger classes with reference to the extension and duration of the fire has been tested and it is found that the model is able to integrate the main fire danger indexes present in Literature and thus providing an appropriate tool for identifying the different indexes in different territorial and climatic conditions. RISICO serves to be used as an integrated approach to wildland fires management both during the phases of prevention and firefighting.

The RISICO system has been used by Civil Defense in Lebanon to develop the fire risk bulletin that aims to inform involved parties about Likelihood of a fire occurring in a particular area. The fire risk alert is the result of the hard labor and collaboration between the Italian Cooperation, CIMA foundation and local Lebanese partners such as the civil defense, LARI, the Shouf Cedar Nature Reserve and AFDC. The bulletin relies on static and dynamic information to give daily predictions of Likelihood of forest fire occurrence in any given Lebanese locality. Static data includes the land topography, soil type, land cover, elevation, etc. whereas dynamic data includes changing weather patterns such as precipitation, wind speed, temperature, cloud cover, etc. The bulletin started as a general

alert system lacking the fine-tuning needed to organize efforts on local-municipal level. Later on, the alert was refined and developed into an easy tool with clear representation of the color legend. The refined version allows each municipality and local Civil Defense center to coordinate efforts in case of high fire risk.

1.5. The obstacles that led to the failure of this policy

The fire danger index is obtained as the weighted average of FWI where a long and complicated algorithm is followed to estimate the output. Unfortunately, the obtained index was not calibrated by the Italian representatives in Lebanon because of the lack of opportunities to monitor and report fire accidents occurring in Lebanon. For this reason the same thresholds calibrated in Italy were applied. The Italian thresholds were defined on the basis of the fires occurred in Italy in the period 2007-2011.

This leads to being overestimated upon application in Lebanon. Thus the bulletin cannot be considered as the optimal index for Lebanon.

1.6. Proposed actions for policy makers

- ✓ Environmental awareness before anything.
- ✓ Taking into consideration the different weather conditions between Lebanese countries.
- ✓ Developing simple scientific policy that can use between Lebanese people
- ✓ Using Data for policy purpose includes relevant official documents and interviews conducted with key government officials.
- ✓ Prevention policies should be cross-sectorial obliging coordination between all parties in Lebanon.
- ✓ Translating the policy into law to be considered a success by Lebanese people.
- ✓ Scientific research should prompt better insights of fire causes and should analyze existing prevention actions to develop new prevention methodologies.
- ✓ Legal aspects should be illuminated and improved through the enhancement of motivations and commitments concerning wildfire preventive actions.
- ✓ Definition of wildfire risk areas taking into account the fire incidence, fuels, value of forests, protected areas, forest-urban interfaces and forest ownership.

1.7. Thesis objectives

Forest fires numbers increase day after day which leads to catastrophic results on human life and biodiversity. The main objective of this study is to prevent our forests from fire disasters. The importance of this study is to put new scientific rules using new methodologies in prediction of pre and post forest fires.

1.7.1. Pre-forest fire

Recent initiative studies showed that different data mining techniques methods recorded high accuracy in forest fire prediction which led us to apply various data mining methods to predict forest fires in Lebanon and then make a comparative study in order to find the best accurate technique based on meteorological factors in forecasting forest fire before occurrence.

In addition, a new mathematical model with fire potential scale was proposed to reduce forest fires occurrences. An overall outlook has been first made on the most powerful and influential meteorological indices. The area and data under scope are then described. Thereafter data analysis techniques are used to identify the most affecting attributes on fire occurrence and derive the equation of the new Mediterranean index. The performance of the obtained model is tested afterwards.

1.7.2. Post-forest fire

As we know, forest fire is uncontrollable fire after occurring. For this reason we applied a new methodology in predicting the optimal fire suppression measures. Our proposed model studies the spread mechanism of forest fires in Lebanon and the Mediterranean. It uses cellular automata (CA) to demonstrate fire spreads using different affecting attributes: vegetation, topography and meteorological parameters. This methodology helps fire fighters to predict the spread of fire and manage it before destroying other green acres and houses.

1.8. Thesis structure

Our work is subdivided into two major parts. In the first part, there are two main topics: prediction of forest fire using different data mining techniques methods (Neural Networks, Support Vector Machine, Linear Discriminate analysis, Decision Tree and Fuzzy logic); and proposal of a new mathematical model to predict forest fire in Lebanon and Mediterranean based on meteorological data analysis.

In the second part, cellular automata model based on influencing factors is applied, to find a new fire spread model with elliptical basis to predict forest fire behavior using

different attributes that affect fire behavior and validate this model over a real fire case from Lebanon.

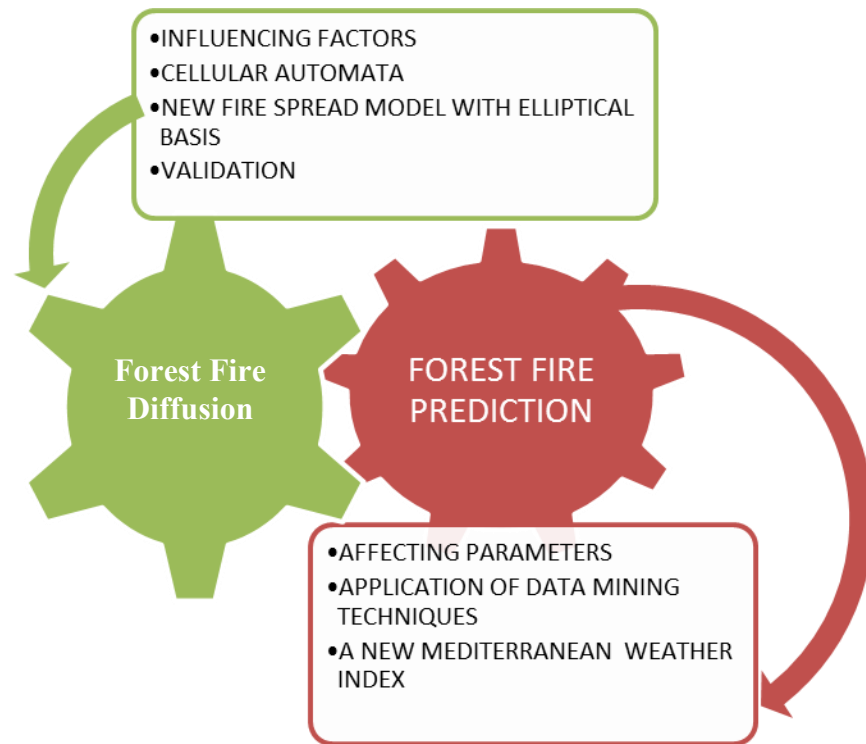

Fig. 5: Thesis structure

References of chapter 1

[1]M.Venkataramanan and Smitha, "Causes and effects of global warming", Indian Journal of Science and Technology, Vol:4(3), pp, 226-229, 2001

[2]P.vanLierop, E.Lindquist, S.Sathyapala, G.Franceschini. "Global forest area disturbance from fire, insect pests, diseases and severe weather events", Forest Ecology and Management journal Vol. 352, PP. 78–88, 2015

[3]State of Lebanon's wildfire in 2010, Ecosystems at the Ministry of Environment and the Biodiversity Program at the Institute of the Environment, University of Balamand", 2015

[4]AFDC, ICN, MoE, MoA & MoIM, "Lebanon's National Forest Fire Management Strategy-Second Draft",December 2008

[5]M.Mhaweja, G.Faour, C.Abdallah, J.Adjizian, "Towards an establishment of a wildfire risk system in a Mediterranean country",Ecological Informatics, Vol.32 ,PP.167-184, 2016

[6]E.Knusten, Civil defense extinguish a forest fire in Betshai, The Daily Star newspaper, May 2014

[7]Issam Fares Institute for Public Policy and International Affairs, "A Case Study on Lebanon's National Strategy for Forest Fire Management", 2011

[8]Republic of Lebanon, Ministry of Environment, "Lebanon's Second National Communication to the United Nations Framework Convention on Climate Change", Beirut, February, 2011

[9]R.El-Hajj and C.Khater, Environmental Mapping and Preliminary Ecological Vulnerability Assessment of the Upper Akkar Watershed, Lebanon, Search Partnership for Social, Ecological and Agricultural Resilience in the Face of Climate Change (Mada/SPNL/IUCN/EU), Beirut, Lebanon, 2011

[10]MD.Flannigan, CE.VanWagner, "Climate Change and wildfire in Canada. Canadian Journal of Forest Research", Vol: 21, PP, 66 - 72. 1991

[11]C.A.Pope, R.Burnett ,M.Thun, E.Calle, D.Krewski, K.Ito and GD.hurston, "Lung cancer, cardiopulmonary mortality, and long-term exposure to fine particulate air pollution" JAMA, 287, pp. 1132–41, 2002

[12]M.Andrea, Paolo.F, F.Gaetani and D.Negro, "RISICO: A decision support system (DSS) for dynamic wildfire risk evaluation in Italy", Geophysical Research Abstracts,Vol.12, EGU2010-11102-1,2010,EGU General Assembly 2010

[13]G.Ramadan, A.yaacoub, G.Haroutunian, G.Akl, L.Smaha, M.Abboud and R.Kanj, "Biodiversity and Forests" State and Trends of the Lebanese Environment,Vol:5, pp,150-160 2010

Part 2: New Approaches in Forest Fire Prediction

Résumé

Au début du 20ème siècle, les scientifiques ont commencé à développer des modèles mathématiques pour prédire la probabilité d'occurrence des incendies de forêt. Les

paramètres météorologiques, comme la température et l'humidité quotidienne ont été principalement utilisés. Dans ce chapitre nous avons révisé les neuf indices de prévision des incendies les plus utilisables dans le monde qui sont Angstrom, Keetch-Byram, Keetch-Byram Modifié, indice de feu météorologique Canadien, Nesterov, Nesterov Modifié, Macarthur, FD et indice de Baumgartner. Une étude comparative, y compris les équations mathématiques, les propriétés, les caractéristiques, la performance et le champ d'application de chaque modèle est présentée. Les différents modèles développés ont été optimisés pour les caractéristiques locales du lieu d'étude. La problématique de la pertinence et de la conformité des indices est discutée dans d'autres régions avec des conditions différentes.

Récemment, l'initiative des études dans la prédiction des incendies ont été transférées aux techniques d'exploration de données après avoir enregistré une grande précision dans la prédiction d'incendie; où ces modèles évitent la complexité entre les facteurs météorologiques et les accidents d'incendie.

Aujourd'hui, les scientifiques s'intéressent aux méthodes de techniques d'exploration de données après l'enregistrement d'un haut degré de précision dans la prédiction des phénomènes complexes.

Ce chapitre présente un aperçu sur les opportunités intéressantes et les défis en développant et appliquant les techniques de l'extraction de données dans différents domaines.

Le but de cette étude est de prédire les incendies de forêt dans le nord du Liban, afin de réduire la fréquence des incendies sur la base de 4 paramètres météorologiques (température, humidité, précipitations et vitesse du vent) en utilisant différentes techniques d'exploration de données: Les réseaux de neurones, arbres de décision (J48), logique floue, analyse discriminante linéaire (LDA) et la machine à vecteurs de support (SVM). Une étude comparative a ensuite été faite pour trouver la technique la plus performante pour aider à gérer une telle crise naturelle. C'est avec un arbre de décision (J48) que nous avons enregistré la meilleure précision dans la prévision des feux de forêt (97,8%).

La prévention est considérée comme l'un des outils essentiels pour combattre le danger de l'incendie de forêt. Cela est en particulier appliqué dans les pays en développement où la suppression du feu est peu abordable. Dans cette partie, pour que le mécanisme de prévention ait lieu, nous nous appuyons sur des analyses pour construire un nouvel modèle d'indice de danger d'incendie qui prédit le risque de développement de l'incendie au nord du Liban.

Nous utilisons des méthodes de corrélation telle que la régression statistique, les index de Pearson, de Spearman et le Taux de Kendall pour identifier la plupart des paramètres ayant un effet sur l'allumage du feu au cours des six dernières années dans le nord du Liban. Les corrélations de ces attributs avec la fréquence des incendies sont étudiées afin de développer l'indice de danger d'incendie. Ensuite, la dérivation des attributs est fortement corrélée. Nous comptons sur la régression linéaire pour modéliser l'indice d'incendie en fonction d'un ensemble de paramètres météorologiques réduits qui sont faciles à mesurer. Cela est essentiel car il facilite l'application de ces modèles de prévention dans les pays en développement comme le Liban. Les résultats obtenus de validation de l'indice proposé montrent des performances élevées dans les régions libanaises. Nous sommes convaincus que cet indice permettra d'améliorer la capacité des mesures de prévention des incendies dans la zone du bassin méditerranéen.

Abstract

At the beginning of the 20th century, scientists began to develop mathematical models in order to predict the probability of occurrence of forest fires. Meteorological parameters, such as daily temperature and humidity, were used. In this chapter, we focus on the widely used weather indices for the fire predictions in the world, including Angstrom, Keetch-Byram, Modified Keetch- Byram, Canadian fire weather index, Nesterov, Modified

Netserov, Macarthur, FD and Baumgartner Index. A comparative study including the mathematical equations, properties, characteristics, performance and field of application of each model is presented. Different models were developed and optimized to find the most convenient in the place of study complying with its local characteristics. In contrast, different conditions in another areas show problems of finding suitable indices. Recently, initiative studies in the wildfire prediction were shifted to data mining techniques after recording high accuracy in the fire prediction; where these models avoid complexity between meteorological factors and fire accidents.

Now a day scientists interested in data mining techniques methods after recording high accuracy in prediction complex phenomena. This chapter presents an overview of the exciting opportunities and challenges in developing and applying data mining techniques in different fields. The goal of this study is to predict forest fires in North Lebanon in order to reduce fire occurrence based on 4 meteorological parameters (Temperature, Humidity, Precipitation and Wind speed) using different data mining techniques: Neural networks, decision tree (J48), fuzzy logic, linear discriminant analysis (LDA) and support vector machine (SVM). A comparative study was then made to find the best performing technique tending to manage such a natural crisis. Decision tree (J48) recorded the best accuracy in forest fire prediction (97.8%) while SVM registered the lowest accuracy in predicting forest fire (68.4%).

Prevention is considered as one of the very essential tools to tackle forest fire danger. This is especially true in developing countries where fire suppression cannot be affordable. In this part, to enable a prevention mechanism, we rely on analytics to build a novel fire danger index model that predicts the risk of a developing fire in north Lebanon. We use correlation methods such as statistical regression, Pearson, Spearman and Kendall's Tau correlation to identify the most affecting parameters on fire ignition during the last six years in north Lebanon. The correlations of these attributes with fire occurrence are studied in order to develop the fire danger index. The strongly correlated attributes are then derived. We rely on linear regression to model the fire index as function of a reduced set of weather parameters that are easy to measure. This is critical as it facilitates the application of such prevention models in developing countries like Lebanon. The outcomes resulting from validation tests of the proposed index show high performance in the Lebanese regions. It is strongly believed that this index will help improve the ability of fire prevention measures in the Mediterranean basin area.

Chapter 2: Analytical Review on the Most widely Used Metrological Models

2.1. Introduction

The numbers of fire incidents have been increasing rapidly in different areas around the world, where millions of hectares of green areas have burnt in the last decades, which

affected both health and livelihoods of thousands of people. This also leads to lose millions of dollars. Thus, forest fire remains a critical dangerous problem facing our life nowadays.

Wildland fire is a result of chemical reaction occurring between three important factors: fuel, heat, and oxygen. The presence of all of the three factors together is necessary for the fire occurrence. The fire triangle below shows the correlation between these factors.

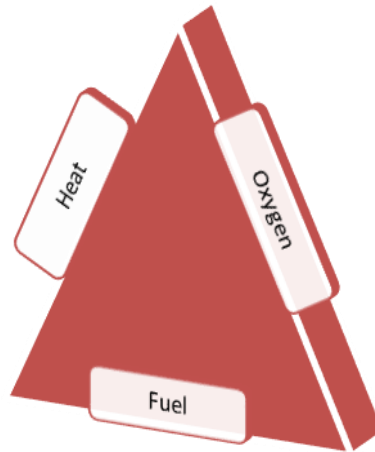

Fig. 6: Fire Triangle

During the combustion reaction, the fuel is transformed into combustible gases that leads to a pyrolysis process. During pyrolysis, the fuel starts to lose its moisture content that makes it quick combustible with the neighbor fire spots. The out coming heat energy produces combustible fuel in turn, which then combusts to produce more and more heat.

In the last decades, scientists focused on both the meteorological factors and historical data to predict the danger of fire occurrence, since a strong correlation was found between meteorological factors and fire occurrence. Forest fires are greatly affected by weather conditions especially in summer season where the fuel moisture is reduced to its minimal rates due to high temperature and low air humidity [1]. In addition; weather parameters are organized in specific meteorological fire danger indices in order to estimate the fire occurrence with the interval of time. It is well known that the combination between high temperature and drought conditions raises the risk of forest fire; therefore climate appears to have a direct impact on the frequency of forest fire.

Fire danger rating system which is based on meteorological data becomes more precise when it uses the weather forecast of the previous evening or previous day [2]. Also it warns the forest owners in advance from the high fire risk and thus appropriate readiness measures could be taken to permit the fire outbreaks.

Calculation methods often lead to a numerical index that is translated as a level of alarm which rises with the increase in likelihood of fire occurrence conditions. Over the past decades, a variety of fire-risk rating systems relying on various meteorological variables have been arisen in different locations, such as the Keetch-Bayram, Modified Keetch-Bayram, Nesterov, Modified Nesterov, Angstrom, Baumgartner McArthur, Canadian weather index, simple fire danger index and fire danger index (FD).

In this chapter we review the most usable indices in forest fire prediction. These fire risk indices are reflected by vegetation fuel, water status, and atmospheric dryness. In addition, suitability problem of indices under different weather conditions is also discussed. For this reason a comparative study were done to find similarities and differences between forest fire indices. Finally the recent initiative studies on the forest fire prediction models and their validity in different countries are presented.

2.2. Literature review on widely used weather fire indices

Fire danger rating is a fire management system that integrates the facets of selected fire danger factors into one or more qualitative or numerical indices of current protection needed [3]. These systems are used by fire and land management agencies to determine levels of preparedness, to issue public warnings and to provide an appropriate scale for management, research and laws for fire related matters. Most fire indices are based on empirical models and are therefore adequate only for the specific type of climate or vegetation where they developed. Transferring fire indices from one region to another can be critical in some situations and has to be undertaken with caution.

All these systems which integrate weather variables to assess fire danger are calculated as a numerical index. They have the ability of providing quantitative estimation for the possibility of a forest fire incidence. And they also allow taking precautions that contribute in preventing fire occurrence or reduce its consequences in worst cases.

Fire danger ratings are typical reflectors of the general conditions over an extended area affecting an initiating fire. These ratings are developed in such a way they can be used as a guide for the future decisions that might be subjected to the limits of the forecasting system.

This study shows the most useful indices over the world. The aim of this part is to find the similarities and differences between parameters, place of studies, accuracy, validity of indices and newest studies in forest fire prediction field.

2.1.1. Angstrom index

Angstrom index was developed in Sweden in the first half of the twentieth century to predict forest fire before occurrence [4]. It is based on relative humidity and air temperature only. It provides an indication of the likely number of fires on any given day [3]. The mathematical equation is given below:

$$I = \frac{R}{20} + \frac{27-T}{10} \quad (2.1)$$

Where R is the relative humidity (%), T is the air temperature (°C).

Angstrom presented his potential scale divided into 5 danger levels as shown in Table.3

Fire Risk Index (I)	Risk Of Forest Fire
I>4.0	Fire occurrence unlikely
4.0<I<3.0	Occurrence unfavorable
3.0<I<2.5	Fire conditions favorable
2.5<I<2.0	Fire conditions more favorable
I<2.0	Fire occurrence very likely

Table 3: Angstrom fire potential scale

2.1.2. Nesterov Index

Nesterov, 1949, created an empirical drought Index to be used in the former Soviet Union and then to establish a range of discrete fire-risk levels [5]. The Nesterov index of ignition is based on the difference between temperature and dew point, and is weighted by temperature. Other variables such as wind speed or daily humidity are not taken in consideration in this model. The index is based on a simple mathematical model that is the weighed difference between temperature and dew point, as given in the following equation:

$$N = \sum_{i=1}^w T_i(T_i - D_i) \quad (2.2)$$

Where N is the Nesterov Index, w is the number of days since last rainfall greater than 3 mm, T_i is the mid-day temperature (°C) and D_i is dew point temperature (°C).

Nesterov divided fire danger potential scale into 5 danger levels as shown in Table 4.

Nesterov (N)	Risk Of Fire
--------------	--------------

$N \leq 300$	No fire risk
$301 \leq N \leq 1.000$	Low risk
$1.001 \leq N < 4.000$	Medium risk
$4.001 \leq N \leq 10.000$	High risk
$N \geq 10.001$	Extremely risk

Table 4: Nesterov

fire potential scale

2.1.3. Modified Nesterov Index

The Modified Nesterov index was developed in 1952, it is also known as drought index [6]. The index is widely used in the Russian fire rating system together with the Nesterov index by taking the reduction factor (K) into consideration. The mathematical equation is given as follows:

$$MNI = K \sum_{i=1}^w Ti(Ti - Di) \quad (2.3)$$

Where K, representing an indication of rain quantity takes the values of the Table below, in dependence of the current rainfall; its range is listed in Table 5.

R(mm)	0	0.1-0.9	1.0-2.9	3.0-5.9	6.0-14.9	15.0-19.0	>19
K	1	0.8	0.6	0.4	0.2	0.1	0

Table 5: K-Value in Function of Rain Quantity

The Fire Risk level is classified using the following potential scale:

Modified Nesterov	Risk Of Fire
$100 < MN < 1000$	No fire risk
$1001 < MN < 2500$	Low risk
$2501 < MN < 5000$	Medium risk
$5.001 < MN < 10.000$	High risk
$MN > 10.000$	Extremely risk

Table 6: Modified Nesterov Fire Potential Scale

2.1.4. Baumgartner Index

The Baumgartner Index, developed in 1967, was in use in West Germany until unification [7]. It is based on the amount of precipitation and the potential evapotranspiration [4].

It is calculated as follows:

$$BI = P - PE \quad (\text{Sum of 5 days}) \quad (2.4)$$

Where P is the precipitation (mm) and PE is the potential evapotranspiration (mm). The fire potential scale of Baumgartner index is given in Table 7. It is divided into five different classes that classifies fire risk in increasing order of danger (Table 7).

Fire danger classes/Month (mm)	1	2	3	4	5
March	+5>	[+5,-3]	[-3,-9]	[-9,-15]	-15[
April	+3>	[+3,-8]	[-8,-16]	[-16,-27]	-27[
May	-3>	[-3,-16]	[-16,-25]	[-25,-35]	-35[
June	-12>	[-12,-24]	[-24,-32]	[-32,-41]	-41[
July	-12>	[-12,-24]	[-24,-31]	[-31,-40]	-40[
August	-8>	[-8,-20]	[-20,-28]	[-28,-37]	-37[
September	-6>	[-6,-18]	[-18,-26]	[-26,-35]	-35[
October	-6>	[-6,-18]	[-18,-26]	[-26,-35]	-35[

Table 7: Baumgartner Fire Potential Scale

2.1.5. KeetchByram Drought Index

John Keetch and George Byram created a fire prediction model for the United States Department of Agriculture's Forest Service in 1968. The KBDI model measured the likelihood of wild fire occurrence based on soil upper layer measurements. The goal of this drought index is to provide fire control managers with a continuous scale of reference for estimating deep drying conditions in areas, where such information may be useful in planning forest fire operations. The KBDI is a measure of meteorological drought; it reflects water gain or loss within the soil. Keetch and Byram had put a range of drought where a value of 800 represents the extreme dry conditions [8]. Drought index is defined as a number representing the net effect of evapotranspiration and precipitation in producing cumulative moisture deficiency in or upper soil layers. The mathematical model of KBDI is defined by the following equation:

$$KBDI_t = KBDI_{t-1} + DF \quad (2.5)$$

While the drought factor DF could be calculated using the following:

$$DF = \frac{[800 - KBDI_{t-1}] [0.968e^{(0.0875T + 1.5552)} - 8.30] dt}{1 + 10.88e^{(-0.001736R)}} 10^{-3} \quad (2.6)$$

T is the daily maximum temperature (C°), R is the mean annual rainfall (mm), dt is the time increment (days) and $KBDI_{t-1}$ is the Keetch-Byram Drought index for time (t-1). Daily precipitation decreases the KBDI when the total of precipitation measured over 24 hours is greater than 5 mm (0.2 inches). KBDI fire danger potential scale is divided into 5 danger levels as shown in Table 8.

KBDI Range	General Description	Forest Fire Potential
0 -150	Upper soil and surface litter are wet.	No fire risk
150 -300	Upper soil and surface litter are moist and does not contribute to fire intensity	Low risk
300 -500	Upper soil and surface litter are dry and may contribute to fire intensity.	Medium risk
500 -700	Upper soil and surface litter are very dry. Surface litter and organic soil material contribute to fire intensity.	High risk
700 -800	Upper soil and surface litter are extremely dry. Live understory vegetation burns actively and contributes to fire potential.	Extremely risk

Table 8: KBDI Fire Potential Scale

2.1.6. Canadian Forest Fire Weather Index (FWI)

The Canadian Forest Fire Weather Index (FWI) was issued in 1970. It uses four meteorological parameters: noon relative humidity; noon temperature; precipitation during 24h and the maximum speed of the average wind. The FWI System is comprised of six components: three fuel moisture codes (Fine fuel moisture code, Duff Moisture code & Drought code) and three fire behavior indices (Initial spread index, Buildup index & Fire weather index) as shown in Fig. 7 [10].

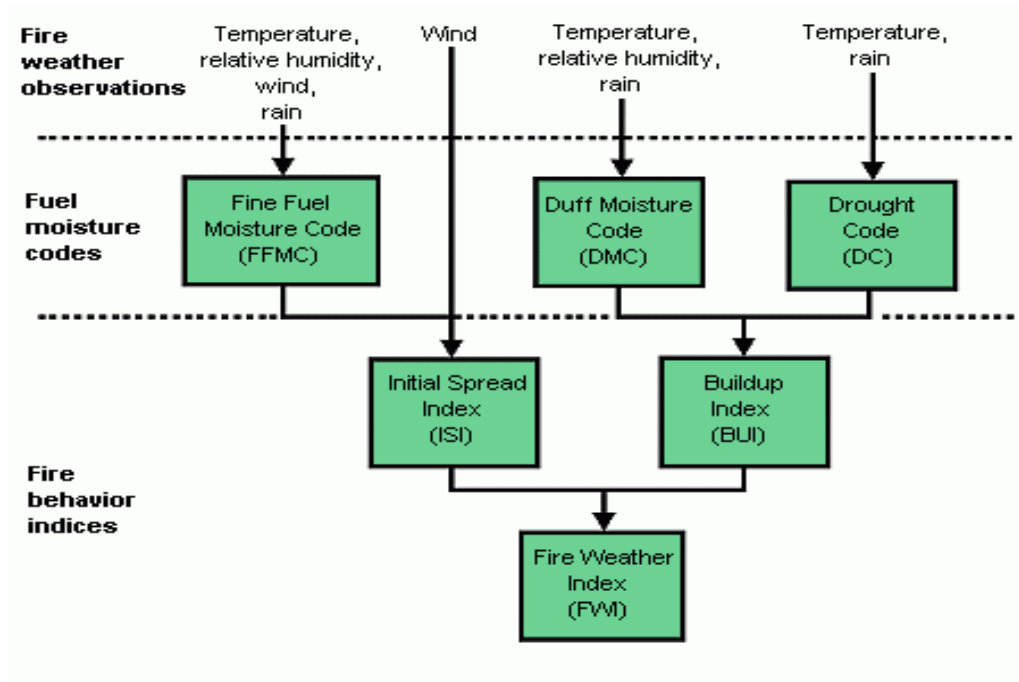

Fig. 7: Structure of the Canadian forest fire weather index system

Each component has a convenient scale, but the original scale of each was found to be not uniform across Canada [9]. Thus a new index was then developed for each that is to obtain a uniform national scale.

To calculate the Canadian fire index we shall find the duff moisture function as follows:

$$f(D) = 0.626U^{0.809} + 2 \quad (2.7)$$

Where $f(D)$ the duff moisture function and U is the Buildup index .

$$B = 0.1R f(D) \quad (2.8)$$

Where B is the intermediate form of FWI, R is Initial Spread Index.

Final form S of FWI can be calculated as follows:

$$\ln S = 2.72[0.434 \ln B]^{0.647} \text{ if } B > 1 \quad (2.9)$$

$$S = B \text{ if } B \leq 1 \quad (2.10)$$

FWI values 0-5 indicates low fire danger and values in excess of 22 extreme fire dangers.

The risk level is stated in Table 9.

FWI range	Forest Fire Potential
[0, 1.0]	Fire occurrence very low
]1.0 , 4.0]	Fire occurrence unlikely
]4.0 , 8.0]	Fire occurrence unfavorable
]8.0 , 16.0]	Fire conditions favorable
]16.0 , 29.0]	Fire conditions more favorable
<29.0	Fire occurrence very likely

Table 9: The Fire Potential Scale of FWI

2.1.7. McArthur Forest Fire Danger Index (FFDI)

Forest fire danger index (FFDI) was developed in the 1970s by A.G. McArthur to measure the degree of danger of fire in Australian forests [10]. It indicates the probability of a fire ignition and its rate of spread. It was originally defined in the late-1960 to assist foresters to relate the weather to the associated fire danger. McArthur index is relatively more sensitive to temperature and humidity, and less sensitive to wind speed and rainfall, than the Canadian Fire Weather Index.

The mathematical equations are given as follows:

$$FFDI = 2e^{(-0.45+0.978 \ln(DF)-0.0345RH+0.0338T+0.0234U)} \quad (2.11)$$

Where T is the temperature ($^{\circ}$ C), U is the wind speed (km/h), RH is the relative humidity (%) and DF is the drought factor.

The Drought factor is a measure of moisture in the fuel which is affected by rains and number of days since last rain.

Drought factor can be calculated from the following equation:

$$DF = \frac{[0.191(I+104)(N+1)^{1.5}]}{3.52(N+1)^{1.5}+R-1} \quad (2.12)$$

Where N is the number of days since last rain fall, R is the total rain in the last 24 hours (mm) and I is the amount of rain needed to restore soil moisture to (200mm).

FFDI fire danger potential scale is divided into 6 danger levels as shown in Table 10.

Forest Fire Danger Index(FFDI)	Risk Of Fire
Catastrophic	100+
Extreme	75-99
Severe	50-74
Very High	25-49
High	12-24
Low to Moderate	0-11

Table 10: FFDI Fire Potential Scale

2.1.8. Simple Fire Danger Index (F)

Sharples et al, developed Simple fire danger index (F) in Australia. Fire danger rating systems combine meteorological information with estimates of the moisture content of the fuel to produce a fire danger index [11]. This index calculated as follows:

$$F = \frac{\max(U_0, U)}{FMI} \quad (2.13)$$

U denotes wind speed in km/h and U₀ is some threshold wind speed introduced to ensure that fire danger rating is greater than zero. FMI is the fuel moisture index calculated as follows:

$$FMI = 10 - 0.25(T - H) \quad (2.14)$$

Where T is the temperature (°C) and H is the relative humidity (%). Simple Fire Danger Index (F) divided danger scale into 5 danger levels as shown in Table 11.

Simple Fire Danger Index(F)	Fire Risk
[0 , 0.7]	Low
[0.7 , 1.5]	Moderate
[1.5 , 2.7]	High
[2.7 , 6.1]	Very High
I>7	Extreme

Table 11: Simple fire danger (F) potential scale

2.1.9. Modified Keetch-Byram Drought Index.

Previous research has indicated that KBDI is not a good indicator to predict forest fire in USA -Georgia and Mississippi [12] [13] [14].

Then it has been necessary for an improvement to be made on this model. The improvement was proposed by Petros et al, for use in the Mediterranean conditions after

taking into account the annual rainfall parameter in this region as shown in equation (15) [15][16].

$$DF = \frac{[200 - KBDI_{t-1}][1.713e^{(0.0875T+1.5552)} - 14.59]dt}{1 + 10.88e^{(-0.001736R)}} * 10^{-3} \quad (2.15)$$

By setting the threshold R to 3 (mm), the modified Keetch-Byram equation is obtained:

$$\text{Mod KBDI} = \text{ModKBDI}_{t-1} + DF - (R - 3) \quad (2.16)$$

2.1.10. Fire danger index (FD)

(Martin et al, 2014) proposed a new fire danger index related to Czech Republic to predict forest fire danger [17]. This fire danger index is based on combination between meteorological information and soil moisture.

This index has been activated from 15th of March to 15th of October, calculated as follows:

$$FD = \frac{(b1U - b2F)}{(b3T - b4H)} \quad (2.17)$$

Where T the air temperature in (°C), H the air humidity (%), U is the wind speed in m/s, F is the soil moisture (%), and b1, b2, b3, b4 are the error coefficient for each founded parameter .

The fire danger potential scale of Simple Fire Danger Index (FD) is divided into 5 danger levels as shown in Table 12.

FD Range	Fire Danger Classes
Very Low	< 0.9
Low	0.9 - 1.7
Moderate	1.7 - 3.0
High	3.0 - 6.0
Very High	≥ 6.0

Table 12: FD Fire Potential Scale

2.3. Comparative study between classical models

Forest fire indices play an important role in evaluating regional fire risk potential over time. They have the ability of providing quantitative estimates on the possibility of a forest fire incidence.

Many efforts have been put into finding the best fire danger indices for particular regions. Their construction varies widely from one index to another, reflecting different underlying approaches. Several indices were adopted by places and rejected by other places according to the accuracy in prediction of forest fires.

2.3.1. Meteorological parameters and places of studies

Many studies show that there is a high relationship between fire occurrence and meteorological factors. Meteorology is the science of the atmosphere and study of the characteristics of the weather elements and meteorological conditions including certain meteorological parameters like temperature, drought, wind speed etc. Each place are affected by different meteorological factors.

Fire regimes are strongly related to weather conditions that directly and indirectly influence fire ignition. This led researchers in forest fire to build their indices on different meteorological parameters, to forecast forest fire in their countries.

The specificity of the conditions, for which fire danger indices are developed, makes their practical adoption problematic in areas with different conditions. On the other hand, the adoption of existing fire danger rating systems could be felicitous in a new area of application and serves to decrease the time and the costs involved in developing a rating approach.

Indices	T	H	R	D	P	E	N	U	S	Place of study	Climate characteristics
KBDI	•		•							Southern United States	Hot and dry weather in summer with high humidity
M-KBDI	•		•				•			Greece	Mediterranean weather (Mild)
Nesterov	•			•						Russia	Polar Climate, high humidity
M-Nesterov	•			•			•			Russia	Polar Climate, high humidity
Angstrom	•	•								Sweden	Polar Climate, high precipitation and humidity
Baumgartner					•	•				Germany	High precipitation cold and cloudy weather in winter
Canadian Index	•	•			•					Western Canada	Wet and high precipitation in summer , very cold in winter

McArthur	•	•										Australia	High precipitation and high humidity in summer and high wind speed
Simple Fire danger index		•										Australia	High precipitation and high humidity in summer and high wind speed
Fire danger index (FD)	•	•										Czech Republic	Warm and dry in summer , cold in winter with high wind speed

T: Temperature; H: Relative Humidity; R: Mean Annual Rain Fall; D: Dew Point; P: Precipitation; E: Potential Evapo-transpiration; N: Number of days since last rain fall; U: wind Speed; S: Soil moisture

Table 13: Meteorological parameters used in fire indices and climate characteristics in their countries of origin

Upon analyzing Table 13, we can deduce that air temperature, relative humidity and wind speed have been used as inputs in most fire risk systems to estimate meteorological risks. While the potential evapotranspiration parameter (Baumgartner index), and soil moisture (FD) were ignored in most fire indices.

After comparing climate characteristics and metrological factors between indices, we can't find a real relationship between them since some of humid countries ignored humidity factor (southern United States, Australia and Russia)while wind speed was common factor between cities affected by high wind speed (Czech Republic and Australia)[18].

Furthermore, most of the indices mentioned the effect of drought indirectly using precipitation, evapotranspiration, soil moisture and rainfall due to complexity of drought [19].

Each index is built on the available climate that is related to its own place of study, which affect directly on fire occurrence. Cold places have high rainfall and humidity over the year [20], while the Mediterranean and hot places have high temperature and dry summers [21].

2.3.2. Validity and accuracy of models

The most usable empirical drought indices in forestry fire risk management and prediction were examined under many conditions in different regions as shown in Table 14 [22][23][24].

Table 14: Characteristics and Areas of Application of Models

Fire Danger Indices	Model Characteristics	Tested and Adopted Places
Angstrom	Daily Empirical Index, simple equation	Sweden, Germany
Nesterov	Cumulative index, simple equation	Slovakia, Germany
M-Nesterov	Cumulative index, simple equation	Russia and Canada
KBDI	Cumulative index, complex formula	United States, Australia, Indonesia
Baumgartner	Cumulative index, simple equation	Germany
M-KBDI	Cumulative index, complex formula	Greece, Indonesia, Malaysia
FWI	Cumulative index, complex formula	Canada, China, Chile, Fiji, Indonesia, Malaysia, Mexico, New Zealand, Portugal, South Africa, Spain, Sweden, Thailand, United Kingdom, Argentina
FFDI	Cumulative index, complex formula	Australia, Italy, Spain, USA, Portugal, Greece and Canada
Simple Fire Danger(F)	Cumulative index, simple equation	Australia and Switzerland
FD	Cumulative index, simple equation	Czech Republic, Germany and Sweden

As it is known, fire danger indices are divided into two categories; cumulative and daily indices. Most of the indices are cumulative and follow a similar pattern in their evolution over time; they increase steadily in the absence of rain and go back to zero when rain occurs. A cumulative index, due to its cumulative concept, presents especially high values during the end of September like KBDI, whereas fire activity is normally reduced, due to atmospheric conditions.

Dolling et al, found a strong relationship between the KBDI and fire activity in the Hawaiian Islands [25]. The strongest relationship between the KBDI and total area burned was found in the islands of Oahu, Maui and Hawaii. The Pearson correlation was also used to investigate the relationship between the KBDI and the monthly number of fires occurring on each Hawaiian island. This test was statistically significant between KBDI and the number of fires [26]. In addition, Malaysia adopted KBDI software to predict forest fire risk level during the period of 1990-1995 which resulted in recording optimal results in fire prediction [27].

Modified Keetch Bayram can only be used in summer season when the climate is dry, since this index known as a drought index. This model was tested and adopted in different

places in the Mediterranean. It showed more acceptable results than KBDI in forest fire prediction especially after decreasing the scale of dry condition of soil (0- 250) [1] [26].

The Russian Nesterov index has been adopted for use in Portugal and Austria after reports of high prediction accuracy [28] [29]. They also applied the model to estimate areas burnt on a macro scale (10-100 km) in human-dominated ecosystems in the Iberian Peninsula. It proved to produce realistic results, which were well correlated, both spatially and temporally, with the fire statistics [30]. Likewise, Nesterov index was comparatively tested with KBDI in East Kalimantan, Indonesia to predict fire occurrence [31]. Generally, it was proved applicable and a useful tool for early warning.

Modified Nesterov index showed good results after being applied in Lebanon to predict the forest fire [36]. It has been comparatively tested with other indices (Keetch-Byram drought index, and Nesterov by testing their values versus forest fire statistics where it appeared well performing as an applicable fire prediction index.

Angstrom index has been used all over the Scandinavian Peninsula after recording high accuracy in forest fire map prediction [32]. Alves White found that Angstrom accuracy was 46.6% in Northern Brazil which can be an acceptable result to predict the number of fires [33].

The Canadian model has been tested and adopted in New Zealand, Fiji, Alaska, Mexico, Chile, Argentina and Europe. The system is characterized by many desirable traits. It was found that the Drought Code of the sub-model Forest Fire Weather Index can be used to estimate the moisture content of live fine fuel of shrub type fuels during the summer period in Central Portugal and Catalunya (NE Spain) [34]. The Drought Code of the system was also selected to investigate the spatial correlation between meteorological fire risk indices and satellite derived variables in Andalucia, southern Spain [35].

Baumgartner Index was comparatively evaluated, with two other indices (Nesterov and Angstrom) in the Slovak Paradise National Park during two large forests fire events. In these local conditions, it rarely appeared approaching the highest fire risk levels (class5)[9]. Also Baumgartner index was evaluated in Valais (Western Alps) and recorded a good result in forest fire prediction [37].

McArthur index was found the most accurate and usable index to predict forest fire danger rating in Australia [38], Canada [39], USA [40] and Europe, mainly Greece, Italy [41], Portugal [42] and Spain [43].

Simple Fire Danger Index showed a good performance in prediction after being tested in Austria [44], while it showed a limited performance in Italy [45].

Fire danger index in turn was adopted in Germany and Sweden and recorded good results in predicting forest fires [46].

2.4. Recent initiative studies on fire prediction

Nowadays, Scientists are interested in data mining techniques as it is the case in classical statistical analysis of complex phenomena. These techniques are still usable in forest fire predictions which can break down the non-linear relationship between meteorological factors and fire occurrence. Data mining techniques facilitate the comprehension of spatial data, discovery of relationships between spatial and non-spatial factors, determination of the spatial distribution patterns of a specific complex phenomenon further to supporting the envisagement of the pattern trends. Data mining techniques like ANN, LDA, DT, SVM and Fuzzy logic, are used in fire prediction, after taking into account the historical meteorological data.

Amparo et al. utilized forest fire prediction model in north Spain based on a neural network whose output is classified into four symbolic risk categories, obtaining an accuracy of 80% [47].

Imas et al. developed classification models for hotspots occurrence using decision tree in Riau Province (Indonesia), the result showed that decision tree got the best accuracy (69.59 %) compared to other techniques [48].

Illiadis et al, adopted fuzzy logic to predict forest fire in Greek; the accuracy retrieved was 85.25% [49].

Zahou et al. used LDA technique to predict forest fires in Shanxi (China).The test results showed that the method was generally practical with an average accuracy of 82% in the test region [50].

Sakr et al. presented two forest fire risk prediction algorithms, based on support vector machines and artificial neural networks. They used weather data of 9 years covering the Lebanese territory in addition to the daily number of forest fires. Six meteorological

parameters were provided: the minimum temperature, the maximum temperature, solar radiation, average wind speed, average humidity and the cumulative annual precipitation. The proposed method introduces a fire risk index on a scale of 1 to 4, where 1 corresponds to the lowest fire risk and 4 to the highest fire risk. This index is based on the number of fires that occurred on a specific day and hence can be used to estimate the range of number of fires that could happen on that day. A challenge was to have this index independent of weather prediction mechanisms; and thus avoid the problem created by potential erroneous weather forecasting. It was found that the average error in the number of fires predicted per class for ANN is less than the average error for SVM. In general, both algorithms gave acceptable results for all fire months[51].

Further, a spatial clustering (FASTCID) was adopted by Hsu et al, to detect forest fire spots in satellite images [52]. In 2005, satellite images from North America forest fires were fed into a SVM, which could obtain 75% accuracy at finding smoke, at the 1.1-km pixel level. They applied Logistic Regression, Random Forest and DT to detect fire occurrence in the Slovenian forests using both satellite-based and meteorological data. The best model was obtained by a bagging DT, with an overall 80% accuracy, confirmed by several countries like Slovenia and United States.

Yu chang et al. applied a logistic regression model based on climatic factors (average annual mean temperature and precipitation) and meteorological conditions (daily minimum temperature, daily minimum humidity, daily mean humidity, and mean wind speed) to predict forest fire before occurrence in Heilongjian Province, China. This model was adopted in china after it recorded good accuracy in predicting forest fire[53].

Conclusion

In this chapter, we viewed the most widely used indices. These indices are based on different meteorological factors to predict forest fire prior to occurrence. Some regions tested and rejected indices due to modified climate conditions. The comparative study showed that each index is related to its own place of study as it is affected by local meteorological factors. In addition; temperature, humidity and wind speed are the most usable parameters in forest fire indices.

Canadian and Australian fire weather indices are found the most adopted all over the world with more than twenty countries applying each. On the other hand, Baumgartner index is the least usable index in forest fire prediction models.

Newest studies showed that the idea saying that fire occurrence can be translated into a mathematical equation is not a pretty good one. This is due to the ultra-complexity of the forest fires phenomena. This deduction urged scientists to apply new models based on data mining techniques in order to predict forest fire. Data mining techniques methods proved to record high accuracy in pre-forest fire and are actually adopted by many cities.

References of chapter 2

- [1]S.Liao,P.Chu, P.Hsiao, "Data Mining Techniques and Applications – A Decade Review from 2000 to 2011", *Expert Systems with Applications*, 39, pp.11303–11311, 2012
- [2]NP.Gillett, AJ.Weaver, F.Z.W.Wiers and MD.Flannigan, Detecting the effect of climate change on Canadian forest fires, *Geophys. Res. Lett*, 31, pp. 82-189, 2004
- [3]C.Chandler, P.Cheney, P. Thomas, L.Trabaud, D.Williams, "Fire in Forestry - Forest Fire Behavior and Effects", JohnWiley & Sons, New York, Chinchester, Brisbane, Toronto, Singapore, 1983
- [4]J.Skvarenina, J.Mindas,J.Holecy and J.Tucek, "Analysis of the natural and meteorological conditions during two largest forest fire events in the Slovak Paradise National Park", In *Proceeding of the Int, Scientific Workshop on Forest Fires in the Wildland-Urban Interface and Rural areas in Europe*, Athens, Greece, 2003
- [5]V.G.,Nesterov, "Combustibility of the Forest and Methods for its Determination", USSR StateIndustry Press (In Russian), 1949
- [6]S.Venevsky, K.Thonicke, S.Sitch,W.Cramer, "Simulating fire regimes in human-dominated ecosystems", *Iberian Peninsula Case Study, Global Change Biology*,8, pp.984-998, 2002.

- [7]A.Baumgartner, L.Klemmer, G.Waldmann, Waldbrände in Bayern 1950 bis 1959. In: Mitteilungen aus der Staatsforstverwaltung Bayerns, 36, 1967
- [8]J.Keetch and G.M.Bayram, "A Drought Index for Forest Fire Control", USDA Forest Service, South Eastern Forest Experiment Station, Research Paper SE-38, pp.32, 1968
- [9]K.Anderson, P.Englefield, R.Carr, Predicting fire-weather severity using seasonal forecasts, Canadian Forest Service, 2008
- [10] J.Sharples, "Lateral bushfire propagation driven by the interaction of wind, terrain and fire", 2011
- [11] J.Sharples, R H D. McRae, R O. Weber and Gil A M , "A simple index for assessing fire danger rating, Environmental Modeling & Software", 24, pp. 764–774
- [12]H.Cooke, G.Anantharaj, C.Wax, M.Jolly, K.Grala, P.Dixon, J.Dyer, L.Evans and B.Goodrich, Integrating climatic and fuels information into national fire risk decision support tools. In: Proceeding RMRS-P-46CD, Fort Collins, CO,US. Department of Agriculture, Forest Service, Rocky Mountain Research Station, (26)30, pp.555-569,2007
- [13]J.Choi, H.Cooke, D.Stevens, "Development of a water budget management system for fire potential mapping", GISci, Sens, 46 (1), pp.39-42, 2009
- [14]W.Chan, T.Paul, A.Dozier, "KeetchBayram Drought Index: can it help predict wildlandfires?", Fire Management Today, 64(2), pp.39-42, 2004
- [15]G.Petros, M.Antonis, T.Marian, "Development of an adapted empirical drought index to the Mediterranean conditions for use in forestry", Agric for Meteorol, 151, pp.241-250, 2004
- [16]G.Petros, M.Antonis, T.Marian, "Development of an adapted empirical drought index to the Mediterranean conditions for use in forestry", Agric for Meteorol, 151, pp. 241-250, 2011
- [17]M.Martin and B.Daniel, "Forecast danger of vegetation fires in the open countryside in the Czech Republic", Mendel a bioklimatologie, 3 pp. 5-9, 2014
- [18]S.Green, M.Morrissey, S.Johnson, "Wind Climatology, Climate Change, and Wind Energy", Geography Compass, PP. 1592–1605, 2010
- [19]RR.Heim, "A review of twentieth-century drought indices used in the United States, American Meteorological Society BAMS", pp.1149-1165, 2000
- [20]Kevin E T (2005). The Impact Of Climate Change And Variability On Heavy Precipitation, Floods, And Droughts, National Center For Atmospheric Research, Boulder, CO, USA, pp, 3-11
- [21]P.T.Nastos, C.S.Zerefos, "Climate Change and Precipitation in Greece", Hellenic Journal of Geosciences, 45, pp. 185-192, 2007
- [22]D.Paton, J.Shroder, "Wildfire Hazards, Risks, and Disasters", Hazards and Disasters Series, Elsevier, 2014
- [23]M.V.K.Sivakumar, P.R. Motha, P.H. Das, "Natural Disasters and Extreme Events in Agriculture: Impacts and Mitigation", Springer, 2005

- [24]N.Hamadeh, A.Hilal, B.Daya and P.Chuavet, "An Analytical Review on the Most widely Used Metrological Models in Forest Fire Prediction", IEEE TAECE2015, The Third International Conference on Technological Advances in Electrical, Electronics and Computer Engineering, pp. 239-244, Beirut, Lebanon 29 April – 1 May 2015
- [25]K.Dolling, P.Shin Chu and F.Fujioka , "A climatological study of the Keetch/Byram drought index and fire activity in the Hawaiian Islands", Agricultural and Forest Meteorology, 133, pp. 17–27,2005
- [26]N.Ainuddin and J.Ampun, "Temporal Analysis of Keetch-Bayram Drought Index in Malaysia: Implications for Forest Fire Management", Journal of Applied Sciences, 21, pp. 3994-398, 2008
- [27]N.A.Ainuddin and J.Ampun, Temporal Analysis of Keetch-Byram Drought Index in Malaysia: Implications for Forest Fire Management", Journal of Applied Sciences, 8, PP. 3991-3994, 2008
- [28]A.Arpaci, H.Vacik, H.Formayer, and A.Beck, "A collection of possible Fire Weather Indices (FWI) for alpine landscapes", Tech rep, Alpine Forest Fire warning System, 2010
- [29]A.Camia, Forest Fires in Europe 2007, Tech. Rep. 8, European Commission Joint Research Center Institute for Environment and Sustainability", 2008
- [30]S.Venevsky, K.Thonicke, S.Sitch.,W.Cramer, "Simulating fire regimes in human-dominated ecosystems: Iberian Peninsula case study",Global Change Biology, 8, pp. 984-998, 2002
- [31]G.Buchholz and D.Weidemann, "The use of simple Fire Danger Rating System as a tool for early warning in forestry", International Forest Fire News, 23, pp. 32-36, 2000
- [32]C.Willis, B.van Wilgen, K.Tolhurst, C. Everson D, P.Abreton, Pero.L, G.Fleming, "Development of a national fire danger rating system for South Africa". Department of Water Affairs and Forestry, Pretoria,2001
- [33]BL.Alves White, L.Secundo, T.White, Ribeiro and M.Fernandes," Development Of A Fire Danger Index For Eucalypt Plantations In The Northern Coast Of Bahia", Brazil, Floresta, Curitiba, PR,43, pp.601 – 610, 2013
- [34]DX.Viegas, J.Pinol, MT.Viegas and R.Oraya, "Estimating live fine fuels moisture content using meteorologically based indices. International Journal of Wildland Fire", 10, pp. 223-240, 2001
- [35]I.Aguado, E.Chuvienco, P.Martin and J.Salas, "Assessment of forest fire danger conditions in southern Spain from NOAA images and meteorological indices". Int.J. Remote Sensing, 24, pp.1653-1668, 2003
- [36]A.Karouni, B.Daya and S.Bahlak, "Forest fire prediction: A comparative study of applicability of fire weather indices for Lebanon", Global Journal on Technology, 5, pp. 8-7, 2014.
- [37]C.Wastl, C.Schunk, M.Leuchner, B.GianniandA.Menzel, "Recent climate change: Long-term trends in meteorological forest fire danger in the Alps", Agricultural and Forest Meteorology, 162–163, pp. 1–13, 2012

- [38]AJ.Dowdy, GA.Mills, K.Finkele and W.De Groot ,“Australian fire weather as represented by McArthur Forest Fire Danger Index and the Canadian Forest Fire Weather Index”, CAWCR Technical Report No. 10, CSIRO and Bureau of Meterology, Canberra,2009
- [39]KN.Abbott, B.Leblon, GC.Staples, DA.McLean and ME.Alexander, “Fire Danger Monitoring using RADASAT1 over Northern Boreal Forests”, International Journal of Remote Sensing, 28(6), pp. 1317-1378, 2007
- [40]CC.Hardy. And CE. Hardy, “Fire danger rating in the United States of America: an evolution since 1916, International Journal of Wildland Fire”, 16, pp. 217–23, 2007
- [41]P.Good, M.Moriondo, C.Giannakopoulos and M.Bindi, “The meteorological conditions associated with extreme fire risk in Italy and Greece: relevance to climate model studies”, International Journal of Wildland Fire, 17, pp. 155–165, 2008
- [42]P.M.Fernandes, “Fire spread prediction in shrub fuels in Portugal”, Forest Ecology and Management, 144, pp. 67-74, 2001
- [43]M.Bisquert,JM.Sánchez and V.Caselles, “Modeling Fire Danger in Galicia and Asturias (Spain) from MODIS Images”, Remote Sensing journal, 6(1), pp. 540-554, 2014
- [44]A.Alexander,S E.Chris and V.Harald,“Selecting the best performing fire weather indices for Austrian ecoregions”, TheorApplClimatol 114, pp. 393–406, 2013
- [45]S.Donatella,B.Valentina,S.Michele,S.Costantino,“Fire Behaviour modeling”,Project EU Italia-FranciaMarittimo 2007-2013 Programme, pp. 200-218, 2012
- [46]M.Martin, T.Miroslav, B.Daniel, P.Vera, H.PetrandZ. Zdeněk, Siškal.(Eds),Towards Climatic Services, pp.19-25,2015
- [47]A.Betanzos, O.Romero, B.Berdin~as, E.Pereira, M.Inmaculada,E.Jime´nez, J.Soto, T.Carballas, “An intelligent system for forest fire risk prediction and fire Fighting management in Galicia”, Journal of Expert Systems with Applications, pp.545–554, 2003
- [48]I.Sitanggang, R.Yaakob, N.Mustapha, A.Ainuddin, “Application of classification algorithms in data mining for hotspots occurrence prediction in Riau province Indonesia” Journal of Theoretical and Applied Information Technology , 43 No.2 ,September 2012
- [49]L.Iliadis, A.Papastavrou, P.Lefakis, “A heuristic expert system for forest fire guidance in Greece” J Environ Manage, pp.327-36, July, 2002
- [50]Z.Jing, M.Weiqing and Z.Ye, “Fisher Linear Discriminant Method for Forest Fire Risk Points on Transmission Line”, International Journal of Smart Home, 9, pp. 25-34, 2015
- [51]G.Sakr, I.Elhajj, G.Mitri and U.Wejinya, “Artificial Intelligence for Forest Fire Prediction”, International Conference on Advanced Intelligent Mechatronics Montréal, Canada, pp. 1311-1316, July 6-9, 2010

[52]W.Hsu, M.Lee,J. Zhang, "Image Mining: Trends and Developments", Journal of Intelligent Information Systems,19(1) pp. 7–23, 2002

[53]Y.Chang, Z.Zhu, R.Bu, "Predicting fire occurrence patterns with logistic regression in Heilongjiang Province, China". Ecol journal, Vol. 28, pp.1989-1992, 2013

Chapter 3: Comparative study of different data mining techniques in predicting forest fire in Lebanon and Mediterranean

3.1. Introduction

As forest fires are causing enormous ecological damage and human suffering, this helped focus world attention on what is an increasing problem. Forest fires are considered to be one of the most dangerous problems which lead to a variety of environmental disasters that affect human life. Fires have notable influence over the ecological and economic utilities of the forest, being a prime constituent in a great number of forest ecosystems. In the Mediterranean basin, 50,000 fires are reported every year with an average burned area of 500000 ha per year [1].

In the last decades, a global substantial effort was made from scientists to build early warning systems based on meteorological data that serve to reduce the risk of forest fires. Most models used mathematical indices to predict forest fire occurrence like: Nesterov in Russia, Angstrom in Sweden, Ketch Bayram in USA, Baumgartner in Germany, Canadian Fire Weather Index in Canada and many others mathematical indices [2] [3], as stated in Chapter 2. Calculation methods lead to a numerical index that is

translated as a level of alarm which rises with the increase in probability of fire occurrence conditions. The statistics based on point-to-point correlation in function of time appear to be a poor method to describe the non-linear relationship between fire risk indices and fire occurrence what made it a complicated phenomenon [4].

Nowadays, scientists are interested in Data Mining as the classical statistical analysis seems to break down in the presence of complex phenomena. Indeed, several Data Mining techniques have been applied to the fire detection domains like neural networks, decision tree and fuzzy logic and actually adopted in many regions as good predictors [5] [6].

The aim of this study is to apply techniques of artificial intelligence that allow to predict forest fire occurrence and extract the best performing among (Neural networks, Decision tree, Fuzzy logic, Support vector machine and linear discriminate analysis).

3.2. Data Mining and its fields

Data mining is the process of exploration and analysis, by automatic or semi-automatic means, of large quantities of data in order to discover meaningful patterns and rules [7]. Data mining solutions implement advanced data analysis techniques used by companies for discovering unexpected patterns extracted from vast amounts of data, patterns that offer relevant knowledge for predicting future outcomes.

Nowadays, different technologies and measures are used by scientists to adapt to their societies. Features such as the use of barcode for commercial manufacturing, employing computer in business, sciences and governmental services, improving tools and collecting data serve as essential conditions for adaptations [8]. Knowledge has played an important role on human and has influenced his activities since his development. Data mining extracts the needed knowledge and information from a large amount of data. In addition, data mining is a process that uses a variety of data analysis tools to discover patterns and relationships in data that may be used to make decisions and valid predictions. Data mining has various applications and these applications have enriched the various fields of human life, including business, education, medical, scientific etc.

3.2.1. Accounting and finance fields

Many fields adopted data mining technologies because of fast access of data and valuable information obtained from a large amount of data. Data mining has been used extensively in the banking and financial markets [9]. In the banking field, it is used to predict credit card fraud, to estimate risk and to analyze the trend and profitability. In the financial markets, data mining techniques such as artificial neural networks (ANN) and support vector machine (SVM) are used in stock forecasting and price prediction which recorded above 80% accuracy in prediction [10].

3.2.2. Medical fields

Also data mining techniques have become a popular research tool for medical researchers to identify and exploit patterns and relationships among a large number of variables, to make them able to predict the outcome of a disease diagnosis using the historical datasets. In the medical field, data mining is used to predict breast cancer with high accuracy in prediction using neural networks (90%), and decision tree (94.5%) [11] [12]. In addition, the techniques of data mining succeed in predicting heart diseases obtaining high accuracies in decision tree (95%), Bayesian classification (86.5%) and neural networks (85.3%) [13].

3.2.3. Geo-science fields

Moreover, data mining has been adopted by many countries, (ex. California-USA and Iran) in the field of Geo-technique science to predict earthquakes using fuzzy systems and neural networks based on historical data. It is shown that they can be good predictors for earthquakes (accuracy above 60%) [14].

3.2.4. Telecommunication fields

Data mining stirs in globalization dramatically, especially in telecommunication fields. Telecommunication networks contain thousands of components, which are interconnected. These components are capable of generating error and status messages which lead to a large volume of network data.

Data mining technologies are used in identification of network faults by extracting automatic extraction of knowledge from network data that is also generated in real time, which can be accomplished by applying a time window to the data [15].

Scientists applied decision tree technique and neural network to predict and reduce customer churn rate and error ratio in the telecommunication system using different data sets. Decision tree recorded the best accuracy (98.3%) [16].

3.2.5. Education fields

Education has a large share in data mining. In particular, educational data mining methods have enabled researchers to make higher-level inferences about students' behavior, such as when a student is gaming the system, when a student has "slipped" (making an error despite knowing a skill), and when a student is engaging in self-explanation [17]. These richer student models have increased the ability to predict student knowledge and future performance. These incorporating models of guessing and slipping into predictions of student future performance have increased the accuracy of these predictions by up to 48% [18].

3.3. Place of study and data

The Lebanese Republic is divided into six regional administrative districts: Beirut, North Lebanon, South Lebanon, The Beqaa and Nabatiyeh. North Lebanon is the second largest territory, includes six administrative districts (Akaar, Al denyeh, zgharta, Batroun al Koura and Bshari). Its weather is mild having cool, wet winters and hot dry summers.

North Lebanon is invaded by severe fires every year. During the last 12 years, this place has lost 7567 hectares as shown in Fig. 8 [19].

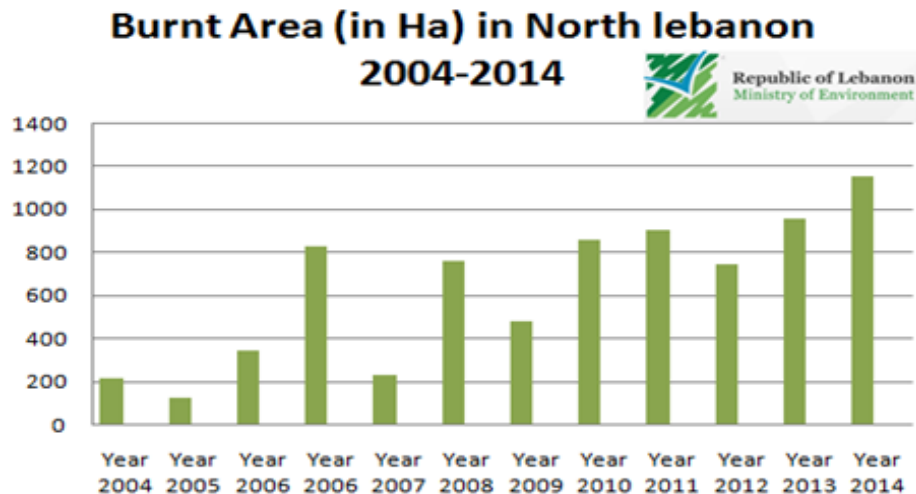

Fig. 8: Burnt area (Ha) in North Lebanon during The years 2004-2014

Also North Lebanon is known by different surface cover types: agriculture areas, sparse vegetation, forests and humid soils. But unfortunately, forest areas overshadowed in north Lebanon. Fig. 9 shows that 81% of fires attack forests; this clearly shows how far the forest wealth in North Lebanon is in real danger.

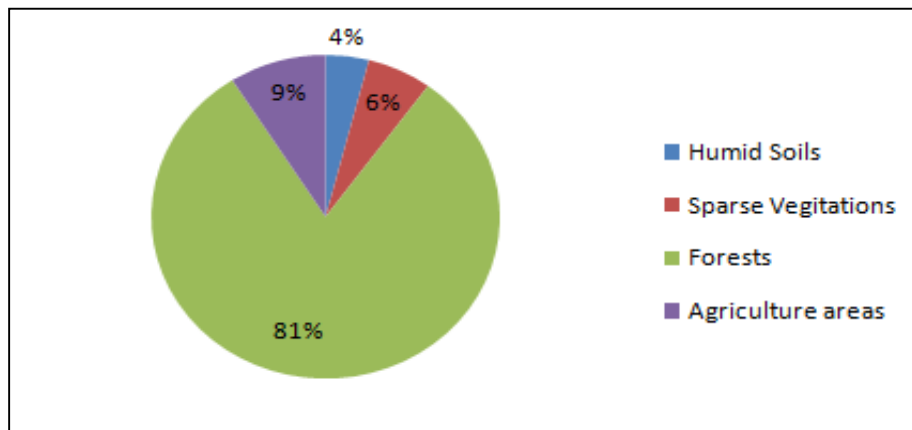

Fig. 9: Distribution of the fires in North Lebanon during the years 2009-2014 versus surface cover type

The meteorological data is provided by LARI station found in a Kfarchakhna city in North Lebanon during the years of 2009-2014, where 94 forest fires are registered by Lebanese internal security forces.

Kfarchakhna city is about 220 meters above the sea level, its 25 kilometers from the Mediterranean Sea and 80 kilometers from Beirut capital [20].

3.4. Methodology and data classification preliminaries

The objective of this study is to find the best Data Mining technique method in predicting forest fire in North Lebanon. In this study we applied five different methods (Neural Networks, Decision Tree, Support Vector Machine, Linear Discriminate Analysis and Fuzzy Logic) that were tested using MATLAB software.

Our study was conducted on 2189 days comprising four parameters: Temperature, Humidity, Precipitation and wind speed. These parameters represent the inputs of techniques, and for each day corresponds a target value (0 or 1) which indicates the occurrence of fire in a specified day. From within the data set under scope, forest fires were detected in 94 days. For that and to balance the data, the days with fire were multiplied by 22.

During machine learning phase, we divided the samples randomly, and then we used the selected numbers to divide the dataset into training (80%) and testing (20%) dataset as shown in the following Table 15:

	percentage	Nb of days	Nb of days with no fire	Nb of days with fire

Training data	80%	3331	1676	1654
Testing data	20%	832	419	414
Total		4163	2095	2068

Table 15: Distribution of testing and training data

We aim to find the accuracy, precision specificity and the area under curve (ROC) to make a comparative study that allows finding the best accurate model among chosen data mining techniques in predict forest fire in North Lebanon.

3.5. Artificial Neural Networks (ANN)

ANN is a branch of Artificial intelligence that has been accepted as a new technology in computer science. Neural networks process information in a similar way the human brain does. The network is composed of a large number of highly interconnected processing neurons working in parallel to take decisions and to solve a problem. One of the most usable supervised learning is the back propagation technique which is based on the Gradient Descent method that attempts to minimize the error of the network by moving down the gradient of the error curve [21]. This is the most popular in the supervised learning architecture because of the weight error correct rules [22].

Multi-layer Perceptron (MLP) is a network that can have several layers. Each layer has a weight matrix W , a bias vector b , and an output vector a . Note that the outputs of each intermediate layer are the inputs to the following layer as shown in Fig. 10. The layers of a multilayer network play different roles. A layer that produces the network output is called an output layer. All other layers are called hidden layers. The supervised learning problem of the MLP can be solved with the back-propagation algorithm.

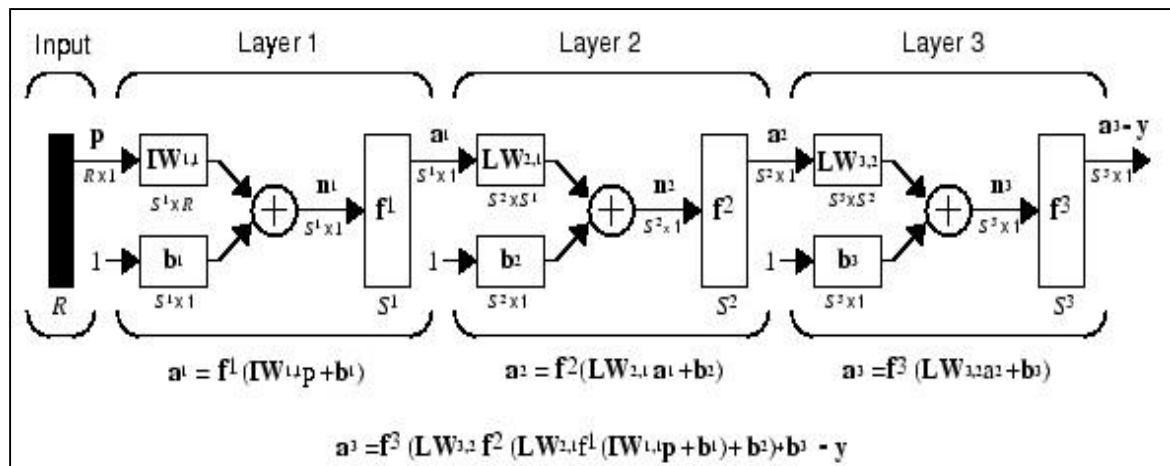

Fig. 10: MLP Diagram

3.5.1. Neural network validations in predicting forest Fires

Forest fires incidents are resulting from natural processes. Wildland fire danger estimation systems based on ANN have been developed by many countries. Amparo et al (2003) utilized forest fire prediction model in north Spain based on a neural network whose output is classified into four symbolic risk categories, obtaining an accuracy of 80% [23]. Christos et al (2007) applied neural network using MLP to predict forest fire in Greece based on meteorological data; and obtained about 90% accuracy [24]. Fabio et al (2015) adopted ANN to predict wild fire in Maranhao, northeast Brazil after recording a good accuracy of 84.79% [25].

3.5.2. Application of Neural Networks

After collecting the data, it is time now for developing, training and testing the neural network. Learning and training are fundamental to nearly all neural networks. Training is the procedure by which the network learns. Learning consists of making systematic changes to the weights to improve the network's response performance to acceptable levels. The networks learn by adjusting the weights connecting the layers. The network finds non-linear relationships between the inputs (4 meteorological parameters) and the unique output (fire/no fire). The three trained networks differ in the number of neurons in the hidden layer: 8, 12 and 16 are assumed for the three used networks respectively as shown in Fig. 11.

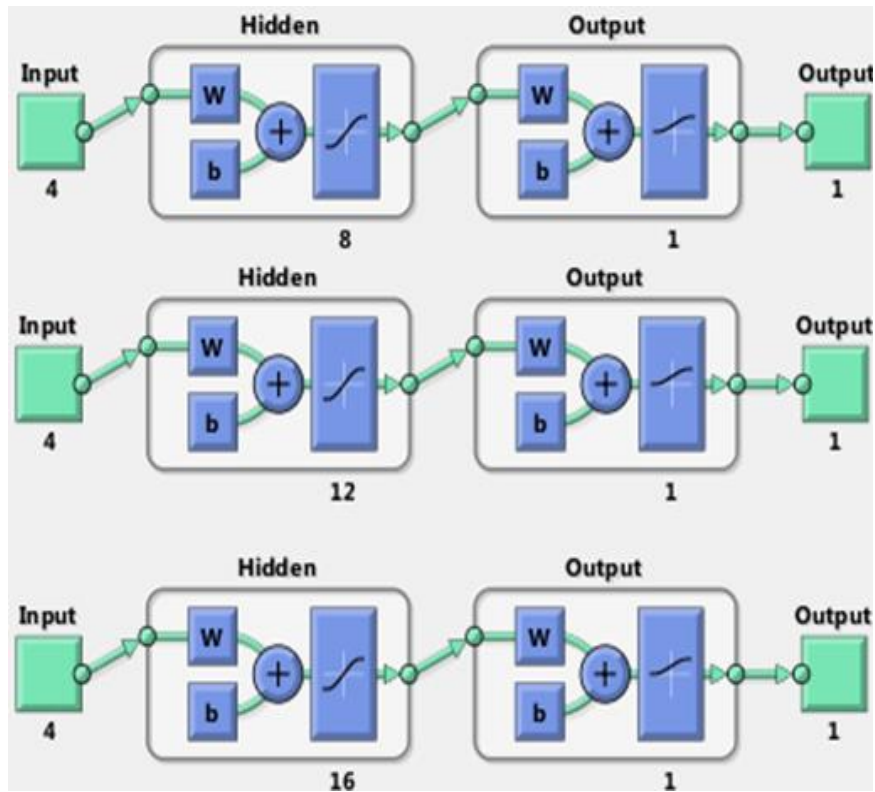

Fig. 11: Feed-Forward Back Propagation Networks Used 8,12 and 16 Neurons in the Hidden Layer

Also three different algorithms are used for each network to train and test the data:

- ✓ Trainlm: it is a network training function that updates weight and bias values according to Levenberg-Marquardt optimization.
- ✓ Traingdx: it is a network training function that updates weight and bias values according to gradient descent momentum and an adaptive learning rate.
- ✓ Trainrp: it is a network training function that updates weight and bias values according to the resilient back propagation algorithm.

One of the most popular methods to evaluate performance of a network is by plotting the confusion matrix for training and testing data as shown in the following figure (Fig. 12):

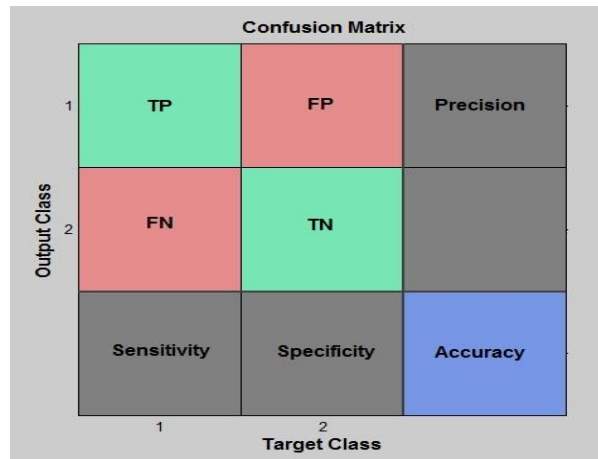

Fig. 12: Confusion Matrix architecture

Where:

- TP= true positive (the network predicts a true fire) .
- FP=false positive (the network predicts a non-existing fire).
- TN=true negative (the network predicts a true absence of fire).
- FN=false negative (the network does not predict a true fire).
- Sensitivity = $TP / (TP+FN)$: Probability of correctly labeling members of the target class.
- False Alarm = $FP / (TN+FP)$.
- Specificity = $TN / (TN+FP) = 1 - \text{FalseAlarm}$: a statistical measure of how well a binary classification test correctly identifies the negative cases.
- Precision = $TP / (TP+FP)$: Probability that a positive prediction is correct.
- Accuracy = $(TP+TN) / \text{total samples}$.

Accuracy indicates overall how often the classifier is correct. Precision specifies how often it is correct when it predicts FIRE. Sensitivity helps in another way that is indicating how often it predicts FIRE when it is actually FIRE. Similarly, specificity shows how often it predicts NO FIRE when it is actually NO FIRE.

AUC is an abbreviation for area under Receiver Operating Characteristic (ROC) curve. It is used in classification analysis in order to determine which of the used models predicts the best classes. It tests whether positives are ranked higher than negatives, then the closer AUC for a model comes to 1, the better it is.

Precision, Specificity, Sensitivity, Accuracy, Area under Receiver Operator Characteristic (ROC) curve AUC, and Mean Squared Error (MSE) are the measures adopted as shown in Table 16 and Table 17. Numbers of training steps are fixed to 1000 epochs.

	Training function	Number of neurons in hidden layer	Precision %	Specificity %	Sensitivity %	Accuracy %	Area under ROC%	Mean square error
Training data	Trainlm	8	96.6	97.7	83.7	90.3	92.3	0.08
		12	99.9	99.9	80.8	90.4	92	0.061
		16	98.8	98.9	89.4	94.1	92.4	0.058
	Traindgx	8	95.6	96.5	75.1	85.7	90	0.1
		12	97.2	97.7	77.7	87.6	90	0.10
		16	98.6	98.9	77.5	88.1	90	0.10
	Trainrp	8	97.1	97.1	76.7	87.1	90	0.12
		12	98	98.8	77.3	88	91	0.11
		16	97.1	97.6	97.1	88.3	92	0.10

Table 16: Measures of Precision, Specificity, Sensitivity, Accuracy, Mean Squared Error and AUC for the Training Data

	Training function	Number of neurons in hidden layer	Precision %	Specificity %	Sensitivity %	Accuracy %	Area under ROC%	Mean squared error
Training data	Trainlm	8	94.7	95.7	83.7	86.2	80	0.1
		12	100	100	75.7	87.9	93.3	0.09
		16	98.3	98.6	84.2	91.4	90	0.07
	Traindgx	8	97	97.8	70.4	84	87.7	0.12
		12	98.1	98.6	73	85.7	87	0.122
		16	98.1	98.6	73	85.7	88	0.127
	Trainrp	8	58	98.6	71.4	84.9	88	0.1
		12	99.3	99.5	72.6	86	87	0.12
		16	98.7	99	73	86	90	0.12

Table 17: Measures of Precision, Specificity, Sensitivity, Accuracy, Mean Squared Error and Area under Roc Curve for the Testing Data

After analyzing Table 16 and Table 17, we can say that in the training phase, trainlm algorithm with 16 hidden neurons network records the best results in precision (98.8%), specificity (98.9%), sensitivity (89.4%), accuracy (94.1%), area under ROC (92.4%) and least mean squared error (0.06) as shown in Fig. 13.

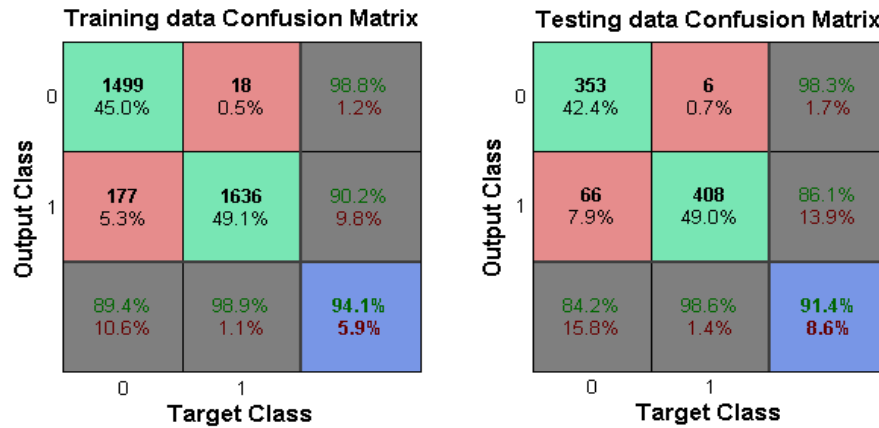

Fig. 13: Training and testing neural networks performance upon Implementing trainlm algorithm with 16 hidden neurons

Moreover the best training performance recorded 0.0586 at 1000 epochs as shown in Fig. 14.

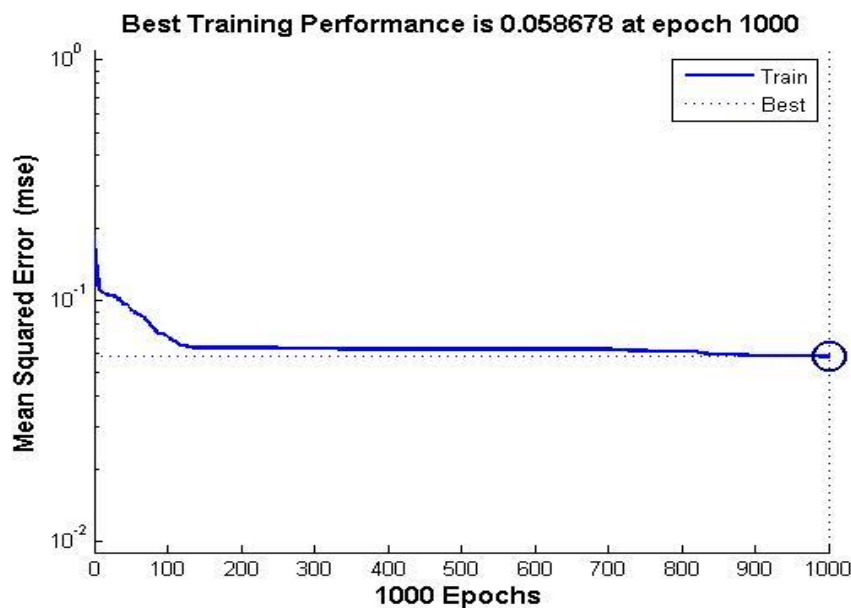

Fig. 14: Best training performance

The same result is obtained upon analyzing testing data: precision (98.3%), specificity (98.6%), sensitivity (84.2%), accuracy (91.4%), area under ROC curve (90%) and mean squared error (0.07).

3.6. Decision Tree

A decision tree like tree structure consists of nodes that form a rooted tree, meaning it is a directed tree starting with a node called root that has no incoming edges. All other

nodes have exactly one incoming edge. A node with outgoing edges is called an internal or test node. The other nodes are called leaves. In a decision tree, each internal node splits the instance space into two or more sub-spaces according to a certain discrete function of the input attributes values. Moreover, each leaf is assigned to one class representing the most appropriate target value. The J84 (C4.5) decision tree is the most usable classification algorithm. It was developed by J. Ross Quinlan during the late 1970s and early 1980 (ID3). The basic idea of ID3 algorithm is to construct the decision tree by employing a top-down flowchart testing each attribute at every node using Information Gain property which separates the training examples according to their target classification. To obtain such gain, entropy is to be calculated [26]. Entropy E is a measure characterizing the impurity of an arbitrary set of examples S . Its formula is as follows:

$$E = - \sum_{i=1}^c p(c_i) \log_2 p(c_i) \quad (3.1)$$

Where c is the set of classes, $P(c_i)$ is the portion of the number of elements in class c to the number of elements in Set S .

Gain is the information gained by selecting attribute A_i to branch the data; it is given by the difference of prior entropy and the entropy of selected branch. The attribute with the highest gain is chosen to split the tree.

3.6.1. Decision Tree validations in predicting forest Fire

Scientists applied decision tree to predict forest fire in many areas. Andres et al (2011) used decision trees as classification strategy in his research and obtained up to 96.8% of satisfactory classification prediction of forest fires in Spain [27]. Imas et al (2005) developed classification models for hotspots occurrence using decision tree in Riau Province (Indonesia), the result shows that decision tree got the best accuracy (69.59%) compared to other techniques [28]. Daniela et al (2006) applied decision tree algorithm in Slovenia to and this model showed high accuracy in Kras(76%), Primorska (80%) and Continental Slovenia (81%) [29]. Vasanth et al (2011) found that decision tree has high accuracy (above 80%) in forest fires prediction in Portugal [30].

3.6.2. Application of Decision Tree

The same data used to create the neural network are used for creating a classification tree to predict forest fires in North Lebanon. The additional objective of using decision tree is to find the most affective parameters in forest fire occurrence in descending order of significance.

One of the algorithms used to create a classification tree is shown below:

- ✓ Start with all input data, and examine all possible binary splits on every predictor.
- ✓ Select a split with best optimization criterion.
- ✓ Impose the split.
- ✓ Repeat recursively for the two child nodes (Fire/no fire).

MATLAB software was used to build up the Decision Tree algorithm as shown in Fig. 15.

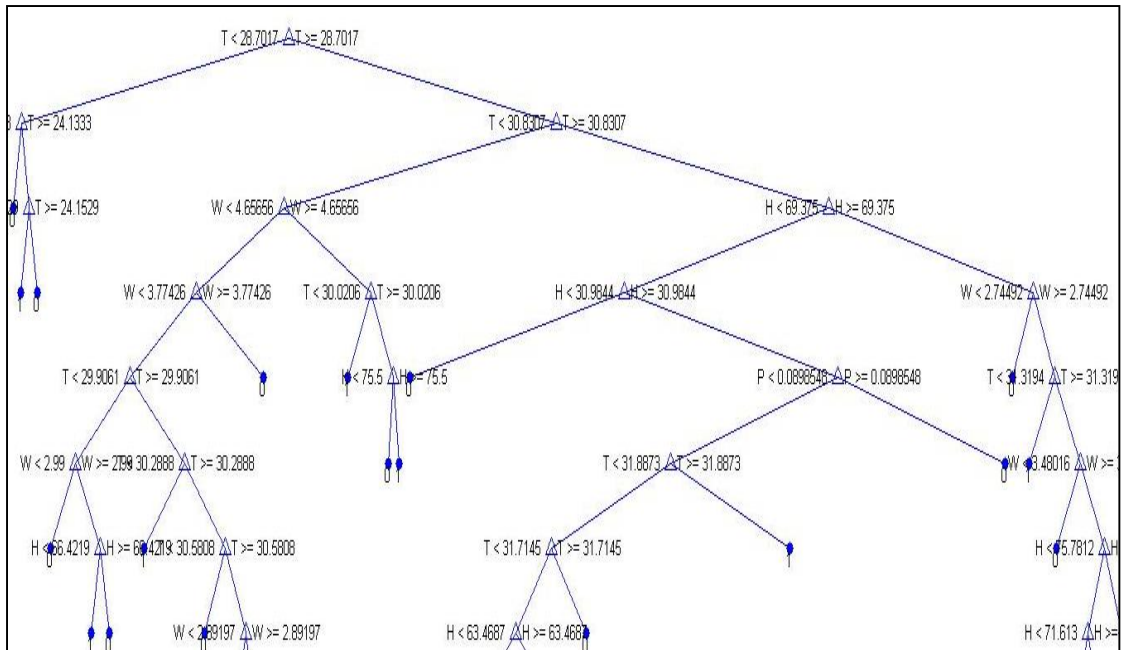

Fig. 15: Decision Tree architecture

Fig.15 shows that some attributes are more significant than others. It is clear that the temperature (T) and relative humidity (H) are found to be the root and the first descendant. They are more informative than wind speed (W) and precipitation (P) as temperature acquired the greatest gain and the next generation of the subsets is split according to the judgment of relative humidity.

The confusion Matrix of the Decision tree is shown in the following figure:

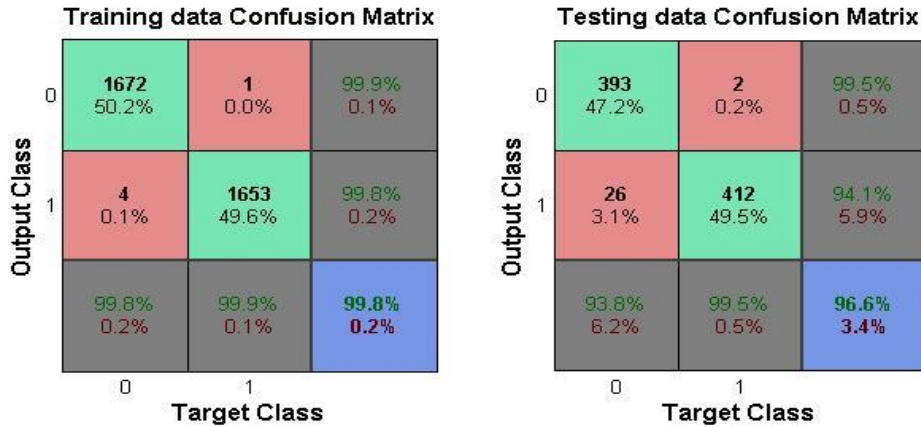

Fig. 16: Training and testing confusion matrix of Decision tree

The performance results, shown in the confusion matrix, for the created decision tree concerning the training and testing data are stated in the following table (Table 18):

Decision Tree	Precision %	Specificity %	Sensitivity %	Accuracy %	Area under ROC%
Training data	99.9	99.9	99.8	99.8	99
Testing data	99.5	99.5	93.8	96.9	97.6

Table 18: performance results for the created decision tree concerning the training and testing data

After analyzing Table 18, we found that decision tree recorded high values in training data, precision (99.9%), specificity (99.9%), sensitivity (99.8%), accuracy (99.8%) and area under ROC (99%). Also testing data recorded excellent values in prediction, precision (99.5%), specificity (99.5%), sensitivity (93.2%), accuracy (96.9 %) and area under ROC (97.6%).

3.7. Fuzzy Logic

Fuzzy logic was first proposed by Dr. Lotfi Zadeh by the University of California at Berkeley in the 1960 [31]. Fuzzy logic includes 0 and 1 as extreme cases of truth ("the state of matters" or "fact") but also includes the various states of truth in between. Fuzzy logic seems closer to the way of our brains judge. Fuzzy models are used wherever it is difficult to create a mathematical model, but the actions can be described in a qualitative way, by using fuzzy rules. They are applied to processes that have strong cross-coupling, nonlinear relationships between quantities, large distortions and time delays. To describe a system and perform inference, rules such as "If A then B" (implication A to B) are used. A is referred to as an antecedent and B is known as a consequent, where both A and B

are fuzzy sets. Such linguistic rules are called Mamdani-type ones. Mamdani model is a set of rules in which every rule defines one fuzzy point in the domain. They were named after E.H. Mamdani used this kind of statement in a fuzzy rule base to control a plant. The other commonly used model is Takagi-Sugeno one, which has a function in the conclusion (consequence) instead of fuzzy sets.

In conventional set theory, it is possible to classify elements only as members or non-members of a given set. In the fuzzy set theory, however, the membership of a given element to a given set is characterized by the value of the so called membership function μ (abbreviated as MF), which ranges from 0 to 1. Some typical MFs are shown in Fig. 17.

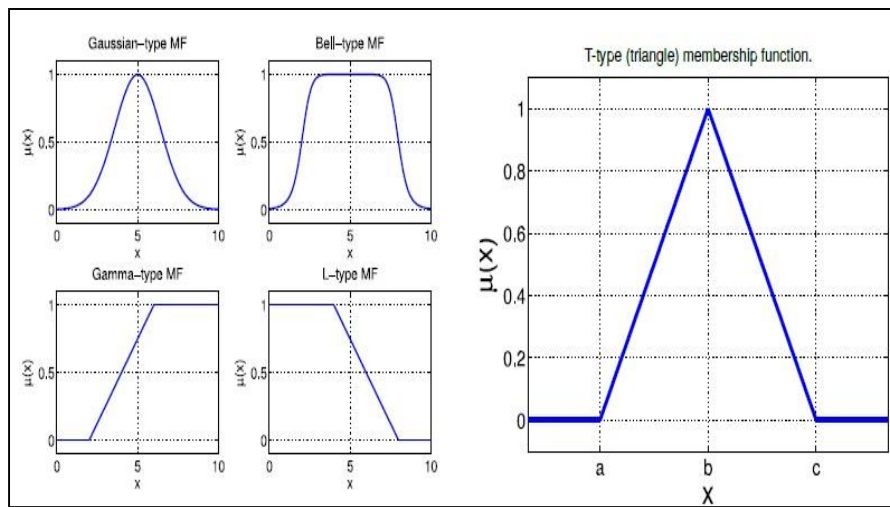

Fig. 17: Exemplary membership functions

To assess what a degree of a truth level is for each individual rule, the inference should be performed. It is a process of mapping membership values from the input windows, through the rule base, to the output window.

A fuzzy set (A) is built from a reference set called universe of discourse. The reference set is never fuzzy. If we suppose that $U = X_1, X_2, \dots, X_n$ then a fuzzy set (A) in U ($A \subset U$) is defined as set of order pairs :

$$\{(x_i, \mu_A(x_i))\} \tag{3.2}$$

Where $x_i \in U$, $\mu_A: U \rightarrow [0, 1]$ is the membership function of A and $\mu_A(x) \in [0, 1]$ is the degree of membership of x in A .

Rules can contain an internal logical "AND" expression or a logical "OR" expression. Mathematically, the first operation can be explained as intersection of two fuzzy sets A and B :

$$\mu A \cap \mu B = \min\{\mu A(u), \mu B(u)\} \text{ for all } u \in U \quad (3.3)$$

And the second operation can be characterized as union of the two fuzzy sets:

$$\mu A \cup \mu B = \max\{\mu A(u), \mu B(u)\} \text{ for all } u \in U \quad (3.4)$$

Fuzzy rules are stated linguistically as follows:

$$\text{IF } e \text{ is } A \text{ AND } \delta e \text{ is } B \text{ THEN } \delta u = C \quad (3.5)$$

The whole so called max-min inference process is given by the following equation:

$$\mu A(\delta u) = \max\{\min\{\mu A(e), \mu B(\delta e)\} \quad (3.6)$$

While the defuzzification is the procedure of acquiring the crisp value representing the fuzzy output set obtained in the inference process, the most well-known defuzzification technique is called centroid method: the crisp value is the value located under the center of gravity of the area that is given by the following formula:

$$\text{Crisp out put value} : \frac{\text{Sum of first moments of areas}}{\text{Sum of areas}} \quad (3.7)$$

The crisp single output (z) using center of mass technique is then:

$$z = \frac{\sum_{j=1}^q Z_j U_c(Z_j)}{\sum_{j=1}^n U_c(Z_j)} \quad (3.8)$$

Where z is the center of mass and U_c is the membership in class c at value z_j .

The advantage of this method is that all active rules are part of the defuzzification process what provide greater sensitivity of the fuzzy model to the changes in input data. However, the drawback of this approach is its computational complexity.

3.7.1. Fuzzy logic validations in predicting forest Fires

Forest fire is a complex phenomenon which leads researchers to apply fuzzy logic using different fuzzy rules sets. Illiadis et al (2002) adopted fuzzy logic to predict forest fire in Greece; the accuracy retrieved was 85.25% [32].

Keith et al (2006) applied fuzzy logic to identify the areas that can be affected by forest fire suppression in southeastern Idaho in United States. They found that that fuzzy logic recorded greater than 80% in accurately capture fire susceptibility [33].

André et al (2003) adopted fuzzy logic to predict forest fire in Brazil obtaining a success percentage of 86.3%. This application can draw up a fire risk map in Peassoa, based on land use, Slope, density, hydrography, roads, substandard and rainfall [34].

Hamid et al (2014) predicted and assessed forest fire maps in Iran using modified analytical hierarchy process and Mamdani fuzzy logic models in a geographic information system (GIS) environment. The result showed an excellent performance with AUC=88.2% [35].

3.7.2. Applying Fuzzy Logic

Our fuzzy logic system is built on Mamdani rules because of the reasonable results with the relatively simple structure it provides [36]. The fuzzy logic model is created using MATLAB fuzzy logic toolbox. In this study, the same 4 parameters were used to create MFs and to set the rule base: Temperature, Relative Humidity and Wind Speed and Precipitation. Only one output is given by the fuzzy system which is the fire probability for the desired day. To apply fuzzy logic technique to a real application, the following steps (illustrated in Fig.17) are required:

- a) Fuzzification: convert the crisp data into fuzzy data or MFs.
- b) Fuzzy Inference Process: combine MFs with the control rules to derive the fuzzy output.
- c) Defuzzification: use different methods to calculate each associated output and put them into a table: the lookup table. Pick up the output from the lookup table based on the current input during an application.

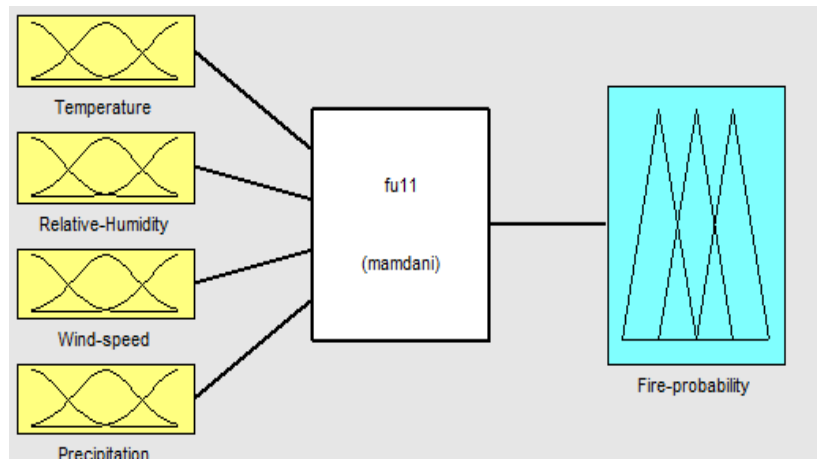

Fig. 18: Fuzzy logic model

To assess what a degree of a truth level is for each individual rule, the inference should be performed. It is a process of mapping membership values from the input windows, through the rule base, to the output window. As previously mentioned, rules can contain an internal logical “AND” expression or a logical “OR” expression. The inputs are connected to the outputs with eleven Mamdani base rules as shown in Fig. 18. Here we applied 11 different rules benefiting from the obtained decision tree in the previous part. It is worth to note that our balanced data are divided between inputs and outputs (2095 without fire & 2068 with fire).

1. If (Temperature is high) then (Fire-probability is high) (1)
2. If (Temperature is moderate) and (Relative-Humidity is high) then (Fire-probability is low) (1)
3. If (Temperature is moderate) and (Relative-Humidity is moderate) and (Wind-speed is moderate) and (Precipitation is moderate) then (Fire-probability is low) (1)
4. If (Temperature is moderate) and (Relative-Humidity is moderate) and (Wind-speed is low) then (Fire-probability is low) (1)
5. If (Temperature is moderate) and (Relative-Humidity is low) and (Precipitation is high) then (Fire-probability is high) (1)
6. If (Temperature is moderate) and (Relative-Humidity is low) and (Precipitation is low) then (Fire-probability is high) (1)
7. If (Temperature is low) and (Relative-Humidity is low) then (Fire-probability is low) (1)
8. If (Temperature is low) and (Relative-Humidity is moderate) then (Fire-probability is low) (1)
9. If (Temperature is low) and (Relative-Humidity is high) and (Precipitation is high) then (Fire-probability is low) (1)
10. If (Temperature is low) and (Relative-Humidity is high) and (Precipitation is moderate) then (Fire-probability is low) (1)
11. If (Temperature is low) and (Relative-Humidity is high) and (Precipitation is low) then (Fire-probability is low) (1)

Fig. 19: System based rules

Our typical membership functions are shown in Fig. 20 and Fig. 21.

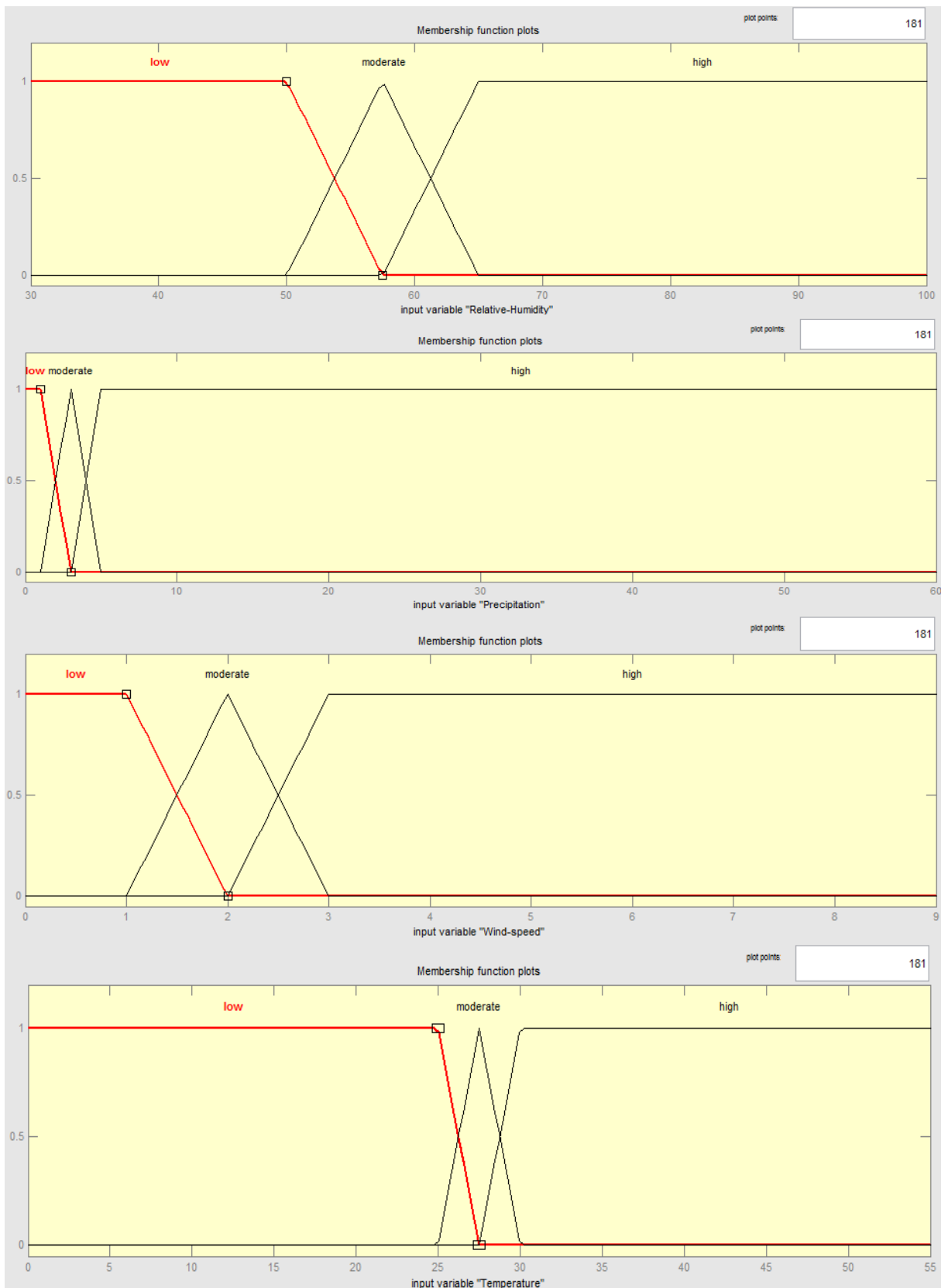

Fig. 20: Inputs membership functions

In our study we have used triangular membership function named by trimf. Each function is built on four input variables of temperature, humidity, precipitation and wind speed.

The obtained MFs figures for each block parameter three degrees of membership (low, moderate and high) as shown in Fig. 21.

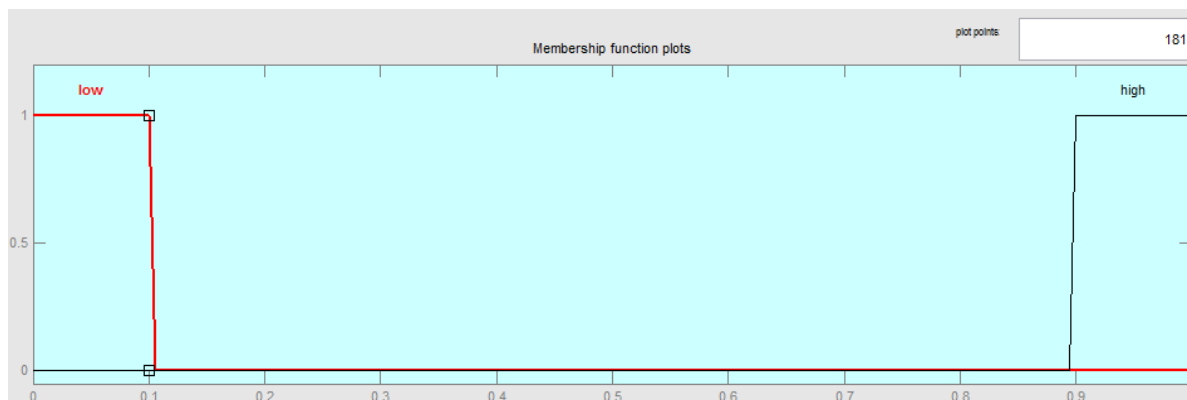

Fig. 21: Output membership functions

Fig. 21 views the output MF representing the MF of danger.

To test the performance of our model, we shall find the confusion matrix and the area under curve as shown in the following figure:

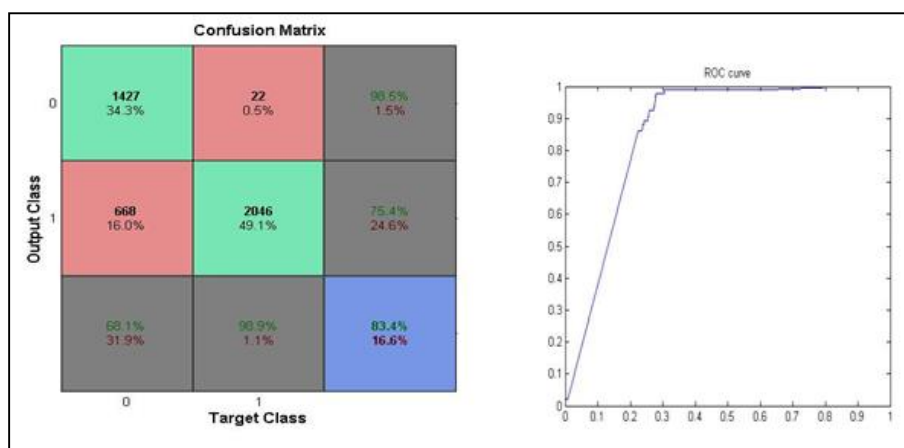

Fig. 22: Confusion Matrix and ROC curve for the fuzzy logic system

Fuzzy logic	Precision %	Specificity %	Sensitivity %	Accuracy %	Area under ROC%
	98.5	98.9	68.1	83.4	86

Table 19: Fuzzy logic testing data

After analyzing Table 19 and Fig. 22, we have found that fuzzy logic prediction system recorded acceptable results over testing data: precision (98.5%), specificity (99.9%), sensitivity (68.1%), accuracy (83.4 %) and area under ROC (86%).

As known, the main objective in this application is to have an accurate danger alarm for forest fire, then the most important testing measures are specificity and accuracy which can summarize the false alarm.

3.8. Linear Discriminate analysis (LDA)

One of the most popular data classification techniques and dimensionality reduction is the Linear Discriminate Analysis. This classification method originally developed in 1936 by R. A. Fisher [38],[39]. Linear Discriminate Analysis easily handles the case where the within class frequencies are unequal and their performance has been examined on randomly generated test data. This method maximizes the ratio of between class variance to the within-class variance in any particular data set thereby guaranteeing maximal separability. Nowadays, LDA has been extensively studied in computer vision and pattern recognition. It has been widely used for feature extraction and dimension reduction in face recognition and text classification.

In LDA data sets can be transformed and test vector can be classified in the transformed sets by 2 different approaches. First approach is the Class dependent transformation where main objective is to maximize this ratio so that adequate class separability is obtained. Second approach is class independent transformation that aims to use only one optimizing criterion to transform the data sets and hence all data points irrespective of their class identity.

LDA can make predictions by estimating the probability that made up of a new set of inputs belonging to each class. The class that gets the highest probability is the output class and a prediction is made. This model is based on Bayes theorem to estimate the probability of the output class (k) given the input class (x) using the probability for each class and the probability of data that belong to each class. The Bayes probability equation is as follows:

$$P(Y = x|X = x) = (PI_k * f_k(x)) / \text{sum}(PI_l * f_l(x)) \quad (3.9)$$

Where PI_k refers to the base probability of each class (k) observed in your training data. In Bayes Theorem the PI_k can be calculated using the number of instances with class k (n_k) as follows:

$$PI_k = n_k/n \quad (3.10)$$

The $f_k(x)$ above is the estimated probability of x belonging to the class. A Gaussian distribution function is used for $f(x)$. By introducing the Gaussian into the above equation and simplifying, we end up with the equation below. This is called a discriminate function and the class is calculated as having the largest value will be the output classification (y):

$$D_k(x) = x * (\mu_k/\sigma^2) - (\mu_k^2/(2 * \sigma^2)) + \ln(\pi_k) \quad (3.11)$$

$D_k(x)$ is the discriminate function for class k given input x , μ_k is the mean value of x for the class k , σ^2 is the variance across all inputs (x) and π_k are all estimated from our data.

Moreover LDA can be used using 2 classes algorithms to find a good projection vector; we need to define a measure of separation. The mean vector of each class in X-space and Y-space can be written as follows:

$$(\mu_i) = \frac{1}{N_i} \sum_{x \in \omega_i} x \quad \text{And} \quad \tilde{\mu}_1 = \frac{1}{N_1} \sum_{y \in \omega_1} y = \frac{1}{N_1} \sum_{x \in \omega_1} w^T x = W^T \mu_i \quad (3.12)$$

Where ω and N are the 2 classes, μ_i is the mean vector, y is the scalar by projecting the sample and T is the constant number calculated by projecting scalar sample of x onto a line in order to choose the distance between projected means using the following equation :

$$w = |\tilde{\mu}_1 - \tilde{\mu}_2| = w^T (\mu_1 - \mu_2) \quad (3.13)$$

3.8.1. LDA validations in predicting forest Fire

Researchers found that LDA is a good predicting technique in the field of forest fires prediction. Jock et al (1999) predicted forest cover types of cartographic variables in Northern Colorado when built a new system based on LDA. It recorded 71.1% of accuracy in testing data [40]. Michael et al (2015) adopted LDA to predict fire risk in Atlanta, where its accuracy recorded 73.3% [41]. Zahou et al (2015) also applied LDA technique to predict forest fire in Shanxi (China), the test results show that the method is generally practical with an average accuracy of 82% in the test region [42].

3.8.2. Application of LDA

In our application we applied the simplest LDA technique between 2 classes. The basic of

this application is to find a linear classifier between fire and no fire, using training and testing sets.

$$y_i = \sum_j^{n=4} w_{ij}X_{ij} + d \quad (3.14)$$

Where X_{ij} are 4 impact factors which correspond to M_i and w_{ij} are weight coefficients of X_{ij} , and d is a constant which could be given according to empirical data.

After Using MATLAB toolbox software we apply LDA ($obj=fitcdiscr$) and thus get the accuracy, precision, specificity, sensitivity and area under ROC afterwards.

Our model is built on the same data that we used on the above model.

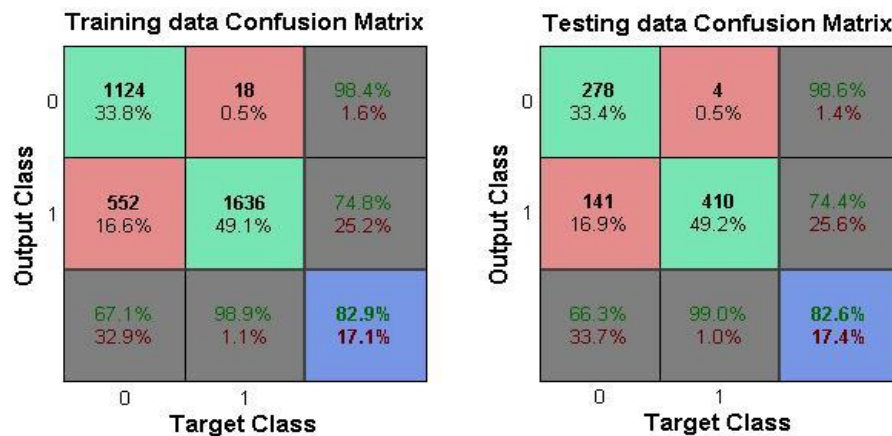

Fig. 23: Training and testing data Confusion Matrix for Discriminate analysis system

After testing this model, we can find that our model predicts 278 true fires (True positive) and misses 141 true fires (False Negative). Furthermore, this system predicts only 4 non-existing fires (False Positive) and 410 true non-fire cases (True Negative). The false alarm in predicting forest fire recorded 0.966%, calculated as follows:

$$FalseAlarm = \frac{Total\ number\ of\ non\ existing\ fires}{Total\ number\ of\ true\ absence\ of\ fires + Total\ number\ of\ non\ existing\ fires} * 100 \quad (3.15)$$

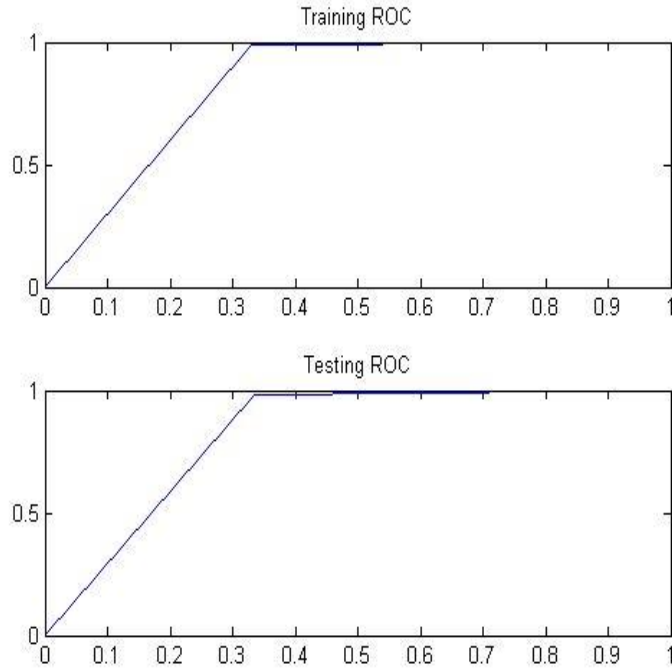

Fig. 24: Training and testing ROC

After analyzing Fig.23 & 24, we can find that the following results are obtained in training: precision (98.9%), specificity (99.9%), sensitivity (66.8%), accuracy (82.9 %) and area under ROC (83%). On the other side, testing data have recorded the following results: precision (96.9%), specificity (97.8%), sensitivity (66.6%), accuracy (82.1 %) and area under ROC (83%) (Refer to Table 20).

LDA	Precision %	Specificity %	Sensitivity %	Accuracy %	Area under ROC %
Training data	98.4	98.9	67.1	82.9	83
Testing data	98.6	99.6	66.3	82.6	82

Table 20: Linear discriminates analysis training and testing data

3.9. Support Vector Machine

Support Vector Machine (SVM) is a supervised machine learning algorithm which can be used for both classification and regression challenges. SVM was introduced by Vladimir Vapnik [43]. The basic idea of SVM is to map the original data X into a feature space F with high dimensionality through a nonlinear mapping function and construct an optimal hyper-plane in the new space as shown in the following figure:

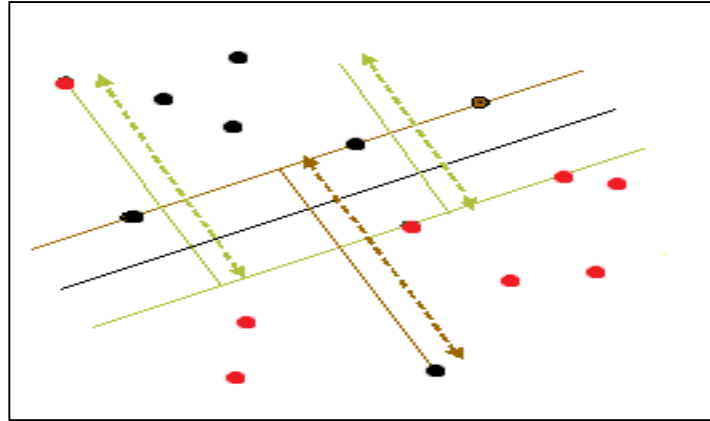

Fig. 25: Representation of Hyper planes

This figure represents the maximum margin trained by 2 samples (Red & black). Given a training set of input and output pairs where output y_i ranges between -1 and 1. The solution of the following optimization problem guarantees the restriction of maximization marginal space. The more formal definition of an initial dataset in set theory is:

$$D = \{x_i, y_i \mid x_i \in \mathbb{R}^p, y_i \in \{-1, 1\}\}_{i=1}^n \quad (3.16)$$

Where D is the data set of n couples of element (x_i, y_i) and p is dimensional vector with dimension p . The distance of closest point on hyper plane to origin can be found by maximizing the distance between 2 planes H_0 and H_1 . The same thing is considered on the other side points, we have a similar scenario. Thus by solving and subtracting the two distances, we can get the summed distance from the separating hyper plane to nearest points as shown in the following Figure:

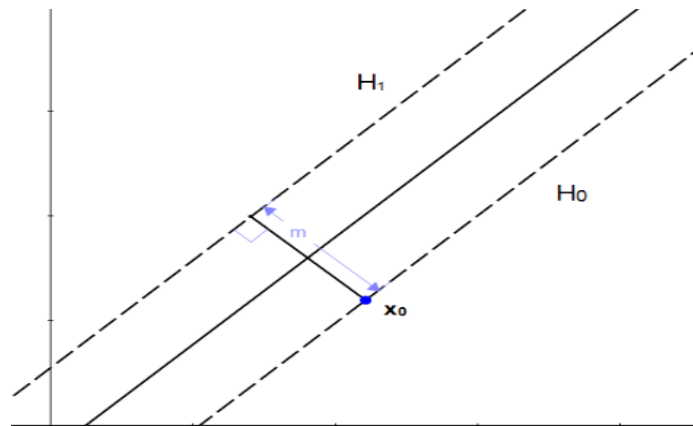

Fig. 26: The distance between the two hyper planes

To find the magnitude of m we should make a perpendicular line between 2-planes H_1 and H_2 . Knowing that H_1 having the equation $wx+b=1$ and H_0 have the equation $wx+b=-1$ while x_0 is a point in a hyper plane as shown in Fig. 26.

Here we can transform our scalar m into a vector k which we can use to perform an addition with the vector x_0 .

$$k = m \frac{w}{\|w\|} \quad (3.17)$$

Knowing that $\|k\| = m$ and k is perpendicular to H_1 since it has same direction of vector u .

In support vector machines we can use different modeling methods (kernel) when data are not linear such as: polynomial, sigmoid, and Gaussian Radial Basis Function. One of the most common strategies is using Kernel Radial Basis Function (RBF) and optimizing its sigma parameter jointly with the C parameter. This method is applied, for instance, by Wu et al (2007) to optimize an SVM model capable of predicting bankruptcy [44]. Also the RBF kernel is usually used for its flexibility in fitting data, other popular kernel methods such as the polynomial or sigmoid kernel methods are also applied in a similar manner [45]. The different Kernel functions are listed below:

- a. Polynomial: It is used for non-linear modeling.
- b. Gaussian Radial Basis Function: It is commonly used with a Gaussian form.
- c. Exponential Radial Basis Function: A radial basis function produces a piecewise linear solution.
- d. Multi-Layer Perceptron: The long established, with a single hidden layer, also has a valid kernel representation.

3.9.1. SVM validations in predicting forest Fire

Mazzomi et al (2005) fed satellite images of forest fires from North America into an SVM which obtained 75% accuracy at finding smoke at the 1.1-km pixel level [44]. George et al (2010) applied SVM using Gaussian radial basis function kernel. The algorithm depended on previous weather conditions in order to predict the fire hazard level in Lebanon after dividing the system into four classes of fire danger; high accuracy of 96% was recorded [43]. Quayen et al (2016) applied SVM to predict forest fire in Portugal based on same weather factors used in Canadian index, and got about 60% accuracy which is an acceptable result [46]. Moreover, after applying different data mining tools (MLP, SVM and RBF Networks) in Turkey using historical forest fire data for prediction, SVM recorded 76% success in predicting forest fire [47].

3.9.2. Application of SVM predictor algorithms

In this study we applied SVM to predict forest fires in Lebanon by dividing our system into 2 classes (fire and no fire). Three different training functions are used: Gaussian Radial Basis Function, Sigmoid (Default scaling factor sigma of 1) and linear function. The goal of this study is to find the best accurate algorithm serving the purpose. SVM predictor algorithms are built using MATLAB software.

Training Kernel Functions	Precision %	Specificity %	Sensitivity %	Accuracy %	Area under ROC%
Linear	80.8	87.9	51.4	69.8	69
Gaussian Radial Basis Function	88.4	95	38.3	66.8	66
Sigmoid	63.6	45.7	93.6	69.8	72

Table 21: Support vector machine training kernel functions

Testing Kernel Functions	Precision %	Specificity %	Sensitivity %	Accuracy %	Area under ROC%
Linear	74.5	83.5	48.8	66.2	66
Gaussian Radial Basis Function	84.3	93.1	37.7	65.5	65
Sigmoid	62.8	45.2	91.4	68.4	71

Table 22: Support vector machine testing kernel functions

Tables 21 and Table 22 show the training and testing data using different functions. In training function sigmoid kernel function shows the best results in precision (65.5%), specificity (53.3%), sensitivity (87.4%), accuracy (70.5 %) and area under ROC (69%). The same function (Sigmoid) shows the best results in testing data, precision (62.8%), specificity (45.2%), and sensitivity (91.4%), and accuracy (68.8 %), area under ROC (71%).

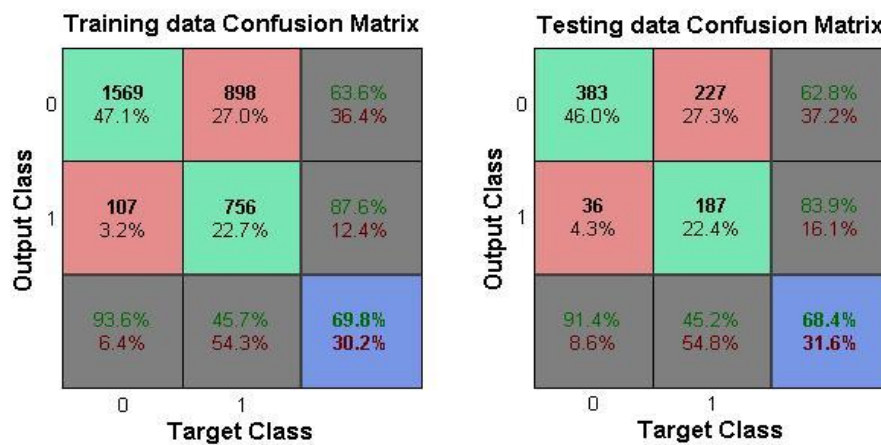

Fig. 27: Confusion matrix for best train and test Algorithm (Sigmoid Function)

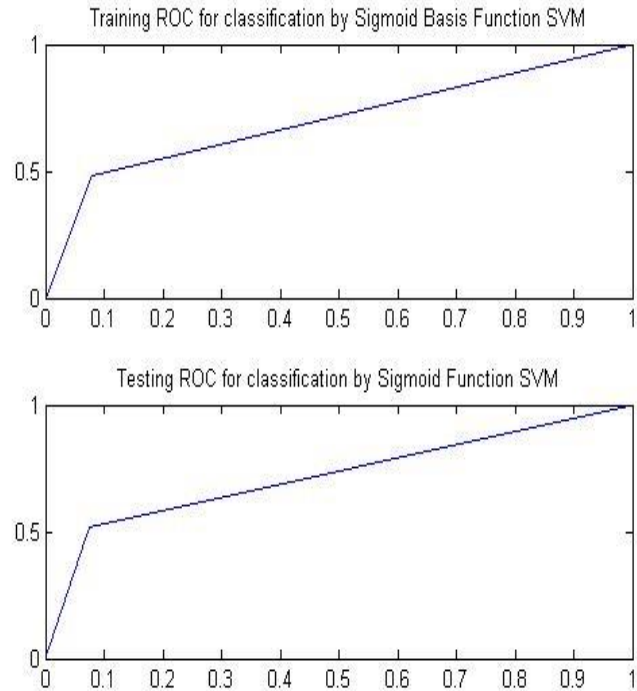

Fig. 28: ROC curve for best train and test Algorithm (Sigmoid Function)

3.10. Comparative study between different data mining techniques applications

Our goal from this comparative study is to find the technique that best fits to the Lebanese Republic aiming to tackle forest fires.

In this study, the accuracies of five data mining techniques are compared as well as AUC, sensitivity, accuracy, specificity, and precision measures. The experimental testing results of all applications are summarized in Table 23.

Data Mining Technique	Precision %	Specificity %	Sensitivity %	Accuracy %	Area under ROC %
Neural Networks	100	100	85.2	92.6	92
Decision Tree (J48)	99.5	99.5	93.8	96.6	97
Fuzzy Logic	98.5	99.4	98.9	83.4	86
LDA	98.6	99.6	66.3	82.6	82
SVM	62.8	45.2	91.4	68.4	71

Table 23: Data mining techniques testing results

Table 23 shows us the experimental testing results of the various data mining techniques

implemented over the same dataset collected from North Lebanon. The results clearly show that decision tree has recorded the best accuracy (96.6%) and the highest ROC (97%) while SVM technique has recorded the lowest results in accuracy (68.4%) and ROC (71%).

Conclusion

Fire plays a vital role in a majority of the forest ecosystems. In the last decades, a substantial effort was made to build efficient detection tools that could assist fire management systems in different cities.

In this chapter we briefly review the various data mining trends and applications from its inception to the future. Five different data mining techniques (Neural Networks, J48 Decision Tree, Fuzzy Logic, LDA and SVM) are employed to predict occurrence of fire at North Lebanon using 4 meteorological parameters (Temperature, Humidity, precipitation and wind speed) collected over 6 years (2009-2014). J48 is found to record the best accuracy in prediction (96.6%) which we can adopt it as best data mining technique in predicting forest fire in Lebanon. Neural Networks using trainlm function with 16 hidden neurons follows J48 technique retrieving the second highest accuracy.

To get better results in neural networks and thus to minimize MSE and get higher rates of statistical measures, the number of years taken for training and testing is suggested to be increased.

In the future we suggest testing the proposed approach by using an online learning environment as part of a fire management system. This will allow us to obtain after some time a valuable feedback from the firefighting managers, in terms of validity and acceptance of these alternative solutions.

References of Chapter 3

- [1]WWF, An analysis of key issues that underlies forest fires and shape subsequent fire management strategies in 12 countries in the Mediterranean basin, WWF project 9Z0731. I, Final Report, May 2001
- [2]C.S.Eastaugh, A.Arpaci, and H.Vacik, "A cautionary note regarding comparisons of fire danger indices", *Nat. Hazards Earth Syst. Sci*, 12, pp. 927–934, April 2012
- [3]N.Hamadeh, A.Hilal, B.Daya and P.Chauvet, "An Analytical Review on the Most widely Used Metrological Models in Forest Fire Prediction", *IEEE TAECE2015, The Third International Conference on Technological Advances in Electrical, Electronics and Computer Engineering*, pp. 239-244, Beirut, Lebanon 29 April – 1 May 2015
- [4]J.Roads, F.Fujioka, S.Chen, "Seasonal Fire Danger Forecasts for the USA", *International Journal of Wild land Fire*, 14 pp. 1-18, 2005
- [5]P.Cortez, A.Morais. "A Data Mining Approach to Predict Forest Fires using Meteorological Data", *13th Portuguese Conference on Artificial Intelligence, Associação Portuguesa para a Inteligência*, pp. 512-523, 2007
- [6]N.Hamadeh, A.Karouni, B.Daya, "Predicting Forest Fire Hazards Using Data Mining Techniques: Decision Tree and Neural Networks", *Advanced Materials Research*, 1051 pp. 466-470, 2014
- [7]M.Berry and G.Linoff."Mastering Dam Mining".New York, 2000
- [8]J.Han, and M.Kamber, "Data Mining: Concepts and Techniques". San Diego Academic Press, 2001
- [9]E.Hajizadeh, H.Ardakani ,J.Shahrabi, "Application of data mining techniques in stock markets:A survey", *Journal of Economics and International Finance* , 2 (7), pp. 109-118, July 2010
- [10]H.Wang, "Prediction of Stock Market Index Movement by Ten Data Mining Techniques", *Modern applied science, CCSE journal*, Vol.3, December 2009
- [11]S.Kharya, "Using Data Mining Techniques For Diagnosis And Prognosis Of Cancer Disease", *International Journal Of Computer Science, Engineering And Information Technology (Ijcseit)*, Vol.2, No.2, April 2012
- [12]R.Sumbaly, N.Vishnusri. and S.Jeyalatha, "Diagnosis of Breast Cancer using Decision Tree Data Mining Technique, " *International Journal of Computer Applications (0975 – 8887) Volume 98– No.10, July 2014*
- [13]J.Soni, U.Ansari ,D.Sharma, "Predictive Data Mining for Medical Diagnosis: An Overview of Heart Disease Prediction", *International Journal of Computer Applications (0975 – 8887) Volume 17– No.8, March 2011*
- [14]L.Dehbozorgi, "A brief comparison matrix of different features for Short term Earthquake Prediction Using Neuro-Fuzzy and Mlp Classifiers", *BULLETIN OF THE GEORGIAN NATIONAL ACADEMY OF SCIENCES* , vols. 8, no. 1, 2014
- [15]R.Marwaha, "Data Mining Techniques and Applications in Telecommunication Industry", *International Journal of Advanced Research in Computer Science and Software Engineering*, Vol. 4, September 2014
- [16]M.Balasubramanian , M.selvarani, "CHURN PREDICTION IN MOBILE TELECOM SYSTEM USING DATA MINING TECHNIQUES" , *international Journal of Scientific and Research Publications*, Vol.4, Issue 4, April 2014

- [17]B.Shih, K.R.Koedinger, R.Scheines, " A Response-Time Model for Bottom-Out Hints as Worked Examples", Proceedings of the First International Conference on Educational Data Mining, pp.117-126, 2008
- [18]R.Baker, A.Carvalho., "Labeling Student Behavior Faster and More Precisely with Text Replays", Proceedings of the First International Conference on Educational Data Mining, pp. 38-47, 2008
- [19]Republic of Lebanon, Ministry of Environment, "Lebanon's Second National Communication to the United Nations Framework Convention on Climate Change", Beirut, February, 2011
- [20]UNDP/GEF and MPWT/DGU, "Climatic Zoning for Buildings in Lebanon", 2005
- [21]N.Hamid , N.Nawi , "Accelerating Learning Performance of Back Propagation Algorithm by Using Adaptive Gain Together with Adaptive Momentum and Adaptive Learning Rate on Classification Problems", International Journal of Software Engineering and its Applications, 5, No.4, pp.31-44, 2011
- [22]M.Alsmedi, K.Bin Omar and S.Noah ,"Back Propagation Algorithm: The Best Algorithm among the Multi-layer Perceptron Algorithm", International Journal of Computer Science and Network Security, Vol.9, No.4, pp.378-383,2009
- [23]A.Betanzos, O.Romero, B.Berdinas, E.Pereira, M.Inmaculada, E.Jime´nez, J.Soto, T.Carballas, "An intelligent system for forest fire risk prediction and fire Fighting management in Galicia", Journal of Expert Systems with Applications, pp.545–554, 2003
- [24]C.Vasilakos, K.Kalabokidis, J.Hatzopoulos, G.Kallos and Yi.Matsinos, "Integrating new methods and tools in fire danger rating", International Journal of Wildland Fire, pp.306–316, 2007
- [25]F.Teodoro, T.Koerner, R.Chlad, "A data-based model for predicting wildfires in Chapada das Mesas National Park in the State of Maranhão", Journal of Environmental Earth Science , 8 May 2015
- [26]S.Sitanggang, R.Yaakob, N.Mustapha, A.Ainuddin, "Classification Model for Hotspot Occurrences using Spatial Decision Tree Algorithm", Journal of Computer Science, pp.244-251, 2013
- [27]A.Cencerrado, A.Cort´es, T.Margalef, "Prediction Time Assessment in a DDDAS for Natural Hazard Management: Forest Fire Study Case", Procedia Computer Science, vol.4, pp.1761–1770, 2011
- [28]I.Sitanggang, R.Yaakob, N.Mustapha, A.Ainuddin, "application of classification algorithms in data mining for hotspots occurrence prediction in Riau province Indonesia" Journal of Theoretical and Applied Information Technology, Vol. 43 No.2 ,September 2012
- [29]D.Stojanova, P.Panov, A.Kobler, S.Džeroski, KaterinaTaškova, "Learning to predict forest fires with different Data Mining techniques", Conference on Data Mining and Data Warehouses (SiKDD 2006),Ljubljana, Slovenia, pp. 255-258, October 9, 2006
- [30]V.Iyer, S.Iyengar, N.Paramesh, G.Murthy, M.Srinivas , "Machine Learning and Data mining Algorithms for Predicting Accidental Small Forest Fires", The Fifth International Conference on Sensor Technologies and Applications, pp.116-121, 2011
- [31]L.Zadeh, "Fuzzy Sets", Intl Journal of Information Control, 8, PP. 338-353, 1965

- [32]L.Iliadis, A.Papastavrou, P.Lefakis, "A heuristic expert system for forest fire guidance in Greece" J Environ Manage, pp.327-36, July, 2002
- [33]K.weber, J.Langille and R.Neves, "Modeling Wildland Fire Susceptibility Using Fuzzy Systems", GIScience & Remote Sensing, 43, No. 3, pp. 268-282, 2006
- [34]A.Oliveira and M.Nero, "Applying of Fuzzy Logic in Predicting of Fire Joao City - Brazil", Geo-Informatics in Resource Management and Sustainable Ecosystem journal , 399, pp. 323-334, 2013
- [35]H.Pourghasemi, M.Beheshtirad and B.Pradhan, "A comparative assessment of prediction capabilities of modified analytical hierarchy process (M-AHP) and Mamdani fuzzy logic models using Netcad-GIS for forest fire susceptibility mapping", Geomatics, Natural Hazards and Risk, 2014
- [36]J.Jassbi, P.Serra, R.Ribeiro, A.Donati. "A comparison of mamdani and Sugeno inference systems for a space fault detection application". Automation Congress, pp.24-26, 2006
- [37]P.Belhumeur, J.Hespanha, and D.Kriegman, "Eigenfaces vs. Fisherfaces: Recognition Using Class Specific Linear Projection", IEEE Transactions on Pattern Analysis and Machine Intelligence, 1997
- [38]R.A.Fisher, "The use of multiple measurements in taxonomic problems", Annals of Eugenics, pp.179-188, 1936
- [39]R.Duda, P.Hart, and D. "Stork. Pattern Classification", John Wiley and Sons 2nd edition, 2000
- [40]J.Blackard, D.Dean, "Comparative accuracies of artificial neural networks and discriminant analysis in predicting forest cover types from cartographic variables", Computers and Electronics in Agriculture, pp.131-151, 1999
- [41]M.Madaio, O.Haimson, W.Zhang, X.Cheng ,M.Aldrich, Bistra. Chau, "Identifying and Prioritizing Fire Inspections: A Case Study of Predicting Fire Risk in Atlanta", Bloomberg Data for Good Exchange Conference, New York City, NY, USA. 28-Sep-2015
- [42]Z.Jing, M.Weiqing and Z.Ye, "Fisher Linear Discriminant Method for Forest Fire Risk Points on Transmission Line", International Journal of Smart Home, 9, pp. 25-34 2015
- [43]V.Vapnik, "The Nature of Statistical Learning Theory", Springer- Verlag, New York, 1995
- [44]C.Wu, G.Tzeng, Y.Goo, and W.Fang, "A real-valued genetic algorithm to optimize the parameters of support vector machine for predicting bankruptcy", Expert Systems with Applications, pp.397-408, 2007
- [45]H.Lin and C.Lin, "A study on sigmoid kernels for SVM and the training of non- PSD kernels by SMO-type methods", Technical report, Department of Computer Science, National Taiwan University, 2003
- [46]Q.Nguyen, G.Chakraborty, "Predicting forest fire occurrence and incremental fire rate using SASR 9.4 and SASR Enterprise Miner TM 14.1", Oklahoma State University, Paper 9361, 2016

[47]A.MuratOzbayoglu and R.Bozer, "Estimation of the burned area in forest fires using computational intelligence techniques", Procedia Computer Science, 12, PP.282 – 287, 2012

Chapter 4: A Proposal of New Weather Index for Lebanon and the Mediterranean: Assessment versus Prevalent Meteorological indices

4.1. Introduction

Nowadays, scientific research is oriented towards natural disasters threatening our ecosystems. Natural crises such as earthquakes, tornados, floods and forest fires may cause damage to the shape of the land besides their threat to living things. Forest Fires are considered among the most dangerous. Their frequencies are increasing day after day especially in the prevailing local and global climate changes which make these kind of natural disasters a complex phenomenon to tackle. This is despite the fact that wildfire is an important part of nature. It plays a key role in shaping ecosystems by serving as an agent of renewal and change.

Scientists have been working hard to predict forest fire danger since 1940. Many mathematical models, based on weather data, were implemented to estimate fire danger level. Fire danger rating based on meteorological data is more precise when it is based on weather forecast of the previous evening or previous day [1][2]. Calculation methods lead to a numerical index that is translated as a level of alarm which rises with the increase in probability of fire occurrence conditions. Fire regimes have serious consequences on the local environment and boost global climate change through emission of long-lived greenhouse gases and physical changes in vegetation structures [3][4]. According to a recent study by Van Der Werf [5], in the last two decades, forest fires have contributed approximately 15% of the world's total carbon emissions. Although the contribution of global warming in changing fire regimes is still unclear, it's expected that higher temperatures will result in increasing the risk of fire occurrence.

This research focuses on the case of Lebanon which has been facing the threat of fires in the last decades and is considered one of the most affected areas in the Mediterranean region by forest fires. Forests had covered most of Lebanon landscape in the past. According to the Association for Forests Development and Conservation AFDC, only 13% of the Lebanese area is still forested [6]. To conduct this research, North Lebanon is an appropriate place to be studied because 94 fires have been reported during the last 6 years (2009 and 2014).

In recent years with climate change, Lebanon has become more susceptible to fires. Previous research applied artificial intelligence based methods. Sakr et al. (2011) used two parameters only: relative humidity and cumulative precipitation and showed the ability of support vector machine (SVM) and neural networks (NN) to precisely predict the possibility of fire / no fire [7]. Likewise, a preliminary work on a system of remote sensing was designed by El hajj et al. (2009) [8] for prediction of forest fires and rapid fire detection. The system consists of sensors, a weather station and a website. The

sensors with the weather station are able to discover different environmental conditions and retransmit them on the website where SVM and NN are combined to predict the estimated area of fire. These contributions didn't present a quantitative weather index. This is the first time such a model is developed to analyze forest fire risk in Lebanon.

As concluded in Chapter 2, a weather index is related to its own place of study as it is affected by local meteorological factors. The main purpose of this chapter is to have an early warning index adapted to Lebanon and its conditions that contributes in reducing forest fires occurrence. A simple linear mathematical model is derived from data analysis, and comparison between meteorological data and the occurred fires in North Lebanon. Our real data were collected from the Lebanese Agriculture Research Institute (LARI) during the last 6 years. Our goal from data analysis is to find the appropriate parameters in the given inputs: temperature, soil temperature, relative humidity, wind speed, precipitation and dew point and the occurrence of fire. Then the relationships between the selected attributes are used to develop a fire danger index. The new obtained index is then verified to be conforming to the Lebanese environment and its characteristics.

4.2. Place of study and data

Lebanon is part of the Middle East, located at approximately 35°N; 35°E. The area of the Lebanese Republic is 10452 Km², divided into five regional administrative districts: Beirut, North Lebanon, South Lebanon, The Beqaa and Nabatiyeh. Its weather is generally mild. In winter, it is cool and wet; while in summer it is hot and dry. During the last several decades, green and forest areas declined rapidly in the country. This created an urgent need for intervention which requires strict governmental policies and support of non-governmental organizations as well.

Fig. 29 shows a summary of the collected data, the obtained maximum and minimum values and the correlation of each parameter with fire occurrence. The effect of each weather attribute on the occurrence of fire is shown in the following graphs. North Lebanon Governorate is the most affected place by fires in the country.

The meteorological data (temperature, soil temperature, relative humidity, wind speed, precipitation and dew point) are provided by Lebanese Agriculture Research Institute, LARI collected from their station located in Kfarchakhna city. The inputs for 6 years (2009-2015) are undertaken for study. Data prior to 2009 are unfortunately not available. Kfarchakhna is a city which lies about 220 meters above sea level, 25 kilometers from the Mediterranean Sea and about 80 kilometers north of Beirut. The distribution of fires over the six years taken for our study is shown in Fig. 29.

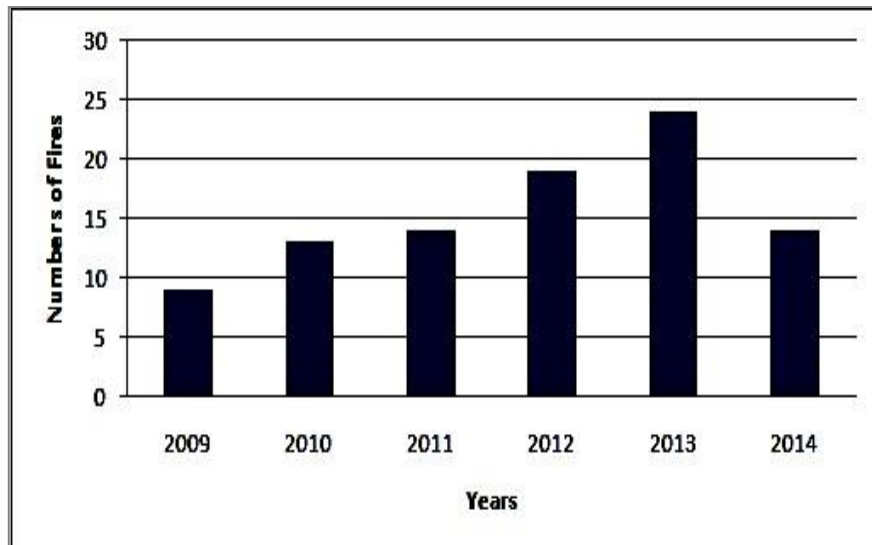

Fig. 29: Numbers of forest fire over the period 2009-2014

4.3. Data analysis to identify the influential parameters

Meteorological factors such as dew point, soil temperature, air temperature, humidity, precipitation and wind speed have a major impact on the occurrence of forest fires as these climatic factors change with time and space rapidly; we can't ignore the effect of the relationships among the involved parameters.

To predict a forest fire, we should find the effective parameters that facilitate fire occurrence. Here, we tend to use the regression analysis to find the influential meteorological parameters that affects fire occurrence.

In our work, we adopted the following key attributes: temperature, Humidity, dew point, soil temperature in the upper layer, wind speed, and precipitation as function of fire occurrence during the 6 years (2009-2014) have been adopted to build the model for fire index. During the last 6 years, there were 2095 days with No fire and 94 days with fire (A total of 2189 days). To balance the data, we multiplied the number of days with fire by 22 to have 2068 days with fire and 2095 days with no fire as shown in Table 24.

In the following figures (Fig. 30 to Fig. 35), the studied parameter (scatter plots) is viewed in function of day number over the 6 years of study (2189 days) where the bars indicate the day numbers where a fire incidence took place.

Parameters	Total Number of Days	Days with No Fire	Days With Fire	Linear Regression Correlation Coefficient	Maximum	Minimum

Temperature (°C)	4163	2095	2068(94days presented 22 times)	0.72	37.36	0.75
Relative Humidity (%)	4163	2095	2068(94days presented 22 times)	0.02	93	34
Dew Point (°C)	4163	2095	2068(94days presented 22 times)	0.61	23.25	-5.7
Precipitation (mm)	4163	2095	2068(94days presented 22 times)	0.19	53.2	0
Soil Temperature (°C)	4163	2095	2068(94days presented 22 times)	0.65	54	8.18
Wind Speed (m/S)	4163	2095	2068(94days presented 22 times)	0.21	29.9	0.9

Table 24: Correlation coefficient of studied parameters with fire occurrence after balancing dataset

4.3.1. Temperature

Temperature is the inner energy of motion presented by the atoms and molecules composing a substance and is important in determining the ease of fuel ignition. It is this heat energy that is crucial in the beginning of the evaporative phase of combustion [9]. So, higher temperatures heat forest fuels and predispose them to ignition once sufficient source of ignition is available.

Fig. 30 shows that as temperature increases, fire danger increases (during the six years). This reveals that there is a high positive correlation of 0.72 between temperature and the number of fire occurrences.

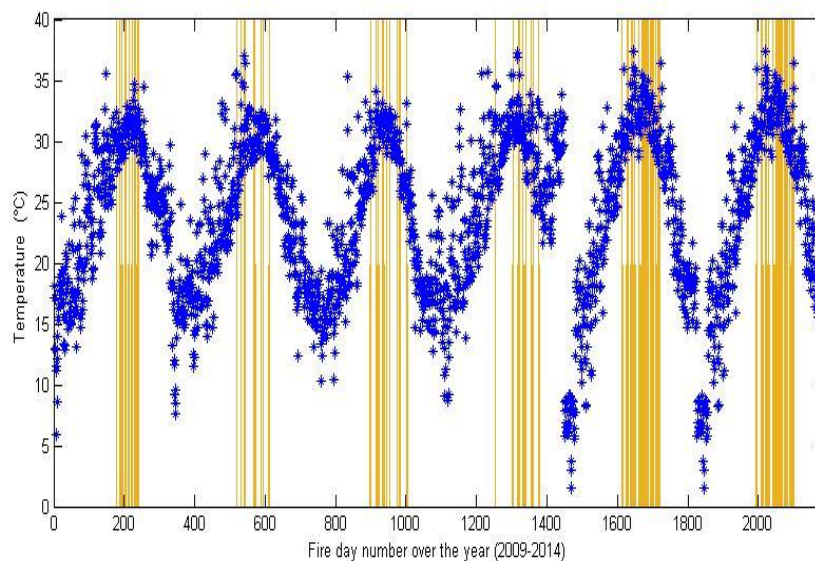

Fig. 30: Temperature (°C) in function of fire occurrence per day over the 6 years (2189 days)

4.3.2. Relative Humidity

Relative humidity is an expression of the amount of moisture the air is capable to hold at that temperature and pressure. Preferred relative humidity for prescribed under burning varies from 30 to 55 percent [10]. When the air can't "hold" all the moisture, then it condenses as dew when relative humidity falls below 30 percent, prescribed burning becomes dangerous.

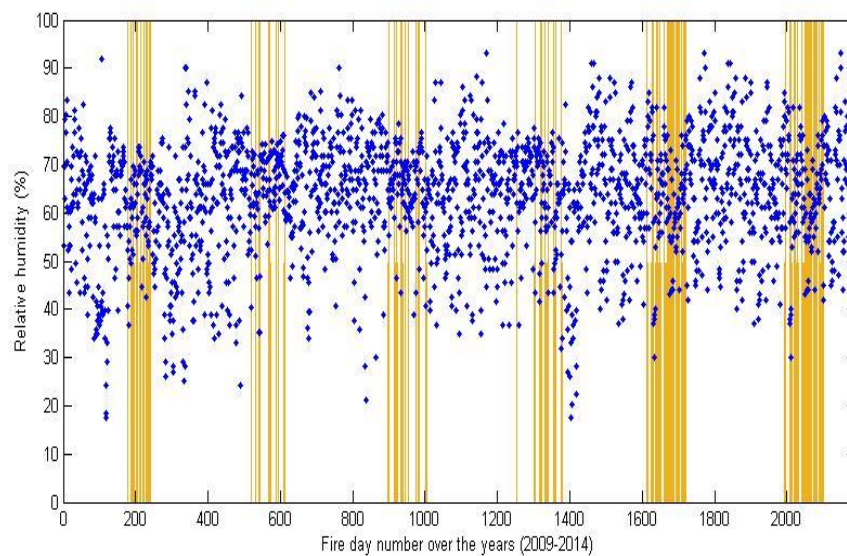

Fig. 31: Relative humidity (%) in function of fire occurrence per day over the 6 years

The effect of relative humidity on fire occurrence is not clearly shown in Fig.31 where the fire occurrence accidents occurred when relative humidity ranged from 45 to 90%. Fig.31 shows a low correlation of 0.02 between relative humidity and fire occurrence.

4.3.3. Dew Point temperature

Dew point is the temperature at which air cannot hold the water vapor which is mixed with it. Moreover, some of the water vapor must condense into liquid water. The dew point is always lower than (or equal to) the air temperature. When we have higher dew point it means that the atmosphere is humid.

The dew point temperature measured by device called Hygrometer which it consists of a polished metal mirror which is cooled as air passed over it.

Fig. 32 views the dew point in function of fire occurrence. As the dew point rates increase, the danger of fire increases drawing a high correlation coefficient of 0.61.

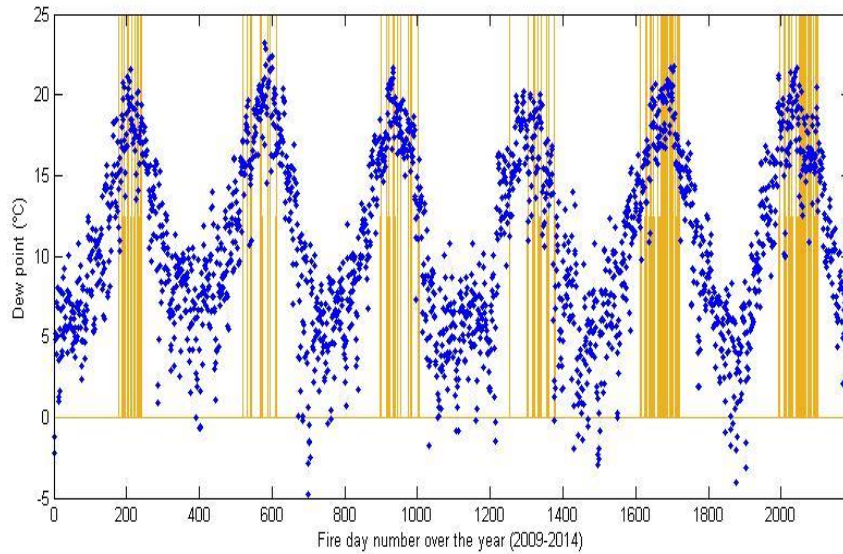

Fig. 32: Dew point in function of fire occurrence per day over the 6 years

4.3.4. Soil Temperature

Soil is affected directly by the air temperature and sun radiation absorbed by the micro substances between layers [11]. It has been assumed that high temperatures affect seedlings, first, by increasing evaporative demand, and second, by direct tissue damage where seedlings are in contact with hot surfaces which increase the drought in soil and thus increase the chance of fire occurrence.

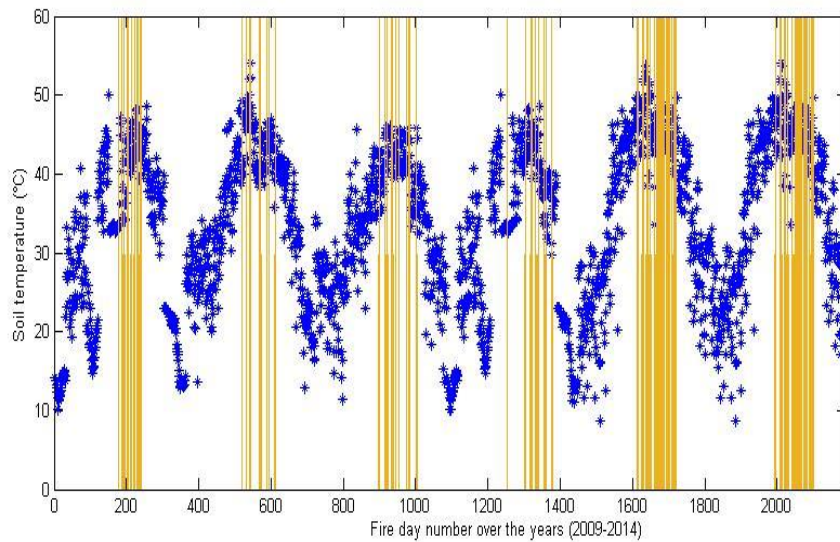

Fig. 33: Soil temperature in function of fire occurrence per day over the 6 years

Fig. 33 clearly shows the effect of soil temperature on fire occurrence. Fire danger increases with the increase of soil upper layer temperature. The high correlation recorded is 0.65.

4.3.5. Wind Speed

Wind is the most important factor on wildland fire. Fire behavior is strongly affected by wind speed and its direction, which vary in time at the scale on the order of hours, minutes, and seconds [12]. But it has limited effect on burning process (pre- fire) [13].

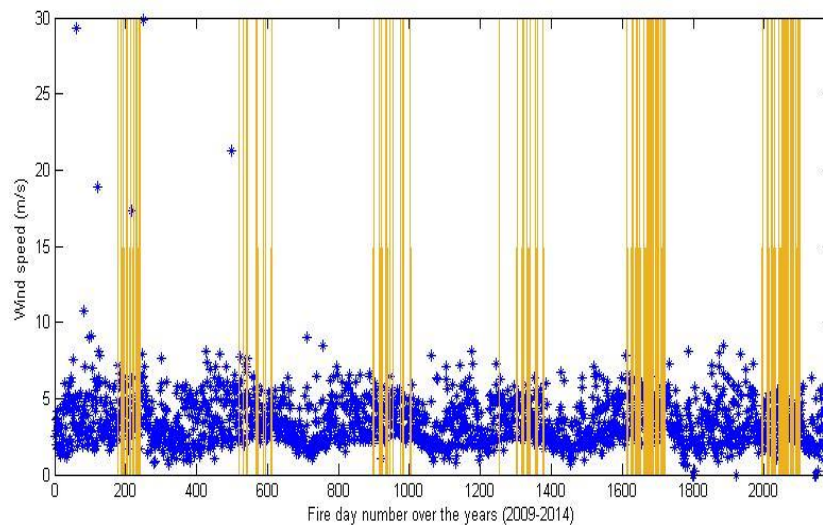

Fig. 34 : Wind speed (m/s) in function of fire occurrence per day over the 6 years

Fig. 34 shows weak correlation between fire occurrence and wind speed (low correlation of 0.21) .

4.3.6. Precipitation

Precipitation includes all of the moisture that falls from the atmosphere and reaches the earth's surface. Also if affected directly from the evaporation during summer season. But it has a negative effect on fire occurrence. Several previous studies have focused on the highly non-linear nature of precipitation and fire occurrence in the region; severe fire happens only below a threshold (>1mm) of seasonal precipitation [14] [5].

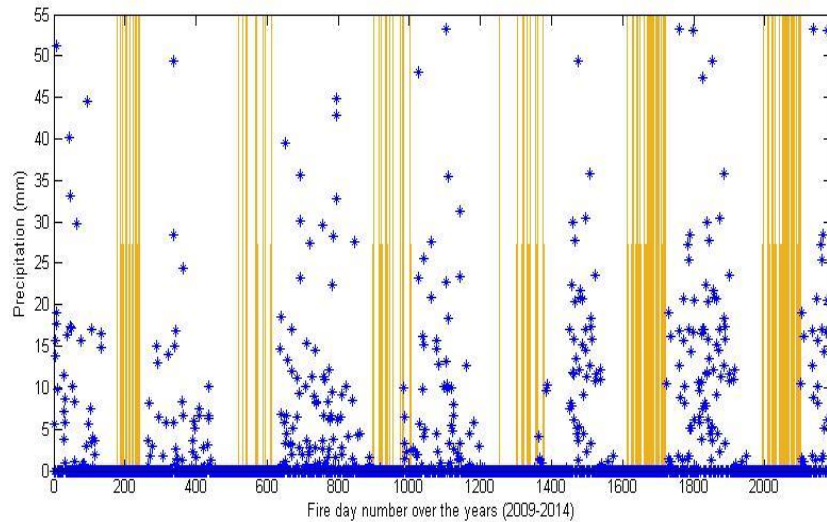

Fig. 35: Precipitation (mm) in function of fire occurrence per day over the 6 years

After analyzing Fig. 35, 80% of fire occurrence was reported when the precipitation was less than the threshold but as a theory the correlation recorded 0.19 which means that there is low correlation. Based on the obtained correlation coefficients, it is demonstrated that temperature, dew point, upper layer soil, temperature are strongly correlated with fire occurrence, and thus they are selected to build the desired early warning model.

4.4. Pearson, Spearman and Kendall correlative data analysis

Correlation coefficient is a measure of association between two variables, and it ranges between -1 and 1 . Several correlation coefficients based on different statistical hypothesis are popular today. They are Pearson correlation coefficient; Spearman rank correlation coefficient and Kendall rank correlation coefficient [15]. These correlation methods have been used in several statistical studies in economics, accounting, and geography and many other studies.

4.4.1. Pearson correlative data analysis

Pearson's correlation is a parametric test created by Bravais in 1846 but Karl Pearson described it in 1896. It is used to measure the degree of relationship between two linear related commodities assuming that data is normally distributed about the regression line [16]. Pearson is a product moment correlation that attempts to draw a best fit line between two variables. In Pearson correlation, r -value indicates how far away all these data point from the best fitting line. It takes the range between -1 and 1 . When the r -value is greater than 0 this implies that there is a positive correlation while when r -value

is less than 0, the correlation is negative. Having a dataset ($x_1...x_n$) containing n -values and another dataset ($y_1...y_n$) containing n -values, we can use the following equation to calculate the r -value:

$$r = \frac{\sum_{i=1}^n (x_i - \bar{x})(y_i - \bar{y})}{\sqrt{\sum_{i=1}^n (x_i - \bar{x})^2} \sqrt{\sum_{i=1}^n (y_i - \bar{y})^2}} \quad (4.1)$$

In our study we applied Pearson correlation method between fire occurrence and the metrological parameters of the years 2009-2014, recalling that 94 forest fires have been occurred during these years.

Parameters	p-value	Pearson's Correlation Coefficient
Temperature (°C)	~0	0.6391
Relative Humidity (%)	1.29625×10^{-39}	-0.2021
Dew Point (°C)	~0	0.5767
Precipitation (mm)	2.15909×10^{-41}	-0.2067
Soil Temperature (°C)	~0	0.6071
Wind Speed (m/S)	1.63716×10^{-26}	0.1641

Table 25: Pearson correlation coefficient between fire occurrence and weather parameters

The above table views the P-value and the Pearson correlation coefficient for each metrological factor (Temperature, Relative humidity, Dew point, Precipitation and Soil temperature). P-value is a measure that tests the significance of the correlation coefficient. It tells you whether the correlation coefficient is significantly different from 0 and how it is. It is often compared to significance level α that usually takes the values 0.02-0.05. The correlation between two variables is said to be statistically significant if and only if the p-value is less than or equal to the significance level.

Table 25 clearly shows that Temperature, Soil temperature and Dew point have recorded the highest correlation coefficient between meteorological factors, while relative humidity and precipitation have showed limited negative correlations.

According to Cohen's standard, coefficients above 0.5 represent a large association. It can be noticed that all obtained p-values are less than the chosen significance

level $\alpha=0.05$ which means that the desired outcome from statistical correlations attain statistical significance, thereby rejecting the null hypothesis.

4.4.2. Spearman's correlative data analysis

Spearman's correlation method is a non-parametric measure of correlation between two variables. This method indicates the magnitude and the direction of association between two variables. It is a simple method which can be calculated without computer. For a correlation between variables x and y , the formula for calculating the Spearman's correlation coefficient is given as the following:

$$r_s = 1 - \frac{6 \sum_{i=1}^n d_i^2}{n(n^2-1)} \quad (4.2)$$

Where r_s represents the Spearman's rank correlation, d_i represents the difference rank between values of variable for each item.

The Spearman's rank correlation coefficient can be used to test for association between both ordinals and continuous variables. Also the relationship between variables shall be monotonic. That is, generally speaking, the variables should either increase in values together, or when one gets increased, and then the other should get decreased.

So, the main goal of Spearman's rank correlation coefficient is to investigate the existence of any association in the underlying variables. The null hypothesis is constructed as having no rank correlation between the variables. Spearman's correlation method has been applied between numbers of fires occurrence and metrological parameters to find the correlation coefficient as shown in Table 26.

Parameters	Spearman's Correlation Coefficient
Temperature (°C)	0.6748
Relative Humidity (%)	-0.2031
Dew Point (°C)	0.5517
Precipitation (mm)	-0.2574
Soil Temperature (°C)	0.6231
Wind Speed (m/S)	0.2288

Table 26: Spearman correlation coefficient between

fire occurrence and weather parameters

Table 26 clearly shows that Temperature (0.6748), Dew point (0.5517) and Soil temperature (0.6231) recorded the best correlation coefficient with numbers of fires. While Relative humidity (-0.2031), Precipitation (-0.2574) and Wind speed (0.2288) showed weak correlation with fire occurrence.

4.4.3. Kendall's tau correlative data analysis

The Kendall rank correlation coefficient, named by Kendall's tau, is used to measure the association between two variables [16]. The name tau means the non-parametric (it does not depend upon the assumptions of various underlying distributions) hypothesis test for statistical dependence based on the tau coefficient.

Kendall's tau represents a probability difference between the probabilities that the observed data are in the same order versus the probability that the observed data are not in the same order.

To get Kendall correlation coefficient, we have to find concordant pairs (x and y) and discordant pairs (x and y) of n random variables defined as the following:

$$\tau = \frac{(\text{number of concordant pairs}) - (\text{number of discordant})}{n(n-1)/2} \quad (4.3)$$

Parameters	Kendal's Tau Correlation Coefficient
Temperature (°C)	0.7093
Relative Humidity (%)	0.0199
Dew Point (°C)	0.6007
Precipitation (mm)	0.6951
Soil Temperature (°C)	0.3068
Wind Speed (m/S)	-0.2655

Table 27: Spearman correlation coefficient between fire occurrence and weather parameters

After applying Kendall's method, it's revealed that Temperature, Dew point and Soil temperature have showed a strong correlation between fire accidents and meteorological factors, while the other factors have recorded a limited association.

4.5. Finding the relationships among affective parameters to derive Lebanese Index (LI)

Before going through elaborating the index, it is necessary to find the mutual relationships between the vital parameters, which are temperature (°C), soil temperature (°C) and dew point (°C) using the same datasets coming from 2189 days.

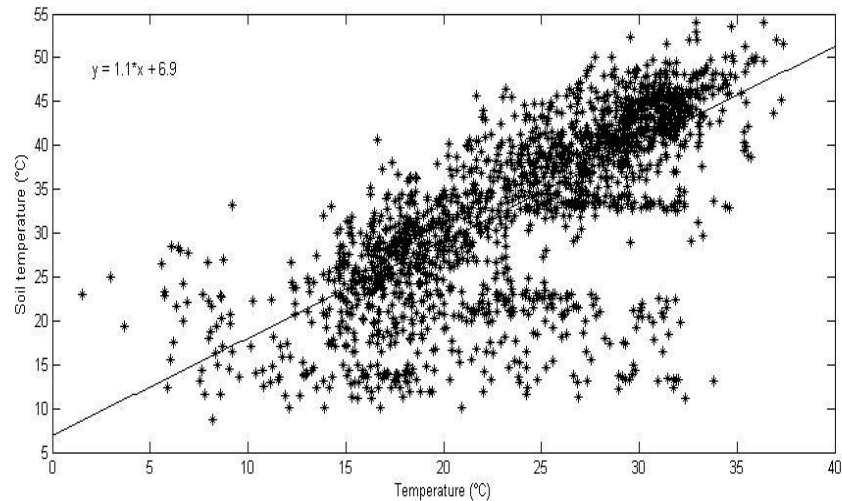

Fig. 36: The relationship between temperature (°C) and soil temperature on the upper layer

Fig. 36 shows the strong relationship between temperature (°C) and soil temperature (°C) over the 2198 days after recording a high positive correlation between the two parameters (correlation=0.69). As shown in the figure, a linear equation with positive slope describes the relation-ship between both attributes.

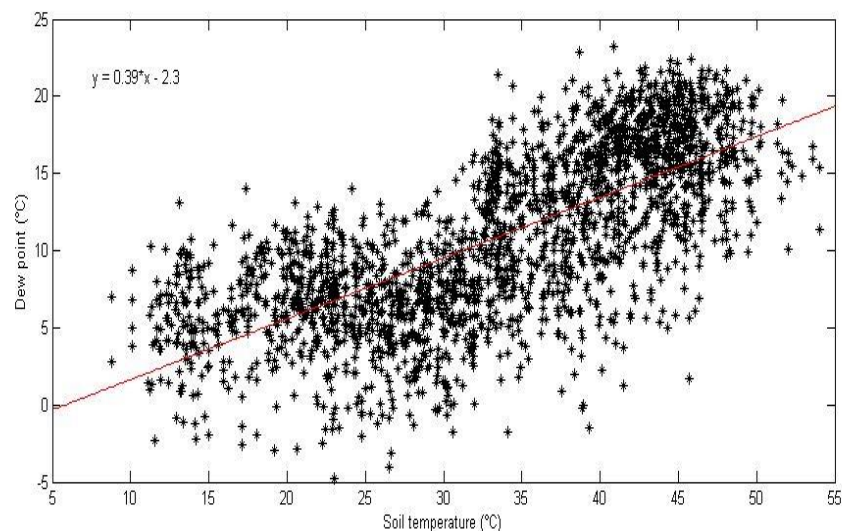

Fig. 37: The relationship between dew point (°C) and soil upper layer temperature (°C)

Fig. 37 shows the relationship between dew point (°C) and upper layer soil temperature (°C) over the six years. We can notice that as dew point varies, the soil temperature varies in the same direction deriving a high positive of 0.67.

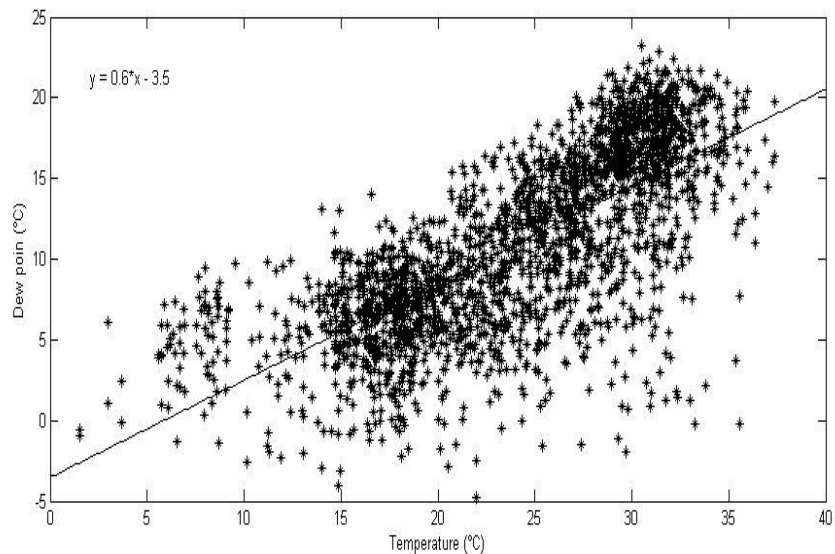

Fig. 38: The relationship between temperature (°C) and dew point (°C)

Similarly, Fig. 38 displays the linear interpolation showing the strong relationship between temperature (°C) and dew point (°C) over the 2189 days. As temperature increases, the dew point increases. The reported correlation coefficient is 0.69. Based on the above; the three elected parameters show strong mutual correlations among themselves (Table 28).

Parameters	Correlation	Linear Equation
Temperature & Soil Temperature(°C)	0.73	$Y = 1.1X + 6.9$
Temperature & Dew Point(°C)	0.69	$Y = 0.39X - 2.3$
Dew Point & Soil Temperature(°C)	0.67	$Y = 0.6X - 3.5$

Table 28: Mutual correlations among selected parameters based on linear regression technique

The entire interpretation results show that fire occurrence is mainly affected by three attributes (temperature, dew point and soil upper layer temperature) among the familiar six attributes that we used in our study. Out of these factors, temperature is the easiest to measure using simple apparatus. Dew point can be obtained in the same manner but with a little bit more advanced tools which commensurate with the situation of Lebanon and other developing countries.

Dew point temperature can be calculated using Equations 4.4 & 4.5 [17].

$$B_i = \frac{\ln\left(\frac{RH}{100}\right) + \frac{17.27 \cdot T}{237.3 + T}}{17.27} \quad (4.4)$$

$$D = \frac{237.3 \cdot B_i}{1 - B_i} \quad (4.5)$$

Where T is the air temperature (Dry Bulb) (°C), RH is the relative humidity (%), Bi is an intermediate value (no unit) and D is the dew point (°C)

On the other hand, soil temperature (w/m²) depends on heat flux and heat conduction for soil upper layer. Its equation is shown in Equation 4.6 [18].

$$R_n - G = LE + H \quad (4.6)$$

Where R_n is the net radiation, G is the soil heat flux density at the soil surface, and LE and H are the latent and sensible heat flux densities, respectively (All in w/m²).

The new simplified model that fits developing countries in the Mediterranean and their affordability is then the summation of the three picked out parameters (T, D, and S) taking into account the strength of correlation of each parameter among temperature, dew point and soil temperature with the desired output (having correlations of 0.72, 0.61 & 0.65 respectively with fire occurrence, Table 4.1). It is shown in equation 4.7.

$$LI = 1.18T + 1.07S + D \quad (4.7)$$

Where LI is the fire danger index, D is the dew point (°C), T is the temperature (°C) and S is the soil temperature (°C).

4.6. Validation of Lebanon Index

The Index has been applied on the year of 2015 and almost 2016 at Kfarchakna city which was used in our study. The equation is calculated over 617 days to examine the performance of LI against the 29 fires which occurred during this period.

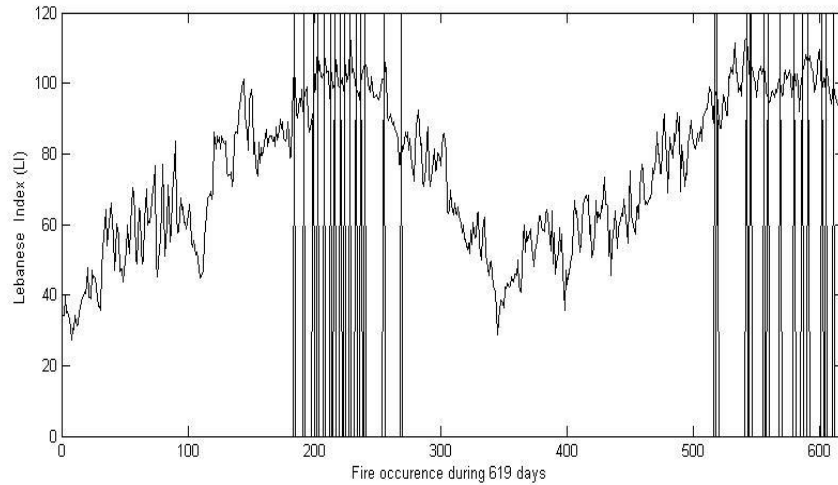

Fig. 39: Validation of fire danger index in function of fire occurrence

Fig.39 displays LI in function of the number of fires. We can notice that when LI increases, the fire risk increases especially in summer season when the output of LI is greater than 90. Contrary, there is no risk when the index is less than or equal 70.

Here we can state the risk range of our proposed index as shown in Table 29.

Index	Fire Risk
$I \leq 70$	No Fire
$70 < I \leq 80$	Low Risk
$80 < I \leq 90$	Medium Risk
$90 < I \leq 100$	High Risk
$I > 100$	Extremely High Risk

Table 29: New index potential scale

After stating its potential scale, we test LI over the said dataset. In order to reach our goal of validation, our index is assumed to predict the occurrence of fire when values corresponding to high and extremely high fire risks are achieved. Certain measures are used for testing and evaluation. The values of True Positive (TP), False Positive (FP), True Negative (TN) and False Negative (FN) are computed to calculate Precision, Accuracy, Specificity, Sensitivity and AUC; Area under the curve of receiver operating characteristic (ROC) as shown in Table 30.

TP	TN	FN	FP	Precision (%)	Accuracy (%)	Specificity (%)	Sensitivity (%)	AUC (%)
28	424	1	164	14.58	73.26	72.11	96.55	84.33

Table 30: Measurements of Precision, Accuracy, Specificity, Sensitivity and AUC for LI

In the field of forest fire prediction, TP and FN tend to be the most important parameters that would affect negatively on the index decision, while FP and TN are less significant. Human beings lives, their properties and the environment are much more valuable than the costs that could be spent on preventive measures in case of false alarms. Thus in our case study, AUC and Sensitivity found to be the most critical measurements for an adequate evaluation, as both formulas depend on TP and FN [19]. The computed sensitivity (96.55%), AUC (84.33%) and are relatively very high while precision is low (14.58%). The low precision is caused by small dataset used for testing (only 29 fires out of 617 cases).

To better examine the performance of our index, the mean square error MSE is calculated using equation 4.8:

$$MSE = \frac{1}{n} \sum_{i=1}^n (Y_i - y_i)^2 \quad (4.8)$$

Y_i and y_i represent the predicted value of the new index and the real value of the day irrespectively. Y_i and y_i can take the values 0 when no fire is detected and 1 in case of fire. The obtained mean squared error (MSE) for the tested dataset is 0.267, which is very good while dealing with the discrete values 0 and 1 only.

4.7. Assessment of Lebanon Index versus prevalent meteorological indices

The vital features of the currently adopted weather models are stated in Table 4.7 allowing having a reasonable assessment of the novel index. The chosen indices for this mission are as follows: Angstrom, Nesterov, Modified Nesterov, KBDI, Baumgartner, Modified KBDI, Canadian FWI, FFDI, Simple Fire Danger Index and FD.

Fire Danger Indices	Place Of Study	Year Of Study	Characteristics Of Place Of Study	Parameters Used	Model Characteristics	Tested and Adopted Places
Angstrom	Sweden	1949	Polar Climate, high precipitation and humidity	Temperature and Humidity	Daily Empirical Index, Easy to measure.	Sweden, Germany
Nesterov	Russia	1967	Polar Climate, high humidity	Dew Point and Temperature	Cumulative index, easy to measure.	Slovakia, Germany

Table 31: Forest fire danger indices feature

M-Nesterov	Russia	1968	Polar Climate, high humidity	Dew Point and Temperature	Cumulative index, easy to measure.	Russia and Canada
KBDI	Southern United States	1968	Hot and dry weather in summer with high humidity	Temperature and mean annual rain fall	Cumulative index, Hard to measure.	United States, Australia, Indonesia
Baumgartner	Germany	1967	High precipitation cold and cloudy weather in winter	Precipitation and evapotranspiration	Cumulative index, easy to measure.	Germany
M-KBDI	Greece	2011	Mediterranean weather (Mild)	Temperature and mean annual rain fall	Cumulative index, Hard to measure.	Greece, Indonesia, Malaysia
FWI	Canada	1970	Wet and high precipitation in summer , very cold in winter	Temperature , relative humidity and precipitation	Cumulative index, Hard to measure.	Canada, China, Chile, Fiji, Indonesia, Malaysia ,Mexico, Thailand, United Kingdom, Argentina
FFDI	Australia	1970	High precipitation and high humidity in summer	Precipitation, relative humidity, temperature and wind speed	Cumulative index, Hard to measure.	Australia, Italy, Spain , USA , Portugal , Greece and Canada
Simple Fire Danger(F)	Australia	2008	High precipitation and high humidity in summer	Temperature and relative humidity	Cumulative index, easy to measure.	Australia and Switzerland
FD	Czech Republic	2014	Warm and dry in summer , cold in winter with high wind speed	Relative humidity , temperature, wind speed and soil moisture	Cumulative index, easy to measure.	Czech Republic, Germany and Sweden
LI	Lebanese Republic	2016	Mediterranean weather (Mild)	Temperature , Dew point and soil temperature	Cumulative index, easy to measure.	Lebanon

Upon analyzing Table 31, we can notice that air temperature, relative humidity and wind speed have been used as input parameters in several fire risk systems to estimate meteorological risks. While the potential evapotranspiration parameter (Baumgartner index), soil temperature (LI) and soil moisture (FD) are ignored in most fire indices.

All the above indices mentioned the effect of climate indirectly on drought using precipitation, evapotranspiration, soil temperature, soil moisture and rainfall due to complexity of drought [20]. LI claims to take into consideration the influence of drought.

As known, fire danger indices are either cumulative or daily indices. Most of the indices are of the first category. These increase steadily in the absence of rain and go back to zero when rain occurs. A cumulative index, due to its cumulative concept, presents especially high values during the end of September like KBDI [21], whereas fire activity is normally reduced, due to atmospheric conditions. This limitation doesn't exist in the daily LI.

Baumgartner and Simple fire danger index have limitations on forest fire prediction over the year (9 months) as their potential scales have maximal end to reach and beyond they are unable to predict, while the other indices involving LI have no upper limit to predict.

The Nesterov Index, by definition, falls down to zero if we have more than 3 mm precipitation which makes it a weak index [22]. As precipitation is ignored by LI, then this condition is not attributable and the corresponding weakness is avoided.

Among the studied indices, only two have been developed in the Mediterranean region: M-KBDI (Greece) and our LI. Factors including field capacity (200mm) and R-threshold (3mm) were changed in the modified version of M-KBDI to adapt to the Mediterranean conditions. It has been tested and accepted in many countries (Greece, Italy and Spain). It has proven its efficiency in Lebanon as well [19].

It seems interesting to present a comparison between M-KBDI and our proposed index. While M-KBDI is a cumulative drought index that, because of the cumulative conception, could wrongly forecast high levels in fire danger rating; LI is a daily index, where the daily conception may affect its precision as the weather information of the previous day are ignored. Further, the equations of both indices imposed some simplifications and estimations upon derivation: the drought factor incorporated in M-KBDI, expressing the water loss in the system and expressed by potential evapotranspiration PET, is difficult to obtain accurately, and the same is considered in the litter moisture content; on the other side, the equations used in LI are estimated based on regression equations and corresponding correlation coefficients. Here, in the point of estimations, appears the advantage of LI over M-KBDI as the LI's incorporated estimations are limited to one trend which is not the case in M-KBDI. Regarding the inclusion of drought factor in M-KBDI, it is good to point-out that LI also considers this factor indirectly by the inclusion of soil temperature. High soil temperatures lead to increasing evaporative demand and thus increase the drought in soil. Other advantage is recorded to LI is its ignorance of precipitation. Conversely, another disadvantage is recorded to M-KBDI represented in the index initialization based on assumptions and suggestions, for example, the index starts

up when the mean daily temperature is 6 (°C) for three consecutive days, as the Canadian FWI suggests. Initialization is not needed in LI at all.

Conclusion

Lebanon's green areas are in a critical situation because it is close to losing up to 90% of it. For this reason, this study focuses on the effects of six meteorological data on fire ignition during the last 6 years in North Lebanon. The study found out that three parameters (Temperature, Soil Temperature and Dew point) are the most influential ones that induce fire occurrences. These parameters show a good correlation with fire occurrence, while the other parameters (Humidity, precipitation and wind speed) demonstrate limited weak correlations with fire occurrence. In order to find a new index that could fit Lebanon's situation, we have studied the mutual association among the weather data themselves. The research has found linear regression relationships between the selected vital parameters and the number of fires. Based on this finding, the new index is created. Other widely used correlation techniques were applied (Pearson, Spearman and Kendall), and the results show compliance with those obtained by regression.

Validation of LI shows conformity between the index predictions and the real fire occurrences after testing over the year 2015 and 2016. Good results were recorded upon finding mean square error (0.267), sensitivity (96.55%) and AUC (84.33%). Accordingly, we can implement this new early warning index which is based on three meteorological parameters and can be simplified into two parameters that are easy to collect in the developing countries of the Mediterranean. The purpose of this index is to support the Lebanese republic to fight against fire occurrences.

The new index can be easily adopted by the Lebanese government and other parties concerned in forest management to define the forests; most prone to fires; and declare them as natural reserves. The next step that should be taken is to apply the index on daily basis through reporting and recording the observations. This will allow placing these susceptible areas under controlled surveillance especially after determining the proactive measures to deal with different expected fire scenarios. These preliminary actions constitute a danger-level specific policy and a first action necessary to foresee and thus tackle significant fire activity.

References of chapter 4

[1]S.J.Pyne, P.L.Andrews, R.D.Laven. "Introduction to wildland fire". New York, NY: John Wiley & Sons, Inc. pp: 769, 1996

[2]N.P.Gillett, A.J.Weaver ,F.W.Zwiers , M.D.Flannigan. "Detecting the effect of climate change on Canadian forest fires, Geophys Res Lett 31, pp: 182-189, 2004

[3]M.Galanter, I.Levy, G.Carmichael. "Impacts of biomass burning on tropospheric CO, NO_x, and O₃". Journal of Geophysical Research: Atmospheres Vol, 105, pp: 6633- 6653

[4]H.Winkler, P.Formenti, D.J.Esterhuyse, R.J.Swap, G.Helas, H.J.Annegarn, M.O.Andreae. "Evidence for large-scale transport of biomass burning aerosols from sun photometry at a remote South African site". Atmospheric Environment Vol 42, pp:5569-5578, 2008

- [5]GR.Van der Werf, J.DempewolfSN.Trigg, JT.Randerson, PS.Kasibhatla, L.Giglio, D.Murdiyaso, W.Peters, DC.Morton, GJ.Collatz, AJ.DolmanRS.DeFries. "Climate regulation of fire emissions and deforestation in equatorial Asia". Proceeding of the National Academy of Sciences Vol, 105, pp: 20350–20355, 2008
- [6]E.Knusten. Civil defense extinguish a forest fire in Betshai, The Daily Star newspaper, May 12, 2014
- [7]G.Sakr, I.Elhajj, G.Mitri , "Efficient forest fire occurrence prediction for developing countries using two weather parameters. International Scientific Journal Engineering Applications of Artificial Intelligence 24(5): 888-894, 2011
- [8]I.ElHajj and G.Mitri, "Remote sensing for forest fire prediction and detection. 7emes journées géographiques Télédétection, Statistiques et Sciences Sociales": Quelles interactions pour quelles fins, Beirut, 29-30 April 2009
- [9]EA.Johnson, K.Miyanishi. "Forest fires: behavior and ecological effects". Academic press, San Diego, California, USA, 2001.
- [10]RE.Sosebee, DB.Wester, CM.Britton, ED.McArthur, SG Kitchen .Proceedings: Shrubland dynamics fire and water; 2004 August 10-12; Lubbock, TX. Proceedings RMRS-P-47. Fort Collins, CO: U.S. Department of Agriculture, Forest Service, Rocky Mountain Research Station, pp:173, 2007
- [11]EK.Eric, LE.Becky, NS. "Carl. Ecological effects of prescribed fire season: a literature review and synthesis for managers United States Department of Agriculture Forest Service" Pacific Southwest Research Station, General Technical Report PSW-GTR-224 September 2009
- [12]RC.Rothermel . "A mathematical model for predicting fire spread in wildland fuels, USDA Forest Service". Intermountain Forest and Range Experiment Station Research Paper INT -15,1972
- [13]PE.Dennison, MA.Moritz, RS.Taylor ."Evaluating predictive models of critical live fuel moisture in the Santa Monica Mountains, California". International Journal of Wildland Fire Vol, 17, pp: 18-27, 2008
- [14]RD.Field, SP.Shen. "Predictability of carbon emissions from biomass burning in Indonesia from 1997 to 2006". Journal of Geophysical research Vol, 113, pp: 690-694.
- [15]G.Atila and İ.Öznur . "A Comparison of the most commonly used measures of association for doubly ordered square contingency tables via simulation". Metodološki zvezki ,Vol, 8 (1), pp: 17-37, 2011
- [16]H.Jan, K.Tomasz. "Comparison of values of Pearson's and Spearman's correlation coefficients on the same sets of data". Questions geographical, Vol, 30(2), pp: 87-93, 2011
- [17]R.Snyder and R.Snow. "Converting Humidity Expressions with Computers and Calculators". University of California Division of Agricultural Sciences, 1984
- [18]J.Thomas and R.Horton. Soil Heat Flux. Micrometeorology in Agricultural Systems Agronomy Monograph Vol, 47, pp: 131-154, 2005
- [19]A.Karouni, B.Daya and S.Bahlak. "A comparative study of applicability of fire weather indices for Lebanon". Global Journal on Technology Vol, 5, pp: 8-7,2014

[20]RR Heim. "A review of twentieth-century drought indices used in the United States", American Meteorological Society 83, pp. 1149-1165, 2002

[21]D.Spano, P.Duce, RL.Snyder, P.Zara, A.Ventura, "Assessment of fuel dryness index on Mediterranean vegetation", In: Proceedings of the 6th Symposium on Fire and Forest Meteorology, Cammore, Canada, October 24-27, 2005

[22]G.Buchholzand D.Weidemann, "The use of simple fire danger rating system as a tool for early warning in forestry", International Forest Fire News 23: pp. 32-36, 2000

Part 3: Forest Fire Diffusion

Chapter 5: Overview on Widely Used Fire Behavior Models

Abstract

Fires are known as destructive natural phenomena. They are classified into 3 types: Surface, ground and crown fire. Researchers unanimously agreed that all fire types are

affected directly by three main factors: topography, weather and fuel. They found that fire spreads to have an elliptical shape. Many mathematical models were applied in order to manage fire crises. With the scientific advances in computing system, scientists developed different software tools based on Rothermel equations in order to simulate fire spread in an accurate and relatively quick way.

Currently researchers are interested in new techniques in modeling natural dynamic phenomena; such as percolation and cellular automata. Cellular automata (1D and 2D) have recorded a great success in predicting fire spread and its evolution with time. While techniques like percolation were limited in predicting such phenomena.

In this unit, we propose a new computerized model for simulating the spread of a fire front in homogeneous and inhomogeneous landscapes aiming to tackle fire crisis and control its consequences. It is based on a 2D cellular automata model, in which the dynamic diffusion is driven by local rules derived from experimental studies carried out in the past by Fons. The proposed model incorporates the attributes of wind, vegetation fuel and terrain topography; and sorts them into global and local agents. An innovative feature of the model is the fire spread demonstration on elliptical fronts. The developed fire behavior model has been tested using spatial data from the 2007 fires that broke up on Aandqet village, North Lebanon in June of 2007 and destroyed a major part of its forest. Results from the simulations of the proposed model and the real incident observations indicate an excellent agreement. Comparison with Karafyllidis Linear Model and Modified Karafyllidis Circular Model showed that outperformance of the new model and as such could be used as an efficient preventive tool in forest fire management.

Résumé

Les incendies sont connus comme des phénomènes naturels destructeurs. Ils sont classés en 3 types : surface, sol et couronne du feu. Les chercheurs ont convenu à l'unanimité que tous les types d'incendie sont directement affectés par trois facteurs principaux: topographie, météo et carburant. Ils ont constaté que le feu se diffuse pour avoir une forme elliptique. De nombreux modèles mathématiques ont été appliqués pour gérer les crises d'incendie. Avec les progrès scientifiques dans le système informatique, les scientifiques ont développé différents outils logiciels différents basés sur les équations de Rothermel afin de simuler la propagation du feu d'une manière précise et relativement rapide.

Actuellement, les chercheurs s'intéressent aux nouvelles techniques de modélisation des phénomènes dynamiques naturels; tels que la percolation et les automates cellulaires. Les automates cellulaires (1D et 2D) ont connu un grand succès dans la prédiction de la propagation du feu et de son évolution dans le temps. Bien que des techniques comme la percolation aient été limitées dans la prévision de tels phénomènes.

Dans cette unité, nous proposons un nouveau modèle informatisé pour simuler la propagation d'un front d'incendie dans des paysages homogènes et inhomogènes visant à lutter contre les incendies et à en contrôler les conséquences. Il est basé sur un modèle d'automates cellulaires 2D, dans lequel la diffusion dynamique est guidée par des règles locales dérivées d'études expérimentales réalisées dans le passé par Fons. Le modèle proposé intègre les attributs du vent, de la végétation et de la topographie du terrain; et les classifie en agents mondiaux et locaux. Une caractéristique novatrice du modèle est la démonstration de propagation du feu sur les fronts elliptiques. Le modèle développé de comportement du feu a été testé à partir des données spatiales des feux de 2007 qui ont éclaté au village d'Aandqet, au nord du Liban en juin 2007, et qui ont détruit une grande partie de sa forêt. Les résultats des simulations du modèle proposé et des observations réelles d'incidents indiquent un excellent accord. La comparaison avec le modèle linéaire de Karafyllidis et le modèle circulaire de Karafyllidis modifié a montré que la surperformance du nouveau modèle et en tant que telle pourrait être utilisée comme outil préventif efficace dans la gestion des feux de forêt.

5.1. Introduction

Wild land fires pose a serious problem to human life and property when homes are built in fire-prone ecosystems. Fire behavior prediction is a troublesome mission that is defined as the manner in which fuel ignites, flame develops, and fire spread and exhibits. A wildfire is an uncontrolled fire that destructing out many acres of forests, shrubs, grassland as well as animals species. The scientific synonym of fire behavior is used to describe the direction and the intensity of fire spread. Fire behavior directly affected by meteorological and physical conditions. The combination between physical and meteorological conditions is almost infinite, and since the point of ignition unpredictable, the fire behavior has univocal characteristics.

The behavior and effects of individual fires can be described by fire severity . Fire severity can be defined by degree of dominant over story species mortality, the amount of organic

biomass consumed on or in the soil, heat penetration into the soil, change in soil color or ash color, or a combination of all these, however, in mapping fire regimes, severity is usually defined by the amount of mortality of fuel [1], [2]. The major influencing factors in determining individual fire behavior and severity are weather, topography, fuels and fuel breaks. Some studies have found that weather is more strongly associated with fire behavior than fuels [3]. Wind in particular may be a major factor in fire spread [4], [5]. Dry years that are preceded by wet years also tend to experience a higher frequency of fires and increases in fire severity [6]. However, when climatic conditions are not extreme, topographic features in the landscape have a strong influence on fire spread and behavior [7].

In this chapter a literature review is made on fire behavior models which reveals that the most affective parameters on fire behavior are divided into 3 elements (Weather, Fuel and Topography), where each element consists of different types of parameters that have direct and indirect effects on fire behavior [8] [9]. Regarding the shape of fire, the researchers found that fire spreads in elliptical shape. But the sticking point among researchers was the fuel modeling, since every researcher implemented his model according to the place of study and its conditions.

In the last decade, many models were applied to predict fire spread phenomenon. These models are mainly divided into two types: classical models and computerized models. The improvement in computing technologies led researchers interested in computer systems and methodologies to conduct the spatial expansion of fire behavior prediction through computers. These models are easy to use by anybody involved in forest conservation. Most of computer model are based on Rothermel equations and geographical information systems (GIS), which recorded acceptable accuracy in wildfire prediction.

5.2. Fire behavior foundations

Fire behavior is the term used to describe the intensity, direction and magnitude of how a fire spreads. During the chemical combustion fire behaviors affected by different scenarios. Since 1948, there are conflicting opinions among researchers about fire behavior types and morphology. In recent studies about this phenomenon, the researchers have agreed on new foundations that show how fire starts and ends.

5.2.1. Fire types

A forest fire could occur and evolve assuming different characteristics. Researchers divided wildfire into three different types to enable fire management; Ground, Surface and Crown fires. These types classified fire according to its shape and propagation and intensity.

Most fires are ground fires that consume mostly the duff layer and don't produce visible flame. Ground fires can also burn out stumps and follow and burn decaying roots and decayed logs in the soil. These fires usually occur during periods of protracted drought when the entire soil organic layer may dry sufficiently.

Crown fires occur when stand structure, weather and ladder fuels allow surface or ground fires to ignite tree crowns and spread to other crown and thus burning continues through the top layer of foliage on a tree, known as the canopy or crown fires. Crown fires, the most intense type of fire and often the most difficult to contain, need strong winds, steep slopes and a heavy fuel load to continue burning.

Surface fires can spread with a flaming front and burn leaf litter, fallen branches and other fuels located at ground level also named by underground fire. The topology of fire types is shown in Fig. 40.

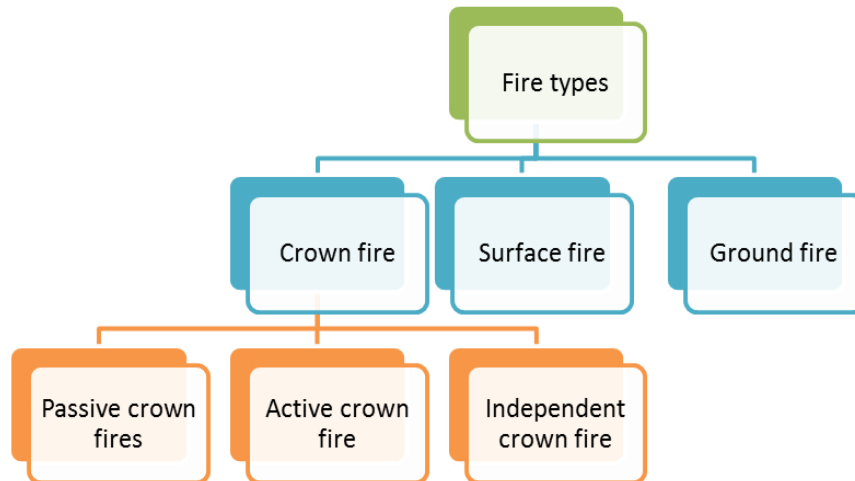

Fig. 40: Topology of fire types

a) Crown fires

Crown fire is a fire that spread through a fuel complex burning to the treetops. Crown fire is the most dangerous type, because this type is very difficult to fight. Crown fires have been divided into three types depending on the crown phase [10]:

- ✓ Passive crown fires: This type of fire is less than the critical fire spread rate which can never make a total combustion that leads to crown fire. The crown

phase will depend on the surface phase, where spread rate will condition the flame front displacement.

- ✓ Active crown fire: This type is also known by running fire, since it presents a solid wall of flame from the surface through the canopy fuel layers.
- ✓ Independent crown fire: This type of fire rarely occurs because the conditions that support it: the dense canopy fuel with decline slope or strong wind and sparse or unavailable surface fuel; are limited in spatial and temporal extent.

b) Surface fire

This type of fire spread with a flaming front and burn wooded leaves, litters, small shrubs and anything on the ground. But surface can be controlled by fire fighters because it has medium fire intensity that burn on the surface of the ground.

c) Ground fire

This type is not usually appearing on the land surface, since it burns the humus and the roots of plants. This type rarely occurs, because of the lack of fuel on this layer. Since ground fuels are compact, have limited oxygen supply and are protected from wind, a persistent slow burning fire is produced. In addition, it is hardy to burn because it meets with moisture contents which late the pyrolysis can process before burning.

5.2.2. Fire morphology

Many researchers concerned with the prediction of fire shape have focused on the elliptical model of fire perimeter growth. Since when ignition occurs, the fire will start to draw an elliptic shape as fire creeps. This prompts the researchers to divide the parts of elliptic fire in order to manage the fire creeping [11] [12]. The morphology of wild fire can be divided into two different patterns: quality and quantity. The quality comprises the shape of burned and unburned zones while the quantity signifies the orientation of the flaming front with respect to the direction of maximum spread which represents the relative spread direction.

The dependence on the elliptical template has been widespread because most fire behavior models only predict the head rate of spread.

Van Wagner (1969) introduced the methodologies of the elliptical model of fire spread. He examined the shapes produced by rapid-moving and high intensity. In addition he simplified the final shape of fire spread by a simple elliptical shape [13].

Green et al (1983) also found the elliptical model to be a satisfactory descriptor of the perimeter of a free burning fire [14].

Anderson (1983) found that the shape of fire using different wind speeds is made up of two ellipses based on common axis with the backward fire described by an ellipse with a shorter major axis. Anderson based his approach on the results of a series of 198 laboratory fires conducted in a wind tunnel by Fons in 1939 [11].

Richard (1993) explained that fire spread can move like a fan shape during the variation of wind speed and its direction and thus an elliptical spread pattern is obtained. Richard found that fire spread is independent of the shape of the fire front [15].



Fig. 41: Elliptical fire spread shape

To describe the parts and the shape of fire, researchers divided the elliptical shape into 9 parts as shown in Fig. 42 [16] [17].

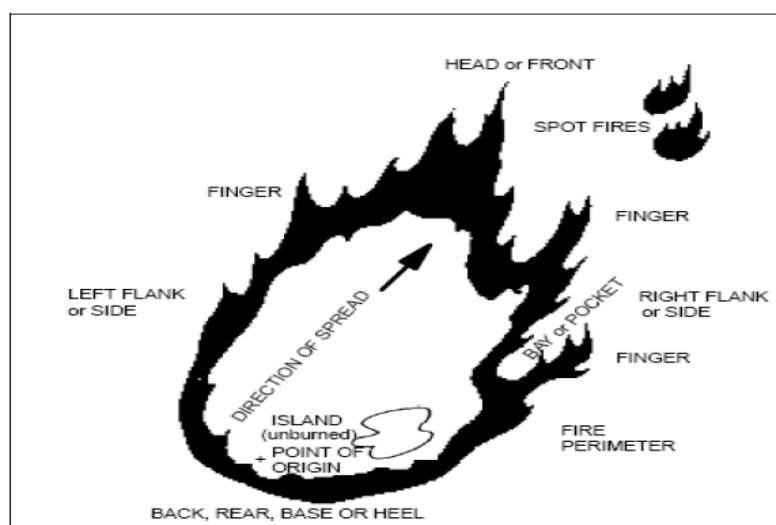

Fig. 42: Anatomical parts of fire

- ✓ Point of origin, it is the accurate location where a competent ignition source came into contact with the fuel.
- ✓ Head of a fire, which is the side of the fire having the rapid rate of fire spread.
- ✓ Flank of a fire, is the part of a fire's perimeter that is roughly parallel to the main direction of spread.
- ✓ Rear of a fire, is the Portion of a fire spreading directly into the wind and opposite to the head.
- ✓ Fire perimeter, is the Boundaries of a fire.
- ✓ Finger of a fire, is the long narrow extensions of a fire projecting from the main body.
- ✓ Pockets of a fire, is the slow burning areas.
- ✓ Island, is the area of unburned fuel inside the fire perimeter.
- ✓ Ejected fire spots.

In brief, we can describe the morphology of a wildfire by shape and by relative spread direction. Wildfire can be physically specified by relative spread direction, which is the angle between the heading direction of a fire and the direction the flaming front faces. For a heading fire, the flaming front is facing directly in the heading direction. On the flank of a fire, the flaming front faces 90 degrees off of the heading direction. The flaming front at the rear of a fire faces directly opposite 180 degrees the heading direction.

5.3. Parameters that affect the behavior of wildfire

The fire effects on natural ecosystems involve the response of living organisms to the release of heat energy through the combustion of plant material. The study of fire behavior reveals realizing the factors that influence fire diffusion. Wildfire modeling attempts to reproduce fire behavior includes how quickly the fire spreads, in which direction, how much heat it generates. Fire modeling also aims to estimate fire effects, such as the ecological and hydrological effects. Wildfire behavior is directly affected by surrounding environment. Fire behavior factors influence the intensity of fire suppression as summarized in Table 32.

Fire behavior factors		Effects on fire behavior
Weather	Temperature	Influence the temperature of the fuel to have a rapid ignition
	Relative humidity	Dries up the moisture content of the fuel when it is in high rates.

	Wind speed	<ul style="list-style-type: none"> a. Increase the fuel combustion b. Increase the rate of fire spread. c. Wind causes the angle of the flames to become more acute.
Fuel	Fuel quantity	The quantity of fuel increases the rate of combustion chemical reaction.
	Fuel continuity	<ul style="list-style-type: none"> a. As there is a continuity of fuel, the fire will creep without any hit. b. If there is no continuity, the fire pocket shape will occur.
	Fuel size	<ul style="list-style-type: none"> a. Small fuels can be heated and ignited faster. b. Small fuels absorb low moisture content than big ones.
	Fuel arrangement	Vertical or horizontal arrangement affects fire intensity and surface flame.
	Fuel Moisture content	As the moisture content of fuel increases, the ignition will be down or slow due to unburned zones.
Topography	Slope	<p>Slope significantly influences the forward rate of spread of surface fires by modifying the degree of preheating of the unburned fuel immediately in front of the flames.</p> <p>The steeper the slope, the faster the fire moves and the more severe it becomes.</p>
	Aspect	<ul style="list-style-type: none"> a. Is the direction of the slope b. Affects how much solar radiation a site receives. c. North slopes are cooler and have more vegetation d. South slopes receive much higher solar radiation and are warmer.
	Elevation	<ul style="list-style-type: none"> a. It affects the fire behavior by Influencing the amount and timing of precipitation. b. Affects the seasonal drying of fuel.

Table 32: Fire behavior factors and its effects on fire spread

5.3.1. Weather

Weather parameter is the most important variable that influent fire spread. Weather directly affects temperature, relative humidity and wind speed. Hot temperatures release the moisture content in fuel which leads to a rapid fuel ignition.

Wind speed and its direction are the most influential factors of weather when we are dealing with fire suppression. Wind is a physical force that affects the propagation of fire. It increases the pyrolysis process by drying the fuel and feed fire head more and more oxygen to expand [18].

Also wind causes the angle of the flames to become sharper. With increased wind velocities the flames are forced into the un-burnt components ahead of the fire front resulting in more efficient pre-heating of the fuel and greater rates of expansion in surface

head fires[19], [20]. Accordingly, fire fighters should be aware of wind speed and its direction since it can change the propagation pattern and severity in every second and lead to catastrophic results.

5.3.2. Topography

Topography has an impact on a variety of aspects of fire behavior including fire line intensity and direction of spread. That is fire burns more rapidly up a slope, or hill [21], [22]. While fire acceleration will slow down when fire move down slope as shown in Fig. 43.

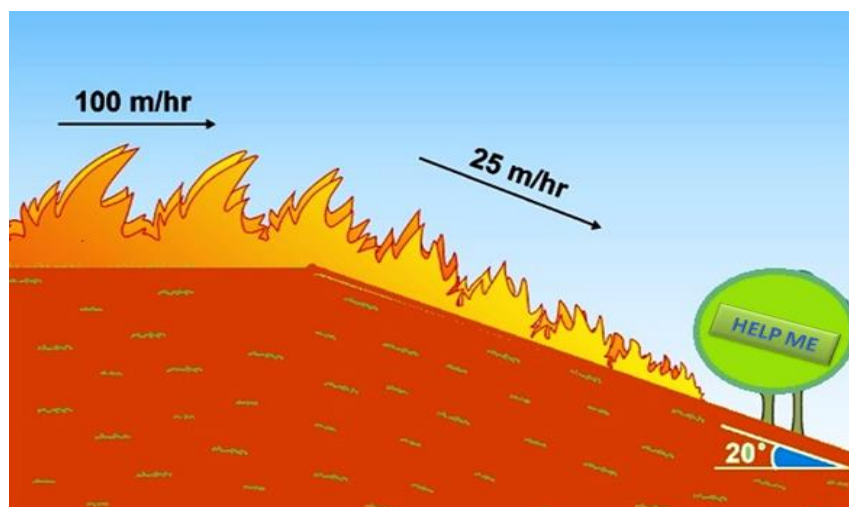

Fig. 43: Effect of topography on fire spread

Topography is mainly divided into three types which affect directly on fire diffusion: Slope, Elevation and Aspect.

a) Slope

Slope has direct effects in different ways on fire behavior. First the acute angle slope fast the fires rate of spread upslope [23]. The rapid spread is caused by small angle between ground and flame. The steeper the slope, the faster the fire moves and the more severe it becomes. Also different terrain shapes can affect the fire spread. Hills slow fire spread because they decrease the pre-heating of fuel on the opposite side of the hill.

Saddle slope is one of the most dangerous cases especially for fire fighters because the spread direction will be unpredictable, since we have upward slopes and ridges in the same area.

In addition, slope can provide shelter for small fires and allow them to grow gradually without being put out by the wind.

b) Elevation

Elevation is also a very important factor for fire behavior that accelerates the amount and timing of precipitation and exposure to prevailing wind. When the elevation is low, fuels will tend to dry out earlier because there will be a high temperature and low precipitation, while at higher elevations, the precipitation is high, as well as fuels need time to dry up [23].

c) Aspect

Solar radiation plays a key role on the fuel to be more combustible in a short time. Aspect affects fire behavior as it dictates the amount of the solar radiation received by surface fuel [1]. It's known that the north facing aspect will receive high amount of solar radiation than south facing aspect. On the other side, east and west aspects will receive less amount of solar radiation. This means that southern aspect has high potential of fire spread due to the effect of high amount of solar radiation absorbed by fuel. Potential of fire spread due to the effect of high amount of solar radiation absorbed by fuel.

5.3.3. Fuel

Fuel is a general term that is capable to combust and thus releases heat energy. In Forest fire fuel means the vegetation type such as; grass, shrubs and tree. Vegetation types play a key factor on fire intensity, because the availability of vegetation is determined by its combustibility. This means that high quantity of vegetation will lead to high fire intensity.

Beside types, fuel has different characteristics that affect the amount of heat energy and fire rates: fuel loading and fuel availability as shown in Fig. 44.

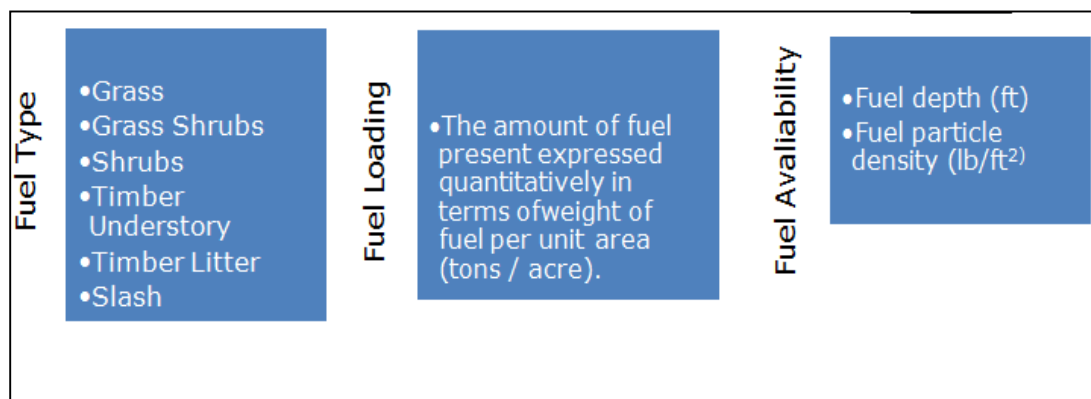

Fig. 44: Fuel characteristics

a) Fuel size

When we are talking about fuel size, this means we are talking about fuel diameters. Since small fuel diameters such as grass, flashy and tree leaves can quickly ignite and tend to be consumed during heat combustion. Small fuel diameters rapidly lose the

moisture content inside which leads to quick chemical combustion. Experimental studies show that fuels less than 0.25 inches are almost completely consumed by fire over a wide range condition. Besides, light woody branches between 0.25 and 3 inches are also consumed in a fast manner [24].

b) Fuel shape and arrangement

Fuel shape also accelerates or sustains a fire spread. The continuity and the distribution of fuel definitely affect the continuity of fire spread because fuels have the ability to roll down existing slopes and create new fires in different zones. New fires are the results of volatile sparks on continual fuel which led to start hundreds of fires from original fire line. Also fuel arrangement can be horizontal or vertical which influence how easy for fire to gain or lose its intensity. In different words, fuel that lacks horizontal continuity can lose its intensity and put it out. In a likely manner, fuel that lacks vertical continuity can impede the fire spread from surface fires [24].

5.4. Fire behavior classical models

In the last decades, wildfire occurrence has increased dramatically which raised the interest of researchers in the modeling of wildfire behavior. Fire behavior modeling is used across a variety of spatial and temporal scales, from planning the management of a wildfire incident over the next few days or weeks to land management planning over millions of acres for decades to come.

Three schools have pioneered fire modeling: North America, Canada and Australia. They have become a guide to predict the spread of wildfire all over the world.

Scientists divided fire behavior models into three types: physical, empirical and semi empirical models [25], [26]. Empirical models are statistical descriptions of wildland fires. They are those concerned with fire shape prediction. Semi-empirical models are those based on the observation of experimental studies and the subsequent use of dimensional analysis to maintain. Physical models are those based on mathematical equations which include the primary key of physical and chemical processes of fire propagation.

5.4.1. Fon's model

Fons (1946) was the first one who developed surface fire spread theoretical model in the United States. He conducted fire spread versus logarithmic growth of fuel bed temperature. The fuel bed temperature can be found by applying the energy conservation equation to a uniform volume of solid particles in fire line. Fon focused on the head of

the fire where the fine fuels carry the fire and where there is ample oxygen to support combustion [27].

5.4.2. George Byram model

In 1959, George Byram created an empirical model to predict the fire behavior for the United States Department of Agriculture's Forest Service. Byram defined fire line intensity as the rate of heat energy release per unit time per unit length of fire front, regardless of the depth or width of the zone of active flaming combustion [28]. Fire line intensity may be used to establish and set limits for prescribed burning and fire control and to estimate the fire break width necessary to halt a given fire.

Byram's model is based on three characteristics: fire spread, fuel consumption and heat production. Equation 5.1 refers to the linear rate of advance:

$$I = H * W * R \quad (5.1)$$

Where I , is the fire line intensity (kw/m), H is the heat of combustion (KJ/Kg), W is the fuel consumed (Kg/m²) and R is the linear rate of spread (m/sec).

5.4.3. Mcarthur model

A.G Mcarthur (1966) developed a mathematical equation to model fire spread in Australia. Mcarthur has obtained empirical rules for factors affecting fire propagation from the observations of large number of fires in Australia [29]. His model based on fuel moisture content, fuel weight and Wind speed.

$$R = 0.43Wf(M)e^{v/v_0} \quad (5.2)$$

where R is the Rate of Spread (m/s), W is the fuel weight in tones/hectare, V is the wind speed in m/s at 10 meters above ground with $V_0 = 6.9\text{m/s}$, while the M is the fuel moisture content in percent of oven dry weight and $f(M)$ can calculate as the following:.

$$f(M) = e^{-0.0897M} \quad (5.3)$$

5.4.4. Rothermel model

Since 1972, Rothermel founded his model in USA to predict the fire spread phenomena in Montana [30]. This model is based on a complex mathematical equation for modeling the propagation of fire. Rothermel model focused on the head of fire that achieves fire behavior by employing ensuing ignition of fine fuel in the landscape [10]. Indeed this

model uses 17 input variables that describe fuel types, moisture content, slope, aspect, wind speed and its direction.

Rothermel mathematical model produces a quantitative value of fire spread rate that should be regarded as appraised value of given fuel and environmental conditions.

Equation 5.4 summarizes the mathematical model of Rothermel that predicts the intensity of fire rate:

$$R = \frac{I_R \mathcal{E} (1 + \phi_W + \phi_S)}{\rho_b \mathcal{E} Q_{ig}} \quad (5.4)$$

Where R is the rate of spread (ft/min), I_R is the reaction of intensity (b.t.u/ft². min), ϕ_W is the wind coefficient, ϕ_S is the slope factor, ρ_b is the oven dry bulk density (lb/ft³), \mathcal{E} is the effecting heating number Q_{ig} is the heat pre-ignition (b.t.u/lb).

Rate of spread is very important fire propagation characteristic for two reasons: First reason, it informs how large the wildfire can become during specific time, and accelerates the likelihood that a wildfire will reach certain places of concern on a landscape. Second reason, rate of spread is a significant parameter affecting fire line intensity and flame size, which are important for determining fire effects. In addition, he published 11 fuel models related to his spread model. At that time, extinction moisture content was not listed for each fuel model separately, but instead it was held at 30% for all models. Thus, variation in predicted spread rate among models could be attributed to fuel load by size class, fuel arrangement and fuel bed depth.

5.4.5. Albini Model

Albini (1979) found a new initiative mathematical model to calculate the maximum spotting distance in United States where a firebrand is completely consumed and reaches the ground [31]. But Albini's model is known as very complicated process, since his model divided into 6 sub models:

- ✓ The structure of the steady flame within the canopy
- ✓ The structure of the buoyant plume above the canopy
- ✓ The burning rate of firebrands
- ✓ The lofting of firebrands into the plume
- ✓ The surface wind carrying lofted firebrands

Albini's work culminated in the following formula for calculating the maximum spot distance for flat terrain:

$$x = 0.0136Uz_0 \left(\frac{z_0}{g}\right)^{0.5} \left(0.0362 + 0.5 \left(\frac{z_v}{z_0}\right)^{0.5} \ln\left(\frac{z_v}{z_0}\right)\right) \quad (5.5)$$

Where x is the maximum distance from the fire front (m), Uz_0 is the wind speed at the treetop (m/s), z_0 is the tree height (m), g is the acceleration of gravity (m/s^2) and z_v is the maximum vertical distance a firebrand travels in order to land on the ground the moment of complete consumption (m). In addition Albini found 13 fuel models known by original 13 fire behavior fuel models. Whereas extinction moisture content was held constant for Rothermel's 11 fuel models, Albini's fuel models specified this value separately for each fuel model.

5.4.6. Anderson Model

In 1983 Anderson describes the length to width ratio of a fire spreading as a double ellipse as a function of mid flame wind speed [32]. Because Rothermel's original fire spread equation assumes that the wind is aligned directly with slope so the effect of cross slope winds must be quantified as shown in the following equation:

$$\frac{L}{W} - 1 = 0.5592 U_{ef} \quad (5.6)$$

The above equation shows the relationship for effective wind (U_{ef}) in m/s with length (L) and width (w) in m.

Anderson described the 13 fuel models listed by Albini and provided aids to select a fuel model. Fuel model parameters did not change from Albini's set. Anderson listed only fuel load by size class, fuel bed depth, and dead fuel extinction moisture. Anderson also provides a similarity chart for cross referencing the 13 fuel models to the 20 fuel models used in the National Fire Danger Rating System (NFDRS), used in the United States to provide a measure of the relative seriousness of burning conditions and threat of fire.

5.4.7. Van Wanger model

In April 1989, Van Wanger developed the first model that can predict fire spread phenomena in Canada. His model was designed to give rate of spread, fire line intensity and crown fuel consumption; and to be applicable in operation [13]. Van Wanger's model is a semi-empirical model for obtaining the rate of active and passive crown fire in Canadian conifer plantations. He chose this kind of vegetation because of its clear classification and its low fuel arrangement variability compared with naturally regenerated areas. In his model, he concentrated on wind speed and fuel distribution during 60 different fires occurred in conifer forests. The front intensity of fire could be estimated by the following equation:

$$SFI = 300RSS * SFC \quad (5.7)$$

Where SFI in kW/m, RSS is surface spread rate in m/min, and SFC is the surface fuel consumption in kg/m².

Van Wanger assumed that the degree of crowning would depend on the amount by which the predicted surface intensity (SFI). The amount by which the predicted surface spread rate (RSS) exceeded the spread rate (RSO) associated with the critical intensity. The desired transition function, called the Crown Fraction Burned (CFB) calculated as following:

$$CFB = 1 - \text{EXP}[-a(RSS - ROS)] \quad (5.8)$$

Where, a=0.23 which is the result of determining both the resultant crown-fire spread rate and the degree of crown consumption. The final equation shape can calculated as the following:

$$ROS = RSS + CFB(RSC - RSS) \quad (5.9)$$

Where ROS is the rate of spread, RSS is the surface spread rate, RSC is the crown spread rate and CFB is the crown function burned.

Many models composed of a different of equations which relate meteorological parameters to fire behavior variables followed that of Van Wagner. They were emerged from the fire activity over these years.

5.4.8. Weber model

Weber (1991) found a new mathematical model to predict surface fire spread to incorporate physical principles [26]. Typically, such models regress the rates of fire spread observed in the field against variables such as wind speed, slope, fuel moisture content, fuel bed depth, and fuel load. Weber attempted to develop his theoretical model for surface fire behavior since the beginning of his research in US area. This model was based on the idealization of fuel, fire line and flames in a simplified system in which mass, momentum and energy conduction, convection and radiation transfer equations could be applied to give a quantitative description of fire spread variables.

$$R = \frac{\sum_{m=1}^u(qm)}{\sum_{n=1}^v(Qn)} \quad (5.10)$$

Where R is the rate of fire spread (m/s), is equal to the ratio of the heat received by un-ignited fuel ahead of the fire, q (J/s.m²), over the heat required to ignite the fuel at the leading edge of the fire, Q (J/m³). The total energy flux received by the un-ignited fuel, q is equal to the sum of the individual u energy fluxes received due to heat transfer via radiation, convection and conduction. The total energy required to ignite a unit volume of fuel, Q , is equal to the sum of the heat required to bring the individual v components of the fuel bed from ambient temperature to ignition temperature.

5.5. Computer models and simulators

Wildland fire modeling is still considered in its entirety a challenging task. With the beginning of the second part of the 21st century, computational sciences have become an important tool for ecological researchers. Due to complexity of fire spread modeling, researchers refuge to computer features and systems to predict the growth of forests fire for long time periods. These applications have the ease of use during system simulation.

Fire spread prediction models depend on multiple parameters (topography, weather and fuel). The investigation of fire spread prediction becomes more and more difficult if we take into consideration the fact that the weather prediction science often induces errors, especially when maximum weather phenomena occur. Depending on the plenty and variability of involved parameters, as well as the limitations to be considered, numerous projects worldwide have developed trying for solutions.

5.5.1. Canadian Forest Fire Danger Rating System (CFFDRS)

In 1968, the Canadian government developed the Canadian Forest Fire Danger Rating System (CFFDRS) to predict fire spread using Byram's fire intensity equation. This model comprises parameters of topography, fuel types and weather. This model is divided into two sub layers, which are pre and post fire prediction models. FWI is the first layer which predicts forest fire before occurrence (Pre-forest fire). While the second layer, known as post fire which predicts the spread of fire after the ignition occurred, is named by fire behavior prediction (FBP). The FBP computing system provides actual quantitative estimates of various fire spread factors for 16 distinct fuel types (See Table 33) and topographic situations based on inputs from the FWI System [33].

Abbreviation	Fuel Type
C1	Spruce woodland
C2	Boreal Spruce
C3	Mature Jack pine

C4	Immature Jack pine
C5	Red and white pine
C6	Conifer plantation
C7	Ponderosa pine
D1	Leafless aspen
M1	Boreal mixed wood-leafless
M2	Boreal mixed wood –green
M3	Dead Balsam-leafless
M4	Dead Balsam –Green
S1	Pine slash
S2	Balsam slash
S3	Costal-cedar
O1a	Matted grass

Table 33: Fuel types and its abbreviations

Table 33 summarizes the 16 dominant fuel types that exist in Canada to help the model in predicting the propagation of fire.

After stating the table of vegetation type, the CFFDRS model can predict fire intensity by applying Byram’s equation with a minor discrepancy, since the model has considered heat energy a constant number (18000kJ/Kg). This constant number is the average of heat combustion for the 16 fuel type in Canada based on indoor measurements. The final equation of CFFDRS model is shown in equation 5.11:

$$FI = 18000 * TFC * ROS \quad (5.11)$$

Where FI is the fire intensity (kW/m), TFC is the predicted of total fuel consumption (kg/m²) and ROS is rate of spread (m/min).

5.5.2. National Fire Danger Rating System (NFDRS)

The United States governments developed in 1972 the National Fire Danger Rating System (NFDRS), which establish the probability of fire outbreak [34]. This model has three major parts: Scientific Principles, User Controlled Assumptions, and Data. The base of this system is the Rothermel mathematical spread model equation. In addition NFDRS model can calculate worst case fire scenarios using mid-day weather inputs and glorified fuel over typical area. Fire danger ratings are typically reflective of the general conditions that reflect the potential over large area for fire ignite and spread. The five key components of a fire danger rating system are:

- ✓ Models representing the relationships between fuels, weather, and topography
- ✓ A system to gather data necessary to produce the rating numbers.
- ✓ System to convert inputs to outputs and perform data analysis.
- ✓ A communication system to send and receive fire rating information between entities.
- ✓ Storage data system to retain data for historic reference.

NFDRS gives the fire fighters a tool to decrease the crisis in any day. NFDRS outputs provide information to help managers:

- ✓ Establish staffing levels, preplanned dispatch actions, and daily adjective fire danger ratings.
- ✓ Helps define preparedness levels at local, geographic, and national levels.
- ✓ Supports severity requests.

5.5.3. Behave plus

Behave plus developed in 1980 by the United States forest service [16]. The Behave plus system automatically creates a worksheet made up of graphs and charts that requests the necessary input variables based on the modules (grouping of mathematical fire models for a worksheet), output variables selected by the user. This system is divided into 2 parts; fire modeling and learning methods for new fire management trainees. In addition, this system has many abilities of fire modeling tools. Behave plus use wind speed, wind direction, slope, fuel moisture and fuel model numbers (see Table 34) as input variables. These inputs variables are derived from Rothermel model.

Fuel Model	Fuel complex
1	Short grass
2	Timber
3	Tall Grass
4	Chaparral
5	Brush
6	Hardwood slash
7	Southern rough
8	Closed timber litter
9	Hardwood litter
10	Timber
11	Light slash
12	Medium slash

13	Heavy slash
-----------	-------------

Table 34: complex Fuel models

Fuel models view a particular fuel complex through parameters like fuel loading, fuel depth, heat content and moisture content. The moisture extinction as an upper limit of dead fuel moisture content leads fire to be no longer propagating with uniform front [22].

The ability to specify heat content is primarily employed for greater precision when building a custom fuel model. The original 13 fuel models are still used with a single value of 18,622 kJ/kg (8000 BTU/lb) for live and dead heat content. Training on the original 13 fuel models is available in the National Wildfire Coordinating Group.

5.5.4. Fire Area Simulator (FARSITE)

FARSITE (Fire Area Simulator) developed by Finney in 1995 in the United States of America [35]. This system is a fire growth simulating modeling system. FARSITE uses specific information on topography, fuels along with weather files. This model is a deterministic modeling system, because the simulation results can be directly compared to inputs. This system can predict two types of fire spread: Crown and surface propagation patterns into a 2-dimensional growth models. FARSITE model is based on six different parameters: Fuel model, Elevation, Slope, Aspect, Weather, Canopy cover. FARSITE incorporates other modules in order to simulate crown fires, spotting, post fire combustion, and fire acceleration.

FARSITE describes the spatial and temporal spread and behavior of fire under different terrains, fuels, and weather conditions. This model computes wildfire growth and behavior for long time periods under heterogeneous conditions of terrain, fuels, and weather. FARSITE uses existing fire behavior models for surface fire, crown fire spread, post frontal combustion, and dead fuel moisture.

During the last 20 years, FARSITE becomes one of the most popular models to predict fire behavior in Mediterranean region. This model has recorded high accuracy in predicting fire spread in Mediterranean countries, using two statistical indicators derived from the error matrix: Cohens Kappa (Statistical coefficient which measures inter-rater agreement for qualitative items) and Sorensen coefficient (For comparing the similarity between two samples).

5.5.5. Phoenix

This software was developed in 2008 in Australia as fire risk strategy [36]. This simulation software directly relates the impact of various management strategies to changes in fire characteristics across the landscape. Phoenix model is also known as dynamic model. This model is based on weather, fuel and topographic conditions. This model operates in a landscape divided into uniform sized square cells. Every cell has many attributes used as inputs or outputs in the simulation process. These attributes are stored in a personal geographical database. Each cell size can be specified by the user to create a grid. In this model, a grid specified by 5m can be used for detailed analysis of a small area, but a grid size of 100m or 200m is usually found to be sufficient for most operational goals.

Phoenix model is made up 2 model sets. The first set deals with the effect of spot fire induced in draughts at the fire front, ember transport and distribution, spot fire ignition, wind-slope interactions, linear disruption to fire behavior, fuel accumulation rates, solar radiation and fuel moisture models. The second set of models is used to describe the spread of fire across the landscape given the general fire behavior conditions.

5.5.6. Bushfire

Bushfire model improves decision making in different scenarios. It is very reliable in bushfire spread simulation and intimation technology supporting a wide range of fire management activities that include risk analysis, prescribed burning, fire propagation and incident control training. Bushfire simulations are based on topography, weather, fuel and historical learning of fire behavior captured within a computer model. The outcomes include visual display and usable interface for fire intimation. This model was validated and tested only in Australia.

5.5.7. PYROCART

Green et al (1999) developed a simulation models in New Zealand [37]. This model implements Rothermel's model using geographical information system (GIS) to predict the fire spread shape. PYROCART model is based on the wind speed, fuel type and slope that appear to be the most influencing factors on fire spread. It is found that the predicted burnt area and real burnt area tend to be similar in shape. It is found however that at high wind speeds the model over predicts rates of fire spread in some directions. Generally, due to the complex input data and parameterization techniques it requires, it is less suitable for in-site fire management.

5.5.8. HFire

Hfire (Highly Optimized Tolerance Fire Spread Model) model developed in south California in 2001, to predict surface fire spread and its direction [38]. This model is the outcome of cooperation between researchers in north California and NASA. A global sensitivity analysis was conducted on HFire, a spatially explicit raster model developed for modeling fire spread in chaparral fuels. This model based on the Rothermel's spread equations using C# programming language. The global sensitivity analysis provided a quantitative measure of the importance of each of the model inputs on the predicted fire size. The advance of the fire through the simulation domain is restricted to the degrees of freedom of the underlying lattice and reflects the finite distance traveled between the lattice cell centers during a single time interval.

Hfire model parameters subdivided into three groups:

- ✓ Temporally static fuel variables
- ✓ Temporally static landscape variables
- ✓ Temporally dynamic environmental variables

In order to predict fire spread using Rothermel's equation each group made up of different variables as shown in Fig. 45.

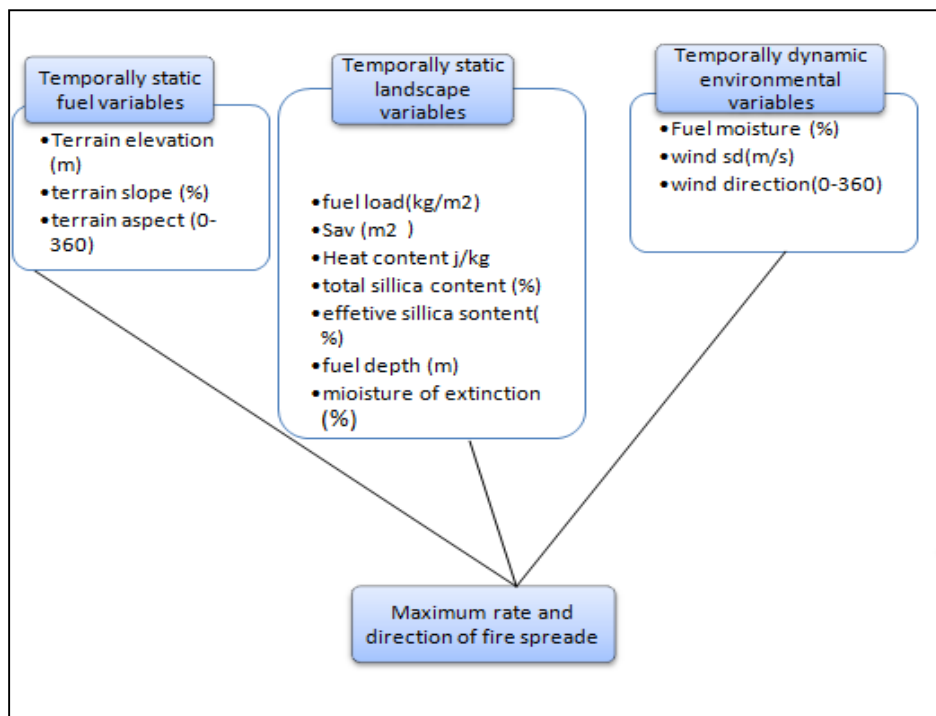

Fig. 45:Hfire structure

5.5.9. Firementor

Markatos et al (2004) developed wildfire model in Greek [39]. This model is based on sensor networks which broadcast information on temperature and the changes in a forest over a day. A single sensor include thermometer, microcomputer and wireless communication unit. These sensor works as alarm that deliver a risk message notification to the central node. Also the sensors are installed and record their exact position using GPS. Firementor system does not only detect a fire, but it also predicts the evolution and the propagation of fire, in order to indicate the best location and routing of response units. This allows assessment of the risks inherent in a possible evacuation of the area in case of dangerous situation. The essential input digital data in Fire mentor are:

- ✓ Three-dimensional digital map of the region
- ✓ High-resolution satellite images,
- ✓ Information about building blocks and population of the region, iv) digital road maps, v) fuel maps, and
- ✓ Real time meteorological data (temperature, humidity, wind speed and direction).

5.6. Simulators validity and characteristics

In the last decades, fire simulator models have been realized by scientists using different fire prediction models and simulation techniques in order to predict fire phenomenon. These models are adopted in various countries after recording great success in predicting fire behavior. Each model has its own characteristics, parameters and equations. The differences among simulators include the integration of procedures, treatment of fire extinction and fire effects.

Simulator models	Inputs	Outputs	Based on	Adopted	Main Goal(s)
CFFDRS	Topography, fuel types, Temperature, humidity, wind speed and direction	Fireline intensity map	George Bayram	Mexico, Florida and North Brazil	Assists in determining current and future forest fire danger.
NFDRS	Mid day weather inputs (Temperature, humidity, wind speed and direction) and fuel	Fire spread with burning severity	Rothermel	United states	Integrates the effects of existing and expected states of selected fire danger factors into one or more numeric index

Behave Plus	Wind speed, wind direction, slope, fuel moisture and fuel model codes	Rate of spread map	Rothermel	United states, Canada and Greek	Describes fire behavior, fire effects, fire environment, spotting distance, scorch height and tree mortality
FARSITE	Fuel model, Elevation, Slope, Aspect Weather and Canopy cover	Fire behavior map	Rothermel & Finney	Sardinia , Iran , Canada and United States	Predicts 2-dimensional surface fire, crown fire, spotting, post frontal combustion, and fire acceleration shape
Phoenix	Temperature, humidity, wind speed and direction, fuel and topographic conditions.	Fire spread map	Macarthur	Canada, New Zealand and France	Predicts the future development of bushfire propagation
Bushfire	Mid day Temperature, humidity, wind speed and direction, fuel arrangement and topographic conditions.	a) Statistics View b) Fire perimeter c) Fuel breaks d) Risk Map	Rothermel	Australia	Predicts fire propagation using fire risk analysis
PYROCARD	Wind speed, fuel types and slope	Fire spread map	Rothermel	New Zealand	Predicts over all fire spread shape
Firementor	Temperature, humidity, wind speed and direction	a) Weather Stream. b) Total fuel consumption	Rothermel	Greek	Predicts fire spread using sensors networks
Hfire	Temperature, humidity, wind speed, wind direction, fuel arrangement and fuel moisture content and topographic conditions.	a) Flame length, b) Reaction intensity c) Fire spread map	Rothermel and Albini	United States	Predicts fire spread and size using quantities measures

Table 35: simulator models characteristics

CFFDRS has been adopted, in Mexico and Florida because of its simplicity and its strong interpretive products after showing acceptable results in fire mapping [40].In spite of

this, it showed a limited performance during two consecutive fire seasons in the Mediterranean environment of Crete, Greece [41].

Molders (2010) used regional numerical weather inputs to drive the NFDRS system showing good prediction in Alaska. He found that NFDRS has the lowest prediction errors after comparing it with CFFDRS [42].

Preisler et al. (2009) used a combination of forecast model outputs and satellite observations to extend the spatial information provided by station based fire index calculation in the United States. NFDRS tended to record acceptable results [43].

Marrco et al (2003) applied BEHAVE plus under Mediterranean conditions to predict fire spread in forest of conifer trees. A few adjustments to the actual fuel situation allowed precise predictions about fire spread rate. Also BEHAVE plus was found to notice high variability of fuels and wind conditions during the burn. The model output met the onsite observations. Rate of spread and the flame length were modeled accurately [44].

Arca et al (2007) applied FARSITE model to predict fire behavior in west Sardinia after analyzing the effect of fuel models, weather conditions and topography. Arca et al, classified the fuel models in west Sardinia into Standard fuel models include: FM1, FM2, FM4, SH5 while SH7; CM28 is a custom fuel model designed and developed for scrubland vegetation of the Mediterranean region. The parameters of custom fuel model are in agreement with several studies conducted to determine the fuel types of Mediterranean vegetation. FARSITE model recorded 0.61 of Cohen Kappa in predicting fire spread between simulated and real case [45].

Jahdi et al (2010) applied FARSITE model to simulate spread and behavior of two real fires that had occurred in Northern Forests of Iran during 2010 summer and fall seasons in a spatially and temporally explicit manner taking into account the fuel, topography, and prevailing weather in the area. They used Anderson fuel classification models (53 fuel models), elevation, aspect, slope and canopy cover that were prepared and formatted in GIS along with weather and wind files. This model was adopted in Northern Iran after recording 0.81 of Cohens Kappa while using spatial varying wind data [46].

Pugnet et al (2013) developed Phoenix model to predict the fire spread in Cavailon in southern France. Observations of the Cavailon fire supplied by the local fire brigade were used to reconstruct the actual fire progression. A simulation of the fire using available data was compared to the real fire. The area of simulated fire recorded 67% of the real fire area [47].

George et al (2001) applied PYROCART to predict fire behaviour in New Zealand to assess the applicability of GIS to spread prediction. The overall system accuracy of the model recorded 80% within different fuel types and slope angles [48].

Markatos et al (2007) found that FIREMENTOR model is capable to recognize fire ignition points and simulate the fire evolution using the temperature, humidity, wind speed, direction parameters and the region's fuel map. In the case of a real event, the status of the sensors network can also be considered to predict fire evolution in Greece [49].

Morais (2001) found that HFire was accurate for modeling fire spread phenomenon in California using two historical chaparral fires under both extreme and moderate wind conditions. This model was tested using Rothermel parameters and Albini fuels codes [50].

Clark et al (2008) developed Hfire model in Santa Ana states to predict fire size. HFire model structure represents the physical process of fire spread. Contrary, fine dead fuel moisture was responsible for less than 15 % of the variation in simulated fire size. Generally, Hfire model was found to be an acceptable model in predicting fire size in Santa Ana [51].

The two most important models to us are the FARSITE and Firementoras they were applied and validated in Mediterranean regions. But these simulators are complicated enough to be adopted in developing countries like Lebanon. FARSITE cannot be applied to Mediterranean conditions as it showed some limitations in predicting fire spread map: First the wind speed parameter is calculated every 1 hour in FARSITE system, which doesn't reflect truly the actual variability of such parameter. Second, as most models, it requires spatial Landscape information to run (GIS), which is not possible in these regions. Regarding Firementor, we can never apply it in Mediterranean countries like Lebanon, since this model is a very expensive model which needs sensors, computer systems and workers to monitor the fire in every green forest spot.

Furthermore, there are many initiative projects and computer models developed in Europe and are under experience in many countries such as:

- ✓ Fore Fire is fire simulation software that predicts the fire spread propagation in Corsica France [52]. This model is based on Discrete Event System Specification (DEVS) formalism to simulate the fire behavior propagation as a function of time. The requirement parameters for this model are: Fuel, weather, wind and elevation

of terrain. These parameters are in the form of input files that are defined in XML files. This model has recorded acceptable results upon comparison with real fire cases.

- ✓ FIREFLY is a software tool developed in France to predict and simulate the propagation of surface wildland fires at regional scales [53]. FIREFLY is based on Rothermel equations relevant to rate of fire spread, and aims to track the time evolution of the fire front location. The recorded results of data driven simulations are capable of correcting inaccurate predictions of the fire front positions.
- ✓ IGNIS project is an emergency service founded by partners from 4 European countries (France, Italy, England and Portugal). This project aims to predict fire propagation in effectively and efficiently way using meteorological parameters. In addition, this tool is upgraded to be a mobile simulation tool which can be used within the partner countries in Europe [54].

5.7. New generation in wildfire prediction

Current studies in fire spread modeling oriented toward mathematical and computer modeling. Some studies propose percolation and cellular automata models for modeling forest fires. These models are a formal mathematical idealization of physical systems in which space and time are discretized; and physical quantities take on a finite set of values. In addition percolation and cellular automata can be used to predict any dynamic phenomena such as gas spread, disease spread etc.

Percolation theory deals with the statistics of random arrays. Recently, it has been used as a mathematical model of fire propagation. Matchsticks are randomly placed in a square lattice which can describe the transition rule between extinction and uncontrolled spread. It provides a theoretical framework for the description of marginal fires which has been examined on an empirical basis [55].

Percolation provides a framework to allow separate identification of wind induced and terrain induced fluctuations in fire spread. Percolation is based on the probability to check whether the grid will burn or not. One can account for static attributes, such as fuel type, elevation and slope, as well as dynamic attributes, such as wind direction, humidity and air temperature. A cluster in this case is a set of cells corresponding to trees that are totally burnt or are burning. One may be interested in determining the probability that a certain point is reached by the burning cluster. While a cellular automata model is made up of individual cells that interact based on the neighborhood coherence principle. Any given cell tends to impose itself on neighboring cells, and results in a tendency of local coherence. It outputs a display complex overall fire behavior. CA is implemented as a

dynamic system that operates on a uniform regular lattice that is characterized by local interactions with a surrounding neighborhood of cells over discrete time steps. In the next chapter, we will study in depth the cellular automata models and its applications in fire behavior modeling.

5.7.1. Percolation theory and fire behavior application

Percolation theory was founded by Flory (1940) as a mathematical theory [56]. It was then popularized in the physics community and intensively studied by physicists. Percolation is one of the easiest models in statistical mechanics that display the phase transitions signaled by the emergence of a giant connected component. Percolation theory has a great success after been applied to describe a large variety of natural, dynamic phenomena and social systems. Percolation models serve as important universal classes in critical phenomena characterized by a set of critical exponents which correspond to a rich fractal and scaling structure of their geometric features.

Percolation is divided into two types: the site percolation where intermediates exist at each site of a given area with probability q and the bond percolation where each couple of neighboring sites connects with probability q . These are the most usable percolation models. Examples are found in the next figure: 2 dimensional square lattice percolations (Fig. 46) and bond percolation also named by cluster (Fig. 47), where sites correspond to cells of probabilistic cellular automata.

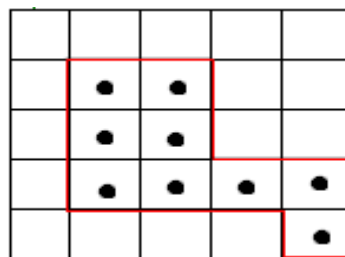

Fig. 46: Square lattice site percolation

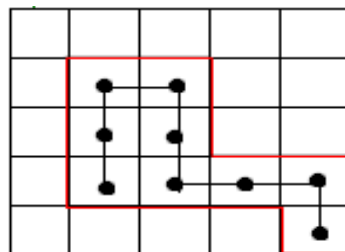

Fig. 47: Square lattice bond percolation

To understand the percolation theory, we consider the cluster C that contains the origin. Then, for a given probability q , we define $\theta(q)$ as:

$$\partial(q) = Pq(|C_0| = \infty) \quad (5.12)$$

Where C_0 represents the number of the sites contain in the cluster C , $\partial(q)$ describes the probability that the cluster having infinite number of sites exists.

By using $\partial(q)$ we define the critical probability that a medium spreads such as gas spread infinitely as:

$$q_c = \inf\{q \in [0,1]: \partial(q) > 0\} \quad (5.13)$$

The probability q_c represents the probability q above which there is a possibility of existence of the cluster having infinite amount of sites. That is, a medium does not spread infinitely with probability q that satisfies $q < q_c$. q_c is known to be 0.592746 approximately [57]. Visually, we can find the probability between in every lattice group (group=4cells), example if we have 2 dots out of 4, the probability is found to be $q = 0.5$.

Caldarelli et al (2001) investigated percolation using meteorological and topographical factors in wildfires by analyzing satellite imagery of burned area. They found that dynamical Percolation was capable to reproduce fire behavior by mapping fire dynamics onto the percolation models [58].

Nahmias et al (2000) developed percolation test to utilize scaled laboratory experiment and field experiment in which the fuel had been manipulated to replicate the combustible or non-combustible distribution of lattice cells in percolation test. Nahmias percolation model was based on the effect of wind on fire spread. He found that that a simple directed percolation model is not adequate to describe fire propagation under wind or no wind conditions [59].

Simeoni et al (2011) proposed fire spread model in heterogeneous fuel conditions based on percolation theory. The model was able to provide rate of fire spread, temperature distribution and energy transfers. The results provided the same critical fire behavior as described in both percolation theory and laboratory experiments but the results were quantitatively different because the neighborhood computed by the model varied in time and space with the geometry of the fire front [60].

Hunt et al (2007) applied percolation theory to analyze the effects of anisotropy in landscape as well as climatic conditions on fire statistics in California (Baja). He found that it was impossible to confirm that the cluster statistics of percolation theory are relevant

to the fire frequency area statistics observed in Baja. Their percolation framework was based in 2-dimensional using topography and wind direction parameters [61].

Hernandez et al (2015) derived a relationship between burnt area and wind speed over the Mediterranean region and Eastern Europe using satellite observation of fire size. He found that in Eastern Europe, the percolation threshold never exceeded those of observed wind speeds.

In the Mediterranean, he found two behaviors: During middling hot weather, the percolation threshold was passed when the wind grew strong. While in cases of severe Mediterranean heat waves, moderate wind speed values reduced the propagation of the wildfire against the wind and did not sufficiently accelerate the propagation to allow a growth of wildfire size [62].

As it is clear, the percolation technique is not based on physical processes. Percolation models probabilities are adjusted by an empirical fire behavior mathematical model by using historical fire data [63]. Percolation theory is random simulated model with infinite cells, which means that computed cells by the model varied in time and space with the geometry of the fire front.

So, when we are dealing with forest fire phenomenon using percolation theory we can only rely on theoretical framework and numerical values without describing how real fire propagates and varies with non-stable conditions (weather, topography, fuel) at each time step. This leads us to study fire modeling in the next chapter using cellular automata which is proven more realistic in fire behavior prediction.

Conclusion

Fire spread is a result of heat transfer that is when a material is immediately next to a flame, it is heated enough to ignite. There are three parameters for a fire to spread: Topography, weather and fuel. At the beginning of fire spread, the fire starts to draw an elliptical shape each time interval. Fires are divided into three types (Crown, Surface and Ground fires). Fire behavior is directly affected with fuel types and fuel arrangement.

Fire models are useful in every aspect of fire protection activity: before fire, during fire and after fire. Many mathematical models (Rothermels, Albini, Anderson etc...) were implemented in different countries to predict fire spread phenomenon using different parameters and fuel types.

In the last decades, the scientific accumulation in fire modeling leads researcher to apply computer models which have the possibility to predict and simulate fire behavior. Interestingly, all computer and classical models were developed and tested in United States and Canada except Macarthur's model in Australia. In addition, since 1972 Rothermel's equations are used and still as a guide in fire behavior prediction in both classical and computerized models.

Newest studies tend to surpass complicated mathematical equations including Rothermel's model to use more dynamic simulation techniques such as percolation and cellular automata methodologies.

References of chapter 5

[1]P.Morgan, C.Hardy, T.Swetnam ,M.G.Rollins and D.G.Long, "Mapping fire regimes across time and space", International Journal of Wildland Fire Vol.10, pp. 329-342, 2001

[2]WC.Bessie, and EA.Johnson, The relative importance of fuels and weather on fire behavior in subalpine forests, Ecology journal, Vol. 76, pp. 747-762, 1995

- [3]P.Johnston, G.Milne and D.Klemitz, "Overview of bushfire spread simulation systems," BUSHFIRE CRC Project B6.3, Project progress report, March 2005.
- [4] W.Baker and K.Kipfmueller, "Spatial Ecology of Pre-Euro-American Fires in a Southern Rocky Mountain Subalpine Forest Landscape, *Professional Geographer*, Vol. 53, PP. 248-262, 2001
- [5]KR.Anderson, MD.Flannigan, G.Reuter,"Using ensemble techniques in fire-growth modelling in: 6th Symp. on Fire and Forest Meteorology", Canmore, Alberta AmerMeteorolSoc, Boston, MA, Vol. 2.4, pp 1-6, 24-27,2005
- [6]PZ.Fule, T.Crouse, M.Heinlein, W.Moore, W.Covington, and G.Verkamp, Mixed-severity fire regime in a high-elevation forest of Grand Canyon, Arizona, USA , *Landscape Ecology* Vol. 18 pp. 465-486, 2003
- [7]M.Turner and W.Romme, *Landscape dynamics in crown fire ecosystems". Landscape Ecology*,Vol. 9, pp.59-77, 1995
- [8]A.Zachary, W.Holden and M.Jolly, *Modeling topographic influences on fuel moisture and fire danger in complex terrain to improve wildland fire management decision support",2011*
- [9]NJ.Sanders, MW.Jarrood and W.Diane, "Patterns of ant species richness along elevational gradients in an arid ecosystem", *Global Ecology and Biogeography*, Vol. 12, pp. 93-102, 2003
- [10]JH.Scott, T.Reinhard, D.Elizabeth, "Assessing crown fire potential by linking models of surface and crown fire behavior", Res. Pap. RMRS-RP-29, Fort Collins, CO: U.S. Department of Agriculture, Forest Service, Rocky Mountain Research Station. pp. 59-62,2001
- [11]HE.Anderson, *Predicting wind-driven wildland fire size and shape*, USDA Forest Service Research Paper INT-305. Washington, DC: USDA, 1983
- [12]J.Glasa and H.Ladislav, "On elliptical model for forest fire spread modeling and simulation", *Mathematics and Computers in Simulation*, Vol. 78 pp. 76-88, 2008
- [13]CE.Van Wagner, "Prediction of crown fire behavior in stands", *Proceedings at the 10th Conference on Fire and Forest Meteorology*, Ottawa, Canada, pp. 207 -13, 1989
- [14]DG.Green, "Shapes of similar fires in discrete fuels" *Ecological Modelling*, vol.20, PP.21-32, 1983
- [15]GD.Richards,"The properties of elliptical wildfire growth for time dependent fuel and meteorological conditions". *Combustion Science echnology*, vol.92, pp. 145-170, 1983
- [16]k.Grabner, "Using Behave as a prescribed fire planning tool in maintaining oak savannahs", *Notes forest Managers*, Missouri Department of Conservation, University of Missouri, November 1999
- [17]M.Alexannder ,"fire Behavior as a Factor in forest and Rural Fire Suppression ", *Forest Research*, Rotorua in association with the National Rural Fire Authority, Forest Reseach , Bulletin No.179 Report No.5, pp.30, 2000
- [18]AA.Brown,KP.Davis, "Forest fire: control and use", McGraw Hill Book Co., New York,1973

- [19]RH.Luke, and AG.McArthur, "Bush fires in Australia", Australian Govt. Pub. Serv., Canberra, 1978
- [20]NP.Cheney, Fire behavior. In: Fire and the Australian biota. Eds. A.M. Gill, R.H. Groves, I.R. Noble.Australian Acad. Sci., Canberra. Pp.151-175,1981
- [21]AG.McArthur, "Fire Behavior in Eucalypt Forests", Ninth Common wealth Forestry Conference, Leaflet No. 107, 1986
- [22]RC Rothermel, "How to predict the spread and intensity of forest and range fires", USDA Forest Service, Intermountain Forest and Range Experiment Station General Technical Report INT-143 (Ogden, UT), 1983
- [23] Principle of Fire Behavior, compact disk, Environment training center, Hilton ,Alberta, Canada . ISBN:0-7785-0073-X, 1993
- [24]RE.Martin, WF.David W.Frewing, and LM.James,"Average biomass of four Northwest shrubs by fuel size class and crown cover", USDA, For. Serv. Res. Note PNW-74, Portland, pp.6,1981
- [25]T.Beer, "Bushfire rate of spread forecasting: deterministic and statistical approaches to fire modeling", Journal of Forecasting vol.10, pp.301-307,1991
- [26]RO.Weber, "Modelling fire spread through fuelbeds", Progress in Energy and Combustion Science, vol.17, pp.67-82,1991
- [27]WL.Fons, "Analysis of fire spread in light forest fuels", J Agric Res 194,; vol.72(3),pp. 93-121
- [28]GM.BYRAM, "Combustion of forest fuels", In Forest fire: control and use, Edited by KP. Davis. McGraw-Hill, New York, pp.61-89, 1959
- [29]AG.McArthur, "Weather and grassland fire behavior", Comm. Aurt.For.Timb Eur. Leaflet 100, pp.23, 1966
- [30]RC.Rothermel, "A mathematical model for predicting fire spread in wildland fires", USDAForest Service Research Paper INT-115, 1972
- [31]FA.Albini and RG.Baughman, "Estimating windspeeds for predicting wildland fire behavior", Research Paper INT-221, USDA Forest Service, Intermountain Forest and Range Experiment Station, Odgen, UT, 1979
- [32]HE.Anderson, "Predicting wind-driven wildland fire size and shape", USDA, Forest Service, Intermountain Forest and Range Experiment Station. Research Paper, INT-305. Ogden, Utah. 26p, 1983
- [33]KG.Hirsch, "Canadian forest fire behavior prediction system: Users Guided, Vancouver, BC, Canada, UBC press ,PP.1, 1996
- [34]J.Wearth,"National Fire Danger Rating System", National Fire Danger Rating System<http://www.seawfo.noaa.gov/fire/olm/nfdrs.html>.
- [35]M.Finney, "FARSITE: Fire Area Simulator-User Guided and technical documentation", System for environmental Mangment, Version 3.0,pp.156,1997

- [36]K.Tolhurst, B.Shields and D.Chong, "Phoenix: development and application of a bushfire risk management tool", *The Australian Journal of Emergency Management*, vol. 23, no. 4, pp. 47-54, November 2008
- [37]GL.Perry, AD.Sparrow and IF.Owens, "A GIS-supported model for the simulation of the spatial structure of wildland fire, Cass Basin,New Zealand," *Journal of Applied Ecology*, vol. 36, no. 4, pp. 502-518, 1999
- [38]SH.Peterson, ME.Morais, JM.Carlson, PE.Dennison, DA.Roberts, MA.Moritz and DR.Weise, "Using HFire for Spatial Modeling of Fire in Shrublands," *USDA Forest Service, Pacific Southwest Research Station, Research Paper PSW-RP-259*, January, 2009
- [39]N.Markatos, "Operational system for planning and decision support in forest fire management," *Gen. Tech. Rep.*, p. 4, Athens, Greece, 2004
- [40]BS.Lee, ME.Alexander, BC.Hawkes, TJ.Lynham, BJ.Stocks and P.Englefield, *Information systems in support of wildland fire management decision making in Canada. Computers and Electronics in Agriculture*, 2002
- [41]AP.Dimitrakopoulos, AM.Bemmerzouk, ID.mitsopoulos, "Evaluation of the Canadian fire weather index system in an eastern Mediterranean environment", vol.18 (1), pp. 83–9327 July 2011
- [42]N.Molders, "Comparison of Canadian forest fire danger rating system and national fire danger rating system fire indices derived from weather research and forecasting (wrf) model data for the June 2005 interior Alaska wildfires. *Atmospheric Research*, vol. 95 (2), pp. 290–306, 2010
- [43]HK.Preisler, RE.Burgan, JC.Eidenshink, J.M.Klaver and RW.Klaver, "Forecasting distributions of large federal-lands fires utilizing satellite and gridded weather information' *International Journal of Wildland Fire*, vol. 18 (5), pp. 508–516, 2009
- [44]G.Marco. Hille and G.Johann, "Dispatching and modeling of fires in Central European pine stands: New research and development approaches in Germany",*Global Fire Monitoring Center (GFMC) and Fire Ecology Research Group*, 2003
- [45]B.Arca, P.Duce, G.PellizzaroV.Bacciu , M.Salis , D.Spano, "Evaluation of FARSITE Simulator in a Mediterranean Area", *Sevilla-Espana wildfire*, 2007
- [46]R.Jahdi, AA.Darvishsefat, V.Etemad , and MA.Mostafavi, " Wind Effect on Wildfire and Simulation of its Spread (Case Study: Siahkal Forest in Northern Iran)", *J. Agr. Sci. Tech*, Vol. 16, pp. 1109-1121, 2014
- [47]L.Pugnet, DM.Chong, TJ.Duff and KG.Tolhurst, "Wildland–urban interface (WUI) fire modelling using PHOENIX Rapidfire: A case study in Cavaillon, France", *20th International Congress on Modelling and Simulation, Adelaide, Australia*, pp-228-234, 1–6 December 2013
- [48]L.George, A.sparrow and F.Ian, "OWENS, "GIS-supported model for the simulation of the spatial structure of wildland fire, Cass Basin, New Zealand, *Journal of Applied Ecology*, vol.36, pp. 502-518,1999
- [49]N.Markatos, V.Vescoukis, C.Kiranoudis, P.Balatsos, "Towards an integrated system for planning and decision support in forest fire management", *Sevilla-Espana Wildfire 2007, Athens, Greece*.

- [50] M. Morais, "Comparing spatially explicit models of fire spread through chaparral fuels": a new algorithm based upon the Rothermel fire spread equation. Thesis, University of California, Santa Barbara, USA, 2001
- [51] R.E. Clark, A.S. Hope, S. Tarantola, D. Gatelli, P.E. Dennison, and M.A. Moritz, "Sensitivity Analysis of a Fire Spread Model in a Chaparral Landscape", vol. 4 (1), pp 1-13, 2008
- [52] B. Nader, J. Filippi and P. Bisgambiglia, "An experimental frame for the simulation of forest fire spread", IEEE Xplore, 09 February 2012
- [53] M.C. Rochoux, C. Emery, S. RICCI, B. CUENOT, A. TROUVÉ, "Towards predictive simulation of wildfire spread at regional scale using ensemble-based data assimilation to correct the fire front position", 2014
- [54] IGNIS National Exercise No. 1: 14th to 18th November 2016 Sintra, Portugal
- [55] R.A. Wilson, "Observations of extinction and marginal burning states in free burning porous fuel beds", *Combust. Sci. and Tech.* vol. 44, pp. 179-193, 1985
- [56] F. Paul, Molecular size distribution in three dimensional polymers. I. gelation, *Journal of the American Chemical Society*, vol. 63(11), pp. 3083-3090, 1941
- [57] H. Kesten, "The critical probability of bond percolation on the square lattice equals $1/2$," *Commun. Math. Phys.*, vol. 74, pp. 41-59, 1980
- [58] G. Caldarelli, R. Frondoni, A. Gabrielli, M. Montuori, R. Retzlaff and C. Ricotta, Percolation in real wildfires. *Europhysics Letters*, vol. 56(4), pp. 510-516, 2001
- [59] J. Nahmias, H. Tephany, J. Duarte, and S. Letaconnoux, "Fire spreading experiments on heterogeneous fuel beds", applications of percolation theory, *Canadian Journal of Forest Research*, vol. 30(8), pp. 1318-1328, 2000
- [60] A. Simeoni, P. Salinesi and F. Morandini, "Physical modelling of forest fire spreading through heterogeneous fuel beds", *International Journal of Wildland Fire*, vol. 20(5), pp. 625-632, 2011
- [61] A. Hunt, "A New Conceptual Model for Forest Fires Based on Percolation Theory", Wiley online library, vol. 13 (3), pp 12-17, 2007
- [62] C. Hernandez, P. Drobinski, S. Turquety, and J.L. Dupuy, "Size of wildfires in the Euro-Mediterranean region: observations and theoretical analysis", *Nat. Hazards Earth Syst Sci*, vol 15, pp. 1331-1341, 2015
- [63] E. Pastor, L. Zarate, E. Planas, J. Arnaldos, "Mathematical Models and Calculation Systems for the Study of Wildland Fire Behaviour", *Progress in Energy and Combustion Science* 29, 139-153, 2003

Chapter 6: Cellular Automata

6.1. Background

The importance and the need of mathematical tools to model a wide range of spatial problems have been counted in the last decades as a significant approach to scientific planning. Cellular automata (CA) are dynamical systems operating in discrete space and time, on a uniform, regular lattice and characterized by "local" interactions. CA were created and used by J. von Neumann, followed by A.W. Burks and E. F. Codd, to solve the problem of non-trivial self-reproduction in a logical system [1].

CA ensure the computational method which can simulate the process of a complex system by simple individuals following simple rules [2] [3]. CA represent a common complex systems modeling approach that can capture both the spatial and temporal dynamics inherent to dynamic geographic phenomena [4]. CA consist of a regular network of finite state cells that change their states depending on the states of their neighbors, according to local update rules (Transition rules). At initial time, cells are in states describing the initial condition, and then the CA evolve changing the state of all cells simultaneously at discrete steps according to the transition rules, where these rules serve as the algorithms that code real world behavior into artificial CA world. CA transition rules govern the state of each cell based primarily upon the states of its neighbors, which can result in surprisingly complex behavior, even with a limited number of possible states [5].

CA are now becoming an attractive area for researchers of various fields due to their parallel nature and great success in prediction and simulation which can break down the non-linear relationships involved in natural phenomena. In addition, researchers found that CA algorithm is one of the most important dynamic-computing models which can get affected by many factors every time step.

The aim of this chapter is to give a brief description of CA and how to deal with CA algorithms. After great success of CA in different fields (image processing, cryptography, dynamic phenomena etc...), we present the most usable application models based on CA techniques (1D and 2D) showing their performance in prediction, dynamic simulations and analysis.

6.2. Elementary cellular automata (1D)

Elementary cellular automata (ECA) are discrete dynamical systems that describe the evolution of black and white cells, denoted as binary notation (1,0) correspondingly, arranged in horizontal lines. ECA, also known as 1-d cellular automata, were developed by Wolfram (1986) [3]. Wolfram found 256 rules that are organized in their rule space, and whether two rules sitting next to each other are likely to have the same dynamical behavior. These rules are numbered from 0 to 255 by binary numbers formed from the assigned digits and then converted to decimals.

The rule for each cell can be calculated as the following:

$$x_i^{t+1} = f(x_{i-1}^t, x_i^t, x_{i+1}^t) \quad (6.1)$$

Where i is the subscript of spatial position and t is the time with x_i belong to 0 or 1. The rule table is a binary sequence with length $8=2^3$ as shown in Table 36:

0 0 0	0 0 1	0 1 0	0 1 1	1 0 0	1 0 1	1 1 0	1 1 1
0	1	0	1	1	0	1	0

Table 36: Binary rules sequence

We can read the binary rules from left to right $\{t_7, t_6, t_5, t_4, t_3, t_2, t_1, t_0\}$ which means that the block configuration (0 0 0) maps to t_0 while (0 0 1) maps to t_1 and (1 1 1) maps to t_7 . Similarly, we can elaborate the total number of rules which comprise $2^8=256$ points in elementary cellular automata.

6.2.1. ECA Transition rule

The cells of the lattice needs time to evolve, and this is made in an unusual manner by considering changes to the states of cells in the lattice only at discrete time steps $t=0, 1, 2, 3, \dots$. Knowing that time $t=0$ usually denotes the initial time period before any change of the cells' states has taken place.

To understand the simple case of ECA, Wolfram assumed that the radius of the cell $r=1$ and $k=2$ where k represents the different states, knowing that k is a finite number equal to or greater than 2. In this instance a three cell neighborhood with 2 different states 0 and 1 for each cell can be expressed in 8 (2^3) different ways. These 8 neighborhood can be stated with $r=1$ and $k=2$, so k^{2r+1} .

Fig.48 gives a brief description how the eight neighborhoods are elaborated:



Fig. 48: Neighborhood cells state

To find the transition rule, if $c_i(t)$ is the state of the i th cell at time t , then in the next step $t+1$, the cell state will be $c_i(t+1)$, $c_{i+1}(t)$ on the right hand and $c_{i-1}(t)$ on the left hand which are the neighbors of central cell $c_i(t)$ at time step t . So the transition function will be as in the following:

$$c_i(t+1) = \delta [c_{i-1}(t), c_i(t), c_{i+1}(t)] \quad (6.2)$$

For example if we supposed that the generation 0 is (0, 1, 0) which means that we are taking the 6th neighborhood from Fig.48. According to binary rules in Table.36, the first generation will be 0 (White color) and move down to the next row and so on. The evolution will take its place every iteration as shown in the following figure:

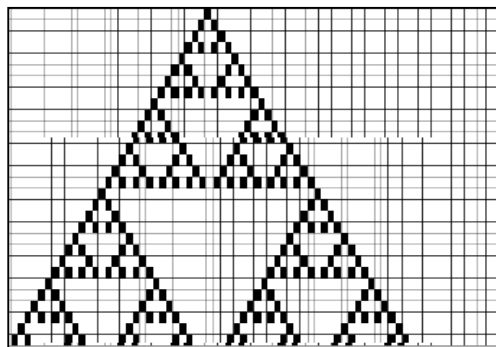

Fig. 49: Evolution of ECA

6.3. 2-D CA concepts

A cellular automata model consists of: Z^d , a grid of cells; S , a set of cell's state; N , a neighborhood pattern; and a transition rule. The transition rule describes how the cell's state changes from one state to next state, through the main simulation algorithm at each time step. Between two consecutive time steps, the transition rule expresses how each cell's state of the N neighborhood influences the next cell's state considered at time t . In a cellular space, each cell has the form of $X = (x_1, x_2, x_3, \dots, x_m)$, where m is the dimension of the space and S is a non-empty finite set of automaton states. Each cell can take only one state at any time step from a set of states, $s \in S$. N is the state of any cell which depends on its own state and modifications of other cells in the neighborhood n of that cell. The state of cells in discrete time steps,

are updated based on a series of transition rules. These rules are defined based on neighboring cells as follows:

$$S_{(i,j)}^{(t+1)} = f(S_{(i,j)}^{(t)}, S_{\delta(i,j)}^{(t)}) \quad (6.3)$$

This equation shows that the state of (i,j) which is the central cell at time $t+1$, is a function of its own state $S_{(i,j)}^{(t)}$ and the state of neighboring cells $S_{\delta(i,j)}^{(t)}$ at time t .

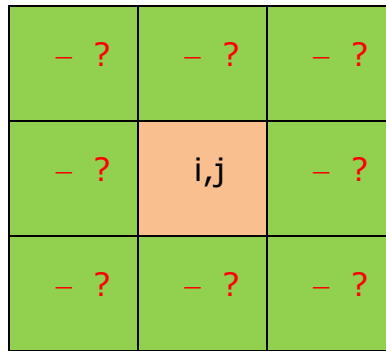

Fig. 50 : Central cell i, j

While the state of all cells at each time step t is calculated as in the following matrix:

$$\begin{pmatrix} S_{(1,1)}^{(t+1)} & \dots & S_{(1,n)}^{(t+1)} \\ \vdots & \ddots & \vdots \\ S_{(n,1)}^{(t+1)} & \dots & S_{(n,n)}^{(t)} \end{pmatrix} \quad (6.4)$$

This matrix can view the structure of cellular automata at every iteration in function of time t . So, if we want to describe CA we can compose it of five elements:

- Cell space: It is composed of individual cells which can be in any geometrical shape.
- Cell state: Each cell represents any spatial variables.
- Time step: where the cell will be able to update simultaneously based on transition rule
- Transition rule: It is the heart of CA that leads to dynamic evolution
- Neighborhood: In 2-dimensions there are 2 ways von Neumann neighborhood or Moore neighborhood (8 or 4 neighborhood).

In modeling complex systems using cellular automata systems, the algorithms of the 2 mathematician pioneers Von Neumann or Moore are adopted.

6.3.1. Von Neumann's neighborhood

John von Neumann is Hungarian mathematician who made important contributions to knowledge in mathematics, computer science, and the area of artificial life [7]. Von Neumann automata theory is based on 2-dimensional cellular space models. In his 2-dimensional model, a cellular space is formed of cells that could be in one of several possible states. So a cell would change its state according to a local rule that derives the new state as a function of the four nearest neighboring cells. Von Neumann neighborhood is made up of five cells, consisting of central cell and its four immediate non-diagonal neighbors and has a radius of 1 as shown in Fig. 51.

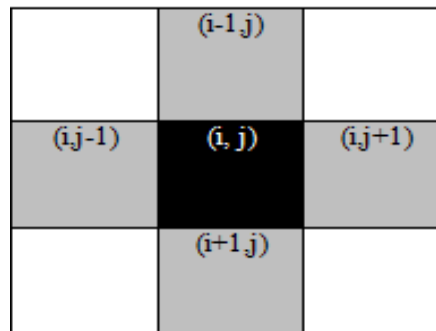

Fig. 51: Von Neumann

The radius of a neighborhood is defined to be the optimum distance from the central cell which can be horizontally or vertically to cells in the neighborhood. Moreover the state of the central cell (i, j) at time $t+1$ depends on the state of itself (q_i) and the cells in the neighborhood at time t . Van Neumann transition rule is shown in the following equation:

$$q_{i,j}(t + 1) = f [q_{i,j}(t), q_{i+1,j}(t), q_{i-1,j}(t), q_{i,j-1}(t), q_{i,j+1}(t)] \quad (6.5)$$

As the local transition rule is applied to all the cells in the CA cells, the global configuration of the CA changes. This is also called the CA global map.

We can give a real description how transition rule of Von Neumann evolves with time. Suppose that the central cell is a cancer cell in human lung, and the lung is finite lattice. Where 0 represents no disease (white color) and 1 represents a disease (black color). This cancer cell will spread at time step t as shown in Fig. 52:

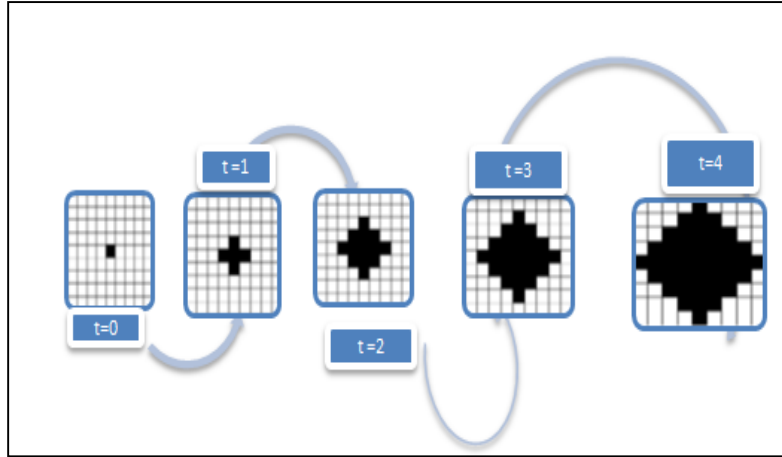

Fig. 52: Von Neumann transition rule evolution with time

6.3.2. Moore's neighborhood

In 1962, Edward F. Moore was one of the founders of Automata Theory [8]. He introduced what has become known as the Moore Machines, which are Finite Automata with output associated with each state. Moore neighborhood is also known as the simplest model; it is the most usable algorithm in CA due to its high accuracy and fast response in simulation [9]. Moore neighborhood has nine cells, consisting of the central cell and eight surrounding neighbors which are the adjacent and diagonal neighbors and has a radius of 1 as shown in Fig. 53.

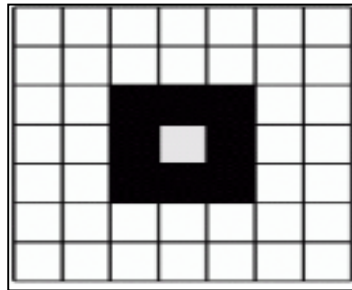

Fig. 53: Moore neighborhood

In ECA case with $k=2$ and $r=1$ then we can have $2^3=8$ possible neighborhood. The same methodology ($k=2, r=1$) will be applied to find how many possible states in Moore's neighborhood can be obtained. We can simply find that there are $2^9 = 512$ possible neighborhood-states ranging from all white to all black with all the various 510 other combinations of white and black cells in between. Moore's neighborhood differs from Von Neumann since the central cell can move in adjacent and diagonal directions (North-east, South-east, south-west, and north-west). Moore neighborhood transition rule is shown hereunder:

$$q_{i,j}(t+1) = f[q_{i,j}(t), q_{i,j+1}(t), q_{i+1,j+1}(t), q_{i+1,j}(t), q_{i+1,j-1}(t), q_{i,j-1}(t), q_{i-1,j-1}(t), q_{i-1,j}(t), q_{i-1,j+1}(t)] \quad (6.6)$$

6.3.3. Hexagonal Cellular automata

Later on, Conway found a new design of cellular automata model. He changed the shape of the cell to be hexagonal [22]. The central cell evolution is affected directly by the status of the 6 surrounding cells. This model can update only in binary notation. Also the evolution of the transition rule occurs to the adjacent cells as shown in the following figure:

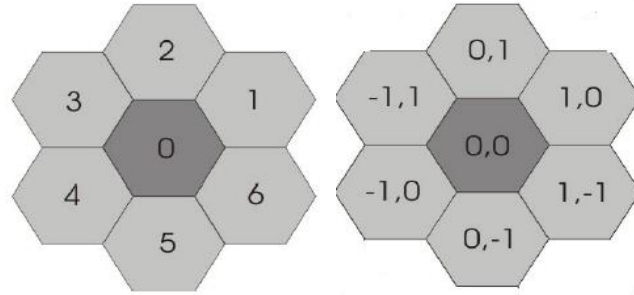

Fig. 54: Hexagonal cellular automata

If central cell (dark gray) starts its evolution and surrounded by 6 neighborhoods, we will find 64 possible neighborhoods (2^6).

So the transition rule of the central cell can be written as follows:

$$C0 = f[q_1(t), q_2(t), q_3(t), q_4(t), q_5(t), q_6(t), q_7(t)] \quad (6.7)$$

Knowing that this transition rule can vary according to some specified given matrices.

6.3.4. Probabilistic cellular automata

Probabilistic CA (PCA), also known by Stochastic CA are discrete dynamical system, which update at each discrete time step according to simple rule. This rule is a homogeneous rule which can be applied to all cells at the same time. PCA are CA whose states of evolution are chosen according to some probability distributions.

The general dynamics of PCA is given by a master equation:

$$p[x_i^{t+1}] = \sum_{x_i^t} P[(x_i^t)] \prod_i |P[x_i^{t+1} | (x_i^t)] \quad (6.8)$$

Where $\sum_{x_i^t} P[(x_i^t)]$ is the sum of the probabilities of the global states (x_i^t) at time t , $P[x_i^{t+1} | (x_i^t)]$ is the local probability transition function.

Here we can deduce from the above equation that the evolution of CA start at a cell (x_i^t) and updates the other cells by using the homogeneous transition rule (Local transition probability function).

6.4. Cellular automata applications

CA have served as one of the best techniques in modeling natural phenomena. Scientists were and still interested in the CA models due to their high potential and accuracy in prediction. CA are not only used in the field of engineering but also used in many fields of science. The reason behind the popularity of CA can be traced to their simplicity, and to the enormous potential they hold in modeling complex systems despite their simplicity [6].

In this part, we view some applications that are based on CA algorithms (1D-2D):

6.4.1. Image Processing

Currently, researchers are interested in image processing field. Image processing is a technique used by biological, geographical and physical sciences, in order to predict and detect information from image analysis. The image is converted into digital form where some operations are performed on it to extract needed features or information.

Wongthanavasv and Tangvoraphonkchai (2007) investigated CA algorithms for medical image processing using Moore neighborhood algorithm. These medical images named Mammogram images are used to specify the spot of breast cancer. CA algorithm and their evolution are presented and studied to deal with binary and grayscale images. The results of the proposed algorithms are helpful for doctors in the diagnosis of breast cancer [10].

Lee et al. (2010) proposed the concept of using Moore CA algorithm and adapted two algorithms for edge detection in hyper spectral images. They developed two CAs to analyze the image: an edge detection CA and a post-processing CA that implements morphological operations for identifying the edges. Results demonstrated the CA method is very promising for both unsupervised and supervised edge detection in hyper spectral imagery [11].

Paul et al (2014) developed CA model to various image processing tasks and feature detection. The main point of their research is to train the CA system using 3 function rules which can detect real image. Each cell is established to be a pixel denoted by binary notation. Paul compared the results with previous method based on threshold

decomposition, and are found to be generally superior. In his study, he deduced that CA was able to detect a real image from the fake [12].

6.4.2. Cryptography

Cryptographic techniques are very important nowadays as dominated by the growth of digital information storage and transmission. Cryptography is the art of encryption used to increase the level of security in electronics, emails communication, credit cards and corporate data. CA have plan their way into a plethora of encryption schemes.

Porod et al (1999) developed a novel nano-electronic scheme for computing with coupled quantum dots, where information is encoded by the arrangement of single electrons. They concluded that Quantum-dot cellular automata (QCA) may be used for binary information processing. They experimentally realized the key elements of QCA operation. Their studies are the first experiments to demonstrate the control of a single electrons using QCA [13].

Tomassini and Perrenoud (2000) described cryptography system based on non-uniform one-dimensional or two-dimensional CA. A single key cryptographic system based on cellular automata is described to be high quality pseudo random bit sequences produced by 1-D and 2-D non-uniform CA. The authors demonstrated that a further advantage of the proposed scheme is that it is eminently suitable for hardware implementation [14].

Seredynski et al (2003) applied non-uniform CAs (1-D) that are considered as a generator of pseudorandom number sequence used in cryptography with the secret key. The authors found that the result of collective behavior of discovered set of CA rules is well performing [15].

Kar et al (2011) discovered a set of CA rules which produce PNS of a very high statistical quality for a CA-based cryptosystem. The latter is resistant on breaking a cryptography key. The authors deduced that CAs(1-D) are an attractive approach for cryptographic applications. They are simple and modular logic systems that can generate good quality pseudorandom bit streams as required in robust cryptographic systems [16].

6.4.3. Physical Evolution

Researchers utilized CA to predict the spread of many complex phenomena such as diseases, fluids, crystallization and urbanization spread based on CA. These complex

phenomena are dynamic that can change their behavior each time step due to physical and environmental effects.

Situngkir (2004) investigates CA computational analysis as the dynamic model of spatial epidemiology. The author used 1-D CA in analyzing avian influenza disease in Indonesia. The result of simulation showed the spreading-rate of influenza in a simple way and described a possible preventive action through isolation of infected areas as a major step of preventing pandemic [17].

Yin et al. (2008) introduced a realizing format of SLEUTH, an existing CA urban growth model, and applied the model to simulate urban growth and its coefficients, transform rules and calibration process of the Chinese city, Changsha between 1996 and 2005 and forecast its morphology in 2015 and 2030, and the accuracies were found acceptable.

White (2009) applied a new mathematical model to simulate the spreading of an epidemic disease based on 2-D cellular automata. It was supposed that the distribution of the population isoccurringinhomogeneous conditions in which all cells have the same population. The obtained laboratory simulations were found to be in agreement with the expected behavior of a real epidemic [18].

Cirbus and Podhoranyi (2013) used a hexagonal CA technique for simulating the spreading of liquid, using simple rules and physical conditions that include several factors affecting the spreading of water such as slope, roughness and infiltration. The authors demonstrated that the grid cell can be a carrier of information which can identify some of the natural processes. The comparison of the model output with real measurements showed good agreement, demonstrating that, despite the simplicity of the model, a CA approach can provide realistic results for a complex natural process like liquid runoff [19].

Wang et al. (2015) developed 2-D CA using Moore's neighborhood model to simulate the crystal growth of semi-crystalline polymer during cooling stage after considering the effect of temperature on the nucleation density. The results showed that rapid cooling produces small crystals and slower cooling produces larger ones. Besides, the growth rate was increasing with the increase of the cooling rate upon adopting CA [20].

6.4.4. Social Science

Social science is another interesting field of application of multi-agent systems. Racial segregation has always been an adverse social problem in the United States. Although

much effort has been extended to desegregate schools, churches, and neighborhoods, the US continues to be segregated by race.

In 1971, the American economist Thomas Schelling created an agent-based model that might help explain why segregation is so difficult to struggle. His model of segregation showed that even when individuals (or "agents") didn't mind being surrounded or living by agents of a different race, they would still choose to segregate themselves from other agents over time! Although the model is quite simple, it gives a fascinating look at how individuals might self-segregate, even when they have no explicit desire to do so.

Schelling's model is explained in Fig.55 [23]. There are two types of agents: X and O that might represent different races, ethnicity, economic status, etc. Two populations of the two agent types are initially placed into random locations of a neighborhood represented by a grid. After placing all the agents in the grid, each cell is either occupied by an agent or is empty as shown below.

X	X	O	X	O
	O	O	O	O
X	X			
X	O	X	X	X
X	O	O		O

Fig. 55: Schelling's model with two agents placed randomly in a grid

Schelling's model works on the satisfaction of each agent with its current location. A satisfied agent is one that is surrounded by at least t percent of agents that are like itself. This threshold t is one that will apply to all agents in the model, even though in reality everyone might have a different threshold they are satisfied with. Note that the higher the threshold, the higher the likelihood the agents will not be satisfied with their current location.

For example, if $t = 30\%$, agent X is satisfied if at least 30% of its neighbors are also X. If fewer than 30% are X, then the agent is not satisfied, and it will want to change its location in the grid. The picture below (left) shows a satisfied agent because 50% of X's neighbors are also X ($50\% > t$). The next X (right) is not satisfied because only 25% of its neighbors are X ($25\% < t$). Notice that in this example empty cells are not counted when calculating similarity.

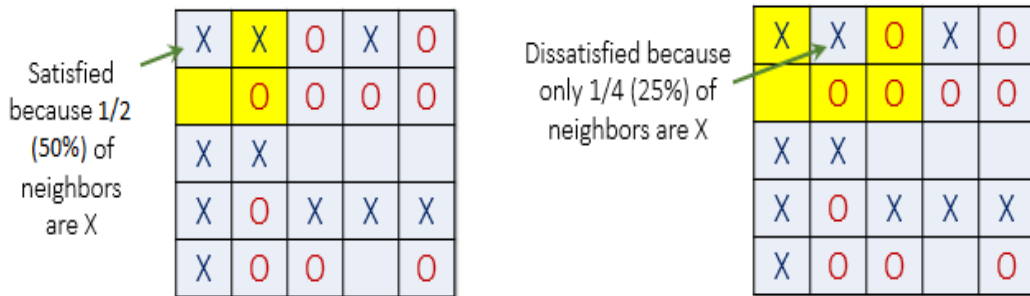

Fig. 56 : Satisfaction and Dissatisfaction of agents for t=30%

When an agent is not satisfied, it can be moved to any vacant location in the grid. Any algorithm can be used to choose this new location. In the image below (left), all dissatisfied agents have an asterisk next to them. The image on the right shows the new configuration after all the dissatisfied agents have been moved to unoccupied cells at random. It is to be noted that the new configuration may cause some agents which were previously satisfied to become dissatisfied! A new round begins and rounds continue until all agents in the neighborhood are satisfied with their location.

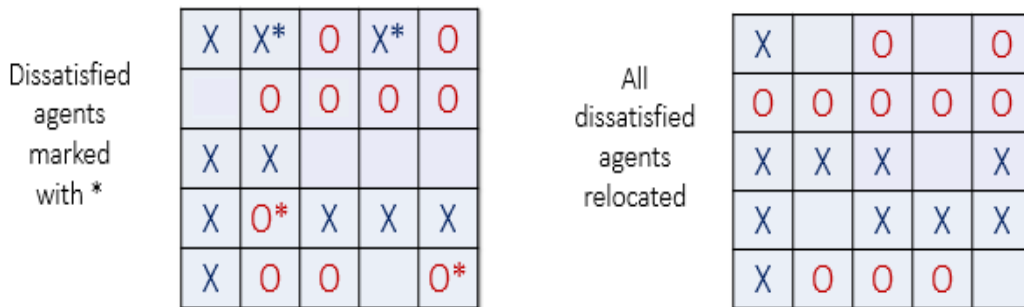

Fig. 57: Relocation of dissatisfied agents to be satisfied

Conclusion

A cellular automaton is a discrete dynamical system defined on a lattice of sites with finite number of states. A CA models based on transition update rules allowing for evolution. CA are divided into two main branches: ECA and 2dimensional cellular algorithm. ECA are known by the 1-D CA which consists of 256 rules while 2-D (Moore and Von Neumann neighborhood) CA can consist of thousands of rules which made from it more complex than ECA. The main benefit of the CA is the fact that the simulations can be efficiently run on parallel machines, which is an important feature considering today's highly parallel supercomputers. Besides the high performance in solving complex phenomena in different fields, researchers have considered CA model as relatively new technique which found its place in computational physics.

Due to high validity and performance of CA models in solving and simulating natural phenomena, we wish to apply in the next chapter 2 D-CA model that can simulate the diffusion of wildland fire that helps in suppression. Since the diffusion of wildland fire is a very complex natural phenomenon affected by various physical and environmental factors, CA seem to be the optimal tool to be used for fire behavior modeling.

References of Chapter 6

- [1]R.White, G.Engelen, "High-resolution integrated modelling of the spatial dynamics of urban and regional systems", *Comput. Environ. Urban Syst*, vol.24, pp.383–400, 2000
- [2]S.Wolfram, *Appendix of Theory and Applications of Cellular Automata*, ed. World Scientific, 1986

- [3]I.Benenson and ,PM.Torrens. Geo-simulation Automata-based modeling of urban phenomena, John Wiley & Sons Ltd, Chechester. xxiii, 287, 2004
- [4]Li.Xiadong, W.Magill, "Modeling fire spread under environmental influence using a cellular automation approach", Complexity International, 2001
- [5]M.Gardner, (1970), "The fantastic combinations of John Conway's new solitary game of Life".,Scientific American, pp.120–123, 1970
- [6]S.Wolfram, 2002, " A new kind of science", Wolfram Media, Inc.
- [7]P. Torrens, How cellular models of urban systems work (1. Theory), CASA Working Papers Series. Accessed in November 2005
- [8]F.Edward.Moore, "Machine models of self-reproduction", Proc. Sympos. Appl. Math., vol. 14, Amer. Math. Soc., Providence, R.I., 1962, pp. 17-33
- [9]G.Tzedakis, E.Tzamali, Ko.Marias, and V.Sakkalis, "The Importance of Neighborhood Scheme Selection in Agent-based Tumor Growth Modeling", vol.14, pp.67–81, 2015
- [10]S.Wongthanavasv and V.Tangvoraphonkchai, "Cellular automata-based algorithm and its application in medical image processing", International Conference on Image Processing IEEE January 2007
- [11]MA.Lee and LM.Bruce, " Applying Cellular Automata to Hyper-spectral Edge Detection, IEEE (IGARSS), pp. 2202-2205, 2010
- [12]L.Paul, S.Xianfang, "Edge Detection Using Cellular Automata", Cellular Automata in Image Processing and Geometry, Emergence, Complexity and Computation 10, Springer International Publishing Switzerland 2014
- [13]P.Wolfgang, SL.Craig, HB.Gary, OO.Exei, A.Islamshah, LS.Gregory, and JL.Merz, "Quantum-dot cellular automata: computing with coupled quantum dots", INT.J. ELECTRONICS, 5, vol. 86, pp.549-590, 1999
- [14]M.Tomassini and M.Perrenoud, "Nonuniform Cellular Automata for Cryptography", Complex Systems Publications, Inc, vol.12, pp.71-81 , 2000
- [15]F.Seredyński, P.Bouvry, A.Zomaya, "Secret Key Cryptography with Cellular Automata", IEEE Xplore Conference Paper, DOI: 10.1109/AICCSA.2003.1227512, august 2003.
- [16]B.Kar, C.Rao, A.KumarRath, "Generating PNS for Secret Key Cryptography Using Cellular Automaton", International Journal of Advanced Computer Science and Applications, vol. 2, No. 5, 2011
- [17]H.Situngkir, "Epidemiology through cellular automata Case of Study: Avian Influenza in Indonesia", report on computational sociology research, Working Paper WPF2004, January 29, 2004
- [18]H.White, "Using Cellular Automata to Simulate Epidemic Diseases", Applied Mathematical Sciences, Vol. 3, no. 20, pp.959 – 968, 2009
- [19]J.Cirbus, and M.Podhoranyi, "Cellular Automata for the Flow Simulations on the Earth Surface, Optimization Computation Process", An International Journal Applied Mathematics & Information Sciences, vol.7, no. 6, pp. 2149-2158, 2013

[20]X.Wang and J.Ouyang, Phase-Field Simulation of Polymer Crystallization during Cooling Stage, International Journal of Chemical Engineering and Applications, vol. 6, pp 28-39 No. 1, 2015

[21]J.Quartieri, N.Mastorakis, G.Iannone, C.Guarnaccia, "A Cellular Automata Model for Fire Spreading Prediction"ISBN: 978-960-474-204-2

[22]John H. Conway: On numbers and games, Academic Press, London (1976),
Second edition: A. K. Peters, Wellesley/MA, 2001

Chapter7: A new Methodology for Spatial Simulation of Forest Fire Behavior Using Cellular Automata

7.1. Introduction

Wild land fires pose a serious problem to human life and property when homes are built in fire-prone ecosystems. Fire behavior prediction is a troublesome mission that is defined as the manner in which fuel ignites, flame develops, and fire spread and exhibits. Several factors influence the intensity of wildfires and their potential to damage or destroy structures. Researchers have shown that the most important factors influencing building survival during a wildfire are fire intensity, vegetation characteristics, and building materials [1] [2]. Fire behavior is a function of fuels, weather, and topography.

Cellular Automata (CA) are dynamic systems operating discrete in space and time, on a uniform, regular lattice and characterized by local interactions. CA were created and used by J. von Neumann, followed by A.W. Burks and E. F. Codd, to solve problem of the non-trivial self reproduction in a logical system [3]. CA represents the modeling approaches to common complex systems that can capture both the spatial and temporal dynamics [4]. CA has become an attractive area for researchers of various fields due to its parallel nature, which can break down the non-linear relationships involved in natural phenomena. CA has been used in almost all sciences' fields: Urban development, Crystallization, Turbulence in fluids, Gas behavior, fire propagation, etc.

Here we can review some of CA applications. In the field of urban development [5] presented a class of urban models through a GIS-based CA integrated within software that is able to generate many random configurations of land uses. They defined various decision rules that comprise distance and direction, density, and transition probabilities into the model's dynamics. Nevertheless, Yin et al. (2008) introduced a realizing format of SLEUTH, an existing CA urban growth model, and applied the model to simulate urban growth and its coefficients, transform rules and calibration process of the Chinese city, Changsha between 1996 and 2005 and forecast its morphology in 2015 and 2030, and the accuracies were found acceptable [6].

In Crystallization, Lee et al. (2010) [7] developed a CA model with partial fraction and controlled time step to simulate the dynamic re-crystallization of pure copper during hot deformation. The system validation was generally in good agreement with the experimental flow stresses and grain sizes determined from hot compression tests.

Likewise, Hallberg et al. (2010) employed CA algorithm with probabilistic cell switches in the simulation of dynamic discontinuous re-crystallization in pure Cu under hot compression [8]. The developed model was validated as a multilateral tool for studying the micro structural changes in a material during thermo-mechanical processing, where experimental results were replicated in good agreement with the simulations. In the same manner, Schyndel et al. (2014) adapted a CA based computational fluids dynamics following the Discrete Event System Specification (DEVS) formalism [9]. The defined solver implemented variable time-step thus increasing its efficiency. They claimed to aid in the simulation of complex systems in biomechanics and engineering fields.

CA based models have been also used for simulating ecological phenomena [10] [11] [12]. Perez et al (2012) developed a hybrid model that combines swarm intelligence, agent-based modeling and CA with GIS for simulating tree mortality patterns introduced by insect infestations at a landscape spatial scale. The discrete nature of CA proved beneficial when modeling complex ecological processes that evolve over time [13].

Forest Fires is another phenomenon that is extremely urgent to find effective solutions to deal with. The spread of forest fire is a highly non-linear problem sensitive to kinds of factors including weather and geographical conditions. It is very difficult to take all those factors into account using a traditional mathematical analytic approach. In forest fires, scientists break the role of forest fire complexity using CA modeling to predict forest fire propagation. Karafyllidis et al. (1997) developed CA model based on diagonal grid movement to predict fire spread rate under various scenarios of climate (wind speed and direction), topography (elevation and slope) and vegetation type. Their theoretical model showed acceptable results after simulation in homogenous and heterogeneous environments [14]. Hargrove et al. (2000) applied a probabilistic model of fire spread in heterogeneous landscape based on CA to understand how this natural process operates on the landscape in USA [15]. Utilizing a square lattice (50m x50m), a stochastic model of fire spread was developed in which the ignition around a burning cell is based upon an ignition probability that is isotropic in no wind and biased in wind using three classes of wind speed. The Validation of CA model showed considerable results in predicting fire propagation. Malamud et al. (2000) presented a simple CA approach using a programmed model. This model consists of a square grid, in which at each time step a tree is randomly dropped on a chosen site. Every $1/f_s$ time step a match is randomly dropped (f_s is the sparking frequency) [16]. If a tree falls on an unoccupied cell it is planted. If a match drops on a tree, that tree and all non-diagonally adjacent ones are burned in a fire. This model showed a limited performance after experimenting different fire frequencies. Sullivan et al. (2004) combined a simple 2D 3-state CA for fire spread with a simplified

semi physical model of convection. This model explored the possible interactions between a convection column, the wind field and the fire to replicate the parabolic head of fire shape observed in experimental grassland fires [17]. It used local cell based spread rules that incorporated semi stochastic rules with spread direction based on the vector summation of the mean wind field vector and a vector from the cell to the center of convection. The results showed a high accuracy after simulation and comparison between real and simulated fire. Alexandridis et al. (2008) proposed a probabilistic CA model to predict forest fires in Greek Spetses Island based on meteorological data (Vegetation density, Vegetation type, Wind speed and Wind direction) and spotting phenomenon [18]. The developed model is based on simple transition rule to find the probability of each cell state using Moore's neighboring in heterogeneous terrains (burned, unburned, will be burned and completely burned). It showed a good performance after comparison between the actual fire and the simulated one. Yassemia et al. (2008) developed a forest fire behavior model based on CA with intuitive and simple transition rules [19]. Their work improved the previous CA based models using unique and particular transition rules that can accurately calculate fire spread within and between cells and also synchronize fire with wind direction and slope. Also, they developed a GIS modeling tool based on user interface to provide a flexible environment for modeling that served facilitating the presentation of simulation results. Indeed, they presented a direct comparison between CA and fire spread wave approach. Hui et al. (2010) proposed a multi-state probability CA model of forest fires which analyzed changes in the occupancy of forest trees under two sets of conditions; one being that they exist in spaces with no growth and are not susceptible to fires, the other being that the trees differ from their neighborhood due to deforestation [20]. This model showed very good results once implemented in many regions. Ghisuet al. (2015) presented a numerical optimization approach to find the maximum values for the correction factors in fire spread rate [21]. The results were compared to the ones obtained by other cell-based simulators based on a CA paradigm and showed a significantly improved accuracy, in the presence of a comparable computational cost.

This paper presents a new methodology for predicting the spread of wildfires based on the principles of CA. Specifically, it is an improvement model of the pioneer model proposed by Karafyllidis and Thanailakis (Karafyllidis et al.1997) time [14]. Special care has been taken to formulate the rules that define the interactions between the adjacent and diagonal cells and comprising a 2-dimensional automaton based on the transfer of fractional burned area but using elliptical fronts this thus derives the hypothetical transition rule. External influences of wind, vegetation fuel and topography are then incorporated to deduct the transition rule that fits heterogeneous terrains. The developed model is then used to simulate the wildfire that swept through the forest of Aandqet

village, North Lebanon. Obtained simulation results are compared with reported results of the real incident and with the simulations of Karafyllidis model and Gazmeh-Modified Karafyllidis model.

7.2. Place of study

Lebanon is situated east of the Mediterranean Sea. Its climate is typically Mediterranean, with heavy rains in winter season (January to May) and dry and arid conditions in the remaining 7 months of the year.

The Republic of Lebanon has been known throughout history for its rich forests and iconic cedars. Today, forests cover only 13 percent of the total land area of Lebanon; though still of the most forested countries in the Middle East [22]. But the fact that green areas continued to decline dramatically during the last decades, it imposes a prompt intervention with strict governmental policies and support of nongovernmental organizations.

North Lebanon is the second largest governorate in Lebanon. Its weather is mild having cool, wet winters and very hot dry summers. This governorate is known by its forests diversity (Pine, Cedar, and Oak). During the last 12 years, this place has lost 7567 hectares as shown in Fig. 58, which made from this place an important region to study.

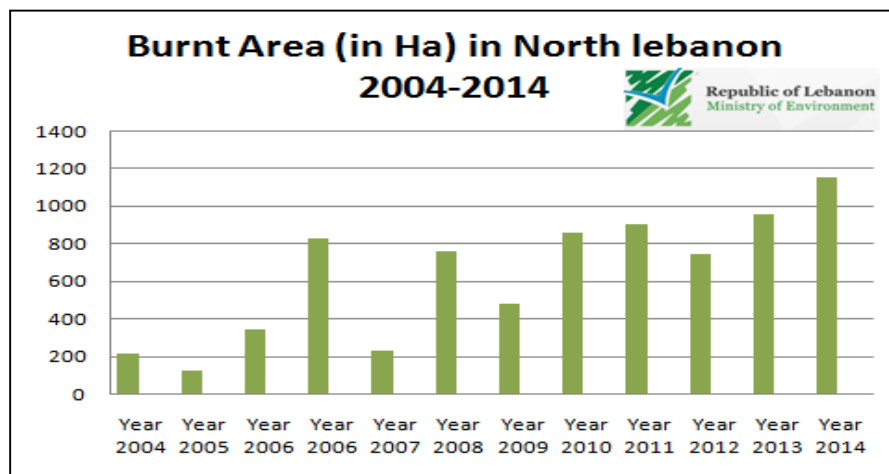

Fig. 58: Burnt area (ha) in North Lebanon during the years2004-2014
(By Ministry of Environment MOE)

7.3. CA Structure for fire fronts simulation

In its basic description, a CA model of a system is an object structure that uses a 2D grid picturing the forest area to a number of cells with a rectangular, hexagonal, or other topology. Each cell, representing a small patch of the forest, interacts with a group of cells in the neighborhood through a set of transition rules. In parallel, the rules are entirely applied to all the cells leading the CA to evolve in both time and space.

The state of a cell (i,j) at a time t can take values from 0 to 1. $S_{ij}^t = 0$ means that the cell (i,j) is still unburned at time t ; $S_{ij}^t = 1$ means that the cell is completely burned out at time t . Otherwise, the cell (i,j) is partially burned out at time t . As CA evolution occurs in discrete time steps, it is important to specify the size of such time step. It is actually the time needed for fire to spread from a cell to another neighbor cell. In a flat homogeneous forest with no wind conditions, the required time for fire to spread from a burned out cell to another cell is $t=x/R$, where x represents the distance covered fire and differs between adjacent and diagonal cells; and R represents the rate of fire spread.

The rate of fire spread of the cell (i,j) , R_{ij} , is influenced by the physical composition of the cell. That is to note that if (i,j) is an incombustible patch, then $R_{ij} = 0$ and $S_{ij} = 0$ at any time. Each cell has a set of characteristics that indicate the value of the cell. For each cell, fire spread rate (R_{ij}), wind speed and direction (W_{ij}), surface fuel type or vegetation (V_{ij}) and topography (T_{ij}) are considered. In our case study the fire spread rate is used similar to McRaei (1989) [23].

The state of each cell is updated simultaneously at discrete time steps following the transition rules, based on the states of the neighboring cells. These rules are defined as follows:

$$S_{(i,j)}^{(t+1)} = f(S_{(i,j)}^{(t)}, S_{\delta(i,j)}^{(t)}) \quad (7.1)$$

The states of all cells at each time step t are obtained as comes in the following matrix:

$$\begin{pmatrix} S_{(1,1)}^{(t+1)} & \dots & S_{(1,n)}^{(t+1)} \\ \vdots & \ddots & \vdots \\ S_{(n,1)}^{(t+1)} & \dots & S_{(n,n)}^{(t+1)} \end{pmatrix} \quad (7.2)$$

This matrix is updated every iteration viewing the structure of CA as a function of time t .

7.4. Karafyllidis CA models for fire spreading

In this section, we will review Karafyllidis proposed models (Karafyllidis et al., 1997) [14] based on 2-dimensional CA for fire spreading.

7.4.1. Karafyllidis linear Model

Karafyllidis applied linear fire spread models in homogeneous conditions using the Moore neighborhood CA process after considering that each cell of forest fire is hypothetical square cell with side length a , where each cell state Karafyllidis defined as follows:

$$S_{(i,j)}^{(t+1)} = \frac{|Burned\ Area\ (i,j)|}{|Total\ Area(i,j)|} \quad (7.3)$$

He supposed that, if central cell unburned and only one of its adjacent sides is completely burned after time t , it can be calculated as per the following equation:

$$t = \frac{a}{R(i,j)} \quad (7.4)$$

Where a is the cell length (m) and R is the spread rate (m/s).

Otherwise if one of diagonal neighbors is completely burned, the central cell will also be completely burned after time t , calculated as follows:

$$t = \frac{\sqrt{2}a}{R(i,j)} \quad (7.5)$$

Where $\sqrt{2}a$ is the length of diagonal of the cell.

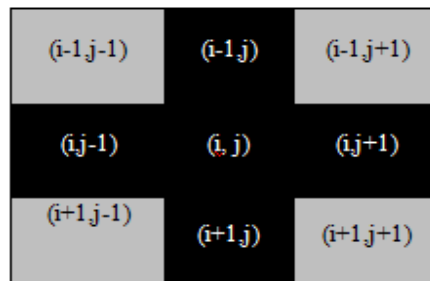

Fig. 59: Adjacent fire spreading

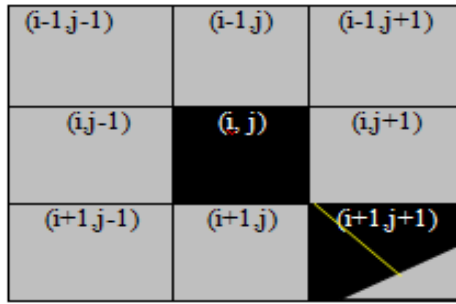

Fig. 60: Diagonal fire spreading

Karafyllidis assumed that if the central cell (i, j) is completely burned, $S_{(i,j)}^{(t)} = 1$. After a time step t , all the neighbor adjacent cells will be totally burned, that is covering the distance a (Fig. 59). Meanwhile, the neighbor diagonal cells will be partially burned while covering the same distance (Fig. 60). The state of each of the diagonal cells can be calculated as per the following equation:

$$S_{(i,j)}^{(t+1)} = \frac{a^2 - ((a^2(\sqrt{2}-1))^2)}{a^2} \approx 0.83 \quad (7.6)$$

Thus the state of the central cell at $t+1$ describing the transition rule of the linear spread can be calculated as in the following equation, while neglecting all external conditions such as wind:

$$S_{(i,j)}^{(t+1)} = S_{(i,j)}^{(t)} + \left(S_{(i-1,j)}^{(t)} + S_{(i,j-1)}^{(t)} + S_{(i,j+1)}^{(t)} + S_{(i+1,j)}^{(t)} \right) + 0.83 * \left(S_{(i-1,j-1)}^{(t)} + S_{(i+1,j-1)}^{(t)} + S_{(i+1,j+1)}^{(t)} + S_{(i-1,j+1)}^{(t)} \right) \quad (7.7)$$

7.4.2. Improved Karafyllidis Non- linear Model

Since the forest fire spread always occurs in non-linear propagation, Gazmeh et al. (2012) assumed that the fire spread shall be studied using circular fronts, where the center of the circle is the point of ignition [24]. This proposed model was applied to flat hypothetical forest as shown in Fig. 61.

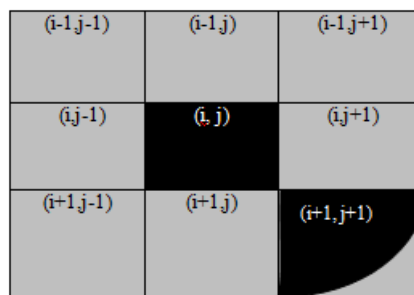

Fig. 61: Circular spreading

While taking no external environmental influences into account, if only one cell is totally burned out, the time needed is computed as follows:

$$t = \frac{a}{r} \quad (7.8)$$

Where a is the side length (m) of a cell and r is the rate of fire spread in non-linear shape (m/s). After a time step, the state of all neighbor adjacent cells will be 1 as in the precedent linear model. In time, the diagonal cells will burn partially at time $t+1$ drawing a state calculated as follows:

$$S_{(i,j)}^{(t+1)} = \frac{\pi a^2}{4a^2} \approx 0.78 \quad (7.9)$$

So the state of the central cell at $t+1$ describing the transition rule of the circular spread can be calculated as in the following equation:

$$S_{(i,j)}^{(t+1)} = S_{(i,j)}^{(t)} + \left(S_{(i-1,j)}^{(t)} + S_{(i,j-1)}^{(t)} + S_{(i,j+1)}^{(t)} + S_{(i+1,j)}^{(t)} \right) + 0.78 * \\ \left(S_{(i-1,j-1)}^{(t)} + S_{(i+1,j-1)}^{(t)} + S_{(i+1,j+1)}^{(t)} + S_{(i-1,j+1)}^{(t)} \right) \quad (7.10)$$

7.4.3. The proposed CA-Model

Our proposed model aims to study the spread of forest fires in Lebanon and the Mediterranean. The model uses CA to demonstrate fire spreads on elliptical fronts. We tend to use elliptical shape as the final shape of fire is empirically proved to be elliptical [25][26][27] and then we are assuming that since ignition and at any time t of diffusion, the shape is elliptical and is expanded over time till it reaches its final shape at the end. The elliptical model is based on Moore neighborhood process. Our goal in this part is to find the transition rule of the elliptical shape of forest fire spread (Fig. 62).

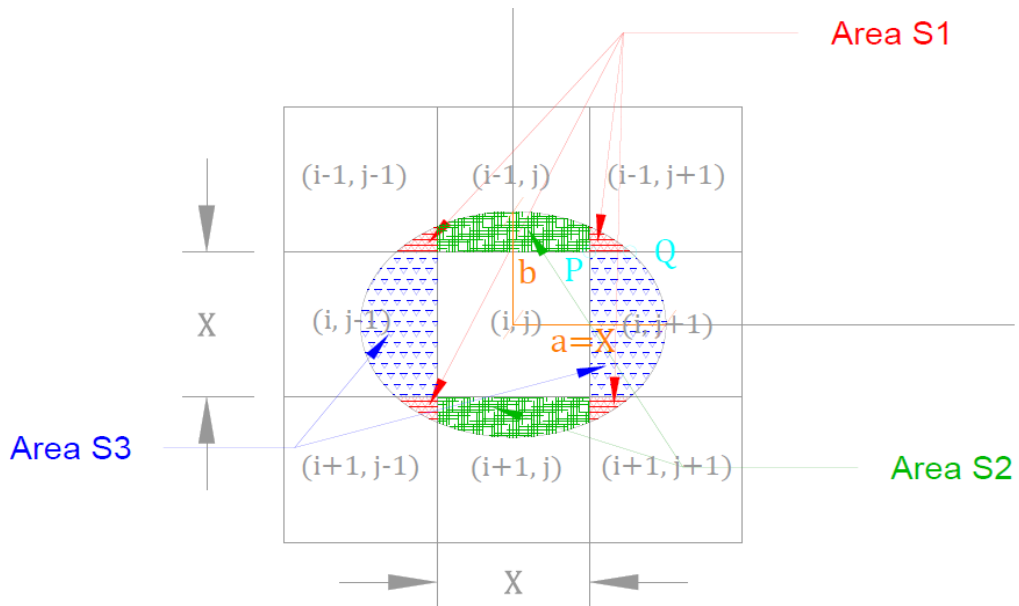

Fig. 62: Elliptical fire fronts

In this study we supposed that the fire starts at the center of the central cell (i,j) which is completely burned at time step t , then the fire propagates into the eight neighbor cells at time $t+1$ drawing an elliptical shape and turning the cells incompletely burned-out. To find the state of the central cell at time $t+1$, we need to find the burned areas of diagonal and adjacent cells (S1, S2 and S3) as in the following.

Our approach is based on the equations derived by Anderson who based his approach on the results of a series of 198 laboratory fires conducted in a wind tunnel by Fons in 1939 [27].

Anderson stated that a few of the variables contributing to an irregular and longer fire edge are wind speed and direction, slope and topography, and changes in fuel distribution. The greatest benefit of using equations, that had previously used or adapted to make estimates of the fire dimensions [28][29][30] is that only two input variables - wind at mid flame height and rate of speed - are needed to compute area, perimeter, backing fire distance, flanking fire distance, their ratios to the heading fire, and the maximum length to width ratio and thus the size and the elliptical shape of fire to estimate.

Anderson found that the ratio of the total fire length to the maximum fire width l/w could be obtained in function of mid flame wind speed (at 1.5 ft) only. We build our model using Anderson's equations.

Generally, the equation of an ellipse is:

$$\left(\frac{X}{a}\right)^2 + \left(\frac{Y}{b}\right)^2 = 1$$

As per Anderson, the ratio length/width is calculated as per the following equation:

$$\frac{l}{w} = 0.936e^{0.1147U} + 0.461e^{-0.0692U}$$

Where l is the length of the ellipse (mi), w is the width of the ellipse (mi) and U is the wind speed (mi/h)

$$l = 2X = 2a \quad (\text{Refer to Fig. 62})$$

$$w = 2b$$

Then

$$\frac{a}{b} = 0.936e^{0.1147U} + 0.461e^{-0.0692U}$$

In the area of study, North Lebanon, weather data of 6 years (2009-2014) were broadcasted.

Over the 6 years, we found that: $2.237 \leq U_{(\text{mi/hr})} \leq 67.11$

Back to Anderson:

$$b = 0.543e^{-0.1147U}$$

Then we get:

$$a = X = f_1(U)$$

$$b = f_2(U)$$

Upon plotting the values of a and b for the given interval of U , we obtained a simple linear equation with high coefficient of correlation R^2 :

$$b = f(a) = 2.7459a - 1.3559; R^2 = 0.9517$$

Also upon comparing the values of ab and a^2 , we obtain:

$$ab = 1.5212a^2 - 0.372; R^2 = 0.9714$$

Area S1:

S1 is to be calculated as per the following method:

Take as reference the axis (O, X, Y);

$P(\frac{a}{2}, \frac{a}{2}); Q(c, \frac{a}{2})$ where P & Q are the base points of the portion S1 as shown in Fig. 62.

As Q belongs to the ellipse then

$$c^2 = a^2 \left(1 - \frac{a^2}{4b^2}\right) = a^2 \left(\frac{29.16a^2 - 29.785a + 7.354}{30.16a^2 - 29.785a + 7.354}\right) \approx 0.9669a^2;$$

hence $c \approx 0.9832a$

$$S1 = \int_{\frac{a}{2}}^c [b\sqrt{1 - (\frac{x}{a})^2} - \frac{a}{2}] dx$$

$$S1 = \left| \int_{\frac{a}{2}}^c b\sqrt{1 - (\frac{x}{a})^2} dx - \int_{\frac{a}{2}}^c \frac{a}{2} dx \right| = \left| K - \int_{\frac{a}{2}}^c \frac{a}{2} dx \right| = \left| K - \frac{ac}{2} + \frac{a^2}{4} \right|$$

$$= |K - 0.24164a^2|$$

Change of Variables:

$$\text{Let } \frac{x}{a} = \sin \alpha$$

$$\frac{a}{2} \leq x \leq c;$$

$$\frac{1}{2} \leq \sin \alpha \leq 0.9832 ;$$

$$\frac{\pi}{6} \leq \alpha \leq 1.3872;$$

$$x = a \sin \alpha ; dx = a \cos \alpha d\alpha$$

$$K = ab \int_{\frac{\pi}{6}}^{1.3872} (\cos \alpha)^2 d\alpha = ab \int_{\frac{\pi}{6}}^{1.3872} \frac{(1 + \cos 2\alpha)}{2} d\alpha = \left| \frac{ab}{2} \left[\alpha + \frac{1}{2} \sin 2\alpha \right] \right|$$

$$= |0.305ab|$$

$$\text{Using } ab = 1.5212a^2 - 0.372$$

$$\text{Then } K = |0.464a^2 - 0.1135|$$

And finally we get:

$$\mathbf{S1 = |0.2224a^2 - 0.1135|} \quad (7.11)$$

Our target is to retrieve the state of each cell (i,j):

$$S_{(i,j)}^{(t)} = \frac{|burnt\ out\ area\ in\ cell\ (i,j)|}{|total\ area\ of\ cell\ (i,j)|}$$

$$S_{(i-1,j+1)}^{(t)} = S_{(i-1,j-1)}^{(t)} = S_{(i+1,j+1)}^{(t)} = S_{(i+1,j-1)}^{(t)} = \frac{S1}{a^2} = \frac{|0.2224a^2 - 0.1135|}{a^2}$$

Area S2:

$$S2 = 2 \left| \int_0^{\frac{a}{2}} [b\sqrt{1 - (\frac{x}{a})^2} - \frac{a}{2}] dx \right|$$

$$S2 = 2 \left| \int_0^{\frac{a}{2}} b \sqrt{1 - \left(\frac{x}{a}\right)^2} dx - \int_0^{\frac{a}{2}} \frac{a}{2} dx \right| = 2 \left| \Gamma - \int_0^{\frac{a}{2}} \frac{a}{2} dx \right| = 2 \left| \Gamma - \frac{a^2}{4} \right|$$

$$= 2 |\Gamma - 0.25a^2|$$

Change of Variables:

$$\text{Let } \frac{x}{a} = \sin \alpha$$

$$0 \leq x \leq \frac{a}{2};$$

$$0 \leq \sin \alpha \leq \frac{1}{2};$$

$$0 \leq \alpha \leq \frac{\pi}{6};$$

$$x = a \sin \alpha ; dx = a \cos \alpha d\alpha$$

$$\Gamma = ab \int_0^{\frac{\pi}{6}} (\cos \alpha)^2 d\alpha = ab \int_0^{\frac{\pi}{6}} \frac{(1 + \cos 2\alpha)}{2} d\alpha = \frac{ab}{2} \left[\alpha + \frac{1}{2} \sin 2\alpha \right]$$

$$= |0.4783ab|$$

$$\text{Using } ab = 1.5212a^2 - 0.372$$

$$\text{Then } \Gamma = |0.7276a^2 - 0.1779|$$

And finally we get:

$$S2 = |2 * [0.4776a^2 - 0.1779]| = |0.955a^2 - 0.3559| \quad (7.12)$$

Thus the state of the corresponding cells is as follows:

$$S_{(i+1,j)}^{(t)} = S_{(i-1,j)}^{(t)} = \frac{S2}{a^2} = \frac{|0.955a^2 - 0.3559|}{a^2}$$

Area S3:

$$S3 = 2 \left| \int_0^{\frac{a}{2}} \left[a \sqrt{1 - \left(\frac{y}{b}\right)^2} - \frac{a}{2} \right] dy \right|$$

$$S3 = 2 \left| \left[\int_0^{\frac{a}{2}} a \sqrt{1 - \left(\frac{y}{b}\right)^2} dy - \int_0^{\frac{a}{2}} \frac{a}{2} dy \right] \right| = 2 \left| \left[\Psi - \int_0^{\frac{a}{2}} \frac{a}{2} dy \right] \right| = 2 \left| \left[\Psi - \frac{a^2}{4} \right] \right|$$

$$= 2 |[\Psi - 0.25a^2]|$$

Change of Variables:

$$\text{Let } \frac{y}{b} = \sin \alpha$$

$$0 \leq y \leq \frac{a}{2};$$

$$0 \leq \sin \alpha \leq \frac{a}{2b};$$

$$\text{Using } b = 2.7459a - 1.3559$$

$$\frac{a}{2b} \approx 0.182 = \sin^{-1} \frac{a}{2b} \text{ (for small angles)}$$

$$0 \leq \alpha \leq 0.182;$$

$$y = b \sin \alpha ; dy = b \cos \alpha d\alpha$$

$$\begin{aligned} \Psi &= ab \int_0^{0.182} (\cos \alpha)^2 d\alpha \\ &= ab \int_0^{0.182} \frac{(1 + \cos 2\alpha)}{2} d\alpha = \left| \frac{ab}{2} \left[\alpha + \frac{1}{2} \sin 2\alpha \right] \right| = |0.18ab| \end{aligned}$$

$$\text{Using } ab = 1.5212a^2 - 0.372$$

$$\text{Then } \Psi = |0.274a^2 - 0.067|$$

And finally we get:

$$\mathbf{S3} = |0.048a^2 - 0.134| \quad (7.13)$$

Thus the state of the corresponding cells is as follows:

$$S_{(i,j+1)}^{(t)} = S_{(i,j-1)}^{(t)} = \frac{S3}{a^2} = \frac{|0.048a^2 - 0.134|}{a^2}$$

For the given interval of $0 < U_{m/s} \leq 30$ in Lebanon, we can calculate the states as per the deducted formulas and assume the averages for our simulations. Hence the average states are as follows:

$$S_{(i-1,j+1)}^{(t)} = S_{(i-1,j-1)}^{(t)} = S_{(i+1,j+1)}^{(t)} = S_{(i+1,j-1)}^{(t)} = \frac{S1}{a^2} = \frac{|0.2224a^2 - 0.1135|}{a^2} = 0.209$$

$$S_{(i+1,j)}^{(t)} = S_{(i-1,j)}^{(t)} = \frac{S2}{a^2} = \frac{|0.955a^2 - 0.3559|}{a^2} = 0.408$$

$$S_{(i,j+1)}^{(t)} = S_{(i,j-1)}^{(t)} = \frac{S3}{a^2} = \frac{|0.048a^2 - 0.134|}{a^2} = 0.461$$

Now, we can get the CA local transition rule:

$$\begin{aligned} S_{(i,j)}^{(t+1)} = & S_{(i,j)}^{(t)} + 0.209 * \left(S_{(i-1,j+1)}^{(t)} + S_{(i-1,j-1)}^{(t)} + S_{(i+1,j+1)}^{(t)} + S_{(i+1,j-1)}^{(t)} \right) + \\ & 0.408 * \left(S_{(i-1,j)}^{(t)} + S_{(i+1,j)}^{(t)} \right) + 0.461 * \left(S_{(i,j-1)}^{(t)} + S_{(i,j+1)}^{(t)} \right) \end{aligned} \quad (7.14)$$

Following this equation, the state of cells at a time step could be larger than 1, then we assume for $S_{(i,j)} > 1$, $S_{(i,j)} = 1$.

7.4.4. Hypothetical Simulation of Proposed Model

In this section we are going to simulate our proposed model using the obtained CA transition rule through Matlab. At this stage, the forest is supposed homogeneous and thus all external factors are ignored.

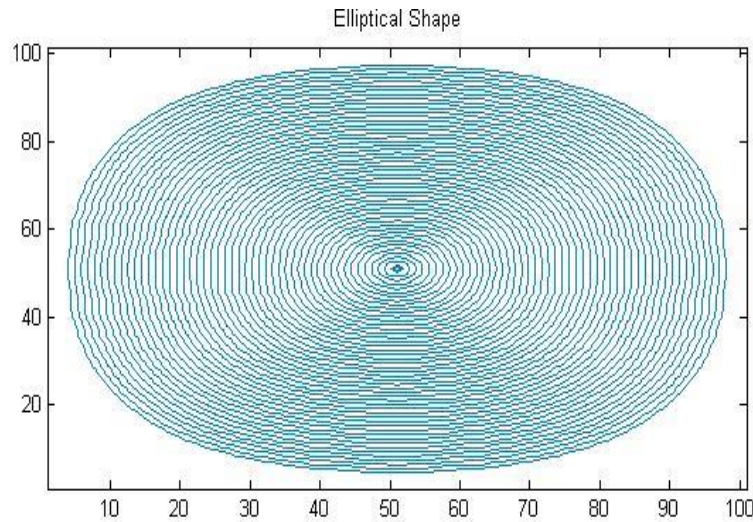

Fig. 63: Elliptical shape in homogenous conditions

A 100*100 grid is taken for simulation and the fire starts from the core cell (central cell) at time step t and spreads to draw the first ellipse at time $t+1$, as shown in Fig. 63. The figure clearly shows the diffusion of fire elliptical shape as we proposed for Lebanon and Mediterranean after each time step.

7.5. Attributes affecting fire behavior

Many studies showed that the most important parameters that influence the fire spreading are the presence of fuel, topography, wind speed and its direction

[19][31][32]. In our study, we have categorized these parameters into global and local agents. We've assumed that during a fire the wind speed and direction are constant over space. We are going to call them global agents. While topography parameters and fuel type do vary from one cell to another within the grid under scope, we'll name these agents by local agents.

7.5.1. Wind speed and direction

Wind speed and direction are the most important factors that affect fire spread [33]. Wind is vitally involved in heat transfer between fuels. It comprises heating prior to ignition and transfer of flame. Wind induces a forward tendency of the flame front, what increases the distance between the flame and fuel causing this flame. The high wind speed increases the rate of convective heat transfer between the heated air and the fuel particles. All of these effects are greatest in the prevalent direction of the blowing wind.

To examine the impact of wind direction in our proposed model, we use the wind matrix in different directions as shown in Table 37. The simulations conducted in Table 37 neglect all external factors other than wind.



Wind direction	East to west	West to east	South to north	North to south	South east to north west	North west to south east	North east to south west	South west to north east
Matrices	$\begin{pmatrix} 0.2 & 1 & 2 \\ 0.2 & 1 & 2 \\ 0.2 & 1 & 2 \end{pmatrix}$	$\begin{pmatrix} 2 & 1 & 0.2 \\ 2 & 1 & 0.2 \\ 2 & 1 & 0.2 \end{pmatrix}$	$\begin{pmatrix} 2 & 2 & 2 \\ 1 & 1 & 1 \\ 0.2 & 0.2 & 0.2 \end{pmatrix}$	$\begin{pmatrix} 0.2 & 0.2 & 0.2 \\ 1 & 1 & 1 \\ 2 & 2 & 2 \end{pmatrix}$	$\begin{pmatrix} 1 & 0.2 & 0.2 \\ 2 & 1 & 0.2 \\ 2 & 2 & 1 \end{pmatrix}$	$\begin{pmatrix} 1 & 0.2 & 0.2 \\ 2 & 1 & 0.2 \\ 2 & 2 & 1 \end{pmatrix}$	$\begin{pmatrix} 0.2 & 0.2 & 1 \\ 0.2 & 1 & 2 \\ 1 & 2 & 2 \end{pmatrix}$	$\begin{pmatrix} 2 & 2 & 1 \\ 2 & 1 & 0.2 \\ 1 & 0.2 & 0.2 \end{pmatrix}$
Simulation								

Table 37: Simulation of proposed model applying different wind directions

7.5.2. Vegetation

Fuel types can be described according to a number of physical attributes that are known to influence fire behavior [26]. Surface fires burn in dead and live fuels at the surface of the ground mostly by flaming combustion [34]. Surface fuels embrace grasses, shrubs, litter, and woody material lying on the ground. Surface fires ignite low vegetation, woody debris and litter. Dead and live fuels affect the fire behavior directly. The dead fuel has no moisture content which can burn quickly, while live fuel is more prone to enter pyrolysis process and then takes more time to burn.

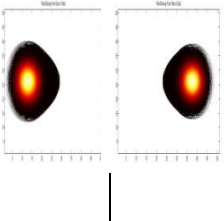
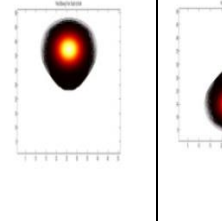
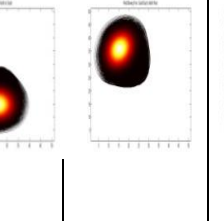
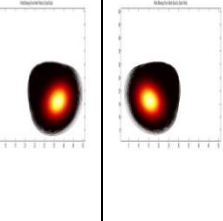
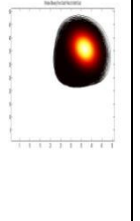
To examine the effect of surface fuel types on the behavior of fire in our model, we've first classified the surface fuel types according to speed of ignition. So fuels are arranged from high density to low density vegetation types as shown in Table 38. In this study, the categorization of vegetation type and density is based on this table. The values assigned to each category are chosen arbitrarily according to vegetation density.

Vegetation Type	No fuel	Live woody	Dead woody	Live shrubs	Dead Shrubs	Live grass	Dead grass
Impact Value	0	1.2	1.6	1.8	2	2.5	3

Table 38: Impact values of surface fuel types

In heterogeneous forest case, there are various kinds of vegetation. An arbitrary grid of (10*10) is chosen to examine the influence of vegetation type. The corresponding matrix is shown in Table 39.

0	0	0	0	0	0	0	0	0	0
0	0	0	0	0	1.2	0	1.2	3	0
0	0	0	0	0	1.2	0	1.8	1.2	0
0	1.2	1.6	1.6	1.6	0	1.6	3	1.2	0
1.2	1.6	1.6	1.6	1.6	0	1.6	0	0	0
2.5	2.5	1.6	1.6	1.6	0	1.6	0	0	0
1.6	1.6	1.6	1.6	1.6	1.2	1.6	1.6	0	0
1.6	1.6	1.8	1.8	1.6	1.2	1.6	1.6	0	0
1.6	1.6	2	1.6	1.6	1.6	1.6	0	0	0
1.6	1.6	2	1.8	2	1.8	1.6	1.2	0	0

Table 39: Matrix of vegetation type for an arbitrary chosen grid (10*10)

As it is clear in Fig. 64, where vegetation values are larger, fire fronts spread faster.

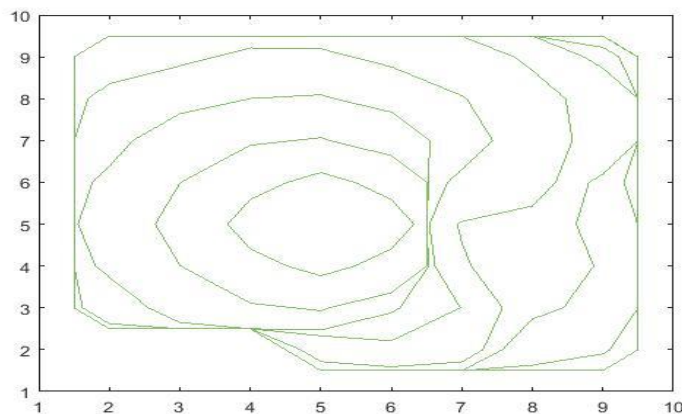

Fig. 64: Fire fronts in heterogeneous forest with no wind and no topography

7.5.3. Topography

Topography in turn has its impact on various aspects of fire behavior including fire line intensity and direction of spread. In other words, the differences in topography influence fire behavior, since fire burns more rapidly up a slope, or hill [35] [26]. Here, the angle between flame and terrain is brought down what facilitates transfer of heat to upward patches and the rate of fire spread increases consequently. Topography is mainly divided into three types that affect interestingly on fire diffusion: Elevation, slope and aspect [36] [37].

In Fig. 65, a grid of 50*50 with arbitrary elevations is simulated in our model. The yellow point is the ignition point. It is clearly shown that fire spreads with higher intensity in upward slopes.

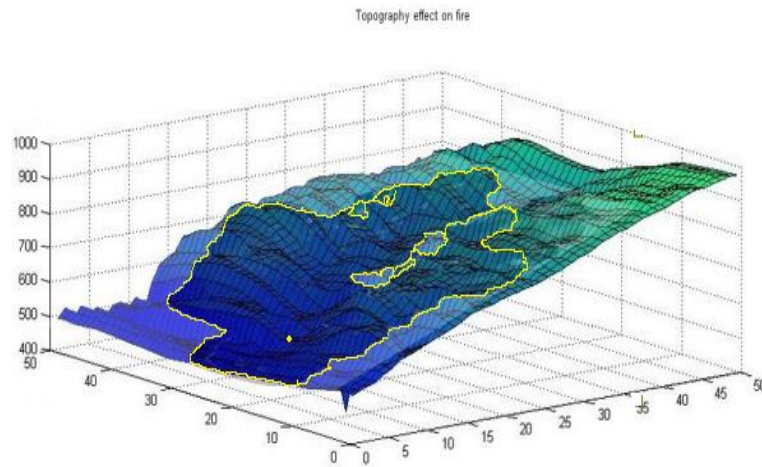

Fig. 65: Effect of topography on forest fire spread

The elevation effect appears clearly in the difference of altitude considered between each pair of cells. This is definitely the slope that we will be conducted in our study to express the influence of topography. Depending on whether the two neighboring cells are adjacent or diagonal, slope can be calculated [33]:

For adjacent cells,

$$Slope = \frac{H_1 - H_2}{L} \quad (7.15)$$

For diagonal cells,

$$Slope = \frac{H_1 - H_2}{L\sqrt{2}} \quad (7.16)$$

Where H_1 & H_2 represent the altitude of the two cells and L represents the length of the square side.

7.6. Transition Rule for Heterogeneous Forests

Fire propagation can be defined by the capability of fire to diffuse from a cell to its neighbors. Ignition of neighbor cells would never occur without the agitation of external parameters that are vegetation, wind and land slope. Trying to evaluate their weights, the matrices representing these external influences are computed before the application of our CA model. This allows for a more dynamic prediction of a wildfire behavior. The transition rule is upgraded accordingly to incorporate both global and local parameters:

$$\begin{aligned}
 S_{(i,j)}^{(t+1)} &= S_{(i,j)}^{(t)} \\
 &+ 0.209 * \left(\begin{array}{l} W_{(1,3)} * V_{(i-1,j+1)} * \left(1 + \frac{(H_{(i,j)} - H_{(i-1,j+1)})}{L\sqrt{2}} \right) * S_{(i-1,j+1)}^{(t)} + \\ W_{(1,1)} * V_{(i-1,j-1)} * \left(1 + \frac{(H_{(i,j)} - H_{(i-1,j-1)})}{L\sqrt{2}} \right) * S_{(i-1,j-1)}^{(t)} + \\ W_{(3,3)} * V_{(i+1,j+1)} * \left(1 + \frac{(H_{(i,j)} - H_{(i+1,j+1)})}{L\sqrt{2}} \right) * S_{(i+1,j+1)}^{(t)} + \\ W_{(3,1)} * V_{(i+1,j-1)} * \left(1 + \frac{(H_{(i,j)} - H_{(i+1,j-1)})}{L\sqrt{2}} \right) * S_{(i+1,j-1)}^{(t)} \end{array} \right) \\
 &+ 0.408 * \left(\begin{array}{l} W_{(1,2)} * V_{(i-1,j)} * \left(1 + \frac{(H_{(i,j)} - H_{(i-1,j)})}{L} \right) * S_{(i-1,j)}^{(t)} + \\ W_{(3,2)} * V_{(i+1,j)} * \left(1 + \frac{(H_{(i,j)} - H_{(i+1,j)})}{L} \right) * S_{(i+1,j)}^{(t)} \end{array} \right) \\
 &+ 0.461 * \left(\begin{array}{l} W_{(2,1)} * V_{(i,j-1)} * \left(1 + \frac{(H_{(i,j)} - H_{(i,j-1)})}{L} \right) * S_{(i,j-1)}^{(t)} + \\ W_{(2,3)} * V_{(i,j+1)} * \left(1 + \frac{(H_{(i,j)} - H_{(i,j+1)})}{L} \right) * S_{(i,j+1)}^{(t)} \end{array} \right) \quad (7.17)
 \end{aligned}$$

7.7. The Case Study and Simulation Results

The proposed methodology was applied for the prediction of the spread of a real wildfire that devastated the forest stretching on Aandqet village in the Akkar District of North Governorate, Lebanon. The forest fire occurred on the 28th of June 2007 at 2:00 PM (Fig.

66).The fire caused ecological hazards like the burning of various species of trees lying in the region: cypress, olive, pine, shrubs and grass. The wind was blowing from west to east. The forest altitude ranges from 460m to 967m above sea level. The total burnt area was 146 Ha. A Satellite image of the area is reported in Fig. 66, where the ignition point is also indicated. The land under scope is represented by a lattice (50*50) where each square cell is 27m². Before applying our proposed model, we generated the states of the global attribute matrix (wind) and those of local attributes matrices (altitude and vegetation density and type) following the measures previously stated.

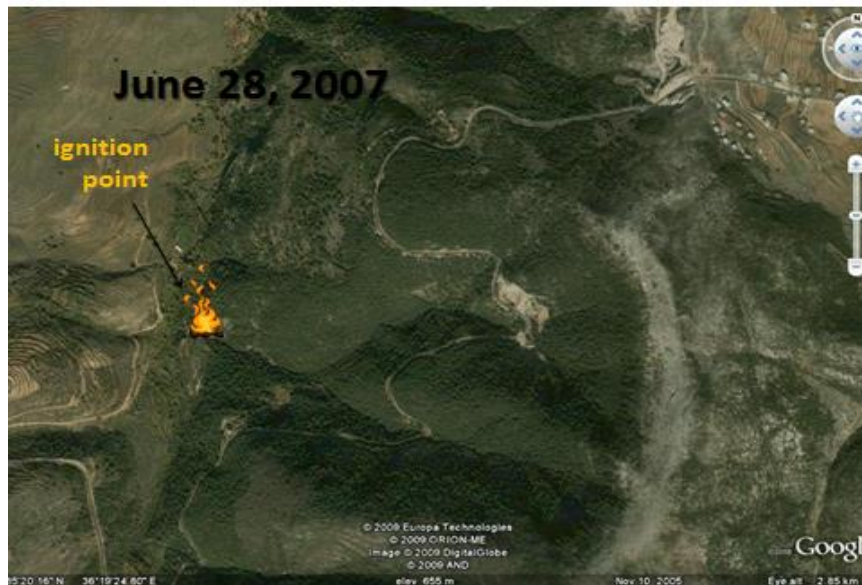

Fig. 66: Satellite image of the affected area in Aandqet, Akkar, North Lebanon

We chose to model this particular fire incident for two major reasons: the first is that most of the results of the particular wildfire (e.g. total burned area, terrain and elevation, wind direction, etc) were well attested by Association for Forest Development and Conservation AFDC; and the second one is that the specific terrain of the wildland with steep changes in the elevation, and variation in the vegetation types and density provides a convenient environment for evaluating the performance of the proposed CA-based model.

In Fig.67, we can witness the progress of the occurred fire until it was suppressed after turning the land totally barren.



Fig. 67: Progress of the occurred fire

We here present the parameters introduced to our cellular automata model. Fig. 68 illustrates the topography matrix. It shows how elevation differs from one cell to another and thus draws the topographic map of the studied land. Horizontal axes represent the grid (50*50), while the vertical axis defines the elevation in meters.

Fig. 69 monitors the vegetation matrix and thus declaring the type of fuel at each cell. Here, the vertical axis represents the impact value of fuel type following Table 39.

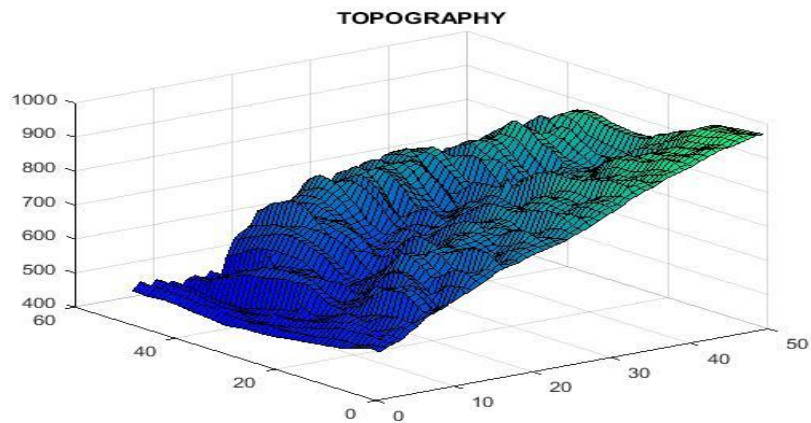

Fig. 68: Topographic map of the studied land

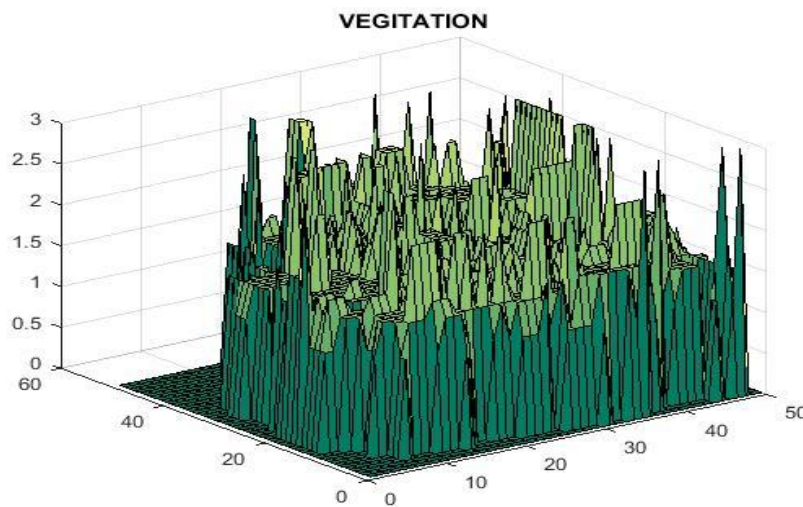

Fig. 69: Vegetation map of the studied map

As the wind was recorded blowing from west to east then the wind matrix is taken as follows:

$$W = \begin{pmatrix} 2 & 1 & 0.2 \\ 2 & 1 & 0.2 \\ 2 & 1 & 0.2 \end{pmatrix} \quad (7.18)$$

The simulation result of our cellular automata model describing the dynamics of the forest fire spread is presented versus the actual fire shape as reported by AFDC (Fig. 70).

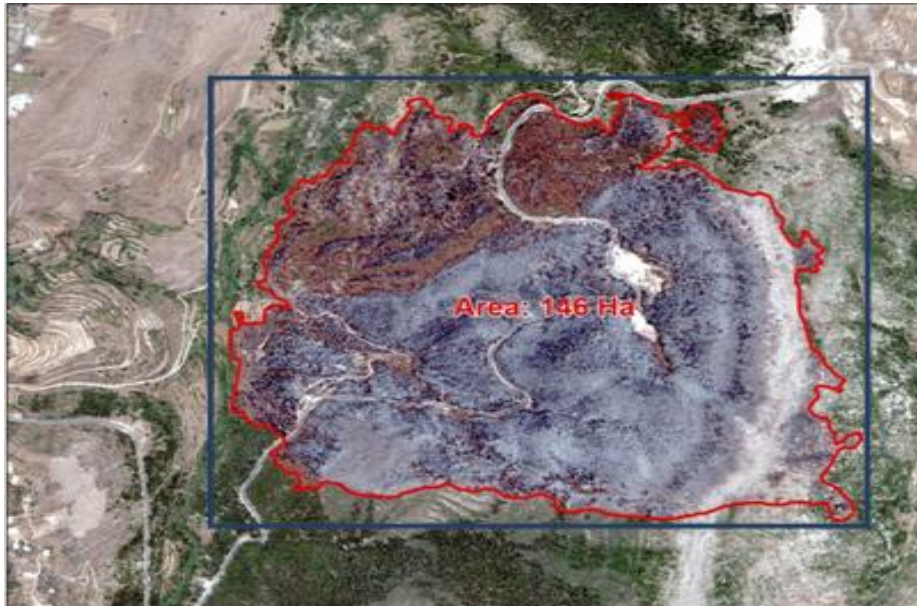

Fig. 70: Satellite image of the land with highlighted burnt area

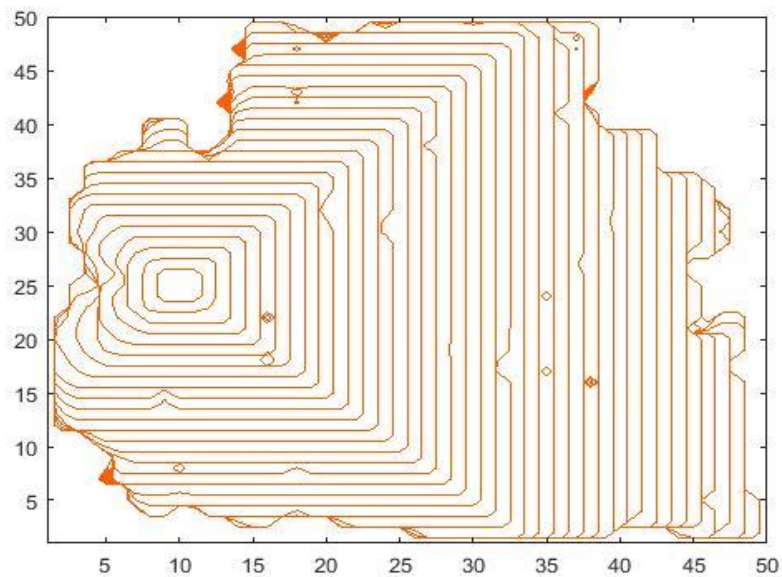

Fig. 71: Simulated fire fronts

The comparison between the simulation and the observed results showed that our proposed model predicts in a quite adequate manner the evolution characteristics of the real incident. The simulated and real fire contours are by far in good agreement and even matching; and a comparison between figures shows that the burned area predicted by the simulation is quite close to the actual one.

Indeed, it can be noticed that our proposed model can easily incorporate incombustible cells in simulation. Values of incombustible cells in each time step remain null. These unable-to-burn cells lead to distort elliptical fronts or even create holes as shown. The deformed fronts are back elliptical after several time steps.

7.8. Real Case Simulations on Karafyllidis, Modified Karafyllidis Models versus Proposed Model

We tended to simulate spatially the spreading process of the wildfire that burst on adequate village destroying one of its forests by implementing the linear model of Karafyllidis [14] and the circular model of Gazmeh, Modified Karafyllidis model [24]. The results are shown in Fig. 72 & Fig. 73.

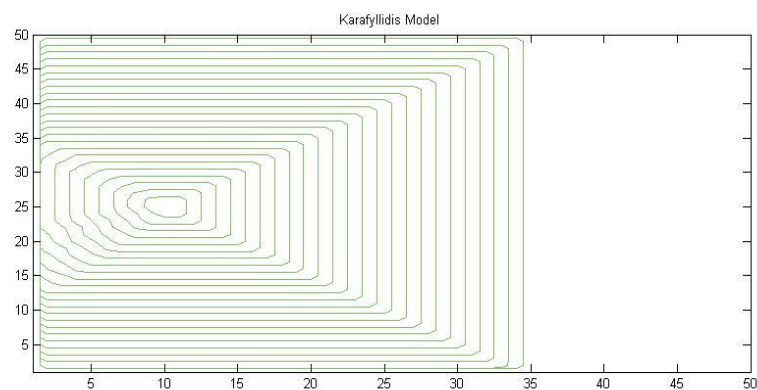

Fig. 72: Simulated Fire using Karafyllidis Model

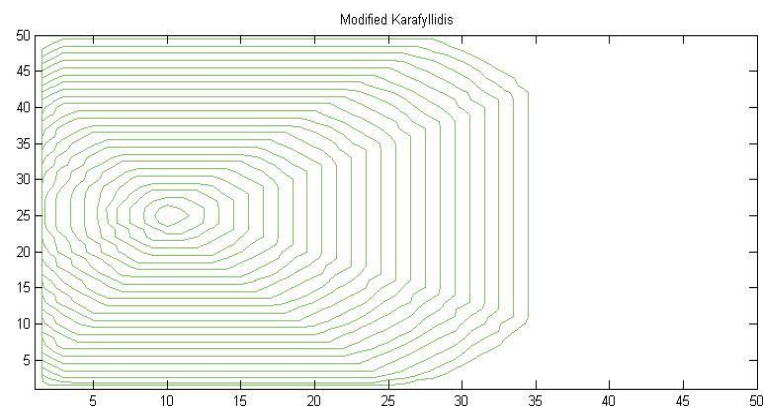

Fig. 73: Simulated Fire using Gazmeh-Modified Karafyllidis Model

Upon interpreting above figures, we can find that the final obtained fire shapes are far from the real shape in Fig. 70 . None of the contours match with the contour reported by AFDC for Aandqet fire incident, which is not the case in our proposed model where the predicted burnt area was quite close to the real one.

Knowing that the total studied area is 182.25 Ha, we state the burnt areas obtained and the corresponding percentage upon implementing the three models in Table 40.

Cases	Burnt area (Ha)	Percentage of burnt area (%)
Real Case	146	80.1
Karafyllidis Model	115.48	63.36
Modified Karafyllidis Model	111.78	61.33
Proposed Model	135.15	74.15

Table 40: Burnt areas and their percentages using Karafyllidis, Modified Karafyllidis and Proposed model

The above table (Table 40) shows that the proposed could retrieve the closest percentage to the actual one with an accuracy of 92.6% compared to those of Karafyllidis (79.1%) and Modified Karafyllidis (76.6%).

Conclusion

In this work, a new model for the prediction of forest fire behavior has been developed. It is based on the use of cellular automata and comprises weather, land topography and vegetation attributes. Those attributes have been differently categorized into global and local agents. The states of cells are determined by a transition rule based on the elliptical transfer of fractional burned area. The sorting adopted for the influencing attributes besides the novel elliptical pattern assigned to the fire front evolution claim to formulate the robustness of the methodology. The model can adequately determine the fire fronts in both homogeneous and heterogeneous forests.

The proposed methodology has been applied to simulate the dynamics of a real wildfire that burst on Aandqet forest, Akkar District, North Lebanon. The special nature of the terrain, including steep changes in the topography and various types and densities of vegetation provides a good reference for evaluating the proposed approach.

The simulation results are very close to the actual ones thus confirm that the proposed methodology can be employed for adequate and efficient prediction of forest fires in inhomogeneous terrains. Its outstanding performance appears clearly in the progress of

the shape, the final fire shape and the estimated burnt area. The model is capable of simulating fire fronts at any time and location precisely.

The performance of the implemented fire model is evaluated by comparison with fire spread simulations derived from Karafyllidis Model and Gazmeh –Modified Karafyllidis Model revealing the outperformance of the produced model over these models.

Evidently, the simulations while implementing the new model tend to run fast and allow for a low computational cost. They could be used not only for planning effective fire suppression policies, but also as a real-time decision support and risk management systems.

This work confirms the potential of the CA approach for fire behavior modeling. The weights of the introduced parameters have been duly chosen according to their impact in the burning process. The evaluation of these weights can be re-performed by means of various efficient decision algorithms, such as Analytic Hierarchy Process.

However, the scalability of the new model can be validated by applying it to predict various large-scale real world fire incidents.

Moreover, the possibility to combine such model with Geographical Information System (GIS) and satellite imagery has been explored in literature. We think that such integration may contribute to develop a fire behavior model with a flexible and user-friendly interface.

Furthermore, it can be worked on calibration of our CA model time steps by means of algorithms like Honey Bee Foraging, Particle Swarm Optimization and Genetic Algorithm.

References of chapter 7

- [1] P. Bernard, S. Joe, A. Anne, P. Susan and K. Laurie, "Developing custom fire behavior fuel models from ecologically complex fuel structures for upper Atlantic Coastal Plain forests", *Forest Ecology and Management*, vol. 273, pp. 50–57, 2012
- [2] K. Thonicke, A. Spessa, I. Prentice, S. Harrison, L. Dong, and C. Carmona, "The influence of vegetation, fire spread and fire behaviour on biomass burning and trace gas emissions: results from a process-based model" *Bio-geosciences*, vol. 7, pp. 1991–2011, 2010
- [3] F. Codd *Cellular Automata* Academic Press, New York, 1968
- [4] R. White and G. Engelen, "High-resolution integrated modelling of the spatial dynamics of urban and regional systems" *Comput. Environ. Urban Syst.*, vol. 24, pp. 383–400, 2000
- [5] M. Batty, Y. Xie, Z. Sun, "Modeling urban dynamics through GIS based CA", *Computers, Environment and Urban Systems*, Vol. 21, pp. 205–233, 1999
- [6] C. Yin, D. Yu, H. Zhang, S. You and G. Chen, "Simulation of urban growth using a CA-based model in a developing nation's region," *Geo-informatics 2008 and Joint Conference on GIS and Built Environment*, Vol. 7143, China, 2008
- [7] L. Won, I. Hand and M. Taek (2010), "CA Modeling of Grain Coarsening and Refinement during the Dynamic Re crystallization of Pure Copper", *Materials Transactions*, vol. 51, pp. 1614–1620, Japan
- [8] H. Hakan, W. Mathias, R. Matti, "Simulation of discontinuous dynamic re-crystallization in pure Cu using a probabilistic cellular automaton", *Computational Materials Science*, vol. 49, pp. 25–34, 2010
- [9] M. Van Schyndela, G. Wainer, R. Goldstein, J. P. M. Mogk, A. Khan, "On the definition of a computational fluid dynamic solver using cellular discrete-event simulation", *Journal of Computational Science* vol. 5, pp. 882–890, 2014
- [10] H. Balzter, P. W. Braun, W. Köhler, "CA models for vegetation dynamics. *Ecol. Model.*, vol. 107, pp. 113–125, 1998
- [11] J. Yang, Z. Wang, D. Yang, Q. Yang, J. Yan, He. M, "Ecological risk assessment of genetically modified crops based on CA modeling" *Biotechnol. Adv.*, vol. 27, pp. 1132–1136, 2009
- [12] S. Dragicevic, "Modeling the dynamics of complex systems using cellular, fuzzy sets and GIS: Invasive species propagation", *Geogr. Compass*, vol. 4, pp. 599–615, 2014
- [13] L. Perez, S. Dragicevic, "Landscape-level simulation of forest insect disturbance: Coupling swarm intelligent agents with GIS-based CA model". *Ecol. Model.*, vol. 231, pp. 53–64, 2012
- [14] I. Karafyllidis and A. Thanailakis, "A model for prediction forest fire spreading using CA", *Ecological Modeling Journal*, pp. 87–97, 1997
- [15] W. Hargrove, R. Gardner, M. Turner, W. Romme and D. Despain, "Simulating fire patterns in heterogeneous landscapes", *Ecological Modeling*, pp. 243–263, 2000
- [16] B. Malamud and D. Turcotte, "Cellular-Automata models applied to natural hazards", *IEEE Computing in Science & Engineering*, Vol. 2, No. 3, pp. 42–51, 2000

- [17]A.Sullivan and I.Knight, "A hybrid CA/semi-physical model of fire growth", Asia-Pacific Conference on Complex Systems, Cairns, pp. 64–73,2004
- [18]A.Alexandridis, D.Vakalis, C.Siettos and G.V.Bafas, "A CA model for forest fire spread prediction: The case of the Wildfire that swept through Spetses Island in 1990", Applied Mathematics and Computation, pp. 191–201,2008
- [19]S.Yassemia, S.Dragicevic and M.Shmidt, "Design and implementation of an integrated GIS-based CA model to characterize forest fire behavior", Ecological modeling journal, Vol. 210, pp. 71–84, 2008
- [20]Z.Hui, W.Tao and W.Daimu, Polymorphism forest fire probability CA model and its application, Journal of Fu Yang normal college (Natural Sciences), Vol. 27, pp. 23-26, 2010
- [21]T.Ghisu, B.Arca, G.Pellizzaro. and P.Duce, "An optimal CA algorithm for simulating wildfire spread", Environmental Modelling and Software Vol. 71, pp. 1–14, 2015
- [22]T.Masri, C.Khater, N.Masri and C.Zeida, "Regeneration capability and economic losses after fire in Mediterranean forests – Lebanon, Lebanese Science Journal", Vol. 7, No. 1, 2006
- [23]R.McRaei, "Use of digital terrain data for calculating rates of fire spread with PREPLAN computer system", Paper presented at the Proc of the 8th biennial conference and bushfire dynamics workshop, Canberra, 1989
- [24]H.Gazmeh, A.Alesheikh, M.Karimi, "A new Methodology in Modeling ForestFire Spread Using Cellular Automata", Journal of Advanced Science and Engineering Research Vol 2, No 4 December (2012) 308-322
- [25]Van WagnerC.E, A simple fire growth model, 1969
- [26]Rc.Rothermel, "A mathematical model for predicting fire spread in wildland fuels", USDA Forest Service, Intermountain Forest and Range Experiment Station Research Paper INT-115, 1972
- [27]Anderson.H.E, Predicting Wind-Driven Wildland Fire Size and Shape, Research Paper, 1983
- [28]Albini, FA, Estimating wildfire behavior and effects. Gen. Tech. Rep. INT-30. Ogden, UT: U.S.Department of Agriculture, Forest Service, Intermountain Forest and Range Experiment Station; 1976a
- [29]Albini, FA, Computer-based models of wildland fire behavior: a user's manual. Ogden, UT: U.S. Department of Agriculture, Forest Service, Intermountain Forest and Range Experiment Station 1976b.
- [30]FA.Albini, CH.Chase, "Fire containment equations for pocket calculators", USDA Forest Service, Intermountain Forest and Range Experiment Station, Research Paper RP-INT-268. (Ogden, UT), 1980
- [31]RD.McRae, "Use of digital terrain data for calculating rates of fire spread with the PREPLAN computer system", Proceedings of 8th Biennial Conference and Bushfire Dynamics Workshop, Canberra, Australia, pp, 579-585, 2006

[32]EL Hernandez, WS Hoya, Martin Rey A, Rodriguez Sanchez G. "Modeling forest fire spread using hexagonal CA", Applied Mathematical Modelling, vol.31, pp. 1213–1227, 2007

[33]Nelson Jr R.M, Adkins C.W, A dimensionless correlation for the spread of wind-driven fires. Canadian Journal of Forest Research vol. 18 N.4, pp, 391-397, 1989

[34]Paysen, Timothy, R.J.Ansley, J.Brown, G.Gottfried, S.Haase, M.Harrington, M.Narog, S.Sackett, R.Wilson, Fire in Western Shrubland, Woodland, and Grassland Ecosystems. Chapter 6. USDA Forest Service Gen. Tech. Rep. RMRS-GTR-42, 2000

[35] AG.McArthur, "Fire Behaviour in Eucalypt Forests", Ninth Commonwealth Forestry Conference. Leaflet No. 107, 1968

[36]A.Zachary, W.Holden and Jolly.Matt, "Modeling topographic influences on fuel moisture and fire danger in complex terrain to improve wildland fire management decision support", 2001

[37]G.Buchholz, D.Weidemann, "The use of simple fire danger rating systems as a tool for early warning in forestry", Int. Forest Fire News, Vol .23, pp. 32–37, 2000

General conclusion

Forest fire is a destructive phenomenon in nature. Wildfires become a serious world problem, after it destroyed millions of green hectares and threatened the lives of thousands of people worldwide. Forest fire problem was and still aggravating, especially in Middle East. Lebanon is a part of Middle East facing such critical threat. According to the Lebanese Ministry of Environment (MOE), 1036 fires occurred during the last 5 years in various Lebanese regions; and about 1,500 hectares of Lebanese woodland are invaded by fires every year. In 2009, the Lebanese the Council of Ministers approved a national policy to manage forest fires, but this policy was never implemented and responsibilities were not defined.

Forest fire prediction and its techniques contribute in preventing fire occurrence or reducing its catastrophic consequences. Scientists employed different meteorological parameters to build mathematical models related to their own place of study to predict forest fire before occurrence. These weather models were applied and adopted by developed countries such as; Angstrom, Keetch-Byram, Modified Keetch- Byram, Canadian fire weather index (FWI), Nesterov, Modified Netserov, Macarthur, FD and Baumgartner Index. FWI and Macarthur fire weather indices are found the most adopted all over the world, while Baumgartner index is the least usable index in forest fire prediction models.

In forest fire prediction, researchers are interested in the algorithms of data mining that quite serve to break down the complexity of non-linear phenomena. We applied different data mining techniques: Artificial Neural Networks (ANN), Fuzzy logic (FL), Decision Tree (DT), Support Vector Machine (SVM) and Linear Discriminant Analysis (LDA) based on 4 parameters (temperature, wind speed, precipitation and humidity) to predict pre-fires in North Lebanon during 2009-2014. In our study, we found that DT recorded the best accurate result (96.6%) followed by ANN using trainlm algorithm with 16 neuron (92.6%).

To find the most influential parameters that affect forest fire, we applied different correlative data analysis algorithms (Linear regression, Pearson, Spearman and Kendall-tau) over meteorological parameters (Temperature, Wind speed, Precipitation, Humidity, Dew point and Soil Temperature) versus fire occurrence in North Lebanon. It was proven that temperature, Dew point and soil temperature are the most influential parameters that induce fire occurrence. These parameters show a good correlation with fire occurrence, while the other parameters (Humidity, precipitation and wind speed)

demonstrate limited weak correlations with fire occurrence. The study detected linear regression relationships between the selected vital parameters and the number of fires. A mathematical model was then derived from these 3 attributes in order to predict fire before occurrence in North Lebanon. The proposed Lebanese Index (LI) recorded quite excellent results upon computing mean square error (0.267), sensitivity (96.55%) and AUC (84.33%) after being applied on the data of the years 2015-2016. Accordingly, we can implement this new early warning index which is based on three meteorological parameters that are relatively easy to collect particularly in the developing countries of the Mediterranean.

After studying the pre-fire phase, we studied the post-fire phase that is studying the behavior of fire diffusion. Wildland fires can be classified into 3 types (Crown, Surface and ground fire) according to the shape and propagation. Fire behavior is mainly affected by wind, topography and fuel. Since long time ago, researchers such as Fons, George Bayram, McArthur, Rothermel, Albini, Anderson, Vanwanger and Weber applied many classical mathematical models to predict fire diffusion and its evolution with time based on these agents. Due to the complexity of this phenomenon, scientists applied many computer software tools to predict and simulate graphically the post-fire. With the need of modeling fire spread and its evolution with time, researchers found that Cellular automata technique can be used to predict forest fire diffusion in every time step after recording acceptable results in various domains of application. This led us to propose a new diffusion model based on 2D cellular automata to tackle forest fire crisis in North Lebanon. The states of cells are determined by a transition rule in every time step based on the elliptical transfer of fractional burned area. Our proposed model incorporates the attributes of wind, vegetation fuel and topography and sorts them into global and local agents. The proposed model recorded 92.6% of accuracy, after comparing the simulation results to the actual results of the real Lebanese fire case (2007) taken for study. In addition our proposed model is found to outperform the linear model of Karafyllidis and the circular model of Gazmeh in predicting forest fire spread in non-homogenous conditions.

Forest fire risk prediction and behavior prediction could be the base from which forest fire management is launched. Forest fire management is a worldwide concern that aims to reduce and limit fire occurrence and caused damage. Its efficiency could be obtained in developing countries if the government, non-governmental organizations and various stakeholders have the tendency to coordinate and push in the direction of strategy implementation and cost effectiveness in time. This dissertation holds efficient methodologies that claim to support all involved parties in this purpose.

List of Figures

Fig. 1: Lebanese forest area map	8
Fig. 2: Effect of Lebanese climate change on forest fire	9
Fig. 3: Vegetation levels in Lebanon	14
Fig. 4: Vegetation covers in Lebanon	15
Fig. 5: Thesis structure	19
Fig. 6: Fire Triangle	25
Fig. 7: Structure of the Canadian forest fire weather index system	31
Fig. 8: Burnt area (Ha) in North Lebanon during.....	48
Fig. 9: Distribution of the fires in North Lebanon during the years	49
Fig. 10: MLP Diagram.....	51
Fig. 11: Feed-Forward Back Propagation Networks Used.....	52
Fig. 12: Confusion Matrix architecture.....	53
Fig. 13: Training and testing neural networks performance upon	55
Fig. 14: Best training performance	55
Fig. 15: Decision Tree architecture	57
Fig. 16: Training and testing confusion matrix of Decision tree.....	58
Fig. 17: Exemplary membership functions	59
Fig. 18: Fuzzy logic model	62
Fig. 19: System based rules	62
Fig. 20: Inputs membership functions	63
Fig. 21: Output membership functions	64
Fig. 22: Confusion Matrix and ROC curve for the fuzzy logic system.....	64
Fig. 23: Training and testing data Confusion Matrix	67
Fig. 24: Training and testing ROC.....	68
Fig. 25: Representation of Hyper planes.....	69
Fig. 26: The distance between the two hyper planes	69
Fig. 27: Confusion matrix for best train and test Algorithm	71
Fig. 28: ROC curve for best train and test Algorithm	72
Fig. 29: Numbers of forest fire over the period 2009-2014	80
Fig. 30: Temperature (°C)in function of fire occurrence per day	81
Fig. 31: Relative humidity (%) in function of fire	82
Fig. 32: Dew point in function of fire occurrence.....	83
Fig. 33: Soil temperature in function of fire occurrence	83
Fig. 34 : Wind speed (m/s) in function of fire occurrence.....	84
Fig. 35: Precipitation (mm) in function of fire occurrence.....	85

Fig. 36: The relationship between temperature (°C)	89
Fig. 37: The relationship between dew point (°C)	89
Fig. 38: The relationship between temperature (°C)	90
Fig. 39: Validation of fire danger index in function of fire occurrence.....	92
Fig. 40: Topology of fire types.....	103
Fig. 41: Elliptical fire spread shape	105
Fig. 42: Anatomical parts of fire	105
Fig. 43: Effect of topography on fire spread	108
Fig. 44: Fuel characteristics	109
Fig. 45: Hfire structure.....	120
Fig. 46: Square lattice site percolation	126
Fig. 47: Square lattice bond percolation	126
Fig. 48: Neighborhood cells state	136
Fig. 49: Evolution of ECA.....	136
Fig. 50 : Central cell i, j.....	137
Fig. 51: Von Neumann	138
Fig. 52: Von Neumann transition rule evolution with time.....	139
Fig. 53: Moore neighborhood	139
Fig. 54: Hexagonal cellular automata	140
Fig. 55: Schelling's model with two agents	144
Fig. 56 : Satisfaction and Dissatisfaction of agents for t=30%.....	145
Fig. 57: Relocation of dissatisfied agents to be satisfied	145
Fig. 58: Burnt area (ha) in North Lebanon during the years2004-2014.....	152
Fig. 59: Adjacent fire spreading	154
Fig. 60:Diagonal fire spreading.....	155
Fig. 61: Circular spreading.....	155
Fig. 62: Elliptical fire fronts.....	157
Fig. 63: Elliptical shape in homogenous conditions.....	162
Fig. 64:Fire fronts in heterogeneous forest with	164
Fig. 65: Effect of topography on forest fire spread	165
Fig. 66: Satellite image of the affected area in Aandqet,.....	167
Fig. 67: Progress of the occurred fire	168
Fig. 68: Topographic map of the studied land.....	168
Fig. 69: Vegetation map of the studied map	168
Fig. 70: Satellite image of the land with highlighted burnt area	169
Fig. 71: Simulated fire fronts	169
Fig. 72: Simulated Fire using Karafyllidis Model.....	170
Fig. 73: Simulated Fire using Gazmeh-Modified	170

List of Tables

Table 1: The degradation of forest types during the years 2009-2014.....	9
Table 2: Different vegetation levels and their description	14
Table 3: Angstrom fire potential scale	27
Table 4: Nesterov fire potential scale.....	28
Table 5: K-Value in Function of Rain Quantity.....	28
Table 6: Modified Nesterov Fire Potential Scale	28
Table 7: Baumgartner Fire Potential Scale.....	29
Table 8: KBDI Fire Potential Scale.....	30
Table 9: The Fire Potential Scale of FWI.....	32
Table 10: FFDI Fire Potential Scale.....	33
Table 11: Simple fire danger (F) potential scale	33
Table 12: FD Fire Potential Scale	34
Table 13: Meteorological parameters used in fire indices and climate characteristics in their countries of origin	36
Table 14: Characteristics and Areas of Application of Models	36
Table 15: Distribution of testing and training data.....	50
Table 16: Measures of Precision, Specificity, Sensitivity, Accuracy,	54
Table 17: Measures of Precision, Specificity, Sensitivity, Accuracy,	54
Table 18: performance results for the created decision tree concerning.....	58
Table 19: Fuzzy logic testing data.....	64
Table 20: Linear discriminates analysis training and testing data.....	68
Table 21: Support vector machine training kernel functions	71
Table 22: Support vector machine testing kernel functions	71
Table 23: Data mining techniques testing results.....	72
Table 24: Correlation coefficient of studied parameters with fire occurrence after balancing dataset.....	81
Table 25: Pearson correlation coefficient between	86
Table 26: Spearman correlation coefficient between	87
Table 27: Spearman correlation coefficient between fire occurrence and weather parameters	88
Table 28: Mutual correlations among selected parameters	90
Table 29: New index potential scale	92

Table 30: Measurements of Precision, Accuracy, Specificity,.....	92
Table 31: Forest fire danger indices feature	93
Table 32: Fire behavior factors and its effects on fire spread	107
Table 33: Fuel types and its abbreviations	116
Table 34: complex Fuel models	118
Table 35: simulator models characteristics	122
Table 36: Binary rules sequence	135
Table 37: Simulation of proposed model applying different wind directions.....	163
Table 38: Impact values of surface fuel types	164
Table 39: Matrix of vegetation type for an arbitrary chosen grid (10*10).....	164
Table 40: Burnt areas and their percentages using Karafyllidis, Modified Karafyllidis and Proposed model	171

Publications

- I. N. Hamadeh, A. Hilal, B. Daya and P. Chauvet, "An Analytical Review on the Most widely Used Metrological Models in Forest Fire Prediction", IEEE TAECE2015, The Third International Conference on Technological Advances in Electrical, Electronics and Computer Engineering, pp. 239-244, Beirut, Lebanon 29 April – 1 May 2015.
- II. N. Hamadeh, B. Daya, A. Hilal and P. Chauvet, "Studying the Factors Affecting the Risk of Forest Fire Occurrence and Applying Neural Networks for Prediction", IEEE, SAI Intelligent Systems International Conference 2015, pp. 522-526 , 10-11 Nov, London, UK.
- III. N. Hamadeh, A. Karouni, B. Daya and P. Chauvet, "Comparative Study of Different Data Mining Techniques in Predicting Forest Fire In Lebanon and Mediterranean", IEEE, SAI Intelligent Systems International Conference 2016, London, UK.
- IV. N. Hamadeh, A. Karouni, B. Daya and P. Chauvet, "Using Correlative Data Analysis to Develop Weather Index That Estimates the Risk of Forest Fires in Lebanon and Mediterranean: Assessment versus Prevalent Meteorological Indices", Case Studies in fire Safety (Elsevier-journals-Press). <http://dx.doi.org/10.1016/j.csfs.2016.12.001>
- V. N. Hamadeh, A. Karouni, B. Daya and P. Chauvet, "A new Methodology for Spatial Simulation of Forest Fire Behavior Using Cellular Automata", Submitted to Natural Hazards Journal for acceptance (NHAZ-D-17-00052 - Springer).