



HAL
open science

Dynamic prediction of milk yield and composition responses to dietary changes in dairy cows

Jean-Baptiste Daniel

► To cite this version:

Jean-Baptiste Daniel. Dynamic prediction of milk yield and composition responses to dietary changes in dairy cows. Animal production studies. Université Paris Saclay (COMUE), 2016. English. ⟨NNT : 2016SACLA009⟩. ⟨tel-02164017⟩

HAL Id: tel-02164017

<https://theses.hal.science/tel-02164017v1>

Submitted on 24 Jun 2019

HAL is a multi-disciplinary open access archive for the deposit and dissemination of scientific research documents, whether they are published or not. The documents may come from teaching and research institutions in France or abroad, or from public or private research centers.

L'archive ouverte pluridisciplinaire **HAL**, est destinée au dépôt et à la diffusion de documents scientifiques de niveau recherche, publiés ou non, émanant des établissements d'enseignement et de recherche français ou étrangers, des laboratoires publics ou privés.



HAL Authorization

NNT : 2016SACLA009

THESE DE DOCTORAT
DE
L'UNIVERSITE PARIS-SACLAY
PRÉPARÉE À
AGROPARISTECH (INSTITUT DES SCIENCES ET INDUSTRIES
DU VIVANT ET DE L'ENVIRONNEMENT)

ECOLE DOCTORALE N°581
Agriculture, alimentation, biologie, environnement et santé

Spécialité de doctorat : Sciences Animales

Par

Jean-Baptiste Daniel

Dynamic prediction of milk yield and composition responses
to dietary changes in dairy cows

Thèse présentée et soutenue à Paris, le 23 novembre 2016:

Composition du Jury :

Philippe Lescoat, Professor, AgroParisTech (Paris, France), Chairman
Harald Volden, Professor, Tine Rådgeving (As, Norway), Rapporteur
Jan Dijkstra, Associate professor, Wageningen University (Wageningen, The Netherlands), Rapporteur
Luc Delaby, Researcher, INRA (Rennes, France), Examiner
John Metcalf, Research manager, Trouw Nutrition (Burford, Canada), Examiner
Nicolas Friggens, Head MoSAR, INRA (Paris, France), Thesis supervisor
Daniel Sauvant, Professor, AgroParisTech (Paris, France), Thesis supervisor
Harmen Van Laar, Researcher, Trouw Nutrition (Boxmeer, The Netherlands), Thesis co-supervisor

Jean-Baptiste Daniel

Dynamic prediction of milk yield and composition responses to dietary changes in dairy cows, 230 pages.

PhD thesis, University Paris-Saclay, AgroParisTech, Paris, France (2016)

With references, with summary in French.

Table of Contents

Chapter 1	General Introduction	7
Chapter 2	Milk yield and milk composition responses to change in predicted net energy and metabolizable protein: A meta-analysis	23
Chapter 3	A method to estimate cow potential and subsequent responses to energy and protein supply according to stage of lactation	67
Chapter 4	Modelling homeorhetic trajectories of milk component yields, body composition and dry-matter intake in dairy cows: Influence of parity, milk production potential and breed	101
Chapter 5	Incorporation of dairy cow responses to change in dietary composition into a model that generates lactation curves of performance for cows of different potential	153
Chapter 6	General Discussion	187
	French summary	209
	English abstract	224
	French abstract	225
	Peer reviewed scientific publications	226
	Conference and symposium proceedings	227
	Acknowledgements	228

Chapter 1

General Introduction

Introduction

Feed unit systems represent a major factor of progress in dairy production systems for calculating the most appropriate diets according to the type of animal. The traditional approach used to improve feed unit systems has been, until now, mainly focused on characterising the feedstuffs and determining animal requirements (with the aim of increasing accuracy in their estimations). This has allowed the formulation of rations to achieve a pre-defined production level. However, this approach cannot adapt to the increasing diversity of objectives of dairy production systems (e.g. feed efficiency, animal health, animal longevity, etc.). The reciprocal and complementary approach (see Figure 1) is therefore to better understand and quantify the animal's multiple responses to dietary changes (Oldham and Emmans, 1989; Sauvant, 1992; Dijkstra et al., 2007).

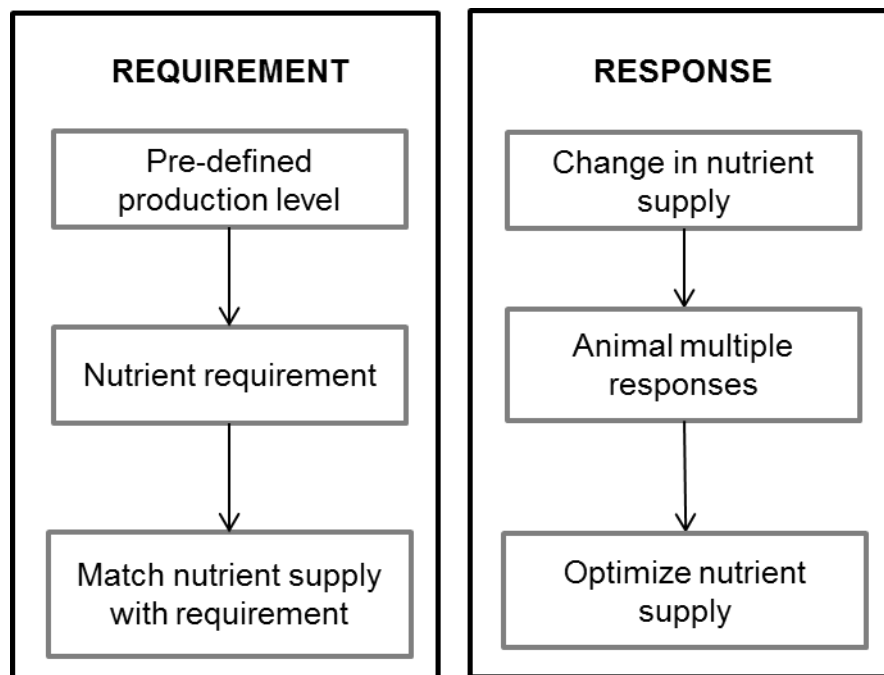

Figure 1. The requirement and response approaches

However this task is currently difficult because there is a lack of robust and operational models to predict the responses in milk yield and composition of dairy cows to changes in feed composition. In particular, available equations to predict milk responses (Brun-

Lafleur et al., 2010; Huhtanen and Nousiainen, 2012; Jensen et al., 2015) are characterized by a relatively poor ability to include animal effects. These limitations have been recently reviewed by Friggens et al. (2013). The most important ones are that they cannot accommodate differences in the milk production potential of different genotypes. Furthermore these equations are static, and thus do not integrate the effects of physiological status (stage of lactation, parity...), which have important effects on milk and milk composition responses (Broster, 1972; Broster and Thomas, 1981; Kirkland and Gordon, 2001). Response equations to changes in nutrition that integrate the effects of animal production potential and physiological status will, by construction, be more generic.

Effect of nutrition on milk yield and composition responses

Protein

As depicted in Figure 1, the requirements approach starts from a pre-defined production level to calculate the amount of nutrient required. For metabolizable protein (**MP**), this is done by multiplying the pre-defined milk protein yield with a fixed coefficient, which is the utilization efficiency of MP. The MP efficiency used by feed unit systems was 0.64 for INRA (Faverdin et al., 2007), 0.67 for NRC (2001) and CNCPS (Van Ambourgh et al., 2015) or 0.68 for AFRC (1993). On average, this approach was shown to be satisfactory for differentiating between animals of different production potential but was unable to predict for a given group of animals the milk protein yield response to change in MP supply (Arriola Apelo et al., 2014). This is because MP efficiency varies widely with the level of MP supply. It was shown that, when MP supply is increased from 25% below the estimated requirement to 25% above the estimated requirements, the efficiency of conversion of MP into milk protein decreases from 0.77 to 0.50 (Metcalf et al., 2008). Recent meta-analysis have shown similar decreases: from 0.80 to 0.55 when the MP supply/net energy for lactation (**NEL**) supply increases from 13.5 to 19 g MP/MJ NEL (Volden, 2011) or from 0.83 to 0.54 when dietary MP content increases from 70 to 130 g MP/kg DM (Sauvant et al., 2015). For this reason, the Dutch protein system (DVE/OEB₂₀₁₀, Van Duinkerken et al., 2011) proposed equations based on the work of Subnel et al. (1994) that predict a MP efficiency response to change in MP content in

order to better estimate the MP requirement. Similarly, the NorFor system (Volden, 2011), and more recently the PDI system (Sauvant et al., 2015), also implemented such equations. Because of this significant variation in MP efficiency, the response approach (Figure 1) is needed to directly quantify the effect of protein supply on dry-matter intake, milk yield and milk composition. Responses for milk yield and milk protein content generally show a curvilinear relationship with respect to either crude protein (CP) content (Roffler and Wray, 1986) or MP content (Figure 2, Vérité and Delaby, 2000). In these studies, positive curvilinear effects of CP and MP content on dry-matter intake were also observed; explaining part of the milk yield response observed. As a consequence, the proportion of nitrogen not retained in milk increases with increasing MP content. As indicated by the linear relationship observed between urinary nitrogen and MP content (Figure 2), a great majority of this nitrogen is excreted in urine.

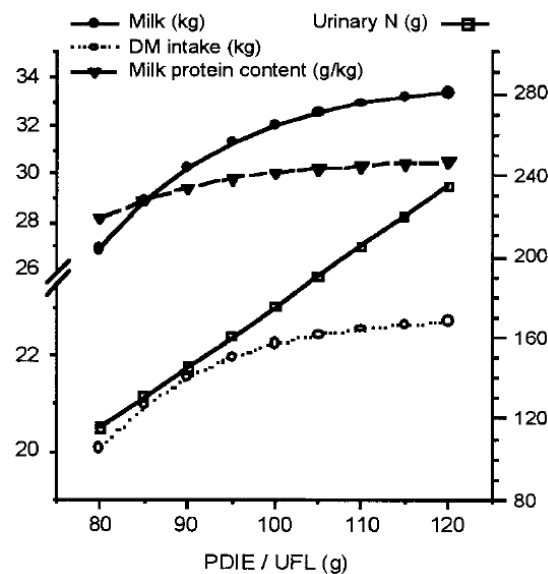

Figure 2. Dry-matter intake, milk yield, milk protein content and urinary N responses to change in PDIE/UFL ratio in the diet (Reproduced from Vérité and Delaby, 2000). PDIE = French unit for metabolizable protein (1 g PDIE ~ 1 g MP), UFL = French unit for net energy (1 UFL ~ 7.1 MJ NE_L).

Energy

With respect to energy, the metabolic efficiency, used to convert metabolizable energy (ME) to NE_L is considered to vary depending on the ration. In contrast to nitrogen, dairy

cows have a little ability to excrete extra energy (i.e. carbon chains) and consequently this energy is stored as body gain (essentially as lipid in adult dairy cows). However, feed unit systems do not attempt to predict the partition of NE_L between milk and body, nor between the major milk components within milk. This observed shift in NE_L partition from milk to body with increasing NE_L supply (Broster and Thomas, 1981; Friggens et al., 2010) is mainly explained by the fact that the capacity of the mammary gland to produce milk has a limit (i.e. the animal approaches its potential milk production). An illustration of this shift is shown in Figure 3 where the net energy flows to milk fat, milk lactose, milk protein and the calculated energy balance are shown relative to total ME supply. In this meta-analysis, linear responses were observed for milk lactose and milk protein, whereas milk fat showed a clear curvilinear response. As fat represents, on average, about 50% of the energy secreted into milk, the total milk energy response to change in NE_L supply is also curvilinear (Jensen et al., 2015). Such equations provide energy partitioning rules between major energy outflows in dairy cows.

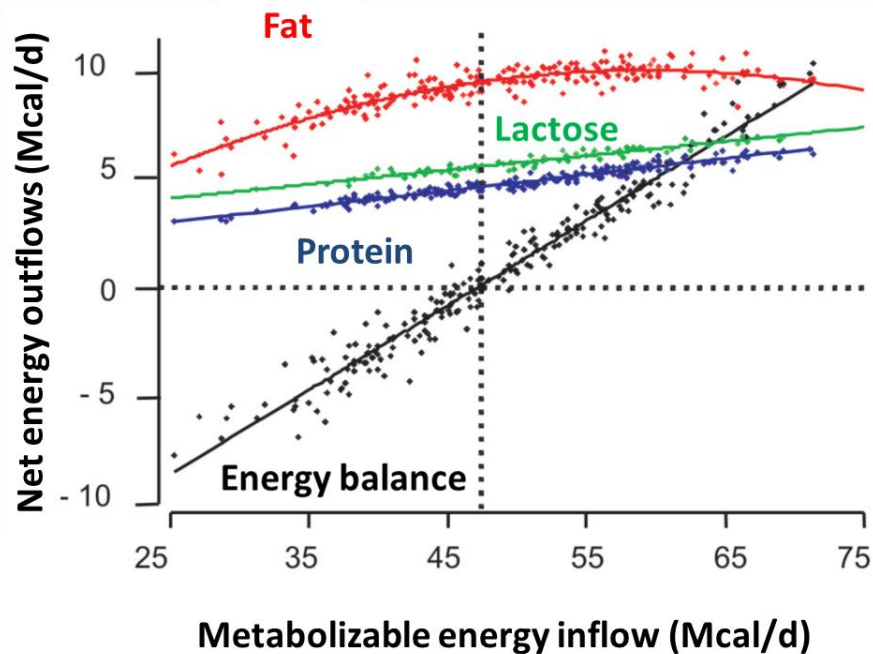

Figure 3. Net energy outflows of major milk components and calculated energy balance relative to ME supply (reproduced from Friggens et al., 2010).

However, these equations don't consider the effect of protein. Equally, the equations of Vérité and Delaby (2000) for response to MP don't consider the effect of energy. However, it is known that energy influences the efficiency of conversion of MP into milk protein yield, and that protein also influences energy partitioning. Therefore, energy and protein supply need to be considered simultaneously in the same response equation.

Protein x energy

When the effects of MP supply and NE_L supply are considered together, a problem of collinearity can arise simply because both independent variables are calculated using dry-matter intake. Nonetheless, it is important to study if there are interactions between MP supply and NE_L supply. Several experiments have been designed to investigate potential interactions (Broderick, 2003; Rius et al., 2010; Brun-Lafleur et al., 2010) but reveal divergent conclusions. The experiments of Broderick (2003) and Rius et al. (2010) did not find any interaction between dietary CP and NDF levels, and between MP and NE_L supply, respectively, for any of the milk variables. In contrast, interactions were found for milk yield, milk protein yield and milk protein content between MP and NE_L supply in the study of Brun-Lafleur et al (2010). The abundance of published papers, with reported milk yield and composition for different ration compositions provides an opportunity to summarize quantitatively the literature and establish response equations to change in both MP and NE_L supply. This would also provide insight on the absence or presence of an interaction between MP supply and NE_L supply. In this meta-analysis an important challenge would be to consider the effect of animal production potential and thereby to derive response equations equally applicable to low and to high producing animals.

Effect of animal potential on milk yield and composition responses

Static aspect: phenotypic potential

The accurate application of any response equation on-farm requires an estimation of the production potential (i.e. production at which marginal response is zero) of the cows in question. For example, on a farm where the observed production is 30 kg/d and the maximum production potential is also 30 kg/d, one expects zero response to an increase in feed quality. However, on a farm where the observed production is 30 kg/d but the

maximum production potential is 50 kg/d one clearly expects a positive response to supplementation. Thus, there is a need to estimate the relative production level, that is, how far the animal is from its potential. The further away the animal is relative to its potential, the greater the expected response to extra nutrient will be. This has been recognized for a long time with the principle of diminishing return (Brody, 1945) and frequently modelled in mechanistic models with Michaelis-Menten equations (e.g. Baldwin et al., 1987a). An illustration of this principle is shown in Figure 4. The observation is the production (e.g. milk yield, milk component yield...) at current nutrient supply (e.g. NEL or MP supply). Depending of the production potential (POT 1 or POT 2) of the dairy cow in question, the expected response to a change in this nutrient supply would differ largely, with a much greater response for POT 1 as compared to POT 2. Therefore this notion of potential appears to be necessary to estimate if a given animal would respond (and to what degree) to a change in nutrient supply.

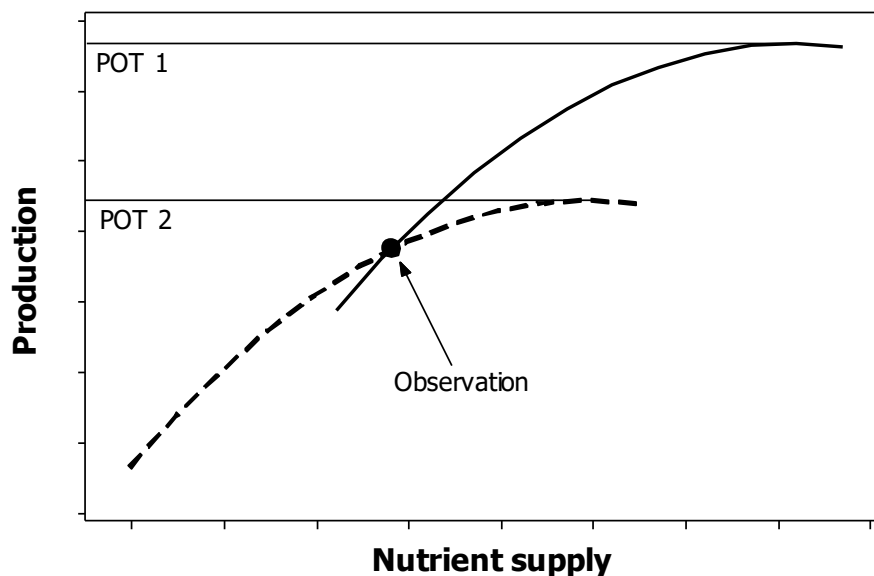

Figure 4. Theoretical representation of a production response to a change in nutrient supply. *Where the animal is relative to its potential?*

However the notion of potential is more complex than this theoretical example. First in a situation where multiple responses (milk yield, milk component yields, body weight change) are to be predicted, there are a priori as many different potentials per animal as there are components to be estimated. Second, the response curve to a given component

of the ration does not necessarily follow the same rule as that illustrated in Figure 4. For example, milk fat yield first increases between 30 and 55 Mcal/day (approximately) and then decreases after 55 Mcal/day (Figure 2). Further, the linear responses to ME supply observed for milk protein and lactose yields indicate that maximum productions were not reached within the data. Thus relative to ME supply, potential milk fat yield and potential milk protein and lactose yields are not reached at the same ME supply. This indicates that different rations are needed to maximize milk fat yield on the one hand and milk protein and lactose yields on the other hand. When NEL supply and MP supply were considered together, it was shown that at fixed MP supply, milk yield and milk protein yield reached a plateau at 1.7 Mcal/day (expressed relative to a control treatment, Brun-Lafleur et al. 2010), indicating potential productions might be reached. However at this level of NEL, increasing MP supply increases both, milk yield and milk protein yield. All of this highlights the difficulty of having environmental conditions that allow the production potential to be expressed and therefore the difficulty of estimating it.

Another difficulty is that the animal potential is not static but dynamic. Even if a dairy cow is kept on the same ration throughout the whole lactation, milk component yields change with time. This is the result of homeorhesis (Bauman and currie, 1980) which controls the metabolism in support of growth and reproductive physiological processes, pregnancy and lactation. This immediately raises the question of potential existing interactions between responses to nutrition and physiological stage.

Dynamic aspect: physiological status

In order to predict dairy cow responses to nutrition over lactation, potential performance relative to lactation stage and parity are needed because they are the basis from which to develop rules for nutrient partitioning in all feeding situations. The first models to simulate whole lactation potential performance have focused on milk yield (Wood, 1967; Neal and Thornley, 1983). Within these models, we can distinguish two different modelling approaches, differing in their level of complexity and biological representation. The model of Wood (1976) consists of a simple equation that describes the lactation curve with 3 parameters. Although each of these parameters have a meaning (time and size of the peak, persistency), this approach does not describe the underlying biological

mechanisms that causes the lactation curves. Such biological description was the basis of models of Neal and Thornley (1983) and Dijkstra et al. (1997), which simulate the lactation curves from the representation of secretory cells within the mammary gland. This type of model, categorized as mechanistic model (bottom-up approach, see review of Friggens et al., 2013), is by construction more complex than the former model (Wood, 1967). The utilization of these 2 models for a predictive purpose is nevertheless difficult because it either required historical data to define the parameters (Wood, 1967) or used inputs that are difficult to measure on-farm (Neal and Thornley, 1983). Furthermore, these models only simulate the lactation curve for milk yield. Other mechanistic models were built with the objective of increasing our understanding of nutrient partitioning (Baldwin et al., 1987a,b,c; Baldwin, 1995; Danfær, 1990; Danfaer et al., 2005a,b; Martin and Sauvant, 2007) and represent a more complete description of the metabolism of the dairy cow. Alternatively, Martin and Sauvant (2010a,b) developed a teleonomic model of lifetime partitioning, constructed on the basis of conceptual animal priority. All of these models simulate, among other things, milk yield, milk composition, body weight change and body composition change across lactation stage and parity. However the use of these models for prediction on-farm can be difficult due to their complexity as they require input parameters that are not easily available. Therefore first integrations of the consequence of homeorhesis on dairy cow performance by feed unit systems have favoured simpler empirical equations (Faverdin et al., 2007; Volden, 2011; Zom et al., 2012). Until now, none of these systems have developed a full set of equations that predict the main dairy cow performance, i.e. body weight and composition change, milk yield and composition, dry-matter intake, along the lactation. Further, these equations, as the mechanistic models previously mentioned, still require information about animal potential and therefore the question of measuring it remains valid. For the estimation of animal potential, herd-test day models which include fixed effects (farm, gestation, length of dry-period, calving month, etc.) and random effects (genetic and permanent environment) represent a valuable approach (Leclerc, 2008). However, such models assume that the differences in nutritional environment are adequately captured by the fixed effect of farm, and for prediction purposes require information from the previous lactation. An alternative approach that uses initial cow performance with initial plan of nutrition (i.e. available inputs

on-farm) to estimate cow potential could facilitate the configuration of these models that generates whole-lactation curves of performance.

Conclusion

In order to move from a requirement-based approach to a response approach, feed unit systems require robust equations that predict dry-matter intake, milk yield and composition responses to changes in both, energy and protein content of the ration. The numerous published studies that have look at the relation between changes in nutrient supply and milk production represent a valuable source of information to develop such equations and investigate the absence or presence of interactions between energy supply and protein supply. A key point for the genericity of these response equations will be their compatibility with animals of different production potential. Further, as the production potential of a dairy cow varies with time, the model will need to accommodate the effect of physiological status (growth, lactation, pregnancy). Finally to be use for prediction, this response model should use only inputs that can be measured on-farm or estimated from available farm data.

Objective and outline of this thesis

The main objective of this thesis is to develop and evaluate a model to predict the responses in dry-matter intake, milk yield, milk component yields and contents to changes in dietary composition in dairy cows. A key element of this model would be its ability to be used across animals of different potential and physiological status. The model should therefore provide an approach to estimate the relative production level for the different milk components, that is, distances between observed productions and maximum potential productions. This would subsequently enable the estimation of the size of milk responses for the given observation at a given time. The ultimate ambition was that the model developed could be applied on-farm, that is, its predictive ability should be sufficiently accurate and input variables used to key in the model should be measurable or estimated from available data on-farm.

In Chapter 2, a meta-analysis of the literature was conducted to quantify dry-matter intake, milk yield and milk composition responses to change in NEL and MP

content/supply. In Chapter 3, a method to estimate animal production potential is proposed in order to more accurately apply the response equations developed in Chapter 2. This method was evaluated against two independent datasets. In Chapter 4, a dynamic model was developed to predict the homeorhetic trajectories for milk component yields, body composition changes and dry-matter intake of dairy cows fed a favourable diet. As such, the effects of stage of lactation, stage of gestation and growth on milk and body composition were quantified. This model was calibrated across a large range of animal production potentials within the Holstein breed using a herd dataset where animals received the same ration. Further, the model structure was evaluated with another dataset of Holstein, Jersey and Danish Red breeds fed identical rations. Based on the same dataset, simple scaling factors were incorporated to simulate differences in trajectories between breeds. Finally, Chapter 5 presents the integration of the static response equations (Chapter 2) into the dynamic model (Chapter 4) using the approach proposed in Chapter 3 to estimate animal production potential. In this Chapter, the combined model, predicting the effect of nutrition, physiological status and genotype on dry-matter intake, milk yield, milk component yields, milk composition and body weight was evaluated using two independent datasets. In Chapter 6, a general discussion of the thesis is presented with focus on the methodology used to develop the model, the complementarity, and comparison, with feed unit systems, and the practical considerations regarding the model application on-farm.

References

- Agriculture and Food Research Council 1993. Energy and protein requirements of ruminants. An advisory manual prepared by the AFRC Technical Committee on Responses to Nutrients. CAB International, Wallingford, UK.
- Arriola Apelo SI, Knapp JR, and Hanigan MD 2014. Invited review: Current representation and future trends of predicting amino acid utilization in the lactating dairy cow. *Journal of Dairy Science* 97, 4000–4017.
- Baldwin RL 1995. Modeling ruminant digestion and metabolism. Chapman & Hall, London, UK.
- Baldwin RL, France J and Gill M 1987a. Metabolism of the lactating cow. I. Animal elements of a mechanistic model. *Journal of Dairy Research* 54, 77–105.
- Baldwin RL, Thornley JHM and Beever DE 1987b. Metabolism of the lactating cow. II. Digestive elements of a mechanistic model. *Journal of Dairy Research* 54, 107–131.
- Baldwin RL, France J, Beever DE, Gill M and Thornley JHM 1987c. Metabolism of the lactating cow. III. Properties of mechanistic models suitable for evaluation of energetic relationships and factors involved in the partition of nutrients. *Journal of Dairy Research* 54, 133–145.
- Bauman DE and Currie WB 1980. Partitioning of nutrients during pregnancy and lactation: A review of mechanisms involving homeostasis and homeorhesis. *Journal of Dairy Science* 63, 1514–1529.
- Broderick GA 2003. Effects of varying dietary protein and energy levels on the production of lactating dairy cows. *Journal of Dairy Science* 86, 1370–1381.
- Brody S 1945. Bioenergetics and growth, with special reference to the efficiency complex in domestic animals. Reinhold, New York, NY.
- Broster W 1972. Effect on milk yield of the cow of the level of feeding during lactation. Pages 265-288 in *Proceeding Dairy Science Abstracts*
- Broster W and Thomas C 1981. Influence of level and pattern of concentrate input on milk output. *Recent advances in animal nutrition*.
- Brun-Lafleur L, Delaby L, Husson F and Faverdin P 2010. Predicting energy x protein interaction on milk yield and milk composition in dairy cows. *Journal of Dairy Science* 93, 4128–4143.
- Danfær A, Huhtanen P, Udén P, Sveinbjörnsson J and Volden H 2005a. The nordic dairy cow model, Karoline – Description. In *Nutrient digestion and utilization in farm animals: modelling approaches* (ed. E Kebreab, J Dijkstra, A Bannink, WJJ Gerrits and J France), pp. 383–406. CAB International, Wallingford, UK.
- Danfær A, Huhtanen P, Udén P, Sveinbjörnsson J and Volden H 2005b. The nordic dairy cow model, Karoline – Evaluation. In *Nutrient digestion and utilization in farm animals: modelling approaches* (ed. E Kebreab, J Dijkstra, A Bannink, WJJ Gerrits and J France), pp. 407–415. CAB International, Wallingford, UK.
- Danfær A. 1990. A dynamic model of nutrient digestion and metabolism in lactating dairy cows. Ph.D. Diss., National Institute of Animal Science, Foulum, Denmark.
- Dijkstra J, France J, Dhanoa MS, Maas JA, Hanigan MD, Rook AJ, Beever DE 1997. A model to describe growth patterns of the mammary gland during pregnancy and lactation. *Journal of Dairy Science* 80, 2340–2354.

- Dijkstra J, Kebreab E, Mills JAN, Pellikaan WF, López S, Bannink A and France J 2007. Predicting the profile of nutrients available for absorption: From nutrient requirement to animal response and environmental impact. *Animal* 1, 99–111.
- Faverdin P, Delagarde R, Delaby L and Meschy F 2007. Alimentation des vaches laitières. Pages 23-58 in: Alimentation des bovins, ovins et caprins. Besoins des animaux - Valeur des aliments - Tables INRA 2007, mise à jour 2010. Editions Quae, Versailles, France.
- Friggens N, Sauvant D, Martin O 2010. Vers des définitions opérationnelles de la robustesse s'appuyant sur des faits biologiques. L'exemple de la nutrition. *INRA Production Animales*, 23: 43-52.
- Friggens NC, Brun-Lafleur L, Faverdin P, Sauvant D and Martin O. 2013. Advances in predicting nutrient partitioning in the dairy cow: Recognizing the central role of genotype and its expression through time. *Animal* 7, 89–101.
- Huhtanen P and Nousiainen J 2012. Production responses of lactating dairy cows fed silage-based diets to changes in nutrient supply. *Livestock Science* 148, 146–158.
- Jensen C, Østergaard S, Schei I, Bertilsson J and Weisbjerg MR 2015. A meta-analysis of milk production responses to increased net energy intake in Scandinavian dairy cows. *Livestock Science* 175, 59–69.
- Kirkland R and Gordon F 2001. The effects of milk yield and stage of lactation on the partitioning of nutrients in lactating dairy cows. *Journal of Dairy Science* 84, 233-240.
- Leclerc H 2008. Development of the French dairy cattle test-day model genetic evaluation and prospects of using results for herd management. Ph.D. Thesis. AgroParisTech, Paris, France.
- Martin O and Sauvant D 2007. Dynamic model of the lactating dairy cow metabolism. *Animal* 1, 1143–1166.
- Martin O and Sauvant D 2010a. A teleonomic model describing performance (body, milk and intake) during growth and over repeated reproductive cycles throughout the lifespan of dairy cattle. 1. Trajectories of life function priorities and genetic scaling. *Animal* 4, 2030–2047.
- Martin O and Sauvant D 2010b. A teleonomic model describing performance (body, milk and intake) during growth and over repeated reproductive cycles throughout the lifespan of dairy cattle. 2. Voluntary intake and energy partitioning. *Animal* 4, 2048–2056.
- Metcalf J, Mansbridge R, Blake J, Oldham J and Newbold J 2008. The efficiency of conversion of metabolisable protein into milk true protein over a range of metabolisable protein intakes. *Animal* 2, 1193–1202.
- National Research Council 2001. Nutrient Requirements of Dairy Cattle. 7th rev. ed. Natl. Acad. Press, Washington, DC.
- Neal HDSC and Thornley JHM 1983. The lactation curve in cattle: A mathematical model of the mammary gland. *Journal of Agricultural Science* 101, 389–400.
- Oldham JD and Emmans GC 1989. Prediction of responses to required nutrients in dairy cows. *Journal of Dairy Science* 72, 3212–3229.

- Rius AG, McGilliard ML, Umberger C and Hanigan MD 2010. Interactions of energy and predicted metabolizable protein in determining nitrogen efficiency in the lactating dairy cow. *Journal of Dairy Science* 93, 2034–2043.
- Roffler RE and Wray JE 1986. Production responses in early lactation to additions of soybean meal to diets containing predominantly corn silage. *Journal of Dairy Science* 69, 1055–1062.
- Sauvant D 1992. La modelisation systémique en nutrition. *Reproduction Nutrition Development* 32, 217–230.
- Sauvant D, Cantalapiedra-Hijar G, Delaby L, Daniel JB, Faverdin P and Nozière P 2015. Actualisation des besoins protéiques des ruminants et détermination des réponses des femelles laitières aux apports de protéines digestibles dans l'intestin (PDI). *INRA Production Animales*, 28: 347-368.
- Subnel APJ, Meijer RGM, Van Straalen WM and Tamminga S 1994. Efficiency of milk protein production in the DVE protein evaluation system. *Livestock Production Science* 40, 215–224.
- Van Amburgh ME, Collao-Saenz EA, Higgs RJ, Ross DA, Recktenwald EB, Raffrenato E, Chase LE, Overton TR, Mills JK and Foskolos A. 2015. The Cornell Net Carbohydrate and Protein System: Updates to the model and evaluation of version 6.5. *Journal of Dairy Science*, 98:6361–6380.
- van Duinkerken G, Blok MC, Bannink A, Cone JW, Dijkstra J, van Vuuren AM and Tamminga S 2011. Update of the Dutch protein evaluation system for ruminants: The DVE/OEB2010 system. *Journal of Agricultural Science* 149, 351–367.
- Vérité R and Delaby L 2000. Relation between nutrition, performances and nitrogen excretion in dairy cows. *Annales de Zootechnie* 49, 217-230.
- Volden H 2011. *NorFor - The Nordic Feed Evaluation System*. EAAP Publication. Wageningen Academic Publishers, Wageningen, the Netherlands.
- Wood PDP 1967. Algebraic model of the lactation curve in cattle. *Nature* 216, 164–165.
- Zom RLG, Andre G and van Vuuren AM. 2012. Development of a model for the prediction of feed intake by dairy cows: 1. Prediction of feed intake. *Livestock Science* 143, 43–57.

Chapter 2

Milk yield and milk composition responses to change in predicted net energy and metabolizable protein: A meta-analysis

J.B. Daniel^{1,2}, N.C. Friggens¹, P. Chapoutot¹, H. Van Laar² and D. Sauvant¹

Accepted for publication by Animal

¹UMR Modélisation Systémique Appliquée aux Ruminants, INRA, AgroParisTech, Université Paris-Saclay, 75005 Paris, France

²Trouw Nutrition R&D, P.O. Box 220, 5830 AE Boxmeer, the Netherlands

Abstract

Using a meta-analysis of literature data, this study aimed to quantify: the dry-matter intake response to changes in diet composition, and milk responses (yield, milk component yields and milk composition) to changes in dietary net energy (**NE_L**) and metabolizable protein (**MP**) in dairy cows. From all studies included in the database, 282 experiments (825 treatments) with experimentally induced changes in either **NE_L** or **MP** content were kept for this analysis. These treatments covered a wide range of diet characteristics and therefore a large part of the plausible **NE_L** and **MP** contents and supplies that can be expected in practical situations. The average **MP** and **NE_L** contents were respectively (mean \pm SD) 97 ± 12 g/kg DM and 6.71 ± 0.42 MJ/kg DM. On a daily supply basis, there were high between-experiment correlations for **MP** and **NE_L** above maintenance. Therefore, supplies of **MP** and **NE_L** above maintenance were respectively centred on **MP** supply for which **MP** efficiency into milk protein is 0.67, and **NE_L** above maintenance supply for which the ratio of **NE_L** milk/**NE_L** above maintenance is 1.00 (centred variables were called **MP₆₇** and **NE_{L100}**). The majority of the selected studies used groups of multiparous Holstein-Friesian cows in mid-lactation, milked twice a day. Using a mixed model, between and within-experiment variation was split to estimate dry-matter intake and milk responses. The use of **NE_{L100}** and **MP₆₇** supplies substantially improved the accuracy of the prediction of milk yield and milk component yields responses with, on average, a 27% lower RMSE relative to using dietary **NE_L** and **MP** contents as predictors. For milk composition (g/kg), the average RMSE was only 3% lower on a supply basis compared to a concentration basis. Effects of **NE_L** and **MP** supplies on milk yield and milk component yields responses were additive. Increasing **NE_L** supply increases energy partitioning towards body reserve whereas increasing **MP** supply increases the partition of energy towards milk. On a nitrogen basis, the marginal efficiency decreases with increasing **MP** supply: from 0.34 at **MP₆₇** = - 400 g/d to 0.07 at **MP₆₇** = 300 g/d. This difference in **MP₆₇** supply, assuming reference energy level of **NE_{L100}** = 0, equates to a global nitrogen efficiency decrease from 0.82 to 0.58. The equations accurately describe dry-matter intake response to change in dietary contents and milk responses to change in dietary supply and content of **NE_L** and **MP** across a wide range of dietary compositions.

Keywords: dairy cow, milk composition, energy, protein, meta-analysis

Introduction

Adapting dairy cow rations to cope with feed and milk price volatility whilst taking into account environmental, animal health and welfare concerns represents a major challenge for dairy producers. There is a need to predict not only the nutritional requirements but also the response of animals to diet changes (Oldham and Emmans, 1989; Sauvant, 1992; Dijkstra *et al.*, 2007). In order to be able to predict responses, three key processes need to be quantified. Firstly, the prediction of dry-matter intake response to dietary changes, secondly rumen digestion and fermentation processes to obtain accurate estimates of nutrients available for absorption (Van Duinkerken *et al.*, 2011; Volden, 2011; Sauvant and Nozière, 2016), and thirdly the partition of those absorbed nutrients between different life functions (Bauman, 2000; Friggens *et al.*, 2013). One aspect of nutrient partitioning, the relation between changes in nutrient supply and milk production and composition, has received a lot of attention. In particular, the effects of changes in either metabolizable protein (Vérité *et al.*, 1987; Metcalf *et al.*, 2008) or net energy (Coulon and Rémond, 1991) on milk outputs have been largely characterized. However, it is still unclear how to quantitatively combine the effects of changes in net energy and metabolizable protein, including possible interactions between them, for predicting milk yield and milk composition responses. The divergent conclusions regarding the existence of net energy x metabolizable protein interaction on milk yield and milk protein yield found in recent studies (Broderick, 2003; Brun-Lafleur *et al.* 2010; Rius *et al.*, 2010) highlight the need to quantitatively summarize the available studies. Given the large diversity of studies focused on the effect of dietary energy and protein content, meta-analysis represents a useful approach for quantifying milk production and milk composition responses to combined changes of net energy and metabolizable protein.

The objectives of this study were therefore to establish (1) average dry-matter intake response to dietary changes, (2) average milk yield and composition responses to net energy and metabolizable protein, both on a concentration and a supply basis, and to (3) quantify any interactions between net energy and metabolizable protein contents and supplies on responses of milk yield and milk composition.

Material and methods

Database creation

A literature search was conducted using Scopus and ScienceDirect with the following key words: dairy cows, milk production, protein, energy, concentrate, forage, degradability. References included in the resulting papers were also checked. As a result, 261 publications (1316 treatments means) were considered for possible inclusion in the dataset. The minimum prerequisite for a published study to be included in the dataset was: that feed description in term of ingredients (% DM of the total diet), dietary CP content (g/kg DM), dry-matter intake (**DMI**, kg/d), milk yield (kg/d), milk fat and protein yields (g/d), and body weight (**BW**, kg) were reported or could be easily calculated, and that the animals were fed *ad libitum*. After selection, 237 publications, consisting of 1174 treatment means that satisfied the above criteria, were kept. The final list of publications used in the meta-analysis can be found in Annex 1.

Calculations

The digestibility of the organic matter (**OMD**), CP flows at duodenum, net energy for lactation (**NE_L**) and metabolizable protein (**MP**) values were calculated for all diets in the dataset using the recently updated INRA Systali feed units system (Sauvant and Nozière, 2016). Briefly, this update consisted of quantifying the effect of digestive interactions on nutrient supplies, and subsequently on **NE_L** and **MP** values (see Annex 2 for further details). The required inputs to calculate these values are: **BW** of the animals, **DMI**, the proportion of concentrate in the ration, the percentages of every ingredient included in the diet (DM basis) and their corresponding tabulated feed number code from the INRA feed library (Baumont *et al.*, 2007). Forages and concentrate ingredients listed in the publications were matched with tabulated feeds on the basis of their CP and NDF contents. For each treatment, the CP and NDF concentrations of the total diet were calculated and compared with measured chemical characteristics in the publications. If several codes were available for one ingredient (e.g. forages, soybean meal) and that no analysis was reported for that ingredient, the code was chosen to minimize the differences between the estimated and measured CP and NDF of the total diet. For the set of studies where measured values were available, the slope of the within-study relationship between estimated and observed values of: **OMD** (number of treatment, **Nt**=474) and CP flow to the duodenum (**Nt**=115)

was tested against one (=bisector) with an F-test. Root mean square error (**RMSE**) was used to assess the quality of the estimates.

Data coding

The full set of selected studies was coded. Unless several studies were reported within a publication, a study was equivalent to a publication. Data were coded at the level of experiments (**Nexp**), where an experiment is defined as a group of treatments (with a minimum of 2 treatments) relating to a particular objective within any given study. These experiment codes were subsequently used to split the within- and between-experiment variation, as recommended in the meta-analysis review of St-Pierre (2001). These codes also enabled the selection of subsets of experiments with the same objective as a means to avoid confounding factors (Sauvant *et al.*, 2008). The two experiment types coded for were MP level and NEL level experiments. The latter pooled experiments with various inclusion levels of concentrate or various starch: fibre ratios. The two columns of codes for "energy" and "protein" experiments were concatenated in a "energy x protein" column. For studies with a factorial arrangement of energy and protein levels, the code for study was used to concatenate. This increases the statistical power of the model to detect any significant interaction between MP and NEL. Experiments lacking within-experiment differences, for both variables dietary MP and NEL contents, were discarded (Nt=22). Experiments with lipids levels/sources as treatment were not selected as it was not our present objective (Nt=89). Other treatments in our database, which were not related with dietary energy or protein (Nt=238, particle size, silage hybrids, enzyme, feeding frequency, BST...) were also discarded. Consequently, from the 1174 treatments means that satisfied the original prerequisites for selection, a total of 825 treatments (Publication=168, Nexp=282) were kept (see Annex 1).

Statistical analysis

Statistical analyses were carried out using PROC MIXED of SAS (SAS Institute Inc., 2004). The first objective was to quantify, within-experiment, milk yield, milk component yields and milk composition responses to change in dietary NEL and MP contents. The model used for that purpose was

$$Y_{ij} = \mu + S_i + e_1.dE + p_1.dP + e_2.dE^2 + p_2.dP^2 + a.dP \cdot dE + \epsilon_{ij},$$

[1] where Y_{ij} is the milk yield, milk component yields or milk composition for experiment

i and treatment j , dE and dP were the mean-centred concentrations of NE_L (MJ/kg DM) and MP (g/kg DM). The values used to centre NE_L and MP were 6.7 MJ/kg DM and 100 g/kg DM, respectively. These variables were centred to reduce the correlations between intercept and slope. μ is the centred intercept that gives directly the mean value of the Y variable; S_i is the fixed effect of experiment i , e_1 and e_2 are the linear and quadratic coefficients of dE ; p_1 and p_2 are the coefficients for the linear and quadratic effects of dP ; a is the coefficient adjusting the response slope for the interaction between dP and dE ; and ε_{ij} the residual for experiment i and treatment j . As discussed by St-Pierre (2001), the underlying assumption for using an adjustment based on a random effect is that the observations in question are in fact a random sample from the wider population. In the present meta-analysis, the experiments selected were not picked at random. Only experiments that used dietary treatments related to amount or quality of protein and/or energy were selected. Among those experiments, we chose to discard those with dietary lipid levels/sources as treatment. Also experiments lacking variation in dietary NE_L and MP contents between treatments were not retained. For these reasons, we chose to include the experiment effect as a fixed effect. Further, when the experiment effect is assumed random the statistical distribution of the adjustments for experiment should generally follow a normal Gaussian law. This was not the case for the majority of dependent variables studied in our dataset. For completeness, a comparison of fixed and random model outputs is given in Annex 3 and 4. Treatment observations were not weighted according to their standard errors because there was no benefit of doing so (see Annex 5). The same model [1] was used to quantify the DMI response with the exception that dietary NE_L was replaced by dietary forage NDF content (**FNDF**, g/kg). Forage NDF was mean centred, on 250 g/kg DM. The quadratic effect of FNDF and interactions of FNDF with MP were also tested but were not found to be significant.

The second objective was to quantify, within-experiment, milk yield, milk component yields and milk composition responses to changes in NE_L and MP supplies above maintenance. These co-variables were preferred over total NE_L and MP supplies to correct for different energy and protein maintenance requirements, i.e. to avoid biases due to different BW and DMI. The equations and method used for calculating MP and NE_L maintenances are given in full detail in Annex 2. Because there was a strong inter-experiment co-linearity between NE_L supply and MP supply (by construction both contain DMI), it was necessary to centre these predictors on reference values that

reduced this co-linearity (see figure 1). Centring on the global means does not achieve this. We chose to adjust MP supply by expressing it relative to the MP supply needed for an efficiency of 0.67. This efficiency was chosen because it is equivalent to an average dietary MP content of 100 g/kg DM (Sauvant *et al.*, 2015), the reference value chosen in the concentration analysis. Moreover, the NRC (2001) also uses 0.67 as a constant MP efficiency. To centre the data, the slope (α) of the linear relation between MP above maintenance supply (S_{ij}) and MP efficiency (F_{ij}) was first determined (with experiments fitted as a fixed effect). The centred MP supply ($=MP_{67}$) was then calculated as $S_{ij} - S_i + \alpha (F_i - 0.67)$ where S_i is the experiment mean MP above maintenance supply and F_i is the experiment mean MP efficiency. Similarly, the centred NE_L supply ($=NE_{L100}$) was calculated as $S_{ij} - S_i + \alpha (F_i - 1.00)$ where S_i is the experiment mean NE_L above maintenance supply, F_i is the experiment mean milk NE_L efficiency ($=NE_L$ in milk/ NE_L above maintenance) and α is the slope of the linear relation between NE_L above maintenance supply (S_{ij}) and milk NE_L efficiency (F_{ij}). The milk NE_L efficiency of 1 was chosen because it is equivalent to a zero energy balance. Finally, responses were estimated with model [1] where dE and dP are NE_{L100} and MP_{67} .

Akaike's information criterion (**AIC**) was used to select the best model, with non-significant terms being progressively dropped. Differences in AIC greater than three between two models indicate that there is good evidence that the model with the smaller AIC is significantly better than the model with the larger AIC (Burnham and Anderson, 2002). Co-linearity between independent variables was assessed using their mutual correlations and the variance inflation factor (**VIF**) generated with PROC REG of SAS (SAS Institute Inc., 2004). In general, estimability is assumed acceptable when all VIF are below 10 (St-Pierre and Glamocic, 2000). Observations from model [1] were considered as outliers when their studentized residuals were higher than three (Sauvant *et al.*, 2008). In this case, they were removed stepwise until there were no such outliers left. For each analysis, the percentages of outliers removed are reported in the Results section together with the RMSE.

Results

Reliability of calculated nutritional values

The average calculated diet contents of CP, NDF, FNDF and starch were 172 (SD 22), 349 (62), 253 (71) and 234 (96) g/kg DM, respectively. The reliability of these calculated diet content was evaluated by regression of the analysed diet contents (dependant variables) on the calculated diet contents (independent variables). The slope of the global relationship between analysed and calculated CP was 0.98 (SE 0.01, number of treatment, Nt = 825, RMSE = 7) and was not different from 1 (P=0.148). Between analysed and calculated NDF the global slope was 0.86 (SE 0.02, Nt = 794, RMSE = 30) and significantly differs from 1 (P<0.001). However, for FNDF the global slope, 0.99 (SE 0.01, Nt = 691, RMSE=20), was not significantly different from 1 (P=0.361). For starch, the global slope of 0.98 (SE 0.02, Nt=373, RMSE=30) did not differ from 1 (P=0.214). The within-experiment slope between analysed and calculated OMD (mean \pm SD, 69.0 \pm 5.8%, Nt =474) was 0.97 (SE 0.05) and did not differ significantly from 1 (P = 0.548), with RMSE of 1.6 % units of OMD. For the 115 treatments that analysed CP flows at duodenum (mean \pm SD, 3404 \pm 756 g CP/d), the within-experiment slope between analysed and calculated value, 0.85 (SE 0.09) was not significantly different from 1 (P=0.119, RMSE=206).

General description of the dataset

The average year of publication was 2001 \pm 8 (mean \pm SD) and studies mainly originated from North America (64%) and Europe (34%). The experimental designs used were, Latin square (63.2%), randomized block design (26.4%) and change-over design (10.4%). The average number of animal used per treatments was 10 \pm 7. In 74% of the treatments, animals were fed a total mixed ration, with the remaining 26% fed forage and concentrate separately. The principal diet ingredients are displayed in Annex 6. The most frequently used forages were maize silage and alfalfa silage, followed by grass silage. However the average inclusion of the latter, when present, was higher than that of maize and alfalfa silages (54 \pm 20 vs 35 \pm 16 and 29 \pm 18 % of DM, respectively). Ground maize was the ingredient most frequently used as an energy source in the concentrate. With respect to protein sources, soybean meal (solvent extracted, expeller and extruded), followed by rapeseed meal were the most frequently used sources of rumen degradable protein (**RDP**). Sources of rumen undegradable

protein (**RUP**) were mainly heat treated soybean meal, maize gluten meal, fish meal and blood meal.

Table 1 shows the animal characteristics and the milk production data. The predominant breed was Holstein-Friesian (90% of all cows) and 86% of the cows were multiparous. From the 819 treatments where stage of lactation was reported, no treatments were conducted with cows averaging under 50 days in milk (**DIM**) and only 64 treatments used groups of cows in late lactation (with an average >200 DIM). Thus 92% of treatments used cows in mid lactation (50<DIM<200). In most of the experiments (91%), cows were milked twice daily with the remaining 9% milked three times a day. The means of SEM reported in the publications for the dependent variables were (SD in parentheses): DMI = 0.62 kg/d (0.35, Nt = 763), milk yield = 1.07 kg/d (0.66, Nt = 794), milk fat yield = 56.9 g/d (34.5, Nt =687), milk protein yield = 38.4 g/d (30.9, Nt =695), milk lactose yield = 56.8 g/d (37.9, Nt = 411), milk fat content = 1.30 g/kg (0.63, Nt = 788), milk protein content = 0.55 g/kg (0.63, Nt = 794) and milk lactose content = 0.42 g/kg (0.29, Nt=522).

Table 1 Animal performance characteristics

Variable	Nt	Mean	SD	Minimum	Maximum
DIM (d)	819	131	51	50	337
BW (kg)	825	618	48	385	769
DMI (kg/d)	825	21.5	3.5	5.6	31.8
DMI (%BW)	825	3.48	0.47	0.90	4.91
Concentrate (%DMI)	825	47	13	0	82
Milk (kg/d)	825	31.1	7.0	13.8	49.3
Milk component yields (g/d)					
Fat	825	1131	246	510	1715
Protein	825	973	203	381	1505
Lactose	545	1484	347	596	2304
Milk component contents (g/kg)					
Fat	825	36.8	5.3	21.9	52.5
Protein	825	31.5	2.3	26.0	41.0
Lactose	545	47.7	2.0	37.5	54.8

Nt= Number of treatment means; DIM = Days in milk, defined as the mean during the measurement period; BW= Body weight; DMI = Dry-matter intake.

Meta-designs in the database

Table 2 shows the measured and calculated chemical composition of the published treatments, and the calculated nutritional values with the INRA Systali model. The mean of MP₆₇ was negative (-46 g/d). This is because the mean MP efficiency of this dataset (0.69) was higher than the reference MP efficiency (0.67) used to centre MP above maintenance supply. In contrast the reference for energy, NE_L in milk/NE_L above maintenance supply of 1, was very close to the mean of the dataset (0.99) which explains why the mean of NE_{L100} is close to 0.

Table 2 Chemical compositions of the published treatments and calculated nutritional values with INRA Systali feed unit system.

Variable	Nt	Mean	SD	Minimum	Maximum
Analysed chemical composition (g/kg DM)					
CP	825	172	22	86	271
NDF	794	346	62	220	647
FNDF	691	250	75	99	647
ADF	623	202	43	103	408
Starch	377	225	98	0	476
EE	244	43	12	15	84
Calculated chemical composition (g/kg DM)					
CP	825	172	22	88	259
NDF	825	349	62	198	637
FNDF	825	253	71	94	637
Starch	825	234	96	0	435
EE	825	41	12	17	90
Nutritional values calculated with INRA Systali feed unit system					
NE _L (MJ/kg DM)	825	6.71	0.42	5.18	7.85
MP (g/kg DM)	825	97	12	64	152
MP above maintenance (g/d)	825	1428	330	444	2377
NE _L above maintenance (MJ/d)	825	97	23	21	160
MP ₆₇ (g/d)	825	-46	207	-847	603
NE _{L100} (MJ/d)	825	0.45	15	-59	41
NE _L in milk/NE _L above maintenance	825	0.99	0.17	0.60	1.82
MP efficiency	825	0.69	0.08	0.42	1.06

FNDF = Forage NDF; EE = Ether extract; NE_L = Net energy for lactation; MP = Metabolizable protein, MP₆₇ = MP above maintenance supply centred on supply for which MP efficiency is 0.67; NE_{L100} = NE_L above maintenance supply centred on supply for which the ratio of NE_L in milk/NE_L above maintenance is 1.00; MP efficiency = Efficiency to convert MP above maintenance into milk protein.

Among the 282 experiments (Nt=825) selected to study the effect of NE_L and MP interaction on milk responses, 47% compared two treatments, 26% compared three treatments and the remaining more than three treatments (from 4 to 12). Experiments were characterized according to three main types of treatments: those with treatments that varied mainly in dietary MP content (458 Nt), those with treatments that varied mainly in dietary NE_L content (208 Nt), and experiments with treatments that varied in both dietary NE_L and MP contents (159 Nt). For the 142 experiments with variation in NE_L, the within-experiment relationship between calculated starch content and calculated NDF content (g/kg DM) was negative and linear: Starch = 684 (SE 12) - 1.31 (0.03) NDF (RMSE = 21). For the 213 experiments with MP variation, a strong within-experiment relationship linked MP and RUP (g/kg DM) with MP = 44.0 (0.6) + 0.91 (0.01) RUP (RMSE = 1.8). The slope of 0.91 highlighted clearly that variation in MP are mainly the result of variation in dietary bypass protein.

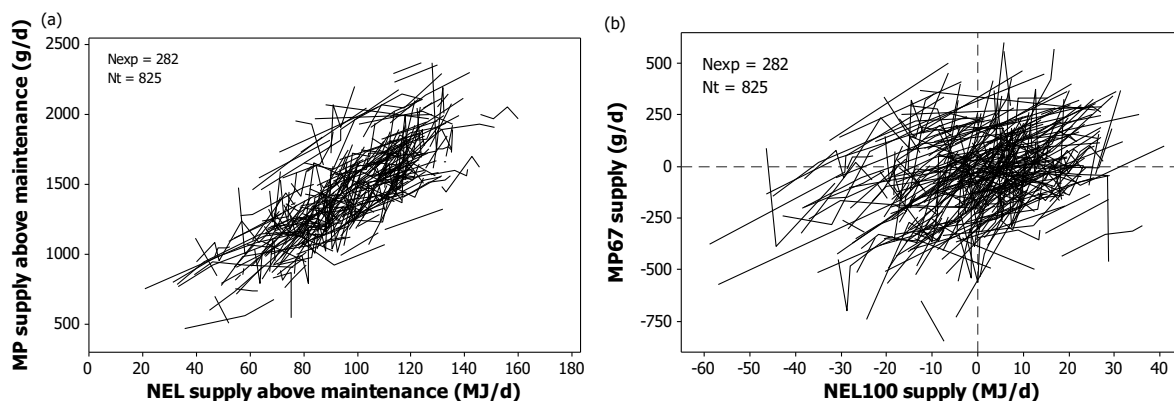

Figure 1 Meta-designs showing the relations between (a) MP above maintenance supply (g/d) and NE_L above maintenance supply (MJ/d) and (b) between MP₆₇ supply (g/d) and NE_{L100} supply (MJ/d). MP₆₇ = MP above maintenance supply centred on supply for which MP efficiency is 0.67; NE_{L100} = NE_L above maintenance supply centred on supply for which the ratio NE_L in milk/NE_L above maintenance is 1.00. Each line represents one experiment group (N_{exp}=282) including 825 treatments (N_t).

The meta-design shown in Figure 1 (a) shows the relationship between NE_L and MP above maintenance supplies before they are centred (NE_L milk/NE_L above maintenance=1.00, MP efficiency =0.67). Figure 1 (b) shows the relationship between daily NE_{L100} supply and daily MP₆₇ supply after centring. The within-experiment correlation between NE_{L100} and MP₆₇ supply was naturally unaffected by these adjustments (adjusted R² = 0.42, RMSE=91 g/d) but the global correlation, i.e.

including both inter- and intra- experiment variation, was largely reduced (adjusted $R^2 = 0.13$ vs 0.59) as intended. Between MP and NE_L contents, the global and within-experiment correlations were low with an adjusted R^2 of 0.09 and 0.10 , respectively. For the prediction of DMI response, FNDF was used instead of NE_L in the model. The within-experiment correlation between dietary FNDF content and MP had an adjusted R^2 of 0.11 . For all analysis, there were no independent variables with a $VIF > 2$ and therefore the estimability of coefficients was assumed acceptable.

Dry-matter intake response to change in forage NDF and metabolizable protein contents

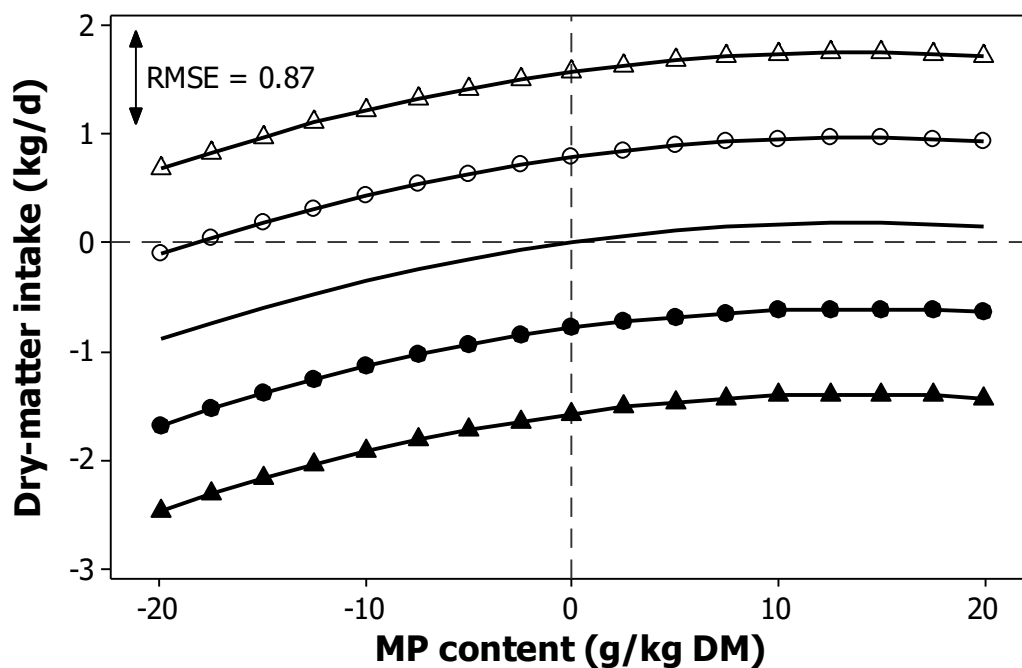

Figure 2 Prediction of the average dry-matter intake response to change in MP content (g/kg DM) and in forage NDF content (g/kg DM). Forage NDF effects are shown by the vertical displacement that are each for a forage NDF content: -100 g/kg DM (Δ), -50 g/kg DM (\circ), 0 g/kg DM (no symbol), $+50$ g/kg DM (\bullet), $+100$ g/kg DM (\blacktriangle). All variables are expressed relative to global mean values (MP= 100 g/kg DM, Forage NDF= 250 g/kg DM) with average dry-matter intake of 21.8 kg/d. The RMSE is indicated by the double-headed arrow.

The average DMI (kg/d) decreased linearly with change in dietary FNDF (%/kg DM centred on- 25% /kg DM) and increased curvilinearly with change in dietary MP content (kg/kg DM centred on- 0.1 kg/kg DM). The regression is (standard errors of coefficients are reported in parentheses):

DMI = 21.78 (0.05) + 25.8 (5.8) MP – 933.7 (217.6) MP² – 0.1568 (0.0094) FNDF
(N_{exp} = 281; N_t = 807; Outlier = 2.2%; RMSE = 0.87).

There was no significant interaction between MP and FNDF in this analysis. The simulated DMI response, shown in Figure 2, illustrates the magnitude of the response to changes in MP and FNDF contents.

Milk responses to change in net energy and metabolizable protein contents

The model coefficients obtained for milk yield, milk component yields and milk composition responses to change in dietary NE_L and MP contents are presented in Table 3. These coefficients can be used to predict milk responses within the ranges of 5.9 – 7.6 MJ/kg DM for NE_L and 73 – 121 g/kg DM for MP (means ± 2 SD), which reflect the current dataset. Milk yield and composition variables were all affected by NE_L and MP contents, with the exception of milk lactose content which was not significantly influenced by dietary MP.

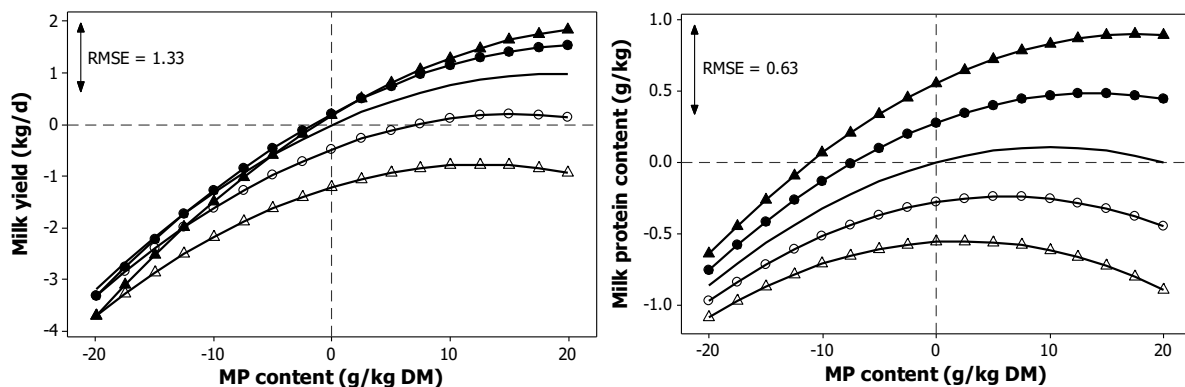

Figure 3 Prediction of average milk yield milk protein content responses to change in MP content (g/kg DM) and to change in NE_L content (MJ/kg DM). Energy effects are shown by the vertical displacement between the lines that are each for a NE_L content: -0.70 MJ/kg DM (solid line with Δ), -0.35 MJ/kg DM (solid line with \circ), 0 MJ/kg DM (blank solid line), +0.35 MJ/kg DM (solid line with \bullet), +0.70 MJ/kg DM (solid line with \blacktriangle). All variables are expressed relative to global mean values (NE_L=6.7 MJ/kg DM, MP=100 g/kg DM) with average milk yield of 32.1 kg/d and milk protein content of 31.6 g/kg. The RMSE is indicated by the double-headed arrow.

Figure 3 shows the predicted responses of milk yield, and milk protein content, to change in dietary MP content. The effect of MP was positive and curvilinear for milk yield, milk component yields and milk protein content. The slope of the response to dietary MP was greatest for milk lactose yield and lowest for milk fat yield. As an

example, for a level of energy of 6.7 MJ/kg DM, increasing MP content from 80 to 120 g/kg DM increases milk lactose yield, milk protein yield and milk fat yield by 244 g/d, 144 g/d and 114 g/d, respectively. The milk lactose yield response was associated with the greatest RMSE, followed by milk fat yield and milk protein yield (Table 3). The influence of MP and NEL content changes on milk lactose and protein yield responses was reflected in milk yield response. With respect to milk composition, milk fat content was the most influenced by changes in dietary NEL and MP. It decreases with increasing dietary NEL, as illustrated in Figure 4.

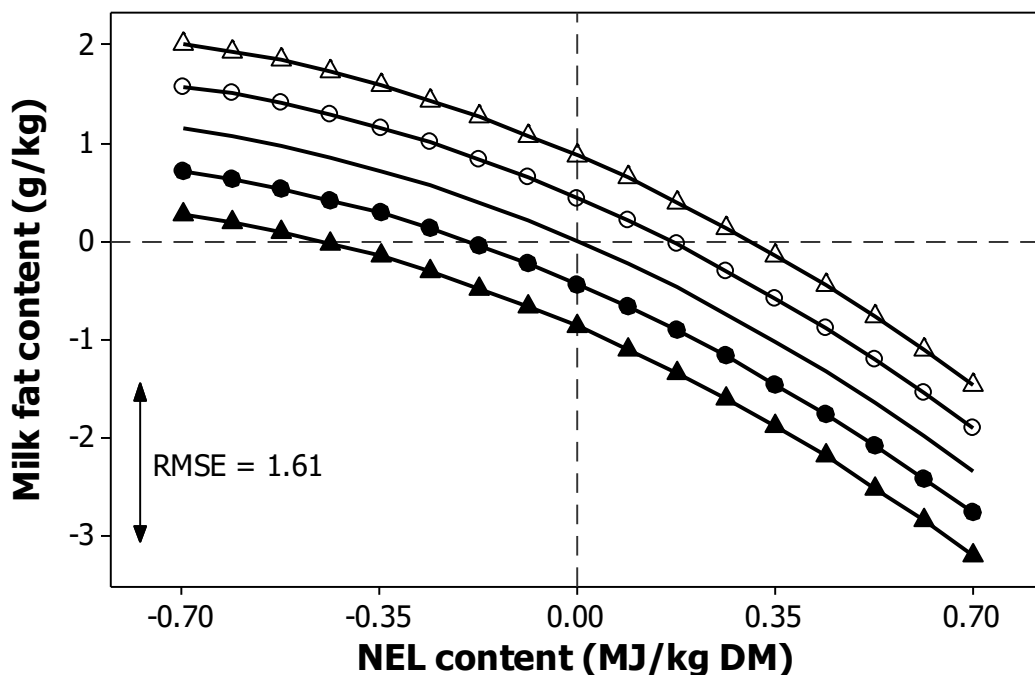

Figure 4 Prediction of average milk fat content response to change in NEL content (MJ/kg DM) and to change in MP content (g/kg DM). Protein effects are shown by the vertical displacement between the lines that are each for a MP content: -20 g/kg DM (solid line with Δ), -10 g/kg DM (solid line with \circ), 0 g/kg DM (blank solid line), +10 g/kg DM (solid line with \bullet), +20 g/kg DM (solid line with \blacktriangle). All variables are expressed relative to global mean values (6.7 MJ/kg DM, 100 g/kg DM) with average milk fat content of 36.8 g/kg. The RMSE is indicated by the double-headed arrow.

Not surprisingly, milk lactose content was the least influenced. The hierarchy of RMSE between milk component contents was consistent with the magnitude of the observed responses. The NEL x MP interaction was positive and significant ($P < 0.01$) for milk yield (Figure 3), milk protein yield, milk lactose yield and milk protein content (Figure 3). Thus, the response to NEL content was more pronounced at higher MP contents

and less pronounced at lower MP contents. In contrast, for milk fat yield and milk fat content (Figure 4) the effects of dietary NE_L and MP contents were additive. Milk energy output was consistent with the responses found for milk component yields (Table 3). The negative influence of NE_L on milk fat yield together with the positive relationship between NE_L and yield of lactose and protein resulted in a quadratic milk energy response to dietary NE_L .

Table 3 Responses of milk yield and milk composition to changes in dietary NE_L content (MJ/kg DM) and MP content (g/kg DM). The co-variables are mean centred on: NE_L = 6.7 MJ/kg DM, MP = 100 g/kg DM.

	Nexp	Intercept	Linear NE _L	Quadratic NE _L	Linear MP	Quadratic MP	NE _L x MP	Outlier (%)	RMSE
Milk (MJ/d)	278	96.01 (0.26) ¹	—	-5.09 (0.98)	0.286 (0.024)	-0.0083 (0.0010)	0.183 (0.046)	2.4	3.81
Milk (kg/d)	279	32.09 (0.10)	0.99 (0.29)	-1.05 (0.34)	0.104 (0.009)	-0.0028 (0.0003)	0.050 (0.016)	2.1	1.33
Milk component yields (g/d)									
Fat	279	1165 (4)	-56.7 (12.0)	-70.3 (13.6)	2.85 (0.38)	-0.071 (0.014)	—	2.1	57.3
Protein	280	1006 (4)	58.4 (10.7)	-30.3 (12.8)	3.60 (0.34)	-0.116 (0.013)	2.70 (0.61)	2.2	48.9
Lactose	177	1542 (7)	56.2 (19.3)	-71.8 (23.2)	6.11 (0.71)	-0.14 (0.03)	3.03 (1.11)	0.9	77.4
Milk component contents (g/kg)									
Fat	280	36.79 (0.10)	-2.49 (0.34)	-1.22 (0.38)	-0.044 (0.011)	—	—	1.8	1.60
Protein	276	31.61 (0.04)	0.80 (0.13)	—	0.022 (0.004)	-0.0011 (0.0002)	0.024 (0.007)	2.3	0.63
Lactose	174	47.82 (0.03)	—	-0.37 (0.11)	—	—	—	2.2	0.44

Nexp=Number of experimental groups; Outlier = Observations with studentized residuals higher than 3 (or lower than -3); RMSE=Root mean square error after adjusting for the effect of experiment.

¹ Standard errors of the coefficient are reported in parentheses.

Models were chosen based on AIC (see Material and methods). All coefficients were significantly different from 0 at least at the level P<0.05.

These coefficients can be used to predict milk responses within the ranges of 5.9 – 7.6 MJ/kg DM for NE_L and 73 – 121 g/kg DM for MP (means ± 2 SD), which reflect the current dataset.

Milk responses to change in net energy and metabolizable protein above maintenance supplies

Table 4 shows the model coefficients obtained for milk yield, milk component yields and milk composition responses to change in NE_L and MP above maintenance supplies. Predictions of average milk yield, milk fat yield, milk protein yield and milk lactose yield responses to change in NE_{L100} and MP_{67} supplies are illustrated in Figure 5. Yields of milk, milk protein and milk lactose were all increased curvilinearly with increasing MP_{67} supply. The relationships between milk yield and milk protein yield with NE_{L100} supply were also curvilinear whereas it was linear for milk lactose yield. For milk fat yield, the response to changes in both MP_{67} and NE_{L100} supplies were curvilinear. There were no significant $NE_{L100} \times MP_{67}$ interactions for any of the variables studied (Figure 5). The RMSE of responses in yield were smaller (27% in average) when using dietary supply above maintenance in the models compared to models based only on dietary content. In contrast, the responses obtained for milk fat, protein and lactose contents were not notably improved (RMSE 3% lower in average). The global MP efficiency is defined as the ratio between milk protein yield and MP above maintenance supply, whereas the marginal MP efficiency is the slope of the relationship between milk protein yield and MP above maintenance supply (i.e. per unit extra MP supply). Assuming reference energy level of $NE_{L100} = 0$, the global MP efficiency decreased from 82%, 67% to 58% for levels of MP_{67} of -400, 0 and 300 g/d. For the same levels of MP_{67} , the marginal MP efficiency decreased linearly from 34%, 19% to 7%. In comparison the slope of the response was higher for milk lactose yield with marginal efficiency of 42%, 28% and 18% at MP_{67} of -400, 0 and 300 g/d. The slope coefficient for milk energy yield suggests that at $NE_{L100}=0$, only 16.6% of extra NE_L supply is partitioned into milk. This value is very consistent with the sum of the linear responses of fat, protein and lactose interpreted in term of energy. At $NE_{L100} = 0$ MJ/d, the marginal response (MJ/MJ, %) to NE_{L100} was largest for protein (7.5%), followed by lactose (6.9%) and fat (2.4%). The significant quadratic term for the effect of NE_{L100} supply on milk energy yield was mainly driven by the milk fat yield response. The marginal energy efficiency (MJ/MJ, %) decreases from 23.8 to 9.4% when NE_{L100} change from -20 to 20 MJ/d. Milk fat and lactose contents were not affected by MP_{67} supply and are therefore only predicted by NE_{L100} supply. In the case of milk protein content, it was significantly increased in a curvilinear manner by MP_{67} supply (Table 4).

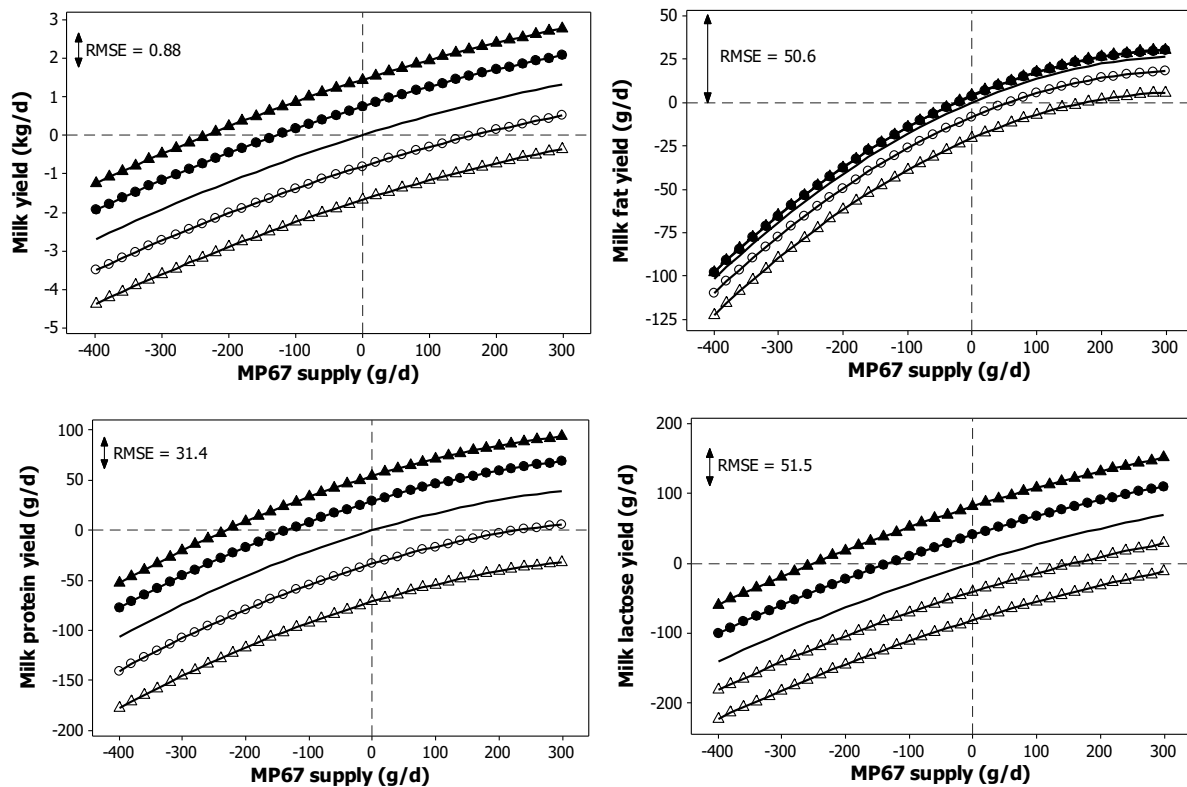

Figure 5 Prediction of average milk yield and milk component yields responses to change in MP_{67} supply (g/d) and to change in NE_{L100} supply (MJ/d). MP_{67} = MP above maintenance supply centred on supply for which MP efficiency is 0.67; NE_{L100} = NE_L above maintenance supply centred on supply for which the ratio of NE_L in milk/ NE_L above maintenance is 1.00. Energy effects are shown by the vertical displacement between the lines that are each for a NE_{L100} supply: -20 MJ/d (solid line with Δ), -10 MJ/d (solid line with \circ), 0 MJ/d (blank solid line), +10 MJ/d (solid line with \bullet), +20 MJ/d (solid line with \blacktriangle). Average milk yield, milk fat yield, milk protein yield and milk lactose yield were respectively 31.65 kg/d, 1155 g/d, 997 g/d and 1519 g/d at $MP_{67}=0$ g/d and $NE_{L100}=0$ MJ/d. RMSE are indicated by double-headed arrows.

Calculated energy balance

Calculated energy balance, hereafter refers as **EB**, is obtained by subtracting NE_L requirements (maintenance and milk) from NE_L supply (see Annex 2 for detail). So an inherent relationship between EB and NE_L supply exists. However, quantifying the relationship between EB and both co-variables, NE_{L100} (MJ/d) and MP_{67} (kg/d), provides an insight on the change in energy status of the animal. The relationship was as follow: EB (MJ/d) = 1.03 (0.02) NE_{L100} + 0.0021 (0.0006) NE_{L100}^2 - 18.13 (1.39) MP_{67} + 22.67 (2.70) MP_{67}^2 . The constant was not different from 0 ($P=0.286$) and was removed from the equation. At zero energy balance (or NE_L in milk/ NE_L above

maintenance=1), marginal EB response to change in NE_{L100} was 103%. This is six times greater than the marginal response of milk energy yield (17%). The sum of both marginal efficiency is different from 100% because of the different ME conversion used for NE_L milk and NE_L body reserves (see Annex 2 for further details). These coefficients indicate that extra energy is much more directed towards body reserves than it is exported into milk. Moreover, increasing NE_{L100} from -20 to 20 MJ/d increases the marginal EB efficiency from 94% to 111%. This is consistent with the decrease in marginal NE_L efficiency for milk. With MP_{67} , a negative curvilinear relationship is observed. Within the range of NE_{L100} (-20 to +20 MJ/d) and MP_{67} values (-400 to +300 g/d), the magnitude of the EB response with MP supply was much less than that with NE_L supply (ca. 15 vs 41 MJ/d).

Table 4 Responses of milk yield and milk composition to changes in NE_{L100} supply (MJ/d) and MP_{67} supply (kg/d). The co-variables are mean centred on supplies for which: NE_L in milk/ NE_L above maintenance = 1.00, Milk protein yield/ MP above maintenance = 0.67.

	Nexp	Intercept	Linear NE_{L100}	Quadratic NE_{L100}	Linear MP_{67}	Quadratic MP_{67}	Outlier (%)	RMSE
Milk (MJ/d)	277	95.0 (0.2) ¹	0.166 (0.017)	-0.0018 (0.0005)	15.09 (1.16)	-17.28 (2.25)	1.3	2.93
Milk (kg/d)	279	31.65 (0.05)	0.078 (0.005)	-0.0003 (0.0001)	5.40 (0.35)	-3.31 (0.69)	1.6	0.88
Milk component yields (g/d)								
Fat	278	1155 (3)	0.611 (0.303)	-0.021 (0.008)	159.18 (20.30)	-238.16 (39.16)	2.3	50.6
Protein	277	997 (2)	3.137 (0.184)	-0.021 (0.005)	190.00 (12.60)	-192.57 (24.33)	1.8	31.4
Lactose	177	1519 (3)	4.076 (0.338)	—	282.81 (24.90)	-172.43 (50.47)	0.7	51.5
Milk component contents (g/kg)								
Fat	279	36.68 (0.06)	-0.0656 (0.0071)	—	—	—	2.2	1.57
Protein	275	31.54 (0.03)	0.0270 (0.0034)	—	0.60 (0.24)	-2.00 (0.45)	2.3	0.59
Lactose	173	47.78 (0.02)	0.0097 (0.0021)	—	—	—	2.2	0.43

Nexp = Number of experimental groups; Outlier = Observations with studentized residuals higher than 3 (or lower than -3); RMSE=Root mean square error after adjusting for the effect of experiment.

¹Standard errors of the coefficient are reported in parentheses.

Interaction between NE_{L100} and MP_{67} was not significant for any of the variables studied.

Models were chosen based on AIC (see material and methods). All coefficients were significantly different from 0 at least at the level $P < 0.05$.

Discussion

The objectives of this meta-analysis have been met, with the derivation of empirical equations for response in dry-matter intake to change in diet content, and responses in milk yield and composition to change in dietary NE_L and MP, both on concentration basis and supply basis. The large set of published experiments used, with treatments focused on the changes in dietary energy and/or protein, enabled the development of equations with a satisfactory level of accuracy (Tables 3 and 4). As can be seen from the meta-designs (Figure 1), this study was successful in collecting data that covered a wide range of diet characteristics and therefore a large part of the plausible ranges of NE_L and MP supplies that can be expected in practical situations. However, these equations predict average milk responses of multiparous (only 14% of the data were from primiparous cows) Holstein cows at mid lactation (50 to 200 DIM), milked twice a day. Accordingly, and in common with most of the published equations and models, the present equations should be used with caution outside of these conditions. The majority of the experiments (73.6%) were conducted using Latin square or change-over designs with an average period length of 26 (± 12 SD) days. The rest of the experiments, using randomized block designs, had an average period length of 90 ± 56 days. However despite large differences in the duration of periods of the two main types of experimental design, no significant differences existed in SEM of independent variables. As an example, the average SEM for milk yield in Latin square and change-over designs was 1.08 ± 0.68 kg/d compared to 1.05 ± 0.59 kg/d in randomized block designs. Thus no major differences in responses between the designs are expected. Further, Huhtanen and Hetta (2012) concluded that production responses to change in supply of nutrients were generally similar in studies conducted using continuous and change-over designs. Another potential disadvantage of meta-analysis of various feeding trials relates to between study differences in determination of feed values. In the present study this effect was minimised by using a common digestive model to calculate standardized NE_L and MP outputs from feed ingredients across all treatments. The within-experiment comparison between observed and predicted OMD, the major determinant of the energy value of feed and diets, showed no slope bias (for the subset reporting OMD). The same was true for CP flow to the duodenum. Thus, the common estimation method for NE_L and MP did not bias the calculated milk responses.

Dry-matter intake response

The calculated DMI response quantified the impact of both physical regulation, through FNDF content, and metabolic regulation through MP content. Similar to the finding of the present study, decreasing DMI with NDF or FNDF content has been widely reported in the literature (Mertens, 1985; Allen, 2000). The DMI response to increase in MP was positive and curvilinear with a diminishing marginal response with higher MP content (Figure 2). A very similar response was found by Vérité and Delaby (2000) who summarized results from five studies including more than 30 treatments that explored different dietary MP contents. Although the DMI response developed in the current meta-analysis was based on the dietary MP content, it cannot be *a priori* concluded that this response is strictly the result of a metabolic regulation. Because dietary CP and MP contents were positively related, this effect could also be partly explained through an improvement in rumen OMD (Allen, 2000). In the 91 experiments (Nt=247; MP = 96 ± 11 g/d) from the MP sub-dataset where measured OMD was relatively constant (<2% of absolute variation), the MP content relationship with DMI was still significantly positive ($P < 0.001$, results not shown). This suggests that at least part of the positive DMI response to change in dietary MP occurs through metabolic effects. One hypothesis for this effect could be that the increase in milk yield generated by increasing MP content drives the increased DMI. Additionally, a stimulating effect of dietary protein at metabolic level on intake has been previously observed in a duodenal infusion study using soya protein isolate as protein source (Faverdin *et al.*, 2003).

Milk responses

The curvilinear milk protein yield response found to change in either protein content or supply has also been found in other quantitative studies (Vérité and Delaby, 2000; Brun-Lafleur *et al.*, 2010; Huhtanen and Nousiainen, 2012). At $MP_{67}=0$ g/d, the marginal milk protein yield response to extra MP_{67} supply was 19%. As an estimation of body protein change is included in the calculation of MP above maintenance (see Annex 2 for full detail) the slope of 19% suggests that a large part of the extra nitrogen (N) coming from MP is excreted into urine. In a subset of 58 experiments (167 treatments) where urinary N

excretion was measured, the slope of response of N excreted in urine to change in MP₆₇ supply (obtained by within-experiment regression with MP₆₇) was, in terms of CP, 81% (SE 12%). This number is very consistent with the marginal milk protein yield response, and confirms that a high amount of N provided through an increase in MP is lost in urine. Given this large proportion of deaminated MP, extra MP supply increases the amount of carbon chains available for the animal. However, this increase in supply of glucose precursors does not seem to be the driven force behind the observed increased milk lactose yield (Lapierre *et al.*, 2010) and more research is needed to understand the relationship between protein supply and milk lactose. The partition of NE_L shifted from milk to body reserves with increasing NE_L above maintenance supply. In agreement with our study, curvilinear milk yield and energy-corrected milk responses to respectively ME and NE_L were reported in the meta-analyses of Huhtanen and Nousiainen (2012) and Jensen *et al.* (2015). Increased MP supply may increase the partition of energy towards milk because it was associated with a small, but significant, decrease in EB, as previously reported (Orskov *et al.*, 1987, Law *et al.*, 2009, Brun-Lafleur *et al.*, 2010).

A key question with respect to milk responses relates to the presence or not of interactions between NE_L and MP supply. Contrasting results have been reported, finding either an interaction between energy and protein (Cowan *et al.*, 1981, Brun-Lafleur *et al.*, 2010) or additive effects of energy and protein (Macleod *et al.*, 1984; Broderick, 2003, Rius *et al.*, 2010, Huhtanen and Nousiainen, 2012; Alstrup *et al.*, 2014) on milk yield. The present meta-analysis did not confirm the interaction between NE_L supply and MP supply found in the experiment of Brun-Lafleur *et al.*, (2010), which was specifically designed to reveal such interaction. This difference could potentially be due to the fact that, in our case, co-variables were expressed relative to reference efficiencies whereas Brun-Lafleur expressed MP and NE_L supplies relative to a central treatment. Additionally, in the study of Brun-Lafleur *et al.* (2010), DMI was restricted whereas in the present meta-analysis, DMI was ad libitum. The role of DMI can be seen by comparing, in the present study, the results for NE_L and MP supplies (that implicitly include DMI), where there was no interaction, with the results for dietary concentrations of NE_L and MP, which showed significant interactions between NE_L x MP for milk yield, milk lactose yield, milk protein yield and milk protein content. Although no interaction was found between NE_L and MP

content on DMI itself, a positive dietary NE_L x MP content interaction (P=0.018) was found for NE_L intake (results not shown). This interaction could explain these differences between the effects of content as compared to supply. However due to correlated effects between NE_L and MP supply (adjusted R² = 0.42), care is needed in the interpretation of the absence of interaction found. One possible way to reduce this correlation is to select the experiments which have a low variation in dry-matter intake. A sub-dataset of 91 experiments comprising 242 treatments means (~29% of the total dataset) had on average, a maximum difference between highest and lowest dry-matter intake of 0.47 ± 0.24 kg/d. The average and standard deviation of independent variables on this sub-group were: MP₆₇=-62±189 g/d NE_{L100}=1.76±12.97 MJ/d, which covers a large range of variation. In this sub-group the correlation between NE_L supply and MP supply was low as assessed by an adjusted R² of 0.13. Despite the absence of correlation between independent variables, the interaction between NE_L supply and MP supply was still not significant (results not shown). This strengthens our results found of additive effect between NE_L and MP supply. Therefore, considering the majority of the results, it seems that in an ad libitum situation, the effect of energy and protein supplies on milk component productions can be considered as additive.

Milk component yield response equations calculated from NE_L and MP supplies had RMSE values lower than the average SEM reported in the literature (see Results section and Table 4). Thus, the equations are sufficiently accurate in describing the multiple responses of dairy cows to change in NE_L and MP supplies. Given that the higher energetic values in our study were achieved largely by an increase of starch: NDF ratio, the prediction equations developed may not be applicable to estimate milk fat content responses when the NE_L increase is achieved by fat supplementation (Van Knegsel *et al.*, 2007). Further, milk fat content response is affected by a great number of others factors (Bauman and Griinari, 2003) not accounted for in our model.

Conclusion

This meta-analysis has produced empirical equations for response in dry-matter intake to changes in forage NDF and MP contents, and for responses in milk (yield, component yields and composition) to changes in dietary NE_L and MP, both on concentration basis

and on a supply basis. Those equations were obtained from standardized dietary NE_L and MP contents across all treatments by using a common digestive model. Effects of NE_L and MP supplies were additive for all milk component yield responses. Finally, the developed equations accurately describe milk responses over a wide range of dietary NE_L (5.9 – 7.6 MJ/kg DM) and MP contents (73 – 121 g/kg DM).

Acknowledgements

The authors wish to thank Philippe Faverdin and Luc Delaby for valuable discussions on the different aspects covered in this text.

References

- Allen MS 2000. Effects of diet on short-term regulation of feed intake by lactating dairy cattle. *Journal of Dairy Science* 83, 1598–1624.
- Alstrup L, Weisbjerg MR, Hymøller L, Larsen MK, Lund P and Nielsen MO 2014. Milk production response to varying protein supply is independent of forage digestibility in dairy cows. *Journal of Dairy Science* 97, 4412–4422.
- Bauman DE 2000. Regulation of nutrient partitioning during lactation: Homeostasis and homeorhesis revisited. In *Ruminant Physiology: Digestion, Metabolism and Growth and Reproduction*. (ed. PB Cronjé), pp. 311–327. CABI Publishing, New York, NY.
- Bauman DE and Griinari JM 2003. Nutritional regulation of milk fat synthesis. *Annual Review of Nutrition* 23, 203–227.
- Baumont R, Dulphy JP, Sauvant D, Meschy F, Aufrère J and Peyraud JL 2007. Valeur alimentaire des fourrages et des matières premières: tables et prévision. In *Alimentation des bovins, ovins et caprins. Besoins des animaux - Valeur des aliments - Tables INRA 2007, mise à jour 2010*. pp. 153–290. Editions Quae, Versailles, France.
- Broderick GA 2003. Effects of varying dietary protein and energy levels on the production of lactating dairy cows. *Journal of Dairy Science* 86, 1370–1381.
- Brun-Lafleur L, Delaby L, Husson F and Faverdin P 2010. Predicting energy × protein interaction on milk yield and milk composition in dairy cows. *Journal of Dairy Science* 93, 4128–4143.
- Burnham KP and Anderson DR 2002. *Model selection and multimodel inference*, second edition. Springer Verlag, New York.
- Coulon JB and Rémond B 1991. Variations in milk output and milk protein-content in response to the level of energy supply to the dairy cow - A review. *Livestock Production Science* 29, 31–47.
- Cowan RT, Reid G, Greenhalgh J and Tait C 1981. Effects of feeding level in late pregnancy and dietary protein concentration during early lactation on food intake, milk yield, liveweight change and nitrogen balance of cows. *Journal of Dairy Research* 48, 201–212.
- Dijkstra J, Kebreab E, Mills JAN, Pellikaan WF, López S, Bannink A and France J 2007. Predicting the profile of nutrients available for absorption: From nutrient requirement to animal response and environmental impact. *Animal* 1, 99–111.
- Faverdin P, M'Hamed D and Vérité R 2003. Effects of metabolizable protein on intake and milk production of dairy cows independent of effects on ruminal digestion. *Animal Science* 76, 137–146.
- Friggens NC, Brun-Lafleur L, Faverdin P, Sauvant D and Martin O 2013. Advances in predicting nutrient partitioning in the dairy cow: recognizing the central role of genotype and its expression through time. *Animal* 7, 89–101.
- Huhtanen P and Hetta M 2012. Comparison of feed intake and milk production responses in continuous and change-over design dairy cow experiments. *Livestock Science* 143, 184–194.
- Huhtanen P and Nousiainen J 2012. Production responses of lactating dairy cows fed silage-based diets to changes in nutrient supply. *Livestock Science* 148, 146–158.
- Jensen C, Østergaard S, Schei I, Bertilsson J and Weisbjerg MR 2015. A meta-analysis of milk production responses to increased net energy intake in Scandinavian dairy cows. *Livestock Science* 175, 59–69.
- Lapierre H, Galindo CE, Lemosquet S, Ortigues-Marty I, Doepel L and Ouellet DR 2010. Protein supply, glucose kinetics and milk yield in dairy cows. In *Energy and Protein Metabolism and Nutrition* (ed. G. M. Croveto), pp. 275–286. Wageningen Academic Publishers, Wageningen, the Netherlands.

- Law RA, Young FJ, Patterson DC, Kilpatrick DJ, Wylie ARG and Mayne CS 2009. Effect of dietary protein content on animal production and blood metabolites of dairy cows during lactation. *Journal of Dairy Science* 92, 1001-1012.
- Macleod GK, Grieve DG, McMillan I and Smith GC 1984. Effect of varying protein and energy densities in complete rations fed to cows in first lactation. *Journal of Dairy Science* 67, 1421–1429.
- Mertens DR 1985. Factors influencing feed intake in lactating cows: from theory to application using neutral detergent fiber. *Proceedings of the Georgia Nutrition Conference, 1985, Atlanta, Georgia, USA, 1–18.*
- Metcalf J, Mansbridge R, Blake J, Oldham J and Newbold J 2008. The efficiency of conversion of metabolisable protein into milk true protein over a range of metabolisable protein intakes. *Animal* 2, 1193–1202.
- National Research Council 2001. *Nutrient requirements of dairy cattle, Seventh revised edition.* National Academy Press, Washington DC.
- Oldham JD and Emmans GC 1989. Prediction of responses to required nutrients in dairy cows. *Journal of Dairy Science* 72, 3212–3229.
- Ørskov ER, Reid GW, Tait CAG 1987. Effect of fish meal on the mobilization of body energy in dairy cows. *Animal Production* 45, 345-348.
- Rius AG, McGilliard ML, Umberger C and Hanigan MD 2010. Interactions of energy and predicted metabolizable protein in determining nitrogen efficiency in the lactating dairy cow. *Journal of Dairy Science* 93, 2034–2043.
- Sauvant D 1992. La modelisation systémique en nutrition. *Reproduction Nutrition Development* 32, 217–230.
- Sauvant D and Nozière P 2016. The quantification of the main digestive processes in ruminants : the equations involved in the renewed energy and protein feed evaluation systems. *Animal*, Accepted.
- Sauvant D, Cantalapiedra-Hijar G, Delaby L, Daniel JB, Faverdin P and Nozière P 2015. Actualisation des besoins protéiques des ruminants et détermination des réponses des femelles laitières aux apports de protéines digestibles dans l'intestin (PDI). *INRA Production Animales*, 28: 347-368.
- Sauvant D, Schmidely P, Daudin JJ and St-Pierre NR 2008. Meta-analyses of experimental data in animal nutrition. *Animal* 2, 1203–1214.
- St-Pierre NR 2001. Integrating quantitative findings from multiple studies using mixed model methodology. *Journal of Dairy Science* 84:741–755.
- St-Pierre NR and Glamocic D 2000. Estimating unit costs of nutrients from market prices of feedstuffs. *Journal of Dairy Science* 83, 1402–1411.
- van Duinkerken G, Blok MC, Bannink A, Cone JW, Dijkstra J, van Vuuren AM and Tamminga S 2011. Update of the Dutch protein evaluation system for ruminants: The DVE/OEB₂₀₁₀ system. *Journal of Agricultural Science* 149, 351–367.
- van Knegsel ATM, van den Brand H, Dijkstra J, van Straalen WM, Heetkamp MJW, Tamminga S and Kemp B 2007. Dietary energy source in dairy cows in early lactation: Energy partitioning and milk composition. *Journal of Dairy Science* 90, 1467–1476.
- Vérité R and Delaby L 2000. Relation between nutrition, performances and nitrogen excretion in dairy cows. *Annales De Zootechnie* 49, 217–230.
- Vérité R, Michalet-Doreau B, Chapoutot P, Peyraud JL and Poncet C 1987. Révision du système des protéines digestibles dans l'intestin (PDI). *Bulletin Technique CRZV Theix, INRA*. 70, 19–34.
- Volden H 2011. *NorFor - The Nordic Feed Evaluation System.* EAAP Publication. Wageningen Academic Publishers, Wageningen, the Netherlands.

Annex 1. The list of references used for the meta-analysis

- Aguerre MJ, Wattiaux MA, Powell JM, Broderick GA and Arndt C 2011. Effect of forage-to-concentrate ratio in dairy cow diets on emission of methane, carbon dioxide, and ammonia, lactation performance, and manure excretion. *Journal of Dairy Science* 94, 3081–3093.
- Aikman PC, Beever DE and Humphries DJ 2006. The effect of incremental replacement of wheat with soya hulls in diets for Jersey cows on lactational performance, diet digestibility and feeding behaviour. *Livestock Science* 104, 23–32.
- Allen DM and Grant RJ 2000. Interactions between forage and wet corn gluten feed as sources of fiber in diets for lactating dairy cows. *Journal of Dairy Science* 83, 322–331.
- Aston K, Fisher WJ, McAllan AB, Dhanoa MS and Dewhurst RJ 1998. Supplementation of grass silage-based diets with small quantities of concentrates: Strategies for allocating concentrate crude protein. *Animal Science* 67, 17–26.
- Aston K, Fisher WJ, McAllan AB, Dhanoa MS, and Dewhurst RJ 1998. Supplementation of grass silage-based diets with small quantities of concentrates: Strategies for allocating concentrate crude protein. *Animal Science* 67, 17–26.
- Bal MA, Shaver RD, Al-Jobeile H, Coors JG and Lauer JG 2000. Corn silage hybrid effects on intake, digestion, and milk production by dairy cows. *Journal of Dairy Science* 83, 2849–2858.
- Batajoo KK and Shaver RD 1994. Impact of nonfiber carbohydrate on intake, digestion, and milk production by dairy cows. *Journal of Dairy Science* 77, 1580–1588.
- Beauchemin KA 1991. Effects of dietary neutral detergent fiber concentration and alfalfa hay quality on chewing, rumen function, and milk production of dairy cows. *Journal of Dairy Science* 74, 3140–3151.
- Beauchemin KA, Farr BI, Rode LM and Schaalje GB 1994. Optimal neutral detergent fiber concentration of barley-based diets for lactating dairy cows. *Journal of Dairy Science* 77, 1013–1029.
- Beauchemin KA, Rode LM and Eliason MV 1997. Chewing Activities and Milk Production of Dairy Cows Fed Alfalfa as Hay, Silage, or Dried Cubes of Hay or Silage. *Journal of Dairy Science* 80, 324–333.
- Beauchemin KA, Yang WZ and Rode LM 1999. Effects of grain source and enzyme additive on site and extent of nutrient digestion in dairy cows. *Journal of Dairy Science* 82, 378–390.
- Bell JF, Offer NW and Roberts DJ 2007. The effect on dairy cow performance of adding molassed sugar beet feed to immature forage maize at ensiling or prior to feeding. *Animal Feed Science and Technology* 137, 84–92.
- Benchaar C, Hassanat F, Gervais R, Chouinard PY, Petit HV and Massé DI 2014. Methane production, digestion, ruminal fermentation, nitrogen balance, and milk production of cows fed corn silage- or barley silage-based diets. *Journal of Dairy Science* 97, 961–974.
- Benchaar C, Petit HV, Berthiaume R, Ouellet DR, Chiquette J and Chouinard PY 2007. Effects of essential oils on digestion, ruminal fermentation, rumen microbial populations, milk production, and milk composition in dairy cows fed alfalfa silage or corn silage. *Journal of Dairy Science* 90, 886–897.
- Bertilsson J and Murphy M 2003. Effects of feeding clover silages on feed intake, milk production and digestion in dairy cows. *Grass and Forage Science* 58, 309–322.
- Bharathan M, Schingoethe DJ, Hippen AR, Kalscheur KF, Gibson ML and Karges K 2008. Conjugated linoleic acid increases in milk from cows fed condensed corn distillers solubles and fish oil. *Journal of Dairy Science* 91, 2796–2807.
- Blouin JP, Bernier JF, Reynolds CK, Lobley GE, Dubreuil P and Lapierre H 2002. Effect of supply of metabolizable protein on splanchnic fluxes of nutrients and hormones in lactating dairy cows. *Journal of Dairy Science* 85, 2618–2630.

- Borucki Castro SI, Phillip LE, Lapierre H, Jardon PW and Berthiaume R 2008. The relative merit of ruminal undegradable protein from soybean meal or soluble fiber from beet pulp to improve nitrogen utilization in dairy cows. *Journal of Dairy Science* 91, 3947–3957.
- Bowman JM, Grieve DG, Buchanan-Smith JG and Macleod GK 1988. Response of dairy cows in early lactation to sodium hydroxide-treated soybean meal. *Journal of Dairy Science* 71, 982–989.
- Brask M, Lund P, Hellwing ALF, Poulsen M and Weisbjerg MR 2013. Enteric methane production, digestibility and rumen fermentation in dairy cows fed different forages with and without rapeseed fat supplementation. *Animal Feed Science and Technology* 184, 67–79.
- Brito AF and Broderick GA 2006. Effect of varying dietary ratios of alfalfa silage to corn silage on production and nitrogen utilization in lactating dairy cows. *Journal of Dairy Science* 89, 3924–3938.
- Brito AF and Broderick GA 2007. Effects of different protein supplements on milk production and nutrient utilization in lactating dairy cows. *Journal of Dairy Science* 90, 1816–1827.
- Broderick GA 1985. Alfalfa silage or hay versus corn silage as the sole forage for lactating dairy cows. *Journal of Dairy Science* 68, 3262–3271.
- Broderick GA 1992. Relative value of fish meal versus solvent soybean meal for lactating dairy cows fed alfalfa silage as sole forage. *Journal of Dairy Science* 75, 174–183.
- Broderick GA 1995. Performance of lactating dairy cows fed either alfalfa silage or alfalfa hay as the sole forage. *Journal of Dairy Science* 78, 320–329.
- Broderick GA, Koegel RG, Walgenbach RP and Kraus TJ 2002. Ryegrass or alfalfa silage as the dietary forage for lactating dairy cows. *Journal of Dairy Science* 85, 1894–1901.
- Burke F, Murphy JJ, O'Donovan MA, O'Mara FP, Kavanagh S and Mulligan FJ 2007. Comparative evaluation of alternative forages to grass silage in the diet of early lactation dairy cows. *Journal of Dairy Science* 90, 908–917.
- Cabrita ARJ, Bessa RJB, Alves SP, Dewhurst RJ and Fonseca AJM 2007. Effects of dietary protein and starch on intake, Milk production, and milk fatty acid profiles of dairy cows fed corn silage-based diets. *Journal of Dairy Science* 90, 1429–1439.
- Cabrita ARJ, Dewhurst RJ, Melo DSP, Moorby JM and Fonseca AJM 2011. Effects of dietary protein concentration and balance of absorbable amino acids on productive responses of dairy cows fed corn silage-based diets. *Journal of Dairy Science* 94, 4647–4656.
- Cabrita ARJ, Fonseca AJM, Dewhurst RJ, Sampaio CVP, Miranda MFS, Sousa GNS, Miranda IMF and Gomes E 2003. Nitrogen supplementation of corn silages. 1. Effects on feed intake and milk production of dairy cows. *Journal of Dairy Science* 86, 4008–4019.
- Cameron MR, Klusmeyer TH, Lynch GL, Clark JH and Nelson DR 1991. Effects of urea and starch on rumen fermentation, nutrient passage to the duodenum, and performance of cows. *Journal of Dairy Science* 74, 1321–1336.
- Casper DP and Schingoethe DJ 1989. Lactational response of dairy cows to diets varying in ruminal solubilities of carbohydrate and crude protein. *Journal of Dairy Science* 72, 928–941.
- Casper DP, Maiga HA, Brouk MJ and Schingoethe DJ 1999. Synchronization of carbohydrate and protein sources on fermentation and passage rates in dairy cows. *Journal of Dairy Science* 82, 1779–1790.
- Castillo AR, Kebreab E, Beaver DE, Barbi JH, Sutton JD, Kirby HC and France J 2001. The effect of energy supplementation on nitrogen utilization in lactating dairy cows fed grass silage diets. *Journal of Animal Science* 79, 240–246.
- Chan SC, Huber JT, Theurer CB, Wu Z, Chen KH and Simas JM 1997. Effects of Supplemental Fat and Protein Source on Ruminal Fermentation and Nutrient Flow to the Duodenum in Dairy Cows. *Journal of Dairy Science* 80, 152–159.

- Charbonneau E, Chouinard PY, Allard G, Lapierre H and Pellerin D 2007. Milk from forage as affected by rumen degradable protein and corn grinding when feeding corn - and alfalfa silage-based diets. *Journal of Dairy Science* 90, 823–832.
- Charmley E, Robinson PH and McQueen RE 1993. Corn or alfalfa as the forage source in predominantly silage diets for late lactation dairy cows. *Canadian Journal of Animal Science* 13, 67–77.
- Chibisa GE and Mutsvangwa T 2013. Effects of feeding wheat or corn-wheat dried distillers grains with solubles in low- or high-crude protein diets on ruminal function, omasal nutrient flows, urea-N recycling, and performance in cows. *Journal of Dairy Science* 96, 6550–6563.
- Chibisa GE, Christensen DA and Mutsvangwa T 2012. Effects of replacing canola meal as the major protein source with wheat dried distillers grains with solubles on ruminal function, microbial protein synthesis, omasal flow, and milk production in cows. *Journal of Dairy Science* 95, 824–841.
- Chow LO, Baron VS, Corbett R and Oba M 2008. Effects of planting date on fiber digestibility of whole-crop barley and productivity of lactating dairy cows. *Journal of Dairy Science* 91, 1534–1543.
- Christen KA, Schingoethe DJ, Kalscheur KF, Hippen AR, Karges KK and Gibson ML 2010. Response of lactating dairy cows to high protein distillers grains or 3 other protein supplements. *Journal of Dairy Science* 93, 2095–2104.
- Christensen RA, Cameron MR, Klusmeyer TH, Elliott JP, Clark JH, Nelson DR and Yu Y 1993b. Influence of amount and degradability of dietary protein on nitrogen utilization by dairy cows. *Journal of Dairy Science* 76, 3497–3513.
- Christensen RA, Lynch GL, Clark JH and Yu Y 1993a. Influence of amount and degradability of protein on production of milk and milk components by lactating Holstein cows. *Journal of Dairy Science* 76, 3490–3496.
- Colmenero JJO and Broderick GA 2006. Effect of amount and ruminal degradability of soybean meal protein on performance of lactating dairy cows. *Journal of Dairy Science* 89, 1635–1643.
- Cunningham KD, Cecava MJ and Johnson TR 1993. Nutrient digestion, nitrogen, and amino acid flows in lactating cows fed soybean hulls in place of forage or concentrate. *Journal of Dairy Science* 76, 3523–3535.
- Cunningham KD, Cecava MJ, Johnson TR and Ludden PA 1996. Influence of Source and Amount of Dietary Protein on Milk Yield by Cows in Early Lactation. *Journal of Dairy Science* 79, 620–630.
- Da Cruz CR, Brouk MJ and Schingoethe DJ 2005. Lactational response of cows fed condensed corn distillers solubles. *Journal of Dairy Science* 88, 4000–4006.
- Dado RG and Allen MS 1995. Intake limitations, feeding behavior, and rumen function of cows challenged with rumen fill from dietary fiber or inert bulk. *Journal of Dairy Science* 78, 118–133.
- Davidson S, Hopkins BA, Diaz DE, Bolt SM, Brownie C, Fellner V and Whitlow LW 2003. Effects of amounts and degradability of dietary protein on lactation, nitrogen utilization, and excretion in early lactation holstein cows. *Journal of Dairy Science* 86, 1681–1689.
- De Campeneere S, De Brabander DL and Vanacker JM 2006. Milk urea concentration as affected by the roughage type offered to dairy cattle. *Livestock Science* 103, 30–39.
- Dewhurst RJ, Evans RT, Scollan ND, Moorby JM, Merry RJ and Wilkins RJ 2003b. Comparison of grass and legume silages for milk production. 2. In vivo and in sacco evaluations of rumen function. *Journal of Dairy Science* 86, 2612–2621.
- Dewhurst RJ, Fisher WJ, Tweed JKS and Wilkins RJ 2003a. Comparison of grass and legume silages for milk production. 1. Production responses with different levels of concentrate. *Journal of Dairy Science* 86, 2598–2611.

- Dewhurst RJ, Wadhwa D, Borgida LP and Fisher WJ 2001. Rumen acid production from dairy feeds. 1. Effects on feed intake and milk production of dairy cows offered grass or corn silages. *Journal of Dairy Science* 84, 2721–2729.
- Dschaak CM, Williams CM, Holt MS, Eun JS, Young AJ and Min BR 2011. Effects of supplementing condensed tannin extract on intake, digestion, ruminal fermentation, and milk production of lactating dairy cows. *Journal of Dairy Science* 94, 2508–2519.
- Einarson MS, Plaizier JC and Wittenberg KM 2004. Effects of barley silage chop length on productivity and rumen conditions of lactating dairy cows fed a total mixed ration. *Journal of Dairy Science* 87, 2987–2996.
- Ekinci C and Broderick GA 1997. Effect of Processing High Moisture Ear Corn on Ruminant Fermentation and Milk Yield. *Journal of Dairy Science* 80, 3298–3307.
- Erasmus LJ, Botha PM and Meissner HH 1994. Effect of protein source on ruminal fermentation and passage of amino acids to the small intestine of lactating cows. *Journal of Dairy Science* 77, 3655–3665.
- Erfle JD, Sauer FD, Mahadevan S and Teather RM 1986. Response of lactating dairy cows to formaldehyde-treated soybean meal when fed with control or urea-treated corn silage. *Canadian Journal of Animal Science* 66, 85–95.
- Eun JS and Beauchemin KA 2005. Effects of a proteolytic feed enzyme on intake, digestion, ruminal fermentation, and milk production. *Journal of Dairy Science* 88, 2140–2153.
- Faverdin P, Dulphy JP, Coulon JB, Vérité R, Garel JP, Rouel J and Marquis B 1991. Substitution of roughage by concentrates for dairy cows. *Livestock Production Science* 27, 137–156.
- Ferris CP, Gordon FJ, Patterson DC, Kilpatrick DJ, Mayne CS and McCoy MA 2001. The response of dairy cows of high genetic merit to increasing proportion of concentrate in the diet with a high and medium feed value silage. *Journal of Agricultural Science* 136, 319–329.
- Ferris CP, Gordon FJ, Patterson DC, Mayne CS and Kilpatrick DJ 1999. The influence of dairy cow genetic merit on the direct and residual response to level of concentrate supplementation. *Journal of Agricultural Science* 132, 467–481.
- Fischer JM, Buchanan-Smith JG, Campbell C, Grieve DG and Allen OB 1994. Effects of forage particle size and long hay for cows fed total mixed rations based on alfalfa and corn. *Journal of Dairy Science* 77, 217–229.
- Fitzgerald JJ and Murphy JJ 1999. A comparison of low starch maize silage and grass silage and the effect of concentrate supplementation of the forages or inclusion of maize grain with the maize silage on milk production by dairy cows. *Livestock Production Science* 57, 95–111.
- Gehman AM and Kononoff PJ 2010a. Nitrogen utilization, nutrient digestibility, and excretion of purine derivatives in dairy cattle consuming rations containing corn milling co-products. *Journal of Dairy Science* 93, 3641–3651.
- Gehman AM and Kononoff PJ 2010b. Utilization of nitrogen in cows consuming wet distillers grains with solubles in alfalfa and corn silage-based dairy rations. *Journal of Dairy Science* 93, 3166–3175.
- Gencoglu H, Turkmen II, Deniz G and Biricik H 2006. Short communication: The effect of partial replacement of corn silage on rumen degradability, milk production and composition in lactating primiparous dairy cows. *Italian Journal of Animal Science* 6, 71–80
- Groff EB and Wu Z 2005. Milk production and nitrogen excretion of dairy cows fed different amounts of protein and varying proportions of alfalfa and corn silage. *Journal of Dairy Science* 88, 3619–3632.
- Grum DE, Drackley JK, Hansen LR and Cremin Jr JD 1996. Production, Digestion, and Hepatic Lipid Metabolism of Dairy Cows Fed Increased Energy from Fat or Concentrate. *Journal of Dairy Science* 79, 1836–1849.

- Harvatine DI, Firkins JL and Eastridge ML 2002. Whole linted cottonseed as a forage substitute fed with ground or steam-flaked corn: Digestibility and performance 1,2. *Journal of Dairy Science* 85, 1976–1987.
- Hassanat F, Gervais R, Julien C, Massé DI, Lettat A, Chouinard PY, Petit HV and Benchaar C 2013. Replacing alfalfa silage with corn silage in dairy cow diets: Effects on enteric methane production, ruminal fermentation, digestion, N balance, and milk production. *Journal of Dairy Science* 96, 4553–4567.
- Herrera-Saldana R and Huber JT 1989. Influence of varying protein and starch degradabilities on performance of lactating cows. *Journal of Dairy Science* 72, 1477–1483.
- Ipharraguerre IR and Clark JH 2005. Varying protein and starch in the diet of dairy cows. II. Effects on performance and nitrogen utilization for milk production. *Journal of Dairy Science* 88, 2556–2570.
- Janicek BN, Kononoff PJ, Gehman AM and Doane PH 2008. The effect of feeding dried distillers grains plus solubles on milk production and excretion of urinary purine derivatives. *Journal of Dairy Science* 91, 3544–3553.
- Jerred MJ, Carroll DJ, Combs DK and Grummer RR 1990. Effects of fat supplementation and immature alfalfa to concentrate ratio on lactation performance of cattle. *Journal of Dairy Science* 73, 2842–2854.
- Johnson TR and Combs DK 1992. Effects of inert rumen bulk on dry matter intake in early and midlactation cows fed diets differing in forage content. *Journal of Dairy Science* 75, 508–519.
- Kalscheur KF, Baldwin Vi RL, Glenn BP and Kohn RA 2006. Milk production of dairy cows fed differing concentrations of rumen-degraded protein. *Journal of Dairy Science* 89, 249–259.
- Kalscheur KF, Teter BB, Piperova LS and Erdman RA 1997. Effect of Dietary Forage Concentration and Buffer Addition on Duodenal Flow of Trans-C18:1 Fatty Acids and Milk Fat Production in Dairy Cows. *Journal of Dairy Science* 80, 2104–2114.
- Kalscheur KF, Vandersall JH, Erdman RA, Kohn RA and Russek-Cohen E 1999. Effects of dietary crude protein concentration and degradability on milk production responses of early, mid, and late lactation dairy cows. *Journal of Dairy Science* 82, 545–554.
- Kargar S, Ghorbani GR, Alikhani M, Khorvash M, Rashidi L and Schingoethe DJ 2012. Lactational performance and milk fatty acid profile of Holstein cows in response to dietary fat supplements and forage:Concentrate ratio. *Livestock Science* 150, 274–283.
- Keery CM and Amos HE 1993. Effects of source and level of undegraded intake protein on nutrient use and performance of early lactation cows. *Journal of Dairy Science* 76, 499–513.
- Keith EA, Colenbrander VF, Lechtenberg VL and Bauman LF 1979. Nutritional value of brown midrib corn silage for lactating dairy cows. *Journal of Dairy Science* 62, 788–792.
- Kelzer JM, Kononoff PJ, Gehman AM, Tedeschi LO, Karges K and Gibson ML 2009. Effects of feeding three types of corn-milling coproducts on milk production and ruminal fermentation of lactating Holstein cattle. *Journal of Dairy Science* 92, 5120–5132.
- Khan NA, Tewoldebrhan TA, Zom RLG, Cone JW and Hendriks WH 2012. Effect of corn silage harvest maturity and concentrate type on milk fatty acid composition of dairy cows. *Journal of Dairy Science* 95, 1472–1483.
- King KJ, Huber JT, Sadik M, Bergen WG, Grant AL and King VL 1990. Influence of dietary protein sources on the amino acid profiles available for digestion and metabolism in lactating cows. *Journal of Dairy Science* 73, 3208–3216.
- Kleinschmit DH, Schingoethe DJ, Hippen AR and Kalscheur KF 2007. Dried distillers grains plus solubles with corn silage or alfalfa hay as the primary forage source in dairy cow diets. *Journal of Dairy Science* 90, 5587–5599.

- Klusmeyer TH, Lynch GL, Clark JH and Nelson DR 1991a. Effects of calcium salts of fatty acids and proportion of forage in diet on ruminal fermentation and nutrient flow to duodenum of cows. *Journal of Dairy Science* 74, 2220–2232.
- Klusmeyer TH, Lynch GL, Clark JH and Nelson DR 1991b. Effects of calcium salts of fatty acids and protein source on ruminal fermentation and nutrient flow to duodenum of cows. *Journal of Dairy Science* 74, 2206–2219.
- Klusmeyer TH, McCarthy Jr RD, Clark JH and Nelson DR 1990. Effects of source and amount of protein on ruminal fermentation and passage of nutrients to the small intestine of lactating cows. *Journal of Dairy Science* 73, 3526–3537.
- Kononoff PJ and Heinrichs AJ 2003. The effect of corn silage particle size and cottonseed hulls on cows in early lactation. *Journal of Dairy Science* 86, 2438–2451.
- Krause KM, Combs DK and Beauchemin KA 2002. Effects of forage particle size and grain fermentability in midlactation cows. I. Milk production and diet digestibility. *Journal of Dairy Science* 85, 1936–1946.
- Kung Jr L, Huber JT and Satter LD 1983. Influence of nonprotein nitrogen and protein of low rumen degradability on nitrogen flow and utilization in lactating dairy cows. *Journal of Dairy Science* 66, 1863–1872.
- Kuoppala K, Rinne M, Nousiainen J and Huhtanen P 2008. The effect of cutting time of grass silage in primary growth and regrowth and the interactions between silage quality and concentrate level on milk production of dairy cows. *Livestock Science* 116, 171–182.
- Law RA, Young FJ, Patterson DC, Kilpatrick DJ, Wylie ARG and Mayne CS 2009. Effect of dietary protein content on animal production and blood metabolites of dairy cows during lactation. *Journal of Dairy Science* 92, 1001–1012.
- Law RA, Young FJ, Patterson DC, Kilpatrick DJ, Wylie ARG, Ingvarsten KL, Hameleers A, McCoy MA, Mayne CS and Ferris C 2011. Effect of precalving and postcalving dietary energy level on performance and blood metabolite concentrations of dairy cows throughout lactation. *Journal of Dairy Science* 94, 808–823.
- Lechartier C and Peyraud JL 2010. The effects of forage proportion and rapidly degradable dry matter from concentrate on ruminal digestion in dairy cows fed corn silage-based diets with fixed neutral detergent fiber and starch contents. *Journal of Dairy Science* 93, 666–681.
- Lechartier C and Peyraud JL 2011. The effects of starch and rapidly degradable dry matter from concentrate on ruminal digestion in dairy cows fed corn silage-based diets with fixed forage proportion. *Journal of Dairy Science* 94, 2440–2454.
- Lee C, Hristov AN, Heyler KS, Cassidy TW, Lapierre H, Varga GA and Parys C 2012. Effects of metabolizable protein supply and amino acid supplementation on nitrogen utilization, milk production, and ammonia emissions from manure in dairy cows. *Journal of Dairy Science* 95, 5253–5268.
- Lu CD, Jorgensen NA and Satter LD 1988. Site and extent of nutrient digestion in lactating dairy cows fed alfalfa protein concentrate or soybean meal. *Journal of Dairy Science* 71, 697–704.
- McCarthy Jr RD, Klusmeyer TH, Vicini JL, Clark JH and Nelson DR 1989. Effects of source of protein and carbohydrate on ruminal fermentation and passage of nutrients to the small intestine of lactating cows. *Journal of Dairy Science* 72, 2002–2016.
- Mooney CS and Allen MS 1997. Physical Effectiveness of the Neutral Detergent Fiber of Whole Linted Cottonseed Relative to that of Alfalfa Silage at Two Lengths of Cut. *Journal of Dairy Science* 80, 2052–2061.
- Moorby JM, Dewhurst RJ, Evans RT and Danelón JL 2006. Effects of dairy cow diet forage proportion on duodenal nutrient supply and urinary purine derivative excretion. *Journal of Dairy Science* 89, 3552–3562.

- Moorby JM, Dewhurst RJ, Thomas C and Marsden S 1996. The influence of dietary energy source and dietary protein level on milk protein concentration from dairy cows. *Animal Science* 63, 1–10.
- Moran JB, Lemerle C and Trigg TE 1988. The intake and digestion of maize silage-based diets by dairy cows and sheep. *Animal Feed Science and Technology* 20, 299–312.
- Mowrey A, Ellersieck MR and Spain JN 1999. Effect of fibrous by-products on production and ruminal fermentation in lactating dairy cows. *Journal of Dairy Science* 82, 2709–2715.
- Mullins CR, Grigsby KN, Anderson DE, Titgemeyer EC and Bradford BJ 2010. Effects of feeding increasing levels of wet corn gluten feed on production and ruminal fermentation in lactating dairy cows¹. *Journal of Dairy Science* 93, 5329–5337.
- Mulrooney CN, Schingoethe DJ, Kalscheur KF and Hippen AR 2009. Canola meal replacing distillers grains with solubles for lactating dairy cows. *Journal of Dairy Science* 92, 5669–5676.
- Murphy M, Åkerlind M and Holtenius K 2000. Rumen fermentation in lactating cows selected for milk fat content fed two forage to concentrate ratios with hay or silage. *Journal of Dairy Science* 83, 756–764.
- Mustafa AF, Christensen DA and McKinnon JJ 2000. Effects of pea, barley, and alfalfa silage on ruminal nutrient degradability and performance of dairy cows. *Journal of Dairy Science* 83, 2859–2865.
- Nielsen TS, Straarup EM, Vestergaard M and Sejrsen K 2006. Effect of silage type and concentrate level on conjugated linoleic acids, trans-C18:1 isomers and fat content in milk from dairy cows. *Reproduction Nutrition Development* 46, 699–712.
- Oba M and Allen MS 2000. Effects of brown midrib 3 mutation in corn silage on productivity of dairy cows fed two concentrations of dietary neutral detergent fiber: 1. Feeding behavior and nutrient utilization. *Journal of Dairy Science* 83, 1333–1341.
- Oba M and Allen MS 2003. Effects of corn grain conservation method on feeding behavior and productivity of lactating dairy cows at two dietary starch concentrations. *Journal of Dairy Science* 86, 174–183.
- Oliveira JS, Huber JT, Simas JM, Theurer CB and Swingle RS 1995. Effect of sorghum grain processing on site and extent of digestion of starch in lactating dairy cows. *Journal of Dairy Science* 78, 1318–1327.
- Olmos Colmenero JJ and Broderick GA 2006a. Effect of dietary crude protein concentration on milk production and nitrogen utilization in lactating dairy cows. *Journal of Dairy Science* 89, 1704–1712.
- Olmos Colmenero JJ and Broderick GA 2006b. Effect of dietary crude protein concentration on ruminal nitrogen metabolism in lactating dairy cows. *Journal of Dairy Science* 89, 1694–1703.
- O'Mara FP, Fitzgerald JJ, Murphy JJ and Rath M 1998. The effect on milk production of replacing grass silage with maize silage in the diet of dairy cows. *Livestock Production Science* 55, 79–87.
- Onetti SG, Reynal SM and Grummer RR 2004. Effect of alfalfa forage preservation method and particle length on performance of dairy cows fed corn silage-based diets and tallow. *Journal of Dairy Science* 87, 652–664.
- Overton TR, Cameron MR, Elliott JP, Clark JH and Nelson DR 1995. Ruminal fermentation and passage of nutrients to the duodenum of lactating cows fed mixtures of corn and barley. *Journal of Dairy Science* 78, 1981–1998.
- Palmquist DL, Weisbjerg MR and Hvelplund T 1993. Ruminal, intestinal, and total digestibilities of nutrients in cows fed diets high in fat and undegradable protein. *Journal of Dairy Science* 76, 1353–1364.

- Pantoja J, Firkins JL, Eastridge ML and Hull BL 1994. Effects of fat saturation and source of fiber on site of nutrient digestion and milk production by lactating dairy cows. *Journal of Dairy Science* 77, 2341–2356.
- Peyraud JL, Delaby L and Marquis B 1994. Intérêt de l'introduction de luzerne déshydratée en substitution de l'ensilage de maïs dans les rations des vaches laitières. *Annales de Zootechnie* 43, 91–104.
- Pires AV, Eastridge ML, Firkins JL and Lin YC 1997. Effects of Heat Treatment and Physical Processing of Cottonseed on Nutrient Digestibility and Production Performance by Lactating Cows. *Journal of Dairy Science* 80, 1685–1694.
- Poorer MH, Moore JA, Swingle RS, Eck TP and Brown WH 1993. Response of lactating holstein cows to diets varying in fiber source and ruminal starch degradability. *Journal of Dairy Science* 76, 2235–2243.
- Poos MI, Bull LS and Hemken RW 1979. Supplementation of diets with positive and negative fermentation potential with urea and soybean meal. *Journal of Animal Science* 49, 1417–1426.
- Putnam DE, Schwab CG, Socha MT, Whitehouse NL, Kierstead NA and Garthwaite BD 1997. Effect of Yeast Culture in the Diets of Early Lactation Dairy Cows on Ruminal Fermentation and Passage of Nitrogen Fractions and Amino Acids to the Small Intestine. *Journal of Dairy Science* 80, 374–384.
- Qiu X, Eastridge ML and Wang Z 2003. Effects of corn silage hybrid and dietary concentration of forage NDF on digestibility and performance by dairy cows. *Journal of Dairy Science* 86, 3667–3674.
- Ramirez HAR, Nestor K, Tedeschi LO, Callaway TR, Dowd SE, Fernando SC and Kononoff PJ 2012. The effect of brown midrib corn silage and dried distillers' grains with solubles on milk production, nitrogen utilization and microbial community structure in dairy cows. *Canadian Journal of Animal Science* 92, 365–380.
- Ranathunga SD, Kalscheur KF, Hippen AR and Schingoethe DJ 2010. Replacement of starch from corn with nonforage fiber from distillers grains and soyhulls in diets of lactating dairy cows. *Journal of Dairy Science* 93, 1086–1097.
- Randby ÅT, Weisbjerg MR, Nørgaard P and Heringstad B 2012. Early lactation feed intake and milk yield responses of dairy cows offered grass silages harvested at early maturity stages. *Journal of Dairy Science* 95, 304–317.
- Recktenwald EB, Ross DA, Fessenden SW, Wall CJ and Van Amburgh ME 2014. Urea-N recycling in lactating dairy cows fed diets with 2 different levels of dietary crude protein and starch with or without monensin. *Journal of Dairy Science* 97, 1611–1622.
- Reynal SM and Broderick GA 2005. Effect of dietary level of rumen-degraded protein on production and nitrogen metabolism in lactating dairy cows. *Journal of Dairy Science* 88, 4045–4064.
- Rinne M, Huhtanen P and Jaakkola S 2002. Digestive processes of dairy cows fed silages harvested at four stages of grass maturity. *Journal of Animal Science* 80, 1986–1998.
- Rius AG, McGilliard ML, Umberger CA and Hanigan MD 2010. Interactions of energy and predicted metabolizable protein in determining nitrogen efficiency in the lactating dairy cow. *Journal of Dairy Science* 93, 2034–2043.
- Robinson PH 1997. Modifying duodenal flow of amino acids by manipulation of dietary protein sources. *Canadian Journal of Animal Science* 77, 241–251.
- Robinson PH and Kennelly JJ 1990. Evaluation of a duodenal cannula for dairy cattle. *Journal of Dairy Science* 73, 3146–3157.
- Rook JA, Muller LD and Shank DB 1977. Intake and digestibility of brown midrib corn silage by lactating dairy cows. *Journal of Dairy Science* 60, 1894–1904.

- Ruiz TM, Bernal E, Staples CR, Sollenberger LE and Gallaher RN 1995. Effect of dietary neutral detergent fiber concentration and forage source on performance of lactating cows. *Journal of Dairy Science* 78, 305–319.
- Rustomo B, Alzahal O, Odongo NE, Duffield TF and McBride BW 2006. Effects of rumen acid load from feed and forage particle size on ruminal pH and dry matter intake in the lactating dairy cow. *Journal of Dairy Science* 89, 4758–4768.
- Santos JEP, Huber JT, Theurer CB, Nussio LG, Nussio CB, Tarazon M and Lima-Filho RO 1999b. Performance and nutrient digestibility by dairy cows treated with bovine somatotropin and fed diets with steam-flaked sorghum or steam-rolled corn during early lactation. *Journal of Dairy Science* 82, 404–411.
- Santos JEP, Huber JT, Theurer CB, Nussio LG, Tarazon M and Santos FAP 1999a. Nutrition, feeding, and calves: Response of lactating dairy cows to steam-flaked sorghum, steam-flaked corn, or steam-rolled corn and protein sources of differing degradability. *Journal of Dairy Science* 82, 728–737.
- Shingfield KJ, Jaakkola S and Huhtanen P 2001. Effects of level of nitrogen fertilizer application and various nitrogenous supplements on milk production and nitrogen utilization of dairy cows given grass silage-based diets. *Animal Science* 73, 541–554.
- Shingfield KJ, Vanhatalo A and Huhtanen P 2003. Comparison of heat-treated rapeseed expeller and solvent-extracted soya-bean meal as protein supplements for dairy cows given grass silage-based diets. *Animal Science* 77, 305–317.
- Soita HW, Christensen DA and McKinnon JJ 2000. Influence of particle size on the effectiveness of the fiber in barley silage. *Journal of Dairy Science* 83, 2295–2300.
- Soita HW, Fehr M, Christensen DA and Mutsvangwa T 2005. Effects of corn silage particle length and forage:concentrate ratio on milk fatty acid composition in dairy cows fed supplemental flaxseed. *Journal of Dairy Science* 88, 2813–2819.
- Stensig T and Robinson PH 1997. Digestion and Passage Kinetics of Forage Fiber in Dairy Cows as Affected by Fiber-Free Concentrate in the Diet. *Journal of Dairy Science* 80, 1339–1352.
- Sterk A, Johansson BEO, Taweel HZH, Murphy M, van Vuuren AM, Hendriks WH and Dijkstra J 2011. Effects of forage type, forage to concentrate ratio, and crushed linseed supplementation on milk fatty acid profile in lactating dairy cows. *Journal of Dairy Science* 94, 6078–6091.
- Stern MD, Rode LM, Prange RW, Stauffacher RH and Satter LD 1983. Ruminal protein degradation of corn gluten meal in lactating dairy cattle fitted with duodenal T-type cannulae. *Journal of Animal Science* 56, 194–205.
- Sutton JD, Aston K, Beever DE and Dhanoa MS 1996. Milk production from grass silage diets: Effects of high-protein concentrates for lactating heifers and cows on intake, milk production and milk nitrogen fractions. *Animal Science* 62, 207–215.
- Tackett VL, Bertrand JA, Jenkins TC, Pardue FE and Grimes LW 1996. Interaction of Dietary Fat and Acid Detergent Fiber Diets of Lactating Dairy Cows. *Journal of Dairy Science* 79, 270–275.
- Tice EM, Eastridge ML and Firkins JL 1993. Raw soybeans and roasted soybeans of different particle sizes. 1. Digestibility and utilization by lactating cows. *Journal of Dairy Science* 76, 224–235.
- Valadares Filho SC, Broderick GA, Valadares RFD and Clayton MK 2000. Effect of replacing alfalfa silage with high moisture corn on nutrient utilization and milk production. *Journal of Dairy Science* 83, 106–114.
- Valadares RFD, Broderick GA, Valadares Filho SC and Clayton MK 1999. Effect of replacing alfalfa silage with high moisture corn on ruminal protein synthesis estimated from excretion of total purine derivatives. *Journal of Dairy Science* 82, 2686–2696.

- Vazirigohar M, Dehghan-Banadaky M, Rezayazdi K, Krizsan SJ, Nejati-Javaremi A and Shingfield KJ 2014. Fat source and dietary forage-to-concentrate ratio influences milk fatty-acid composition in lactating cows. *animal* 8, 163–174.
- Voelker JA, Burato GM and Allen MS 2002. Effects of pretrial milk yield on responses of feed intake, digestion, and production to dietary forage concentration. *Journal of Dairy Science* 85, 2650–2661.
- Wang C, Liu JX, Yuan ZP, Wu YM, Zhai SW and Ye HW 2007. Effect of level of metabolizable protein on milk production and nitrogen utilization in lactating dairy cows. *Journal of Dairy Science* 90, 2960–2965.
- Wattiaux MA, Combs DK and Shaver RD 1994. Lactational responses to ruminally undegradable protein by dairy cows fed diets based on alfalfa silage. *Journal of Dairy Science* 77, 1604–1617.
- Weiss WP and Wyatt DJ 2002. Effects of feeding diets based on silage from corn hybrids that differed in concentration and in vitro digestibility of neutral detergent fiber to dairy cows. *Journal of Dairy Science* 85, 3462–3469.
- Weiss WP and Wyatt DJ 2006. Effect of corn silage hybrid and metabolizable protein supply on nitrogen metabolism of lactating dairy cows. *Journal of Dairy Science* 89, 1644–1653.
- Weiss WP, St-Pierre NR and Willett LB 2009. Varying type of forage, concentration of metabolizable protein, and source of carbohydrate affects nutrient digestibility and production by dairy cows. *Journal of Dairy Science* 92, 5595–5606.
- Widyobroto BP 1992a. Influence de la proportion et de la nature du concentré sur les sites et la dynamique de la digestion chez la vache haute productrice - Essai 1. PhD thesis, Université de Rennes I, France, 26–48.
- Widyobroto BP 1992b. Influence de la proportion et de la nature du concentré sur les sites et la dynamique de la digestion chez la vache haute productrice - Essai 2. PhD thesis, Université de Rennes I, France, 49–79.
- Woodford ST and Murphy MR 1988. Dietary alteration of particle breakdown and passage from the rumen in lactating dairy cattle. *Journal of Dairy Science* 71, 687–696.
- Yang WZ and Beauchemin KA 2007. Altering physically effective fiber intake through forage proportion and particle length: Digestion and milk production. *Journal of Dairy Science* 90, 3410–3421.
- Yang WZ, Beauchemin KA and Rode LM 2001. Effects of grain processing, forage to concentrate ratio, and forage particle size on rumen pH and digestion by dairy cows. *Journal of Dairy Science* 84, 2203–2216.
- Yang WZ, Beauchemin KA, Koenig KM and Rode LM 1997. Comparison of Hull-less Barley, Barley, or Corn for Lactating Cows: Effects on Extent of Digestion and Milk Production. *Journal of Dairy Science* 80, 2475–2486.
- Yu P, Huber JT, Santos FAP, Simas JM and Theurer CB 1998. Effects of Ground, Steam-Flaked, and Steam-Rolled Corn Grains on Performance of Lactating Cows. *Journal of Dairy Science* 81, 777–783.
- Zerbini E, Polan CE and Herbein JH 1988. Effect of dietary soybean meal and fish meal on protein digesta flow in Holstein cows during early and midlactation. *Journal of Dairy Science* 71, 1248–1258.
- Zhu JS, Stokes SR and Murphy MR 1997. Substitution of Neutral Detergent Fiber from Forage with Neutral Detergent Fiber from By-Products in the Diets of Lactating Cows. *Journal of Dairy Science* 80, 2901–2906.

Annex 2. INRA Systali feed units system

Brief description of recent updates

Full details for the calculations of net energy for lactation (NE_L) and metabolizable protein (MP) values are given in Sauvant and Nozière, 2016¹. Briefly the update of INRA Systali feed units system consisted on quantifying the effect of digestive interactions on nutrients supplies and subsequently on NE_L and MP values by numerous meta-analyses of literature data. The main causes of digestive interactions included in the model are the feed intake level (DMI, % BW), the dietary proportion of concentrate and the rumen protein balance (RPB). The latter which is the difference between CP intake and CP flow to the duodenum (NH₃ excluded) is also used, together with the fermentable organic matter to calculate the amount of microbial CP measured at duodenum. Therefore, the former distinction between MP limited by energy (PDIE) and MP limited by N (PDIN) used in the previous version of the INRA MP system is no longer applied and replaced by the couple, MP and RPB (Sauvant and Nozière, 2016)¹. Practically, MP values are equivalent to the PDIE and are expressed in grams of protein digested in the small intestine supplied by rumen undegradable protein and by microbial protein.

Calculation of non-productive N requirements

The MP above maintenance was calculated according to the recent update of INRA protein unit system (Sauvant *et al.*, 2015)². In this paper, three major losses of N, resulting in non-productive N requirements, were quantified. In order of importance they are the faecal metabolic CP losses, calculated from DMI (kg/d) and organic matter non-digested (OMnd, g/kg DM) as $\text{DMI} * [5 * (0.57 + 0.0074 * \text{OMnd})] / \text{MP efficiency}$, the urinary endogenous N losses = $0.312 * \text{BW}$, and the scurf CP losses = $(0.2 * \text{BW}^{0.6}) / \text{MP efficiency}$. It should be noted that the same MP efficiency, conversion of MP above maintenance into milk protein, is also used for scurf CP losses, for faecal metabolic CP losses and for body protein retention/mobilisation (g/d). This last item is indexed on energy balance (EB) (= $4.479 * \text{EB} / \text{MP efficiency}$). The MP efficiency is calculated iteratively by using an initial value of 0.67, value used as reference in the NRC protein unit system (2001)³.

Calculation of energy balance

For energy, the last updates of the French unit system were applied (Sauvant *et al.*, 2015)⁴. NE_L requirement for milk expressed in MJ per day was calculated from milk fat content (MFC, g/kg) and milk protein content (MPC, g/kg), according to Faverdin *et al.* (2007)⁵, as: $7.1 \times (\text{kg of milk} \times (0.44 + (0.0055 \times (\text{MFC} - 40)) + (0.0033 \times (\text{MPC} - 31))))$ where the factor 7.1 converts the French energy unit UFL into MJ.

In the current work, EB was expressed as NE_L in MJ per day and calculated as: [daily DMI x dietary metabolizable energy (ME) content – (0.607 x BW^{0.75} + daily NE_L requirement for milk / k_{ls})] x k_{gt} where: 0.607 represents the ME requirement for maintenance. The coefficient k_{ls} is the efficiency to convert dietary ME into milk NE_L, calculated as $k_{ls} = 0.65 + 0.247 \times [(ME/GE) - 0.63]$ with GE as gross energy. The coefficient k_{gt} is the efficiency to convert NE_L from body reserves into milk NE_L and also to convert dietary ME into NE_L body reserves. The coefficient k_{gt} is calculated as follow: $k_{gt} = k_{ls} + 0.15$.

¹Sauvant D and Nozière P 2016. The quantification of the main digestive processes in ruminants: the equations involved in the renewed energy and protein feed evaluation systems. *Animal*, Accepted.

²Sauvant D, Cantalapiedra-Hijar G, Delaby L, Daniel JB, Faverdin P and Nozière P 2015. Actualisation des besoins protéiques des ruminants et détermination des réponses des femelles laitières aux apports de protéines digestibles dans l'intestin (PDI). *INRA Production Animales*, 28: 347-368.

³National Research Council 2001. Nutrient requirements of dairy cattle, Seventh revised edition. National Academy Press, Washington DC.

⁴Sauvant D, Ortigues-Marty I, Giger-Reverdin S and Nozière P 2015. Actualisation des besoins et efficacités énergétiques des femelles laitières. *Rencontre Recherche ruminants 2015*, 22: 225-228.

⁵Faverdin P, Delagarde R, Delaby L and Meschy F 2007. Alimentation des vaches laitières. In: *Alimentation des bovins, ovins et caprins. Besoins des animaux - Valeur des aliments - Tables INRA 2007, mise à jour 2010*. pp. 23-58. Editions Quae, Versailles, France.

Annex 3. Random model outputs with dietary NE_L and MP contents as co-variables**Table S1** Responses of milk yield and milk composition to changes in dietary NE_L content (MJ/kg DM) and MP content (g/kg DM). The co-variables are mean centred on: NE_L = 6.7 MJ/kg DM, MP = 100 g/kg DM.

	Nexp	Intercept	Linear NE _L	Quadratic NE _L	Linear MP	Quadratic MP	NE _L x MP	Outlier (%)	RMSE
Milk (MJ/d)	278	96.14 (1.07) ¹	—	-5.25 (0.96)	0.294 (0.024)	-0.0088 (0.0010)	0.185 (0.045)	2.4	3.81
Milk (kg/d)	279	32.15 (0.39)	0.96 (0.28)	-1.12 (0.34)	0.110 (0.009)	-0.0030 (0.0003)	0.050 (0.016)	2.1	1.33
Milk component yields (g/d)									
Fat	279	1166 (15)	-54.3 (11.5)	-70.5 (13.2)	2.90 (0.37)	-0.078 (0.014)	—	2.1	57.3
Protein	280	1009 (11)	53.0 (10.1)	-35.2 (12.4)	3.83 (0.33)	-0.126 (0.013)	2.64 (0.59)	2.2	49.0
Lactose	177	1546 (24)	49.1 (18.7)	-80.5 (22.7)	6.32 (0.68)	-0.15 (0.03)	2.94 (1.10)	0.9	77.1
Milk component contents (g/kg)									
Fat	280	36.71 (0.31)	-2.29 (0.31)	-0.96 (0.37)	-0.056 (0.010)	—	—	1.8	1.63
Protein	276	31.59 (0.14)	0.69 (0.13)	—	0.018 (0.004)	-0.0010 (0.0002)	0.025 (0.007)	2.3	0.63
Lactose	174	47.82 (0.15)	—	-0.38 (0.10)	—	—	—	2.2	0.44

Nexp=Number of experimental groups; Outlier = Observations with studentized residuals higher than 3 (or lower than -3); RMSE=Root mean square error after adjusting for the effect of experiment.

¹ Standard errors of the coefficient are reported in parentheses.

Models were chosen based on AIC (see material and methods). All coefficients were significantly different from 0 at least at the level P<0.05.

These coefficients can be used to predict milk responses within the ranges of 5.9 – 7.6 MJ/kg DM for NE_L and 73 – 121 g/kg DM for MP (means ± 2 SD), which reflect the current dataset.

Annex 4. Random model outputs with NE_{L100} and MP₆₇ supplies as co-variables**Table S2** Responses of milk yield and milk composition to changes in NE_{L100} supply (MJ/d) and MP₆₇ supply (kg/d). The co-variables are mean centred on supplies for which: NE_L in milk/NE_L supply above maintenance = 1.00, Milk protein yield/MP above maintenance = 0.67.

	Nexp	Intercept	Linear NE _{L100}	Quadratic NE _{L100}	Linear MP ₆₇	Quadratic MP ₆₇	Outlier (%)	RMSE
Milk (MJ/d)	277	95.0 (1.2) ¹	0.158 (0.017)	-0.0020 (0.0005)	14.88 (1.14)	-17.34 (2.24)	1.5	2.93
Milk (kg/d)	279	31.66 (0.42)	0.077 (0.005)	-0.00034 (0.00014)	5.30 (0.35)	-3.33 (0.69)	1.3	0.88
Milk component yields (g/d)								
Fat	278	1157 (15)	—	-0.026 (0.008)	174.6 (15.9)	-240.8 (38.9)	2.2	50.8
Protein	277	997 (12)	3.093 (0.180)	-0.023 (0.005)	184.5 (12.4)	-192.9 (24.2)	1.2	31.4
Lactose	177	1518 (25)	4.090 (0.333)	—	275.2 (24.6)	-169.7 (50.3)	0.9	51.5
Milk component contents (g/kg)								
Fat	279	36.69 (0.29)	-0.073 (0.0068)	—	—	—	2.5	1.57
Protein	275	31.54 (0.14)	0.0267 (0.0033)	—	0.50 (0.23)	-2.01 (0.44)	2.3	0.60
Lactose	173	47.78 (0.15)	0.0091 (0.0021)	—	—	—	2.2	0.43

Nexp = Number of experimental groups; Outlier = Observations with studentized residuals higher than 3 (or lower than -3); RMSE=Root mean square error after adjusting for the effect of experiment.

¹Standard errors of the coefficient are reported in parentheses.

Interaction between NE_{L100} and MP₆₇ was not significant for any of the variables studied.

Models were chosen based on AIC (see material and methods). All coefficients were significantly different from 0 at least at the level P<0.05.

Annex 5. Effect of weighting the observations on model coefficients estimate: Milk yield response to change in NE_L and MP contents as an example

Table S3 Model comparison for the milk yield response to changes in dietary NE_L content (MJ/kg DM) and MP content (g/kg DM). The co-variables are mean centred on: NE_L = 6.7 MJ/kg DM, MP = 100 g/kg DM.

	Nexp	Intercept	Linear NE _L	Quadratic NE _L	Linear MP	Quadratic MP	NE _L x MP	Outlier (%)	RMSE
Milk (kg/d)									
Model 1	267	32.16 (0.09)	0.81 (0.29)	-1.19 (0.33)	0.098 (0.009)	-0.0031 (0.0004)	0.061 (0.016)	2.5	1.26
Model 2	267	32.18 (0.10)	0.87 (0.29)	-1.29 (0.34)	0.102 (0.009)	-0.0031 (0.0004)	0.059 (0.016)	2.5	1.31
Model 3	279	32.09 (0.10)	0.99 (0.29)	-1.05 (0.34)	0.104 (0.009)	-0.0028 (0.0003)	0.050 (0.016)	2.1	1.33

Nexp=Number of experimental groups; Outlier = Observations with studentized residuals higher than 3 (or lower than -3); RMSE=Root mean square error after adjusting for the effect of experiment.

¹ Standard errors of the coefficient are reported in parentheses.

Model 1= Weighting of the observations with their reverse standard error of the mean (SEM) centred on the global average SEM, using only the dataset where SEM were reported (Nexp=272); Model 2= No weighting of the observations, using only the dataset where SEM were reported (Nexp=272); Model 3= No weighting of the observations, using the complete dataset (Nexp=282).

Standard errors of the coefficient are reported between brackets.

Models were chosen based on AIC (see material and methods). All predictions were significantly different from 0 at least at the level P<0.005.

Annex 6. Main ingredient of the investigated treatments**Table S4** Main ingredients of the investigated treatments.

Variable	Nt	Mean	SD	Minimum	Maximum
Ingredient, % of DM					
Maize silage	488	35.2	15.8	7.0	97.7
Alfalfa silage	299	29.4	18.1	1.0	100.0
Grass silage	205	53.8	19.6	7.0	100.0
Alfalfa hay	193	23.1	15.5	3.5	81.2
Ground maize	367	23.2	11.0	1.2	51.9
Maize gluten meal	128	3.5	3.3	0.3	19.0
Maize gluten feed	103	8.4	6.8	1.7	33.6
Dry distillers grains with solubles	93	8.0	6.6	0.2	30.1
Wheat	168	9.7	6.6	1.0	50.2
Barley	256	14.1	10.6	1.2	58.2
Beet pulp ¹	158	8.5	8.2	0.1	58.3
Molasses ²	280	1.8	1.4	0.2	6.8
Fish meal	136	2.0	1.7	0.2	12.9
Blood meal	111	1.6	2.1	0.2	9.4
Soybean meal	614	7.2	5.0	0.2	23.6
Soybean meal, rumen bypass	162	6.5	4.4	0.3	20.1
Soybean hulls	160	8.0	6.2	0.2	31.6
Rapeseed meal	155	5.3	4.5	0.2	24.1
Fat supplements ³	324	1.4	1.2	0.1	6.0
Urea	187	0.56	0.45	0.03	3.70

Statistics on inclusion percentage of feed ingredients were performed only with the treatments for which the diet included the ingredient studied.

¹Beet-pulp either molassed or unmolassed

²Molasses from either sugarcane or sugar beet.

³Fat supplements included oils from vegetables (maize, rapeseed, soybean and sunflower) or from fish or Ca-salt of fatty acids, tallow and yellow grease.

Chapter 3

A method to estimate cow potential and subsequent responses to energy and protein supply according to stage of lactation

J.B. Daniel^{1,2}, N.C. Friggens¹, H. Van Laar², C.P. Ferris³ and D. Sauvant¹

Journal of Dairy Science. In press.

¹UMR Modélisation Systémique Appliquée aux Ruminants, INRA, AgroParisTech, Université Paris-Saclay, 75005 Paris, France

²Trouw Nutrition R&D, P.O. Box 220, 5830 AE Boxmeer, the Netherlands

³Agri-Food and Biosciences Institute, Hillsborough, Co. Down, BT26 6DR, United Kingdom

Abstract

Milk responses to dietary change are influenced by the relative production level, that is, the distance between observed production and potential production. The closer the animal is to its potential, the smaller the expected response is to extra nutrients. Therefore, the aim of this work was to provide a method to quantify cow potential, in order to estimate subsequent responses to changes in nutrient supply. The observed efficiencies in net energy for lactation (NE_L) and metabolizable protein (MP) are proposed as a basis to estimate the relative production level of the animal. The rationale for using NE_L and MP efficiency (ratios of milk energy yield/NE_L above maintenance supply and milk protein yield/MP above maintenance supply) builds on the uniformity of the observed relationships between size of the milk responses and extra NE_L supply and MP supply, when centered on a given efficiency. From there, a pivot nutritional situation where MP and NE_L efficiency are 0.67 and 1.00, respectively, was defined, from which milk responses could be derived across animals varying in production potential. An implicit assumption of using response equations centered on reference efficiency pivots is that the size of the response to a fixed change in nutrient supply, relative to the pivot, is identical for animals with different production capacities. The proposed approach was evaluated with 2 independent datasets, where different dietary treatments were applied during the whole lactation. In these datasets, MP and NE_L above maintenance supply were calculated weekly using the recently updated INRA Systali feed units system. Differences in NE_L and MP supply above maintenance between the extreme dietary treatments were large, on average 667 g MP/d and 13 MJ NE_L/d (3.11 Mcal/d) in the first dataset, and 513 g MP/d and 29 MJ NE_L/d (6.93 Mcal/d) for the second dataset. Milk energy yield and milk component yields were predicted with root mean square prediction errors between 7.6 and 13.5% and concordance correlation coefficients between 0.784 and 0.934. Assessed by the Akaike's information criterion, significant differences existed in the accuracy of prediction for milk energy yield and milk component yields between stages of lactation. However, the effects of stage of lactation were not consistent between datasets and, for most of the predicted variables, relatively small. It is concluded that the pivot concept can be used to predict milk energy yield and milk component yields responses to dietary change with a good accuracy for diets that are substantially different, and across all stages of lactation.

Keywords: energy, protein, response, potential, milk yield and composition

Introduction

In the context of an increasing demand for feed efficiency, the importance of accurately predicting animal responses to dietary changes is growing. In dairy cows, several quantitative reviews of the literature (Huhtanen and Nousiainen, 2012; Jensen et al., 2015; Daniel et al., 2016) or specific experiments (Brun-Lafleur et al., 2010) have generated equations that aim to predict milk yield and/or milk composition response to a dietary change. However, the accurate application of these equations on-farm requires an estimation of the production potential of the cows in question. For example, on a farm where the observed production is 30 kg/d and the maximum production potential is also 30 kg/d, one expects zero response to an increase in feed quality. However, on a farm where the observed production is 30 kg/d but the maximum production potential is 50 kg/d one clearly expects a positive response to supplementation. Thus, there is a need to estimate the relative production level, that is, how far the animal is from its potential. Although the concept of potential appears useful, this notion is partly theoretical and often refers, as stated above, to the maximum production achievable in a non-limiting environment (Neal and Thornley, 1983; Vetharanian et al. 2003). In the context of predicting responses, a more useful definition would be the maximum production that can be achieved by a given animal in a standardized nutritional status. For the prediction of such a potential, herd-test day models which include fixed effects (farm, gestation, length of dry-period, calving month, etc.) and random effects (genetic and permanent environment) represent a valuable approach (Leclerc, 2008). However, such models assume that the differences in nutritional environment are adequately captured by the fixed effect of farm, and for prediction purposes require information from the previous lactation. The objective of this work is to propose an alternative approach to determine the relative production level of the dairy cow and derive subsequent expected milk responses to changes in MP and NE_L supply, that could be easily applied on-farm. The MP and NE_L efficiencies are proposed as status indicators to determine the relative production level, distance between the observed production and the potential production. The rationale and quantitative basis for this choice are presented in the paper. The second objective of this work was to evaluate the method for predicting milk yield and milk component yields responses to changes in MP and NE_L supply using 2 independent datasets.

Rationale

Relationship Between Size of Milk Responses and MP and NE_L Efficiencies

Milk responses to nutrient supply are usually modelled by quadratic or exponential equations. This reflects the widely established principle of diminishing returns (Brody, 1945). At the metabolic level, once non-productive MP requirements and NE_L maintenance requirement are discounted (see Sauvant et al., 2015a,b and appendix 1 for details of calculations used in this study), the principle of diminishing returns to increasing MP and NE_L supply is mostly explained by a change in partitioning. This is induced by a limitation of the mammary gland synthesis capacity. As NE_L above maintenance increases, energy partitioning progressively shifts from milk to body lipid. Similarly, with increasing MP supply above maintenance, nitrogen partitioning progressively shifts from milk protein to urinary nitrogen. These effects were observed using milk protein and energy yield equations developed by meta-analysis (Figure 1, Daniel et al., 2016).

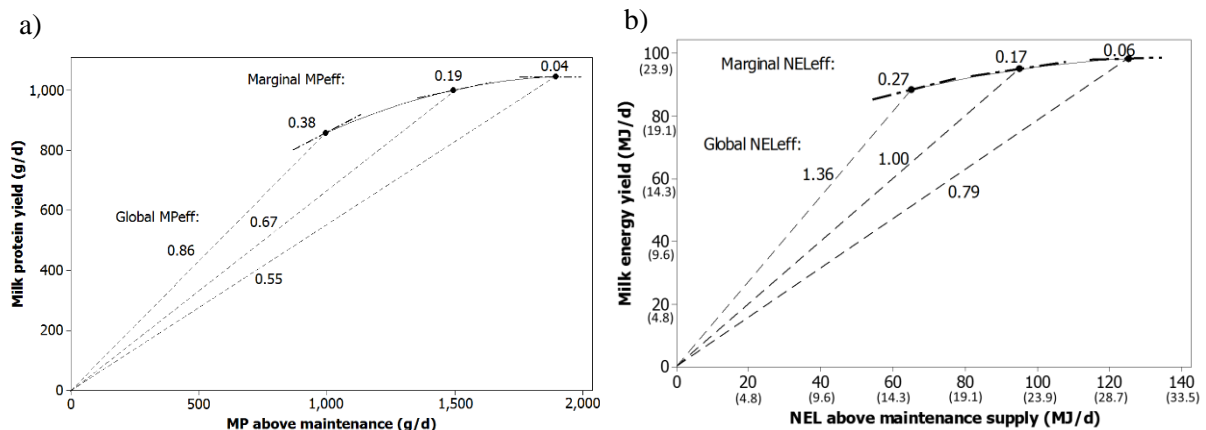

Figure 1 Average response curves of milk protein yield to changing MP supply above maintenance and milk energy yield to NE_L supply above maintenance (equations from Daniel et al., 2016). The global MP and NE_L efficiencies (MP_{eff} and NE_L_{eff}), i.e. the ratio between milk protein yield and MP above maintenance and between milk energy yield and NE_L above maintenance, respectively, are represented with dashed lines. The marginal MP_{eff} and NE_L_{eff} are the derivative of the response curves and indicate the proportion of protein and energy secreted in milk per extra unit supply of MP and NE_L, respectively. In parentheses, energy values are reported in Mcal/d.

In the illustrated example, the marginal MP efficiency or partitioning (i.e. the slopes of the curves in Figure 1, panel a) decreases from 0.38 to 0.19 when MP supply increases from 993 to 1493 g/d. A further increase from 1,493 to 1,893 g/d results to a decrease in marginal MP efficiency from 0.19 to 0.04. The consequences of this partitioning is

that the overall, global MP efficiency ($MP_{eff} = \text{Milk protein yield}/\text{MP supply above maintenance}$) decreases from 0.86 to 0.67 (when MP supply above maintenance increases from 993 to 1,493 g/d), and from 0.67 to 0.55 (when MP supply above maintenance increases from 1,493 to 1,893 g/d). With respect to energy (Figure 1, panel b), a similar relationship was found between marginal NE_L efficiency in milk and the global NE_L efficiency ($NE_{Leff} = \text{Milk energy}/\text{NE}_L \text{ supply above maintenance}$). When NE_L supply increases from 65 to 95 MJ/d (15.54 to 22.71 Mcal/d) and from 95 to 125 MJ/d (22.71 to 29.88 Mcal/d), the marginal NE_L efficiency decreases from 0.27 to 0.17 and from 0.17 to 0.06, respectively, and global NE_{Leff} decreases from 1.36 to 1.00 and from 1.00 to 0.79, respectively. With these positive relationships observed between global and marginal efficiencies, we hypothesized that MP and NE_L efficiencies could provide a mean to estimate the relative production level of the animal, i.e. how far the animal is from potential, and thereby provide the basis for predicting response to dietary changes in MP and NE_L . It should be noted that the potential, here, does not refer to genetic potential, in the sense of maximum production achieved in a truly non-limiting environment. Instead, it refers to cow performance on a standardized nutritional situation within its given environment. Therefore, this notion of potential includes current and past environmental effects on the cow production capacity.

Estimation of Pivots from which to Predict Milk Responses

Using data collected from a large number of experiments (see Daniel et al., 2016 for the full list of references), Figure 2 shows the relationships between milk protein yield and MP supply above maintenance (panel a), and between milk energy and NE_L supply above maintenance (panel b). On Figure 2, the dashed lines represent the global efficiencies $MP_{eff} = 0.67$ (panel a) and $NE_{Leff} = 1$ (panel b). These efficiency lines intersect most of the curves within the range of data, i.e. from low to high producing animals. Therefore it was decided to use the fixed efficiency values as a reference point, or pivot, that is relevant across the whole range of production levels. In the situation of predicting responses, the reference efficiency line can be seen as being a 'rail' along which the response curve would move up or down according to animal potential. This principle, already suggested by Huhtanen and Nousiainen (2012), extends the applicability of response equations by including the effect of animal production capacity. The chosen values of efficiency for the pivot are consistent with established feeding system values for protein (NRC, 2001; Sauvant et al., 2015a). For

energy, $NE_{Leff}=1.00$ was chosen because it is equivalent to zero energy balance and this value is very close to the average found in a dataset of 825 treatment means (0.99, Daniel et al., 2016). In Figure 2 (panels c and d), intersections between the reference efficiency lines (panel c, $MP_{eff}=0.67$; panel d, $NE_{Leff}=1.00$) and each of the 3 response curves representing low, medium and high producing animals give on the x-axis, the levels of MP and NE_L supply above maintenance at the reference situation for a given type of animal. These levels are called ‘pivot’ because they are the central points around which the response curve can be applied. Using the MP_{pivot} , the milk protein yield response (ΔMPY) can then be written as follows (assuming changes in NE_L are zero):

$$\Delta MPY \text{ (g/d)} = MPY - MPY_{pivot} = 0.19 (MP - MP_{pivot}) - 0.000193 (MP - MP_{pivot})^2 \quad [1]$$

where MPY is the observed milk protein yield (g/d), $MPY_{pivot} = 0.67 * MP_{pivot}$, and MP is the observed MP supply above maintenance (g/d). The coefficients 0.19 and 0.000193 are derived from the meta-analysis of Daniel et al. (2016). As MPY_{pivot} is calculated from MP_{pivot} , the only unknown variable in this equation is MP_{pivot} . This value can be calculated from any pair of observed values of MPY and MP . Once this pivot has been calculated, the milk protein yield response to any dietary MP changes can be predicted. This is true under the assumption that MP_{pivot} do not vary with dietary MP changes for that particular animal and at that particular time.

A similar type of equation describes the milk energy response (ΔMEY) to NE_L supply (assuming changes in MP are zero):

$$\Delta MEY \text{ (MJ/d)} = MEY - MEY_{pivot} = 0.166 (NE_L - NE_{Lpivot}) - 0.0018 (NE_L - NE_{Lpivot})^2 \quad [2]$$

where MEY is the observed milk energy yield (MJ/d), $MEY_{pivot} = 1 * NE_{Lpivot}$, and NE_L is the observed NE_L supply above maintenance (g/d). As for equation 1, coefficients 0.166 and 0.0018 are derived from the meta-analysis of Daniel et al. (2016). An implicit assumption of using response equations centered on reference efficiency pivots is that, when global $MP_{eff}=0.67$ and global $NE_{Leff}=1.00$, the size of the response to extra MP or NE_L supply is identical regardless of differences in animal production capacity (Figure 2c and d). By expressing NE_L and MP supply relative to

the efficiency pivots the effects of protein and energy supply on performance are standardized, which means that they can be dissociated from performance differences due to animal production capacity, providing animals are at the same physiological status (parity, lactation stage, etc.). Aspects related to stage of lactation are discussed later in the paper.

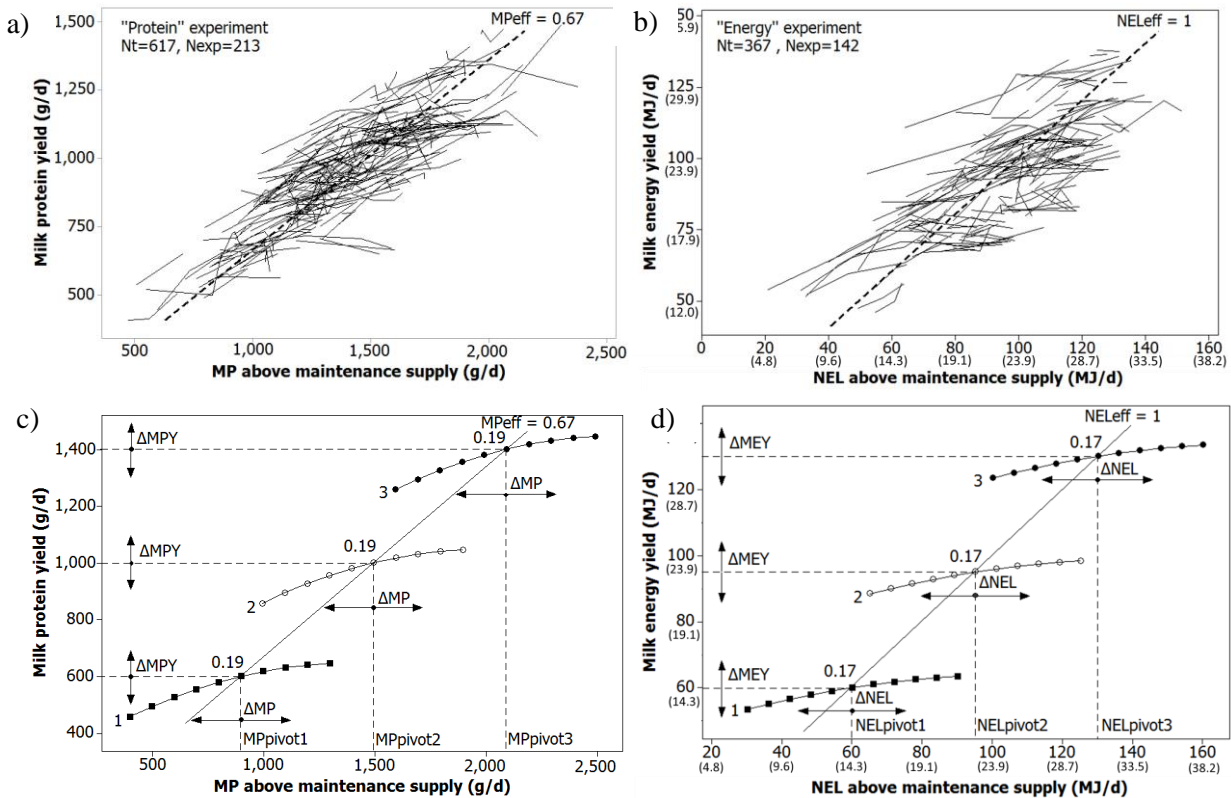

Figure 2 (a) The relationship between milk protein yield and MP above maintenance supply observed with experiments where MP supply was the main factor of variation between treatments. The global MP efficiency (MPEff) of 0.67 is represented by the dashed line. Each solid line represents one experiment group (Nexp=213) including 617 treatments (Nt). (b) The relationship between milk energy yield and NEL above maintenance supply observed with experiments where NEL supply was the main factor of variation between treatments. The global NEL efficiency (NELeff) of 1 is represented by the dashed line. Each solid line represents one experiment group (Nexp=142) including 367 treatments (Nt). (c) milk protein yield response to MP supply above maintenance for 3 groups of animals with low (■), medium (○) and high (●) production levels. The levels of MP supply above maintenance required when global MPEff is 0.67 are called MPpivot. (d) milk energy yield response to NEL supply above maintenance for 3 groups of animals with low (■), medium (○) and high (●) production levels. The level of NEL supply above maintenance required when global NELeff is 1 is called NELpivot. Equations from Daniel et al. (2016). In parentheses, energy values are reported in Mcal/d.

For the sake of simplicity, energy and protein were represented independently in Figures 1 and 2. However, NEL supply influences milk protein yield response and MP

supply influences milk energy response (Daniel et al., 2016). A more comprehensive representation of milk protein and energy responses is presented in Figure 3 for an average group of animals producing at a level equivalent to pivots of 1,000 g/d of milk protein and 95 MJ/d (22.71 Mcal/d) of milk energy. The effect of NE_L supply on milk protein yield (panel a) and of MP supply on milk energy yield (panel b) are shown by vertical displacement of the lines. The straight line $MP_{eff}=0.67$ crosses each level of NE_L supply above maintenance represented on the Figure 3a, indicating that multiple combination of NE_L and MP supplies can result in $MP_{eff}=0.67$. This is because independently from MP supply, an increase in NE_L supply positively influences milk protein yield, thereby increasing MP_{eff} . Similarly, independently from NE_L supply, extra MP supply increases milk energy yield, which increases NE_{Leff} , and thus multiple combinations of NE_L and MP supplies can result in $NE_{Leff}=1.00$. Nevertheless, only one combination simultaneously gives $MP_{eff}=0.67$ and $NE_{Leff}=1$. In the case of the example illustrated in Figure 3, $MP_{eff}=0.67$ and $NE_{Leff}=1.00$ are simultaneously achieved when $MP_{pivot}=1,493$ g/d and $NE_{Lpivot}=95$ MJ/d (22.71 Mcal/d). Because of the influence of both NE_L and MP supply on MP_{pivot} and NE_{Lpivot} , the pivots need to be calculated by simultaneously taking into account the milk energy and protein responses. Incorporating the NE_L effect (Daniel et al., 2016) in equation 1 and the MP effect in equation 2, we have:

$$MPY - MPY_{pivot} \text{ (g/d)} = 0.19 (MP - MP_{pivot}) - 0.000193 (MP - MP_{pivot})^2 + 3.137 (NE_L - NE_{Lpivot}) - 0.021 (NE_L - NE_{Lpivot})^2, \text{ with } MPY_{pivot} = 0.67 * MP_{pivot} \quad [3]$$

$$MEY - MEY_{pivot} \text{ (MJ/d)} = 0.166 (NE_L - NE_{Lpivot}) - 0.0018 (NE_L - NE_{Lpivot})^2 + 0.015 (MP - MP_{pivot}) - 0.000017 (MP - MP_{pivot})^2, \text{ with } MEY_{pivot} = 1 * NE_{Lpivot} \quad [4]$$

This is a system of 2 equations with 2 unknowns (MP_{pivot} and NE_{Lpivot}) which can in principle be solved algebraically when MPY , MEY , MP and NE_L are observed. However, because of the quadratic nature of the equations, there are mathematically 4 possible solutions to the system. An optimization procedure was developed to handle this aspect (details are presented in Appendix 2). With this approach, pivot values calculated are uniquely defined, with MP_{pivot} and NE_{Lpivot} being the levels of MP and NE_L supplies above maintenance resulting in global $MP_{eff}=0.67$ and global $NE_{Leff}=1.00$. Equations 3 and 4 are therefore used for 2 purposes: the first is to calculate the pivots from a given observation when the supplies in MP and NE_L and

the actual production are known. For that purpose, the appropriate response curve, corresponding to the production potential of that animal, is associated with the observation. Secondly, once MP_{pivot} and NEL_{pivot} are known, equations 3 and 4 can be applied to predict milk protein and energy yield responses to nutritional manipulation (i.e. new inputs of MP and NEL supply).

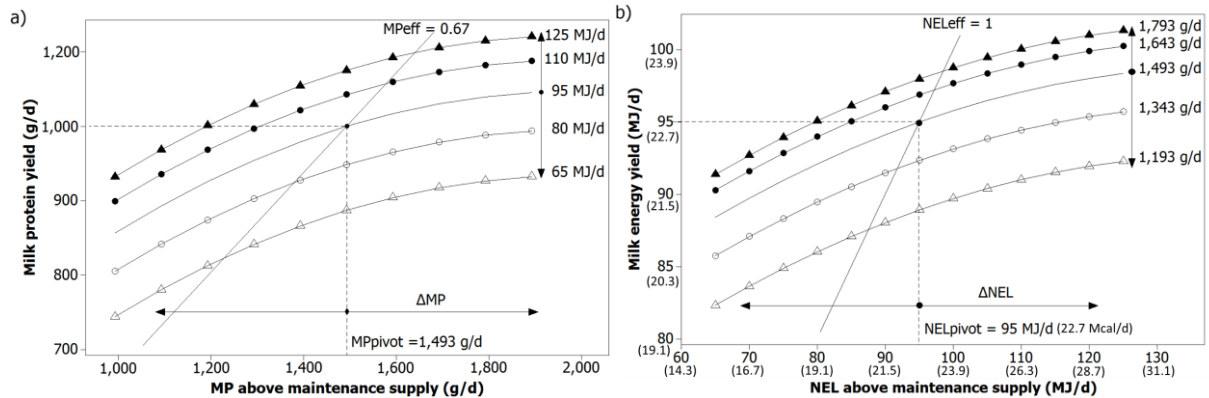

Figure 3 Average milk protein yield (a) and milk energy yield (b) responses to change in MP and NEL supply for a group of animal producing 1,000 g/d of protein and 95 MJ/d (22.71 Mcal/d) of energy at pivots. MP_{pivot} = Level of MP above maintenance supply for which MP efficiency is 0.67 and NEL_{pivot} = Level of NEL above maintenance supply for which NEL efficiency is 1 and MP efficiency is 0.67. Figure 1a was adapted from Daniel et al. (2016). In parentheses, energy values are reported in Mcal/d.

Given MP_{pivot} and NEL_{pivot}, pivot values can also be calculated for milk fat yield and milk lactose yield. For that, the distances between observed MP and MP_{pivot}, and between observed NEL and NEL_{pivot} are used to estimate the distances between observed milk fat yield and pivot milk fat yield, and between observed milk lactose yield and pivot milk lactose yield:

$$\Delta MFY = 0.159 (MP - MP_{pivot}) - 0.000238 (MP - MP_{pivot})^2 + 0.611 (NEL - NEL_{pivot}) - 0.021 (NEL - NEL_{pivot})^2 \quad [5]$$

$$\Delta MLY = 0.283 (MP - MP_{pivot}) - 0.000172 (MP - MP_{pivot})^2 + 4.076 (NEL - NEL_{pivot}) \quad [6]$$

where ΔMFY and ΔMLY are the distances between observed and pivot production for milk fat yield and milk lactose yield respectively. Distances are estimated using response equations to change in NEL and MP supply developed in Daniel et al. (2016). The actual pivot values for milk fat yield (MFY_{pivot}) and milk lactose yield (MLY_{pivot})

can then be calculated by subtracting ΔMFY from the observed milk fat yield (MFY), and ΔMLY from the observed milk lactose yield (MLY):

$$\text{MFY}_{\text{pivot}} \text{ (g/d)} = \text{MFY} - \Delta\text{MFY} \quad [7]$$

$$\text{MLY}_{\text{pivot}} \text{ (g/d)} = \text{MLY} - \Delta\text{MLY} \quad [8]$$

With these pivots, the consequences of changes from observed MP and NE_{L} supply on milk fat yield and milk lactose yield can be estimated. Given the assumption about fixed efficiency referencing production level relative to potential, we now have a system to predict milk energy yield and milk component yield responses for animals of different potential at that time.

Implication of stage of lactation on pivot values

The choice of reference values for MP_{eff} and NE_{Leff} was derived using a dataset mainly based on observations in mid-lactation ($n=819$, average \pm SD = 131 ± 51 days in milk, Daniel et al., 2016). However, a clear effect of stage of lactation is observed on MP_{eff} and NE_{Leff} , even when the ration composition does not change. These effects are illustrated in Figure 4, which shows data for the least constraining nutritional treatments from the 2 datasets used for model evaluation (Friggens et al., 1998; Law et al., 2009). In both experiments the ration remained constant throughout lactation. For protein, the calculation of MP above maintenance is adjusted for an estimation of body protein change scaled on energy balance (**EB**, Sauvant et al., 2015a). Thus in theory, nitrogen from MP can only be partitioned into milk or urine. Assuming that the efficiency of biochemical transformation of 1 g of MP into milk protein does not change with time, the observed linear decreasing MP efficiency throughout lactation is the result of a progressive shift in nitrogen partitioning from milk towards urine. For energy, the effect of stage of lactation observed on NE_{Leff} is essentially the result of homeorhetic regulation. The shape of the NE_{Leff} curve reflects the well-established patterns of energy balance, i.e. changing patterns of body reserve mobilization and accretion, as the animal progresses through lactation (Friggens et al., 2007). The high efficiency (>1) in early lactation reflects body energy mobilization and the low efficiency (<1) in late lactation indicates body energy deposition. Therefore changes in NE_{Leff} with stage of lactation are also the consequences of changes in energy partitioning. These lactation profiles of changing MP and NE_{L} efficiencies have consequences on

the expected size of responses to dietary changes. As illustrated in Figure 1, the size of the response decreases with decreasing MP_{eff} and $NE_{L\text{eff}}$, respectively. Thus an implicit assumption of using fixed reference MP_{eff} and $NE_{L\text{eff}}$ as pivots throughout lactation is that because of the high efficiencies observed in early lactation, and the low efficiency observed in late lactation, the size of the response in milk will be greater in early than in late lactation. This is consistent with the animal changing priority of nutrient partitioning through lactation (Bauman and Currie, 1980). Accordingly, fixed pivots of $MP_{\text{eff}}=0.67$ and $NE_{L\text{eff}}=1.00$ are used independently of the lactation stage. Combining this consideration with the rationale presented above, we suggest that milk responses can be predicted at any stage of the lactation.

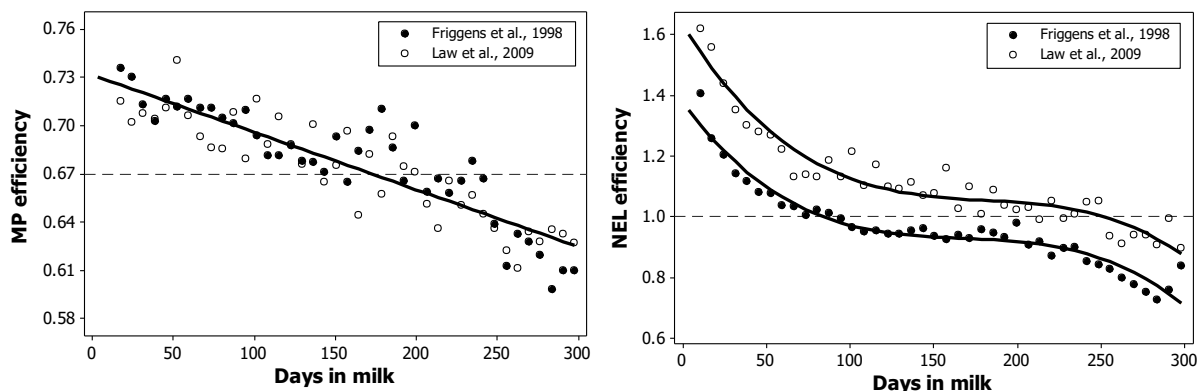

Figure 4 MP and NE_L efficiency relative to days in milk calculated for the treatment with 59% concentrate (DM basis) in Friggens et al. (1998) and for the treatment with 17.3% CP (DM basis) in Law et al. (2009).

Model evaluation

Data used for Model Evaluation

The original data from two entire lactation experiments with large differences in either MP and/or NE_L supply between treatments were selected to evaluate the accuracy of the method presented to predict milk energy yield and milk component yields. Briefly, the first experiment (Friggens et al., 1998) was characterized by 2 levels of dietary concentrate (27% and 59%, DM basis) offered to twenty-four multiparous Holstein cows in a full 2 x 2 change-over design with control treatments. The experiment of Law et al. (2009) involved 3 rations with different CP content (11.4%, 14.4% and 17.3%, DM basis) fed to ninety Holstein cows (50% primiparous) in a 3 x 2 change-over design where half of the animals of each treatment were allocated to an alternative dietary CP

content at mid-lactation. For the purpose of evaluating model predictions, weekly average values of each treatment group were used in both experiments. In Friggens et al. (1998), a total of 168 weekly average values were used (42 weekly averages * 4 dietary treatments) and in Law et al. (2009), a total of 258 weekly average values were used (43 weekly averages * 6 dietary treatments). From those data, dietary NE_L and MP contents were calculated using the recently updated INRA Systali feed units system (Sauvant and Nozière, 2016). Supplies of NE_L and MP above maintenance were then calculated by subtracting non-productive MP requirements (Sauvant et al., 2015a) and NE_L maintenance requirement (Sauvant et al., 2015b) from total supplies. A minor modification was proposed in the calculation of MP above maintenance relative to Sauvant et al. (2015a). In the original publication, the body protein balance (g/d), used to adjust MP above maintenance, was estimated as a constant ratio of EB (equal to 4.479 * EB, equivalent to a protein content of BW change of 166 g/kg). This approach of using a constant ratio is also used in other feed unit systems (NRC, 2001; Thomas, 2004; Volden, 2011). This suggests that the composition of the gain or loss (ratio fat: protein) throughout the lactation is constant, despite evidence that this is not the case (Belyea et al., 1978; Gibb et al., 1992; Tamminga et al. 1997). To improve this, published experiments (Belyea et al. 1978; Martin and Ehle, 1986; Chilliard et al., 1991; McGuffey et al., 1991; Gibb et al., 1992; Andrew et al., 1994; Komaragiri and Erdman, 1997; Komaragiri et al., 1998), with measured body lipid and protein changes relative to stage of lactation, were used. From these experiments the following empirical relationship between body protein balance and EB (MJ/d) was obtained:

$$\text{Body protein balance (g/d)} = (21.2 + 56.04e^{-0.033DIM})(EB / 7.37) \quad [9]$$

This relationship simulates an increasing fat-to-protein ratio within the mobilized tissue as DIM increases. The final NE_L and MP above maintenance values, calculated for the 2 experiments are shown in Tables 1 and 2.

Table 1. Intake, milk production and calculated nutritional values with INRA Systali feed unit system for weekly data of Law et al. (2009). Means are for cows that received the same dietary treatment throughout the entire lactation¹.

	11.4% CP	14.4% CP	17.3% CP
DMI, kg/d	16.7 (\pm SD, 1.2)	17.5 (1.3)	18.2 (1.7)
Milk yield, kg/d	22.7 (1.8)	29.3 (3.0)	31.7 (4.3)
Milk fat yield, g/d	957 (88)	1,131 (107)	1,166 (129)
Milk protein yield, g/d	745 (38)	982 (74)	1,061 (103)
Milk lactose yield, g/d	1,104 (79)	1,420 (133)	1,523 (218)
Nutritional values calculated with INRA Systali feed unit system			
NE _L , MJ/kg DM ;	7.22 (0.04) ;	7.26 (0.05) ;	7.30 (0.07) ;
Mcal/kg DM	1.73 (0.01)	1.74 (0.01)	1.74 (0.02)
MP, g/kg DM	81 (0)	97 (1)	113 (1)
NE _L above maintenance, MJ/d ;	74 (7) ;	81 (9) ;	87 (11) ;
Mcal/d	17.7 (1.7)	19.4 (2.2)	20.8 (2.6)
MP above maintenance, g/d	904 (24)	1,260 (74)	1,571 (120)
NE _L efficiency	1.02 (0.17)	1.15 (0.14)	1.14 (0.21)
MP efficiency	0.82 (0.04)	0.78 (0.04)	0.67 (0.03)
NE _L pivot ² , MJ/d ; Mcal/d	89 (13) ; 21.3 (3.1)	113 (14) ; 27.0 (3.3)	106 (20) ; 25.3 (4.8)
MPpivot ² , g/d	1,361 (196)	1,795 (193)	1,741 (303)

¹Means of 43 weekly means are presented. Number of cows per treatment was 16, 15 and 16 for 11.4% CP, 14.4% CP and 17.3% CP, respectively.

²NE_Lpivot = Level of NE_L above maintenance supply for which NE_L efficiency is 1 and MP efficiency is 0.67; MPpivot = Level of MP above maintenance supply for which MP efficiency is 0.67 and NE_L efficiency is 1.

Table 2. Intake, milk production and calculated nutritional values with INRA Systali feed unit system for weekly data of Friggens et al. (1998). Means are for cows that received the same dietary treatment throughout the entire lactation¹.

	27% concentrate	59% concentrate
DMI, kg/d	16.1 (\pm SD, 1.2)	20.4 (1.7)
Milk yield, kg/d	24.2 (3.5)	31.0 (6.9)
Milk fat yield, g/d	1,075 (176)	1,182 (263)
Milk protein yield, g/d	747 (93)	990 (194)
Milk lactose yield, g/d	1,074 (177)	1,477 (356)
Nutritional values calculated with INRA Systali feed unit system		
NE _L , MJ/kg DM ;	7.39 (0.04) ; 1.77 (0.01)	7.31 (0.06) ; 1.75 (0.01)
Mcal/kg DM		
MP, g/kg DM	82 (1)	100 (1)
NE _L above maintenance, MJ/d ;	69 (8) ; 16.5 (1.9)	98 (13) ; 23.4 (3.1)
Mcal/d		
MP above maintenance, g/d	929 (73)	1,442 (217)
NE _L efficiency	1.15 (0.24)	0.96 (0.13)
MP efficiency	0.80 (0.04)	0.68 (0.04)
NE _L pivot ² , MJ/d ; Mcal/d	97 (19) ; 23.2 (4.5)	97 (28) ; 23.2 (6.7)
MPpivot ² , g/d	1,382 (247)	1,498 (424)

¹Means of 42 weekly means are presented (43 for DMI and milk yield). Number of cows per treatment was 5.

²NE_Lpivot = Level of NE_L above maintenance supply for which NE_L efficiency is 1 and MP efficiency is 0.67; MPpivot = Level of MP above maintenance supply for which MP efficiency is 0.67 and NE_L efficiency is 1.

To evaluate the use of the pivot values for protein and energy to predict milk responses, weekly NEL and MP supplies above maintenance were used together with milk energy and protein yields to calculate pivot values for MP and NEL. The MP_{pivot} and NEL_{pivot} were calculated for each week using the mean of the data from one treatment and applied together with the response equations to predict milk energy yield and milk components yields of the other treatments. In Friggens et al. (1998), the treatment with high concentrate (59%, DM basis) was first used to calculate pivots and comparisons of model predictions with data were performed with the rest of the treatments. In that case, a total of 126 comparisons of weekly averages were made (42 weekly averages * (4-1) dietary treatments). Further, because the treatment used to calculate the pivots could potentially influence the accuracy of the prediction, the procedure was repeated using the treatment with low concentrate level (27%, DM basis) to calculate the pivots and predict milk energy yield and milk component yields of the other treatments. Thus, in total, 252 comparisons of weekly averages were made (126 with pivot calculated from high concentrate treatment and 126 with pivot calculated from low concentrate treatment). The same approach was applied to the experiment of Law et al. (2009) where the pivots were calculated 3 times: from the treatment with low CP content (215 weekly averages = 43 weekly averages * (6-1) dietary treatments), with medium CP content (215 weekly averages) and with high CP content (215 weekly averages). So in total, for Law et al. (2009), 645 comparisons of weekly averages were made.

For this evaluation, the quality of the independent predictions was evaluated using the concordance correlation coefficient (CCC), calculated as described in Lin (1989), and the root mean square prediction error (RMSPE) computed as previously described (Theil, 1966; Bibby and Toutenburg, 1977). The RMSPE can be decomposed into error due to overall bias (ECT), error due to deviation of the regression slope from unity (ER) and error due to the disturbance (random error; ED; Bibby and Toutenburg, 1977). Finally, the effects of stage of lactation on the quality of the model prediction for milk energy yield and milk component yields were evaluated with the corrected Akaike's information criterion (AICc). For that purpose 3 groups of stage of lactation were created: Early-lactation (<15 weeks in milk), mid-lactation ($15 \leq$ weeks in milk <30) and late lactation (≥ 30 weeks in milk). Based on these 3 groups, 2 dummy variables were created: M (1 for mid-lactation, 0 for early- and late-lactation) and L (1 for late-lactation, 0 for early- and mid-lactation). To evaluate the effect of stage of lactation, a reduced

model was compared to a full model using PROC REG (SAS Institute Inc., Cary, NC, USA). The reduced model was:

$$Y_{ij} = \mu + \alpha X_{ij} + \varepsilon_{ij} \quad [10]$$

where Y_{ij} are the observed milk energy yield, milk fat yield, milk protein yield and milk lactose yield; μ is the overall intercept; X_{ij} is the corresponding predicted values; α is the overall slope between Y and X , ε_{ij} is the residual error; i is the treatment used to calculate the pivot; and j is the week of lactation. The full model is:

$$Y_{ijk} = \mu + \alpha M_k + \beta L_k + (\lambda + \gamma M_k + \omega L_k) X_{ij} + \varepsilon_{ijk} \quad [11]$$

The difference between model [10] and [11] is that, in the latter, the slope and intercept are allowed to vary between the 3 groups created for stage of lactation. Therefore μ is the intercept of the early-lactation group; α and β are the coefficients adjusting the intercept for mid- and late-lactation groups respectively; λ is the slope between observed Y and predicted X for early-lactation; γ and ω are the coefficients adjusting the slope for mid- and late-lactation groups respectively; k is the stage of lactation. The full model [11] was compared to the reduced model [10] based on the AICc and the RMSE. Differences in AICc >3 between the full and the reduced models indicate that there is good evidence that the model with the smaller AICc is significantly better than the model with the larger AICc (Burnham and Anderson, 2002).

Results

Results of the comparison between predicted and observed milk energy yield and milk component yields for the 2 datasets are shown in Table 3. Milk energy yield and milk component yields were predicted with a maximum RMSPE of 13.5% (for milk fat yield) and a minimum CCC of 0.784 (also for milk fat yield). The slope of the relationships between observed and predicted milk energy yield and milk component yields was within range of 0.75 and 1.03, indicating no major slope bias. In fact, the largest part of the prediction error was the random error component (minimum ED was 75.1% for milk fat yield). This quality of prediction was achieved despite large differences in MP and NE_L supply between treatments in dataset 1 (667 g/d in MP and 13 MJ/d (3.11 Mcal/d) in NE_L, see Table 1) and in dataset 2 (513 g/d in MP and 29 MJ/d (6.93 Mcal/d) in NE_L, see Table 2).

Table 3. Summary of observed vs predicted milk energy yield and milk component yields from 2 independent datasets using weekly MP and NE_L supply above maintenance as inputs. Predictions were made using response equations centered on MP and NE_L pivots (see equations 3 and 4 in the text).

	Dataset ¹	N	Observed ²	Predicted ²	RMSPE% ³	ECT% ⁴	ER% ⁵	ED% ⁶	CCC ⁷	Slope (SE)
Milk energy yield, MJ/d (Mcal/d)	1	645	90.3 ± 12.2 (21.6 ± 2.9)	88.3 ± 12.6 (21.1 ± 3.0)	7.6	8.1	9.8	82.1	0.848	0.83 (0.019)
	2	252	85.9 ± 21.8 (20.5 ± 5.2)	86.8 ± 19.9 (20.7 ± 4.8)	10.3	1.0	0.0	99.0	0.910	1.00 (0.028)
Milk component yields, g/d										
Fat	1	645	1,115 ± 145	1,084 ± 154	8.9	10.0	14.9	75.1	0.784	0.75 (0.022)
	2	252	1,115 ± 288	1,117 ± 246	13.5	0.0	0.0	100.0	0.843	1.00 (0.039)
Protein	1	645	951 ± 141	942 ± 145	9.3	1.0	11.6	87.3	0.807	0.79 (0.023)
	2	252	858 ± 217	866 ± 219	9.6	0.8	4.4	94.8	0.928	0.92 (0.023)
Lactose	1	645	1,402 ± 224	1,371 ± 201	9.1	6.1	1.1	92.8	0.822	0.93 (0.024)
	2	252	1,250 ± 360	1,278 ± 328	10.0	4.8	0.8	94.5	0.934	1.03 (0.024)

¹Dataset 1: Law et al. (2009), model prediction of the 6 dietary treatments (excluding the treatment used to calculate the pivots) with weekly data was performed from week 1 to week 43. Overall mean of the 3 predictions (using treatments (1) 11.4% CP, (2) 14.4% CP and (3) 17.3% CP to calculate the pivots) are presented. Dataset 2: Friggens et al. (1998), model prediction of the 4 dietary treatments (excluding the treatment used to calculate the pivots) with weekly data was performed from week 2 to week 43. Overall mean of the 2 predictions (using treatments (1) 27% concentrate and (2) 59% concentrate to calculate the pivots) are presented.

²Mean ± SD.

³Root mean square prediction error expressed as a percentage of the observed mean.

⁴Error due to intercept bias, as a percent of total MSPE.

⁵Error due to slope bias, as a percent of total MSPE.

⁶Error due to disturbance, as a percent of total MSPE.

⁷Concordance correlation coefficient (scale from -1 to 1).

⁸Slope of predicted vs. observed regression as determined in PROC REG (SAS Institute Inc., Cary, NC, USA).

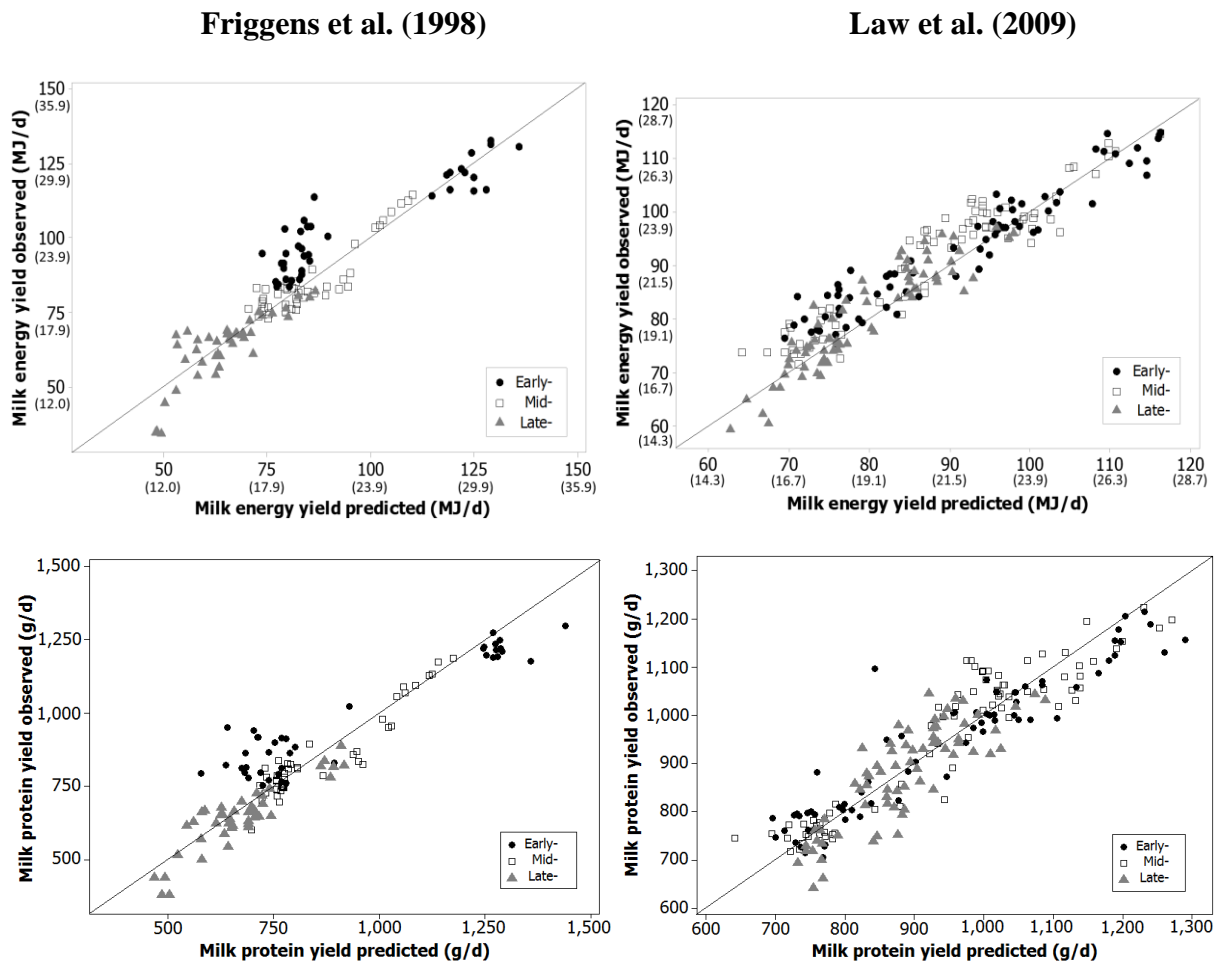

Figure 5 Comparison between observed values of milk yield and milk protein yield and predicted values. The highest quality nutritional treatment in both experiments was used to calculate MP_{pivot} and $NE_{L,pivot}$. Equations published in Daniel et al (2016) were then applied with the calculated pivots to predict values for the other treatments. MP_{pivot} = Level of MP above maintenance supply for which MP efficiency is 0.67 and $NE_{L,pivot}$ = Level of NE_L above maintenance supply for which NE_L efficiency is 1 and MP efficiency is 0.67. Regressions are plotted by groups of lactation stage with: Early lactation (<100 DIM, solid line with ●), mid lactation (100<DIM<200, dashed line with □) and late lactation (>200 DIM, solid line with ▲). Each data point represents a treatment mean in a given week of lactation. In parentheses, energy values are reported in Mcal/d.

Illustration of the prediction quality is shown in Figure 5 for milk energy yield and milk protein yield of both datasets. Prediction of milk energy yield and milk component yields were predicted with equivalent accuracy between the 2 datasets. However, in the dataset from Law et al. (2009), better predictions were achieved for milk energy yield and milk component yields when the pivot was calculated from the high CP treatment (i.e. 17.3% CP, DM basis) as compared to the low CP treatment (i.e. 11.4% CP, DM basis). As an example milk energy yield was predicted with a CCC of 0.903 and a

RMSPE of 5.2% when the high CP treatment was used to calculate the pivots whereas CCC and RMSPE were only 0.689 and 9.6% respectively, when the low CP treatment was used to calculate the pivots. This effect was not observed in the dataset from Friggens et al. (1998). The full details of the effect of the nutritional treatment used to calculate the pivot can be found in appendix 3 (Table A3.1 for Law et al., 2009 and Table A3.2 for Friggens et al., 1998).

The importance of the pivots can be evaluated by comparing the current approach with application of the response curves without any pivot (i.e. assuming the pivot is the observed production). Assessed through the RMSPE and the CCC, the approach using pivot values for NE_L and MP performed substantially better than the one without pivots (see Table 3 vs Table A3.3). For dataset 1, RMSPE and CCC of milk energy yield and milk component yields were improved by 44% and 29% respectively when pivots were used. Similarly in dataset 2, RMSPE and CCC were improved by 26% and 8% respectively. This clearly demonstrates the value of calculating a pivot before applying the response curve.

Based on the AICc, regression models relating pivot-method predicted values to observed values were improved by allowing these models to have different slopes (and intercept) according to stage of lactation (early, mid and late), indicating significant differences in prediction between groups (see Table 4). However, the effects of stage of lactation were not coherent across datasets. In the dataset of Law et al. (2009), for milk protein yield, the slopes were 0.84, 0.78 and 0.62 for early, mid- and late-lactation groups, respectively. This indicates less bias in the predicted values for early- than late-lactation data. This improvement was nevertheless moderate as the RMSE only decreases from 83 to 81 g/d between the reduced and the full model. Similar observations were made for milk energy yield and milk lactose yield with less bias in predicted values in early- and mid-lactation as compared to late lactation. Also, for milk energy yield and milk lactose yield the RMSE decreases only moderately between the reduced and the full model, respectively from 6.2 to 5.7 MJ/d (1.48 to 1.36 Mcal/d) and from 123 to 118 g/d. In the dataset of Friggens et al. (1998), the slopes for milk protein yield were 0.72, 0.90 and 0.93 for early-, mid- and late-lactation groups, respectively. In this case, the model fit was judged better for mid- and late-lactation as compared to early-lactation. The decrease in RMSE for milk protein yield was larger in this dataset, from 81 to 69 g/d between the reduced and the full model. This trend was not observed

for milk lactose yield and reduction of RMSE between full and reduced model was minor: 122 to 121 g/d. In the case of milk fat yield, the slopes indicated better predictions in late-lactation as compared to early- and mid-lactation for both of the datasets (see Table 4).

Table 4. Comparison between reduced and full models in AICc, RMSE and slope of the relationships between observed vs predicted milk energy yield and milk component yields from 2 independent datasets

	Model ¹	N	AICc ²	RMSE ³	Slope (SE) ⁴		
					Early-lactation	Mid-lactation	Late-lactation
Law et al., 2009							
Milk energy yield	Reduced	645	2,361	6.2 (1.48)	-	-	-
	Full	645	2,260	5.7 (1.36)	0.85 (±0.030)	0.72 (±0.036)	0.70 (±0.034)
Milk fat yield	Reduced	645	5,752	86	-	-	-
	Full	645	5,613	77	0.62 (±0.038)	0.58 (±0.038)	0.71 (±0.038)
Milk protein yield	Reduced	645	5,705	83	-	-	-
	Full	645	5,674	81	0.84 (±0.039)	0.78 (±0.038)	0.62 (±0.043)
Milk lactose yield	Reduced	645	6,211	123	-	-	-
	Full	645	6,164	118	0.98 (±0.046)	0.85 (±0.045)	0.71 (± 0.044)
Friggens et al., 1998							
Milk energy yield	Reduced	252	1,099	8.8 (2.10)	-	-	-
	Full	252	1,017	7.4 (1.77)	0.70 (±0.041)	0.79 (±0.073)	0.97 (±0.082)
Milk fat yield	Reduced	252	2,530	151	-	-	-
	Full	252	2,447	127	0.58 (±0.062)	0.58 (±0.108)	0.83 (±0.120)
Milk protein yield	Reduced	252	2,215	81	-	-	-
	Full	252	2,142	69	0.72 (±0.030)	0.90 (±0.055)	0.93 (±0.061)
Milk lactose yield	Reduced	252	2,424	122	-	-	-
	Full	252	2,420	121	0.96 (±0.064)	1.08 (±0.075)	0.92 (± 0.053)

¹Reduced: See equation 10 in the text. Full: See equation 11 in the text.

²Corrected akaike's information criterion.

³Root mean square error, expressed in g/d, except for milk energy yield, in MJ/d and Mcal/d in parentheses.

⁴Slope of the relationship between observed vs predicted. Early-lactation: <15 weeks in milk; Mid-lactation: 15≤ weeks in milk <30; Late-lactation: ≥30 weeks in milk

Discussion

As demonstrated in Figure 5, the pivot concept can be used to predict milk energy yield and milk component yields responses to dietary change with RMSPE below 13.5% and CCC above 0.784 for diets that are substantially different (Table 1 and 2), and across all stages of lactation. The 2 datasets used to evaluate the equations in combination with pivot values were very challenging as there were large differences in the NE_L and MP supply spectrum, far greater (at least for MP supply) than average differences observed within each experiment used to calibrate the equations. In the original dataset (Daniel et al., 2016), those average differences in MP and NE_L supply above maintenance were 181 ± 116 g/d and 12 ± 9 MJ/d (2.87 ± 2.15 Mcal/d), respectively whereas in datasets 1 and 2, average differences were 513 g/d and 13 MJ/d (3.11 Mcal/d), respectively. Expressed relative to pivot, the range of MP supply above maintenance in the original dataset was between -460 and 368 g/d (mean \pm 2 SD), whilst this range was between -1144 and 490 g/d in dataset 1 and between -1023 and 534 g/d in dataset 2. With respect to NE_L supply above maintenance, the original range was between -30 and 30 MJ/d (-7.17 and 7.17 Mcal/d), whilst this range was between -63 and 27 MJ/d (-15.06 and 5.50 Mcal/d) in dataset 1 and between -62 and 42 MJ/d (-14.82 and 10.04 Mcal/d) in dataset 2. Thus, the equations in combination with the concept of using efficiency pivots appear to be robust even in extreme situations. The concept of using a response curve centered on fixed MP_{eff} and NE_L_{eff} has emerged from correlations observed between size of expected responses and efficiency, in the context where nutrition is the main driver (Figure 1). This concept was then extrapolated across lactation stages where NE_L_{eff} and MP_{eff} are not only influenced by nutrition but also driven by homeorhetic regulation (see Figure 4). The hypothesis was that partitioning of surplus nutrients would be independent of the driving factor, either dietary manipulation or animal physiology. The consequence is that, due to the higher efficiency observed in early lactation as compared to late lactation, responses would be greater in early lactation, consistent with previous work (Broster, 1972; Broster and Thomas, 1981; Kirkland and Gordon, 2001). With this hypothesis, milk energy yield and milk component yields responses were predicted with similar accuracy across stages of lactation (Figure 5 and Table 4). Another implicit consequence of using fixed reference efficiencies to center response equations is that at fixed nutrient intake, greater responses are expected for a high producing as

compared to a low producing cow. This is because, at same nutrient intake, the lower producing animal is closer to its maximum capacity of production than the high producing dairy cow is. In agreement with our approach, this effect has previously been observed in a context where cows of different potential are fed at fixed nutrient intake (Brody, 1945; Broster and Thomas, 1981). However, using the pivot (i.e. at same production level relative to potential), low and high producing cows are expected to respond with our approach the same way to an increase in nutrient supply. This could explain the divergent conclusion relative to the effect of animal production level on the size of the milk yield response in *ad libitum* feeding systems (no significant effect: Huhtanen and Nousiainen, 2012; significant effect: Boerman et al., 2015).

Within the large range of data used to calibrate the response equation, no evidence of interaction was found for any of the milk variables (Daniel et al., 2016) and thus the prediction of responses and the calculation of pivots were constructed on this basis. However, difficulties in calculating the pivot values were encountered when the observation was characterized by both, high NE_{Leff} and high MP_{eff} . In these specific conditions, often observed in the first days of the lactation (e.g. Figure 4) or in case of very poor nutrition, no real solutions for the pivot values were found. Extrapolation of these cases revealed that in the area of extreme high efficiency for both NE_L and MP , the milk protein yield response equation can lead to prediction of a positive milk protein yield even when the MP supply above maintenance is zero (depending on NE_L supply above maintenance). This suggests that there is an interaction between NE_L and MP supply, which comes into play when observed NE_L and MP supplies are far below their respective pivots (Figure 1) and out of the original range of data used for the calibration of the equations (Daniel et al., 2016). In the present paper, in order to preserve the simplicity of the pivot method, it was decided to ignore this interaction (i.e. use the original meta-analysis equations of Daniel et al. 2016) and solve the problem of complex numbers through an optimization procedure (detailed in Appendix 2). However, this issue clearly merits further study if the model is to be deployed in relatively extreme situations.

In the current paper, the pivot method was evaluated using group averages, albeit containing small numbers of cows (see Table 1 and 2). This represents the most common situation where currently feeding data are available on a group basis. In the context of the increasing development of precision livestock feeding, a next step would

be to evaluate the accuracy of this approach when applied at the level of individual cows. Assuming the method is sufficiently accurate, dairy cows within a farm could be ranked based on their estimated production at pivots. This is because the level of production at pivot is adjusted for the effect of nutrition (on an energy and protein basis). Therefore production at $MP_{\text{eff}}=0.67$ and $NE_{L\text{eff}}=1.00$ is assumed to be standardized, which means that differences in production between animals are assumed not to be due to current nutrition. The ranking of animals generated by this approach would theoretically represent differences in genetics as well as individual difference in permanent environment effects (e.g. past environmental effects).

With respect to predicting responses to change in ration composition under field conditions, the approach presented here is only partly predictive. This is because it uses NE_L and MP supply as input values whereas in practice, they first need to be estimated from the composition of the ration together with a quantification of dry-matter intake response to change in ration composition. Therefore, integration of a dry-matter intake response equation within this approach is necessary to predict short-term response to change in ration composition under field conditions.

Conclusion

This paper provides a method, based on NE_L and MP efficiency, to estimate the production level of the animal relative to its potential and subsequent milk responses to change in NE_L and MP supply. This method uses as a pivot the supply of NE_L and MP , equivalent to NE_L and MP efficiency of 1 and 0.67 respectively, from which milk energy yield and milk component yields responses can be derived. Independent evaluation using 2 contrasting datasets demonstrated the utility of the pivot concept. Finally, milk energy yield and milk component yields were predicted across lactation stages with RMSPE below 13.5% and CCC above 0.784, with a large part of the error due to random variation (above 75.1%).

Acknowledgments

We gratefully acknowledge the work of Rafael Munoz Tamayo (UMR MoSAR, INRA, Paris) who developed the optimization procedure used to calculate pivot values on MatLab software.

References

- Andrew, S., D. Waldo, and R. Erdman. 1994. Direct analysis of body composition of dairy cows at three physiological stages. *J. Dairy Sci.* 77:3022-3033.
- Bauman, D. E., and W. B. Currie. 1980. Partitioning of nutrients during pregnancy and lactation: A review of mechanisms involving homeostasis and homeorhesis. *J. Dairy Sci.* 63:1514–1529.
- Belyea, R., G. Frost, F. Martz, J. Clark, and L. Forkner. 1978. Body composition of dairy cattle by potassium-40 liquid scintillation detection. *J. Dairy Sci.* 61:206-211.
- Bibby, J., and H. Toutenburg. 1977. *Prediction and Improved Estimation in Linear Models.* Wiley, Berlin, Germany.
- Boerman, J., S. Potts, M. VandeHaar, M. Allen, and A. Lock. 2015. Milk production responses to a change in dietary starch concentration vary by production level in dairy cattle. *J. Dairy Sci.* 98:4698-4706.
- Brody, S. 1945. *Bioenergetics and growth, with special reference to the efficiency complex in domestic animals.* Reinhold, New York, NY.
- Broster, W. 1972. Effect on milk yield of the cow of the level of feeding during lactation. Pages 265-288 in *Proc. Dairy Sci. Abstr.*
- Broster, W. and C. Thomas. 1981. Influence of level and pattern of concentrate input on milk output. *Recent advances in animal nutrition.*
- Brun-Lafleur, L., L. Delaby, F. Husson, and P. Faverdin. 2010. Predicting energy× protein interaction on milk yield and milk composition in dairy cows. *J. Dairy Sci.* 93:4128-4143.
- Burnham, K.P., and D.R. Anderson. 2002. *Model selection and multimodel inference,* 2nd edition. Springer Verlag, New York City, New York, USA.
- Chilliard, Y., M. Cisse, R. Lefaivre, and B. Remond. 1991. Body composition of dairy cows according to lactation stage, somatotropin treatment, and concentrate supplementation. *J. Dairy Sci.* 74:3103-3116.
- Council, N. R. 2001. *Nutrient requirements of dairy cattle,* 7th revised edition. National Academy Press, Washington, DC, USA.
- Daniel, J.B., N. Friggens, P. Chapoutot, H. Van Laar, and D. Sauvant. 2016. Milk yield and milk composition responses to change in predicted net energy and metabolizable protein: a meta-analysis. *Animal.* Accepted.
- Friggens, N., G. Emmans, I. Kyriazakis, J. Oldham, and M. Lewis. 1998. Feed intake relative to stage of lactation for dairy cows consuming total mixed diets with a high or low ratio of concentrate to forage. *J. Dairy Sci.* 81:2228-2239.
- Friggens, N. C., P. Berg, P. Theilgaard, I. R. Korsgaard, K. L. Ingvarsten, P. Løvendahl, and J. Jensen. 2007. Breed and parity effects on energy balance profiles through lactation: Evidence of genetically driven body energy change. *J. Dairy Sci.* 90:5291–5305.
- Gibb, M., W. Ivings, M. Dhanoa, and J. Sutton. 1992. Changes in body components of autumn-calving Holstein-Friesian cows over the first 29 weeks of lactation. *Anim. Prod.* 55:339-360.
- Huhtanen, P. and J. Nousiainen. 2012. Production responses of lactating dairy cows fed silage-based diets to changes in nutrient supply. *Livest. Sci.* 148:146-158.
- Jensen, C., S. Østergaard, I. Schei, J. Bertilsson, and M. R. Weisbjerg. 2015. A meta-analysis of milk production responses to increased net energy intake in Scandinavian dairy cows. *Livest. Sci.* 175:59-69.
- Kirkland, R. and F. Gordon. 2001. The effects of milk yield and stage of lactation on the partitioning of nutrients in lactating dairy cows. *J. Dairy Sci.* 84:233-240.
- Komaragiri, M. V., D. Casper, and R. Erdman. 1998. Factors affecting body tissue mobilization in early lactation dairy cows. 2. Effect of dietary fat on mobilization of body fat and protein. *J. Dairy Sci.* 81:169-175.
- Komaragiri, M. V. and R. A. Erdman. 1997. Factors affecting body tissue mobilization in early lactation dairy cows. 1. Effect of dietary protein on mobilization of body fat and protein. *J. Dairy Sci.* 80:929-937.

- Law, R., F. Young, D. Patterson, D. Kilpatrick, A. Wylie, and C. Mayne. 2009. Effect of dietary protein content on animal production and blood metabolites of dairy cows during lactation. *J. Dairy Sci.* 92:1001-1012.
- Lin, L.I.K. 1989. A concordance correlation coefficient to evaluate reproducibility. *Biometrics.* 45:255-268.
- Leclerc, H. 2008. Development of the French dairy cattle test-day model genetic evaluation and prospects of using results for herd management. Ph.D. Thesis. AgroParisTech, Paris, France.
- Martin, R. and F. Ehle. 1986. Body composition of lactating and dry Holstein cows estimated by deuterium dilution. *J. Dairy Sci.* 69:88-98.
- McGuffey, R., R. Basson, and T. Spike. 1991. Lactation response and body composition of cows receiving somatotropin and three ratios of forage to concentrate. *J. Dairy Sci.* 74:3095-3102.
- National Research Council. 2001. *Nutrient Requirements of Dairy Cattle.* 7th rev. ed. Natl. Acad. Press, Washington, DC.
- Neal, H. D. S. C., and J. H. M. Thornley. 1983. The lactation curve in cattle: A mathematical model of the mammary gland. *J. Agric. Sci. (Camb.)* 101:389-400.
- Sauvant, D., G. Cantalapiedra-Hijar, L. Delaby, J. Daniel, P. Faverdin, and P. Nozière. 2015a. Actualisation des besoins protéiques des ruminants et détermination des réponses des femelles laitières aux apports de protéines digestibles dans l'intestin. *INRA Prod. Anim.* 28:347-368.
- Sauvant, D. and P. Nozière. 2016. Quantification of the main digestive processes in ruminants: The equations involved in the renewed energy and protein feed evaluation systems. *Animal* 10:755-770.
- Sauvant, D., I. Ortigues-Marty, S. Giger-Reverdin, and P. Nozière. 2015b. Actualisation des besoins et efficacités énergétiques des femelles laitières. *Renc. Rech. Ruminants* 22:225-228.
- Tamminga, S., P. Luteijn, and R. Meijer. 1997. Changes in composition and energy content of liveweight loss in dairy cows with time after parturition. *Livest. Prod. Sci.* 52:31-38.
- Theil, H. 1966. *Applied economic forecasting.* North-Holland Publishing Company, Amsterdam, the Netherlands.
- Thomas, C. 2004. *Feed Into Milk: A new applied feeding system for dairy cows.* Nottingham University Press, Nottingham, UK.
- Vetharaniam, I., S. R. Davis, M. Upsdell, E. S. Kolver, and A. B. Pleasants. 2003. Modeling the effect of energy status on mammary gland growth and lactation. *J. Dairy Sci.* 86:3148-3156.
- Volden, H. 2011. *NorFor – The Nordic feed evaluation system.* EAAP Publications No 130. Wageningen Academic Publishers, the Netherlands.

Appendix 1**1. Energy calculations**

$$- \text{Milk energy (MJ/d)} = 39.8 * \text{MFY} + 23.9 * \text{MPY} + 16.5 * \text{MLY}$$

with MFY (kg/d) = Milk fat yield, MPY (kg/d) = Milk protein yield and MLY (kg/d) = Milk lactose yield.

$$- \text{NE}_L \text{ supply (MJ/d)} = \text{DMI} * \text{NE}_L$$

with DMI (kg/d) = dry-matter intake, NE_L (MJ/kg DM) = Dietary NE_L content

$$- \text{NE}_L \text{ maintenance (MJ/d)} = 0.394 * (\text{avgBW}^{0.75})$$

with avgBW (kg) = average BW of the lactation

$$- \text{NE}_L \text{ gestation (MJ/d)} = 7.1 * (0.00072 * 45 * \exp(0.116 * \text{WIP}))$$

with 7.1 converts UFL (French energy unit for milk) into MJ; WIP = week in pregnancy.

All animals were assumed pregnant at week 14 of lactation.

$$- \text{NE}_L \text{ above maintenance (MJ/d)} = \text{NE}_L \text{ supply} - (\text{NE}_L \text{ maintenance} + \text{NE}_L \text{ gestation})$$

$$- \text{EB (MJ/d)} = (\text{NE}_L \text{ supply} - (\text{Milk energy} + \text{NE}_L \text{ maintenance} + \text{NE}_L \text{ gestation})) / \text{kls} * \text{kgt}$$

where EB = energy balance, k_{is} is the efficiency to convert dietary ME into milk NE_L calculated as $k_{is} = 0.65 + 0.247 * [(ME/GE) - 0.63]$ with ME = metabolizable energy and GE = gross energy; kgt is the efficiency to convert NE_L from body reserves into milk NE_L and also to convert dietary ME into NE_L body reserves. The coefficient k_{gt} is calculated as: $k_{gt} = k_{is} + 0.15$.

2. Protein calculations

$$- \text{Faecal metabolic CP losses (g/d)} = \text{DMI} * [5 * (0.57 + 0.0074 * \text{OMnd})]$$

where DMI (kg/d) = dry-matter intake, OMnd (g/kg DM) = Organic matter non-digested

$$- \text{Urinary endogenous N losses (g/d)} = 0.312 * \text{avgBW}$$

$$- \text{Scurf CP losses (g/d)} = 0.2 * \text{avgBW}^{0.6}$$

with avgBW (kg) = average BW of the lactation

$$- \text{BPB (g/d)} = (21.2 + 56.04 * \exp(-0.033 * \text{DIM})) * (\text{EB} / 7.37)$$

with BPB = body protein balance, DIM = days in milk, EB = Energy balance

$$- \text{MP supply (g/d)} = \text{DMI} * \text{MP}$$

with DMI (kg/d) = dry-matter intake, MP (g/kg DM) = Dietary MP content

- MP gestation (g/d) = $0.07 \cdot 45 \cdot \exp(0.111 \cdot \text{WIP}) \cdot 0.64$

WIP = week in pregnancy. All animals were assumed pregnant at week 14 of lactation.

The coefficient 0.64 converts MP requirement for gestation into MP utilized for gestation.

- MP efficiency, BPB requirement and MP above maintenance supply are calculated iteratively by using an initial value of 0.67
 1. BPB requirement (g/d) = if $EB < 0$ then $\text{BPB} \cdot \text{MP efficiency}$, if $EB > 0$ then $\text{BPB} / \text{MP efficiency}$.
 2. MP above maintenance (g/d) = $\text{MP supply} - (\text{Faecal metabolic CP losses} / \text{MP efficiency}) - \text{Urinary endogenous N losses} - (\text{Scurf CP losses} / \text{MP efficiency}) - \text{BPB requirement} - (\text{MP gestation} / \text{MP efficiency})$
 3. MP efficiency = $\text{Milk protein yield} / \text{MP above maintenance}$
 4. Steps 1 to 3 were repeated 20 times using MP efficiency calculated in step 3.

Appendix 2

Our mathematical approach aims at solving the following equations:

$$E_1: \mathbf{MPpivot} * 0.67 - \mathbf{MPY} + 0.19 * (\mathbf{MP} - \mathbf{MPpivot}) - 0.000193 * (\mathbf{MP} - \mathbf{MPpivot})^2 + 3.137 * (\mathbf{NE}_L - \mathbf{NE}_L\mathbf{pivot}) - 0.021 * (\mathbf{NE}_L - \mathbf{NE}_L\mathbf{pivot})^2 = 0$$

$$E_2: \mathbf{NE}_L\mathbf{pivot} - \mathbf{MEY} + 0.015 * (\mathbf{MP} - \mathbf{MPpivot}) - 0.000017 * (\mathbf{MP} - \mathbf{MPpivot})^2 + 0.166 * (\mathbf{NE}_L - \mathbf{NE}_L\mathbf{pivot}) - 0.0018 * (\mathbf{NE}_L - \mathbf{NE}_L\mathbf{pivot})^2 = 0$$

where MP is the MP above maintenance supply (g/d), NE_L is the NE_L above maintenance supply (MJ/d), MPY is the milk protein yield (g/d), MEY is the milk energy yield (MJ/d), MPpivot is the level of MP above maintenance supply for which MP efficiency is 0.67 (g/d), and NE_Lpivot is the level of NE_L above maintenance supply for which NE_L efficiency is 1 (MJ/d). MP, NE_L, MPY and MEY are given as input and NE_Lpivot and MPpivot are the variables to be found to satisfy E₁ and E₂.

To solve these equations the symbolic toolbox of Matlab® was used. Due to the nature of the equations (2 quadratic effects within each equation), there are 4 combination of values for NE_Lpivot and MPpivot. These values were obtained by using the Matlab function *solve* which provides symbolic solutions for algebraic equations. When evaluating numerically the 4 couples of solutions obtained, two give systematically complex numbers and were discarded. Between the 2 real solutions, the chosen solution was the one with smaller differences between MP and MPpivot, and between NE_L and NE_Lpivot.

When applying the symbolic derived solutions to a large database of the literature (1299 treatment means), all four solutions had complex numbers in 19.3% of the cases. When the four solutions contained complex numbers, it was then decided to calculate the pivot values by setting an optimization problem that minimizes the following cost function F

$$F = |E_1| + 10.716 * |E_2|$$

The value of 10.716 is a weighting coefficient to express the errors equivalently by considering the units of E_1 and E_2 . This coefficient was calculated from original root mean square error of E_1 and E_2 ($31.4/2.93$, Daniel et al., 2016).

The optimization procedure was performed in Matlab® by the function *fminsearch* that uses as algorithm of optimization the Nelder-Mead method (Lagarias et al., 1998)

References:

Daniel, J.B., N. Friggens, P. Chapoutot, H. Van Laar, and D. Sauvant. 2016. Milk yield and milk composition responses to change in predicted net energy and metabolizable protein: a meta-analysis. *Animal*. Accepted.

Lagarias, J. C., Reeds, J. A., Wright, M. H., Wright, P. E., 1998. Convergence properties of the Nelder-Mead simplex method in low dimensions. *SIAM J. Optim.* 9, 112–147.

Appendix 3

Table A3.1. Summary of observed vs predicted milk energy yield and milk component yields from the dataset of Law et al. (2009) using weekly MP and NE_L supply above maintenance as inputs. Predictions were made using response equations centered on MP and NE_L pivots (see equations 3 and 4 in the text).

	Pivot ¹	N	Observed ²	Predicted ²	RMSPE% ³	ECT% ⁴	ER% ⁵	ED% ⁶	CCC ⁷	Slope (SE)
Milk energy yield, MJ/d	1	215	88.3 ± 12.1	86.3 ± 12.7	5.2	14.1	8.3	77.5	0.903	0.90 (0.021)
	2	215	89.4 ± 13.0	92.4 ± 14.1	7.1	21.9	11.5	66.7	0.892	0.85 (0.025)
	3	215	93.0 ± 10.8	86.2 ± 9.6	9.6	58.1	0.2	41.6	0.689	0.95 (0.041)
Milk component yields, g/d										
Fat	1	215	1,099 ± 145	1,037 ± 151	9.1	36.4	7.2	56.4	0.779	0.83 (0.034)
	2	215	1,106 ± 151	1,132 ± 170	8.5	7.5	20.0	72.5	0.831	0.75 (0.032)
	3	215	1,140 ± 134	1,082 ± 125	9.1	31.3	3.8	64.9	0.708	0.84 (0.046)
Protein	1	215	924 ± 140	924 ± 145	6.2	0.0	8.3	91.6	0.912	0.89 (0.026)
	2	215	940 ± 153	994 ± 165	9.2	38.6	8.7	52.7	0.861	0.85 (0.026)
	3	215	988 ± 121	907 ± 101	11.5	49.6	0.7	49.6	0.585	0.90 (0.055)
Lactose	1	215	1,367 ± 220	1,361 ± 225	6.2	0.4	6.7	92.9	0.908	0.91 (0.025)
	2	215	1,388 ± 242	1,438 ± 205	8.2	19.3	1.6	79.0	0.875	1.07 (0.034)
	3	215	1,451 ± 202	1,313 ± 146	11.7	66.2	3.8	30.0	0.644	1.23 (0.044)

¹Pivot 1: Pivots were calculated using the dietary treatment with 17.3% CP over the whole lactation. The model prediction for the 5 others dietary treatments with weekly data was performed from week 1 to week 43. Pivot 2: Pivots were calculated using the dietary treatment with 14.4% CP over the whole lactation. The model prediction for the 5 others dietary treatments with weekly data was performed from week 1 to week 43. Pivot 3: Pivots were calculated using the dietary treatment with 11.4% CP over the whole lactation. The model prediction for the 5 others dietary treatments with weekly data was performed from week 1 to week 43.

²Mean ± SD.

³Root mean square prediction error expressed as a percentage of the observed mean.

⁴Error due to intercept bias, as a percent of total MSPE.

⁵Error due to slope bias, as a percent of total MSPE.

⁶Error due to disturbance, as a percent of total MSPE.

⁷Concordance correlation coefficient (scale from -1 to 1).

⁸Slope of predicted vs. observed regression as determined in PROC REG (SAS Institute Inc., Cary, NC, USA).

Table A3.2. Summary of observed vs predicted milk energy yield and milk component yields from the dataset of Friggens et al. (1998) using weekly MP and NE_L supply above maintenance as inputs. Predictions were made using response equations centered on MP and NE_L pivots (see equations 3 and 4 in the text).

	Pivot ¹	N	Observed ²	Predicted ²	RMSPE% ³	ECT% ⁴	ER% ⁵	ED% ⁶	CCC ⁷	Slope (SE)
Milk energy yield, MJ/d	1	126	83.5 ± 20.4	81.5 ± 19.1	9.6	5.8	0.1	94.2	0.918	0.99 (0.037)
	2	126	88.4 ± 22.9	92.1 ± 19.4	10.9	14.4	3.5	82.1	0.899	1.09 (0.040)
Milk component yields, g/d										
Fat	1	126	1,097 ± 276	1,046 ± 227	12.1	15.0	2.7	82.3	0.864	1.10 (0.048)
	2	126	1,133 ± 300	1,188 ± 245	14.6	10.8	0.4	88.9	0.820	1.04 (0.057)
Protein	1	126	818 ± 201	814 ± 213	10.1	0.2	11.4	88.4	0.919	0.87 (0.033)
	2	126	899 ± 227	917 ± 214	9.1	5.1	0.1	94.8	0.930	0.99 (0.034)
Lactose	1	126	1,183 ± 326	1,274 ± 347	10.5	52.9	5.9	41.2	0.934	0.91 (0.021)
	2	126	1,317 ± 380	1,282 ± 309	9.6	8.0	19.2	72.7	0.934	1.18 (0.031)

¹Pivot 1: Pivots were calculated using the dietary treatment with 59% concentrate over the whole lactation. The model prediction for the 3 others dietary treatments with weekly data was performed from week 2 to week 43. Pivot 2: Pivots were calculated using the dietary treatment with 27% concentrate over the whole lactation. The model prediction for the 3 others dietary treatments with weekly data was performed from week 2 to week 43.

²Mean ± SD.

³Root mean square prediction error expressed as a percentage of the observed mean.

⁴Error due to intercept bias, as a percent of total MSPE.

⁵Error due to slope bias, as a percent of total MSPE.

⁶Error due to disturbance, as a percent of total MSPE.

⁷Concordance correlation coefficient (scale from -1 to 1).

⁸Slope of predicted vs. observed regression as determined in PROC REG (SAS Institute Inc., Cary, NC, USA).

Table A3.3. Summary of observed vs predicted milk energy yield and milk component yields from 2 independent datasets using weekly MP and NE_L supply above maintenance as inputs. Weekly predictions were made using response equations centered on MP and NE_L supply above maintenance of one of the treatments (i.e. application of the response equations without any pivot).

	Dataset ¹	N	Observed ²	Predicted ²	RMSPE% ³	ECT% ⁴	ER% ⁵	ED% ⁶	CCC ⁷	Slope (SE)
Milk energy yield, MJ/d	1	645	90.3 ± 12.2	85.9 ± 10.9	12.1	16.1	8.7	75.3	0.583	0.70 (0.034)
	2	252	85.9 ± 21.8	83.0 ± 16.7	12.8	7.1	5.1	87.9	0.842	1.15 (0.039)
Milk component yields, g/d										
Fat	1	645	1,115 ± 145	1,051 ± 131	12.2	22.1	8.9	69.0	0.560	0.69 (0.034)
	2	252	1,115 ± 288	1,067 ± 213	15.7	7.5	1.5	90.9	0.765	1.10 (0.050)
Protein	1	645	951 ± 141	915 ± 122	14.1	7.2	12.5	80.2	0.500	0.61 (0.039)
	2	252	858 ± 217	823 ± 176	13.3	9.6	1.2	89.1	0.836	1.07 (0.039)
Lactose	1	645	1,402 ± 224	1,350 ± 191	12.0	9.6	3.5	86.9	0.681	0.83 (0.032)
	2	252	1,250 ± 360	1,252 ± 312	12.8	0.0	0.4	99.6	0.886	1.03 (0.032)

¹Dataset 1: Law et al. (2009), model prediction of the 6 dietary treatments (excluding the treatment used to center the equation) with weekly data was performed from week 1 to week 43. Overall mean of the 3 predictions (using treatments (1) 11.4% CP, (2) 14.4% CP and (3) 17.3% CP to center the equation) are presented. Dataset 2: Friggens et al. (1998), model prediction of the 4 dietary treatments (excluding the treatment used to calculate the pivots) with weekly data was performed from week 2 to week 43. Overall mean of the 2 predictions (using treatments (1) 27% concentrate and (2) 59% concentrate to calculate the pivots) are presented.

²Mean ± SD.

³Root mean square prediction error expressed as a percentage of the observed mean.

⁴Error due to intercept bias, as a percent of total MSPE.

⁵Error due to slope bias, as a percent of total MSPE.

⁶Error due to disturbance, as a percent of total MSPE.

⁷Concordance correlation coefficient (scale from -1 to 1).

⁸Slope of predicted vs. observed regression as determined in PROC REG (SAS Institute Inc., Cary, NC, USA).

Chapter 4

Modelling homeorhetic trajectories of milk component yields, body composition and dry-matter intake in dairy cows: Influence of parity, milk production potential and breed

J.B. Daniel^{1,2}, N.C. Friggens¹, H. Van Laar², K.L. Ingvarlsen³ and D. Sauvant¹

Submitted to *Animal*

¹*UMR Modélisation Systémique Appliquée aux Ruminants, INRA, AgroParisTech, Université Paris-Saclay, 75005 Paris, France*

²*Trouw Nutrition R&D, P.O. Box 220, 5830 AE Boxmeer, the Netherlands*

³*University of Aarhus, Faculty of Agricultural Sciences, Research Center Foulum, PO Box 50, DK-8830 Tjele, Denmark*

Abstract

The control of nutrient partitioning is complex and affected by many factors, among them physiological state and production potential. Therefore, the current model aims to provide for dairy cows a dynamic framework to predict a consistent set of reference performance patterns (milk component yields, body composition change, dry-matter intake) sensitive to physiological status across a range of milk production potentials (within and between breeds). Flows and partition of net energy toward maintenance, growth, gestation, body reserves and milk components are described in the model. This level of representation is complementary with current feed unit systems. The structure of the model is characterized by 2 sub-models, a regulating-sub model of homeorhetic control which sets dynamic partitioning rules along the lactation, and an operating sub-model that translates this into animal performance. The regulating sub-model describes lactation as the result of 3 driving forces: (1) Use of previously acquired resources through mobilization, (2) acquisition of new resources with a priority of partition towards milk, and (3) subsequent use of resources towards body reserves gain. The dynamics of these 3 driving forces were adjusted separately for fat (milk and body), protein (milk and body) and lactose (milk). Milk yield is predicted from lactose and protein yields with an empirical equation developed from literature data. The model predicts desired dry-matter intake as an outcome of net energy requirements for a given dietary net energy content. The parameters controlling milk component yields and body composition changes were calibrated using 2 datasets in which the diet was the same for all animals. Weekly data from Holstein dairy cows was used to calibrate the model within breed across milk production potentials. A second dataset was used to evaluate the model and to calibrate it for breed differences (Holstein, Danish Red and Jersey) on the mobilization/reconstitution of body composition and on the yield of individual milk components. These calibrations showed that the model framework was able to adequately simulate milk yield, milk component yields, body composition changes and dry-matter intake throughout lactation for primiparous and multiparous cows differing in their production level.

Keywords: dairy cow, milk composition, dynamic model, energy

Implications

The effect of production potential or physiological status of dairy cattle is not always adequately described in applied models for nutrient requirements and feeding management. Accordingly, we developed a model of homeorhetic regulation, complementary to current feed unit systems. The model was calibrated based on two large datasets characterized by groups of animals under the same ration but expressing large differences in production potential and breed. This model provides a robust basis against which to predict performance responses to dietary change.

Introduction

Modern feed unit systems for dairy cows require consideration of the driving forces that alter nutrient partitioning as the physiological state of the animal changes through lactation. Without some quantification of homeorhetic regulation through time, it is difficult to include in simulations the effects of milk production potential, parity, days in milk and days in pregnancy on nutrient partitioning. So far, this type of regulation, as described in Bauman and Currie (1980), has mostly been considered in research models (Baldwin et al., 1987; Danfaer, 1990; Martin and Sauvant, 2007). However the use of these models for prediction on-farm can be difficult due to their complexity as they require input parameters that are not easily available. Therefore, the first integrations of the consequence of homeorhesis on dairy cow performance by feed unit systems have favoured simpler empirical equations (NRC, 2001; Faverdin *et al.*, 2007; Volden, 2011). Until now, none of these systems have developed a full set of equations that predict the dairy cow performance trajectories, i.e. body weight and composition change, milk yield and composition, dry-matter intake, through lactation. Therefore, the aims of this paper are: (1) To develop a model of homeorhetic regulation in order to simulate curves of milk yield and composition, body composition changes and dry-matter intake relative to days in milk for different parities (2) To calibrate the model within-breed across milk production potentials using a large dataset of Holstein cows (3) To evaluate the model and calibrate it for breed differences (Danish Red, Holstein and Holstein) using another large dataset.

Model description

The structure of the model is characterized by 2 sub-models, a regulating-sub model of homeorhetic control, which sets dynamic partitioning rules along the lactation, and an operating sub-model that describes animal performance and major underlying

nutrients flows (Figure 1). This approach was proposed by Sauvant (1994) and has been previously used in a dairy goat model (Puillet *et al.*, 2008), and in a dairy cow model of lifetime partitioning (Martin and Sauvant, 2010). The final equations used in the model are listed in Supplementary Material S1.

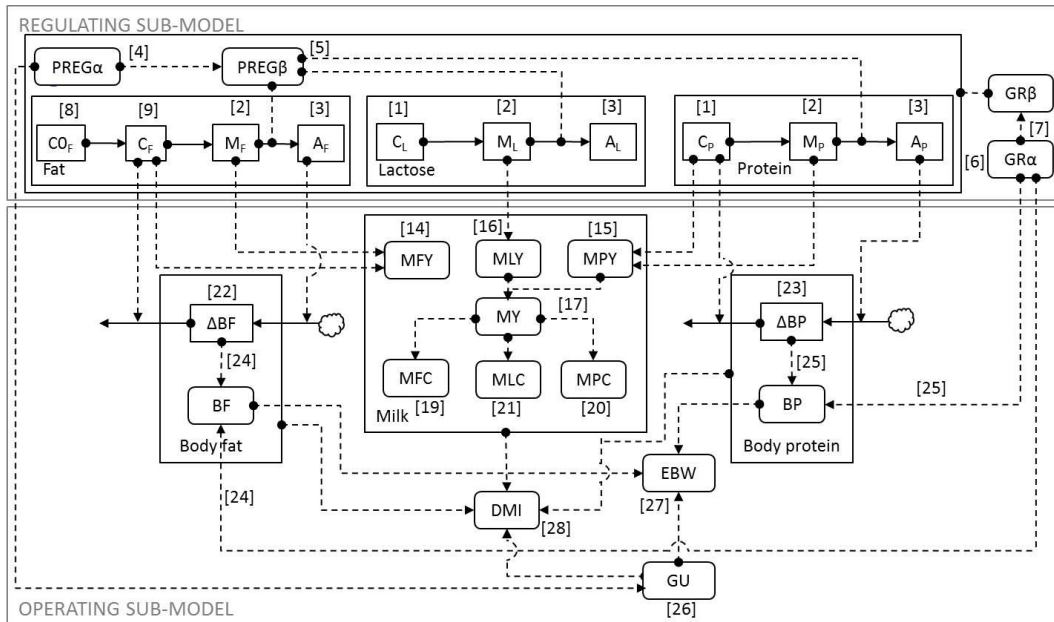

Figure 1 Model diagram of the regulating and operating sub-models. Solid arrows indicate fluxes and stippled arrows indicate information. Rounded rectangles indicate model variables and rectangle indicate model state variables. C_{0F} = Fictitious dynamic priority (detailed in Supplementary Material S2), C, M and A = Catabolism, milk and anabolism relative priorities for fat, lactose and protein (subscript F, L and P, respectively), $PREG(\alpha, \beta)$ = Pregnancy functions, $GR(\alpha, \beta)$ = Growth functions, MFY = Milk fat yield, MLY = Milk lactose yield, MPY = Milk protein yield, MY = Milk yield, MFC = Milk fat content, MLC = Milk lactose content, MPC = Milk protein content, GU = Gravid uterus, EBW = Empty BW, BP = Body protein, BF = Body fat, ΔBP and ΔBF = Change in BP and BF induced by lactation and pregnancy, DMI = Dry-matter intake. Equations are presented in the text.

Description of the regulating sub-model

Rationale. The regulating sub-model represents the driving forces that alter nutrient partitioning as the physiological state of the animal changes through lactation. It pilots the operating sub-model with respect to allocation of resources for growth, gestation, milk and body reserves. The 2 major physiological processes that occur during the productive life of a dairy cows are pregnancy and lactation. Therefore, the basis behind those coordinated physiological changes is the cycle of shift in reproductive priorities, between the current and future offspring, respectively lactation and pregnancy

(Friggens, 2003). To ensure the survival of the new-born calf, a large part of body energy is genetically mobilized in early lactation (Friggens *et al.*, 2004). Therefore the priority for the current offspring can be split into a priority to mobilize body reserves (called C, as in catabolism) and a priority to acquire new resources to sustain the growth of the calf (called M, as in milk). The priority for the future offspring (body reserve) is to acquire new resources to safeguard the reproductive investment and therefore replenish body reserves (called A, as in anabolism). Successive changes of priorities are described by the following differential equations, which follow a simple mass action law, applied to theoretical state variables, representing priorities C, M and A:

$$\frac{dC}{dt} (/day) = -k_{CM} \times C, \quad \text{with } C = 1 - Mt_0 \text{ at } t=0 \quad (1)$$

$$\frac{dM}{dt} (/day) = (k_{CM} \times C) - (k_{MA} \times M), \quad \text{with } M = Mt_0 \text{ at } t=0 \quad (2)$$

$$\frac{dA}{dt} (/day) = k_{MA} \times M, \quad \text{with } A = 0 \text{ at } t=0 \quad (3)$$

Where parameters k_{CM} and k_{MA} control the kinetics of the shift between C, M and A, and Mt_0 control the initial compartment size of C and M. All definitions and values of the parameters of the regulating sub-model are presented in Table 1. Figure 2 shows the kinetics of C, M and A (applied to fat, see later in the text). The exponential decay in time of C is consistent with principles applied in the mammary gland model of Neal and Thornley (1983). Beyond the inherent recognition of two successive reproductive priorities, this model structure also introduces a substitution between mobilization (C) and feed intake (M and A). However, as mobilization and intake occur simultaneously from the first day of lactation, initial values of priority C and M are set, respectively to $(1-Mt_0)$ and Mt_0 . The priority for the future offspring is assumed to be null at onset of the lactation. So, the initial value of A is 0. Therefore, as modelled previously (Baldwin *et al.*, 1987; Martin and Sauvant, 2007) there is a clear substitution between trajectories of catabolism and anabolism (Figure 2). For completeness, these driving forces are also modulated by pregnancy and growth (see Supplementary Material S2).

Dissociation between secretion of fat, protein and lactose. For a long time, ratios between lactose, protein and fat have been known to change with days from calving.

However, this outcome is difficult to achieve when regulation of fat, protein and lactose secretion is solely controlled by the same regulating sub-model (milk). To simulate milk composition, it was therefore decided to have 3 regulating sub-models: 1 for fat, 1 for protein and 1 for lactose based on the model structure described above with a minor modification (see Supplementary Material S2). In this way, different patterns of priority through time for C, M and A can be created for each nutrient using the same basic principle described above but with different values of parameters k_{CM} , k_{MA} and Mt_0 . Parameters for the regulating sub-models of fat, protein and lactose can be found in Table 1. A greater value of parameter k_{CM_P} relative to k_{CM_F} indicates a shorter protein mobilization phase as compared to the fat mobilization phase. Persistencies of fat and protein secretion, indicated by values of k_{MA_F} and k_{MA_P} , were assumed to be identical in the model but higher than lactose secretion persistency.

With the above elements, the regulating sub-model described above is sufficient to simulate dynamic priorities required to generate the lactation performance of an average dairy cow.

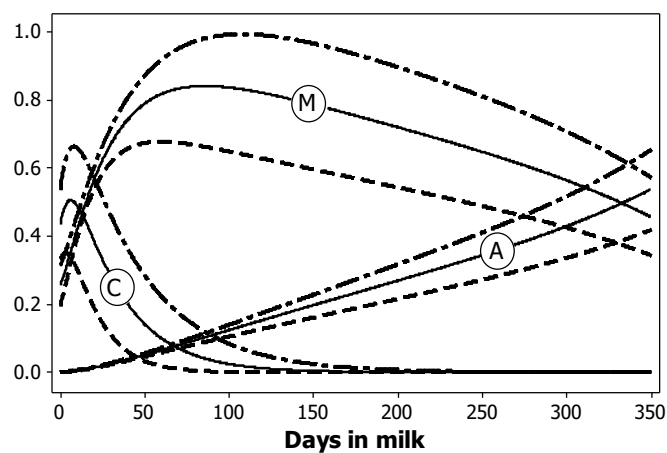

Figure 2 Dynamic of C_F , M_F and A_F from the regulating sub-model of fat relative to DIM for a third lactation dairy cow with a conception date at 100 days in milk. Effect of potential parameter (POT) is shown for levels 20 (even stippled line), 35 (solid line) and 50 kg/day (uneven stippled line). See Table 1 for parameters.

Effect of production potential. Within a given favourable environment, where dairy cows are fed an identical ration, individual cows typically have different levels of production. One key objective of the model was to accurately simulate those differences in performances (milk yield and composition, empty BW, dry-matter intake (DMI))

between animals that differ in potential (POT). With that objective, a single parameter POT was introduced in the regulating sub-model. As there is a regulating sub-model for each milk component, there are associated conversion factors to scale the overall POT to the different milk components (see Supplementary Material S2). For calibration purposes, POT was defined as the observed milk yield at peak of lactation for third parity cows (=mature cows) in a favourable environment. Also, because all parameters from the regulating sub-model were calibrated for an average animal producing 35 kg of milk at peak, POT was included in the model so that it does not affect performance of the average animal. Therefore the ratio POT/POT_{REF} was used, with $POT_{REF} = 35$ as detailed in Supplementary Material S2.

Table 1. Parameters of the regulating sub-models for fat, protein and lactose describing the dynamics of relative priorities C, M and A

Parameter	Description	Value	Equation ¹
k_{CM_F}	Fractional rate between C_F and M_F (/day)	0.035	2, 3
k_{CM_P}	Fractional rate between C_P and M_P (/day)	0.200	5, 6
k_{CM_L}	Fractional rate between C_L and M_L (/day)	0.055	8, 9
k_{MA_F}	Fractional rate between M_F and A_F (/day)	0.00170	3, 4
k_{MA_P}	Fractional rate between M_P and A_P (/day)	0.00170	6, 7
k_{MA_L}	Fractional rate between M_L and A_L (/day)	0.00262	9, 10
M_{Ft0}	Initial value of M_F when POT=35 (unitless)	0.260	1, 2, 3
M_{Pt0}	Initial value of M_P when POT=35 (unitless)	0.630	5, 6
M_{Lt0}	Initial value of M_L when POT=35 (unitless)	0.416	8, 9
$k_{PREG\alpha}$	Controls the shape of pregnancy function $PREG\alpha$ (/day)	0.017	11
DP	Duration of pregnancy (days)	284	11
Conc. date	Conception date (in days in milk)	100	11 ²
$k_{PREG\beta}$	Adjustment factor for the effect of $PREG\alpha$ (unitless)	4	12
P	Parity number	User	13
k_{GR0}	Empty BW/mature empty BW at first calving (unitless)	0.85	13
$k_{GR\alpha}$	Controls the shape of growth function $GR\alpha$ (/day)	1.4	13
$k_{GR\beta}$	Adjustment factor for the effect of $GR\alpha$ (unitless)	2.2	14
k_{C0_F}	Adjustment for initial value of C_F (unitless)	0.6	1, 2
k_{C0C_F}	Fractional rate between $C0_F$ and C_F (/day)	0.150	1, 2
POT	Milk yield at peak in third parity (kg/day)	User	1-10, 18
POT_{REF}	Reference milk yield at peak in third parity (kg/day)	35	1-10, 18
k_{M_F}	Adjustment of the effect of POT on M_{Ft0} (unitless)	1.84	1, 2, 3
k_{M_P}	Adjustment of the effect of POT on M_{Pt0} (unitless)	1.43	5, 6
k_{M_L}	Adjustment of the effect of POT on M_{Lt0} (unitless)	1.10	8, 9

¹Equation numbers are from Supplementary Material S1.

²Conc. date triggers DIP.

Description of the operating sub-model

The operating sub-model describes performance of the dairy cow in term of body composition as well as milk yield and composition (Figure 1). This sub-model also describes the fluxes of NEL associated with performance, growth, pregnancy and maintenance. Finally a description of how DMI is estimated as an output of the model is provided. All parameters of the operating sub-model are presented in Table 2.

Milk yield and composition. To construct curves of milk fat yield (MFY, g/day) and milk protein yield (MPY, g/day), simple scaling parameters kMFY and kMPY are used to convert kinetics of C and M, generated by the regulating sub-models of fat and protein, into grams of fat and protein (equations 15 to 16 in Supplementary Material S1). As no storage of glucose was considered in the model, milk lactose yield (MLY, g/day) is simply predicted from the dynamic priority M_L and a scaling parameter kMLY (equation 17 in Supplementary Material S1). An empirical equation was developed from a large database of the literature (Daniel *et al.*, 2016) to predict milk yield (MY, kg/day) from milk component yields. Based on 787 treatments means (179 experiments), the following within-experiment relationship (i.e. adjusting for differences between laboratories in milk analyses) was obtained, with a RMSE of 0.24 kg/day:

$$MY \text{ (kg/day)} = a + 0.0173 (\pm 0.0002) \times MLY + 0.0043 (\pm 0.0004) \times MPY. \quad (4)$$

The intercept of the equation was significantly different from 0 (mean \pm SE, 1.26 ± 0.15), which could reflect the effect of mineral contents on the osmotic pressure of milk. It can be noted that the effect of milk fat yield was largely insignificant and was consequently removed from the equation. The coefficients 0.0173 and 0.0043 indicate that for 1 kg of lactose, 17.3 kg of milk are secreted and for 1 kg of protein, 4.3 kg of milk are secreted, highlighting the importance of lactose in milk secretion. In the model, an intercept a was used to reflect observed decrease in milk lactose content with milk production potential (equation 18 in Supplementary Material S1). Milk composition was simply predicted as the ratio between secretion of fat, protein and lactose and milk yield (equation 19 to 21 in Supplementary Material S1).

Empty body weight and composition. Changes of body fat and body protein during lactation were predicted from kinetics controlled by regulating sub-models of fat (A_F and C_F) and protein (A_P and C_P) with the following differential equations:

$$\frac{d\Delta BF}{dt} (\text{kg/day}) = ((A_F \times GR\beta) \times kA_F) - ((C_F \times GR\beta) \times kC_F), \quad (5)$$

$$\frac{d\Delta BP}{dt} (\text{kg/day}) = ((A_P \times GR\beta) \times kA_P) - ((C_P \times GR\beta) \times kC_P), \quad (6)$$

The parameters kA_F , kC_F , kA_P and kC_P are used to convert kinetics A and C (adjusted for the effect of growth) into kilograms of fat/protein being deposited/mobilised. A first set of values for these parameters were obtained based on measured body fat and protein changes from literature (see Supplementary Material S3). These values were then adjusted by calibration against the changes in empty BW observed in dataset 1 (Table 2). To construct curves of total body fat (BF) and total body protein (BP), start of lactation values of BF and BP are required. This is done using 2 input parameters: Mature empty BW (MEBW, kg), assumed to be reached in third parity, and body condition score (BCS) at calving under favourable conditions, i.e. reflecting the animals genetically determined level of fatness (BCSc, 1-5 scale). Body fat is calculated as:

$$BF (\text{kg}) = 0.037683 \times \left(\frac{(BCSc - 0.5) \times 8}{4} \right) \times MEBW \times (1 - GR\alpha) + \Delta BF, \quad (7)$$

where 0.037683 is the coefficient from the relationship established in NRC (2001) between body fat content and BCS. The calculation $((BCSc - 0.5) \times 8/4)$ is used to convert the 1-5 BCS scale into 1-9 BCS scale (originally used by the NRC to establish the previous relationship). A small comparison with other equations from literature is given in Supplementary Material S3. The function $(1 - GR\alpha)$ represents the degree of maturity of the animal (see description of the regulating sub-model in Supplementary Material S2) and is used to multiply MEBW. When the animal is mature, $GR\alpha = 0$ and MEBW is unaffected. Body protein is then calculated from the fat-free mass (Empty BW – BF) assuming a protein content of this fraction of 21.5% (NRC, 2001):

$$BP (\text{kg}) = \left((MEBW \times (1 - GR\alpha)) - 0.037683 \times \left(\frac{(BCSc - 0.5) \times 8}{4} \right) \times MEBW \times (1 - GR\alpha) \right) \times 0.215 + \Delta BP, \quad (8)$$

Assuming that the water fraction of body fat is negligible, empty BW can be calculated as:

$$\text{Empty BW (kg)} = BF + \frac{BP}{0.215} + GU, \quad (9)$$

where GU is the weight of the gravid uterus (see Supplementary Material S2). Finally, BCS can be calculated according to NRC (2001) with:

$$\text{BCS (1-5 scale)} = \left(\left(\frac{\left(\frac{\text{BF}}{\text{Empty BW}} \right)}{0.037683} \right) \times \frac{4}{8} \right) + 0.5, \quad (10)$$

Scaling parameters between breeds. The parameter POT was calibrated on a Holstein dataset to simulate differences in performance between low and high producing cows within this breed. As such, POT does not permit simulation of different milk composition for animals that produce the same amount of milk from, for example, different breeds. To achieve this, scaling parameters for milk composition traits (kMFY, kMPY, kMLY) and body composition traits (kCF, kAF, kCP and kAP) were adjusted depending on the type of animals (as detailed in Supplementary Material S4).

NE_L requirements and dry-matter intake. To calculate NE_L maintenance requirements, a BW standardized for lipid content and gut fill proportion was calculated as:

$$\text{BW}_{\text{std}} \text{ (kg)} = \frac{\left(\frac{\text{BP}}{0.215} \right)}{0.8 \times 0.8}, \quad (11)$$

This assumes that maintenance requirements for NE_L are not influenced by body fat change but only by body protein change (Birnie *et al.*, 2000). The parameters used to calculate BW_{std} were derived from experiments with measured body composition (see Supplementary Material S3) in which the average empty BW/BW ratio was 0.80 (N = 60, SE 0.04), i.e. gut fill represented 0.25 * empty BW, and average fat-free mass / empty BW ratio was 0.80 (N = 69, SE 0.05), i.e. lipid content was 0.20 * empty BW. The NE_L requirement for maintenance was assumed to be:

$$\text{NE}_{\text{L maintenance}} \text{ (MJ/day)} = 0.394 \times \text{BW}_{\text{std}}^{0.75}, \text{ (Sauvant } et al., 2015). \quad (12)$$

The NE_L requirement for milk was simply the sum of energy from fat, protein and lactose secreted in the milk:

$$\text{NE}_{\text{L milk}} \text{ (MJ/day)} = 39.8 \times \frac{\text{MFY}}{1000} + 23.9 \times \frac{\text{MPY}}{1000} + 16.5 \times \frac{\text{MLY}}{1000}, \quad (13)$$

Growth requirement in NE_L was:

$$\text{NE}_{\text{L growth}} \text{ (MJ/day)} = \frac{\left((\text{BP growth} \times 23.9) + (\text{BF growth} \times 39.8) \right)}{k_{\text{gt}} \times k_{\text{ls}}}, \quad (14)$$

with k_{gt} , the efficiency of conversion from ME to NE_G and k_{ls} , the conversion of ME to NE_L (Sauvant *et al.*, 2015; Table 2). Growth rates for BP and BF are respectively derived from equations 32 and 33 in Supplementary Material S1. The calculated NE_L requirement for growth was in agreement with other feed unit systems (AFRC, 1993; NRC, 2001). For pregnancy the net energy content of the gravid uterus (NE_{GU}) was first calculated as:

$$NE_{GU}^{preg} \text{ (MJ/day)} = k_{NE_{L, GU}} \times PREG\alpha, \quad (15)$$

where $k_{NE_{L, GU}}$ corresponds to the maximum value of NE_{GU}^{preg} reached at the last day of the pregnancy. This value was chosen so that NE_{GU}^{preg} is consistent with the data from Bell *et al.* (1995). The pregnancy requirement in NE_L was then calculated assuming an efficiency of ME use by the gravid uterus, k_{GU} , of 0.14 (Ferrell *et al.*, 1976):

$$NE_{L}^{preg} \text{ (MJ/day)} = \left(\frac{NE_{GU}^{preg}}{k_{GU}} \right) \times k_{ls}, \quad (16)$$

The resulting shape of the exponential function for pregnancy NE_L requirement was in agreement with INRA (Faverdin *et al.*, 2007) and NorFor (Volden, 2011) feed unit systems. Additionally this model simulates an average of NE_{L}^{preg} of 12.4 MJ/d during the last 100 days of gestation. This value was consistent with average prediction (13.0 MJ/day) of the NRC (2001), which only considered NE_{L}^{preg} after 190 days of gestation with a linear increase. Requirements for energy balance (positive for anabolism, negative for catabolism) are calculated based on body fat and protein changes with corresponding efficiencies:

$$NE_{L}^{body} \text{ (MJ/day)} = \frac{\left(\frac{d\Delta BF}{dt} \times 39.8 + \frac{d\Delta BP}{dt} \times 23.9 \right)}{k_{gt} \times k_{ls}}, \quad (17)$$

Adding these factors together we can predict all NE_L requirements (maintenance, milk, growth, pregnancy and body mass change). Thus providing that dietary NE_L content is known, desired DMI, can be estimated as follows:

$$DMI \text{ (kg/day)} = \frac{\text{Total } NE_L \text{ requirement}}{\text{Dietary } NE_L \text{ content}}, \quad (18)$$

with dietary NE_L content in MJ/kg DM.

Data used for model calibration and testing.

For the purpose of the calibration, two datasets were selected. They both respect the important criterion that within each dataset the ration fed was identical for all animals. Therefore, differences in production between animals from the same dataset are largely unaffected by the diet offered and therefore should reflect differences in potential. In the first dataset (called dataset 1), weekly data of milk component yields and empty BW of Holstein cows from the experimental dairy farm of Trouw Nutrition R&D (Kempenshof, Boxmeer, the Netherlands) recorded between 2003 and 2012 were used. All animals were fed forages separately, mainly a mixture of maize and grass silages, *ad libitum* in roughage boxes and concentrates in concentrate feeders (calculated nutritional values of the diet presented in Supplementary Material S5). The provision of concentrate was determined individually based on observed milk yield and adjusted weekly to match NE_L and MP requirements. Consequently the amount of concentrate fed follows the lactation curve. This dataset was used to calibrate all model parameters. In Dataset 2, weekly average milk component yields, empty BW and BCS data of three dairy breeds (Danish Red, Holstein and Jersey) were used. Data originated from an experiment conducted at Aarhus University (Denmark). A detailed description of this experiment can be found in Nielsen *et al.* (2003). For the purpose of the present study, only cows receiving the normal energy density diet (6.64 MJ/kg DM) were used (calculated nutritional values of the diet presented in Supplementary Material S5). The particularity is that these cows were fed the same TMR *ad libitum* during the whole lactation. Dataset 2 was used for evaluation of the model (previously parameterized using Dataset 1), and a subset (parity 2) was also used to derive the 7 breed scaling parameters, i.e. adjust the relative secretion of milk components (kMFY, kMPY, kMLY) and changes in body composition (kC_F , kA_F , kC_P and kA_P) according to breed.

The ability of the model to fit the observed data was evaluated using the concordance correlation coefficient (CCC), calculated as described in Lin (1989), and the root mean square prediction error (RMSPE), computed as previously described (Bibby and Toutenburg, 1977). The RMSPE can be decomposed into error due to overall bias (ECT), error due to deviation of the regression slope from unity (ER) and error due to the disturbance (random error; ED; Bibby and Toutenburg, 1977).

Table 2. Parameters of the operating sub-model

Parameter	Description	Dataset 1	Dataset 2		Equation ¹	
		Holstein	Danish Red	Holstein		Jersey
Milk production						
kMFY	Scale change applied to (C _F +M _F) (g/day)	1600	1490	1600	1818	15
kMPY	Scale change applied to (C _P +M _P) (g/day)	1315	1241	1315	1344	16
kMLY	Scale change applied to M _L (g/day)	1950	1950	1950	1915	17
kMY	Intercept adjustment of equation 17 (unitless)		0.4			18
Empty BW and gravid uterus						
kC _F	Scale change applied to C _F (kg/day)	2.00	1.80	2.28	1.80	22
kA _F	Scale change applied to A _F (kg/day)	0.50	1.00	0.90	0.50	22
kC _P	Scale change applied to C _P (kg/day)	1.00	2.40	1.50	3.75	23
kA _P	Scale change applied to A _P (kg/day)	0.06	0.12	0.06	0.03	23
MEBW	Mature empty BW (kg)	512-555	540	545	375	24,25,32,33
BCSc	Body condition score at calving (1-5 scale)	3.25	3.65	3.50	3.30	24,25,32,33
BCS_BF	From BCS (1-5 scale) to body fat content (unitless)		0.037683			24,25,28,32,33
BP_FFM	Protein content of fat-free mass		0.215			25,27,29,32,33
GUcalv	Weight of the gravid uterus before calving (kg)		87			26
NE _L requirements						
EBW_BW	Empty BW/BW ratio (unitless)		0.80			29
FFM_EBW	Fat-free mass / empty BW ratio (unitless)		0.80			29
k _M	Maintenance requirement (MJ/kg ^{0.75})		0.394			30
k _{is}	Efficiency from ME to NE _L (unitless)		0.65			34, 36, 37
k _{gt}	Efficiency from ME to NE _G (unitless)		0.80			34,37
k _{NEL_GU}	Scale change applied to PREGα for NE _L requirement (unitless)		5.5			35
k _{GU}	Efficiency of ME use by the gravid uterus (unitless)		0.14			36
E _F	Energy content of 1 kg fat (MJ/kg)		39.8			31,34,37
E _P	Energy content of 1 kg protein (MJ/kg)		23.9			31,34,37
E _L	Energy content of 1 kg lactose (MJ/kg)		16.5			31
[NE _L]	Dietary NE _L content (MJ/kg DM)		User			39

ME=Metabolizable energy; NE_L=Net energy for lactation; NE_G=Net energy for body gain

¹Equation numbers are from Supplementary Material S1.

Model implementation.

The model was implemented with the Modelmaker 3.0 software (Cherwell Scientific Ltd, 2000) using the Runge–Kutta 4 numerical integration procedure and a fixed integration step of 1 day for t ranging from 0 to 350 days. For clarity, a summary of model calibration is given in Supplementary Material S4. The model was also tested for identifiability (Supplementary Material S4)

Results

The effect of parity, within dataset 1, between primiparous and multiparous (average parity number = 3.4 ± 1.5) of the highest producing groups is plotted on Figure 3 with lines and circles representing respectively the predicted values and observed weekly values. It can be seen that differences between primiparous and multiparous simulated by the model are in good agreement with data. The only exception was observed for milk lactose content. The model predicted higher milk lactose content for multiparous than for primiparous (45.3 vs 44.6 g/kg) whereas the data shows the opposite (44.8 vs 46.4 g/kg). Complete statistics from the model calibration on dataset 1 are presented in Supplementary Material S6.

The observed and simulated effect of potential within multiparous Holstein cows of dataset 1 is shown in Figure 4 for milk yield, milk component yields, empty BW (expressed relative to empty BW at calving for clarity) and DMI. Assessed visually with Figure 4, differences between groups of production were globally satisfactorily captured by the model. Although this effect was calibrated with the multiparous set, the simulated differences between groups of primiparous were also in agreement with observations (Supplementary Material S6). The time of the peak of milk yield, mainly determined by the peak of milk lactose yield, was unaffected by animal potential and this was correctly simulated by the model. Within multiparous, the error of prediction of empty BW decreased with production level POT, from RMSPE=5.5% for the lowest producing group to RMSPE=2.7% for the highest producing group (Supplementary Material S6). The error of empty BW prediction was larger for multiparous (RMSPE=3.8%) than for primiparous (RMSPE=1.7%) and this was mainly due to an over prediction of empty BW loss in early lactation for multiparous, therefore inducing an under prediction of empty BW.

The fitted breed scaling parameters used to adjust differences in reference curves between Holstein, Danish Red and Jersey breeds are presented in Table 2. Intentionally, scaling parameters for milk production of the Holstein breed were unchanged as compared to value obtained on the first dataset. However, after fitting BCS and empty BW curves, k_{CF} , k_{AF} , k_{CP} and k_{AP} were changed for all breeds. This change substantially improves the fit of BCS and empty BW of Holstein from dataset 2 and allows better comparisons of scaling parameters estimates between breeds. The comparison between predicted and observed milk component yields, empty BW, BCS (respectively expressed relative to empty BW and BCS at calving for clarity) and DMI is shown in Figure 5. Errors of prediction across breed for parity 2 are presented in Table 3 (statistics for parity 1 are in Supplementary Material S6). Mean RMSPE per variable and breed were systematically lower than 8.9%. This illustrates the overall ability of the model to adequately simulate sets of performance for Danish Red, Holstein and Jersey breeds. These results were obtained using the same overall model calibrated on Dataset 1 (Holstein), by simply changing the 7 scaling parameters. The comparison between predicted and observed milk yield and milk composition is shown in Figure 6. The largest error in the prediction of milk fat and protein content was observed for the Jersey breed (respectively RMSPE of 8.9% and 8.2%). Those errors were largely explained by an over prediction in early lactation (first 7 weeks) as observed in Figure 6. As in dataset 1, milk lactose content decreased with parity (1.07 g/kg lower for second parity cow) but the model simulated a slight increase (+ 0.28 g/kg in average, Table 3 and Supplementary Material S6).

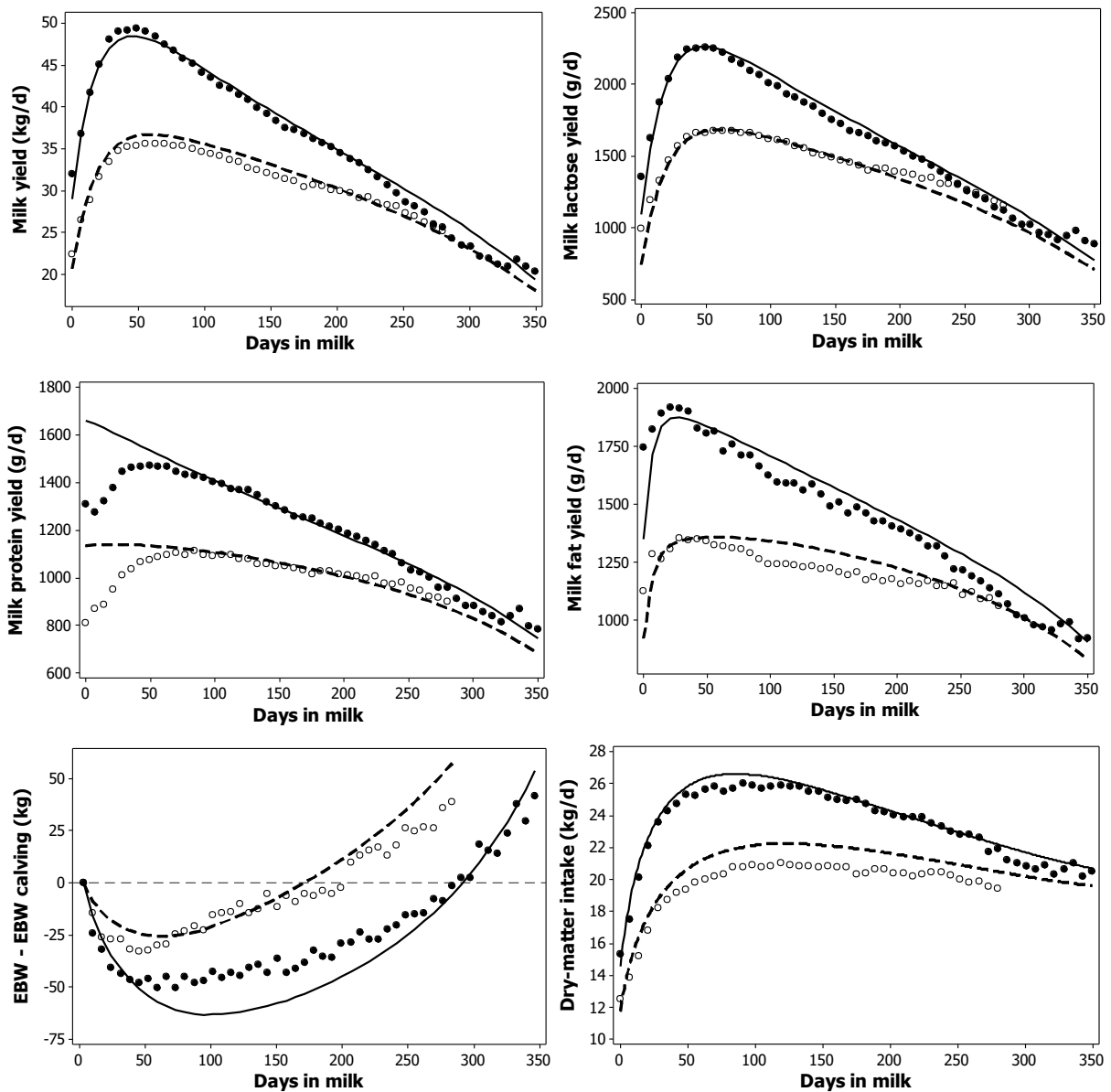

Figure 3 Comparison between observed (circles) and predicted values (lines) of milk yield, milk component yields, empty BW change from calving and dry-matter intake relative to days in milk for primiparous (open circle, stippled line) and multiparous (solid circle, solid line) Holstein cows. Model differences between primiparous and multiparous were obtained by changing parity number P from 1 to 3. Parameters POT and conception date (Conc. date) were set to 49.4 kg/day and 100 days in milk, respectively.

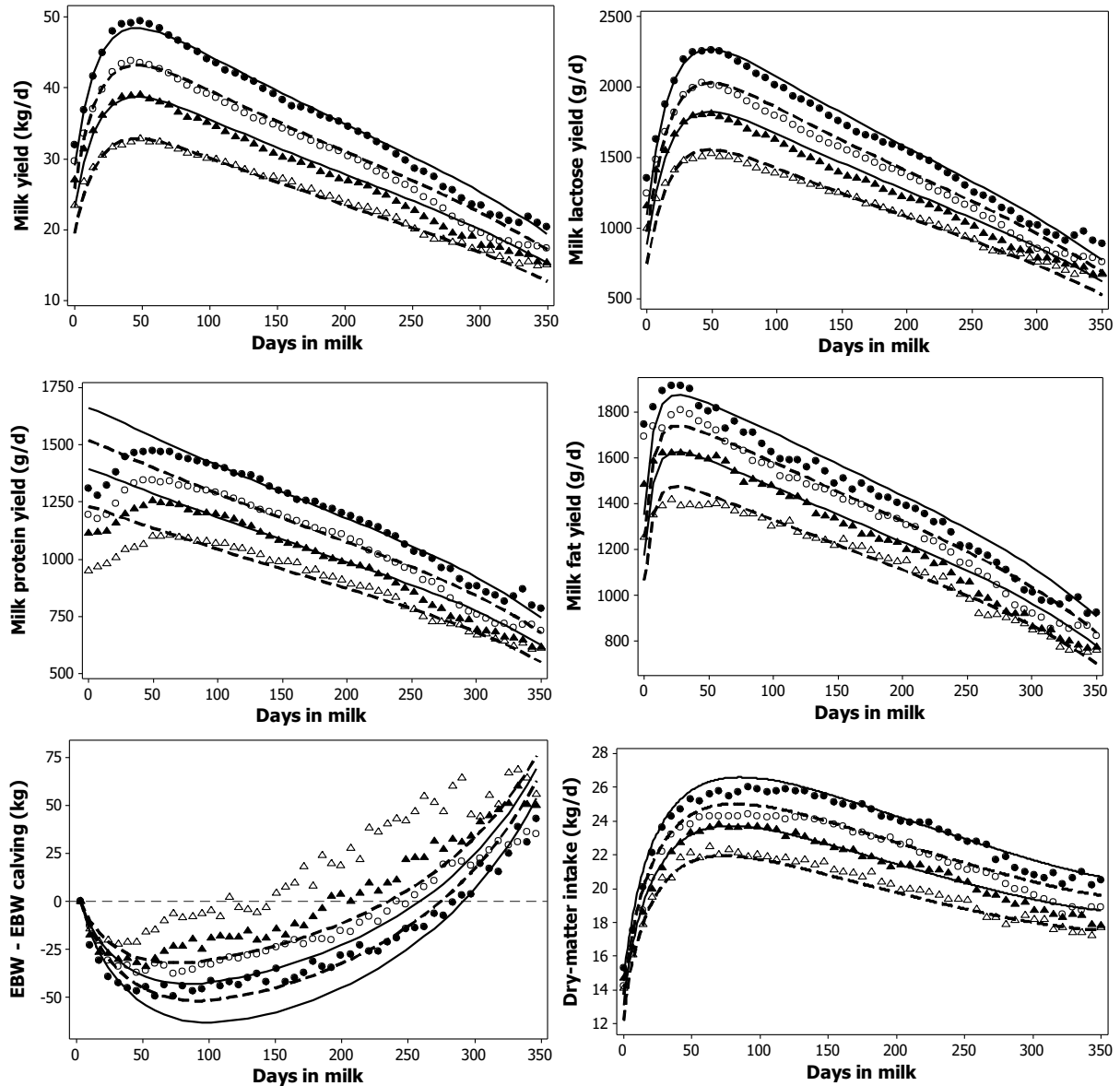

Figure 4 Comparison between observed (marker) and predicted values (lines) of milk yield, milk component yields, empty BW change from calving and dry-matter intake relative to days in milk for multiparous Holstein cows with different potential (POT). Differences between simulated lines were achieved by adjusting parameter POT to the observed milk yield at peak of lactation, respectively 32.8 (Δ , stippled line), 39.1 (\blacktriangle , solid line), 43.8 (\circ , stippled line) and 49.4 kg/day (\bullet , solid line). Parameters P and Conc. date were set to 3 and 100 DIM, respectively.

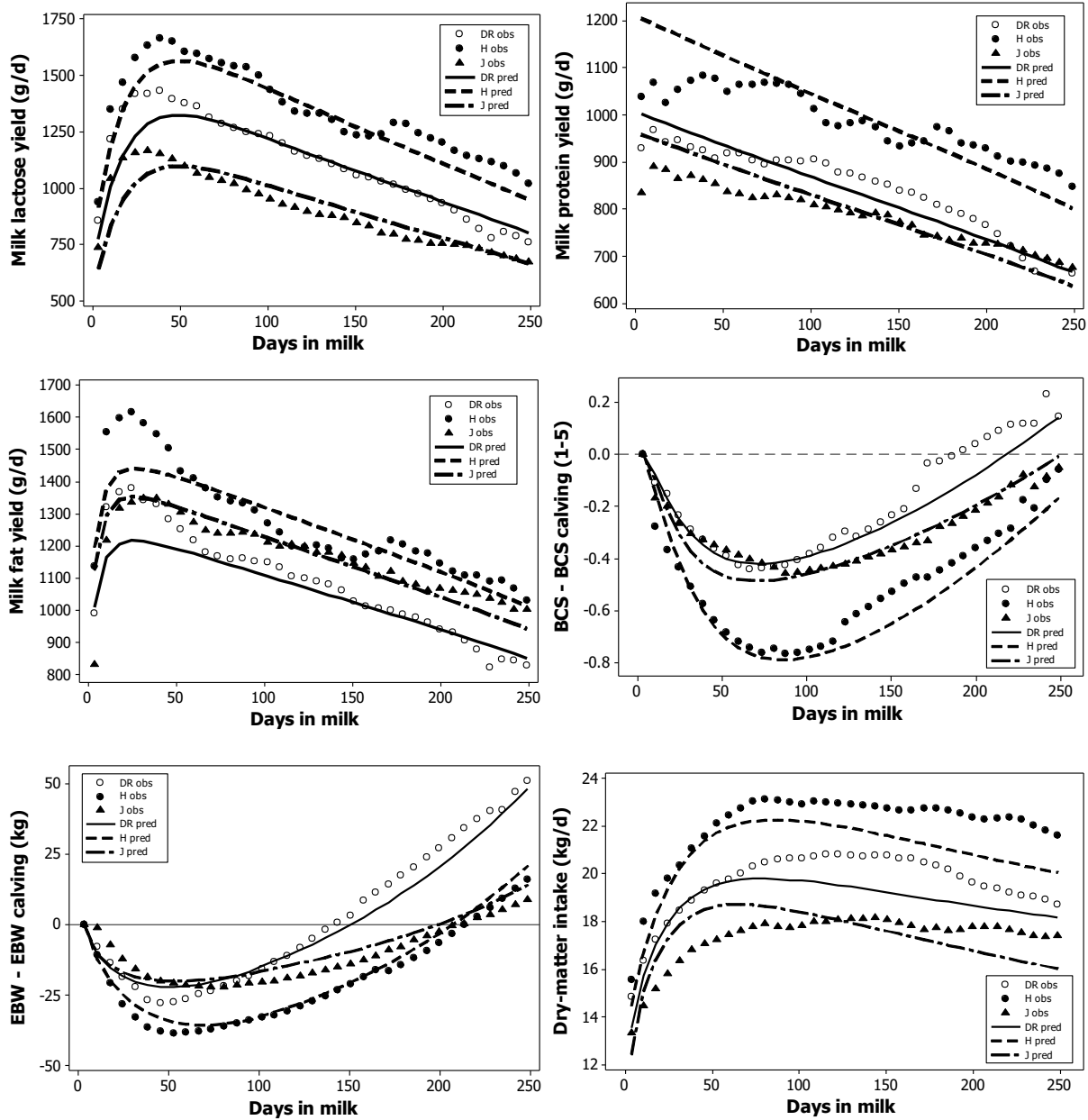

Figure 5 Comparison between observed (marker) and predicted values (lines) of milk component yields, empty BW change from calving, body condition score change from calving and dry-matter intake relative to days in milk for second lactation Danish Red (RD), Holstein (H) and Jersey (J) cows. Breed scaling parameters are presented in Table 2. Values of POT were 29.1, 35.0 and 24.0 kg/day for DR, H and J cows, respectively. Parameters parity (P) and conception date (Conc. date) were set to 2 and 100 days in milk, respectively.

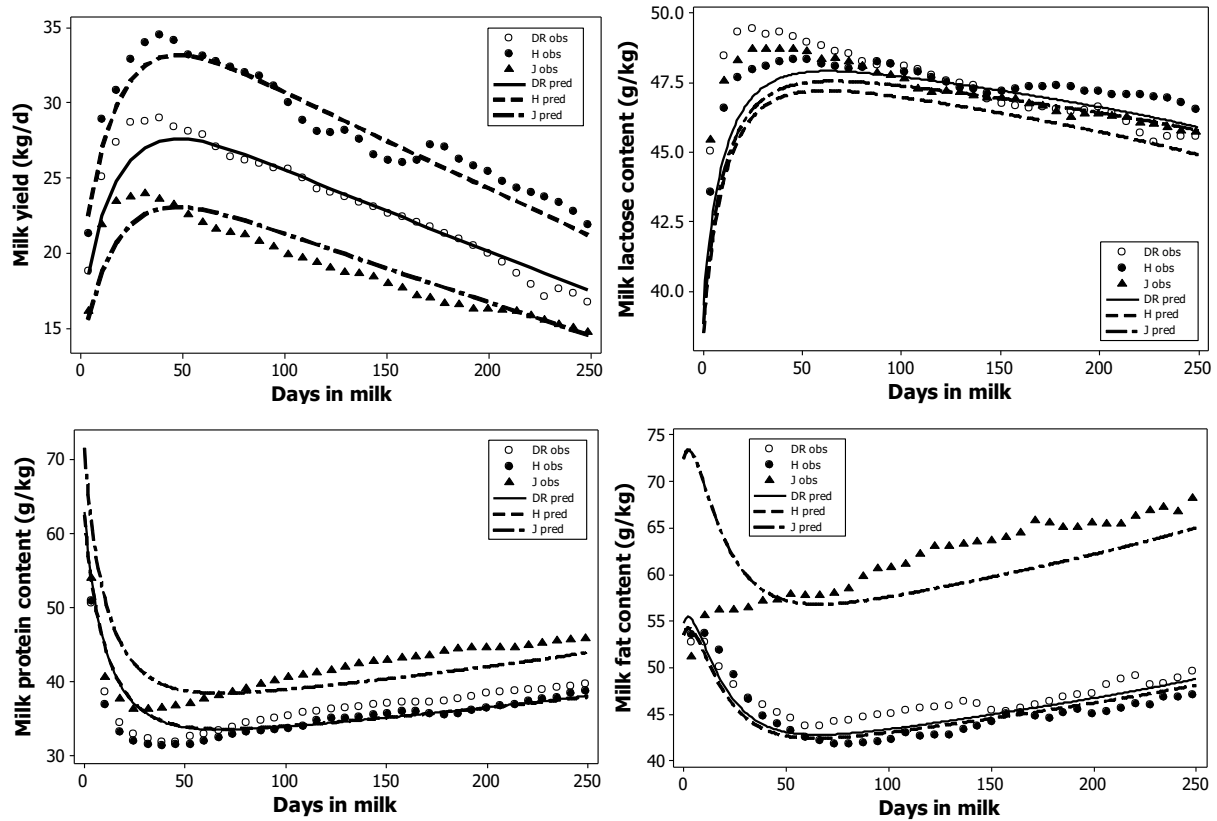

Figure 6 Comparison between observed (marker) and predicted values (lines) of milk yield and milk component contents relative to days in milk for second lactation Danish Red (RD), Holstein (H) and Jersey (J) cows. Breed scaling parameters are presented in Table 2. Values of the potential parameter (POT) were 29.1, 35.0 and 24.0 kg/day for DR, H and J cows, respectively. Parameters parity (P) and conception date (Conc. date) were set to 2 and 100 days in milk, respectively.

Table 3. Summary of observed versus predicted outputs (empty BW, body condition score, dry-matter intake, milk yield, milk component yields, milk component contents) for second parity cows across breeds (Danish Red (DR) with POT¹=29.1, Holstein (H) with POT=35.0, Jersey (J) with POT=24.0) of dataset 2.

	Observed ²	Predicted ²	RMSPE% ³	ECT% ⁴	ER% ⁵	ED% ⁶	CCC ⁷
Empty BW (kg)							
DR	513 ± 24	511 ± 21	0.8	13.4	45.4	41.2	0.99
H	497 ± 16	499 ± 17	0.6	56.5	7.4	36.1	0.98
J	340 ± 10	342 ± 10	1.2	24.3	4.9	70.8	0.92
Body condition score (1-5 scale)							
DR	3.47 ± 0.21	3.43 ± 0.17	2.0	37.7	17.1	45.2	0.95
H	2.96 ± 0.21	2.92 ± 0.22	3.0	24.6	10.4	65.0	0.92
J	3.01 ± 0.12	3.00 ± 0.16	1.7	1.1	51.2	47.8	0.96
Dry-matter intake (kg/day)							
DR	19.6 ± 1.4	18.8 ± 1.2	5.0	71.3	0.0	28.7	0.76
H	22.0 ± 1.6	20.9 ± 1.6	5.5	82.2	0.6	17.2	0.77
J	17.3 ± 1.1	17.4 ± 1.3	5.5	0.0	33.4	66.6	0.67
Milk yield (kg/day)							
DR	23.3 ± 3.8	23.2 ± 3.3	4.1	1.5	19.3	79.2	0.97
H	28.2 ± 3.8	27.9 ± 3.9	3.7	10.2	4.2	85.6	0.96
J	19.0 ± 2.9	19.3 ± 2.8	6.0	8.5	0.8	90.8	0.92
Milk fat yield (g/day)							
DR	1084 ± 161	1053 ± 113	5.8	24.4	49.1	26.5	0.95
H	1268 ± 166	1251 ± 133	5.7	5.2	6.3	88.5	0.90
J	1164 ± 119	1167 ± 127	4.9	0.2	13.4	86.3	0.89
Milk protein yield (g/day)							
DR	843 ± 89	835 ± 100	3.6	5.8	23.1	71.1	0.95
H	986 ± 69	1004 ± 120	6.3	8.4	76.5	15.1	0.92
J	786 ± 60	800 ± 95	5.0	10.7	81.4	7.8	0.97
Milk lactose yield (g/day)							
DR	1109 ± 210	1090 ± 172	6.5	6.6	14.2	79.2	0.95
H	1341 ± 198	1289 ± 203	5.6	47.1	2.7	50.2	0.93
J	900 ± 155	904 ± 142	7.6	0.3	0.2	99.4	0.90
Milk fat content (g/kg)							
DR	46.7 ± 2.2	45.7 ± 2.7	2.8	61.1	16.9	22.1	0.88
H	45.1 ± 3.0	45.1 ± 2.5	2.8	0.4	2.6	97.0	0.91
J	61.7 ± 4.2	60.7 ± 3.6	8.9	4.8	23.1	72.1	0.31
Milk protein content (g/kg)							
DR	36.6 ± 3.3	36.3 ± 3.8	6.2	1.8	23.9	74.4	0.80
H	35.3 ± 3.4	36.3 ± 3.7	6.3	17.0	15.3	67.7	0.81
J	41.9 ± 3.7	41.7 ± 4.3	8.2	0.6	31.6	67.8	0.63
Milk lactose content (g/kg)							
DR	47.4 ± 1.3	46.9 ± 1.1	2.6	14.3	9.1	76.7	0.53
H	47.4 ± 0.8	46.1 ± 1.2	2.9	88.2	7.9	3.9	0.51
J	47.2 ± 1.0	46.6 ± 1.1	2.5	22.7	26.4	50.9	0.47

¹POT is the parameter controlling the overall effect of milk production potential (see Table 1).

Breed scaling parameters used for the simulation can be found in Table 2.

²Mean ± SD

³Root mean squared prediction error expressed as a percentage of the observed mean.

⁴Error due to intercept bias, as a percent of total MSPE.

CHAPTER 4

⁵Error due to slope bias, as a percent of total MSPE.

⁶Error due to disturbance, as a percent of total MSPE.

⁷Concordance correlation coefficient (scale from -1 to 1).

Discussion

The model presented here is based on a high-level description of homeorhesis expressed as relative priorities between life functions (regulating sub-model) that drive the partition of nutrients to different physiological processes through lactation (maintenance, milk components, body and pregnancy). This high-level description of homeorhesis fits within the top-down approach to modelling nutrient partitioning described in the review of Friggens *et al.* (2013). With this approach and a relatively simple model structure, animal performance (body, milk, intake) was predicted in average with RMSPE=4.4% and CCC=0.83 (see Table 3). Further, as a result of the unified structure, the model simulates a mutually consistent set of outputs, in term of milk yield, milk composition, empty BW, BCS and DMI for dairy cows of different parity and potential.

A key element of this model is its ability to simulate differences in performance trajectories that are due to differences in potential and for different breeds. These effects were regulated by the model at 2 levels: (1) In the regulating sub-model, by the parameter POT which allows the relative priorities to be globally adjusted for milk production potential across the different biochemical units (fat, protein and lactose). (2) In the operating sub-model, by independent scaling parameters which allow adjustment for specific correlations between outputs such as those capturing the differences between breeds in milk composition. This model structure was sufficient to predict performance of Danish Red, Holstein and Jersey cows.

Milk yield and composition

Nutrition can have a strong influence on the shape of the lactation curves. However, given the objective of this study to describe homeorhetic changes, datasets were chosen to minimize the interference of nutrition on the lactation curves simulated by the model. The shapes of the curves for milk fat, protein and lactose yields were calibrated with dataset 1, in which amount of concentrate offered was determined weekly based on observed milk yield. A possible effect of this feeding regime on the lactation shape could have been expected. However, when tested on the dataset 2, where animals were fed a TMR *ad libitum* throughout the all lactation, the shape of the lactation curves simulated were consistent with the data (Figure 5 and 7) and RMSPE of milk yield for Holstein was even lower than for dataset 1 (3.7 vs 4.0%, Table3 and Supplementary Material S6). Furthermore, the lactation curves simulated here were in

close agreement with published average lactation curves (NRC, 2001; Leclerc, 2008; Spurlock *et al.*, 2012) or equations developed to predict potential milk yield (Faverdin *et al.*, 2007; Volden, 2011; Zom, 2014). The use of different parameters between breeds to control the shape of the lactation curve as applied in the NorFor system (Volden, 2011), was not necessary in this model (Figure 6).

The model structure assumes a simple linear decrease of milk protein yield from the first day of lactation onwards. However the Holstein data (dataset 1) of different productions levels (Figure 4) showed a clear increase during the first 50 days in milk. Consequently milk protein yield of the first dataset was over predicted in early lactation (by 250 g/day the first week). In this dataset, concentrate-to-forage ratio increased from 0.28 to 0.45 during the first 4 weeks of lactation thus it is not clear to what extent this early lactation increase of milk protein was nutritionally driven, which could partly explain the observed increase in milk protein yield. Although this early lactation increase was not observed in dataset 2, milk protein yield was still over predicted in early lactation, and this was mainly due to a slope bias (Table 3). However, as in other prediction curves (Faverdin *et al.*, 2007; Zom, 2014), we chose to simulate maximum milk protein yield at the onset of lactation. Further comparison with other milk protein yield curves would be useful to better characterize the homeorhetic regulation of protein secretion in early lactation.

The negative genetic correlation observed between milk yield and milk fat content (-0.51) or milk yield and milk protein content (-0.55, Loker *et al.*, 2012) was reproduced in this model. Nevertheless, the CCC of milk lactose content, characterized by the lowest variation throughout lactation, was low (0.50, Table 3). In particular, and in common for both of the datasets, milk lactose content was under predicted in early and late lactation. This coincides with times where the relative role of protein compared to lactose in the empirical equation used to predict milk yield is the highest. This further suggests that the fixed coefficient of osmotic pressure attributed to protein (4.3 g milk/g protein) is confounded with the effect of minerals in milk. With this coefficient, higher milk lactose content was predicted for multiparous than for primiparous whereas data in this study and others (Miglior *et al.*, 2007) shows a negative effect of parity on milk lactose content. Knowledge of the effect of stage of lactation and parity on minerals content would help in improving the milk lactose content prediction.

Empty body weight and composition

In the dataset 1, there was a positive relationship between empty BW at first week after calving and potential. Animals with average values of POT of: 32.8, 39.1, 43.8 and 49.4 kg/day had empty BW of 500, 514, 523, 541 kg respectively. However, this positive trend disappeared when empty BW was calculated as the average across lactation (first 41 weeks). This is in agreement with the reported genetic correlations between milk yield and live weight, which are positive and moderate (0.18-0.37) in the first week post-calving (Veerkamp and Thompson, 1999) but low (-0.01) in the overall lactation (Berry *et al.*, 2003). However, the main purpose in simulation of body composition was not to predict empty BW and BCS at calving but to quantify changes in empty BW and BCS through lactation. With the dissociation of empty BW into body protein and body fat, the model was able to simulate different rates of mobilization/reconstitution between protein and lipid through the lactation. In particular, a shorter protein mobilization phase as compared to lipid mobilization was simulated resulting in an increasing fat-to-protein ratio within the mobilized tissue, in agreement with literature values of body fat and protein change (see Supplementary Material S3). As a consequence, the observed difference in DIM between nadir empty BW and nadir BCS (Spurlock *et al.*, 2012) was appropriately reproduced by the model. The regulating sub-model explicitly creates a positive correlation between body fat mobilization and production levels. Using the scaling parameters obtained with dataset 1, Holstein cows producing 20 and 50 kg of milk at peak mobilized 17 kg and 64 kg of lipid, respectively. This increase in body fat mobilization with potential results in a greater and longer negative energy balance for high producing animals, consistent with literature (Faverdin *et al.*, 1987; Coffey *et al.*, 2004). The greater mobilization in early lactation and greater reconstitution in late lactation for multiparous than for primiparous simulated in this model was also consistent with previous observations (Coffey *et al.*, 2002; Spurlock *et al.*, 2012).

Dry-matter intake

Desired DMI was predicted based on the energy requirements defined by the model. Therefore, DMI was considered as pull-driven by energy requirements. As such, a positive relationship between energy balance and DMI was introduced. Therefore, the low DMI in early lactation simulated by the model was the consequence of energy mobilization. The DMI curve simulated for the average multiparous animal (POT=35

kg/day) was in agreement with empirical equation developed for lactating dairy cows (NRC, 2001; Fox *et al.*, 2004). The effect of parity traduced by a lower and flatter DMI curve for primiparous than multiparous was also in line with curves reported for first and later parities (Coffey *et al.*, 2002; Spurlock *et al.*, 2012).

The model presented in this paper is explicitly designed to simulate homeorhesis, and as such it does not predict dairy cows responses to change in dietary composition. However, this model provides a strong basis for incorporating dairy cow responses because it provides the baselines, the genetically driven partition of macronutrients between milk and body reserves, against which to predict the environmentally driven responses. Given that the model handles the effect of breed, parity, and milk production potential on these baseline trajectories, it facilitates the future developments of models that predict homeostatic adaptation and responses to dietary changes.

Conclusion

The model presented here predicts a mutually consistent set of trajectories for milk yield and composition, empty body composition change and DMI through lactation, as affected by homeorhetic regulation. Further, this model allows the prediction of differences in those trajectories between animals of different milk production potential within Holstein breed, and between Danish Red, Holstein and Jersey breeds. Using a model structure which requires few user-input parameters, dairy cow performance (body, milk and intake) were predicted in average with RMSPE of 4.4% and CCC of 0.83.

References

- AFRC 1993. Energy and Protein Requirements of Ruminants. An advisory manual prepared by the AFRC Technical Committee on response to Nutrients. CAB International, Wallingford, UK.
- Baldwin RL, France J, Beever DE, Gill M and Thornley JHM 1987. Metabolism of the lactating cow: III. Properties of mechanistic models suitable for evaluation of energetic relationships and factors involved in the partition of nutrients. *Journal of Dairy Research* 54, 133–145.
- Bauman DE and Currie WB 1980. Partitioning of nutrients during pregnancy and lactation: A review of mechanisms involving homeostasis and homeorhesis. *Journal of Dairy Science* 63, 1514–1529.
- Bell AW, Slepetic R and Ehrhardt RA. 1995. Growth and accretion of energy and protein in the gravid uterus during late pregnancy in Holstein cows. *Journal of Dairy Science* 78, 1954–1961.
- Berry DP, Buckley F, Dillon P, Evans RD, Rath M, and Veerkamp RF. 2003. Genetic relationships among body condition score, body weight, milk yield, and fertility in dairy cows. *Journal of Dairy Science* 86, 2193–2204.

- Bibby J and Toutenburg H. 1977. Prediction and Improved Estimation in Linear Models. Wiley, Berlin, Germany.
- Birnie JW, Agnew RE and Gordon FJ. 2000. The influence of body condition on the fasting energy metabolism of nonpregnant, nonlactating dairy cows. *Journal of Dairy Science* 83, 1–7.
- Cherwell Scientific Ltd. 2000. Modelmaker user manual. Cherwell Scientific Ltd, Oxford, England.
- Coffey MP, Simm G and Brotherstone S 2002. Energy balance profiles for the first three lactations of dairy cows estimated using random regression models. *Journal of Dairy Science* 85, 2669–2678.
- Coffey MP, Simm G, Oldham JD, Hill WG and Brotherstone S 2004. Genotype and diet effects on energy balance in the first three lactations of dairy cows. *Journal of Dairy Science* 87, 4318–4326.
- Danfaer A 1990. A dynamic model of nutrient digestion and metabolism in lactating dairy cows. Ph.D. Thesis. National Institute of Animal Science, Foulum, Denmark.
- Daniel JB, Friggens NC, Chapoutot P, Van Laar H and Sauvant D 2016. Milk yield and milk composition responses to change in predicted net energy and metabolizable protein: A meta-analysis. *Animal* 10, 1975-1985.
- Faverdin P, Hoden A and Coulon JB 1987. Recommandations alimentaires pour les vaches laitières. INRA, Bulletin Technique CRZV Theix 70, 133–152.
- Faverdin P, Delagarde R, Delaby L and Meschy F 2007. Alimentation des vaches laitières. Pages 23-58 in: Alimentation des bovins, ovins et caprins. Besoins des animaux - Valeur des aliments - Tables INRA 2007, mise à jour 2010. Editions Quae, Versailles, France.
- Ferrell CL, Garrett WN, Hinman N and Grichting G 1976. Energy utilization by pregnant and non-pregnant heifers. *Journal of Animal Science* 42, 937–950.
- Fox DG, Tedeschi LO, Tylutki TP, Russell JB, Van Amburgh ME, Chase LE, Pell AN and Overton TR 2004. The Cornell Net Carbohydrate and Protein System model for evaluating herd nutrition and nutrient excretion. *Animal Feed Science and Technology* 112, 29–78.
- Friggens NC 2003. Body lipid reserves and the reproductive cycle: Towards a better understanding. *Livestock Production Science* 83, 219–236.
- Friggens NC, Ingvarsen KL and Emmans GC 2004. Prediction of body lipid change in pregnancy and lactation. *Journal of Dairy Science* 87, 988–1000.
- Friggens NC, Brun-Lafleur L, Faverdin P, Sauvant D and Martin O. 2013. Advances in predicting nutrient partitioning in the dairy cow: Recognizing the central role of genotype and its expression through time. *Animal* 7, 89–101.
- Leclerc H 2008. Development of the French dairy cattle test-day model genetic evaluation and prospects of using results for herd management. Ph.D. Thesis. AgroParisTech, Paris, France.
- Lin LIK 1989. A concordance correlation coefficient to evaluate reproducibility. *Biometrics* 45, 255-268.
- Loker S, Bastin C, Miglior F, Sewalem A, Schaeffer LR, Jamrozik J, Ali A and Osborne V. 2012. Genetic and environmental relationships between body condition score and milk production traits in Canadian Holsteins. *Journal of Dairy Science* 95, 410–419.
- Martin O and Sauvant D 2007. Dynamic model of the lactating dairy cow metabolism. *Animal* 1, 1143–1166.
- Martin O and Sauvant D 2010. A teleonomic model describing performance (body, milk and intake) during growth and over repeated reproductive cycles throughout the lifespan of dairy cattle. 1. Trajectories of life function priorities and genetic scaling. *Animal* 4, 2030–2047.
- Miglior F, Sewalem A, Jamrozik J, Bohmanova J, Lefebvre DM and Moore RK 2007. Genetic analysis of milk urea nitrogen and lactose and their relationships with other production traits in Canadian Holstein cattle. *Journal of Dairy Science* 90, 2468–2479.
- NRC 2001. Nutrient requirements of dairy cattle, 7th revised edition. National Academy Press, Washington, DC, USA.
- Neal HDSC and Thornley JHM 1983. The lactation curve in cattle: A mathematical model of the mammary gland. *Journal of Agricultural Science* 101, 389–400.

- Nielsen HM, Friggens NC, Lovendahl P, Jensen J and Ingvarsten KL 2003. Influence of breed, parity, and stage of lactation on lactational performance and relationship between body fatness and live weight. *Livestock Production Science* 79, 119–133.
- Puillet L, Martin O, Tichit M and Sauvant D. 2008. Simple representation of physiological regulations in a model of lactating female: Application to the dairy goat. *Animal* 2, 235–246.
- Sauvant D 1994. Modelling homeostatic and homeorhetic regulations in lactating animals. *Livestock Production Science* 39, 105–113.
- Sauvant D, Ortigues-Marty I, Giger-Reverdin S and Nozière P 2015. Updating energy requirements and efficiency of dairy ruminant females. *Rencontre Recherche Ruminants* 22, 225–228.
- Spurlock DM, Dekkers JCM, Fernando R, Koltz DA and Wolc A 2012. Genetic parameters for energy balance, feed efficiency, and related traits in Holstein cattle. *Journal of Dairy Science* 95, 5393–5402.
- Tylutki TP, Fox DG, Durbal VM, Tedeschi LO, Russell JB, Van Amburgh ME, Overton TR, Chase LE and Pell AN 2008. Cornell Net Carbohydrate and Protein System: A model for precision feeding of dairy cattle. *Animal Feed Science and Technology* 143, 174–202.
- Veerkamp RF and Thompson R. 1999. A covariance function for feed intake, live weight, and milk yield estimated using a random regression model. *Journal of Dairy Science* 82, 1565–1573.
- Volden H 2011. *NorFor – The Nordic feed evaluation system*. EAAP Publications No 130. Wageningen Academic Publishers, Wageningen, the Netherlands.
- Zom R 2014. The development of a model for the prediction of feed intake and energy partitioning in dairy cows. Ph.D. Thesis. Wageningen University, Wageningen, the Netherlands.

Supplementary Material S1

1. Regulating sub-model

All definitions and values of the parameters of the regulating sub-model are presented in Table 1 of the manuscript.

1.1. Regulating sub-model for fat

$$\frac{dC_0}{dt} (/day) = -kC_0 C_F \times C_0, \quad (1)$$

$$C_0 = (1 - kC_0) \times (1 - M_F t_0) \times \left(\frac{kM_F + \left(\frac{POT}{POT_{REF}} \right) - 1}{kM_F} \right) \text{ at } t=0$$

with

$$\frac{dC_F}{dt} (/day) = (kC_0 C_F \times C_0) - \left(\frac{kC_M \times C_F}{\frac{POT}{POT_{REF}}} \right), \quad (2)$$

$$C_F = kC_0 \times (1 - M_F t_0) \times \left(\frac{kM_F + \left(\frac{POT}{POT_{REF}} \right) - 1}{kM_F} \right) \text{ at } t=0$$

with

$$\frac{dM_F}{dt} (/day) = \left(\frac{kC_M \times C_F}{\frac{POT}{POT_{REF}}} \right) - ((kM_A \times M_F) \times PREG\beta), \quad (3)$$

$$M_F = M_F t_0 \times \left(\frac{kM_F + \left(\frac{POT}{POT_{REF}} \right) - 1}{kM_F} \right) \text{ at } t=0$$

with

$$\frac{dA_F}{dt} (/day) = (kM_A \times M_F) \times PREG\beta, \quad (4)$$

with $A_F = 0$ at $t=0$

1.2. Regulating sub-model for protein

$$\frac{dC_P}{dt} (/day) = - \left(\frac{kCM_P \times C_P}{\frac{POT}{POT_{REF}}} \right), \quad (5)$$

with $C_P = (1 - M_P t_0) \times \left(\frac{kM_P + \left(\frac{POT}{POT_{REF}} \right) - 1}{kM_P} \right)$ at $t=0$

$$\frac{dM_P}{dt} (/day) = \left(\frac{kCM_P \times C_P}{\frac{POT}{POT_{REF}}} \right) - ((kMA_P \times M_P) \times PREG\beta), \quad (6)$$

with $M_P = M_P t_0 \times \left(\frac{kM_P + \left(\frac{POT}{POT_{REF}} \right) - 1}{kM_P} \right)$ at $t=0$

$$\frac{dA_P}{dt} (/day) = (kMA_P \times M_P) \times PREG\beta, \quad (7)$$

with $A_P = 0$ at $t=0$

1.3. Regulating sub-model for lactose

$$\frac{dC_L}{dt} (/day) = -kCM_L \times C_L, \quad (8)$$

$$C_L = (1 - M_L t_0) \times \left(\frac{kM_L + \left(\frac{POT}{POT_{REF}} \right) - 1}{kM_L} \right) \text{ at } t=0$$

with

$$\frac{dM_L}{dt} (\text{/day}) = (kC_M \times C_L) - ((kM_{A_L} \times M_L) \times PREG\beta), \quad (9)$$

$$M_L = M_L t_0 \times \left(\frac{kM_L + \left(\frac{POT}{POT_{REF}} \right) - 1}{kM_L} \right) \text{ at } t=0$$

with

$$\frac{dA_L}{dt} (\text{/day}) = (kM_{A_L} \times M_L) \times PREG\beta, \quad (10)$$

with $A_L = 0$ at $t=0$

1.4. Effect of pregnancy

$$PREG\alpha = e^{(k_{PREG\alpha} \times (DIP - DP))}, \quad (11)$$

$$PREG\beta = 1 + k_{PREG\beta} \times PREG\alpha, \quad (12)$$

1.5. Effect of growth

$$GR\alpha = (1 - k_{GR0}) \times e^{\left(-k_{GR\alpha} \times \left(P - 1 + \frac{t}{365} \right) \right)}, \quad (13)$$

$$GR\beta = 1 - k_{GR\beta} \times GR\alpha, \quad (14)$$

2. Operating sub-model

All definitions and values of the parameters of the operating sub-model are presented in Table 2 of the manuscript.

2.1. Milk yield and composition

$$MFY (\text{g/day}) = kMFY \times ((C_F + M_F) \times GR\beta), \quad (15)$$

$$\text{MPY (g/day)} = \text{kMPY} \times ((C_p + M_p) \times \text{GR}\beta), \quad (16)$$

$$\text{MLY (g/day)} = \text{kMLY} \times (M_L \times \text{GR}\beta), \quad (17)$$

$$\text{MY (kg/day)} = 1.26 \times \left(\frac{\text{kMY} + \left(\frac{\text{POT}}{\text{POT}_{\text{REF}}} \right) - 1}{\text{kMY}} \right) + 0.0173 \times \text{MLY} + 0.0043 \times \text{MPY}, \quad (18)$$

$$\text{Milk fat content (g/kg)} = \frac{\text{MFY}}{\text{MY}}, \quad (19)$$

$$\text{Milk protein content (g/kg)} = \frac{\text{MPY}}{\text{MY}}, \quad (20)$$

$$\text{Milk lactose content (g/kg)} = \frac{\text{MLY}}{\text{MY}}, \quad (21)$$

2.2. Body weight, body composition and gravid uterus

$$\frac{d\Delta\text{BF}}{dt} (\text{kg/day}) = ((A_F \times \text{GR}\beta) \times \text{kA}_F) - ((C_F \times \text{GR}\beta) \times \text{kC}_F), \quad (22)$$

$$\frac{d\Delta\text{BP}}{dt} (\text{kg/day}) = ((A_P \times \text{GR}\beta) \times \text{kA}_P) - ((C_P \times \text{GR}\beta) \times \text{kC}_P), \quad (23)$$

$$\text{BF (kg)} = 0.037683 \times \left(\frac{(\text{BCSc} - 0.5) \times 8}{4} \right) \times \text{MEBW} \times (1 - \text{GR}\alpha) + \Delta\text{BF}, \quad (24)$$

$$\text{BP (kg)} = \left((\text{MEBW} \times (1 - \text{GR}\alpha)) - 0.037683 \times \left(\frac{(\text{BCSc} - 0.5) \times 8}{4} \right) \times \text{MEBW} \times (1 - \text{GR}\alpha) \right) \times 0.215 + \Delta\text{BP}, \quad (25)$$

$$\text{GU (kg)} = \text{GUcalv} \times \text{PREG}\alpha, \quad (26)$$

$$\text{Empty BW (kg)} = \text{BF} + \frac{\text{BP}}{0.215} + \text{GU}, \quad (27)$$

$$\text{BCS (1-5 scale)} = \left(\left(\left(\frac{\text{BF}}{\text{Empty BW}} \right) \right) \times \frac{4}{8} \right) + 0.5, \quad (28)$$

$$BW_{std} \text{ (kg)} = \frac{\left(\frac{BP}{0.215} \right)}{0.8 \times 0.8}, \quad (29)$$

2.3. Energy requirements and dry-matter intake

$$NE_L \text{ maintenance (MJ/day)} = 0.394 \times BW_{std}^{0.75}, \quad (30)$$

$$NE_L \text{ milk (MJ/day)} = 39.8 \times \frac{MFY}{1000} + 23.9 \times \frac{MPY}{1000} + 16.5 \times \frac{MLY}{1000}, \quad (31)$$

$$BF \text{ growth (kg/day)} = \frac{\left(0.037683 \times \left(\frac{(BCSc - 0.5) \times 8}{4} \right) \times MEBW \right) \times kGR\alpha \times GR\alpha}{365}, \quad (32)$$

$$BP \text{ growth (kg/day)} = \frac{\left(\left(MEBW - 0.037683 \times \left(\frac{(BCSc - 0.5) \times 8}{4} \right) \times MEBW \right) \times 0.215 \right) \times kGR\alpha \times GR\alpha}{365}, \quad (33)$$

$$NE_L \text{ growth (MJ/day)} = \frac{\left((BP \text{ growth} \times 23.9) + (BF \text{ growth} \times 39.8) \right)}{k_{gt} \times k_{ls}}, \quad (34)$$

$$NE_{GU} \text{ preg (MJ/day)} = k_{NEL_GU} \times PREG\alpha, \quad (35)$$

$$NE_L \text{ preg (MJ/day)} = \left(\frac{NE_{GU} \text{ preg}}{k_{GU}} \right) \times k_{ls}, \quad (36)$$

$$NE_L \text{ body (MJ/day)} = \frac{\left(\frac{d\Delta BF}{dt} \times 39.8 + \frac{d\Delta BP}{dt} \times 23.9 \right)}{k_{gt} \times k_{ls}}, \quad (37)$$

$$\text{Total } NE_L \text{ requirement (MJ/day)} = NE_L \text{ maintenance} + NE_L \text{ milk} + NE_L \text{ growth} + NE_L \text{ preg} + NE_L \text{ body}, \quad (38)$$

$$DMI \text{ (kg/day)} = \frac{\text{Total } NE_L \text{ requirement}}{\text{Dietary } NE_L \text{ content}}, \quad (39)$$

Supplementary Material S2

1. Effect of Pregnancy

1.1. In the regulating sub-model

The effect of pregnancy on the lactation curves was included in the regulating sub-model and assumed to influence the shift between the dynamic priorities of partitioning between milk and body reserves. Pregnancy was represented by a simple exponential function (unit-less):

$$\text{PREG}\alpha = e^{(k_{\text{PREG}\alpha} \times (\text{DIP} - \text{DP}))}, \quad (1)$$

DIP and DP are the days in pregnancy and the length of the pregnancy, respectively. The conception date triggers DIP.

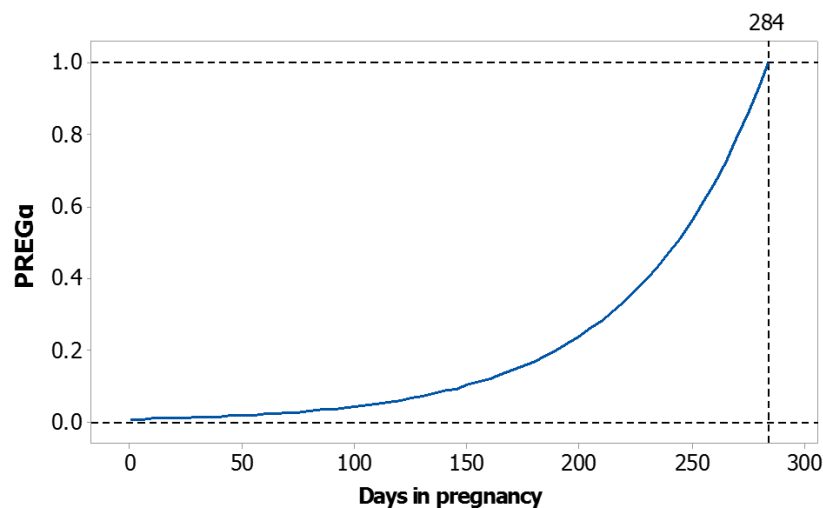

Figure S1. Function $\text{PREG}\alpha$ relative to days in pregnancy (DIP). Parameters values can be found in Table 1 of the manuscript.

As can be seen in Figure S1, the function $\text{PREG}\alpha$ goes from 0 when non-pregnant, to 1 at the end of pregnancy. The parameter $k_{\text{PREG}\alpha}$ controls the shape of the exponential function and was calibrated on the milk yield difference between non-pregnant and pregnant cows assessed by the test-day genetic evaluation model from Leclerc (2008). The effect of $\text{PREG}\alpha$ on the regulating sub-model was applied through the following equation, where $\text{PREG}\beta$ is used as a multiplier of the parameter k_{MA} (in equations 3,4,6,7,9 and 10 in Supplementary Material S1):

$$\text{PREG}\beta = 1 + k_{\text{PREG}\beta} \times \text{PREG}\alpha, \quad (2)$$

where $k_{PREG\beta}$ is the maximum size effect of function $PREG\alpha$ on kMA . As for the parameter $k_{PREG\alpha}$, $k_{PREG\beta}$ was fitted with data from Leclerc (2008). When there is no pregnancy, $PREG\alpha=0$, and thus $PREG\beta = 1$, which leaves parameter kMA unaffected by the $PREG\beta$ function. However, when there is a pregnancy, $PREG\beta >1$ and kMA is increased. This has the direct consequences to decrease lactation persistency but also to simultaneously increase body reserve gain. This means that the model implicitly ascribes different body condition score targets (or amount of lipid to store) for pregnant and non-pregnant cow. Direct experimental evidence in favour or against this effect is lacking. However, there is no doubt that pregnancy affects the persistency of milk yield and this effect has been quantified (Oltenacu *et al.*, 1980; Coulon *et al.*, 1995; Olori *et al.*, 1997).

1.2. In the operating sub-model

The function $PREG\alpha$ (equation 1) was also used to estimate the weight of the gravid uterus (GU) as:

$$GU \text{ (kg)} = GU_{calv} \times PREG\alpha, \quad (3)$$

where GU_{calv} , the weight of the gravid uterus at the last day of pregnancy, was assumed to be fixed across animal, and equal to 87 kg (Bell, 1995). The weight of the gravid uterus was then used to estimate the empty BW (see equation 27 in Supplementary Material S1).

2. Effect of growth

2.1. On priorities C, M and A

A fourth priority, for growth, was incorporated into the model so that it takes a priority over all other dynamic priorities. The shape of this priority was controlled by $GR\alpha$:

$$GR\alpha = (1 - k_{GR0}) \times e^{\left(-k_{GR\alpha} \times \left(P - 1 + \frac{t}{365}\right)\right)}, \quad (4)$$

where k_{GR0} represents the degree of maturity of the cow at first calving that is, the ratio of empty BW at first calving on mature empty BW. Therefore when the animal has reached maturity, $GR\alpha=0$. Parameter P is the parity number and t is the number of days in milk. With the assumption that cows reach maturity in the third lactation, the ratio between BW in first lactation and mature BW was found to be 0.85 and was not affected by breed (Friggens *et al.*, 2007). Accordingly, the slope parameter, $k_{GR\alpha}$, was

fitted so that $GR\alpha$ is approximately 0 at the onset of the third lactation for an animal that started the first lactation with a degree of maturity of 0.85. Figure S2 illustrates the shape of $GR\alpha$ for a primiparous cows that started the first lactation with a degree of maturity of 0.85. From that figure, it can be seen that this animal would reached 95% $[(1-GR\alpha)*100]$ of its mature weight at approximately 290 days in milk.

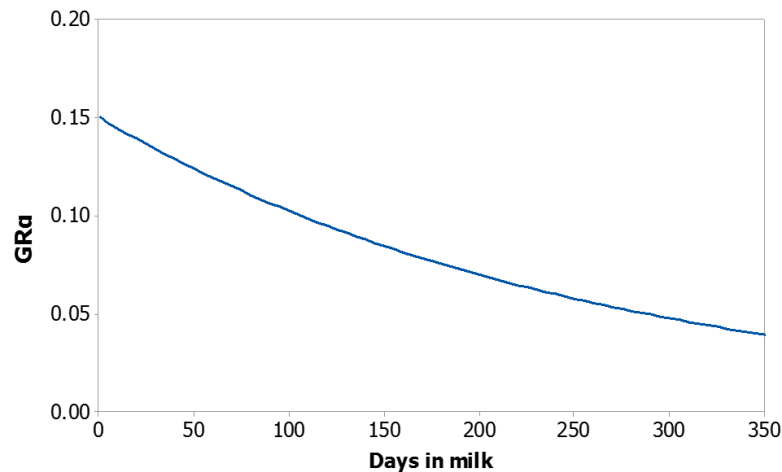

Figure S2. Function $GR\alpha$ relative to days in milk for a primiparous cow calving with a body weight equal to 85% of its mature body weight. Parameters values can be found in Table 1 of the manuscript.

This conceptual priority for growth $GR\alpha$, based on the degree of maturity, was then used to affect the others priorities C, M and A through the following function, called $GR\beta$ (equation 5). $GR\beta$ multiplies priorities C, M and A each time there are used in the operating sub-model (see equations 15, 16, 17, 22 and 23 in Supplementary Material S1). In such way, when the animal is growing, the size effect of C, M and A is decreased. However, when the animal is mature, $GR\alpha = 0$, and thus $GR\beta = 1$, which leave dynamic priorities C, M and A unaffected.

$$GR\beta = 1 - k_{GR\beta} \times GR\alpha, \quad (5)$$

where $k_{GR\beta}$ is a scaling factor that adjusts the effect of function $GR\alpha$. The parameter $k_{GR\beta}$ was fitted using dataset 1 so that realistic differences were simulated by the model in milk yield between primiparous and multiparous cows.

2.2. On developmental growth

The degree of maturity ($= 1-GR\alpha$) multiply with the mature empty BW (MEBW) give the empty BW of the animal. This empty BW is used to obtained the size of body fat and

body protein (see equation 24 and 25 in Supplementary Material S1). The rate of growth (in kg/d) for body fat (BF, equation 32 in Supplementary Material S1) and body protein (BP, equation 33 in Supplementary Material S1), needed to estimate the net energy requirement for growth, is obtained using the derivative of BF and BP (equations 24 and 25 in Supplementary Material S1, excluding changes in body fat and protein due to lactation).

3. Specificity of the regulating sub-models of fat and lactose

Regarding the regulating sub-models of fat and lactose, minor modifications were introduced. In the case of fat, secretion of milk fat is generally not maximal at the onset of lactation, with a very rapid increase during the first weeks. To simulate this effect, a small adaptation to the regulating sub-model structure was necessary for fat. Therefore, a fictitious dynamic priority C_{0F} was added previous to C_F with a mass action law controlling a delay of $1/kC_0C_F$ between C_{0F} and C_F .

$$\frac{dC_{0F}}{dt} (/day) = -kC_0C_F \times C_{0F}, \quad \text{with } C_{0F} = (1 - kC_0C_F) \times (1 - M_F t_0) \text{ at } t=0 \quad (6)$$

The resulting differential equation for C_F is:

$$\frac{dC_F}{dt} (/day) = (kC_0C_F \times C_{0F}) - (kC_M F \times C_F), \quad \text{with } C_F = kC_0C_F \times (1 - M_F t_0) \text{ at } t=0 \quad (7)$$

This results in a rapid increase priority for fat catabolism (C_F) during the first weeks of lactation, followed by a subsequent decrease, as can be seen in Figure 2 of the manuscript.

With respect to the regulation sub-model for lactose, body glycogen storage was assumed negligible and therefore no glucose compartment was needed in this model. This assumption was justified because model outputs were generated daily. Therefore, lactose production is only driving by priority M_L whose shape resembles a lactation curve, as described by the gamma function of Wood (1967) or simulated mechanistically in the mammary gland model of Neal and Thornley (1983). Consequently, priorities C_L and A_L were only used to generate a priority M_L to acquire lactose precursor from the diet.

4. Application of POT in the regulating sub-model

The final equations as applied in the regulating sub-model are in Supplementary Material S1. This part describes in 3 steps the way POT was included in the model:

(1) An overriding adjustment of POT was used to scale all non-null initial values (C, M and C_{0F}) as illustrated for C and M:

$$C = (1 - Mt_0) \times \left(\frac{POT}{POT_{REF}} \right) \text{ at } t=0 \quad (8)$$

$$M = Mt_0 \times \left(\frac{POT}{POT_{REF}} \right) \text{ at } t=0 \quad (9)$$

The effect of POT increases priorities C and M in the same proportion. This means that mobilization and feed intake will both increase with POT. These effects are consistent with the existing positive genetic correlations, between loss of body condition score and milk yield in early lactation (Berry *et al.*, 2002) and between DMI and milk yield (Veerkamp *et al.*, 1995).

(2) Differences in the effect of POT have been observed between milk components in a dataset of Holstein cows receiving the same ration (dataset 1). For an increase of 10 kg of milk at peak, the proportional increase of lactose secretion was larger than the increase in protein secretion, itself larger than the increase in fat secretion. In order to simulate this, the ratio POT/POT_{REF} was adjusted for each milk component using a parameter (kM) as follows:

$$\left(\frac{kM + \left(\frac{POT}{POT_{REF}} \right) - 1}{kM} \right) \quad (10)$$

Therefore the function (POT/POT_{REF}) from equation 8 and 9 was replaced by equation 10 using kM_F, kM_P or kM_L. A value of kM = 1 indicates no adjustment effect of kM on POT, values of kM < 1 amplify the effect of POT and values > 1 reduce the effect of POT.

(3) Furthermore, increasing length of mobilization phase has been found in cows selected for maximum compared to average milk production (Coffey *et al.*, 2004). To

reproduce this effect, kCM_F (equations 2 and 3 in Supplementary Material S1) and kCM_P (equations 5 and 6 in Supplementary Material S1), within the regulating sub-models of fat and protein, respectively, were adjusted with POT to allow varying length of mobilization:

$$\frac{\frac{kCM}{POT}}{POT_{REF}} \quad (11)$$

5. References

- Bell AW, Slepatis R and Ehrhardt RA. 1995. Growth and accretion of energy and protein in the gravid uterus during late pregnancy in Holstein cows. *Journal of Dairy Science* 78, 1954–1961.
- Berry DP, Buckley F, Dillon P, Evans FD, Rath M and Veerkamp RF 2002. Genetic parameters for level and change of body condition score and body weight in dairy cows. *Journal of Dairy Science* 85, 2030–2039.
- Coffey MP, Simm G, Oldham JD, Hill WG and Brotherstone S 2004. Genotype and diet effects on energy balance in the first three lactations of dairy cows. *Journal of Dairy Science* 87, 4318–4326.
- Coulon JB, Pérochon L and Lescourret F 1995. Modelling the effect of the stage of pregnancy on dairy cows' milk yield. *Animal Science* 60:401–408.
- Friggens NC, Berg P, Theilgaard P, Korsgaard IR, Ingvarsen KL, Løvendahl P and Jensen J 2007. Breed and parity effects on energy balance profiles through lactation: Evidence of genetically driven body energy change. *Journal of Dairy Science* 90, 5291–5305.
- Leclerc H 2008. Development of the French dairy cattle test-day model genetic evaluation and prospects of using results for herd management. Ph.D. Thesis. AgroParisTech, Paris, France.
- Olori VE, Brotherstone S, Hill WG and McGuirk BJ 1997. Effect of gestation stage on milk yield and composition in Holstein Friesian dairy cattle. *Livestock Production Science* 52, 167–176.
- Oltenuacu PA, Rounsaville TR, Milligan RA and Hintz RL 1980. Relationship between days open and cumulative milk yield at various intervals from parturition for high and low producing cows. *Journal of Dairy Science* 63, 1317–1327.
- Veerkamp RF, Simm G and Oldham JD 1995. Genotype by environment interaction: experience from Langhill. Pages 59–66 in *Breeding and feeding the high genetic merit dairy cow*. Lawrence TL, Gordon FJ and Carson A, ed.: British Society of Animal Science Occasional Publications, Midlothian, Scotland.
- Wood PDP 1967. Algebraic model of the lactation curve in cattle. *Nature* 216, 164–165.

Supplementary Material S3

1. Body protein and body fat relative to days in milk

Available data from literature with measured body fat and protein changes relative to days in milk were selected. A total of 8 publications (72 treatments means, 13 intra-experiment comparisons) were used: Belyea *et al.* 1978; Martin and Ehle, 1986; Chilliard *et al.*, 1991; McGuffey *et al.*, 1991; Gibb *et al.*, 1992; Andrew *et al.*, 1994; Komaragiri and Erdman, 1997; Komaragiri *et al.*, 1998. In this publications, body protein and body fat were adjusted to correct for the between experiment variability by centring body protein on 85 kg and body fat on 105 kg. Unadjusted and adjusted values (body protein 85, body fat 105) are presented in Figure S3.

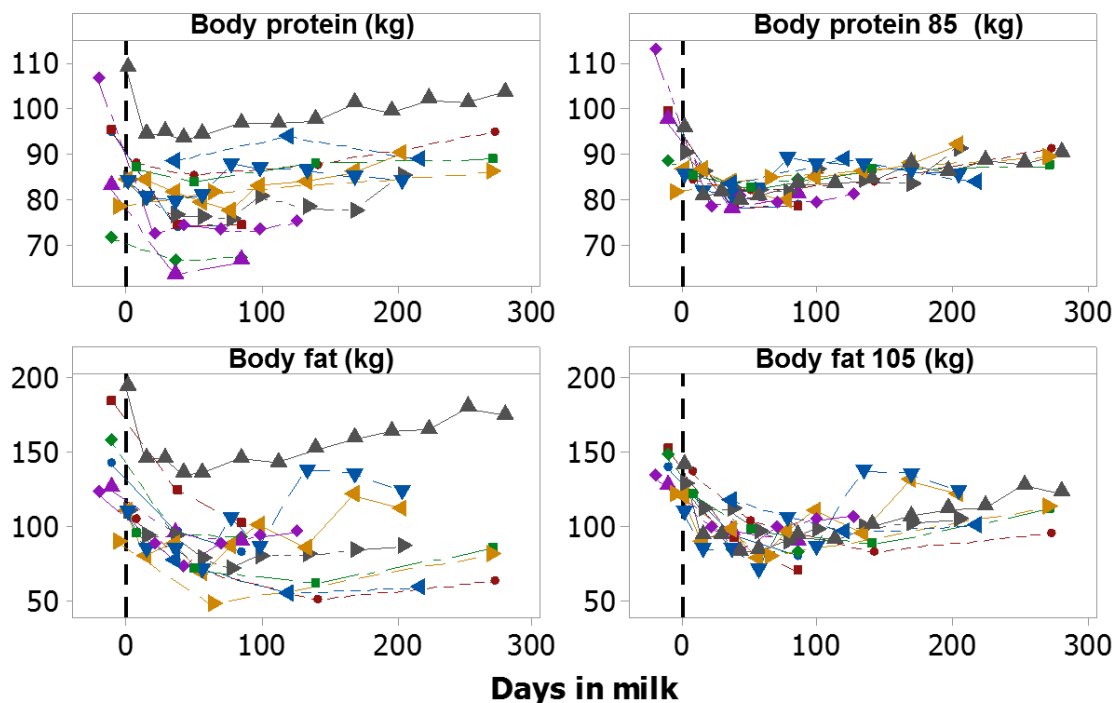

Figure S3. Body protein and body fat relative to days in milk, unadjusted (left panels) and adjusted (right panels) for the between-experiment variation. Each line represents one intra-experiment comparison (total of 13) including 72 treatments means.

Adjusted body protein and fat were then used to calibrate parameters k_{AF} , k_{CF} , k_{AP} and k_{CP} , that control the size of fat/protein being deposited/mobilised. These values were then adjusted by calibration against the changes in empty BW observed in dataset 1 (see manuscript). The final result of these calibration is shown on Figure S4 across 3 milk production potentials (POT=20, 35 and 50kg) for an animal with mature

empty BW of 520 kg and with body condition score at calving of 3.5 (1-5 scale). For comparison, the adjusted data from Figure S3 are also presented in grey.

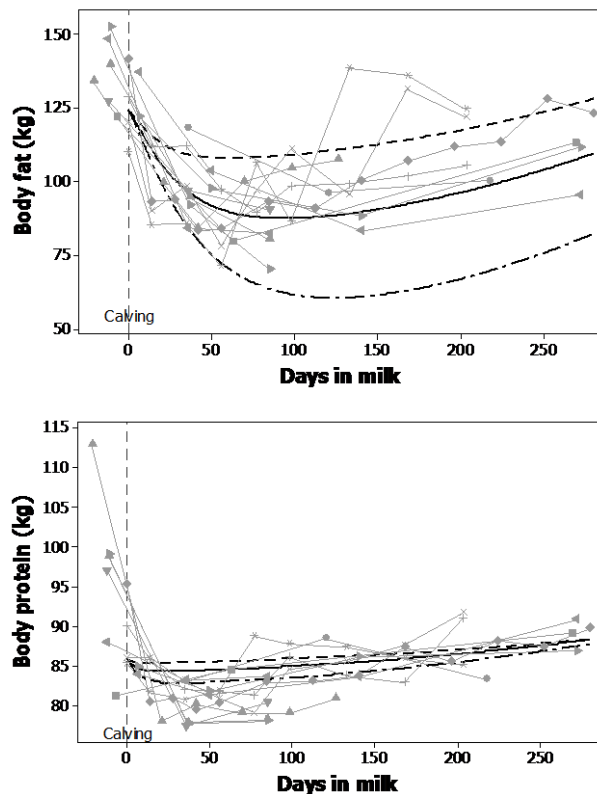

Figure S4 Effect of potential parameter POT, at levels 20 (even stippled line), 35 (solid line) and 50 kg (uneven stippled line), on body protein and body fat (kg) relative to DIM for a third lactation Holsteins cows, together with data from literature (see text for reference). Parameters for mature empty BW (MEBW), body condition score at calving (BCSc) and conception date were 520 kg, 3.50 and 100 DIM, respectively.

2. Relationship between body fatness and BCS

In the model body fatness (ratio between body fat and body weight) is estimated from BCS using the relationship established in NRC (2001). This relationship was compared to the one proposed by Yan *et al.* (2005) and the within-experiment relationship between body fatness and BCS, obtained with 25 treatment means from 4 experiments (Wright and Russel, 1984; Chilliard *et al.*, 1991; Komaragiri and Erdman, 1997; Komaragiri *et al.*, 1998), which was:

$$\text{BF/Empty BW} = 0.0777 + 0.0563 \times \text{BCS} \quad (\text{RMSE}=0.0237). \quad (1)$$

The comparison between these 3 equations is shown in Figure S5. The relationship from NRC (2001) retained in the model is an intermediate between the 2 others propositions.

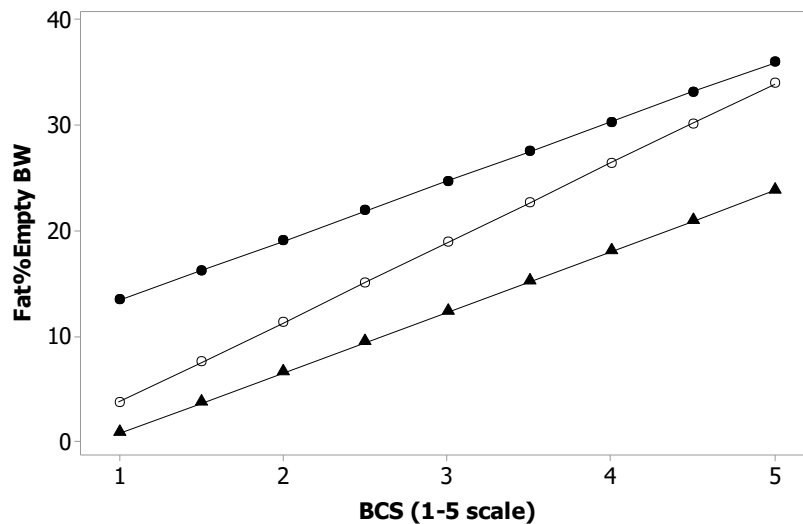

Figure S5. Comparison of 3 equations that predict body fatness (% of fat in empty BW) from BCS (1-5 scale). Equation 1: ●; NRC (2001): ○; Yan *et al.* (2005): ▲.

3. References

- Andrew SM, Waldo DR and Erdman RA 1994. Direct analysis of body composition of dairy cows at three physiological stages. *Journal of Dairy Science* 77, 3022–3033.
- Belyea RL, Frost GR, Martz FM, Clark JL and Forkner LG 1978. Body composition of dairy cattle by potassium-40 liquid scintillation detection. *Journal of Dairy Science* 61, 206–211.
- Chilliard Y, Cisse M, Lefaiivre R and Remond B. 1991. Body composition of dairy cows according to lactation stage, somatotropin treatment and concentrate supplementation. *Journal of Dairy Science* 74, 3103–3116.
- Gibb MJ, Irvings WE, Dhanoa MS and Sutton JD 1992. Changes in body components of autumn-calving Holstein Friesian cows over the first 29 weeks of lactation. *Animal Production* 5, 339–360.
- Komaragiri MVS and Erdman RA. 1997. Factors affecting body tissue mobilization in early lactation dairy cows. 1. Effects of dietary protein on mobilization of body fat and protein. *Journal of Dairy Science* 80, 929–937.
- Komaragiri MVS, Casper DP and Erdman RA. 1998. Factors affecting body tissue mobilization in early lactation dairy cows. 2. Effect of dietary fat on mobilization of body fat and protein. *Journal of Dairy Science* 81, 169–175.
- Martin RA and Ehle FR 1986. Body composition of lactating and dry Holstein cows estimated by deuterium dilution. *Journal of Dairy Science* 69, 88–98.
- McGuffey RK, Basson RP and Spike TE 1991. Lactation response and body composition of cows receiving somatotropin and three ratios of forage to concentrate. *Journal of Dairy Science* 74, 3095–3102.
- NRC 2001. Nutrient requirements of dairy cattle, 7th revised edition. National Academy Press, Washington, DC, USA.
- Wright IA and Russel AJF. 1984. Partition of fat, body composition and body condition score in mature cows. *Animal Production* 38, 23–32.
- Yan T, Agnew RE and Mayne CS. 2005. Prediction of body weight and composition in lactating dairy cows: Relationship between body condition score and body composition. In: *The Proceedings of BSAS Annual Meeting*, p180, York, U.K.

Supplementary Material S4

1. Model calibration using dataset 1

The model was calibrated against data of multiparous cows from dataset 1. For some parameters, others datasets were used in combination with dataset 1 (see details in Table S1). Parameters not listed in Table S1 were either fixed by the user (POT, POT_{REF}, P, DP, Conc. date, [NE_L]) or based on others sources described in the text as they are introduced: BCS_{BF} and BP_{FFM} from NRC (2001), GU_{calv} and k_{NEL_GU} from Bell *et al.* (1995), EBW_{BW} and FFM_{EBW} from literature dataset detailed in Supplementary Material S3, k_M, k_{Is} and k_{gt} from Sauvant *et al.* (2015), k_{GU} from Ferrell *et al.*, 1976.

Table S1. Source of data used for the calibration of model parameters

Parameters	Role	Data used for calibration
kC0 _F , kCM _F , kCM _P , kCM _L , kMA _F , kMA _P , kMA _L	Parameters controlling the shape of the dynamic priorities (C0 _F , C _F , M _F , A _F , C _P , M _P , A _P , C _L , A _L , M _L)	Multiparous of dataset 1
kC0 _F , M _{Ft0} , M _{Pt0} , M _{Lt0}	Parameter controlling initial size of priority compartments	Multiparous of dataset 1
kM _F , kM _P , kM _L	Parameters controlling the effect of POT on each regulating sub-model (fat, protein and lactose)	Multiparous of dataset 1
kPREG _α , kPREG _β	Parameters controlling the effect of pregnancy	Multiparous of dataset 1 and Leclerc (2008)
kGR _α , kGR _β	Parameters controlling the effect of growth	Multiparous and primiparous of dataset 1
kMY, kMFY, kMPY, kMLY,	First set of scaling factors for milk production	Multiparous of dataset 1
kC _F , kA _F , kC _P , kA _P , MEBW, BCSc	First set of scaling factors for milk production	Multiparous of dataset 1 and literature dataset (see Supplementary Material S3)

2. Model calibration using dataset 2

A subset of dataset 2 (parity 2) was used to derive the 7 breed scaling parameters, i.e. adjust the relative secretion of milk components (kMFY, kMPY, kMLY) and changes in body composition (kC_F, kA_F, kC_P and kA_P) according to breed. The set of parameters for milk composition were estimated through a least square procedure performed with the simplex algorithm of the Modelmaker 3.0 software (Cherwell Scientific Ltd, 2000) using values estimated with dataset 1 as default values and 100 convergence steps.

Scaling parameters for body composition were estimated iteratively based on observed changes in BCS and empty BW relative to calving of the multiparous cows from Dataset 2 as follows. First, k_{AF} and k_{CF} were adjusted to achieve a minimal difference between observed and predicted BCS. Second, k_{CP} and k_{AP} were adjusted to achieve a minimal difference between observed and predicted empty BW. Finally, steps 1 and 2 were repeated until model fit was considered graphically satisfactorily. Before the estimation of those scaling parameters, POT was changed to match the observed peak of lactation in second parity for each breed. Additionally, MEBW and BCSc were changed so that predicted calving empty BW equal observed calving empty BW and predicted BCSc equal observed BCSc. The estimated scaling parameters are displayed in Table 2 of the manuscript (Dataset 2).

3. Model identifiability

The full model was tested for identifiability. For that purpose, Matlab software GenSSI (Chis *et al.* 2011), which uses the generating series approach, was used. When all 24 parameters related to identifiability testing were considered as totally unknown the analysis concluded that the model is not globally identifiable. However, assuming the initial conditions of the compartments C and M are known (i.e. k_{MF} , k_{MP} , k_{ML} , M_{Ft0} , M_{Pt0} , M_{Lt0} = all parameters dealing with the effect of potential) the identifiability analysis led to the conclusion that the model is structurally locally identifiable.

4. References

- Bell AW, Slepatis R and Ehrhardt RA. 1995. Growth and accretion of energy and protein in the gravid uterus during late pregnancy in Holstein cows. *Journal of Dairy Science* 78, 1954–1961.
- Cherwell Scientific Ltd. 2000. Modelmaker user manual. Cherwell Scientific Ltd, Oxford, England.
- Chis O, Banga JR and Balsa-Canto E 2011. GenSSI: a software toolbox for structural identifiability analysis of biological models. *Bioinformatics* 27, 2610–2611.
- Ferrell CL, Garrett WN, Hinman N and Grichting G 1976. Energy utilization by pregnant and non-pregnant heifers. *Journal of Animal Science* 42, 937–950.
- Leclerc H 2008. Development of the French dairy cattle test-day model genetic evaluation and prospects of using results for herd management. Ph.D. Thesis. AgroParisTech, Paris, France.
- NRC 2001. Nutrient requirements of dairy cattle, 7th revised edition. National Academy Press, Washington, DC, USA.
- Sauvant D, Ortigues-Marty I, Giger-Reverdin S and Nozière P 2015. Updating energy requirements and efficiency of dairy ruminant females. *Rencontre Recherche Ruminants* 22, 225–228.

Supplementary Material S5

1. Calculated nutritional values of the rations

Table S2 shows the calculated chemical composition of the ration fed, and the calculated nutritional values with the INRA Systali model (Sauvant and Nozière, 2016).

Table S2. Calculated nutritional values with INRA Systali feed unit system

Variables	Dataset 1 ¹		Dataset 2 ¹	
	(Trouw Nutrition R&D)		(Nielsen <i>et al.</i> 2003)	
	Mean	SD	Mean	SD
CP (g/kg DM)	164	13	147	4
RDP (g/kg DM)	112	9	104	4
RUP (g/kg DM)	52	7	43	2
NDF (g/kg DM)	385	26	352	25
Forage NDF (g/kg DM)	303	50	236	25
Starch (g/kg DM)	193	26	97	14
EE (g/kg DM)	36	6	34	0
Concentrate inclusion (% DM)	34	11	49	0
NE _L (MJ/kg DM)	7.17	0.24	6.64	0.31
MP (g/kg DM)	90.0	6.5	83.5	1.4

¹Statistics of 30 514 weekly individual data are presented for dataset 1 and 6 591 weekly individual data are presented for dataset 2.

2. Creation of subsets within dataset 1 and 2

In dataset 1, average lactation curves for milk yield, milk component yields and BW were calculated. The multiparous cows were divided into 4 groups based on average milk production between weeks 4 and 14 (MY_{peak}), thus there were: 87 cows with MY_{peak}<35kg/d, 142 cows with 35<MY_{peak}<40 kg/d, 122 cows with 40<MY_{peak}<45 kg/d and 69 cows with MY_{peak}>45 kg/d. For primiparous cows, cows were assigned into 3 groups based on average milk yield between weeks 4 and 18 as follows (MY_{peak}_primi): 65 cows with MY_{peak}_primi <28kg/d, 99 cows with 28<MY_{peak}_primi <32kg/d and 96 cows with MY_{peak}_primi >32 kg/d.

In dataset 2, 6 average lactation curves for milk yield, milk component yields, BW and BCS were obtained: Holstein parity 1 (52 cows); Holstein parity 2 (41 cows), Danish Red parity 1 (44 cows), Danish Red parity 2 (36 cows), Jersey parity 1 (40 cows) and Jersey parity 2 (34 cows).

3. Estimation of empty BW

As one of the ambitions of the model was to simulate the empty BW trajectory through lactation, an estimation of gut fill was necessary for both of the datasets. An equation predicting the liquid weight within reticulo-rumen (**RRLiq**, %BW) was derived from a meta-analysis database (Sauvant and Nozière, 2016) using NDF intake (NDFI, kg) and BW (kg) as predictors, the resulting equation was (517 treatment means, $R^2=0.94$, RMSE=0.74):

$$\text{RRLiq (\%BW)} = 12 + 3.78 \times \left(\left(\frac{\text{NDFI}}{\text{BW}} \times 100 \right) - 1 \right), \quad (1)$$

Gut fill was then calculated as (Martin and Sauvant, 2003):

$$\text{Gut fill (kg)} = \frac{\left(\frac{\left(\frac{\text{RRLiq} \times \text{BW}}{100} \right)}{\left(\frac{100-11.4}{100} \right)} \right)}{\left(\frac{69.6}{100} \right)}, \quad (2)$$

where 11.4 % is the DM content of the reticulo-rumen and 69.6% is the weight of the reticulo-rumen contents relative to the weight of the whole digestive tract contents.

Finally empty BW was calculated as:

$$\text{Empty BW (kg)} = \text{BW} - \text{Gutfill},$$

4. References

- Martin O and Sauvant D 2003. Modeling digestive tract contents in cattle. *Rencontre Recherche Ruminants* 10, 167–170.
- Nielsen HM, Friggens NC, Lovendahl P, Jensen J and Ingvarsten KL 2003. Influence of breed, parity, and stage of lactation on lactational performance and relationship between body fatness and live weight. *Livestock Production Science* 79, 119–133.
- Sauvant D and Nozière P. 2016. Quantification of the main digestive processes in ruminants: the equations involved in the renewed energy and protein feed evaluation systems. *Animal* 10, 755-770.

Supplementary Material S6

Table S3. Summary of observed versus predicted outputs (empty BW, dry-matter intake, milk yield, milk component yields, milk component contents) for primiparous cows across milk production potential (P1 is POT¹=35.0; P2 is POT=42.2; P3 is POT=49.4) of dataset 1.

	Observed ²	Predicted ²	RMSPE% ³	ECT% ⁴	ER% ⁵	ED% ⁶	CCC ⁷
Empty BW (kg)							
P1	451 ± 25	454 ± 26	1.5	15.4	7.0	77.6	0.97
P2	452 ± 20	455 ± 25	2.0	10.6	49.1	40.4	0.95
P3	454 ± 20	459 ± 25	1.8	26.1	38.8	35.1	0.96
Dry-matter intake (kg/day)							
P1	17.6 ± 1.5	17.9 ± 1.4	2.0	53.7	8.0	38.2	0.98
P2	18.7 ± 1.7	19.4 ± 1.6	4.3	85.4	0.1	14.5	0.89
P3	19.7 ± 1.9	20.9 ± 1.8	6.3	94.1	0.0	5.9	0.81
Milk yield (kg/day)							
P1	22.8 ± 2.4	22.6 ± 3.0	4.0	5.6	53.0	41.4	0.97
P2	26.5 ± 3.1	27.0 ± 3.6	4.0	23.8	32.5	43.6	0.96
P3	31.2 ± 3.4	31.5 ± 4.2	3.0	10.5	66.5	23.0	0.99
Milk fat yield (g/day)							
P1	1031 ± 73	1013 ± 85	3.7	18.3	21.9	59.8	0.87
P2	1124 ± 83	1133 ± 94	3.8	2.6	24.2	73.2	0.78
P3	1219 ± 79	1254 ± 103	6.0	49.7	30.1	20.1	0.89
Milk protein yield (g/day)							
P1	807 ± 59	817 ± 62	7.1	3.0	25.6	71.3	0.55
P2	908 ± 69	935 ± 71	7.3	16.5	17.6	65.9	0.58
P3	1019 ± 73	1054 ± 80	8.7	15.3	30.3	54.4	0.39
Milk lactose yield (g/day)							
P1	1078 ± 129	1028 ± 167	7.2	40.6	31.8	27.6	0.90
P2	1247 ± 160	1220 ± 198	5.5	15.0	40.8	44.2	0.95
P3	1449 ± 175	1412 ± 229	5.2	24.1	58.2	17.8	0.97
Milk fat content (g/kg)							
P1	45.5 ± 2.2	45.3 ± 2.8	3.6	1.4	38.1	60.5	0.80
P2	42.6 ± 2.4	42.2 ± 2.5	2.2	16.3	9.4	74.3	0.93
P3	39.3 ± 3.0	40.1 ± 2.3	3.8	25.7	8.3	66.0	0.88
Milk protein content (g/kg)							
P1	35.6 ± 1.8	36.8 ± 5.1	13.9	5.4	82.5	12.2	0.29
P2	34.4 ± 1.9	35.1 ± 4.8	12.6	2.1	83.0	14.9	0.41
P3	32.8 ± 1.8	33.9 ± 4.6	13.2	6.2	80.1	13.7	0.37
Milk lactose content (g/kg)							
P1	47.3 ± 0.7	45.4 ± 1.7	4.8	68.1	27.4	4.5	0.30
P2	47.0 ± 0.7	44.9 ± 1.8	5.1	71.9	24.8	3.3	0.30
P3	46.4 ± 0.6	44.6 ± 1.8	4.7	64.4	34.1	1.5	0.35

¹POT is the parameter controlling the overall effect of milk production potential (see Table 1 in the manuscript)

²Mean ± SD

³Root mean squared prediction error expressed as a percentage of the observed mean.

⁴Error due to intercept bias, as a percent of total MSPE.

⁵Error due to slope bias, as a percent of total MSPE.

⁶Error due to disturbance, as a percent of total MSPE.

⁷Concordance correlation coefficient (scale from -1 to 1).

Table S4. Summary of observed versus predicted outputs (empty BW, dry-matter intake, milk yield, milk component yields, milk component contents) for multiparous cows across milk production potential (M1 is POT¹=32.8; M2 is POT=39.1; M3 is POT=43.8; M4 is POT=49.4) of dataset 1.

	Observed ²	Predicted ²	RMSPE% ³	ECT% ⁴	ER% ⁵	ED% ⁶	CCC ⁷
Empty BW (kg)							
M1	510 ± 25	485 ± 16	5.5	76.9	3.5	19.6	0.47
M2	504 ± 19	487 ± 16	3.8	64.7	0.8	34.4	0.52
M3	505 ± 16	490 ± 17	3.1	48.3	13.5	38.2	0.44
M4	508 ± 14	497 ± 18	2.7	30.6	33.5	35.9	0.35
Dry-matter intake (kg/day)							
M1	20.4 ± 1.8	20.1 ± 1.6	2.4	30.2	8.0	61.8	0.96
M2	21.6 ± 2.0	21.7 ± 1.8	2.0	3.9	14.3	81.8	0.98
M3	22.5 ± 2.2	22.9 ± 1.9	3.2	33.1	8.8	58.1	0.95
M4	24.0 ± 2.2	24.4 ± 2.0	3.1	34.6	2.7	62.6	0.95
Milk yield (kg/day)							
M1	26.6 ± 4.4	26.3 ± 4.6	3.9	7.2	9.2	83.6	0.97
M2	30.6 ± 5.8	31.1 ± 5.4	4.8	10.6	1.2	88.2	0.97
M3	34.2 ± 6.4	34.6 ± 6.0	4.0	10.0	3.2	86.8	0.98
M4	38.7 ± 7.2	38.9 ± 6.7	3.2	1.8	7.7	90.6	0.99
Milk fat yield (g/day)							
M1	1217 ± 156	1224 ± 167	3.9	1.9	12.0	86.0	0.95
M2	1342 ± 211	1355 ± 182	5.3	2.6	2.0	95.4	0.92
M3	1450 ± 231	1454 ± 194	6.3	0.1	3.8	96.1	0.92
M4	1538 ± 233	1572 ± 207	6.3	10.2	0.2	89.6	0.90
Milk protein yield (g/day)							
M1	959 ± 116	982 ± 149	8.9	6.9	37.3	55.8	0.82
M2	1066 ± 145	1112 ± 169	8.2	27.1	19.3	53.6	0.86
M3	1161 ± 147	1209 ± 183	8.7	21.6	29.1	49.3	0.84
M4	1276 ± 155	1325 ± 201	8.5	19.6	35.1	45.3	0.85
Milk lactose yield (g/day)							
M1	1216 ± 217	1215 ± 242	5.5	0.0	24.5	75.5	0.96
M2	1392 ± 284	1426 ± 284	6.7	12.7	2.1	85.2	0.95
M3	1550 ± 313	1583 ± 316	5.6	14.9	2.0	83.1	0.96
M4	1741 ± 351	1771 ± 353	5.0	11.4	1.8	86.8	0.97
Milk fat content (g/kg)							
M1	46.1 ± 2.5	46.9 ± 3.0	3.2	31.7	22.1	46.2	0.88
M2	44.2 ± 2.8	44.0 ± 2.8	1.9	6.5	1.2	92.2	0.95
M3	42.7 ± 3.5	42.3 ± 2.6	3.1	10.0	23.8	66.2	0.94
M4	40.1 ± 3.6	40.7 ± 2.5	3.9	16.4	38.8	44.8	0.94
Milk protein content (g/kg)							
M1	36.4 ± 2.0	37.8 ± 5.4	14.2	7.3	80.1	12.6	0.34
M2	35.2 ± 2.2	36.2 ± 5.2	13.2	4.5	78.6	17.0	0.45
M3	34.4 ± 2.4	35.3 ± 5.1	13.1	4.4	74.4	21.2	0.46
M4	33.4 ± 2.5	34.5 ± 4.9	12.5	6.5	69.9	23.6	0.54
Milk lactose content (g/kg)							
M1	45.7 ± 0.7	46.0 ± 1.6	2.5	9.0	78.8	12.2	0.79
M2	45.4 ± 0.8	45.7 ± 1.7	2.4	7.0	74.4	18.7	0.80
M3	45.2 ± 0.9	45.5 ± 1.7	2.3	9.7	76.4	13.9	0.86
M4	44.8 ± 0.9	45.3 ± 1.7	2.6	17.5	68.1	14.5	0.79

¹POT is the parameter controlling the overall effect of milk production potential (see Table 1 in the manuscript)

²Mean \pm SD

³Root mean squared prediction error expressed as a percentage of the observed mean.

⁴Error due to intercept bias, as a percent of total MSPE.

⁵Error due to slope bias, as a percent of total MSPE.

⁶Error due to disturbance, as a percent of total MSPE.

⁷Concordance correlation coefficient (scale from -1 to 1).

Table S5. Summary of observed versus predicted outputs (empty BW, BCS, dry-matter intake, milk yield, milk component yields, milk component contents) for primiparous cows across breeds (Danish Red (DR) with POT¹=29.1, Holstein (H) with POT=35.0, Jersey (J) with POT=24.0) of dataset 2.

	Observed ²	Predicted ²	RMSPE% ³	ECT% ⁴	ER% ⁵	ED% ⁶	CCC ⁷
Empty BW (kg)							
DR	458 ± 20	479 ± 29	5.0	83.2	16.4	0.4	0.72
H	462 ± 20	470 ± 24	2.0	66.8	24.9	8.2	0.94
J	311 ± 11	322 ± 16	4.5	58.2	23.0	18.8	0.64
Body condition score (1-5 scale)							
DR	3.58 ± 0.14	3.48 ± 0.16	3.2	69.0	8.1	22.9	0.76
H	3.06 ± 0.15	3.05 ± 0.19	2.3	3.8	49.3	46.9	0.94
J	3.01 ± 0.13	3.08 ± 0.14	3.1	41.9	7.6	50.5	0.78
Dry-matter intake (kg/day)							
DR	17.4 ± 1.0	16.7 ± 1.3	3.9	82.6	12.7	4.7	0.86
H	19.6 ± 1.7	18.5 ± 1.6	5.7	93.2	0.1	6.7	0.81
J	15.3 ± 1.6	15.3 ± 1.1	5.7	0.4	6.8	92.9	0.85
Milk yield (kg/day)							
DR	19.5 ± 1.6	19.3 ± 2.1	4.8	5.9	45.7	48.4	0.90
H	23.8 ± 2.0	23.3 ± 2.5	4.3	28.1	30.0	41.8	0.92
J	17.0 ± 1.6	16.0 ± 1.8	8.3	46.2	9.8	44.0	0.70
Milk fat yield (g/day)							
DR	886 ± 39	870 ± 54	4.1	18.1	38.2	43.7	0.75
H	1060 ± 59	1034 ± 63	4.6	26.8	12.9	60.2	0.70
J	1017 ± 50	965 ± 60	6.8	56.2	14.7	29.1	0.45
Milk protein yield (g/day)							
DR	721 ± 16	690 ± 42	6.6	41.5	50.8	7.8	0.29
H	838 ± 19	829 ± 51	5.3	3.8	83.3	12.9	0.48
J	690 ± 15	660 ± 40	7.3	35.1	56.3	8.6	0.07
Milk lactose yield (g/day)							
DR	956 ± 91	901 ± 115	7.8	54.3	18.7	27.0	0.79
H	1150 ± 113	1065 ± 136	8.3	78.0	8.7	13.3	0.77
J	818 ± 92	747 ± 95	11.1	59.9	5.0	35.1	0.63
Milk fat content (g/kg)							
DR	45.6 ± 2.1	45.4 ± 2.6	3.0	1.5	36.7	61.9	0.85
H	44.7 ± 2.3	44.7 ± 2.5	1.1	0.6	13.5	85.9	0.98
J	60.1 ± 4.0	60.5 ± 3.6	7.2	0.7	25.4	73.9	0.33
Milk protein content (g/kg)							
DR	37.2 ± 2.7	36.1 ± 3.7	6.7	18.3	39.9	41.8	0.75
H	35.6 ± 3.7	35.9 ± 3.6	4.8	5.0	3.4	91.6	0.89
J	40.9 ± 3.3	41.5 ± 4.3	10.0	2.1	46.0	51.9	0.43
Milk lactose content (g/kg)							
DR	48.9 ± 0.8	46.6 ± 1.2	4.9	94.2	3.4	2.3	0.23
H	48.3 ± 0.9	45.7 ± 1.2	5.4	97.4	1.7	0.9	0.25
J	48.0 ± 1.0	46.5 ± 1.2	3.5	84.0	5.1	11.0	0.40

¹POT is the parameter controlling the overall effect of milk production potential (see Table 1 in the manuscript). Breed scaling parameters used for the simulation can be found in Table 2 of the manuscript.

²Mean ± SD

³Root mean squared prediction error expressed as a percentage of the observed mean.

CHAPTER 4

⁴Error due to intercept bias, as a percent of total MSPE.

⁵Error due to slope bias, as a percent of total MSPE.

⁶Error due to disturbance, as a percent of total MSPE.

⁷Concordance correlation coefficient (scale from -1 to 1).

Chapter 5

Incorporation of dairy cow responses to change in dietary composition into a model that generates lactation curves of performance for cows of different potential

J.B. Daniel^{1,2}, N.C. Friggens¹, H. Van Laar², C.P. Ferris³ and D. Sauvant¹

To be submitted

¹UMR Modélisation Systémique Appliquée aux Ruminants, INRA, AgroParisTech, Université Paris-Saclay, 75005 Paris, France

²Trouw Nutrition R&D, P.O. Box 220, 5830 AE Boxmeer, the Netherlands

³Agri-Food and Biosciences Institute, Hillsborough, Co. Down, BT26 6DR, United Kingdom

Abstract

A dynamic model of a dairy cow, designed to predict whole lactation curves for dry-matter intake (**DMI**), milk yield, milk composition and body weight change is described. The model is a combination of two previously described models. The first quantified important homeorhetic regulation (effect of lactation, gestation and growth) on animal performance across a range of milk production levels, and the second quantified the effect of nutrition on DMI, milk yield and milk composition. The integration of these two models into one was achieved by using a common pivot nutritional situation, where metabolizable protein (**MP**) and net energy for lactation (**NE_L**) efficiency are 0.67 and 1 respectively. Dynamic pivot curves were thus estimated relative to days in milk, from which the responses could be predicted. In order to be used, the model required few input parameters, such as actual animal performance and diet fed, that can be derived in practice. These inputs are used to key the model into animal type (breed, parity, production capacity) on that farm and generate whole lactation curves of production for the current diet fed. From there, the consequences of dietary changes on those curves can be predicted by providing new values of ration composition (for **NE_L**, **MP** and forage neutral detergent fibre). The combined model was evaluated with 2 independent data sets, where different dietary treatments (effect of dietary level of crude protein or concentrate) were applied during the whole lactation. The prediction of whole lactation curves for DMI, milk yield and milk component yields of the highest dietary quality treatments were globally satisfactory with CCC range (and RMSPE range) from 0.516 to 0.914 (from 4.3% to 11.2%) in the first data set and from 0.883 to 0.983 (from 3.8 to 6.9%) in the second data set. The prediction accuracy of the consequences of the dietary change for DMI, milk yield and milk component yields on the second dataset was superior to the first dataset. In the first data set, CCC range from 0.099 to 0.496 and RMSPE range from 8.2% to 31.8%, whereas in the second data set, CCC range from 0.538 to 0.806 and RMSPE range from 8.0 to 17.1%. Such contrasting results were mainly explained by the accuracy of the prediction of change in **NE_L** and **MP** supply (therefore DMI, **NE_L** and **MP**) between the two dietary treatments.

Keywords: homeorhesis, milk response, potential, energy and protein

Introduction

The prediction of dairy cow performance, namely DMI, milk yield, milk composition and BW change requires quantification of effects of both, nutrition and physiological status (lactation, pregnancy, growth). Effects of nutrition on milk production have been intensively studied and recently empirical equations describing milk production response to dietary changes were proposed, either from specifically designed experiment (Brun-Lafleur et al., 2010) or from meta-analysis studies (Huhtanen and Nousiainen, 2012; Jensen et al., 2015; Daniel et al., 2016). These equations require a baseline performance (milk yield and composition, DMI and ration composition), around which the response is predicted. However, independently from nutrition, the baseline performance changes with time due to homeorhesis. Therefore, response equations can only predict the effect of a nutritional change on the long-term if the effects of homeorhetic regulations on future performance are also predicted.

Existing models that predict homeorhetic curves are numerous and diverse. Some describe lactation curve for milk yield with a single equation (Wood, 1967). Others, more complete, generate performance curves for milk yield, milk composition and body composition based on a mechanistic description of digestive and metabolic processes (Baldwin et al., 1987a,b,c; Baldwin, 1995; Danfaer, 1990; Martin and Sauvant, 2007). Alternatively, other modelling approaches, based on the concept of changing priority between physiological functions, has been used (Martin and Sauvant, 2010a; Daniel et al., submitted A) to simulate animal performance. In the present study, the model of Daniel et al. (submitted A) was chosen to provide the “baseline” homeorhetic lactation curves from which to predict responses to change in diet composition. It has been shown to fit well (milk component yields, body change, DMI) across different breeds, parities, and cows of differing production potential. However this model, explicitly designed to simulate homeorhesis, does not predict dairy cow responses to change in dietary composition.

Therefore, the objectives of the current paper were (1) to extend the predictive ability of the dynamic model of homeorhesis by incorporating equations that predict dry-matter intake and milk component yields response to change in dietary composition, (2) to

evaluate the combined model at predicting DMI, milk yield, milk components yields and contents, and BW using adequate independent datasets.

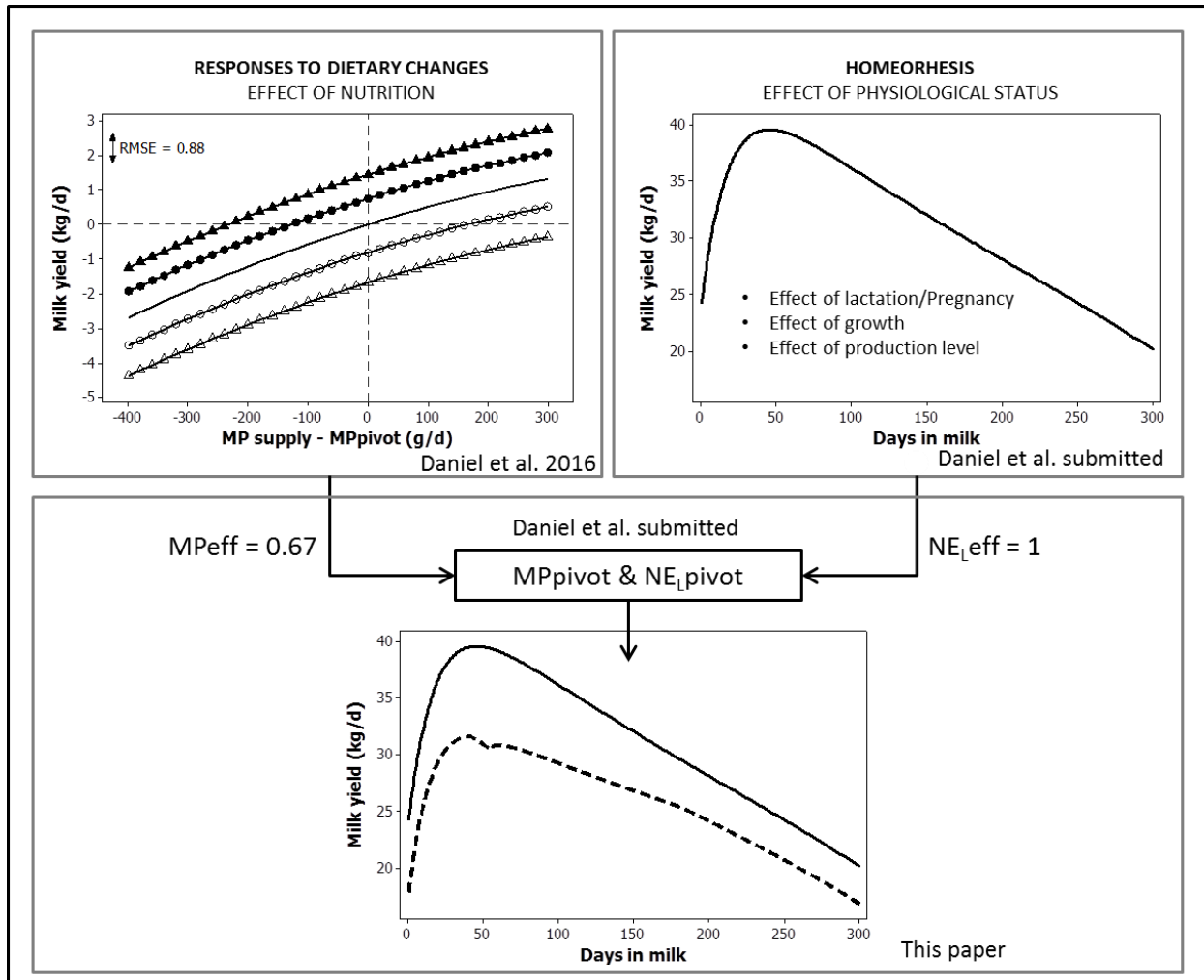

Figure 1 Overview of the full model combining response equations and homeorhetic curves, using the example of milk yield. Response equations derived from meta-analysis predict the consequence of changing NE_L and MP supply on milk yield (Daniel et al., 2016) and the homeorhetic model predicts the effect of physiological states on milk yield (Daniel et al. submitted A). The two models were combined by expressing milk yield relative to fixed MP and NE_L efficiency pivots (Daniel et al., submitted B), in both models. With that, milk yield response to change in dietary NE_L and MP content can be predicted over a complete lactation.

Model description

Calculation of Dynamic Pivots

This paper describes the combination of a homeorhetic model of the lactation with a response model that captures nutritional effects on animal performance (Figure 1). Briefly, the homeorhetic model simulates curves of milk yield and composition (yields and contents), empty BW and composition, and DMI through days in milk for cows of different potential and parity. These curves represent the performance trajectories of groups of animals fed a non-limiting diet. The full description of the model can be found in Daniel et al., (submitted A). The response model consists of empirical equations, derived from meta-analysis (Daniel et al., 2016), that quantify milk yield and composition (yield and content) responses to change in NE_L and MP supply. The particularity of these response equations is that they are centred on a pivot nutritional situation where MP efficiency (Milk protein yield/MP above maintenance) is 0.67 and NE_L efficiency (NE_L in milk/ NE_L above maintenance) is 1. The principle advantage of using these reference efficiencies was that, they anchor the response equations at a fixed proportion of the production capacity of the animal, and thus allow to be applied across animals of widely differing production capacity. This approach was evaluated using 2 independent datasets across lactation stage (Daniel et al., submitted B). In these datasets, strong effects of stage of lactation on MP and NE_L efficiency were observed, with higher efficiency in early lactation and lower efficiency in late lactation. Despite these trends of changing efficiencies with stage of lactation, the prediction of the response around fixed efficiency pivot was shown to be satisfactory at different lactation stages, with greater response simulated in early as compared to late lactation (Daniel et al., submitted B). In these evaluations, the pivot supplies of MP and NE_L (MP_{PIVOT} and NE_{L_PIVOT}) were calculated weekly from observed production (milk protein and energy yields) and supply (MP and NE_L). For forward prediction, e.g. from the start of the lactation, a homeorhetic model is needed so that instead of calculating MP_{PIVOT} and NE_{L_PIVOT} from observed data, pivots can be calculated from the homeorhetic curves. This then gives the relevant pivot for any given time in lactation from which to predict responses. This is done the same way that MP_{PIVOT} and NE_{L_PIVOT} were calculated from static observations (Daniel et al. submitted B) but using at each time step the trajectories of milk protein yield, milk energy yield, MP supply and

NE_L supply generated by the homeorhetic model (thereafter referred to using the suffix 'REF'); with one small adjustment. In the homeorhetic model maintenance requirements for energy are readily calculated from the BW curves providing NE_L supply above maintenance but MP maintenance is not readily calculated. To deal with this, MP supply above maintenance was back calculated from the simulated milk protein yield associated with the homeorhetic curve, assuming the following general MP efficiency change through lactation (MP_{EFF_REF}):

$$MP_{EFF_REF} = 0.7725 - 0.004882 (\pm 0.000298) \text{ Weeks of lactation} \quad [1]$$

The linear slope relating MP_{EFF_REF} and stage of lactation was fitted using calculated MP efficiency data from an experiment where animals were offered free choice between a high and a low CP diet along the lactation (Tolkamp et al., 1998). This situation was assumed to best represent optimal protein feeding, and thus the homeorhetic drive of the animal to partition nitrogen along the lactation. The intercept was adjusted so that MP efficiency is equal to 0.67 at mid lactation (150 days in milk). Consequently MP supply above maintenance (MP_{REF_supply}) was calculated as:

$$MP_{REF_supply} = MPY_{REF} * MP_{EFF_REF} \quad [2]$$

The system of 2 equations (i.e. response equation published in the meta-analysis of Daniel et al., 2016) was used to calculate algebraically MP_{PIVOT} and NE_{L_PIVOT} homeorhetic curves of milk protein yield (MPY_{REF}), milk energy yield (MEO_{REF}), MP_{REF_supply} and NE_L supply above maintenance (NE_{L_REF_supply}) as described in Daniel et al. (submitted B):

$$MPY_{REF} - MPY_{PIVOT} \text{ (g/d)} = 0.19 (MP_{REF_supply} - MP_{PIVOT}) - 0.000193 (MP_{REF_supply} - MP_{PIVOT})^2 + 3.137 (NE_{L_REF_supply} - NE_{L_PIVOT}) - 0.021 (NE_{L_REF_supply} - NE_{L_PIVOT})^2, \\ \text{with } MPY_{PIVOT} = 0.67 * MP_{PIVOT} \quad [3]$$

$$MEO_{REF} - MEO_{PIVOT} \text{ (MJ/d)} = 0.166 (NE_{L_REF_supply} - NE_{L_PIVOT}) - 0.0018 (NE_{L_REF_supply} - NE_{L_PIVOT})^2 + 0.015 (MP_{REF_supply} - MP_{PIVOT}) - 0.000017 (MP_{REF_supply} - MP_{PIVOT})^2, \text{ with } MEO_{PIVOT} = 1 * NE_{L_PIVOT} \quad [4]$$

The full description on how to solve the system has been given previously (Daniel et al., submitted B). In addition to MP_{PIVOT} and NE_{L_PIVOT} , the pivot production for energy (ME_{O_PIVOT}) and protein (MPY_{PIVOT}) are also obtained, using the fixed MP and NE_L efficiencies assumed at pivot (0.67 and 1, respectively). The pivots of production for milk fat and lactose yields can also be estimated on an energy and protein basis, using the differences between actual supply and estimated pivot supply of MP ($MP_{REF_supply} - MP_{PIVOT}$) and NE_L ($NE_{L_REF_supply} - NE_{L_PIVOT}$) as inputs in the following response equations (Daniel et al., 2016):

$$\Delta MFY_{REF-PIVOT} = 0.611 (NE_{L_REF_supply} - NE_{L_PIVOT}) - 0.021 (NE_{L_REF_supply} - NE_{L_PIVOT})^2 + 0.15918 (MP_{REF_supply} - MP_{PIVOT}) - 0.00023816 (MP_{REF_supply} - MP_{PIVOT})^2 \quad [5]$$

$$\Delta MLY_{REF-PIVOT} = 4.076 (NE_{L_REF_supply} - NE_{L_PIVOT}) + 0.28281 (MP_{REF_supply} - MP_{PIVOT}) - 0.00017243 (MP_{REF_supply} - MP_{PIVOT})^2 \quad [6]$$

These give the distances, in milk fat yield and milk lactose yield, between reference curves and pivot curves. Thus, using these differences and the reference curves generated by the homeorhetic model (MFY_{REF} and MLY_{REF}), the actual values for pivot of milk fat yield and milk lactose yield are:

$$MFY_{PIVOT} \text{ (g/d)} = MFY_{REF} - \Delta MFY_{REF-PIVOT} \quad [7]$$

$$MLY_{PIVOT} \text{ (g/d)} = MLY_{REF} - \Delta MLY_{REF-PIVOT} \quad [8]$$

Prediction of DMI, milk and BW curves from current plan of nutrition

Initialization of the model. The aim of this part is to generate whole lactation curves for DMI, milk yield, milk component yields and BW from one time point inputs (e.g. weekly average, monthly average, longer-period average, ect.). The longer the period used to generate these average inputs, the more reliable these inputs data will be. Required inputs data to run the model from an on-farm situation consist of: initial values of parity number, stage of lactation, milk component yields, mature BW, BCS at calving, DMI and ration composition (forage NDF, MP and NE_L). Thereafter those input data are referred to using the suffix 'INI'. It is then possible to estimate the initial pivot supply of MP and NE_L

(respectively called MP_{PIVOT_INI} and $NE_{L_PIVOT_INI}$), as well as pivot for milk component yields (MFY_{PIVOT_INI} , MPY_{PIVOT_INI} , MLY_{PIVOT_INI}) according to the approach proposed in Daniel et al., (2016). Based on the inputs, parameters of the homeorhetic model are then adjusted in the following order:

- (1) The parameter POT, controlling the overall production capacity, is adjusted to achieve minimum difference between MLY_{PIVOT_INI} and the respective pivot (MLY_{PIVOT}) simulated by the model for the given stage of lactation and parity.
- (2) The scaling parameters for milk fat yield (kMFY) and milk protein yield (kMPY) were adjusted to minimize the differences between MFY_{PIVOT_INI} and MPY_{PIVOT_INI} , calculated from the input data, and the respective pivots (MFY_{PIVOT} and MPY_{PIVOT}) simulated by the model for the given stage of lactation and parity.

These steps are necessary to key the model into animal type (breed, parity, production capacity) on that farm. The homeorhetic model then generates whole-lactation reference curves for milk component yield (MFY_{REF} , MPY_{REF} and MLY_{REF}) and for BW and body composition, of animals fed a diet that gives an overall lactation mean efficiency of 0.67 for MP and 1 for NE_L . Depending on the type of ration fed to the observed group of animals, the production may be below or above these reference productions. In that case, the fixed distances between the initial supply (MP_{INI_supply} and $NE_{L_INI_supply}$) and supply at reference, at identical lactation stages ($MP_{REF_supply_t}$ and $NE_{L_REF_supply_t}$), can be used to simulate the relevant production curves for the given ration composition (see Figure 2):

$$\Delta NE_{L_ (INI-REF)_supply} \text{ (MJ/d)} = (NE_{L_INI_supply} - NE_{L_REF_supply_t}) + (NE_{L_REF_supply} - NE_{L_PIVOT}) \quad [9]$$

$$\Delta MP_{_ (INI-REF)_supply} \text{ (g/d)} = (MP_{INI_supply} - MP_{REF_supply_t}) + (MP_{REF_supply} - MP_{PIVOT}) \quad [10]$$

The distances ($NE_{L_REF_supply} - NE_{L_PIVOT}$) and ($MP_{REF_supply} - MP_{PIVOT}$), differences in supply between the reference curves and the pivot curves are used to adjust the size

of the response according to stage of lactation, thereby respecting the concept of using responses centred on reference efficiencies.

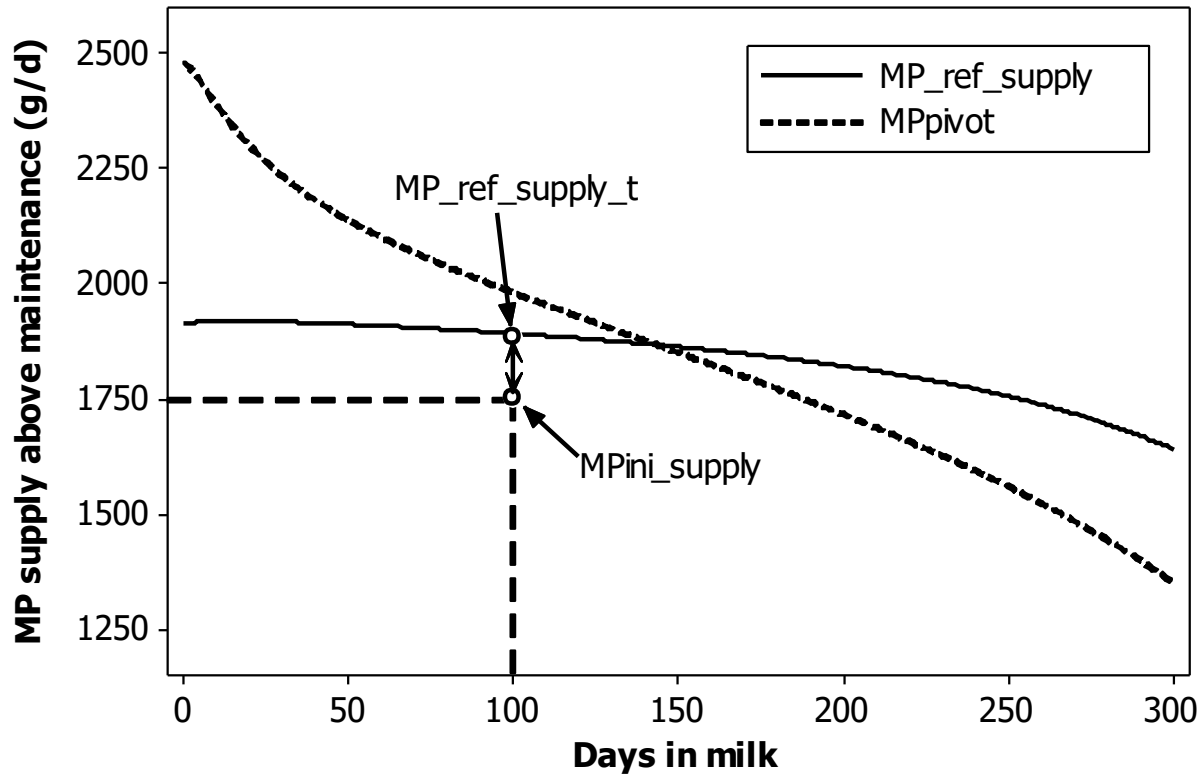

Figure 2 Schematic representation of MP supply above maintenance relative to days in milk. The MP_{REF_supply} is the MP supply above maintenance simulated by the model at reference. The MP_{PIVOT} is the MP supply above maintenance that gives a MP efficiency of 0.67. The MP_{INI_supply} is the initial MP supply above maintenance, calculated from an on-farm situation.

Milk yield and composition. Milk component yields (MFY, MPY and MLY) can then be calculated using corresponding pivot and response equations (Daniel et al., 2016) with $\Delta NE_{L_ (INI-REF)_supply}$ and $\Delta MP_{_ (INI-REF)_supply}$ as inputs:

$$MFY \text{ (g/d)} = MFY_{PIVOT} + 0.611 (\Delta NE_{L_ (INI-REF)_supply}) - 0.021 (\Delta NE_{L_ (INI-REF)_supply})^2 + 0.15918 (\Delta MP_{_ (INI-REF)_supply}) - 0.00023816 (\Delta MP_{_ (INI-REF)_supply})^2 \quad [11]$$

$$MPY \text{ (g/d)} = MPY_{PIVOT} + 3.137 (\Delta NE_{L_ (INI-REF)_supply}) - 0.021 (\Delta NE_{L_ (INI-REF)_supply})^2 + 0.19 (\Delta MP_{_ (INI-REF)_supply}) - 0.00019257 (\Delta MP_{_ (INI-REF)_supply})^2 \quad [12]$$

$$\text{MLY (g/d)} = \text{MLY}_{\text{PIVOT}} + 4.076 (\Delta\text{NE}_{\text{L}_{(\text{INI-REF})}_{\text{supply}}}) + 0.28281 (\Delta\text{MP}_{(\text{INI-REF})_{\text{supply}}}) - 0.00017243 (\Delta\text{MP}_{(\text{INI-REF})_{\text{supply}}})^2 \quad [13]$$

where MFY, MPY and MLY are the whole-lactation curves for milk fat yield, milk protein yield and milk lactose yield, respectively, corresponding to current nutrition (forage NDF, MP and NE_L). Milk yield (kg/d) is then predicted from MPY and MLY as described in Daniel et al. (submitted A) and milk composition (g/kg) was simply predicted from the ratio between secretion of fat, protein and lactose (g/d) with milk yield (kg/d).

Body Weight. We assumed that fat is the only fraction of the body reserves affected by dietary changes. The deviation from the homeorhetic curve of body fat was predicted with the classical approach used to calculate EB. The difference between the input energy supply ($\text{NE}_{\text{L}_{\text{INI}_{\text{supply}}} - \text{NE}_{\text{L}_{\text{REF}_{\text{supply}_t}}$) and the associated change in milk energy yield from reference was therefore assumed to be deposited or mobilized from the body:

$$\Delta\text{EB}_{\text{INI-REF}} \text{ (MJ/d)} = \{(\text{NE}_{\text{L}_{\text{INI}_{\text{supply}}} - \text{NE}_{\text{L}_{\text{REF}_{\text{supply}_t}}) - [(\text{MLY} - \text{MLY}_{\text{REF}}) * 16.5 + (\text{MPY} - \text{MPY}_{\text{REF}}) * 23.9 + (\text{MFY} - \text{MFY}_{\text{REF}}) * 39.8] / k_{\text{Is}} * k_{\text{gt}} \quad [14]$$

where MLY_{REF} , MPY_{REF} and MFY_{REF} are the reference curves for milk lactose yield, milk protein yield and milk fat yield. The coefficients 16.5, 23.9 and 39.8 are the energetic values, in MJ/kg for lactose, protein and fat, respectively. The coefficient k_{Is} is used to convert NE_L back to ME and k_{gt} is the efficiency of conversion from ME to NE_G. In the model, the average values of 0.65 and 0.80 were used for k_{Is} and k_{gt} , respectively (Sauvant et al., 2015). The deviation of body fat (ΔBF) from the reference curve of body fatness, expressed as a rate was calculated as follows:

$$d\Delta\text{BF}_{\text{INI-REF}} / dt \text{ (kg/d)} = \Delta\text{EB}_{\text{INI-REF}} / 39.8 \quad [15]$$

At any given time point, total body fat mass is the sum of this deviation and the body fat at reference (BF_{REF}):

$$\text{BF (kg)} = \text{BF}_{\text{REF}} + \Delta\text{BF}_{\text{INI-REF}} \quad [16]$$

BW can finally be calculated as:

$$\text{BW (kg)} = (\text{BF} + \text{BF}_{\text{REF}} / 0.215 + \text{GU}) / 0.8 \quad [17]$$

with the assumptions that (1) the water fraction of body fat is negligible, (2) the protein content of the fat-free mass is 21.5% (NRC, 2001). The equation for the gravid uterus (GU) and the justification for the coefficient 0.8, used to convert empty BW into BW, are given in Daniel et al. (submitted A).

DMI, NE_L supply and MP supply. Predicted total NE_L supply for the initial feeding situation is calculated from predicted requirements as in Daniel et al., (submitted A) as:

$$\text{NE}_L \text{ supply (MJ)} = \text{NE}_L \text{ maintenance} + \text{NE}_L \text{ growth} + \text{NE}_L \text{ preg} + \text{NE}_L \text{ body} + \text{NE}_L \text{ milk} + \Delta\text{EB} * k_{ls} / k_{gt} \quad [18]$$

where NE_L maintenance, NE_L growth, NE_L preg and NE_L body are the energy requirements for maintenance, growth, pregnancy and energy balance (positive for anabolism, negative for catabolism) respectively, of the reference curves calculated as described in Daniel et al., (submitted A). The energy requirement for milk, NE_L milk, is the sum of energy secreted in milk (MLY * 0.0165 + MPY * 0.0239 + MFY * 0.0398) and ΔEB is the difference between reference EB and current EB (equation 10), converted in NE_L (using k_{ls} and k_{gt}). Thus DMI can be predicted as:

$$\text{DMI (kg/d)} = \text{NE}_L \text{ supply} / \text{dietary NE}_L \text{ content} \quad [19]$$

with dietary NE_L content in MJ/kg DM. Further, multiplying DMI with the dietary MP content give the total supply of MP:

$$\text{MP supply (g/d)} = \text{DMI} * \text{dietary MP content} \quad [20]$$

With all the material presented above, whole-lactation curves for milk, body change and intake specific to the animal type (breed, parity, production capacity) and the ration fed (forage NDF, MP and NE_L contents) can be simulated. These are the basis against which deviation from dynamic curves of intake, milk and body are predicted for a change in diet, i.e. by providing new values for forage NDF, MP and NE_L contents.

Prediction of responses to change in diet composition

In this part, predicted performances for any change in ration composition are referred to using the suffix 'RES'.

DMI response to dietary changes. In order to calculate the change in NE_L supply and MP supply resulting from a change in diet composition it is necessary to calculate the response in intake. The response equation derived from meta-analysis (Daniel et al., 2016) quantifies the impact on DMI of physical regulation through forage NDF content (g/kg), and metabolic regulation through MP content (g/kg):

$$DMI_{RES} \text{ (kg/d)} = DMI + 0.0258 (MP_{RES} - MP) + 0.000934 [(MP - 100)^2 - (MP_{RES} - 100)^2] - 0.01568 (\text{forage NDF}_{RES} - \text{forage NDF}) \quad [21]$$

where DMI is the current predicted DMI (from equation [19]), MP and Forage NDF are the dietary contents of the current ration, and MP_{RES} and forage NDF_{RES} are the new values after the change in ration composition, resulting in the new DMI (DMI_{RES}).

NE_L and MP supply responses to changes in ration composition. New supplies of NE_L and MP are simply calculated by multiplying DMI_{RES} with new values of dietary NE_L and MP contents:

$$NE_{L_RES_supply} \text{ (MJ/d)} = DMI_{RES} * NE_{L_RES} \quad [22]$$

$$MP_{RES_supply} \text{ (g/d)} = DMI_{RES} * MP_{RES} \quad [23]$$

The difference between $NE_{L_RES_supply}$ and the NE_L supply predicted by the homeorhetic model (adjusted to the given farm situation, equation [18]) is equal to the difference between NE_L supply above maintenance before and after the change. This is because, in this model, NE_L requirements for maintenance, pregnancy and growth are assumed to be unaffected by dietary change. This simplification was assumed to be reasonable given that the main objective of the model is to predict milk yield and milk component yields and contents. However, the same does not apply to MP supply. This is because one of the largest non-productive MP requirements, faecal protein metabolic loss, is dependent on DMI, non-digested organic matter and MP efficiency, all of which are affected by a dietary change. This is a problem for predicting milk protein yield and consequently MP efficiency, as both of them need to be estimated from MP supply above maintenance. To solve this problem we used historical data where milk protein yield and MP supply were reported and thus MP supply above maintenance could be calculated. Using those data, the slope

of the relationship between MP supply and MP supply above maintenance (mean \pm SE, 0.71 ± 0.005) was obtained (Daniel et al., 2016). Thus it was assumed that the difference between MP supply above maintenance before and after the dietary change was obtained by multiplying the difference in MP supply with 0.71. Therefore, differences of NE_L and MP supply above maintenance relative to NE_L and MP supplies predicted by the homeorhetic model (equations [18] and [20], respectively) are:

$$\Delta \text{NE}_{L_supply} \text{ (MJ/d)} = \text{NE}_{L_RES} \text{ supply} - \text{NE}_{L} \text{ supply} \quad [24]$$

$$\Delta \text{MP_supply} \text{ (g/d)} = 0.71 (\text{MP}_{RES} \text{ supply} - \text{MP supply}) \quad [25]$$

As response equations are applied around pivot curves, differences in supply between homeorhetic curves (adjusted for the given farm situation) and pivot curves (equations [9] and [10]) are added to differences in supply between homeorhetic curves (adjusted for the given farm situation) and predicted response curves (equations [24] and [25]):

$$\Delta \text{NE}_{L_RES-REF} \text{ supply (MJ/d)} = \Delta \text{NE}_{L_supply} + \Delta \text{NE}_{L_INI-REF} \text{ supply} \quad [26]$$

$$\Delta \text{MP}_{RES-REF} \text{ supply (g/d)} = \Delta \text{MP_supply} + \Delta \text{MP}_{INI-REF} \text{ supply} \quad [27]$$

These differences are then used as inputs of the response equations to estimate milk component yields curves associated to the new ration.

Milk yield, milk composition and BW responses to dietary changes. Those differences in MP and NE_L supply (equations [26] and [27]) are then used to predict milk component yields (MFY_{RES}, MPY_{RES} and MLY_{RES}) for the new ration (forage NDF_{RES}, MP_{RES}, NE_L_{RES}), using equations 11 to 13 (therefore by replacing [$\Delta \text{NE}_{L_INI-REF_supply}$] by [$\Delta \text{NE}_{L_RES-REF} \text{ supply}$] and [$\Delta \text{MP}_{INI-REF_supply}$] by [$\Delta \text{MP}_{RES-REF} \text{ supply}$]). Milk yield (kg/d) is then predicted from MPY_{RES} and MLY_{RES} as described in Daniel et al. (submitted A) and milk composition (g/kg) is obtained as the ratio between secretion of fat, protein and lactose (g/d) with milk yield (kg/d). The increase or decrease in energy supply, not accounted for by change in milk production was assumed, as in equation 14, to be deposited or mobilized from body energy:

$$\Delta EB \text{ (MJ/d)} = \{\Delta NE_{L_supply} - [(MLY_{RES} - MLY) * 16.5 + (MPY_{RES} - MPY) * 23.9 + (MFY_{RES} - MFY) * 39.8] / 1000\} / k_{ls} * k_{gt} \quad [28]$$

Finally, body fat and BW are calculated as in equation 16 and 17:

$$BF_{RES} \text{ (kg)} = BF + \Delta BF \quad [29]$$

$$BW_{RES} \text{ (kg)} = (BF_{RES} + BP_{REF} / 0.215 + GU) / 0.8 \quad [30]$$

Model evaluation

The second objective of the present study was to evaluate the accuracy of prediction of the combined model. Thus published experiments (Friggens et al., 1998; Law et al., 2009) were used for this test. They compared over an entire lactation different dietary treatments, differing in either dietary MP and/or NE_L contents. Briefly, the first experiment (Friggens et al., 1998) was characterized by 2 levels of dietary concentrate content (27% and 59%) offered to twenty-four multiparous Holstein cows in a full 2 x 2 change-over design with control treatments. The experiment of Law et al. (2009) involved 3 rations with different CP content (11.4%, 14.4% and 17.3%) fed to ninety Holstein cows (50% primiparous) in a 3 x 2 change-over design where half of the animals of each treatment were allocated to an alternative dietary CP content at mid-lactation. For the evaluation, only the highest and lowest quality treatments were used. Nutritional values for the rations were calculated with the INRA feed unit system (Sauvant and Nozière, 2016). In Friggens et al. (1998), dietary contents for NE_L, MP and forage NDF were 7.31 MJ/kg DM, 100 g/kg DM and 216 g/kg DM, respectively, for the high concentrate treatment and 7.39 MJ/kg DM, 82 g/kg DM and 382 g/kg DM, respectively, for the low concentrate treatment. In Law et al. (2009), dietary contents for NE_L, MP and forage NDF were 7.30 MJ/kg DM, 113 g/kg DM and 215 g/kg DM, respectively, for the high CP treatment and 7.22 MJ/kg DM, 81 g/kg DM and 215 g/kg DM, respectively, for the low CP treatment.

This evaluation aimed at approximating prediction under applied conditions and therefore only uses inputs that could be measured on-farm: average parity and stage of lactation, averages of milk component yields, dietary contents of forage NDF, MP and NE_L, average DMI, and BW and BCS at calving. For the current evaluation, for each experiment,

average data of the highest nutritional treatment, in mid-lactation (between 100 and 200 days in milk) were used as input data from which pivots were calculated (as in Daniel et al. submitted B). This then allowed initialization of the homeorhetic model as described above. Responses were evaluated by comparing the predicted performance resulting from a ration composition change equivalent to moving to the low nutritional treatment, with the observed performance on that treatment.

For this evaluation, the quality of the independent predictions was evaluated using the concordance correlation coefficient (CCC), calculated as described in Lin (1989), and the root mean square prediction error (RMSPE) computed as follows:

$$RMSPE = \sqrt{\frac{1}{n} \sum_{i=1}^n (O_i - P_i)^2}$$

Where O_i is the i th observed value, P_i is the i th predicted value and n is the total number of observations. The RMSPE can be decomposed into error due to overall bias (ECT), error due to deviation of the regression slope from unity (ER) and error due to the disturbance (random error) (ED) (Bibby and Toutenburg, 1977).

Model implementation

The model was implemented with the Modelmaker 3.0 software (Cherwell Scientific Ltd, 2000) using the Runge–Kutta 4 numerical integration procedure and a fixed integration step of 1 day for t ranging from 0 to 301 days (43 weeks).

Results

The values for the 6 parameters adjusted to key the model into the type of animal under observation are presented in Table 1. The rest of the parameters were unchanged as compared to the original homeorhetic model (Daniel et al., submitted A). Finally, calculated nutritional values (forage NDF, MP and NE_L contents) for the high and low treatments were used as inputs. The overall quality of the model at predicting DMI, BW, milk yield, milk component yields, and milk component contents over the whole lactation

are detailed in Table 2 and 3, for experiment of Law et al. (2009) and Friggens et al. (1998), respectively.

Table 1. List and values of model parameters adjusted based on average data observed

Adjusted parameters ¹	Law et al., 2009	Friggens et al., 1998
POT, animal potential	53	40
P, parity number	1.46	4.80
kMFY, scaling for milk fat yield	1353	1380
kMPY, scaling for milk protein yield	1315	1165
MEBW, mature empty BW (kg) ²	480	530
BCSc, BCS at calving (1-5 scale) ²	3.00	3.25

for the highest quality treatment of the 2 data sets: Law et al. (2009) and Friggens et al. (1998).

¹See Daniel et al., (submitted A) for full description of each parameter.

²Parameters MEBW and BCSc were adjusted to achieve a minimal difference between observed and predicted BW and BCS at calving.

The rest of model parameters were the same than the ones used for the Holstein breed of the dataset 1 in Daniel et al., (submitted A).

DMI Prediction

The comparison between predicted and observed DMI is shown in Figure 3. As can be seen, the intake of DM was better predicted for highest quality treatments (RMSPE \leq 4.5% and CCC \geq 0.867) than for lowest quality treatments (RMSPE \leq 8.8% and CCC \geq 0.496). Such result is not surprising considering the type of approach used. The change in DMI simulated between the high and low treatments in Friggens et al. (1998) were smaller than the observed differences in the first half of the lactation. Similarly, in Law et al. (2009), predicted DMI responses due to change in ration composition were smaller than observed differences for most of the lactation. These resulted in an overall underestimation of predicted differences in NE_L and MP supply above maintenance between the 2 nutritional treatments (Figure 4). On average, in Law et al. (2009), observed differences in MP and NE_L supply were (mean \pm SD) 666 \pm 109 g/d and 14 \pm 6 MJ/d whereas predicted differences were only 475 \pm 34 g/d and 9 \pm 0 MJ/d. For Friggens et al. (1998), underestimations were smaller, with observed differences in NE_L and MP supply of 513 \pm 166 g/d and 28 \pm 11 MJ/d, and predicted differences of 460 \pm 16 g/d and 23 \pm 0 MJ/d. These differences are important to keep in mind when looking at the

prediction of milk responses as NE_L and MP supply are used as inputs in the response equations.

Milk Yield and Composition Prediction

The comparison between predicted and observed milk component yields is shown in Figure 5. In general, milk component yields predictions of the high quality treatments were satisfactory with $RMSPE \leq 11.2\%$ in Law et al. (2009) and $\leq 6.9\%$ in Friggens et al. (1998). Nevertheless, in the Law dataset, a clear over prediction of milk protein yield was seen in the first 50 days (Figure 5), which mainly explains the low CCC obtained for that treatment (0.516). This large increase in milk protein yield observed during the first 50 days in milk was not seen in the data of Friggens et al. (1998) where milk protein yield decreased from first week of lactation. As expected predictions for lowest quality treatments were less accurate. In Law et al. (2009), milk fat yield was predicted with a $RMSPE$ below 10% whereas milk protein and lactose yield were predicted with $RMSPE > 23\%$. For the secretion of protein and lactose, a large part of the error was explained by over estimation (90.2% and 55.6% of MSPE, respectively, was due to bias on the intercept). In Friggens et al. (1998), findings were similar for the prediction of milk lactose yield, with a general over prediction (52.2% of the total MSPE) which resulted in a $RMSPE$ of 17.1%. However, milk protein yield was predicted with much greater accuracy and precision ($CCC=0.806$, $RMSPE = 8\%$). In Figure 5, abrupt deviations in the prediction curves around days in milk 50 (Friggens et al., 1998) or 70 (Law et al., 2009) can be observed. These are explained by the optimization method used to calculate dynamic pivot curves for NE_L and MP supply. The system of two equations used to estimate the pivot (Daniel et al., submitted B) could not be solved algebraically in early lactation (< 50 or 70 DIM) and, in that case, pivot values were estimated by extrapolation (see Daniel et al., submitted B). Therefore these abrupt deviations represent the shift between estimated values and values obtained by algebra.

The accuracy of prediction of milk yield, mainly driven by the prediction of milk lactose yield, naturally follows similar trends to those for lactose yield (Table 2 and 3). As milk composition was estimated from the ratios between component yields and milk yield, the accuracy of prediction is largely dependent on good predictions of yields. Except for milk

fat content of the low treatment in Law et al. (2009), milk composition was predicted with a range of RMSPE from 1.2% to 13.0%. However, in Law et al. (2009), CCC values were rather low ($0.004 \leq \text{CCC} \leq 0.539$). In comparison, higher values of CCC were observed in Friggens et al. (1998) with range of CCC from 0.559 to 0.879 for the high quality treatment, and from 0.255 to 0.814 for the low quality treatment. In both experiments, fat and lactose contents predicted after the dietary change had the least accuracy and prediction, as indicated by the CCC values.

BW Prediction

The comparison between predicted and observed BW is shown in Figure 6. As can be seen, the prediction of BW in Friggens et al. (1998) for the high quality treatments was satisfactory with CCC of 0.780 and RMSPE of 3.1%. This was not the case for the high quality treatment of Law et al. (2009) where a clear over-prediction of tissue mobilization was simulated, resulting in a large under-prediction of BW. Further in that experiment, the simulated effect of the dietary change on BW was opposite to the observed effect. The reduction in dietary CP from 17.3% to 11.4% (of total DM) had no significant effect on BW (Law et al., 2009) whereas a large decrease in fat mobilization was simulated by the model. In Friggens et al. (1998), the simulated consequence of increasing the forage-to-concentrate ratio on BW shows a better consistency with the data (Figure 6).

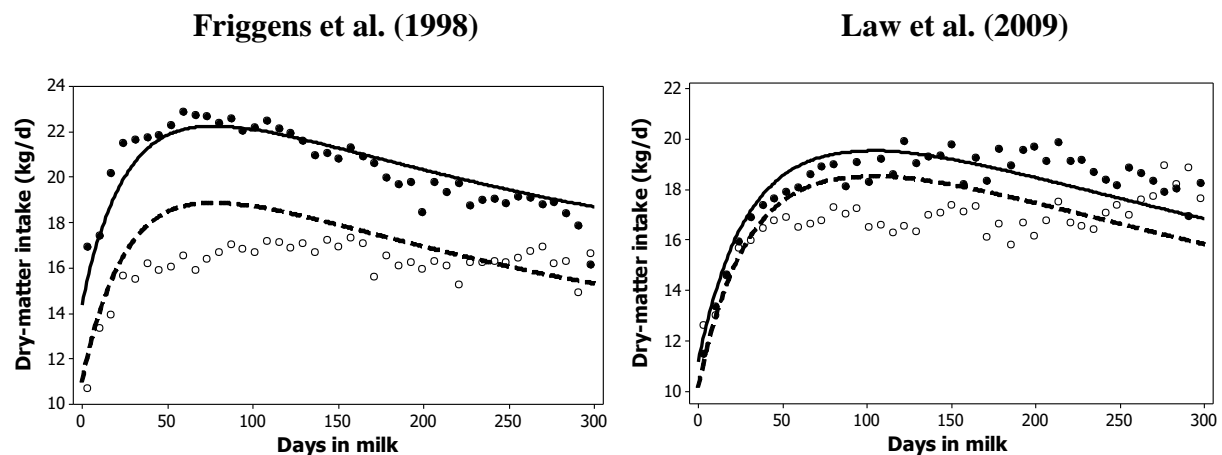

Figure 3 Comparison between observed (symbols) and predicted values (lines) of dry-matter intake relative to days in milk for the 2 extreme nutritional treatments. In Friggens et al. (1998): 27% of concentrate (\circ , stippled line) vs 59% of concentrate (\bullet , solid line). In Law et al. (2009): 11.4% of CP (\circ , stippled line) vs 17.3% of CP (\bullet , solid line).

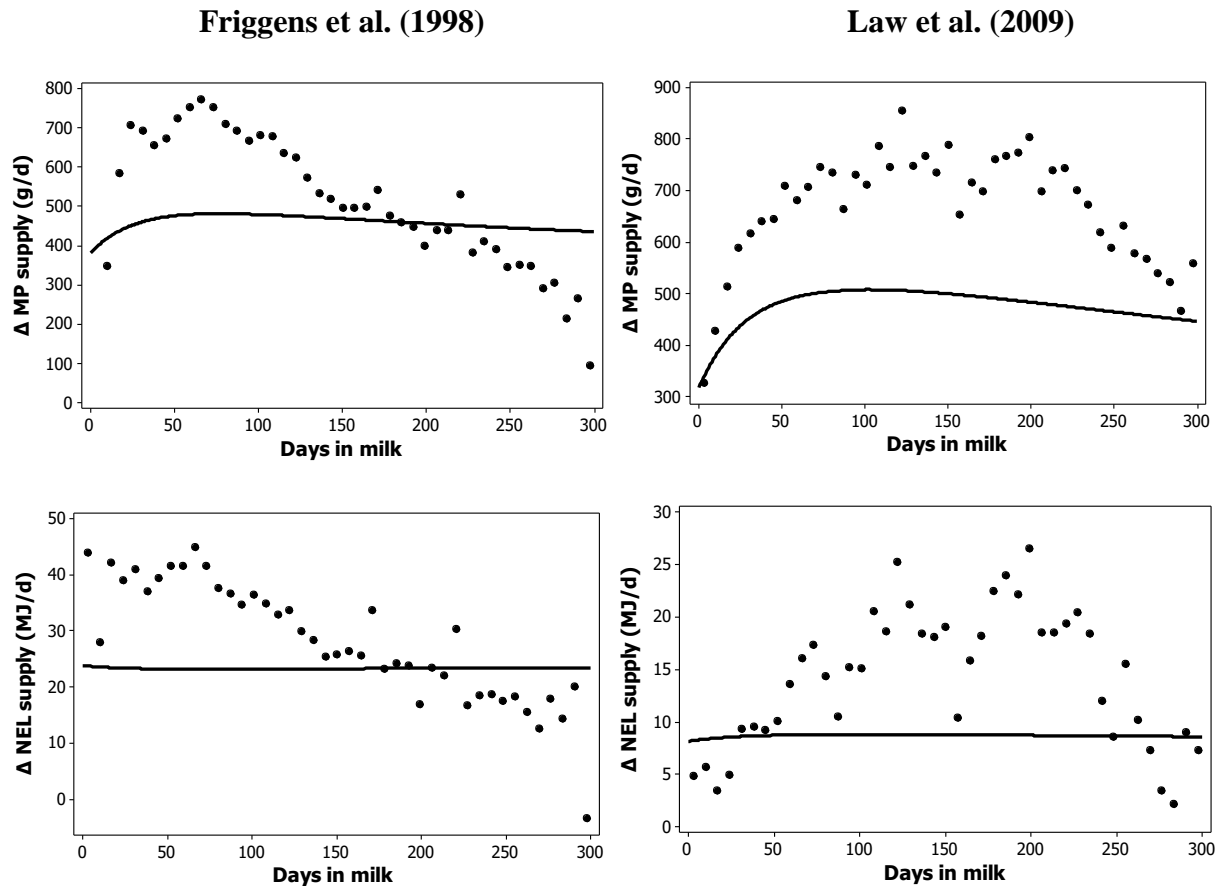

Figure 4 Comparison between observed (●) and predicted differences (solid line) in NE_L and MP supply above maintenance between the 2 extreme nutritional treatments, relative to days in milk. In Friggens et al. (1998): Differences were calculated between treatments with 59% and 27% of concentrate. In Law et al. (2009): Differences were calculated between treatments with 17.3% and 11.4% of CP.

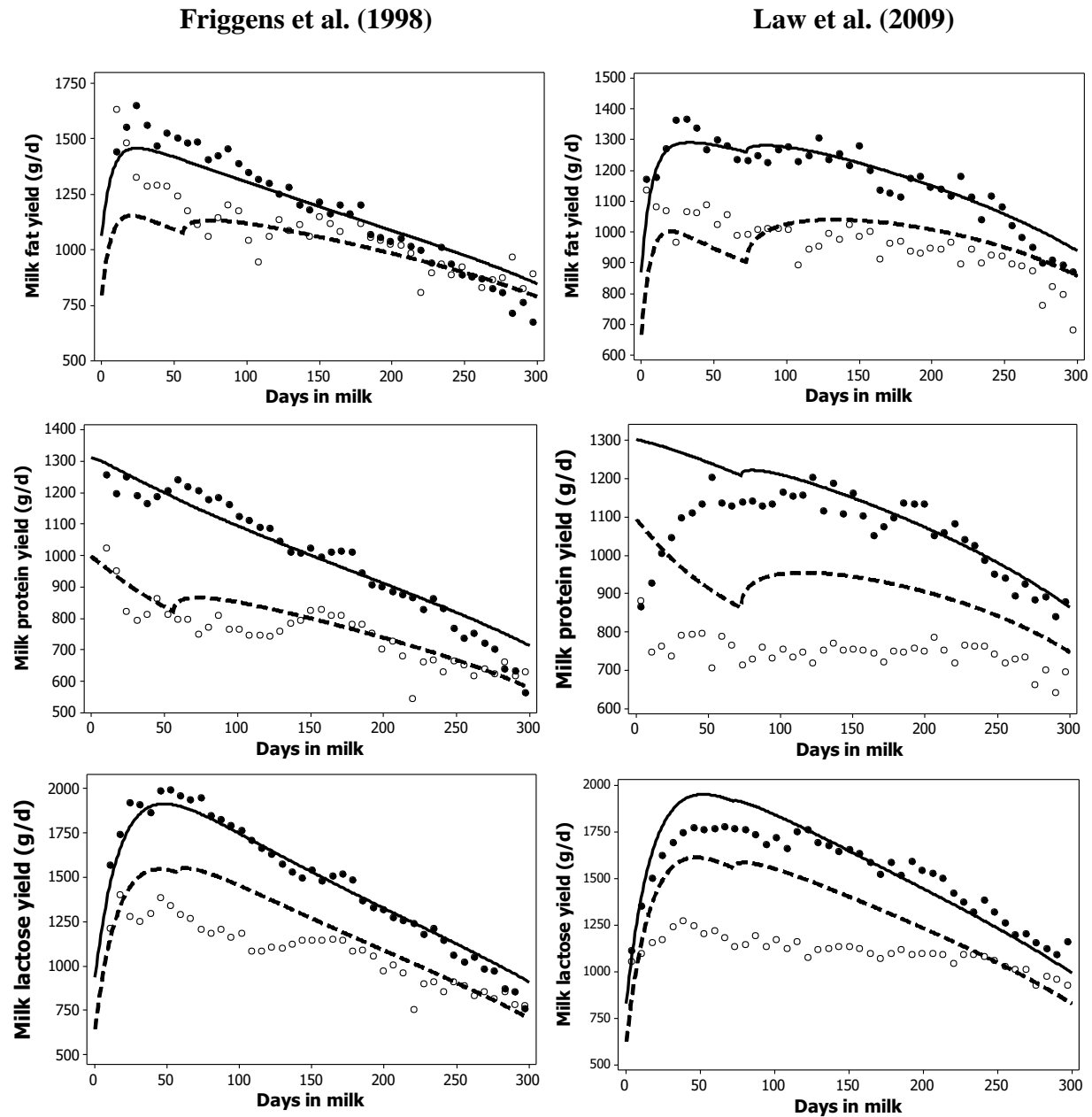

Figure 5 Comparison between observed (symbols) and predicted values (lines) of milk component yields relative to days in milk for the 2 extreme nutritional treatments. In Friggens et al. (1998): 27% of concentrate (○, stippled line) vs 59% of concentrate (●, solid line). In Law et al. (2009): 11.4% of CP (○, stippled line) vs 17.3% of CP (●, solid line).

Table 2. Summary of observed vs predicted DMI, BW, milk yield, milk component yields, and milk component contents from highest (17.3% CP) and lowest (11.4% CP) quality treatments of Law et al. (2009)¹.

	Treatment	N ²	Observed ³	Predicted ³	RMSPE% ⁴	ECT% ⁵	ER% ⁶	ED% ⁷	CCC ⁸
DMI, kg/d	17.3% CP	43	18.2 ± 1.7	18.1 ± 1.5	4.5	1.2	0.4	98.4	0.867
	11.4% CP	43	16.7 ± 1.2	17.1 ± 1.5	8.2	10.0	40.2	49.7	0.496
BW, kg	17.3% CP	43	541 ± 25	459 ± 20	16.9	80.2	15.0	4.7	0.079
	11.4% CP	43	557 ± 28	527 ± 19	5.8	87.9	6.0	6.1	0.497
Milk yield, kg/d	17.3% CP	43	31.7 ± 4.3	34.5 ± 5.6	10.6	69.3	19.0	11.7	0.804
	11.4% CP	43	22.7 ± 1.8	29.4 ± 4.4	31.8	84.4	14.5	1.1	0.219
Milk component yields, g/d									
Fat	17.3% CP	43	1166 ± 129	1176 ± 107	4.3	3.7	6.4	89.9	0.908
	11.4% CP	43	957 ± 88	978 ± 55	9.6	4.8	12.0	83.2	0.226
Protein	17.3% CP	43	1061 ± 103	1123 ± 123	11.2	27.0	25.8	47.1	0.516
	11.4% CP	43	745 ± 38	909 ± 69	23.1	90.2	6.9	3.0	0.099
Lactose	17.3% CP	43	1523 ± 218	1551 ± 299	7.1	6.5	65.7	27.8	0.914
	11.4% CP	43	1104 ± 79	1305 ± 246	24.3	55.6	42.6	1.8	0.321
Milk component contents, g/kg									
Fat	17.3% CP	43	37.2 ± 2.2	34.5 ± 2.7	9.3	61.5	14.0	24.5	0.387
	11.4% CP	43	42.3 ± 1.9	33.9 ± 4.4	22.7	76.0	20.3	3.7	0.004
Protein	17.3% CP	43	33.8 ± 2.0	32.9 ± 3.4	8.5	10.2	56.9	33.0	0.487
	11.4% CP	43	33.0 ± 2.0	31.5 ± 4.3	10.1	21.4	65.0	13.6	0.539
Lactose	17.3% CP	43	48.0 ± 1.0	44.7 ± 1.6	7.6	82.1	10.9	7.0	0.082
	11.4% CP	43	48.6 ± 1.1	44.2 ± 1.9	10.3	79.7	15.7	4.6	0.004

¹Parity number and averages for milk component yields, NE_L and MP supply above maintenance of the highest treatments between 100 and 200 days in milk were used to set parameters P, POT, kMFY, kMPY (see Daniel et al., submitted A for a full description of the

CHAPTER 5

parameters). Parameters MEBW and BCSc were adjusted to achieve a minimal difference between observed and predicted BW and BCS at calving.

²Number of weekly comparison between observed and predicted values. The first 43 weeks of lactation were used here.

³Mean \pm SD

⁴Root mean square prediction error expressed as a percentage of the observed mean.

⁵Error due to intercept bias, as a percent of total MSPE.

⁶Error due to slope bias, as a percent of total MSPE.

⁷Error due to disturbance, as a percent of total MSPE.

⁸Concordance correlation coefficient (scale from 0 to 1)

Table 3. Summary of observed vs predicted DMI, BW, milk yield, milk component yields, and milk component contents from highest (59% concentrate) and lowest (27% concentrate) quality treatments of Friggens et al. (1998)¹.

	Treatment	N	Observed ²	Predicted ²	RMSPE% ³	ECT% ⁴	ER% ⁵	ED% ⁶	CCC ⁷
DMI, kg/d	59% conc.	43	20.4 ± 1.7	20.5 ± 1.5	3.8	3.3	2.0	94.7	0.883
	27% conc.	43	16.1 ± 1.2	17.1 ± 1.5	8.8	47.3	19.6	33.1	0.538
BW, kg	59% conc.	43	635 ± 20	638 ± 37	3.1	2.9	85.0	12.1	0.780
	27% conc.	43	612 ± 25	617 ± 11	2.6	10.3	57.9	31.8	0.684
Milk yield, kg/d	59% conc.	43	31.0 ± 6.9	31.5 ± 6.0	3.8	12.6	45.4	41.9	0.983
	27% conc.	43	24.2 ± 3.5	25.8 ± 5.0	11.7	30.9	40.8	28.2	0.792
Milk component yields, g/d									
Fat	59% conc.	42	1182 ± 263	1182 ± 186	6.9	0.0	81.9	18.1	0.933
	27% conc.	42	1075 ± 176	1022 ± 107	11.8	17.5	5.0	77.6	0.640
Protein	59% conc.	42	990 ± 194	998 ± 165	5.2	2.5	19.1	78.4	0.958
	27% conc.	42	747 ± 93	777 ± 97	8.0	24.3	8.5	67.2	0.806
Lactose	59% conc.	42	1477 ± 356	1478 ± 311	4.1	0.0	45.7	54.2	0.983
	27% conc.	42	1074 ± 177	1207 ± 265	17.1	52.2	31.6	16.2	0.713
Milk component contents, g/kg									
Fat	59% conc.	42	37.6 ± 1.7	37.7 ± 2.0	4.5	0.6	35.9	63.6	0.559
	27% conc.	42	44.7 ± 3.1	40.1 ± 4.0	13.0	60.9	17.6	21.4	0.255
Protein	59% conc.	42	31.6 ± 1.6	31.8 ± 2.0	2.8	8.1	38.4	53.6	0.879
	27% conc.	42	30.9 ± 1.9	30.4 ± 2.8	4.7	13.7	55.3	31.0	0.814
Lactose	59% conc.	42	46.7 ± 1.1	46.6 ± 1.1	1.2	0.6	7.0	92.4	0.849
	27% conc.	42	44.0 ± 0.8	46.3 ± 1.5	5.6	88.3	9.0	2.7	0.268

¹Parity number and averages for milk component yields, NE_L and MP supply above maintenance of the highest treatments between 100 and 200 days in milk were used to set parameters P, POT, kMFY, kMPY (see Daniel et al., submitted A for a full description of the

parameters). Parameters MEBW and BCSc were adjusted to achieve a minimal difference between observed and predicted BW and BCS at calving.

²Number of weekly comparison between observed and predicted values. The first 43 weeks of lactation were used here. For milk components, the first week was not included because of the absence of observed data.

³Mean \pm SD

⁴Root mean square prediction error expressed as a percentage of the observed mean.

⁵Error due to intercept bias, as a percent of total MSPE.

⁶Error due to slope bias, as a percent of total MSPE.

⁷Error due to disturbance, as a percent of total MSPE.

⁸Concordance correlation coefficient (scale from 0 to 1)

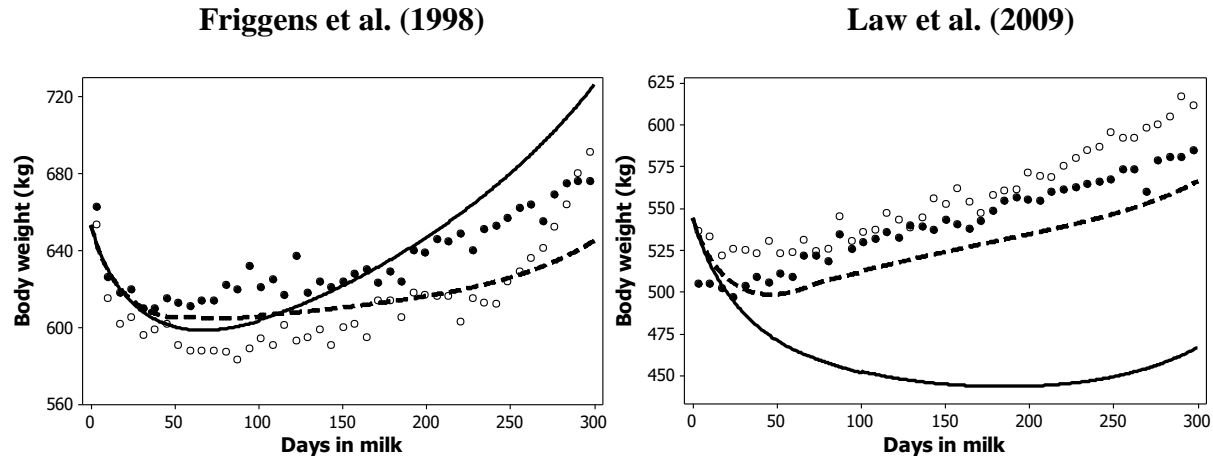

Figure 6 Comparison between observed (symbols) and predicted values (lines) of body weight relative to days in milk for the 2 extreme nutritional treatments. In Friggens et al. (1998): 27% of concentrate (\circ , stippled line) vs 59% of concentrate (\bullet , solid line). In Law et al. (2009): 11.4% of CP (\circ , stippled line) vs 17.3% of CP (\bullet , solid line).

Discussion

The primary objective of this paper was to describe the integration of production response equations, sensitive to effect of nutrition, into a dynamic model of the lactation, sensitive to physiological state and animal potential. Thanks to the calculation of dynamic pivot curves (i.e. at which NEL efficiency is 1 and MP efficiency is 0.67) associated with homeorhetic curves (Daniel et al. submitted A), this integration was consistent with the method of using response curves centred on reference NEL and MP efficiency (Daniel et al., submitted B). With this addition, the combined model is characterized by 2 types of regulation of nutrient partitioning. Thus, performance (milk yield, body change) is driven by the genetic potential of the animal (pull), but may be constrained or stimulated by nutrition (push). This duality between push and pull has been previously used in mechanistic models to describe performance, either implicitly or explicitly (Danfaer, 1990; Baldwin, 1995; Martin and Sauvant, 2010a,b). Other examples of model with such dual regulations are the lactation model of Brun-Lafleur (2011), the energy partitioning model of Zom (2014) and the recent model of milk production developed by Johnson et al. (2016). However, in all of those models, the notion of potential was either absent (Zom, 2014) or included using theoretical parameters that are difficult to estimate in practice. In

this model, the notion of potential was clearly defined, through the use of a nutritional pivot situation equivalent to fixed MP and NE_L efficiency. This has the advantage that the animal potential can be derived directly from observed data of production and intake. The model only uses input parameters that can be derived in practice (actual animal performance, parity, lactation and pregnancy rate). Further, an important criterion when developing the present model was that it remained consistent with current feed unit systems. For that reason, NE_L and MP, used in most of the feed tables to characterize feeds (NRC, 2001; Baumont et al., 2007; CVB, 2007; Volden et al., 2011), were used as inputs to characterize the ration in our model. A common drawback of the current feed unit systems is that they do not predict the animal component of responses to a dietary manipulation. Thus, this model represents a theoretical improvement to optimize rations based on energetic and protein status observed on a group of dairy cows. In the present analysis, the feed unit system from INRA (Sauvant and Nozière, 2016) was used to generate feed values. However in theory, any other digestive model that generates NE_L and MP values could be used as input to the current model.

The second objective of the paper was to evaluate the combined model with 2 lactation experiments, characterized by treatments with large differences in ration composition. Overall, prediction of whole lactation curves for DMI, milk yield and milk component yields of the highest dietary quality treatments were satisfactory (Figures 3 and 5, Tables 2 and 3). With respect to the prediction of the whole lactation curves for lowest dietary quality treatments (i.e. after the dietary change), results were contrasted between data sets, where predicted response were globally satisfactory in Friggens et al. (1998) but globally poor in Law et al. (2009). In the latter experiment, it was also found that differences in MP and NE_L supply between the high and the low treatments were largely under-estimated (Figure 4), leading to bias in the equations that predict milk responses to change in NE_L and MP supply. Noticeable differences were also observed between the simulated effect of the dietary change on BW and the observed effect on the data of Law et al. (2009) (Figure 6). This finding prompted us to verify the consistency between cumulative energy balance, calculated with the traditional approach (energy in – energy out) and cumulative energy balance, calculated from BW and BCS change. Details of calculation of the two approaches are given in annex 1. This comparison is illustrated in Figure 7 for the two

experiments. Although differences between the 2 approaches existed in Friggens et al. (1998), the relative differences between the 2 treatments in this experiment were comparable. This was not the case in Law et al. (2009), energy balance calculated directly from observed body changes resulted in similar profile of cumulative energy balance between the 2 treatments. In contrast, the traditional approach leads to a strong effect of treatment on the cumulative energy balance profiles (Figure 7). This suggests that the data used as inputs in the model for Law et al. (2009) are inconsistent. In fact, the profiles of BW simulated by the model are consistent with the input data used (Figure 6 and traditional cumulative energy balance in Figure 7, panel B). Therefore it is most likely that such inconsistency within the input data would generate bias in the model prediction, irrespective of the quality of the quality of the current model. It has previously been shown that small differences in assumed diet energy content or small biases in measurement of feed intake can all readily accumulate into significant inconsistencies over a whole lactation. If we assume that this is the case in the experiment of Law, we can apply an adjustment to the reported diet energy content to correct the inconsistency.

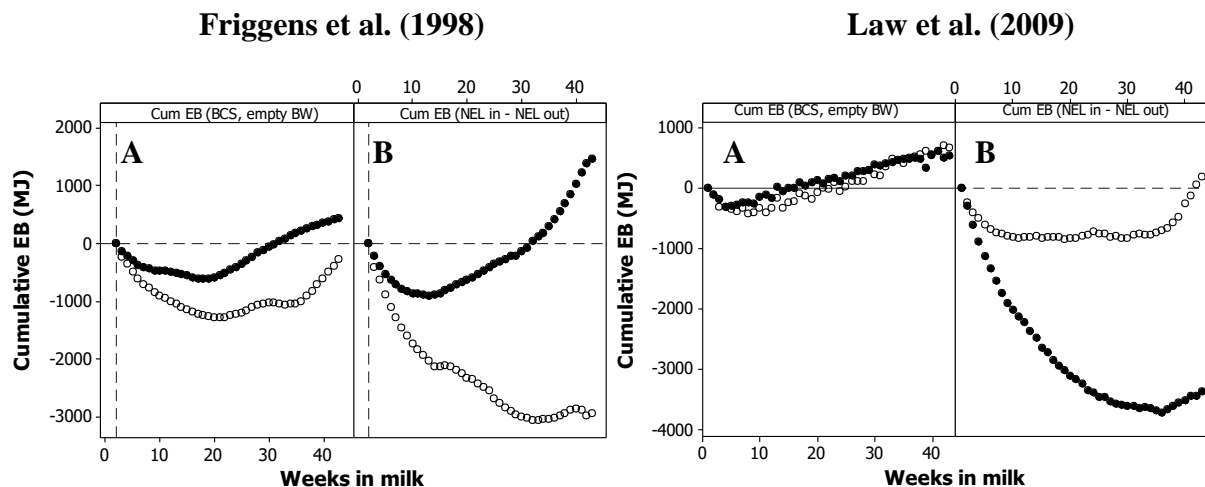

Figure 7 Cumulative energy balance (in MJ) calculated (A) using changes in BW and BCS and (B) using the classical approach (energy input minus energy output). In Friggens et al. (1998): 27% of concentrate (○) vs 59% of concentrate (●). In Law et al. (2009): 11.4% of CP (○) vs 17.3% of CP (●).

Some design issues of the model merit discussion: When integrating the response module into the homeorhetic model, we chose to integrate the 4 main response equations

(DMI, milk lactose yield, milk fat yield and milk protein yield) with the pivot concept (Daniel et al. submitted B), into the dynamic model using the minimum number of modifications needed for the integration. This choice has resulted in some simplifications, most of them related to body composition and intake. In particular, the relationship between the level of body fat and intake was not modelled, whereas it is known that (relative to normal BCS) high BCS down regulates intake, and low BCS up-regulates intake (Garnsworthy and Topps, 1982, Broster and Broster, 1998). Further, the surplus of energy relative to reference supply of energy, not partitioned into milk, was assumed to be entirely deposited as body fat. Therefore the reference curve for body protein was unaffected by nutrition. Until equations that quantify body protein and lipid responses to dietary change in non-growing ruminants become available, we have assumed that this simplification was reasonable with respect to the purpose of the model. Another simplification, with respect to prediction of DMI, was the absence of a feed intake capacity related to the size of the animal. This notion has been widely used in feed unit systems to predict intake since the publication of Conrad et al. (1964). In the current model, intake was mainly driven by the energy requirement (pull) and modulated by the dietary MP and forage NDF content (push). However, because no feed intake capacity was introduced, the DMI by cows offered the high forage diet (in Friggens et al. 1998) was still related to milk yield whereas the data do not show such a relationship (i.e. the intake curve was flat). We explored the inclusion in the model of feed intake capacity, scaled on BW. This revealed that simulated DMI was very sensitive to BW and consequently we thus chose not to integrate it in the model. In general, prediction of intake was satisfactory for high nutritional treatment (Figure 4, Tables 2 and 3). The DMI response should however be improved.

Conclusion

This paper described the integration of empirical equations, which predict DMI and milk component yields response to change in dietary composition, into a dynamic model of homeorhesis, which generates whole lactation curves for DMI, milk yield, milk component yields and BW change based on the animal characteristics (animal potential, parity, lactation and pregnancy stages) and current diet fed. This integration was made possible by using a common nutritional pivot situation, where MP efficiency is 0.67 and NE_L

efficiency is 1. The independent evaluation resulted in better prediction of whole lactation curves for DMI, milk yield and milk component yields of the highest dietary quality treatments as compared to lowest dietary quality treatments. The quality of prediction of the curves from the lowest dietary treatment was mainly explained by the accuracy of prediction of the change in NE_L and MP supply (therefore DMI, dietary NE_L and MP contents) between the highs and the lows treatments.

Acknowledgments

We gratefully acknowledge the work of Rafael Munoz Tamayo (INRA MoSAR, Paris) who developed the optimization procedure used to calculate pivot values on MatLab software.

References

- Baldwin RL 1995. Modeling Ruminant Digestion and Metabolism. Chapman and Hall, London, UK.
- Baldwin RL, France J and Gill M 1987a. Metabolism of the lactating cow: I. Animal elements of a mechanistic model. *Journal of Dairy Research* 54, 77–105.
- Baldwin RL, France J, Beever DE, Gill M and Thornley JHM 1987. Metabolism of the lactating cow: III. Properties of mechanistic models suitable for evaluation of energetic relationships and factors involved in the partition of nutrients. *Journal of Dairy Research* 54, 133–145.
- Baldwin RL, Thornley JHM and Beever DE 1987b. Metabolism of the lactating cow: II. Digestive elements of a mechanistic model. *Journal of Dairy Research* 54, 107–131.
- Baumont R, Dulphy JP, Sauvant D, Meschy F, Aufrère J and Peyraud JL 2007. Valeur alimentaire des fourrages et des matières premières: tables et prévision. Pages 153-290 in: Alimentation des bovins, ovins et caprins. Besoins des animaux – Valeur des aliments – Tables INRA 2007, mise à jour 2010. Editions Quae, Versailles, France.
- Bibby J and Toutenburg H 1977. Prediction and Improved Estimation in Linear Models. Wiley, Berlin, Germany.
- Broster WH and Broster VJ 1998. Body score of dairy cows. *Journal of Dairy Research* 65, 155–173.
- Brun-Lafleur L 2011. Modélisation du fonctionnement d'un troupeau laitier pour anticiper les conséquences de son pilotage. PhD thesis, Agrocampus-Ouest, Rennes, France.
- Brun-Lafleur L, Delaby L, Husson F and Faverdin P 2010. Predicting energy x protein interaction on milk yield and milk composition in dairy cows. *Journal of Dairy Science* 93, 4128–4143.
- Conrad HR, Pratt AD and Hibbs JW 1964. Regulation of feed intake in dairy cows. 1. Change in importance of physical and physiological factors with increasing digestibility. *Journal of Dairy Science* 47, 54–62.
- CVB 2007. CVB Tables Ruminants 2007. Lelystad, The Netherlands: Centraal Veevoeder Bureau.
- Danfaer A 1990. A dynamic model of nutrient digestion and metabolism in lactating dairy cows. Ph.D. Thesis. National Institute of Animal Science, Foulum, Denmark.
- Daniel JB, Friggens NC, Van Laar H, Ferris CP and Sauvant D (This thesis Chapter 3). A method to estimate cow potential and subsequent responses to energy and protein supply according to stage of lactation. Submitted to *Journal of Dairy Science*
- Daniel JB, Friggens NC, Van Laar H, Ingvarsten KL and Sauvant D. (This thesis Chapter 4). Modelling homeorhetic trajectories of milk component yields, body composition and dry-matter intake in dairy cows: Influence of parity, phenotypic potential and breed. Submitted to *Animal*
- Daniel JB, Friggens NC, Chapoutot P, Van Laar H and Sauvant D 2016. Milk yield and milk composition responses to change in predicted net energy and metabolizable protein: A meta-analysis. Accepted for publication in *Animal*.
- Friggens NC, Emmans G, Kyriazakis I, Oldham J and Lewis M 1998. Feed intake relative to stage of lactation for dairy cows consuming total mixed diets with a high or low ratio of concentrate to forage. *Journal of Dairy Science* 81, 2228-2239.
- Garnsworthy PC and Topps JH 1982. The effect of body condition of dairy cows at calving on their food intake and performance when given complete diets. *Animal Production* 35, 113–119.
- Huhtanen P and Nousiainen J. 2012. Production responses of lactating dairy cows fed silage-based diets to changes in nutrient supply. *Livestock Science* 148, 146-158.

- Jensen C, Østergaard S, Schei I, Bertilsson J and Weisbjerg MR. 2015. A meta-analysis of milk production responses to increased net energy intake in Scandinavian dairy cows. *Livestock Science* 175, 59-69.
- Johnson IR, France J and Cullen BR 2016. A model of milk production in lactating dairy cows in relation to energy and nitrogen dynamics. *Journal of Dairy Science* 99, 1605–1618.
- Law R, Young F, Patterson D, Kilpatrick D, Wylie A and Mayne C 2009. Effect of dietary protein content on animal production and blood metabolites of dairy cows during lactation. *Journal of Dairy Science* 92, 1001-1012.
- Leclerc H, Duclos D, Barbat A, Druet T and Ducrocq V 2008. Environmental effects on lactation curves included in a test-day model genetic evaluation. *Animal* 2, 344–353.
- Lin LIK 1989. A concordance correlation coefficient to evaluate reproducibility. *Biometrics*. 45, 255-268.
- Martin O and Sauvant D 2007. Dynamic model of the lactating dairy cow metabolism. *Animal* 1, 1143–1166.
- Martin O and Sauvant D 2010a. A teleonomic model describing performance (body, milk and intake) during growth and over repeated reproductive cycles throughout the lifespan of dairy cattle. 1. Trajectories of life function priorities and genetic scaling. *Animal* 4, 2030–2047.
- Martin O and Sauvant D 2010b. A teleonomic model describing performance (body, milk and intake) during growth and over repeated reproductive cycles throughout the lifespan of dairy cattle. 2. Voluntary intake and energy partitioning. *Animal* 4, 2048–2056.
- National Research Council 2001. *Nutrient Requirements of Dairy Cattle*. 7th rev. ed. Natl. Acad. Press, Washington, DC.
- Sauvant D and Nozière P 2016. Quantification of the main digestive processes in ruminants: The equations involved in the renewed energy and protein feed evaluation systems. *Animal* 10, 755-770.
- Sauvant D, Ortigues-Marty I, Giger-Reverdin S and Nozière P 2015. Actualisation des besoins et efficacités énergétiques des femelles laitières. *Rencontres Recherches Ruminants* 22, 225-228.
- Tolkamp BJ, Dewhurst RJ, Friggens NC, Kyriazakis I, Veerkamp RF and Oldham JD 1998. Choice of diet by dairy cows. 1. Selection for feed protein content during the first half of lactation. *Journal of Dairy Science* 81, 2657–2669.
- Volden H 2011. *NorFor – The Nordic feed evaluation system*. EAAP Publications No 130. Wageningen Academic Publishers, the Netherlands.
- Wood PDP 1967. Algebraic model of the lactation curve in cattle. *Nature* 216, 164–165.
- Zom R 2014. The development of a model for the prediction of feed intake and energy partitioning in dairy cows. Ph.D. Thesis. Wageningen University, Wageningen, the Netherlands.

Annex 1. Energy balance calculations

1. EB calculated with the traditional approach (energy in – energy out)

$$\text{Milk energy (MJ/d)} = 39.8 * \text{MFY} + 23.9 * \text{MPY} + 16.5 * \text{MLY}$$

with MFY (kg/d) = Milk fat yield, MPY (kg/d) = Milk protein yield and MLY (kg/d) = Milk lactose yield.

$$\text{NE}_L \text{ supply (MJ/d)} = \text{DMI} * \text{NE}_L$$

with DMI (kg/d) = dry-matter intake, NE_L (MJ/kg DM) = Dietary NE_L content

$$\text{NE}_L \text{ maintenance (MJ/d)} = 0.394 * (\text{avgBW}^{0.75})$$

with avgBW (kg) = average BW of the lactation

$$\text{NE}_L \text{ gestation (MJ/d)} = 7.1 * (0.00072 * 45 * \exp(0.116 * \text{WIP}))$$

with 7.1 converts UFL (French energy unit for milk) into MJ; WIP = week in pregnancy.

All animals were assumed pregnant at week 14 of lactation.

$$\text{NE}_L \text{ above maintenance (MJ/d)} = \text{NE}_L \text{ supply} - (\text{NE}_L \text{ maintenance} + \text{NE}_L \text{ gestation})$$

$$\text{EB (MJ/d)} = (\text{NE}_L \text{ supply} - (\text{Milk energy} + \text{NE}_L \text{ maintenance} + \text{NE}_L \text{ gestation})) / \text{kls} * \text{kgt}$$

where EB = energy balance, k_{ls} is the efficiency to convert dietary ME into milk NE_L calculated as $k_{ls} = 0.65 + 0.247 * [(ME/GE) - 0.63]$ with ME = metabolizable energy and GE = gross energy; k_{gt} is the efficiency to convert NE_L from body reserves into milk NE_L and also to convert dietary ME into NE_L body reserves. The coefficient k_{gt} is calculated as: $k_{gt} = k_{ls} + 0.15$.

2. EB calculated from BW and BCS change

An equation predicting the liquid weight within reticulo-rumen (**RRLiq**, %BW) was derived from a meta-analysis database (Sauvant and Nozière, 2016) using NDF intake (**NDFI**, kg) and BW (kg) as predictors. The resulting equation was:

$$\text{RRLiq} = 12 + 3.78 * [(\text{NDFI}/\text{BW} * 100) - 1] \quad (517 \text{ treatment means, } R^2=0.94, \text{ RMSE}=0.74)$$

Gut fill was then calculated as:

- Gut fill (kg) = $[(RRLiq * BW/100) / ((100-11.4)/100)] / (69.6/100)$ (Martin and Sauvant, 2003)

where 11.4 % is the DM content of the reticulo-rumen and 69.6% is the weight of the reticulo-rumen contents relative to the weight of the whole digestive tract contents. Finally empty BW was calculated as:

- Empty BW (kg) = BW – Gut fill

Empty BW free gravid uterus (**EBWFGU**) was then calculated as:

EBWFGU (kg) = empty BW – Gravid uterus

with Gravid uterus (kg) = $\exp(0.017*(DIP-284))*87$

The coefficient 0.017 is controlling the shape of the exponential function for gravid uterus growth and was in agreement with the shape of NE_L requirement for gestation simulated by INRA (Faverdin et al., 2007) and NorFor (Volden, 2011) feed unit systems; DIP was the days in pregnancy, 284 was the duration of the pregnancy and 87 was the weight of the gravid uterus at the last day of pregnancy (Bell, 1995). All animals were assumed pregnant at days in milk 98 of lactation. Total body fat (BF) and total body protein (BP) were then calculated as

- BF (kg) = $0.037683*((BCS-0.5)*8/4)*EBWFGU$
- BP (kg) = $(EBWFGU-BF)*0.215$

where 0.037683 is the coefficient from the relationship established in NRC (2001) between body fat content and BCS. The calculation $((BCS_c - 0.5)*8/4)$ is used to convert the 1-5 BCS scale into 1-9 BCS scale (originally used by the NRC to establish the previous relationship).

Total body energy (MJ/d) = BF * 39.8 + BP * 23.9

Cumulative EB was the difference between total body energy at each week of the lactation with the first week of lactation.

Chapter 6

General Discussion

Introduction

Milk production in dairy cows is a complex system with constantly increasing technical, economic, environmental and societal requirements. Because of the expected population growth more food will be required in the near future. However due to limited resources, a large part of the required increased production in dairy cow would have to be met by higher efficiency of converting feed into edible high-quality food (milk and meat). At the same time, there is a need to reduce the environmental impact of milk production, while also improving animal health and welfare. Ultimately, all of these challenges would have to be met while ensuring an income to the dairy producer. In a context of high volatility of feed and milk prices, optimizing revenue for dairy farmers requires frequent adaptations of the ration fed. The decisions on how to change the diet to cope with price volatility rely heavily on the quantitative understanding of multiple dairy cow responses to dietary changes, that is, what would be the impact of a dietary change in terms of milk production, milk composition, environmental excretion, animal health, fertility, etc. Therefore, models that predict animal response are of particular interest to help dairy farmers in optimizing the diet. In this thesis, we focus on the quantification of milk yield and composition responses to dietary changes (Chapter 2) and on the application of the developed response equations across dairy cows of different production potential (Chapter 3). These static equations were then integrated in a dynamic model of the lactation (Chapter 4 and 5) to enable simulation of the consequences of a dietary change on a whole lactation. Along this thesis, empirical and teleonomic modeling approaches were used to build the full model. Empirical regression equations (responses to dietary change) were integrated into a teleonomic model that predicts the effect of physiological status on dairy cow performance. This integration enables the teleonomic model to benefit from the relationship established on a large dataset of the literature and the empirical equations to benefit from the flexibility of a mechanistic framework (e.g. adapting responses in situation not much represented in the calibration dataset).

For evaluating the approach chosen, several points should be considered. 1. The advantages and limitations of the meta-analytic approach used to develop the response equations. 2. The complementarity of the dynamic response model, developed in this

thesis, with feed unit systems. Recent propositions by feed unit systems, with similar objective as the current work, are also discussed. 3. The choice of using the aggregated feed unit NE_L instead of individual energetic nutrients as input to predict milk responses. 4. The application of the current model on-farm.

Methodological considerations

Minimizing confounding factors

In Chapter 2, we have used a meta-analysis approach to quantify milk yield and milk composition responses to change in NE_L and MP. As opposed to experimental study, where the researcher can have full control on the experimental design, meta-analyses combines a mix of several experimental studies and by nature does not allow full control of the data. This is because the design is not determined prior to the collection of data as in classic randomized experiments. Nevertheless, several critical steps can be taken to maximize this control, thereby minimizing possible confounding factors. The first is to block the studies, in order to focus on the within-experiment variation (St-Pierre, 2001). This is because the variability between studies is not simply explained by the independent factors we want to quantify but by a great numbers of other known or unknown factors (e.g. physiological status of animal used, housing and feeding condition, weather, laboratory analysis, etc.). In contrast, within an experiment, differences between treatments are only explained by the factors investigated. Therefore, for the estimation of response equations, the interest is clearly in the within-experiment variability.

The inclusion of an experiment effect in a statistical model often requires the creation of specific code depending on the objective of the meta-analysis and the types of experiment present in the dataset (Sauvant et al., 2008). Such code enables to filter treatments within experiment based on their relevance relative to the objective of the study, but also to create multiple comparisons within experiment while avoiding confounding factors. As an example, an experiment of Weiss and Wyatt (2006) with 2 levels of MP x 2 hybrids of corn silage was split into 2, in order to focus on the effect of MP independently from the effect of corn silage hybrid. The comparisons between the 2 hybrids were excluded from the analysis because both estimated NE_L and MP values of the 2 hybrids were identical.

Therefore these comparisons are not appropriate to be used for our objective of quantifying, within-experiment, milk responses to NE_L and MP change.

Despite the use of specific codes to strictly focus on a specific effect (e.g. different NE_L content) within-experiment, the absence of confounding factors cannot be guaranteed. In particular, because adjusting for the effect of experiment centers the variables on the Y-axis (i.e. dependent variable) but not on the X-axis (i.e. independent variable). That is an experiment with higher milk protein yield than average at corresponding higher MP supply would be adjusted down toward this average (i.e. vertical adjustment), but no adjustment is made on the horizontal axis (MP supply in Figure 1, panel A). This is a problem when the ranges of values for the independent variables (i.e. in the example illustrated: MP supply) don't overlap between experiments. In that case, the milk production potential of the animal is confounded with MP supply (Figure 1, panel A). As can be seen by the increase in overlap of experiments in MP supply (Figure 1, panel B), the approach chosen to center MP supply on the supply for which MP efficiency is 0.67 minimizes the problem (Figure 1, panel B). This disentangles the effect of nutrition from the effect of animal potential. Note that this could have been achieved simply by adjusting NE_L and MP supply on the means of each experiment. However, this comes down to centering each experiment on a different nutritional status. In some experiments, milk production may be restricted by the mean supplies of NE_L and MP and in others it may not. This is far from ideal to estimate the true slope of the milk response to change in feed supply. Instead, we prefer fixed MP and NE_L efficiency to center MP and NE_L supply, respectively, because it refers to a clearly defined nutritional status.

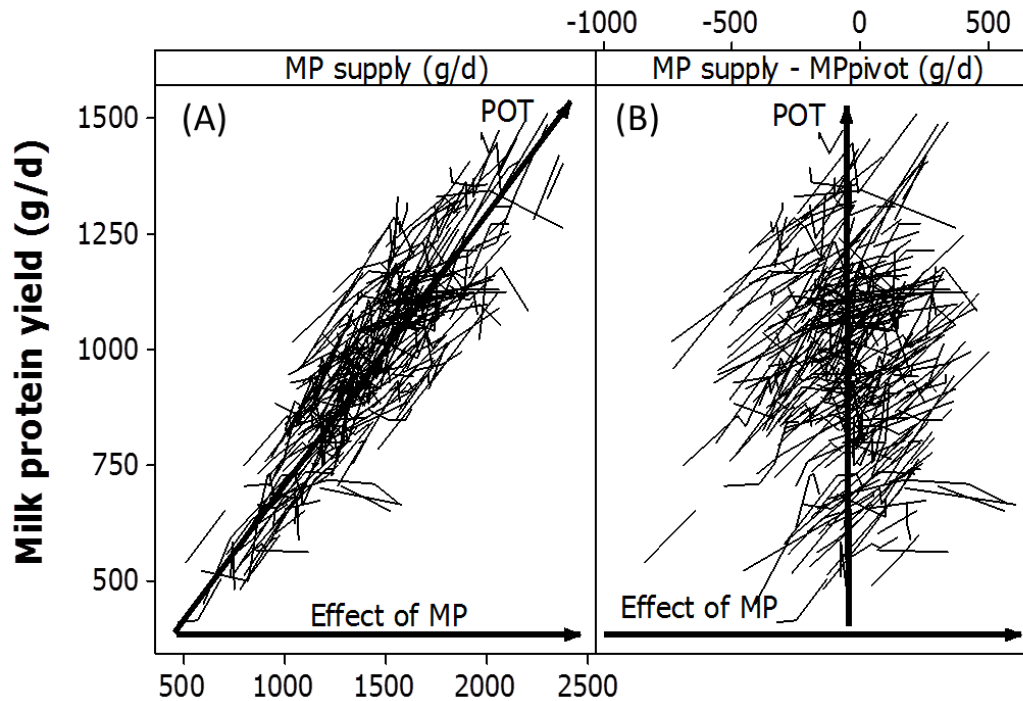

Figure 1 Meta-design showing the relations between milk protein yield and MP supply above maintenance, (A) not centered and (B) centered on MPpivot. MPpivot = Level of MP above maintenance supply for which MP efficiency is 0.67. POT represents the effect of production level (i.e. animal potential).

In the regression applied to quantify milk response, and in common to other ordinary least-squares regressions, all errors in the independent variable (Figure 1, MP supply) are transferred to the dependent variable (Figure 1, milk protein yield) because the method minimizes the sum of squares of the vertical distances between observations and their predictions. This implies that MP supply is measured without error, which is obviously not the case. In fact, and logically, the accuracy of measuring milk protein yield is higher than the accuracy of estimating the true supply of MP. Therefore a comparison of the coefficients obtained with least-square regressions and those obtained with other types of regression that enable to partition the error on both axes, horizontal and vertical (St-Pierre, 2016), would be interesting.

The problem of complex numbers

Another strong advantage of centering MP and NE_L supply on fixed efficiency has been presented in Chapter 3. We assumed that by combining two response equations (milk protein yield and milk energy yield), the relevant level of production (for each major milk component) on which the response equation is applied can be derived directly from observed production and intake. This is an important functionality as it provides a mathematical method to determine where the animal is relative to potential (defined as the production at MP efficiency equal to 0.67 and NE_L efficiency equal to 1), essential information to subsequently predict the size of the response to a change in nutrition. The supplies of MP and NE_L, at which MP efficiency is 0.67 and NE_L efficiency is 1, called pivots, were estimated by algebra using a system of two equations (see Chapter 3 for full description). However, using the complete dataset collected for the meta-analysis (a total of 1299 treatment means), the system of equations could not be solved in 19.3 % of cases as it resulted in solutions with a complex number (e.g. square root of a negative values). Most of the observations that give complex numbers were characterized by simultaneously high MP efficiency and high NE_L efficiency. In order to find out the exact reason why this occurs for those observations, milk energy yield and milk protein yield response equations (Chapter 2, Table 4) were simulated for an animal with MP pivot of 1488 g/d and NE_L pivot of 95 MJ/d (i.e. averages of the dataset in Chapter 2). This simulation was done with extreme deviation of NE_L supply relative to pivot supply (from -95 to +115 MJ/d), and extreme deviation of MP supply relative to pivot supply (-1488 to +1512 g/d). Such extreme (and unrealistic) scenarios of supply for a given animal was used on purpose to study the behavior of MP and NE_L efficiency, thereby exploring whether the system of equations enables the simulation of, simultaneously, high MP and NE_L efficiency. A graphical representation of the results is shown in Figure 2. It clearly shows an area where the combination of values for MP and NE_L efficiency is not supported by the equations (top-right corner). A frontier, that resembles the edge of an oval form, can be seen as the separation between real and complex numbers. This Figure explains why for some of the observations, that appear to fall in the area not supported by the equations, no solutions with real numbers could be found.

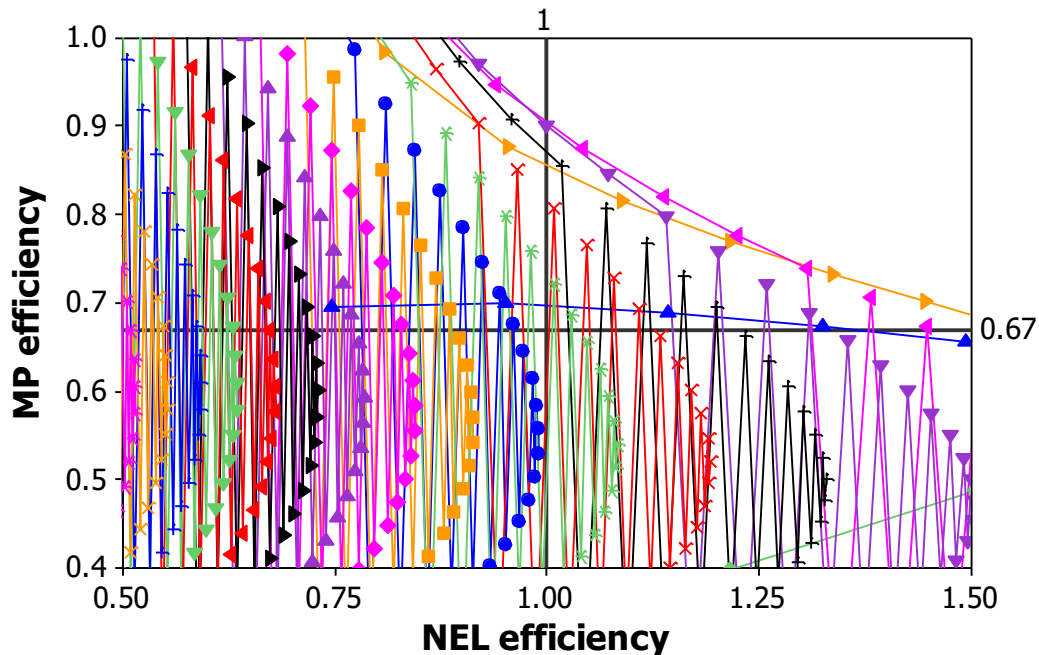

Figure 2. Simulated MP efficiency relative to simulated NE_L efficiency using milk protein yield and milk energy yield response equations developed in Chapter 2 (Table 4). The simulation used an animal with MP pivot supply of 1488 g/d and NE_L pivot supply of 95 MJ/d. Expressed relative to pivot supply, MP supply simulated goes from -1488 to +1512 g/d, and NE_L supply from -95 to +115 MJ/d. Points of the same color linked by a line are at same NE_L supply.

Another representation of this extreme simulation is represented in Figure 3 with milk protein yield against MP above maintenance supply for various level of NE_L supply. This alternative representation is interesting because it highlights a discrepancy between the behavior of the equation and what is expected theoretically. In theory, one would expect no milk protein yield when MP supply above maintenance is zero, whatever the NE_L supply. However, using the equations, up to 400 g/d of protein can be secreted with no MP available for milk protein production.

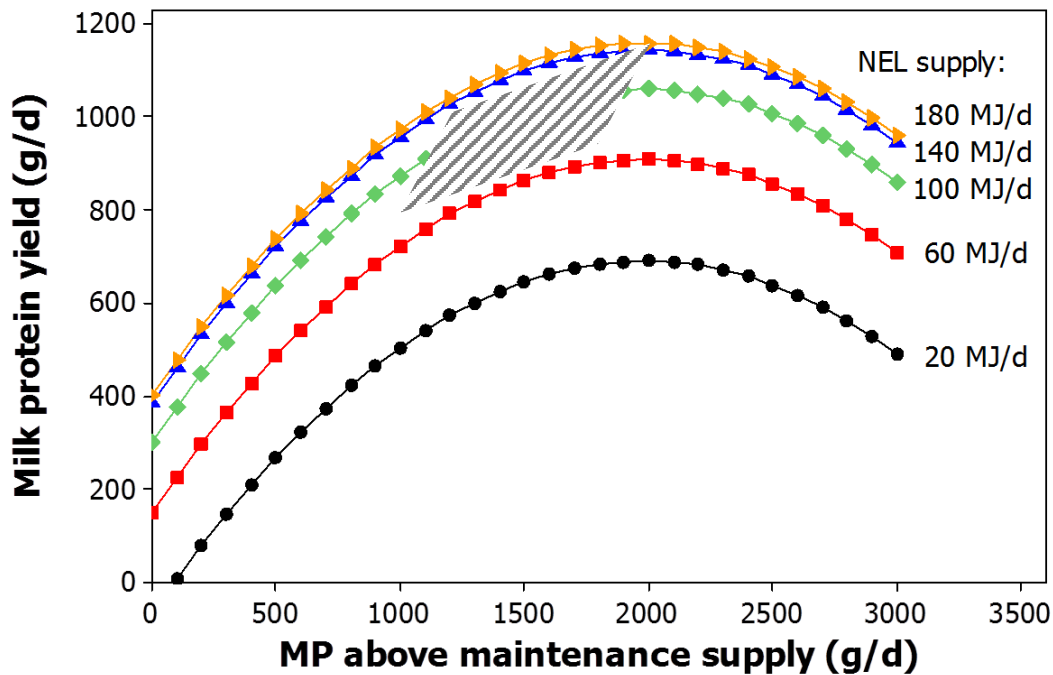

Figure 3. Simulated milk protein yield relative to MP above maintenance supply using milk protein yield response equation presented in Chapter 2 (Table 4) for an animal producing 997 g/d of milk protein yield and 95 MJ/d of milk energy yield at pivot efficiency. The NE_L effects are shown by the vertical displacement between the lines. The area with upward diagonal grey lines represents the range of data used for the calibration of the equations (mean \pm 2 SD; -460 to +368 g MP/d and -30 to +30 MJ NE_L /d, expressed relative to pivot).

This suggests the existence of an interaction between NE_L and MP supply, which comes into play when observed NE_L and MP supplies are far below their respective pivots, an area outside the calibration dataset (see upward diagonal grey lines in Figure 3). Alternatively, this could also suggest that MP nonproductive requirements (faecal CP loss, endogenous urinary N) may not be correctly evaluated when nutrient supply is very low. Including such interaction in both response equations for milk protein yield and milk energy yield solves the problem of the complex number found for the 19.2 % of the treatment means of the dataset. However, within the 825 treatment means used in the meta-analysis (see range of data used for calibration in Figure 1), no interactions were observed between NE_L and MP supply for any of the milk responses quantified. Even with the subset of data (242 treatment means) with low within-experiment variation in DMI, in

which the correlation between NEL and MP supply was also low (adjusted $R^2 = 0.13$), the interaction was still not significant. However it should be recognized that meta-analysis studies are not well adapted to detect interactions. In contrast, significant interactions with strong effect were found in a study designed to reveal such interaction (Brun-Lafleur et al., 2010). In this study, the relationship between NEL and MP supply was orthogonal with a range (differences between highest dietary and lowest dietary treatment) of 30 MJ/d for NEL and 400 g/d for MP (60 MJ/d and 928 g/d in our meta-analysis, based on mean \pm 2 SD). A particularity of this study, to create this orthogonality, was that an increase in NEL supply was achieved mainly by an increase in DMI whereas an increase in MP supply was achieved at iso-DMI by changing the feed composition (i.e. thus animals were restricted). Finally due to the majority of the results with an additive effect of NEL and MP (Macleod et al., 1984; Broderick, 2003; Rius et al., 2010; Huhtanen and Nousiainen, 2012; Alstrup et al., 2014; Daniel et al., 2016), we decided to leave the response equations unchanged, with no interaction between NEL and MP supply, and to solve the problem of complex numbers differently. For the situation that could not be solved by algebra, an optimization procedure was used that minimize the error of the system of two equations (details in Chapter 3). However, this point would certainly deserve more work to test other possibilities to solve the problem.

Comparison and complementarity of the current work with feed unit systems

Major efforts have been dedicated to improving the accuracy of feed unit systems to predict feed values and animal requirements. Feed unit systems allow rations to be formulated with the objective of matching nutrient supply with nutrient requirement. However, this approach is not suitable to predict milk responses to a change in diet composition. This is because requirements in feed evaluation systems are calculated using fixed efficiency. The Figure 4 illustrates both the “true” milk protein yield response (red curve) to extra MP supply and the expected response when a fixed MP efficiency is used (black line). It clearly shows that using the fixed efficiency of a requirement system in prediction would underestimate milk protein yield at low MP supply and overestimate milk protein yield at high MP supply. In fact, the relevant efficiency to predict milk protein

yield response is the marginal MP efficiency (i.e. fraction of the extra MP partitioned into milk, blue curve). Depending on the MP supply, this marginal efficiency was shown to vary between 34% and 7% (Chapter 2). This is far below the global MP efficiency of 0.67 used by feed unit systems (NRC, 2001; Van Amburgh et al., 2015; Faverdin et al., 2007).

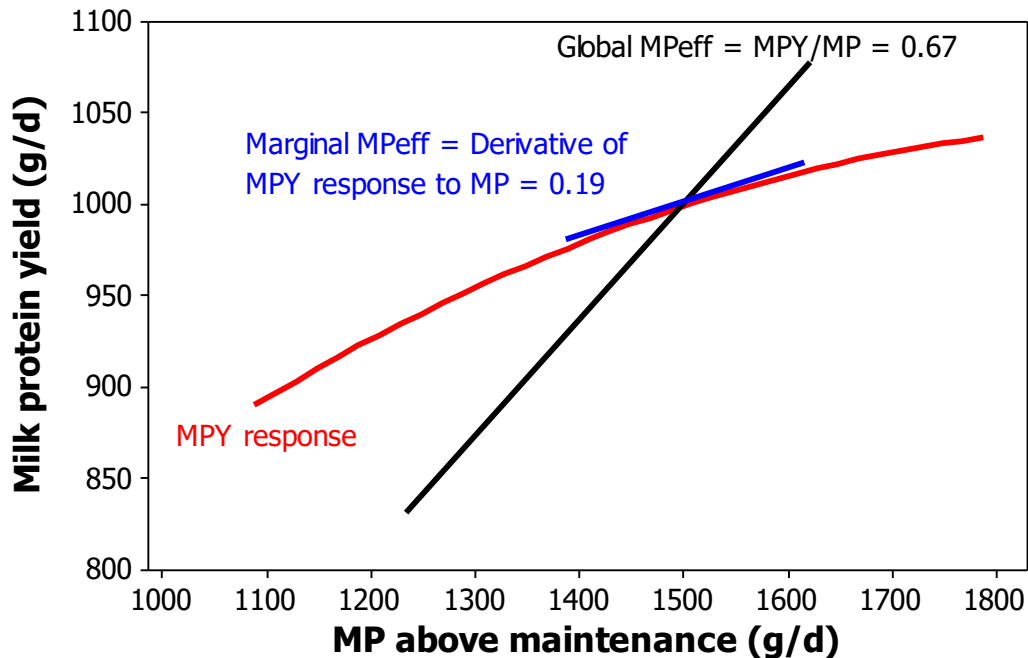

Figure 4. A schematic representation of milk protein yield response to MP above maintenance supply. The black line represents the fixed global MP efficiency of 0.67. The blue line, derivative of the response curve, represents the marginal MP efficiency of 0.19, when global MP efficiency is equal to 0.67.

Therefore as such the response equations developed in Chapter 2, which reflect the decreasing marginal efficiency, will improve prediction of production response by feed unit systems which use fixed efficiency. Response equations, sensitive to nutrition have also been proposed by others (Brun-Lafleur et al. 2010; Huhtanen and Nousiainen, 2012; Zom, 2014; Jensen et al. 2015). However these equations have limitations that we have tried to handle. Recent equations from Zom (2014) and Jensen et al. (2015) are only sensitive to energy supply and only equations for milk energy response were proposed. We have integrated the effect of change in protein and energy supply to predict multiple milk responses (lactose, protein and fat, both in content and yield, and milk yield). The

milk yield and composition response equations from Brun-Lafleur et al. (2010) were constructed from one single experiment. Although the design of this experiment was adequate and powerful for quantification of response to simultaneous change in energy and protein supply, it is only one experiment. In contrast, the meta-analytic approach used in Chapter 2 assembled a large number of experiments, and therefore a large diversity of rations fed. Additionally, the principle difference is the integration of the animal potential effect, which generalizes its utilization. This approach enables to move the response curves up or down along the pivot efficiency line according to animal potential. It should be noted that this method has not attempted to measure potential in any way, but instead estimates it based on NEL and MP efficiency. This enables to run a first diagnosis with respect to the current plane of nutrition in relation to the type of animal. Having established this base point and the subsequent response to additional nutrients, feed unit systems can then be used to formulate the diet according to different objectives (feed efficiency, maximizing production). Ultimately, by combining an economic module to the model (feed and milk prices), the ration that would optimize profit for the farmer could be designed.

Theoretically any feed unit system (NRC, CNCPS, CVB, INRA, NorFor, Feed into Milk, etc) should be suitable to supply NEL and MP data, as long as it has similar accuracy and precision as the system used to develop the equations. A comparison between latest versions of each major feed unit systems (NRC, 2001; Thomas, 2004; Volden, 2011; Van Duinkerken et al., 2011; Van Amburgh et al., 2015; Sauvant and Nozière, 2016), with respect to accuracy of prediction of digestive outcomes and nutrient supply could give valuable information on the interchangeability of the various feed evaluation systems.

The response equations developed were embedded in a dynamic model of the lactation (presented in Chapter 4) to deal with the effect of physiological status (lactation, gestation, growth) on milk yield and composition as well as dry-matter intake, body weight and body composition. This model explicitly integrates genetically driven trajectories for milk component yields and body components, all affected by the animal potential and animal maturity. Those trajectories, associated with the response curves, are very valuable to predict the long-term (i.e. one lactation) consequences of different diets on milk yield and composition. The value of these trajectories has been recognized by feed unit systems

which use a potential curve for milk yield (Faverdin et al., 2007; Zom, 2014), energy-corrected milk curves (Volden, 2011), potential milk composition curves (Faverdin et al., 2007; Zom, 2014), body energy mobilization curves (Faverdin et al., 2007; Zom, 2014), feed intake capacity curves (Faverdin et al., 2007; Volden, 2011; Zom et al., 2012) or dry-matter intake curves (NRC, 2001). However for the application of these curves, an estimation of animal potential is required. This notion of potential has often referred to the maximum production achievable in a non-limiting environment (Neal and Thornley, 1983; Vetharanian et al., 2003). However, those conditions are never guaranteed and it is therefore difficult to estimate in practice. In the approach developed in this thesis, the notion of potential was defined as the nutritional situation resulting in a MP efficiency of 0.67 and a NE_L efficiency of 1. These values are close to the averages efficiency observed with 825 treatment means of the literature (Chapter 2, MP efficiency = 0.69 and NE_L efficiency = 0.99). Using average values of efficiency is likely to result in a better estimate of the production potential than using maximum production. In particular because simulation of milk component yields response to NE_L supply indicates that maximum milk protein and lactose yields are not reached within the extensive range of data used for the calibration of the equation (Figure 5).

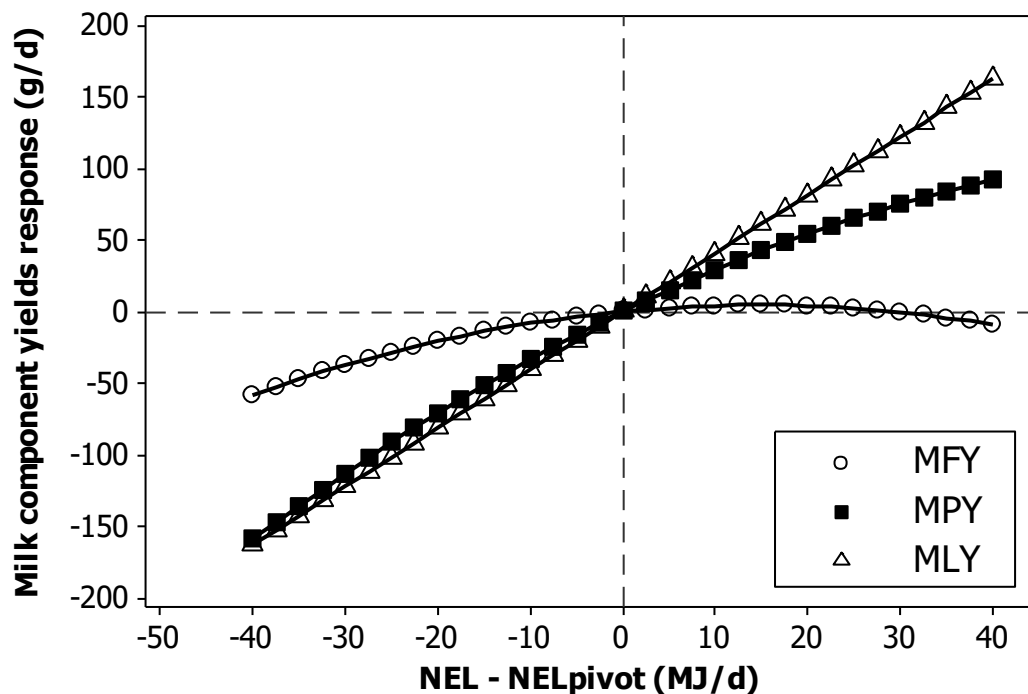

Figure 5. Milk component yields response to NE_L supply above maintenance (expressed relative to NE_{Lpivot}, MJ/d). NE_{Lpivot} = Level of NE_L above maintenance supply for which NE_L efficiency is 1.

With the definition of potential chosen in thesis, potential milk component yield curves can be estimated from initial production and intake (using the approach presented in Chapter 3 and 5). Additionally to potential milk curves, potential curves for dry-matter intake, body weight and body composition were also simulated by the dynamic model. All those curves were calibrated using a common dataset, ensuring a consistency between all trajectories simulated. This was also the case for the model of Zom (2014). However, Zom (2014) only calibrated average (reference) lactation curves (milk yield, milk composition and body weight), which does not distinguish between animals of different milk performance potential. Therefore the shape of the curves was not influenced by the level of production whereas a clear correlation exists between milk yield at peak and the decreasing slope of milk yield (Friggens et al., 1999). An alternative approach to simulate potential curves is to use a genetic test-day model as used in the lactation model of Brun-Lafleur (2011). This approach requires information on previous lactation, the large number of data used by genetic test-day model could a priori result in more reliable lactation curves than the current approach. However, genetic test-day model assume that the differences in nutritional environment are adequately captured by the fixed effect of farm.

Comparison between nutrient vs NE_L approach

Preliminary analyses were conducted to test if replacing the aggregated unit of NE_L by 3 nutrient categories, namely fatty acids, non-lipid ketogenic nutrients (acetate and butyrate) and glucogenic nutrients (glucose and propionate), would better describe milk component yields responses. The experiments (825 treatment means) focused on the effect of NE_L and/or MP, used for the meta-analyses presented in Chapter 2 were also used for that purpose. The flows of volatile fatty acids were estimated using equations presented in Nozière et al. (2011) and the flow of fatty acids using equations described in Sauvant and Nozière (2016). Results are presented here below:

Milk fat yield (g/d) = 1481 (51) + 2.12 (0.36) [MP – 100] – 0.089 (0.014) [MP – 100]² -1.97 (0.30) [Ac + Bu] (*Ntrt* = 796, *Nexp* = 276, *RMSE* = 56.6 g/d)

Milk protein yield (g/d) = 926 (63) + 4.12 (0.30) [MP – 100] – 0.098 (0.012) [MP – 100]² – 1.18 (0.26) [Ac + Bu] + 1.95 (0.23) [Glu + Pro] + 1.96 (0.83) FA (*Ntrt* = 795, *Nexp* = 277, *RMSE* = 46.0 g/d)

Milk lactose yield (g/d) = 1412 (103) + 6.15 (0.57) [MP – 100] – 0.135 (0.030) [MP – 100]² – 2.34 (0.42) [Ac + Bu] + 3.55 (0.41) [Glu + Pro] + 4.65 (1.42) FA (*Ntrt* = 531, *Nexp* = 175, *RMSE* = 67.6 g/d)

with MP, the metabolizable protein content (g/kg DM), [Ac + Bu], the sum of acetate and butyrate at the duodenum, expressed in g/kg DM, [Glu + Pro], the sum of glucose and propionate at the duodenum, expressed in g/kg DM and FA, the fatty acid at duodenum, expressed in g/kg DM. Standard errors of the coefficient are reported in parentheses. Abbreviations *Ntrt*, *Nexp*, and *RMSE* are used for numbers of treatment means, number of experiments and root mean square prediction error.

Globally, the improvements in *RMSE* were low as compared to equivalent analyses using the aggregated unit of net energy. A decrease in *RMSE* of 0.7, 2.9 and 9.8 g/d was observed for milk fat yield, milk protein yield and milk lactose yield, respectively (see Chapter 2, Table 3 for comparison). These results don't indicate a clear benefit of splitting energy into these 3 major energetic nutrient categories. The additional uncertainty related to the estimation of individual VFA flows at duodenum could partly explain these results. Therefore, at this stage, *NE_L* seems to be a good compromise between the level of accuracy at which it can be estimated and the proportion of the variance in milk response that is predictable from *NE_L*. Furthermore, with this type of regression that contains many predictors (MP, C3-like, Glu+Pro, FA), problem of co-linearity becomes more important. Nevertheless, the absence of experiments focused on the effect of lipid supplementation could also be one of the reasons for the low improvement in *RMSE*. In our dataset, as generally in practice, the higher energetic values were achieved largely by an increase of starch: NDF ratio. However, increasing *NE_L* with lipid or with starch is known to induce different responses (Van Knegsel et al., 2007). Therefore, with a mix of these 2 types of experiments, distinguishing the main types of energetic nutrient would likely result in better prediction of milk component yield responses.

On-farm model application

In relation to prediction accuracy

One stated objective of this thesis was that the model created should be operational, that is, applicable on-farm to predict milk yield and composition response to change in ration composition. So is the method accurate enough? The RMSE of the milk component yield response equations developed by meta-analysis varies from 31.4 g for milk protein yield to 50.6 g for milk lactose yield. These errors, expressed relative to the amplitude of change in milk component yield response, indicate error of 9% for milk protein yield and 10% for milk lactose yield (see Table 1).

Table 1: Simulation of milk component yields response to change in NE_L and MP supply (expressed relative to pivot)

Inputs (NE_L , MP)	Milk fat yield response (g/d)	Milk protein yield response (g/d)	Milk lactose yield response (g/d)
A ¹ : -30 MJ/d, -460 g/d	-161	-241	-289
B ² : +30 MJ/d, 368 g/d	26	119	203
C: Amplitude (B-A)	187	360	492
D: Equation RMSE	50.6	31.4	51.5
D/C*100 (%)	27%	9%	10%

¹mean - 2 SD (NE_{L100} : $0.45 - 2 * 15$; MP67: $-46 - 2 * 207$)

²mean + 2 SD (NE_{L100} : $0.45 + 2 * 15$; MP67: $-46 + 2 * 207$)

Alternatively NE_L and MP explained 84% of the variance not accounted for by the effect of experiment (i.e. the within-experiment variation) for both, milk lactose yield and milk protein yield. The explained variation and the prediction accuracy of the response equations for lactose and protein indicate the equations are adequate to be used for prediction. The prediction of milk fat yield was less accurate with an RMSE (expressed

relative to the amplitude of variation) of 27%. However, all of these statistics reflect the accuracy of the equation after adjusting for the effect of experiment. In predictive situation, such adjustment cannot be done and therefore the accuracy of the equation would naturally largely decrease. The effect of experiment is not negligible and is even the major source of variation in a context of meta-analysis. In Chapter 2, the experiment effect explains 79, 76 and 90% of the total variation for milk lactose yield, milk protein yield and milk fat yield, respectively. To circumvent this issue, the equations were developed around fixed efficiency pivot for MP and NEL. This has the principle advantage that actual efficiency observed on a farm can be used to estimate where the cows are relative to pivot efficiency, thereby calibrating the equation according to the context. By this way, the approach captures most of the variability explained by the experiment effect in the context of meta-analysis.

The first attempt to evaluate the full model to predict milk component yields was done with two key experiments (Friggens et al., 1998; Law et al., 2009). Because of the low number of experiment used for the evaluation, it does not represent a strong and robust evaluation. It simply represents the ability of the model to simulate response on these two particular situations. Using the means of dry-matter intake and milk component yields measured between days in milk 100 and 200, and the estimated dietary NEL and MP contents, lactation curves for milk component yields were estimated. With the exception of the first 50 days in milk for milk protein yield in Law et al. (2009) experiment, the shapes of the lactation curves were adequate ($CCC > 0.908$ and $RMSPE < 7.1\%$) for milk component yields. The prediction of the deviation from these lactation curves for a change in ration composition reveals that dry-matter intake response was not adequately predicted by the model. The size of the response was under predicted in Law et al. (2009) during most of the lactation and in Friggens et al. (1998) during the first half of the lactation. This is obviously problematic to predict subsequent response in milk component yields. This indicates further work would be required to better predict dry-matter intake response to change in dietary composition. In particular, the effect of stage of lactation on the size of the response deserves better quantification.

The accuracy of prediction of the body weight curve during lactation (i.e. body weight loss and gain) was adequate for the Friggens et al. (1998) experiment but largely inadequate for the Law et al. (2009) experiment (Chapter 5). In the model, body mobilization is sensitive to milk yield potential and degree of maturity. However, for animals of similar milk yield potential and parity, important variability still remained with respect to the amount of body tissue that can be mobilized in early lactation. As the model cannot adjust for this variability, the prediction of body weight change is likely to result in large variability in prediction accuracy as observed with these two experiments. The use of different scaling factor for size of mobilization for the Holstein breed between the 2 datasets used in Chapter 4 (Aarhus dataset and Trouw Nutrition dataset) also reflects the difficulty of predicting body weight. As observed for milk component yields response in the Law et al. (2009) experiment, body weight response also suffered from a lack of accuracy. However a comparison between energy balance estimated from the body (from actual measure of BW and BCS) and energy balance estimated from the traditional approach (energy in – energy out) has revealed a large inconsistency within the data of Law et al. (2009), which logically impacted the model prediction.

In practical conditions, errors in estimating feed values are expected to be more important than in experimental conditions. It will be therefore necessary to estimate the sensitivity of the model output to any source of error in model input. For that purpose, a Bayesian approach has been shown to be suitable (Reed et al., 2016), resulting in a confidence interval for the predicted response.

In relation to the model structure

Model positioning. Figure 6 illustrates the positioning of the model related to required inputs. As the dynamic response model does not deal with digestive processes, it needs to be associated with a digestive model in order to convert feed chemical composition into ration nutrient composition. The initial animal performance (milk yield and composition, BW and BCS) as well as animal physiological status are also required to adjust the model for the given farm situation. The model then predicts whole-lactation curves for the initial rations as well as for a new ration.

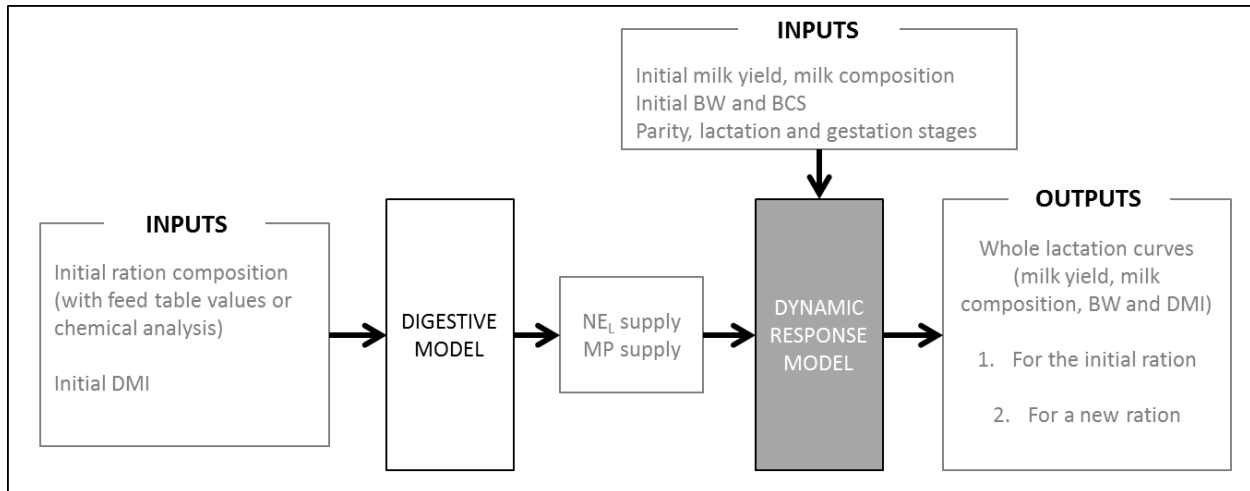

Figure 6. Overview of the model inputs and outputs.

Dry-matter intake on-farm. In the model evaluation, the aim was to only use data that could be measured or estimated on-farm in order to approximate prediction under applied conditions. However, some important differences are expected between the conditions of this evaluation and those of a commercial dairy farm. In the evaluation, dry-matter intake, experimentally measured, was used to first calculate the pivot productions. In reality however dry-matter intake is not measured and needs to be estimated. Depending on the accuracy of this estimation, this can be an important limitation for the method to be applied on-farm. Alternatively the milk response equations to change in dietary content (also presented in Chapter 2) do not require dry-matter intake as input. This is because the milk response equations to change in dietary composition indirectly include the average dry-matter intake response of the dataset. Therefore, only milk component yields data and the ration composition (NE_L and MP content) are required. These 2 different approaches to predict milk responses should be compared in practical situations to evaluate whether the response equation based on supply of NE_L and MP around pivot efficiency are more accurate.

The use of the model for individual prediction. Although the model was not used on individuals during this thesis, the model structure is technically compatible with prediction of individual performance. However the limitation of dry-matter intake prediction highlighted above is likely to be a constraint for individual prediction. With the increasing

amount of high frequency measurements (automated cow weighing technology, milk yield and composition, automatic BCS system), estimating dry-matter at the individual level could become realistic. Using estimation of energy maintenance requirement, total NE_L supply could be estimated from daily measurement of milk production and change in BCS and BW. The dry-matter intake would then be estimated by dividing the total NE_L supply with the dietary NE_L content (approach used in Chapter 4).

Conclusions

The present thesis has led to empirical equations, established by a meta-analysis of a large dataset of literature, which predict responses of:

- Dry-matter intake to change in forage NDF and MP contents
- Milk yield, milk component yields and contents to change in dietary MP and NE_L content
- Milk yield, milk component yields and contents to change in dietary MP and NE_L supply above maintenance

In these equations, the mutual influence of MP and NE_L on milk yield and composition was quantified using a large dataset with a wide spectrum in NE_L content (5.9 to 7.6 MJ/kg DM) and MP content (73 to 121 g/kg DM). No interaction between MP supply and NE_L supply was found in any of the milk responses.

In order to gain applicability across dairy cows of different potential, the equations were centered on fixed efficiency pivot: 67% for MP efficiency (milk protein yield/MP above maintenance) and 100% for NE_L efficiency (milk energy yield/ NE_L above maintenance). This has the principal advantage that the relative production level, that is, the distance between current production and potential production (i.e. production at fixed efficiencies pivot) can be estimated directly from current cow performance (milk yield and composition, NE_L and MP supply above maintenance). Using this approach, milk yield and milk component yields response were predicted across lactation stages with RMSPE below 13.5% and CCC above 0.784, with a large part of the error due to random variation (above 75.1%).

A dynamic model, simulating whole-lactation curves for dry-matter intake, milk yield, milk component yields, milk component contents and body weight for cows within a favourable environment was built. The effect of physiological status (growth, gestation and lactation stages) and animal potential on these whole-lactation curves were calibrated using a large herd dataset in which the diet was the same for all animals. Assessed by another dataset, the model structure was adequate to simulate whole-lactation curves of Jersey, Danish Red and Holstein breeds.

The dry-matter intake and milk component yields response equations were integrated in the dynamic model of the lactation to simulate the effect of varying dietary composition on the whole-lactation curves. A preliminary evaluation of the combined model indicates prediction of dry-matter intake response to dietary change is key for accuracy of milk component yields and milk yield.

References

- Alstrup L, Weisbjerg MR, Hymøller L, Larsen MK, Lund P and Nielsen MO 2014. Milk production response to varying protein supply is independent of forage digestibility in dairy cows. *Journal of Dairy Science* 97, 4412–4422.
- Broderick GA 2003. Effects of varying dietary protein and energy levels on the production of lactating dairy cows. *Journal of Dairy Science* 86, 1370–1381.
- Brun-Lafleur L 2011. Modélisation du fonctionnement d'un troupeau laitier pour anticiper les conséquences de son pilotage. PhD thesis, Agrocampus-Ouest, Rennes, France.
- Brun-Lafleur L, Delaby L, Husson F and Faverdin P 2010. Predicting energy x protein interaction on milk yield and milk composition in dairy cows. *Journal of Dairy Science* 93, 4128–4143.
- Daniel JB, Friggens NC, Chapoutot C, Van Laar H and D Sauvant. 2016. Milk yield and milk composition responses to change in predicted net energy and metabolizable protein: A meta-analysis. *Animal Accepted*.
- Faverdin P, Delagarde R, Delaby L and Meschy F. 2007. Alimentation des vaches laitières. Pages 23-58 in: Alimentation des bovins, ovins et caprins. Besoins des animaux - Valeur des aliments - Tables INRA 2007, mise à jour 2010. Editions Quae, Versailles, France.
- Friggens N, Emmans G, Kyriazakis I, Oldham J and Lewis M. 1998. Feed intake relative to stage of lactation for dairy cows consuming total mixed diets with a high or low ratio of concentrate to forage. *Journal of Dairy Science*, 81:2228-2239.
- Huhtanen P and Nousiainen J 2012. Production responses of lactating dairy cows fed silage-based diets to changes in nutrient supply. *Livestock Science* 148, 146–158.
- Jensen C, Østergaard S, Schei I, Bertilsson J and MR Weisbjerg. 2015. A meta-analysis of milk production responses to increased net energy intake in Scandinavian dairy cows. *Livestock Science*, 175:59-69.
- Law R, Young F, Patterson D, Kilpatrick D, Wylie A and Mayne C. 2009. Effect of dietary protein content on animal production and blood metabolites of dairy cows during lactation. *Journal of Dairy Science*, 92:1001-1012.
- Macleod GK, Grieve DG, McMillan I and Smith GC 1984. Effect of varying protein and energy densities in complete rations fed to cows in first lactation. *Journal of Dairy Science* 67, 1421–1429.
- National Research Council. 2001. Nutrient Requirements of Dairy Cattle. 7th rev. ed. Natl. Acad. Press, Washington, DC.
- Neal HDSC and Thornley JHM 1983. The lactation curve in cattle: A mathematical model of the mammary gland. *Journal of Agricultural Science* 101, 389–400.
- Nozière P, Glasser F and Sauvant D 2011. In vivo production and molar percentages of volatile fatty acids in the rumen: a quantitative review by an empirical approach. *Animal* 5, 403–414.
- Reed KF, Arhonditsis GB, France J and Kebreab E 2016. Technical note: Bayesian calibration of dynamic ruminant nutrition models. *Journal of Dairy Science* 99, 6362–6370.
- Rius AG, McGilliard ML, Umberger C and Hanigan MD 2010. Interactions of energy and predicted metabolizable protein in determining nitrogen efficiency in the lactating dairy cow. *Journal of Dairy Science* 93, 2034–2043.
- Sauvant D and Nozière P 2016. The quantification of the main digestive processes in ruminants : the equations involved in the renewed energy and protein feed evaluation systems. *Animal* 10, 755-770.
- Sauvant D, Schmidely P, Daudin JJ and St-Pierre NR 2008. Meta-analyses of experimental data in animal nutrition. *Animal* 2, 1203–1214.
- St-Pierre NR 2001. Integrating quantitative findings from multiple studies using mixed model methodology. *Journal of Dairy Science* 84:741–755.

- St-Pierre NR 2016. Comparison of model predictions with measurements: A novel model-assessment method. *Journal of Dairy Science*. Article in press.
- Thomas C 2004. *Feed into milk: a new applied feeding system for dairy cows*. Nottingham University Press, Nottingham, UK.
- Van Amburgh ME, Collao-Saenz EA, Higgs RJ, Ross DA, Recktenwald EB, Raffrenato E, Chase LE, Overton TR, Mills JK and Foskolos A. 2015. The Cornell Net Carbohydrate and Protein System: Updates to the model and evaluation of version 6.5. *Journal of Dairy Science*, 98:6361–6380.
- van Duinkerken G, Blok MC, Bannink A, Cone JW, Dijkstra J, van Vuuren AM and Tamminga S 2011. Update of the Dutch protein evaluation system for ruminants: The DVE/OEB₂₀₁₀ system. *Journal of Agricultural Science* 149, 351–367.
- van Knegsel ATM, van den Brand H, Dijkstra J, van Straalen WM, Heetkamp MJW, Tamminga S and Kemp B 2007. Dietary energy source in dairy cows in early lactation: Energy partitioning and milk composition. *Journal of Dairy Science* 90, 1467–1476.
- Vetharaniam I, Davis SR, Upsdell M, Kolver ES and Pleasants AB 2003. Modeling the effect of energy status on mammary gland growth and lactation. *Journal of Dairy Science* 86, 3148–3156.
- Volden H 2011. *NorFor - The Nordic Feed Evaluation System*. EAAP Publication. Wageningen Academic Publishers, Wageningen, the Netherlands.
- Weiss WP and Wyatt DJ 2006. Effect of corn silage hybrid and metabolizable protein supply on nitrogen metabolism of lactating dairy cows. *Journal of Dairy Science* 89, 1644–1653.
- Zom R. 2014. The development of a model for the prediction of feed intake and energy partitioning in dairy cows. Ph.D. Thesis. Wageningen University, Wageningen, the Netherlands.
- Zom RLG, G Andre and van Vuuren AM. 2012. Development of a model for the prediction of feed intake by dairy cows: 1. Prediction of feed intake. *Livestock Science*, 143:43–57

French summary

Prédiction dynamique des lois de réponses de production et composition du lait aux régimes alimentaires chez la vache laitière.

Les systèmes d'unités d'alimentation constituent un levier majeur du progrès des filières animales en permettant le calcul des régimes les plus appropriés en fonction du type d'animal. Jusqu'à présent, l'approche traditionnelle utilisée pour améliorer les systèmes d'unités d'alimentation a principalement porté sur la caractérisation des aliments et la détermination des besoins des animaux (dans le but d'accroître leur précision d'estimation). Cela a permis de formuler des rations adéquate pour atteindre un niveau de production prédéfini, éventuellement potentiel.

Cependant, cette approche ne peut pas s'adapter à la diversité croissante des objectifs des systèmes de production laitière (par exemple l'efficacité alimentaire, la santé animale, la longévité animale, etc.). L'approche réciproque et complémentaire est donc de mieux comprendre et quantifier les réponses multiples de l'animal aux changements alimentaires (Oldham et Emmans, 1989, Sauvant, 1992 ; Dijkstra et al., 2007). Cependant, cette tâche est actuellement rendue difficile en raison du manque de modèles robustes et opérationnels qui prédisent les réponses de production laitières des vaches aux changements de régime alimentaire. En particulier, les équations disponibles pour prédire les réponses laitières (Brun-Lafleur et al., 2010, Huhtanen et Nousiainen, 2012, Jensen et al., 2015) ne tiennent pas compte de l'influence du potentiel de production laitière. Or, sans la prise en compte de ce dernier, l'application précise de lois de réponses aux régimes alimentaires sur une exploitation donnée est très difficile. En effet, un animal qui produit 30 kg/j de lait et dont le potentiel de production est de 30 kg/j, ne répondra pas à une augmentation de la teneur énergétique et/ou protéique de la ration. En revanche si ce même animal, possède un potentiel de production de 50 kg/j, on peut s'attendre à une réponse de production laitière positive.

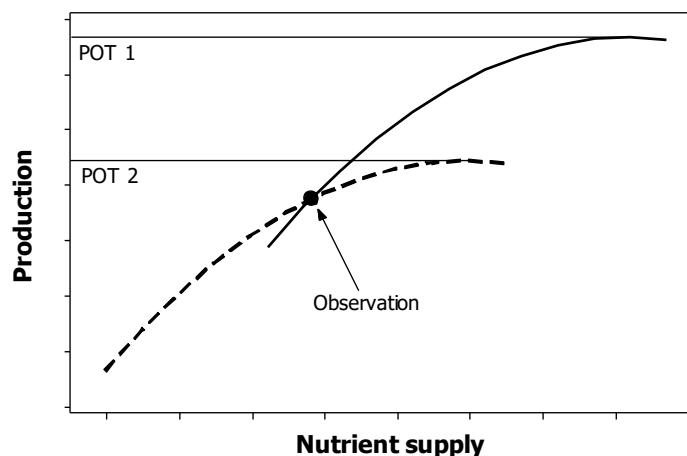

Figure 1. Représentation théorique d'une réponse laitière à un changement d'apport alimentaire. Quel est le potentiel laitier maximale : POT 1 ? POT 2 ?

L'effet du potentiel de production sur la réponse attendue est illustrée sur la Figure 1 qui nous montre que plus la vache est loin en dessous de son potentiel et plus la réponse attendue à un même changement d'alimentation sera importante. Par conséquent, cette notion de potentiel semble cruciale pour estimer si un animal donné répondrait (et dans quelle mesure) à un changement de régime alimentaire. En revanche le potentiel de production est difficile à estimer en pratique, d'autant plus qu'il varie en fonction du statut physiologique (stade de lactation, croissance, gestation). L'objectif principal de cette thèse est donc de développer des équations de réponse aux régimes alimentaires qui soient génériques et repérées par des pivots définis sans ambiguïté, c'est-à-dire qui intègrent explicitement les effets du potentiel de production animale et du statut physiologique.

1. Les réponses laitières des vaches aux apports protéiques et énergétiques

La première étape a été de quantifier de la façon la plus précise possible l'effet des apports de protéines métabolisables (PDI) et d'énergie nette (NE_L) sur l'ingestion de matière sèche, ainsi que sur la production et la composition du lait de la vache laitière. Pour ce faire et étant donné la grande diversité d'essais publiés dans la littérature sur le sujet, il nous a semblé opportun d'utiliser une approche par méta-analyse. Les essais publiés dans la littérature dont l'objectif était d'étudier l'effet de l'alimentation sur la production laitière ont donc été rassemblés dans une grande base de donnée. Suite à cela, les valeurs nutritionnelles des rations ont été calculées en appliquant la dernière version du système d'unité d'alimentation INRA, Systali (Sauvant and Nozière, 2016). Les différents essais ont ensuite été codés en fonction (1) des objectifs annoncés dans les publications originales et (2) des variations intra-essais de la teneur en PDI et NE_L . Ceci a permis de constituer une sous base d'essais focalisés sur l'effet des PDI et/ou de NE_L (282 essais, 825 traitements). Le nombre conséquent d'essais a permis de couvrir une large diversité de régime, en particulier de fourrages, et donc une grande partie des teneurs plausibles en PDI et NE_L susceptible d'être rencontrées en situations pratiques. Les teneurs moyennes en PDI et NE_L étaient respectivement (moyenne \pm écart-type) de 97 ± 12 g/kg MS et $6,71 \pm 0,42$ MJ/kg MS.

Afin de s'assurer de la précision des valeurs PDI et NE_L de cette sous base, nous avons confronté les mesures de flux de protéine au duodénum (115 traitements) à celles prédites par Systali, ainsi que les mesures de digestibilité de la matière organique (474 traitements) à celles prédites. Cette comparaison, effectuée en intra-essais n'a montré aucun biais sur aucun des 2 critères, laissant indiquer que les valeurs PDI et NE_L sont non biaisées. Il convient de signaler que la variabilité inter-essais était, comme souvent, très importante. Exprimés en apports journaliers, les PDI et NE_L au-dessus de l'entretien était très corrélés entre eux (Figure 2A, R^2 ajusté = 0.59). Pour tenter de réduire cette

corrélation entre les variables explicatives, les apports de PDI disponibles ont été centrés dans chacun des essais sur l'apport de PDI disponibles correspondant à une efficacité d'utilisation des PDI disponible en protéine laitière de 67%. De même, les apports de NE_L disponibles ont été centrés dans chacun des essais sur l'apport de NE_L disponibles correspondant à une efficacité d'utilisation des NE_L disponible en énergie du lait de 100% (situation nutritionnelle équivalente à un bilan énergétique nul). Les apports centrés ont été appelés PDI₆₇ et NE_{L100}. Cet ajustement des apports a permis de diminuer grandement la corrélation globale entre les variables explicatives (Figure 2B, R² ajusté = 0.13).

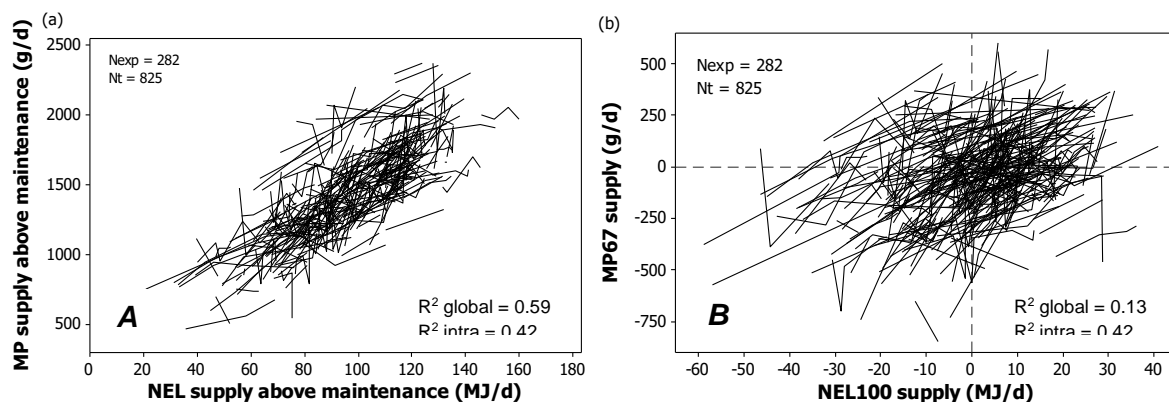

Figure 2. Relation **(A)** entre les apports en PDI disponible et NE_L disponible et **(B)** entre les apports en PDI₆₇ et NE_{L100}.

À l'aide d'un modèle d'analyse de covariance, les variations inter- et intra-essais ont été séparées afin de se focaliser sur les effets intra-essais. L'interprétation s'est faite à travers un polynôme de degré des variables explicatives :

$$\text{Réponse}_{ij} = \mu + S_i + e_1 \times \text{NE}_{L100} + p_1 \times \text{PDI}_{67} + e_2 \times \text{NE}_{L100}^2 + p_2 \times \text{PDI}_{67}^2 + a \times \text{PDI}_{67} \times \text{NE}_{L100} + \varepsilon_{ij},$$

où Réponse_{ij} correspond à la production laitière (kg/j), les composants du lait (en g/j) ou la composition du lait (en g/kg) pour l'essai *i* et le traitement *j*, μ est l'intercepte du modèle, S_i correspond à l'effet essai et ε_{ij} est la résiduelle du modèle pour l'essai *i* et le traitement *j*.

Deux types de modèles ont été développés: (1) les réponses laitières (lait brut, sécrétion de lactose, de matière grasse et de matière protéique ainsi que du TB, TP et taux de lactose) aux teneurs en PDI et UFL et (2) les mêmes réponses laitières aux apports de PDI₆₇ et NE_{L100}. Nous avons montré que les quantités de lactose, de matière grasse, de matière protéique et du lait brut étaient mieux prédites à partir des apports de PDI₆₇ et de NE_{L100} qu'à partir des teneurs en PDI et de NE_L (ETR réduit de 27% en moyenne). Ce gain de précision n'a pas été observé pour la composition du lait (g/kg). Aucune interaction statistique n'a été observée entre les PDI₆₇ et l'NE_{L100} sur la quantité de lait

produite et la sécrétion des composants du lait. Cependant, il y a non additivité des effets des PDI_{67} et de NE_{L100} en raison des effets curvilinéaires associés (Figure 3).

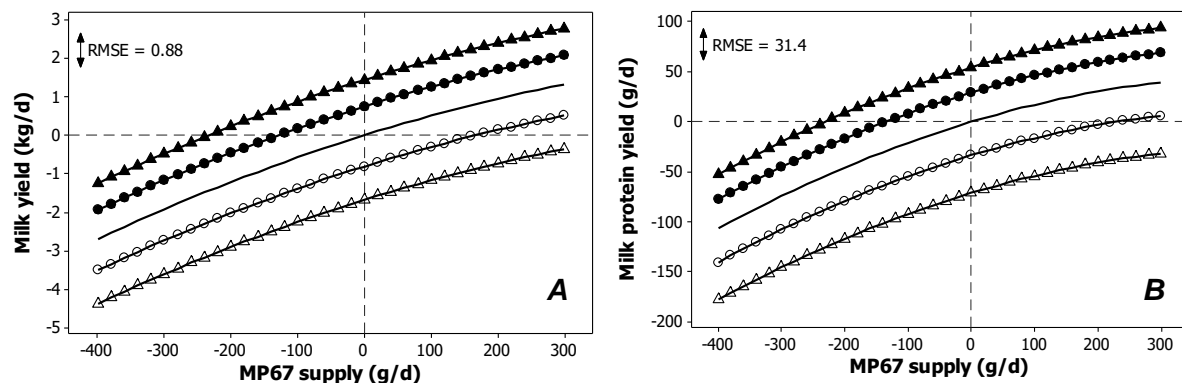

Figure 3. Réponse intra-expérience de la production de lait (A) et de protéines lactières (B) par les vaches en fonction des apports de PDI_{67} et NE_{L100} .

L'accroissement des apports de NE_{L100} augmente la partition de l'énergie vers les réserves corporelles alors que l'accroissement des apports de PDI_{67} augmente la partition de l'énergie vers le lait. D'un point de vue protéique, l'efficacité marginale (dérivée de la courbe de réponse) d'utilisation des PDI en protéine lactière diminue logiquement avec l'augmentation des apports de PDI_{67} : de 0,34 à $MP_{67} = -400$ g/j à 0,07 à $MP_{67} = 300$ g/j. Parallèlement, l'efficacité globale des PDI diminue de 0,82 à 0,58. En conclusion, les équations obtenues par cette méta-analyse décrivent avec une précision satisfaisante les réponses lactières aux régimes alimentaires et ceci sur une grande amplitude de rations (de 5.9 à 7.6 MJ NE_L /kg MS et de 73 à 121 g PDI/kg MS).

2. Application des lois de réponses à travers différents potentiels laitiers : l'intérêt d'un pivot nutritionnel

Une des ambitions de cette thèse était de proposer des équations de réponses applicables à travers des animaux de différents potentiel de production. Par conséquent, le but de ce travail était de proposer une méthode d'estimation du potentiel de la vache, qui permettrait de raccrocher les équations de réponses développées par méta-analyse, au potentiel de production correspondant à la vache étudiée. La méthode proposée s'appuie sur l'efficacité de transformation des PDI disponibles en protéine lactière et de l'efficacité de transformation des NE_L disponibles en énergie du lait. En effet les efficacités des PDI et NE_L sont très corrélées à l'amplitude des réponses (= efficacités marginale) que l'on cherche à prédire. En intra-expérience, nous avons montré que l'efficacité globale des PDI diminuait en même temps que l'efficacité marginale lorsque l'apport des PDI disponibles augmentait. La même observation a été fait sur l'efficacité des NE_L . Il semble donc que les efficacités globales soient de bons indicateurs du potentiel de

production de la vache. Dans ce cas, le potentiel de production maximale (=efficacités marginales nulles) est atteint lorsque les efficacités globales des PDI et des NE_L sont faibles. Cependant la zone où les efficacités marginales approchent 0 est caractérisée par peu de données et ne peut donc être définie avec précision.

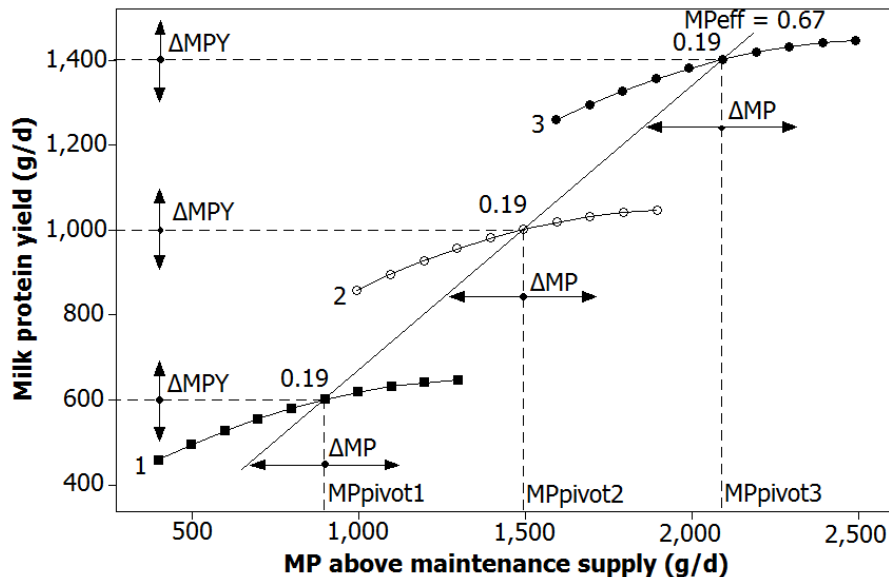

Figure 4. Réponse de la production de protéines laitières en fonction des apports de PDI disponible pour 3 groupes de vaches à potentiel laitier faible (■), moyen (○) et fort (●), produisant 600 g/j, 1000 g/j et 1400 g/j de protéines laitières au pivot protéique, respectivement.

Nous avons donc préféré nous appuyer sur une situation nutritionnelle pivot parfaitement définie et équivalente aux moyennes d'efficacités globales des PDI et des NE_L de la base de donnée (67% pour les PDI et 100% pour les NE_L) sur laquelle les équations de réponses s'appliquent. En faisant l'hypothèse que les efficacités marginales en PDI et en NE_L sont constantes au pivot pour n'importe quel potentiel de production, le pivot peut être utilisé pour estimer où se situe une vache donnée par rapport à son potentiel. En effet avec cette hypothèse, la distance entre la production au pivot et la production potentiel est fixe pour toutes vaches. La Figure 4 illustre l'intérêt du pivot pour l'application de la courbe de réponses de production de protéine laitière à travers 3 vaches de potentiels différents. On peut voir que le pivot permet de faire « coulisser » la courbes de réponse le long de l'efficacité globale des PDI de 67% selon le potentiel de l'animal considéré. A noter que sur cette Figure, l'effet de NE_L sur la sécrétion de la protéine laitière est ignoré. Lorsque que les effets simultanées des PDI et des NE_L sont considérés (Figure 5), on peut voir que pour une vache donnée, plusieurs situations nutritionnelles conduisent à une efficacité globale des PDI de 67%. En revanche la situation nutritionnelle au pivot, déterminé par une efficacité globale des PDI de 67% et une efficacité globale des NE_L de 100%, est unique. Dans l'exemple de la Figure 5, le pivot

est atteint lorsque la vache secrète 95 MJ/j d'énergie dans le lait et 1000 g/j de protéine dans le lait.

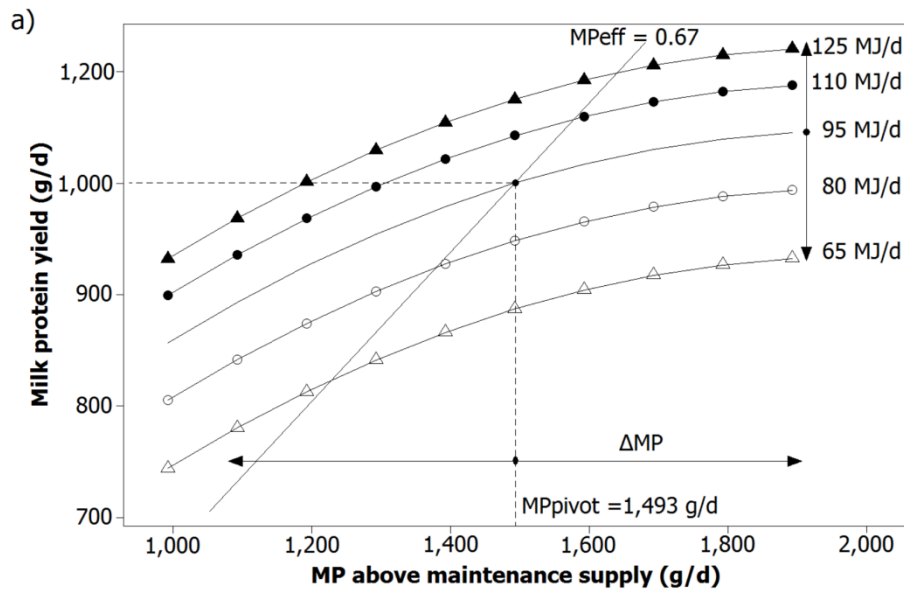

Figure 5. Réponse de la production de protéines laitières en fonction des apports de PDI disponible et NE_L disponible pour une vache produisant 1000 g/j de protéines laitières au pivot nutritionnelle.

L'intérêt de ce double pivot protéique et énergétique est qu'il peut être calculé algébriquement en combinant les réponses des sécrétions d'énergie et de protéine laitière à partir d'une situation de départ (production laitière, ingestion, ration). Une fois le pivot calculé, les réponses multiples (quantité et composition du lait) aux changements de PDI et/ou de NE_L peuvent être prédites. Cette approche de proposer des équations de réponses centrées sur un pivot a été évaluée à l'aide de deux jeux de données indépendants, où différentes rations ont été appliquées pendant toute la lactation. Les deux jeux de données ont été décrits entièrement par Friggens et al. (1998) et Law et al. (2009). Celui de Friggens et al. (1998) se caractérise par 2 rations différentes : une à faible proportion de concentré (PCO_{BAS} , 27% de la MS) et une à forte proportion de concentré (PCO_{HAUT} , 59% de la MS). Dans l'essai de Law et al. (2009), trois teneurs en protéine de la ration ont été testées (MAT_{BAS} de 11.4%, MAT_{MOYEN} de 14.4%, MAT_{HAUT} de 17.3%). Dans ces deux expériences, une ration alternative a été offerte à la moitié des animaux de chacun des traitements à partir du milieu de lactation (environ 150 jours). A titre d'exemple, 50% des animaux recevant la ration MAT_{BAS} a reçu la ration MAT_{MOYEN} à partir de 150 jours de lactation et ce jusqu'à la fin de la lactation. Nous avons donc cherché à prédire, à l'aide des données d'un des traitements offerts, la production au pivot pour chaque semaine de la lactation. Ce pivot a ensuite été utilisé pour appliquer les équations de réponses et prédire ainsi les productions des autres traitements. Les expériences de Friggens et al. (1998) et de Law et al. (2009) représentent un défi

considérable pour l'évaluation des équations de réponses. D'une part, parce que les équations ont été calibrées majoritairement sur des animaux en milieu de lactation. Et d'autre part, car les différences d'apport en PDI et NE_L entre les deux rations extrêmes de chacune des expériences étaient bien importantes que la moyenne des différences d'apports de tous les essais utilisés pour calibrer les équations. Malgré ce contexte d'évaluation difficile, les équations centrées sur le pivot nutritionnel ont permis de prédire les quantités de lait brut, de lactose, de matière grasse et de matière protéique avec des écarts type de prédiction compris entre 8.5 et 13.5% (exprimés en pourcentage des moyennes observées) et des CCC (= indicateur de précision et de répétabilité) compris entre 0.784 et 0.944 (un coefficient de 1 traduit une prédiction parfaite). On peut noter que des effets significatifs sur la précision de la prédiction entre phase de lactation (début, milieu et fin) ont été observés. Cependant l'amplitude de ces effets était pour la plupart très faible. Il est donc conclu que l'approche proposée de centrer les équations de réponses sur un pivot nutritionnel bien défini peut être utilisée pour prédire les réponses laitières à un changement alimentaire avec une bonne précision indépendamment du stade de lactation.

Dans cette évaluation, le pivot a été estimé pour chaque semaine de la lactation à partir des données hebdomadaire d'un des traitements. En revanche en pratique, les données dans le temps ne sont pas disponibles. Il est donc nécessaire de pouvoir prédire les trajectoires de production au cours de la lactation pour un animal dont la ration ne changerait pas. Nous avons donc centré notre attention sur la modélisation des effets homéorhèse (effet du stade physiologique de l'animal) sur la production et composition du lait.

3. Modèle dynamique de la lactation : Influence de la parité et du potentiel laitier intra- et inter-races

Dans cette partie, l'objectif était de construire un modèle qui puissent simuler les principaux effets du stade physiologique (stade de lactation, de gestation, de croissance) et du potentiel laitier sur les trajectoires de production et composition du lait. Sachant l'influence de l'état des réserves corporelles sur l'ingestion et donc sur la production laitière, nous avons également cherché à prédire les changements de composition corporelle ainsi que l'ingestion au cours de la lactation. Le modèle a donc pour but de simuler un ensemble de trajectoires de référence cohérent pour une grande diversité de type de vaches. Une approche de modélisation top-down (voir Friggens et al., 2013), inspirée de la proposition originale de Sauvant (1994) a été appliquée. Cette approche reconnaît explicitement les finalités téléonomiques de l'animal et introduit des règles de régulation de partition de nutriments dictées par les changements de ses priorités de l'animal. Pour ce faire, la structure du modèle développé se caractérise par deux sous-

modèles, un sous modèle de régulation d'homéorhèse qui établit des règles de partition dynamique le long de la lactation, et un sous-modèle opérationnel qui traduit ces règles de partition en performance animale. Le sous-modèle de régulation décrit la lactation comme le résultat de trois forces motrices liées: (1) l'utilisation des ressources déjà acquises par la mobilisation des réserves corporelles, (2) l'acquisition de nouvelles ressources avec une priorité de partition des nutriments vers le lait, et (3) vers les réserves corporelles. La dynamique de ces trois forces motrices a été ajustée séparément pour les matières grasses (laitières et corporelles), les matières protéiques (laitières et corporelles) et le lactose (lait). Cette structure permet de générer des trajectoires de sécrétion de lactose, matières grasses et matières protéiques laitières ainsi que des variations de réserves lipidiques et protéiques. Afin de rester en complémentarité des systèmes d'unités d'alimentation, les flux énergétiques associés à l'entretien, la croissance, la gestation, les réserves corporelles et les composants du lait sont décrits dans le modèle en adoptant les valeurs retenues dans le projet Systali-INRA. Ils permettent de prédire les besoins en énergie nette de l'animal ainsi que l'ingestion de matière sèche nécessaire pour couvrir ces besoins. La quantité de lait brut est prédite à partir des sécrétions de lactose et de matières protéiques laitières prédites grâce à une équation empirique précise développée à partir de nombreuses données de la littérature. Les coefficients de cette équation indiquent que pour 1 kg de lactose sécrété, on obtient 17 kg de lait tandis que pour 1 kg de protéine sécrétée, on a 4 kg de lait. Cette équation montre bien le rôle dominant du lactose sur la pression osmotique du lait. On peut aussi noter que les matières grasses n'ont pas d'effet significatif sur la sécrétion du lait. Ce résultat n'est pas surprenant sachant que celles-ci n'ont pas d'influence sur la pression osmotique. Une fois le lait brut prédit, la composition du lait (g/kg) est simplement prédite en faisant le rapport entre les sécrétions de composant du lait avec celle du lait brut. Un élément clé de ce modèle est sa capacité à simuler des trajectoires de performance pour différent type d'animaux que ce soit en intra-race à travers différent potentiel laitier ou à travers différentes races de vaches laitières. Ces effets liés au potentiel de production ont été régulés par le modèle à 2 niveaux: (1) Dans le sous-modèle de régulation, par un paramètre potentiel unique (appelé POT) qui permet d'ajuster globalement les priorités de partition (2) Dans le sous-modèle opérationnel, par des paramètres de facteurs d'échelle indépendants (7 au total) qui permettent d'ajuster certaines corrélations spécifiques entre les sorties du modèle, telles que celles capturant les différences entre les races dans la composition du lait.

L'ensemble des paramètres du modèle a été calibré à partir des données hebdomadaires du troupeau de la ferme laitière expérimentale Trouw Nutrition R&D (Kempenshof, Boxmeer, Pays-Bas) récoltées entre 2003 et 2012. Dans ce jeux de données, les vaches de race Holstein ont reçu une ration semi-complète à base d'ensilage de maïs et d'ensilage d'herbe complétée par un concentré de production fournit séparément. Cette ration est considérée comme satisfaisante pour exprimer au mieux le potentiel des

animaux. Grâce à la grande variabilité des niveaux de production, nous avons créé quatre sous-groupe d'animaux de potentiel laitier différents. Pour chacun de ces quatre groupes, les courbes moyennes de lait brut, de sécrétions des composants du lait, de variation de poids vifs et d'ingestion ont été utilisé pour calibrer les paramètres du modèle. La figure 6 donne un aperçu de la calibration du modèle pour le lait brut et la protéine laitière à travers les quatre lots d'animaux de potentiel différent. Les différences entre les quatre courbes présentées sur cette figure sont uniquement due au paramètre POT, qui permet d'ajuster l'ensemble des courbes du modèle selon le potentiel de la vache laitière.

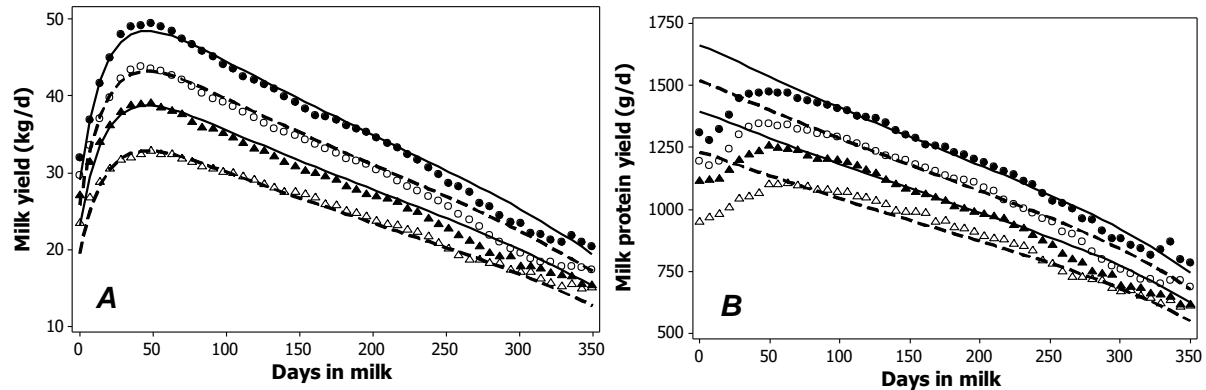

Figure 6. Comparaison entre valeurs observées (Δ , \blacktriangle , \circ , \bullet) et prédites (courbes) de la production de lait (A) et de protéines laitières (B) en fonction du stade de lactation pour 4 lots de vaches multipares de race Holstein de potentiel de production différent : 33 (Δ), 39 (\blacktriangle), 43 (\circ) et 49 (\bullet) kg de lait au pic.

Pour l'ajustement des changements de réserves corporelles, en plus des données de poids vifs disponible dans la base de données de Trouw Nutrition, nous avons rassemblé l'ensemble des données de la littérature où la composition corporelle a été mesurée à plusieurs moments de la lactation. Ainsi la calibration des changements de réserves corporelles représente un compromis entre les deux jeux de données. Confronté aux données mesurées (base Trouw Nutrition) de poids vifs, ingestion de MS, lait brut, sécrétions des composants du lait et composition du lait, la moyenne des écarts type de prédiction était 5.4% (exprimés en pourcentage des moyennes observées) pour un CCC moyen de 0.779. Ces résultats traduisent une bonne capacité du modèle à simuler un ensemble de trajectoires au cours de lactation pour quatre groupes d'animaux de potentiel laitier bien différent chez les primi- et multipares. En particulier, l'ingestion de MS qui est la résultante des besoins énergétiques simulés par le modèle est prédite avec une moyenne d'écarts type de prédiction de 3.7% et un CCC moyen de 0.931. C'est un résultat tout à fait intéressant sachant au combien il est difficile de prédire l'ingestion de MS.

Le deuxième niveau de régulation du potentiel a été ajusté sur un deuxième jeu de données décrit en détail par Nielsen et al. (2003). Brièvement ce jeu de donnée se

caractérisé par 3 races laitières (Rouge Danoise, Holstein et Jersiaise) qui ont reçu la même ration complète *ad libitum* (6,64 MJ de NE_L/kg MS) pendant toute la lactation. Ce jeu de données a permis d'ajuster les 7 paramètres de facteur d'échelle (3 pour le lait, 2 pour les réserves corporelles lipidiques associés à 2 pour les réserves corporelles protéiques) pour chacune des races. De plus il a aussi permis l'évaluation du modèle précédemment paramétré à l'aide du jeu de données de Trouw Nutrition. Au global, pour toute les sorties du modèle pour les 3 races, l'écart type de prédiction moyen était 4.4% (exprimés en pourcentage des moyennes observées) et le CCC moyen de 0.832. Ces résultats montrent que la structure du modèle est bien adaptée pour simuler les trajectoires de races de vache différente. La Figure 7 illustre la comparaison entre valeurs observées et prédites pour le lait brut et la sécrétion de protéine laitière.

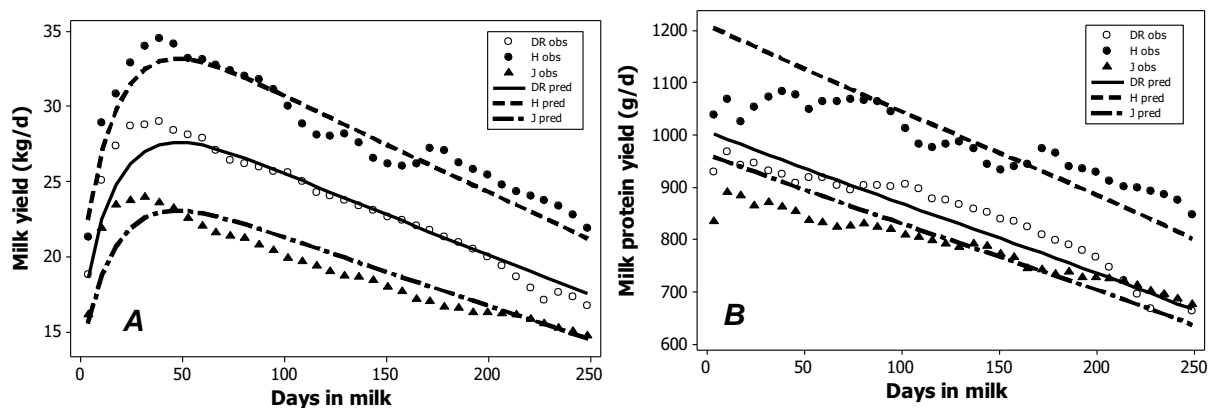

Figure 7. Comparaison entre valeurs observées (▲, ○, ●) et prédites (courbes) de la production de lait (A) et de protéines laitières (B) en fonction du stade de lactation pour 3 races de vaches multipares: Jersiaise (▲), Rouge Danoise (○) et Holstein (●).

On peut observer que, comme sur la Figure 6, la sécrétion de protéine laitière pour la race Holstein est surestimée en début de lactation. En revanche, il a été observé que sur d'autres jeux de données (ex. Faverdin et al. 1987; Zoom, 2014), la sécrétion de protéine laitière est maximale dès le premier jour de la lactation, comme simulé par le modèle. Il serait donc intéressant de confronter encore le modèle à d'autres jeux de données afin de caractériser au mieux l'effet du stade de lactation sur cette courbe.

En conclusion, le modèle prédit un ensemble cohérent de trajectoires, reflétant les effets de l'homéorhèse, pour la production et composition du lait, les changements de composition corporelle et l'ingestion de MS sur l'ensemble d'une lactation. De plus, ce modèle permet de prédire les différences de trajectoires entre les animaux de différents potentiels de production laitière au sein de la race Holstein et entre les races Rouge Danoises, Holstein et Jersiaise. En utilisant une structure de modèle qui exige peu de paramètres d'entrée pour l'utilisateur, les performances et caractéristiques animales (poids vifs, lait, ingestion) ont été prédites en moyenne avec un écart type de prédiction de 4,4% et un CCC de 0,83. L'originalité principale de ce modèle est qu'il s'appuie sur un

ensemble de trajectoires cohérents, tiré de deux grandes bases de données, qui sont représentatifs d'une large diversité de types d'animaux (Holstein de différents potentiels laitier, Jersiaise et Rouge Danoises) pour différentes parités.

4. Intégration des lois de réponses dans le modèle dynamique

Afin de prédire les conséquences d'un changement alimentaire sur le long terme, la dernière étape de cette thèse a consisté à combiner les deux grands modèles décrits précédemment. Le premier modèle, décrit dans la partie 3, quantifie les effets du stade physiologique (stade de lactation, stade de gestation et croissance) sur un ensemble de trajectoires (ingestion MS, production et composition du lait, poids vif et composition corporelle) au cours d'une lactation pour différents types de vaches laitières (inter et intra-race). Le deuxième, décrit dans la première partie quantifie l'effet de la nutrition sur l'ingestion, la production et la composition du lait. Ces courbes de réponses sont centrées sur un pivot nutritionnel qui donne simultanément une efficacité des PDI de 67% et des NE_L de 100%. En revanche, les courbes dynamiques sont représentatives d'animaux en situation nutritionnelle plutôt favorable à l'expression du potentiel. Il convient donc de se poser la question de la trajectoire des efficacités des PDI et NE_L associées à ces courbes dynamiques. Il se trouve que les efficacités des PDI et de NE_L diminuent avec l'avancement de la lactation (Figure 8).

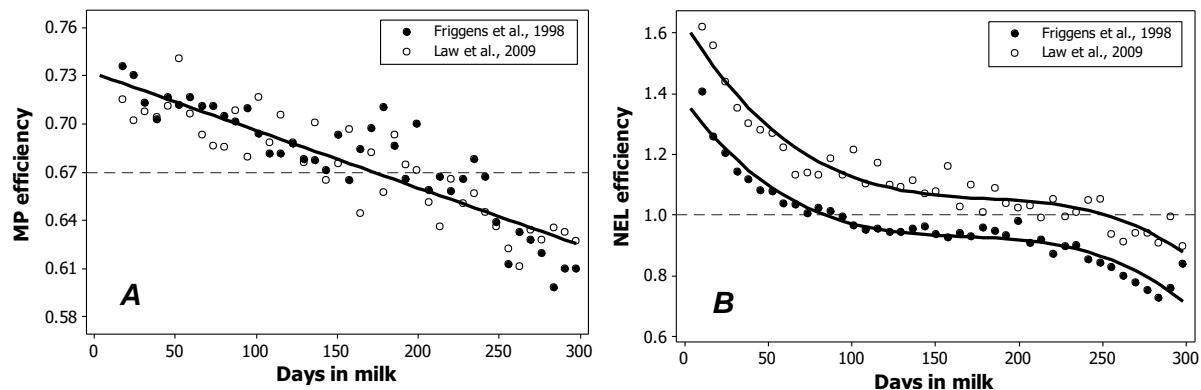

Figure 9. Efficacités des PDI disponibles (A) et de NE_L disponible (B) au cours de la lactation calculées pour les traitements PCO_{HAUT} et MAT_{HAUT} publiés, respectivement par Friggens et al. (1998) et Law et al. (2009).

Ce qui veut dire que les courbes dynamiques ne correspondent en réalité pas exactement à la situation nutritionnelle pivot utilisée pour centrer les équations de réponses. Il est donc nécessaire de calculer des courbes pivot dynamiques. L'approche de calcul du pivot, présenté en deuxième partie, a donc été utilisée en partant cette fois des courbes simulées par le modèle dynamique. La Figure 9 illustre l'intégration des lois de réponses

laitières au sein du modèle dynamique, rendu possible grâce à l'utilisation d'une situation nutritionnelle pivot commune aux deux modèles.

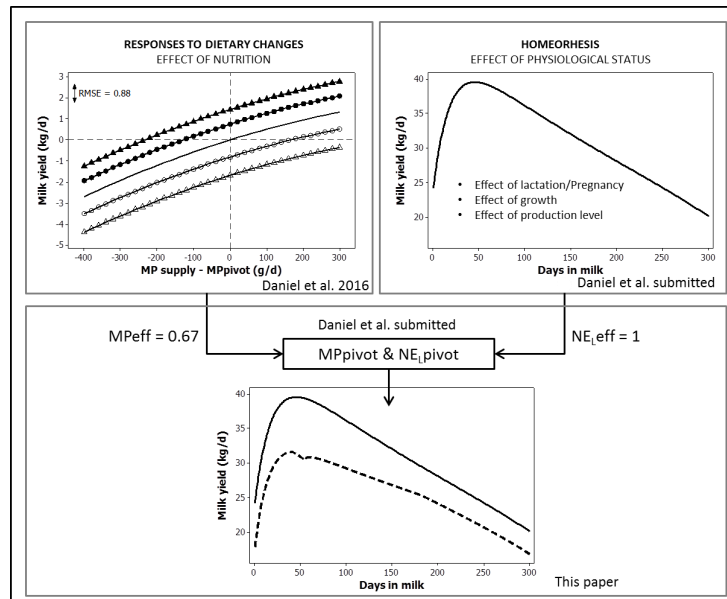

Figure 9. Démarche d'intégration des lois de réponses lactières au sein du modèle dynamique de la lactation: Exemple du lait brut

Les données d'entrée nécessaires pour utiliser le modèle sont la production et composition laitière ainsi que les quantités de NE_L et PDI disponibles ingérées. Ces données peuvent donc être dérivées en pratique à la condition que l'ingestion puisse être estimée de façon suffisamment précise. Ces données servent à calibrer le modèle en fonction du type de vache laitière (race, parité, capacité de production) de l'exploitation en question. A ce stade, le modèle prédit les trajectoires futures (ingestion de MS, production et composition du lait, composition des réserves corporelles) que la vache suivrait si la ration restait inchangée jusqu'à la fin de la lactation. De là, les conséquences des changements alimentaires sur ces courbes peuvent être prédites en fournissant de nouvelles valeurs de la composition des rations.

Le modèle ainsi combiné a été évalué avec les deux ensembles de données, utilisés dans la deuxième partie (Friggens et al., 1998 ; Law et al., 2009) dans lesquelles différents traitements alimentaires (effet de la teneur en concentré et effet de la teneur MAT, respectivement) ont été appliqués pendant toute ou partie la lactation. La prévision des courbes de lactation pour la MS ingérée, la production et composition du lait des rations haute (en concentré pour Friggens et al., 1998 ; et en MAT pour Law et al., 2009) était globalement satisfaisante avec des écarts type de prédiction allant de 3,8% à 11,2% (exprimés en pourcentage des moyennes observées) et des CCC allant de 0,516 à 0,983. En revanche, la prédiction des conséquences d'un changement de régime alimentaire sur l'ingestion de MS, la production et composition du lait était nettement moins

satisfaisante dans l'ensemble avec des écarts type de prédiction allant de 8,0% à 31,8% et des CCC allant de 0.099 à 0.496. Cette moins bonne prédiction est en majorité expliquée par une sous-estimation des réponses de l'ingestion de MS en début de lactation, ce qui se traduit par une nette surestimation de l'ingestion pour les rations faible en concentrée (Friggens et al. 1998, Figure 10) et faible en MAT (Law et al. 2009). Cet effet peut être observé sur la figure 10 dans le cas du jeux de donnée de Friggens et al. (1998).

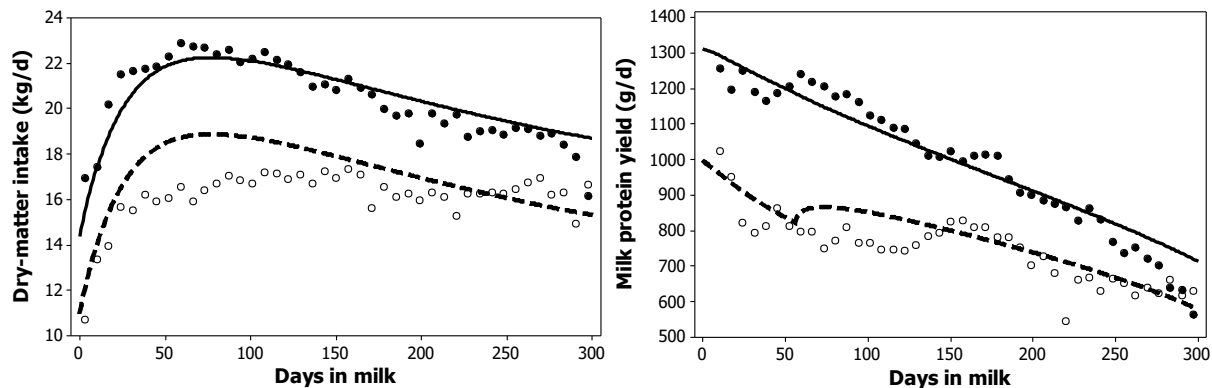

Figure 10. Comparaison entre valeurs observées (○,●) et prédites (courbes) de l'ingestion de matière sèche (A) et de la production de protéines laitières (B) en fonction du stade de lactation pour une ration à forte teneur en concentré (59% de la matière sèche ●) et à faible teneur en concentré (27% de la matière sèche ○).

En conclusion, le modèle construit est le premier à intégrer les deux grands types de régulation biologique (homéostasie et l'homéorhèse) chez la vaches laitières et permettant de prédire les performances animales à partir d'une définition précise du potentiel laitier. Grâce à l'utilisation du pivot, le potentiel de l'animal peut être calculé à partir des données de production et d'ingestion. Il permet donc d'estimer où se trouve l'animal par rapport à son potentiel maximal et par conséquent sa capacité à répondre à un changement alimentaire. L'utilisation du pivot permet aussi de calibrer le modèle en fonction du type de vache laitière en appliquant une démarche calculatoire précise. L'évaluation préliminaire du modèle sur deux jeux de donnée a montré que des biais important pouvaient exister. Afin d'améliorer la précision de prédiction, une attention particulière devrait être donnée à la réponse de l'ingestion de MS aux changements de régimes alimentaires et en particulier à l'effet du stade physiologique sur cette réponse. En effet cette question de l'effet du stade physiologique sur la réponse de MS ingérée (interaction réponse x stade) n'a pas vraiment été abordé durant la thèse.

Références

Brun-Lafleur L, Delaby L, Husson F and Faverdin P 2010. Predicting energy x protein interaction on milk yield and milk composition in dairy cows. *Journal of Dairy Science* 93, 4128–4143.

- Dijkstra J, Kebreab E, Mills JAN, Pellikaan WF, López S, Bannink A and France J 2007. Predicting the profile of nutrients available for absorption: From nutrient requirement to animal response and environmental impact. *Animal* 1, 99–111.
- Faverdin P, Hoden A and Coulon JB 1987. Recommandations alimentaires pour les vaches laitières. INRA, Bulletin Technique CRZV Theix 70, 133–152.
- Friggens NC, Brun-Lafleur L, Faverdin P, Sauvant D and Martin O. 2013. Advances in predicting nutrient partitioning in the dairy cow: Recognizing the central role of genotype and its expression through time. *Animal* 7, 89–101.
- Friggens NC, Emmans G, Kyriazakis I, Oldham J and Lewis M 1998. Feed intake relative to stage of lactation for dairy cows consuming total mixed diets with a high or low ratio of concentrate to forage. *Journal of Dairy Science* 81, 2228-2239.
- Huhtanen P and Nousiainen J 2012. Production responses of lactating dairy cows fed silage-based diets to changes in nutrient supply. *Livestock Science* 148, 146–158.
- Jensen C, Østergaard S, Schei I, Bertilsson J and Weisbjerg MR 2015. A meta-analysis of milk production responses to increased net energy intake in Scandinavian dairy cows. *Livestock Science* 175, 59–69.
- Law R, Young F, Patterson D, Kilpatrick D, Wylie A and Mayne C 2009. Effect of dietary protein content on animal production and blood metabolites of dairy cows during lactation. *Journal of Dairy Science* 92, 1001-1012.
- Nielsen HM, Friggens NC, Lovendahl P, Jensen J and Ingvarsten KL 2003. Influence of breed, parity, and stage of lactation on lactational performance and relationship between body fatness and live weight. *Livestock Production Science* 79, 119–133.
- Oldham JD and Emmans GC 1989. Prediction of responses to required nutrients in dairy cows. *Journal of Dairy Science* 72, 3212–3229.
- Sauvant D 1992. La modélisation systémique en nutrition. *Reproduction Nutrition Development* 32, 217–230.
- Sauvant D 1994. Modelling homeostatic and homeorhetic regulations in lactating animals. *Livestock Production Science* 39, 105–113.
- Sauvant D and Nozière P 2016. The quantification of the main digestive processes in ruminants : the equations involved in the renewed energy and protein feed evaluation systems. *Animal*, Accepted.
- Zom R 2014. The development of a model for the prediction of feed intake and energy partitioning in dairy cows. Ph.D. Thesis. Wageningen University, Wageningen, the Netherlands

Title : Dynamic prediction of milk yield and composition responses to dietary changes in dairy cows

Keywords : Dairy cows, milk responses, production potential, nutrition, modelling

Abstract : In order to better cope with the increasing diversity of objective in dairy production (e.g. feed efficiency, animal health, animal longevity, etc.) in a context of high volatility of feed and milk prices, quantification of animal's multiple responses to dietary changes is of particular interest to help dairy farmers in optimizing the diet. The main aim of the present study was to develop and evaluate a model to predict the responses in dry-matter intake, milk yield, milk component yields and contents to changes in dietary composition in dairy cows. A meta-analysis of the literature was conducted to quantify dry-matter intake response to changes in diet composition, and milk responses (yield, milk component yields and milk composition) to changes in dietary net energy (NE_L) and metabolizable protein (MP) in dairy cows. A key point in the development of these response equations was that they could be apply on animals of varying production potential. This was achieved by expressing MP and NE_L supply relative to a pivot nutritional status, defined as the supply of MP and NE_L resulting to MP efficiency of 0.67 and NE_L efficiency of 1. Based on MP and NE_L efficiency, an approach was proposed to estimate the pivot MP and NE_L supplies, around which the response equations can be applied. Evaluated with two independent datasets, this approach predicted milk

yield and milk component yields responses to change in MP and NE_L supply with a good accuracy for diets that are substantially different, and across all stages of lactation. In another model, the effect of physiological status (lactation stage, gestation, growth) on animal performance, i.e. milk yield, milk component yields, body composition change and dry-matter intake, were quantified across a range of animal potential. It was found that the model structure was adequate to simulate performance of different dairy breeds (Holstein, Danish Red and Jersey). To predict the long-term consequences of a dietary change, response equations, centred on the pivot nutritional status, were integrated into the dynamic model. This integration has been possible by applying the pivot concept into the dynamic model. This way, lactation pivot curves were calculated, from which response equations are applied. The model built is the first to integrate the two major biological regulations (homeostasis and homeorhesis) in dairy cows that predicts animal performance using a precise definition of milk potential.

Titre : Prédiction dynamique des lois de réponses de production et composition du lait aux régimes alimentaires chez la vache laitière

Mots clés : Vaches laitières, lois de réponses, potentiel de production, nutrition, modélisation.

Résumé: Afin de répondre à la diversification des objectifs de la filière laitière (ex. efficacité alimentaire, santé et longévité des animaux, etc.), et ceci dans un contexte de forte volatilité des prix du lait et des intrants, la quantification des réponses multiples aux changements de régimes alimentaires représente un intérêt afin d'aider les producteurs laitiers à optimiser la ration des animaux. Le principal objectif de ce travail a consisté à développer et évaluer un modèle de prédiction des réponses de l'ingestion, de la quantité et composition du lait aux changements de régimes alimentaires chez la vache laitière. Une méta-analyse a ainsi été appliquée sur une grande base de données de la littérature afin de quantifier la réponse de l'ingestion aux régimes, et les réponses laitières (quantité totale, sécrétion des composants du lait et composition du lait) aux changements d'énergie nette (**UFL**) et protéines métabolisables (**PDI**) de la ration. Un élément clé dans le développement de ces équations de réponses était qu'elles soient applicables à travers différent potentiel laitier. Ceci a pu être atteint en exprimant les apports PDI et UFL par rapport à une situation nutritionnel pivot, qui correspond à une efficacité d'utilisation des PDI de 67% et une efficacité d'utilisation des UFL par lait de 100% (équivalente à un bilan énergétique nul). Construite à partir des efficacités PDI et UFL, une approche a été proposée pour estimer les apports PDI et UFL à la situation pivot, à partir desquels les équations de réponses peuvent s'appliquer. Evalué sur deux jeux de données indépendants, cette approche a

permis de prédire les réponses de production laitière, productions de matières grasses, lactose et protéines du lait aux changements d'apports PDI et UFL avec une bonne précision pour des rations considérablement différentes, et à travers différents stades de lactation. Dans un autre modèle, les effets du stade physiologique (stade de lactation, stade de gestation, croissance) sur les performances animal, i.e. production laitière, productions de matières grasses, lactose et protéines du lait, changement de composition corporelle et ingestion, ont été quantifiés à travers des animaux de potentiel laitier différent. Il a été constaté que la structure du modèle était adéquate pour simuler les performances de différentes races laitières (Holstein, Rouge Danoise et Jersiaise). Afin de prédire les conséquences d'un changement alimentaire sur le long terme, les équations de réponses, centrées sur la situation nutritionnel pivot, ont été intégrées au sein du modèle dynamique. Cette intégration a pu se faire en appliquant le concept du pivot au modèle dynamique afin d'obtenir des courbes pivot, à partir desquelles les lois de réponses s'appliquent. Le modèle construit est le premier à intégrer les deux grands types de régulation biologique (homéostasie et l'homéorhèse) chez la vaches laitière permettant de prédire les performances animales à partir d'une définition précise du potentiel laitier.

Peer reviewed scientific publications

Ferreira LMM, Daniel JB, Celaya R, Santos AS, Osoro K, Rodrigues MAM, Pellikaan WF 2014. Utilization of carbon isotope enrichments ($\delta^{13}\text{C}$) of alkanes as faecal markers to estimate diet composition of goats fed with heathland vegetation. *Animal Feed Science and Technology* 191, 26-38.

Daniel JB, Van Laar H, Warner D, Dijkstra J, Navarro-Villa A and Pellikaan WF 2015. Passage kinetics of dry matter and neutral detergent fibre through the gastro-intestinal tract of growing beef heifers fed a high-concentrate diet measured with internal $\delta^{13}\text{C}$ and external markers. *Animal Production Science* 54, 1471-1475.

Sauvant D, Cantalapiedra-Hijar G, Delaby L, Daniel JB, Faverdin P and Nozière P 2015. Actualisation des besoins protéiques des ruminants et détermination des réponses des femelles laitières aux apports de protéines digestibles dans l'intestin. *INRA Productions Animales* 28, 347-368.

Daniel JB, Friggens NC, Chapoutot P, Van Laar H and Sauvant D 2016. Milk yield and milk composition responses to change in predicted net energy and metabolizable protein: A meta-analysis. *Animal* 10, 1975-1985.

Daniel JB, Friggens NC, Van Laar H, Ingvarsten KL and Sauvant D. Modelling homeorhetic trajectories of milk component yields, body composition and dry-matter intake in dairy cows: Influence of parity, phenotypic potential and breed. Submitted to *Animal*.

Daniel JB, Friggens NC, Van Laar H, Ferris CP and Sauvant D. A method to estimate cow potential and subsequent responses to energy and protein supply according to stage of lactation. *Journal of Dairy Science*. In press.

Daniel JB, Friggens NC, Van Laar H, Ferris CP and Sauvant D. Incorporation of dairy cow responses to change in dietary composition into a model that generates lactation curves of performance for cows of different potential. To be submitted.

Faverdin P, Sauvant D, Delaby L, Daniel JB, Agabriel J and Friggens N. The responses of intake and production to changes in PDI and UF supply around their requirements: In dairy females. In *INRA Feed Unit Systems for Ruminants* (ed. P Nozière, L Delaby L and D Sauvant), Wageningen Academic Publishers. To be submitted.

Conference and symposium proceedings

Daniel JB, Van Laar H, Warner D, Dijkstra J, Navarro-Villa A and Pellikaan WF 2014. Passage kinetics of dry matter and neutral detergent fibre through the gastro-intestinal tract of growing beef heifers fed a high-concentrate diet measured with internal $\delta^{13}\text{C}$ and external markers. In: 30th Proceedings of the Australian society of animal production, 8-12 September 2014, Canberra, Australia.

Daniel JB, Friggens NC, Chapoutot P, Van Laar H and Sauvant D 2015. Milk yield and composition responses to changes in supply of net energy and metabolizable protein: A meta-analysis. In: Journal of Dairy Science 98, Supplement 2, p. 608, 9-12 July 2015, Orlando, Florida, USA.

Sauvant D, Daniel JB, and Nozière P 2016. Comparative prediction of digestive interactions in dairy cows. In: 67th Annual Meeting of the European Federation of Animal Science, 29 August-2 September 2016, Belfast, Northern Ireland.

Sauvant D, Daniel JB, Cantalapiedra-Hijar G and Nozière P 2016. Meta-analysis of the efficiency of metabolizable protein utilization in dairy cows and goats. In: Proceedings of the 5th EAAP International symposium on energy and protein metabolism and nutrition, 12-15 September 2016, Warsaw, Poland.

Daniel JB, Friggens NC, Van Laar H, Ingvarlsen KL and Sauvant D 2016. Modelling homeorhetic trajectories of milk component yields, body composition and dry-matter intake in dairy cows: influence of parity, phenotypic potential and breed. In: Proceedings of the 5th EAAP International symposium on energy and protein metabolism and nutrition, 12-15 September 2016, Warsaw, Poland.

Acknowledgement

First and foremost, I would like to thank my supervisors Nicolas and Daniel for all they have done for me. Your ability to understand and explain the complexities of biological systems is inspiring. I am very lucky to know such good scientists and persons. I have the utmost respect for both of you.

I want to especially thank Harmen for giving me the opportunity to embark on a journey that I never imagined I would have done. Thank you for your help, advice and support provided along this thesis. I am grateful to Patrick and Rafael who were always available to help me when I needed their expertise.

I would like to thank the members of my thesis advisory committee, Philippe Faverdin, Sophie Lemosquet, Erwin Koenen, John Metcalf, Jeroen Doorenbos and Nathalie Trottier for their support and for their helpful comments at key times of the PhD process. I am also grateful to have had the privilege to be part of the last years of the *Systali* meetings, in which I have had stimulating scientific debates.

Conrad Ferris and Klause Ingvarsten are gratefully acknowledged for sharing data with us.

I thank all the members of the unit MoSAR in which I had the pleasure to spend part of these three years. Special thanks to Marie-Paul and Ghislaine for their assistance and to Frédéric, Phuong, Diana and Rafael for providing a stimulating and fun environment.

I warmly thank the whole RRC team and, in particular, Rachel, for the nice discussions and years of fun sharing an office. Thanks to Javier Martín-Tereso and Leo den Hartog who gave me the opportunity to pursue at Nutreco. I am looking forward for a great collaboration.

Of course, I would like to thank my Portuguese-Polish speaking community, Leonel, Alcina, Radek, Isabela, Gustavo and Justyna, with whom we share a lot of fun moments. Obrigado & Dziękuję.

Je remercie toute ma famille, en particulier mes parents, Erwan et Annette, ainsi que mon frère Francis qui m'ont toujours soutenu bien au-delà de la thèse. J'ai une pensée très particulière à Eugénie avec qui j'aurais aimé pouvoir partager beaucoup plus. Tout s'est arrêté beaucoup trop tôt pour toi...

Por fim, muito obrigado à Inês pelo apoio e carinho diários, pela força que tu me deste em todos os momentos. Para além de tudo, tu és a minha melhor amiga. Obrigado também à tua família: Luís, Ana, Catarina, Quim Zé, Guilherme e Gonçalo.

Title : Dynamic prediction of milk yield and composition responses to dietary changes in dairy cows

Keywords : Dairy cows, milk responses, production potential, nutrition, modelling

Abstract : In order to better cope with the increasing diversity of objective in dairy production (e.g. feed efficiency, animal health, animal longevity, etc.) in a context of high volatility of feed and milk prices, quantification of animal's multiple responses to dietary changes is of particular interest to help dairy farmers in optimizing the diet. The main aim of the present study was to develop and evaluate a model to predict the responses in dry-matter intake, milk yield, milk component yields and contents to changes in dietary composition in dairy cows. A meta-analysis of the literature was conducted to quantify dry-matter intake response to changes in diet composition, and milk responses (yield, milk component yields and milk composition) to changes in dietary net energy (NE_L) and metabolizable protein (MP) in dairy cows. A key point in the development of these response equations was that they could be apply on animals of varying production potential. This was achieved by expressing MP and NE_L supply relative to a pivot nutritional status, defined as the supply of MP and NE_L resulting to MP efficiency of 0.67 and NE_L efficiency of 1. Based on MP and NE_L efficiency, an approach was proposed to estimate the pivot MP and NE_L supplies, around which the response equations can be applied. Evaluated with two independent datasets, this approach predicted milk yield and milk component yields

responses to change in MP and NE_L supply with a good accuracy for diets that are substantially different, and across all stages of lactation. In another model, the effect of physiological status (lactation stage, gestation, growth) on animal performance, i.e. milk yield, milk component yields, body composition change and dry-matter intake, were quantified across a range of animal potential. It was found that the model structure was adequate to simulate performance of different dairy breeds (Holstein, Danish Red and Jersey). To predict the long-term consequences of a dietary change, response equations, centred on the pivot nutritional status, were integrated into the dynamic model. This integration has been possible by applying the pivot concept into the dynamic model. This way, lactation pivot curves were calculated, from which response equations are applied. The model built is the first to integrate the two major biological regulations (homeostasis and homeorhesis) in dairy cows that predicts animal performance using a precise definition of milk potential.

Titre : Prédiction dynamique des lois de réponses de production et composition du lait aux régimes alimentaires chez la vache laitière

Mots clés : Vaches laitières, lois de réponses, potentiel de production, nutrition, modélisation.

Résumé : Afin de répondre à la diversification des objectifs de la filière laitière (ex. efficacité alimentaire, santé et longévité des animaux, etc.), et ceci dans un contexte de forte volatilité des prix du lait et des intrants, la quantification des réponses multiples aux changements de régimes alimentaires représente un intérêt afin d'aider les producteurs laitiers à optimiser la ration des animaux. Le principal objectif de ce travail a consisté à développer et évaluer un modèle de prédiction des réponses de l'ingestion, de la quantité et composition du lait aux changements de régimes alimentaires chez la vache laitière. Une méta-analyse a ainsi été appliquée sur une grande base de données de la littérature afin de quantifier la réponse de l'ingestion aux régimes, et les réponses laitières (quantité totale, sécrétion des composants du lait et composition du lait) aux changements d'énergie nette (UFL) et protéines métabolisables (PDI) de la ration. Un élément clé dans le développement de ces équations de réponses était qu'elles soient applicables à travers différent potentiel laitier. Ceci a pu être atteint en exprimant les apports PDI et UFL par rapport à une situation nutritionnel pivot, qui correspond à une efficacité d'utilisation des PDI de 67% et une efficacité d'utilisation des UFL par lait de 100% (équivalente à un bilan énergétique nul). Construite à partir des efficacités PDI et UFL , une approche a été proposée pour estimer les apports PDI et UFL à la situation pivot, à partir desquels les équations de réponses peuvent s'appliquer. Evalué sur deux jeux de données indépendants, cette approche

a permis de prédire les réponses de production laitière, productions de matières grasses, lactose et protéines du lait aux changements d'apports PDI et UFL avec une bonne précision pour des rations considérablement différentes, et à travers différents stades de lactation. Dans un autre modèle, les effets du stade physiologique (stade de lactation, stade de gestation, croissance) sur les performances animal, i.e. production laitière, productions de matières grasses, lactose et protéines du lait, changement de composition corporelle et ingestion, ont été quantifiés à travers des animaux de potentiel laitier différent. Il a été constaté que la structure du modèle était adéquate pour simuler les performances de différentes races laitières (Holstein, Rouge Danoise et Jersiaise). Afin de prédire les conséquences d'un changement alimentaire sur le long terme, les équations de réponses, centrées sur la situation nutritionnel pivot, ont été intégrées au sein du modèle dynamique. Cette intégration a pu se faire en appliquant le concept du pivot au modèle dynamique afin d'obtenir des courbes pivot, à partir desquelles les lois de réponses s'appliquent. Le modèle construit est le premier à intégrer les deux grands types de régulation biologique (homéostasie et l'homéorhèse) chez la vaches laitière permettant de prédire les performances animales à partir d'une définition précise du potentiel laitier.