



HAL
open science

Cross-layer spectral and energy efficient scheduling algorithms with adaptive modulation and coding in LTE heterogeneous networks

Rima Hatoum

► **To cite this version:**

Rima Hatoum. Cross-layer spectral and energy efficient scheduling algorithms with adaptive modulation and coding in LTE heterogeneous networks. Networking and Internet Architecture [cs.NI]. Université Pierre et Marie Curie - Paris VI, 2014. English. NNT : 2014PA066159 . tel-02167631

HAL Id: tel-02167631

<https://theses.hal.science/tel-02167631v1>

Submitted on 28 Jun 2019

HAL is a multi-disciplinary open access archive for the deposit and dissemination of scientific research documents, whether they are published or not. The documents may come from teaching and research institutions in France or abroad, or from public or private research centers.

L'archive ouverte pluridisciplinaire **HAL**, est destinée au dépôt et à la diffusion de documents scientifiques de niveau recherche, publiés ou non, émanant des établissements d'enseignement et de recherche français ou étrangers, des laboratoires publics ou privés.

Thèse de Doctorat
Université Pierre et Marie Curie – Paris 6

Spécialité

TÉLÉCOMMUNICATION ET INFORMATIQUE

présentée par

Mme. Rima HATOUM

pour obtenir le grade de

Docteur de l'université Pierre et Marie Curie – Paris 6

**Algorithmes d'Ordonnancement Inter-Couches avec
Adaptation de Modulation et de Codage
dans les Réseaux Hétérogènes LTE**

Soutenue le 26 Juin 2014

Membres de Jury

Salah Eddine Elayoubi	Rapporteur	Ingénieur de recherche, Orange Labs
Nadjib Achir	Rapporteur	Professeur, Université Paris Nord
Khaldoun ElAgha	Examinateur	Professeur, Université Paris Sud
Anne Fladenmuller	Examinatrice	Maître de Conférence, Université Pierre et Marie Curie
Thi-Mai-Trang Nguyen	Examinatrice	Maître de Conférence, Université Pierre et Marie Curie
Guy Pujolle	Directeur de thèse	Professeur, Université Pierre et Marie Curie
Alaa Ghaith	Co-Directeur de thèse	Maître de Conférence, Université Libanaise

Numéro bibliothèque :

Doctor of Science Thesis
University Pierre and Marie Curie – Paris 6

Specialization

COMPUTER and COMMUNICATION NETWORKS

presented by

Ms. Rima HATOUM

Submitted in partial satisfaction of the requirements for the degree of
DOCTOR OF SCIENCE of the Pierre et Marie Curie University –
Paris 6

**Cross-Layer Spectral and Energy Efficient Scheduling
Algorithms with Adaptive Modulation and Coding
in LTE Heterogeneous Networks**

June 26, 2014

Committee in charge:

Salah Eddine Elayoubi	Reviewer	Research engineer, Orange Labs
Nadjib Achir	Reviewer	Professor, University of Paris Nord
Khaldoun ElAgha	Examinator	Professor, University of Paris Sud
Anne Fladenmuller	Examinator	Associate professor, University of Pierre and Marie Curie
Thi-Mai-Trang Nguyen	Examinator	Associate professor, University of Pierre and Marie Curie
Guy Pujolle	Advisor	Professor, University of Pierre and Marie Curie
Alaa Ghaith	Supervisor	Associate professor, Lebanese University

Résumé

Les systèmes de communication sans fil caractérisés par des services à haute vitesse sont en évolution permanentes malgré les restrictions en termes de la capacité du système et les conflits de couverture intérieure. Récemment, les réseaux “SmallCells” basés sur le standard LTE présentent une solution prometteuse en offrant les services demandés avec une meilleure couverture à l’intérieur et augmentant la capacité du système.

Cependant, de nombreux défis rencontrent les constructeurs et les opérateurs pour un déploiement efficace de ces systèmes.

Dans cette thèse, afin de développer ce type de réseaux et d’apporter des améliorations considérables de Qualité de Service (QoS) et de débits, nous adoptons une stratégie se basant complémentirement sur deux différents niveaux : couche de liaison (MAC) et couche physique.

En première partie, au niveau de la couche de liaison, nous proposons deux algorithmes d’ordonnancement et d’allocation conjointes de ressources se basant sur la technique d’Adaptation de Modulation et de Codage (AMC) et sur le contrôle de puissance pour les deux liaisons descendante et montante respectivement. Deux catégories distinctes d’utilisateurs qui diffèrent par la Qualité de Service demandée sont considérées. Ces algorithmes sont nommés respectivement : “Downlink AMC-QRAP” et “Uplink AMC-QRAP”. L’adaptation conjointe de puissance de transmission et de type de Modulation&Codage répond forcément aux variations de la qualité de la liaison sur chaque canal radio destiné à être alloué. Cependant, les deux liaisons, descendante et montante diffèrent par leurs spécificités. En particulier, comme mode de transmission du signal, le système 3GPP LTE utilise la technique OFDMA pour la liaison descendante et la technique SC-FDMA, plus efficace en termes d’énergie, pour la liaison montante. Une modélisation sous forme de problèmes d’optimisation linéaire est ainsi conçue. Comme compromis entre les architectures de réseaux : centralisée et distribuée, nous utilisons l’architecture de groupes ou “clusters” ainsi proposée dans la littérature.

Dans la deuxième partie de notre recherche, nous avons abordé les techniques de la “couche physique” en termes de traitement de signal comme une approche d’amélioration du système LTE. Ainsi, deux contributions basées sur la “transformée en ondelettes” (wavelet Transform) sont proposées. Premièrement, vu que la technique de modulation multi-porteuse OFDM souffre de plusieurs limitations en termes d’efficacité spectrale et énergétique, de synchronisation et d’interférence entre porteuses, nous proposons une méthode alternative basée sur les ondelettes. Nous avons démontré que la substitution de la transformée de Fourier par la transformée en ondelettes dans la technique OFDM permet de dépasser les

différentes limitations de l'OFDM. Enfin, nous avons proposé une approche pour délimiter et détecter les différents canaux de ressources alloués. Elle est utilisée dans l'algorithme d'ordonnancement de la transmission montante pour améliorer la fiabilité de la transmission et réduire le temps de convergence du problème d'optimisation.

Des simulations étendues selon différentes densités de réseau ont été réalisées, en utilisant plusieurs paramètres tels que l'efficacité spectrale, la puissance de transmission, le taux de satisfaction en termes de débits demandés et la capacité du réseau. Nous avons comparé nos méthodes à plusieurs travaux existants dans la littérature et prouvé la surperformance pour les différents paramètres pris en compte.

Abstract

Responding to the huge demand for high data rates and satisfying Quality of Service (QoS) requirements are the main objectives of the wireless mobile operators. LTE-based small cell system is a promising technology offering the required services, enhanced indoor coverage and increased system capacity. However, many challenges face the constructors and the operators for an effective deployment of these systems. In this thesis, in order to evolve such systems and adduce significant enhancement in terms of QoS and throughput, we adopt a complementary strategy based on both data link layer and physical layer.

First, we propose, on the link layer level, two scheduling and joint resource allocation algorithms based on the Adaptive Modulation and Coding (AMC) and the power control mechanisms for OFDMA-Downlink and SC-FDMA-Uplink connections respectively. Namely, they refer to: “Downlink AMC-QRAP” and “Uplink AMC-QRAP”. The joint adaptation of the transmission power and the Modulation and Coding Scheme reliably interacts with the link quality on each allocated sub-channel. Two distinct user categories are considered to differentiate between different QoS levels required. Accordingly, a linear optimization model is performed for the problem resolution. A clustering approach proposed in the literature has been used as a tradeoff between centralized and distributed schemes. Particularly, we used the spectrum sensing technique as proposed on the physical layer to detect surrounding transmissions.

After that, we tackle the physical layer “signal processing” techniques as an LTE enhancement approach. Thus, two contributions based on the “wavelet transform” (WT) are proposed.

The “wavelet-based OFDM” technique is firstly proposed as an alternative transmission mode for both downlink and uplink of the LTE and beyond wireless systems. In fact, the OFDM suffers from several limitations in terms of PAPR, spectral efficiency, synchronization cost and the inter-carrier interference. We proved that with substituting the Fourier transform by the wavelet transform in the OFDM technique, the different OFDM limitations can be significantly overcome. Second, we proposed an enhanced spectrum sensing approach based on WT tool that accurately delimits the occupied resource blocks in the whole spectrum. These physical layer enhancements help improving the scheduling algorithm for the uplink proposed in our second contribution.

Extensive network simulations with different network densities have been conducted, using several metrics such as spectral efficiency, throughput satisfaction rate, user outage and transmission power. We have compared our methods to several existing works in the literature and proved the outperformance for the different considered metrics.

List of Figures

1.1	Enhance coverage: (a) Distributed antennas, (b) Microcells, (c) Femtocells .	26
2.1	Downlink and Uplink wireless transmissions	38
2.2	Downlink and Uplink accessing resource grid	39
2.3	FDD and TD-LTE Comparison	40
2.4	Link Adaptation: (a) power control and (b) rate control	46
2.5	Spectrum Sensing Algorithms Comparison	54
3.1	Two-tier Femto-Macro Heterogeneous Network	59
3.2	SINR thresholds selection for different MCSs	64
3.3	Modulation constellations: (a) QPSK, (b) 16-QAM and (c) 64-QAM	65
3.4	Downlink interference scenarios in two-tier network	67
3.5	Throughput satisfaction rate vs. Network density	74
3.6	Mean SSR vs. Network density	75
3.7	Rate of rejected users	75
3.8	Efficiency per resource block	76
3.9	CDF of power transmission per femtocell in high density networks	77
3.10	Transmission power per user demands	78
3.11	Transmission power per resource block	78
4.1	SC-FDMA and OFDMA communality structure	84
4.2	Symbols transmission comparison between SC-FDMA and OFDMA	86
4.3	Localized mapping vs. Interleaved mapping	86
4.4	SC-FDMA and OFDMA PAPR Comparison	88
4.5	Throughput vs. Network Density	99
4.6	Outage Probability	100
4.7	Mean spatial spectrum reuse - SSR	101
4.8	Fairness	102
4.9	CDF power transmission per femtocell user	102
4.10	Transmit Power vs. Distance	103
4.11	Transmit Power vs. Demand	103
4.12	Mean Power per RB vs. Network Density	104
4.13	Average power transmission per tile	105
5.1	DWT decomposition filtering process	115

5.2	IDWT synthesis filtering process	116
5.3	Spectrum decomposition: (a) logarithmic for DWT and (b) linear for WPT	116
5.4	WPT decomposition filtering process	117
5.5	Fourier-OFDM symbol vs. wavelet-OFDM symbol	121
5.6	Wavelet-based OFDM transmission chain	122
5.7	DWT transceiver	122
5.8	Spectral efficiency comparison between: DWT-OFDM, FFT-OFDM and single carrier 16-QAM signals	125
5.9	PAPR comparison between DWT-OFDM and FFT-OFDM	126
5.10	BER comparison of DWT-OFDM vs. FFT-OFDM in AWGN channel . . .	127
5.11	Dynamic spectrum allocation	127
5.12	N frequency band with different PSD levels	129
5.13	Détection de l'énergie et des bordures se basant sur la transformée en Ondelettes	130

List of Tables

2.1	Peak data rate requirements in the downlink for different standards	36
2.2	Downlink Bandwidth and number of Physical Resource Blocks	37
3.1	Modulation and Coding Schemes (MCSs)	63
4.1	Uplink interference scenarios in two-tier network	90
5.1	DWT-OFDM system simulation parameters	124

List of Abbreviations

AMC	Adaptive Modulation and Coding
AWGN	Additive White Gaussian Noise
BER/BLER	Bit/Block Error Rate
BPSK	Binary Quadrature Shift Keying
CDF	Cumulative Density Function
CH	Cluster Head
CSI	Channel State Information
CWT	Continuous Wavelet Transform
DFT/IDFT	Discrete Fourier Transform/Inverse Discrete Fourier Transform
DWT/IDWT	Discrete Wavelet Transform/Inverse Discrete Wavelet Transform
DwPTS	Downlink Pilot Time Slot
FAP	Femtocell Access Point
FBS	Femtocell Base Station
FDD/TDD	Frequency Division Duplex/Time Division Duplex
FFT/IFFT	Fast Fourier Transform/Inverse Fast Fourier Transform
FMC	Fixed Modulation and Coding
HetNet	Heterogenous Network
I-FDMA	Interleaved single-carrier Frequency Division Multiple Access
ICI/ISI	Inter-Carrier Interference/Inter-Symbol Interference
LOS/NLOS	Line of sight/non-line of sight
LTE	Long Term Evolution
L-FDMA	Localized single-carrier Frequency Division Multiple Access
MBS	Macrocell Base Station
MCS	Modulation and Coding Scheme
MUE	Macrocell User Equipment
OFDM	Orthogonal Frequency Division Multiplexing
OFDMA	Orthogonal Frequency Division Multiple Access
PAPR	Peak-to-Average-Power Ratio
PRB	Physical Resource Block
PSD	Power Spectral Density

QAM	Quadrature Amplitude Modulation
QMF	Quadrature Mirror Filter
QoS	Quality of Service
QPSK	Quadrature Phase Shift Keying
RB	Resource Block
RF	Radio Frequency
RRM	Radio Resource Management
SC-FDMA	Single Carrier- Frequency Division Multiple Access
SC-OFDM	Single Carrier- Orthogonal Frequency Division Multiplexing
SINR/SNR	Signal to Interference plus Noise Ratio
TBS	Transport Block Size
TD-LTE	Time Division LTE
UE	user Equipment
UpPTS	Uplink Pilot Time Slot
WPT	Wavelet Packet Transform

Table of contents

1	Introduction	25
1.1	Problem Statement	27
1.2	Thesis Contributions	28
1.2.1	Adaptive Modulation and Coding for QoS-based Femtocell Resource Allocation with Power Control: AMC-QRAP Approach	28
1.2.1.1	OFDMA-based Downlink AMC-QRAP	29
1.2.1.2	SC-FDMA-based Uplink AMC-QRAP	29
1.2.2	Physical Layer LTE Enhancements	30
1.2.2.1	Wavelet-based OFDM Multicarrier Transmission Approach	30
1.2.2.2	Wavelet-based Edge Detection for Spectrum Sensing	30
1.3	Thesis Outline	31
2	State of The Art	35
2.1	Introduction	35
2.2	Long Term Evolution (LTE) System	35
2.2.1	LTE Design Goals	35
2.2.2	LTE Physical Layer Specifications	37
2.2.2.1	Downlink Direction Characteristics	37
2.2.2.2	Uplink Direction Characteristics	39
2.2.2.3	Duplex schemes and framing	40
2.3	Femto-Small Cells Networks	41
2.3.1	Femtocells' benefits	42
2.3.2	Femtocells' Challenges	42
2.4	Fundamental Wireless Communication Notions	44
2.5	Link Adaptation Issue	45
2.6	Literature Review	47
2.6.1	Downlink resource allocation approaches	47
2.6.2	Uplink resource allocation approaches	49
2.6.3	Wavelet-based signal processing enhancements	51
2.6.3.1	Alternative wavelet-based OFDM approaches	52
2.6.3.2	Spectrum Sensing techniques	53
2.7	Conclusion	55

3	Downlink Joint Resource Allocation with Adaptive Modulation and Coding	57
3.1	Introduction	57
3.2	System Description and Notations	58
3.2.1	Network Model	59
3.2.2	Propagation Model	60
3.2.3	Notations	61
3.3	Adaptive Modulation and Coding Concept	63
3.3.1	Definition	63
3.3.2	Modulation & Coding Scheme and Link Quality	64
3.3.3	Fixed Modulation and Coding (FMC) vs. Adaptive Modulation and Coding (AMC)	65
3.4	Downlink OFDMA AMC-based Joint Resource Allocation Proposal	66
3.4.1	Problem Formulation	66
3.4.2	Problem Resolution	70
3.5	Performance Metrics	72
3.5.1	Throughput Satisfaction Rate (TSR)	72
3.5.2	Spectrum Spatial Reuse (SSR)	72
3.5.3	Rate of rejected users	72
3.5.4	Average channel efficiency	73
3.5.5	Transmission power	73
3.6	Performance Evaluation	73
3.7	Conclusion	77
4	Uplink Joint Resource Allocation with Adaptive Modulation and Coding	81
4.1	Introduction	81
4.2	SC-FDMA Transmission Mode	83
4.2.1	What is SC-FDMA and Why using it?	83
4.2.2	SC-FDMA v.s. OFDMA	83
4.2.2.1	Block Diagram and Symbol Transmission	84
4.2.2.2	SC-FDMA and OFDMA PAPR Comparison	87
4.3	System Description	88
4.3.1	System and Transmission Model	88
4.3.2	Notations	89
4.4	Uplink AMC-based Joint Resource Allocation Proposal	90
4.4.1	Problem Formulation	90
4.4.1.1	Uplink Interference Scenarios	90
4.4.1.2	Spectrum Sensing Phase	92
4.4.1.3	Resource Allocation Phase	93
4.4.2	Problem Resolution	94
4.5	Performance Metrics	97
4.5.1	Throughput Satisfaction Rate (TSR)	97
4.5.2	Rate of rejected users	97
4.5.3	Spectrum Spatial Reuse (SSR)	97

4.5.4	Transmission power	98
4.5.5	Fairness	98
4.6	Performance Evaluation	98
4.7	Conclusion	106
5	Wavelet-based LTE Physical Layer Enhancements	109
5.1	Introduction	109
5.2	Wavelet Signal Processing Tool	110
5.2.1	Fourier Transform: Analysis and Limitations	110
5.2.2	Short Term Fourier Transform- STFT	111
5.2.3	Wavelet Transform: Multi-Resolution Analysis	112
5.2.3.1	Definition and Characteristics	112
5.2.3.2	Types of the Wavelet Transform	113
5.2.3.3	Wavelet in Communications and Application fields	117
5.3	Wavelet-based OFDM Multicarrier Approach	119
5.3.1	Fourier-based OFDM Limitations	119
5.3.2	Wavelet Orthogonal basis for Multicarrier Transmission	120
5.3.3	Wavelet-based OFDM Alternative System	121
5.3.4	How the wavelet alleviates the Fourier-based OFDM problems?	122
5.3.5	Simulation Results and Comparison	124
5.4	Automatic Wavelet-based Edge Detection for Spectrum Sensing	127
5.4.1	Edge Detection Wavelet Property	128
5.4.2	Wavelet-based Spectrum Sensing Approach	128
5.4.2.1	System Model	129
5.4.2.2	Approach Description	130
5.4.2.3	Automatic Local Maxima Detection	131
5.5	Wavelet Applications for the LTE Mobile System	131
5.5.1	5th Generation Roadmap	132
5.5.2	Wavelet-based Downlink Enhancement	133
5.5.3	Wavelet-based Uplink Enhancement	134
5.6	Conclusion	135
6	Conclusion and Future Works	137
6.1	Conclusion	137
6.2	Future works and perspectives	139
7	List of Publications	143
	Bibliography	145

Chapter 1

Introduction

Evolution from voice-only to multimedia type applications proliferates the need for higher data rate communications. Thus, combining cellular and Internet technologies in the same personal mobile device becomes an attractive issue for the advanced wireless communication systems. Therefore, based to this developed issue, the third Generation Partnership Project's (3GPP's) launches the Long Term Evolution (LTE) standard as the 3.9 Generation wireless communication system [1]. Initially defined as the release 8 by the end of 2009, the system is considered as a smooth evolution from earlier 3GPP systems such as Wide-Band Code Division Multiple Access/High-Speed Packet Access (WCDMA/HSPA) and the 3GPP2 systems such as Code Division Multiple Access (CDMA 2000).

The LTE is a high-speed communication system, offering fast and reliable wireless experience for many applications such as fast web browsing, high quality Voice over IP (VoIP), smooth video streaming and speedy applications downloads. In addition, the access to wider range of the natural frequency spectrum emerged in order to provide larger data volume. Practically, in 2007 users paid 30\$ – 45\$ per month for 25 MB (MegaBytes) data consuming. Today, by introducing LTE standard, users pay 30\$ per month and consume over 500MB of data [2].

Moreover, due to the high speed services, the global LTE subscription significantly grows in recent years: from 9 million in December 2011 to 200 million in December 2013 in developed regions. For example, by the end of 2014, it is expected that more than 93 percent of U.S. Cellular customers will have access to LTE speeds that are up to 10 times faster than 3G [3].

To satisfy the demands, operators need to provide high quality services, with better coverage for a huge number of subscriptions. Hence, two major problems for operators in

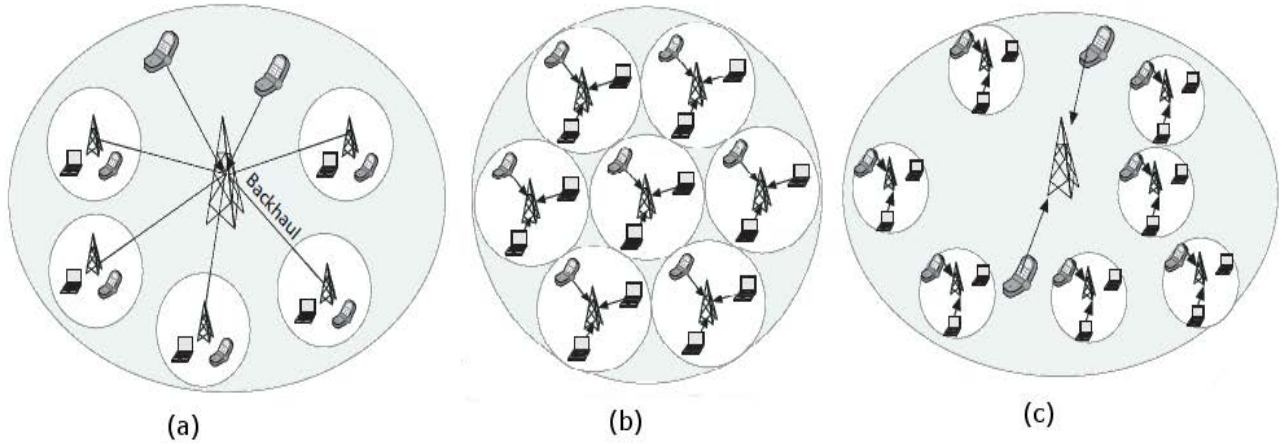

Figure 1.1: Enhance coverage: (a) Distributed antennas, (b) Microcells, (c) Femtocells

mobile communications are considered: indoor coverage and system capacity problems. Accordingly, three main issues based on the network architecture are proposed by the wireless cellular network designers in order to increase the system capacity and/or enhance indoor coverage. First, the wireless link capacity can be enhanced through the “distributed antennas” strategy where the operator installs several antenna elements in spatially separated places connected to the MBS by a dedicated backhaul link, Figure 1.1 (a). The second that contributes to enhance capacity is the “Microcell deployment” concept; operator installs cell towers, which improve coverage in urban areas with poor reception Figure 1.1 (b). However, these two techniques suffer from the expensive installation and deployment costs.

Recently, more than 50% of total voice calls and more than 70% of data traffic are established indoors (home and enterprises) [2]. However, transmitted signal from Macrocell Base Station (MBS) is weakly received by the indoor User Equipment (UE) due to the penetration loss and barriers absorption effect causing a degradation of the signal quality. Unfortunately, the architectures mentioned above cannot guarantee the satisfied indoor coverage.

Therefore, basing on the fact that the best way to increase the system capacity is by decreasing cell size or the transmitter-receiver distance, a new architecture appears and consists to deploy a small size home base station randomly by an end user (femto: 10^{-15} size order). The femtocell base stations also called Femtocell Access Point (FAP) are connected to the MBS through a broadband connection (e.g., ADSL, fiber optic, etc.). This is the

Femtocell architecture shown in Figure 1.1(c). Consequently, femtocells first improve the coverage in indoor environments, and secondly increase system capacity and spatial reuse by reducing cell sizes and offloading macrocells.

1.1 Problem Statement

The LTE-based femtocell network is launched as “release 9”; it submerges in a macro-cell one resulting a hybrid two-tier network known as Heterogeneous Network (HetNet). Therefore, significant challenges confront the femtocells deployment. The major issue in such context is related to the resource allocation and interference management. In fact, two interference types are emerged in such HetNet: cross-tier interference (femto-macro interference) and co-tier interference (femto-femto interference).

In fact, LTE-based system is characterized by a wide licensed bandwidth to achieve high peak data rate. Although that, allocating channel resource, especially for the urban environment and in peak hours, is a major problematic due to the spectrum resource scarcity. Moreover, the femtocells operate in the same licensed spectrum of the macrocell. Especially, with increasing of higher data rate services requirements, scarce available spectrum must be carefully exploited to avoid severe transmission interference and enhance spectral efficiency.

Thus, the available radio spectrum must be efficiently distributed among femtocells and macrocell to provide satisfactory user experience and increase overall system capacity while mitigating the interference. Furthermore, other substantial objectives need special attention for a successful application of LTE-femtocell new technology. Such that are increase overall system data rate, increase spectrum spatial reuse as well as enhance power and spectral efficiency. Therefore, to reach such objectives, physical layer considerations can be exploited in addition to the resource allocation issue considered as MAC layer scheduling task. Particularly, power control and Adaptive Modulation and Coding (AMC) mechanisms are performed. Furthermore, signal processing tools are manipulated as helpful way in such context.

Due to the power control mechanisms, sharing spectrum becomes a promising way to increase spectral efficiency while mitigate interference. On the other hand, Adaptive Modulation and Coding technique, consisting to adjust data rate to the link quality, contributes to increase spectral reuse and overall system throughput and capacity. Both mechanisms are performed respecting to a Signal-to-Interference-plus-Noise Ratio (SINR) threshold as a channel-quality key indicator. Thus, there are three main resources to be simultaneously assigned by the scheduling task for different users: channel, power and Modulation and

Coding Scheme (MCS).

In this thesis, we tackle these topics following two steps: first, an optimization joint resource allocation model is proposed for OFDMA-based Downlink femtocell connection; then, for SC-FDMA-based Uplink femtocell connection regarding its specifications. Second, performance improvements of the LTE-based transmission are provided by introducing the wavelet signal processing tool.

Indeed, The link layer scheduling algorithms are deeply exploited to enhance interference mitigation by intelligently allocating resources among users. However, some limitations of the OFDMA and SC-FDMA schemes need to be overcome to allow the expansion of the required services that operators need to provide. Hence, physical layer improvements are necessary and combined to reach the objectives of the next generation service requirements.

To answer to the above issues, we present in what follows the results of our work. Three contributions are studied in order to provide effective solutions for the challenges and practical deployment of heterogeneous networks.

1.2 Thesis Contributions

We are interested in developing the advanced mobile networks, especially LTE-based femtocell networks. Two major orientations are adopted based on: 1) data link layer, in terms of resource access and interference management and 2) physical layer, in terms of link adaptation and enhancement of the signal transmission reliability.

The main contributions proposed in this thesis can be summarized as follows:

1.2.1 Adaptive Modulation and Coding for QoS-based Femtocell Resource Allocation with Power Control: AMC-QRAP Approach

We have proposed two new approaches for the downlink (forward) and uplink (reverse) transmissions respectively, for LTE-femtocell mobile network. Commonly, the architecture for these approaches is based on previously proposed architectures in the literature that considers clustered network architecture as a hybrid centralized/distributed way. It combines the high performance (centralized) and the low computational complexity (distributed) advantageous effects.

Furthermore, we considered the Quality of Service (QoS) factor required by each user. Relatively to this factor, we assign a priority value specific for each user and thus, we can distinguish between two user type categories: High Priority (HP) users and Best Effort (BE) users. Consequently, the scheduler first serves HP users then the BE ones. The user differentiation allows enhancing user experience under both low and heavy loaded networks.

LTE spectrum resource is shared between all users in active transmission mode in the network (the co-channel assignment is adopted).

1.2.1.1 OFDMA-based Downlink AMC-QRAP

The first contribution focuses on the downlink LTE-based femtocell network where the multi-user access technology used is the OFDMA (adopted by the 3GPP LTE system). In this case, users attempt to access the time-frequency grid region composed from several physical resource blocks. In the downlink case, there is no constraint on the manner to allocate the resource blocks for each user, but the interference on each allocated resource block must be mitigated. Our objective is to allocate resource blocks based on the link adaptation strategy in both senses of: 1) power control and 2) adaptive modulation and coding on each resource block. In fact, the link status is qualified by the Signal-to-Interference-plus-Noise Ratio (SINR) parameter for each resource block. Thus, each femtocell base station transmits enough power to serve its own users while minimizing interference to neighboring users. It respects a minimum required SINR level for reliable signal reception and adaptively it assigns higher transmit power to the cell-edge users compared to less-interfered closed-center users. On other hand, the modulation and channel coding schemes are combined together to provide a rating amount as additional resources to be exploited. Indeed, the femtocell adaptively assigns modulation and coding scheme (MCS) for users in accordance to the channel quality, respecting a target Block Error Rate (BLER). For high SINR, high-order MCSs are used in order to maximize spectral efficiency; otherwise, the robust low-order MCSs are performed to maintain transmission link and enhance bit error protection at the reception. This contribution is referenced in [4] and the forthcoming publication [5].

1.2.1.2 SC-FDMA-based Uplink AMC-QRAP

In order to provide a complete framework about the LTE-femtocell networks, we are motivated to perform the above mentioned resource allocation problem for the uplink transmission taking into account many specifications. The 3GPP LTE standard adopts for the uplink connection the Single Carrier-Frequency Division Multiple Access (SC-FDMA) as an alternative scheme of the OFDMA. The main reason behind this is the low Peak-to-Average-Power Ratio (PAPR) value characterizing the SC-FDMA scheme. This is a critical feature for the mobile terminal in term of energy efficiency and components cost. Therefore, in our second contribution, we proposed a SC-FDMA uplink optimization resource allocation problem under the constraint of contiguous allocated physical resource blocks for each user. Unlike most previous uplink works considering constant power and fixed MCS

over all resource blocks allocated to a user, we propose to adopt a joint power control and adaptive modulation and coding mechanisms over the resource blocks depending on the channel status. Moreover, we introduced a spectrum sensing technique that we detailed in the third contribution, in order to estimate the interference power values over the occupied resource blocks and reduce the complexity of the optimization problem. This contribution is the object of the reference [6].

1.2.2 Physical Layer LTE Enhancements

In the second part of our research, we have tackled the physical layer “signal processing” techniques as basic LTE enhancement approach. Thus, two contributions based on the “wavelet transform” (WT) signal processing have been proposed for the mentioned issues.

1.2.2.1 Wavelet-based OFDM Multicarrier Transmission Approach

As a third contribution in our thesis, we aim to develop the signal transmission mode of the OFDM-based modulation technique. As well known, the OFDM is the fundamental basis for both OFDMA-based downlink and SC-FDMA-based uplink transmissions. However, it suffers from several limitations in terms of PAPR, spectral efficiency, synchronization cost and the inter-carrier interference due to the lack of orthogonality. Fortunately, the wavelet transform offers an orthogonal basis guarantying the robustness against inter-carrier interference and promising to significantly increase the transmission data rate. Therefore, we proved that with substituting the Fourier transform by the wavelet transform, the mentioned OFDM limitations can be overcome. Furthermore, the performance in term of bit error rate is significantly enhanced. Thus, we are motivated to suggest the “wavelet-based OFDMA” as an alternative transmission mode for both downlink and uplink of the LTE and beyond wireless communication standards. This contribution is the object of the reference [7].

1.2.2.2 Wavelet-based Edge Detection for Spectrum Sensing

Finally, we proposed an enhanced spectrum sensing approach based on wavelet transform tool that accurately delimits the occupied resource blocks in the whole spectrum. In fact, the wavelet transform is an attractive tool that exhibits excellent ability to analyze signal singularities within a discontinuous structure by zooming on localized signal features. Notably, the wideband received cellular signal is characterized by its irregular structure in the frequency domain. Therefore, the wavelet transform presents at these discontinuities positions maxima peak modulus. Additionally, in order to improve the detection performance, the white noise effect can be reduced by introducing the wavelet transform of the signal

autocorrelation instead of the raw signal. Moreover, we proposed an automatic method to pick these local maxima based on the windowing and characterized by its precise results. In the second contribution of our thesis, in order to identify the allocated resource blocks of the localized SC-FDMA uplink signal for each user, we suggest applying the wavelet transform-based spectrum sensing as an accurate and promised approach. As already mentioned, it helped detect more precisely the used blocks and reduced the complexity of the optimization problem. This contribution appears under the reference [8].

1.3 Thesis Outline

In what follows we present the organization of our thesis :

We begin in Chapter 2 by introducing some fundamental notions of the wireless mobile communications. Then, we describe the LTE standard basically adopted in this thesis, presenting its main properties and the physical layer characteristics. The concept of the femtocells is exhibited while highlighting the main benefits and the challenges fronting the deployment of this technology. Finally, a relevant bibliography on the different contributions of this thesis dealing with previous related works on these topics is presented.

In Chapter 3, we present our first contribution in joint power and channel allocation with Adaptive Modulation and Coding (AMC) for Downlink OFDMA LTE-based femto-cell networks. Especially, we first describe the system in terms of network and propagation models, and we present some fundamental preliminaries to facilitate the problem formulation. Then, we explain the interest of the Adaptive Modulation and Coding strategy. After that, we formulate the joint resource allocation problem as a multi-objective non-linear optimization problem considering the HP and BE users. Our problem is then transformed to single-objective problem dealing with the linear form. Thus, it is resolved as a linear optimization problem with the Linear Programming (LP) tools. To confirm our contribution benefits, we consider several performance metrics and finally we present the performance evaluation comparing with three previous works in the literature.

We address in Chapter 4, the SC-FDMA uplink scenario and present our second contribution in the resource allocation problem addressed in the previous Chapter taking into account the uplink specifications and the SC-FDMA constraints. First, the SC-FDMA scheme is described, furthermore, we prove its deployment alternatively to the OFDMA for the uplink. Next, we present the system model before formulating our uplink optimization resource allocation problem. We adopt the spectrum sensing technique in order to alleviate the additional uplink constraints and interference inputs. Our proposal for the uplink is then presented and described. Performance evaluation with extensive simulation

is performed.

The physical layer signal processing tools to enhance the data rate as well as the performance of the LTE system will be tackled in Chapter 5. Initially, we describe the wavelet transform as an alternative way of the Fourier transform presenting its essential characteristics. Then, our third contribution in the wavelet-based OFDM multi-carrier as a basis modulation scheme is presented. After that, the fourth contribution in the spectrum sensing enhancement based on the wavelet transform is introduced. We complete this chapter by applying these signal processing promising techniques to our adopted LTE standard in order to enhance its performance in terms of data rate, spectral and energy efficiencies and quality of service (QoS).

Finally, we conclude this thesis in chapter 6 and present a perspective for future works and research.

Chapter 2

State of The Art

2.1 Introduction

The cell sizes have been decreasing to meet the speedily increasing subscribers' amount and the high data rate and bandwidth requirement, in many fields from TV broadcasting to satellite communications and to mobile voice and data communications.

In what follows, We find very essential to describe our considered based system and carefully pay attention to its specific properties.

Therefore, we first depict in Section 2.2 the LTE standard characteristics adopted in the femtocell network. This latter is also presented in Section 2.3 while tackling its benefits as well as the challenges that it faces. Next, we present some fundamental notions related to the cellular networks that are helpful throughout the thesis in Section 2.4. Then, in Section 2.5 we exhibit the concept of the link adaptation and show how it can be introduced in wireless communication systems in order to enhance throughput and performance. In Section 2.6 We make a particular attention to the literature works dealing with our different contributions including the adaptive modulation and coding (AMC)-based resource allocation approaches for the downlink and the uplink respectively, in addition to the wavelet-based physical layer improvements. We conclude this chapter by the Section 2.7.

2.2 Long Term Evolution (LTE) System

2.2.1 LTE Design Goals

The LTE system is designed by the way to offer enhancements obviously observed in the application layer building on the physical layer specifications. The high throughput is the major benefit ahead; in addition the spectrum flexibility, coverage improvement, very low latency, increased spectral-and energy-efficiency and other benefits are also provided. We describe some of that in what follows.

High data rate

LTE system provides high data rate services due to the large bandwidth occupation, high order digital modulation utilization, up to 6 bits/symbol for the 64-QAM, link adaptation based on the channel status and adopting of the Multiple Input Multiple Output (MIMO) transmission scheme. These techniques and others are introduced offering a remarkable increasing of the data rate. Indeed, the peak data rate offered by the LTE in 20 MHz, reaches 100 Mbps (Mega bits per second) in Downlink transmission while the Uplink offers 50 Mbps.

Table 2.1: Peak data rate requirements in the downlink for different standards

Standard	Peak data rate (Downlink)
EDGE	250 kbps
WCDMA/UMTS	2 Mbps
HSPDA	14 Mbps
HSPDA +	42 Mbps
LTE(Rel.8)	100 Mbps
4G requirement	1 Gbps
LTE Advanced	> 1 Gbps

Spectrum flexibility

The LTE system supports scalable bandwidths, 1.4 to 20 MHz as shown in Table 2.2. Moreover, the Orthogonal Frequency Division Multiplexing (OFDMA) and the (Single Carrier-Frequency Division Multiple Access (SC-FDMA) techniques are the basis of the LTE system transmission (will be discussed later). These techniques are characterized by the high bandwidth flexibility and dynamically assignment to users; thus, they are adapted to the nomadic and mobile applications. In addition, LTE system supports both Frequency Division Duplexing (FDD) and Time Division Duplexing (TDD) to alternate between downlink and uplink traffics. This duality also offers spectrum flexibility.

Low latency

Latency is an important communication factor reflecting the QoS. Users' consideration latency is defined as the time taken by the data packet to be transmitted from the UE's

data buffer and the serving gateway of the core network and vice versa. Comparing to the older telecommunication system (e.g. GPRS or EDGE) where the round-trip latencies of the data networks are ranged in the 600 – 700 ms, the LTE round-trip latencies are in the 50 ms range.

Improved coverage

Full performance services still provided for up to 5 km, and services are maintained with slight degradation for distance between 5 Km and 30 Km. The coverage improvement in addition to high performance transmission enhances the overall system capacity.

Table 2.2: Downlink Bandwidth and number of Physical Resource Blocks

Bandwidth (MHz)	1.4	2.5	5.0	10.0	15.0	20.0
Subcarrier bandwidth (kHz)	15					
Subcarriers per Physical resource block (PRB)	12					
Bandwidth per PRB (kHz)	180					
Number of available PRBs	6	12	25	50	75	100

2.2.2 LTE Physical Layer Specifications

The LTE system requirements differ between the downlink (forward) and uplink (reversed) transmissions since the front-ends of the link: base station and UE terminal differ in several ways (e.g. power consumption, equipment deployment and sizes, BS sophisticated infrastructure)-Figure 2.1. We present in what follows the LTE specifications of both directions.

2.2.2.1 Downlink Direction Characteristics

The basic of the transmission in downlink is the Orthogonal Frequency Division Multiplexing (OFDM) technique. A large number of orthogonal, overlapping, narrowband sub-channels (sub-carriers) are transmitted in parallel and divide the available transmission bandwidth. Doing that, the multipath fading effect is combated and so, the Inter-Symbol Interference (ISI) problem is mitigated. Indeed, for each sub-channel the channel status is considered as flat. This technique is based on the Fast Fourier Transform (FFT) of the information data. In order to mitigate the residue interference and the Inter-Carrier Interference (ICI), a Cyclic Prefix (CP) is added to the head of modulated stream. The CP is

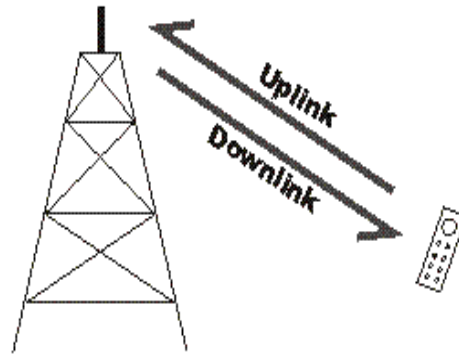

Figure 2.1: Downlink and Uplink wireless transmissions

a number of symbols copied from the tail, so we obtain the OFDM symbol. Consequently, the fading effect of the channel is overcoming without need to complex equalizers and expansive components at the receiver front-end. In downlink, where the receiver is the User Equipment (UE), this fact is very suitable since the power consumption and the terminal cost are notably reduced.

For multi-user access, the Orthogonal Frequency Division Multiple Access (OFDMA) is adopted as a basis of the LTE multi-access Downlink transmission. The media access is the time-frequency domain as represented in Figure 2.2. The smallest unit to allocate is called a Resource Element (RE) represented by one subcarrier during one OFDM period. Each user is allocated a determined number of Resource Blocks (RBs). In LTE system, each RB is composed from 6 or 7 OFDM symbols forming one slot and carried upon “12” subcarriers spaced by “15KHz”. The number of OFDM symbols in each slot depends on the CP length. Thus, the allocation granularity is “180 KHz” in frequency domain and a one slot of “0.5 msec” in time domain. Two CP types are considered: normal and extended, depending on the channel delay spread. For highly spreading environments, the extended CP is used and one slot corresponds to “6” OFDM symbols instead of “7” OFDM symbols for normal CP.

The OFDMA is a multi-carrier transmission scheme that enhances the spectral efficiency. However, as will be described later, this scheme presents some limitations. Especially, the OFDM technique suffers from high level Peak-to-Average Power Ratio (PAPR). This is due to the fact that each OFDM sub-carrier is independently modulated and as known each modulation scheme presents a different symbol power. Indeed, a high PAPR imposes high power consumption at the transmitter front-end and sophisticated non-linear amplifiers. This fact does not meet with the small size constraint of the UE in the Uplink transmission. Therefore, for the uplink, an alternative transmission technique is adopted by the LTE standard in order to overcome the high PAPR effect, however presenting other

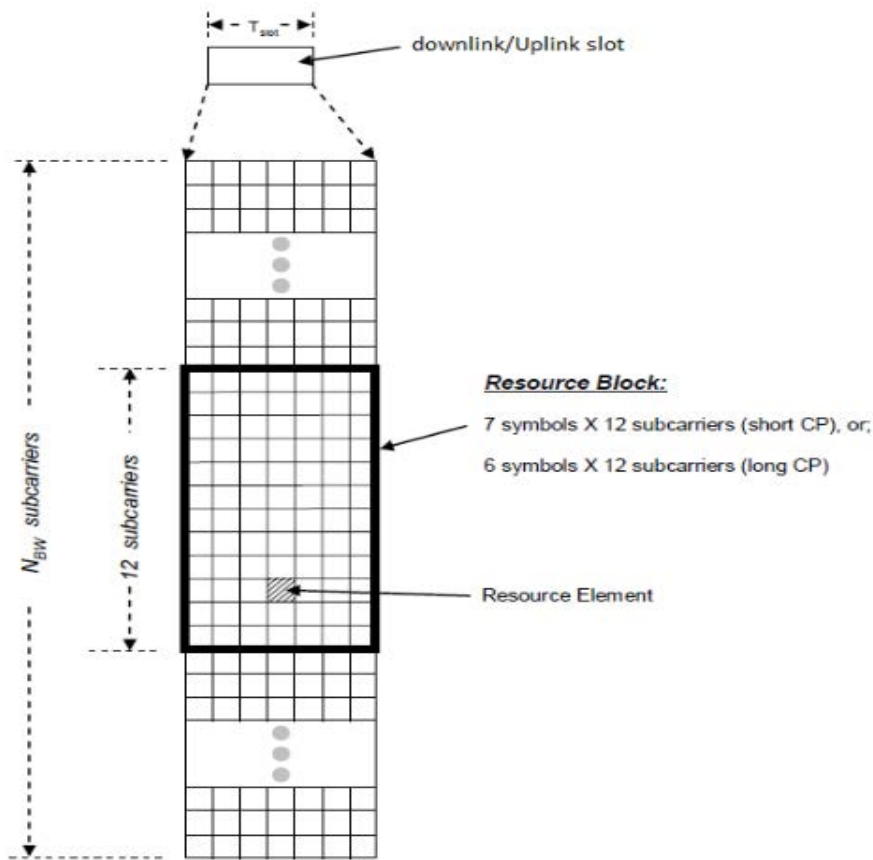

Figure 2.2: Downlink and Uplink accessing resource grid

limitations.

2.2.2.2 Uplink Direction Characteristics

In the uplink, the User Equipment (UE) transmits data by using a pre-determined number of RBs in the same manner described for the downlink transmission in Figure 2.2. The difference is by the multi-access modulation scheme. The Single Carrier-Frequency Division Multiple Access (SC-FDMA) is the multiple access scheme currently adopted for the uplink in the 3GPP LTE system. The reason behind is the need to the highly 'power-efficient' transmission for the UE, enabling improved coverage and reduced equipment complexity. In the LTE standard, the SC-FDMA is based on the Discrete Fourier Transform (DFT)-precoded OFDM that presents smaller PAPR than conventional OFDM. Thus, during each Resource Element (RE) a DFT-precoded OFDM symbol is transmitted instead of the OFDM symbol. The SC-FDMA has a similar performance as conventional OFDMA and

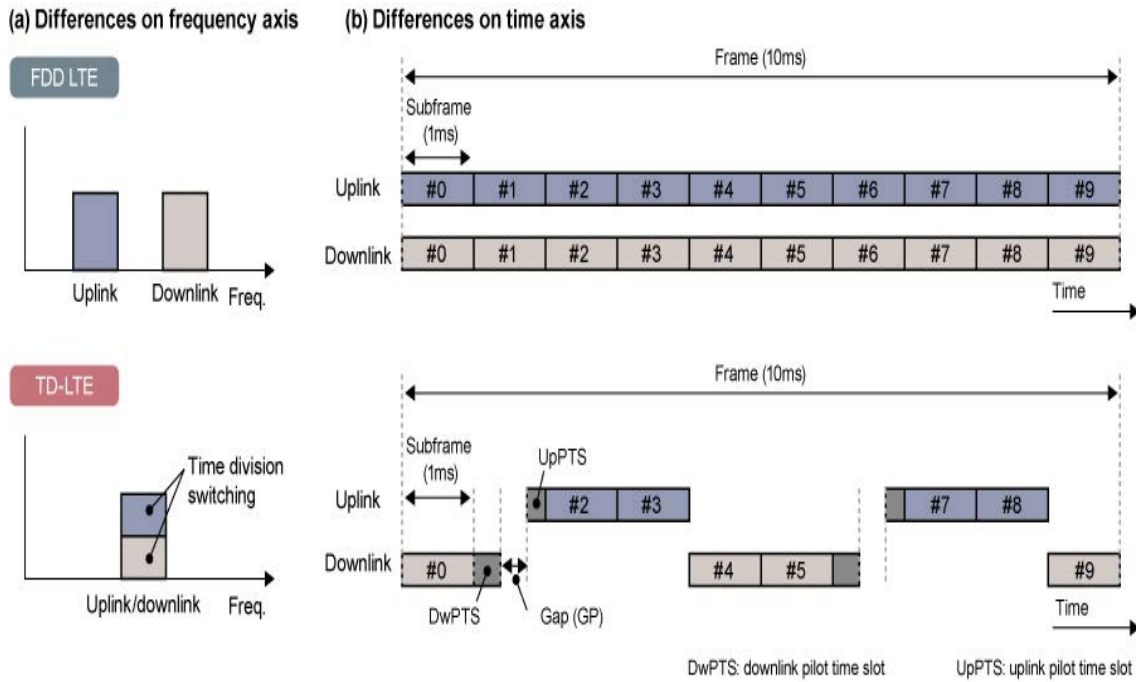

Figure 2.3: FDD and TD-LTE Comparison

it offers the same degree of multipath mitigation. This scheme is actually a hybrid format that combines the low peak to average ratio provided by single-carrier systems with the multi-path interference resilience and flexible sub-carrier frequency allocation that OFDM provides.

2.2.2.3 Duplex schemes and framing

The duplexing is the mode adopted to differentiate between the downlink and uplink traffics. The scheduler at the base station controls both transmissions. The FDD is operated on a paired spectrum and the TDD on an unpaired spectrum. In addition, FDD deployment prepares the way for the 3G services while the TDD is matched for the evolution to the Time Division-Synchronous Code Division Multiple Access (TD-SCDMA).

The 3GPP LTE standard is designed in manner to support both duplex schemes: the Frequency Division Duplex (FDD) and the Time Division Duplex (TDD) also called TD-LTE [9]. The duplex duality offers spectrum flexibility according to the spectrum allocation and it simplifies the implementation of different standards with different duplex modes [10]. Although the physical layer processing is closely similar for FDD and TDD, these two schemes mainly differ by the transmitted frame structure. Thus, we consider two frame

types: “type 1” for FDD duplex mode and “type 2” for TDD duplex mode as displays in Figure 2.3.

- FDD frame structure: One radio FDD frame is transmitted during 10 ms and it is composed to 10 subframes of 1 ms duration each one. Each subframe is divided to two slots of 0.5 ms. The uplink and the downlink are transmitted simultaneously but each transmission over a specified frequency band with respect to a set of FDD scheme configurations. This duplex scheme is complex due to the synchronization requirements.
- TDD frame structure: As in the FDD case, there is 10 subframes or 20 slots that constitutes the 10 ms total frame. For the TDD scheme, the guard period is widely necessary in order to avoid overlapping between the Downlink and Uplink transmissions. Thus, a 'special subframe' represents this guard period. This subframe is divided to three parts: a Downlink part (DwPTS), a guard part (GP) and an Uplink part (UpPTS), as mentioned in Figure 2.3. Since the Downlink and Uplink share the same frame, the two transmissions occur simultaneously within the active cell. Generally the uplink and downlink traffics are not symmetrical depending on the data services and demands.

2.3 Femto-Small Cells Networks

Alternatively to be served by the central far-away macrocell base station, the subscriber can be easily connected to a small femtoCell base station also referred to the eNodeB that it independently deployed whenever and wherever he desired. The eNodeB also known as femtocell access point (FAP) is a low-power access point, based on mobile technology, providing wireless connections to customers suffering from coverage issues in confined environments or spectrum capacity problems in high density urban areas. Thus, the FAP acts as a cellular base station designed for use in indoor environments [11]. Nowadays, the major constructors develop modules that can be directly plugged onto existing Wi-Fi hotspots and act as a standard LTE base station in an indoor location. All FAPs are connected to a femtocell gateway where the traffic is transmitted through the operator's core network [12]. The limited coverage area of a FAP allows a smaller number of users to take full advantage of the available spectrum.

Femtocells can serve simultaneously up to 10 or 20 users and deliver higher data rate connections depending on the transmission technology.

2.3.1 Femtocells' benefits

We present here some of the major benefits of femtocells and their impact on the network.

Transparent cellular standards support - Femtocells are detected by the end devices as standard cellular base stations and user equipments can be connected seamlessly independently of the technology: LTE, WiMAX, GSM, UMTS, CDMA, WCDMA and many other existing and future standardized protocols.

Low RF power and energy efficiency - Unlike Wi-Fi access points, the transmit power of femtocells is between 10 and 100 milli-watts and is automatically adjusted over each resource block. Additionally, due to the short range, the mobile device can transmit at lower power than needed to reach the macrocell base station. Thus, the energy efficiency is improved with a better battery consumption.

Capacity - The low-power connection and the short range transmission limit the femto-cell coverage area. This allows a higher spectrum reuse and increases the network capacity. Moreover, users that cannot connect to the macrocell can be offloaded and served by the femtocell; This provides better experience for the mobile users and enhances the overall system capacity.

Auto-configuration and Cost benefits - The most important aspect of the femto-cell is operation cost reduction. From the operator's perspective, FAP should to be simple to install and connect [13]. The zero configuration aspect of femtocells make it very convenient and cost effective for a massive deployment especially in dense areas. In fact, no network planning or special configuration is required as in the macrocell base stations.

2.3.2 Femtocells' Challenges

Many challenges arises from the femtocells deployment. Some of them are particular to small cells and some are a depending on the cellular technology. In our case, considering the LTE scheme, we differentiate several challenges [14].

Access method and handoff- Three access modes are configured by the femtocells: open access, closed access and hybrid access [15].

For open access, all users can be connected to the femtocell, fact that increases the overall network capacity when the macrocell coverage is deficient. However, this method increases

the number of signaling and applies a security issues.

The closed access method allows service for only home (indoor) environment users [16]. As a drawback, this method increases the interference to the macrocell since the femto-user radiation leaks from windows and/or doors.

In the hybrid access scenario, femtocell allows nonsubscribers to be connected, but with a limited amount of shared subchannels and with less priorities.

The choice to adopt depends on the transmission scheme to be used and the particularity and density of the deployment area.

Timing and synchronization- Perfect time synchronization is essential to avoid multi-access interference: cross-tier between macrocells and femtocells and co-tier between femtocells when uplink period of some cells overlaps with the downlink of others in TDD scheme. Since the centralization management is absent regarding the self-deployment of the ad-hoc location femtocells, the transmission synchronization becomes difficult. In addition, high-precision oscillator's equipments are so complex to be integrated in low-cost femtocells. Thus, the need to efficient approaches to achieve synchronization emerges.

Mobility management- When mobile user equipment enters in the coverage area of a new cell, it automatically triggers its connection to that cell.

For the femtocell, this handoff mechanism occurs frequently and more than in the macrocell case due to the small area coverage of the femtocell. This fact significantly increases the network signaling especially for open access mode. Consequently, reliable handoff management methods are needed to deal with these issues.

Interference management- The deployment of the femtocell by the end-user independently from the centralize macrocell operator, introduces interference between the macrocell and the femtocells (cross-tier interference). Moreover, the installation the femtocell at the vicinity of another one leads into co-tier interference.

This issue is the major problem facing constructors for an effective deployment of this technology. Thus, interference avoidance or cancellation techniques must be applied in order to manage allocation of resources and successfully exploit the femtocell network. This challenge is firstly treated in this thesis where an interference mitigation approach is proposed for the forward (downlink) and reversed (uplink) links under the channel conditions and user requirements constraints.

2.4 Fundamental Wireless Communication Notions

In this part we present the notions and parameters used through this thesis to better explain the different propositions.

a) Signal to Interference plus Noise Ratio (SINR)

This parameter measures the strength of the received signal depending on: 1) the user position, 2) channel status: number and position of the interferers and 3) the noise at the receiver. It is expressed as follows:

$$\gamma_{u,k} = \frac{P_u^n(k) \cdot g_u^n}{\sum_{m \neq n} P_u^m(k) \cdot g_u^m + \sigma^2} \quad (2.1)$$

where $P_u^n(k)$ is the power transmitted by the the FAP F_n to the user u on the Resource Block k . $P_u^m(k)$ is the interferer power transmitted by the neighboring interferer FAP F_m to the user u on the same Resource Block k . g_u^n and g_u^m are the gain of the physical link between the FAPs F_n and F_m respectively and the user u . They are the inverse of the path-loss channel factor, and determined by the A1-type generalized path loss models for the frequency range 2-6 GHz presented in WINNER [17] as we will detail later. We assume that these parameters are independent from the frequency block. In addition, the channel is flat faded over the Resource Blocks. σ^2 is the Additive White Gaussian Noise (AWGN) variance.

b) Target BLock Error Rate (Target BLER)

The BLER is the ratio of the erroneous received frame to the total received ones. It changes inversely with respect to the channel status or the SINR factor. It is closely related to the modulation and coding scheme used for data transmission. In addition, taking into consideration the service types, a tolerable level of BLER can be fixed in sense to provide a reliable and approved service. Thus, for each application we talk about a Target BLER.

c) Modulation and coding rate

Three main modulation schemes are considered in the LTE system: i) Quadrature Phase Shift Keying (QPSK), ii) 16-Quadrature Amplitude Modulation (16-QAM) and iii) 64-QAM. They are characterized by a square constellation suitable to efficient recovering data. They are differed by constellation size or 2^b , where b is the modulation efficiency equal to the number of bits per symbol.

As for the channel coding, the turbo code is used in LTE as a near capacity channel coding with respect to the Shannon limit. The information bits stream is coded at the transmitter with a coding rate $r = m/n$ where m data bits are protected by $n - m$ additional bits.

d) User Capacity

The data rate on a Resource block (RB) depends on the system configuration and the MCS selected. It is given by Equation 2.2:

$$Eff_l = \Theta \times \eta_l = \frac{N_s \times N_f}{T_{subframe}} \times \eta_l \quad (2.2)$$

where η_l is the efficiency of the MCS l with respect to the Table 3.1. Θ is a fixed parameter, where N_s and N_f are the numbers of OFDM symbols and OFDM subcarriers per symbol respectively; (i.e. $N_s = 7$, $N_f = 12$ and $T_{subframe} = 0.5$ ms).

In order to achieve the user data rate requirement, each user needs to be allocated a determined number of resource blocks in the time-frequency grid resource. The data rate gained by the user is calculated by summation of the different RBs efficiencies, as shown in the Equation 2.3:

$$BR_u = \sum_{l=1}^{L_v} \sum_{k=1}^K Eff_l \times \alpha_{u,k} \quad (2.3)$$

2.5 Link Adaptation Issue

As well known, the physical wireless channel presents fluctuations depending on several factors. These include the time, allocated spectrum, user position and the distance from the base station and the interference amount suffered on such link. Thus, we talk about a dynamic channel. The transmission quality is widely affected by these fluctuations; so the channel condition between the user equipment and the base station can be qualified by the Channel State Information (CSI) parameter referring to the SINR measurement.

Consequently, the Quality of Service is closely related to the channel condition. The system performance degrades and the bit errors occurrence increases at the receiver front-end for worse channel condition. Conversely, the link is reliable and faithfully conveyed signal in good channel condition. For the dynamic channel, the link doesn't present a constant behavior.

In order to compensate the channel quality variations, we can get the signal ability to

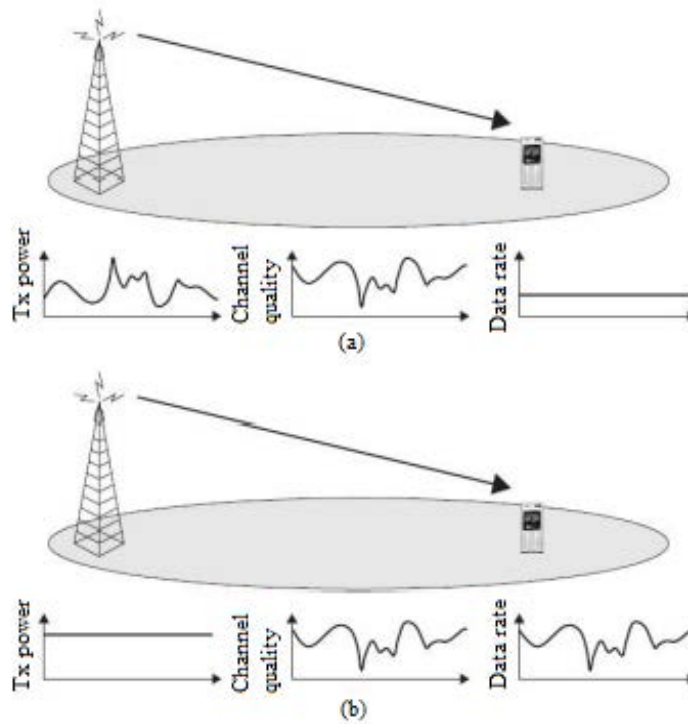

Figure 2.4: Link Adaptation: (a) power control and (b) rate control

confront worse channel conditions and exploit good ones. Thus, the signal transmission must be adapted to both conditions and automatically adjusted to provide a satisfying QoS and better user experience. Two major adaptation mechanisms have been treated in the literature:

- **Power control:** the transmission power varies with respect to the channel variations under a constant receiver data rate. This way is applied in the CDMA based systems Figure 2.4 (a).
- **Rate control:** under a fixed power, the transmission data rate adaptively varies with the channel condition. This way is mainly suited for systems needed for high data rate. Essentially, it is applied for packet switched based systems Figure 2.4 (b).

In fact, selection between the power control and the rate control applications widely depends on the types of the provided service and the system performance targets.

The rate control consists of adjusting the data volume transmitted per second. A promising way in such context is a rate control mechanism referred to as the “Adaptive

Modulation and Coding (AMC) technique” [18, 19]. For the AMC, the rate is determined by the combination of the modulation and coding rate amounts together. Several corresponding Modulation and Coding Schemes (MCSs) becomes established [20]. The main objective of the AMC is the selection of the suitable MCS to transmit information in order to achieve dual goals of 1) maximizing the data rate and 2) answering to the minimum received SINR requirement under a desired target BLER.

Many researches were established to determine the accurate SINR threshold values that allow switching between the MCSs under a fixed target BLER value [21, 22].

Aiming to provide an efficient resource allocation approach that increases the overall system capacity and the system throughput, we mainly propose an AMC technique for the LTE-based femtocell network. This achieves a satisfied user demand and enhances the overall spectral efficiencies as will be shown in Chapters 3 and 4 for the downlink and uplink transmissions respectively. Based on the MCS index table provided in the technical specification of the 3GPP [23], a chosen MCS specifies a transport block size (TBS) which represents the number of bits that can be transmitted in a subframe/transmit time interval (TTI) with respect to bandwidth. The TBS for downlink and uplink differs and depends also on the user equipment category. As for example if we consider the higher order MCS which is 26 for downlink and 21 for uplink [23], it results for a category 3 UE in a 75316 TBS for downlink and 51024 for uplink. Thus, TBS affects directly the data rate and thus the overall spectral efficiency of the system. Hence a suitable order of MCS needs to be chosen and adapted to the network and link conditions.

2.6 Literature Review

Nowadays, resource allocation and interference mitigation issues are hot topics in the literature [24].

2.6.1 Downlink resource allocation approaches

Different approaches are performed to mitigate the co-tier/cross-tier interferences of the OFDMA-femtocell networks [25–30]. The main objective is how the available resources can be efficiently exploited in order to achieve overall operator-users system benefit goals.

In [26], a co-channel assignment cognitive approach is presented to provide autonomous scheduling at the FAPs. Thus, each femtocell independently identifies the appropriate RB to be allocated by listening to the surrounding and hence, minimizing the interference and enhancing the channel reusability.

Contrary to this autonomous view, a collaborative approach is proposed by [27] for the

cross-tier interference. The FAPs coordinate with the MBS to overcome the unreliable information due to the spectrum sensing lacks and uses the RB allocated by the far away MBS.

With respect to the information exchange, the clustering approach becomes a trade-off between the distributed and the centralized methods [28]. The cluster architecture is advantageous since it alleviates the loading through the backhaul as well as it benefits from the knowledge sharing between cluster elements. Another approach is based on the power control when each FAP aims to reduce the transmission power to mitigate interference. Advantageous side of such approach is evidenced since the base stations can share the entire bandwidth while cooperating about the interference.

In [31], authors combine between the clustering and the power control approaches taking into account the users differentiation as QoS impact. They present an optimization approach to solve the resource allocation and interference mitigation problems for the down-link co-tier femtocell network.

All aforementioned works deal with resource allocation problem in terms of RB and power transmission. However, none of them addresses to the modulation schemes and channel coding. Recently, this method is progressively introduced in the literature [18, 32–34]. The use of the AMC technique in an OFDMA-WIMAX system is discussed in [18, 35, 36]. The work in [18] presents two main approaches to select the suitable MCS, first based on the channel state technique and the second considers the frame error rate depending on the previous frames.

Authors in [33] perform in their invention an AMC method for general mobile communication system. The mobile terminal measures the channel status and selects the appropriate Modulation and Coding Scheme (MCS) that is transmitted to the base station among 5 bits information. Depending to this MCS the base station transmitted data to the mobile. Furthermore, in the invention [34], authors provide a theoretical study of a cross-layer AMC technique by combining the physical layer consideration and MAC layer specifically in term of optimal packet length and Packet Error Probability (PER). Whereas, this invention does not addressed the MAC layer in term of scheduling for the multi-user system and resource allocation.

Nevertheless, the above-mentioned AMC proposals assume a fixed transmitted power. Moreover, the inventions present completely theoretical methods.

In contrast, authors in [37] introduce the AMC scheme in the OFDMA-LTE network for the resource allocation and interference management context. The research consists to allocate MCS, RB and power. The problem resolution is divided into two subproblems. As first step, they fix the MCS and search the optimal solution for the power control RB allocation. Then, with a meta-heuristic way, they find the suitable MCS. However, this is a

complex method with a sequential problem resolution resolution leading to an order of one second time resolution. Thus, it is not suitable for real-time and delay sensitive applications.

2.6.2 Uplink resource allocation approaches

Recent works on the SC-FDMA uplink resource allocation and interference management issues are investigated in the literature [38–44].

Authors in [39] design an energy efficient model to allocate power and sub-channels under the main constraints respected by the SC-FDMA adopted for the uplink LTE transmission; in particular, all resource blocks assigned to a user must be “contiguous” (Localized SC-FDMA), and the power transmitted by a user over all allocated resource blocks must be constant. In addition, each resource block can be allocated to one user at most. To resolve the optimization problem of the effective capacity maximization under the cited constraints as well as the QoS constraints in term of services delay and data rate requirements, they referred to the Canonical Duality Theory (CDT) for the complexity considerations.

Unlike the joint allocation problem presented in [39] that assumes a constant power for all resource blocks allocated by each user, the authors in [42] propose a sequentially joint power and resource blocks allocation where the power depends on the allocated subcarrier. Furthermore, they treat the case of both Localized and Interleaved SC-FDMA. The optimization problem is based on the maximization of the overall system capacity. In the first step, they optimize allocation of the power under the Karush-Kuhn-Tucher (KKT) conditions. The second step is the optimization of the subcarriers allocation. They assumed orthogonality between users and one resource block is assigned to each user. They evidenced the outperformance of the power control allocation through the subcarriers in term of overall system throughput by comparison with the channel-dependent scheduling presented in [45] considering equal power for each subcarrier. However, the sequentially power then sub-channels allocation problem is not suitable for the time sensitive applications and especially for high density networks due to the considerable time convergence.

Authors in [46] investigated the resource allocation and interference management problem in the macrocell LTE Uplink system aiming to enhance the cell edge throughput and the overall spectrum efficiency. They coupled the power control with the adaptive modulation and coding scheme (MCS). In order to enhance the edge-cell user’s throughput, coordination among adjacent sectors of different cells is achieved and a primary sector is selected among every three adjacent hexagon sectors. Indeed, each sector independently allocates resources while considering interference to and from adjacent sectors. Then, the

MCS is selected basing on the information conveyed to the primary sector that re-allocates the power and the Physical Resource Blocks (PRBs) of all users. Whereas, the AMC performing is just introduced as a critical factor in the fractional power control expression suggested by the LTE working groups [47] and it represents the corresponding target SINR values.

In [48], authors proposed a distributed co-channel Radio Resource Management (RRM) method for the uplink transmission in the traditional LTE cellular systems. They considered different types of services to be taken into account in the scheduling strategy. As the first stage, they classed the served users with respect to the priority order. In a second stage, by an iterative way, the scheduler allocates jointly the Physical Resource Block (PRB), the transmit power as well as the Modulation and Coding Scheme (MCS). At this stage, first, the PRBs and the MCS are allocated by considering transmitting the maximum allowed power to all users. Then, Based on these allocated PRBs and MCS, each base station autonomously re-allocate the transmit power based on the closed-loop adjustment. Thus, the PRBs and MCS are re-allocated depending on the adjusted power taking into consideration an overall cell interference limit to be not exceeded. Unfortunately, beginning by the maximum allowed power transmission is not beneficial in sense of energy efficiency and the iterative strategy results higher time convergence. These facts are not appropriate for the smallcell-Femtocell- networks where the energy efficiency is more crucial factor comparing with the traditional macrocell network.

Previous works, although take into account the selection of the appropriate MCSs according to the channel quality, they don't present enough description of the Adaptive Modulation and Coding (AMC) technique based on the physical layer argumentation. In addition, they jointly allocate sub-channels, power and MCS, but, effectively, the scheduler must fix power for select the corresponding MCS and/or fix the MCS to calculate the transmit power. This way significantly decelerates the convergence and it is not perfectly considered as "joint" allocation problem.

Thus, we propose for the SC-FDMA-based uplink femtocell-LTE networks a joint resource allocation problem where the power, the RBs and the MCSs are simultaneously and optimally allocated while mitigating the interference. Neither the power nor the MCS are enforced to be constant over all RBs allocated by one user. Doing that we aim to deal with our main scope in this thesis in sense of increasing the data rate and offering an enhanced user experience while increasing the spectral and power efficiencies.

In particular, the overall system capacity increases and the Quality of Service is enhanced. However, such multi-user allocation strategies for both downlink and uplink reach their stability when the MAC layer scheduling problems win to exploit most available radio resources. Therefore, this is our motivation to go toward the physical-layer-based tools and exploit the benefit properties of the wavelet signal processing and combine it with the link layer optimization techniques.

2.6.3 Wavelet-based signal processing enhancements

A brief historical overview of the wavelet transform is presented before tackle the applications of the wavelet transform in the literature for both the OFDM transmission scheme and the spectrum sensing technique.

Wavelet Historical Overview

Wavelet theory has been recently presented as a unifying framework although large works are executed around 1930. Principal historical sources about the wavelet transform began with Joseph Fourier in 1807 with their frequency analysis theories or Fourier analysis. After that, the mathematicians progressively passed from *frequency analysis* to the *scale analysis*.

The windowed Fourier transform was developed as the most important contribution being made by a Hungarian named Dennis Gabor.

After slight development of wavelet theory between the 1930s – 1970s, a major contribution was proposed by the French geophysicist Jean Morlet. He is the first who used the term “ondelettes” or wavelet.

The next major advancement in wavelet theory is in 1981 where coordinate work of Morlet and Alex Grossman has led to outlining the wavelet transformation and considered that a function could be transformed by a wavelet basis and reconstructed without loss of information.

In 1986, Stephane Mallat treated the wavelet transform as a Multi-Resolution Analysis tool generated by a pair of digital filters where the finite impulse response is formed by the scaled wavelet coefficients.

Fortunately, the wavelet transform offers promising benefits exploitable for increasing the data rate transmission as well as enhancing the system performance. This fact encourages researchers to pay significant attention for the wavelet transform to be the basic for many communication applications [49–51].

By the physical sense, non-stationary signal is characterized by the variation of the

frequency behavior with the time. Most real signals are non-stationary ones; especially, the cellular signal, based on the time-frequency resource access such as OFDMA or SC-FDMA scheme, presents different frequency components for each time slot. As result, the Fourier transform is not suitable to analyze such signals since it is exclusively adopted for stationary signals. This fact orients scientists to find another efficient transform with a “multi-resolution analysis”. Researchers have led to the powerful “Wavelet Transform” tool that presents a local analysis of different signal components.

2.6.3.1 Alternative wavelet-based OFDM approaches

An alternative OFDM design was proposed to overcome the limitations of the FFT based OFDM system. This is done by implementing a system with a Discrete Wavelet Transform (DWT) instead of the FFT.

Recently, the wavelet OFDM approach has been introduced into the communication field and it is included in the IEEE 1901 – 2010 standard. Introducing of the DWT with the OFDM is extended to another form of wavelet transform; it is the Wavelet Packet Transform (WPT). Many researchers have been carried out on this domain. In [52], the conventional Fast Fourier Transform (FFT) based OFDM is replaced by the discrete wavelet transform (DWT) in order to prove the denoising effect of the wavelet transform. Authors prove that the transmitted signal can be perfectly reconstructed at the receiver front-end through the Inverse discrete wavelet transform (IDWT). They present a scatter plot analysis for the Inphase-Quadrature plan in AWGN environment.

Analytical study has been presented in [53] and proved the increasing of the transmission data rate in the LTE system considering the wavelet-based OFDM. The downlink transmission link is considered where the transmission access mode is the OFDMA. The wavelet transform is introduced as an alternative way of the Fourier transform in the OFDM modulation. Mathematical expression of the system data rate is shown and it applies for the wavelet-based and Fourier-based OFDM. By comparing, authors confirm the increasing of the data rate by an amount of $\text{CyclicPrefix/TimeSymbol}\%$.

The wavelet transform has been applied for the DVB-T system in [54], and it presents an orthogonal basis to transmit data in orthogonal multicarrier mode. Authors consider two wavelet filters Daubechies 1 and Daubechies 2 and analysis the performance of two wavelets (db1) and (db2) in OFDM. Through the results, the wavelet db1 outperforms the wavelet db2 which presents better performance than the OFDM.

Furthermore, in [55], the wavelet transform is introduced for the satellite system which supports the OFDM transmission technique. Authors introduced an extension form of the

wavelet transform called the Wavelet Packet Transform (WPT) considered as a multicarrier modulation outperforming the conventional multicarrier OFDM. The Peak-to-Average-Power Ratio (PAPR) is a critical factor for the satellite transmissions. A single-carrier OFDM (SC-OFDM) scheme is proposed as a promising scheme to decrease the PAPR value and then it is compared to the single-carrier WPT that outperforms the conventional SC-OFDM.

2.6.3.2 Spectrum Sensing techniques

The spectrum sensing technique is a basic issue in the cognitive radio and opportunistic spectrum access concepts. It provides the obtaining awareness about spectrum usage and existence of interferers' transmission in a geographical area. A number of different spectrum sensing techniques are proposed in the literature. We present here some of the most common spectrum sensing techniques:

Energy detector

Energy detector approach, also referred to radiometry or periodogram is the most widespread spectrum sensing way view its low computational and implementation complexity [56]. The received signal energy (particularly, the power spectral density, PSD) is compared with a determined threshold which depends on the noise floor [57]. However, this approach is unable to differentiate the interference signals from the noise. It suffers from low performance at low SNR levels and for spread spectrum signals. In addition, the noise must be a stationary signal with a known variance.

Cyclostationarity-based sensing:

This method consists of exploiting the cyclostationarity features of the received signal when this latter or its statistics parameters (mean or autocorrelation) are characterized by the periodicity. The cyclic autocorrelation of the received signal is used for detecting signals in a given band instead of the PSD. Since there is no correlation in the noise, the cyclostationarity approach can distinguish between the noise and the interference signals [58]. However, in fading channel, the cyclostationarity features are completely lost and this approach requires perfect sampling frequency synchronization.

Matched filtering

In this method, the interfered received signal must be demodulated, so knowledge about signal features such as modulation type, pulse shaping and operating frequency is required. The matched filter approach provides a short time to converge to a certain value of mis-

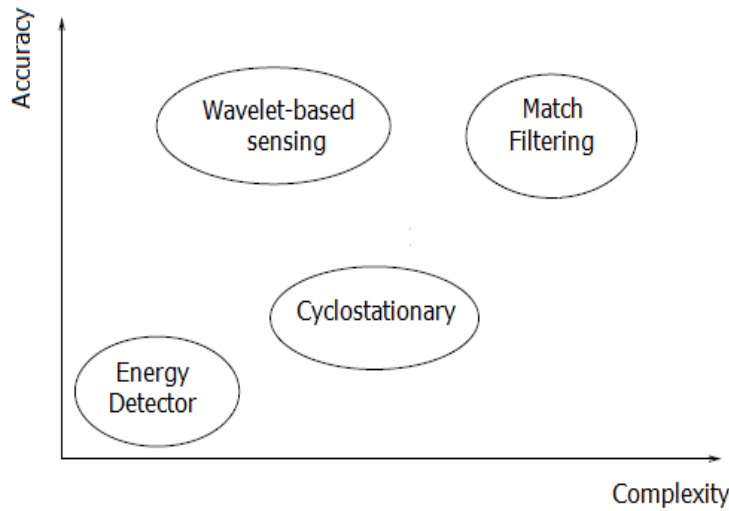

Figure 2.5: Spectrum Sensing Algorithms Comparison

detection or false alarm probability [59]. However, this approach suffers from the large implementation complexity and the large power consumption.

Wavelet-based sensing

An alternative spectrum sensing method based on the wavelet transform features is recently adopted. It emerged as a promising way due to its low power consumption and enabling real-time operation, it doesn't require any knowledge about the received signal. In [60], multi-resolution wavelet-based spectrum sensing is achieved by varying the basis functions without changing of the sensing structure. When the wavelet function and the analyzed signal correlate suitably, the wavelet transform presents a maximum modulus. In other terms, the basis functions, represented by the wavelet family functions, can be change by adjusting the wavelet's pulse width and carrier frequency. Consequently, the sensing operation becomes fast by focusing on the frequencies with active transmissions after an initial coarse sensing.

As proposed LTE system enhancement techniques, we adopt this spectrum sensing approach since the considered LTE signal is non-stationary. Indeed, the presence of co-channel or adjacent channel interferers contributes to the non-stationarity of the transmitted mobile signal and the noise signal. Thus, although the energy detector is the most common sensing technique, the wavelet-based spectrum sensing is most suitable for non-stationary noise and it is considered as a trade off technique between the sensing accuracy and the complexity, as shown in Figure 2.5.

2.7 Conclusion

We presented, in this chapter the preliminaries of the wireless transmission while focusing on the Link adaptation. A global description of the adopted LTE-based Femtocells network was addressed. Thus, we described the principal key features and physical layer properties of the 3GPP LTE standard. Then, we highlighted both the benefits and the challenges of the Femtocell small size architecture. Finally, the related works and literature propositions are treated concerning the downlink and the uplink resource allocation and interference management approaches. Further, the related works on the wavelet-based physical layer enhancement introduced for both OFDM and spectrum sensing techniques were respectively exhibited.

In the next chapter, we start by presenting our first contribution concerning the AMC-based resource allocation for the downlink transmission. A detailed description with extensive simulations will be presented while comparing with existing proposals.

Chapter 3

Downlink Joint Resource Allocation with Adaptive Modulation and Coding

3.1 Introduction

As presented in the previous chapter, the new standards and network architectures adopted today in the wireless mobile communication aim to achieve both operator and user service goals. These latter mainly include increasing the system capacity, which allows improving the revenues of the operator, also delivering good indoor coverage and enhancing the service speed and quality allowing to provide better user experience.

Nevertheless, The LTE-based femtocell network is confronted with serious challenges due to the random and independent user deployment of the femtocell access points (FAPs). Essentially, the Heterogeneous Network (HetNet) performance is threatened by the cross-tier interference and/or co-tier interference. Therefore, since femtocell network operates on the same macrocell licensed spectrum, different strategies are proposed in order to overcome this effect by including interference mitigation and interference avoidance approaches. In high density network and at peak hours, accessing the available resources becomes more frequent and creates a congestion situation in the network. Consequently, seeing the scarcity of the costly bandwidth resources, reusability of the spectrum is a necessary target to exploit the limited spectrum and enhancing the overall spectral efficiency and increasing the system capacity.

Thus, several solution have been proposed to overcome these issues. Two different directions have been used, a centralized approach wich has a better view of the network and delivers optimal allocation, but suffers from scalability issues and fails to provide any feasible solution when the network nodes increase above a certain limit. A distributed approach

which reduces the complexity of the resolution, however fall in the convergence and efficient allocation problem when high interference occurs especially in dense environments. The work presented in [25, 31] proposed a clustering approach as a tradeoff between fully centralized/distributed approaches. It was shown to be more efficient in different network scenarios and provides a better performance. Hence, in our architecture we consider the same clustering approach based on the mentioned work. Part of this work dealt with power and QoS constraints; however, did not consider Adaptive Modulation and Coding schemes. The fixed link layer considerations restricts the performance of the algorithm. Hence, we provide in this chapter a new scalable and joint power with adaptive modulation and coding scheduling algorithm to improve the performance of the LTE-based OFDMA network in the downlink, namely **Downlink AMC-QRAP**.

Moreover, as in [31] we consider users differentiation to provide QoS guarantee. We believe that it is an effective method to offer different quality service plans. In fact, the system serves both, High priority HP users, who's requirements need to be fully satisfied in exchange of a service level they pay for, and Best Effort BE users with different level of application or service requirements who's demands need to be maximized. We recall that HP and BE users can be differentiated by the price of the service they pay for; or HP users can be the FAP's owner, while BE users are the visitors (in open or hybrid access); we note that this differentiation resolves the cross-tier interference between femtocells and macrocells, where macro users passing nearby a femtocell can connect as HP users (with different weights and priorities) or as BE users. Our objective is to find the best allocation of Resource Blocks (RB) and transmission power, and automatically adjust the modulation and coding scheme in order to fully satisfy HP users and serve BE users as much as possible.

The rest of this chapter is organized as follows. Section 3.2 describes the system model and presents some preliminary notations. In Section 3.3 we present the modulation and coding scheme concept and compare the adaptive and fixed schemes. We formulate the optimization problem and describe our proposal **AMC-QRAP** solution in Section 3.4. The evaluation metrics are discussed in Section 3.5 and simulation results are analyzed in Section 3.6. Section 3.7 concludes this chapter.

3.2 System Description and Notations

We present in this section a global description of our system including the network model, the physical propagation model and lastly summarize all notations used in the sequel.

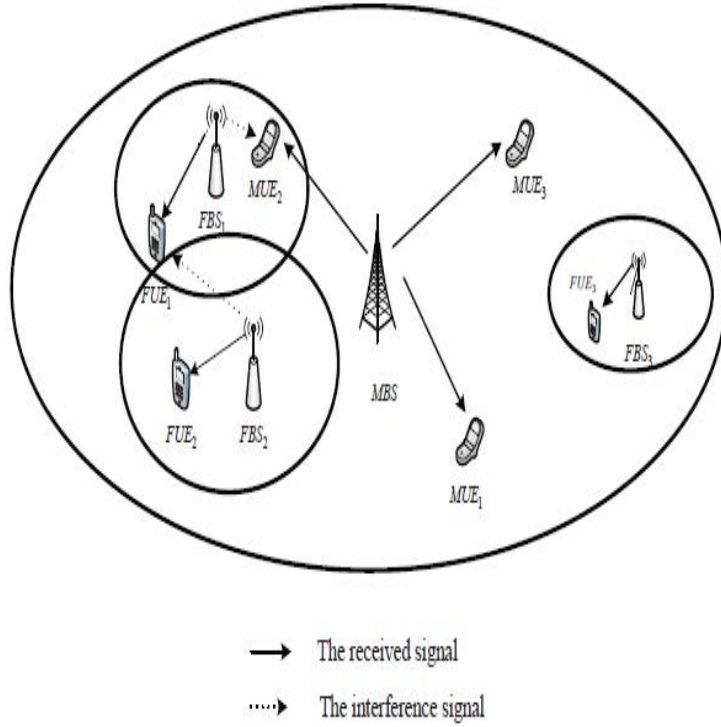

Figure 3.1: Two-tier Femto-Macro Heterogeneous Network

3.2.1 Network Model

Two-tier femto-macro heterogeneous network is assumed, where a set \mathcal{F} of N Femtocells base stations (FBSs), also known as Femtocell Access Points (FAPs), submerge in a macro-cell base station coverage area (Figure 3.1). As cited above, the downlink direction is treated in this chapter where the base stations try to serve their users with a forward transmission link.

As femtocell network architecture, we distinguish between three different categories known in the literature: distributed, centralized and clustered architectures. They differ by the scenario of resource allocation scheduling and the selection of the “network brain” or the decision center of the allocation problem. These architectures are presented as follows:

- **Centralized:** in this case, the scheduling and the resource allocation take place uniquely at a centralized base station referred as allocator. This central scheduling collects information about available resources, user positions and channel quality measurements. All users send their requests and the allocator responds considering the available resources and the interference relative to each user.

The main advantage of this way is the high accuracy and service performance since

all necessary allocation parameters are known. However, it cannot be applied to dense networks, since the allocator gets heavily loaded and the bottleneck connection increases the network complexity.

- **Distributed:** conversely, in the distributed way, each FAP presents a self scheduling to allocate resources for its own users. It should be able to learn about the surrounding environment and efficiently allocate resource to ensure satisfied user experience. This approach reduces the network complexity especially for high density networks. However, due to the lack of knowledge about the surrounding, this way is less reliable. With respect to the previous centralized approach.
- **Clustered:** in order to trade off between the centralized and the distributed techniques, a hybrid approach is adopted in many references [25, 28]. It aims to enhance scheduling reliability while reducing the network complexity. Several neighboring femtocells constitute one entity basing on the mutual interference criterion. The scenario is explained as follows:
 - First, each FAP collects the knowledge about the surrounding network by sensing the transmissions of the neighboring cells as well as receiving reports from its own users.
 - Second, a set of one-hop neighbors interfering FAPs is formed by each FAP regarding to the received knowledge. The element number of this set is the basic-key useful for constituting the clusters, so-called “*interference degree*”.
 - Third, each FAP interference degree is broadcasted to each element of the set.
 - Final, the FAP that has the highest interference degree is selected as the *cluster head* (CH) and others FAP are the cluster members.

The cluster architecture is a promising approach for urban dense environment, since it reduces the bottleneck and complexity while providing relative knowledge about the FAPs cluster members. However, it presents a limitation after a certain number of FAP members. In such case, we can refer to the centralized architecture.

3.2.2 Propagation Model

The indoor femtocell base stations (FAPs) are assumed to be in a corridor or in rooms. Thus, two link types are considered: corridor-to-corridor link referred to the line of sight

(LOS) case and corridor-to-room link referred to the non-line of sight (NLOS) case. As named, in the LOS case, there is no path-loss effect considered since no barriers. In contrast, in the NLOS case, the basic path-loss is measured on the link between the corridor where the FAP is situated and the adjacent rooms. In addition, for rooms farther away from the corridor, wall-absorptions must be applied to the walls parallel to the corridors. Further, Floor Loss (FL) of the vertical radiations for propagation from floor to floor is modeled. For the same distance between floors, the Floor Loss is constant and it increases with the floor separation. Thus, the Floor Loss must be added to the path-loss calculated for each floor.

Therefore, the A1-type generalized path loss model is considered as the propagation model for the frequency range 2 – 6 GHz developed in WINNER [17]. The path loss models are thus summarized in the following form:

$$PL = A \log_{10}(d[m]) + B + C \log_{10} \left(\frac{f_c[\text{GHz}]}{5.0} \right) + X \quad (3.1)$$

In Equation 3.1, d is the distance between the transmitter and the receiver in $[m]$, f_c is the system carrier frequency in $[\text{GHz}]$, the fitting parameter A includes the path-loss exponent, parameter B is the intercept, parameter C describes the path loss frequency dependence, the shadow fading distribution is log-normal. X is an optional, environment-specific term.

3.2.3 Notations

A list of notations is presented in what follows summarizing essential parameters useful in this chapter:

- $\mathcal{F} = \{F_1, \dots, F_N\}$ is the set of FAPs, where N is the total number of femtocells deployed in the network.
- $\mathcal{H} = \{u_1, \dots, u_{n_{hp}}\}$ is the set of HP users.
- $\mathcal{B} = \{v_1, \dots, v_{n_{be}}\}$ is the set of BE users.
- $\mathcal{S} = \{S(1), \dots, S(L_v)\}$ is the set of SINR thresholds for different MCSs. Where L_v is the total number of MCS levels. In our work, we consider 6 MCS levels L_v as shown in Table 3.1.
- $\mathcal{C} = \{C(1), \dots, C(L_v)\}$ is the set of the MCS efficiencies.

- R_u denotes the demand of the user $u \in \mathcal{H} \cup \mathcal{B}$.
- $\mathcal{K} = \{1, \dots, K\}$ is the set of physical resource blocks (RBs) available for the network.
- $\Delta_u(k)$ is the binary resource allocation vector for user $u \in \mathcal{H} \cup \mathcal{B}$, with 1 or 0 in position k according to whether the RB k is used or not.
- $\alpha_{u,k}(l)$ is the binary resource and MCS allocation vector for user $u \in \mathcal{H} \cup \mathcal{B}$, with 1 or 0 in position k according to whether the MCS l is selected by the user u on RB k or not.
- $P_u^n(k)$ is the power transmitted from FAP F_n to its user u on the RB k , where $P_{min} < P_u^n(k) \leq P_{max}$ if RB k is used by the user u or $P_u^n(k) = 0$ otherwise.
- P_{max} is the maximum power transmission fixed by the network operator. P_{min} is the antenna power sensitivity.
- $\gamma_{u,k}$ is the required SINR for user u on RB k .

$$\gamma_{u,k} = \frac{P_u^n(k) \cdot g_u^n}{\sum_{m \neq n} P_{u'}^m(k) \cdot g_u^m + \sigma^2} \quad (3.2)$$

g_u^n is the gain of the physical link between the FAPs F_n and the user u . It is the inverse value of the path-loss value just modeled above. σ^2 is the Additive White Gaussian Noise (AWGN) variance.

For each resource block, if the SINR value at a mobile receiver is less than its minimum required threshold, it suffers from interference. Thus, the scheduler discards the transmission link on such RB and tries other resources.

Therefore, fixing a unique SINR threshold value is a hard condition that threatens to reduce the spectral reuse and the global system throughput while increasing the rejected rate. Consequently, the user satisfaction rate and the overall system capacity radically decrease.

Motivating by this fact, we propose to switch between several SINR thresholds depending on the channel status on the considered resource block. The transmission rate is harmonically selected accordingly to the adopted SINR threshold. This is what's referred to the "Adaptive Modulation and Coding" concept describe in the follow section.

3.3 Adaptive Modulation and Coding Concept

3.3.1 Definition

Adaptive Modulation and Coding (AMC) is a smart technique that optimizes usage of the network resources and efficiently exploits the channel capacity depending on its quality.

It is well known that the wireless channel presents fluctuations depending on the time, user position and the degree of interference as well as received joule noise [61]. Thus, in terms of communication, the channel status for each user is qualified by the SINR parameter, presented in Equation 3.2.

In fact, for the multi-access resource allocation, scheduling is periodically achieved for each time slot (in the LTE case, for each subframe equivalent to two time slots); hence, we assume that the channel quality and the received noise are constant over one time slot. Consequently, the concerned channel varies in accordance with the interference degree on each RB. Furthermore, the interference degree is related to the number and positions of interferer users allocating the same RB.

Therefore, scheduling with AMC automatically reacts to the channel fluctuations and dynamically matches the modulation and coding rate with the radio link quality for each RB. This is a “rate control” mechanism where the transmission spectral efficiency represents the amount of information bits per symbol resulted from the combination of the modulation and coding schemes as presented in Table 3.1.

Each system fixes its proper TBLER that must not be exceeded. With respect to this

Table 3.1: Modulation and Coding Schemes (MCSs)

Modulation type	Coding rate	Efficiency(bits/sym)	SINR level(dB)
QPSK	1/2	1	9.4
QPSK	3/4	1.5	11.2
16-QAM	1/2	2	16.4
16-QAM	3/4	3	18.2
64-QAM	2/3	4	22.7
64-QAM	3/4	4.5	24.4

BLER threshold, the AMC approach provides a set of discrete SINR thresholds picked corresponding to the predefined set of MCSs [20]. There are many algorithms proposed for accurately determine the SINR thresholds (or SNR in single user transmission case) respectively corresponding to the adopted MCSs under a fixed TBLER value [62, 63].

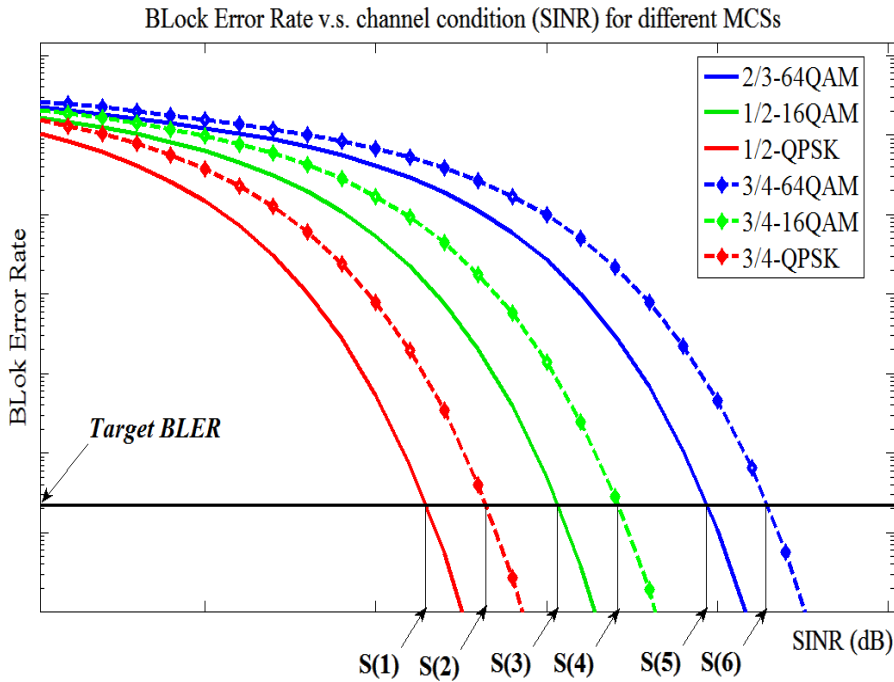

Figure 3.2: SINR thresholds selection for different MCSs

3.3.2 Modulation & Coding Scheme and Link Quality

How the modulation and coding rate interacts with the radio link conditions? The system performance is closely related to the Modulation and Coding Scheme (MCS) selected for the signal transmission in accordance with the channel link quality. Figure 3.2 illustrates the reliability of the transmission in term of the Block Error Rate (BLER) in function of the channel quality (SINR) for different MCSs. This is described as follows:

- High-order MCSs require good channel conditions to reliably decode information at the receiver side. Indeed, high-order modulations are characterized by a dense symbols constellation in the Inphase-Quadrature plan as shown in Figure 3.3-(c). Thus, the modulated signal becomes more vulnerable to the distortion and fading effects since the symbols are much closed to each others.
As for coding rate, for good channel quality, high-order channel coding schemes are required where less redundant bits protecting the information bits are added.
- In other hand, for worse channel conditions, low-order MCSs are needed.
In fact, low-order modulation schemes are more robust against transmission distortion since the symbols in the constellation are sufficiently separated Figure 3.3-(a). In addition, in worse link quality, more protector coding bits are required, fact that

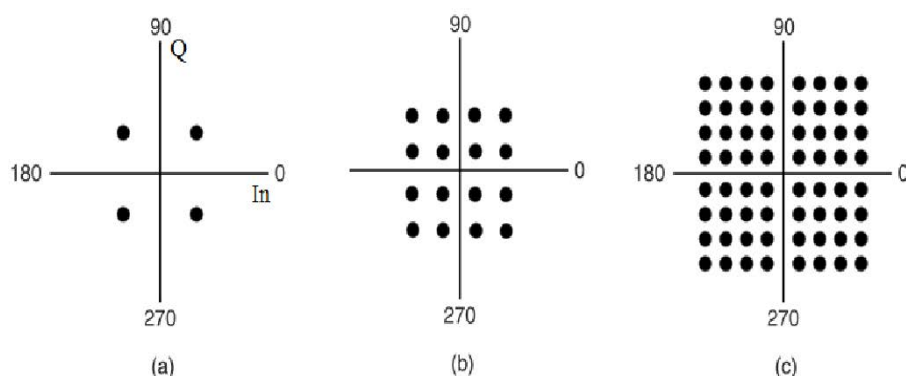

Figure 3.3: Modulation constellations: (a) QPSK, (b) 16-QAM and (c) 64-QAM

decreases the coding order.

3.3.3 Fixed Modulation and Coding (FMC) vs. Adaptive Modulation and Coding (AMC)

For fixed SINR threshold and respecting a target BLER to ensure a desired performance, the base station transmits signal with a fixed MCS that is the same for all allocated resource blocks. As presented above, the channel condition differs from RB to another.

So, if the MCS selected has a high-order, it is exclusively suitable for good condition RBs or when the SINR value is more matched; else, unfortunately, the *performance degrades* and the *power efficiency decreases* since a considerable amount of transmitted information bits is erroneously received by the user equipment.

Otherwise, only for harsh channel conditions, the low-order MCSs may be applied to avoid losing the transmission on the corresponding RBs. Else, using low-order MCSs for better channel quality dissipates available spectrum and profitlessly decreases rating amount; as the results, *throughput, spectral efficiency and the system capacity significantly decrease*.

Thereby, the assignment of Fixed Modulation and Coding (FMC) rate with respect to the different RB status is not a competent approach for improved user experience and enhanced operator revenue.

Alternatively, adaptive MCS allocation is a promising way to efficiently allocate RBs in accordance to their relative statuses. Thus, the overall operator-users goals are thoughtfully achieved with respect to two major considerations as follows:

1) Throughput and spectral efficiency

By sending much more information bits per symbol, high-order modulation scheme and high-level coding rate offer an increased throughput data and enhance the spectral efficiency.

2) Availability and maintenance link quality

Low-order modulation scheme and low-level coding rate are more robust against weakness and instability channel quality. They present relatively low error rates. Thus, the communication link does not lose its availability in such cases and the service data flow is maintained without increasing the signal power.

With regard to the description above, the benefits of the AMC technique clearly shine to trade off between desirable throughput and satisfied system performance.

3.4 Downlink OFDMA AMC-based Joint Resource Allocation Proposal

Our objective in this chapter is to perform scheduling for the OFDMA-based Downlink transmission and optimally exploit three major resources: power, Modulation-Coding Scheme MCS and channel distribution. We aim to attain satisfaction in terms of: 1) throughput and performance - user viewpoint and 2) network capacity, represented by the number of simultaneous served users - operator viewpoint.

3.4.1 Problem Formulation

For scheduling, two user categories are considered: High Priority (HP) and Best Effort (BE).

1. **High Priority users:** their requirements need to be fully satisfied in exchange of a desired QoS guarantee and a service level they pay for. Thus, they assign high priority. All HP are permanent owner FAP users.
2. **Best Effort users:** they have not a priority to be fully served, but try to reach as maximum as possible their demands with different level of applications. BE users may be owner FAP with lower priority or visitors (in open or hybrid access).

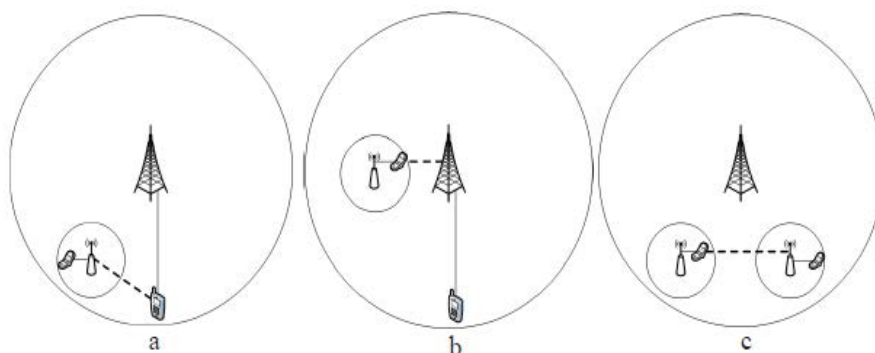

Figure 3.4: Downlink interference scenarios in two-tier network

Notably, for the Downlink transmission in the Heterogeneous Networks, there are three distinct interference scenarios presented in the Figure 3.4:

- **FAP to MUE interference:** In this case, the interference aggressor is the femtocell base station. The victim is the femtocell user equipment. When the mobile macro-user becomes at the proximity of the home or the office where the FAP is installed, it receives its radiations. Hence, if they operate using the same spectrum bands, a severe interference occurs at this MUE degrading the signal reception from the macrocell.

However, in this thesis, we assume that MUE becomes detached from the macrocell base station and is considered as a BE user of the corresponding FAP with a lower priority of the owner FAP users. Thus, this interference type is ignored as a cross-tier interference scenario.

- **MBS to FUE interference:** The MBS transmits power in accordance with the distance from its mobile subscriber. When this latter is far-away, the MBS increases the signal transmitted power to be able to reach the destination. In this case, a neighbor FUE suffers from a severe interference if it operates on common RBs with the corresponding MUE. In this thesis we consider that although the macrocell base station transmits ordinarily higher power than the FAP, the FUE receives higher power from the FAP attached to. This is because the closed FUE-FAP distance and also the attenuation of the signal MBS power due to the path-loss and barriers absorption effects.
- **FAP to FUE interference:** Neighboring FAPs are the cause of co-tier interfer-

ences to each other on the commonly used RBs. Indeed, the radiations can be leaked through the windows and/or doors and reach to the neighboring FUEs. We consider the interference caused by a one-hop adjacent FAPs since these leakage radiations are denied by the multi-level barriers separating non-adjacent FAPs.

Based on the above description, our scope in this chapter is the third interference scenario as the co-tier interference.

In order to provide QoS guarantee to HP users and serve BE users as much as possible, while maximizing the number of accepted users, our objective is to mitigate the interference by minimizing the transmitted power, with respect to appropriate SINR thresholds corresponding to the modulation/coding schemes. At the same time, we aim to maximize the user efficiency rate over each RB to use the higher order MCS when possible.

In order to increase spectral reuse, adaptive power control is performed to allow transmission of neighboring FAPs on the same resources when possible, if their respective users are protected. By minimizing transmission power [64], edge users are allocated the less interfered channels, since they need a higher transmission power, compared to centered users closer to their FAP requiring less power and more protected from interferers.

In the fixed MCS case [31], the minimum SINR value (or the SINR threshold) required to maintain the communication link respecting a target BLER limit, is not always achievable. Hence, it poses some limitation on the transmission power, and if failed to obtain a satisfactory channel, the link is discarded without the possibility to use the resource. With the introduction of the adaptive MCS, this limitation disappears as the model will automatically adjust to use the resource with a lower order MCS, according to the received SINR. However, the decrease in the modulation order will impact the channel efficiency of the resource, thus requiring more RBs to achieve the desired throughput.

On the other hand, as previously mentioned, power minimization technique allows for an easier reuse of the same resources, with less transmission power, enough to achieve the lower order SINR.

Our optimization problem starts by allocating higher order MCS and if failed switches to lower ones, while minimizing the transmission power respecting the corresponding threshold of SINR.

The constraint for an HP user to be admitted to the network is to achieve its total throughput requirement, while BE users have no QoS constraints; they will be served after admit-

Problem 3.1 Joint resource allocation with power control and adaptive MCS for HP and BE users

$$\begin{aligned} \min \quad & \sum_{u \in \mathcal{H} \cup \mathcal{B}} \sum_{k=1}^K P_u(k) \times \Delta_u(k) \\ \max \quad & S = \sum_{l=1}^{Lv} S(l) \times \alpha_{u,k}(l) \end{aligned}$$

$$\min \sum_{v \in \mathcal{B}} \sum_{k=1}^K s_v(k)$$

subject to:

$$(a) \quad \forall k, \quad \forall u \in \mathcal{H} \cup \mathcal{B}, \quad \forall v \in \mathcal{F}^m \neq \mathcal{F}^n :$$

$$P_u^n(k) \geq \left[\sum_{l=1}^{Lv} S(l) \cdot \alpha_{u,k}(l) \right] \cdot \left(\sum_{m \neq n} (P_v^m(k) \cdot g_u^m + \sigma^2) / g_u^n \right)$$

$$(b) \quad \forall k, \quad \forall u \in \mathcal{H} \cup \mathcal{B} : P_u^n(k) \geq P_{min} \times \Delta_u(k)$$

$$(c) \quad \forall k, \quad \forall u \in \mathcal{H} \cup \mathcal{B} : \sum_u \sum_{k=1}^K P_u^n(k) \leq P_{max}$$

$$(d) \quad \forall u \in \mathcal{H} : \sum_{k=1}^K \sum_{l=1}^{Lv} \alpha_{u,k}(l) \cdot C_l = R_u$$

$$(e) \quad \forall v \in \mathcal{B} : \sum_{k=1}^K \sum_{l=1}^{Lv} \alpha_{v,k}(l) \cdot C_l + s_v(k) = R_v$$

$$(f) \quad \forall k, \quad \forall u \in \mathcal{H} \cup \mathcal{B} : \sum_{l=1}^{Lv} \alpha_{u,k}(l) = \Delta_u(k)$$

$$(g) \quad \forall k, \quad \forall u \in \mathcal{H} \cup \mathcal{B} : \alpha_{u,k}(l) \in \{0, 1\}, \Delta_u(k) \in \{0, 1\}$$

$$(h) \quad \forall k, \quad \forall F_i \in \mathcal{F}, \quad \forall u, u' \in \mathcal{F}_i : \Delta_u(k) + \Delta_{u'}(k) \leq 1$$

ting the maximum number of fully satisfied HP users. The joint resource allocation problem with power control and MCS adaptation can be formulated as shown in Problem 3.1.

To better understand the objective and the constraints in this Problem:

- Constraint (a) ensures that the SINR threshold $S(l)$ corresponding to the MCS l value must be obtained if this scheme is used on the allocated RB k , $\alpha_{u,k}(l) = 1$.
- (b) takes into account the antenna sensitivity.
- Constraint (c) means that the total sum of powers transmitted by a FAP cannot exceed a maximum value P_{max} .
- (d) ensures that HP user requirements must be fully satisfied over the sum of the allocated RB.
- in (e), s_v represents a slack vector, it is defined as the difference between the required and the obtained throughput for the BE users. $s_v(k)$ needs to be minimized.
- (f) ensures the exclusivity, at least one MCS should be used on the RB k if it is allocated.
- (g) denotes that $\alpha_{u,k}(l)$ is a binary variable $\Delta_u(k)$ is a binary variable and that it is impossible to use more than MCS level l on the same RB k if it is allocated.
- (h) ensures the orthogonality assignment between users in the same femtocell.

3.4.2 Problem Resolution

In our proposal, called “AMC QoS-based Resource Allocation with Power control” **AMC-QRAP**, the cluster head intends to optimally exploit the available spectrum and apply both power and rate control for all attached FAP users. It must assign for each user the suitable MCS, the transmitted power and the set of RBs needed to acquire its demand. The HP users must completely satisfy their demands to be admitted into the network. BE users are served as much as possible, so, they partially or completely attain their demands relatively to the network capacity regarding the link adaptation benefit.

Problem 3.1 is an NP hard, multi-objective non-linear optimization problem. For resolution we should transform the objective function and the constraints into a linear form. We design a linear optimization model and solve it using Linear Programming (LP) tools [65–67].

Let us define $\hat{P}_{u,k}(l)$ as the transmission power of the user u on the RB k corresponding to the selected MCS l . Indeed, we assumed that $P_u^n(k)$ can be expressed as:

$$P_u^n(k) = \sum_{l=1}^{Lv} \hat{P}_{u,k}(l) \times \alpha_{u,k}(l) \quad (3.3)$$

Problem 3.2 Linear joint AMC-power control and resource allocation problem for HP users

$$\min \sum_{u \in \mathcal{H}} \sum_{k=1}^K \sum_{l=1}^{Lv} \hat{P}_{u,k}(l) - \sum_{u \in \mathcal{H}} \sum_{k=1}^K \sum_{l=1}^{Lv} S(l) \times \alpha_{u,k}(l)$$

subject to:

$$(a) \quad \forall u, \quad \forall k, \quad \forall l :$$

$$\hat{P}_{u,k}(l) \geq S(l) \cdot (\sum_{m \neq n} P_v^m(k) \cdot g_u^m + \sigma^2) / g_u^n$$

$$-(1 - \alpha_{u,k}(l)) \cdot P_{max} \cdot M$$

$$(b) \quad \forall u, \quad \forall k, \quad \forall l : \hat{P}_{u,k}(l) \geq P_{min} \times \alpha_{u,k}(l)$$

$$(c) \quad \forall k, \quad \forall u \in \mathcal{H} \cup \mathcal{B} : \sum_u \sum_{k=1}^K \sum_{l=1}^{Lv} \hat{P}_{u,k}(l) \leq P_{max}$$

$$(d) \quad \forall u \in \mathcal{H} : \sum_{k=1}^K \sum_{l=1}^{Lv} \alpha_{u,k}(l) \cdot C_l = R_u$$

$$(e) \quad \forall v \in \mathcal{B} : \sum_{k=1}^K \sum_{l=1}^{Lv} \alpha_{v,k}(l) \cdot C_l + s_v(k) = R_v$$

$$(f) \quad \forall k, \quad \forall u \in \mathcal{H} \cup \mathcal{B} : \sum_{l=1}^{Lv} \alpha_{u,k}(l) = \Delta_u(k)$$

$$(g) \quad \forall k, \quad \forall u \in \mathcal{H} \cup \mathcal{B} : \alpha_{u,k}(l) \in \{0, 1\}, \Delta_u(k) \in \{0, 1\}$$

$$(h) \quad \forall k, \quad \forall F_i \in \mathcal{F}, \quad \forall u, u' \in \mathcal{F}_i : \Delta_u(k) + \Delta_{u'}(k) \leq 1$$

So, if $\alpha_{u,k}(l) = 1$, the power transmitted is exclusively equal to the $\hat{P}_{u,k}(l)$ (constraint (f) of the Problem 3.1).

Therefore, the linear mono-objective model for HP users becomes as represented in Problem 3.2. The objective power variable becomes the $\hat{P}_{u,k}(l)$ accorded to the MCS level selected.

Therefore, for the selected MCS l , $\hat{P}_{u,k}(l)$ value must deal with the required SINR threshold $S(l)$ on the RB k as well as with the antenna sensitivity. The two linear monomials in the second member in constraint the (a) are explained as follows: if user u uses the MCS l on the RB k , so $\alpha_{u,k}(l) = 1$, the second monomial is canceled and SINR threshold

condition is verified. Otherwise, if $\alpha_{u,k}(l) = 0$, the second monomial takes a very high negative value that neglects the first monomial since we have introduced a positive high-value integer “M” [66, 68]. Hence, the corresponding $\hat{P}_{u,k}(l)$ value is set to 0.

Similarly for BE users, the objective function is presented in Equation 3.4:

$$\min \sum_{u \in \mathcal{H}} \sum_{k=1}^K \sum_{l=1}^{Lv} \hat{P}_{u,k}(l) + s_v(k) - \sum_{u \in \mathcal{H}} \sum_{k=1}^K \sum_{l=1}^{Lv} S(l) \times \alpha_{u,k}(l) \quad (3.4)$$

Furthermore, since existing HP users have more priority, they should be served first before allocating to BE users. Thus, we start resolving for HP users then we allocate the remaining resources for BE users.

3.5 Performance Metrics

The performance evaluation of our proposal is based on the following QoS metrics: Throughput Satisfaction Rate, Spectrum Spatial Reuse, Rate of rejected users, Channel Efficiency and Transmission power. Below is a definition of these different metrics:

3.5.1 Throughput Satisfaction Rate (TSR)

TSR denotes the satisfaction degree of a user with respect to the requested resources. For each user u attached to a FAP $\mathcal{F}_n \in \mathcal{F}$, $TSR(u)$ is defined as the ratio of the allocated number of RBs to the requested ones and can be expressed as follows: $\forall u$, $TSR(u) =$

$$\left(\sum_{k=1}^K \Delta_u(k) \right) / \mathcal{R}_u$$

For a network with U users, the TSR metric can be thus given by: $TSR = \sum_u TSR(u) / U$.

3.5.2 Spectrum Spatial Reuse (SSR)

SSR denotes the average portion of FAPs using the same RB within the network. Therefore, it is defined as the mean value of RBs’ spatial reuse. The SSR metric can be thus expressed as follows:

$$SSR = \frac{1}{K \times |\mathcal{F}|} \sum_{k=1}^K \sum_{u \in \mathcal{H} \cup \mathcal{B}} \Delta_u(k)$$

3.5.3 Rate of rejected users

This metric represents the percentage of HP and BE users not admitted in the network during the scheduling period. Recall that, once accepted, HP users are completely satisfied, whereas for BE users, their satisfaction degree will be maximized.

3.5.4 Average channel efficiency

The average channel efficiency represents for each resource block (RB) the mean value of achieved efficiency over the whole network expressed in bits/symbol. It is thus expressed as follows:

$$Eff_{average}(k) = \frac{1}{|\mathcal{F}|} \sum_{l=1}^{L_v} \sum_{u \in \mathcal{HUB}} C(l) \times \alpha_{u,k}(l)$$

3.5.5 Transmission power

We compute the transmission power allocation on each tile. This latter parameter is computed regarding: *i*) The variation in demand or users' requirements, to show the impact of the number of allocated Resource Blocks for each user on the total received power. *ii*) the average distribution of power over the different available resource blocks in the network used for transmission.

3.6 Performance Evaluation

We compare the performance of our method with three existing techniques mentioned above: 1) Q-FCRA [25] (without power control nor MCS adaptation) and 2) QP-FCRA [31] that only considers power control and 3) DRAPM [37] that considers a totally distributed approach. We calculate the mean value of performance metrics after running extensive simulations to reach a confidence level of 99.70%. The simulation results are obtained using the solver "IBM ILOG CPLEX" [69].

As in [25] and [31], we consider a typical downlink LTE OFDMA frame with a system bandwidth of 10 MHz and a total number of $K = 100$ RBs. Different network densities are studied to show the impact of network load on the performance and efficiency of our method. It ranges from 50 FAPs for low density networks and reaches 200 FAPs in higher density deployments. The FAPs are randomly distributed in a 2-D $400m \times 400m$ area, within $10m \times 10m$ residences. Users are distributed uniformly in the residence with a maximum number of 10 users per FAP. The number of users, their bandwidth requirements as well as their locations is varied at each simulation. In each FAP we allow up to 4 HP users and 6 BE users. In what follows we present the simulation results for each of the above mentioned metrics.

1) Throughput Satisfaction Rate (TSR)

The average throughput for all the users in the network is plotted in Figure 3.5. We can observe for the low density network scenario an average throughput of more than

99% for all users. It is obvious that AMC-QRAP outperforms the other methods and that power minimization jointly with MCS adaptation increases noticeably the results. The same observation is shown with regards to the distributed approach where the throughput decreases below 95% for low density networks.

The difference is made clear for high density networks where our proposal remains scalable and reaches the rate of 98% whereas the other approaches drop to below 96%, 92% and 82% for QP-FCRA, Q-FCRA and DRAPM respectively. The reason is due to the higher interference degree experienced by users with a congested network, where the distributed approach fails to adapt rapidly and Q-FCRA without power control is less flexible to allocate resources efficiently. Hence, for both low and high density networks, users' satisfaction and quality of experience are considerably enhanced with AMC-QRAP.

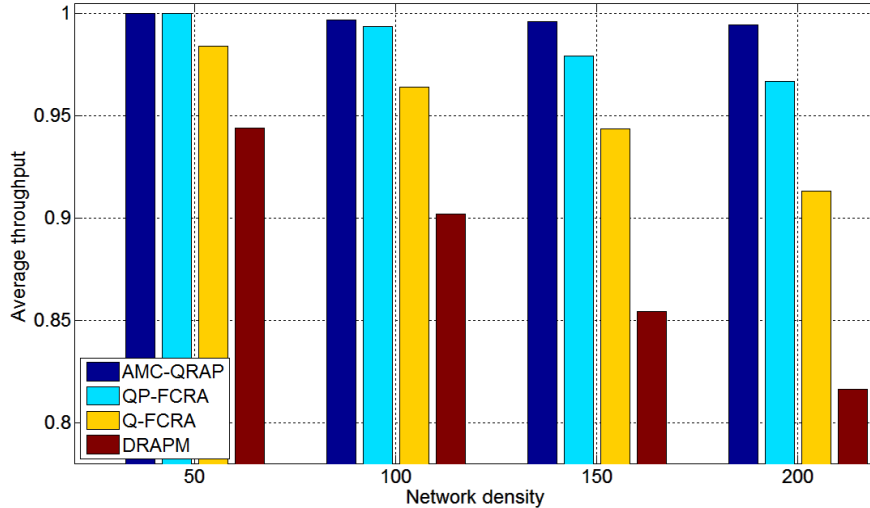

Figure 3.5: Throughput satisfaction rate vs. Network density

2) Spectrum Spatial Reuse (SSR)

Figure 3.6 plots the mean spectrum spatial reuse for the different schemes for both low and high density networks. We can notice, with power control and adaptive modulation the improvement especially in high density networks, with a mean SSR of 19%, an increase of around 40% is detected compared to Q-FCRA and an improvement of 15% compared to QP-FCRA.

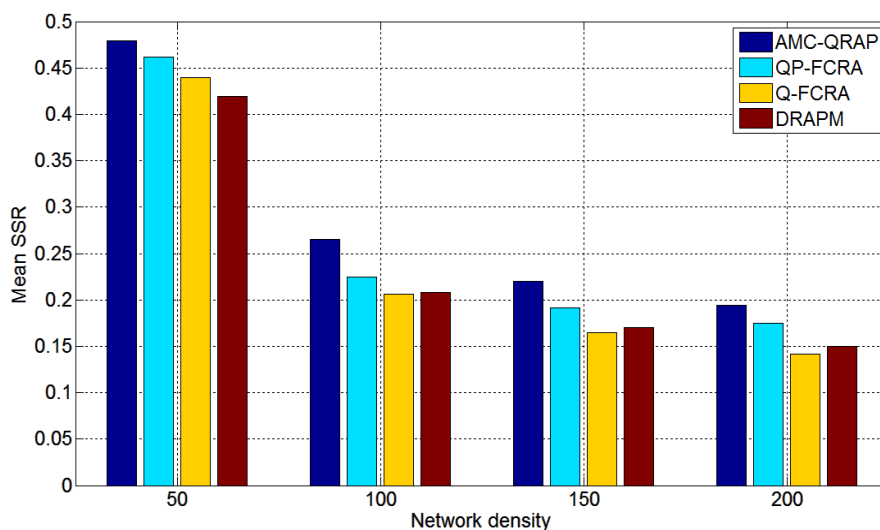

Figure 3.6: Mean SSR vs. Network density

3) Rate of rejected users

When considering the number of accepted users, the concept of QoS differentiation between users reveals the impact of our method on the performance. Indeed, as observed from Figure 3.7, the distributed method, which does not consider QoS, is less performing than the two other methods. We can see that for low density networks, the rate of rejected users is around 2% for both AMC-QRAP and QP-FCRA, however this rate goes up to 8% for DRAPM. In high density networks, a more important observation is made clear. For QP-FCRA, since

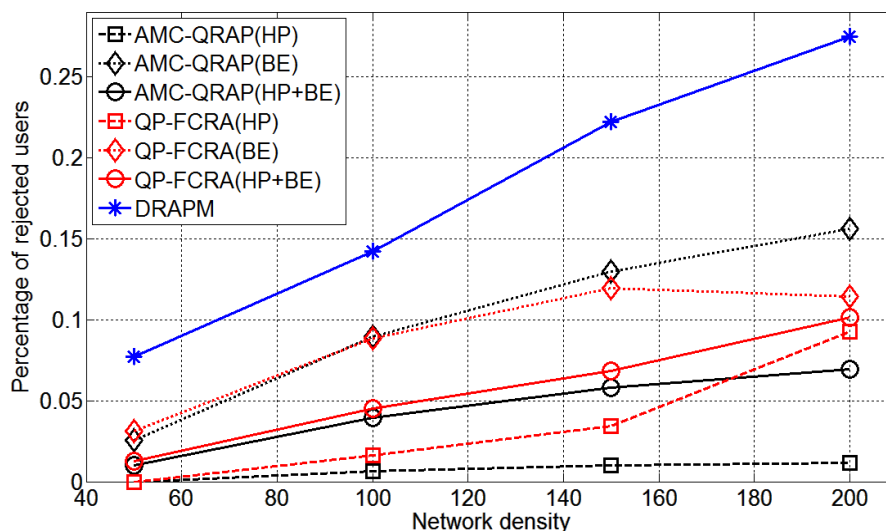

Figure 3.7: Rate of rejected users

HP users failing to obtain their required demand are not admitted into the network, BE users will acquire the unused resource blocks. We notice here that the HP rejection rate is high and reaches around 27%. Whereas with AMC-QRAP, This rate drops drastically to less than 3%. On the other hand, with a fewer rejection of HP users with QP-FCRA, a lower number of BE users are able to be served compared to QP-FCRA. This is obviously due to the fact that more HP users are better served over the entire bandwidth, leaving fewer resources available for BE users, but still ensuring a high admission ratio and a better overall admission rate for the network. We can state for these results that our AMC-QRAP method allows for a better QoS differentiation and a much smaller rejection ratio.

4) Average channel efficiency

Figure 3.8 shows the average efficiency for each used RB in the high density network scenario. This efficiency expressed in bits/symbol, shows how our method allocates mostly the high order MCS for users. Allowing them to achieve their high bandwidth demands with a fewer number of resource blocks. This is due mainly to the power minimization technique, which allows for a better spectral reuse. Hence, we notice that on the average, most of the users are able to obtain a high satisfactory SINR.

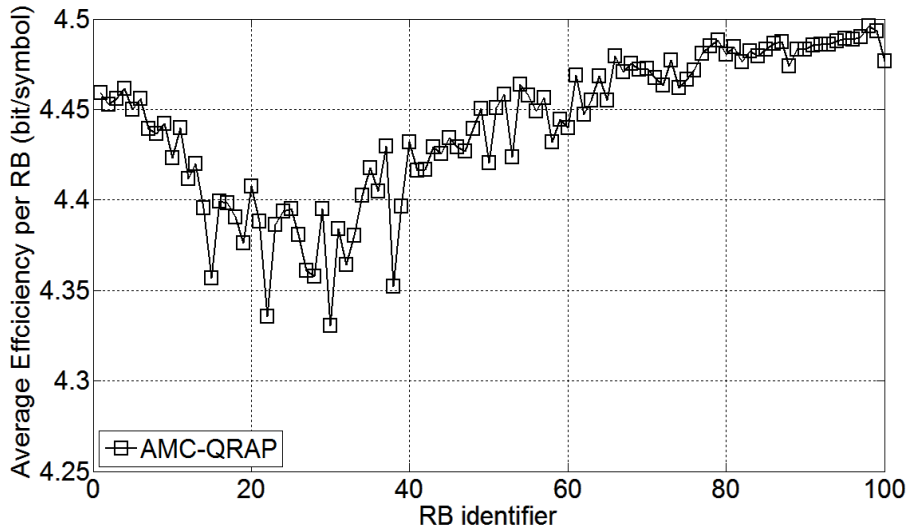

Figure 3.8: Efficiency per resource block

5) Power allocation

We first start by showing the CDF distribution of femtocells per power transmission. Figure 3.9 shows this distribution of power transmission for the high density network envi-

ronment. As we can observe with **AMC-QRAP**, 50% of femtocells have a transmission power below 10 *mW*, this rate increase to around 30 *mW* for **QP-FCRA** and **DRAPM**. Moreover, we notice that more than 90% of femtocells transmit below 20 *mW* thus considerably decreasing interference in the network and allowing for more spectrum reuse compared to the other methods that may reach more than 70 *mW* for some of the femtocells.

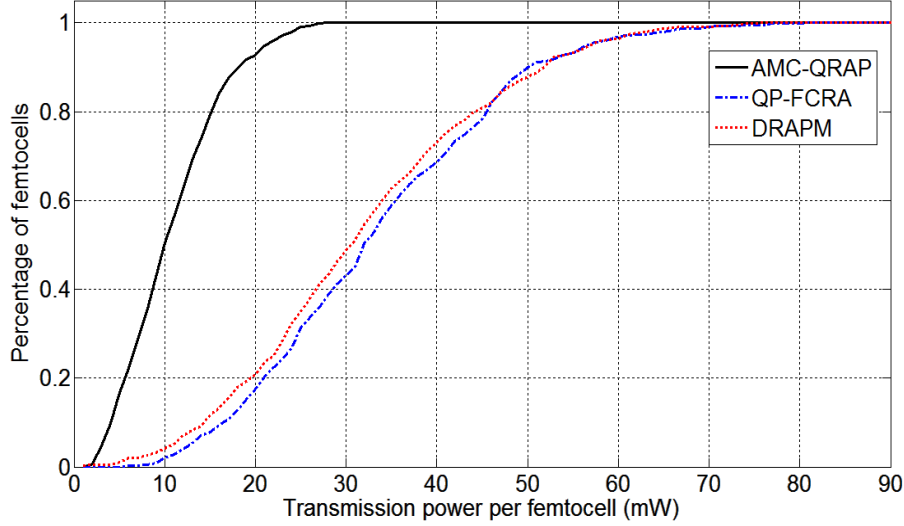

Figure 3.9: CDF of power transmission per femtocell in high density networks

Figure 3.10 shows the increase of the received power sum for the three methods with the variation of users' demands. As we can observe from the plot, with **AMC-QRAP** all the users have an average below 7 *mW* for the higher demands where this ratio reaches up to 12 *mW* and 14 *mW* respectively for **QP-FCRA** and **DRAPM**. The outperformance of our proposal is clearly shown in this metric.

Furthermore, Figure 3.11 shows the decrease in the transmission power over the entire spectrum for **AMC-QRAP** compared to the mentioned methods.

3.7 Conclusion

We have presented in this chapter a joint resource allocation method, named **AMC-QRAP**, for the OFDMA femtocell clustered network. Our proposal performs an Adaptive Modulation and Coding (AMC) technique as well as a power control mechanism. Essentially, the transmission is adapted to the channel quality reflected by the SINR Key factor. Our resource allocation objective has been achieved through two substantial orientations of : 1)

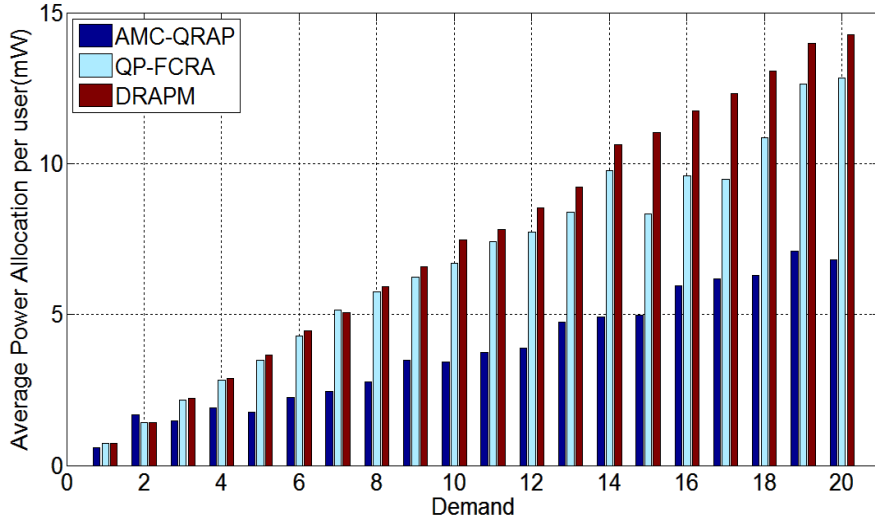

Figure 3.10: Transmission power per user demands

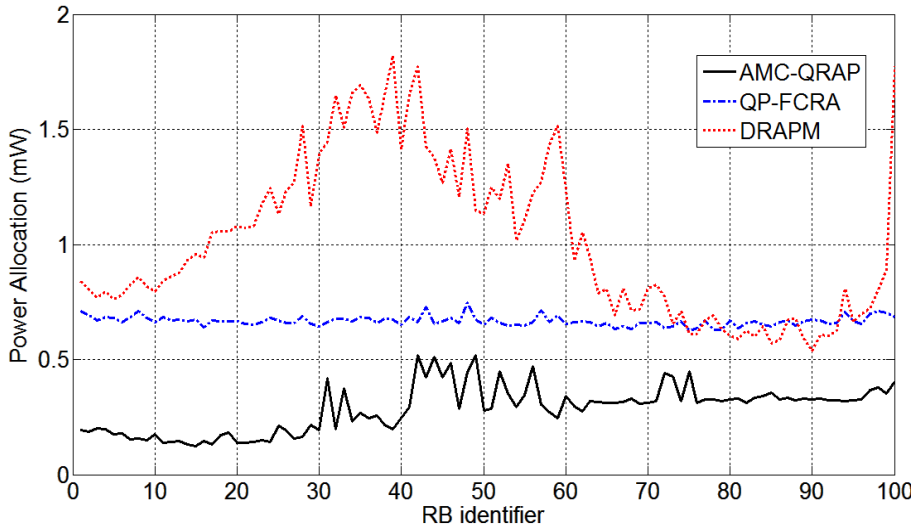

Figure 3.11: Transmission power per resource block

minimizing the overall transmit power to mitigate interference under data rate requirement and minimum SINR threshold constraints; 2) maximizing the data rate in term of selected MCS efficiency under BLER constraint. We consider users differentiation to provide QoS guarantee by serving two types of users, High Priority (HP) users and Best Effort (BE) users. This allows enhancing user experience under both low and heavy loaded networks. Extensive simulations are performed using IBM ILOG Cplex to resolve our linear optimization problem. We compared our method with three existing approaches. Q-FCRA with QoS guarantee, QP-FCRA with power control and DRAPM a distributed approach which considers power minimization for resource allocation has been investigated. We showed, for all

the considered metrics that our solution outperforms the mentioned schemes and hence, improves the overall network performance and allows a better user experience and QoS. It is worth mentioning that the resolution and convergence time of **AMC-QRAP** is slightly higher than **QP-FCRA** which is due to the higher number of constraints, but is still very low, allowing real time, fast scheduling mechanisms and scalable deployment of femtocells. The work proposed in this chapter deals with downlink transmission link. However, the transmission for the uplink needs to be considered as new interactive and real-time applications are demanding in the uplink as much as the downlink and none of the mentioned schemes used for comparison in this chapter studied this aspect. In the next chapter we cover this part and introduce our second contribution.

Chapter 4

Uplink Joint Resource Allocation with Adaptive Modulation and Coding

4.1 Introduction

In order to provide a complete framework for the LTE Heterogeneous Network in term of resource scheduling based on the Adaptive Modulation and Coding technique, we were motivated to consider the case of the “Uplink transmission” as a continued part of the downlink approach proposed in the previous chapter. Whereas, the LTE uplink scheduling literature is not as affluent as for the downlink due to the complexity of the uplink scheduling optimization problem.

However, the uplink-direction mobile communication is an important topic receiving huge attention today. Moving toward 4G, the uplink speeds become more ultimate with the emerging interactive applications requiring high bandwidth for upload data as much as download. The LTE network is evolved to meet the real world requirements and answer to proliferate demands of the mobile broadband networks. As application examples we cite: Skype, FaceTime, Video Gaming, some social networking applications like Facebook and Twitter, File Transfer Protocol (FTP), Cloud storage like Dropbox and SkyDrive and other recent applications requiring higher uplink network capacity and speed.

Therefore, looking forward high data rate techniques and increasing overall system capacity while optimally exploiting available resources become the major objectives for the uplink mobile communications.

Notably, the uplink transmission specifications differ from those of downlink since the base station and the user equipment are widely different in structure and features. So, these specifications must be taken into consideration in the resource scheduling problem. Mainly, while the 3GPP LTE adopts the OFDMA transmission scheme for the downlink, it chooses for the Uplink the Single Carrier-Frequency Division Multiple Access (SC-FDMA). The motivation behind is the low Peak-to-Average Power Ratio (PAPR) value characterizing the SC-FDMA scheme which offers enhanced energy efficiency and reduced cost and complexity for the mobile terminal compared to the OFDMA.

Similar to the multi-user downlink case, sharing spectrum promises enhancing spectral efficiency comparing to the split spectrum assignment. Hence, resulted interference can be mitigated by controlling the transmission power in function of the channel status. Furthermore, another beneficial approach promising to increase the system capacity and the power and spectral efficiencies is to adaptively control the transmission rate with the channel quality. This is achieved by the adaptive modulation and coding technique introduced previously in the downlink scheme.

Mostly, prevalent works addressed in the literature for the SC-FDMA Uplink resource allocation considers constant power and fixed Modulation & Coding Scheme (MCS) over all Resource Blocks assigned to each user. Though the SC-FDMA Uplink constraints are taken into consideration, in this chapter we aim to present an optimization approach to jointly and simultaneously allocate power, channel resource blocks and Modulation & Coding Schemes for each accessing user.

We consider a spectrum sensing technique that will be detailed in the next chapter, which helps locate and detect the neighboring energy transmissions, which reduces the complexity of the optimization model and accelerates the convergence of the algorithm. Hence, we propose in this chapter our second contribution, namely, **Uplink AMC-QRAP** which considers the uplink transmission scheme in the scheduling process of the network resources with adaptive modulation and coding.

This chapter is organized as follows. In Section 4.2, we describe the SC-FDMA and argue its application for uplink LTE system with comparison to the OFDMA scheme. We present our system model in Section 4.3. Next, we formulate and resolve our proposal on uplink AMC-QRAP algorithm in Section 4.4. We then present in Section 4.5 the performance metrics considered in the performed simulations. The performance evaluation of the proposal is provided in Section 4.6. Finally, we conclude this Chapter in Section 4.7.

4.2 SC-FDMA Transmission Mode

Unlike the OFDMA, the SC-FDMA is not widespread as a familiar communication notion. Thus, let us describe in this section this promising scheme.

4.2.1 What is SC-FDMA and Why using it?

The SC-FDMA is a multiple access transmission mode based on the Single-Carrier Frequency-Division Multiplexing (SC-FDM) modulation technique. This latter presents similar performance of the OFDM since it offers the same degree of multipath degradation effect resistance. The SC-FDM modulation technique benefits from the “frequency domain equalizers” at the receiver having a beneficial impact in term of low-complexity similar to the OFDM scheme. In fact, this complexity reduction is referred to the multiplication in the frequency domain instead of the convolution product in the time domain to achieve the equalization task at the receiver.

For the multi-user system, the SC-FDMA is elaborated; users access the time-frequency resource grid where each one transmits data performing the SC-FDM modulation scheme.

The essential argument of the 3GPP LTE to alternate toward the SC-FDMA for the uplink transmission is the reduced PAPR level enhancing the energy efficiency compared to the high PAPR in the OFDMA scheme which reduces the energy efficiency especially for user equipments having battery and consumption limitations unlike the base stations. In addition, low PAPR is a critical factor for the small size mobile terminal. In fact, for high PAPR value using linear amplifiers is not suitable for reliable signal reception due to the superfluous distortion. Consequently, the need to non-linear amplifiers with high complexity cost arises. Thus, enhanced energy efficiency allows to improve coverage and reduce equipment complexity.

4.2.2 SC-FDMA v.s. OFDMA

In contrast to the multi-carrier nature of the OFDMA, the SC-FDMA is a single-carrier transmission scheme as its name indicates. This is beneficial particularly for enhancing the power efficiency. In this part, we compare between these two schemes in terms of: 1) the structure and the manner how modulated data is transmitted and 2) the PAPR value.

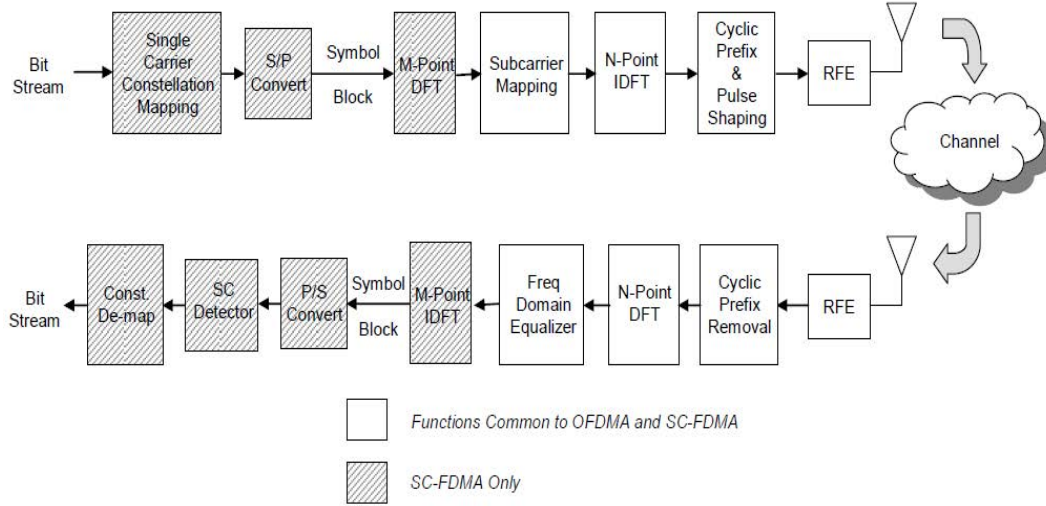

Figure 4.1: SC-FDMA and OFDMA communality structure

4.2.2.1 Block Diagram and Symbol Transmission

The SC-FDM is based on the Discrete Fourier Transform (DFT)-precoded OFDM. It is also called DFT-spreading OFDM. Therefore, it is an important communality between OFDM and SC-FDM structures and the unique difference is the introduction of the “N-DFT” block before the frequency mapping as shown in the Figure 4.1. Thus, the SC-FDMA is equivalent to the OFDMA system plus a DFT mapper.

The functional blocks in the transceiver chain of the SC-FDM and OFDM are described in the following:

- **Single-Carrier Constellation Mapping:** The modulation block transforms the incoming bit stream to single-carrier modulated symbols with respect to the constellation of the QPSK, 16-QAM or 64-QAM modulations adopted in LTE standard. So, the binary symbols are converted to the complex In-phase/Quadrature domain corresponding to the selected modulation mapping.
- **Serial/parallel converter:** Prepare the data to be transformed to the frequency domain by grouping symbol stream to sets of M symbols.
- **M-DFT:** The DFT block converts incoming modulated symbols from time domain to M subcarriers in frequency domain. Figure 4.2 shows that in the SC-FDMA case, each incoming QPSK symbols is carried by all subcarriers at the same time; whereas, for the OFDMA, each modulated QPSK symbol is carried by only one 15 KHz sub-carrier during one OFDMA symbol period. In other terms, we can note that the

modulated symbols are transmitted in parallel for the OFDMA one per subcarrier, while the M symbols are transmitted in series at M times the rate, with each one occupies $M \cdot 15$ KHz.

Therefore, for each user, the packet of subcarriers that carry each data symbol is considered as one frequency band carrying data. The allocated spectrum is sequentially divided for the multi users under the known Frequency Division Multiple Access (FDMA) standard. Now, naming the uplink multiple access scheme as “*Single Carrier-FDMA*” is clearer. It is noticeable that the data spreading over multiple subcarriers offers a frequency selectivity gain and is especially suited in frequency selective channel case.

- **Sub-carrier Mapping:** The DFT outputs is mapped to specified subcarriers in frequency domain and formed a subset of N subcarriers where N must be greater than M .
- **N-IFFT:** The N subcarriers mapped are now converted back to the time domain as in the OFDM case.
- **Cyclic Prefix:** Similarly to the OFDM, a cyclic prefix (CP) is added at the beginning of the SC-FDM symbol. It is a copy of the portion of last samples. It is selected to be slightly longer than the channel delay spreading in order to combat the Inter-Symbol Interference (ISI) and Inter-carrier Interference (ICI).

A parallel to serial converter follows the cyclic prefix addition, and then the resulted signal is converted to analog one by a pulse-shaping filter. At the receiver, the chain is reversed and performing the inverse operations.

According to the subcarrier mapping scenario the SC-FDMA technique can be classified into two main types: Localized SC-FDMA and Distributed SC-FDMA [70]. They are defined as follows:

- **Localized SC-FDMA:** the subcarriers to each user are consecutively mapped in a continuous manner and confined to a limited portion of the whole system bandwidth. The Localized SC-FDMA (L-FDMA) is currently the transmission scheme adopted for the Uplink by the 3GPP LTE system.
- **Distributed SC-FDMA:** the allocated subcarriers of each user are dispersed over the entire spectrum. There are two classes of subcarriers distribution: random or

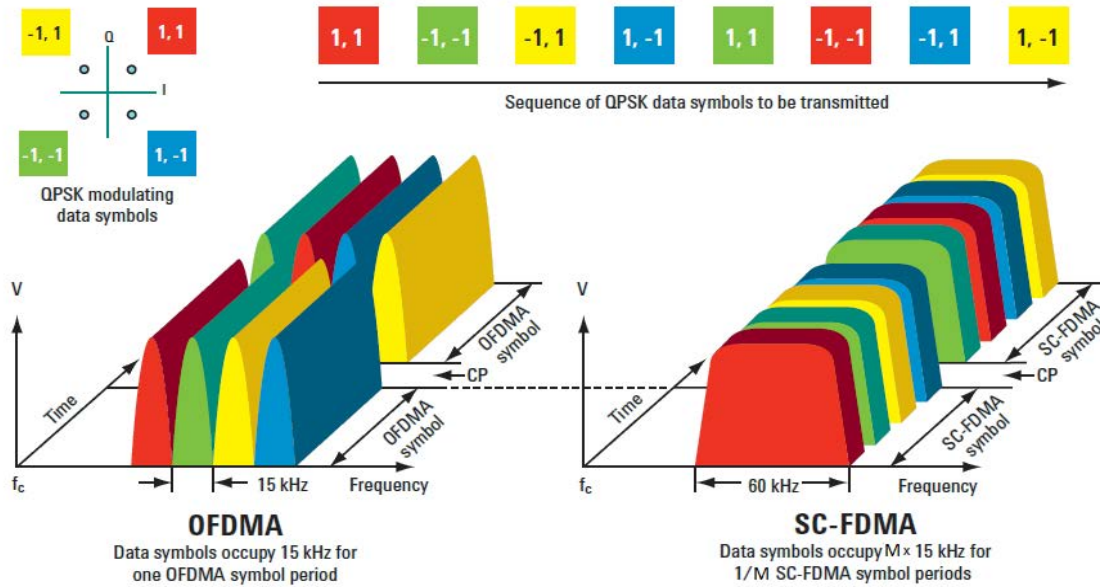

Figure 4.2: Symbols transmission comparison between SC-FDMA and OFDMA

equidistant. When the subcarriers are equidistant, the scheme is thus referred to Interleaved SC-FDMA (I-FDMA). In this case, the subcarriers are uniformly spaced and dispersed over the entire bandwidth filled by zero amplitude of the remaining subcarriers called NULL subcarriers. The relation $N = Q.M$ is satisfied, where the Q is the number of users.

The difference between the localized SC-FDMA (L-FDMA) and Interleaved SC-FDMA (I-FDMA) is shown in Figure 4.3 for three users.

The distributed mapping is more robust in frequency-selective fading environment since

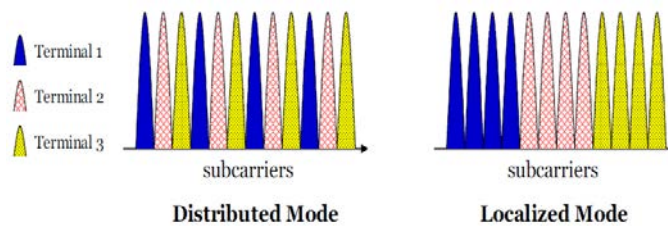

Figure 4.3: Localized mapping vs. Interleaved mapping

it offers a high frequency spreading degree. On other hand, the Interleaved I-SC-FDMA scheme is more promising for reducing the power fluctuations since the signal is the summation of harmonically separated frequency components, thus the PAPR value is decreased [42].

However, the localized SC-FDMA can provide higher system data rate due to the sequential data transmission as presented in the Figure 4.2. Thus, it is much promising for high throughput requirement systems. This fact proves the deployment of the “Localized SC-FDMA” for the uplink transmission by the LTE standard [71]. Although it presents higher PAPR value than the I-SC-FDMA, this value still less than the OFDMA one as described next.

4.2.2.2 SC-FDMA and OFDMA PAPR Comparison

By definition the PAPR value is the ratio of the highest power value to the average overall power of the signal in time domain. It is expressed as shown in Equation 4.1:

$$\frac{\max|x(t)|^2}{\text{mean}|x(t)|^2} \quad (4.1)$$

where $x(t)$ is the analogue transmitted signal.

For the OFDMA scheme, the parallel transmission data over narrowband subcarriers creates higher peaks in the signal envelope. Further, each subcarrier can be independently modulated with different modulation schemes presenting different power fluctuations. So, the OFDMA scheme significantly displays high PAPR level.

Conversely, adding DFT for the SC-FDMA yields spreading each incoming modulated data over all subcarriers, this results a wider-bandwidth single-carrier waveform [72]. The single-carrier behavior reduces the fluctuations of the signal envelope resulting serious reduction of the PAPR level.

As a matter of fact, the power consumption is a critical factor for the mobile terminal due to its impact on the battery life as well as the equipment cost. Fortunately, SC-FDMA is an energy efficient modulation scheme.

Figure 4.4 displays the PAPR comparison between the OFDMA and the SC-FDMA schemes. The modulation order impact on both techniques is also shown. This figure confirms the above mentioned theoretical PAPR comparison, where the SC-FDMA outperforms the OFDMA in term of low PAPR [73].

However, we observe on the other hand, that the SC-FDMA PAPR value increases when the modulation order increases while the OFDMA PAPR approximately still constant. Therefore, a noticeable fact to be mentioned about the SC-FDMA PAPR evaluation is that it becomes higher for higher system data rate.

We look forward to overcome this fact by enhancing both PAPR value and data rate as shown in the Chapter 5.

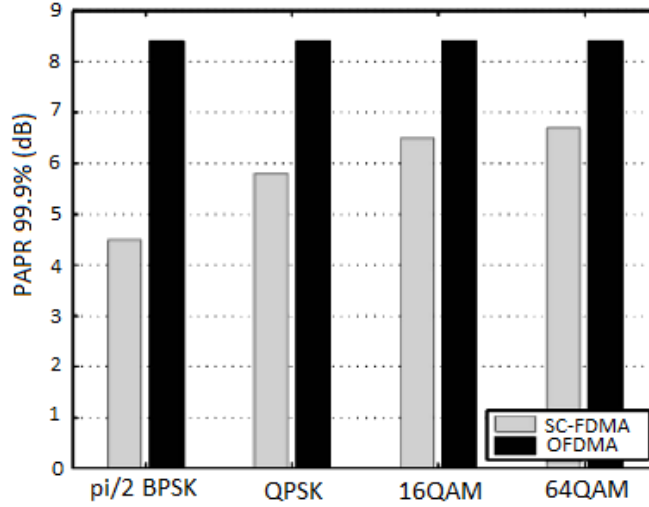

Figure 4.4: SC-FDMA and OFDMA PAPR Comparison

4.3 System Description

For the LTE standard, system requirements differ between the Uplink and the Downlink scenarios. In the uplink, the transmitter is a small device that conveys data in unicast mode toward its base station. In this section, we describe our uplink system model before tackling our uplink resource allocation proposal in next section.

4.3.1 System and Transmission Model

As in the previous chapter, we consider an urban dense environment where a Macrocell area is embedded in a set of N Femtocell Access Points (FAPs) forming a two-tier Heterogeneous Network (HetNet). The FAP can be installed either at home or in the office. Each FAP serves several Femtocell User Equipments (FUEs) randomly and uniformly distributed within the Femtocell coverage zone. Likely, several Macrocell User Equipments (MUEs) are randomly and uniformly distributed within the Macrocell coverage area and communicate with the unique Macrocell Base Station (MBS); they may fall at the proximity of the femtocell coverage area. Thus, in this case, the MUEs uplink radiations may cause macro-femtocell interference.

As in downlink case treated in the previous chapter, the physical propagation link for the uplink transmission, is modeled as the A1-type generalized path-loss model for the frequency range 2 – 6 GHz developed in WINNER [17]. The path-loss expression is given in Equation 3.1.

Unlike the downlink scheme where the OFDMA is the adopted transmission mode, for

the uplink, the 3GPP LTE adopts the Single-Carrier Frequency Division Multiple Access (SC-FDMA) due to the lower Peak-to-Average Power Ratio (PAPR) value.

As in the previous chapter, we distinguish between: High Priority (HP) users and Best Effort (BE) users. Particularly, the HP can be the FAP's subscribed users, while the BE users are the visitors. Moreover, we can classify the HP/BE users with respect to the paid service price or subscribed plan. Furthermore, Handed over MUEs can be dealt with as HP users with different weights or as BE users.

4.3.2 Notations

We recall in the following some useful notations similarly to the previous chapter.

- $\mathcal{S} = \{S(1), \dots, S(L_v)\}$ is the set of SINR thresholds for different MCSs. 6 SINR thresholds are considered in this thesis.
- $\mathcal{C} = \{C(1), \dots, C(L_v)\}$ is the set of the MCSs channel efficiencies.
- R_u denotes the demand of the user $u \in \mathcal{H} \cup \mathcal{B}$.
- $\mathcal{K} = \{1, \dots, K\}$ is the set of resource blocks (RBs) available for the network.
- $\Delta_u(k)$ is the binary resource allocation vector for user u with 1 or 0 in position k according to whether the RB k is used by user or not.
- $\alpha_{u,k}(l)$ is the binary resource allocation vector for user $u \in \mathcal{H} \cup \mathcal{B}$, with 1 or 0 in position k according to whether the MCS l is selected by the user u on RB k or not.
- $P_u^n(k)$ is the power transmitted from FAP F_n to its user u on the RB k , where $P_{min} < P_u^n(k) \leq P_{max}$ if RB k is used by the user u or $P_u^n(k) = 0$ otherwise.
- P_{max} is the maximum power transmission fixed by the network operator. P_{min} is the antenna power sensitivity.
- $\gamma_{u,k}$ is the required SINR for user u on RB k expressed in Equation 3.2.

In the next section we describe our proposal on Uplink scheduling to jointly allocate resources and mitigate interference with adaptive modulation and coding along with power

control contexts.

4.4 Uplink AMC-based Joint Resource Allocation Proposal

In this section, we present our optimization scheduling and resource allocation problem for SC-FDMA uplink femtocell networks. Our objective is to perform an optimal resource allocation problem that jointly assigns RBs, transmit power values and MCSs for each active FUE in order to fully satisfy HP users and then serve BE users as much as possible.

4.4.1 Problem Formulation

In what follows, we formulate our allocation and interference mitigation problem while carefully taking into account the Uplink transmission specifications. First, we cite the Uplink interference scenarios that differ from the downlink case since the characteristics of the forward and reverse communication links are not identical. Then, we introduce the spectrum sensing technique as a beneficial way for the uplink before formulating the resource allocation problem.

4.4.1.1 Uplink Interference Scenarios

For the uplink transmission, we classify three interference scenarios as summarized in Table 4.1. Manage these interference scenarios is the main challenge in order to provide an efficient uplink transmission in terms of quality of service and system throughput.

In what follows, we explain each uplink interference type according to the aggressor (cause)

Table 4.1: Uplink interference scenarios in two-tier network

Scenario	Aggressor	Victim	Interference Type
1	MUE	FAP	Cross-tier
2	FUE	MBS	Cross-tier
3	FUE	FAP	Co-tier

and the interference victim and we present its impact in our scheduling problem.

A. MUE to FAP interference

In general, when the power control is performed for the mobile system, the User Equipment (UE) radiation mainly depends on the distance from the base station. Therefore, when the

MUE communicates with the far-away Macro base Station (MBS), this latter gives the order for the MUE to increase its transmission power to overcome the path-loss and other propagation attenuation effects along the MUE-MBS trajectory. The goal is to achieve a minimum SINR at the MBS receiver side allowing surpassing the interference effect and reaching the MCS considered.

If the MUE location becomes close to a femtocell coverage region, its transmission is thus received by the FAP. In this case, severe cross-tier interference occurs on the RBs commonly used by the MUE and a FUE of the corresponding FAP, especially if the MUE is an edge user requiring more power to reach its MBS. This interference type is considered very frequently.

In our scheduling strategy, we benefit from the HP/BE users differentiation to resolve the cross-tier interference between the MUEs and the FAPs. In fact, when the MUE passes nearby a FAP, it automatically switches its communication from the MBS to the corresponding FAP. It is thus considered as HP or BE femtocell user according to the priority value assigned to it. In case where the closed access is to be used, the MUE will not have access to the FAP resources. Thus, hybrid access scheme allows more flexibility when allocating resources and mitigating interference.

B. FUE to MBS interference

The cell-edge FUE aims to increase its uplink transmitted power trying to attain the target SINR that guarantees reliable transmission. When the FUE is in the vicinity of the MBS, the interference occurs only if the FUE uses the same frequency band of a MUE in transmission mode.

However, in our uplink scheduling strategy, we neglected the influence of the FUE transmitted power on the MBS. Indeed, by definition, the femtocell is a short range region. So, the FUE signal power received by the MBS on a determined RB is very small comparing to the MUE one.

C. FUE to neighboring FAP interference

The third scenario represents the co-tier uplink interference, where FUE is the cause of the interference and neighboring FAP is the victim. As a matter of fact, the cell-edge FUE radiates with an enough power to its FAP respecting the required SINR value. This results a leakage of power to the adjacent FAP through the walls or windows.

Due to the frequency reuse policy, the cell-edge FUE signal and a neighboring femtocell-user signal interfere at the corresponding neighboring FAP over the common RBs. Consequently, a severe interference degrades the signal reception.

In our uplink scheduling approach, we focus on the third interference scenario and we benefit from the potential spectrum sensing technique next presented to be aware of the surrounding interference transmissions.

4.4.1.2 Spectrum Sensing Phase

The spectrum sensing technique is performed to detect and analyze the wireless spectrum. It is originally used to identify free spaces considered as available resources in the whole spectrum for dynamic cognitive radio (CR) transmissions.

For the LTE Heterogeneous Network, by performing the spectrum sensing technique, each FAP listens to its surrounding environment and senses the active transmissions through the frequency domain analysis. Each FAP detects over all available RBs, the free and occupied ones; further, it can measure the interference level on the occupied RBs by measuring the received signal energy.

Indeed, the FAP can more reliably detect the closed transmissions and consider them as aggressor interference. The far-away users are not counted as interferers' aggressor since their transmitted signals reach the FAP location with neglected energy.

The most applications introducing the spectrum sensing technique are mainly based on the occupied/free decision.

Whereas, our uplink allocation problem is based on the spectrum-sharing approach, so the occupied/free decision is not the unique critical factor, but also the energy value of the detected signal on each occupied RB. This detected energy offers a considerable knowledge on the amount of interference on the corresponded RB.

Thus, before allocating a particular RB, the FAP is aware of the RB status.

In the previous chapter, the interference power value is assumed to be unknown and is so introduced in the downlink model as variable to be found for resolving the allocation optimization problem. In this chapter, the interference powers are assumed known due to the spectrum sensing approach; this significantly simplifies our scheduling model and reduces its complexity as well as the convergence time needed after the first allocation process.

Among different spectrum sensing algorithms, we consider the wavelet-based spectrum sensing approach, due to its high accuracy and low implementation complexity. This approach will be detailed in the Chapter 5 as a signal processing-based enhancing technique.

4.4.1.3 Resource Allocation Phase

In our allocation scheduling problem, we take into account the specific constraints of the SC-FDMA Uplink transmission. Particularly, the 3GPP LTE standard adopts the “localized SC-FDMA” for the uplink transmission where all RBs (or subcarriers) allocated to each user are forced to be contiguous to each other. By this way, each user reserves a continuous portion of the overall licensed spectrum.

Notably, as mentioned for the SC-FDMA types, the localized SC-FDMA is more benefit for high throughput systems than the interleaved SC-FDMA (I-SC-FDMA).

Therefore, since our major objective in this thesis is to maximize the system throughput we are motivated to adopt the localized SC-FDMA where the RBs per user must be adjacent to each other.

The previous uplink literature works consider that each user allocates a constant power over all assigned subcarriers, so the total power transmitted by each user equipment allocated $|K_u|$ RBs is given by the following Equation [48]:

$$\mathbf{P}_u^n = |K_u| \cdot P_u^n(k)$$

Furthermore, some of the previous works enforce each user to perform a fixed MCS over all assigned RBs, hence, the spectral efficiency of each user becomes constant for these RBs.

We find that these two uplink assumptions are closely correlated. In fact, the selection of the MCS depends on the channel status over each RB, which is represented by the SINR level on such RB. So, the constant power over all allocated RBs (and the interfered power) imposes a constant channel status (SINR) and consequently constant MCS over those RBs.

In contrast, our uplink resource allocation strategy is based on the “power control mechanism” where the transmit power may be different over the allocated RBs with respect to the minimum required SINR level on each one. In addition, it is not mandatory that each user is assigned the same MCS over all allocated RBs since the interference status becomes different for each RB. Hence, if one RB must be allocated a lower-order MCS due to its worse quality, others RBs are not forced to use those MCS and can select higher-order MCS accordingly with the channel quality. This fact allows increasing the user spectral efficiency and the overall system throughput.

4.4.2 Problem Resolution

We propose an uplink resource allocation and interference management model handling the link adaptation issue in terms of both: 1) power control and 2) Adaptive Modulation and Coding (AMC) mechanisms.

The overall transmitted power is minimized under user demands constraints; at the same time, the overall data rate is maximized under performance (BLER) constraints.

In this chapter, each FAP exploits the spectrum sensing for getting on each occupied RB the interference level and allows the control for each user of the power transmission with additional surrounding knowledge. These information are provided to the cluster head to which the FAP is attached.

Based on this knowledge, the optimization model becomes simpler since the power constraint is thus relaxed to match the linear form which will be discussed next.

On each assigned RB, the power is controlled independently in order to mitigate co-tier interference as operating in the downlink case. Particularly, for this purpose the overall transmit power of the whole system is thus “minimized” under the constraint to be as enough as to satisfy the minimum SINR required for a reliable signal reception and decoding.

On the other hand, the Adaptive Modulation and Coding (AMC) technique is adopted in order to maximize the overall system data rate, increase the spectrum reuse and reduce the outage probability. In fact, the hard condition of the fixed and unique required SINR threshold (for the fixed MCS) is relaxed. Several consecutive SINR thresholds are taken into account corresponding to several MCSs with different efficiencies are adopted such as for the downlink allocation problem in the previous chapter. We allow that each user performs on each RB a specific MCS unlike some previous approaches assuming constant MCS on all RBs allocated by each user [48].

Therefore, independently for each RB, our optimization problem starts by allocating the highest order MCS respecting the corresponding SINR threshold. If it fails to reach this SINR level, it switches to the lower order MCS corresponding to lower SINR threshold while minimizing the transmitted power.

The SC-FDMA transmission mode is considered as an additional constraint for our optimization problem compared with the OFDMA downlink mode presented in the previous chapter. For the latter case, the RBs assigned to one user are independently distributed respecting the channel status only without taking into account any arrangement rule.

Now, let us model our joint resource allocation problem for the Uplink transmission as shown in Problem 4.1.

Problem 4.1 Uplink Joint resource allocation with power control and adaptive MCS for HP and BE users

$$\min \sum_{u \in \mathcal{H}} \sum_{k=1}^K \sum_{l=1}^{Lv} \hat{P}_{u,k}(l) - \sum_{u \in \mathcal{H}} \sum_{k=1}^K \sum_{l=1}^{Lv} S(l) \times \alpha_{u,k}(l)$$

subject to:

(a) $\forall u, \forall k, \forall l :$

$$\hat{P}_{u,k}(l) \geq S(l) \cdot (E_u(k) + \sigma^2) / g_u^n - (1 - \alpha_{u,k}(l)) \cdot P_{max} \cdot M$$

(b) $\forall u, \forall k, \forall l : \hat{P}_{u,k}(l) \geq P_{min} \times \alpha_{u,k}(l)$

(c) $\forall k, \forall u \in \mathcal{H} \cup \mathcal{B} : \sum_u \sum_{k=1}^K P_u^n(k) \leq P_{max}$

(d) $\forall k, \forall j = k + 2, k + 3, \dots, K, \forall u \in \mathcal{H} \cup \mathcal{B} : \Delta_u(k) - \Delta_u(k + 1) + \Delta_u(j) \leq 1$

(e) $\forall u \in \mathcal{H} : \sum_{k=1}^K \sum_{l=1}^{Lv} \alpha_{u,k}(l) \cdot C_l = R_u$

(f) $\forall v \in \mathcal{B} : \sum_{k=1}^K \sum_{l=1}^{Lv} \alpha_{v,k}(l) \cdot C_l + s_v(k) = R_v$

(g) $\forall k, \forall u \in \mathcal{H} \cup \mathcal{B} : \sum_{l=1}^{Lv} \alpha_{u,k}(l) = \Delta_u(k)$

(h) $\forall k, \forall u \in \mathcal{H} \cup \mathcal{B} : \alpha_{u,k}(l) \in \{0, 1\}, \Delta_u(k) \in \{0, 1\}$

(i) $\forall k, \forall F_i \in \mathcal{F}, \forall u, u' \in \mathcal{F}_i : \Delta_u(k) + \Delta_{u'}(k) \leq 1$

To better understand the optimization model, let us describe the problem constraints as follows:

- Constraint (a) ensures that the SINR threshold $S(l)$ corresponding to the MCS l value must be obtained if this scheme is used on the allocated RB k , $\alpha_{u,k}(l) = 1$. Due to the spectrum sensing technique introduced before the transmission, the overall power

interference level sensed by each user u on each RB k becomes a known value equal to $E_u(k)$. Consequently, the optimization problem becomes a linear one.

- (b) takes into account the antenna sensitivity.
- Constraint (c) means that the total sum of powers transmitted by a FAP cannot exceed a maximum value P_{max} .
- (d) ensures the “contiguous condition” of the allocated RBs for each user.
- (e) ensures that HP user requirements must be fully satisfied over the sum of the allocated RB.
- in (f), s_v represents a slack vector, it is defined as the difference between the required and the obtained throughput for the BE users. $s_v(k)$ needs to be minimized.
- (g) ensures the exclusivity, at least one MCS should be used on the RB k if it is allocated.
- (h) denotes that $\alpha_{u,k}(l)$ is a binary variable $\Delta_u(k)$ is a binary variable and that it is impossible to use more than MCS level l on the same RB k if it is allocated.
- (i) ensures the orthogonality assignment between users in the same femtocell.

This model is solved as a linear optimization problem using the “IBM ILOG CPLEX” optimization solver.

In award, the uplink scheduling task for each cluster can be summarized as follows: through the spectrum sensing technique, the FAP detects the energy transmitted by the mobile uplink over the spectrum. Based on this input information, instead of absolutely ignoring occupied spectrum, the FAP exploits this information that it sends to the Cluster Head. The Cluster Head collects information resulting from sensing of all FAPs attached to its cluster (FAPs members) and at each scheduling period, it associates the set of RBs/powers/MCSs that must be used by each FAP taking into account the interference detected during this scheduling period. Indeed, the Cluster Head always has a global view of the current interference level in its cluster.

All FAPs will obtain the RBs/powers/MCSs vectors to be used depending on what has been calculated by the Cluster Head and will not change until the next scheduling period. As the Cluster Head associates for each FAP its vector, it will be have the visibility of the interference during this “scheduling period”.

Consequently, since for each cluster the Cluster Head is in charge of allocating the resources,

the intra-cluster problem does not arise.

For inter-cluster case, as the Cluster Heads do not coordinate with each other, it is possible that two or more neighboring and interfering FAPs are attached to two different clusters and they are assigned the same resources. In this case, the resolution happens at the FAPs in the third phase of the algorithm using a ‘‘Bernoulli distribution’’ to keep or discard the resources used. Thus, the probability that a FAP keep the interfered resource is equal to 0.5 until at least one FAP abandon the resource.

In contrast, this would be problematic in the case of fully distributed network where the FAPs do not coordinate with each other. The fact of increasing the transmitted power according to what has been calculated in the sensing phase may increase interference after transmission to others FAPs not aware of the new transmission.

4.5 Performance Metrics

We evaluate the performance of our proposal based on the following metrics: Throughput Satisfaction Rate, Rate of rejected users, Spectrum Spatial Reuse, Channel Efficiency and Transmission power as well as the fairness of the algorithm.

4.5.1 Throughput Satisfaction Rate (TSR)

TSR is the rate of a user’s satisfaction in terms of allocated resources with respect to the requested ones. For each user u attached to a FAP $\mathcal{F}_n \in \mathcal{F}$, $TSR(u)$ can be expressed as follows: $\forall u$,
$$TSR(u) = \left(\sum_{k=1}^K \Delta_u(k) \right) / \mathcal{R}_u$$

For a network with U users, the TSR metric can be thus given by: $TSR = \sum_u TSR(u) / U$.

4.5.2 Rate of rejected users

This metric represents the outage probability or the percentage of users not admitted into the network. Users failing to be served will not be accepted within the scheduling period. HP users constraint imposes that the full demands are satisfied whereas BE users tolerate a lower degree of service.

4.5.3 Spectrum Spatial Reuse (SSR)

SSR represents the average number of FAPs using the same RB. In the uplink scenario, it represents the number users transmitting on the same RB. Hence, it is defined as the mean value of RBs’ spatial reuse. The SSR metric can be expressed as follows:

$$SSR = \frac{1}{K \times |\mathcal{F}|} \sum_{k=1}^K \sum_{u \in \mathcal{H} \cup \mathcal{B}} \Delta_u(k)$$

4.5.4 Transmission power

The computation of the transmission power gives a clear idea on the energy efficiency of the proposed algorithm. The power is computed regarding: *i*) The variation in users' requirements, to show the impact of the number of allocated Resource Blocks for each user on the total received power to achieve its request. *ii*) The variation in users' distance showing the effect of the power minimization process on the edge and center users. *iii*) The average distribution of power over the entire spectrum for each resource block used for transmission.

4.5.5 Fairness

The Jain's fairness index [74], which determines how fairly the resources are distributed among N existing users, is considered to highlight the performance of the algorithm with regards to users satisfaction rate. It can be expressed as follows:

$$\beta = \frac{\left(\sum_{u=1}^N TSR(u)\right)^2}{N \cdot \sum_{u=1}^N TSR(u)^2} \quad (4.2)$$

4.6 Performance Evaluation

We compare the performance of our method with three different techniques: 1) **UPLINK FMC-QRAP** where we consider the same problem but with fixed modulation and coding to prove the efficiency of the AMC and the outperformance in the different metrics. 2) **Downlink AMC-QRAP** presented in the previous chapter to show the difference between the OFDMA and the SC-FDMA schemes and the impact on the different performance metrics where we compare the downlink and uplink user experience. 3) **QP-FCRA** [31] which considers power control but with fixed modulation and coding in the downlink.

We consider a typical UPLINK LTE SC-FDMA frame with a system bandwidth of 10 MHz consisting of $K = 100$ Resource Blocks. As in the previous chapter, low to high network densities are studied to show the impact of network load on the performance and efficiency of our method. We consider 50 FAPs for low density networks reaching up to 200

FAPs for high densities. The FAPs are randomly distributed in a 2-D $400m \times 400m$ area, within $10m \times 10m$ residences. A maximum number of 10 users are distributed uniformly in each residence FAP. The number of users, their bandwidth requirements as well as their locations are varied at each simulation. The simulation results for each of the described metrics are presented below:

1) Throughput Satisfaction Rate (TSR)

As mentioned earlier, the throughput difference between downlink and uplink is noticeable in both FDD and TDD schemes.

As shown in the Figure 4.5, we compare our method to both uplink with no AMC and

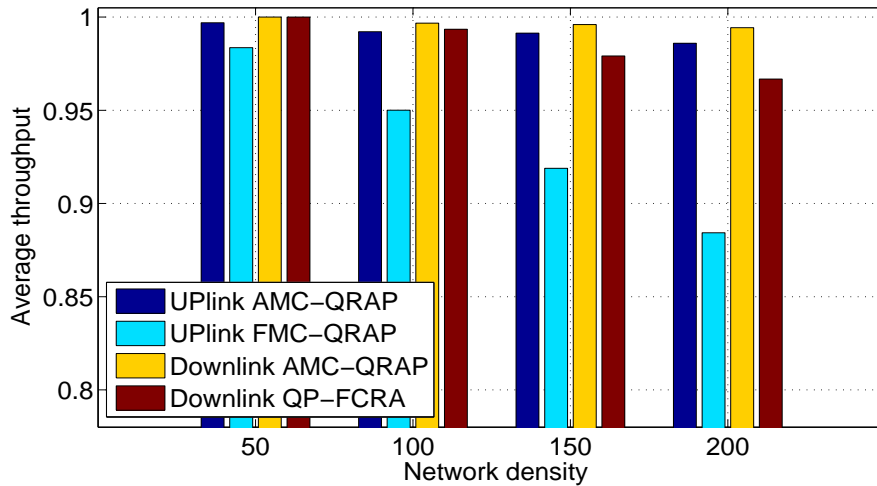

Figure 4.5: Throughput vs. Network Density

to downlink with and without AMC. It is clearly shown how the difference is very small in downlink and uplink when AMC is used. In fact UPLINK AMC-QRAP performs very closely to downlink. When it comes to using AMC, we see the efficiency and the gain compared to uplink with fixed modulation and coding scheme.

Indeed, in Figure 4.5, when comparing UPLINK AMC-QRAP and UPLINK FMC-QRAP, in low density scenario an average throughput of 99% and 98% is respectively achieved. Where in high density scenarios, when using adaptive modulation and coding the throughput for UPLINK AMC-QRAP remain high with about 98% satisfaction where as the scheme with fixed modulation decreases to below 87%.

A very important point is noticed also in this figure: when considering high density scenario, the uplink scheme with AMC can perform even better than QP-FCRA for downlink using fixed modulation and coding, reaching 98% and 96% respectively. This is also due to the spectrum sensing phase used in UPLINK AMC-QRAP which allowed for a better scheduling

of the resources compared to the downlink QP-FCRA.

2) Rate of rejected users

When looking at Figure 4.6 we can make several observations on the outage probability or the number of rejected users. In fact, for low interference scenarios, UPLINK AMC-QRAP is better performing than the other schemes with less than 0.5% of rejection is observed compared to around 1% and 1.2% for the downlink schemes. If we look at the high density scenario, the benefit is evidenced with a rejection of about 2% compared to more than 13%, 7% and 10% respectively for UPLINK FMC-QRAP, Downlink AMC-QRAP and QP-FCRA.

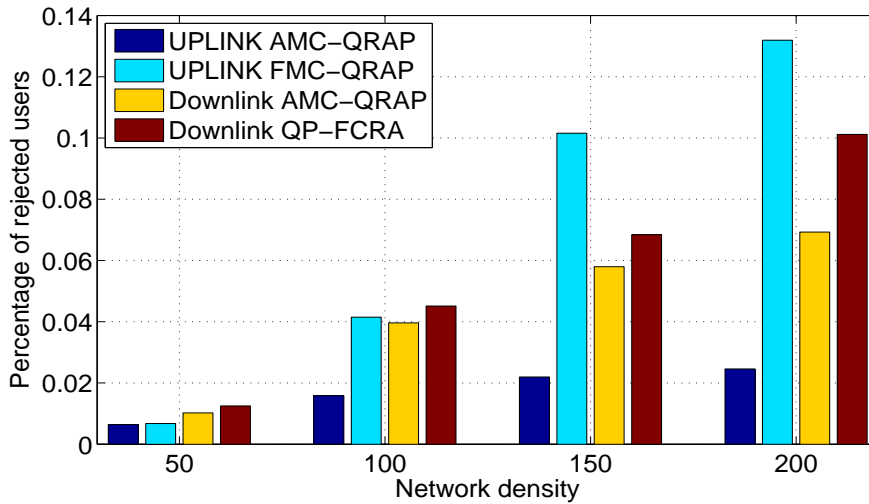

Figure 4.6: Outage Probability

If we consider each one apart we can get to the following conclusion. The AMC clearly increases the performance of the algorithm for both uplink and downlink compared to the scheme with fixed modulation and coding. When comparing both uplink and downlink in the AMC mode, we can observe that the performance of the uplink reaches better results. This is due mainly to the spectrum sensing approach which helps reducing the scheduling complexity by transforming the non linear constraint of the interference part into a known input, thus facilitating the allocation process. Moreover, with a better view of the surrounding in the uplink, the spectrum sensing phase reduces the convergence time needed after the first allocation, thus enhancing the user experience and admission ratio.

3) Spectrum Spatial Reuse (SSR)

Figures 4.7 (a) and 4.7 (b) plot respectively the mean SSR for the network for all densities and the average SSR per tile for the high density network.

In the first figure we notice how the AMC scheme, for both downlink and uplink scenarios,

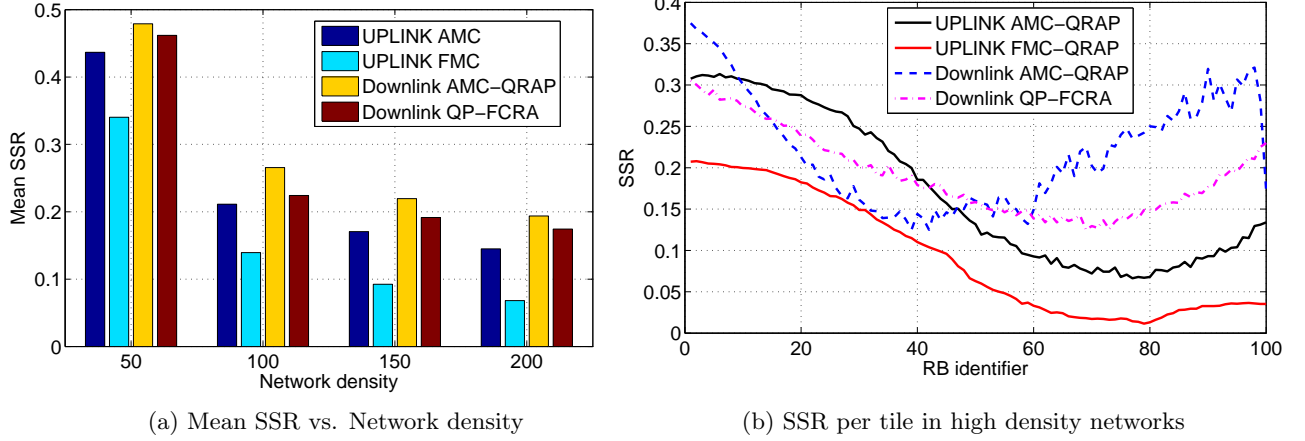

Figure 4.7: Mean spatial spectrum reuse - SSR

gives a better spectral efficiency and reuse compared to the FMC scheme. However, in the uplink mode we observe a lower SSR compared to the downlink. This is mainly due to the fact that in the uplink mode the allocated resources need to be contiguous, where this constraint does not exist in the downlink, as mentioned earlier. Thus, resulting a spread distribution of some of the resources allowing more flexibility for the downlink mode.

4) Fairness

When comparing the above results, we can clearly see an improvement in different metrics. However, it is very important to verify the fairness of the algorithm and show if the resources are equitably distributed among users.

The Jain's Fairness Index, calculated as the average for entire the network and including both types of users, is used to study this metric. We note that in the best case, it reaches 1 and it is attained when all users receive the same allocation.

Figure 4.8 shows the fairness for the different methods. It is observed that, for the low density networks, UPLINK AMC-QRAP and DOWNLINK QP-FCRA are better performing than the others. While all the methods degrade with the network load, UPLINK AMC-QRAP keeps a high degree of fairness and is less affected by the density, where it varies from 99.5% to 98.5% compared to 96% to 93% for DOWNLINK AMC-QRAP and 98% to 87% for UPLINK

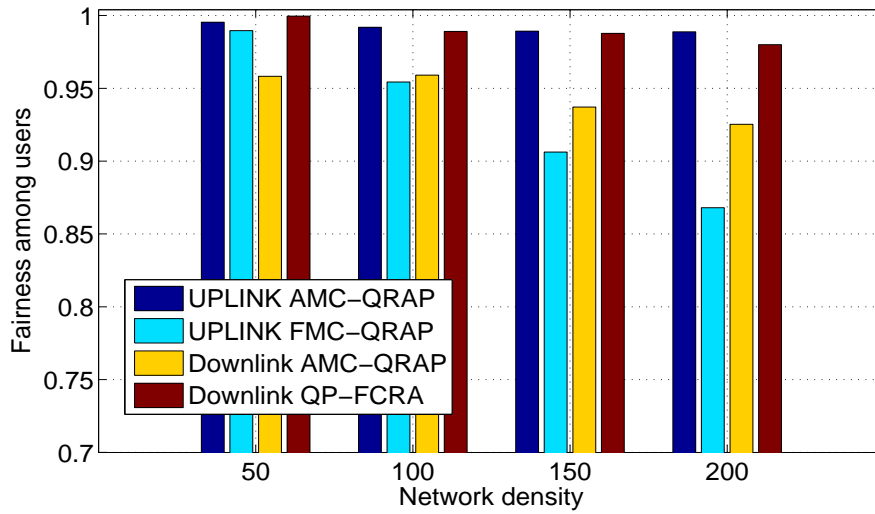

Figure 4.8: Fairness

FMC-QRAP, respectively for both low and high density networks.

5) Power allocation

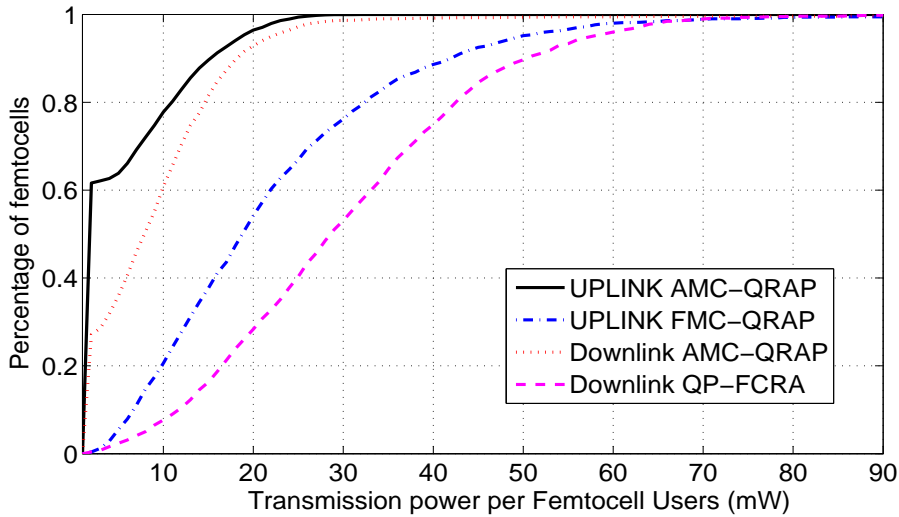

Figure 4.9: CDF power transmission per femtocell user

In this part we investigate the power transmission and the energy efficiency of our algorithm. We use several metrics to study the power control mechanism and compare the different methods.

We first start by showing the cumulative distribution function of the power transmission

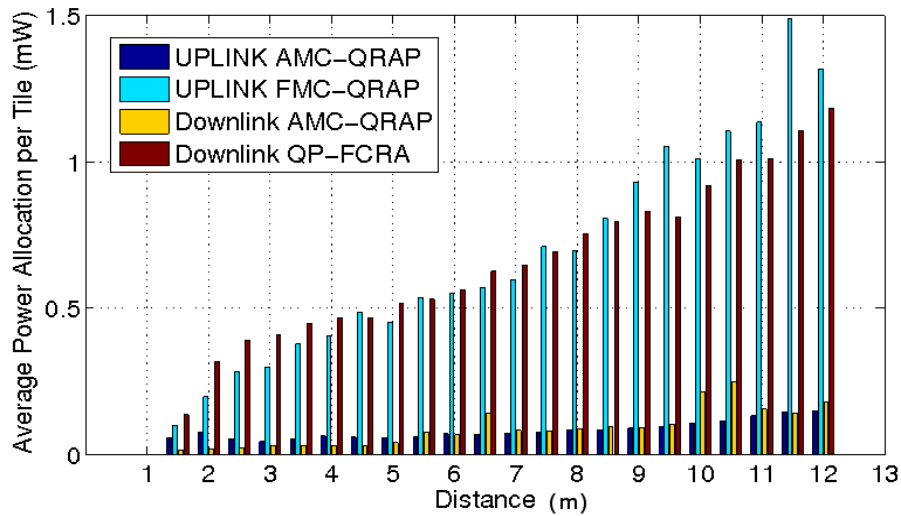

Figure 4.10: Transmit Power vs. Distance

per user over the entire network plotted in Figure 4.9. In this plot we can clearly observe that for UPLINK AMC-QRAP, 90% of user have a total transmission power less than 15 mW, compared to 18 mW for Downlink AMC-QRAP. This rate grows to approximately 40 and 50 mW for UPLINK FMC-QRAP and Downlink QP-FCRA respectively. This difference is obviously due to the AMC techniques which allowed the resources to be used with less transmission power when a lower MCS is needed, resulting in a lower interference over the RB and hence less transmission power required.

The power transmitted vs. distance is plotted in Figure 4.10 where we can see the

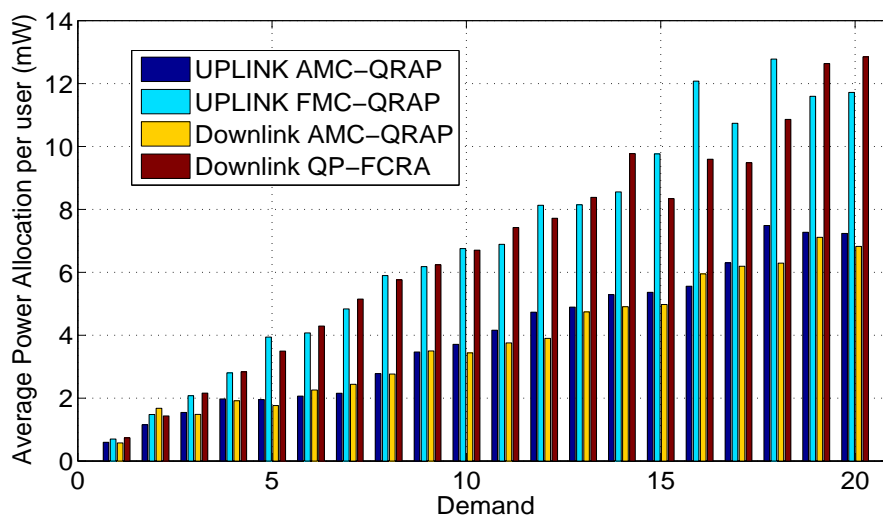

Figure 4.11: Transmit Power vs. Demand

evolution in the total power used based on the distance from the center of the FAP. A power minimization model is used, as the algorithm tries to allocate the best channel to edge users far from their FAP. They will use the channel with less interference so they can consume a lower power and reduce energy consumption, especially when user equipments are sensitive to battery and energy savings. The difference for both uplink and downlink schemes using AMC compared to the same scenarios without AMC is clearly highlighted. With adaptive modulation and coding, when failed to provide the required SINR on some of the resource blocks, users in the uplink scheme will shift to a lower MCS which in most of cases will reduce their power transmission and the interference on neighboring FAPs, and in turn will reduce the transmission power of the other users.

Figure 4.11 displays the transmitted power and its variation over demand. Depending on users requests they will be allocated a number of resources to achieve their requirements. The number of resources depends on the MCS on each resource, hence the power and the SINR change accordingly. We can see from the figure how the power per demand increases almost linearly. Indeed, when users ask for a few resources we tend to allocate them with a high order MCS. Demanding users might be more difficult to satisfy and hence their requests are spread over a larger number of resources if failed to provide the required SINR for the considered MCS.

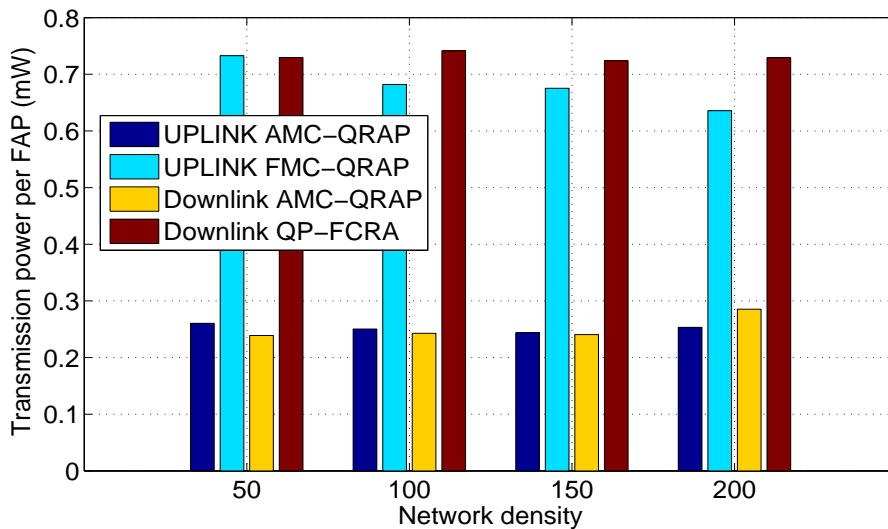

Figure 4.12: Mean Power per RB vs. Network Density

Figure 4.12 represents the average distribution of transmission power per tile over the entire spectrum. As it can be seen from the figure, when using the AMC, the power per tile needed has an average lower than 0.3 mW independently of the network load. Whereas

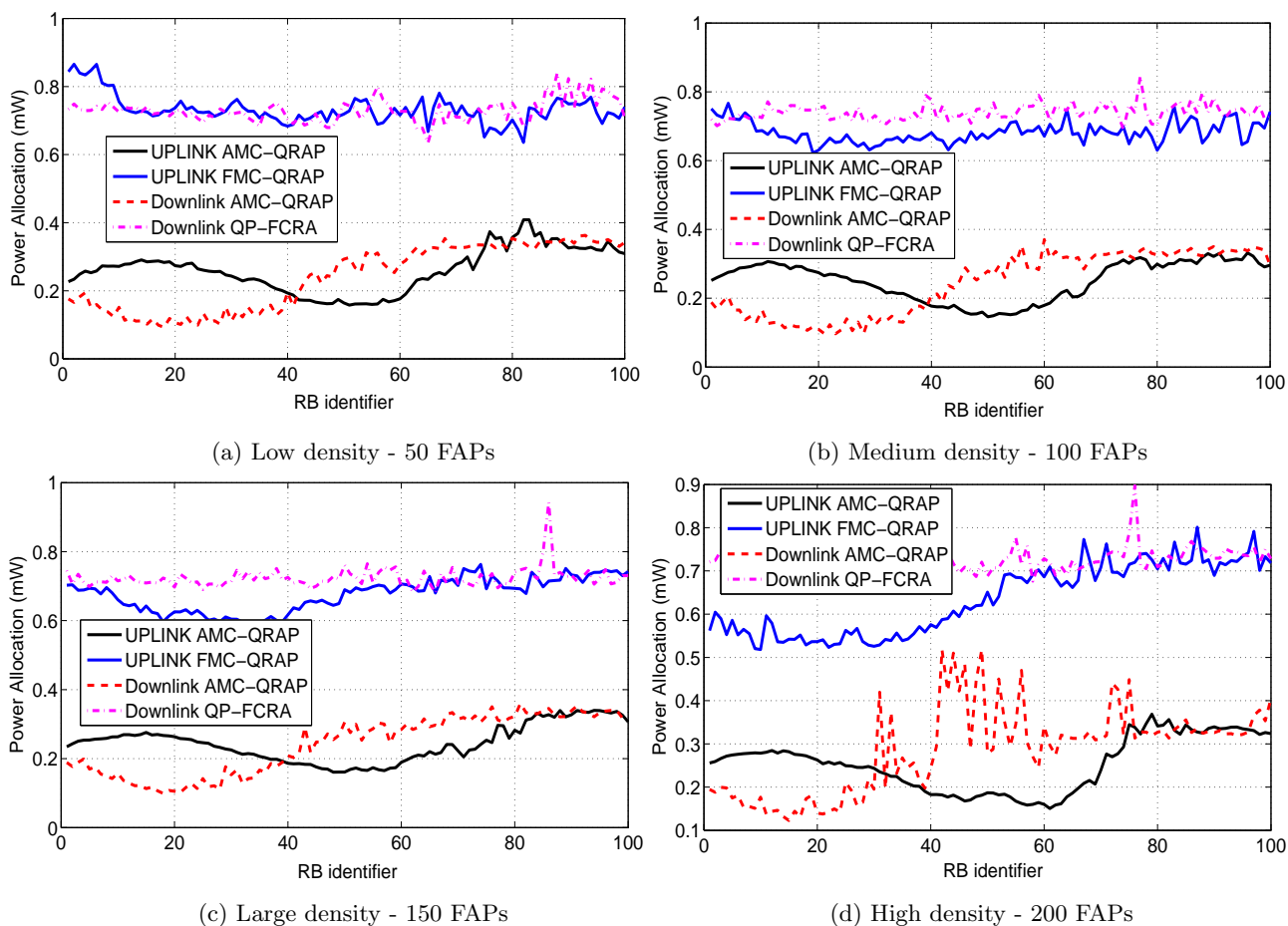

Figure 4.13: Average power transmission per tile

this ratio raises to more than 0.6 mW per tile for the schemes with fixed modulation and coding.

Let us have a more detailed view on the average power transmission on each tile of the spectrum by looking at the Figure 4.13. As shown for the four different network densities, we can observe that the distribution of power for the UPLINK is much smoother than the downlink case. As clearly shown in Fig. 4.13(d) for the high density network, we observe how the power fluctuates for the Downlink AMC-QRAP compared to the UPLINK AMC-QRAP. In fact, since the PAPR in the OFDMA is higher compared to the SC-FDMA, we can see the power distribution accordingly. As mentioned earlier, the PAPR is one of the main reasons to adopt the SC-FDMA in the uplink compared to the OFDMA in the downlink. Hence, on the physical level, other solutions should be investigated, and part of our work in the next chapter focuses on this matter.

4.7 Conclusion

The Uplink AMC-QRAP proposed algorithm is applied for the uplink direction of the LTE-based femtocell networks. The adopted multi-access transmission mode is the SC-FDMA scheme instead of the OFDMA used for the downlink. The motivation behind is the reduced PAPR value offered by this single carrier multiplexing mode. Indeed, this is a critical factor for the uplink since it increases energy efficiency and reduces implementation complexity of the mobile user equipment. In this chapter, before tackling to our uplink proposal model, we have described the SC-FDMA scheme and compared it with the OFDMA in terms of structure and performance. Then, we have described the system model to clearly formulate the proposed method where the spectrum sensing technique has been introduced, which is based on the wavelet transform processing tool. The spectrum sensing allowed us to detect the used blocks in the uplink and gather an interference input which help to reduce the complexity of the optimization model and hence the convergence time needed; this technique will be detailed in the next chapter. We have presented our uplink AMC-based power control and resource allocation algorithm while considering two types of users: HP and BE users as in the previous chapter. This deals with the required QoS differentiation. The optimization model for the uplink, considering a contiguous distribution of the allocated resources for the users has been introduced. With an adaptive modulation and coding scheme, we have based our resolution on the Cplex solver. Through extensive simulation results, we prove the outperformance of our proposal compared with the Fixed Modulation and Coding based approach as well as with the previously proposed approach performed in the downlink.

The power transmission obtained shows the energy consumption efficiency. However, from what is shown in the last two proposals, the downlink using OFDMA, which suffers from an increased PAPR and the uplink schemes using SC-FDMA, which represents limitation in terms of capacity and throughput, reach an asymptotic limit. From here rises the need for other solutions that should be studied and provided. In the next chapter we investigate the physical layer improvement mechanisms using the wavelet based approach to complete the enhancement provided in the link layer proposed in the previous chapters and to describe the spectrum sensing technique used to provide resolution enhancement for the uplink mode.

Chapter 5

Wavelet-based LTE Physical Layer Enhancements

5.1 Introduction

For wireless mobile network, continuously upgrading adopted techniques is an emergency issue for reply to the huge services demand. Considerable works have been achieved in order to develop the LTE-Small Cells techniques and solve their major challenges. Optimal and near-optimal solutions have been established as multi-access scheduling approaches especially for interference management and smart resource allocation.

In Chapters 3 and 4, we have proposed two efficient joint resource allocation algorithms with Adaptive Modulation and Coding technique for downlink and uplink LTE transmission, respectively. Specifically, in these chapters, we aimed to combine between Medium Access Control (MAC) and physical layer specifications. Firstly, multi-user scheduling and resource assignment while dealing with interference were considered. In other hand, modulation schemes and channel coding rate which are *physical layer transmission considerations*, are adaptively exploited in order to maximize throughput and respect a targeted Block Error Rate performance.

So far, preparing for LTE-Advanced standard, multiple proposals were carried out in different orientations in order to enhance performance and answer to rapidly growth services. Although fructuous results of all previous efforts in this domain, the improvements are extremely confronted asymptotically limits. In other terms, currently, the traditional broadband mobile systems reach their *saturation* state in sense of resource allocation and optimization scheduling.

Going deeper, we suggest for future evolving systems (e.g. 5th Generation) to exploit as much as possible the *physical layer signal processing considerations* and exceed traditional barriers. Building on the wavelet transform as a powerful signal processing tool, we aim to apply its encouraging impacts as enhancement basis for the evolution LTE systems.

In particular, we recall that the 3GPP adopts for the Uplink LTE connection the Localized SC-FDMA (L-SC-FDMA) technique alternatively to the OFDMA adopted for the downlink, as shown in the previous chapter. This is because the lower PAPR value offered by the (L-SC-FDMA) comparing with the OFDMA. Therefore, as first contribution in this chapter, we propose to perform the wavelet-based OFDM modulation technique as an alternative way of the Fourier-based OFDM for both uplink and downlink transmissions. Thus, while overcoming the Fourier-based OFDM limitations, the overall system capacity and performance will be considerably enhanced.

Moreover, in the second contribution, we describe the wavelet-based spectrum sensing technique introduced in the uplink resource allocation problem as mentioned in the previous chapter. This allows to increase the transmission reliability and reduce the convergence time of the optimization solution.

The remainder of this chapter is organized as follows. In Section 5.2, we present the wavelet transform as the core signal processing tool and we mention our concerned wavelet communication applications. Section 5.3 describes the Wavelet-based OFDM technique as alternative way of the Fourier-based OFDM. Then, we introduce in Section 5.4 a new proposal Spectrum Sensing technique built on the wavelet transform. In Section 5.5, we discuss the application of the wavelet-based techniques in the LTE wireless mobile system and beyond. Finally, Section 5.6 concludes this chapter.

5.2 Wavelet Signal Processing Tool

By nature, signal transform offers more information than the raw signal and is able to extract implicit signal features helpful for analysis. The wavelet transform is a promising processing tool that be able to analyze time-frequency signal behavior.

Although the Fourier transform is the most-known signal transform, the wavelet transform is more expanded in wider fields due to its powerful signal analysis. In the section, we present the motivation behind this transformation and an adequate description of its types and characteristics.

5.2.1 Fourier Transform: Analysis and Limitations

The Fourier Transform (FT) is the much affluent mathematical tool performed to reflect and analyze the signal frequency behavior while identifying the energy amount for each

elementary frequency in the signal. Essentially, the FT is adopted for the stationary signal where the frequency information doesn't vary with the time (the stationary notion is precisely formalized in the statistical signal processing literature). In the Fourier transform, the signal is globally analyzed regardless the instantaneous behavior of the constituted frequencies. Fourier coefficients are calculated as inner products of the signal with the sine-cosine wave basis, as expressed in the Equation 5.1.

$$T_{Fourier} : X(f) = \int_{-\infty}^{\infty} x(t)e^{-j2\pi ft} dt \quad (5.1)$$

where $x(t)$ is a finite energy function.

Limitations of the Fourier Transform

Although its wide success, the use of Fourier Transform is limited to the stationary signals. In non-stationary case, the FT can recover the frequency components of the signal, but it is not able to identify the time occurrence of each elemental frequency. In this sense, the same spectrum can represent signals that are totally different since the time-frequency information is hidden. In addition, non-causality property imposes knowing the whole time-domain signal for FT calculation; consequently, real-time analysis becomes impossible. Due to that, alternative transformation is necessary to overcome such limitations.

5.2.2 Short Term Fourier Transform- STFT

The Short-Time (or Term) Fourier Transform (STFT) is an elaboration of the FT to overcome some of its limitations; it has been introduced by the physicist Denis Gabor in 1940. Also called windowed Fourier Transform, the STFT is adopted to analyze non-stationary signal. Such signal is treated as sequence of stationary signals within a specific window. For a limited and short time interval, the variations of the signal frequency behavior can be neglected. The Fourier Transform is thus applied to this stationary signal portion. Then, by sweeping the entire signal, the combined time-frequency (f , a) information is evidenced as presented in Equation 5.2.

$$T_{STFT} : X(f, b) = \int_{-\infty}^{\infty} x(t)g(t - b)e^{-j2\pi ft} dt \quad (5.2)$$

This transformation displays the behavior of the frequency f around the position b ; this is a local-spatial analysis. We mean by window (or envelope), a smooth function $g(t)$ that is well localized in time and presents slow changes. Generally, it is chosen as a real and even function. The most known STFT is the *Gabor transform* corresponding to a Gaussian

window $g(t)$.

The window size depends on the signal portion that will be processed and it is filled with oscillations at different frequencies. Therefore, in order to analyze low frequency oscillations, we must employ broad window. The small size window is used to analyze high frequencies that represent fast oscillations and the discontinuities in a signal (i.e. peaks, abrupt changes).

However, the major lack of the STFT is that it is considered as **uniform resolution** analysis tool with respect to the time-frequency domain, since the size of the window doesn't change during the process along the whole signal. The analysis is not adapted to the non-regular signal structure. The high and low frequencies cannot be treated simultaneously. Thus, this fact is translated by a degradation of accuracy analysis where some signal features can be hidden. Therefore, a multi-resolution transform with variable window size becomes an important solution to efficiently analyze the non-stationary signals.

5.2.3 Wavelet Transform: Multi-Resolution Analysis

The uniform resolution transform is not so efficient for non-stationary signals since they are characterized by a high variations degree and present different time scales. In practice, most of the treated signals are non-stationary; thus, scientists have been oriented to find another efficient transform with a “**multi-resolution analysis**”. Researches have led to the “*Wavelet Transform*” tool. Such transform varies the analysis scale in term of the window width containing oscillations and scanning the whole signal. In this section, we present the wavelet transform and its different types.

5.2.3.1 Definition and Characteristics

Unlike the Fourier Transform, the Wavelet Transform WT is adopted for the non-stationary signal and presents a local analysis of different signal frequency components. In contrast of the fixed-windowed Fourier transform, the WT is a Multi-Resolution Analysis (MRA) processing tool where the principal is based on the utilization of an *automatic adjustable window*, short windows for high frequencies and wide windows for low frequencies. This window is defined by a basis window function called wavelet; the term “*wavelet*” means small wave. An original prototype function also called *mother wavelet* is adaptively dilated or contracted as well as translated along the whole signal generating a *family of wavelets* as expressed in Equation 5.3.

$$\psi_{a,b}(t) = \frac{1}{\sqrt{a}}\psi\left(\frac{t-b}{a}\right) \quad (5.3)$$

a and b are the scale and translation parameters respectively. The $a^{-1/2}$ factor is used to normalize the energy for different scales. The wavelet functions oscillate around the position b with a frequency equal to $1/a$. When the scale value a becomes smaller, the oscillations becomes more contracted around the point b and the wavelet performs a zooming effect on the interesting signal region. In other terms, the processing by wavelets is considered as a mathematical microscope with a resolution equal to $1/a$.

The mother wavelet function is an oscillating waveform with a finite length and fast-decaying structure that must satisfy the following conditions:

- Admissibility in the frequency space: Fourier Transform of the wavelet function takes a “null” value for “null” frequency. This implies that the wavelet $\varphi(t)$ has a zero mean value and so band-pass spectrum: $\int_{-\infty}^{\infty} \varphi(t)dt = 0$.
- Continuity, integrability and with finite energy.

We cite some mother wavelet examples related to the type of the window adopted i.e. *Gaussian, Morlet, Haar, Daubechies, Meyer* and so on. Each mother wavelet is specified by its proper characteristics and presents different resolution types. The choice of the mother wavelet is based on the physical process to be analyzed. In the literature, the authors consider that this step is the most important task in the wavelet analysis. The successful function is that closely adapted to the analyzed signal form what the required signature must be extracted. The main factors that characterized a wavelet function are as following:

5.2.3.2 Types of the Wavelet Transform

There are two major types of wavelet transform: the Continuous Wavelet Transform (CWT) and the Discrete Wavelet Transform (DWT). They differ by the method to discretize the scale and translation parameters, a and b respectively. Further, an extension of the DWT referred as Wavelet Packet Transform (WPT) is also presented.

Continuous Wavelet Transform (CWT)

The CWT of a function $x(t)$ is given by the Equation 5.4,

$$T_{wavelet} : C_{(a,b)} = \int_{-\infty}^{\infty} x(t) \cdot \psi_{(a,b)}^*(t) dt \quad (5.4)$$

where $\psi_{a,b}^*(t)$ is the orthonormal wavelet basis given by the scaling and translation of the mother wavelet function, as shown in Equation 5.3. Thus, the CWT is considered as the

inner product of the function to be analyzed and the wavelet basis functions, reflecting the correlation between them. The $C_{(a,b)}$ coefficient is proportional to the $x(t)$ signal and measure its oscillations at the scale $-a-$ around the position $-b-$. Therefore, when the original signal and the wavelet oscillate at the same frequency, their correlation becomes maximized and the CWT coefficient values are increased. Contrarily, when the two functions are not in a resonant state, the $C_{(a,b)}$ coefficient values become neglected, since they are the product result of a zero-mean function $\psi_{(a,b)}^*$ with a practically constant one.

Due to the admissibility condition, the CWT is reversible and thus, the original signal can be perfectly reconstructed with respect to the Equation 5.5

$$S(t) = \frac{1}{C_\Psi} \int_{-\infty}^{\infty} \int_{-\infty}^{\infty} C(a,b) \cdot \hat{\Psi}_{a,b}(t) \frac{dbda}{a^2} \quad (5.5)$$

where $C_\Psi = \int_{-\infty}^0 \frac{|\hat{\psi}(\omega)|^2}{|\omega|} d\omega = \int_0^{+\infty} \frac{|\hat{\psi}(\omega)|^2}{|\omega|} d\omega < \infty$ and $\Psi(w)$ is the Fourier transform of the $\varphi(t)$.

Discrete Wavelet Transform (DWT)

The parameters (a, b) of the CWT takes continuous values, a fact that is not appropriate for the digital computer processing. Thus, the DWT is adopted by discretizing the parameters (a, b) as: $a = a_0^j$ and $b = k \cdot a_0^j b_0$ for $j, k \in \mathbb{Z}$; where $a_0 > 1$ is the dilated scale parameter and $b_0 \neq 0$ is the translation parameter.

Hence, the wavelet family functions becomes as follow:

$$\psi_{j,k}(t) = a_0^{-j/2} \psi(a_0^{-j} t - kb_0) \quad (5.6)$$

So, the DWT of a signal $x(t)$ is given by the Equation 5.7 where the time-frequency plan is discretized basing on a logarithmic sampling.

$$D_x(j, k) = \int \psi_{j,k}^*(t) \cdot x(t) dt = \langle \psi_{j,k}(t) x(t) \rangle \quad (5.7)$$

Wavelet function $\psi(t)$ must be chosen in such way that the basis function set $\psi(j, k)$ formed an orthonormal basis of $L^2(\mathbb{R})$. Inversely, the original signal can be perfectly reconstruct by the Inverse DWT (IDWT) as follow:

$$x(t) = \sum_j \sum_k D_x(j, k) \cdot \psi_{j,k}(t) \quad (5.8)$$

The Multi-Resolution Analysis of the DWT is performed by a filtering process where the coefficients are determined by the wavelet basis functions. the filters types differ according

to the mother wavelet types. A pair of finite impulse response filters, LowPass (h_0) and HighPass (h_1) filters, decomposes the input signal $x(t)$ to “approximation” and “details” coefficients respectively (Figure 5.1). This process is iterated to decompose the approximation signal again at each resolution level. Mathematically, this decomposition algorithm is represented by the following Equations:

$$\begin{aligned} \text{Approximations } A_L^{(j+1)}[K] &= \sum_{i=1}^n A_L^{(j)} \times h_0[2K - i] \\ \text{Details } D_H^{(j+1)}[K] &= \sum_{i=1}^n A_L^{(j)} \times h_1[2K - i] \end{aligned} \quad (5.9)$$

For the standard DWT, the downsampling by a factor “2” is added; the size of approximate (scaling) coefficients and detail (wavelet) coefficients decreases by a factor of two at each successive decomposition level.

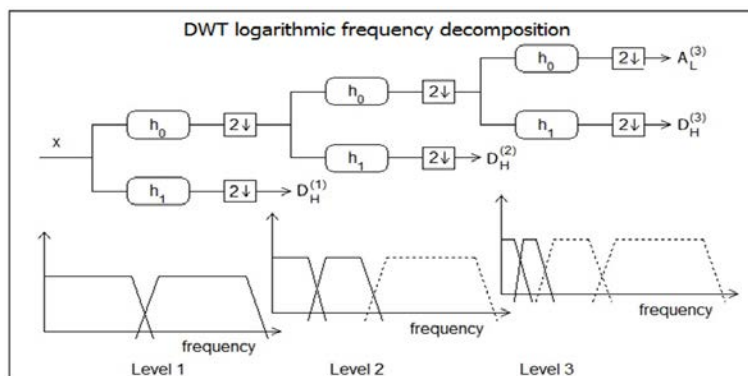

Figure 5.1: DWT decomposition filtering process

As for the frequency domain, the aforementioned signal decomposition is reflected by a logarithmic successive decomposition of the spectrum, as shown in Figure 5.1. It clearly shows that the multi-resolution analysis is accomplished by the multi-level decomposition corresponding to different categories of frequencies. This is the core propriety of the decomposition by the wavelet transform where the resolution can be adjusted by the number of decomposition level performed in the filtering process.

Inversely, the original signal is reconstructed from the last approximation coefficients and all detail coefficients as follow: $A_L^{(j-1)} = A_L^j + D_H^j$. The reconstruction stage is based on the synthesis filters and referred to the synthesis phase as shown in Figure 5.2. In this case the synthesis filter coefficients are closely related to the analysis filters of the decomposition DWT phase (identical but with time reversal). Thus, such relation is such that $\tilde{h}_0 = \text{inverse}(h_0)$ and $\tilde{h}_1 = \text{inverse}(h_1)$; where $y = \text{inverse}(x)$ is defined by $y(K) = x(-K)$, $K \in \mathbb{Z}$.

The combined structure of analysis and synthesis filter bank guarantees the perfect reconstruction of the original signal at the receiver front-end.

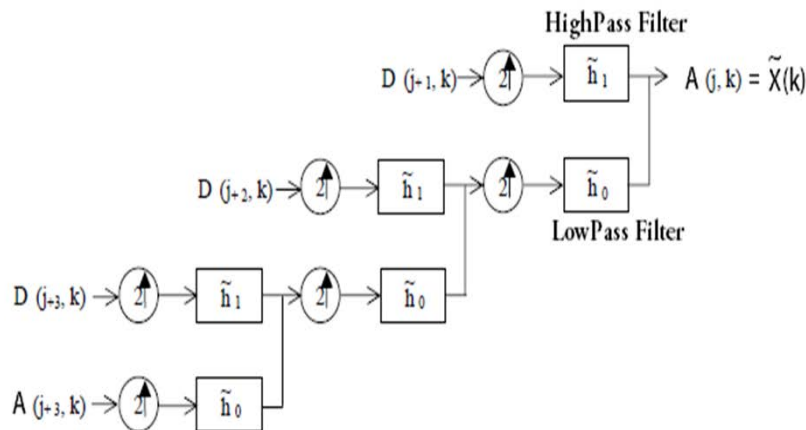

Figure 5.2: IDWT synthesis filtering process

Wavelet Packet Transform (WPT)

In the above decomposition, using the DWT, only the approximate coefficients are decomposed again and decimated by 2. This is translated by a logarithmic decomposition of the bandwidth as shown in Figure 5.3 (a).

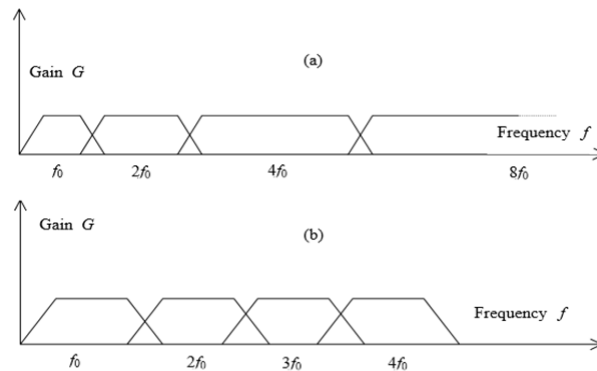

Figure 5.3: Spectrum decomposition: (a) logarithmic for DWT and (b) linear for WPT

The Wavelet Packet Transform is an extension of the DWT obtained where both approximate and detailed coefficients undergo the same operation of decomposition and decimation at each level. It represents a generalization of the multi-resolution analysis.

The orthogonal basis functions associated with this transform are referred as “wavelet packets”. They form basis functions that retain many of the orthogonality, smoothness, flexibility and localization properties of their mother wavelets. The Figure 5.4 presents the block diagram of the WPT where the decomposition offers a uniform bandwidth resolution as shown in Figure 5.3 (b). In fact, the multi-resolution analysis is achieved by selecting the number of decomposition levels.

Thus, this decomposition pattern offers a high flexibility analysis and it is better suitable

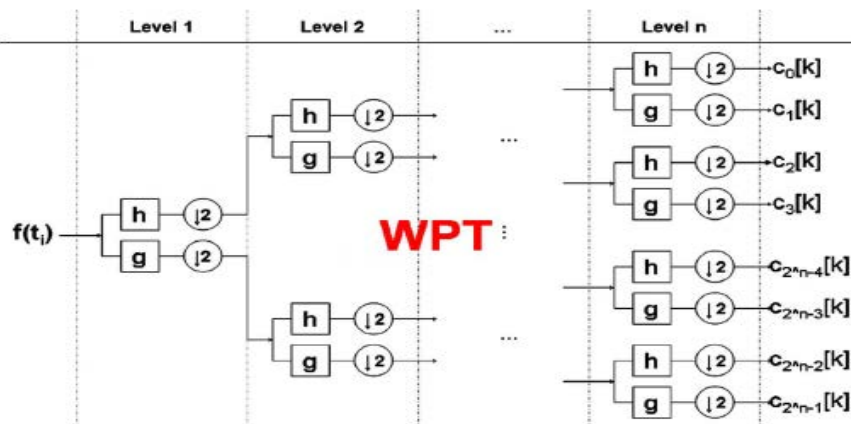

Figure 5.4: WPT decomposition filtering process

for multi-carrier transmission. In addition literature shows that it is robust against tone and impulse noise types but with complex data-structure [55], the computation complexity for WPT is $O(n.\log(n))$.

5.2.3.3 Wavelet in Communications and Application fields

The wavelet transform is widely used in much expanded domains and for many purposes. Originally, it is introduced for the image high resolution compression as 2-Dim analysis. Furthermore, WT is then applied in the biomedical, physics, communication and engineering fields, geophysical area and so on; we cite some applications such as [75]:

- Data and image compression
- Edge detection and extracting abrupt changes locations
- Smoothing de-noising
- Signal processing and speech recognition
- Blood-pressure measure and Electro-Cardio Gram (ECG) analysis
- Biology for cell membrane recognition, to distinguish the normal from the pathological membranes
- Fingerprint verification
- Seism vibrations analysis

Thus, utilizing its multi-resolution capabilities as well as the fast and flexible filter bank implementation, the wavelet transform is satisfied for various application categories.

The scope of our interest is the communication field, so we focus on the wavelet applications oriented to enhance some advanced communication techniques and resolve many problems for such system. Predominantly, we have exploited, in this thesis, the wavelet transform benefits according to two concerned axes in wireless communication:

A. Wavelet-based Orthogonal Frequency Division Multiplexing (DWT-OFDM)

The OFDM is a special form of multi-carrier transmission where a large number of orthogonal, overlapping, narrowband sub-channels are transmitted in parallel and divide the available transmission bandwidth.

However, the conventional Fourier-based OFDM technique suffers from some drawbacks that must be overcome. In the follow Section 5.3, we introduce the wavelet transform to the OFDM system as an alternative based approach. Due to the compact “*orthogonal basis*” of the wavelet family functions as well as the wavelet “*de-noising*” high capability, the multicarrier OFDM system performance becomes enhanced and the OFDM limitations are considerably surpassed.

B. Wavelet-based Spectrum Sensing technique

Moreover, we have introduced the wavelet transform to the spectrum sensing technique. The Spectrum Sensing is principally adopted for the “Cognitive Radio” applications, in order to avoid interference and dynamically manage the spectrum in coexistent standards. In matter of fact, the available free spaces in spectrum, also called “spectrum holes”, must be identified. Originally, over the existing Spectrum Sensing approaches, energy detector based techniques are the most common way of Spectrum Sensing due to their low computational and implementation complexities. Nevertheless, at very low SNR, the energy detector suffers from noise uncertainty and it doesn’t applicable to detect broadband and weak signals such as spread spectrum signals.

Benefit from the “*edge detection capability*” of the wavelet transform, the wavelet-based spectrum sensing technique is treated in the Section 5.4 to accurately locate the spectrum holes and automatically pick the limits of the occupied bandwidths.

C. Symbol period estimation for the Linear digital modulation

In addition to the above contributions that will be treated in the next sections, the wavelet transform is applied to estimate the modulated symbol period of the single-carrier signal. Indeed, in order to correctly recover transmitted data and demodulate received signal, the receiver requires to accurately know the symbol period. In *blind* transmission when the receiver ignores information about the transmitted signal parameters (non-cooperative

network), an efficient estimation of the symbol period is an essential task. For the linear modulation schemes (M-ary ASK, M-ary PSK, M-ary QAM), where the amplitude and/or phase of the signal carry the information, the signal displays abrupt changes at the symbol period or at its multiple values.

Therefore, due to the wavelet high capacity to detect discontinuity structures and zoom on the signal abrupt changes, in [76], we have used this transform to estimate the symbol duration of the linear modulated signal. For sinusoidal oscillations, the wavelet transform coefficients exhibit an oscillatory pattern at scales where the oscillation length in the wavelet window approximates the “period of the modulated sine wave”. We note that this issue is out of the scope of this thesis.

In the next section, we begin by the DWT-OFDM technique presentation as the first concerned wavelet application for this thesis.

5.3 Wavelet-based OFDM Multicarrier Approach

The powerful wavelet transform is introduced to the multicarrier OFDM system as an alternative solution of the Fourier-OFDM limitations and that is notably treated in the recent literature [52, 77]. Consequently, an enhanced wavelet-based multicarrier OFDM technique is proposed providing another form orthogonal basis based on the wavelet functions. This is presented in this section where the performance is analyzed comparing with that of FFT-OFDM system.

5.3.1 Fourier-based OFDM Limitations

Unfortunately, the FFT-based OFDM scheme suffers from several serious limitations that can be summarized in the following:

a) Spectral Efficiency Reduction

For the FFT-based OFDM, a Cyclic Prefix (CP) must be added as redundant information at the head of the transmitted signal. The Inter-Symbol Interference (ISI) becomes mitigated when the length of the CP becomes greater than the spreading delay of the channel. In addition, the FFT-OFDM requires sending pilot tones to facilitate synchronization and carrier offset estimation. However, those additive transmitted bits reduced the spectral efficiency since they don't carry any data information. Practically, this efficiency lack is critical for high data rate requirement systems (e.g. LTE and beyond) since it affects the overall system throughput.

b) High Peak-to-Average Power Ratio (PAPR)

As presented in the Chapter 4, the high PAPR is not so appropriate for energy efficient systems. we recall that in conventional OFDM, each subcarrier independently carries the parallel transmitted symbol and the subcarriers of the same OFDM symbol may experiment different modulations (BPSK, QPSK, 16-QAM, 64-QAM and so on). As well known, symbol constellations of each modulation scheme have a specific average power with respect to the symbol mapping in the *Inphase/Quadrature* complex plan. Consequently, OFDM subcarriers may have different power values and thus, the PAPR may take a high value (Noting that the PAPR expression is given in the previous Chapter by Equation 4.1). In this case, using linear amplifiers, which multiply the whole signal by a constant high factor, is not suitable for a reliable signal reception. Unfortunately, the need for high complexity non-linear amplifiers with large dynamic range arises.

c) Synchronization Requirement(Orthogonality Impairments)

FFT-based OFDM technique suffers from large side lobes appeared in the frequency domain due to the rectangular window employed as pulse shaping filter at the transmitter side. In fact, we remind that any abrupt change in the time domain causes a spreading behavior in the frequency domain and vice versa. So, if the subcarriers orthogonality is not perfectly maintained, the system suffers from a high Inter-Carrier Interference (ICI) level and the complex synchronization techniques become so essential.

Accordingly, performing an alternative approach oriented to overcome FFT-based OFDM limitations becomes an important issue and motivates us to present the new proposal based on the wavelet transform.

5.3.2 Wavelet Orthogonal basis for Multicarrier Transmission

Similarly to the Fourier transform, the wavelet transform offers an orthogonal basis formed by the wavelet family functions and therefore, guarantees the orthogonality of the subcarriers in OFDM symbol. In Fourier analysis, the signal is decomposed into a set of sum “sine” and “cosine” and guaranteeing the orthogonality between the symbol component in the frequency domain. Whereas, in wavelet analysis, the signal is successively decomposed by the pair of orthogonal low-pass (LP) and high-pass (HP) filters referred to the Quadrature Mirror Filters (QMF). In fact, this orthogonal basis constitutes the impulse response coefficients of these filters. Assuming g and h the filter coefficients of the LPF and HPF respectively, they are orthogonal and normal to each other according to the following

conditions:

$$\begin{aligned}
 \langle g, g^* \rangle &= 1 & (a) \\
 \langle h, h^* \rangle &= 1 & (b) \\
 \langle g, h^* \rangle &= 0 & (c) \\
 \langle h, g^* \rangle &= 0 & (d)
 \end{aligned}
 \tag{5.10}$$

where (a) and (b) are related to the normal property and accordingly (c) and (d) are for orthogonal property.

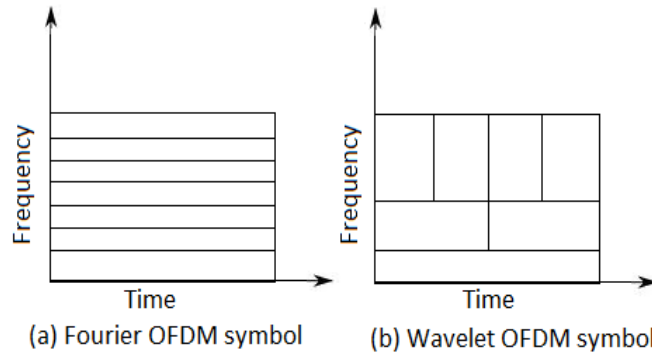

Figure 5.5: Fourier-OFDM symbol vs. wavelet-OFDM symbol

Unlike Fourier Transform that divides the whole bandwidth into orthogonal sub-channels of equal bandwidths, Wavelet Transform is a multicarrier transmission method that assigns data to sub-channels having different time and frequency resolutions as shown in Figure 5.5. Thus, the Wavelet OFDM symbol is characterized by a time-frequency specification.

5.3.3 Wavelet-based OFDM Alternative System

Due to the orthogonal basis provided by the wavelet transform, the wavelet-based OFDM technique becomes a promising multicarrier transmission mode. Particularly, it presents the same combating property of the multipath effect than the Fourier-OFDM and their implementation structures are generally similar. The main differences are the 1) substitution of the FFT component by the DWT one and 2) removing the Cyclic Prefix block. We refer this approach to a DWT-based OFDM presented in the Figure 5.6, where the IDWT/DWT blocks are detailed and explained as a DWT filter bank in the section above.

Focusing on the IDWT block, the data transmission is detailed in the Figure 5.7. The input data stream is modulated and arranged in parallel form. Then, the IDWT is applied to the modulated wavelet symbols: the parallel input data present the lowpass data coefficients or approximation data as designed by “CA” in Figure 5.7. This is the synthesis phase; CA symbols are the inputs of the lowPass filters represented by the approximated wavelet coefficients and explained as reconstruction IDWT filter bank (Figure 5.2).

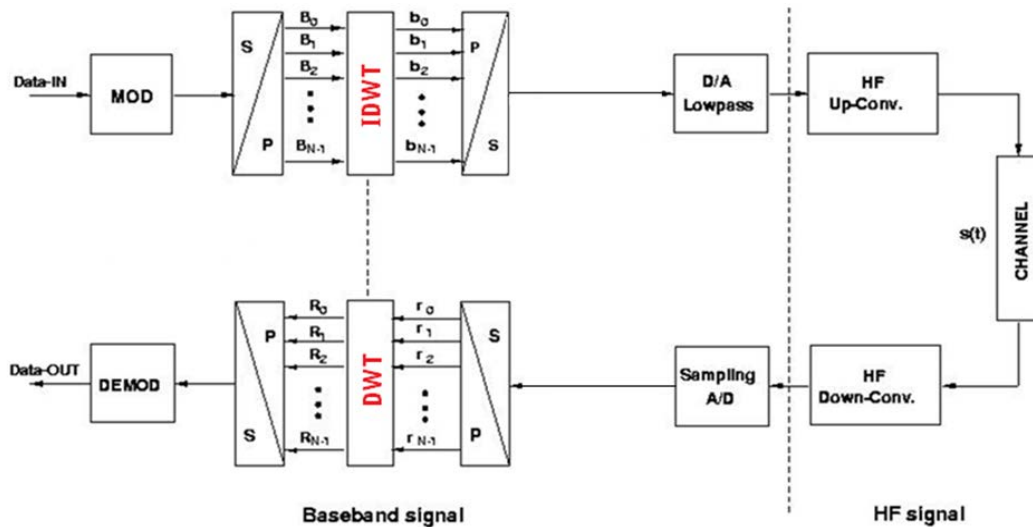

Figure 5.6: Wavelet-based OFDM transmission chain

In other hand, the detailed data, those present the high frequency components are set to “zero” since the digital signal before up-conversion is a lowpass (baseband) signal. The reverse way is performed at the reception where the DWT block refers to the wavelet signal decomposition.

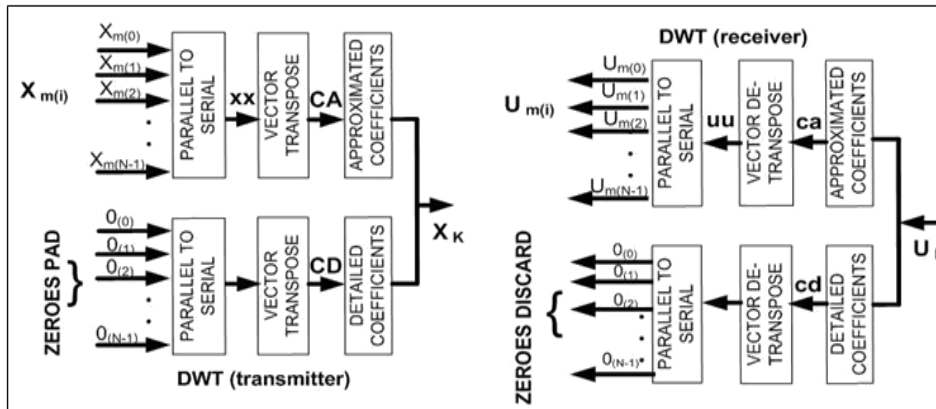

Figure 5.7: DWT transceiver

5.3.4 How the wavelet alleviates the Fourier-based OFDM problems?

a) Spectral Efficiency Improvement

As shown above, unlike Fourier OFDM, the wavelet-based OFDM doesn't require guard interval or cyclic prefix (CP) for OFDM symbol transmission to deal with the channel delay spreading. This is referred to the overlapping nature of wavelet function properties. There-

fore, the data stream doesn't carry redundant information, fact that explicitly enhances the data rate and the spectral efficiency.

b) Low PAPR level

The smoothness property of the wavelet functions contributes to reduce the peaks level in the transmitted signal. Moreover, since the DWT component can be assimilated to filtering process, the pulse shaping of the filter can be controlled by choosing a suitable wavelet functions in order to reduce the PAPR level. In that case, Theorem 1 proves this fact [78]:

Theorem 1: "For a multicarrier modulation with M channels that uses a modulated pulse shaping $\psi(t)$, the PAPR of the transmitted signal is upper bounded by:

$$PAPR \leq M \cdot \max_{0 \leq t \leq T_s} |\psi(t)|^2$$

and $PAPR \leq M$ when $\psi(t)$ is a rectangular pulse shaping used by OFDM modulation.

For the use for multicarrier modulation, we make use of the pulse shaping characteristics and we postulate for low PAPR transmission: $\max_{0 \leq t \leq T_s} |\psi(t)|^2 \leq 1$.

Accordingly, to reduce the PAPR level, the pulse shaping that reduces $\max |\psi(t)|^2$ is adopted without decreasing the symbol energy. Consequently, the reduction of the PAPR level can significantly enhance the energy efficiency of the system [55, 79, 80].

c) ICI and ISI mitigation

In addition, the DWT-based OFDM is a promising way to significantly reduce Inter-Carrier Interference (ICI) and Inter-Symbol Interference (ISI). Indeed, the secondary side lobes of different subcarriers in the frequency domain are reduced. In view of the fact that the type of the window used to translate to the wavelet domain is not rectangular. So, the spectrum occupation shrinks comparing to the Fourier-based OFDM spectrum. Thus, any loss of the subcarriers orthogonality caused by lack of time and/or frequency synchronization doesn't lead to a severe ICI since the additional interference is considered as so slight. Moreover, the need to a complex synchronization requirements and algorithms is ignored. In other hand, as for the ISI, due to the local analysis and the compact support of the wavelet functions the wavelet symbols become well localized in time domain and the overlapping degree between those symbols is decreased.

d) Decreasing Bit Error Rate (BER)

Although the wavelet-based OFDM system presents the same degree of combating multipath effects, its performance is noticeably enhanced thanks to the ‘*de-noising capacity*’ of the wavelet transform [52]. In addition, due to the high capacity to alleviate the ISI and ICI, as explained above, the transmission link is more reliable. Thus, at the receiver, the decoding and data recovering become more efficient and the system is more robust against the overlapping and time/frequency synchronization errors. The transmission quality in term of “Bit Error Rate” is significantly improved.

5.3.5 Simulation Results and Comparison

In order to confirm the above theoretical benefits we present the simulation results obtained in an AWGN environment and with respect to the parameters shown in Table 5.1.

Table 5.1: DWT-OFDM system simulation parameters

Parameters	FFT-OFDM	DWT-OFDM
Modulation Scheme	16-QAM	16-QAM
Number of subcarriers	128	128
CP	26	–
Bit stream	512	512
Repetition time	20000	20000
Wavelet type used	–	Haar
SNR range (dB)	1-20	1-20

A. Spectral Efficiency Metric

The spectral efficiency of the Wavelet-based OFDM is better than for Fourier-based OFDM: 1) first, the data rate significantly increases, and 2) the spectrum occupation shrinks due to the side lobes level reduction. Considering the 16-QAM modulation scheme, Figure 5.8 shows that the signal occupation in the frequency domain decreases from 2.6KHz and 2.4KHz for the raw 16-QAM and FFT-based OFDM respectively to 1.9KHz for the DWT-based OFDM respecting the same level of Power Spectral Density equal to -60dB/Hz .

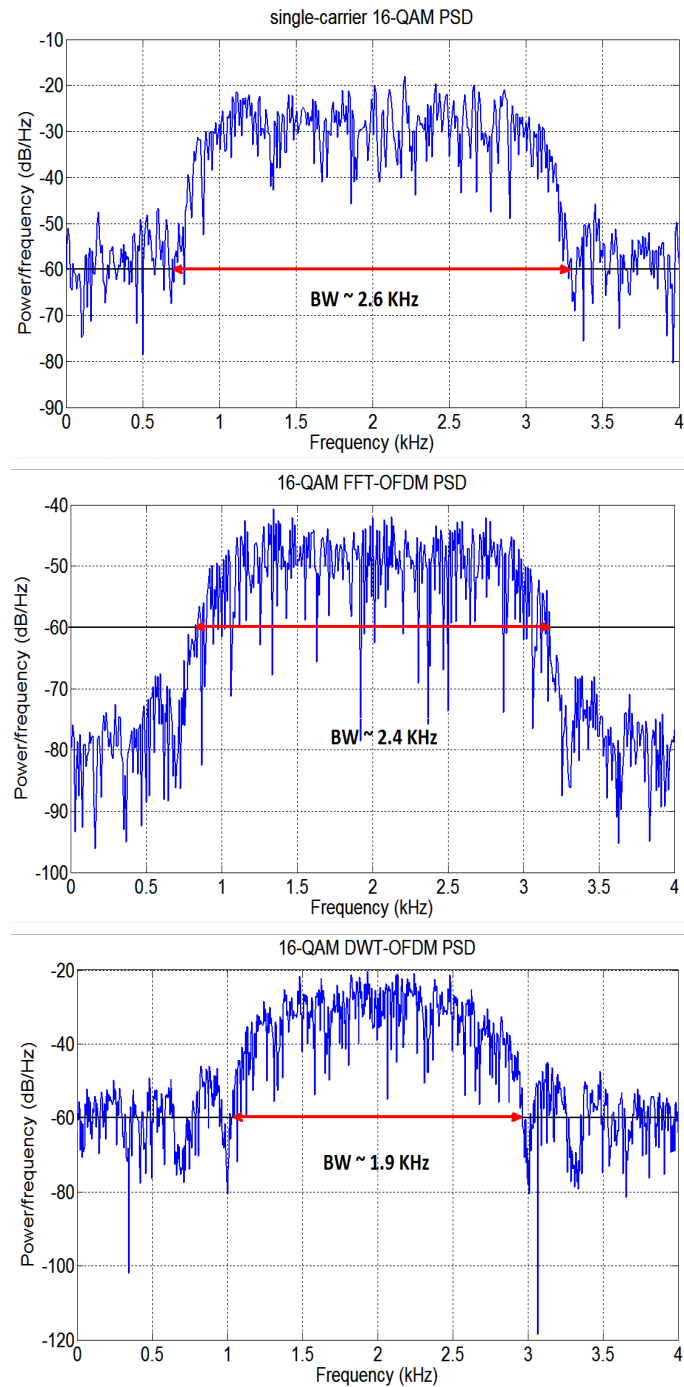

Figure 5.8: Spectral efficiency comparison between: DWT-OFDM, FFT-OFDM and single carrier 16-QAM signals

B. Peak-to-Average-Power Ratio Metric

Figure 5.9 confirms the PAPR-enhancement benefit of the DWT-based OFDM over the FFT-based OFDM. The PAPR is compared for four modulation schemes: BPSK, QPSK,

16-QAM and 64-QAM. As examples, the probability that the PAPR value becomes greater than 11dB decreases from 1 for the FFT-OFDM to 4.10^{-4} for the DWT-OFDM for the 16-QAM modulation. this probability decreases to 8.10^{-2} for the 64-QAM. These results are very considerable in the wireless communication system especially in term of power consumption saving and implementation simplicity. Moreover, we show that the PAPR value proportionally increases with the “modulation order” in the DWT-OFDM case. However, the FFT-OFDM PAPR values are independent from the modulation order. We observe in the Figure that the BPSK and QPSK modulation schemes present the lowest PAPR values for the DWT-OFDM; this is interpreted by the fact the these two modulation types give a constant envelope (fixed amplitude) for the signal.

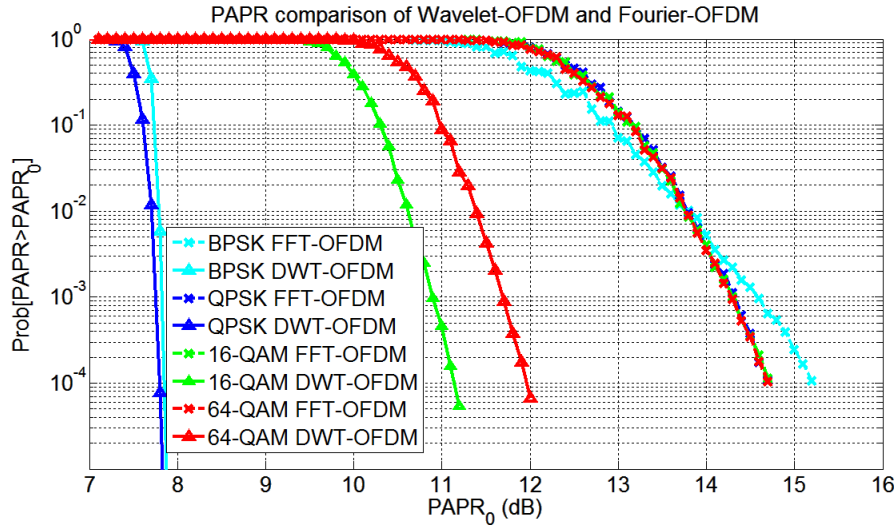

Figure 5.9: PAPR comparison between DWT-OFDM and FFT-OFDM

C. Bit Error Rate Metric

Compared to the FFT-OFDM, the DWT-OFDM is more reliable and the performance in term of Bit Error Rate is notably enhanced as shown in Figure 5.10. In Additive White Gaussian Noise (AWGN), DWT-OFDM presents a “ 3dB SNR gain” over the FFT-OFDM. Thus, the “de-noising” advantageous effect is *automatically incorporated* in the adopted wavelet system and the Gaussian noise effect is consequently reduced.

In this section, we have described the new wavelet-based OFDM proposal as an alternative technique promising to remediate the conventional Fourier-based OFDM. In next section, we present our second concerned application of the wavelet transform useful for our thesis scopes.

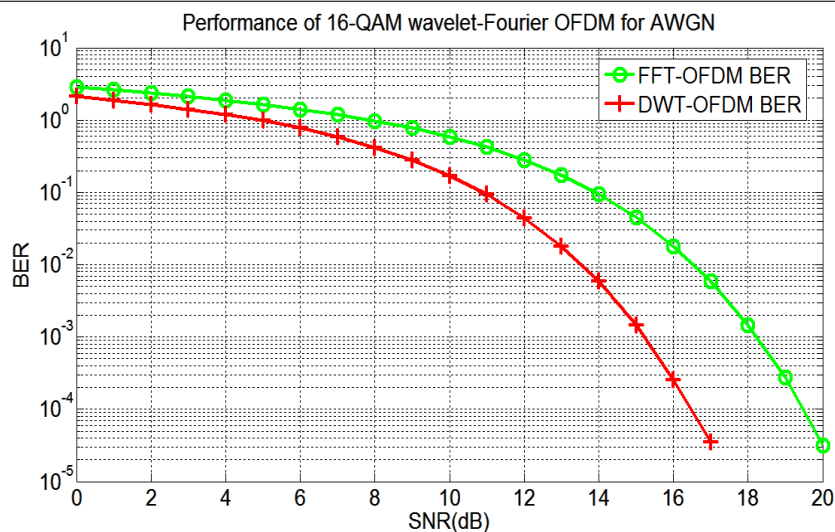

Figure 5.10: BER comparison of DWT-OFDM vs. FFT-OFDM in AWGN channel

5.4 Automatic Wavelet-based Edge Detection for Spectrum Sensing

Spectrum Sensing techniques, principally adopted for the “Cognitive Radio” applications, search the unoccupied channels (white spaces) in the Primary Users (PU) licensed spectrum Figure 5.11. This allows secondary users (SU) to take decisions about the reuse of these holes. Doing that offers dynamical spectrum accessing, fact that maximizes the utilization of the spectrum resource [81–83].

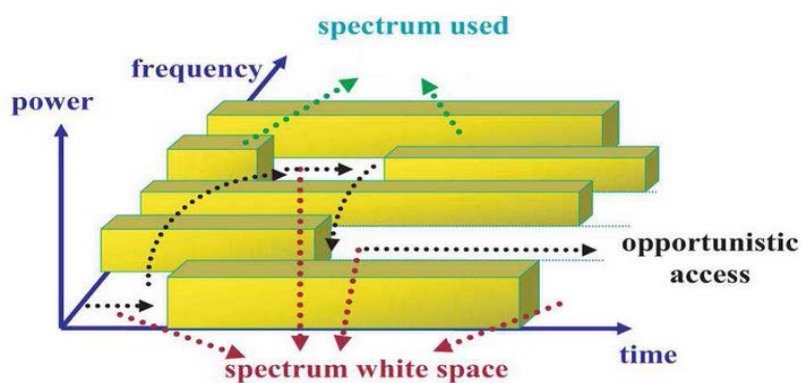

Figure 5.11: Dynamic spectrum allocation

For our uplink scheduling proposal presented in the Chapter 4, we have introduced the spectrum sensing technique in order to enhance the accuracy and performance of the resource allocation problem while mitigating the interference. Particularly, we aim to efficiently detect the allocated resource blocks while accurately delimiting them and measuring

the overall transmit power on each one. Doing that, before transmitting the signal and allocating the RBs for its user, each FAP it is able to clearly and accurately identify the available RB that may be allocated as well as to determine the power value that can be transmitted according to the measured interference level on each RB.

Therefore, the major objective of the spectrum sensing task in such context is the detection of the bandwidth edges of a received signal and measure the power value on each sub-channel over a predefined band of interest. Regarding the excellent ability of the wavelet transform to detect edges and discontinuities of the signal structure, we propose in what follow the wavelet-based spectrum sensing algorithm to achieve the mentioned objectives.

5.4.1 Edge Detection Wavelet Property

Before describing the wavelet-spectrum sensing algorithm, let us present the edge detection wavelet property. Indeed, “Edges Detection” is a significant task in many application fields (i.e. signal and image processing). In fact, singularities and discontinuous structures in a signal often carry essential information and some features and parameters can be reflected by this irregular configuration (for example, in images, discontinuities may represent obscuring contours of objects in a scene). Mathematically, the singularity point is the point where the signal is not continuous or has not a continuous first derivation. We determine a function’s singularity with respect to a coefficient, called “Lipschitz exponent”. If it is lower than 1 at a local point, the function presents singularity at this point [84].

In general, a mathematical signal transform carries more features than a raw signal. Particularly, the wavelet Transform exhibits excellent ability to analyze signal singularities by zooming on localized signal structures. This procedure happens progressively by reducing the scale parameter.

Furthermore, signal features produce relatively large wavelet coefficients at scales where the oscillation in the wavelet correlates best with the signal behavior at a specific local point. Consequently, the local maxima of the wavelet transform modulus provide helpful information to retrieve edges and singularity structures.

5.4.2 Wavelet-based Spectrum Sensing Approach

For spectrum sensing purpose, we describe in this section an automatically wavelet-based edge detection approach. To be aware about the access medium, the occupied bandwidth spaces separated by white spaces must be identified; in other terms the holes in the spectrum must be accurately delimited. In particular, these holes are the licensed spectrum bands, not currently in an exploited state.

5.4.2.1 System Model

At the receiver side, we consider receiving signals from K users allocating N resource blocks where the whole spectrum has a fixed range B as presented in Figure 5.12.

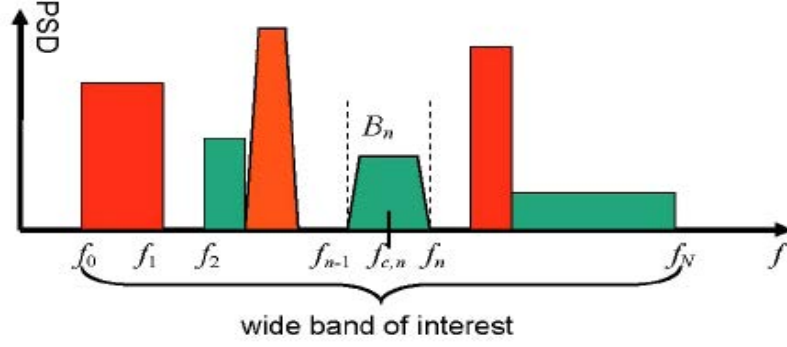

Figure 5.12: N frequency band with different PSD levels

The intercepted signal in the time-domain is:

$$y(t) = \sum_{k=1}^K \alpha_k x_k(t) + w(t) \quad (5.11)$$

where α_k is the path gain and $w(t)$ is the Additive White Gaussian Noise (AWGN) with zero-mean and two-sided PSD $S_w(f) = \frac{N_0}{2}$.

Each transmitted signal $x_k(t)$ is expressed as:

$$x_k(t) = \sum_{j=-\infty}^{+\infty} b_j h(t - jT_s) e^{i2\pi f_c k t} \quad (5.12)$$

where $\{b_j\}$ are the digitally modulated symbols, $h_n(t)$ is the pulse shaping filter response of bandwidth $B_n = f_n - f_{n-1}$ (Figure 5.12).

Due to the whiteness of the additive noise $w(t)$, we can reduce its effect by introducing the autocorrelation. Thus, the interested signal for processing is the autocorrelation of the intercepted signal $y(t)$. Morlet wavelet function is used in this work, it is expressed by: $e^{-\frac{t^2}{2}} \cos(5t)$.

Let us note $P_n(f)$ the Power Spectral Density (PSD) of the received signal on the sub-channel B_n . The receiver must be measure the $P_n(f)$ value for each allocated RB. We note here that this value represents the overall interference power value on the RB and it is useful for the user trying to allocate such RB in order to avoid interference of its uplink transmission.

5.4.2.2 Approach Description

In this method, we focus on the PSD function singularity structures representing the bandwidth edges of the intercepted signal in the frequency domain. We describe our strategy as follow:

- Firstly, the autocorrelation of the intercepted signal is performed in order to reduce the white noise effect. Then, through the Fourier transform, we obtain the autocorrelated signal spectrum $A_y(f)$.
- Secondly, in order to detect spectrum edges, we calculate the wavelet transform of $A_y(f)$: we apply the convolution product between the $A_y(f)$ and the FT of Morlet wavelet function (the convolution refers to the wavelet filtering process).
- Finally, by picking the local maxima of the wavelet modulus we can extract the sub-bands boundaries f_n and f_{n-1} . The choice of the wavelet smoothing function is critical. We have employed the Morlet function due to its robustness against noise.

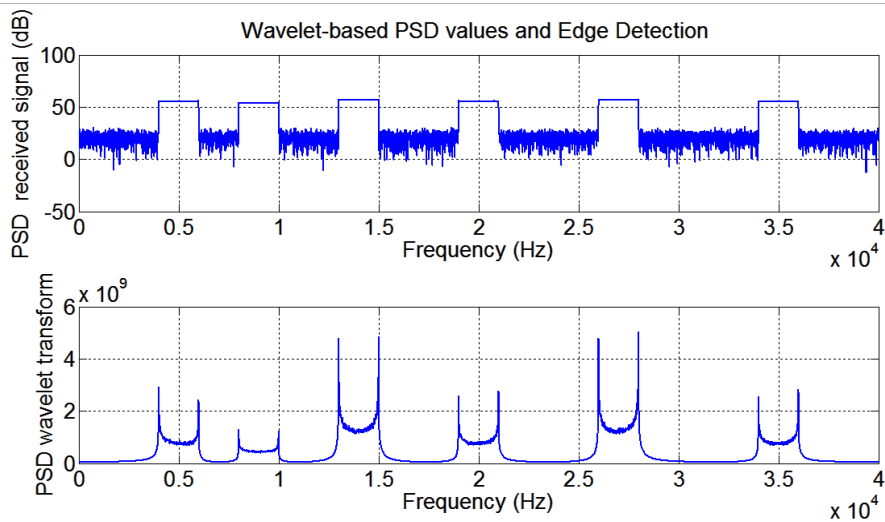

Figure 5.13: Détection de l'énergie et des bordures se basant sur la transformée en Ondelettes

Figure 5.13 shows the excellent capability of the wavelet transform to detect edges of the received signal in the spectrum domain for 6 allocated sub-channels where the wavelet modulus presents a high level peak at each abrupt change of the PSD received signal.

5.4.2.3 Automatic Local Maxima Detection

Visually identify the local maxima of the wavelet modulus is not a satisfying way for time sensitive and real-time applications, since the results are not expected to be accurate, particularly in noisy conditions. This fact motivates us to employ an automatic algorithm to accurately pick frequency edges from the wavelet modulus $S(f)$ local maxima.

We have properly selected the picked decision level “ l ” in order to have a high algorithm robustness against noise. We present the conditions under which each frequency f_i was picked inside the discrete initially defined range $B = [f_{low}, f_{high}]$ as:

$$\begin{aligned}
 &1) \quad S(f_i) > S(f_{i-1}) \text{ and } S(f_i) > S(f_{i+1}) \\
 &2) \quad \frac{(2 * M - 2)S(f_i)}{\sum_{k=2}^M S(f_{i-k}) + S(f_{i+k})} > l
 \end{aligned} \tag{5.13}$$

This approach is similar to windowing with the size equal to “ $2M$ ” and M and l are the robustness algorithm parameters. This window scans all frequency ranges except for the guard range at the extremes of range B . The choice of the parameters M and l is very important: increasing M increases accuracy detection. A high value of l may not show the existence of a peak and a low value of l , may lead to a false decision when considering low peak levels, which are a noise peaks, as bands boundary peaks.

Due to this algorithm, frequency band edges are automatically identified with very high precision. These edges allow us to clearly locate spectrum occupancy of a desired signal in a blind environment or in open-loop system where no information exchange about the spectrum allocation.

With the end of this section, we have achieved presenting the competitive mathematical tool referred to the wavelet transform as well as treating its major applications in the signal processing and communications domains. We have specifically chosen these two research topics in accordance to their promising effects in applicative fields.

Particularly, in the last section of this chapter, we aim to incorporate the wavelet beneficial effects as an applicative framework to enhance the techniques adopted in LTE-smallCells network and going beyond the LTE-Advanced system.

5.5 Wavelet Applications for the LTE Mobile System

With permanently growing demand for mobile broadband service, LTE standard continues to evolve and enhance the deployment techniques; thus, becoming more beneficial in dense

small cells environment. Basic improvement techniques have been adopted by the LTE-Advanced framework as an extended and improved “4th Generation (4G)” standard. While keeping the compatibility with the first release LTE infrastructure, several proposals were carried out for the LTE-Advanced [85]. Enhancements are in accordance with different orientations principally in term of topology and network configuration, spectrum access protocols, spatial diversity (MIMO) as well as autonomous and cognitive radio scenarios. Synchronously with the announcing LTE-Advanced, as tested and trial adopted system in the last two years in several countries in the world, moving to “beyond LTE-Advanced” standards was an active issue for the future wireless revolutionary systems [86].

5.5.1 5th Generation Roadmap

Notably, the “5th Generation (5G)” standard appears as the hottest wireless mobile network. Usually evoking the core tenets of high efficiency and satisfying user experience, the 5G system is in full swing today. Therefore, we are motivated to propose some enhancements that can be applied under those circumstances. Going forward 5G, major key improvements are evidenced from both operator and customer’s perspectives. Herein, we cite some of those improvements:

- Increased peak data rate
- Higher spectral efficiency
- Higher overall system capacity
- Higher transmission reliability
- Lower battery consumption
- Lower outage probability
- Lower latency
- Lower deployment costs
- Flexible and efficient allocation of the available resources

Considerable works have been achieved in order to develop the LTE-Small Cells techniques and solve their sever challenges. Optimally and near-optimally solutions have been proposed as multi-access scheduling approaches especially for interference management and smart resource allocation. Ultimately, these proposals are mostly concentrated at the Medium Access Control (MAC) and Data Link layers.

Nevertheless, researches lead to saturation frontiers and reach the asymptotical limits in

term of allocation and distribution resources, especially for ultra-dense area. In this section, we aim to go deeper and tackle the “physical layer specifications” as basic enhancing techniques. While dealing with highly congestion environment, we hope to significantly progress toward 5G by exploiting the maximum degree of freedom of the overall framework. Consequently, substantial improvements and outperformance results can be picked up in the upper layers.

Specifically, we want to take advantages of the wavelet-based signal processing approaches discussed in previous sections of the chapter and we propose to be introduced for the downlink and Uplink transmissions of the future evolution of the LTE HetNet system.

Notably, as became well-known, the OFDM transmission technique is the basic core of the LTE standard, since the Downlink/Uplink transmission and resource allocation schemes build on the OFDM technique. Moreover, in the uplink transmission, as cited in Chapter 4, the spectrum sensing technique is applied as a primary step to be aware about the surrounding before allocate resources and manage the interference.

5.5.2 Wavelet-based Downlink Enhancement

The OFDMA is currently the multiple-access transmission scheme adopted for the LTE downlink direction. Due to its flexibility and its multi-carrier properties it is promising for dynamic spectrum access. However, Due to the Fourier-based OFDM limitations explained in the Section, we recommend to alternate toward the Wavelet-based OFDM scheme. The overall benefit is achieved in term of data rate, the Bit Error Rate at the receiver front-end, the PAPR level of the transmitted signal as well as the implementation costs.

Indeed, we have proved in the Section that the data rate is significantly increased by introducing the wavelet transform to the OFDM system instead of the Fourier transform. The main reason is the needless of the cyclic prefix and other redundant information.

To the best of our knowledge, no many references treat the wavelet-based OFDM for the LTE-femtocell systems. Though, authors in [53] addressed the introduction of wavelet transform to the LTE cellular system while deriving the mathematical expressions of the data rate for both wavelet-based and Fourier-based OFDM. By comparison, they conclude that “*the DWT-based OFDM outperforms the FFT-based OFDM and the data rate is increased by the amount of: $\text{length}(\text{CyclicPrefix})/\text{SymbolTime}\%$ ”.*

Furthermore, the bit error rate (BER) becomes lower by alternating to the wavelet-OFDM. Hence, the transmission becomes more robust against noise and the user experiences better Quality of Service for the same SNR degree. In result, incorporated as LTE enhancement, this way promises reliable and efficient data transmission. In other hand, for the mobile system, the power consumption as well as the power efficiency is the key consideration for the transmitter, especially for the User Equipment terminal. Therefore, adopting an

efficient way with a reduced PAPR level becomes a very benefit issue.

Fortunately, as confirmed above, the wavelet-based OFDM guarantees the reduction of the PAPR level with respect to the conventional FFT-OFDM. Consequently, we suggest exploiting this hopeful advantage for the LTE-femtocell cellular system. Thus, in the downlink transmission, the Wavelet-OFDM symbols are transmitted instead of the Fourier-OFDM symbols through the time-frequency OFDMA grid. The PAPR is notably reduced while preserving the multi-carrier property though the scaling variation of each sub-channel.

The equipment cost is further reduced regarding to the needless for the sophisticated time and/or frequency synchronization components as well as for complex linear or large range non-linear amplifiers. Hence, power consumption and hardware costs of the future smart devices will be accordingly saved.

5.5.3 Wavelet-based Uplink Enhancement

For the Uplink, the transmission is more sensitive to the battery consumption and the equipment cost. For this reason, conventional LTE standard performs the SC-FDMA transmission scheme instead of the OFDMA view to its capability to considerably reducing the PAPR level. The above beneficial enhancement presented for the downlink can be equally fulfilled for the uplink, especially considering the data rate, BER and cost requirements. By exception, the PAPR level of the SC-FDMA is superior to the wavelet-based OFDMA PAPR. In a logical sense, the power fluctuation of the “single carrier” signals is by nature lesser than the multi-carrier signals. Unfortunately, as for PAPR value, the wavelet-OFDMA is considered as a tradeoff between the Fourier-OFDMA and the SC-FDMA. We note here that we have found in the LTE-Advanced literature proposing a hybrid OFDMA and SC-FDMA transmission scheme in uplink [87]. The reason behind that is under investigation in subject of our future researches. In other hand, the spectrum sensing technique is a main task before assigning resource blocks to the user for the uplink transmission. Traditional spectrum sensing techniques (cited) are used still now in the LTE as well as its evolutionary systems. Basing on the powerful wavelet capacity to detect edges and discontinuity structures, as aforementioned, we suggest including the wavelet-based spectrum sensing approach as the founded surrounding-awareness strategy for the uplink transmission. As result, the available free resource blocks identification becomes more reliable and accurate avoiding severe interference in dynamically spectrum accessing. Moreover, this allows efficient and faster convergence toward optimal resource allocation.

From a global perspective, passing to the new wavelet-based proposal in the uplink is fortunately a promising orientation although the higher PAPR level comparing to the SC-FDMA PAPR. By this way, the framework implementation for both downlink and Uplink

transmissions of the evolved LTE standard turn out the same without the need to make changes in the transmission chains.

5.6 Conclusion

In this chapter, we proposed an original approach for the LTE-Femtocell system founded on the powerful signal processing tool called wavelet transform. Boosting from the physical layer basic enhancement, we aimed to surpass the asymptotical barriers of the LTE-Femtocell network and create the roadmap to go beyond LTE-Advanced standard. First, to be familiar with this tool, we described its different types with their implementations, its main properties and its application fields. We have detailed some communication applicative domains while focusing on the major wavelet benefits such as edge detection, orthogonal basis and de-noising properties. We introduced wavelet transform into two main techniques that are basically incorporated in LTE standard: the multi-carrier OFDM transmission scheme and the spectrum sensing technique. Doing that, we obtained hopeful effects exploitable as promising enhancements for the future wireless standard and opening new horizons for the 5G system.

Chapter 6

Conclusion and Future Works

At the end of this thesis report, we summarize our work and the reached contributions and finally, we signalize our expected future research issues.

6.1 Conclusion

The essential questions we aimed to answer in this thesis are: *How we can provide higher data rates, higher energy efficiency, better spectrum utilization, enhanced performance and increased capacity for the advanced LTE-based Femtocell networks; and what are the degrees of freedom that can be exploited yet?*

In this thesis, we are oriented according to both: multi-user scheduling on the data link layer and basic transmission enhancements on the physical layer.

As related works, we have first exhibited the main features offered by the high-speed SmallCell-LTE network while citing its main challenges as a Heterogenous Network submerging in the macrocell area. We have got an overview of the literature works on the downlink as well as uplink scheduling and resource allocation algorithms, and then, on the wavelet transform applied as an enhancing processing tool.

After that, we have began to explain our first contribution on the management of the radio resource allocation of the OFDMA-based downlink connection basing on the adaptive modulation and coding (AMC) technique and the power control. This is referred as: downlink AMC QoS-based resource allocation with power control or “downlink AMC-QRAP”, where the QoS is respected by differentiating between two user types: High priority and Best Effort users. In the second contribution, we have applied this approach for the SC-FDMA-based uplink connection where an additional hard constraint imposes that the resource blocks assigned to each user must be adjacent; similarly, the approach is named “uplink AMC-QRAP”. the cluster architecture is considered as a hybrid way between the centralized and the distributed architectures. In fact, for both connections, the radio resource

can be shared by different users in order to enhance the spectrum utilization. Therefore, the power control mechanism is introduced to mitigate the resulted interference, where the power transmission of each user must respect a minimum required SINR level at the receiver side. To avoid rejecting user who cannot reach this fixed SINR threshold on its allocated resource, we have proposed to adopt a set of several SINR threshold and respecting them adaptively to the effective channel quality on such resource block. Each SINR threshold corresponds to a specific modulation and coding scheme (MCS) selected under a block error rate performance constraint. We began by the highest SINR threshold value corresponding to the highest order MCS in order to maximize the data rate. This is what we refer to the “rate control” or AMC mechanism. The proposed problems are modeled in accordance to the linear programming tools. As results, the system capacity, the overall throughput, the spacial spectrum reuse and the spectral efficiency are all enhanced as proved by extensive simulations using the IBM ILOG CPLEX solver.

On the other hand, we have tackled the physical layer enhancements basing on the wavelet transform as a powerful signal processing tool. It is first introduced for the OFDM transmission technique to overcome its principal limitations. It conserve the multicarrier and the fading combating properties since it provides an orthogonal basis. There is no need to add a cyclic prefix at the beginning of each OFDM symbol, fact that significantly increases the data rate. In addition, it is a promising way to reduce the peak-to-average-power ratio level and decrease the bit error rate, thus the energy efficiency becomes higher.

Moreover, we have proposed a spectrum sensing technique based on the wavelet transform and it is applied for the uplink scheduling task. It is exploited the capability of the wavelet transform to accurately detect the edges of the allocated bandwidths as well as measure the amount of interference power on each resource block before transmit on it. This allows to simplify the uplink optimization problem while reduce the convergence time toward the optimal solution. Combining the AMC and the spectrum sensing techniques shows a better performance comparing by other approaches.

Finally, we consider that delivering the high-speed services and application of the next generation wireless systems require complementary improvement on both physical and link layer levels. Intelligently and jointly allocating power, sub-channels and power resources while enhance the transmission mode, provides a competent issue for the future generation standards.

6.2 Future works and perspectives

Several orientations can be considered as future works basing on this thesis framework and providing advanced researches topics for evolved systems.

Our scheduling proposal in this thesis is a QoS-based theme since the users are differentiated accordingly to their priority and required QoS they pay to. Going toward more applicative sense, the *service differentiation* can be tackled also. Indeed, each service type deals with specific requirements under many considerations such that: 1) performance represented by a tolerable BLER threshold, 2) throughput and service speed and 3) delay sensitivity. In fact, as application of the adaptive modulation and coding technique, the MCS can be selected with respect to the requested service type. Thus, we can categorize services with respect to two major criteria: I) the tolerable BLER threshold that cannot be exceeded for a reliable service and II) the maximum throughput that can be provided for a satisfied user experience. As examples, the VoIP service requires a low BLER threshold to maintain the connection and guarantee the correctness of the voice signal reception; while the Video on demand service necessitates a high-speed connection that requires a high throughput. Both criteria can be adaptively adjusted depending on the selected MCS related to the corresponding SINR thresholds. In this thesis, we have adopted a set of discrete SINR threshold values. As perspective, we propose to consider a set of continuous interval of SINR threshold values to accurately deal with large service requirements. By this way, it is expected to maximize the system data rate that can be provided under a satisfied performance level while enriching the system flexibility to wide range of service types.

Finally, our second perspective is to exploit the physical layer tools to evolve our system and improve the data rate as well as the spectral and energy efficiencies. Especially, we focus on the modulation type used in the standard. We look to going beyond 6 bits/symbol as efficiency offered by the 64-QAM and introduced higher order modulation schemes. Hence, intuitively, the system data rate and the spectral efficiency increase. Moreover, due to the AMC technique performed, the transmission link becomes more robust against channel quality degradation although higher efficiency is transmitted.

Furthermore, an original approach can be exploited in our next work concerning a new modulation scheme proposed in [88]. The main idea is to use a hexagonal constellation region instead of the rectangular one used usually and drawn by the QAM modulation scheme. The hexagonal mapping is the most compact regular tiling which increases the energy efficiency, but the appropriate symbol element is the “trits” instead of the bits since it is a deviation from the powers-of-two modulation order and it is referred to the

ternary modulation. Authors prove that the convergence of the AMC technique toward achieving maximum throughput for OFDM scheme is greatest. In addition, the symbol error probability and the peak-to-average-power ration are both minimized.

It is expected that the combination of such approach with our thesis framework provides substantial improvements for future advanced cellular standards.

List of Publications

Conferences

1. Rima Hatoum, Abbas Hatoum, Alaa Ghaith and Guy Pujolle, “QoS-based Joint Power and Resource Allocation with Adaptive Modulation and Coding for OFDMA FemtoCell Networks”, IEEE/ACM 22th International Symposium on Quality of Service (IEEE/ACM IWQoS), Hong Kong Polytechnic University, Hong Kong, China, May 2014.
2. Rima Hatoum, Abbas Hatoum, Alaa Ghaith and Guy Pujolle, “Adaptive Modulation and Coding for QoS-based Femtocell Resource Allocation with Power Control”, Submitted to IEEE Global Telecommunications Conference (Globecom), 2014.
3. Rima Hatoum, Abbas Hatoum, Alaa Ghaith and Guy Pujolle, “QoS-based Resource Scheduling with Adaptive Modulation and Coding and Power Control for SC-FDMA Uplink Femtocell Networks”, Submitted to 10th ACM International Symposium on QoS and Security for Wireless and Mobile Networks (Q2SWinet), 2014.
4. Rima Hatoum, Alaa Ghaith and Guy Pujolle, “An Automatic Approach to Blindly Detect Bandwidth Edges Based on the Wavelet Transform”, IEEE 3th International Symposium on Broadband Networks and Fast Internet (RELABIRA), Antonine University, Baabda, Lebanon, June 2012.

Journals

5. Rima Hatoum, Alaa Ghaith and Guy Pujolle, “Generalized Wavelet-based Symbol Rate Estimation of Linear Single-Carrier Digital Modulation in Blind Environment”, European Science Journal (ESJ), 2014.
6. Alaa Ghaith, Rima Hatoum, Hiba Mrad and Ali AlaaEddine, “Performance Analysis of the Wavelet-OFDM new scheme in AWGN channel”, Journal of Physical Science and Application (JPSA), 2013.

Bibliography

- [1] 3GPP TR 36.213, “LTE; Evolved Universal Terrestrial Radio Access (E-UTRA);Physical layer procedures version 10.1.0 Release 10,” 2011.
- [2] 2nd Intl. Conf. Home Access Points and Femtocells, *Presentations by ABI Research, Picochip, Airvana, IP.access, Gartner, Telefonica Espana*.
- [3] *4G Americas, Statistics*, “<http://www.4gamericas.org>”.
- [4] R. Hatoum, A. Hatoum, A. Ghaith, and G. Pujolle, “QoS-based Joint Power and Resource Allocation with Adaptive Modulation and Coding for OFDMA Femtocell Networks,” *IEEE/ACM International Symposium on Quality of Service, (IWQoS '14)*, Hong Kong, 2014.
- [5] R. Hatoum, A. Hatoum, A. Ghaith, and G. Pujolle, “Adaptive Modulation and Coding for QoS-based Femtocell Resource Allocation with Power Control,” *IEEE Global Communications Conference (GLOBECOM)*, 2014.
- [6] R. Hatoum, A. Hatoum, A. Ghaith, and G. Pujolle, “QoS-based Resource Scheduling with Adaptive Modulation and Coding and Power Control for SC-FDMA Uplink Femtocell Networks,” *10th ACM International Symposium on QoS and Security for Wireless and Mobile Networks, (Q2SWinet)*, 2014.
- [7] A. Ghaith, R. Hatoum, H. Mrad, and A. Alaeddine, “Performance Analysis of the Wavelet-OFDM new Scheme in AWGN Channel,” *Journal of Physical Science and Application, (JPSA)*, 2013.
- [8] R. Hatoum, A. Ghaith, and G. Pujolle, “An Automatic Approach to Blindly Detect Bandwidth Edges based on the Wavelet Transform,” *Symposium on Broadband Networks and Fast Internet (RELABIRA)*, pp. 60–64, 2012.
- [9] R.-E. Resource and analysis forelectronics engineers, “LTE FDD, TDD, TD-LTE Duplex Schemes,” <http://www.radio-electronics.com/info/cellulartelecomms/lte-long-term-evolution/lte-fdd-tdd-duplex>.

- [10] D. Astély, E. Dahlman, A. Furuskär, Y. Jading, M. Lindström, and S. Parkvall, "LTE: The evolution of mobile broadband," *IEEE Communications Magazine*, vol. 47, no. 4, no. 4, pp. 44–51, 2009.
- [11] "<http://www.qualcomm.com/solutions/wireless-networks/technologies/1000x-data>,"
- [12] S. Forum, "<http://www.smallcellforum.org>,"
- [13] F. Forum, "<http://www.femtoforum.org>,"
- [14] D. López-Pérez, A. Valcarce, G. de la Roche, and J. Zhang, "OFDMA Femtocells: A roadmap on interference avoidance," *IEEE Communications Magazine*, vol. 47, no. 9, no. 9, pp. 41–48, 2009.
- [15] A. Golaup, M. Mustapha, and L. B. Patanapongpibul, "Femtocell Access Control Strategy in UMTS and LTE," *IEEE Communications Magazine*, vol. 47, no. 9, no. 9, pp. 117–123, 2009.
- [16] Y. Zhang, "Resource Sharing of Completely Closed Access in Femtocell Networks," *IEEE Wireless Communications and Networking Conference (WCNC)*, pp. 1–5, 2010.
- [17] D. WINNER II, "Winner II channel models part I- channel models," *Tech. Rep.*, Sept. 2007.
- [18] R. Fantacci, D. Marabissi, D. Tarchi, and I. Habib, "Adaptive Modulation and Coding Techniques for OFDMA Systems," *IEEE Transactions on Wireless Communications*, vol. 8, pp. 4876–4883, 2009.
- [19] C. Yu, W. Xiangming, L. Xinqi, and Z. Wei, "Research on the Modulation and Coding Scheme in LTE TDD Wireless Network," *International Conference on Industrial Mechatronics and Automation, (ICIMA)*, pp. 468–471, 2009.
- [20] C. Tarhini and T. Chahed, "On Capacity of OFDMA-based IEEE802.16 WiMAX including Adaptive Modulation and Coding (AMC) and Inter-Cell Interference," pp. 139–144, 2007.
- [21] D. Takedal, Y. Chow, P. Strauch, and H. Tsurumi, "Threshold Controlling Scheme for Adaptive Modulation and Coding System," *15th IEEE International Symposium on Personal, Indoor and Mobile Radio Communications, PIMRC*, 2004.
- [22] A. Farrokh, V. Krishnamurthy, and R. Schober, "Optimal Adaptive Modulation and Coding with Switching Costs," *IEEE Transactions on Communications*, vol. 57, no. 3, no. 3, pp. 697–706, 2009.

-
- [23] P. K. Rekhi, M. Luthra, S. Malik, and R. Atri, "Throughput Calculation for LTE TDD and FDD Systems," *White paper*, pp. 1–11, Decembre 2012.
- [24] J. Robson, D. Bevan, and M. Boue-Lahorgue, "Radio Resource Allocation for Cellular Wireless Networks," Feb. 12 2012. US Patent 8,121,100 B2.
- [25] A. Hatoum, R. Langar, N. Aitsaadi, R. Boutaba, and G. Pujolle, "Cluster-based Resource Management in OFDMA Femtocell Networks with QoS Guarantees," *IEEE Transactions on Vehicular Technology*, 2013. Early Access.
- [26] Y.-Y. Li and E. Sousa, "Cognitive Femtocell: A Cost-Effective Approach Towards 4G Autonomous Infrastructure Networks," *Wireless Personal Communications*, vol. 64, no. 1, no. 1, pp. 65–78, 2012.
- [27] M. Sahin, I. Guvenc, M. Jeong, and H. Arslan, "Handling CCI and ICI in OFDMA Femtocell Networks Through Frequency Scheduling," *IEEE Transactions on Consumer Electronics*, Nov 2009.
- [28] M. Jin, S. Chae, and D. Kim, "Per Cluster based Opportunistic Power Control for Heterogeneous Networks," *VTC*, May 2011.
- [29] D. Lopez-Perez, A. Ladanyi, A. Juttner, H. Rivano, and J. Zhang, "Optimization Method for the Joint Allocation of Modulation Schemes, Coding Rates, Resource Blocks and Power in Self-Organizing LTE Networks," *Proceedings IEEE INFOCOM*, pp. 111–115, 2011.
- [30] D. T. Ngo, S. Khakurel, and T. Le-Ngoc, "Joint Subchannel Assignment and Power Allocation for OFDMA Femtocell Networks," *IEEE Transactions on Wireless Communications*, vol. 13, no. 1, no. 1, pp. 342–355, 2014.
- [31] A. Hatoum, R. Langar, N. Aitsaadi, R. Boutaba, and G. Pujolle, "QoS-based Power Control and Resource Allocation in OFDMA Femtocell Networks," *IEEE Global Communications Conference (GLOBECOM)*, pp. 5116–5122, 2012.
- [32] I. Kim, H. L. Lee, B. Kim, and Y. H. Lee, "On the use of linear programming for dynamic subchannel and bit allocation in multiuser OFDM," *IEEE Global Telecommunications Conference, (GLOBECOM)*, vol. 6, pp. 3648–3652, 2001.
- [33] M. I. Lee, B. C. Ihm, J. Y. Chun, S. H. Park, H. S. Ko, and W. B. Lee, "Method for Performing an Adaptive Modulation and Coding Scheme in Mobile Communication System," May 21 2013. US Patent 8,446,882.

- [34] S.-K. Yang and T.-S. Lee, "Adaptive Modulation and Coding Method," Feb. 15 2011. US Patent 7,889,703.
- [35] S.-E. Elayoubi and B. Fourestié, "Performance Evaluation of Admission Control and Adaptive Modulation in OFDMA WiMax Systems," *IEEE/ACM Transactions on Networking*, vol. 16, no. 5, no. 5, pp. 1200–1211, 2008.
- [36] S.-E. Elayoubi and B. Fourestié, "On Inter-Cell Interference and Adaptive Modulation in OFDMA WiMAX Systems," *IEEE Global Telecommunications Conference, (GLOBECOM)*, pp. 1–5, 2006.
- [37] A. Ladanyi, D. Lopez-Perez, A. Juttner, X. Chuy, and J. Zhang, "Distributed Resource Allocation for Femtocell Interference Coordination via power minimisation," *IEEE Global Communications Conference, GLOBECOM*, 2011.
- [38] J. M. Eichinger, Y. Gao, S. Jose, R. Halfmann, T. Haustein, B. Raaf, E. Schulz, and W. ZirWas, "Adaptive Modulation and Coding in a SC-FDMA System," Dec. 10 2013. US Patent 8,605,664 B2.
- [39] A. Aijaz, X. Chu, and A. Aghvami, "Energy Efficient Design of SC-FDMA Based Uplink under QoS Constraints," *IEEE Wireless Communications Letters*, no. 99, no. 99, pp. 1–4, 2014.
- [40] A. Ahmad, "Resource Allocation and Adaptive Modulation in Uplink SC-FDMA Systems," *Springer Science and Business Media New York*, 2013.
- [41] H.-C. Jang and Y.-J. Lee, "QoS-constrained resource allocation scheduling for LTE network," *International Symposium on Wireless and Pervasive Computing (ISWPC)*, pp. 1–6, 2013.
- [42] T. Mert, O. Kaya, and H. Cirpan, "Jointly Optimal Chunk and Power Allocation in Uplink SC-FDMA," *IEEE International Conference on Communications (ICC)*, pp. 3393–3397, 2013.
- [43] M. Wang, Z. Zhong, and Q. Liu, "Resource Allocation for SC-FDMA in LTE Uplink," *IEEE International Conference on Service Operations, Logistics, and Informatics (SOLI)*, pp. 601–604, 2011.
- [44] J. Lim, H. G. Myung, K. Oh, and D. J. Goodman, "Channel-Dependent Scheduling of Uplink Single Carrier FDMA Systems," *IEEE 64th Vehicular Technology Conference, VTC Fall*, pp. 1–5, 2006.

-
- [45] J. Lim, H. G. Myung, K. Oh, and D. J. Goodman, "Channel-Dependent Scheduling of Uplink Single Carrier FDMA Systems," *IEEE 64th Vehicular Technology Conference, (VTC)*, pp. 1–5, 2006.
- [46] L. Li, G. Wu, H. Xu, G. Y. Li, and X. Feng, "A Practical Resource Allocation Approach for Interference Management in LTE Uplink Transmission," *Journal of Communications*, vol. 6, pp. 301–305, JULY 2011.
- [47] 3GPP TR 25.913, "Requirements for Evolved UTRA (EUTRA) and Evolved UTRAN (E-UTRAN),v. 7.0.0," 2009.
- [48] A. Afifi, K. M.F.Elsayed, and A. Khattab, "Interference-aware radio resource management framework for the 3GPP LTE uplink with QoS constraints," *IEEE Symposium on Computers and Communications (ISCC)*, pp. 693–698, 2013.
- [49] Anuradha and N. Kumar, "BER analysis of conventional and wavelet based OFDM in LTE using different modulation techniques," *Recent Advances in Engineering and Computational Sciences (RAECS)*, pp. 1–4, 2014.
- [50] F.Farrukh, S. Baig, and M. Mughal, "Performance Comparison of DFT-OFDM and Wavelet-OFDM with Zero-Forcing Equalizer for FIR Channel Equalization," *International Conference on Electrical Engineering, (ICEE)*, pp. 1–5, 2007.
- [51] S.-E. Elayoubi, A. B. H. Alaya, E. Villebrun, and B. Fourestie, "Wavelet Analysis for Velocity Characterization in Mobile Networks," *IEEE 63rd Vehicular Technology Conference (VTC)*, vol. 2, pp. 793–797, Spring - 2006.
- [52] G. Raju and B.V.Uma, "Design and Simulation of Wavelet OFDM with Wavelet Denoising on AWGN Channel," *International Journal of Advanced Research in Computer and Communication Engineering, (IJARCCE)*, vol. 2, pp. 3015–3018, August 2013.
- [53] A. Shadmam, R. Dilmaghani, M. Ghavami, and M. Shikh-Bahaei, "Wavelet-based Downlink Scheduling and Resource Allocation for Long-Term Evolution Cellular Systems," *IET Communications*, vol. 5, no. 14, pp. 2091–2095, Sept 2011.
- [54] R. Kanti and M. Rai, "Comparative Analysis of Daubechies Wavelets in OWDM with OFDM for DVB-T," *International Journal of Scientific & Engineering Research, (IJSER)*, vol. 4, March 2013.
- [55] H. Sakakibara, E. Okamoto, and Y. Iwanami, "A Wavelet Packet Modulation Method for Satellite Communications," in *IEEE Region 10, (TENCON)*, pp. 1–5, 2005.

- [56] X. Liu and S. Shankar, "Sensing-based Opportunistic Channel Access," *Mobile Networks and Applications*, vol. 11, pp. 577–591, 2006.
- [57] H. Urkowitz, "Energy Detection of Unknown Deterministic Signals," in *Proceedings of the IEEE*, vol. 55, pp. 523–531, 1967.
- [58] Y. Hur, J. Park, W. Woo, K. Lim, C. Lee, H. Kim, and J. Laskar, "A Wideband Analog Multi-Resolution Spectrum Sensing (MRSS) Technique for Cognitive Radio (CR) Systems," in *Proc. IEEE Int. Symposium on Circuits and Systems, (ISCAS)*, 2006.
- [59] S. Kapoor, S. Rao, and G. Singh, "Opportunistic Spectrum Sensing by Employing Matched Filter in Cognitive Radio Network," *International Conference on Communication Systems and Network Technologies*, pp. 580–583, 2011.
- [60] K. Kim, I. A. Akbar, K. K. Bae, J.-S. Um, C. M. Spooner, and J. H. Reed, "Cyclostationary Approaches to Signal Detection and Classification in Cognitive Radio," in *Proc. IEEE Int. Symposium on New Frontiers in Dynamic Spectrum Access Networks, Dublin, Ireland*, pp. 212–215, 2007.
- [61] G. Zhang, "Subcarrier and bit allocation for real-time services in multiuser OFDM systems," *Communications, 2004 IEEE International Conference on*, vol. 5, pp. 2985–2989, 2004.
- [62] J. Lee, R. Amott, K. Hamabe, and N. Takano, "Adaptive Modulation Switching Level Control in High Speed Downlink Packet Access Transmission," *3G Mobile Communication Technologies - IEE*, pp. 156–159, May 2002.
- [63] A. Zalonis, N. Miliou, I. Dages, A. Polydoros, and H. Bogucka, "Trends in Adaptive Modulation and Coding," *Advances in Electronics and Telecommunications*, vol. 1, April 2010.
- [64] V. Chandrasekhar, J. Andrews, T. Muharemovict, Z. Shen, and A. Gatherer, "Power Control in Two-Tier Femtocell Networks," *IEEE Transactions on Wireless Communications*, vol. 8, no. 8, pp. 4316–4328, August 2009.
- [65] J. Hooker and M. Osorio, "Mixed Logical-Linear Programming," *Discrete Applied Mathematics*, vol. 96-97, pp. 395–442, 1999.
- [66] F. D. CROCE, *Concepts of Combinatorial Optimization, Chapter 5: Mixed Integer Linear Programming Models for Combinatorial Optimization Problems* . Wiley-ISTE, 2010.

-
- [67] F. D. CROCE and A. GROSSO, *Concepts of Combinatorial Optimization, Chapter 6: Simplex Algorithms for Linear Programming*. ISTE Ltd, 2010.
- [68] A. Billionnet, *Quadratic Optimization in 0-1 Variables*, ch. 8, pp. 189–233. John Wiley & Sons, Inc., 2013.
- [69] “<http://www-01.ibm.com/software/integration/optimization/cplex-optimizer/>,”
- [70] H. G. Myung, J. Lim, and D. J. Goodman, “Single Carrier FDMA for Uplink Wireless Transmission,” *IEEE Vehicular Technology Magazine*, vol. 1, no. 3, no. 3, pp. 30–38, 2006.
- [71] G. Berardinelli, L. R. D. Temino, S. Frattasi, M. I. Rahman, and P. Mogensen, “OFDMA vs. SC-fdma: Performance Comparison in Local Area IMT-A Scenarios,” *IEEE Wireless Communications Magazine*, vol. 15, no. 5, no. 5, pp. 64–72, 2008.
- [72] “*3GPP: Introducing Single Carrier FDMA*” *Agilent Measurement Journal, Issue 4 2008*.
- [73] B. Furht and S. A. Ahson, *Long Term Evolution: 3GPP LTE Radio and Cellular Technology*. 2009.
- [74] E.L. Hahne, “Round-robin scheduling for max-min fairness in data networks,” *IEEE J. Sel. Areas Commun.*, vol. 9, no. 7, no. 7, 1991.
- [75] M. Sifuzzaman, M. Islam, and M. Ali, “Application of Wavelet Transform and its Advantages Compared to Fourier Transform,” *Journal of Physical Sciences*, vol. 13, pp. 121–134, 2009.
- [76] R. Hatoum, A. Ghaith, and G. Pujolle, “Generalized Wavelet-based Symbol Rate Estimation for Linear Single-Carrier Modulation in Blind Environment,” *European Scientific Journal, (ESJ)*, 2014.
- [77] N. M. Devarajan and M. Chandrasekaran, “A Survey on OFDM Systems based on Wavelets,” *International Journal of Scientific & Engineering Research*, vol. 5, pp. 1055–1058, February 2014.
- [78] M. Gautier, C. Lereau, M. Arndt, and J. Lienard, “PAPR Analysis in Wavelet Packet Modulation,” *3rd International Symposium on Communications, Control and Signal Processing, (ISCCSP)*, pp. 799–803, 2008.
- [79] H. Abdullah and F. Hasan, “Performance Evaluation of Complex Wavelet Packet Modulation (CWPM) System over Multipath Rayleigh Fading Channel,” *Journal of Signal & Information Processing, (JSIP)*, 2012.

- [80] S. Tripathi, A. Rastogi, K. Sachdeva, M. Sharma, and P. Sharma, "PAPR Reduction in OFDM System using DWT with Non Linear High Power Amplifier," in *International Journal of Innovative Technology and Exploring Engineering (IJITEE)*, 2013.
- [81] A. Ghasemi and E. S. Sousa, "Spectrum Sensing in Cognitive Radio Networks: Requirements, Challenges and Design Tradeoffs," *IEEE Communications Magazine*, April 2008.
- [82] Z. Quan, S. J. Shellhammer, W. Zhang, and A. H. Sayed, "Spectrum Sensing by Cognitive Radios at Very Low SNR," *Proceedings IEEE GLOBECOM*, 2009.
- [83] T. Yucek and H. Arslan, "A Survey of Spectrum Sensing Algorithms for Cognitive Radio Applications," *IEEE Communications Surveys & Tutorials*, vol. 11, 2009.
- [84] S. Mallat and W. Hwang, "Singularity Detection and Processing with Wavelets," *IEEE Transactions on Information Theory*, vol. 38, no. 2, pp. 617–643, 1992.
- [85] A. Ghosh and R. Ratasuk, "Essentials of LTE and LTE-A," *Cambridge University Press*, 2011.
- [86] E. Dahlman, S. Parkvall, and J. Skold, "4G: LTE/LTE-Advanced for Mobile Broadband," *Academic Press*, 2011.
- [87] 3GPP TR 36.912, "LTE; Feasibility study for Further Advancements for E-UTRA (LTE-Advanced) version 9.1.0 Release 9," 2010.
- [88] A. Ghaith and A. Alaeddine, "Modulation with hexagonal decision regions for wireless communication systems," *25th International Conference on Microelectronics (ICM)*, pp. 1–4, Dec 2013.

