



HAL
open science

Influence de l'architecture génétique et des variations environnementales sur l'adaptation : la résistance aux insecticides chez les moustiques

Pascal Milesi

► To cite this version:

Pascal Milesi. Influence de l'architecture génétique et des variations environnementales sur l'adaptation : la résistance aux insecticides chez les moustiques. Zoologie des invertébrés. Université Montpellier, 2015. Français. NNT : 2015MONT255 . tel-02172035

HAL Id: tel-02172035

<https://theses.hal.science/tel-02172035>

Submitted on 3 Jul 2019

HAL is a multi-disciplinary open access archive for the deposit and dissemination of scientific research documents, whether they are published or not. The documents may come from teaching and research institutions in France or abroad, or from public or private research centers.

L'archive ouverte pluridisciplinaire **HAL**, est destinée au dépôt et à la diffusion de documents scientifiques de niveau recherche, publiés ou non, émanant des établissements d'enseignement et de recherche français ou étrangers, des laboratoires publics ou privés.

THÈSE

Pour obtenir le grade de
Docteur

Délivré par l'UNIVERSITE DE MONTPELLIER

Préparée au sein de l'école doctorale **SIBAGHE**
Et de l'unité de recherche **ISEM**

Spécialité : **EERGP**
Ecologie, Evolution, Ressources Génétiques, Paléobiologie

Présentée par **Pascal MILESI**

**Influence de l'architecture génétique et des
variations environnementales sur
l'adaptation : la résistance aux insecticides
chez les moustiques**

Soutenue le 18 Décembre 2015 devant le jury composé de :

M. Sylvain BILLIARD, MCF, GEPV, Université de Lille 1	Rapporteur
M. Pierre-Henry GOUYON, Pr, ISYEB, MNHN	Rapporteur
M. Denis BOURGUET, DR, CBGP, INRA-Montpellier	Examineur
M. Sylvain CHARLAT, CR, LBBE, CNRS-Lyon	Examineur
M. Michel RAYMOND, DR, ISEM, CNRS-Montpellier	Examineur
M. Thomas LENORMAND, DR, CEFE, CNRS-Montpellier	Invité
M. Pierrick LABBE, MCF, ISEM, Université de Montpellier	Co-directeur de thèse
M ^{me} Mylène WEILL, DR, ISEM, CNRS-Montpellier	Directrice de thèse



UNIVERSITE DE MONTPELLIER

THESE

Pour obtenir le grade de docteur

Préparée au sein de l'école doctorale
**Systemes Intégrés en Biologie, Agronomie, Géosciences, Hydrosciences, Environnement
(SIBAGHE)**

Et de l'unité de recherche
Institut des Sciences de l'Evolution de Montpellier (ISEM)

Spécialité :
Ecologie, Evolution, Ressources Génétiques, Paléobiologie (EERGP)

Présentée par **Pascal MILESI**

<p>Influence de l'architecture génétique et des variations environnementales sur l'adaptation : la résistance aux insecticides chez les moustiques</p>

Soutenue le 18 Décembre 2015 devant le jury composé de :

M. Sylvain BILLIARD, MCF, GEPV, Université de Lille 1	Rapporteur
M. Pierre-Henry GOUYON, Pr, ISYEB, MNHN	Rapporteur
M. Denis BOURGUET, DR, CBGP, INRA-Montpellier	Examineur
M. Sylvain CHARLAT, CR, LBBE, Université Claude Bernard Lyon 1	Examineur
M. Michel RAYMOND, DR, ISEM, CNRS-Montpellier	Examineur
M. Thomas LENORMAND, DR, CEFE, CNRS-Montpellier	Invité
M. Pierrick LABBE, MCF, ISEM, Université de Montpellier	Co-directeur de thèse
M ^{me} Mylène WEILL, DR, ISEM, CNRS-Montpellier	Directrice de thèse

Laboratoire de recherche :

UMR 5554 Institut des sciences de l'évolution de Montpellier
Université de Montpellier
Bâtiment 22, 1^{er} étage
Place Eugène Bataillon
34 095 Montpellier Cedex 5

Remerciements :

À ma famille, Maman et Papa (et oui, honneur aux dames !), merci de m'avoir laissé faire mes choix et accompagné tout au long de ceux-ci. Merci de m'avoir écouté parler de ma thèse sans me faire remarquer que bon... vous ne compreniez pas toujours grand-chose et plus fort encore de l'avoir relue et corrigée, de m'avoir écouté me plaindre des étudiants sans me rappeler que je m'étais, moi aussi en mon temps, fait virer de quelques... (vous ne le saviez pas ?... oups !). Surtout merci de m'avoir appris à ne jamais tenir les choses pour acquises, de m'avoir poussé à toujours me demander « pourquoi ? », et à réfléchir « par moi-même », ces qualités qui m'ont tellement aidé par la suite... Ha si ! J'allais oublier... merci d'avoir fait ma sœur avant moi, elle qui a essuyé les plâtres, signé quelques mots d'absence en cours et une ou deux heures de colle. Salut Sœurette ! Un peu plus et tu m'écarterais de ma scolarité (si, si les tee-shirts moulants ont changé ma vie)! Merci beaucoup sœurette d'avoir été un modèle pour moi, de m'avoir guidé dans l'adolescence me disant ce qui était cool et ce qui ne l'était pas, en m'apprenant à être un bon élève curieux, sans être la tête de turc et sans passer pour un fayot ;) ! À mes grands-parents, mon oncle et ma tante et aux deux pichouns Maxou (qui me dépasse) et Louloute (qui le fera bientôt), merci pour ces moments de plaisir en famille ; que de bonheur passé tous ensemble et tellement à venir ! Aux deux pichouns, surtout restez curieux et émerveillez-vous le plus possible du monde qui vous entoure, il est riche de sa diversité ! Enfin, un petit mot à celle qui par un « oui », un soir d'octobre, a accepté de faire partie de cette famille, sans toi tout aurait été plus dur... Je vous aime tous très fort !

Aux loutres. Non, je ne suis pas responsable de toutes ces sal***** de moustiques qui nous les bouf**** de longue au temps de l'apéro ! Vous m'avez bien gavé avec vos : fais quelque chose ! à quoi tu sers ? Pourquoi tu les tues pas... Qu'est-ce que tu fous au labo ?! Je veux être CHERCHEUR, pas TROUVEUR, bandes de nouilles ! Plus sérieusement merci pour ces soirées qui m'ont bien fait respirer aux moments difficiles, merci pour votre joie de vivre et puis LOUTROS... HAOU HAOU, HAOU (je ne sais pas si ça s'écrit ainsi, en fait je ne suis pas sûr que ça s'écrive tout court), au 18 les amis pour l'apéro sur un air de coupo santo bien sûr ! Petite mention spéciale à ceux que j'ai rencontrés avant que je ne sache parler, hein mon Sanka, ou que je sois totalement propre, hein mon Fox ! À celui qui m'a accompagné en licence pour de longues discussions autour de cafés en fumant quelques clopes et qui était là quand j'ai re-rencontré ma belle, hein mon Karibou ! Aux partenaires de jeux de société, Ally, Fab, Adri, Lauriane, Nico et Paul, quand il ne fallait pas se coucher trop tard, parce que « y'en a qui bosse » hein ! Aux amis, rencontrés en licence, ceux qui ont eu le courage, que je n'ai pas eu, d'être prof en lycée et collège (hein Will) ou pas, hein Bitch et Léa ! Il y a aussi ceux rencontrés en master, qui sont restés ici ou partis loin, mais qu'un simple coucou de temps en temps, suffit pour raviver de supers souvenirs ! Certains tiennent même à un blog de vulgarisation scientifique (danslestesticulesdedarwin), et d'autres en ont fait leur métier (DirtyBiology), publicité subliminale les copains ! Merci pour ces super moments en votre compagnie, ces douches inoubliables, hein Rutschi ! Ou ces cures de salasso thérapie, hein mon Tim ! Et puis y a Paulo, mon Paulo, copain, bambi etc. cool de t'avoir eu à mes côtés toutes ces années, comme tu l'as dit un soir dans une ambulance avec la clavicule cassée (au moins trois morceaux si t'as oublié), c'est les copains, c'est la famille ! Enfin y'a les autres, stagiaires devenus amis, Cécile, Alex et sa choupinette, Camille. Que de bon moments en votre compagnie ; merci pour tout ! Re-enfin, à celle qui est ma meilleure amie et m'a accompagné depuis six ans déjà, sans toi tout aurait été moins drôle.

Famille et amis c'est fait ! Au boulot maintenant (noter le double sens)!

Tout d'abord je tiens à remercier les membres de mon Jury, les deux rapporteurs, P-H Gouyon et S. Billiard, ainsi que les examinateurs, S. Charlat, D. Bourguet et M. Raymond d'avoir accepté d'évaluer mon travail. Merci beaucoup !

Je tiens ensuite à remercier les membres de mes comités de thèse Nicolas, Diego, Sylvain et Thomas, qui m'ont offert le temps de deux après-midi le privilège de réfléchir avec moi sur des thématiques qui me tiennent à cœur, j'ai vraiment apprécié ces moments ! Merci !

J'ai eu la chance de collaborer un peu plus avec certains ; alors merci Diego, pour m'avoir appris qu'on pouvait disséquer les glandes salivaires de moustiques pour en étaler les chromosomes, si si on peut ! Merci Thomas, d'avoir, dès le début, accepté de faire partie de cette aventure, merci pour tes conseils toujours plus qu'avisés, merci pour ce temps que tu m'as offert !

Au cours de ma thèse j'ai eu la grande chance de pouvoir effectuer un monitorat au sein du département BE et je souhaite vivement remercier tous ceux avec qui j'ai eu le plaisir de travailler pendant ces heures de bonheur qui étaient celles des enseignements ! Vraiment, c'était cool ! Au passage, j'en profite pour me mettre de l'autre côté en tant qu'étudiant, pour remercier cette université dans laquelle je me suis épanoui au cours de ces huit dernières années...

À ceux que j'ai eu la chance de rencontrer pendant cette thèse et qui, par leur conversation au détour d'un couloir, le temps d'un café, d'une petite mousse (ou deux ou trois), d'une clope sur les marches, d'une raclette ou d'un marathon, m'ont permis de me sentir, ici, à l'ISEM comme à la maison ! Une mention spéciale à Céline, Jeanne, Fadela, Cassandra, Agnès, Sylvio, Sébastien, Pierre-Ol, Pierrot, Yohan, toute l'équipe sexe et spéciation et... Alice avec ses histoires truculentes ! Ne voulant vexer personne je me contenterai d'un : « les autres se reconnaîtront j'en suis sûr », vous êtes si nombreux, merci mille fois ! Enfin, à celle qui est ma première collègue avec qui j'ai passé tant de soirées à papoter de sciences et d'enseignement, à corriger des comptes rendus et à préparer les cours de stats de Céline de la semaine d'après ;) ... sans toi ces moments auraient paru tellement plus longs.

Salut à vous, ô armée de stagiaires, que j'ai eu le plaisir d'encadrer au cours de cette thèse et même un peu avant ! Dans l'ordre chronologique, Rachel, Sandra et Sarah, Cécile, Allan et Pacôme, Pierre-Yves, Lyndsay, Julien et Jessica, Lise et enfin Alex. Je vous remercie tous pour l'implication et le sérieux que vous avez mis au cours de vos stages, tant dans l'acquisition des données qui m'ont été et me sont si précieuses, que dans le sérieux avec lequel vous avez abordé l'apéro du mercredi soir. En plus on s'est franchement bien marré ! Cécile, toi qui viens de t'engager dans ce master 1 qui m'a tant tenu à cœur, bon courage, garde toujours confiance en toi et fonce ! Alex, dans trois ans tu seras à ma place, bon courage pour écrire les remerciements mon gars, c'est plus dur qu'il n'y paraît ! Encore merci à toi et ta douce, l'ami, pour ces supers moments et puis... on se voit bientôt hein !!

Enfin, allez faire un tour dans les bureaux 01/22/1/62.0 et 01/22/1/61.1 du bâtiment 22 au 1^{er} étage sur la gauche, on y rencontre des gens super, de passage ou toujours là. Certains parlent de *Wolbachia*, une bactos endosymbiotique fort sympathique, Émilie, Célestine, Manon, Olivier, Mathieu, de super conversations avec vous, toujours riches, merci ! D'autres parlent de génomique, merci Anna de m'en apprendre les bases, on va bien se marrer dans les mois à venir ! Enfin il y a ceux qui font de la résistance... aux insecticides bien sûr !

Que ce soit en Martinique, merci beaucoup André de nous avoir accueillis, où, comme dans la région montpelliéraine, j'ai eu le rare privilège de visiter, toutes les stations d'épurations, égouts, fausses septiques, roubines vaseuses, etc. pour traquer les larves de moustiques. Certains ont la chance de travailler sur des papillons... pas moi ! Au cours de cette thèse tout le monde s'est montré bienveillant et d'une grande aide.

Alors, merci Arnaud pour ces mises au point de manip, et pour m'avoir fait la guerre pour que je manipule « dans les règles » et de manière rigoureuse (non faut pas mâcher ses gants...). Merci beaucoup-beaucoup Sandra pour le nombre d'extractions que tu as envoyées pour moi dans les coups de bourre et pour m'avoir tant de fois crépi parce que je ne rangeais pas les insectariums... ça me rappelait un peu la maison ! Patrick, Patounet, Patou, merci également pour toute l'aide en manip que tu as, sans rechigner accepté de m'apporter et, ô combien nos discussions matinales sur le match de la veille m'ont été agréables tout au long de ma thèse (je n'oublie pas que tu m'as promis un câlin si je deviens docteur) ! Merci Nicole, pour avoir pris le temps de m'aider depuis cinq ans en relisant mes rapports et articles, traquant la moindre faute et m'aidant dans la préparation de mes oraux toujours avec pertinence. Enfin, merci Benoît pour m'avoir prêté tes jouets, *An. gambiae* a plein de chose à nous apprendre et c'est vraiment cool de travailler avec toi ! A bientôt l'ami ! À vous tous, vraiment un grand et sincère merci accompagné d'un très grand sourire !

À vous deux, Pierrick et Mylène, que vous dire ? Il y a cinq ans quand je rentrais pour la première fois dans ce bureau avec une veste de costard et des chaussures pointues vous m'avez dit tout simplement (enfin, simplement si on veut, vous aviez fêté un article de Célestine la veille...) : défonce-toi garçon et on se défoncera pour toi... Merci d'avoir tenu parole, vous formez une sacrée team !

Ha Chef, t'espérais sans doute que j'en reste là et qu'avec une certaine pudeur je n'oserais pas écrire toute ma gratitude. Alors je sais que tu vas me dire que ça faisait partie de ton boulot, etc. mais vraiment : veiller à deux heures du mat pour bosser avec moi, ça faisait partie de ton boulot ? Venir faire du baby-sitting, pour que je ne sois pas en travail isolé les jours fériés et certains week-end, ça faisait partie de ton boulot ? T'arracher les cheveux (hihihi) sur ma prose (encore et encore), ça faisait partie de ton boulot ? Tu m'as apporté tellement plus que tu ne voudras jamais l'admettre, dans les domaines de la recherche et de l'enseignement et dans tout le reste ! Merci, Merci et mille fois Merci de m'avoir aidé à grandir (toujours pas en taille hein)!

Cheffe, tu sais déjà tout ce que je pense de ces cinq dernières années, notamment combien je me suis senti et me sens à la maison dans ce labo, en grande partie grâce à cet esprit, si particulier, que tu sais si bien communiquer. Tout comme Pierrick tu as toujours été là pour moi « chazamant » dans les insectariums pour que les manips fonctionnent ou chantant à tue-tête les chansons passant sur nostalgie des samedis et dimanches après-midis en isolant des femelles, lançant des traitements, matant des matchs de rugby... Mille mercis pour les pieds aux fesses toujours constructifs et pour tout ce que tu m'as apporté dans et en dehors du boulot !

À tous les deux, merci de m'avoir donné ma chance, de m'avoir accompagné et aidé (et c'est pas fini hein !), et surtout d'avoir été là pour parler dans les moments difficiles et pour rire tout le reste du temps... Non, franchement, on s'est bien poilé quand même ?!

Le mot de la fin est pour toi ma belle ; on était loin d'imaginer lors de cette soirée d'épisode cévenol voilà six ans, qu'on soutiendrait nos thèses à deux jours d'intervalle ! Merci d'avoir été et d'être à mes côtés pour regarder vers demain, l'avenir s'annonce plus souriant avec toi.

À tous, un grand et immense merci ! On se voit pour l'apéro, et si vous n'êtes pas là, on se verra au prochain !

Introduction.....	11
<i>Quel est le rôle de l'architecture génétique dans l'adaptation ?.....</i>	17
<i>Comment les variations de l'environnement affectent-elles la dynamique évolutive d'une adaptation ?.....</i>	27
Chapitre 1 : Duplications hétérogènes et compromis avantages-coûts.....	33
1) <i>Les duplications hétérogènes permettent de fixer un compromis évolutif intermédiaire.</i>	33
2) <i>Mêmes causes, mêmes conséquences ? Duplication hétérogène du locus ace-1 chez Anopheles gambiae.....</i>	39
<i>Conclusion</i>	45
Chapitre 2 : Les duplications hétérogènes ont été sélectionnées de manière récurrente malgré leurs coûts	47
<i>Les duplications hétérogènes du locus ace-1 sont largement répandues et générées de manière indépendante à partir de la diversité allélique locale.</i>	49
<i>La majorité des allèles dupliqués sont sublétaux à l'état homozygote mais complémentent.</i>	53
<i>Conclusion</i>	55
Chapitre 3 : Superdominance et duplications hétérogènes	57
<i>Introduction.....</i>	57
<i>Matériel et méthodes.....</i>	59
<i>Résultats et discussion</i>	63
<i>Conclusion</i>	69
Chapitre 4 : Relations entre variations de pression de sélection et variations de la valeur sélective en populations naturelles.....	71
<i>Variations des quantités d'insecticides et dynamiques des allèles de résistance sur la période 1986 - 2012.....</i>	75
<i>L'arrêt des OPs révèle l'existence d'autres agents de sélection et une évolution du coût des allèles de résistance.....</i>	77
<i>Les valeurs sélectives des allèles de résistance dépendent de la dose d'insecticide : de faibles variations affectent-elles leur dynamique ?</i>	79
<i>Conclusion</i>	80
Chapitre 5 : Effet du retrait de la pression de sélection sur la dynamique d'allèles adaptatifs en populations naturelles : Etudes préliminaires.	81
<i>Matériels et Méthodes</i>	82
<i>Résultats et discussion</i>	85
<i>Conclusion</i>	90
Discussion générale.....	93
<i>La valse des adaptations.....</i>	94
Conclusion générale	102
Références.....	103
Communications scientifiques.....	111
Annexes.....	113

Introduction

Les mutations sont à l'origine de la variabilité observée dans les populations naturelles. Les variants phénotypiques, issus de ces variations génétiques, présentant la capacité de produire le plus grand nombre de descendants dans un environnement donné (*i.e.* ayant la meilleure valeur sélective), sont dits adaptatifs. Ils envahissent les populations sous l'action de la sélection naturelle. Ainsi, dans un environnement stable (dans l'espace et dans le temps), les organismes d'une population devraient peu à peu tendre vers un phénotype optimal.

Le phénotype peut être défini comme l'expression d'un ensemble de gènes dans un environnement donné. Il dépend donc des relations entre les allèles d'un même gène (dominance), des interactions entre différents gènes (épistasie) et du fait qu'un même gène peut coder pour différents caractères (pléiotropie). En conséquence, une mutation bénéfique sur un trait particulier peut affecter négativement plusieurs autres traits (*i.e.* effets pléiotropes délétères), constituant ce qu'on appelle le coût sélectif de cette mutation. Le caractère adaptatif d'une mutation dépend donc d'un compromis entre les avantages qu'elle confère et les coûts sélectifs qui lui sont associés. En raison des effets pléiotropes délétères des mutations avantageuses, il est rare d'atteindre un optimum phénotypique en une seule mutation (Fisher 1930 ; Orr 1998).

Plus on est loin de l'optimum phénotypique, plus une nouvelle mutation a une probabilité élevée d'entraîner un compromis avantages-coûts favorable et donc d'être sélectionnée (Fig. 1). Par contre plus on se rapproche de l'optimum phénotypique plus la probabilité que ce compromis soit défavorable est élevée (Fig. 1).

La sélection successive de mutations entraînant des compromis avantages-coûts toujours plus favorables constitue une trajectoire adaptative (Orr 1998) (Fig. 1). Ces trajectoires adaptatives peuvent être dues à l'apparition de nouvelles mutations qui réduisent le coût associé à une mutation précédente. Il peut s'agir par exemple de mutations sur d'autres gènes, qui permettent de corriger, au moins en partie, les effets délétères de la première mutation (mutations compensatoires). Par exemple chez la mouche *Lucilia cuprina*, la mutation du gène *Rop-1* conférant la résistance à un insecticide organophosphoré (OPs) (McKenzie et al. 1980), entraîne des effets pléiotropes délétères. Ces effets sont compensés par la mutation d'un autre gène sur un autre chromosome (Clarke 1997).

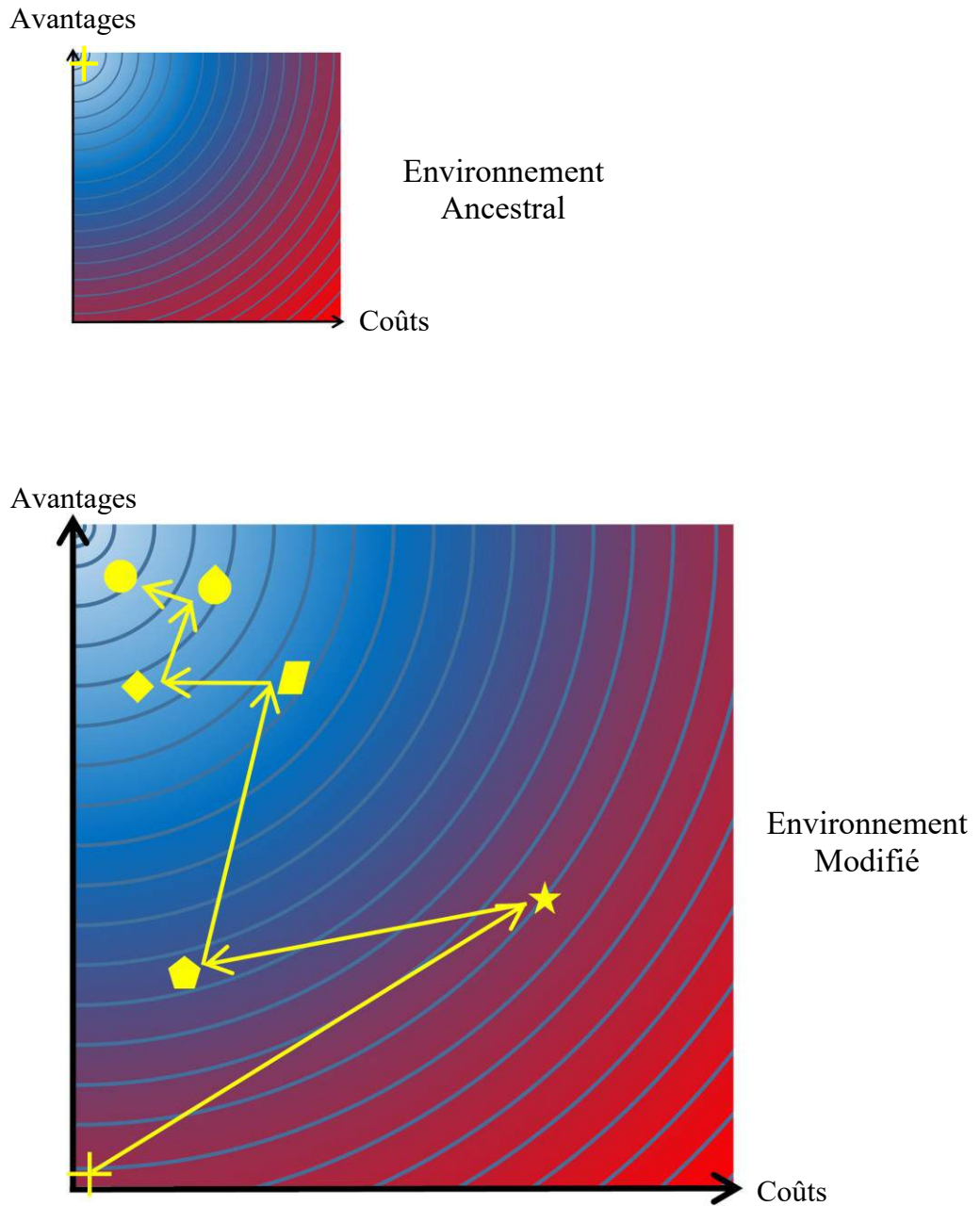

Figure 1 : Trajectoire adaptative du point de vue des compromis avantages-coûts. L'axe des ordonnées représente l'avantage conféré par une mutation et l'axe des abscisses représente les coûts associés. L'optimum phénotypique se situe alors en haut à gauche. Les lignes représentent des isoclines de valeurs sélectives et la coloration reflète la distance à l'optimum phénotypique. Lors d'un changement environnemental, l'optimum phénotypique se déplace, et le phénotype ancestral (croix jaune) n'est plus adapté. La sélection de mutation, entraînant des compromis évolutifs toujours plus avantageux, permet de se rapprocher du nouvel optimum phénotypique.

Une autre possibilité est l'apparition d'un nouvel allèle du même locus présentant un coût réduit (remplacement allélique). Par exemple, dans la région montpelliéraine, chez le moustique *Culex pipiens*, l'allèle *Ester⁴*, conférant la résistance au temephos, un autre insecticide OPs, a remplacé l'allèle de résistance *Ester¹*, précédemment installé dans les populations (Guillemaud et al. 1998) car *Ester⁴* est associé à de moindres effets pléiotropes délétères (Labbé et al. 2009). Ainsi, toute mutation entraînant un compromis avantages-coûts plus favorable sera sélectionnée (Fig. 1) : un coût plus élevé peut être supporté s'il s'accompagne d'un avantage proportionnellement supérieur (ex. *Ester²* chez le moustique *Culex pipiens*, Labbé et al. 2009).

Enfin, l'environnement reste rarement stable sur des périodes prolongées. D'un point de vue de l'adaptation, cela signifie que l'optimum phénotypique se déplace. En conséquence, le génotype conférant le phénotype le plus avantageux dans l'environnement ancestral ne sera probablement pas le même dans un environnement modifié.

Comprendre la dynamique évolutive d'une adaptation en populations naturelles nécessite donc de décrypter les liens génotypes-phénotypes des mutations adaptatives (*i.e.* de mettre en évidence leurs compromis avantages-coûts), dans les différents environnements expérimentés par les individus. Il est également nécessaire de comprendre comment les variations de l'environnement (ex. leur amplitude ou leur fréquence) peuvent affecter la sélection de ces différents compromis et ainsi influencer la trajectoire adaptative.

Pour des raisons pratiques évidentes, peu de modèles biologiques permettent l'étude de l'évolution d'une adaptation à ces différentes échelles, depuis l'identification des mutations qui en sont responsables et la caractérisation de leurs effets sur le phénotype, jusqu'à leurs dynamiques en populations naturelles. C'est cependant souvent le cas d'adaptations à des modifications environnementales d'origine anthropique. Contrairement à de nombreux modèles, les agents responsables de la sélection de ces adaptations sont en effet généralement connus. De plus, on a souvent accès à leur répartition (dans l'espace et le temps), et parfois même à une quantification de leur présence dans l'environnement.

Le complexe d'espèces *Culex pipiens* (ou moustique domestique)

Le complexe d'espèces *Culex pipiens* comprend deux taxons principaux : (i) *Cx. pipiens*, retrouvé dans les zones tempérées et (ii) *Cx. quinquefasciatus*, retrouvé dans les régions tropicales. Le terme générique de *Cx. pipiens* (*i.e.* incluant les deux taxons) sera utilisé de manière générale dans cette thèse ; lorsque nécessaire, le taxon d'origine des individus sera précisé.

Cycle de vie : les femelles sont fertilisables quelques heures après émergence. Après accouplement, le mâle dépose un bouchon spermatique à l'entrée des voies génitales de la femelle empêchant toute autre reproduction. Un repas sanguin est nécessaire à la femelle pour permettre le développement des œufs (jusqu'à 250 œufs par ponte).

Quatre à sept jours après le repas sanguin, les femelles déposent les œufs à la surface d'eaux stagnantes riches en matières organiques. Jusqu'à l'imago, cinq stades aquatiques de développement se succèdent (quatre stades larvaires et un stade nymphal).

Le temps de génération en populations naturelles dépend grandement des conditions environnementales (notamment de la température), et varie d'une quinzaine de jours à environ un mois ; il est d'environ vingt jours au laboratoire. Enfin, dans les régions tempérées, pendant l'hiver, les femelles *Cx. pipiens* sont en diapause et par conséquent ne se reproduisent pas.

C'est le cas notamment des xénobiotiques utilisés pour contrôler les populations naturelles de ravageurs agricoles, de pathogènes ou encore de vecteurs. L'épandage de ces biocides a en effet sélectionné des organismes « résistants » capables de les tolérer ou de les éliminer ; ces résistances constituent une adaptation à la présence de ces composés dans l'environnement (Whalon et al. 2008 ; Labbé et al. 2011 ; Feyereisen et al. 2015). Les modèles de résistance présentent plusieurs avantages précieux, notamment : i) l'origine des réponses adaptatives est souvent plus facile à identifier puisque les principes actifs et les cibles des agents de sélection sont connus ii) ces adaptations ont souvent un déterminisme génétique relativement simple, ce qui facilite la caractérisation du lien génotype-phénotype iii) les organismes ciblés sont des espèces à cycle de vie court, permettant un suivi sur plusieurs générations et iv) les populations sont généralement de grande taille, ce qui limite fortement l'effet de la dérive génétique et permet d'étudier plus directement l'effet de la sélection. Il est ainsi possible d'étudier, grâce à ces modèles, des dynamiques adaptatives en populations naturelles sur des échelles de temps relativement courtes. Parmi ces exemples, la résistance du moustique *Cx. pipiens* aux insecticides organophosphorés (OPs) et carbamates (CXs) est certainement, à ce jour, le mieux décrit.

L'utilisation de ces insecticides depuis le milieu du XXème siècle a exercé une forte pression de sélection sur les populations du complexe d'espèces *Cx. pipiens* (Box 1). En réponse à ce changement environnemental, plusieurs mutations permettant la résistance ont été sélectionnées à différents locus. Un aspect très intéressant est que, au-delà de la vision réductrice souvent retenue, ces mutations présentent une grande diversité d'architectures génétiques (substitution nucléotidique, duplication d'une portion de chromosome, amplification génique). Ce modèle permet donc d'étudier comment différentes architectures génétiques peuvent influencer l'évolution d'une adaptation.

Les dynamiques de ces adaptations en populations naturelles ont en outre été suivies pendant plus de 40 ans dans la région de Montpellier, au gré des changements de molécules et des pratiques de traitements liés à l'évolution de ces résistances, mais aussi, plus largement, au gré des changements de politiques environnementales. De plus, des résistances similaires ont été identifiées et suivies dans diverses régions de la planète et chez d'autres espèces. Ce modèle permet donc aussi de comparer l'évolution de ces adaptations dans différents environnements.

L'étude de ces deux aspects, le rôle de l'architecture génétique dans l'adaptation d'une part, et l'influence des variations de pressions de sélection sur la dynamique d'allèles adaptatifs d'autre part, a constitué les deux objectifs principaux de ma thèse.

Quel est le rôle de l'architecture génétique dans l'adaptation ?

Les mutations à l'origine d'une adaptation peuvent être de natures et d'ampleurs très variées à l'échelle du génome. Elles peuvent n'affecter qu'un seul (ou quelques) nucléotide(s), dans le cas de mutations ponctuelles (substitution, insertion et délétion), mais également des portions de chromosomes plus ou moins grandes (inversions, translocations, délétions et duplications d'un ou de plusieurs gènes). Du fait de ces ampleurs différentes, on peut s'attendre à ce que les effets de ces mutations, notamment en termes de compromis avantages-coûts, soient également différents. Par ailleurs, de par leurs natures différentes, ces mutations ne sont pas associées aux mêmes contraintes. On s'attend donc à ce que l'architecture génétique à l'origine d'une adaptation puisse en influencer sa trajectoire évolutive.

De façon générale, le rôle des mutations ponctuelles est mieux documenté que celui des mutations de plus large ampleur : elles sont plus faciles à étudier et ont des effets généralement considérés comme moins complexes à comprendre (même si une simple substitution dans une séquence régulatrice peut avoir des effets en cascade très complexes). A l'inverse les effets phénotypiques des mutations de large ampleur sont plus difficiles à anticiper : en affectant une portion d'ADN plus large, qui peut contenir plusieurs gènes, ces mutations peuvent potentiellement affecter plusieurs traits, rendant le lien génotype-phénotype plus complexe à caractériser. On a également longtemps considéré que de telles mutations devaient être rares et avoir une forte probabilité d'être délétères, et que, par conséquent la majorité d'entre elles ne jouaient qu'un rôle limité dans l'évolution.

On sait toutefois que des événements rares de polyploïdisation (doublement du génome) ont joué un rôle crucial dans l'évolution des vertébrés (Dehal & Boore 2005) et dans la branche des téléostéens (Jaillon et al. 2004) ou plus encore chez les plantes (par exemple dans les processus de spéciation comme pour *Spartina anglica*, un allotétraploïde invasif issu du croisement *Spartina alterniflora* x *Spartina maritima*, Marchant 1967).

Table. 1 : Comparaison des taux de duplications (μ D) et de substitutions (μ) par générations

Espèces	μ D (/gène/gén.)	μ (/site/gén.)	Références (μ D / μ)
<i>D. melanogaster</i>	1.25×10^{-7}	$5.49 \cdot 10^{-9}$	Schrider et al. 2013
<i>C. elegans</i>	1.25×10^{-7}	$2 \cdot 10^{-9}$	Denver et al. 2009 / Lipinski et al. 2011
<i>S. cerevisiae</i>	3.4×10^{-6}	3.3×10^{-10}	Lynch et al. 2008
<i>H. sapiens</i>	1.7×10^{-5} to 8.7×10^{-7} ^a 2.98×10^{-8} ^b	1.1×10^{-8}	Lupski 2007 ; Turner et al. 2008 Pan & Zhang 2007 / Roach et al. 2010

^a Estimation basée sur quatre locus

^b Originellement en gène. Ma^{-1} , ramené en génération en considérant des générations de 20ans.

Les duplications de gènes sont également soupçonnées d'avoir un rôle majeur dans l'évolution des génomes, en tant que "carburant" de l'évolution à long-terme (Ohno 1970). On considère en effet que la grande majorité des gènes actuels peuvent être reliés, par ascendance, à quelques gènes ancestraux (Zhang 2003) : des duplications successives de ces gènes (générant des familles de gènes paralogues) auraient fourni le matériel génétique supplémentaire permettant l'émergence de nouvelles fonctions. L'idée générale est que la duplication d'un gène permet de relaxer la sélection sur l'une ou l'ensemble des différentes copies qui la composent. De nouvelles mutations pourraient ainsi faire émerger de nouvelles fonctions, soit *de novo* (néofonctionnalisation, Ohno 1970 ; Lynch & Conery 2000), soit par spécialisation des copies filles dans des fonctions différentes supportées auparavant par un unique gène-père pléiotrope (subfonctionnalisation, Hughes & Hughes 1993 ; Lynch & Force 2000).

Ces événements de duplications, bien que considérés comme fondamentaux dans l'évolution à long terme, sont généralement considérés comme peu fréquents. Toutefois, de nombreuses études récentes, basées sur les nouvelles techniques de séquençage, ont montré qu'un grand nombre de gènes présentait des variations du nombre de leurs copies entre individus d'une même espèce (voir Schrider and Hahn 2010 pour une revue). Les plus récentes estimations ont ainsi montré que le taux de duplication par gène par génération pouvait être équivalent au taux de substitution, voire supérieur de quatre ordres de grandeur (Tab. 1) (Lynch et al. 2008 ; Lipinski et al. 2011 ; Katju and Bergthorsson 2013 ; Schrider et al. 2013).

Dans de nombreuses études, la dynamique précoce des duplications a souvent été négligée pour se concentrer uniquement sur leur devenir à long terme. Ces études considéraient généralement que, puisqu'une duplication entraînait au départ une redondance d'information génétique, on pouvait la considérer comme neutre lors de son apparition. La découverte de la fréquence des duplications ségrégeant dans les populations et une meilleure compréhension de leurs conséquences phénotypiques directes ont provoqué une réévaluation de cet *a priori*. En effet, il est peu probable que ces réarrangements génomiques complexes n'affectent pas la valeur sélective. En modifiant la structure génomique, ces duplications peuvent en effet entraîner de nombreux troubles d'ordre structurel, par exemple une perte de fonction lorsqu'une séquence régulatrice ou un gène sont rompus par l'insertion de la copie surnuméraire.

De plus, une duplication entraîne une augmentation immédiate de la quantité de protéine produite, susceptible de causer de nombreux troubles d'ordre biochimique : coût énergétique à l'expression de protéines superflues, perturbation d'un équilibre métabolique pour des gènes en interaction, ou dépassement de la quantité optimale d'une protéine (pour une revue voir Kondrashov and Kondrashov 2006). Ainsi de nombreux auteurs ont commencé à suggérer que, loin d'être neutres, la plupart des duplications de gènes néoformées seraient au contraire probablement délétères et soumises à une forte pression de sélection purifiante (Emerson et al. 2008 ; Itsara et al. 2009 ; Reams et al. 2010 ; Langley et al. 2012 ; Katju and Bergthorsson 2013). Cette prédiction a été confirmée chez *Drosophila melanogaster* : une étude d'accumulation de mutations a ainsi estimé que 99 % des duplications néoformées étaient fortement délétères et seraient rapidement éliminées (Schridder et al. 2013).

La fréquence des variations du nombre de copies a également amené de nombreux auteurs à reconsidérer le rôle des duplications de gènes dans l'adaptation à plus court terme. Si le destin de la plupart des duplications de gènes néoformées est d'être éliminées par sélection purifiante, on sait que certaines y échappent néanmoins, et qu'elles peuvent être adaptatives. De nombreuses études ont ainsi montré que les répétitions identiques d'un même gène pouvaient être sélectionnées précisément parce qu'elles entraînent une augmentation de la production de protéines (Brown et al. 1998 ; Hastings et al. 2000). C'est le cas, par exemple, de la multiplication des copies du gène de l'amylase chez l'homme et le chien, sélectionnée car elle permettrait l'assimilation plus importante d'une alimentation basée sur les céréales (Perry et al. 2007 ; Axelsson et al. 2013). C'est aussi le cas de l'adaptation aux xénobiotiques, où des gènes codant pour des protéines détoxifiantes sont dupliqués, ce qui permet une élimination plus rapide de ces produits (ex : les métaux lourds, Maroni et al. 1987). Les duplications sont dans ce cas adaptatives (et donc sélectionnées) parce qu'elles confèrent un avantage d'ordre quantitatif.

Il existe toutefois un autre type de duplications, dont on pense qu'elles pourraient présenter un avantage plus qualitatif (Haldane 1954 ; Spofford 1969) : il s'agit des duplications hétérogènes, qui associent sur un même chromosome des allèles différents d'un même gène. Elles permettent ainsi à un même individu de produire des combinaisons de protéines différentes.

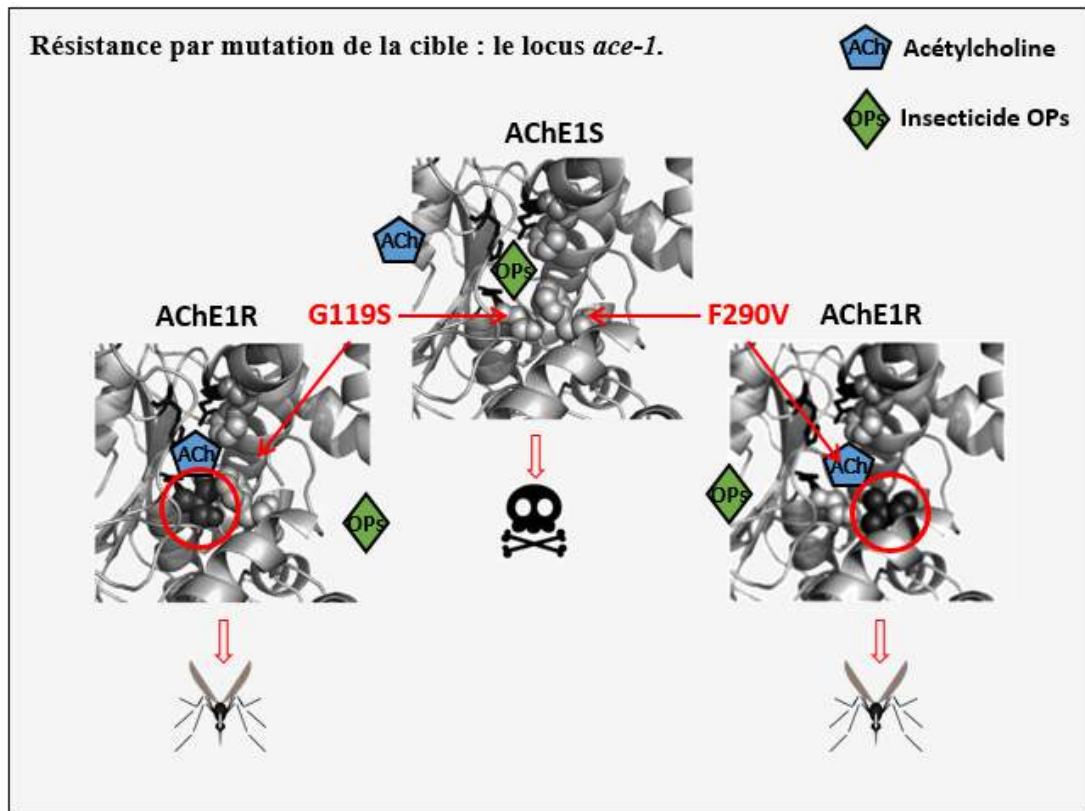

Figure 2 : substitutions nucléotidiques du locus *ace-1* conférant la résistance chez *Cx. pipiens* (d'après Alout et Weill 2008). Le remplacement du glycine en une serine en position 119 (G119S) ou celui d'une phénylalanine en une valine en position 290 (F290V) au niveau du site actif de l'acétylcholinestérase (AChE1) empêche la fixation des insecticides (OPs) mais pas celle de son substrat, l'acétylcholine (ACh).

Cette propriété peut se révéler avantageuse, comme, par exemple, dans le cas des immunoglobulines, où les duplications de régions variables ont généré une grande diversité d'anticorps, et donc une réponse immunitaire spécifique vis-à-vis d'un plus grand nombre de pathogènes (Demuth et al. 2006). Toutefois, du fait du nombre restreint d'exemples empiriques, le rôle de ces duplications a principalement été étudié de manière théorique (Haldane 1954 ; Spofford 1969 ; Lynch et al. 2001 ; Otto and Yong 2002 ; Proulx and Phillips 2006 ; Hahn 2009 ; Innan and Kondrashov 2010).

Le modèle de la résistance aux insecticides OPs et CXs chez les moustiques offre une opportunité unique, puisqu'on retrouve une grande diversité d'architectures génétiques à l'origine de cette adaptation.

Par exemple, deux substitutions nucléotidiques différentes (G119S et F290V) ont été identifiées dans le gène *ace-1* chez le moustique *Cx. pipiens*. Ce gène code pour la cible des OPs et CXs, l'acétylcholinestérase (AChE1), une enzyme impliquée dans la régulation de l'influx nerveux. Les deux substitutions provoquent une fermeture partielle du site actif de l'AChE1, empêchant la fixation des insecticides (Fig. 2) ; elles permettent ainsi la survie des individus qui en sont porteurs (Weill et al. 2003 ; Alout et al. 2007b). Néanmoins, il a été montré que le changement de conformation induit par la mutation G119S entraînait une diminution de l'activité AChE1 (Weill et al. 2003 ; Alout et al. 2008), associée à de forts coûts sélectifs (ex. réduction de la survie larvaire et de la fertilité, prédation et temps de développement accrus, Berticat et al. 2002, 2004 ; Bourguet et al. 2004 ; Duron et al. 2006). Enfin, les niveaux de résistance conférés par ces deux substitutions diffèrent selon les insecticides (Alout et al. 2007a). Elles génèrent donc des compromis adaptatifs différents.

Le phénotype résistant chez *Cx. pipiens* peut également être conféré par une architecture génétique différente, impliquant le superlocus *Ester*. Ce dernier est composé de deux gènes en tandem séparés par moins de 6 kb, *Est-2* et *Est-3* (Pasteur et al. 1981 ; Rooker et al. 1996 ; Guillemaud et al. 1997), qui co-ségrègent (Pasteur et al. 1977 ; Raymond et al. 1998). Ils codent pour des estérases, des enzymes de détoxification capables de séquestrer et de dégrader les OPs et CXs avant qu'ils n'atteignent leur cible. La résistance est conférée par la surproduction de ces enzymes (Pasteur et al. 1981, 1984 ; Mouchès et al. 1986 ; Fournier et al. 1987 ; Raymond et al. 1989 ; Poirié et al. 1992 ; Cui et al. 2007).

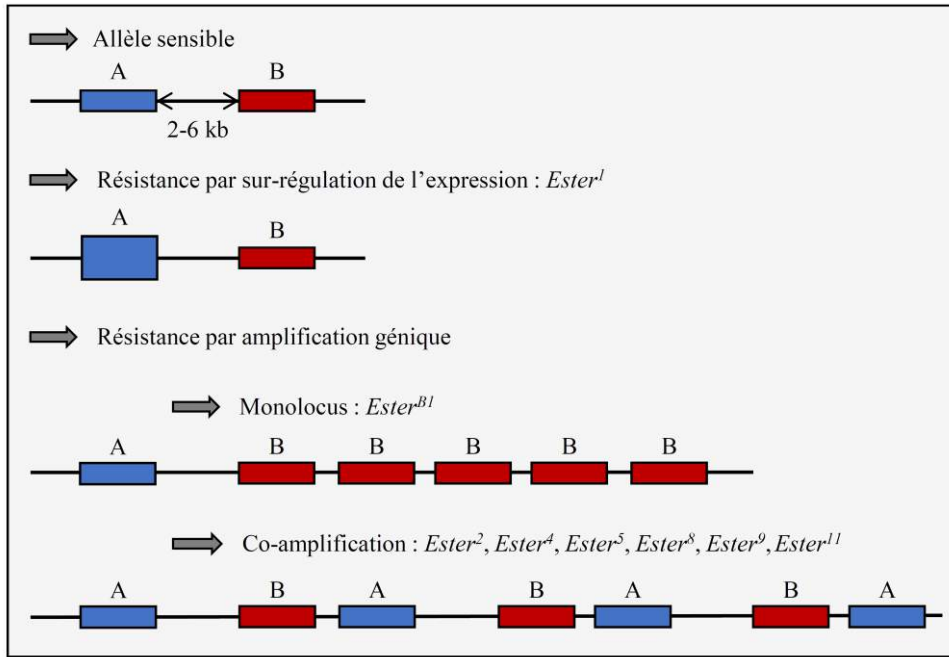

Figure 3 (d'après Weill et al. 2003): Architectures génétiques à l'origine de la surproduction d'estérase chez *Cx. pipiens*. *Est-2* et *Est-3*, super locus *Ester*, codent pour les estérase A et B qui séquestrent et dégradent les OPs et CXs. Dans les cas de résistance, ces estérase sont produites en excès grâce à un processus de sur-régulation de leur expression ou d'amplification du nombre de copies d'un ou des deux gènes qui les codent dans le génome. *Ester^I*, l'allèle de résistance *i*.

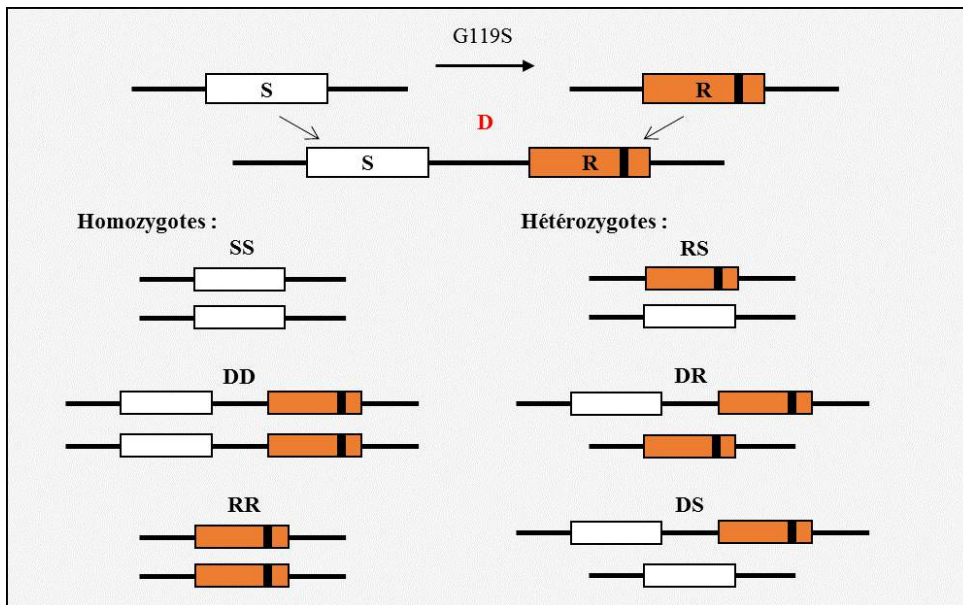

Figure 4 : Duplication hétérogène au locus *ace-1* et génotypes correspondants. Les duplications hétérogènes du locus *ace-1* (D) associent sur un même chromosome une copie sensible (S) et une copie résistante portant la substitution G119S (R). Les différents génotypes possibles sont représentés : les homozygotes sensibles SS, les résistants mono-copie RR et les dupliqués DD, ainsi que les hétérozygotes standards RS, les dupliqués-sensibles DS et les dupliqués-résistants mono-copie DR.

Cette résistance peut être due à une sur-régulation d'un des deux locus, mais elle est généralement la conséquence de duplications répétées d'un ou des deux locus (*i.e.* des amplifications géniques) (Fig. 3, pour une revue voir Raymond et al. 1998). Pour les allèles amplifiés, le niveau de résistance qu'ils confèrent est fortement corrélé au nombre de copies *Ester* dont ils sont constitués (Weill et al. 2000). S'ils sont sélectionnés pour cet avantage quantitatif, ces allèles sont toutefois également associés à des coûts sélectifs plus ou moins forts selon l'allèle : là-encore les compromis avantages-coûts varient (Labbé et al. 2009).

Plus récemment, des duplications hétérogènes du locus *ace-1* ont été décrites dans les populations naturelles du moustique *Cx. pipiens* : elles associent une copie sensible et une copie résistante portant la mutation G119S (Bourguet et al. 1996 ; Lenormand et al. 1998a ; Labbé et al. 2007a,b ; Alout et al. 2010 ; Osta et al. 2012) (Fig. 4). Les conséquences phénotypiques de ces duplications hétérogènes sont beaucoup moins bien comprises que celles des substitutions du locus *ace-1* ou des allèles du locus *Ester*. Les premières études ont suggéré qu'elles pourraient permettre de réduire le coût sélectif associé à la substitution G119S sur *ace-1* (Lenormand et al. 1998a ; Labbé et al. 2007a,b). Toutefois, leurs dynamiques en populations naturelles pourraient indiquer un patron plus complexe. En effet, deux allèles dupliqués au locus *ace-1* sont rapidement montés en fréquence dans les populations naturelles de la région de Montpellier avant de stagner à une fréquence d'environ 0.2 ; ces allèles sont sublétaux à l'état homozygote (Labbé et al. 2007b). A l'inverse, un autre allèle dupliqué du locus *ace-1* semble avoir envahi les populations de Martinique (Yébakima et al. 2004).

Lors de ma thèse, je me suis surtout attaché à mieux comprendre comment et pourquoi ces duplications hétérogènes étaient sélectionnées, en explorant plus particulièrement deux questions :

1) Comment les duplications hétérogènes du locus *ace-1* affectent-elles le phénotype en présence et en absence d'insecticides ? Le premier chapitre de ma thèse exposera les études auxquelles j'ai participé et que j'ai développées pour décrire les relations génotypes-phénotypes des duplications hétérogènes du locus *ace-1* chez deux espèces de moustiques. Outre *Cx. pipiens*, on retrouve en effet la même substitution (G119S) au locus *ace-1* chez *Anopheles gambiae* (Weill et al. 2003) ainsi qu'une duplication associant une copie sensible et une copie résistante de ce gène (Djogbénou et al. 2008). Je pourrai ainsi

comparer les conséquences phénotypiques de ces duplications dans des fonds génétiques différents.

2) Peut-on retracer l'histoire de la résistance au locus *ace-1* et que nous apprend-elle du rôle des duplications hétérogènes dans l'évolution de cette adaptation ? Le deuxième chapitre présentera une étude de la diversité et de la distribution mondiale des allèles de résistance au locus *ace-1*, au cours de laquelle nous avons pu comparer la prévalence de chaque type de mutations (substitution ou duplication) dans les populations naturelles. Grâce à des analyses en laboratoire, nous avons également évalué quel était le phénotype majoritaire conféré par les duplications hétérogènes (sublétales ou non), afin d'expliquer la distribution géographique mondiale de ces allèles.

De façon plus générale, en mettant en rapport ces études avec celles déjà réalisées sur d'autres allèles de résistance chez les moustiques, j'essaierai de dégager ce qu'elles nous permettent de comprendre de l'impact de l'architecture génétique sur la dynamique de cette adaptation.

Comment les variations de l'environnement affectent-elles la dynamique évolutive d'une adaptation ?

Une même mutation peut entraîner des compromis avantages-coûts différents selon les environnements : par exemple, un allèle résistant est favorisé en présence d'insecticide, mais désavantagé en son absence, à cause de son coût. Une telle observation ne traduit toutefois pas la complexité de la réalité écologique, car les environnements naturels fluctuent.

Comment les variations dans l'espace et le temps de l'environnement affectent-elles la sélection des compromis avantages-coûts, et donc la trajectoire adaptative ? Répondre à cette question, plus particulièrement en populations naturelles, nécessite de lever plusieurs verrous. Il est d'abord nécessaire d'être capable de suivre un caractère adaptatif dans les populations, pour pouvoir mesurer les valeurs sélectives des différents variants. Il faut ensuite mettre en regard de ces variations de valeur sélective des variations environnementales, ce qui nécessite de pouvoir identifier précisément l'agent de sélection.

Pour estimer les valeurs sélectives des différents variants dans les populations naturelles, deux grands types d'approches sont possibles : prospectifs ou rétrospectifs (Lenormand et al. 2015). Les approches prospectives consistent à inférer la valeur sélective de différents variants à partir des mesures de différents traits d'histoire de vie choisis *a priori* (Belaousoff & Shore 1995 ; Galloway & Etersson 2007 ; Geyer et al. 2007 ; Shaw et al. 2008). Les approches rétrospectives, plus intégratives, consistent à inférer la valeur sélective de différents variants à partir de suivis dans le temps. On peut ainsi suivre des variations de fréquences alléliques, génotypiques, ou phénotypiques (ex. fréquence d'allèles de résistance chez le moustique *Cx. pipiens*, Lenormand et al. 1999 ; Lenormand & Raymond 2000 ; Labbé et al. 2009, fréquence des variants mélaniques chez la phalène du bouleau, *Biston betularia*, revue dans Cook & Saccheri 2013), ou encore des variations de la moyenne de divers traits phénotypiques (ex. chez les pinsons de Darwin, *Geospiza fortis*, Grant & Grant 1995). Ces méthodes ont permis de mesurer les paramètres de la sélection, mais également de montrer qu'elle varie dans le temps et l'espace (revue respectivement dans Kawecki & Ebert 2004 ; Siepielski et al. 2009). Toutefois, l'interprétation de ces variations est rendue difficile par l'existence de variables confondantes, telles que l'effet de la dérive génétique, les erreurs de mesures ou encore la plasticité phénotypique (Mitchell-olds & Shaw 1987 ; Rausher 1992 ; Bell 2008 ; Millstein

2008 ; Gallet et al. 2012 ; Lenormand et al. 2015). Un autre problème récurrent est le manque de suivis sur le long terme : par exemple la majorité des études de sélection phénotypique basent leurs estimations sur un maximum de trois points seulement, souvent très rapprochés dans le temps (Siepielski et al. 2009). Enfin, la valeur sélective peut varier à différentes échelles spatiale et temporelle mais la prise en compte de toutes ces variations n'est pas forcément pertinente : par exemple, lorsqu'on s'intéresse à la dynamique évolutive d'une adaptation, considérer des variations de la sélection à des échelles inférieures au temps de génération n'est pas forcément approprié.

Un autre défi est de relier les variations de valeur sélective mesurées à leurs causes proximales. Il est en effet souvent impossible d'identifier précisément l'agent de la sélection parmi un ensemble de facteurs environnementaux, potentiellement interdépendants. Dans certains cas, l'agent de sélection peut raisonnablement être déduit à partir des données de terrain (Grant & Grant 1995 ; Losos et al. 1997, voir aussi dans Endler 1986) et confirmé par la suite par des expérimentations (Reznick & Bryga 1987 ; Losos et al. 1997 ; Rundle et al. 2003 ; Bradshaw et al. 2004). Cependant même dans ces cas, les données permettant d'estimer quantitativement le lien entre variations environnementales et variations de la valeur sélective ne sont généralement pas disponibles. Elles nécessitent, en effet, d'être capable de quantifier les variations de l'agent de sélection à des échelles relativement fines dans le temps et l'espace, et surtout compatibles avec les variations de valeur sélective mesurées.

Il convient en effet de pouvoir décrire l'environnement avec un grain adapté à celui des variations de valeur sélective mesurées. Les variations environnementales sur des temps inférieurs à celui d'une génération sont souvent moins pertinentes pour expliquer la dynamique à long terme d'une adaptation : à cette échelle, la valeur sélective résulte des effets de l'ensemble des différents environnements expérimentés par les individus au cours de leur vie. De même, mesurer des variations de valeur sélective à une échelle spatiale ou temporelle trop grande par rapport aux variations environnementales affectant les compromis avantages-coûts d'une adaptation pourrait conduire à sous-estimer l'intensité de la sélection. Néanmoins, des événements extrêmes, mais rares par rapport à l'échelle d'observation et donc difficiles à caractériser, peuvent sélectionner certains phénotypes : beaucoup de ces perturbations sont souvent au cœur du fonctionnement des écosystèmes (incendies, inondations, tempêtes, etc.) et jouent un rôle important dans l'adaptation. Il est donc nécessaire d'estimer les variations de sélection et d'environnement de manière

répétée, à une échelle pertinente dans l'espace et dans le temps au regard de l'organisme et de l'adaptation considérés.

Ces diverses contraintes rendent rares les modèles et les situations qui permettent d'explorer ces liens entre variations de la valeur sélective et variations environnementales. Là encore, les adaptations à des modifications de l'environnement d'origine anthropique sont intéressantes, puisque bien souvent l'agent de sélection est identifié et quantifiable, et les dynamiques des réponses adaptatives sont connues ; c'est le cas par exemple de la résistance aux insecticides (Whalon et al. 2008), aux antibiotiques (Gonzales-Candels et al. 2011), ou de la tolérance aux métaux lourds (Janssens et al. 2009). Cependant, même dans les cas les plus favorables, le lien entre les variations de l'environnement et de la valeur sélective reste essentiellement qualitatif. L'environnement est généralement résumé à un contraste binaire, par exemple zones non polluées vs polluées (*Biston betularia*, Cook et al. 1986, 1999), terres minières vs pâturages (*Holcus lanatus*, Macnair 1987), ou zones traitées vs non traitées (résistance aux insecticides, Lenormand et al. 1999), sans prise en compte des variations quantitatives de la pression de sélection (concentration en particules, en métaux lourds ou en pesticides).

Dans le cas des insecticides, où la molécule responsable de la sélection est ajoutée à dessein dans l'environnement, ces données quantitatives sont parfois accessibles : le contrôle des populations de moustiques étant généralement réalisé dans le cadre de politiques publiques, les zones traitées, les périodes de traitement, les types d'insecticides et les quantités utilisées sont généralement connus. Les pratiques de traitement génèrent des environnements très hétérogènes à la fois dans l'espace (zone traitées vs non traitées, types d'insecticide) et dans le temps. De plus, les données de suivis de la résistance sont parfois disponibles à différentes échelles spatiales et temporelles, puisqu'elles doivent permettre d'ajuster les pratiques de traitements à ces résistances.

C'est justement le cas pour la résistance aux OPs et CXs chez *Cx. pipiens*, notamment dans la région montpelliéraine. Depuis 1969, un organisme semi-public, l'Entente Interdépartementale pour la Démoustication (EID), est chargé des traitements pour le contrôle des populations littorales de moustiques. Les quantités employées d'insecticide, ainsi que leur répartition spatiale et temporelle, sont donc disponibles, au moins pour les 25 dernières années. Par ailleurs la dynamique des allèles de résistance dans la région est suivie depuis plus de 40 ans aux locus *ace-1* et *Ester*, le long d'un transect sud-nord. La

répartition des insecticides est en effet hétérogène le long de ce transect, puisque l'EID ne traite qu'une bande littorale au sud. Ce modèle réunit donc toutes les conditions requises pour étudier l'influence des variations de pressions de sélection sur la dynamique d'une adaptation.

Les interactions entre dynamique adaptative des allèles de résistance et pratiques de traitement ont d'ailleurs déjà été explorées à des grains plus ou moins fins. Les distributions mondiales des mutations G119S et F290V du locus *ace-1* ont ainsi été rapprochées de la nature des molécules insecticides employées dans les différentes régions, ces deux mutations présentant des profils de résistance très différents selon les insecticides (Alout et al. 2007a). A l'échelle plus réduite de la région montpelliéraine, la répartition hétérogène des traitements résulte en des pressions de sélection antagonistes : les allèles de résistance sont sélectionnés en zone traitée, car la résistance qu'ils procurent est un avantage qui peut surpasser les coûts qu'ils entraînent, mais ce compromis est en revanche défavorable en zone non-traitée, où les coûts affectent la valeur sélective des résistants. La fréquence des allèles de résistance suit donc une distribution clinale le long du transect. Ces clines de fréquence et leurs variations ont permis la quantification de paramètres déterminants pour la dynamique à long terme des allèles de résistance, tels que le taux de migration ou les coefficients de sélection en fonction de la zone, traitée ou non (Lenormand et al. 1998b, 1999 ; Lenormand & Raymond 2000 ; Labbé et al. 2009). Le lien entre variations annuelles de traitement et variations de valeur sélective a ainsi été exploré. En effet, les traitements ne sont appliqués que l'été, période d'activité privilégiée des moustiques (et période favorable à leur rencontre avec les touristes !), alors que les femelles sont en diapause l'hiver. Les variations des coûts et avantages des allèles de résistance en réponse à ces variations saisonnières dans l'utilisation des OPs ont ainsi été mesurées (Lenormand et al. 1999). Toutefois l'hétérogénéité spatiale et temporelle de l'environnement était résumée à présence/absence de traitement et zone traitée ou non.

Le suivi à long terme de cette zone d'étude a également permis de décrire deux remplacements d'allèles successifs au locus *Ester* : remplacement d'*Ester*¹ par *Ester*⁴ puis invasion d'*Ester*² (Guillemaud et al. 1998 ; Labbé et al. 2009). Ces remplacements ont été expliqués par des compromis avantages-coûts différents entre allèles : *Ester*⁴ présentant un coût moindre que *Ester*¹ pour un avantage similaire, et *Ester*² présentant un avantage supérieur aux autres malgré un coût plus élevé (Labbé et al. 2009). Mais l'évolution des

pratiques de traitements n'avait pas été prise en compte dans ces études, et l'hétérogénéité spatiale et temporelle de l'environnement résumée au contraste zone traitée ou non.

J'ai voulu plus spécifiquement explorer au cours de ma thèse le lien entre la quantité de traitements (*i.e.* la dose), et la valeur sélective des allèles de résistance, par des études au laboratoire et par l'analyse de données en populations naturelles tirant avantage des suivis à long terme disponibles pour *Cx. pipiens*, à travers trois questions :

1) Comment les variations quantitatives de pressions de sélection peuvent-elles favoriser l'émergence des duplications hétérogènes au locus *ace-1* ? Il a été proposé (Lenormand et al. 1998a ; Labbé et al. 2007b, 2014) que les duplications du locus *ace-1* permettent de réduire le coût sélectif associé à la mutation G119S, conférant un phénotype intermédiaire qui serait avantageux dans un environnement hétérogène (superdominance marginale, Wallace 1968). Grâce à une étude d'évolution expérimentale mettant en compétition différents allèles, dupliqués ou non, avec des pressions de sélection variables, j'ai testé l'hypothèse selon laquelle des pressions de sélection intermédiaires pourraient favoriser l'émergence et la sélection de duplications hétérogènes en créant une situation de superdominance. J'exposerai ces travaux dans le chapitre 3.

2) Comment les variations quantitatives des pressions de sélection affectent-elles la dynamique adaptative des allèles de résistance au locus *Ester* dans la région montpelliéraine ? Grâce aux données disponibles j'ai voulu au cours de ma thèse analyser directement comment les variations dans les doses d'insecticides appliquées par l'EID dans la région montpelliéraine affectaient la dynamique des allèles de résistance. J'ai testé en particulier la possibilité de l'existence d'un lien entre ces variations quantitatives de la pression de sélection et la valeur sélective des différents allèles du locus *Ester*. Cette étude qui a porté sur une période de plus de 25 ans de données de traitements insecticides et de fréquences au locus *Ester* (de 1986 à 2012) sera présentée dans le chapitre 4.

3) Quels sont les points communs et les divergences dans les réponses adaptatives à des variations de pression de sélection similaires dans des environnements différents ? En 2007, l'utilisation d'insecticides OPs et CXs a été interdite sur directive européenne. A partir d'échantillons collectés avant et après l'arrêt des traitements OPs et CXs en Martinique, à Mayotte et à Montpellier, nous avons pu suivre l'évolution des fréquences des différents allèles de résistance aux locus *ace-1* et *Ester* suite au retrait de la pression de

sélection, dans ces différents environnements. Les résultats de cette étude comparative seront présentés dans le chapitre 5.

En faisant lien avec les premiers chapitres, je m'attacherai à dégager ce que ces études nous permettent de comprendre de l'impact des variations de pression de sélection sur les trajectoires de diverses adaptations, par exemple en favorisant une architecture génétique ou un compromis avantages-coûts particulier.

Chapitre 1 : Duplications hétérogènes et compromis avantages-coûts.

Les duplications de gènes entraînent un bouleversement plus ou moins étendu dans le génome. L'impact de ces modifications de l'architecture génomique sur la valeur sélective est difficile à anticiper. Dans le cas de duplication de gènes entraînant une redondance stricte de l'information génétique, les liens génotypes-phénotypes sont plutôt bien décrits : les avantages et les coûts sélectifs qui leur sont associés sont liés à des modifications du dosage génique (nombre de copies d'un gène), et lui sont donc généralement proportionnels. Comprendre comment la sélection joue sur des duplications de gènes qui associent deux copies déjà divergentes est moins évident. En effet, la sélection peut opérer sur la quantité totale de protéines, mais également sur la quantité relative produite par l'une ou l'autre des copies. Les duplications hétérogènes du locus *ace-1* nous fournissent la possibilité d'étudier les compromis évolutifs résultant de ces architectures génétiques complexes.

1) Les duplications hétérogènes permettent de fixer un compromis évolutif intermédiaire.

Article 1 : « Gene-dosage effects on fitness in recent adaptive duplications: *ace-1* in the mosquito *Culex pipiens* » Pierrick Labbé, Pascal Milesi, André Yébakima, Nicole Pasteur, Mylène Weill, Thomas Lenormand. 2014. *Evolution*.

Chez *Cx. pipiens*, la mutation G119S du locus *ace-1* confère une très forte résistance à différents types d'OPs et CXs (jusqu'à 10 000 fois la dose létale pour les individus sensibles). Toutefois, parce qu'elle affecte le site actif de la cible des insecticides (AChE1), cette substitution induit une forte réduction de l'activité de l'acétylcholinestérase (AChE1R < ~ 60% AChE1S) (Bourguet et al. 1997; Alout et al. 2008). Cette baisse d'activité est probablement la cause de nombreux effets pléiotropes délétères qui affectent différents traits d'histoire de vie (THV) des individus résistants comme révélés par des études en populations naturelles (Lenormand et al. 1998b) ou en laboratoire (Berticat et al. 2002; Bourguet et al. 2004; Duron et al. 2006). Il existe donc un compromis évolutif irréductible entre l'activité protéique et le niveau de résistance.

Avant ma thèse, seules deux duplications hétérogènes du locus *ace-1* avaient fait l'objet d'une étude sur leurs conséquences phénotypiques, D₂ et D₃ dans la région de Montpellier (Labbé et al. 2007b). Une analyse de la fertilité et de la mortalité relatives des génotypes DS et DD avait permis de montrer que ces duplications étaient sublétales à l'état homozygote ; D₃ ne semblait pas entraîner de coût important sur le développement à l'état hétérozygote. Ces résultats préliminaires semblaient expliquer la dynamique particulière de ces allèles en populations naturelles : après une invasion rapide, ils stagnaient en effet autour de 20%. En revanche, concernant l'allèle D₁, les populations de Martinique étaient constituées majoritairement d'individus présentant un phénotype enzymatique hétérozygote, sans quasiment aucun individu RR (Yébakima et al. 2004). Cela suggérait que D₁ était avantageux (y compris à l'état homozygote) et que cet allèle avait remplacé l'allèle mono-copie R local.

L'objet de la première étude à laquelle j'ai participé visait à comprendre les compromis évolutifs générés par les duplications hétérogènes du locus *ace-1* chez *Cx. pipiens*, en présence ou non d'insecticides. Plus spécifiquement, nous nous sommes attachés à deux questions principales : i) l'activité protéique est-elle proportionnelle au nombre de copies ? ii) quels sont les compromis évolutifs des différentes combinaisons génotypiques entre allèles dupliqués et/ou mono-copie et comment sont-ils reliés aux variations de dosage génique et d'activité protéique ?

Pour y répondre, nous avons utilisé quatre souches de laboratoires, homozygotes pour différents allèles du locus *ace-1* : l'allèle mono-copie sensible S issu de la souche Slab (Georghiou et al. 1966), l'allèle mono-copie résistant R issu de la souche SR (Berticat et al. 2002), et les allèles dupliqués D₁ et D₃, issus respectivement des souches Ducos et Biface (Labbé et al. 2007b). Toutes ces souches ont été back-crossées au moins 14 fois avec la souche sensible : elles possèdent donc essentiellement le même fond génétique, hormis autour du locus *ace-1*. Neufs génotypes ont été étudiés : les souches nous ont fourni directement les homozygotes (RR, SS, D₁D₁ et D₃D₃) et leurs croisements ont généré les divers génotypes hétérozygotes : standard (RS), dupliqué-S (D₁S et D₃S) et dupliqué-R (D₁R et D₃R).

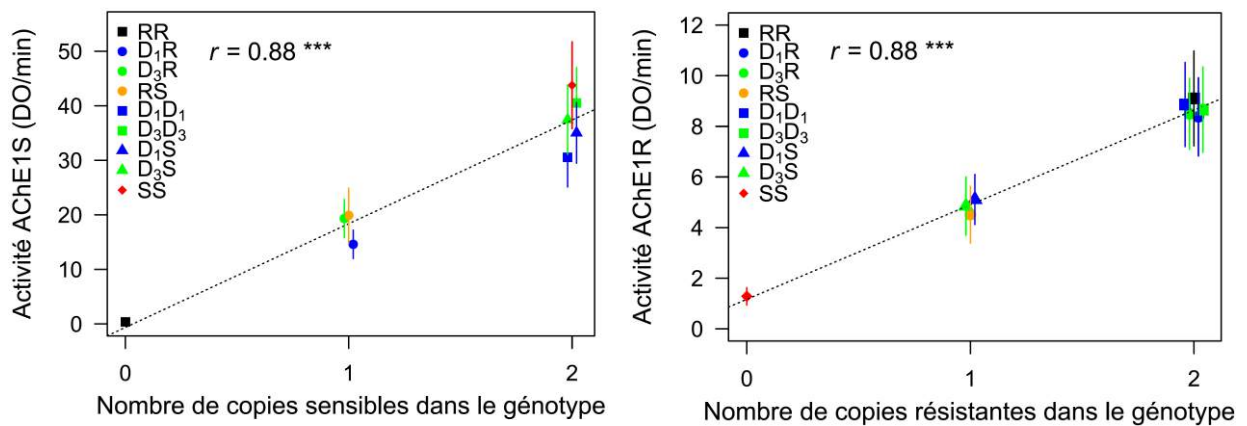

Figure 5 : Activité sensible et résistante des différents génotypes. Les activités moyennes des AChE1S (gauche) et AChE1R (droite) sont présentées respectivement en fonction du nombre de copies sensibles et résistantes dans les différents génotypes. Le coefficient de corrélation (r) ainsi que le niveau de significativité sont aussi indiqués (***, $p < 0.001$). La droite représente l'attendue sous hypothèse de stricte additivité.

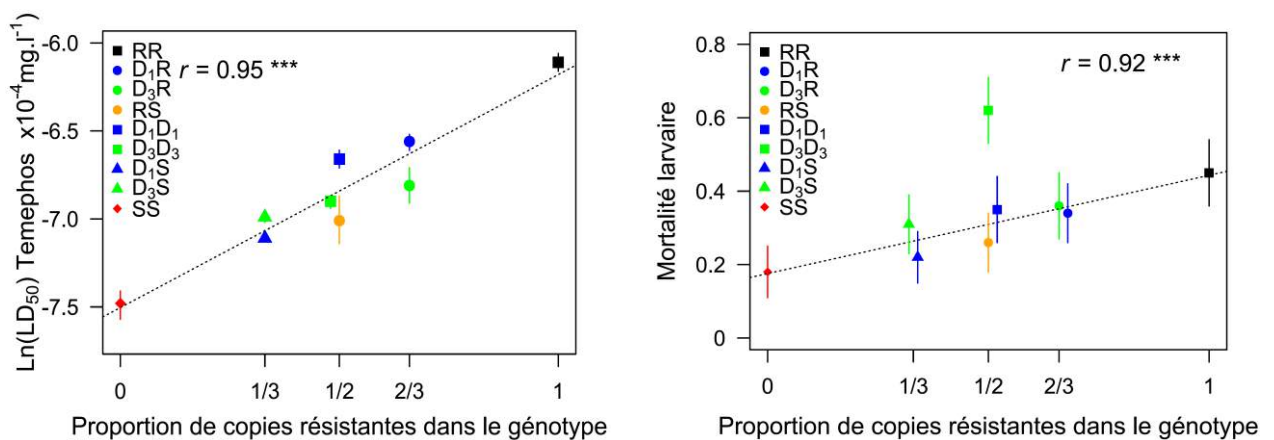

Figure 6 : Résistance et mortalité larvaire. Le niveau de résistance (gauche) et la mortalité larvaire (droite) moyens sont présentés, pour les différents génotypes, en fonction de la proportion de copies résistantes dans le génotype. Le coefficient de corrélation (r) ainsi que le niveau de significativité (***, $p < 0.001$) sont indiqués. Les droites représentent les régressions linéaires entre les différentes variables. La mortalité du génotype D_3D_3 n'a pas été prise en compte dans l'analyse (voir ci-dessous).

L'activité AChE1 est proportionnelle au nombre de copies R ou S d'un génotype, mais c'est leur proportion qui détermine le phénotype.

Afin d'établir le lien entre le dosage génique de ces différents génotypes et l'activité protéique qui en résulte, les activités des acétylcholinestérases résistantes (AChE1R) et sensibles (AChE1S) ont été mesurées par spectrophotométrie (d'après le protocole établi par Bourguet et al. 1996). La figure 5 présente les activités AChE1R et AChE1S moyennes en fonction du nombre de copies respectivement résistantes ou sensibles pour les différents génotypes. Il apparaît que l'activité dépend directement de ce nombre de copies, de manière quasi-additive. Ainsi les individus DD (D_1D_1 et D_3D_3) ont le double des activités AChE1R et AChE1S d'un individu RS, bien qu'ayant la même proportion de copies R (*i.e.* le nombre de copies R rapporté au nombre total de copies, $\%R = 0.5$).

Nous avons ensuite évalué comment cette activité et le dosage génique des différents génotypes affectaient la valeur sélective à travers le compromis résistance-coût. Deux indicateurs ont été utilisés: i) le niveau de résistance a été mesuré par la DL_{50} (*i.e.* la dose létale pour la moitié des individus d'un génotype donné) à partir de bioessais (mesure de la mortalité en fonction de doses croissantes d'insecticide); ii) le coût a été mesuré par la mortalité larvaire dans des élevages individuels. Des régressions ont permis de montrer que le meilleur prédicteur du niveau de résistance et de la mortalité larvaire induits par un génotype donné était sa proportion de copies résistantes ($\%R$) (Fig. 6): plus le $\%R$ est élevé, plus le niveau de résistance est élevé, mais plus la mortalité larvaire est importante. Ainsi, bien que les homozygotes dupliqués (DD) présentent le double de l'activité des hétérozygotes standard (RS), ils possèdent le même pourcentage de copies résistantes $\%R = 0.5$, et confèrent donc un phénotype similaire.

Le fait que ce soit la proportion de copies résistantes dans le génotype qui détermine le phénotype, et non pas leur nombre absolu, semble indiquer que la quantité de protéines produites est en excès par rapport à la quantité de protéines effectivement utilisées. En effet, un recrutement aléatoire parmi le pool de protéines AChE1 produites expliquerait pourquoi c'est la proportion, et non la quantité absolue, de chaque copie qui détermine le phénotype.

Quoi qu'il en soit, il apparaît que les allèles dupliqués génèrent un nouveau compromis avantages-coûts : les génotypes contenant ces allèles présentent des phénotypes intermédiaires entre RR et SS, tant en termes de résistance qu'en termes de coûts. La seule exception est l'homozygote dupliqué D_3D_3 (Fig. 6) : ce génotype, bien que présentant une résistance et une activité AChE1 conformes à l'attendu, entraîne une mortalité larvaire

particulièrement forte. Cette étude confirme donc que le caractère sublétal de cet allèle n'est pas lié au niveau d'activité AChE1 mais plus probablement à l'événement de duplication en soi (rupture de gènes ou mutations létales récessives embarquées). En revanche, l'allèle D₁ ne présente pas ce coût à l'état homozygote, confirmant les inférences issues des dynamiques en populations naturelles de Martinique.

2) Mêmes causes, mêmes conséquences ? Duplication hétérogène du locus *ace-1* chez *Anopheles gambiae*

Article 2 : « An *ace-1* gene duplication resorbs the fitness cost associated with resistance in *Anopheles gambiae*, the main malaria mosquito » Benoît S. Assogba, Luc S. Djogbénou, Pascal Milesi, Arnaud Berthomieu, Julie Perez, Diego Ayala, Fabrice Chandre, Michel Makoutodé, Pierrick Labbé, Mylène Weill. 2015. *Scientific Report*.

Les insecticides pyréthrinoïdes (PYR) ont été largement utilisés pour contrôler les populations d'*Anopheles gambiae*, vecteur principal de *Plasmodium falciparum*, un pathogène responsable du paludisme. Leur utilisation massive a rapidement sélectionné des résistances qui ont envahi les populations d'Afrique sub-saharienne, menaçant l'efficacité des stratégies de contrôle du vecteur (Nauen 2007; Ranson et al. 2011). Les insecticides OPs et CX.s, déjà utilisés par ailleurs pour le contrôle de ravageurs agricoles, ont alors été proposés comme alternatives pour contrôler les Anophèles.

Malheureusement, on trouve au locus *ace-1* chez *An. gambiae* la même mutation que chez *Cx. pipiens* (G119S, Weill et al. 2003, 2004a,b). Les protéines AChE1S et AChE1R présentent les mêmes propriétés chez les deux espèces de moustiques, en particulier la forte baisse de l'activité pour la molécule résistante (Alout et al. 2008). Une étude préliminaire a suggéré que la mutation pourrait également entraîner un coût sélectif chez *An. gambiae* (taux de mortalité plus élevé au stade nymphal, Djogbénou et al. 2010).

Les suivis de la résistance au locus *ace-1* en populations naturelles, en détectant des individus porteurs de trois allèles à ce locus, ont par ailleurs révélé l'existence d'une duplication de ce locus (*ace-1^D*), associant comme chez *Cx. pipiens* une copie sensible et une copie résistante (Djogbénou et al. 2008, 2009).

Dans le cadre d'une collaboration avec un autre doctorant du laboratoire, Benoît S. Assogba, nous avons donc entrepris de caractériser les conséquences phénotypiques de cette duplication du locus *ace-1* chez *An. gambiae*. Cette étude nous a fourni un point de comparaison indépendant de *Cx. pipiens* pour explorer le rôle de ces duplications hétérogènes dans l'adaptation. Par ailleurs, nous disposons de ressources beaucoup plus étendues dans le cas d'*An. gambiae*, ce qui nous a également permis de caractériser la structure et la nature de cette duplication au niveau chromosomique et moléculaire.

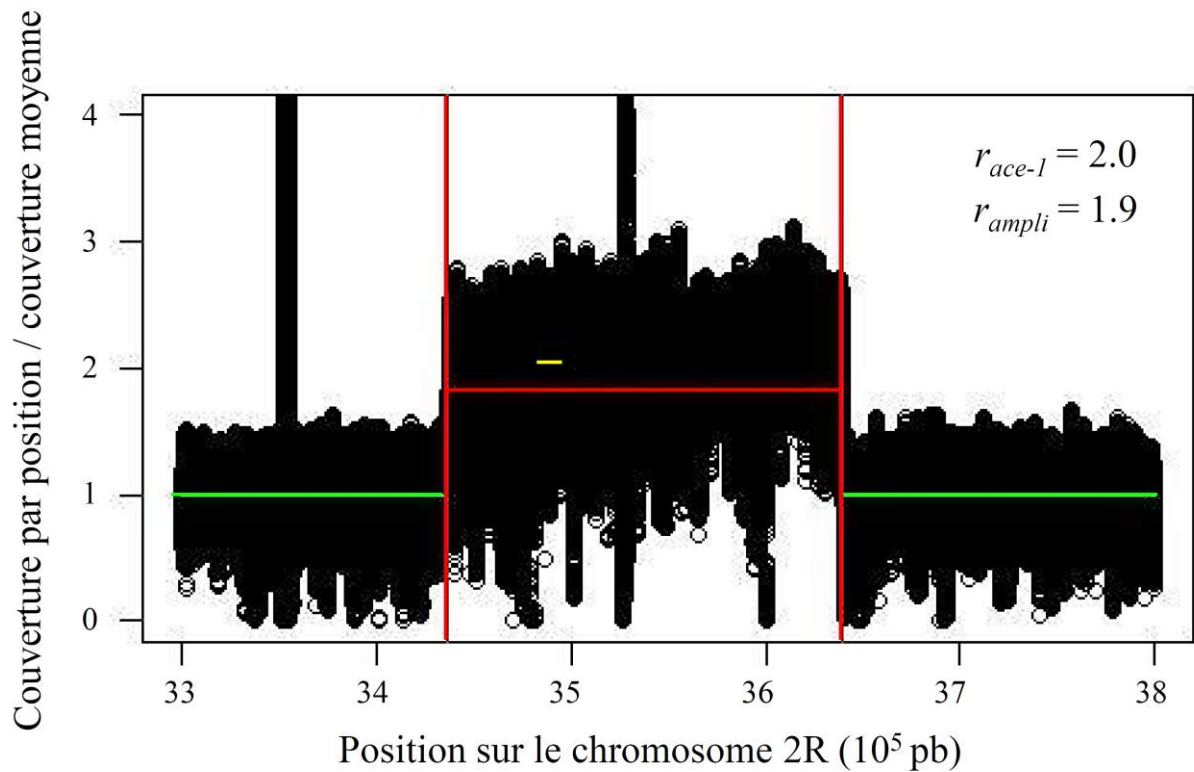

Figure 7 : Duplication comprenant le locus *ace-1* chez *An. gambiae*. La couverture par position a été calculée à partir du mapping des reads sur le génome de référence (PEST : AgamP4.3). Le ratio entre la couverture de chaque position et la couverture moyenne le long du chromosome 2R de la souche AcerDupliKis (DD) est représenté en fonction de la position sur ce chromosome. La couverture moyenne a été calculée sur la zone comprise entre 2 et 5 Mb sur le chromosome 2R en excluant la zone de l’amplicon délimitée par les bornes rouges. Le ratio moyen dans l’amplicon (r_{ampli}) est représenté par la ligne horizontale rouge. Le ratio moyen du locus *ace-1* (r_{ace-1}), est représenté en jaune.

Un unique événement de duplication par crossing-over inégal permet de réduire largement le coût élevé associé à la mutation G119S

La souche AcerDupliKis a été créée: elle est homozygote pour l'allèle dupliqué (isolé à partir d'une population d'*Anopheles gambiae* de Baguida, au Togo), avec un fond génétique similaire à celui de la souche sensible de référence (Kisumu, SS).

La divergence des séquences d'un fragment de 2241pb de chacune des copies, sensible D(S) et résistante D(R) de cet allèle a montré qu'il s'était probablement formé à partir d'un crossing-over inégal chez un individu RS. Par ailleurs, il apparaît que cet allèle est le même que celui précédemment décrit dans des populations d'Afrique de l'Ouest (Djogbénu et al. 2008, 2009). Une analyse par PCR quantitative a confirmé que l'allèle dupliqué est constitué de deux copies (une R et une S).

Des marquages chromosomiques par hybridation de sondes fluorescentes (FISH) ont ensuite été réalisés sur des individus DD (AcerDupliKis) ou SS (Kisumu). Ils ont permis de montrer que les deux copies étaient disposées en tandem, et séparées par une distance inférieure à 500 kb sur le chromosome 2R.

Nous avons récemment séquencé le génome de la souche AcerDupliKis (Illumina). L'analyse du chromosome 2R nous a permis de montrer que chacune des copies du gène *ace-1* appartenait en fait à un amplicon d'environ 200 kb, contenant 12 autres gènes putatifs, et que les deux amplicons étaient directement accolés sur le chromosome (Fig. 7, données non publiées, Assogba, Milesi et al. in prep.).

Ainsi au-delà des seules copies du locus *ace-1*, c'est un large fragment de chromosome qui est en fait dupliqué. Il s'agit donc bien d'un bouleversement génomique de large ampleur. Quelles en sont les conséquences au niveau du phénotype ?

Nous avons abordé cette question de façon analogue à l'étude précédente des duplications de *Cx. pipiens*. Des estimateurs de l'avantage et du coût sélectifs ont ainsi été mesurés pour différents génotypes, comprenant ou non l'allèle dupliqué, et générés à partir des trois souches de référence possédant des fonds génétiques similaires Kisumu, AcerKis et AcerDupliKis (génotypes homozygotes SS, RR et DD, respectivement), et de leurs croisements (génotypes hétérozygotes DR, DS et RS).

Table 2 : Estimateurs de la valeur sélective en absence d'insecticides

Génotype	Mortalité larvaire (%)	Dév. (en jour)	Succès ♂ ^a	(# larves / ♀)
SS	29 (20 - 38)	8.2 ± 0.7	-	37.6 ± 33
DD	43 (32 - 52) <i>ns</i>	8.7 ± 1.3 <i>ns</i>	0.48 ± 0.08 <i>ns</i>	33.1 ± 24 <i>ns</i>
RR	71 (60 - 79) ***	10.5 ± 0.8 ***	0.32 ± 0.12 ***	21.5 ± 22 **

^a Succès de paternité en compétition avec des mâles SS pour l'accès aux femelles.

Pour chaque génotype, la valeur moyenne de chaque trait d'histoire de vie, la mortalité larvaire, le temps de développement (Dév.), le succès de paternité (Succès ♂) et le succès reproducteur femelle (# larves / ♀), est présentée ainsi que les intervalles de confiance à 95% (pour la mortalité) ou les écarts-types qui lui sont associés. La significativité des écarts aux valeurs de THV du génotype SS est également indiquée (*ns*, $p > 0.05$; **, $p < 0.01$; ***, $p < 0.001$).

Le niveau de résistance a été mesuré par bioessais (DL_{50}). Comme chez *Cx. pipiens*, c'est le pourcentage de copies résistantes (%R) qui prédit le mieux cette résistance (du plus sensible au plus résistant, l'ordre des génotypes est $SS < DS < RS \approx DD < DR < RR$); les individus porteurs de l'allèle D ont donc un phénotype proche des hétérozygotes standards (RS).

Différents traits d'histoire de vie ont été mesurés pour estimer le coût de l'allèle dupliqué. La survie larvaire, le temps de développement, le succès des mâles à l'accouplement et la fertilité des femelles ont été comparés entre les trois génotypes homozygotes (RR, SS et DD). Cette étude a d'abord permis de montrer que la mutation G119S induit un fort coût sélectif chez *An. gambiae*, de façon similaire à ce qui est observé chez *Cx. pipiens*. Et là encore, il apparaît que le coût est grandement réduit pour l'allèle dupliqué D : pour l'ensemble des traits mesurés, les individus DD présentent des phénotypes qui ne sont pas significativement différents de ceux des individus sensibles SS (Tab. 2). Toutefois, leurs performances sont toujours légèrement inférieures à celles des SS. Ceci suggère donc l'existence d'un coût limité porté par les individus DD, comme observé pour les homozygotes D_1D_1 (allèle martiniquais) chez *Cx. pipiens*.

Conclusion

La résistance au locus *ace-1*, est due à la mutation ponctuelle G119S. L'architecture très simple de cette adaptation génère néanmoins un compromis irréductible entre résistance et activité protéique : c'est la même cause, une augmentation de l'encombrement stérique du site actif de l'AChE1, qui entraîne à la fois une baisse de l'affinité de cette protéine pour ses inhibiteurs et pour son substrat naturel, ce qui induit un coût élevé en termes de valeur sélective.

Une architecture alternative, résultant du réarrangement d'une portion importante du chromosome concerné qui permet d'associer une copie sensible et une copie résistante, restaure l'activité protéique tout en maintenant un niveau de résistance conséquent (bien qu'inférieur à celui des individus RR). Les duplications du locus *ace-1* génèrent donc un nouveau compromis.

Or, on retrouve pour *An. gambiae* et *Cx. pipiens* des observations globalement similaires : les allèles dupliqués hétérogènes génèrent un phénotype intermédiaire entre SS et RR, similaire à celui des hétérozygotes standards RS. Ils ont néanmoins un avantage par rapport au génotype RS : ils n'endurent pas de fardeau de ségrégation et peuvent se fixer dans les populations. Un phénotype hétérozygote favorisé, par exemple du fait des pratiques de traitements, pourrait donc expliquer la sélection de ces duplications chez plusieurs espèces.



GENE-DOSAGE EFFECTS ON FITNESS IN RECENT ADAPTIVE DUPLICATIONS: *ace-1* IN THE MOSQUITO *CULEX PIFIENS*

Pierrick Labbé,^{1,2} Pascal Milesi,¹ André Yébakima,³ Nicole Pasteur,¹ Mylène Weill,¹ and Thomas Lenormand⁴

¹CNRS, Université Montpellier 2, ISEM – UMR 5554, 34065, Montpellier, France

²E-mail: pierrick.labbe@univ-montp2.fr

³Conseil Général/Agence Régionale de Santé Martinique, 97264, Fort de France, France

⁴CNRS, CEFE–UMR 5175, 34293, Montpellier, France

Received October 14, 2013

Accepted January 22, 2014

Gene duplications have long been advocated to contribute to the evolution of new functions. The role of selection in their early spread is more controversial. Unless duplications are favored for a direct benefit of increased expression, they are likely detrimental. In this article, we investigated the case of duplications favored because they combine already functionally divergent alleles. Their gene-dosage/fitness relations are poorly known because selection may operate on both overall expression and duplicates relative dosage. Using the well-documented case of *Culex pipiens* resistance to insecticides, we compared strains with various *ace-1* allele combinations, including two duplicated alleles carrying both susceptible and resistant copies. The overall protein activity was nearly additive, but, surprisingly, fitness correlated better with the relative proportion of susceptible and resistant copies rather than any absolute measure of activity. Gene dosage is thus crucial, duplications stabilizing a “heterozygote” phenotype. It corroborates the view that these were favored because they fix a permanent heterosis, thereby solving the irreducible trade-off between resistance and synaptic transmission. Moreover, we showed that the contrasted successes of the two duplicated alleles in natural populations depend on genetic changes unrelated to *ace-1*, confirming the probable implication of recessive sublethal mutations linked to structural rearrangements in some duplications.

KEY WORDS: Fitness cost, gene dosage, gene duplication, overdominance, resistance gene.

The role of gene duplications in the evolution of new functions, organismal complexity, and adaptation has long been advocated (Ohno 1970; Lynch and Conery 2000; Conant and Wolfe 2008). Several authors suggested that selection plays a role in early duplication evolution, that is, in their initial fixation (segregation avoidance models; Haldane 1954; Spofford 1969) rather than chance (Ohno 1970; Walsh 1995; Zhang 2003; Kondrashov and Kondrashov 2006). Today, the evolution of duplications and new functions remains controversial, owing to the large number of possible evolutionary scenarios that can operate (Bergthorsson et al. 2007; Labbé et al. 2007a; Hahn 2009; Innan and Kondrashov 2010; Kondrashov 2012).

Duplications are indeed likely to be non-neutral when they arise: unless they are tightly regulated, their immediate effect

is to increase the duplicated gene expression. As it is the case for random mutation in general, such genetic change is likely to be deleterious, either because of the unnecessary overexpression cost or because of a disruption in gene dosage (Papp et al. 2003; Wagner 2005; Kondrashov and Kondrashov 2006; Sopko et al. 2006; Conant and Wolfe 2008). For instance, in the human *PMP22* gene, an increased dosage by heterozygous duplication causes Charcot-Marie-Tooth type 1 disease, whereas a decreased dosage by heterozygous deletion causes a hereditary neuropathy (Lupski and Stankiewicz 2005).

However, in the subset of duplications that spread—and eventually fix—in populations, the change in gene dosage may not be too large a handicap or may even be the reason of its selection. When expression is tightly regulated, duplications may have no

strong phenotypic impact and spread neutrally despite the change in gene dosage. However, the increased expression caused by duplications may be directly selected for this reason. This is a widespread mechanism (see Kondrashov et al. 2002). For instance, the number of copies of the amylase gene *AMY1* increases with starch amount in the diet (Perry et al. 2007). Understanding the gene-dosage impact on the fate of duplication is thus fairly straightforward when the two duplicates are identical to start with: in these cases, the evolution of new function requires subsequent divergence of the duplicates (Force et al. 1999; Lynch and Conery 2000; Otto and Yong 2002; Zhang 2003; Lynch and Katju 2004; Taylor and Raes 2004; Ward and Durrett 2004; Rastogi and Liberles 2005; Bergthorsson et al. 2007; Cusack and Wolfe 2007; Conant and Wolfe 2008; Storz 2009; Innan and Kondrashov 2010; Katju 2012).

Less straightforward is the case where duplications are initially favored because they combine already functionally divergent alleles (i.e., segregation avoidance models; Haldane 1954; Spofford 1969; Lenormand et al. 1998a; Labbé et al. 2007a; Remnant et al. 2013). In this case, the gene-dosage/fitness relations are very poorly known. When the two duplicates (say R and S) are divergent (with expression E_R and E_S), the gene-dosage/fitness relationships become more complex, as selection may operate on overall expression level ($\Sigma E_R + \Sigma E_S$) as well as on relative dosage between R and S ($\Sigma E_R / \Sigma E_S$) in the various possible diploid genotypes. The latter possibility is particularly important in situations where selection favors expression of both R and S (which is the main condition favoring the fixation of duplication in segregation avoidance models; Haldane 1954; Spofford 1969). For instance, selection on overall expression level may have deleterious consequences (by causing a departure from the wild-type gene dosage and expression), whereas co-expression of divergent duplicates may be favorable. In this (or similar situations), further evolution would be expected to tune overall expression as well as relative duplicate expression. Such expression repatterning is expected to be fast when duplications are initially favored by the heterotic advantage of combining divergent duplicates.

Examples of duplication favored by this heterotic advantage are the *ace-1* duplications in the mosquito *Culex pipiens* (Lenormand et al. 1998a; Labbé et al. 2007a). In this system, several recent and still polymorphic duplications have been selected worldwide, providing natural replicates of duplication early evolution. In this article, we took advantage of this unique system to understand the gene-dosage/fitness relationships of young duplications under selection.

We briefly present this system as it is well described in Labbé et al. (2007b). *ace-1* duplications recently evolved (<40 years) in the context of resistance to organophosphate (OP) and carbamate (CX) insecticides in several mosquito species (Labbé

et al. 2007a,b; Djogbénu et al. 2008, 2009; Alout et al. 2010; Osta et al. 2012). The target of these insecticides is a synaptic enzyme, the acetylcholinesterase (AChE1), encoded by the *ace-1* locus (Weill et al. 2002). A single-nucleotide mutation (G119S)—which reduces AChE1 affinity for the insecticide molecules—has been repeatedly selected in treated natural populations of several mosquito species (Weill et al. 2003, 2004a; Alout et al. 2007). It is associated with more than 60% activity reduction of the mutated AChE1, as compared to the susceptible one (Bourguet et al. 1997; Alout et al. 2008). This lower activity is probably the cause of this resistance allele (*ace-1^R*) high fitness cost in absence of pesticide revealed both by field surveys (Lenormand et al. 1998b) and laboratory experiments (Berticat et al. 2002; Bourguet et al. 2004; Duron et al. 2006). Duplications of the *ace-1* locus arose in the 90s, combining copies of both the resistant (*ace-1^R*) and the susceptible (*ace-1^S*) alleles on the same chromosome. As of today, 13 distinct duplicated alleles (globally named *ace-1^D*) have been identified in both *Cx. p. quinquefasciatus* and *Cx. p. pipiens* subspecies (Bourguet et al. 1996b; Lenormand et al. 1998a; Labbé et al. 2007a; Alout et al. 2010; Osta et al. 2012); a similar duplication has been found in Western African *Anopheles gambiae* (Djogbénu et al. 2008, 2009). These duplications do not segregate at detectable rates in laboratory crosses, they behave as “alleles,” at least at the scale of few generations (Labbé et al. 2007a,b). The present study focuses on two of these alleles. One arose in Martinique (D_1) and rapidly replaced *ace-1^R* in natural populations of *Cx. p. quinquefasciatus* (Yébakima et al. 1995, 2004). In natural populations of *Cx. p. pipiens* in the South of France, the other allele (D_3) was selected for when rare, but did not reach high frequency. The D_3D_3 homozygotes indeed have a particularly low fitness (Labbé et al. 2007b). This low fitness in homozygotes was hypothesized to be the consequence of D_3 being associated with an inversion carrying a recessive sublethal mutations (gene disruption at breakpoints or hitch-hiking deleterious allele; Lenormand et al. 1998a; Labbé et al. 2007b).

Using laboratory crosses of isogenic strains, we analyzed this system to specifically investigate three questions. First, we investigated whether the quantity of protein activity is proportional to the gene copy number of each duplicate in various genotypes, to determine whether there was a specific regulation associated to duplicated alleles. Then, we investigated the fitness impact of the different diploid combinations of duplicates and single copies and their relations to gene dosage and protein activity. This was done in presence (resistance measurements) or absence of pesticides (life-history traits), as both environments are relevant to understand these duplications evolution. Third, we investigated how these results relate to the field evolution of these duplications. We finally examine how this case study informs us more generally on the fitness impact of gene-dosage alterations on divergent duplicates.

Methods

MOSQUITO STRAINS AND CROSSES

Experiments were conducted with four homozygous strains, and five F1 offspring of crosses between these strains, that is, on nine different *ace-1* genotypes (Fig. S1). The strains used were SLAB, the reference susceptible strain (Georghiou et al. 1966), homozygous for *ace-1^S* (SS); SR, homozygous for the resistance allele *ace-1^R* (RR; Berticat et al. 2002); BIFACE-DFix, homozygous for *ace-1^{D3}* (D₃D₃), a duplicated allele from Montpellier area (Labbé et al. 2007b); and DUCOS-DFix, isolated from the Martinique strain DUCOS and homozygous for the duplicated allele *ace-1^{D1}* (D₁D₁; established following the protocol of Labbé et al. 2007b, using specific PCR tests described in Figs. S2 and S3). The five heterozygous genotypes (RS, D₁S, D₁R, D₃S, and D₃R) were the F1 of mass crosses between these different strains (SLAB/SR, DUCOS-DFix/SLAB, DUCOS-DFix/SR, BIFACE-DFix/SLAB, and BIFACE-DFix/SR, respectively). SR and the two strains with duplicated alleles have been backcrossed for at least 14 generations with SLAB before fixation of their *ace-1* allele. Thus, the nine genotypes studied shared the same genetic background and differed from one another almost only by their *ace-1* genotype.

MEASURE OF AChE1 ACTIVITY

The AChE1 activity was measured using the procedure described by Bourguet et al. (1996a) to test for an effect of gene dosage. Briefly (details in Fig. S4), ethanol and propoxur (CX, Baygon™, Chem-Service, West Chester, PA, 99%) were added to two wells of a microtitration plate containing extracts from the same mosquito. After incubation, a substrate solution (DTNB + acetylthiocholine) was added to each well to measure AChE1 activity. The first well (ethanol) provides the total activity $A_{TOT} = A_S + A_R$ (A_S being the activity of AChE1S, susceptible, and A_R that of AChE1R, resistant), whereas the second one (propoxur) provides A_R only. Note that activity in the second well is never equal to 0: even susceptible individuals present a very low slope due to the spontaneous degradation of DTNB.

We first analyzed AChE1R activity (A_R) using a following linear model:

$$A_R = N_R + E_{RS} + E_{D1S} + E_{D1R} + E_{D1D1} + E_{D3S} + E_{D3D3} + \epsilon$$

It includes the number of R copies (N_R , reflecting the sum of activity of each R copy), the departures from additivity occurring in the different possible genotypes (E_{ij} terms) and a normal error parameter (ϵ). The model without any E_{ij} departures term (i.e., $A_R = N_R$) was used to infer the activity of one R copy under a strictly additive model.

Similar models were then used to analyze AChE1S activity (A_S), as a function of the number of S copies (N_S) of each genotype, and the activity of one S copy under a strictly additive model.

For clarity, and because there are sex differences, we report separate analyses for males and females. This measure has been shown to be reproducible and independent of the mosquito size (Alout et al. 2008). Moreover, the densities and conditions of rearing were controlled to ensure they were similar for the various genotypes.

INSECTICIDE RESISTANCE

To assess the impact of gene dosage on resistance, bioassays were performed on batches of 20 young fourth instar larvae of the nine genotypes in 100 ml of water in plastic cups, as described in Raymond and Marquine (1994). Each bioassay included at least four replicates for at least six insecticide concentrations, inducing mortality between 0 and 100%. The final concentration of solvent (ethanol) was systematically adjusted to 1% for standardization. Mortality was recorded after 24 hours of exposure. Two of the most-used OP insecticides were tested, Temephos (Pestanal®, Riedel-de Haën, Seelze, Germany, 96.4%) and Chlorpyrifos-ethyl (Chem Service, West Chester, PA, 99.5%).

Dose–mortality responses observed for the nine genotypes were then compared using the GLM $MORT = GENO + \log(DOSE) + GENO.\log(DOSE) + \epsilon$, where MORT is the proportion of dead larvae, GENO the genotype tested, and DOSE the amount of insecticide. The “.” denotes the interaction of the two variables. ϵ is the error, following a quasi-binomial distribution to take overdispersion into account, if present. The lethal dose for 50% of the individuals (LD_{50}) was computed for each genotype from the dose–mortality responses, using the dose.p function (MASS package, Venables and Ripley 2002) in the R free statistical software (version 2.15.1, <http://www.r-project.org>).

PREIMAGINAL MORTALITY

To assess the fitness cost associated with variation in gene dosage, the various genotypes preimaginal mortality was measured, following the protocol developed by Agnew et al. (2004). Females' oviposition was synchronized for the nine genotypes, and single L1 larvae were isolated in standard *Drosophila* tubes containing 4 ml of mineral water. Food was provided once by adding 1 ml solution containing 2 mg TetraMin® powdered fish food/larva. Tubes were stored on racks (three racks per genotype) holding 40 tubes and arranged on a single shelf (25°C, 12:12 hours light:dark, >60% humidity), with three racks (i.e., 120 larvae) per genotype ($N_{total} = 1080$ larvae). Racks were randomly distributed. Numbers of emerging adults were recorded. The percentage of mortality before emergence was estimated by the ratio of the number of emerging adults over the initial number of larvae in each rack.

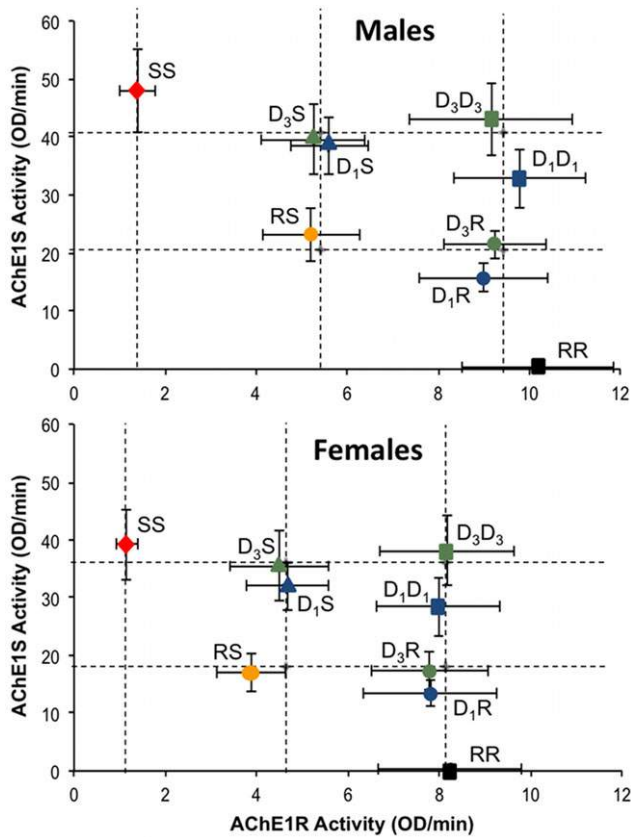

Figure 1. Mean AChE1R and AChE1S activities of the various genotypes. The mean activities (given as the variation in optical density [OD] per minute) and associated standard errors for each genotype are presented for both AChE1R and AChE1S, for males (top) and females (bottom). The predicted activity of one S copy and one R copy were inferred from the strictly additive model (see text). These activities and those of two copies are indicated by horizontal (S) and vertical (R) dotted lines.

GENE DOSAGE AND FITNESS

To explore how gene-dosage impacts on fitness, we used regression models of resistance and cost proxies on various predictors connected to different biological explanations. All computations were performed using the R free software (version 2.15.1, <http://www.r-project.org>) and the models were simplified according to Crawley (2007) (i.e., using F -tests, nonsignificant terms were removed starting from the higher order, and nondifferent factor levels of qualitative variables were grouped). When applicable, the residuals were tested for normality (Shapiro and Wilk 1965) and homoscedasticity (Breusch and Pagan 1979).

Results

AChE1 ACTIVITIES: CLOSE TO ADDITIVITY

The AChE1 activity was measured on single mosquitoes (Bourguet et al. 1996a) from nine different *ace-1* genotypes, combining

two duplicated alleles (D_1 and D_3) as well as susceptible and resistant reference alleles (S and R). For each genotype and sex, the total AChE1 activity (A_{TOT} , see Fig. S5; the number of individuals analyzed for each sex and genotype is indicated) was decomposed into the activities due to the resistant (A_R) and susceptible (A_S) AChE1 (Fig. 1), to assess whether A_{TOT} followed an additive model (i.e., the sum of each copy activity) or was regulated following gene-dosage modifications. This analysis confirmed that the AChE1 activity corresponding to one R copy is approximately a fifth of that corresponding to one S copy (Table 1; Bourguet et al. 1996a). However, it showed that, although close to it (Fig. 1), A_S and A_R are not strictly the sum of the activity of each S or R copy present in the different genotypes. Despite large variance of activities within a genotype, there were indeed significant departures from the additivity hypothesis (Table 1; Fig. 1) suggesting that the total AChE1 activity may somehow be slightly regulated. All genotypes including duplicated haplotypes indeed displayed lower activities than expected, with departures larger for males than females, and for AChE1S than AChE1R. Finally, individuals carrying *ace-1^{D1}* displayed consistently slightly lower activities, either at homozygous or heterozygous states, than individuals carrying *ace-1^{D3}* (Fig. 1), suggesting some minor differences between the two duplicated haplotypes. Nevertheless, these departures again were generally mild and overall an increased number of copies proportionally increased the genotype total activity.

RESISTANCE AND FITNESS COST DEPEND ON THE RATIO OF R AND S COPIES

To understand how gene-dosage modifications impact fitness, we investigated the resistance (fitness advantage) and the larval mortality (fitness cost) of the nine genotypes. As it is very difficult to predict from existing information what should be the fitness effects of the genotypes carrying the duplications and single-copy alleles various diploid combinations, we tested various hypotheses: fitness could be proportional to either the number of R copies (nR), or the percentage of R copies [$\%R = nR/(nR + nS)$], or the resistant activity (A_R), or the percentage of resistant activity ($\%A_R = A_R/A_{TOT}$) or to the total AChE1 activity (A_{TOT}). We used regressions of resistance (LD_{50}) and cost (preimaginal mortality) proxies on these predictors to identify the most likely link between gene dosage and fitness.

Resistance to two OPs, Chlorpyrifos and Temephos were measured through bioassays (see Fig. S6). The results of the regressions between the various genotypes LD_{50} (see Table S1) and the gene-dosage predictors are presented in Table 2 (the LD_{50} have been log-transformed for linearity). It appeared that the best predictor was by large the $\%R$ (Spearman's correlation parameter $r = 0.96$, $P < 0.001$ and $r = 0.95$, $P < 0.001$, for Chlorpyrifos and Temephos, respectively). No strong difference appeared in terms

Table 1. Additivity of AChE1 activities.

Model		A_x	Sex	b	R	S	E_{RS}	E_{D1D1}	E_{D3D3}	E_{D1S}	E_{D1R}	E_{D3S}	E_{D3R}	%TD
A_R	M	1.4 ± 0.2***	4.4 ± 0.2				-0.6 ± 0.3 ^{NS}	-0.4 ± 0.4 ^{NS}	-1.0 ± 0.4**	-0.2 ± 0.3 ^{NS}	-1.2 ± 0.4**	-0.5 ± 0.3 ^{NS}	-1.0 ± 0.4*	84.26
	F	1.2 ± 0.2***	3.5 ± 0.2				-0.8 ± 0.3**	-0.3 ± 0.3 ^{NS}	-0.1 ± 0.3 ^{NS}	0.0 ± 0.3 ^{NS}	-0.4 ± 0.3 ^{NS}	-0.2 ± 0.3 ^{NS}	-0.4 ± 0.3 ^{NS}	80.88
A_S	M	0.4 ± 1.2 ^{NS}	23.8 ± 0.8			23.8 ± 0.8	-1.0 ± 1.2 ^{NS}	-15.2 ± 1.3***	-5.1 ± 1.3***	-9.5 ± 1.3***	-8.4 ± 1.2***	-8.4 ± 1.3***	-2.8 ± 1.2*	88.38
	F	0.4 ± 1.0 ^{NS}	19.4 ± 0.7			19.4 ± 0.7	-2.8 ± 1.1*	-10.8 ± 1.2***	-1.0 ± 1.2 ^{NS}	-7.2 ± 1.2***	-6.3 ± 1.1***	-3.6 ± 1.2**	-2.4 ± 1.1*	87.62

The models tested were $A_x = N_x + E_{RS} + E_{D1D1} + E_{D3D3} + E_{D1S} + E_{D1R} + E_{D3S} + E_{D3R} + \epsilon$, where A_x is the response variable (A_R or A_S), N_x is the number *ace-1* copies (N_R or N_S , respectively), and E_{ij} the specific effect of the genotype ij , and ϵ the normal error (see Methods). Sexes were analyzed separately: males and females are indicated, respectively, by M and F in the Sex column. The magnitudes \pm the standard errors of the activity of one R or one S copy activities are indicated, respectively, in the R and S columns. Magnitudes \pm the standard errors and significances (^{NS}nonsignificant, * $P < 0.05$, ** $P < 0.01$, *** $P < 0.001$) of the various genotype effects are also indicated for each model; they correspond to the increase or decrease in activity (if positive or negative, respectively) observed in the given genotype as compared to a strict additivity. Significant departures from a strict additivity are bolded. b is the intercept of the model, to account for the activity due to the spontaneous degradation of the substrate (see Methods). The percentage of the total deviance explained by the model (%TD) is also presented.

of resistance between the genotypes carrying the duplicated alleles D_1 or D_3 , neither at the heterozygous nor at the homozygous states (Fig. 2A). The duplicated homozygotes DD presented an intermediate resistance, similar to that of the single-copy heterozygotes RS, whereas DR and DS individuals were slightly more and slightly less resistant than RS, respectively (Fig. 2A). In all cases, individuals carrying a duplicated allele were less resistant than RR individuals.

To assess the impact of gene dosage on fitness cost, we used the percentage of preimaginal mortality as a proxy for the cost (Agnew et al. 2004). There was almost one-third more emerging adults in SS (18% mortality) than in RR (45% mortality; Fig. S7). This is similar to previous studies (Duron et al. 2006; Berticat et al. 2008) and evidences the cost associated to the single-copy resistance allele. Similarly to resistance, the best predictor of the fitness cost was the %R (Spearman's correlation parameter $r = 0.8$, $P < 0.001$, without D_3D_3 , see below and Table 2). Heterozygotes carrying either D_1 or D_3 duplicated alleles were less or more costly than standard heterozygotes RS when carrying, respectively, a susceptible (DS) or a resistant (DR) single-copy allele, whereas D_1D_1 displayed a cost similar to RS (Fig. 2B). However, D_3D_3 individuals displayed more than 60% mortality (>RR individuals), in agreement with the large cost already described for the duplicated alleles from Montpellier area (Labbé et al. 2007b). This was the only marked difference between the two duplicated alleles (Fig. 2B). In general, except for D_3D_3 , individuals carrying duplicated alleles displayed a reduced cost compared to single-copy RR.

Discussion

This study aimed at understanding the impact of gene-dosage/fitness relations in the early evolution of divergent duplicates. We analyzed several duplicated alleles of the *ace-1* gene in *Cx. pipiens* that carry both susceptible and resistant copies, and thus result in both quantitative and qualitative changes.

AChE1 ACTIVITY IN DUPLICATED ALLELES IS CLOSE TO ADDITIVITY

An expected immediate effect of duplication is to increase gene dosage and thus protein expression. Our results show that *ace-1* gene-dosage modifications have indeed a strong impact on overall AChE1 activity (Figs. 1 and S5). The expression of both the susceptible and the resistant AChE1 proteins is increased: a DD individual displays a higher activity than an RS individual. Finally, the total activity of a given genotype was close to the sum of the activities provided by each copy (Fig. 1 and Table 1).

However, the genotypes including a duplicated allele generally displayed slightly (and significantly) lower activities than expected under a strict additive model (Fig. 1 and Table 1). These

Table 2. Variance explained by the correlations between fitness components and gene dosage or AChE1 activity.

Predictors	R^2		
	Ln(LD ₅₀) Chlorpyrifos	Ln(LD ₅₀) Temephos	Mortality
nR	0.583*	0.666**	0.587*** (0.50***) ²
%R	0.917***	0.897***	0.636*** (0.29**) ²
A _R	0.600*	0.699**	0.607*** (0.51***) ²
%A _R	0.629* (0.77*) ¹	0.797** (0.81**) ¹	0.505*** (0.00 ^{NS}) ^{1,2}
A _{TOT}			0.400*** (0.00 ¹) ²

¹% A_R of the RR genotype is much larger than %A_R of the others genotypes. Its weight in the regression was tested by removing it. The percentage of total variance explained by the model with RR is given between brackets.

²The D₃D₃ genotype induces a much larger cost than the others genotypes. Its weight in the regression was tested by removing it. The percentage of total variance explained by the model with D₃D₃ is given between brackets.

Fitness components tested are (1) the resistance level (LD₅₀; data were log-transformed for linearity) for Chlorpyrifos and Temephos insecticides, and (2) the cost, estimated by the preimaginal mortality (Mortality column). The correlations between these fitness components and various predictors were independently measured by linear regressions. For each genotype, the predictors were the number of R copies (nR), the percentage of R copies (%R), the resistant activity (A_R), the total activity (A_{TOT}), and the percentage of resistant activity (%A_R; see text for details). For each predictor, the percentage of the total variance explained (R^2) and the regression significance are indicated (P -value: *** < 0.001; ** < 0.01; * < 0.05; ^{NS} > 0.05). The best predictor, that is, the regression with the maximum of variance explained, is bolded and illustrated in Figure 2 (note that these regressions remain significant when only DR, DS, and DD genotypes are considered).

decreases were more pronounced for individuals carrying *ace-1*^{D1} than for those carrying *ace-1*^{D3}, but remained moderate (Fig. 1).

These slight departures from the additive model may indicate that the overall AChE1 expression is partly regulated, suggesting the existence of some limited cost associated with this overexpression. Although unlikely (see Labbé et al. 2007b), it may also be due to other mutations in the *ace-1* gene. Interestingly, individuals carrying D₁ collected in 1994 (Bourguet et al. 1996b) showed a higher activity ratio—that is, total activity of DD over total activity of SS—than those collected in 2003 for the present study (activity ratio = 1.15 ± 0.11 vs. 0.88 ± 0.31, respectively, assuming a stable activity for the wild type). This could indicate that this partial expression regulation is a secondary modification of D₁. As both the AChE1R and AChE1S activities are decreased in duplicated alleles, this could be due to a modification of either the promoters (regulation of the transcription), or the translation rate and/or in the proteins recruitment. More studies are required to pinpoint the actual mechanism, with the additional difficulty that *ace-1* is mostly transcribed in the early larval stages and not in adults (Huchard et al. 2006).

GENE-DOSAGE EFFECT ON FITNESS DEPENDS ON COPY COMPOSITION

In the case of a duplication combining functionally divergent alleles, although the overall expression change is expected to impact the fitness, the relative expression of the divergent alleles is also likely to be under selection. The combined impact of overall versus relative expression on fitness is not trivial: changes in overall

and relative expression can be both beneficial or have antagonistic effects. The latter situation is probably at work with *ace-1* duplications: although the increase in overall AChE1 expression appears to be slightly detrimental—so that minor down-regulation is suspected—the composition of the various genotypes in terms of R and S copies is the major determinant of their fitness in presence or in absence of insecticides.

Both proxies of resistance (LD₅₀) and cost (preimaginal mortality) are indeed better correlated with the percentage of R copies (%R) among the various genotypes than with the number of R copies or any AChE1 activity predictor (Table 2). Thus, in spite of increasing the produced protein quantity, the relative proportions of the heterogeneous duplicate products are more important in terms of fitness than their absolute quantity. Indeed, DD and RS genotypes, which differ in the produced protein quantity (DD > RS) but have similar ratios for R and S copies (1:1), display similar resistances and costs (Fig. 2). Moreover, in heterozygotes carrying a D allele, the nature of the single-copy allele associated is decisive: an R confers more resistance but a higher cost (reduced activity), whereas an S reduces both resistance and cost (Fig. 2).

SYNAPTIC AChE1 IS PROBABLY LIMITED

One possible interpretation of this unexpected pattern affecting both investigated fitness traits (resistance and cost) is that there is only room for a limited number of AChE1 molecules in the synapse, so that increasing the quantity of protein would reduce the relative part of each of them, that is, like a dilution effect.

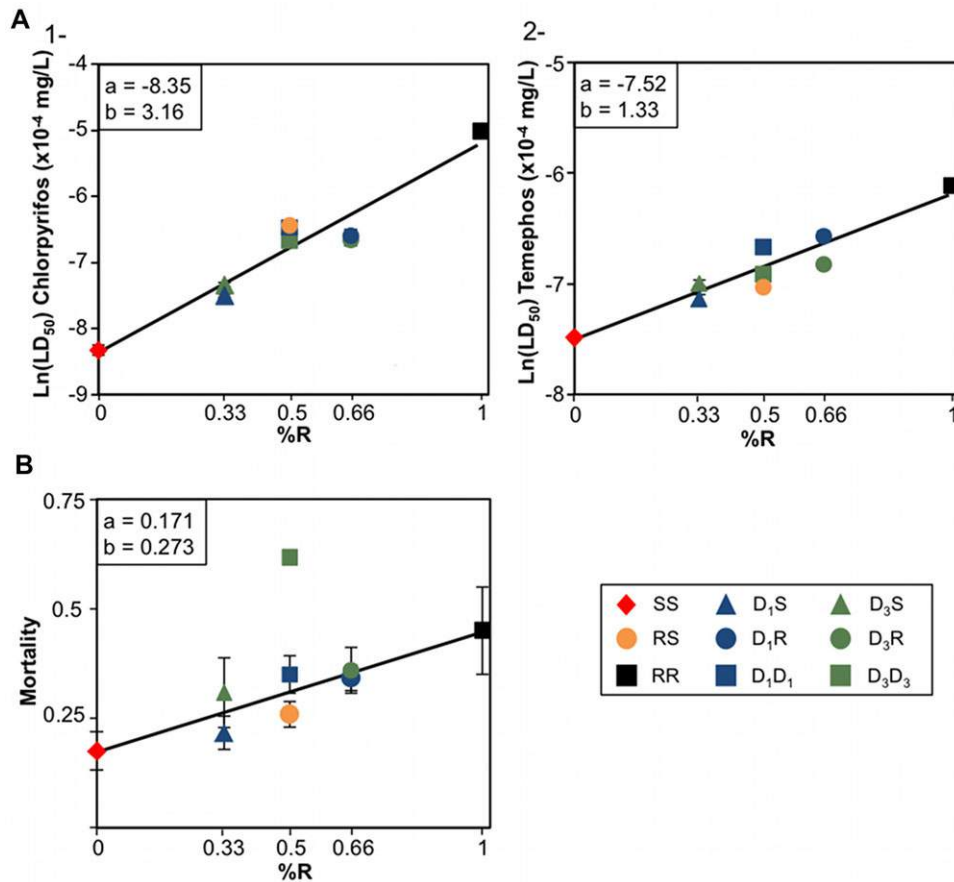

Figure 2. Linear regressions between gene dosage of each genotype and the resistance level (A) or the mortality (B). For each genotype (see legend), the percentage of R copies (%R) is represented as a function (A) of the resistance level (LD₅₀; data were log-transformed for linearity) for Chlorpyrifos (A1) and Temephos (A2) insecticides, and (B) of the preimaginal mortality (Mortality). Standard errors are indicated. For each linear regression (solid line), the slope (b) and the intercept (a) are indicated (they are all significant, P -value < 0.01). The R^2 of these regressions is given in Table 2 (note that only the regression without D₃D₃ is represented in (B), see Table 2).

For example, so many AChE1 molecules only could be released in the synapse or exposed on the membrane of the postsynaptic neuron (Bourguet et al. 1997), randomly picked from the pool produced in the cell (the one we measure). With such a mechanism, the phenotype will depend only on %R but not on total protein production (the number of protein “slots” available in the synapse being fixed and independent of the protein quantity produced in the cell). As a duplicated allele produces both AChE1R and AChE1S, the relative quantity of AChE1R would be reduced, thereby explaining the observed fitness.

This mechanism would thus explain how the proportion of R copies is the main determinant of fitness. However, while of much more limited fitness impact, the overall AChE1 expression may also be under selection. A decrease in overall activity, although limited, was indeed observed for individuals carrying both D₁ or D₃ (Fig. 1). In a situation where overexpression of AChE1 proteins is wasteful (as it would be the case if protein production exceeds the quantity that can be packed in the synapse), we would

expect such overall decrease in protein expression for the duplicated alleles, and thus in activity, to decrease the production cost. Confirming this expression regulation requires further studies, distinguishing the amount of proteins in synapses from the overall quantity produced in the cell, which may prove challenging.

In a larger perspective, it appears that the effect of gene dosage on fitness is less straightforward when the duplicates are functionally different than when they are identical. When they are identical, only quantity matters: the gene-dosage change can be detrimental, for example, the human *PMP22* gene (Lupski and Stankiewicz 2005), or selected for, for example, increased quantity of detoxifying proteins through duplication is a common resistance mechanism in arthropod pests (reviews in Oakeshott et al. 2005; Labbé et al. 2011). Conversely, the *ace-1* duplications associate different copies: their net effects on fitness depend not on the overall activity, but on their ratio, a larger proportion of R copies increasing resistance and a larger proportion of S copies reducing the cost. A probable explanation is that the number of

AChE1 proteins that can be present in the synapse is limited and drawn from a cytoplasmic pool where R and S are represented in proportion of the number of gene copies. Further (and limited) evolution of the expression of each duplicate independently may fine-tune the resistance/cost balance of duplicates in different ecological situations, explaining their widespread worldwide success.

D₃D₃ DELETERIOUS PHENOTYPE IS UNRELATED TO *ace-1*

One notable departure from the pattern described so far concerns D₃ homozygotes. When heterozygous, D₁ and D₃ are indeed very similar for resistance and display comparable costs. But, although D₁D₁ individuals display only a moderate cost, D₃D₃ genotype is sublethal (Fig. 2). However, the various genotypes, including D₃D₃, display AChE1 activities corresponding to their number of S and R copies. These observations thus confirm our previous hypothesis that D₃D₃ extreme deleterious effect is most probably independent of the *ace-1* locus itself, and probably due to a recessive sublethal mutation associated to *ace-1* during the chromosomal rearrangement that produced the duplication. As proposed by Labbé et al. (2007b), this chromosomal rearrangement could be an inversion, a phenomenon often associated with duplications (Katju and Lynch 2003; Ranz et al. 2007). By reducing recombination and preventing the break-up of the R-S heterotic combination, such inversion may even be favored. However, one major evolutionary drawback of inversions is that they can disrupt close genes or regulatory regions, or hitch-hike unbanishable deleterious mutations (Kirkpatrick and Barton 2006). D₁ appears to have escaped this unfortunate fate, explaining its success in Martinique (Yébakima et al. 2004), whereas D₃ stagnates below 20% in Montpellier area (Labbé et al. 2007b). Thus, similar molecular processes can have dramatically different outcomes, and it remains to be known which of the successful or the unfit duplications are the most frequent.

EARLY RISE OF *ace-1* DUPLICATION IS FAVORED BY OVERDOMINANCE

In general, individuals carrying duplicated alleles (D₁ or D₃) displayed resistances and costs very similar to those of standard heterozygotes, that is, intermediate between RR and SS individuals (except for D₃D₃). Consequently, these duplications were not selected because they confer similar resistance level than RR homozygotes at a lower cost, as previously hypothesized (Bourguet et al. 1997; Weill et al. 2004b; Alout et al. 2008). They were advantaged because they confer a more favorable resistance/cost balance across treated and nontreated zones (overdominance). This result strongly corroborates the view that these duplications were favored because they allow the fixation of a permanent heterosis in this polymorphic gene (Haldane 1932; Spofford

1969), thereby solving the irreducible trade-off between resistance (R copy, treated areas) and optimal synaptic transmission (S copy, nontreated areas).

However, duplication remains a risky genomic rearrangement. First, it will disrupt the initial protein balance, which is likely to be deleterious. In our case, this effect is probably mild, as the number of AChE1 protein that can be packed in the synapse seems to be limited and independent of the quantity produced. Second, duplications are likely to arise in combination with chromosomal inversions that could associate them with deleterious mutations and prevent their fixation in natural populations, as shown by D₃. This two effects could contribute to explain the discrepancies between the low rate of duplication measured in interspecific comparisons and the comparatively large intraspecific diversity of copy-number variation uncovered by genomics (Freeman et al. 2006; Korbel et al. 2008 and references 39–55 in Katju 2012): only duplications passing the sieve of short-term selection would fix and become new material for longer term evolution.

ACKNOWLEDGMENTS

We are very grateful to F. Kondrashov and an anonymous reviewer for helpful comments on the manuscript, and to A. Berthomieu, C. Berticat, S. Unal, and C. Bernard for technical assistance. This work was funded in part by ANR Morevol Santé-Environnement and ANR SilentAdapt (*Ministère délégué à la Recherche*). Contribution 2014-016 of the *Institut des Sciences de l'Evolution de Montpellier* (UMR CNRS-UM2 5554).

DATA ARCHIVING

The doi for our data is doi:10.5061/dryad.2s22q.

LITERATURE CITED

- Agnew, P., C. Berticat, S. Bedhomme, C. Sidobre, and Y. Michalakis. 2004. Parasitism increases and decreases the costs of insecticide resistance in mosquitoes. *Evolution* 58:579–586.
- Alout, H., A. Berthomieu, and C. Berticat. 2007. Different amino-acid substitutions confer insecticide resistance through acetylcholinesterase 1 insensitivity in *Culex vishnui* and *Culex tritaeniorhynchus* (Diptera: Culicidae) mosquitoes from China. *J. Med. Entomol.* 44:463–469.
- Alout, H., L. Djogbéno, C. Berticat, F. Chandre, and M. Weill. 2008. Comparison of *Anopheles gambiae* and *Culex pipiens* acetylcholinesterase 1 biochemical properties. *Comp. Biochem. Physiol. B-Biochemistry Mol. Biol.* 150:271–277.
- Alout, H., P. Labbé, N. Pasteur, and M. Weill. 2010. High incidence of *ace-1* duplicated haplotypes in resistant *Culex pipiens* mosquitoes from Algeria. *Insect Biochem. Mol. Biol.* 41:29–35.
- Berghorsson, U., D. I. Andersson, and J. R. Roth. 2007. Ohno's dilemma: evolution of new genes under continuous selection. *Proc. Natl. Acad. Sci.* 104:17004–17009.
- Berticat, C., G. Boquien, M. Raymond, and C. Chevillon. 2002. Insecticide resistance genes induce a mating competition cost in *Culex pipiens* mosquitoes. *Genet. Res. Cambridge* 79:41–47.
- Berticat, C., J. Bonnet, S. Duchon, P. Agnew, M. Weill, and V. Corbel. 2008. Costs and benefits of multiple resistance to insecticides for *Culex quinquefasciatus* mosquitoes. *BMC Evol. Biol.* 8:104. doi:10.1186/1471-2148-8-104.

- Bourguet, D., N. Pasteur, J. A. Bisset, and M. Raymond. 1996a. Determination of *Ace-1* genotypes in single mosquitoes: toward an ecumenical biochemical test. *Pestic. Biochem. Physiol.* 55:122–128.
- Bourguet, D., M. Raymond, J. A. Bisset, N. Pasteur, and M. Arpagaus. 1996b. Duplication of the *Ace-1* locus in *Culex pipiens* from the Caribbean's. *Biochem. Genet.* 34:351–362.
- Bourguet, D., A. Roig, J. P. Toutant, and M. Arpagaus. 1997. Analysis of molecular forms and pharmacological properties of acetylcholinesterase in several mosquito species. *Neurochem. Int.* 31:65–72.
- Bourguet, D., T. Guillemaud, C. Chevillon and M. Raymond. 2004. Fitness costs of insecticide resistance in natural breeding sites of the mosquito *Culex pipiens*. *Evolution* 58:128–135.
- Breusch, T. S., and A. R. Pagan. 1979. A simple test for heteroscedasticity and random coefficient variation. *Econometrica* 47:1287–1294.
- Conant, G. C., and K. H. Wolfe. 2008. Turning a hobby into a job: how duplicated genes find new functions. *Nat. Rev. Genet.* 9:938–950.
- Crawley, M. J. 2007. The R book. John Wiley & Sons Ltd., Chichester, U.K.
- Cusack, B. P., and K. H. Wolfe. 2007. When gene marriages don't work out: divorce by subfunctionalization. *Trends Genet.* 23:270–272.
- Djogbénu, L., F. Chandre, A. Berthomieu, R. K. Dabiré, A. Koffi, H. Alout, and M. Weill. 2008. Evidence of introgression of the *ace-1R* mutation and of the *ace-1* duplication in west African *Anopheles gambiae* s. s. *PLoS One* 3:e2172, 1–7.
- Djogbénu, L., P. Labbé, F. Chandre, N. Pasteur, and M. Weill. 2009. *Ace-1* duplication in *Anopheles gambiae*: a challenge for malaria control. *Malar. J.* 8:70. doi:10.1186/1475-2875-8-70.
- Duron, O., P. Labbé, C. Berticat, F. Rousset, S. Guillot, M. Raymond, and M. Weill. 2006. High *Wolbachia* density correlates with cost of infection for insecticide resistant *Culex pipiens* mosquitoes. *Evolution* 60:303–314.
- Force, A., M. Lynch, F. B. Pickett, A. Amores, Y. Yan, and J. Postlethwait. 1999. Preservation of duplicate genes by complementary, degenerative mutations. *Genetics* 151:1531–1545.
- Freeman, J. L., G. H. Perry, L. Feuk, R. Redon, S. a McCarroll, D. M. Altshuler, H. Aburatani, K. W. Jones, C. Tyler-Smith, M. E. Hurles, et al. 2006. Copy number variation: new insights in genome diversity. *Genome Res.* 16:949–961.
- Georghiou, G. P., R. L. Metcalf, and F. E. Gidde. 1966. Carbamate-resistance in mosquitoes: selection of *Culex pipiens fatigans* Wied (= *Culex quinquefasciatus*) for resistance to Baygon. *Bull. World Heal. Organ.* 35:691–708.
- Hahn, M. W. 2009. Distinguishing among evolutionary models for the maintenance of gene duplicates. *J. Hered.* 100:605–617.
- Haldane, J. B. S. 1954. The biochemistry of genetics. George Allen and Unwin, Lond.
- . 1932. The causes of evolution. Harper, New York.
- Huchard, E., M. Martinez, H. Alout, E. J. P. Douzery, G. Lutfalla, A. Berthomieu, C. Berticat, M. Raymond, and M. Weill. 2006. Acetylcholinesterase genes within the Diptera: takeover and loss in true flies. *Proc. Biol. Sci.* 273:2595–2604.
- Innan, H., and F. Kondrashov. 2010. The evolution of gene duplications: classifying and distinguishing between models. *Nat. Rev. Genet.* 11:97–108.
- Katju, V. 2012. In with the old, in with the new: the promiscuity of the duplication process engenders diverse pathways for novel gene creation. *Int. J. Evol. Biol.* 2012: 341932. doi:10.1155/2012/341932.
- Katju, V., and M. Lynch. 2003. The structure and early evolution of recently arisen gene duplicates in the *Caenorhabditis elegans* genome. *Genetics* 165:1793–1803.
- Kirkpatrick, M., and N. Barton. 2006. Chromosome inversions, local adaptation and speciation. *Genetics* 173:419–434.
- Kondrashov, F. A. 2012. Gene duplication as a mechanism of genomic adaptation to a changing environment. *Proc. Biol. Sci.* 279:5048–5057.
- Kondrashov, F. A., and A. S. Kondrashov. 2006. Role of selection in fixation of gene duplications. *J. Theor. Biol.* 239:141–151.
- Kondrashov, F. A., I. Rogozin, Y. Wolf, and E. Koonin. 2002. Selection in the evolution of gene duplications. *Genome Biol.* 3:research0008.1–research0008.9.
- Korbel, J. O., P. M. Kim, X. Chen, A. E. Urban, S. Weissman, M. Snyder, and M. B. Gerstein. 2008. The current excitement about copy-number variation: how it relates to gene duplications and protein families. *Curr. Opin. Struct. Biol.* 18:366–374.
- Labbé, P., H. Alout, L. Djogbénu, N. Pasteur, and M. Weill. 2011. Evolution of resistance to insecticide in disease vectors. Pp. 363–409 in M. Tibayrenc, ed. *Genetics and evolution on infectious diseases*. Elsevier Publishing Company, Lond., U.K.
- Labbé, P., A. Berthomieu, C. Berticat, H. Alout, M. Raymond, T. Lenormand, and M. Weill. 2007a. Independent duplications of the acetylcholinesterase gene conferring insecticide resistance in the mosquito *Culex pipiens*. *Mol. Biol. Evol.* 24:1056–1067.
- Labbé, P., C. Berticat, A. Berthomieu, S. Unal, C. Bernard, M. Weill, and T. Lenormand. 2007b. Forty years of erratic insecticide resistance evolution in the mosquito *Culex pipiens*. *PLoS Genet.* 3:e205.
- Lenormand, T., T. Guillemaud, D. Bourguet, and M. Raymond. 1998a. Appearance and sweep of a gene duplication: adaptive response and potential for new functions in the mosquito *Culex pipiens*. *Evolution* 52:1705–1712.
- . 1998b. Evaluating gene flow using selected markers: a case study. *Genetics* 149:1383–1392.
- Lupski, J. R., and P. Stankiewicz. 2005. Genomic disorders: molecular mechanisms for rearrangements and conveyed phenotypes. *PLoS Genet.* 1:e49.
- Lynch, M., and J. S. Conery. 2000. The evolutionary fate and consequences of duplicate genes. *Science* 290:1151–1155.
- Lynch, M., and V. Katju. 2004. The altered evolutionary trajectories of gene duplicates. *Trends Genet.* 20:544–549.
- Oakeshott, J. G., C. Claudianos, P. M. Campbell, R. D. Newcomb, and R. J. Russell. 2005. Biochemical genetics and genomics of insect esterases. Pp. 309–381 in L. I. Gilbert, K. Iatrou, and S. S. Gill, eds. *Comprehensive molecular insect science*. Elsevier, Amsterdam.
- Ohno, S. 1970. Evolution by gene duplication. Springer-Verlag, Berlin.
- Osta, M., Z. Rizk, P. Labbé, M. Weill, and K. Knio. 2012. Insecticide resistance to organophosphates in *Culex pipiens* complex from Lebanon. *Parasit. Vectors* 5:132. doi:10.1186/1756-3305-5-132.
- Otto, S. P., and P. Yong. 2002. The evolution of genes duplicates. Pp. 451–484 in J. C. Dunlap and C.-T. Wu, eds. *Homology effects*. Elsevier Science, New York.
- Papp, B., C. Pal, and L. D. Hurst. 2003. Dosage sensitivity and the evolution of gene families in yeast. *Nature* 424:194–197.
- Perry, G. H., N. J. Dominy, K. G. Claw, A. S. Lee, H. Fiegler, R. Redon, J. Werner, F. a Villanea, J. L. Mountain, R. Misra, et al. 2007. Diet and the evolution of human amylase gene copy number variation. *Nat. Genet.* 39:1256–1260.
- Ranz, J. M., D. Maurin, Y. S. Chan, M. von Grotthuss, L. W. Hillier, J. Roote, M. Ashburner, and C. M. Bergman. 2007. Principles of genome evolution in the *Drosophila melanogaster* species group. *PLoS Biol.* 5:e152.
- Rastogi, S., and D. A. Liberles. 2005. Subfunctionalization of duplicated genes as a transition state to neofunctionalization. *BMC Evol. Biol.* 5:28. doi:10.1186/1471-2148-5-28.
- Raymond, M., and M. Marquine. 1994. Evolution of insecticide resistance in *Culex pipiens* populations: the corsican paradox. *J. Evol. Biol.* 7:315–337.

- Remnant, E. J., R. T. Good, J. M. Schmidt, C. Lumb, C. Robin, P. J. Daborn, and P. Batterham. 2013. Gene duplication in the major insecticide target site, *Rdl*, in *Drosophila melanogaster*. *Proc. Natl. Acad. Sci.* 110:14705–14710.
- Shapiro, S. S., and M. B. Wilk. 1965. An analysis of variance test for normality (complete samples). *Biometrika* 52:591–611.
- Sopko, R., D. Huang, N. Preston, G. Chua, B. Papp, K. Kafadar, M. Snyder, S. G. Oliver, M. Cyert, T. R. Hughes, et al. 2006. Mapping pathways and phenotypes by systematic gene overexpression. *Mol. Cell* 21:319–330.
- Spofford, J. B. 1969. Heterosis and the evolution of duplications. *Am. Nat.* 103:407–432.
- Storz, J. F. 2009. Genome evolution: gene duplication and the resolution of adaptive conflict. *Heredity* 102:99–100.
- Taylor, J. S., and J. Raes. 2004. Duplication and divergence: the evolution of new genes and old ideas. *Annu. Rev. Genet.* 38:615–643.
- Venables, W. N., and B. D. Ripley. 2002. *Modern applied statistics with S*. Springer, New York.
- Wagner, A. 2005. Energy constraints on the evolution of gene expression. *Mol. Biol. Evol.* 22:1365–1374.
- Walsh, J. B. 1995. How often do duplicated genes evolve new functions? *Genetics* 139:421–428.
- Ward, R., and R. Durrett. 2004. Subfunctionalization: how often does it occur? How long does it take? *Theor. Popul. Biol.* 66:93–100.
- Weill, M., P. Fort, A. Berthomieu, M.-P. P. Dubois, N. Pasteur, and M. Raymond. 2002. A novel acetylcholinesterase gene in mosquitoes codes for the insecticide target and is non-homologous to the *ace* gene in *Drosophila*. *Proc. R. Soc. Lon. B Biol. Sci.* 269:2007–2016.
- Weill, M., G. Lutfalla, K. Mogensen, F. Chandre, A. Berthomieu, C. Berticat, N. Pasteur, A. Philips, P. Fort, and M. Raymond. 2003. Insecticide resistance in mosquito vectors. *Nature* 423:423–426.
- Weill, M., C. Berticat, G. Lutfalla, N. Pasteur, A. Philips, P. Fort, and M. Raymond. 2004a. Insecticide resistance: a silent base prediction. *Curr. Biol.* 14:R552–R553.
- Weill, M., C. Malcolm, F. Chandre, K. Mogensen, A. Berthomieu, M. Marquine, and M. Raymond. 2004b. The unique mutation in *ace-1* giving high insecticide resistance is easily detectable in mosquito vectors. *Insect Mol. Biol.* 13:1–7.
- Yébakima, A., M. Raymond, M. Marquine, and Pas. 1995. Resistance to organophosphorous insecticides in *Culex pipiens quinquefasciatus* (Diptera: Culicidae) from Martinique. *J. Med. Entomol.* 32:77–82.
- Yébakima, A., M. Marquine, J. Rosine, M. M. Yp-Tcha, and N. Pasteur. 2004. Evolution of resistance under insecticide selection pressure in *Culex pipiens quinquefasciatus* (Diptera, Culicidae) from Martinique. *J. Med. Entomol.* 41:718–725.
- Zhang, J. 2003. Evolution by gene duplication: an update. *Trends Ecol. Evol.* 18:292–298.

Associate Editor: A. Navarro

Supporting Information

Additional Supporting Information may be found in the online version of this article at the publisher's website:

Figure S1. The various *ace-1* alleles and resulting genotypes.

Figure S2. Specific PCR protocols.

Figure S3. Sequence alignment of susceptible ($D_1(S)$) and resistant ($D_1(R)$) copies of the duplicated allele *ace-1^{D1}* (Martinique), the single martiniquan R copy (all present in DUCOS) and the susceptible copy of SLAB, S_{SLAB} .

Figure S4. Detailed AChE1 activity measure protocol.

Figure S5. Total AChE1 activity for males and females of the different genotypes.

Figure S6. Insecticide bioassays.

Figure S7. Preimaginal mortality.

Table S1. LD₅₀ for the various genotypes with Temephos and Chlorpyrifos.

Gene-dosage effects on fitness in recent adaptive duplications: *ace-1* in the mosquito *Culex pipiens*

Pierrick Labbé, Pascal Milesi, André Yébakima, Nicole Pasteur, Mylène Weill and Thomas Lenormand

Supplementary Materials

Fig.S1: The various *ace-1* alleles and resulting genotypes. A- The various alleles studied, with the corresponding nomenclature: S = *ace-1^S*, R = *ace-1^R*, D₁ = *ace-1^{D1}* (Genbank: JX007772.1 and JX007773.1, for the susceptible and the resistant copy, resp.) and D₃ = *ace-1^{D3}* (Genbank: JX007766.1 and JX007767.1, *idem*). B- The different combinations of the four alleles in diploid genotypes, with the corresponding nomenclature and the corresponding symbols used in the main article figures.

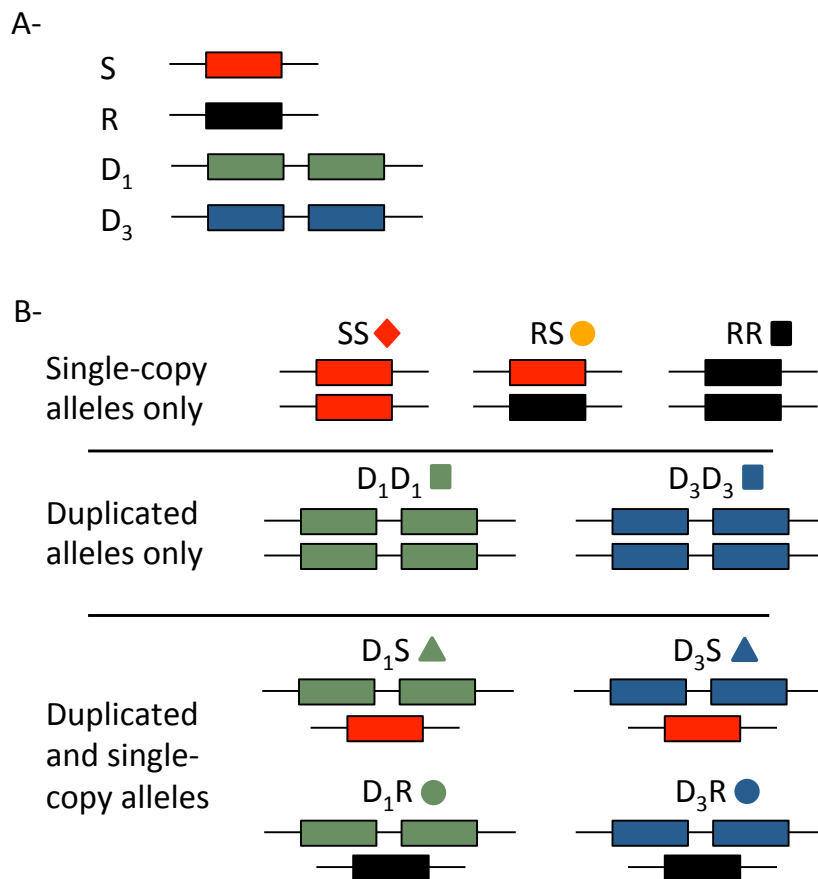

S2: Specific PCR protocols

Partial sequences of *ace-1* exon-3 identified only 5 nucleotides differences between the susceptible copy of the duplicated allele and S_{SLAB}. Individuals from DUCOS and SLAB strains indeed belong to the same subspecies, *C. p. quinquefasciatus*, which displays low genetic variability at the *ace-1* locus (Labbé et al. 2007a). Two pairs of primers amplifying specifically a fragment within this exon 3 were designed: Ex3dirDUCOS 5'-ACA-CTG-GAA-GCG-CCT-AGC-3' and Ex3revDUCOS 5'-CGA-GGC-CAG-CGT-CCG-G-3' (leading to a fragment of 359pb) and, Ex3dirSLAB 5'-TTC-CGT-ACG-CGC-AGC-CC-3', Ex3revSLAB 5'-TGT-GCC-CAG-GAA-GAG-AAA-C-3' (leading to a fragment of 382pb). Using specific PCR conditions (30 cycles, 93 °C for 30s, 60 °C for 30s and 72 °C for 1 min), the first pair amplifies only the three different copies originating from DUCOS (D₁ resistant and susceptible copy and R), whereas the second couple is specific for S_{SLAB} (Fig.S3).

Fig.S3: Sequence alignment of susceptible ($D_1(S)$) and resistant ($D_1(R)$) copies of the duplicated allele $ace-1^{D1}$ (Martinique), the single martiniquan R copy (all present in DUCOS) and the susceptible copy of SLAB, S_{SLAB} . The primers used for DUCOS- and SLAB-specific PCR amplification are highlighted in grey and black, respectively. The position of the G119S mutation (box) distinguishing resistant and susceptible copies is indicated. The first position corresponds to the first nucleotide of exon 3.

							Ex3dirDUCOS	80
D1 (S)	GCCACCGACT	CGGACCCACT	GGTCATAACG	ACGGACAAAG	GCAAAATCCG	TGGAACGACA	CTGGAAGCGC	CTAGCGGAAA
D1 (R)	-----	-----	-----	-----	-----	-----	-----	-----
R	-----	-----	-----	-----	-----	-----	-----	-----
S _{SLAB}	-----	-----	-----	-----G-	-----	-----	-----	-----T-----
								160
D1 (S)	GAAGGTGGAC	GCATGGATGG	GCATTCCGTA	CGCGCAGCCT	CCGCTGGGTC	CGCTCCGGTT	TCGACATCCG	CGACCCGCCG
D1 (R)	-----	-----	-----	-----	-----	-----	-----	-----
R	-----	-----	-----	-----	-----	-----	-----	-----
S _{SLAB}	-----	-----	-----	-----C	-----	-----	-----	-----
				Ex3dirSLAB				
								240
D1 (S)	AAAGATGGAC	CGGTGTGCTG	AACGCGACCA	AACCGCCCAA	CTCCTGCGTC	CAGATCGTGG	ACACCGTGTT	CGGTGACTTC
D1 (R)	-----	-----	-----	-----	-----	-----	-----	-----
R	-----	-----	-----	-----	-----	-----	-----	-----
S _{SLAB}	-----	-----	-----	-----	-----	-----	-----	-----
								320
D1 (S)	CCGGGGGCCA	CCATGTGGAA	CCCGAACACA	CCGCTCTCGG	AGGACTGTCT	GTACATCAAC	GTGGTCGTGC	CACGGCCCAG
D1 (R)	-----	-----	-----	-----	-----	-----	-----	-----
R	-----	-----	-----	-----	-----	-----	-----	-----
S _{SLAB}	-----	-----	-----	-----	-----	-----	-----	-----
								400
D1 (S)	GCCCAAGAAT	GCCGCCGTCA	TGCTGTGGAT	CTTCGGGGGT	GCTTCTACT	CCGGGACTGC	CACGCTGGAC	GTGTACGACC
D1 (R)	-----	-----	-----	-----	-----	-----	-----	-----
R	-----	-----	-----	-----	-----	-----	-----	-----
S _{SLAB}	-----	-----	-----	-----	-----	-----	-----	-----
					G119S			
								480
D1 (S)	ACCGGACGCT	GGCCTCGGAG	GAGAACGTGA	TCGTAGTTTC	GCTGCAGTAC	CGTGTGCAA	GTCTTGGTTT	TCTCTTCTG
D1 (R)	-----	-----	-----	-----	-----	-----	-----	-----
R	-----	-----	-----	-----	-----	-----	-----	-----
S _{SLAB}	-T-----	-----	-----	-----	-----	-----	-----	-----G-----
								Ex3revSLAB
D1 (S)	GGCACA							
D1 (R)	-----							
R	-----							
S _{SLAB}	-----							

S4: Detailed AChE1 activity measure protocol

Each adult mosquito was decapitated and the head was placed in an eppendorf tube with 400 μ l of extraction buffer (20 mM Tris-HCl, pH 7.0, 1 % Triton X-100). It was then homogenized using a pestle and the mix was centrifuge for 1 min at 10,000 rpm. For each mosquito, 100 μ l of supernatant were then distributed into two wells of a microtitration plate. 10 μ L of EtOH were added to the first well and 10 μ l of propoxur (a carbamate insecticide, at 10^{-1} M in EtOH) to the second. The plate was then incubated for 15 min at room temperature. Then, 100 μ l of substrate solution (25 mM sodium phosphate, pH 7.0, 0.2 mM DTNB, 0.35 mM sodium bicarbonate, 2.5 mM acetylthiocholine) were added to each well. The active AChE1 present in the supernatant cleaves the acetylthiocholine into a yellow colored product. Optical density at 412 nm kinetics was recorded every minute for 15 min using a Microplate Reader EL 800 (Bio-Tek Instruments, Inc.). The mean slope of each reaction was computed using the analysis software KCjunior v1.41.4 (Bio-Tek Instruments, Inc.), and was used as a measure of AChE1 activity.

Fig.S5: Total AChE1 activity for males and females of the different genotypes. For each genotype, the distribution of total AChE1 activity (given as the variation in optical density per minute) is represented by a box with a horizontal line for the median value and bottom and top of the box for the 25th and 75th percentiles, respectively. The vertical dashed lines represent either the maximum value or 1.5 times the interquartile range, whichever is the smaller. Rounds indicate outliers. For genotype D₃D₃, D₃R, D₃S, D₁D₁, D₁R, D₁S, RR, RS and SS a total of 28, 28, 25, 27, 27, 25, 16, 26 and 29 males (shaded boxes), and 29, 30, 29, 28, 29, 29, 20, 29 and 27 females (zebra boxes) were analyzed, respectively. The average activity (\pm SE) of each genotype was 49.2 (\pm 8.0), 27.8 (\pm 4.8), 42.3 (\pm 7.1), 39.4 (\pm 6.9), 23.0 (\pm 3.9), 40.1 (\pm 6.4), 9.5 (\pm 1.9), 24.4 (\pm 6.0) and 45.0 (\pm 8.2), respectively.

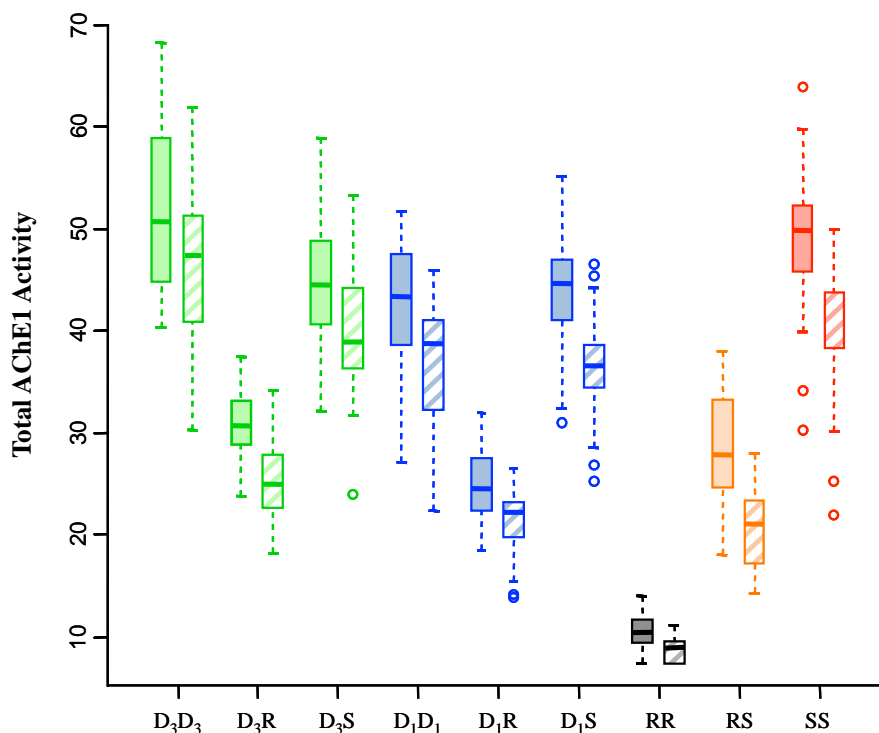

Fig.S6: Insecticide bioassays. The mortality (%) in relation to the insecticide dose is presented for 9 genotypes (see legend) and for the two insecticides used (Temephos, top, and Chlorpyrifos, bottom). The left and right columns respectively present the *ace-1^{D1}* and *ace-1^{D3}* genotypes, SS, RS and RR genotypes being used as references.

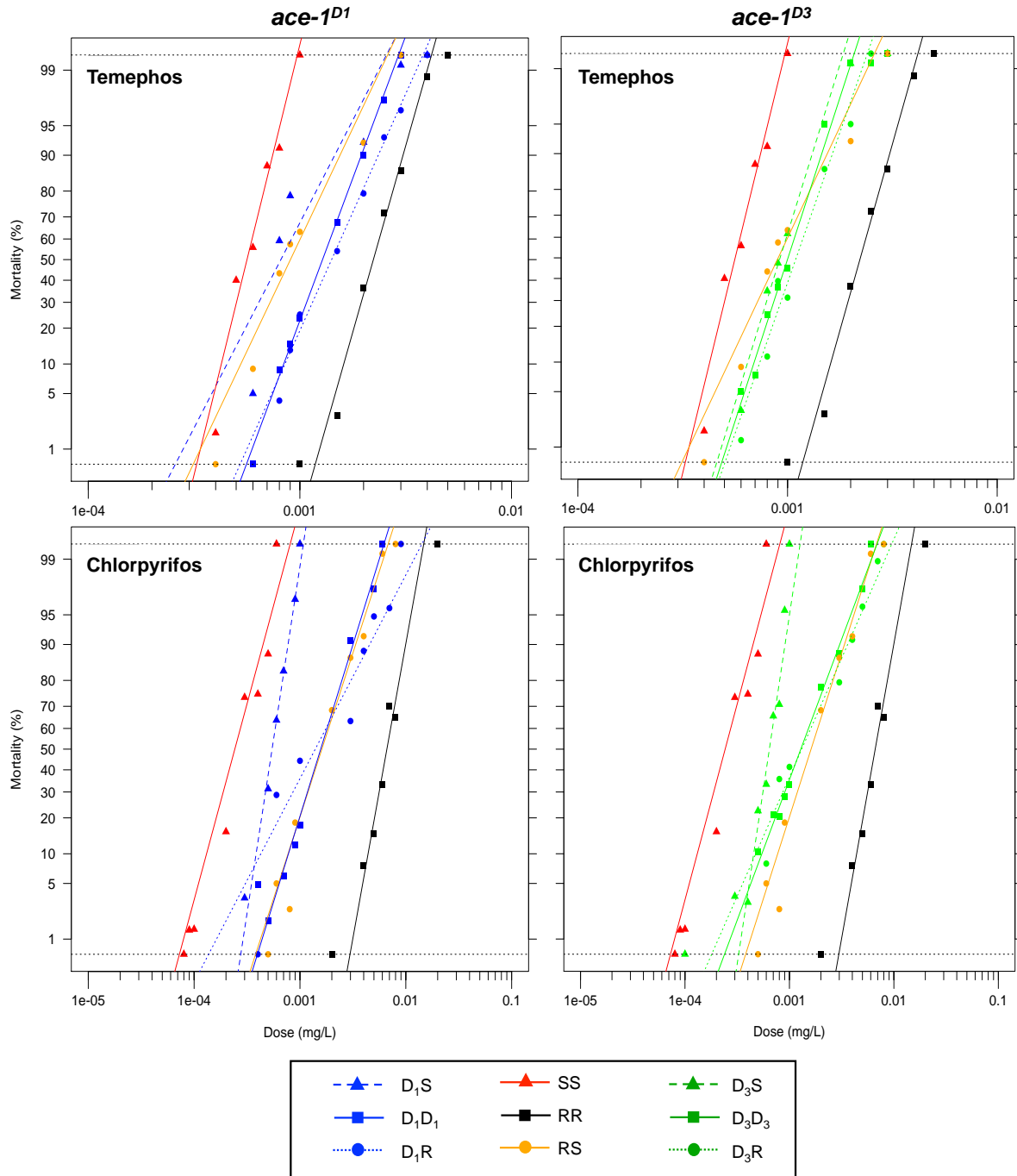
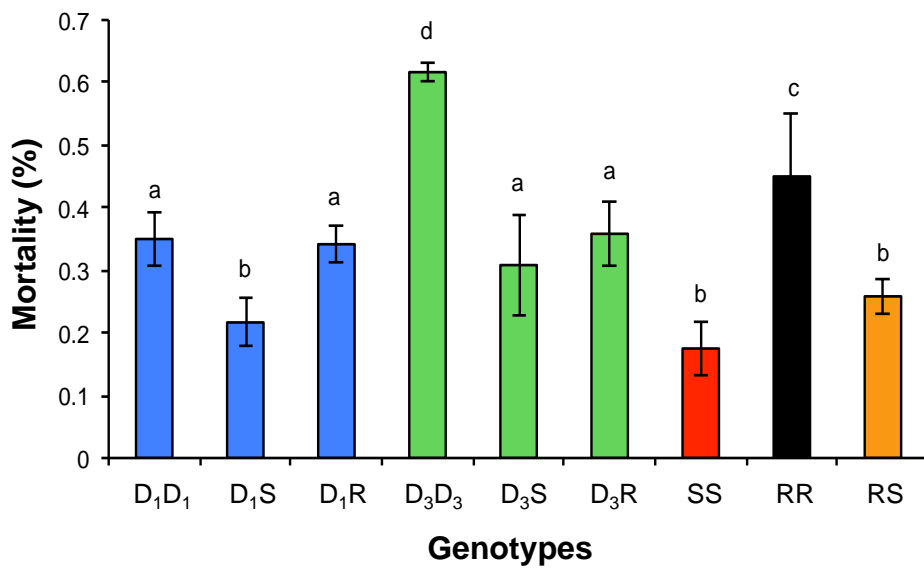



TABLE S7: LD₅₀ for the various genotypes with Temephos and Chlorpyrifos. The 50 % lethal doses (LD₅₀), i.e. the doses expressed in mg/L at which half of the individuals that died are presented for the 9 genotypes. The 95 % confidence intervals are within brackets. The resistance ratios *rr* are also indicated: they correspond to the ratio of the LD₅₀ of the corresponding genotype over the LD₅₀ of the SS genotype.

Genotypes	Temephos		Chlorpyrifos	
	LD ₅₀ (x10 ⁻⁴ mg/l)	<i>rr</i>	LD ₅₀ (x10 ⁻⁴ mg/l)	<i>rr</i>
SS	5.61 (5.47-5.75)	-	2.42 (2.24-2.60)	-
RS	8.89 (8.55-9.24)	1.6	16.0 (14.9-17.0)	6.6
RR	22.2 (21.3-23.1)	4.0	66.3 (63.6-69.1)	27.4
D ₃ D ₃	9.95 (9.67-10.2)	1.8	12.7 (11.8-13.7)	5.3
D ₃ S	9.15 (8.89-9.42)	1.6	6.48 (6.23-6.69)	2.7
D ₃ R	10.9 (10.5-11.3)	1.9	12.7 (11.7-13.8)	5.3
D ₁ D ₁	12.7 (12.2-13.3)	2.3	15.5 (14.5-16.5)	6.4
D ₁ S	7.96 (7.63-8.30)	1.4	5.51 (5.36-5.66)	2.3
D ₁ R	14.1 (13.5-14.6)	2.5	13.7 (12.4-15.1)	5.7

Fig.S8: Pre-imaginal mortality. The mean percentage of individuals dead before emergence for each genotype is indicated, with the standard errors (3 racks of 40 individuals per cross). The data were analyzed using the GLM: $MORTALITY = GENO + BLOC + GENO.BLOC + \epsilon$, where GENO is the genotypes, BLOC the racks of 40 individuals and ϵ the error parameter following a binomial distribution. An identical letter labeling the bar indicates that the number of emerging adults is not different between two genotypes. No BLOC effect was observed. Four groups of genotypes emerged from the highest to the lowest recorded mortality: a) D_1D_1 , D_1R , D_3S and D_3R (30-35% mortality), b) D_1S , SS and RS (18-25% mortality), c) RR (45% mortality), d) D_3D_3 (61.7% mortality).



SCIENTIFIC REPORTS



OPEN

An *ace-1* gene duplication resorbs the fitness cost associated with resistance in *Anopheles gambiae*, the main malaria mosquito

Benoît S. Assogba^{1,2,3,4}, Luc S. Djogbénu^{3,4}, Pascal Milesi^{1,2}, Arnaud Berthomieu¹, Julie Perez¹, Diego Ayala⁵, Fabrice Chandre⁵, Michel Makoutodé^{3,4}, Pierrick Labbé^{1,2} & Mylène Weill^{1,2}

Received: 20 May 2015
Accepted: 25 August 2015
Published: 05 October 2015

Widespread resistance to pyrethroids threatens malaria control in Africa. Consequently, several countries switched to carbamates and organophosphates insecticides for indoor residual spraying. However, a mutation in the *ace-1* gene conferring resistance to these compounds (*ace-1^R* allele), is already present. Furthermore, a duplicated allele (*ace-1^D*) recently appeared; characterizing its selective advantage is mandatory to evaluate the threat. Our data revealed that a unique duplication event, pairing a susceptible and a resistant copy of the *ace-1* gene spread through West Africa. Further investigations revealed that, while *ace-1^D* confers less resistance than *ace-1^R*, the high fitness cost associated with *ace-1^R* is almost completely suppressed by the duplication for all traits studied. *ace-1* duplication thus represents a permanent heterozygote phenotype, selected, and thus spreading, due to the mosaic nature of mosquito control. It provides malaria mosquito with a new evolutionary path that could hamper resistance management.

Vector-borne diseases, among which malaria is preeminent, cause a considerable burden on human populations¹. In sub-Saharan Africa, *An. gambiae* is the major malaria vector. Malaria vaccine is still under experimentation and access to anti-malaria drugs remains difficult and expensive, thus mosquito vectors control is the only affordable measure to fight malaria^{2,3}. Mosquito control worldwide relies essentially on the use of chemical synthetic insecticides that target an insects' vital function⁴. Only four classes of conventional insecticides are licensed by the World Health Organization (WHO): Organochlorines (OCs), Pyrethroids (PYRs), Carbamates (CXs) and Organophosphates (OPs)⁵. Direct control of *Anopheles* breeding sites is usually not possible, and the main option to block or reduce malaria transmission is to prevent the vector-host contact using insecticide-treated bed-nets (ITNs) and indoor residual house spraying (IRS).

Until recently, PYRs were the only insecticides authorized for ITNs and the most used for IRS^{4,6–12}. These tools have been shown to efficiently protect vulnerable populations from endemic countries^{1,13}. Unfortunately, due to large-scale and prolonged treatments, as well as mosquito populations large effective size and their short life span per generation, resistance to PYRs was rapidly selected, and is now widespread in most malaria vectors from sub-Saharan Africa^{14,15}. Several alarming studies predicted that PYR resistance may contribute to malaria vector control failure^{15–18}.

In order to preserve vector control effectiveness, alternative solutions to PYRs are urgently needed. However, with the limited number of insecticides and none expected in the near future¹⁴, OPs and CXs were suggested as potential alternative compounds to control PYR-resistant populations, either alone or in combination with PYRs^{17,19–21}. They have indeed shown a good efficacy in ITNs and IRS, with

¹CNRS, IRD, ISEM—UMR 5554, Montpellier, France. ²University of Montpellier, Montpellier, France. ³IRSP, Ouidah, Benin. ⁴University of Abomey-Calavi, Cotonou, Benin. ⁵IRD, CNRS, MIVEGEC—UMR 224/5290, Montpellier, France. Correspondence and requests for materials should be addressed to P.L. (email: pierrick.labbe@univ-montp2.fr)

high mortality of PYR-resistant (*kdr^R*) *An. gambiae* in Ivory Coast and Benin^{22–24}. Thus, following the American President's Malaria Initiative in collaboration with the National Malaria Control Program, several African countries recently switched partly or entirely from PYRs to CXs (i.e. bendiocarb) or OPs (i.e. chlorpyrifos or pirimiphos methyl) for IRS^{18,22,25,26}.

However, a particular concern for the use of OPs and CXs is that resistance to these insecticides is already present in some *An. gambiae* populations from West Africa^{27–30}. Although resistance has also been shown to result from overexpression of detoxification enzymes^{31,32}, highest resistance levels are due to mutation in the target of OPs and CXs, the acetylcholinesterase (AChE1) encoded by the *ace-1* gene: a single amino acid substitution of glycine by serine at the position 119 (G119S) resulting in a major conformational change³³. This *ace-1^R* resistant allele arose independently several times in distinct mosquito species^{34,35}. In *Culex pipiens* mosquitoes, it entails a large fitness cost for several life history traits^{36–38}. A similar fitness cost appears to exist for *An. gambiae* (a single study showed that pupae carrying *ace-1^R* endure higher mortality rate³⁹). Thus, while resistant mosquitoes survive in the presence of insecticide, they are outcompeted by susceptible in absence of insecticide, due to their lower fitness. This fitness cost is crucial for resistance management: in absence of OPs and CXs selective pressures, *ace-1^R* frequency should indeed decrease (the costlier the faster⁴⁰), allowing insecticide rotation or mosaic strategies to maintain low levels of insecticide resistance.

Worryingly, a new *ace-1* allele has been found in *An. gambiae* and *An. coluzzii* in several West African countries (e.g. Ivory Coast and Burkina Faso)^{41,42}. This allele, named *ace-1^D*, consists in a duplication of the *ace-1* gene, associating a susceptible and a resistant copy probably on the same chromosome. Several similar duplicated alleles have been observed in *Cx. pipiens*^{43,44}, where they have been shown to be selected because they reduce the fitness cost associated with the G119S mutation^{45–47}. A selective advantage was also recently described in *Drosophila melanogaster* with the duplication of the resistance target gene *Rdl^R*⁴⁸. A similar selective advantage of *An. gambiae ace-1^D* allele would facilitate its diffusion in natural populations, thereby spreading OPs and CXs low-cost resistance and endangering malaria vector control strategies. It is thus crucial to evaluate the threat of this *ace-1* duplication by investigating its impacts on the fitness of *An. gambiae*, both in presence and absence of insecticide.

To do so, we constructed a laboratory strain homozygous for the *ace-1^D* allele and sharing a genetic background similar to the reference strains KisumuP and Acerkis, respectively homozygous for the single-copy susceptible *ace-1^S* and resistant *ace-1^R* alleles, a mandatory step to avoid any confounding effect due to other resistance mechanisms or any other mutations. We analyzed the organization of the duplicated *ace-1* gene by a cytogenetic approach, and compared the three strains performances for OPs and CXs resistance levels, as well as several life history traits. This study revealed that *ace-1^D* is indeed expected to spread, threatening the switch to OPs or CXs for malaria mosquito control in countries with PYR-resistant populations.

Results

Characterization of the Acerduplikis strain carrying *ace-1* gene duplication. We collected larvae from a wild population of *An. gambiae* in Baguida⁴⁹, a region suspected to contain *ace-1^D* alleles, because of a large apparent excess of heterozygous [RS] phenotypes at the *ace-1* locus⁴². As no enzymatic or molecular test is currently available for detecting *ace-1* duplication, we used the genetic protocol developed by Labbé *et al.*⁴⁴ for *Cx. pipiens* mosquitoes, to identify females harboring *ace-1^D* alleles (Supp. Fig. 1). The *ace-1^D* allele is composed of susceptible, D(S), and resistant, D(R), copies (see nomenclature in Labbé *et al.*⁴³). They were sequenced in 16 females (2241 bp PCR fragment from exon 2 to exon 7), and all D(S) copies were found identical, as were all D(R) copies. The D(R) copy is strictly identical to the known *ace-1^R* allele³² and differs from the D(S) copy by 24 mutations (Supp. Fig. 2). Both D(S) and D(R) copies were found identical to the sequence of the *ace-1^D* allele previously detected in *An. gambiae* species⁴¹. Progenies of the 16 founding females were mixed to construct the Acerduplikis strain.

The number of *ace-1* gene copies was estimated for 20 Acerduplikis and KisumuP mosquitoes with Real-time quantitative PCR. Differences in copy number among D/D and S/S genotypes was tested by computing the following linear model $Cn = \text{Geno} + \varepsilon$, with CN the copy number, GENO the genotype (S/S or D/D) of each individual and ε the error parameter (Gaussian distribution). It confirmed that Acerduplikis significantly displays twice as much *ace-1* copies (2.13 ± 0.27) as KisumuP (1.00 ± 0.05 ; LRT, $F = 329.9$, $\Delta df = 1$, $p < 0.001$, Supp. Fig. 3).

A fluorescence *in situ* hybridization (FISH) approach was used to localize the positions of the two *ace-1* D(S) and D(R) copies of Acerduplikis *ace-1^D* allele on the chromosomes. Two fluorescent probes were used, *ace-1* and AGAP001373 (probe 2), which are separated by about 500 kb on the 2R chromosome arm of *An. gambiae*. Our results showed a single signal with the *ace-1* probe, at the same location for both KisumuP and Acerduplikis strains (Fig. 1A,B). However, the signal was broader for Acerduplikis. When the two probes were co-hybridized on Acerduplikis polytene chromosomes, we observed two different signals, the broadest corresponding to the *ace-1* probe and the thinner to probe 2 (Fig. 1C). This result evidenced that the two copies of the *ace-1* duplicated allele are in tandem and separated by a distance lower than 500 kb.

Finally, since we aimed at determining the impact of *ace-1^D* allele on mosquito fitness, we performed eight successive backcrosses to introgress this allele into the susceptible KisumuP reference strain genetic background. Polymorphic sequence markers that differentiate KisumuP and Baguida (a mix of

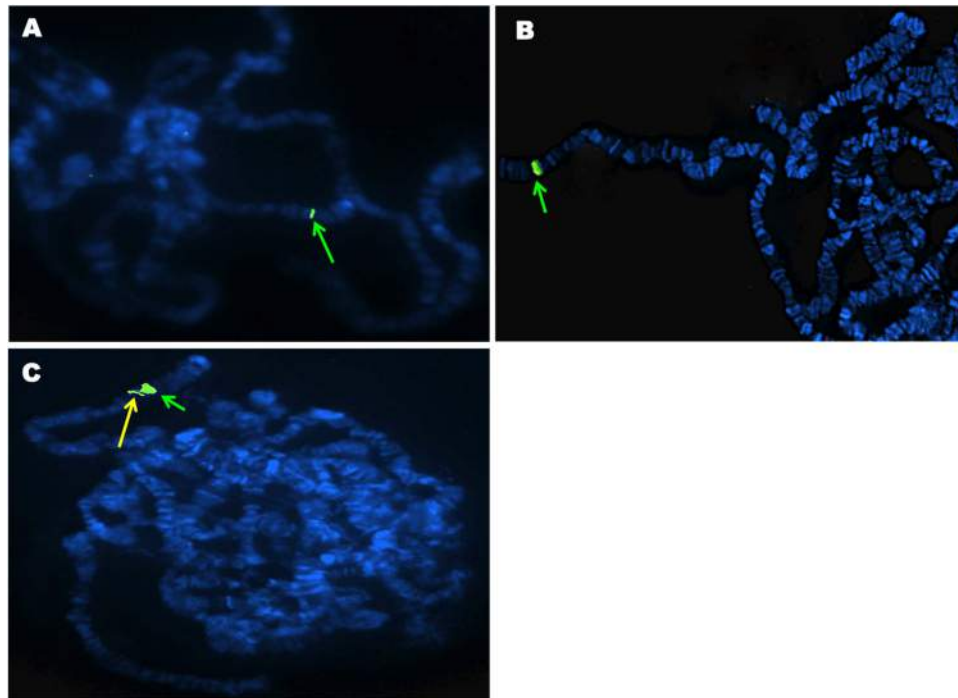

Figure 1. *In situ* hybridization with Cy3 fluorescently labelled DNA probes performed on polytene chromosomes of *An. gambiae* strains. Green and yellow arrows indicate *ace-1* and AGAP001373 probes respectively. (A) *ace-1* probe hybridized on KisumuP strain; (B) *ace-1* probe hybridized on Acerduplikis strain; (C) *ace-1* and AGAP001373 probes co-hybridized on Acerduplikis strain.

10 individuals from the Baguida field population used to establish Acerduplikis) were developed on each chromosome (Supplementary Table 1). The Acerduplikis fixed strain shared all the KisumuP markers, showing that the Acerduplikis genomic background was largely similar to that of KisumuP. Although recombination around the *ace-1* gene is not total, most of the background effects were eliminated, allowing a pertinent assessment of the duplication effects on fitness.

***ace-1^D* provides less resistance to carbamates and organophosphates insecticides than *ace-1^R*.** Bioassays were carried out on larvae from the three strains KisumuP (S/S), Acerkis (R/R) and Acerduplikis (D/D) strains and from their F1 offspring (R/S, D/S and D/R genotypes). One CX (bendiocarb), three OPs (chlorpyrifos methyl, fenitrothion and dichlorvos) and one PYR (permethrin) were tested. For all larval bioassays, mortality in control tests never exceeded 5%. Statistical analyses (chi-square test between observed and expected dead numbers) indicated good fits for the log-dose-mortality regressions (all *p-value* > 0.05, Table 1, Supp. Fig. 4). Moreover, the same susceptibility to permethrin was recorded for KisumuP, Acerkis ($RR_{50} = 1$, $p > 0.05$) and Acerduplikis ($RR_{50} = 1$, $p > 0.05$) showing the absence of pyrethroid resistance mechanism (Table 1). This last result confirmed that only *ace-1* contributed to OPs and CXs resistance in the tested strains.

The Acerduplikis strain (D/D) displayed a significantly lower resistance level to CX (bendiocarb, $RR_{50} = 3.14$ vs 229.3, $p < 0.001$) and OPs (chlorpyrifos-methyl, $RR_{50} = 1.91$ vs 9.03, $p < 0.001$; fenitrothion, $RR_{50} = 6.56$ versus 23.74, $p < 0.001$; dichlorvos, $RR_{50} = 8.78$ vs 12.61, $p < 0.001$) than Acerkis (R/R; Table 1, Supp. Fig. 4). While D/D individuals displayed a resistance level similar to the R/S heterozygotes for all the tested OPs (all *p-value* > 0.05), and a significantly lower resistance level for the CX bendiocarb ($p < 0.001$). For all the tested insecticides, D/S and D/R heterozygotes displayed, respectively, significantly lower and significantly higher resistance levels (all *p-values* < 0.001) than D/D individuals (Table 1), but D/R individuals displayed significantly lower resistance levels than R/R individuals (all *p-values* < 0.001). From the least to the most resistant, the genotype order is thus: SS < DS < DD \approx RS < DR < RR.

***ace-1* duplication induces low, if any, fitness cost.** To measure the fitness cost associated with the different *ace-1* genotypes, several life history traits were compared in Acerkis (R/R), Acerduplikis (D/D) and KisumuP (S/S).

Larval mortality and development time. - Pre-imaginal mortality was followed from egg hatching to adult emergence. The number of dead larvae at each developmental stage was recorded, allowing testing

ace-1 genotypes	Insecticides														
	Bendiocarb			Chlorpyrifos-methyl			Fenitrothion			Dichlorvos			Permethrin		
	^a LC ₅₀ (mg/L)	^b RR ₅₀	^c Chi(p)	^a LC ₅₀ (mg/L)	^b RR ₅₀	^c Chi(p)	^a LC ₅₀ (mg/L)	^b RR ₅₀	^c Chi(p)	^a LC ₅₀ (mg/L)	^b RR ₅₀	^c Chi(p)	^a LC ₅₀ (mg/L)	^b RR ₅₀	^c Chi(p)
S/S (Kisumu)	0.22	NA	0.99	0.004	NA	0.99	0.003	NA	0.99	0.008	NA	1	0.006	NA	0.99
R/R (Acerkis)	50.1	229.3	0.99	0.036	9.04	1	0.061	23.74	0.99	0.096	12.61	0.99	0.006	1	0.99
R/S	27.04	123.9	0.99	0.007	1.72	0.99	0.021	8.39	0.91	0.05	6.4	0.99	NA	NA	NA
D/S	0.28	1.29	1	0.006	1.56	0.99	0.016	6.28	0.99	0.04	5.4	0.99	NA	NA	NA
D/R	26.96	123.5	0.99	0.013	3.21	0.99	0.042	16.57	0.99	0.06	7.62	0.99	NA	NA	NA
D/D (Acerduplikis)	0.68	3.14	1	0.007	1.91	0.99	0.022	8.78	0.99	0.05	6.56	1	0.006	1	0.99

Table 1. Dose-mortality responses to different insecticides observed in reference strains of *Anopheles gambiae* s. s. ^aLC₅₀: lethal concentration in milligrams per liter inducing a mortality of 50%. ^bRR₅₀: resistance ratio at LC₅₀ = LC₅₀(resistant strain)/LC₅₀(Kisumu). ^cChi(p): the *p*-value of chi-square test for linearity of the dose response; *p*-values > 0.05 indicate acceptable fits (i.e. linearity is not rejected).

for differences between strains in overall mortality as well as in mortality dynamics. A Cox proportional hazards regression model (Cox model) was thus computed as: SURV = GENO + ε , with SURV, the proportion of dead larvae at each developmental stage, GENO a three-levels factor corresponding to the different genotypes (S/S, D/D, R/R) and ε the error parameter, following a binomial distribution to take over-dispersion into account, if present. Emerging adults were censored in the analyses.

The duplicated D/D genotype displayed at each larval stage a significantly lower mortality than the R/R genotype ($z = 3.6$, $p < 0.001$). Although it tended to be slightly higher, D/D larval mortality at each stage was not significantly different from the susceptible S/S genotype ($z = 1.9$, $p = 0.06$; Fig. 2A). The overall larval mortalities of each genotype were $m_{RR} = 0.71$ [0.60–0.79]; $m_{DD} = 0.43$ [0.32–0.52]; $m_{SS} = 0.29$ [0.20–0.38] (the 95% confidence intervals, or CI, are given in the brackets).

- *Development time* was recorded as the number of days necessary for a first-instar larva to reach adulthood (i.e. the time until emergence). The sex of each emerging adult was recorded. Differences in development time between genotypes and/or sexes were tested by computing the following Cox model: DEV = GENO + SEX + GENO.SEX + ε , with DEV, the number of adults that emerged at a given day, GENO a three-levels factor (S/S, D/D and R/R), SEX a two-levels factor (male or female), GENO.SEX the interaction between the two factors, and ε the error parameter (binomial distribution).

No interaction between sex and genotype was detected ($\chi^2 = 2.22$, $\Delta df = 2$, $p = 0.33$) allowing studying the impact of each factor independently. As expected in *An. gambiae*⁵⁰, males emerged significantly earlier than females (respectively: 8.5 ± 1.2 and 9.2 ± 1.3 days; $\chi^2 = 8.9$, $\Delta df = 1$, $p < 0.01$). D/D individuals developed significantly faster than R/R individuals (respectively, 8.7 ± 1.3 and 10.5 ± 0.84 ; $t = 7.85$, $df = 76.05$, $p < 0.001$). The mean development time was not significantly different between D/D and S/S individuals (respectively, 8.7 ± 1.3 and 8.2 ± 0.7 ; Student test, $t = 0.83$, $df = 50.67$, $p = 0.41$; Fig. 2B). However, the Cox model showed a larger variance in the development time of D/D than of S/S individuals (i.e. more time between the first and the last adult to emerge; $z = 3.8$, $p < 0.001$; Fig. 2B).

Mating competition. Mating competition trials were performed between pairs of males of different genotypes to compare their capacity to inseminate either KisumuP (S/S) or Acerduplikis (D/D) females. A generalized linear model (GLM) was used to compare paternity success among competing male pairs: PAT = PAIRS + FEM + PAIRS.FEM + ε , with PAT the paternity success (number of egg rafts sired by a given male genotype), PAIRS a three-levels factor corresponding to the pairs of male genotypes in the different trials (D/D vs S/S, D/D vs R/R, and S/S vs R/R), FEM a two-levels factor corresponding to the female genotype (S/S or D/D), PAIRS.FEM the interaction between these two factors, and ε the error parameter (binomial distribution).

The female genotype did not significantly impact the paternity success, either among the trials (PAIRS.FEM: $\chi^2 = 0.07$, $\Delta df = 2$, $p = 0.97$) or for a given trial (FEM: $\chi^2 = 2.22$, $\Delta df = 1$, $p = 0.33$). However, the pairs confronted in each trial did not fare similarly (PAIRS: $\chi^2 = 11.25$, $\Delta df = 2$, $p < 0.01$). Both the D/D and the S/S males sired more progenies than R/R males (i.e. paternity success > 0.5): in DD vs RR trial, D/D paternity success was 0.68 ± 0.11 (> 0.5, Binomial test: $p < 0.001$), while in SS vs RR trial, S/S paternity success was 0.68 ± 0.12 (> 0.5, Binomial test: $p < 0.001$). Paternity successes of the D/D and S/S males were not significantly different, either when confronted to R/R males ($\chi^2 = 0.02$, $df = 1$, $p = 0.89$) or to each other: in DD vs SS trial, D/D paternity success was 0.48 ± 0.08 (not different from 0.5, Binomial test: $p = 0.63$) (Fig. 2C).

Female fecundity and fertility. In order to assess the influence of the duplicated allele on female reproductive success, forty females of each genotype (S/S, D/D and R/R) were allowed to lay eggs. The number of females laying eggs, eggs laid and larvae produced were recorded.

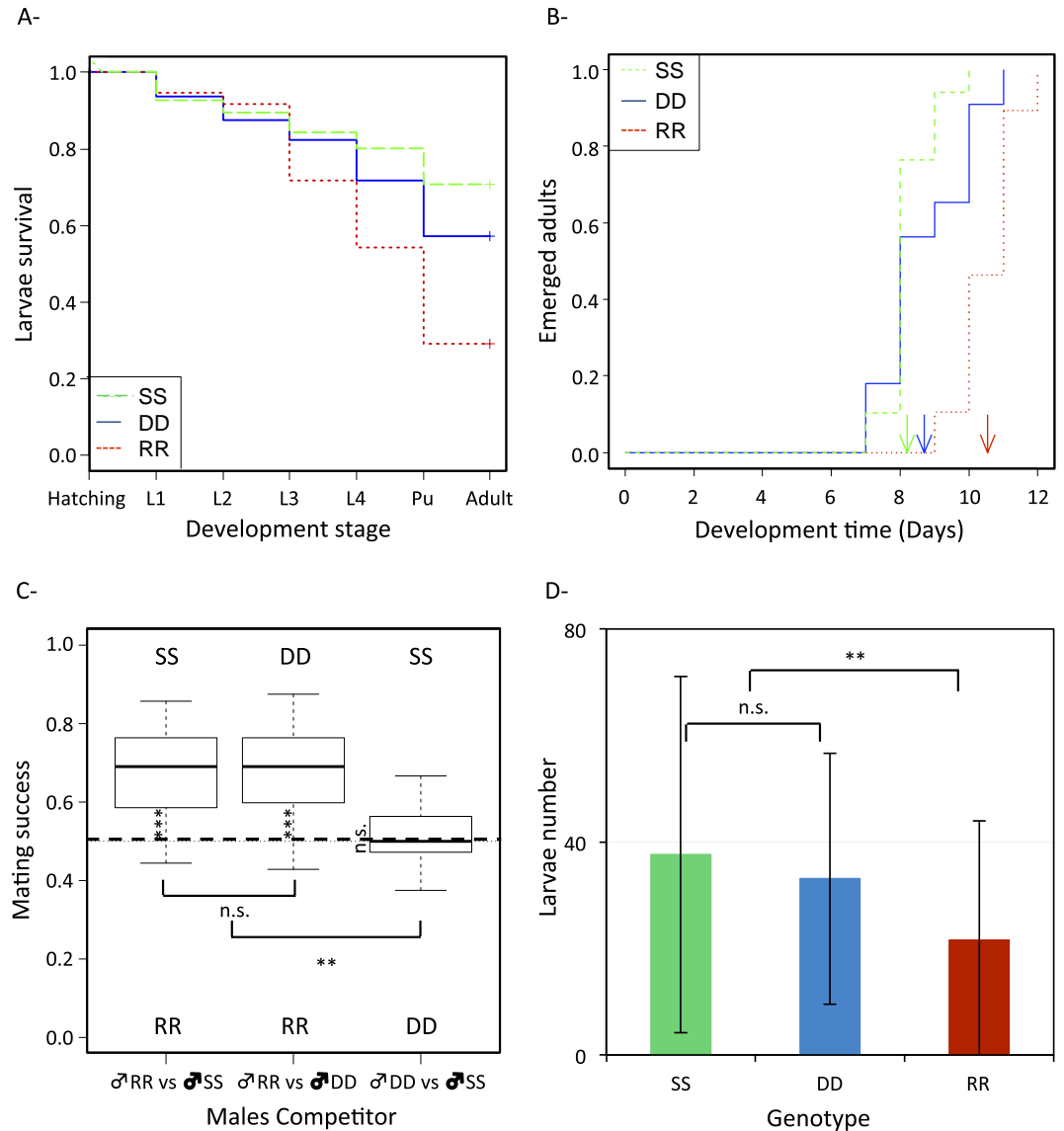

Figure 2. Life history traits of the susceptible KisumuP (SS, green, dash line), resistant Acerkis (RR, red dot line) and resistant duplicated Acerduplikis (DD, blue, solid line) homozygotes. Panel (A) *Larval mortality*. The proportion of larvae surviving at each development stage is presented from hatching to emergence (L_i is the larval stage i and Pu the pupal stage). Crosses represent the proportion of emerged adults. Panel (B) *Development time*. The proportion of emerged adults on each day following the experiment beginning is presented for each genotype. Arrows indicate the mean development time of each genotype. Panel (C) *Mating competition*. Boxplots present the distribution of paternity success. The horizontal dash line symbolizes an equal paternity success of the two types of males. Significance of the departure from 0.5 is indicated vertically and significance of differences among confrontations is indicated horizontally (n.s., $p > 0.05$; * $p < 0.05$; ** $p < 0.01$; *** $p < 0.001$). Panel (D) *Female fecundity*. The average larvae numbers by female are presented with their standard deviation. Significance of the differences in fertility is indicated (n.s., $p > 0.05$; * $p < 0.05$; ** $p < 0.01$; *** $p < 0.001$).

Overall, the reproductive success (R_{suc}) of R/R females was significantly lower (on average 21.5 ± 22 larvae per female) than D/D or S/S females (respectively, on average 33.1 ± 24 and 37.6 ± 33 larvae per female; Fig. 2D) (GLM $R_{suc} = \text{Geno} + \varepsilon$ (Gaussian distribution), $F = 7.04$, $\Delta df = 1$, $p < 0.01$). Moreover, the difference between D/D and S/S females was not significant ($F = 0.56$, $\Delta df = 1$, $p = 0.46$).

The observed differences are due to the fact that R/R females lay fewer eggs than the others; the number of females laying eggs and the hatching rate are not significantly different between the three genotypes. For a detailed analysis see Supplementary materials Supp. Fig. 5.

Overall, the order of the genotypes from the less to the most costly is: $SS \approx DD < RR$.

Discussion

As more advisors urge African countries to switch from PYRs to CXs and OPs for malaria vector control, understanding the already-spreading resistance to these insecticides is urgent. The present study contributes by characterizing the impact of the *ace-1* gene duplication on *An. gambiae* fitness. We constructed a laboratory strain homozygous for the *ace-1^D* allele, sharing a nuclear background similar to the susceptible reference strain, KisumuP, to avoid any confounding effect. We then described this new resistance allele and measured its performances in presence or absence of insecticide compared to single-copy susceptible (*ace-1^S*) and resistant (*ace-1^R*) alleles. Our findings provide clues on how *ace-1^D* has arisen, but darken the perspectives of using OPs and CXs as alternative to PYRs' lurking incapacitation due to rising resistance.

A new resistance allele at the *ace-1* locus. In *Cx. pipiens*, 13 distinct *ace-1* duplicated alleles have been identified so far^{44,51,52}, sometimes with several duplicated alleles in a same population. Although nothing is known about their chromosomal structure, they seem to have arisen from several independent duplication events⁴³.

The situation is quite different in *An. gambiae*, as only one *ace-1^D* allele appears to segregate in West Africa: the unique D(S) and D(R) sequences of the studied allele here and collected in Togo in 2012 are identical to those previously described in Ivory Coast and Burkina Faso in 2006⁴¹. This strongly suggests that they proceed from the same duplication event. The D(S) and D(R) copies are quite divergent at the nucleotide level, but our study shows that they lay in close tandem on chromosome 2R (Fig. 1). These observations suggest that, among the different scenarios generating duplications⁴⁴, this particular allele probably results from an unequal crossing-over in a standard heterozygote (i.e. R/S).

***ace-1* duplication sets a new evolutionary path for *Anopheles gambiae* resistance.** Current genotyping methods for the *ace-1* locus cannot discriminate *ace-1^D* carriers from a standard heterozygote. Therefore, *ace-1^D* frequency in *An. gambiae* natural populations from West Africa has been estimated from the apparent excess of [R/S] phenotypes caused by its presence⁴². Nevertheless, previous estimations suggested that *ace-1^D* is quite frequent in this region^{27,42,53}. Our study provides the clues to understand the reasons.

Insecticide resistance data showed that the resistance level conferred by the duplicated allele *ace-1^D* is lower than the one conferred by *ace-1^R* (Table 1). It also seems correlated to the percentage of R copies carried by mosquitoes: for all tested insecticides, different genotypes resistance order generally as RR > DR > DD ≈ RS > DS > SS, similarly to what was previously described in *Cx. pipiens*⁴⁶. A probable explanation could be the competition existing between AChE1S and AChE1R enzymes in the synapse, as increasing the number of S copies will reduce AChE1R enzymes randomly picked from a pool, thereby decreasing the resistance level⁴⁵. A resistance advantage (both in intensity and specificity) of *ace-1^D* over *ace-1^R* is thus clearly ruled out.

An. gambiae major life history traits analysis (pre-imaginal mortality, larval development time, mating competition, and female fertility) showed that a high fitness cost is associated with the resistant R/R genotype (Fig. 2A–D), confirming the sole previous study available³⁹. Moreover, as anticipated⁵⁴, this cost is similar to the one associated with the same G119S mutation in *Cx. pipiens* for several life-history traits in field and laboratory studies^{36,37,45,46}: for instance, in this study the pre-imaginal mortality for R/R homozygotes is increased compared to the S/S ~2.57 times in *An. gambiae*, versus ~2.43 times in *Cx. pipiens*, ($z = 0.97$, $p = 0.33$;⁴⁶). The fitness cost associated with *ace-1^R* was previously attributed to the reduction of insensitive acetylcholinesterase (AChE1R) activity by more than 60% compared to the susceptible one (AChE1S)⁵⁵, a magnitude similar in both mosquito species⁵⁴.

While the existence of such cost for *ace-1^R* comforts hopes of controlling this resistance allele, our results are grimmer regarding the duplicated allele. The D/D genotype indeed appears less costly than the R/R genotype, to the point that no significant difference was observed between D/D and S/S genotypes on the four life history traits measured (Fig. 2). The D/D genotype performances were nevertheless always slightly lower than S/S ones, which could suggest a low fitness cost. As previously proposed for *Cx. pipiens*⁴⁶, the decreased fitness cost in D/D individuals compared to R/R could result from the reduction of the costly AChE1R relative quantity (as the duplicated allele produces both AChE1R and AChE1S enzymes). To further the comparison between the two mosquito species, the fitness of *An. gambiae ace-1^D* allele seems to be at least similar to that of the fittest duplicated allele analyzed so far in *Cx. pipiens*, *ace-1^{D1}*^{45,46}. For instance, compared to R/R homozygotes, D₁/D₁ pre-imaginal mortality is decreased 1.3 times in *Cx. pipiens*⁴⁶, versus 1.7 times for D/D in *An. gambiae* ($z = -1.89$, $p = 0.06$).

A worrisome observation is that the *Cx. pipiens ace-1^{D1}* allele totally replaced the local *ace-1^R* in Martinique⁵⁶. Similarly, *ace-1^D* appears to be spreading in West Africa. Our study reveals that its higher fitness does not result from a higher resistance level but from a decreased cost, or rather from a new equilibrium between resistance and cost, providing *An. gambiae* mosquitoes with a new evolutionary path.

***ace-1^D* is bad news for malaria vector control in areas with high PYR resistance.** According to the results of our study, it is obvious that the selective pressure intensity, in this case the quantity of insecticide used, will be crucial to determine which of *ace-1^R* or *ace-1^D* will prevail in treated areas: in

highly treated areas, *ace-1^R* should be favored due to its higher resistance level, while *ace-1^D* will be fitter in less treated areas, thanks to its lower cost.

However, the heterogeneity of insecticide usage practices could actually be determinant on a larger geographic scale and explain the selection of the duplicated allele in natural populations. Due to the mosaic nature of mosquito control and mosquito's migration ability, a same individual may experience both treated and untreated areas during its lifespan. This could favor the selection of a more balanced, generalist, phenotypic optimum: a heterozygote individual (R/S) would survive better than R/R individuals in absence of insecticide (lower fitness cost), but also better than S/S individuals in treated areas. Such heterozygote advantage over two contrasted environments is called marginal overdominance⁵⁷. However, heterozygotes cannot become fixed in a population, as the segregation burden leads to the loss of the advantage of having both AChE1S and AChE1R enzymes in half of their progeny. Haldane⁵⁸ proposed that the existence of two functionally divergent alleles leading to overdominance would promote the emergence and selection of a duplication carrying both copies by creating "permanent heterozygotes". Individuals carrying this duplicated allele would keep their advantage across generations and may invade natural populations. The *ace-1^D* allele in *An. gambiae* appears as a perfect example of selection for permanent heterozygosity: our study shows that a D/D genotype results in a phenotype similar to a standard heterozygote R/S, but without the segregation burden. Moreover, its distribution in West African natural populations points to the crucial role of the insecticide usage practices (and their heterogeneity) in the selection of this more generalist allele. In Burkina Faso and Ivory Coast, CXs and OPs selective pressures appear moderate but pervasive, as the *ace-1^D* allele is almost fixed and *ace-1^R* frequency quite low^{23,27,28,53,59}. In contrast, both *ace-1^R* and *ace-1^D* frequencies are still low in Benin, which certainly reflects a low selective pressure^{42,60}.

However, while inspiring from a fundamental biology point of view, the spread of *ace-1^D* in natural populations could represent a serious threat for resistance management strategies. Indeed, such a low-cost resistance allele will be more difficult to root out using classical strategies based on insecticide alternation. Moreover, the currently-deployed American President's Malaria Initiative in collaboration with the National Malaria Control Program could favor *ace-1* duplication spread if the insecticide pressure is too low or the coverage too heterogeneous. This would select for resistance to the new IRS and ITN, and could be quite disastrous. In high PYR resistance areas, *ace-1^D* would spread in populations with high frequencies of the *kdr* allele; yet previous studies showed that *kdr* and *ace-1^R* (*ace-1^D*-*kdr* interaction has not been investigated so far) act in synergy for both resistance levels and fitness costs^{61,62}. Furthermore, a recent study showed that *ace-1* duplication associated with enzyme detoxification seems to confer a very high bendiocarb resistance to *An. gambiae* from Ivory Coast³¹. It could thus be reasonable to take beforehand the time to investigate more thoroughly the potential impact of a shift to CXs and OPs for malaria control, particularly in regions where resistance to these insecticides is already present and where *ace-1^D* is spreading.

Methods

Mosquito strains and collection. Mosquito strains: two laboratory strains of *An. gambiae* were used in this study: KisumuP and Acerkis. KisumuP strain was derived from the reference strain Kisumu susceptible to all insecticides⁶³. As Kisumu was heterogeneous for two susceptible alleles at the *ace-1* locus, we isolated a new strain, KisumuP, homozygous for a single susceptible allele (*ace-1^S* allele or S). Acerkis is a strain homozygous for the G119S mutation in *ace-1* gene (*ace-1^R* allele or R), and resistant to both OPs and CXs insecticides³⁰. Both strains mostly share the same Kisumu genetic background.

Mosquito collection: third instar larvae of *An. gambiae* from Baguida (6°09'47"N—1°19'50"E, Togo) were selected with propoxur at 1 mg/L (a concentration killing only S/S individuals) and resistant larvae were reared until adulthood in the laboratory. At the adult stage, we used morphological test and molecular analysis to identify the members of the *An. gambiae* complex present^{64–66}.

Acerduplikis strain establishment. *Fixation protocol.* The fixation protocol is illustrated in Supplementary Figure 1. It consists in four successive steps: (A) *Detection of females harboring the ace-1^D allele:* Females emerged from field-collected larvae after propoxur selection were crossed with KisumuP S/S males and then isolated to lay eggs. The offspring of each female was selected with 1 mg/L propoxur. Mothers that displayed offspring with no mortality were phenotyped with the *ace-1* RFLP-PCR test to identify [RS] ones³⁵. All these [RS] mothers corresponded either to D/R or D/D genotypes, and thus harbored the duplicated *ace-1^D* (D) allele. (B) *Elimination of the ace-1^R allele:* Once adult, females were crossed with KisumuP S/S males and were allowed to lay eggs individually. They were then screened with a PCR-RFLP test specific of the D(S) copy. Females identified as D/S genotypes were sequenced for *ace-1* Ex2-7 PCR fragment (see below). As all sequences were found identical, progenies were grouped. (C) *Backcrosses on KisumuP:* These female's progenies were used for six successive backcrosses with KisumuP males, in order to homogenize the genetic background. (D) *Elimination of the KisumuP ace-1^S allele:* After the last backcross, the strain was crossed on itself and selected with 1 mg/L propoxur for three generations to increase *ace-1^D* frequency. Progenies were then screened with a PCR test specific of KisumuP. Progenies in which no KisumuP *ace-1^S* allele were found were then mixed to constitute the Acerduplikis strain, homozygous for the duplicated allele *ace-1^D*, and sharing a genetic background largely similar to KisumuP.

Genetic background characterization. After eight backcrosses, most of the Acerduplikis strain was expected to be introgressed by the KisumuP genetic background: at a 5% risk, all the genome except 30cM around the *ace-1* locus is expected to have recombined³⁶. To check this introgression, we developed at least one molecular marker per *An. gambiae* chromosome that was polymorphic between individuals from the KisumuP strain and a mix of ten individuals from the Baguida field population used to establish Acerduplikis (Supp. Table 1). These polymorphic markers were then sequenced on DNA extracted from a mix of about 100 Acerduplikis first-instar larvae.

Specific molecular tests. All PCR were performed with 50 ng of genomic DNA in 40 μ L final under the following conditions: 94 °C for 30 s, annealing temperature for 30 s, and 72 °C for 1 to 2 min for a total of 33 cycles (primers and annealing temperature are listed in Supp. Table 1).

- *D(S) copy specific PCR-RFLP test.* A PCR using Exon3univdir and AgEx4rev2 primers amplifies a 511 bp fragment from all *An. gambiae ace-1* alleles (Supp. Tab. 1 and Supp. Fig. 2). The restriction enzyme *AvaI* cuts the *ace-1^S* and *ace-1^R* alleles into two fragments (28 bp and 483 bp), and the D(S) copy into three fragments (28 bp, 119 bp and 363 bp). 10 μ L of the PCR product were digested with 5 units of enzyme for two hours at 37 °C.

- *KisumuP specific PCR test.* A PCR using Kisumudir2 and Kisumurev1 primers is specific to the KisumuP *ace-1^S* allele; none of the other *ace-1* alleles present was amplified (Supp. Fig. 2).

***ace-1^D* sequencing.** Genomic DNA from single mosquitoes was amplified using the AgEx2dir1 and AgEx7rev2 primers (2241 bp PCR fragment, from exon 2 to exon 7 (Supp. Fig. 2). PCR products were purified using the QIAquick Gel Extraction Kit (QIAGEN). For the KisumuP and Acerkis strains, the purified PCR product was directly sequenced. For Acerduplikis, the purified PCR product was cloned using the TOPO TA Cloning[®] kit following to the manufacturer instructions (Invitrogen Life Science Technologies), to separate the different duplicated copies, D(S) or D(R). The clones were screened for the presence of the G119S substitution, and at least six clones were sequenced for each copy. Sequencing was conducted on an ABI Prism 310 sequencer (BigDye Terminator Kit, Applied Biosystems, Foster City, CA). Each clone was sequenced using the primers AgEx2dir1 and AgEx7rev2, plus an internal primer due to the fragment length, AgIntdir1 (Supp. Fig. 2). Exon 2 to exon 7 sequences of the susceptible single-copy allele from KisumuP (Ag-*ace-1^S*), of the resistant single-copy allele from Acerkis (Ag-*ace-1^R*) and of the susceptible (Ag-*ace-1^D-S*) and resistant (Ag-*ace-1^D-R*) copies of the duplicated allele were deposited in GenBank (accession numbers KM875634, KM875637, KM875635 and KM875636, respectively).

***ace-1* duplication mapping.** Only the strains KisumuP and Acerduplikis were used at this stage.

- *Chromosomes preparation.* Ovaries were pulled out from ~4 days-old half-gravid females, 25 hours post blood-feeding, at Christopher's Stage III of development⁶⁷, and preserved in fresh Carnoy's fixative solution (3 volume ethanol: 1 volume glacial acetic acid). Ovaries were fixed for 24 h at room temperature and stored at -20 °C. Polytenes chromosome slide preparation was performed as described by Sharakhova *et al.*⁶⁸.

- *Probes preparation.* Probe1 was specific to the *ace-1* gene and probe2 was specific of the AGAP001373 gene, located about 500 kb from *ace-1* on chromosome 2R in *An. gambiae* genome (https://www.vectorbase.org/Anopheles_gambiae). Using KisumuP DNA, the probe1 2241 bp fragment was amplified with AgEx2dir1 and AgEx7rev2 primers and the probe2 1861 bp fragment was amplified with Ag0.5MBdir2 and Ag0.5MBrev2 primers (Supp. Table 1). These fragments were cloned with TOPO TA Cloning[®] kit following the manufacturer instructions (Invitrogen Life Science Technologies). DNA probes were labelled separately with DIG-Nick Translation Mix (Digoxigenin-11-dUTP) according to the manufacturer Protocol (Roche Diagnostics). Hybridization and detection followed a previously described procedure⁶⁹. Fluorescent signals were recorded using a Zeiss Axiophot microscope equipped with phase-contrast and fluorescence image analyzer (Cytovision 3.93.2). Three polytenes chromosome slides were hybridized for each strain and each probe then co-hybridized for Acerduplikis strain with probe1 and probe2.

Acerduplikis *ace-1* copy number quantification. The number of *ace-1* gene copies was estimated relatively to a reference gene AGAP010592 = AgRps7 (found in a single copy in the Pest strain genome, Vector Base <https://www.vectorbase.org/>) by Real-time quantitative PCR performed with a LC480 Light Cycler (Roche). Two PCRs were performed on each DNA, one specific of *ace-1* locus (Agace1qtidir2 and Agace1qtirev2 primers) and the other specific of the reference gene (AgS7Ex5qtidir and AgS7Ex5qtirev primers) (Supp. Table 1). 1 ng of each genomic DNA (normalised with the Qubit 2.0 Fluorometer-Invitrogen) was mixed with 0.6 μ M or 0.8 μ M of *ace-1* or *Rps7* specific primers respectively and 3 μ L of mastermix (LightCycler 480 SYBR Green, Roche). PCR was performed with a 95 °C activation step for 8 min followed by 45 cycles of 95 °C for 4 s, 67 °C for 13 s, and 72 °C for 19 s. Each DNA template was analyzed in four replicates for both genes. The ratio between *ace-1* and *Rps7* arbitrary concentrations was determined with the Advanced Relative Quantification method of the LightCycler 480 software 1.5.0.

Bioassays with Carbamate and Organophosphate insecticides. Resistance data for the three strains (KisumuP, Acerkis and Acerduplikis) and their F1 offspring (*ace-1* genotypes R/S (Acerkis x

KisumuP), D/S (Acerduplikis x KisumuP) and D/R (Acerduplikis x Acerkis)) were compared. Five insecticides of technical grade quality were used, one CX: bendiocarb (99.5% pure), three OPs: chlorpyrifos methyl (99.9% pure), fenitrothion (95.2% pure) and dichlorvos (98.9% pure), and one PYR: permethrin (98.3% pure). Insecticide solutions were prepared in 70% ethanol and stored at 4 °C in a dark room to avoid photolysis. A set of 25 late third- and early fourth-instar larvae was incubated in 99 ml of distilled water in plastic cups, to which 1 ml of insecticide solution at the required concentration was added. Four replicates were performed for each concentration. Six to twelve insecticide concentrations providing a range of mortality from 0 to 100% were used for each insecticide tested. Larval mortality was recorded after a 24 hours exposure. Control bioassays were performed by adding 1 ml of ethanol to 99 ml of distilled water. Temperature was maintained at 27 °C ± 2 °C during bioassays (temperature measured using Waranet technology, Waranet Solutions SAS, Auch, France).

The analyses of dose-mortality responses in bioassays were performed using the R software (v.3.0.0). The R script BioRssay (v.6.1;⁷⁰) was used; it is freely available on the website of the Institut des Sciences de l'Evolution de Montpellier. This script computes the doses of insecticide killing 50% and 95% of the tested population or strain (Lethal Concentration 50 and 95, or LC₅₀ and LC₉₅) and the associated confidence intervals, and tests for the linearity of the dose-mortality response (χ^2 test). Finally, it allows the comparison of two or more strains or populations and calculates the resistance ratios, i.e. RR₅₀ or RR₉₅ (=LC₅₀ or LC₉₅ of tested population/LC₅₀ or LC₉₅ of the reference strain, resp.) and their 95% confidence intervals.

Fitness cost parameters. *Larval mortality and development time.* To assess the development time and pre-imaginal mortality associated with different *ace-1* alleles, assays were performed as described by Agnew *et al.*⁷¹. Females' oviposition was synchronized for the three strains. At egg hatching, 96 first-instar larvae from each strain were individually transferred to *Drosophila* tubes for rearing in 1 ml of mineral water at 2 g/L concentration of TetraMin® powdered fish food (Tetramin BabyMin, Tetra GmbH, Melle, Germany). Food was provided once, the first day of experiment. Tubes were arranged on racks and maintained in insectary conditions (27 ± 2 °C, 80 ± 2 humidity, 12h: 12h light:dark). The racks were randomly moved every day to reduce positional effects. Dead larvae or pupae were counted every day to assess the mortality rate at each development stage. Timing of adult emergence was also recorded.

Mating competition. Virgin adults (two-day old) reared under laboratory standard conditions were crossed in cages (30 cm × 30 cm × 30 cm). Trials were performed between two males of each competing genotype (S/S vs R/R, S/S vs D/D or D/D vs R/R) placed in the presence of either ten S/S or ten D/D females. Each competition cage was replicated ten times. Mosquitoes had access *ad libitum* to a honey solution. After three days, females were blood-fed on rabbit and allowed to lay eggs individually. After hatching, each female progeny was selected with an insecticide dose that allows paternity assignment. When females were S/S, paternity in the S/S vs R/R and S/S vs D/D trials was assigned with propoxur at 1 mg/L (which kills only S/S progeny); in the D/D vs R/R trial, paternity was assigned with bendiocarb at 1 mg/L (which kills D/S but not R/S progeny). When females were D/D, paternity in the S/S vs R/R and S/S vs D/D trials was assigned with bendiocarb at 1 mg/L, while paternity in the DD vs RR trial was assigned with bendiocarb at 5 mg/L (which kills D/D but not D/R progeny). The paternity success of a given genotype was defined in each replicate of trial as the percentage of egg-rafts it had sired.

Female fecundity and fertility. All strains were reared under the same soft environmental conditions and crosses were performed between 200 males and 200 females. After at least three days, females were blood-fed and 40 gravid females from each strain were allowed to oviposit individually in plastic cups containing 70 mL dechlorinated water. Three days after blood feeding, the number of egg-laying females and the amount of eggs per female were recorded. Two days after, the number of hatching larvae per female was counted.

Statistical analyses. *ace-1* gene copy number variation among S/S and D/D genotypes was analyzed using linear models. Normality of the model residuals and homoscedasticity were checked using Shapiro-Wilk and Breusch-Pagan tests, respectively⁷⁰.

Larval mortality and development time were analyzed using Cox proportional hazards regression model⁷⁰.

Differences in paternity success between trials were tested using generalized linear models (GLM), with a binomial error distribution. Departure from the expected proportion of 0.5 within each trial (*i.e.* if the two male genotypes display the same ability to fecund females) was then tested using exact binomial tests⁷⁰.

Differences among genotypes in the rate of females laying eggs and in the hatching rate were tested using GLM with binomial error distributions. Differences among genotypes in egg numbers and larvae numbers per female were tested using GLM with Gaussian error distributions⁷⁰.

All computations were performed using the R free software (v.3.1.1, <http://www.r-project.org>). Cox's models and GLM were simplified as follow: significance of the different terms was tested starting from the higher-order terms using likelihood ratio test (LRT). Non-significant terms ($p > 0.05$) were removed⁷². Factor levels of qualitative variables that were not significantly different were grouped (LRT⁷²).

References

1. Organization WH. World Malaria Report 2013. Geneva: World Health Organization; ed[^](eds) (2013).
2. Beier, J. C., Keating, J., Githure, J. I., Macdonald, M. B., Impoinvil, D. E. & Novak, R. J. Integrated vector management for malaria control. *Malaria Journal* **7** Suppl 1, S4 (2008).
3. Michalakis, Y. & Renaud, F. Malaria: Evolution in vector control. *Nature* **462**, 298–300 (2009).
4. Whalon, M., Mota-Sanchez, D. & Hollingworth, R. *Analysis of global pesticide resistance in arthropods: Global pesticide resistance in arthropods*. CAB International, Cambridge, 192 (2008).
5. Stoops, C. A., et al. Environmental factors associated with spatial and temporal distribution of *Anopheles* (Diptera: Culicidae) larvae in Sukabumi, West Java, Indonesia. *Journal of Medical Entomology* **44**, 543–553 (2007).
6. Gu, W. & Novak, R. J. Predicting the impact of insecticide-treated bed nets on malaria transmission: the devil is in the detail. *Malaria Journal* **8**, 256 (2009).
7. Lengeler, C. Insecticide-treated bed nets and curtains for preventing malaria. *Cochrane Database Syst Rev* **2**, CD000363 (2004).
8. Pluess, B., Tanser, F. C., Lengeler, C. & Sharp, B. L. Indoor residual spraying for preventing malaria. *Cochrane Database Syst Rev* **4**, CD006657 (2010).
9. Takken, W. Knols BGJ. Malaria vector control: current and future strategies. *Trends in parasitology* **25**, 101–104 (2009).
10. van den Berg, H. et al. Global trends in the use of insecticides to control vector-borne diseases. *Environmental health perspectives* **120**, 577–582 (2012).
11. Zaim, M., Aitio, A. & Nakashima, N. Safety of pyrethroid-treated mosquito nets. *Medical and veterinary entomology* **14**, 1–5 (2000).
12. Zhou, G., Githeko, A. K., Minakawa, N. & Yan, G. Community-wide benefits of targeted indoor residual spray for malaria control in the Western Kenya Highland. *Malaria Journal* **9**, 67 (2010).
13. Eisele TP, L. K. et al. Effect of sustained insecticide-treated bed net use on all-cause child mortality in an area of intense perennial malaria transmission in western Kenya. *The American journal of tropical medicine and hygiene* **73**, 149–156 (2005).
14. Nauen, R. Insecticide resistance in disease vectors of public health importance. *Pest Management Science* **63**, 628–633 (2007).
15. Ranson, H., N'Guessan, R., Lines, J., Moiroux, N., Nkuni, Z. & Corbel, V. Pyrethroid resistance in African *anopheline* mosquitoes: what are the implications for malaria control? *Trends Parasitol* **27**, 91–98 (2011).
16. N'Guessan, R., Corbel, V., Akogbeto, M. & Rowland, M. Reduced efficacy of insecticide-treated nets and indoor residual spraying for malaria control in pyrethroid resistance area, Benin. *Emerg Infect Dis* **13**, 199–206 (2007).
17. World Health Organization. *Global plan for insecticide resistance management in malaria vectors*. WHO press, Geneva, 24 (2012).
18. Sharp, B. L., Ridl, F. C., Govender, D., Kuklinski, J. & Kleinschmidt I. Malaria vector control by indoor residual insecticide spraying on the tropical island of Bioko, Equatorial Guinea. *Malar J* **6**, 52 (2007).
19. Guillet, P., N'Guessan, R., Darriet, F., Traore-Lamizana, M., Chandre, F. & Carnevale, P. Combined pyrethroid and carbamate 'two-in-one' treated mosquito nets: field efficacy against pyrethroid-resistant *Anopheles gambiae* and *Culex quinquefasciatus*. *Med Vet Entomol* **15**, 105–112 (2001).
20. Hougard, J. M. et al. Efficacy of mosquito nets treated with insecticide mixtures or mosaics against insecticide resistant *Anopheles gambiae* and *Culex quinquefasciatus* (Diptera: Culicidae) in Cote d'Ivoire. *Bull Entomol Res* **93**, 491–498 (2003).
21. Zaim, M. & Guillet, P. Alternative insecticides: an urgent need. *Trends Parasitol* **18**, 161–163 (2002).
22. Akogbeto, M., Padonou, G. G., Bankole, H. S., Gazard, D. K. & Gbedjissi, G. L. Dramatic decrease in malaria transmission after large-scale indoor residual spraying with bendiocarb in Benin, an area of high resistance of *Anopheles gambiae* to pyrethroids. *The American journal of tropical medicine and hygiene* **85**, 586–593 (2011).
23. Asidi, A. N. et al. Experimental hut evaluation of bednets treated with an organophosphate (chlorpyrifos-methyl) or a pyrethroid (lambda-cyhalothrin) alone and in combination against insecticide-resistant *Anopheles gambiae* and *Culex quinquefasciatus* mosquitoes. *Malar J* **4**, 25 (2005).
24. Fontaine RE, P. J., Payne, D., Pradhan, G. D., Joshi, G. P., Pearson, J. A., Thymakis, M. K. & Ramos Camacho, M. E. Evaluation of fenitrothion for the control of malaria. *Bulletin of the World Health Organization* **56**, 445 (1978).
25. Kigozi, R. et al. Indoor residual spraying of insecticide and malaria morbidity in a high transmission intensity area of Uganda. *PLoS One* **7**, e42857 (2012).
26. PMI. President's Malaria Initiative Eighth Annual Report. Available: http://www.fightingmalaria.gov/docs/default-source/default-document-library/pmi-reports/pmi-report_final.pdf (accessed 19 March 2015), (2014).
27. Ahoua Alou, L. P. et al. Distribution of *ace-1^R* and resistance to carbamates and organophosphates in *Anopheles gambiae* ss populations from Côte d'Ivoire. *Malaria Journal* **9**, 1–7 (2010).
28. Dabire, K. R. et al. Distribution of insensitive acetylcholinesterase (*ace-1R*) in *Anopheles gambiae* s.l. populations from Burkina Faso (West Africa). *Trop Med Int Health* **14**, 396–403 (2009).
29. Djogbenou, L. et al. Identification and Geographic Distribution of the ACE-1R Mutation in the Malaria Vector *Anopheles gambiae* in South-Western Burkina Faso, West Africa. *Am J Trop Med Hyg* **78**, 298–302 (2008).
30. Djogbenou, L., Weill, M., Hougard, J. M., Raymond, M., Akogbeto, M. & Chandre, F. Characterization of insensitive acetylcholinesterase (*ace-1R*) in *Anopheles gambiae* (Diptera: Culicidae): resistance levels and dominance. *J Med Entomol* **44**, 805–810 (2007).
31. Edi, C. V. et al. CYP6 P450 enzymes and ACE-1 duplication produce extreme and multiple insecticide resistance in the malaria mosquito *Anopheles gambiae*. *PLoS genetics* **10**, e1004236 (2014).
32. Oduola, A. O. et al. Evidence of carbamate resistance in urban populations of *Anopheles gambiae* ss mosquitoes resistant to DDT and deltamethrin insecticides in Lagos, South-Western Nigeria. *Parasites & Vectors* **5**, 1–8 (2012).
33. Weill, M. et al. Comparative genomics: Insecticide resistance in mosquito vectors. *Nature* **423**, 136–137 (2003).
34. Weill, M. et al. Insecticide resistance: a silent base prediction. *Curr Biol* **14**, R552–553 (2004).
35. Weill, M. et al. The unique mutation in *ace-1* giving high insecticide resistance is easily detectable in mosquito vectors. *Insect Molecular Biology* **13**, 1–7 (2004).
36. Berticat, C., Boquien, G., Raymond, M. & Chevillon, C. Insecticide resistance genes induce a mating competition cost in *Culex pipiens* mosquitoes. *Genetical research* **79**, 41–47 (2002).
37. Bourguet, D., Guillemaud, T., Chevillon, C. & Raymond, M. Fitness costs of insecticide resistance in natural breeding sites of the mosquito *Culex pipiens*. *Evolution* **58**, 128–135 (2004).
38. Lenormand, T. & Raymond, M. Resistance management: the stable zone strategy. *Proc Roy Soc Lond* **265**, 1985–1990 (1998).
39. Djogbenou, L., Noel, V. & Agnew, P. Costs of insensitive acetylcholinesterase insecticide resistance for the malaria vector *Anopheles gambiae* homozygous for the G119S mutation. *Malaria Journal* **9**, 12 (2010).
40. Brown, Z. S., Dickinson, K. L. & Kramer, R. A. Insecticide resistance and malaria vector control: the importance of fitness cost mechanisms in determining economically optimal control trajectories. *Journal of economic entomology* **106**, 366–374 (2013).
41. Djogbenou, L. et al. Evidence of introgression of the *ace-1(R)* mutation and of the *ace-1* duplication in West African *Anopheles gambiae* s. s. *PLoS ONE* **3**, e2172 (2008).
42. Djogbenou, L., Labbe, P., Chandre, F., Pasteur, N. & Weill, M. *Ace-1* duplication in *Anopheles gambiae*: a challenge for malaria control. *Malar J* **8**, 70 (2009).

43. Bourguet, D., Raymond, M., Bisset, J., Pasteur, N. & Arpagaus, M. Duplication of the Ace.1 locus in *Culex pipiens* mosquitoes from the Caribbean. *Biochemical Genetics* **34**, 351–362 (1996).
44. Labbe, P. *et al.* Independent Duplications of the Acetylcholinesterase Gene Conferring Insecticide Resistance in the Mosquito *Culex pipiens*. *Mol Biol Evol* **24**, 1056–1067 (2007).
45. Labbe, P. *et al.* Forty years of erratic insecticide resistance evolution in the mosquito *Culex pipiens*. *PLoS Genet* **3**, e205 (2007).
46. Labbé, P., Milesi, P., Yébakima, A., Pasteur, N., Weill, M. & Lenormand, T. Gene-dosage effects on fitness in recent adaptive duplications: ace-1 in the mosquito *Culex pipiens*. *Evolution* **68**, 2092–2101 (2014).
47. Labbe, P., Sidos, N., Raymond, M. & Lenormand, T. Resistance Gene Replacement in the Mosquito *Culex pipiens*: Fitness Estimation From Long-Term Cline Series. *Genetics* **182**, 303–312 (2009).
48. Remnant, E. J. *et al.* Gene duplication in the major insecticide target site, Rdl, in *Drosophila melanogaster*. *Proceedings of the National Academy of Sciences* **110**, 14705–14710 (2013).
49. Antonio-Nkondjio, C. *et al.* *Anopheles gambiae* distribution and insecticide resistance in the cities of Douala and Yaounde (Cameroon): influence of urban agriculture and pollution. *Malar J* **10**, 154 (2011).
50. Clements, A. Books reviewed: The Biology of Mosquitoes. Volume 1. Development, Nutrition and Reproduction. *American Journal of Tropical Medicine and Hygiene* **52**, 579 (1995).
51. Alout, H., Labbé, P., Pasteur, N. & Weill, M. High incidence of ace-1 duplicated haplotypes in resistant *Culex pipiens* mosquitoes from Algeria. *Insect biochemistry and molecular biology* **41**, 29–35 (2011).
52. Osta, M. A., Rizk, Z. J., Labbé, P., Weill, M. & Knio, K. Insecticide resistance to organophosphates in *Culex pipiens* complex from Lebanon. *Parasit Vectors* **5**, 1–6 (2012).
53. Koffi, A. A., Alou, L. P. A., Kabran, J.-P. K., N'Guessan, R. & Pennetier, C. Re-Visiting Insecticide Resistance Status in *Anopheles gambiae* from Côte d'Ivoire: A Nation-Wide Informative Survey. *PLoS One* **8**, e82387 (2013).
54. Alout, H., Djogbenou, L., Berticat, C., Chandre, F. & Weill, M. Comparison of *Anopheles gambiae* and *Culex pipiens* acetylcholinesterase 1 biochemical properties. *Comp Biochem Physiol B Biochem Mol Biol* **150**, 271–277 (2008).
55. Bourguet, D., Pasteur, N., Bisset, J. & Raymond, M. Determination of Ace.1 Genotypes in Single Mosquitoes: Toward an Ecumenical Biochemical Test. *Pestic Biochem Physiol* **55**, 122–128 (1996).
56. Yebakima, A., Marquine, M., Rosine, J., Yp Tcha, M. M. & Pasteur, N. Evolution of resistance under insecticide selection pressure in *Culex pipiens quinquefasciatus* (Diptera, Culicidae) from martinique. *Journal of Medical Entomology* **41**, 718–725 (2004).
57. Prout, T. Sufficient conditions for multiple niche polymorphism. *American Naturalist* **102**, 493–496 (1968).
58. Haldane, J. B. S. *The biochemistry of genetics*. London, George Allen & Unwin Ltd, (1954).
59. Edi, C. V., Koudou, B. G., Jones, C. M., Weetman, D. & Ranson, H. Multiple-insecticide resistance in *Anopheles gambiae* mosquitoes, Southern Cote d'Ivoire. *Emerg Infect Dis* **18**, 1508–1511 (2012).
60. Djogbénou, L., Pasteur, N., Akogbeto, M., Weill, M. & Chandre, F. Insecticide resistance in the *Anopheles gambiae* complex in Benin: a nationwide survey. *Medical and veterinary entomology* **25**, 256–267 (2011).
61. Assogba, B. S. *et al.* Phenotypic effects of concomitant insensitive acetylcholinesterase (ace-1 R) and knockdown resistance (kdr R) in *Anopheles gambiae*: a hindrance for insecticide resistance management for malaria vector control. *Parasites & Vectors* **7**, 548 (2014).
62. Berticat, C., Bonnet, J., Duchon, S., Agnew, P., Weill, M. & Corbel, V. Costs and benefits of multiple resistance to insecticides for *Culex quinquefasciatus* mosquitoes. *BMC Evol Biol* **8**, 104 (2008).
63. Shute, G. A method of maintaining colonies of East African strains of *Anopheles gambiae*. *Annals of tropical medicine and parasitology* **50**, 92 (1956).
64. Favia, G., Lanfrancotti, A., Spanos, L., Siden Kiamos, I. & Louis, C. Molecular characterization of ribosomal DNA polymorphisms discriminating among chromosomal forms of *Anopheles gambiae* s.s. *Insect Molecular Biology* **10**, 19–23 (2001).
65. Gillies, M. & Coetzee, M. A Supplement to the *Anophelinae* of Africa South of the Sahara. *Publications of the South African Institute for Medical Research* **55**, 1–143 (1987).
66. Scott, J. A., Brogdon, W. G. & Collins, F. H. Identification of single specimens of the *Anopheles gambiae* complex by the polymerase chain reaction. *The American journal of tropical medicine and hygiene* **49**, 520 (1993).
67. Gillies, M. The duration of the gonotrophic cycle in *Anopheles gambiae* and *Anopheles funestus*, with a note on the efficiency of hand catching. *East African medical journal* **30**, 129 (1953).
68. Sharakhova, M. V., Xia, A., McAlister, S. I. & Sharakhov, I. V. A standard cytogenetic photomap for the mosquito *Anopheles stephensi* (Diptera: Culicidae): application for physical mapping. *J Med Entomol* **43**, 861–866 (2006).
69. Veyrunes, F. *et al.* A novel sex determination system in a close relative of the house mouse. *Proceedings of the Royal Society B: Biological Sciences* **277**, 1049–1056 (2010).
70. Milesi Pascal, L. P. BioRssay: A R Script for Bioassay Analyses v. 6.1. <http://www.isem.univ-montp2.fr/recherche/equipes/genomiquedeladaptation/personnel/labbe-pierrick>, (accessed 10 October 2014) (2013).
71. Agnew, P., Berticat, C., Bedhomme, S., Sidobre, C. & Michalakis, Y. Parasitism increases and decreases the costs of insecticide resistance in mosquitoes. *Evolution* **58**, 579–586 (2004).
72. Crawley, M. J. *The R Book*. John Wiley & Sons (2007).

Acknowledgments

We are very grateful to Nicole Pasteur for her helpful comments on the manuscript. This work was funded partly by French ANR program (project “AlterNET” SOC & ENV 2013-2015) and by Wellcome Trust (grant WT093755). Assogba S. Benoit was supported by a fellowship from the IRD. Data used in this work were produced through the technical facilities of the Environmental Genomic Platform of the Labex Centre Méditerranéen Environnement Biodiversité (CeMEB): all sequence data were obtained through GenSeq Platform; FISH hybridization was performed through the Evolutionary Cytogenomic Platform. Contribution number 201x-xxx of the Institut des Sciences de l'Évolution de Montpellier (UMR CNRS-IRD-UM 5554).

Author Contributions

B.S.A., L.S.D., P.L. and M.W. contributed to the conception and design of the experiments; B.S.A., A.B., J.P. and D.A. contributed to the data acquisition; B.S.A., P.M., P.L. and M.W. contributed to the analysis of the data; B.S.A., P.M. and M.W. drafted the article and L.S.D., D.A., F.C., M.M. and P.L. revised it.

Additional Information

Supplementary information accompanies this paper at <http://www.nature.com/srep>

Competing financial interests: The authors declare no competing financial interests.

How to cite this article: Assogba, B. S. *et al.* An *ace-1* gene duplication resorbs the fitness cost associated with resistance in *Anopheles gambiae*, the main malaria mosquito. *Sci. Rep.* **5**, 14529; doi: 10.1038/srep14529 (2015).



This work is licensed under a Creative Commons Attribution 4.0 International License. The images or other third party material in this article are included in the article's Creative Commons license, unless indicated otherwise in the credit line; if the material is not included under the Creative Commons license, users will need to obtain permission from the license holder to reproduce the material. To view a copy of this license, visit <http://creativecommons.org/licenses/by/4.0/>

An ace-1 gene duplication resorbs the fitness cost associated with resistance in Anopheles gambiae, the main malaria mosquito

Benoît S. Assogba, Luc S. Djogbénou, Pascal Milesi, Arnaud Berthomieu, Julie Perez, Diego Ayala, Fabrice Chandre, Michel Makoutodé, Pierrick Labbé, Mylène Weill.

Supplementary information

Supplementary Figure 1: Acerduplikis strain fixation protocol. See Material and Methods text for details.

A) *ace-1^D* detection

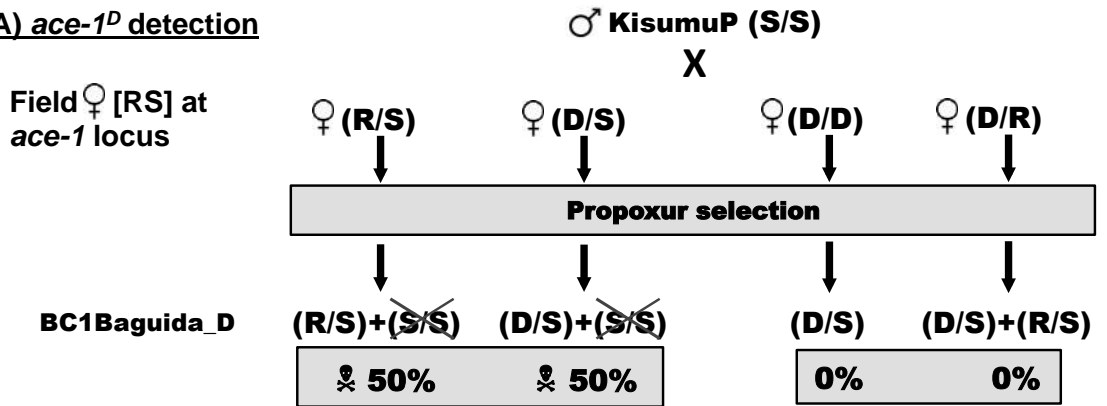

B) *ace-1^R* elimination

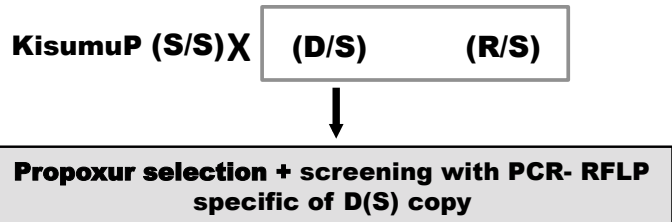

C) KisumuP genetic background introgression

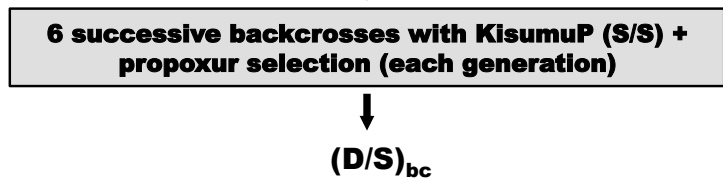

D) *ace-1^S* elimination

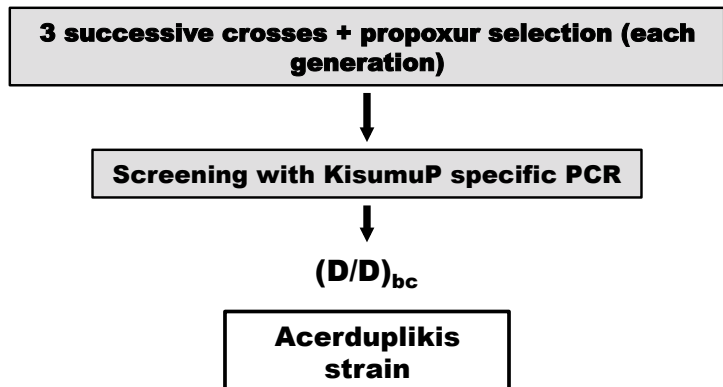

Supplementary Figure 2: Sequences alignment from exon 2 to exon 7 of *ace-1^S* allele from Kisumu, D(S) and D(R) copies of *ace-1^D* allele from Acerduplikis, and *ace-1^R* resistant allele from Acerkis. The G119S mutation in box. The primers used for this study are highlighted in grey. *AvaI* restriction enzyme sites are highlighted in black. Only polymorphic sites with the top sequence are indicated and dash indicates deletions.

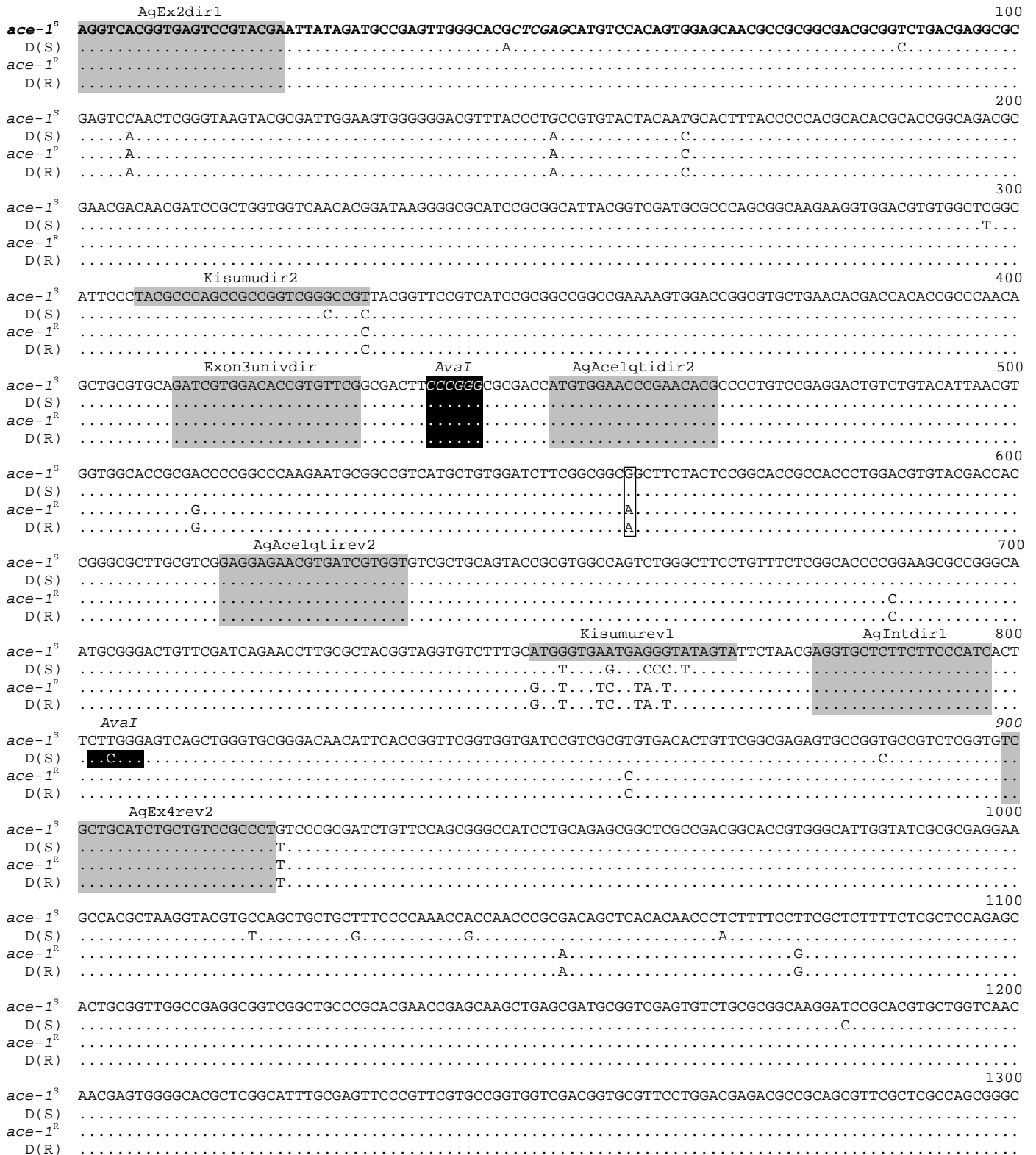

```

1400
ace-1S GCTTCAAGAAGACGGAGATCCTCACCGGCAGCAACACGGAGGAGGGCTACTACTTCATCATCTACTACCTGACCGAGCTGCTGGCAAGGAGGAGGGCGT
D(S) .....
ace-1R .....
D(R) .....

1500
ace-1S GACCGTGACGCGCGAGGAGTTCCCTGCAGGCGGTGCGCGAGCTCAACCCGTACGTGAACGGGGCGGCCCGGAGGCGATCGTGTCGAGTACACCGACTGG
D(S) .....
ace-1R .....
D(R) .....

1600
ace-1S ACCGAGCCGGACAACCCGAACAGCAACCCGGGACGCGCTGGACAAGATGGTGGGCGACTATCACTTCACCTGCAACGTGAACGAGTTCGCGCAGCGGTACG
D(S) .....
ace-1R .....
D(R) .....

1700
ace-1S CCGAGGAGGGCAACAACGTCTACATGTATCTGTACACGCACCGCAGCAAAGGCAACCCGTGGCCGCGCTGGACGGCGTGATGCACGGCGACGAGATCAA
D(S) .....
ace-1R .....
D(R) .....

1800
ace-1S CTACGTGTTCCGGCAACCGCTCAACCCACCCCTCGGCTACACCGAGGACGAGAAAGACTTTAGCCGGAAGATCATGCGATACTGGTCTAACTTTGCCAAA
D(S) .....
ace-1R .....
D(R) .....

1900
ace-1S ACCGGGTAAGTGTGTGTGTGTGTGTGTGTCAAACAGCAGAGTGTGATCGCTCTAACGCC-----TTCTCTCTTCAACAGCAATCCAAATCCCAACACG
D(S) .....A...C.A.A...A..AGCGTC.....T.....A
ace-1R .....A...C.A.A...A..AGCGTC.....T.....A
D(R) .....A...C.A.A...A..AGCGTC.....T.....A

2000
ace-1S GCCAGCAGCGAATTCCCCGAGTGGCCCAAGCACACCGCCACGGACGGCACTATCTGGAGCTGGGCCTCAACACGTCCTTCGTGGTCCGGGGCCACGGT
D(S) .....
ace-1R .....
D(R) .....

2100
ace-1S TGAGGCAGTGTGCCTTCTGGAAGAAGTACCTTCCCCAGCTAGTTGCAGCTACCTGTAAGTCTAGTTGCTGCGCGAGAAACCCCTCCTCTCGCGTCCCA
D(S) .....A.....-.....
ace-1R .....A.....-.....
D(R) .....A.....-.....

2200
ace-1S TCAGGGTCCAGGTTGCAATAACAAATGTATCTCTCTCTCAGTCTCCTTTTCTCCAAAACAGCGAACCTACCAGGGCCAGCACCGCCAGTGAACCGTG
D(S) .....A.A.....A.--..C.....
ace-1R .....A.A.....A.--..C.....
D(R) .....A.A.....A.--..C.....

AgEx7rev2 2241
ace-1S CGAAAGCAGCGCATTTTTTTACCGACCTGATCTGATCGTGC
D(S) .....
ace-1R .....
D(R) .....

```

Supplementary Figure 3: *ace-1* copy number quantification in *Acerduplikis* (DD) and *KisumuP* (SS) strains. Dots indicate the ratios observed in each trial between *ace-1* and *Rps7* genes concentrations determined with Advanced Relative Quantification method of the LightCycler 480 software 1.5.0.

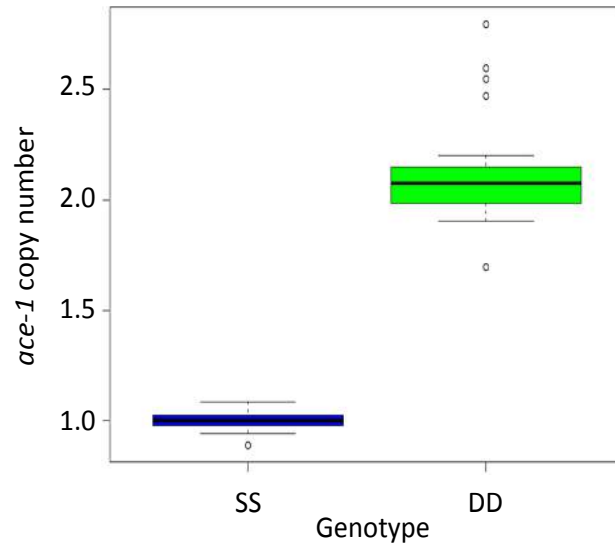

Supplementary Figure 4: OP insecticide bioassays. The mortality in relation to the insecticide dose is presented for six genotypes (see legend below). A, B, C and D panels correspond respectively to bendiocarb, chlorpyrifos-methyl, fenitrothion and dichlorvos insecticide. Graphs were drawn using the BioRssay script (Milesi et al. 2013).

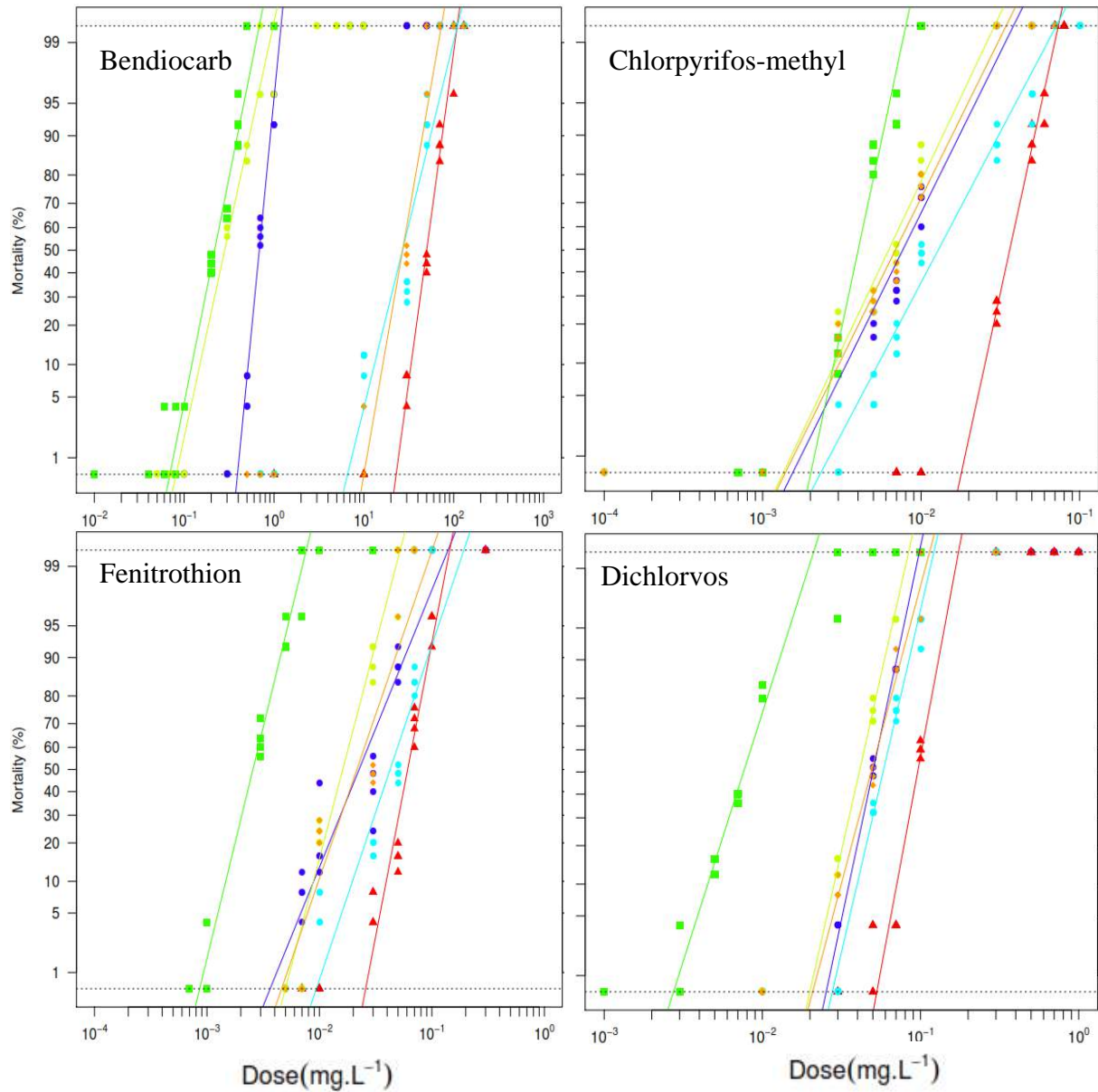

Supplementary Figure 5: Female fertility and fecundity for the susceptible (SS), resistant (RR) and duplicated (DD) homozygotes. (A) Average egg-laying rates (i.e. the number of females that laid eggs over the total number of females assayed) with their 95% confidence intervals (CI), (B) the average eggs number per female with the associated standard deviations (SD). (C) the average hatching rates (i.e. the number of larvae produced over the number of eggs in the raft) with the associated SD and (D) the average larvae number by egg-laying females, with the associated SD, are presented for SS (green), DD (blue) and RR (red). Significance of the differences among the various genotypes is indicated (n.s., $p > 0.05$; *, $p < 0.05$; **, $p < 0.01$; ***, $p < 0.001$).

Analysis: The rate of egg-laying females (ELF) among forty (A) was not impacted by their genotype (GLM $ELF = GENO + \varepsilon$ (binomial distribution), $\chi^2 = 0.46$, $\Delta df = 2$, $p = 0.79$). However, R/R females laid each significantly less eggs (54.3 ± 24) than D/D or S/S females (respectively, 75.8 ± 34 and 86.1 ± 37 ; B) (GLM $NEGGS = GENO + \varepsilon$ (gaussian distribution), $F = 7.63$, $\Delta df = 2$, $p < 0.001$); the difference between D/D and S/S was not significant ($F = 2.86$, $\Delta df = 1$, $p = 0.09$). As the hatching rate (HR, C) was not significantly different between genotypes (GLM $HR = GENO + \varepsilon$ (binomial distribution), $\chi^2 = 0.01$, $\Delta df = 2$, $p = 0.87$), this resulted in significantly reduced numbers of larvae hatching (NLH) in the progenies of females R/R (24.6 ± 22) as compared to the progenies of females D/D and S/S (36.8 ± 21.9 and 44.3 ± 36 ; D) (GLM $NHL = GENO + \varepsilon$ (gaussian distribution), $F = 4.63$, $\Delta df = 2$, $p < 0.05$); the difference between D/D and S/S was again not significant ($F = 2.83$, $\Delta df = 1$, $p = 0.1$).

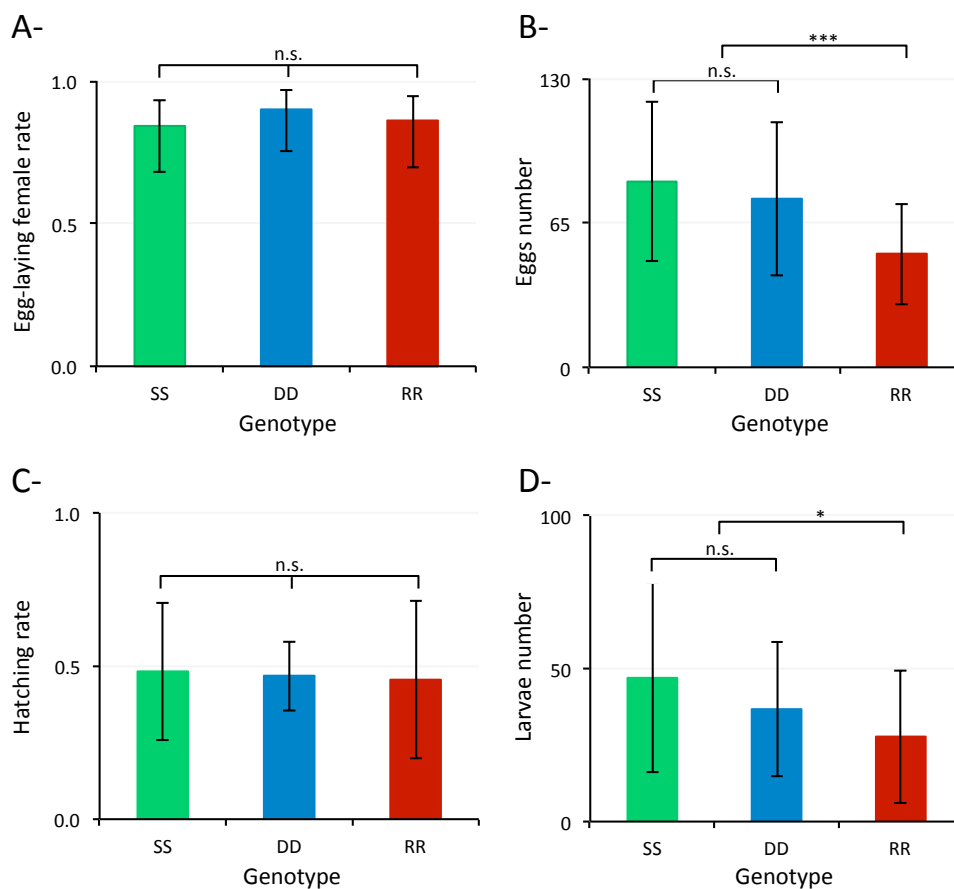

Supplementary Table 1: List of the primers used in this study and amplicon sizes.

Marker name	Locus	Chromosome location	Primer (5'-3')	Size (bp)	Tm (°C)
<i>Chromosome markers</i>					
X2Ag	AGAP000151	X	X2Ag_Dir: TTGAGAGCGAAAGTTCTGAGC X2Ag_Rev: AACCCCTCCTTTTAAACTTCC	300	52
2R14Ag	AGAP002049	2R	2R14Ag_Dir: GTTTGGGCGCAACGAAA 2R14Ag_Rev: CACCAGCCAGTGTTTCCA	247	52
2R55Ag	AGAP004383	2R	2R55Ag_Dir: AAAAGCTGGGCATCACGTT 2R55Ag_Rev: AAGCTCACCGGTAACACGAG	562	52
3R28Ag	AY063776.1	3R	3R28Ag_Dir: TGCCGAAACCTGTGCTATAC 3R28Ag_Dir: GCACCCGTTGATCTCCTCATAG	754	52
<i>Specific molecular tests</i>					
D(S) copy	<i>ace-1</i>	2R	Exon3univdir: GATCGTGGACACCGTGTTCG AgEx4rev2: GGGCGGACAGCAGATGCAGCGA	511	58
KisumuP	<i>ace-1</i>	2R	Kisumudir2: AGCCGCCGGTCGGGCCCGT Kisumurev1: CTATACCCCTCATTCACCCAT	464	61
<i>Sequencing</i>					
	<i>ace-1</i>	2R	AgEx2dir1: AGGTCACGGTGAGTCCCGTACCGA AgEx7rev2: GCACGATCAGATCAGGTCCG + AgIntdir1 (intermediate primer for sequencing): AGGTGCTCTTCTTCCCATC	2241	58
<i>Fish Probe</i>					
	AGAP001373	2R	Ag0.5MBdir2: GATTCGGCTGGTCGTAACCTA Ag0.5MBrev2: ATTTCGCCGAATGAAATCTG	1861	58
<i>qPCR</i>					
	<i>ace-1</i>	2R	Agace1qtidir2 : ATGTGGAACCCGAACACG Agace1qtirev2 : ACCACGATCACGTTCTCCTC	185	67
	AGAP010592	3L	AgS7Ex5qtidir: GTGTACAAGAAGCTGACTGGC AgS7Ex5qtirev : TAGCTGCTGCAAACTTCGG	107	67

Chapitre 2 : Les duplications hétérogènes ont été sélectionnées de manière récurrente malgré leurs coûts

Article 3 : « Many independent heterogeneous gene duplications solve the resistance tradeoff in mosquitoes, but often at a cost. » Milesi, P., Assogba, B. S., Atyame, C. M., Pocquet, N., Unal, S., Makoundou, P., Berthomieu, A., Weill, M., Labbé, P. in prep

Dans le monde entier, les populations de moustiques sont contrôlées à l'aide d'insecticides pour des raisons sanitaires (vecteur) ou économiques (impact des nuisances sur le tourisme). En réponse à ces pressions de sélections, les cycles de vie courts et les grandes tailles efficaces des populations de moustiques ont permis l'émergence rapide de nombreuses résistances (Whalon et al. 2008 ; Labbé et al. 2011 ; Feyereisen et al. 2015). Cependant la répartition des différents allèles de résistance est variable : au locus *Ester* dans le complexe *Cx. pipiens*, par exemple, certains ne sont retrouvés que localement (par ex. *Ester*¹, *Ester*⁴ et *Ester*⁵ sur le pourtour méditerranéen, Pasteur et al. 1981; Poirié et al. 1992) alors que d'autres ont une distribution mondiale (*Ester*², Labbé et al. 2005). La diversité et la répartition des allèles de résistance dans les populations naturelles dépendent essentiellement de leur fréquence d'apparition (par mutation ou migration) et de leurs valeurs sélectives dans chacune des populations. Les valeurs sélectives dépendent elles-mêmes de la nature des traitements insecticides, de leur intensité, ou encore de la présence ou non d'autres allèles de résistance.

Au locus *ace-1*, deux types d'allèles adaptatifs, à l'architecture génétique très différente, ségrégent dans les populations : les allèles R (substitutions G119S) et les allèles D (duplications hétérogènes). Parmi les allèles D, nous avons vu qu'ils étaient associés à deux phénotypes distincts à l'état homozygote (Chap. 1) : le phénotype sublétal (ex : D₂ et D₃ dans le sud de la France, Labbé et al. 2007b), ou non (ex : D₁ qui semble avoir envahi les populations de Martinique, Yebakima et al. 2004; Labbé et al. 2014). Avant ma thèse, différentes études, essentiellement sur le pourtour méditerranéen, avaient permis d'identifier un total de 13 allèles D, (dix chez *Cx. pipiens* et trois chez *Cx. quinquefasciatus* ; Bourguet et al. 1996 ; Lenormand et al. 1998a ; Labbé et al. 2007a; Alout et al. 2010; Osta et al. 2012), contre trois allèles R (mono-copie, un chez *Cx. pipiens* et deux chez *Cx. quinquefasciatus*, Weill et al. 2003 ; Labbé et al. 2007a).

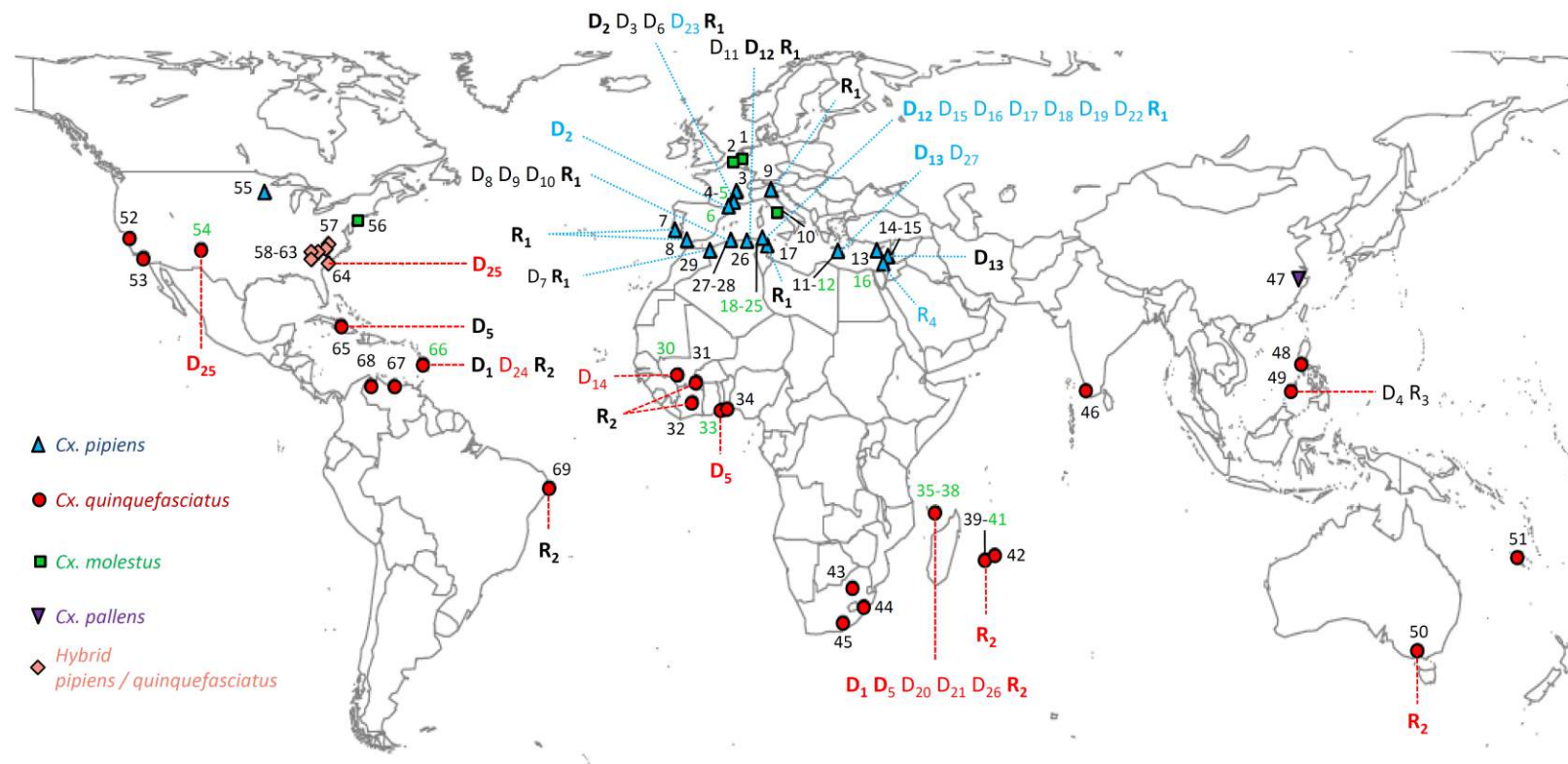

Figure 8 : Localisation des populations échantillonnées et des allèles de résistance du locus *ace-1*. Chaque population est indiquée par un numéro et un symbole correspondant au taxon (voir légende). Dans les populations où ils ont été détectés, les allèles de résistance (D_x et R_x , respectivement dupliqués et mono-copie) sont indiqués par des pointillés bleus pour *Cx. pipiens* et des tirets rouges pour *Cx. quinquefasciatus*. Ceux ayant été décrits dans des études antérieures à ma thèse, sont en noir, ceux au cours de cette étude sont en rouge pour *Cx. quinquefasciatus* et en bleu pour *Cx. pipiens*. Enfin, les allèles de résistance présents dans plusieurs populations sont en gras.

J'ai étudié la diversité et la distribution mondiale de ces différents allèles du locus *ace-1* dans les populations du complexe *Culex pipiens*, afin de mieux comprendre l'histoire évolutive de la résistance à ce locus, et en particulier le rôle qu'y tiennent les duplications de gènes hétérogènes, notamment vis-à-vis des allèles R. Différentes questions ont été abordées : Quelle est la prévalence des deux types d'architectures génétiques, substitution vs duplication ? Les différents allèles sont-ils apparus par mutation ou résultent-ils de migration ? Quel est le phénotype homozygote majoritaire des allèles dupliqués, sublétal ou non ? Leur phénotype peut-il expliquer leur diversité et leur répartition en populations naturelles.

Les duplications hétérogènes du locus *ace-1* sont largement répandues et générées de manière indépendante à partir de la diversité allélique locale.

Nous avons d'abord établi la diversité globale des allèles du locus *ace-1* à partir de 69 échantillons de populations naturelles répartis mondialement dans le complexe d'espèce *Cx. pipiens* (Fig. 8). 20 échantillons ont été collectés vivants car aucun test moléculaire spécifique n'étant disponible, la détection des allèles dupliqués nécessite des croisements avec une souche sensible de référence (Labbé et al. 2007a). La diversité des allèles S, R ou D a été établie sur la base d'un fragment comprenant l'intron 2 et une partie de l'exon 3 (~520 pb, incluant la mutation G119S) du locus *ace-1* ; elle est présentée sur la figure 9.

Cette diversité est fortement structurée entre les taxons *Cx. pipiens* et *Cx. quinquefasciatus* (Fig. 9). L'analyse de huit échantillons provenant d'une zone hybride à l'est des Etats-Unis a permis de montrer qu'un flux de gènes existait néanmoins au locus *ace-1*. Au sein de chaque clade, une structure géographique apparaît, puisque les populations les plus proches tendent à partager les mêmes allèles ou des allèles proches phylogénétiquement. Cependant, des allèles de résistance identiques ont été retrouvés dans des populations éloignées : un fragment plus large du locus *ace-1* (~3 kb chez *Cx. quinquefasciatus* et ~4 kb chez *Cx. pipiens*) a alors été séquencé afin de s'assurer qu'il s'agissait bien du même allèle. Nous avons ainsi pu identifier l'existence de migrations à longue distance pour les allèles R₁, R₂ et D₁ (Fig. 8).

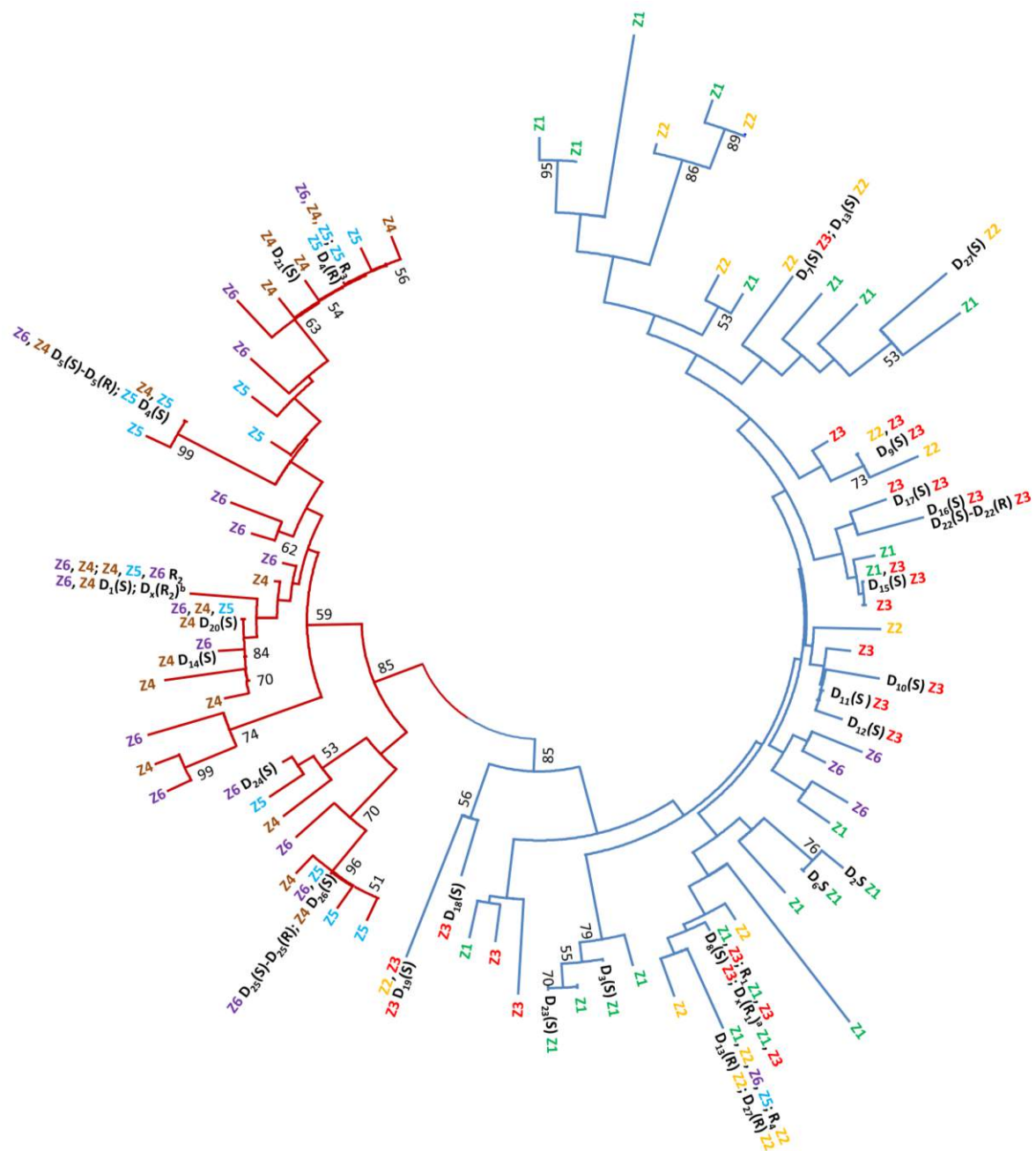

Figure 9 : Diversité de l'ensemble des allèles du locus *ace-1*. La diversité de l'ensemble des allèles du locus *ace-1* est représentée. Deux clades apparaissent, en rouge *Cx. quinquefasciatus*, en bleu, *Cx. pipiens*. L'identité des allèles de résistance est indiquée en bout de branche (mono-copie R_i , ou copies sensibles D_i (S) et copies résistantes D_i (R) des allèles dupliqués D_i). Enfin, la zone géographique dans laquelle l'allèle a été retrouvé est également indiquée (Z_i) Ces zones ont été définies de manière arbitraire comme suit : Z1 (vert), nord-ouest de la méditerranée ; Z2 (jaune), est de la méditerranée ; Z3 (rouge) Maghreb ; Z4 (Afrique Sub-Saharienne) ; Z5 (bleu) Asie du Sud Est et Océanie ; Z6 (violet) Amérique du Nord, Caraïbes.

A partir des 20 échantillons collectés vivants, 14 nouveaux allèles dupliqués ont été décrits (8 chez *Cx. pipiens* et 6 chez *Cx. quinquefasciatus*). En comparaison, pour un effort d'échantillonnage plus large, un seul nouvel allèle de résistance mono-copie a été décrit, en Israël (R₄, Fig. 8). Ceci porte à 27 le total des duplications hétérogènes au locus *ace-1* décrites à ce jour et à 4 le nombre d'allèles R. Les duplications montrent une prévalence très élevée puisque des allèles D ont été trouvés dans 27 des 29 populations résistantes testées (en tenant compte aussi des données publiées précédemment).

La diversité des allèles dupliqués est principalement portée par la copie sensible D(S). La plupart des allèles partagent en effet la même copie résistante D(R) : R₁ pour les populations de *Cx. pipiens*, R₂ pour celles de *Cx. quinquefasciatus*, *i.e.* les allèles R les plus fréquents dans chaque taxon. Majoritairement, les allèles D présentent donc une structure de type D(S) ≠ D(R) qui correspond certainement à un crossing-over inégal chez un individu hétérozygote (Fig. 10, Labbé et al. 2007a). Cependant, cinq allèles présentent des copies D(S) et D(R) identiques (D(S) = D(R)) à la mutation G119 près. Pour les duplications de ce type, le mécanisme d'origine est probablement un glissement de réplication, R-R (ou S-S, mais cela semble moins probable car ne procurant pas d'avantage connu), suivi d'une substitution S119G (ou G119S) sur une des copies (Fig. 10). Plus surprenant, la copie D(R) de trois de ces allèles n'a jamais été observée, ni chez un autre D ni à l'état mono-copie R mais cela peut être lié à l'échantillonnage.

Toutefois, une partie des allèles D pourrait être due à des événements de recombinaisons secondaires, entre un allèle dupliqué et un allèle mono-copie, ou entre deux allèles dupliqués (Fig. 10). Comme il est impossible, à ce stade, de reconnaître ces événements potentiels de recombinaison secondaire, l'estimation d'un nombre exact d'événements indépendants de duplication à l'origine de la diversité observée reste difficile.

Toutefois, il est très probable que ce nombre soit largement supérieur aux quatre allèles R. Deux observations renforcent cette suggestion : i) les allèles D associent généralement des copies, identiques ou similaires (< 3 mutations) aux allèles S et R retrouvés dans les mêmes populations ; les allèles dupliqués semblent donc avoir été majoritairement générés à partir de la diversité allélique locale, après que les allèles R aient envahi les populations. ii) la majorité des allèles D n'ont été observés que dans une seule population ou dans des populations géographiquement proches (Fig. 8) ; ils ne semblent donc pas migrer sur une large échelle, ce qui rend donc les recombinaisons secondaires moins probables.

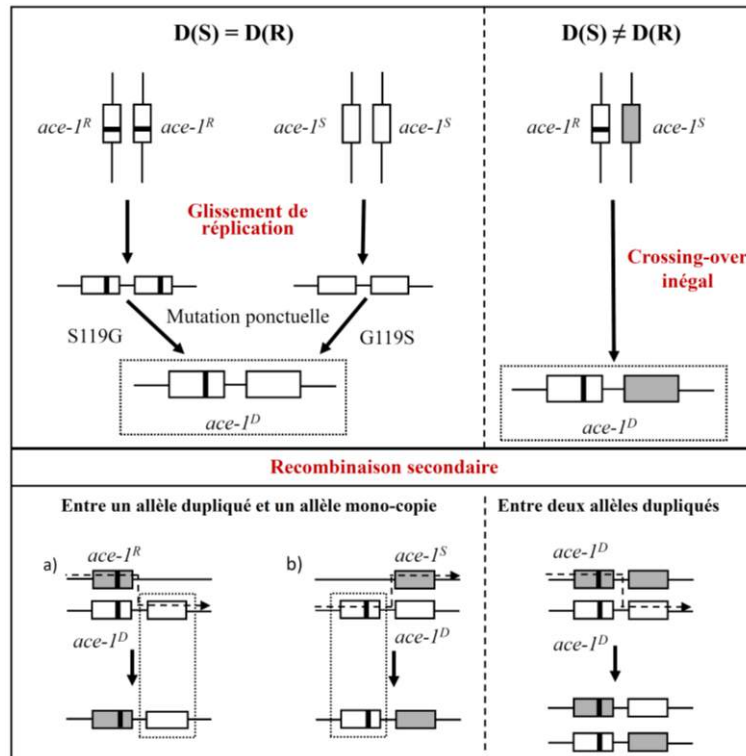

Figure 10 (modifiée d'après Labbé et al. 2007a) : Mécanismes potentiels à l'origine de la diversité des duplications. Cette figure sépare les mécanismes responsables de duplication *sensu stricto* (haut) (*i.e.* création d'un allèle dupliqué depuis un allèle mono-copie), des duplications par recombinaisons secondaires (bas).

Néanmoins, certains allèles D présentent une distribution plus large (D₁₃ : partie orientale de la méditerranée, D₂₅ : sud des Etats-Unis), voire mondiale (D₁ : Martinique et Mayotte et D₅ : Cuba, Togo et Mayotte) (Fig. 8). Ces différences de succès peuvent-elles s'expliquer par le phénotype homozygote conféré par les différents allèles ?

La majorité des allèles dupliqués sont sublétaux à l'état homozygote mais complémentent.

Pour répondre à cette question, nous avons tenté d'isoler, dans des souches séparées, les allèles dupliqués détectés dans les échantillons vivants. Les souches porteuses de ces allèles D ont ensuite été rétro-croisées sur la souche sensible de références (Slab), afin que toutes partagent le même fond génétique. Au total, nous avons réussi à isoler 8 allèles dupliqués depuis les populations naturelles, cinq chez *Cx. pipiens* (D₁₃ et D₂₇, Grèce ; D₁₅, D₁₆ et D₁₉, Tunisie) et trois chez *Cx. quinquefasciatus* (D₁ Mayotte, D₅, Togo et D₂₄ Martinique).

Afin de caractériser le phénotype homozygote DD conféré par ces allèles, une expérience d'évolution expérimentale a été réalisée : nous avons suivi l'évolution de la fréquence des allèles dupliqués au cours de six générations discrètes, chaque nouvelle génération étant exposée à l'état larvaire à un insecticide OP, à une dose éliminant tous les sensibles SS ($w_{SS} = 0$) ; les souches dont le phénotype avait déjà été caractérisé ont servi de références (D₁, Martinique, et D₂ et D₃, région montpelliéraine, Chap. 1 et Labbé et al. 2007b, 2014). La majorité des souches se sont comportées comme celles portant D₂ ou D₃ : la fréquence de l'allèle D n'a pas dépassé 0.5. Ceci démontre que ces duplications sont généralement sublétales à l'état homozygote (Tab. 3). Un modèle simple de génétique des populations a permis d'estimer les valeurs sélectives des homozygotes DD relativement à celles des hétérozygotes DS : elles sont toutes inférieures à 1, et plutôt proches de 0 sauf pour D₁ et D₂₄ (ces derniers semblent donc tout de même légèrement coûteux à l'état homozygote). On observe également que D₂ et D₅ semblent être "moins sublétaux" que les autres allèles. Y aurait-il des différences dans l'expression du coût chez ces allèles D sublétaux ?

Pour tester cette hypothèse, deux traits d'histoire de vie (THV), la mortalité larvaire et le temps de développement, ont été mesurés. Et, en effet, les différents allèles ont présenté des phénotypes différents pour ces deux traits, suggérant une origine différente pour la sublétalité entre allèles. Afin de le confirmer nous avons reproduit, en la systématisant, une expérience de Labbé et al. (2007b).

Table 3 : Caractérisation du phénotype des homozygotes dupliqués.

Allèles	W_{DD} (SL)	Dév.	Mortalité			Phénotype
			Globale	DD	DS	
D ₁ (Martinique)	0.73 (0.63-0.83)	-	-	-	-	☺
D ₁ (Mayotte)	-	ns	16 %	ns	ns	☺
D ₂	0.27 (0.17-0.35)	-	-	-	-	☹
D ₃	0.14 (0.00-0.29)	-	-	-	-	☹
D ₅	0.32 (0.22-0.42)	-	-	-	-	☹
D ₁₃	0.00 (0.00-0.09)	-	-	-	-	☹
D ₁₅	-	***	53 %	***	ns	☹
D ₁₆	0.13 (0.00-0.28)	***	46 %	**	*	☹
D ₁₉	0.02 (0.00-0.19)	***	48 %	***	**	☹
D ₂₄	0.76 (0.63-0.89)	ns	14 %	ns	ns	☺
D ₂₇	0.04 (0.00-0.13)	-	-	-	-	☹

Pour chaque allèle dupliqué, D, sa valeur sélective à l'état homozygote (W_{DD}), relative à celle des SS ($W_{SS} = 0$) et des RS ($W_{RS} = 1$) est présentée avec les bornes associées (SL). Lorsque mesurée, la significativité de la différence du temps de développement entre les individus DD et DS est présentée (Dév.), une différence significative indiquant que les DD se développent plus lentement que les DS. Pour finir, la mortalité larvaire globale est présentée, ainsi que la significativité de la mortalité larvaire par génotype (DD ou DS), (^{ns}, $p > 0.5$; *, $p < 0.05$; **, $p < 0.01$; ***, $p < 0.001$).

Par des analyses de THV (mortalité larvaire et temps de développement), ces auteurs ont en effet montré que l'hétérozygote D_2D_3 ne présentait pas cette sublétalité, mais au contraire un phénotype similaire aux D_2S et D_3S . Une telle complémentation entre allèles démontre qu'ils ne portent pas les mêmes mutations récessives. Tous les allèles D sublétaux issus de la même population (ou de populations très proches) ont été caractérisés par ces tests de complémentation. Globalement, il apparaît que les individus D_xD_y ne présentent ni de surmortalité ni de retard de développement comparés aux individus D_xS et D_yS : dans tous les cas, la complémentation a été observée ; là-encore, cela prouve que les allèles ne portent pas les mêmes mutations délétères récessives.

Cette expérience apporte une autre confirmation : puisque les mutations délétères portées sont différentes, ces allèles sont donc bien issus d'événements de duplications indépendants, et non de recombinaison secondaire. Le taux de duplication au locus *ace-1* est donc très élevé. De plus nous ne détectons que les duplications dont le coût est récessif et notre mode de détection par croisements est laborieux et nécessite de travailler sur du matériel vivant, conduisant également à une sous-estimation du taux de duplication au locus *ace-1*.

Conclusion

L'étude de la diversité et de la répartition des allèles *ace-1* montre des patrons contrastés entre les deux types d'architecture génétique de la résistance à ce locus. Premièrement, la diversité des allèles D est largement supérieure à celle des allèles R ; il apparaît donc que le taux de duplication est très probablement supérieur au taux de substitution à ce locus, en accord avec des études à l'échelle génomique (Lynch et al. 2008 ; Lipinski et al. 2011 ; Katju & Bergthorsson 2013 ; Schrider et al. 2013). Le succès évolutif de ces deux types d'adaptation est différent : on ne retrouve quasiment que deux allèles R, seuls et sur l'ensemble de la planète, alors que la majorité des allèles D sont retrouvés dans des populations géographiquement proches et polymorphes. Cette différence de succès est probablement liée aux différences d'architecture génétique. En effet, nous avons montré que les duplications hétérogènes du locus *ace-1* sont majoritairement sublétales à l'état homozygote. Si les mutations délétères à l'origine de ces phénotypes sublétaux restent à déterminer, il apparaît qu'elles ne sont propres ni à un taxon, ni à un mécanisme particulier de duplication (D_5 chez *Cx. quinquefasciatus* a un profil $D(S) = D(R)$, et D_{15} chez *Cx. pipiens* a un profil $D(S) \neq D(R)$, mais les deux sont sublétaux). De plus l'expérience de complémentation a permis de montrer que ces mutations sont différentes entre allèles D,

ce qui confirme donc que ces allèles proviennent d'événements de duplications indépendants.

Malgré leur caractère sublétal, ces duplications sont sélectionnées lors de leur émergence. En effet, lors de leur apparition, elles sont en faible fréquence et donc le plus souvent à l'état hétérozygote (DS, DR, D_xD_y). En montant en fréquence, elles se retrouvent plus souvent à l'état homozygote et sont donc contre-sélectionnées. Cependant nous avons montré que les hétérozygotes D_xD_y ont une valeur sélective nettement supérieure à celle des homozygotes respectifs D_xD_x et D_yD_y . En présence d'insecticides, cela crée une situation complexe de sélection balancée où tous les hétérozygotes (DS, DR, D_xD_y) ont une meilleure valeur sélective que les homozygotes : les SS sont tués par les insecticides, les D_xD_x et D_yD_y sont sublétaux et les RR souffrent du coût associé à la mutation G119S. Ce patron de super-dominance complexe maintient le polymorphisme allélique. De plus tout nouvel allèle dupliqué qui apparaît dans une population, même sublétal à l'état homozygote, pourra monter en fréquence jusqu'à atteindre un équilibre dans la population. On observe donc la sélection récurrente d'allèles adaptatifs à l'état hétérozygote, bien que sublétaux à l'état homozygote. Cela crée un polymorphisme parfois très important au locus *ace-1* (jusqu'à six allèles D co-ségrégent dans l'échantillon de Testour en Tunisie). Toutefois ce polymorphisme n'est probablement que transitoire. En effet, quelques rares allèles ne semblent associés qu'à des coûts relativement légers : c'est le cas notamment de D_1 (voir aussi chapitre 1). Or cet allèle semble envahir des populations extrêmement distantes (Mayotte et Martinique) et pourrait à terme se fixer dans les populations traitées aux OPs au détriment de R. Cependant, si D_1 est moins coûteux que R, il est aussi moins résistant ; le meilleur compromis pourrait donc dépendre des conditions de traitements, et notamment de leur intensité.

Many independent heterogeneous gene duplications solve the resistance trade-off in mosquitoes, but often at a cost

Pascal Milesi¹, Benoît S. Assogba^{1,2}, Célestine M. Atyame^{1,3}, Nicolas Pocquet^{4,5}, Sandra Unal¹, Patrick Makoundou¹, Arnaud Berthomieu¹, Mylène Weill¹, Pierrick Labbé^{1*}

1- Institut des Sciences de l'Evolution de Montpellier (UMR 5554, CNRS-UM-IRD-EPHE), Montpellier, France.

2- Institut Régional de Santé Publique, Université d'Abomey Calavi, 01BP918 Cotonou, Benin

3- present address: Institut Pasteur, Department of Virology, Arboviruses and Insect Vectors, Paris, France

4- Institut de Recherche pour le Développement (UMR MIVEGEC, IRD 224-CNRS 5290-UM), Montpellier, France.

5- present address: Institut Pasteur de Nouvelle-Calédonie (URE-EnM)

* Corresponding author

Keywords:

acetylcholinesterase
Culex pipiens
recurrent adaptation
natural populations
balanced selection

Summary

New generation sequencing revealed that gene duplications are pervasive and occur at a high rate in most species. Most are thought to be detrimental, but some have been selected for the beneficial increase in proteins produced. The case of heterogeneous duplications, that combine already divergent alleles of a single locus, are sparsely studied due to the lack of empirical data. We investigated the importance in the adaptive process of heterogeneous duplications of the *ace-1* locus, that pair one susceptible and one insecticide resistance copies in *Culex pipiens* mosquitoes, from a phylogenetic, fitness influence and field populations point of view.

Our worldwide survey revealed a high diversity of such duplicated alleles, in striking contrast with the single-copy resistance allele diversity. Moreover, we showed that most duplicated alleles emerged from unequal crossing-over between local single-copy alleles, suggesting a recurrent and easy process. These duplicated alleles are selected in their early stages, probably in selective pressure context where a balanced phenotype that lessen the cost associated with resistance is better achieved by a heterozygous genotype, because they remove the heterozygosity segregation burden. Our data showed that most of these duplications are strongly deleterious at the homozygous state and are maintained in the populations through over-dominance. However, few duplicated alleles are invasive at world wild scale.

Corresponding author:

Pierrick Labbé (pierrick.labbe@univ-montp2.fr)

Institut des Sciences de l'Evolution de Montpellier (UMR 5554, CNRS-UM-IRD-EPHE),

Université de Montpellier, Place Eugene Bataillon, CC065, 34095 Montpellier, France

Introduction

New generation sequencing revealed that copy-number variations (CNVs) are pervasive in most species (reviewed in Schrider and Hahn 2010). CNVs are due to duplication or deletion of genomes' portions, from a few bases to whole genes. Recent studies actually showed that the rate of gene duplication per gene and per generation ranges from the substitution rate to a value four orders of magnitude higher (Lynch et al. 2008; Lipinski et al. 2011; Katju and Bergthorsson 2013; Schrider et al. 2013).

However, most gene duplications are thought to be deleterious, both for structural (gene function disruption) or biochemical (gene-dosage disruption) reasons (reviewed in Kondrashov and Kondrashov 2006), and thus exposed to purifying selection (Emerson et al. 2008; Itsara et al. 2009; Reams et al. 2010; Langley et al. 2012; Katju and Bergthorsson 2013). Backing these assumptions, a recent experiment in *Drosophila melanogaster* showed that 99% of new gene duplications were lost in few generations after their appearance (Schrider et al. 2013). The few duplications that remain are thus likely to be under positive selection (through various scenarios, Labbé et al. 2007a; Hahn 2009; Innan and Kondrashov 2010), although their direct phenotypic and fitness consequences remain generally poorly documented (Katju and Bergthorsson 2013). Nevertheless, many examples showed that identical repetitions of one gene can be selected because they increase the quantity of protein produced (e.g. resistance to xenobiotics through increased detoxification genes, Guillemaud et al. 1998, Maroni et al. 1987, adaptation to novel diet, through increased amylase genes, in human, Perry et al. 2007, and in dog, Axelsson et al. 2013).

Another type of duplications is rarely considered, although it was first theoretically described in 1954 (Haldane): the case of heterogeneous duplications, *i.e.* duplications that combine already functionally divergent alleles of a single locus. When heterozygote is the fittest genotype, or

over-dominance (e.g. when producing two different allozymes is better), such duplications can be favored because they allow fixation of the this phenotype (*i.e.* they cancel the heterozygote segregation cost; Haldane 1954; Spofford 1969). Their importance in the adaptive process was not largely investigated due to lack of empirical examples (Hahn 2009). Here we further investigated the adaptive process of the well-known model of heterogeneous duplications of the *ace-1* gene in *Cx. pipiens* mosquitoes natural populations (Bourguet et al. 1996; Lenormand et al. 1998; Labbé et al. 2007a; Alout et al. 2010; Osta et al. 2012), at world wild scale.

In *Cx. pipiens* mosquitoes, *ace-1* gene encodes the synaptic acetylcholinesterase (AChE1), the enzyme targeted by the organophosphate (OPs) and carbamate (CXs) insecticides. These insecticides inhibit the AChE1 and impede the neurotransmitter acetylcholine hydroxylation, thus inducing death by tetany (Massoulié and Bon 1993). A single-base substitution in the *ace-1* gene (*ace-1^R* allele) results in an amino-acid substitution (G119S) in AChE1, which impedes the insecticide-AChE1 binding, generating resistance (Weill et al. 2002). This substitution has thus been selected in several mosquito species exposed to OPs and CXs (Weill et al. 2003, 2004a,b; Alout and Weill 2008) and similar mutations have been selected in other species (reviewed in Oakeshott et al. 2005 and Feyereisen et al. 2015). However, in the West-Nile mosquito *Culex pipiens* and the malaria mosquito *Anopheles gambiae*, the G119S substitution has also been shown to reduce the affinity of the modified enzyme for its substrate, with a > 60% reduced activity for the resistant protein compared to its susceptible version (Bourguet et al. 1997; Alout et al. 2008). This reduction is most probably the cause of the strong selective cost revealed both by field surveys in *Cx. pipiens* (Lenormand et al. 1999) and laboratory experiments in *Cx. pipiens* (Berticat et al. 2002; Bourguet et al. 2004; Duron

et al. 2006) and *An. gambiae* (Djogbénu et al. 2010; Assogba et al. 2015).

Thirteen distinct heterogeneous *ace-1* duplications (hereafter *ace-1^D*) have been evidenced in natural populations of *Cx. pipiens* and *Cx. quinquefasciatus* (respectively, the temperate and tropical taxa) (Bourguet et al. 1996; Lenormand et al. 1998; Labbé et al. 2007a; Alout et al. 2010; Osta et al. 2012). They pair a susceptible and a resistance copy of the locus. A recent study showed that such heterogeneous duplications restore the protein activity while maintaining a consequent resistance level, thereby conferring mosquitoes a phenotype similar to a standard heterozygote (Labbé et al. 2014b). In natural settings, treatment practices result in a mosaic of treated and untreated areas; in such environments it has been suggested that the heterozygous individuals (and thus those carrying a duplicated alleles) probably reach the best advantage/cost equilibrium) (Labbé et al. 2007b, 2014a). However, *ace-1* duplications also allow cancelling the segregation burden of a standard heterozygote, and have thus been selected for in different mosquito species (Lenormand et al. 1998; Labbé et al. 2007a,b, 2014b; Djogbénu et al. 2008; Alout et al. 2010; Osta et al. 2012; Liebman et al. 2015).

Only three *ace-1* duplicated alleles were investigated so far: they showed contrasted dynamics in natural populations, as one (*ace-1^{D1}*) appeared to have invaded the populations of Martinique (Yebakima et al. 2004), while two others (*ace-1^{D2}* and *ace-1^{D3}*) have been found to segregate at a stable frequency of ca. 20% in Montpellier area (South of France; Labbé et al. 2007b). These differences were caused by sub-lethality in the homozygous state for the Montpellier duplicated alleles, while the *ace-1^{D1}* homozygotes carry little, if any, selective cost (Labbé et al. 2007b, 2014b). In contrast with the 13 duplicated alleles found in a limited geographic range (mostly southern France and Algeria), only three *ace-1^R* alleles have been described so far in the *Cx.*

pipiens species complex, and they are found all over the World (Weill et al. 2003; Cui et al. 2006; Labbé et al. 2007a). The high diversity of adaptive duplicated alleles around the Mediterranean Sea thus appears at odds with their apparent advantages over the single-copy alleles unless they mostly suffer high fitness costs when homozygous and this assumption had to be investigated.

What is the worldwide distribution of *ace-1* heterogeneous duplications? How are they generated and then selected? Do they generally carry a cost when homozygotes or is the *ace-1^{D1}* type more frequent? Why are they so diverse? To answer these questions and better assess the adaptive role of heterogeneous gene duplications, it was necessary to get a more exhaustive understanding of the evolutionary dynamics of the *ace-1* locus. We first established the global *ace-1* allele diversity (single-copy and duplicated) in the *Cx. pipiens* complex, using 69 samples from collections all over the world. We notably screened twenty new live worldwide-collected populations for duplicated alleles (as these alleles can only be identified through crossing experiments). While 14 new duplicated alleles were identified, we managed to isolate 8 alleles in stable lab lines. It allowed us establishing their phenotype and fitness through experimental evolution assays and different life-history traits measurement.

This large-scale and thorough investigation allows us proposing a coherent evolutionary scenario for the appearance and spread of *ace-1* duplicated alleles in natural populations: while it is easy to generate heterogeneous adaptive duplications, most of them carry a high selective cost when homozygotes, and balanced selection plays a key role in their maintenance in natural populations.

Material

Mosquito's collection and strains

We screened samples from 69 populations from the *Culex pipiens* species complex from all

around the world for susceptible (S) and resistance alleles, either single-copy (R) or duplicated (D) (Tab. 1) to establish a worldwide diversity of *ace-1* alleles (Fig. S1 and Fig. 1).

Eight of these samples, originating from hybrid populations from northern USA, were also used to study *ace-1* allele's segregation between the *Cx. pipiens* and *Cx. quinquefasciatus* taxa (Fig. S1 and Fig. 1). For a total of 43 individuals, eight taxon-specific microsatellites were used to assess the proportion of nuclear DNA belonging to *Cx. pipiens* (*i.e.* an hybridization index) as described in Fonseca et al. (2004) and Strickman and Fonseca (2012).

Duplicated alleles can be searched for only using extensive crossing experiments, as they confer a

phenotype similar to RS individuals using current biochemical or molecular test (see below, Labbé et al. 2007b). To this aim, 20 of these samples (Fig. S1) were collected at the larval stage (>500 individuals) and reared in the laboratory until adulthood. Their progenies were exposed to 2 ppm of propoxur (CXs insecticide, Baygon®), a dose that kills all *ace-1* susceptible individuals. In populations where *ace-1* resistance was detected, we applied Labbé et al.'s protocol (2007a) to detect females carrying *ace-1^D* alleles and, when possible, establish lines carrying only one *ace-1^D* allele (D strains). Briefly, females from each sample were crossed with SS males from the susceptible reference strain (Slab strain, Georghiou et al. 1966), and isolated to lay eggs.

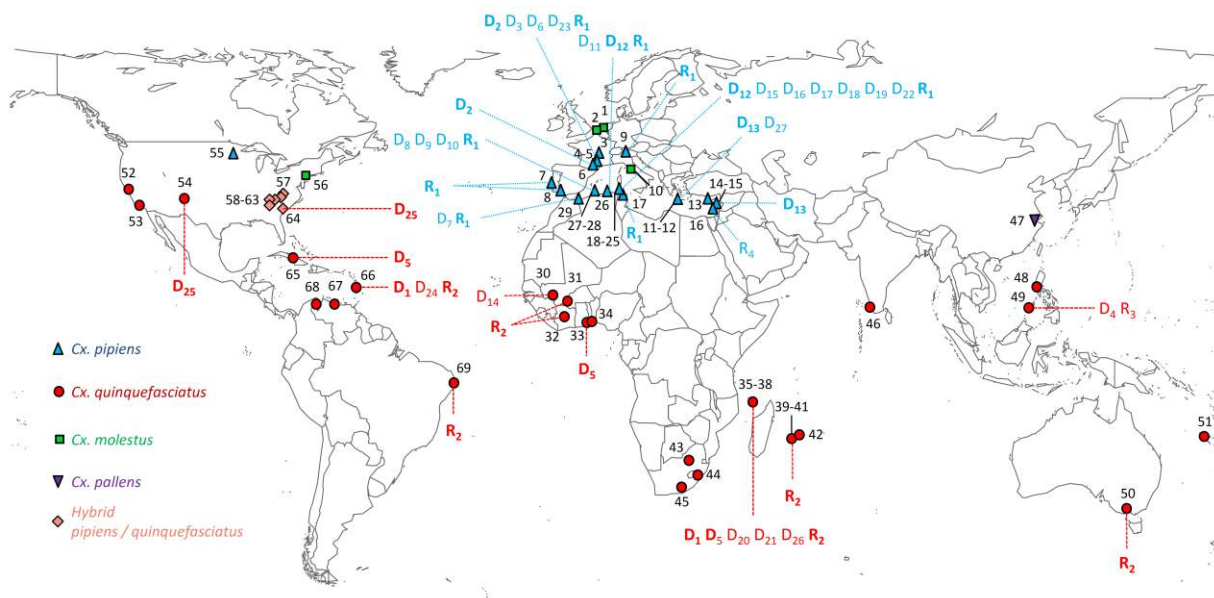

Figure 1: Distribution of sampled populations.

Each population is indicated by its number (Fig. S1) and a symbol corresponding to the taxon (refer to legend). In populations where they were detected, resistance alleles are indicated (D_x and R_x , respectively for *ace-1^D* and *ace-1^R*) in red (dashed line) for *Cx. quinquefasciatus* and in blue (dotted line) for *Cx. pipiens*. Finally, resistance alleles present in several populations are bolded.

They were then phenotyped and the progenies of [RS] females (RS, DS, DD, or DR genotypes) were exposed to 2 ppm of propoxur. A progeny without mortality indicates that the female was carrying a D allele (DD or DR genotypes).

For each sample, all such progenies were pooled and backcrossed at least eight times with SLAB, while the D alleles they harbored were characterized by sequencing the mothers and specific molecular tests designed (see below). All pools thus shared the same genetic SLAB background (> 99%), and differed from each other almost only by their *ace-1* genotype. If several D alleles were found in one pool, they were later isolated and mono-copy R allele eliminated through specific molecular diagnostic tests (Fig S2, D alleles discrimination and S3). The purified D strains were maintained polymorphic for the *ace-1* locus, with the susceptible Slab allele S_{Slab} . Each new generation was exposed to 2ppm of propoxur to increase D frequency.

Finally, three reference strains, fixed for various

D alleles and sharing the SLAB genetic background, were used: DUCOS-DFix (D_1D_1), MAURIN-DFix (D_2D_2) and BIFACE-DFix (D_3D_3), as their phenotypes have already been characterized (Labbé et al. 2007b, 2014b)

ace-1 diversity in natural populations

For each natural population sample, DNA was extracted from single mosquitoes, as described by Rogers and Bendich (1988). A ~580 bp fragment of the *ace-1* gene comprising the intron 2 and most of the exon 3 (including the G119S mutation) was amplified using two generalist primers, Intron2dir1-CpEx3rev (G-PCR), according to Labbé et al. (2007a) (Fig. S2, individuals and clones phenotyping and S3). The G119S mutation (conferring the resistance to OPs and CXs) creates an *AluI* restriction site (Weill et al. 2004b), so that three phenotypes could be discriminated with this PCR-RFLP: [SS], corresponding to the SS genotype, [RR], corresponding to the RR genotype, and [RS], corresponding to four genotypes: RS, DD, DS and DR (Tab. 1).

Table 1: Nomenclature of the different alleles and genotypes at the *ace-1* locus.

Description		Notation	Allele	Allele/Focal copy
Susceptible allele		S_x	<i>ace-1^{Sx}</i>	- S -
Single-copy resistance allele		R_x	<i>ace-1^{Rx}</i>	- R -
Duplicated allele		D_x	<i>ace-1^{Dx}</i>	- R - S -
Susceptible copy in a duplication		D(S)	-	- R - S -
Resistance copy in a duplication		D(R)	-	- R - S -
Genotype description		Notation	Genotype	Phenotype
Susceptible		SS	<i>ace-1^{Sx} / ace-1^{Sx}</i>	[SS]
Homozygotes	Single-copy resistance	RR	<i>ace-1^{Rx} / ace-1^{Rx}</i>	[RR]
	Duplicated	D_xD_x	<i>ace-1^{Dx} / ace-1^{Dx}</i>	[RS]
Heterozygotes	Standard	RS	<i>ace-1^{Rx} / ace-1^{Sx}</i>	[RS]
	Duplicated-susceptible	DS	<i>ace-1^{Dx} / ace-1^{Sx}</i>	[RS]
	Duplicated-single copy resistance	DR	<i>ace-1^{Dx} / ace-1^{Rx}</i>	[RS]
	Duplicated	D_xD_y	<i>ace-1^{Dx} / ace-1^{Dy}</i>	[RS]

For each considered alleles, focal copy or genotype, the abbreviation (Notation), and the name of the allele (Allele) are presented. For each genotype, the molecular phenotype is indicated. Note that the phenotype of an individual carrying a duplicated allele is always heterozygote [RS].

a) Single-copy alleles

The diversity of single-copy susceptible and resistance alleles was established respectively from SS or RR individuals: the PCR product was purified (Qiagen® Purification Kit) and directly sequenced (BigDye Terminator Kit, Applied Biosystems, Foster City, CA; ABI Prism 310 sequencer). When the sequence revealed individuals carrying different S or different R copies, the PCR product was cloned (TOPO® TA cloning Kit, Invitrogen, Paisley, UK); six clones per individual were analyzed, to ensure sequencing both copies and to avoid *Taq* misincorporation error.

b) Duplicated alleles

When detected, we PCR-amplified (G-PCR), cloned, screened clones with the PCR-RFLP test and sequenced (six S and six R clones) the PCR product to identify the susceptible and resistance copies (respectively, D(S) and D(R)). A duplicated allele was considered as new if: i) the sequence of the D(S) or the D(R) copy was different from the closest known sequence or ii) the D(S)-D(R) association has never been described.

Finally, all sequences of D(S), D(R), S and R *ace-1* copies were aligned using Mega software (Tamura et al. 2013), and the number of polymorphic sites and nucleotide diversity (Nei' \square index; Nei and Miller 1987) were estimated using DnaSP (Librado and Rozas 2009).

Specific molecular tests for D strains alleles and purity check

D strains contain only one D allele and the reference S_{Slab} allele. To discriminate them, we designed specific PCR-RFLP tests using the partial *ace-1* fragment (Intron 2–Exon 3) sequences identified during the diversity research (Fig. S2 and S3, as in Labbé et al. 2007a; Alout et al. 2010; Osta et al. 2012). When a diagnostic restriction site was found, the specific test consisted in a PCR using the generalist primers (G-PCR) followed by a restriction reaction using the appropriate enzyme (Fig. S2 and S3). In the absence of diagnostic restriction site, specific primers

were designed to amplify the D or the S_{Slab} allele independently (Fig. S2 and S3).

To check the purity of each D strain, DNA was regularly extracted from pools of first instar larvae (~200 L1 per pool). The partial *ace-1* fragment (Intron 2–Exon 3) was then amplified and directly sequenced. Sequences were compared to the expected ones.

ace-1 resistance alleles dispersion

To get access to more nucleotide diversity a larger fragment (Intron1-Exon3) was sequenced (Fig. S4). A PCR using primers Intron1dir2 and CpEx3rev was carried out (~20 ng of genomic DNA, 10 pmol of each primer, 2.5 units of *Taq* polymerase in 1X reaction mix (GoTaq® Long PCR Master Mix), in a final volume of 50 μ l; 30 cycles: 93°C for 30 s, 55°C for 30 s, and 72°C for 5 min); it generated fragments of ~5.5 kb for *Cx. pipiens* (with a ~4.5 kb Intron1) and of 3 kb for *Cx. quinquefasciatus* (with a ~2 kb Intron1). Because of the fragment sizes, internal primers were used to sequence each fragment, starting by both the 5' and 3' extremities (Fig. S4). For *Cx. quinquefasciatus* the whole fragment was sequenced. For *Cx. pipiens*, the intron 1 was much larger and could not be sequenced entirely. Allele identity was thus assessed for the first ~2 kb (5' extremity) and the last ~2 kb (3' extremity) of the amplified fragment, thus a total of ~4 kb (Fig. S4).

Life-history traits performances

a) D strains

The D strains were used to assess the phenotype conferred by duplicated alleles at the homozygous and heterozygous states. Trials were conducted to compare the performances of DD and DS individuals for two life-history traits: the development time and the pre-imaginal mortality. D strains contain DD, DS and SS genotypes. For each strain, female oviposition was synchronized. Second instar larvae (L2) were treated with 2 ppm of propoxur for 24h to kill SS larvae, and a sub-sample of 48 individuals was genotyped (Fig.

S2, life history traits and complementation experiments, and S3) to estimate the frequency of DD and DS ($f(DD)_{L2}$ and $f(DS)_{L2}$, respectively) before starting experiments.

Preimaginal mortality: For each D strain, 96 other L2 were isolated in standard hemolysis tubes in 2ml of mineral water, with food provided once at the beginning of the experiment (2mg.l⁻¹ of TetraMin® powdered fish food/larva). Tubes were stored on racks (two 48 tubes racks per strain), randomly distributed on a single shelf and regularly shuffled. Rearing conditions were 25°C, 12:12 hours light : dark, >60% humidity (standard conditions). Each emerging adult was genotyped using the molecular test specific of the D allele present in the D strain considered (Fig. S2, life history traits and complementation experiments, and S3), which allowed estimating the DD and DS frequencies in adults ($f(DD)_{ad}$ and $f(DS)_{ad}$, respectively). The DD genotype percentage of preimaginal mortality was estimated as: $m_{DD} = 1 - \frac{DD_{L2}}{DD_{ad}}$. Similarly, for the DS genotype, $m_{DS} = 1 - \frac{DS_{L2}}{DS_{ad}}$. Significances of the differences between genotype frequencies in L2 and adults for the various strains were tested using the following generalized linear model (GLM): MORT = STRAIN + ϵ , with MORT the preimaginal mortality for each strain (STRAIN) and ϵ the error parameter following a binomial distribution (to take into account over-dispersion, if present). Significance of pre-imaginal mortality for each genotypes (DD and DS) of each strain between L2 and adults and significance of differences in pre-imaginal mortality among genotype of each strain were tested using binomials proportion tests (R software v.2.15.1 <http://www.R-project.org/>). Sequential Bonferroni correction for multiple testing was used to identify potential false positive.

Development time: The L2 larvae of each strain remaining after propoxur exposure were reared until adulthood (standard conditions). Each day, emerging adults were collected. The 48 first and

48 last emerging adults were genotyped. The significance of the differences between DD frequencies among the first and the last emerging adults was tested using binomial proportion tests. Sequential Bonferroni correction for multiple testing was used to identify potential false positive.

b) Complementation tests

When several D alleles were found in populations geographically close, we assessed the performances of the heterozygotes carrying two different D alleles (D_xD_y). We crossed individuals from two different D strains. The resulting progeny was a mix of D_xD_y , D_xS , D_yS and SS genotypes. L2 were exposed to 2ppm of propoxur, killing all SS. 48 surviving L2 were genotyped using the adequate specific tests (Fig. S3) to estimate the D_xD_y frequency ($f(DD)_{L2}$). The other larvae were reared in standard conditions and adults were collected during the first and the second week after the first adult emergence. 48 adults emerged in the first week and 48 emerged in the second were genotyped, to estimate the global D_xD_y frequency in adults ($f(DD)_{ad}$), and their frequencies among the first and last emerged ($f(DD)_{first}$ and $f(DD)_{last}$, respectively). The significance of the differences between $f(DD)_{L2}$ and $f(DD)_{ad}$ and between $f(DD)_{first}$ and $f(DD)_{last}$ was tested using binomial proportion tests. Sequential Bonferroni correction for multiple testing was used to identify potential false positive.

Experimental evolution and fitness estimation

For each D strain, an experimental evolution protocol was set up to measure the relative fitness of DD and DS individuals. Females of the D strain (DS or DD) were crossed with Slab males (SS). The progeny was exposed to 2ppm of propoxur to kill all SS, so that only DS heterozygotes remained. The initial D frequency was thus $f(D)_I = 0.5$. The larvae were reared until adulthood under standard conditions and adults were released in a

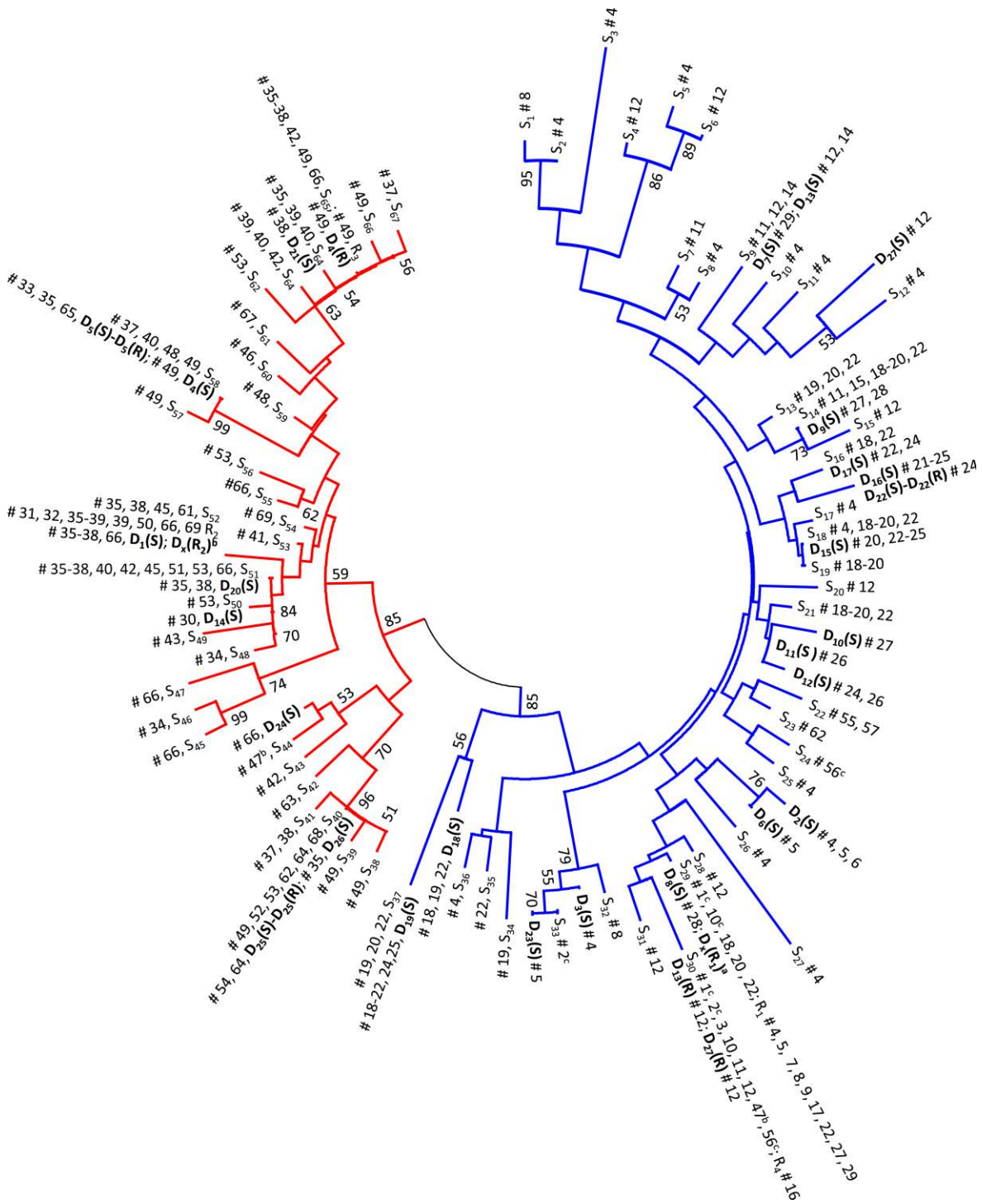

Figure 2: Worldwide diversity of *ace-1* copies.

The diversity of single-copy (R_x and S_x) and duplicated ($D_x(S)$ and $D_x(R)$) *ace-1* alleles is presented using Jukes-Cantor distance (ClustalW). The G119S (i.e. resistance) mutation has been removed to consider only neutral variations. Blue clade essentially corresponds to *Cx. pipiens* alleles and red clade to *Cx. quinquefasciatus*. Bootstraps are indicated as percentages (10,000 bootstraps), only if $>50\%$. For each allele/copy, the population(s) where it was found is indicated (see Fig. S1).

cage to mate freely. Eggs were collected and 96 L2 were genotyped (Fig. S2, D alleles evolutionary experiment, and S3) to estimate the frequency of SS individuals ($f(SS)_2$) and deduce the $f(D)_2$ frequency assuming panmixia. The L2 larvae were then exposed to 2ppm of propoxur, so that only DS and DD individuals survived. The process was repeated five times (the last larvae genotyped were the sixth generation), to follow the evolution of D frequency. To test for significant differences in DD frequencies at the sixth generation ($f(DD)_6$) between the various strains (STRAIN), the following GLM (binomial distribution) was computed: $f(DD)_6 = \text{STRAIN} + \epsilon$. Differences between $f(DD)_6$ and $f(DD)_1$ were then tested for each strain using binomial proportion tests. Sequential Bonferroni correction for multiple testing was used to identify potential false positive.

Relative fitness estimation: To estimate the relative fitnesses of DD and DS genotypes a deterministic genetic model (reproduction-selection, five cycles) was adjusted to the data and optimized through a maximum likelihood approach using the R software:

- Reproduction: The frequency of each genotype in the larvae of generation i was computed from the allelic frequencies in the gametes of the previous generation, assuming panmixia.

- Selection: Selection was computed between larval and adult stages to calculate the frequency of each genotype in adults. All SS individuals were killed by propoxur exposure, so that their fitness $w_{SS} = 0$. The fitnesses of the other genotypes were computed as $w_{DS} = 1$ and $w_{DD} = 1 + s$, with s the selection coefficient varying between -1 and 1. The allelic frequencies in the gametes produced by the surviving adults were then calculated from their genotypic frequencies.

Finally, the support limits associated to the selection coefficient s were estimated using 100 000 simulations to get the likelihood profile; a cut-off was set for the maximum likelihood minus 1.96

to compute the rough equivalents of 95% confidence intervals.

Results

ace-1 allelic diversity is limited but structured

Understanding the origin and the worldwide distribution of the *ace-1^D* alleles required knowing the global *ace-1* allelic diversity. Therefore, it was estimated by sequencing an *ace-1* gene fragment encompassing intron2 and exon3. It appeared that *ace-1* diversity was strongly structured into two clades corresponding to the *Cx. pipiens* and *Cx. quinquefasciatus* taxa (bootstrap value 85%, Fig. 2) regardless of the *ace-1* allele type (S, R or D). In each clade, nucleotide diversity was low and similar (Nei's $\pi \approx 0.02$). Each taxon showed some geographic structure (*i.e.* sequences from the same geographic zone tends to gather in the tree, see also Fig. S5), despite few long-range migrations (Fig. 1 and 2).

To assess whether *ace-1* alleles could introgress between taxa, 43 individuals originating from eight populations of the stable eastern USA hybrid zone (Mattingly et al. 1951) were analyzed. Taxon-specific microsatellites allowed assessing the proportion of *Cx. pipiens* nuclear DNA in hybrid individuals (*i.e.* a hybridization index). For each individual, the number of *Cx. pipiens ace-1* alleles (0, 1 or 2) was attributed by sequencing. A significant correlation appeared between the taxa origins of the genomic backgrounds and of the *ace-1* alleles (Pearson's product moment correlation, $r = 0.58$, $t = 4.5$, $df = 40$, $p < 0.001$ Fig. S6, indicating that, while introgression between the taxa was observed, it is limited enough, so that *ace-1* diversity remained structured at this small geographic scale (Fig. 1).

Susceptible allele diversity was larger than *ace-1^R* diversity: 67 S alleles were found, differing by 1 to 29 mutations, while only four R alleles were identified. Despite intense worldwide sampling, only one new R allele, R₄, was identified in a single *Cx. pipiens* population of Israel (R₄, Tel-Aviv) (Tab. 1 and Fig. S7). Similarly, R₃ (Pa-R in Labbé et al. 2007a) was only found in the Philip-

Table 2: *ace-1* resistance alleles.

<i>Culex pipiens</i>					
<i>ace-1^R</i>			Pop.	Ref.	Accession #
R ₁	-	-	4, 5, 7-9, 17-29	Weill et al. 2003	KT002464 / 65
R ₄	-	-	16	This study	KT002468
<i>ace-1^D</i>			Pop.	Ref.	Accession #
<i>ace-1^{D2}</i>	D ₂ (S)	D ₂ (R) = R ₁	4, 5, 6	Labbé et al. 2007a	JX007768 / 69
<i>ace-1^{D3}</i>	D ₃ (S)	D ₃ (R) = R ₁	4	Labbé et al. 2007a	JX007770 / 71
<i>ace-1^{D6}</i>	D ₆ (S)	D ₆ (R) = R ₁	5	Labbé et al. 2007a	JX007776 / 77
<i>ace-1^{D7}</i>	D ₇ (S)=D ₁₃ (S)	D ₇ (R) = R ₁	29	Alout et al. 2010	JX007778 / 79
<i>ace-1^{D8}</i>	D₈(S)	D₈(R) = R₁	28	Alout et al. 2010	JX007780 / 81
<i>ace-1^{D9}</i>	D ₉ (S)	D ₉ (R) = R ₁	27, 28	Alout et al. 2010	JX007782 / 83
<i>ace-1^{D10}</i>	D ₁₀ (S)	D ₁₀ (R) = R ₁	27	Alout et al. 2010	JX007784 / 85
<i>ace-1^{D11}</i>	D ₁₁ (S)	D ₁₁ (R) = R ₁	26	Alout et al. 2010	JX007786 / 87
<i>ace-1^{D12}</i>	D ₁₂ (S)	D ₁₂ (R) = R ₁	24, 26	Alout et al. 2010	JX007788 / 89
<i>ace-1^{D13}</i>	D ₁₃ (S)=D ₇ (S)	D ₁₃ (R) = R ₄	12, 14	Osta et al. 2012	JX007790 / 91
<i>ace-1^{D15}</i>	D ₁₅ (S)	D ₁₅ (R) = R ₁	20, 22-25	This study	KT002448 / 65
<i>ace-1^{D16}</i>	D ₁₆ (S)=D ₂₂ (S)	D ₁₆ (R) = R ₁	21-25	This study	KT002449 / 65
<i>ace-1^{D17}</i>	D ₁₇ (S)	D ₁₇ (R) = R ₁	22, 24	This study	KT002450 / 65
<i>ace-1^{D18}</i>	D ₁₈ (S)	D ₁₈ (R) = R ₁	18, 19, 22	This study	KT002451 / 65
<i>ace-1^{D19}</i>	D ₁₉ (S)	D ₁₉ (R) = R ₁	18-22, 24, 25	This study	KT002452 / 65
<i>ace-1^{D22}</i>	D₂₂(S) = D₁₆(S)	D₂₂(R)	24	This study	KT002455 / 56
<i>ace-1^{D23}</i>	D ₂₃ (S)	D ₂₃ (R) = R ₁	5	This study	KT002457 / 65
<i>ace-1^{D27}</i>	D ₂₇ (S)	D ₂₇ (R) = R ₄	12	This study	KT002462 / 63
<i>Culex quinquefasciatus</i>					
<i>ace-1^R</i>			Pop.	Ref.	Accession #
R ₂	-	-	31, 32, 35-41, 50, 66, 69	Weill et al. 2003	KT002468
R ₃	-	-	49	Labbé et al. 2007	KT002467
<i>ace-1^D</i>			Pop.	Ref.	Accession #
<i>ace-1^{D1}</i>	D₁(S)	D₁(R) = R₂	35-38, 66	Labbé et al. 2007	JX007766 / 67
<i>ace-1^{D4}</i>	D ₄ (S) = D ₅ (S)	D ₄ (R) = R ₃	49	Labbé et al. 2007	JX007772 / 73
<i>ace-1^{D5}</i>	D₅(S) = D₄(S)	D₅(R)	33, 35, 65	Labbé et al. 2007	JX007774 / 75
<i>ace-1^{D14}</i>	D ₁₄ (S)	D ₁₄ (R) = R ₂	30	This study	KT002447 / 68
<i>ace-1^{D20}</i>	D ₂₀ (S)	D ₂₀ (R) = R ₂	35, 38	This study	KT002453 / 68
<i>ace-1^{D21}</i>	D ₂₁ (S)	D ₂₁ (R) = R ₂	38	This study	KT002454 / 68
<i>ace-1^{D24}</i>	D ₂₄ (S)	D ₂₄ (R) = R ₂	66	This study	KT002458 / 68
<i>ace-1^{D25}</i>	D₂₅(S)=D₂₆(S)	D₂₅(R)	54, 64	This study	KT002459 / 60
<i>ace-1^{D26}</i>	D ₂₆ (S)=D ₂₅ (S)	D ₂₆ (R) = R ₂	35	This study	KT002461 / 68

The list of each resistance allele described so far at the *ace-1* locus is given both for the single copy alleles (*ace-1^{Rx}*) and the duplicated alleles (*ace-1^{Dx}*, with D_x(S) and D_x(R), respectively the susceptible and resistance copies). D_x(R) = R_x means that the D(R) copy of an allele *ace-1^{Dx}* is identical to an *ace-1^{Rx}* allele. For each resistance allele, the sampling population(s) (Pop.), the associated reference (Ref.) and the GenBank accession number are also indicated. Alleles with strictly identical D(S) and D(R) copies (except the G119S mutation) are bolded.

pinus. On the contrary, R₁ and R₂ (respectively G-R and Du-R in Labbé et al. 2007a) were found at a much larger geographic scale: R₁ was found in all western Mediterranean Sea (Z1 and Z3), and R₂ from Americas to Africa, Indian Ocean and

Australia (Z4, Z5 and Z6; Tab. 2 and S1, and Fig. 1). In both cases, we confirmed that it was indeed the same allele by sequencing a larger fragment of the *ace-1* locus in samples from the various regions: the R alleles were identical over 3919

and 2787 pb, respectively in *Cx. pipiens* (Populations 4, 7, 8, 9, 17 and 26) and *Cx. quinquefasciatus* (Populations 31, 32, 38, 40, 50, 66 and 69).

***ace-1^D* alleles are widespread in natural populations**

Resistance to OPs and CXs through *ace-1* mutations was found in 20 new live mosquito samples collected for the present study, from Tunisia (8), South of France (2), Greece (1), Israel (1) (*Cx. pipiens*), and from Mali (1), Togo (1), Mayotte (4), La Reunion Island (1), Martinique (1) and southern USA (1) (*Cx. quinquefasciatus*) (Tab. S1). Duplicated alleles were found in all samples, except two: only single-copy resistance alleles were observed in samples from Tel-Aviv (Israel) and St-Denis (La Reunion Island). In the other samples, four previously known *ace-1* duplicated alleles were identified (D₁, D₂, D₅ and D₁₂), but 14 new alleles were described (Tab. 2 and Fig. S7). Thus, the total number of *ace-1^D* alleles known in the *Cx. pipiens* complex is now 27.

The *ace-1^D* allele diversity was mostly due to variability in the susceptible D(S) copy (Tab. 2). Many alleles indeed shared a similar resistance copy: 15 shared a copy identical to R₁, 6 to R₂, and 2 to R₄ and only three alleles displayed D(R) copies different from each other or any known *ace-1^R* allele (D₅, D₂₂ and D₂₅). In contrast, only four pairs of *ace-1^D* alleles (*ace-1^{D7}* and *ace-1^{D13}*, *ace-1^{D16}* and *ace-1^{D22}*, *ace-1^{D4}* and *ace-1^{D5}*, *ace-1^{D25}* and *ace-1^{D26}*) shared their susceptible copies, *i.e.* diverged only by their D(R) copy. Finally, most *ace-1^D* alleles displayed D(S) and D(R) copies differing by several mutations; however, five displayed D(S) and D(R) copies strictly identical, save for the G119S mutation (D₁, D₅, D₈, D₂₂, D₂₅) (Tab. 1). Sequencing a larger fragment of the susceptible and the resistant copies of the D₁ allele (2787 pb, Fig. S4) confirmed that they were strictly identical.

Many local duplications events

While a limited gene flow was documented for the susceptible alleles between the taxa *Cx. pipiens* and *Cx. quinquefasciatus* (in the USA hybrid zone), none was observed for the resistance alleles: both single-copy or duplicated alleles appeared restricted to their taxa (Fig. 1). However, within each taxon, they show different patterns: a few resistance alleles have indeed largely spread geographically, while the large majority shows a limited distribution range (Fig. 1 and Tab. 2). This limited range is mostly reflected in the copy composition of the duplicated alleles.

An overall pattern is that they are generally composed of D(S) and D(R) similar to those observed as single-copy in the populations where they are segregating (or populations geographically close) (Fig. 1 and S1). For instance, R₁ and R₂ are widespread in *Cx. pipiens* and *Cx. quinquefasciatus* taxa, respectively, and most of the D(R) copies are identical to them. Similarly, the *ace-1^D* alleles carried D(R) copies identical to R₃ and R₄ in populations close to where these single-copy alleles were found: D₄(R) is identical to the R₃ allele segregating in the same Philippines population, and D₁₃(R) from Lebanon is identical to R₄ from Israel. This is even more striking for susceptible copies: D₁, D₃-D₅, D₈-D₁₁, D₁₃, D₁₅, D₁₇, D₁₉-D₂₁, D₂₃, D₂₅, D₂₆ are identical or similar (< 3 mutations) to an S copy found in the same or a geographically close population (Fig. 1).

Globally, while half of the single-copy resistance alleles (2/4) invaded numerous and distant populations (R₁ and R₂, Fig. 1 and Tab. 1), the vast majority of the duplicated alleles (23/27) were only found in few and nearby localities (in accordance with the geographic structuration observed in Figures 1 and S5). However, four presented regional (D₁₃, eastern Mediterranean Sea and D₂₅ USA) or worldwide distributions (D₁,

Newly sampled populations						
Taxa	Geographic Area	Sampled populations	Map #	Duplicated allele		
				Detected	Lost	Isolated
<i>Cx. quinquefasciatus</i>	Martinique	Pool	66	D ₁ , D ₂₄	-	D ₂₄
		Acoua	35	D ₁ , D ₅ , D ₂₀	D ₅ , D ₂₀	-
	Mayotte	M'Tsamoudou	38	D ₁ , D ₂₀ , D ₂₁	D ₂₀ , D ₂₁	-
		Tsoundsou	36	D ₁		D ₁
	Togo	Baguida	33	D ₅		D ₅
<i>Cx. pipiens</i>	Tunisia	Al Battan	23	D ₁₅ , D ₁₆	-	D ₁₆
		Utique	20	D ₁₅ , D ₁₉	-	D ₁₅
		Hamra	24	D ₁₅ , D ₁₆ , D ₁₉	-	D ₁₉
	Djedaida	22	D ₁₅ , D ₁₆ , D ₁₈ , D ₁₉	D ₁₈	-	
		Greece	Heraklion	12	D ₁₃ , D ₂₇	-
	Reference strains					
Taxa	Geographic Area	Sampled populations	Map #	Isolated	Strains	References
<i>Cx. quinquefasciatus</i>	Martinique	Ducos	66	D ₁	DUCOS-DFix	Labbé <i>et al.</i> 2014
		Maurin	5	D ₂	MAURIN-DFix	Labbé <i>et al.</i> 2007b
<i>Cx. pipiens</i>	France	Ganges	4	D ₃	BIFACE-DFix	Labbé <i>et al.</i> 2007b

The belonging taxa and the geographic areas relative to sampled population from each duplicated alleles were isolated are indicated. For each sampled populations the duplicated alleles detected according Labbé *et al.*'s (2007a) protocol, lost during the isolation process or finally isolated in independent strains are also indicated. Finally the same information for the three strains used as references are provided. Finally, note that DUCOS-DFix and D₁ Strain carried the same duplicated allele (D₁), but isolated from different geographic areas (respectively, Martinique, Labbé *et al.* 2007b and Mayotte, this study).

Martinique and Mayotte and D₅, Cuba, Togo and Mayotte Fig. 1 and Tab. 2).

Finally, at most one R allele was present in a given population, while many populations were found polymorphic for D alleles: e.g. five segregated in Tunisia and four in Mayotte (Fig. 1 and Tab. 2).

Most of the duplicated alleles are sub-lethal when homozygote, but they complement

To better understand the global distribution of *ace-1* resistance alleles, characterizing the fitness conferred by the duplicated alleles was required. Three alleles (D₁ from Martinique, and D₂ and D₃ from southern France) have already been characterized (Labbé *et al.* 2007b, 2014); these strains

were used as references for experimental evolution. We also tried to isolate the duplicated alleles from the live samples available: 1 from Martinique, 3 from Mayotte, 1 from Togo, 4 from Tunisia and 2 from Greece, (Tab. 3). 12 different duplicated alleles were found segregating in those 11 samples (Tab. 3). However, we managed to isolate only eight of them in independent strains (D₁ from Mayotte, D₅ from Togo, D₁₃ and D₂₇ from Greece, D₁₅, D₁₆ and D₁₉ from Tunisia, and D₂₄ from Martinique). The others were lost in the process of strain establishment (D₁₈ from Tunisia and D₅, D₂₀, D₂₁, and D₂₆ from Mayotte, Tab. 3). The alleles were introgressed in the Slab background to compare their performances for various life-history traits and experimental evolution.

a) *Experimental evolution.*

Experimental evolution allows an integrative and quantitative assessment of the fitness by taking the whole life cycle into account. Each D allele was set in competition with the susceptible reference S_{slab} allele, at equal initial frequencies ($f(D)_1 = 0.5$). Each generation was exposed to a dose of insecticide that killed all homozygous susceptible individuals (SS) and the surviving adults mated freely in the cages. The evolution of the D frequency was surveyed for six discrete generations (Fig. 3).

Again two statistically different groups of D alleles emerged (LRT, $\chi^2 = 39.6$, $\Delta df = 8$, $p < 0.001$):

- i) D_1 and D_{24} significantly increased in frequency (Binomial tests, all $p < 0.001$) to reach about ~ 0.75 at generation 6 (Fig. 3).
- ii) the frequency of D_3 , D_{13} , D_{15} , D_{16} , D_{19} and D_{27} remain stable at 0.5 for 6 generations (Binomial tests, all $p > 0.05$), while D_2 and D_5 frequency increased significantly, but remained close to 0.5

($f(D_2)_6 = 0.58$, and $f(D_5)_6 = 0.59$; Binomial tests all $p < 0.001$; Fig. 3).

We used a deterministic genetic model to estimate the fitness of the DD ($w_{DD} = 1+s$) genotype compared to DS ($w_{DS} = 1$; for the SS genotype $w_{SS} = 0$, as all SS are killed by propoxur exposure). D_1 and D_{24} homozygotes appeared slightly deleterious compared to their respective DS heterozygotes, ($s = -0.18$ and -0.15 , respectively Tab. 4). By contrast, the other alleles were sublethal at the homozygous state, *i.e.* with DD fitness close to 0 (D_2 , D_3 , D_5 , D_{13} , D_{15} , D_{16} , D_{19} and D_{27} , Tab. 4). To investigate whether the origin of the sublethality was the same for the different duplicated alleles, we measured some life history traits performances (pre-imaginal mortality and development time) of some sublethal alleles, using D_1 and D_{24} alleles as controls.

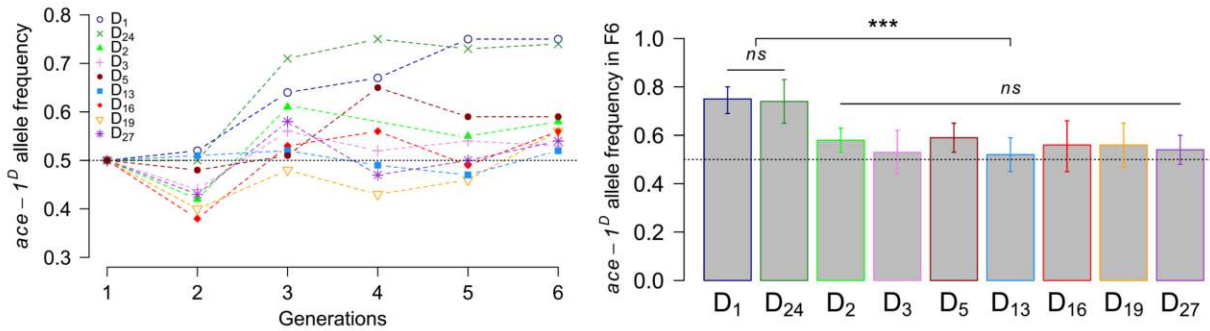

Figure 3: $ace-1^D$ allele dynamic and DD fitness estimations. **Left panel:** Dashed line represent the dynamic of the various duplicated alleles over the six discrete generation artificial selection experiment (D_1 , dark-blue empty circles; D_2 , green triangles; D_3 , pink plus; D_5 , brown full circles; D_{13} , light-blue full squares; D_{16} , red diamonds; D_{19} , orange downward triangles; D_{24} , dark-green crosses and D_{27} , violet stars). The dotted line represent the initial frequency ($f(DD)_1 = 0.5$). Note that the genotype frequencies in the F4 generation for the D_2 allele were not measured due to a lack of larvae; taking off individuals would have threatened the following of the experiment and that D_{15} was withdrawal of the experiment because of strain contamination. **Right panel:** The final frequencies (frequencies in the F6) with their associated 95% confidence intervals are represented for each duplicated allele. The dotted line represent the initial frequency ($f(DD)_1 = 0.5$). Finally, significance of differences in F6 frequencies is also indicated (^{ns}, $p > 0.05$; ^{***}, $p < 0.001$).

b) Pre-imaginal mortality.

For the D₁ (Mayotte), D₁₅, D₁₆, D₁₉, and D₂₄ strains, 96 individuals (N_{Tot}) were reared separately on hemolysis tube from the 2nd instar larvae stage (L2). All emerged adults were collected (N_A). The overall preimaginal mortality (MORT) was computed as $1 - (N_A / N_{Tot})$.

All strains induced significant mortality between L2 and emerging adults (GLM, MORT = STRAIN + ϵ all $p < 0.001$) (Fig. 4A) but two statistically different groups appeared: i) D₁₅, D₁₆ and D₁₉ showed a strong and similar mortality (53, 46 and 48%, resp., LRT, $\chi^2 = 1$, $\Delta df = 1$, $p > 0.05$), similar to that previously observed for D₂ and D₃ (Labbé et al. 2007b), ii) D₁ and D₂₄ showed a significantly lower (14 and 16%, resp., LRT, $\chi^2 = 65.4$, $\Delta df = 4$, $p < 0.001$) and similar (LRT, $\chi^2 = 0.17$, $\Delta df = 1$, $p > 0.05$) mortality (Fig. 4A). Moreover this low mortality is similar to that expected for the Slab reference in similar experiments (Labbé et al. 2014b).

Table 4: Relative fitness.

Genotype	w_i	SL
SS	0.00	-
D _i S	1.00	-
D ₁ D ₁	0.82	(0.69-0.95)
D ₂ D ₂	0.25	(0.15-0.35)
D ₃ D ₃	0.13	(0.00-0.30)
D ₅ D ₅	0.35	(0.24-0.46)
D ₁₃ D ₁₃	0.00	(0.00-0.08)
D ₁₆ D ₁₆	0.13	(0.00-0.30)
D ₁₉ D ₁₉	0.04	(0.00-0.23)
D ₂₄ D ₂₄	0.85	(0.68-1.03)
D ₂₇ D ₂₇	0.00	(0.00-0.12)

The fitness ($w_{DD} = 1 + s$) of each DD genotype and the associated support limits (SL) relative to SS ($w_{SS} = 0$) and DS ($w_{Di} = 1$) individuals were estimated through a population genetic model adjusted to the data of the experimental evolution.

We then assessed the mortality of each genotype, either duplicated homozygotes (DD) or heterozygotes (DS). For each strain, the L2 frequency, estimated from 48 individuals, was used to compute the expected number of each genotype among the 96 individuals at the start of the experiment. Providing no mortality, this should be the expected number of adults of each genotype. These were then compared to the observed numbers of adults of each genotype at the end of the experiment (Fig. 4B). For D₁ and D₂₄, when considering both genotypes (DD or DS), the mortality was not significant (Binomial tests all $p > 0.05$). However, strains suffering higher mortality showed different patterns: i) for D₁₅ the mortality observed was significant only for the DD genotype (Binomial test, $\chi^2 = 43$, $df = 1$, $p < 0.001$ for DD and $\chi^2 = 1.3$, $df = 1$, $p > 0.05$ for DS); ii) for D₁₆ both DD and DS were significantly affected (binomial tests, $\chi^2 = 7.6$, $df = 1$, $p < 0.01$ for DD and $\chi^2 = 5.4$, $df = 1$, $p < 0.05$ for DS) but similarly (Binomial test, $\chi^2 = 2.7$, $df = 1$, $p > 0.05$); and iii) for D₁₉ both DD and DS were significantly affected (binomial tests, $\chi^2 = 10$, $df = 1$, $p < 0.01$ for DD and $\chi^2 = 7$, $df = 1$, $p < 0.01$ for DS) (Fig. 4B) but the mortality was stronger for DD (Binomial test, $\chi^2 = 5.4$, $df = 1$, $p < 0.01$). However, this difference was no more significant after sequential Bonferroni correction.

c) Development time.

For the D₁, D₁₅, D₁₆, D₁₉, and D₂₄ strains, the effect of each duplicated allele on the development time was assessed by comparing the frequency of each genotype (DD or DS) in the 48 first and 48 last emerged adults. As for pre-imaginal mortality, two patterns groups appeared: i) the emergence of DD individuals was delayed compared to DS individuals for D₁₅, D₁₆ and D₁₉ (Binomial tests, $\chi^2 = 92$, $df = 1$, $p < 0.001$, $\chi^2 = 12.7$, $df = 1$, $p < 0.001$ and $\chi^2 = 11.2$, $df = 1$, $p < 0.001$, respectively Fig. 5), while ii) no significant difference was observed between the first and last emerged adults for D₁ and D₂₄ ($\chi^2 = 0.01$, $df = 1$,

$p > 0.05$)

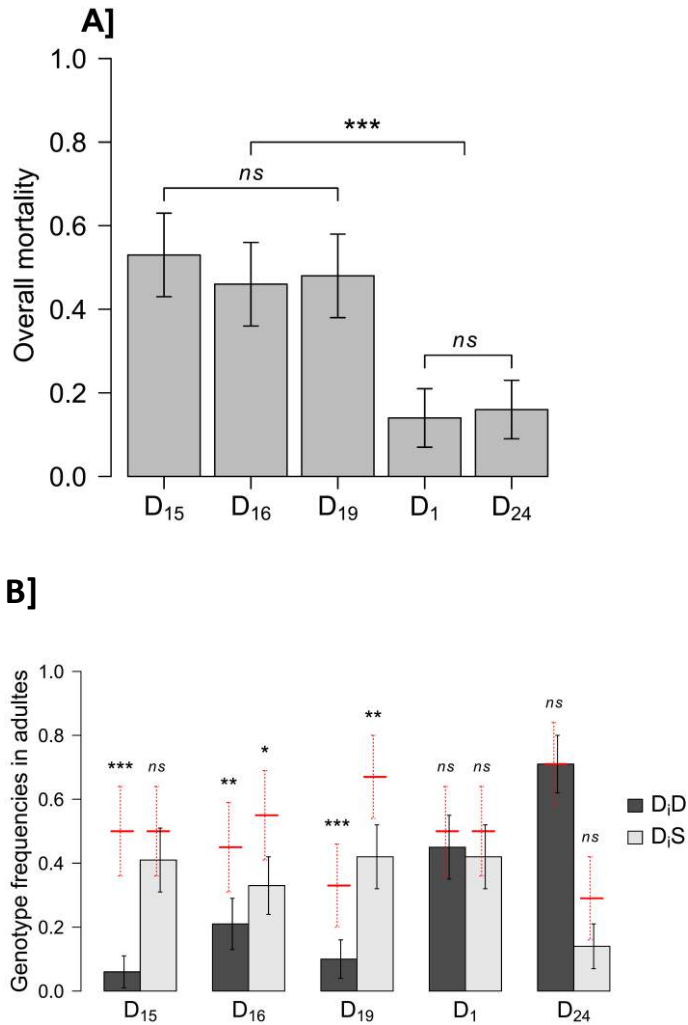

Figure 4: Pre-imaginal mortality. **A:** The percentage of mortality between the L2 stage and the adults are presented (with the associated 95% confidence intervals) for the different trains. **B:** For each genotype, the horizontal red lines are the expected frequencies (with the associated 95% confidence intervals, dot red lines) in emerged adults without larval mortality. Barplots are the observed frequencies (with the associated 95% confidence intervals, solid line) of DD (dark bars) or DS (light bars) genotypes in emerged adults for the different D_x strains.

Significance of differences in overall mortality between the various strains (**A**) and differences between expected and observed frequencies for each genotypes (**B**) are indicated (^{ns} $p > 0.05$, * $p < 0.05$, ** $p < 0.01$, *** $p < 0.001$).

and $\chi^2 = 0.08$, $df = 1$, $p > 0.05$, respectively, Fig. 5).

d) Complementation tests.

Several D alleles were found segregating in natural populations from the same geographic area. For alleles identified as carrying a high homozygous cost, we compared the pre-imaginal mortality and development time of D_xD_y heterozygotes (*i.e.* carrying two different D alleles) to the respective D_xS and D_yS heterozygotes. In all cases, D_xD_y individuals frequencies in L2 were similar to that in adults (Binomial tests, all $p > 0.05$), indicating that D_xD_y mortality was low, and similar to DS (Fig. 6A). Similarly, D_xD_y frequencies were similar between the first and last emerged adults (X^2 tests, all $p > 0.05$), except

for D₁₅D₁₆ and D₁₃D₂₇ (Binomial tests, $p < 0.05$ and $p < 0.05$, respectively) (Fig. 6B), but these differences in development time were no longer significant after sequential Bonferroni correction, suggesting false positives. Thus all D alleles tested segregating in geographically close natural populations and conferring a high fitness cost when homozygotes appear to complement in D_xD_y individuals.

Discussion

Heterogeneous duplications, pairing on a same chromosome one susceptible and one resistance copy of the *ace-1* gene, were repeatedly identified in *Cx. pipiens* and *Cx. quinquefasciatus*

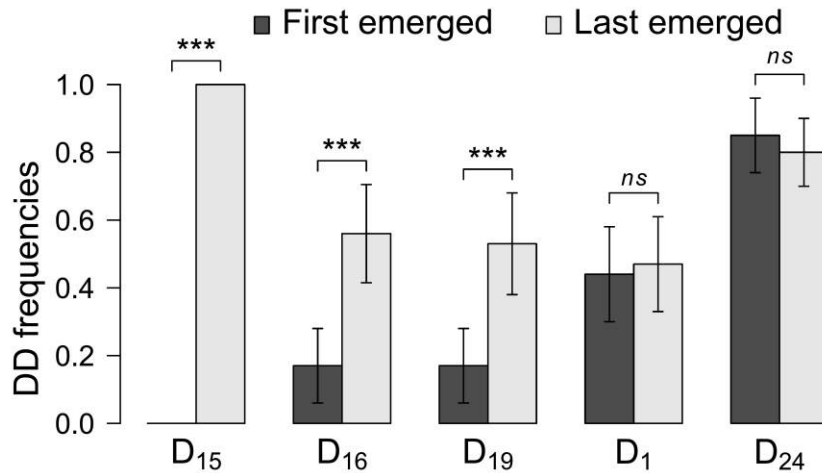

Figure 5: Development time. Barplots represents the frequencies (with the associated 95% confidence intervals) of DD genotype in the first emerged (dark bars) and in the last emerged (light bars) adults for the different D strains. Significance of differences in frequencies between the first and the last emerged adults are also indicated (n.s. $p > 0.05$, *** $p < 0.001$).

natural populations. They provide us with a rare opportunity to study the role of particularly lesser-known heterogeneous duplications, in the adaptive process. The present study investigated their large scale distribution, their structure and their fitness consequences. To this end we screened mosquito populations from all over the world for both duplicated and single-copy alleles of the *ace-1* gene. We then assessed the fitness consequences of ten duplicated alleles for several life-history traits and through experimental evolution.

Heterogeneous *ace-1* gene duplication: a recurrent and pervasive path to solve an irreducible trade-off

This world-scale study allowed detecting only one new mono-copy *ace-1^R* allele, thus a worldwide total of four G119S-substituted alleles described so far (Weill et al. 2003; Labbé et al. 2007a; Alout et al. 2010). In the same time, we detected 14 new *ace-1^D* alleles (Tab. 2), which raises the number of known *ace-1* duplicated alleles to a total of 27 (Labbé et al. 2007a; Alout et al. 2010; Osta et al. 2012). There is thus a striking contrast between the two types of resistance alleles, with a much higher diversity for the duplicated ones (Tab. 2). Identifying these alleles requires live mosquitoes: we were able to gather 20 populations displaying resistance to OPs and

CXs, from various locations, and to test them for the presence of duplicated alleles. Strikingly, we found at least one duplicated allele in 18 out of these 20 samples. These heterogeneous duplications are thus pervasive on a world scale (Fig. 1). In the duplicated alleles, most of the susceptible D(S) and resistance D(R) copies were similar to local *ace-1^S* and *ace-1^R* alleles (Fig. 2). This observation therefore suggests that most of these heterogeneous duplicated alleles (22/27) were formed after the spread of the *ace-1^R* alleles, through unequal crossing-overs in heterozygous individuals carrying local *ace-1^S* and *ace-1^R* alleles. However, we cannot rule out that some of them could have originated from secondary recombination with other single-copy or duplicated alleles (Labbé et al. 2007a). Their number should however be limited, as recombination should be inhibited in the chromosomal region of the duplicated fragment. The five remaining duplicated alleles showed a different pattern, as their D(S) and D(R) copies were strictly identical (G119S excepted), including for the intron 1 sequence longer than 2kb concerning the *ace-1^{D1}* allele we tested. It has been proposed that such patterns were probably generated by replication slippage of the susceptible or resistance allele, followed respectively by the G119S or S119G mutation in one of the copies (Labbé et al. 2007a). In the context of insecticide treatments, the second process

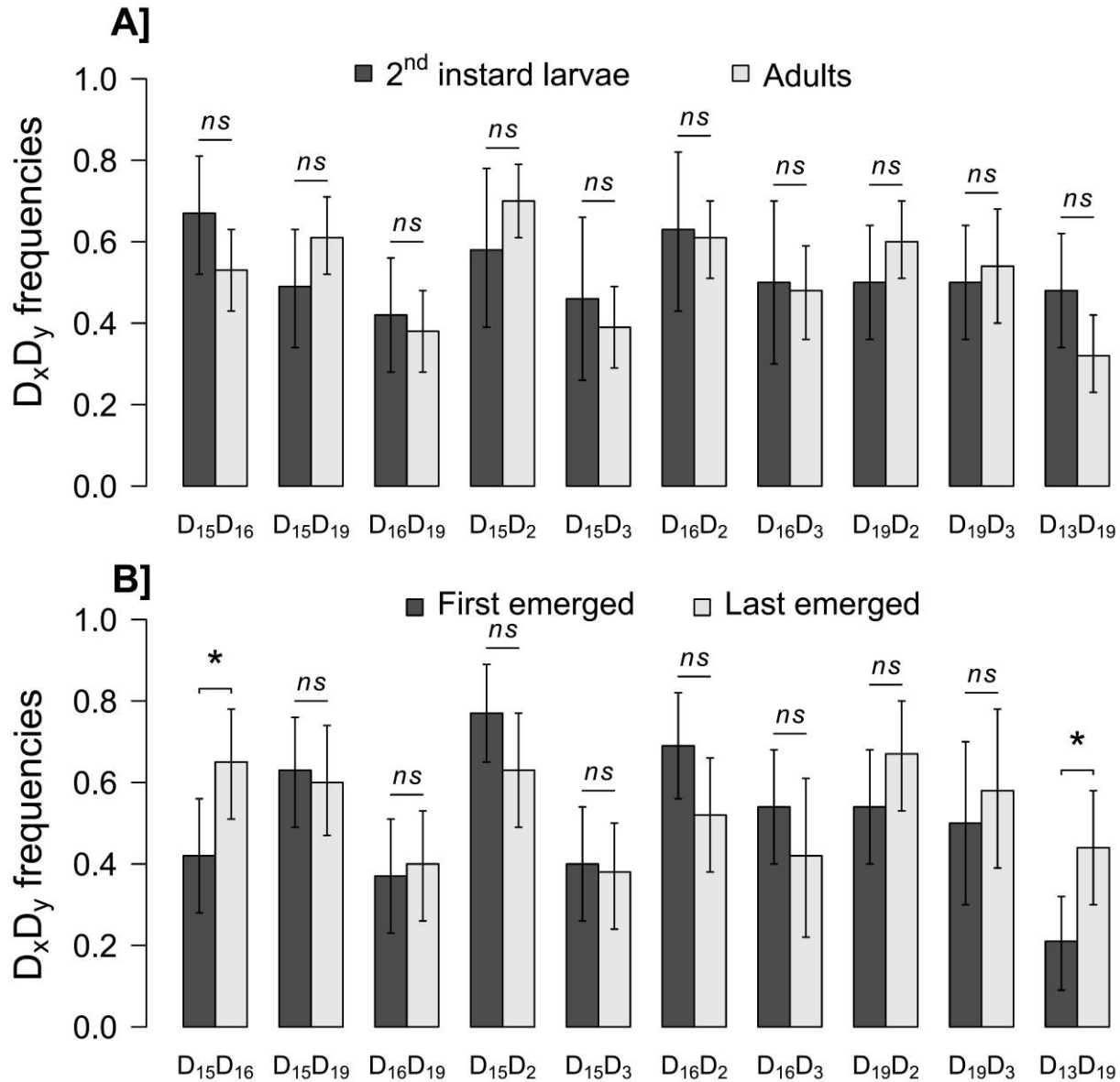

Figure 6: Complementation experiment. A: Frequency of the duplicated heterozygous genotype (D_xD_y) among 2nd instar larvae and adults. No differences in development time was observed for the D_xD_y between L2 stage and adults. **B:** Frequency of the duplicated heterozygous genotype (D_xD_y) among the first and the last emerged adults.

seems more probable, as it could be selected at first for an increased resistant protein activity.

The possibility of secondary recombination events, potentially increasing the diversity, makes it difficult to know precisely how many *sensu stricto* duplication events (*i.e.* events that generate an *ace-1^D* allele from single-copy alleles) actually hap-

pened. However, we can reasonably affirm that many *sensu stricto* duplication events were selected for in natural populations, and more so than G119S point mutation events: the strong structure of *ace-1* diversity between *Cx. pipiens* and *Cx. quinquefasciatus* taxa, indeed supports the occurrence of independent duplication events in each

taxon; each duplicated alleles displaying identical susceptible and resistance copy most probably originated from independent events (the probability of such pattern through unequal crossing-over is extremely low); finally, the *ace-1^D* alleles are mostly restricted to a limited geographic area in *Cx. pipiens*, therefore independent events of duplication have probably occurred in each geographic zone in this taxon. Moreover, the complexity of the detection protocol, which requires live individuals and successive crosses, prevented an exhaustive search: D alleles with a low frequency in the natural populations are probably not detected, which suggests even more alleles than already observed.

This high number of *ace-1* heterogeneous duplications, found in almost all the populations sampled, confirms that they are adaptive. As the insecticides generally target essential proteins, *i.e.* proteins already submitted to intense purifying selection, resistance is often reduced to very few options: only few mutations are possible without lethal consequences for the protein function (this is particularly the case for *ace-1*: the same substitution has been selected at least four times in *Culex pipiens* and the same mutation is present in other species, Weill et al. 2003, 2004a,b; Djogbénu et al. 2007). However, this resistance inevitably comes at high price: the resistance mutation also reduces the protein activity. The case of *Rdl* in *D. melanogaster* seems to be similar: a protein activity decrease is linked to insecticide resistance (Remnant et al. 2013). In both cases, evolutionary outcomes were limited: only the heterogeneous duplications allowed escaping this irreducible trade-off, by restoring the protein activity while maintaining a significant resistance level. In the mosaic of treated and untreated areas resulting from treatment practices, this balanced phenotype is probably the most advantageous.

Are all these duplications successful?

Previous studies analyzing three duplicated alleles have shown that, while one was indeed better than both single-copy alleles and thus invasive in vector

control context, the two others were sublethal when homozygous (Labbé et al. 2007b, 2014b). The present study shows that the successful *ace-1* heterogeneous duplications are actually the exception.

The fitness consequences of ten duplicated alleles were tested, either by measuring their performances for two life-history traits (pre-imaginal mortality and development time), or by measuring their integrative fitness through experimental evolution. In all cases, two phenotypes were found.

Two alleles, D₁ and D₂₄, performed almost as well as SS individuals: they show mortalities similar to that expected for susceptible mosquitoes, with survival and development times similar for DD and DS genotypes, and they rapidly invaded the cage populations during the experimental evolution assay (Tab. 3 and Fig. 4 and 5). Interestingly, they nevertheless appeared to reach a plateau around the sixth generation (Fig. 3). This could suggest a limited cost compared to the susceptible allele, probably due to the production of both susceptible and resistant proteins, the latter being less active, as suggested by a previous study (Labbé et al. 2014).

However, the large majority (8/10) showed a strong fitness cost when homozygous: after six generations of selection they barely increased in frequency for two of them, the other remaining at their initial frequency (Fig. 3). That means that DD individuals barely contributed to the next generation, *i.e.* a fitness close to 0 (similar to the SS killed by the insecticide, Tab. 4). Interestingly, they nevertheless showed diverse patterns in the expression of that cost for the measured life-history traits: for some alleles the DS genotype was also impacted, suggesting that the recessivity of the cost could be variable (Fig. 4 and 5). More importantly, it suggests that these alleles are costly for different reasons. This conclusion is validated further by the complementation experiment: every tested pairs of two homozygous sub-lethal alleles compensated each other's deficiencies in D_xD_y heterozygotes (Fig. 6A and B). This demonstrates

that the selective costs they carry have different origins, independent from the G119S mutation or some biochemical equilibrium disruption due to an increase in gene-dosage (as shown by Labbé et al. 2007b, 2014), and thus results from independent events of duplication.

Two hypotheses have been suggested previously (Labbé et al. 2007a,b): the chromosomal re-arrangements could generate (break points inactivating functional genes) or capture (hitchhiking) recessive lethal mutations, that would be difficult to purge as they also reduce the recombination. These hypotheses are not exclusives and can both contribute to the diversity of the various selective costs we measured. Moreover, the relatively large number of D alleles tested revealed that the selective costs are probably not linked to molecular mechanism at the origin of the duplicated allele: both D₁ and D₅ were probably generated through replication slippage, and D₂₄ and D₃ probably through unequal crossing-over; in both cases the latter allele was sub-lethal when homozygous, while the former carried little cost. Similarly both patterns can be observed in the same sub-species (e.g. D₁ and D₅ in *Cx. quinquefasciatus*).

Studying the fitness consequences of the *ace-1* heterogeneous duplications thus revealed that most are deleterious at the homozygous state and that these costs have different origins. It also demonstrated that the ten alleles studied result from independent duplication events, confirming the high rate of duplication around this locus (and suggesting that secondary recombination events are at best rare). Does it also help us understanding the distribution of these alleles around the World?

Independent and costly duplications are maintained in the populations through complementation and overdominance

Mosquitoes are known for spreading easily and widely thanks to human activities (Asahina 1970; Tatem et al. 2006; Benedict et al. 2007). The distribution of the OPs resistance alleles illustrates this capacity: one allele of the *Ester* locus has in-

vaded the whole world in a few years (Raymond et al. 1991; Guillemaud et al. 1996; Labbé et al. 2005); similarly, the single-copy *ace-1* resistance alleles R₁ and R₂ are widely distributed in *Cx. pipiens* and *Cx. quinquefasciatus*, respectively (Fig. 1): sequences identical over 3919 and 2787 bp (resp.) were retrieved from samples thousand kilometers apart.

The D₁ allele also shows a large geographic distribution: we found the same allele in Mayotte in the Indian Ocean than the allele isolated from a population from Martinique in the Caribbean ten years before and > 12,000 km apart: the sequences are identical over 5574 bp, and both conferred the same low-cost phenotype (Labbé et al. 2014, this study). This allele, which invaded the populations from Martinique, rapidly replacing the local *ace-1^R* (R₂, Yebakima et al. 2004), apparently managed to spread even more widely. The invasive capacity of D₁ is also supported by other observations: series of backcrosses were performed while trying to isolate the various D alleles present in Mayotte samples (D₁, D₅, D₂₀, D₂₁, and D₂₆); at the end, only D₁ was retrieved, the other alleles being lost during the process. Because of its low-cost, D₁ allele was probably selected over the other homozygous sub-lethal alleles (D₅ at least presented this phenotype, Fig. 3).

By contrast, the other *ace-1^D* alleles were mostly restricted to limited geographical ranges: they were generally found in only one population, or in geographically close populations, mostly with several duplications segregating together (Fig. 1). This high degree of polymorphism (up to five D alleles in the same sample) probably results from the majority of the D alleles being sub-lethal when homozygous. When rare, these alleles are mostly at the heterozygous DS state and are thus selected for (D₂ and D₃ invaded Montpellier populations in less than three years; Labbé et al. 2007b). As they increase in frequency, they are more and more found as homozygotes, which are eliminated. However, we showed that heterozygotes carrying two D alleles (D_xD_y) were not affected by the same cost

than the respective D_xD_x and D_yD_y homozygotes (Fig. 6A and B). In presence of insecticides, this creates a complex situation of balanced selection: all the heterozygotes (DS , DR and D_xD_y) are fitter than the homozygotes (SS are killed by the insecticides, RR endure a high fitness cost). This complex overdominance pattern maintains the allelic polymorphism, particularly for the D alleles. This is for example the case in Montpellier area, where both D_2 and D_3 were retrieved after 10 years, and where their combined frequency plateaued at a frequency $\sim 20\%$ for several years (Labbé et al. 2007b, this study).

In conclusion, our study reveals that independent heterogeneous duplications can be generated quite easily: they are selected for in contexts where a balanced phenotype is better achieved by a heterozygous genotype, as they cancel its segregation cost. However, this frequent process is quite messy, as our study shows that most of these alleles are defective when homozygous, preventing them from reaching fixation in natural populations. Moreover, as they can complement each other's flaws, it creates a complex situation of overdominance that favors the maintenance, and can even increase, the D polymorphism in natural populations. Almost none escape that fate (e.g. D_1), but those can then invade populations a World apart.

Acknowledgments

We are very grateful to N Pasteur for helpful comments on the manuscript, to DM Fonseca and BJ Johnson at the Rutgers University (NJ, USA) for providing samples from the USA hybrid zone, and to M Raymond, J Catalan and J Vontas for providing samples. This work was funded by French ANR program (project “SilentAdapt” BIOADTAPT 2013-2015). All sequence data were obtained on the ISEM Environmental Genomic Platform. This study is the contribution of the Institut des Sciences de l'Évolution de Montpellier (UMR 5554, CNRS-UM-IRD-EPHE).

Competing financial interests

The authors declare that they have no competing financial interest.

References

- Alout, H., L. Djogbénu, C. Berticat, F. Chandre, and M. Weill. 2008. Comparison of *Anopheles gambiae* and *Culex pipiens* acetylcholinesterase 1 biochemical properties. *Comp. Biochem. Physiol. B. Biochem. Mol. Biol.* 150:271–277.
- Alout, H., P. Labbé, N. Pasteur, and M. Weill. 2010. High incidence of *ace-1* duplicated haplotypes in resistant *Culex pipiens* mosquitoes from Algeria. *Insect Biochem. Mol. Biol.* 41:29–35. Elsevier.
- Alout, H., and M. Weill. 2008. Amino-acid substitutions in acetylcholinesterase 1 involved in insecticide resistance in mosquitoes. *Chem. Biol. Interact.* 175:138–41.
- Asahina, S. 1970. Transoceanic flight of mosquitoes on the Northwest Pacific. *Japanese J. Med. Sci. Biol.* 23:255–258.
- Assogba, B. S., L. S. Djogbénu, P. Milesi, A. Berthomieu, J. Perez, D. Ayala, F. Chandre, M. Makoutodé, P. Labbé, and W. Mylène. 2015. An *ace-1* gene duplication resorbs the fitness cost associated with resistance in *Anopheles gambiae*, the main malaria mosquito. *Sci. Rep.* 5:1–12.
- Axelsson, E., A. Ratnakumar, M.-L. Arendt, K. Maqbool, M. T. Webster, M. Perloski, O. Liberg, J. M. Arnemo, A. Hedhammar, and K. Lindblad-Toh. 2013. The genomic signature of dog domestication reveals adaptation to a starch-rich diet. *Nature* 495:360–4.
- Benedict, M. Q., R. S. Levine, W. A. Hawley, and L. P. Lounibos. 2007. Spread of the tiger: global risk of invasion by the mosquito *Aedes albopictus*. *Vector Borne Zoonotic Dis.* 7:76–85.
- Berticat, C., G. Boquien, M. Raymond, and C. Chevillon. 2002. Insecticide resistance genes induce a mating competition cost in *Culex pipiens* mosquitoes. *Genet. Res.* 79:41–47.

- Bourguet, D., T. Guillemaud, C. Chevillon, and M. Raymond. 2004. Fitness costs of insecticide resistance in natural breeding sites of the mosquito *Culex pipiens*. *Evolution*. 58:128–135. Wiley Online Library.
- Bourguet, D., M. Raymond, J. Bisset, N. Pasteur, and M. Arpagaus. 1996. Duplication of the *ace-1* locus in *Culex pipiens* mosquitoes from the Caribbean. *Biochem. Genet.* 34:351–362. Springer.
- Bourguet, D., A. Roig, J. P. Toutant, and M. Arpagaus. 1997. Analysis of molecular forms and pharmacological properties of acetylcholinesterase in several mosquito species. *Neurochem. Int.* 31:65–72.
- Cui, F., M. Raymond, A. Berthomieu, H. Alout, M. Weill, and C.-L. Qiao. 2006. Recent emergence of insensitive acetylcholinesterase in Chinese populations of the mosquito *Culex pipiens* (Diptera: Culicidae). *J. Med. Entomol.* 43:878–883.
- Djogbénu, L., F. Chandre, A. Berthomieu, R. Dabiré, A. Koffi, H. Alout, M. M. Weill, R. Dabire, and L. Djogbenou. 2008. Evidence of introgression of the *ace-1R* mutation and of the *ace-1* duplication in west African *Anopheles gambiae* s.s. *PLoS One* 3:e2172, 1–7.
- Djogbénu, L., V. Noel, and P. Agnew. 2010. Costs of insensitive acetylcholinesterase insecticide resistance for the malaria vector *Anopheles gambiae* homozygous for the G119S mutation. *Malar. J.* 9:12.
- Djogbénu, L., M. Weill, J. M. Hougard, M. Raymond, M. Akogbéto, and F. Chandre. 2007. Characterization of insensitive acetylcholinesterase (*ace-1R*) in *Anopheles gambiae* (Diptera: Culicidae): resistance levels and dominance. *J. Med. Entomol.* 44:805–810.
- Duron, O., P. Labbé, C. Berticat, F. Rousset, S. Guillot, M. Raymond, and M. Weill. 2006. High Wolbachia density correlates with cost of infection for insecticide resistant *Culex pipiens* mosquitoes. *Evolution* 60:303–314.
- Emerson, J. J., M. Cardoso-Moreira, J. O. Borevitz, and M. Long. 2008. Natural selection shapes genome-wide patterns of copy-number polymorphism in *Drosophila melanogaster*. *Science* 320:1629–1631.
- Feyereisen, R., W. Dermauw, T. Van Leeuwen, and T. Van Leeuwen. 2015. Genotype to phenotype, the molecular and physiological dimensions of resistance in arthropods. *Pestic. Biochem. Physiol.* 121:61–77.
- Fonseca, D. M., N. Keyghobadi, C. A. Malcolm, C. Mehmet, F. Schaffner, M. Mogi, R. C. Fleischer, and R. C. Wilkerson. 2004. Emerging vectors in the *Culex pipiens* complex. *Science* 303:1535–1538.
- Georghiou, G. P., R. L. Metcalf, and F. E. Gidden. 1966. Carbamate-resistance in mosquitos. Selection of *Culex pipiens fatigans* Wiedemann (= *C. quinquefasciatus* Say) for resistance to Baygon. *Bull. World Health Organ.* 35:691–708.
- Guillemaud, T., T. Lenormand, D. Bourguet, C. Chevillon, N. Pasteur, and M. Raymond. 1998. Evolution of resistance in *Culex pipiens* : Allele replacement and changing environment. *Evolution* (N. Y). 52:443–453. JSTOR.
- Guillemaud, T., S. Rooker, N. Pasteur, and M. Raymond. 1996. Testing the unique amplification event and the worldwide migration hypothesis of insecticide resistance genes with sequence data. *Heredity* (Edinb). 77:535–543.
- Hahn, M. W. 2009. Distinguishing among evolutionary models for the maintenance of gene duplicates. *J. Hered.* 100:605–17.
- Haldane, J. B. S. 1954. *The biochemistry of genetics*. George Allen and Unwin, London.
- Innan, H., and F. Kondrashov. 2010. The evolution of gene duplications: classifying and distinguishing between models. *Nat. Rev. Genet.* 11:97–108.
- Itsara, A., G. M. Cooper, C. Baker, S. Girirajan, J. Li, D. Absher, R. M. Krauss, R. M. Myers, P. M. Ridker, D. I. Chasman, H. Mefford, P. Ying, D. A. Nickerson, and E. E. Eichler. 2009. Population analysis of large copy number variants and hotspots of human genetic disease. *Am. J. Hum. Genet.* 84:148–161.

- Katju, V., and U. Bergthorsson. 2013. Copy-number changes in evolution: rates, fitness effects and adaptive significance. *Front. Genet.* 4:273.
- Kondrashov, F. A., and A. S. Kondrashov. 2006. Role of selection in fixation of gene duplications. *J. Theor. Biol.* 239:141–151. Elsevier.
- Labbé, P., A. Berthomieu, C. Berticat, H. Alout, M. Raymond, T. Lenormand, and M. Weill. 2007a. Independent duplications of the acetylcholinesterase gene conferring insecticide resistance in the mosquito *Culex pipiens*. *Mol. Biol. Evol.* 24:1056–1067.
- Labbé, P., C. Berticat, A. Berthomieu, S. Unal, C. Bernard, M. Weill, and T. Lenormand. 2007b. Forty years of erratic insecticide resistance evolution in the mosquito *Culex pipiens*. *PLoS Genet.* 3:e205. Public Library of Science.
- Labbé, P., T. Lenormand, and M. Raymond. 2005. On the worldwide spread of an insecticide resistance gene: A role for local selection. *J. Evol. Biol.* 18:1471–1484.
- Labbé, P., P. Milesi, A. Yébakima, N. Pasteur, M. Weill, and T. Lenormand. 2014a. GENE-dosage effects on fitness in recent adaptive duplications: *ace-1* in the mosquito *Culex pipiens*. *Evolution* 68:2092–101.
- Labbé, P., P. Milesi, A. Yébakima, N. Pasteur, M. Weill, and T. Lenormand. 2014b. Gene-dosage effects on fitness in recent adaptive duplications: *ace-1* in the mosquito *Culex pipiens*. *Evolution.* 68:2092–2101.
- Langley, C. H., K. Stevens, C. Cardeno, Y. C. G. Lee, D. R. Schrider, J. E. Pool, S. A. Langley, C. Suarez, R. B. Corbett-Detig, B. Kolaczowski, S. Fang, P. M. Nista, A. K. Holloway, A. D. Kern, C. N. Dewey, Y. S. Song, M. W. Hahn, and D. J. Begun. 2012. Genomic variation in natural populations of *Drosophila melanogaster*. *Genetics* 192:533–598.
- Lenormand, T., D. Bourguet, T. Guillemaud, and M. Raymond. 1999. Tracking the evolution of insecticide resistance in the mosquito *Culex pipiens*. *Nature* 400:861–864.
- Lenormand, T., T. Guillemaud, D. Bourguet, and M. Raymond. 1998. Appearance and sweep of a gene duplication: Adaptive response and potential for new functions in the mosquito *Culex pipiens*. *Evolution* (N. Y.).
- Librado, P., and J. Rozas. 2009. DnaSP v5: A software for comprehensive analysis of DNA polymorphism data. *Bioinformatics* 25:1451–1452.
- Liebman, K. A., J. Pinto, J. Valle, M. Palomino, L. Vizcaino, W. Brogdon, and A. Lenhart. 2015. Novel mutations on the *ace-1* gene of the malaria vector *Anopheles albimanus* provide evidence for balancing selection in an area of high insecticide resistance in Peru. *Malar. J.* 14:1–10.
- Lipinski, K. J., J. C. Farslow, K. A. Fitzpatrick, M. Lynch, V. Katju, and U. Bergthorsson. 2011. High spontaneous rate of gene duplication in *Caenorhabditis elegans*. *Curr. Biol.* 21:306–310. Elsevier Ltd.
- Lynch, M., W. Sung, K. Morris, N. Coffey, C. R. Landry, E. B. Dopman, W. J. Dickinson, K. Okamoto, S. Kulkarni, D. L. Hartl, and W. K. Thomas. 2008. A genome-wide view of the spectrum of spontaneous mutations in yeast. *Proc. Natl. Acad. Sci.* 105:9272–7.
- Maroni, G., J. Wise, J. E. Young, and E. Otto. 1987. Metallothionein gene duplications and metal tolerance in natural populations of *Drosophila melanogaster*. *Genetics* 117:739–744.
- Massoulié, J., and S. Bon. 1993. L'acétylcholinestérase: une structure originale pour une fonction vitale. *Ann. l'Institut Pasteur* 4:35–49.
- Mattingly, P. F., L. E. Rozeboom, K. L. Knight, H. Laven, F. H. Drummond, S. R. Christophers, and P. G. Schute. 1951. The *Culex pipiens* complex. *Trans. R. Entomol. Soc. London* 102:331–342.
- Nei, M., and J. C. Miller. 1987. A simple method for estimating average number of nucleotide substitutions within and between populations from restriction data. *Genetics* 125:873–879.

- Oakeshott, J. G., A. L. Devonshire, C. Claudianos, T. D. Sutherland, I. Horne, P. M. Campbell, D. L. Ollis, and R. J. Russell. 2005. Comparing the organophosphorus and carbamate insecticide resistance mutations in cholin- and carboxyl-esterases. *Chem. Biol. Interact.* 157–158:269–275.
- Osta, M. A., Z. J. Rizk, P. Labbé, M. Weill, and K. Knio. 2012. Insecticide resistance to organophosphates in *Culex pipiens* complex from Lebanon.
- Perry, G. H., N. J. Dominy, K. G. Claw, A. S. Lee, H. Fiegler, R. Redon, J. Werner, F. A. Villanea, J. L. Mountain, R. Misra, N. P. Carter, C. Lee, and A. C. Stone. 2007. Diet and the evolution of human amylase gene copy number variation. *Nat Genet* 39:1256–1260.
- Raymond, M., A. Callaghan, P. Fort, and N. Pasteur. 1991. Worldwide migration of amplified insecticide resistance genes in mosquitoes. *Nature* 350:151–153.
- Reams, A. B., E. Kofoid, M. Savageau, and J. R. Roth. 2010. Duplication frequency in a population of *Salmonella enterica* rapidly approaches steady state with or without recombination. *Genetics* 184:1077–1094.
- Remnant, E. J., R. T. Good, J. M. Schmidt, C. Lumb, C. Robin, P. J. Daborn, and P. Batterham. 2013. Gene duplication in the major insecticide target site, *Rdl*, in *Drosophila melanogaster*. *Proc. Natl. Acad. Sci. U. S. A.* 110:14705–10.
- Rogers, S. O., and A. J. Bendich. 1988. Extraction of DNA from plant tissues. Pp. A6:1–10 in S. B. Gelvin and R. A. Schilperoort, eds. *Plant Molecular Biology Manual*. Kluwer Academic Publishers, Boston.
- Schrider, D. R., and M. W. Hahn. 2010. Gene copy-number polymorphism in nature. *Proc. Biol. Sci.* 277:3213–21.
- Schrider, D. R., D. Houle, M. Lynch, and M. W. Hahn. 2013. Rates and genomic consequences of spontaneous mutational events in *Drosophila melanogaster*. *Genetics* 194:937–54.
- Spofford, J. B. 1969. Heterosis and the evolution of duplications. *Am. Nat.* 103:407–432.
- Strickman, D., and D. M. Fonseca. 2012. Autogeny in *Culex pipiens* complex mosquitoes from the San Francisco Bay area. *Am. J. Trop. Med. Hyg.* 87:719–726.
- Tamura, K., G. Stecher, D. Peterson, A. Filipski, and S. Kumar. 2013. MEGA6: Molecular evolutionary genetics analysis version 6.0. *Mol. Biol. Evol.* 30:2725–2729.
- Tatem, A. J., D. J. Rogers, and S. I. Hay. 2006. Estimating the malaria risk of African mosquito movement by air travel. *Malar. J.* 5:57.
- Weill, M., A. Berthomieu, C. Berticat, G. Lutfalla, V. Nègre, N. Pasteur, A. Philips, J.-P. P. Leonetti, P. Fort, and M. Raymond. 2004a. Insecticide resistance: A silent base prediction.
- Weill, M., P. Fort, A. Berthomieu, M. P. Dubois, N. Pasteur, and M. Raymond. 2002. A novel acetylcholinesterase gene in mosquitoes codes for the insecticide target and is non-homologous to the ace gene in *Drosophila*. *Proceeding R. Soc. London* 2007–2016. The Royal Society.
- Weill, M., G. Lutfalla, K. Mogensen, F. Chandre, A. Berthomieu, C. Berticat, N. Pasteur, A. Philips, P. Fort, and M. Raymond. 2003. Insecticide resistance in mosquito vectors. *Nature* 423:136–137.
- Weill, M., C. Malcolm, F. Chandre, K. Mogensen, A. Berthomieu, M. Marquine, and M. Raymond. 2004b. The unique mutation in *ace-1* giving high insecticide resistance is easily detectable in mosquito vectors. *Insect Mol. Biol.* 13:1–7.
- Yebakima, A., M. Marquine, J. Rosine, M.-M. Yp-Tcha, and N. Pasteur. 2004. Evolution of resistance under insecticide selection pressure in *Culex pipiens quinquefasciatus* (Diptera, Culicidae) from Martinique. *J. Med. Entomol.* 41:718–725. BioOne.

Many independent heterogeneous gene duplications solve the resistance trade-off in mosquitoes, but often at a cost

Pascal Milesi¹, Benoît S. Assogba^{1,2}, Célestine M. Atyame³, Nicolas Pocquet^{4,5}, Sandra Unal¹, Patrick Makoundou¹, Arnaud Berthomieu¹, Mylène Weill¹, Pierrick Labbé^{1*}

Supplementary Files

Figure S1: Sampled mosquito populations.

Geographic Zone	Country/Region	Map #	Sampling Period	Species	Localities	References		
Europe Z1	Netherlands	1	1992	<i>Cx. molestus</i>	Heteren	Weill et al. 2003		
	Belgium	2	1991	<i>Cx. molestus</i>	Bruges	Raymond et al. 1996		
	France		3	2003	<i>Cx. pipiens</i>	St-Etienne	Duron et al. 2005	
			4	2001 / 2011	<i>Cx. pipiens</i>	Ganges	Labbé et al. 2007 / This study	
			5	2001 / 2011	<i>Cx. pipiens</i>	Maurin	Labbé et al. 2007 / This study	
			6	2011	<i>Cx. pipiens</i>	Perpignan	This study	
	Portugal	7	1993	<i>Cx. pipiens</i>	Praia de Sado	Bourguet et al. 1996		
	Spain	8	2005	<i>Cx. pipiens</i>	El palmar	Duron et al. 2007		
	Italia		9	1994	<i>Cx. pipiens</i>	Padua	Bourguet et al. 1997	
			10	unknown	<i>Cx. molestus</i>	Rome	Dumas et al. 2013	
	Greece		11	2002	<i>Cx. pipiens</i>	East-Heraklion	Duron et al. 2005	
			12	2014	<i>Cx. pipiens</i>	West-Heraklion	This study	
Near East Z2	Cyprus	13	2003	<i>Cx. pipiens</i>	Nykosia	Duron et al. 2006		
	Lebanon		14	2009	<i>Cx. pipiens</i>	Beirut	Osta et al. 2012	
			15	2010	<i>Cx. pipiens</i>	Beirut	Dumas et al. 2013	
	Israel	16	2010	<i>Cx. pipiens</i>	Tel Aviv	Alout et al. submitted		
Maghreb Z3		17	1990	<i>Cx. pipiens</i>	Sayada	Ben Cheikh & Pasteur 1993		
		18	2011	<i>Cx. pipiens</i>	Ras Jebel	This study		
		19	2011	<i>Cx. pipiens</i>	Azib	This study		
		20	2011	<i>Cx. pipiens</i>	Utica	This study		
		Tunisia		21	2011	<i>Cx. pipiens</i>	Sidi Thabet	This study
				22	2011	<i>Cx. pipiens</i>	DJedeida	This study
				23	2011	<i>Cx. pipiens</i>	Al Battan	This study
				24	2011	<i>Cx. pipiens</i>	Testour	This study
		Algeria		25	2011	<i>Cx. pipiens</i>	Hamra	This study
				26	2006	<i>Cx. pipiens</i>	Constantine	Alout et al. 2010
				27	2006	<i>Cx. pipiens</i>	Algiers	Alout et al. 2010
				28	2006	<i>Cx. pipiens</i>	Algiers	Alout et al. 2010
29	2006			<i>Cx. pipiens</i>	Oued Tafna	Alout et al. 2010		
Sub-Saharan Africa Z4	Mali	30	2008	<i>Cx. quinquefasciatus</i>	Bamako	This study		
	Burkina-Faso	31	2001	<i>Cx. quinquefasciatus</i>	Bobo-diulasso	Weill et al. 2003		
	Ivory Coast	32	1994	<i>Cx. quinquefasciatus</i>	Bouaké	Weill et al. 2003		
	Togo	33	2014	<i>Cx. quinquefasciatus</i>	Baguida	This study		
	Benin		34	2005	<i>Cx. quinquefasciatus</i>	Cotonou	Duron et al. 2007	
			35	2011	<i>Cx. quinquefasciatus</i>	Acoua	Pocquet et al. 2013	
			36	2011	<i>Cx. quinquefasciatus</i>	Tsoundzou	Pocquet et al. 2013	
			37	2011	<i>Cx. quinquefasciatus</i>	Sada	Pocquet et al. 2013	
	Mayotte		38	2011	<i>Cx. quinquefasciatus</i>	M'tsamoudou	Pocquet et al. 2013	
			39	2007	<i>Cx. quinquefasciatus</i>	Ste-Suzanne	Tantely et al. 2010	
			40	2007	<i>Cx. quinquefasciatus</i>	St-Leu	Tantely et al. 2010	
			41	2007	<i>Cx. quinquefasciatus</i>	St-Pierre	Tantely et al. 2010	
Mauritius	42	2010	<i>Cx. quinquefasciatus</i>	Port Louis	Dumas et al. 2013			
South Africa		43	2001	<i>Cx. quinquefasciatus</i>	Johannesburg	Salzberg et al. 2009		
		44	1993	<i>Cx. quinquefasciatus</i>		Weill et al. 2003		

		45	1993	<i>Cx. quinquefasciatus</i>	Bedford	Weill et al. 2003
Asia Z5	India	46	1995	<i>Cx. quinquefasciatus</i>	Cochin	Weill et al. 2003
	China	47	unknown	<i>Cx. pallens</i>	Hangzhou	Dumas et al. 2013
	Philippines	48	2003	<i>Cx. quinquefasciatus</i>	Manila	Duron et al. 2006
		<u>49</u>	<u>2003</u>	<i>Cx. quinquefasciatus</i>	<i>Palawan</i>	<i>Labbé et al. 2007</i>
Oceania Z5	Australia	50	1993	<i>Cx. pipiens</i>	Melbourne	Guillemaud et al. 2007
	New-Caledonia	51	2012	<i>Cx. quinquefasciatus</i>	Poindimié	Dumas et al. 2013
North- America Z6		52	1950	<i>Cx. quinquefasciatus</i>	San Joaquin Valley	Georghiou et al. 1966
		53	1984	<i>Cx. quinquefasciatus</i>	Los Angeles	Duron et al. 2005
		54	2012	<i>Cx. quinquefasciatus</i>	Albuquerque	This study
		55	1987	<i>Cx. pipiens</i>	Minneapolis	Duron et al. 2005
		56	2010	<i>Cx. molestus</i>	New-York	Fonseca DM, unpub. data
	USA	57	2002-2006		Winston-Salem	Fonseca DM, unpub. data
		58	2002-2006		Charlotte	Fonseca DM, unpub. data
		59	2002-2006		Brevard	Fonseca DM, unpub. data
		60	2002-2006	<i>Hybrids</i>	Greenville	Fonseca DM, unpub. data
		61	2002-2006	<i>Cx. pipiens/quinquefasciatus</i>	Blairville	Fonseca DM, unpub. data
		62	2002-2006		Oxford	Fonseca DM, unpub. data
		63	2002-2006		Covington	Fonseca DM, unpub. data
		64	2002-2006		Charleston	Fonseca DM, unpub. data
	Caribbean Sea Z6	Cuba	65	1986	<i>Cx. quinquefasciatus</i>	Havana City
Martinique		66	2003 / 2012	<i>Cx. quinquefasciatus</i>	Ducos	Labbé et al. 2007 / This study
South America Z6	Venezuela	67	1991	<i>Cx. quinquefasciatus</i>	Caracas	This study
		68	1991	<i>Cx. quinquefasciatus</i>	Punto Miranda	This study
	Brazil	69	1995	<i>Cx. quinquefasciatus</i>	Recife	Weill et al. 2003

For each sampled populations, the geographic zone, the country, the locality, the collection year, the taxa and the references where the sample of the population was first described are presented. # refers to the map (Fig. 1). The twenty five samples tested for the presence of *ace-1^D* are bolded. Populations where a duplicated allele has been described are italicized and their # underlined.

Figure S2: Molecular tests

<i>D alleles discrimination in pools</i>							
<u>Alleles discriminated</u>	<u>PCR</u>	<u>Forward</u>	<u>Reverse</u>	<u>RFLP</u>	<u>Size</u>	<u>T°C</u>	<u>Elong.</u>
Generalist	G-PCR	Intron1dir2	CpEx3rev	-	580	55	1'
Slab	Slab-PCR	Slab-F	CpEx3rev	-	509	63	45"
D ₁	D ₁ -PCR	DucosEx3dir	DucosEx3rev	-	339	66	30"
D ₅	G-PCR	Intron1dir2	CpEx3rev	PspOM1	580	55	1'
D ₁₃	G-PCR	Intron1dir2	CpEx3rev	BsrBI	580	55	1'
D ₁₅	D ₁₅ -PCR	D ₁₅ Ex3dir	D ₁₅ Ex3rev	-	492	62	45"
D ₁₆	D ₁₆ -PCR	D ₁₆ Ex3dir	D ₁₆ D ₁₈ Ex3rev	-	170	46	45"
D ₁₈	D ₁₈ -PCR	D ₁₈ Ex3dir	D ₁₆ D ₁₈ Ex3rev	-	176	62	45"
D ₁₉	D ₁₉ S-PCR	D ₁₉ SEx3dir	CpEx3rev	-	508	53	45"
D ₂₁	D ₂₁ -PCR	D ₂₁ Ex3dir	CpEx3rev	Hinfl	575	55	1'
D ₂₄	D ₂₄ S-PCR	D ₂₄ SEx3dir	CpEx3rev	NlaIII	513	53	1'
D ₂₆	G-PCR	Sequencing	-	-	-	-	-
D ₂₇	G-PCR	Intron1dir2	CpEx3rev	BsrBI	580	55	1'
<i>Individuals and clones phenotyping</i>							
<u>Genotypes discriminated</u>	<u>PCR</u>	<u>Forward</u>	<u>Reverse</u>	<u>RFLP</u>	<u>Size</u>	<u>Hybrid.</u>	<u>Elong.</u>
SS vs RR vs (RS, DS, DD and DR)	G-PCR	Intron1dir2	CpEx3rev	AluI	580	55	1'
S vs R	G-PCR	Intron1dir2	CpEx3rev	AluI	580	55	1'
<i>D alleles evolutionary experiment</i>							
<u>Genotype discriminated</u>	<u>PCR</u>	<u>Forward</u>	<u>Reverse</u>	<u>RFLP</u>	<u>Size</u>	<u>Hybrid.</u>	<u>Elong.</u>
SS vs (DS and DD)	G-PCR	Intron1dir2	CpEx3rev	AluI	580	55	1'
<i>Life history traits and complementation experiments</i>							
<u>Genotype discriminated</u>	<u>PCR</u>	<u>Forward</u>	<u>Reverse</u>	<u>RFLP</u>	<u>Size</u>	<u>Hybrid.</u>	<u>Elong.</u>
SS vs D _x S vs D _x D _x [†]	G-PCR	Intron1dir2	CpEx3rev	BsrBI	580	55	1'
SS vs D ₁₉ S vs D ₁₉ D ₁₉	D ₁₉ S-PCR	D ₁₉ SEx3dir	CpEx3rev	Hinfl	508	53	45"
SS vs D ₂₄ S vs D ₂₄ D ₂₄	D ₂₄ S-PCR	D ₂₄ SEx3dir	CpEx3rev	NlaIII	513	53	1'

[†] Either for D₂ or D₃ or D₁₃ or D₁₅ or D₁₆ or D₂₇ alleles

For each experiment, the molecular tests used to discriminate the various alleles, genotypes or phenotypes are indicated. The names of the PCR with the associated primers are given. When necessary, a restriction enzyme (RFLP) was used in addition of the PCR. For each PCR, the size of the amplified fragment, the annealing temperature (T°C) in Celsius degree and the elongation time (Elong.) are given.

Figure S3: Primer sequences

Primers	Sequences	References
Intron1dir2	5' - GCGCGAGCATATCCATAGCACT - 3'	Labbé et al. 2007a
CpEx3rev	5' - GACTTGCGACACGGTACTGCA - 3'	Weill et al. 2003
DucosEx3dir	5' - ACACTGGAAGCGCCTAGC - 3'	Labbé et al. 2007a
DucosEx3rev	5' - CGAGGCCAGCGTCCGG - 3'	Labbé et al. 2007a
Slab-F	5' - GGGTCATTAGCCCTTTGCTT - 3'	This study
D ₁₅ Ex3dir	CTGGGAGGGGGCCATTTC	This study
D ₁₅ Ex3rev	AAACCACGATCACGTTCTCT	This study
D ₁₆ Ex3dir	GAGGGGGCTTTTGGAGTAAT	This study
D ₁₈ Ex3dir	5' - CGGTGAGTTCTGGGAGGGGTCA - 3'	This study
D16D ₁₈ Ex3rev	5' - GTACGGAATGCCCATCCA - 3'	This study
D ₁₉ SEx3dir	5' - TCTGGGAGAGGKYTTTTG - 3'	This study
D ₂₀ Ex3dir	5' - TGAACGCGACCAAACCA - 3'	This study
D ₂₁ Ex3dir	5'- GTGAGTTCCAGGAGTT - 3'	This study
D ₂₄ SEx3dir	5' - GTGAGTTCTGGRAGAGG - 3'	This study

For each primer its sequence is indicated with the reference in which it was described

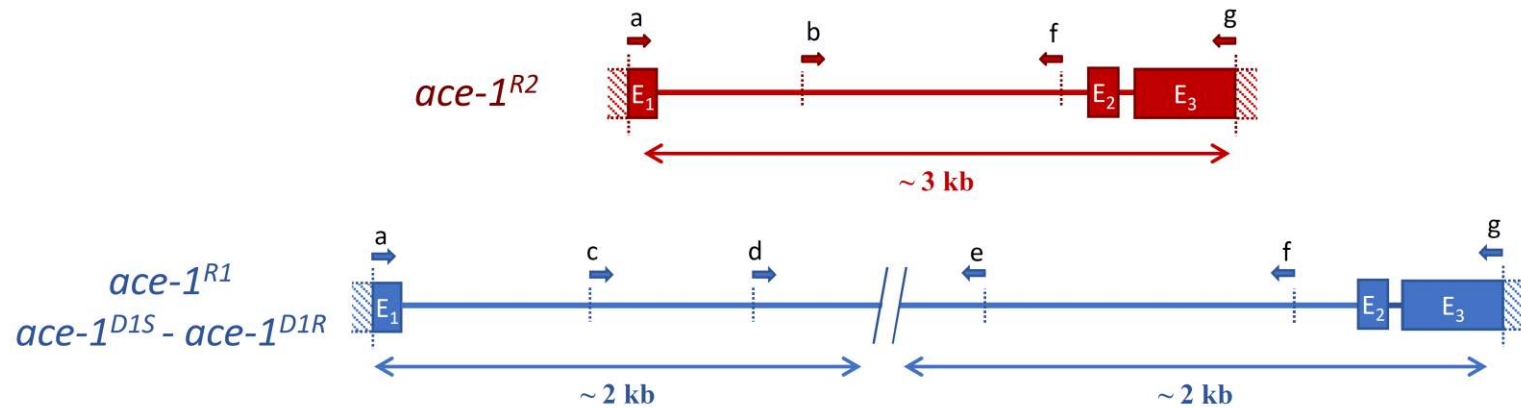
A**B**

Orientation	Primer	Names	Sequences	Taxon
Forward	a	Intron1dir2	5' - CCGGCATCATGACATCGGTAG - 3'	<i>Cx. quinquefasciatus</i> / <i>pipiens</i>
	b	DuMayDir1	5' - ATTCGCCATATTTAAACAGC - 3'	<i>Cx. quinquefasciatus</i>
	c	Rpipint1dir1	5' - CTCTTGATGGCTTTAC - 3'	<i>Cx. pipiens</i>
	d	Rpipint1dir2	5' - AAGGAGGGCATAACAGGG - 3'	<i>Cx. pipiens</i>
Reverse	e	Rpipint1rev1	5' - GCACATTTGGACTGAGTTGC - 3'	<i>Cx. pipiens</i>
	f	DuMauRev1	5' - AAAGCGCGGAACGGATCTC - 3'	<i>Cx. quinquefasciatus</i> / <i>pipiens</i>
	g	CpEx3rev	5' - GACTTGCGACACGGTACTGCA - 3'	<i>Cx. quinquefasciatus</i> / <i>pipiens</i>

Figure S4: *Cx. quinquefasciatus* and *Cx. pipiens* *ace-1* large fragment sequencing. When single-copy resistant alleles were found in several populations, their identity was assessed by *I* locus, encompassing the intron1: ~3 kb and ~ 4 kb respectively for *Cx. quinquefasciatus* and *Cx. pipiens*. Due to the large size of the amplicon, internal primers were necessary to sequence it entirely. **Figure A** represents the position of each primer (arrows) used, with the position of the first amplified base pair. For *ace-1^{R1}* (*Cx. pipiens*) only two non-recovering fragments of the total amplicon were sequenced, starting by each extremity. Positions on each fragment are indicated from 5' to 3' (with a prime for the second fragment). E_i is exon number i. **Table B:** the orientation, the name, the sequence and the corresponding taxon are indicated for each primer. Letters refer to figure A.

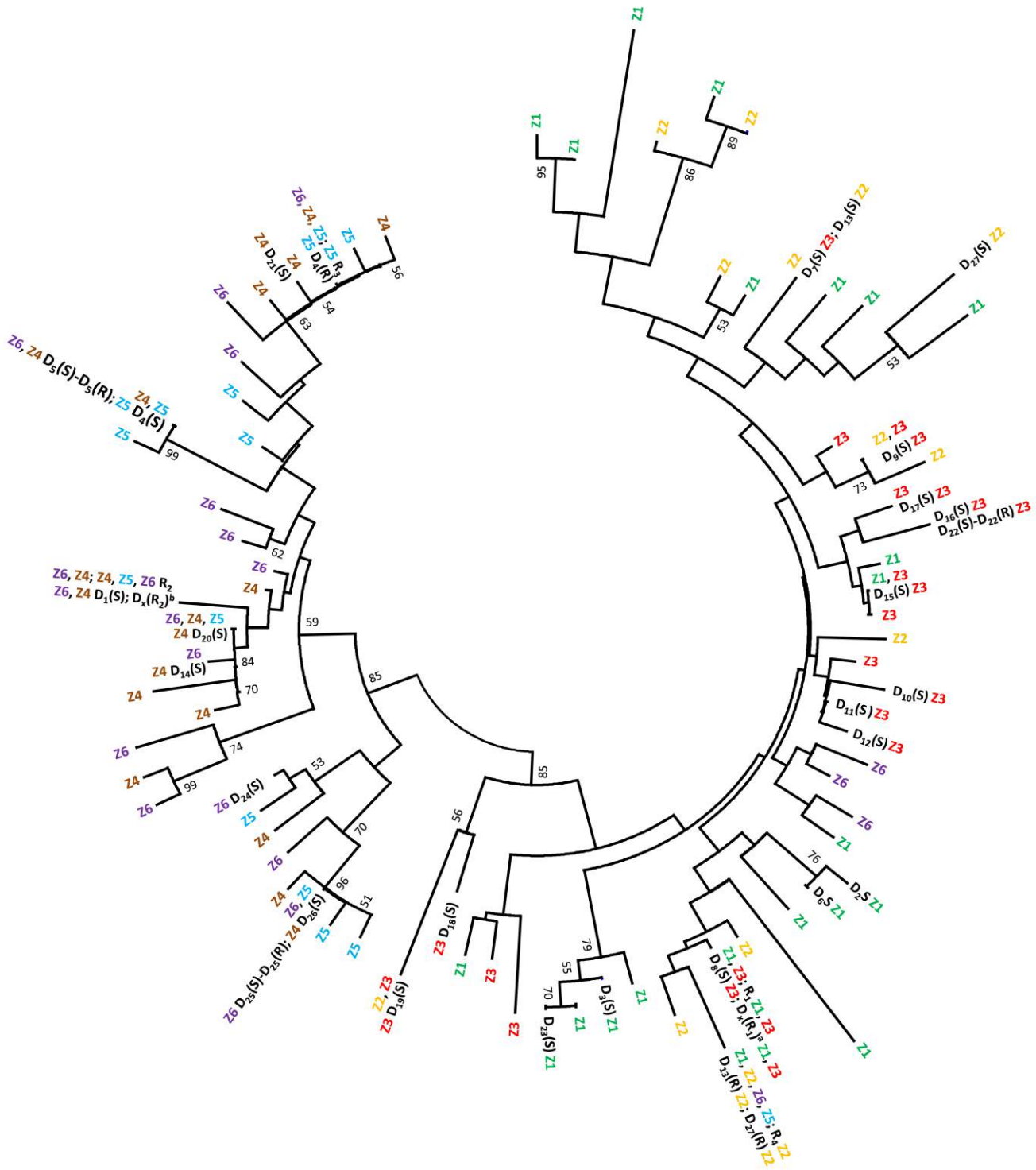

Figure S5: Worldwide distribution of *ace-1* allele diversity. The figure is identical to figure 2 (Jukes-Cantor distance, ClustalW), except only the geographic origin (Z_i, see Tab. S1) is indicated for the susceptible alleles (the resistance alleles are still indicated).

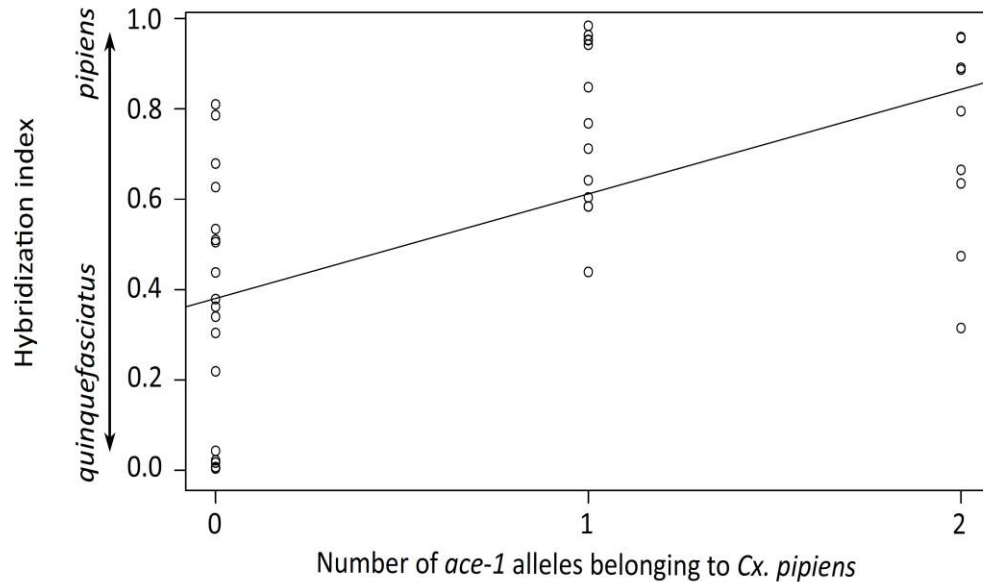

Figure S6: Correlation between the hybridization index and the number of *ace-1* alleles belonging to *Cx. pipiens*. For 43 individuals (dots) originating from eight populations of the eastern USA hybrid zone, two parameters were estimated: i) an hybridization index, estimated as the proportion of *Cx. pipiens* nuclear DNA calculated from taxon-specific microsatellites; ii) the number of *Cx. pipiens ace-1* alleles, which could be 0, 1 or 2 for a diploid individual. The solid line represents the linear regression; the Pearson's product moment correlation coefficient (r) and the significance level are also indicated (topleft, *** $p < 0.001$).

Figure S7: Susceptible and resistant copies in *ace-1* duplications. Mutations are indicated for the D_i(R) and D_i(S) copies of each duplicated haplotype *ace-1*^{D_i}. D₁(R) is the reference sequence. Dashes (-) and stars (*) indicate identities or deletions, respectively. The position from the first nucleotide of intron2 or exon3 is indicated at the top. The mutation at position 367 (boxed) is the only mutation conferring resistance (G119S, see Weill et al. 2003), discriminating between R (which possess an adenine at this position) and S copies (possessing a guanine at this position). Non-synonymous mutations are bolded.

Chapitre 3 : Superdominance et duplications hétérogènes

Introduction

On observe souvent qu'un hybride issu de croisement entre lignées consanguines présente une valeur sélective plus élevée que chacun de ses parents. Ce phénomène de vigueur hybride a été expliqué dès le début du XX^{ème} par le fait que les tares accumulées dans chaque lignée étaient compensées par l'absence des tares dans l'autre lignée, phénomène rassemblé sous le terme général d'hétérosis (East 1908 ; Shull 1908). Ce terme décrivant, au niveau du phénotype une meilleure valeur sélective de l'hybride, a longtemps été expliqué indifféremment, et confusément, par des mécanismes différents (Dobzhansky 1952) dont la traduction actuelle serait : i) une épistasie résultant de la compensation entre allèles de plusieurs locus différents (ex : aa BB x AA bb → Aa Bb : ce génotype qui possède les allèles dominants à chaque locus est donc exempt des effets délétères des mutations récessives fixées chez ses parents) et ii) la superdominance : cas où la valeur sélective des hétérozygotes est supérieure à celles des homozygotes à un locus unique.

Cette notion de superdominance a été formalisée par East (1936), bien que l'idée soit déjà présente dans Fisher (1922). Le terme n'a été proposé que plus tard (Hull 1945). Haldane (1937) puis Crow (1948) ont montré que l'existence de phénomènes de superdominance à un faible nombre de locus serait suffisante pour expliquer le nombre élevé de cas de vigueurs hybrides qui avaient alors été décrits. De même la superdominance a été proposée très tôt comme un mécanisme permettant le maintien du polymorphisme dans les populations naturelles (Fisher 1922). En effet, en raison de la ségrégation mendélienne des allèles, les hétérozygotes dont la valeur sélective est élevée génèrent de nouveaux homozygotes de moindre valeur sélective à chaque nouvelle génération. Ces derniers sont donc éliminés par sélection, et aucun allèle ne peut se fixer dans la population. Ce maintien de génotypes « non-optimaux » dans la population est appelé fardeau de ségrégation. Haldane a ainsi proposé, dès 1954, que la superdominance devrait favoriser l'émergence de duplications hétérogènes associant les deux allèles de l'hétérozygote. En effet, ces nouveaux allèles dupliqués permettraient la fixation du phénotype hétérozygote, car ils ne souffrent pas du fardeau de ségrégation associé aux hétérozygotes standards.

Les exemples empiriques de superdominance sont toutefois restés très limités (à part l'exemple iconique de la drépanocytose en zone impaludée ; Haldane 1949 ; Allison 1956

; Williams et al. 2005)¹. Ce mécanisme a alors été rejeté comme anecdotique par rapport à l'épistasie compensatoire pour expliquer l'hétérosis (Dobzhansky 1952 ; Mather 1955 ; Parsons and Bodmer 1961), et d'autres mécanismes de sélection balancée lui ont été préférés pour expliquer le maintien du polymorphisme (fréquence-dépendance, variation de l'environnement, équilibre mutation/sélection, ...).

De même, malgré le développement des techniques de séquençage et le nombre croissant d'études sur le polymorphisme du nombre de copies de gènes, très peu d'exemples de duplications hétérogènes avantageuses ont été décrit à ce jour (Kondrashov and Kondrashov 2006 ; Hahn 2009). Deux exemples ont toutefois été récemment étudiés : une duplication du locus de résistance *rdl*, associant une copie sensible et une copie résistante dans une souche de laboratoire de *Drosophila melanogaster* (Remnant et al. 2013) et une duplication du gène *kdr* qui pourrait être impliquée dans l'adaptation aux insecticides pyrétrinoïdes chez *Aedes aegypti* (Martins et al. 2013).

Cependant, les duplications hétérogènes du locus *ace-1* chez *Cx pipiens* restent l'exemple le plus approfondi à ce jour. L'étude du phénotype conféré par ces allèles dupliqués D (Chap. 1), a permis de montrer qu'ils confèrent effectivement un phénotype intermédiaire, similaire à celui des hétérozygotes standards RS : en associant une copie sensible S et une copie résistante R sur le même chromosome ils permettent de réduire le coût sélectif associé à la mutation G119S tout en maintenant un niveau de résistance significatif. Pour qu'ils soient avantageux, il faudrait toutefois que le génotype RS soit celui qui confère la plus forte valeur sélective, c'est-à-dire qu'ils apparaissent dans un contexte de superdominance.

Les clines de fréquence observés entre zones traitées ou non dans la région Montpelliéraine étaient expliqués, dans les études précédentes, par l'hypothèse qu'en situation de traitement, le génotype RR était favorisé (niveau de résistance le plus haut), alors qu'en absence de traitement c'est le génotype SS qui était le plus avantageux (à cause des coûts sélectifs associés à la mutation G119S) (Lenormand et al. 1998a). Pourtant, deux allèles D (D₂ et D₃) sont apparus dans ce contexte et ont dans un premier temps été sélectionnés (Labbé et al. 2007b). Il a alors été proposé que les hétérozygotes RS, bien que

¹ Une étude à laquelle j'ai participé (Annexe 1, Diop et al. 2015), a récemment mis en évidence un potentiel phénomène de superdominance au locus *kdr* chez *An. gambiae* : confrontés à des moustiquaires trouées imprégnées de pyrétrinoïdes, alors que la moitié des individus homozygotes sensibles étaient tués avant de pouvoir franchir la moustiquaire et que seuls ~45% des individus homozygotes résistants parvenaient à la franchir (suggérant un coût associé à la mutation des canaux sodiques voltage-dépendants), ~70% des hétérozygotes passaient à travers cette barrière et pouvaient ainsi accéder à un repas sanguin.

n'étant pas le meilleur compromis ni dans la zone traitée ni dans la zone non-traitée, atteignent à une échelle spatiale et / ou temporelle plus large un compromis avantages-coûts plus favorable que chacun des homozygotes (Lenormand et al. 1998a ; Labbé et al. 2014). Ce phénomène appelé superdominance marginale (Wallace 1968) pourrait effectivement permettre la sélection de duplications fixant ce phénotype intermédiaire.

Il existe pourtant une autre possibilité non exclusive. En étudiant les liens génotype-phénotype au locus *ace-1*, nous avons montré que les niveaux de résistance, comme les coûts sélectifs, sont proportionnels à la proportion du nombre de copies résistantes au sein d'un génotype. Ainsi les hétérozygotes ont un niveau de résistance intermédiaire, mais également un coût intermédiaire. Il pourrait donc exister une gamme de doses intermédiaires d'insecticide qui favoriserait directement le compromis avantages-coûts des individus RS (*i.e.* superdominance stricte), et qui serait donc favorable à la sélection des duplications hétérogènes du locus *ace-1*.

J'ai voulu tester cette hypothèse selon laquelle des pressions de sélections intermédiaires pourraient favoriser l'émergence de phénomènes de superdominance au locus *ace-1*. J'ai donc réalisé une étude d'évolution expérimentale dans laquelle j'ai mis en compétition les allèles R et S avec des pressions de sélection (dose d'insecticide, densité larvaire) variables. J'ai également ajouté un allèle dupliqué (D₁) pour tester l'hypothèse de Haldane selon laquelle ces situations de superdominance devraient entraîner la sélection de duplications hétérogènes.

Matériel et méthodes

Souches de moustiques.

Trois souches de laboratoire, homozygotes pour différents allèles du locus *ace-1*, ont été utilisées pour cette étude : l'allèle mono-copie sensible S (souche Slab, Georghiou et al. 1966), l'allèle mono-copie résistant R (souche SR, Berticat et al. 2002) et un allèle dupliqué, D₁ (souche Ducos-DFix, Labbé et al. 2014).

Evolution expérimentale : Cages à populations.

L'élevage a eu lieu en conditions standard d'humidité (> 60 %) et de température (25°C), avec une alternance jour/nuit de 12h. Au départ de l'expérience, un total de 500 larves au deuxième stade larvaire (L2), issues de différentes souches, ont été mélangées en proportions variables. Les larves ont été élevées jusqu'à l'émergence des premiers adultes. Ceux-ci ont été laissés libres de se reproduire et un repas sanguin (poussin) a été proposé

aux femelles. Dès lors l'expérience s'est déroulée sur des cycles hebdomadaires : à j_0 les pontes étaient récoltées et mises ensemble dans un récipient unique contenant environ 400mL d'eau, ce qui induisait une forte densité larvaire ; à j_3 un nouveau repas sanguin était proposé aux femelles ; à j_5 les larves ($\sim L2$) issues des pontes récoltées à j_0 étaient exposées pendant 24h à 0.2ppm de temephos (insecticide OP, Bayer®) ; à j_6 les survivantes étaient rassemblées dans un même récipient, où elles étaient élevées jusqu'à émergence. Les récipients contenant les pontes de semaines successives étaient placés dans la cage pour permettre la libre émergence des adultes.

Les adultes dans les cages étaient donc issus de générations chevauchantes, et ont tous été exposés une fois à l'insecticide au cours de leur vie. Tous les mois, un échantillon de 48 adultes a été prélevé dans la cage pour estimer les fréquences phénotypiques.

Ces conditions d'élevages, haute densité et exposition à 0.2ppm de temephos, ont constitué les conditions de référence de l'expérience. Elles ont été modifiées en diminuant la densité d'élevage des larves ou la dose d'insecticide. Par ailleurs différents allèles ont été mis en compétition, à différentes fréquences initiales.

Phénotypage.

Pour chaque échantillon, le phénotype de 48 moustiques adultes a été établi par spectrophotométrie (test enzymatique TPP, Bourguet et al. 1996). Ce test permet de discriminer trois phénotypes : le phénotype sensible [SS] (génotype SS), le phénotype résistant [RR] (génotype RR), et le phénotype hétérozygote [RS] qui regroupe indistinctement les génotypes RS, DS, DR ou DD.

Des tests moléculaires ont aussi été utilisés. Pour chaque individu testé, l'ADN a été extrait suivant le protocole décrit par Rodgers et Bendich (1988). Un test basé sur une PCR spécifique de la copie sensible de l'allèle D_1 (DucosEx3dir – DucosEx3rev, Labbé et al. 2014) a été réalisé pour discriminer les génotypes contenant cet allèle (DS, DR et DD) de ceux dont il est absent (RR, RS et SS).

Analyses statistiques.

Pour estimer les valeurs sélectives relatives des différents génotypes, un modèle génétique déterministe (reproduction-sélection) considérant des populations infinies et des générations discrètes a été construit :

- Reproduction : la fréquence de chaque génotype dans les larves de la génération i a été calculée à partir des fréquences alléliques dans les gamètes de la génération précédente ($i-1$), sous hypothèse de panmixie.
- Sélection : la sélection a été prise en compte entre les stades larvaire et adulte pour calculer la fréquence de chaque génotype parmi les adultes. Le but étant d'étudier les conditions favorisant l'existence d'une situation de superdominance, les individus hétérozygotes ont servi de référence, soit une valeur sélective $w_{RS} = 1$. Soient S_{SS} et S_{RR} les coefficients de sélections respectifs des homozygotes SS et RR, compris entre -1 et 1 ; les valeurs sélectives de ces deux génotypes sont alors respectivement $w_{SS} = 1 + S_{SS}$ et $w_{RR} = 1 + S_{RR}$. Les fréquences génotypiques chez les adultes survivants (*i.e.* après sélection) permettent ensuite de calculer les fréquences alléliques dans les gamètes.

Le modèle a été ajusté aux données (fréquences phénotypiques) par une approche de maximum de vraisemblance (logiciel R v.3.X, package optim, méthode L-BFGS-B). Les bornes (SL) des coefficients de sélections S_{SS} et S_{RR} ont été estimées à partir du profil de vraisemblance obtenu grâce à 1.10^6 simulations : pour déterminer les équivalents d'intervalles de confiance à 95%, un seuil a été défini à la valeur du maximum de vraisemblance moins 1.96.

Pour tester si les coefficients de sélections étaient différents entre différentes conditions d'élevage, un modèle complet avec un couple de paramètres S_{SS} et S_{RR} par condition a été ajusté aux données. Pour tester la différence entre les deux conditions présentant les couples de paramètres les plus proches, un modèle simplifié, avec un seul couple de paramètres pour ces deux conditions a été comparé au modèle complet par test de ratio des vraisemblances corrigées pour la sur-dispersion (LRT_{od} ; $od = D_{res} / df_{res}$) avec D_{res} et df_{res} , respectivement, la déviance résiduelle et le nombre de degrés de liberté résiduels. Enfin, pour chaque modèle le pourcentage de variance expliquée ($\%TD$) a été calculé : $\%TD = (D_{max} - D_{mod}) / (D_{max} - D_{min})$ avec D_{mod} , D_{min} et D_{max} respectivement la déviance du modèle, la déviance minimale et la déviance maximale.

Table 4 : Les différentes conditions expérimentales réalisées.

Expérience	Condition	Allèles	Dose	Densité
E ₁	c ⁺ d ⁺	S / R	0.20	haute
	c ⁺ d ⁺		0.20	haute
E ₂	c ⁺ d ⁻	S / R	0.20	<i>faible</i>
	c ⁻ d ⁺		<i>0.10</i>	haute
E ₃	c ⁺ d ⁺	S / R	0.20	haute
	c ⁻ d ⁺	S / R	<i>0.14</i>	haute
	D_c ⁺ d ⁺	<i>S / R / D</i>	0.20	haute

Pour chaque expérience, les conditions dans lesquelles les cages ont été maintenues sont présentées. Concentration à 0.2 ppm (c⁺) et élevage à haute densité (d⁺) constituant les conditions standards. Pour chaque condition, le facteur par lequel elle diffère des conditions standards est affiché en gras et italique.

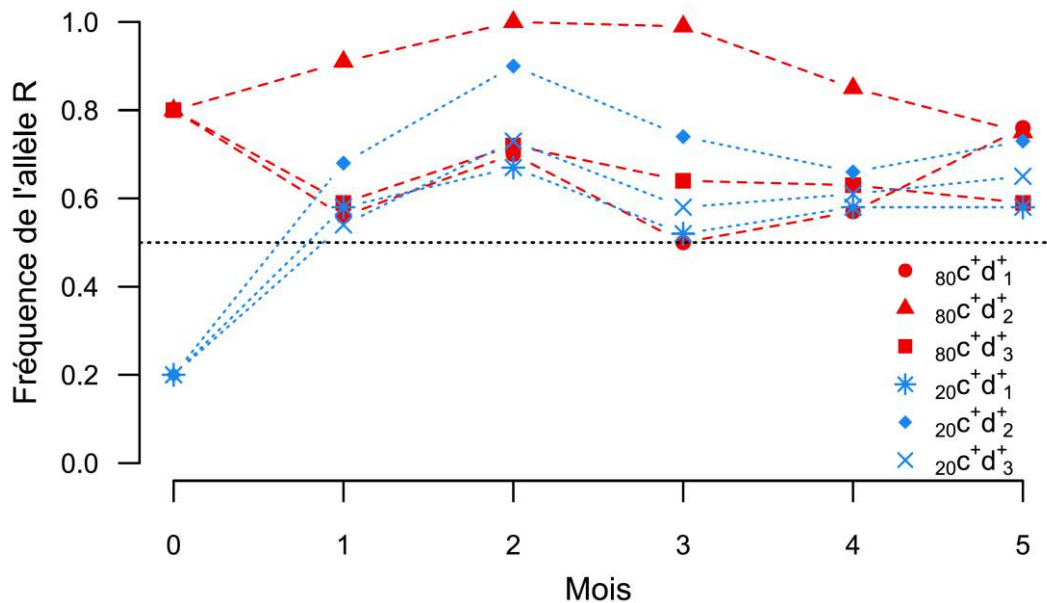

Figure 11 : Dynamique de l'allèle R dans l'expérience 1. La fréquence de l'allèle R estimée chaque mois à partir des fréquences génotypiques est présentée pour chacun des répliques. En rouge (tirets), les répliques dans lesquels l'allèle R était majoritaire au début de l'expérience et en bleu (pointillés), ceux où il était minoritaire. La ligne pointillée horizontale représente la fréquence attendue si seul les individus RS se reproduisent.

Résultats et discussion

En raison du coût de la résistance, une pression de sélection modérée génère une situation de superdominance au locus *ace-1*.

Dans un premier temps, nous avons recherché une situation de superdominance au locus *ace-1* en mettant en compétition uniquement les allèles S et R. Pour la sélection, le temephos a été utilisé car il s'agit de l'insecticide employé pour le traitement des populations autour de Montpellier. Une dose de 0.2 ppm de temephos a été choisie à partir de bio-essais (Labbé et al. 2014) : elle permet de tuer la majorité des homozygotes sensibles SS, une partie seulement des hétérozygotes RS, mais aucun homozygote résistant RR. Par ailleurs, un élevage à haute densité permettait de maximiser le coût associé au génotype RR. Ces conditions (0.2 ppm de temephos, haute densité larvaire) ont constitué les conditions de référence, C_1 (Tab. 4).

Selon la théorie en cas de superdominance, un équilibre identique est atteint pour les fréquences alléliques, quelles que soient leurs valeurs initiales (f_0). Six cages ont donc été lancées en parallèle : dans trois répliques, l'allèle R a été introduit en majorité ($80c^+d^+_1$ à $80c^+d^+_3$; $f_0(R) = 0.8$), et en minorité dans trois autres ($20c^+d^+_1$ à $20c^+d^+_3$; $f_0(R) = 0.2$).

L'évolution de la fréquence de l'allèle R (inférée à partir des fréquences génotypiques) a été suivie pendant cinq mois. Au bout de ces cinq mois, aucun allèle ne s'est fixé et les fréquences de l'allèle R ont convergé dans toutes les cages vers un même plateau ($\sim 0.6 - 0.8$), malgré de fortes variations inter-mensuelles, probablement expliquées par un effet de dérive et d'échantillonnage (Fig. 11). Par exemple dans la cage $80c^+d^+_2$, l'allèle R était quasiment fixé au deuxième mois suite à un fort goulot d'étranglement ; pourtant la fréquence de cet allèle a ensuite convergé avec celles observées dans les autres cages au cinquième mois (Fig. 11).

Les coefficients de sélections S_{SS} et S_{RR} (respectivement associés aux valeurs sélectives des génotypes SS ($w_{SS} = 1 + S_{SS}$) et RR ($w_{RR} = 1 + S_{RR}$), relatives à celle des RS ($w_{RS} = 1$) se sont révélés tous les deux significativement inférieurs à 1, confirmant la superdominance ($w_{SS} < w_{RS} > w_{RR}$). Les individus SS présentent en outre une valeur sélective inférieure aux individus RR, en accord avec les fréquences de l'allèle R, supérieures à 0.5 à l'équilibre (Modèle 1, Tab. 4).

Table 5 : Estimation des coefficients de sélection.

Modèle	Condition	$W_{SS} (SL)$	W_{RS}	$W_{RR} (SL)$	%TD	od
Modèle 1	c^+d^+	0.13 (0.10– 0.16)	1	0.57 (0.43 – 0.53)	0.44	9.07
	c^+d^+	0.17 (0.10 – 0.27)	1	0.78 (0.69 – 0.89)		
Modèle 2	c^+d^-	0.44 (0.34 – 0.73)	1	1.60 (1.39 – 1.87)	0.84	2.74
	c^-d^+	1.21 (1.00 – 1.64)	1	0.69 (0.54 – 0.87)		
Modèle 3	c^+d^+	0.49 (0.42 – 0.57)	1	0.95 (0.70 – 1.27)	0.82	5.46
	c^-d^+	1.63 (1.34 – 1.90)	1	1.64 (0.66 – 1.99)		
	D_ c^+d^+	0.29 (0.26 – 0.36)	1	0.02 (0.00 – 0.08)		

Pour les différents modèles, les valeurs sélectives relatives (w) des différents génotypes ($w_{SS} = 1 + S_{SS}$, $w_{RS} = 1$ et $w_{RR} = 1 + S_{RR}$) dans les différentes conditions ainsi que les bornes qui leur sont associées (SL) sont présentés. Pour chaque modèle, le pourcentage de variance expliqué (%TD) et la sur-dispersion (od) sont également indiqués.

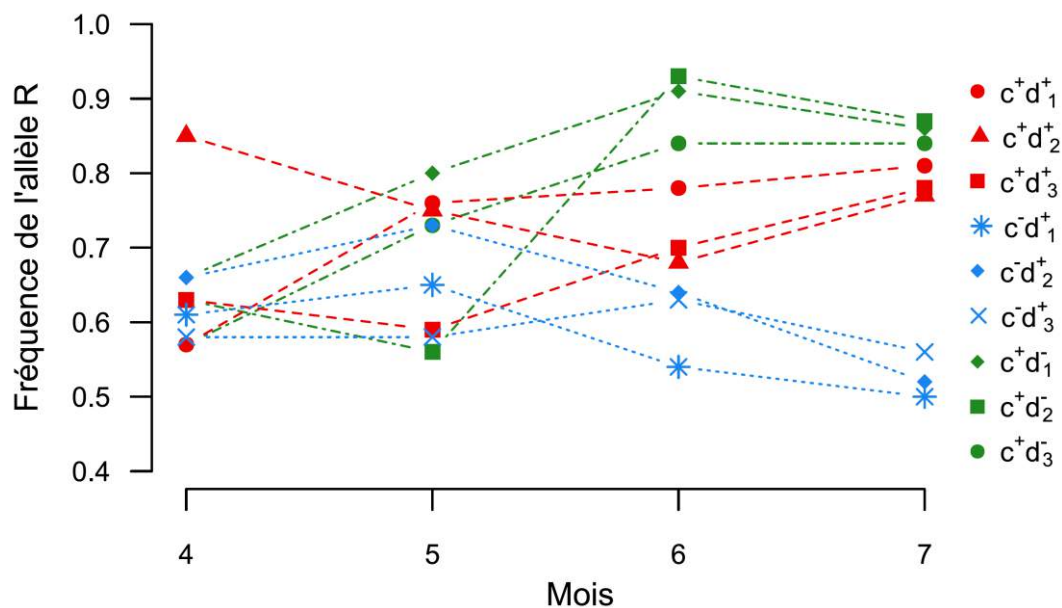

Figure 12 : Dynamique de l'allèle R dans l'expérience 2. La fréquence de l'allèle R estimée chaque mois à partir des fréquences génotypiques est présentée pour chacun des réplicas. Les réplicas servant de référence sont présentés en rouge (tirets), ceux dans lesquels la densité a été réduite sont en vert (alternance tirets points), et ceux dans lesquels la dose a été diminuée sont en bleu (pointillés).

Il existe donc des conditions environnementales pour lesquelles l'avantage en termes de résistance des individus RR ne suffit pas à compenser le coût qu'ils endurent ; comme la majorité des individus SS sont ici éliminés par l'insecticide, le meilleur compromis est alors celui des individus hétérozygotes RS ; on a bien une situation de superdominance. Cet avantage à l'hétérozygote semble en outre, dans notre cas, être suffisamment fort pour compenser des effets de dérive pourtant importants. Est-il possible néanmoins de moduler ce compromis, et donc l'équilibre final, en manipulant les conditions expérimentales ?

Des modifications environnementales peuvent altérer les fréquences à l'équilibre.

Au bout de quatre mois, l'équilibre prédit en cas de superdominance étant atteint, nous avons modifié les conditions environnementales. Des échantillons de larves ont été prélevés dans les cages $80c^+d^+_1$, $20c^+d^+_2$, et $80c^+d^+_3$ pour générer trois nouvelles cages ($c^+d^-_1$, $c^+d^-_2$ et $c^+d^-_3$). Les cages $c^+d^+_1$, $c^+d^+_2$, et $c^+d^+_3$ ont été maintenues dans les conditions standards (haute dose, haute densité, Tab. 4) pour servir de référence. Dans les cages $c^+d^-_1$, $c^+d^-_2$, et $c^+d^-_3$, la dose d'insecticide a été maintenue, mais les larves ont été élevées à faible densité (Tab. 4). En réduisant ainsi la compétition entre larves, le coût relatif des individus RR devrait diminuer, et la fréquence de R devrait donc augmenter.

En parallèle, un mois plus tard, la dose d'insecticide utilisée dans les cages $20c^+d^+_1$, $20c^+d^+_2$, et $20c^+d^+_3$ a été divisée par deux (0.1 ppm), donnant les cages $c^-d^+_1$, $c^-d^+_2$, et $c^-d^+_3$ tout en maintenant un élevage à haute densité (Tab. 4). Cette baisse de la pression de sélection réduit l'impact de l'insecticide sur les génotypes SS et RS, et devrait donc favoriser l'allèle S.

L'évolution de la fréquence de l'allèle R (inférée à partir des fréquences génotypiques) dans ces trois conditions (c^+d^+ , c^+d^- et c^-d^+) a été suivie jusqu'au septième mois inclus. Les résultats ont été conformes aux attendus (Fig. 12) : dans les cages où la densité larvaire a été réduite ($c^+d^-_x$), on a observé une augmentation de la fréquence de l'allèle R, alors que sa fréquence a diminué dans les cages où la dose d'insecticide a été réduite ($c^-d^+_x$).

Notre modèle montre que les dynamiques sont significativement différentes entre les trois conditions (LRT_{od} , $F = 7.6$; $\Delta df = 2$; $p = 0.001$). Toutefois, en raison du nombre de générations relativement faible (que nous avons dû arrêter du fait de problèmes d'élevage), les estimations des coefficients de sélection restent imprécises car aucun équilibre n'a été atteint (sauf pour le contrôle qui reste en situation de superdominance, Tab. 5).

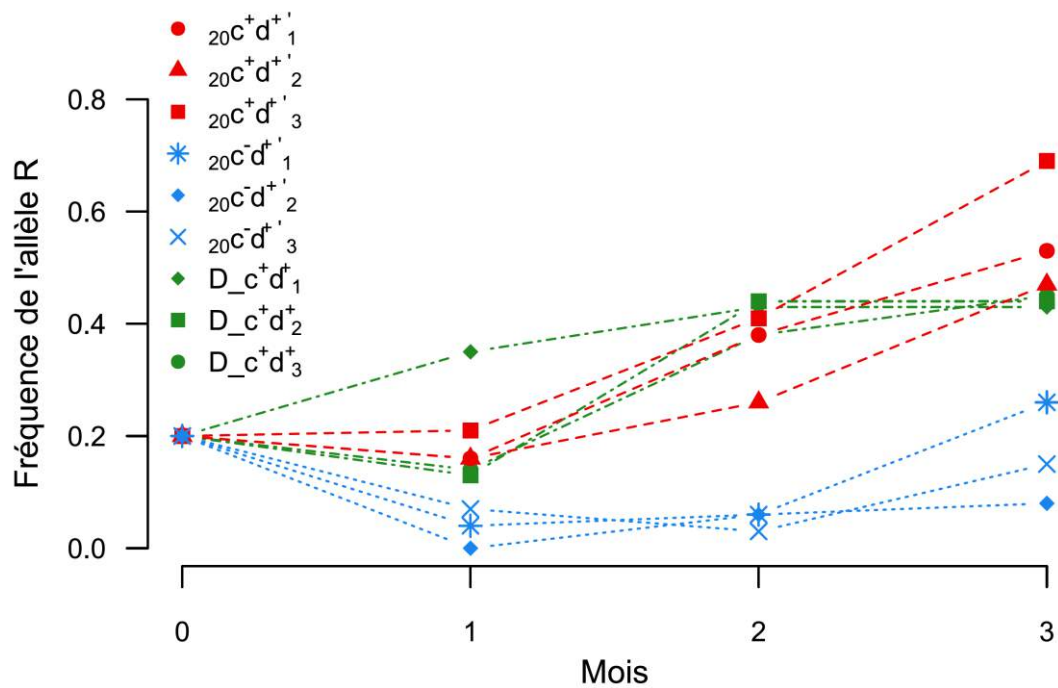

Figure 13 : Dynamique de l'allèle R et valeurs sélectives des différents phénotypes dans l'expérience 3. La fréquence de l'allèle R estimée chaque mois à partir des fréquences phénotypiques est présentée pour chacun des réplicas. Ceux servant de référence sont présentés en rouge (tirets), ceux dans lesquels la dose est réduite sont en bleu (pointillés), et ceux contenant l'allèle D sont en vert (alternance tirets et points).

On ne peut donc pas conclure sur l'issue de l'évolution des fréquences (fixation d'un allèle ou superdominance). Il apparaît en revanche clairement que les compromis avantage-coût sont différents, et donc que les équilibres finaux le seront également.

L'allèle dupliqué est sélectionné en situation de superdominance.

Nous avons relancé une seconde expérience d'évolution en cage. Trois répliques ($20c^+d^+_1$ à $20c^+d^+_3$), identiques aux répliques $20c^+d^+_1$ à $20c^+d^+_3$ (allèles S et R, $f_0(R) = 0.2$, élevage à haute densité, 0.2 ppm de temephos) ont été réalisés pour servir de contrôle (Tab. 4). Par ailleurs, n'ayant pas pu atteindre d'équilibre dans l'expérience précédente, la possibilité de générer une situation de superdominance avec un équilibre différent n'a pas pu être testée. Dans ce but, trois nouveaux répliques ($20c^-d^+_1$ à $20c^-d^+_3$) ont été réalisés avec une dose d'insecticide réduite (0.14 ppm, Tab. 4) ; les autres conditions étaient similaires au contrôle (allèles S et R, $f_0(R) = 0.2$), élevage à haute densité).

Enfin, pour tester l'hypothèse de Haldane selon laquelle une situation de superdominance pourrait favoriser la sélection des duplications hétérogènes, nous avons ajouté l'allèle D_1 dans la compétition (cet allèle a été choisi car il ne présente pas de coût excessif à l'état homozygote, chapitre 1). Trois répliques ont été réalisés ($D_-c^+d^+_1$ à $D_-c^+d^+_3$) avec des fréquences initiales $f_0(S) = 0.8$, $f_0(R) = 0.15$ et $f_0(D_1) = 0.05$; les autres conditions étaient similaires au contrôle (élevage à haute densité, 0.2 ppm de temephos, C_5 , Tab. 4).

L'étude est encore en cours, mais les données sont disponibles pour les trois premiers mois. Comme précédemment, la fréquence de l'allèle de résistance R a été inférée à partir des fréquences phénotypiques (Fig. 13). A nouveau notre modèle confirme que les dynamiques sont significativement différentes entre les 3 conditions (LRT_{od}, $F = 12.1$; $\Delta df = 2$; $p < 0.001$).

Dans les cages contrôle ($20c^+d^+_1$ à $20c^+d^+_3$), on observe une augmentation rapide de cette fréquence : $f_3(R) > 0.5$ dans deux répliques, se rapprochant de la valeur plateau observée dans les mêmes conditions lors de la première expérience et confirmant la possibilité de superdominance. Cependant la courte durée de l'expérience n'a pas encore permis d'atteindre un plateau ; les valeurs sélectives estimées pour les individus RS et RR ne sont donc pas significativement différentes à ce stade (Tab. 5).

Dans les cages où la dose de temephos utilisée est de 0.14 ppm ($20c^-d^+_1$ à $20c^-d^+_3$), la fréquence de l'allèle R au troisième mois (environ 0.15) est nettement inférieure à celle

des cages contrôles ($20c^+d^+_1$ à $20c^+d^+_3$) (Fig. 13). Bien que significativement différentes des contrôles, les estimations des coefficients de sélection pour cette condition restent à ce stade très imprécises, notamment du fait de la dynamique d'abord décroissante puis croissante observée pour l'allèle R dans ces cages (Tab. 5). Toutefois, cette fréquence tend néanmoins à augmenter, suggérant l'existence d'un nouvel équilibre de superdominance (Fig. 13).

Enfin, dans les trois répliquas où il est présent ($D_c^+d^+_1$ à $D_c^+d^+_3$), l'allèle D_1 génère une incertitude pour le phénotype [RS] lors des tests enzymatiques. En effet tout individu porteur de cet allèle présente le phénotype hétérozygote. Dans ces répliquas, ce phénotype correspond donc à quatre génotypes potentiels : RS, D_1S , D_1R et D_1D_1 . Nous avons d'abord estimé la fréquence de l'allèle R comme si seuls les allèles R et S étaient présents : les trois répliquas tendent à marquer un plateau vers 0.5 (Fig. 13). De plus, dans ces cages, on n'observe au troisième mois que des individus de phénotype [RS] et quelques [SS], mais aucun [RR].

Ce résultat correspond à l'attendu s'il ne restait quasiment que des individus porteurs de D_1 (*i.e.* donc de phénotype [RS]). Un test spécifique de l'allèle D_1 a donc été appliqué aux adultes du troisième mois analysés par TPP et échantillonnés après trois mois et a révélé que tous les individus de phénotype hétérozygote [RS] étaient porteurs de l'allèle dupliqué dans les 3 cages. Ainsi il semble que, dans les trois répliquas, l'allèle dupliqué ait quasiment (voire totalement) éliminé l'allèle de résistance mono-copie. Bien que l'on n'ait pas accès aux fréquences génotypiques, la fréquence de l'allèle D_1 peut tout de même être inférée à partir de l'excès d'hétérozygotes, par rapport à l'attendu à l'équilibre d'Hardy-Weinberg, que sa présence entraîne. La fréquence de l'allèle D_1 et les bornes associées au troisième mois, ont ainsi été estimées, par maximum de vraisemblance, dans chacun des répliquas à partir des fréquences phénotypiques mesurées chez les adultes : $f_3(D_c^+d^+_1) = 0.68$ (0.52 - 0.8), $f_3(D_c^+d^+_2) = 0.62$ (0.48 - 0.74) et $f_3(D_c^+d^+_3) = 0.65$ (0.50 - 0.77).

Ainsi, l'hypothèse de Haldane semble donc bien vérifiée dans notre cas : alors que les conditions choisies (haute densité larvaire et sélection à 0.2pppm de temephos) génèrent une situation de superdominance, l'introduction d'un allèle dupliqué hétérogène en faible fréquence permet, en quelques générations, la quasi-fixation du phénotype hétérozygote avantageux.

Conclusion

Les adaptations récentes à un changement environnemental sont généralement associées à un fort coût sélectif ; c'est le cas notamment de la majorité des résistances (Carrière et al. 1994). Dans de telles situations, notre étude démontre qu'une situation de superdominance, où les compromis phénotypiques intermédiaires conférés par les hétérozygotes sont favorisés, peut être générée par des pressions de sélection modérées. Dans les populations naturelles, l'environnement est hétérogène, ce qui induit de nombreuses situations de pressions de sélection intermédiaires. Ainsi les conditions (plus ou moins transitoires) favorables à l'émergence d'une situation de superdominance pourraient être bien plus nombreuses qu'on ne le considère généralement.

Notre étude démontre en outre, comme l'avait suggéré Haldane, qu'une duplication hétérogène associant les deux allèles présents chez un hétérozygote en situation de superdominance pouvait être aisément sélectionnée, puisqu'elle annule le fardeau de ségrégation associé aux hétérozygotes standards (Haldane 1954). Ainsi, les pressions de sélection modérées, en générant des conditions propices à la superdominance, favorisent également l'émergence des duplications hétérogènes.

L'omniprésence des allèles dupliqués chez *Cx pipiens* (Chap. 2) suggère donc que ces moustiques sont en général exposés à des pressions de sélections intermédiaires, du fait de l'intensité des traitements, ou de leur répartition spatiale ou temporelle. Par exemple, dans la région Montpellieraine, il avait été proposé que les allèles dupliqués D₂ et D₃ aient été sélectionnés dans un contexte de superdominance marginale. Toutefois, les premières détections de ces allèles font suite à une réduction drastique de la quantité des traitements OPs utilisés dans la région. Il n'est donc pas impossible qu'ils aient été sélectionnés dans un contexte de superdominance stricte généré par la réduction des pressions de sélection dans ces populations. Ces deux hypothèses ne sont pas exclusives et peuvent toutes deux avoir contribué à la sélection de ces allèles.

Chapitre 4 : Relations entre variations de pression de sélection et variations de la valeur sélective en populations naturelles.

Article 4 : « Long-term fitness-to-dose relations *in natura* » Pascal Milesi, Thomas Lenormand, Christophe Lagneau, Mylène Weill, Pierrick Labbé *Submitted*.

Les variations environnementales peuvent affecter la dynamique des allèles adaptatifs de manière drastique. Toutefois, il est souvent difficile d'identifier, et plus encore de mesurer, les variations de l'environnement à l'origine de la sélection de ces allèles adaptatifs. Ainsi, dans la majorité des études tentant de relier variations de pressions de sélection et adaptation en populations naturelles, l'environnement a généralement été considéré de manière très simplifiée et résumée, en négligeant ses variations d'intensité (Cook et al. 1986 ; Macnair 1987 ; Lenormand et al. 1999).

Peu de modèles permettent d'étudier la façon dont les variations quantitatives de la pression de sélection peuvent affecter les compromis évolutifs des adaptations, et donc leur dynamique évolutive. La conservation, par l'agence responsable de la démoustication dans la région montpelliéraine (EID), des données à long terme sur les quantités d'insecticides utilisées pour contrôler les populations de *Cx. pipiens*, nous en a donné l'opportunité.

Les insecticides OPs ont été utilisés depuis les années 1970 sur une bande littorale d'environ 16 km. Le premier allèle de résistance, *Ester*¹, a été sélectionné rapidement (1972)². Le suivi de l'évolution de la résistance dans la région a ensuite permis de documenter l'émergence des allèles *Ester*⁴ (1986) puis *Ester*² (2002). A partir de 1986, un transect sud-nord (de la mer à l'intérieur des terres) a été échantillonné quasiment chaque année dans le cadre d'un suivi de l'évolution de la résistance au locus *Ester* (Fig. 14A). Le traitement, uniquement littoral, entraîne une distribution clinale de la fréquence des allèles de résistance le long de ce transect : distribution élevée vers la mer et faible à l'intérieur des terres (Fig. 14B). Cette situation a permis, en ajustant des modèles génétiques aux fréquences phénotypiques observées, de quantifier des paramètres importants expliquant la dynamique des allèles de résistances (migrations, coefficients de sélections, dominance) à différentes échelles de temps (annuelle, Lenormand et al. 1998b, 1999 ; Lenormand and Raymond 2000, ou pluriannuelle, Labbé et al. 2009).

² Pour rappel, le locus *Ester* est composé de deux gènes (*est-2* et *est-3*) qui co-ségrègent. Il code pour les estérases, des enzymes de détoxications généralistes capables de séquestrer et de dégrader les OPs. La résistance est conférée par une surproduction des estérases.

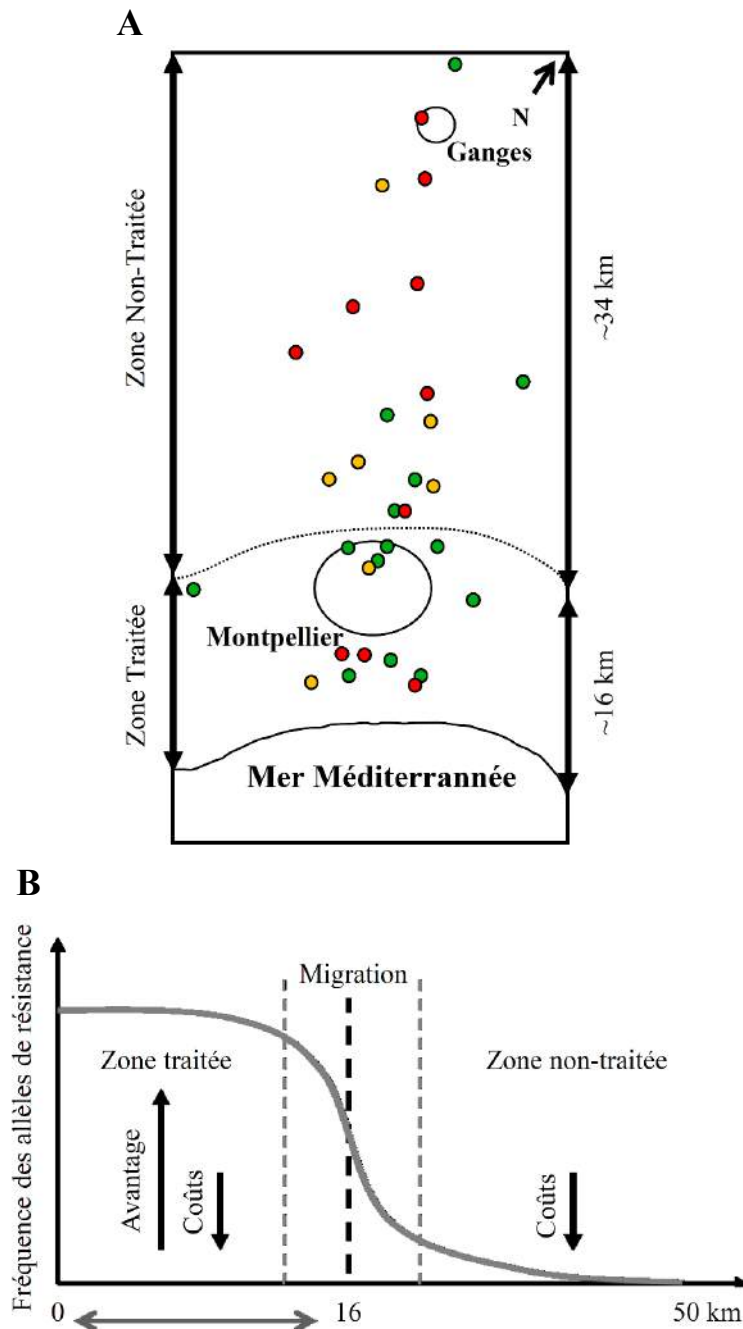

Figure 14 : Transect d'échantillonnage de la région montpelliéraine et cline de fréquence allélique. **A** : Les points représentent les populations échantillonnées une fois par an (fin juin, début juillet) au cours de la période 1986 - 2012. Les couleurs indiquent le nombre de fois qu'une population donnée a été échantillonnée : vert, une seule fois, jaune deux à quatre fois et rouge plus de quatre fois. Le transect étudié comprend deux zones, une côtière, traitée avec des insecticides OPs (temephos), une autre non traitée, plus à l'intérieur des terres. Les deux zones sont séparées par la ligne en pointillés. **B** : Cline de fréquences alléliques résultant des pressions de sélection antagonistes le long du transect d'étude. Les allèles de résistance sont sélectionnés en zone traitée, près de la mer, et sont contre sélectionnés à l'intérieur des terres.

Il a notamment été montré que ces coefficients pouvaient varier au cours d'une même année (Lenormand et al. 1999 ; Lenormand and Raymond 2000) : les allèles de résistance sont sélectionnés par les traitements appliqués en période estivale, mais sont contre sélectionnés par l'absence de traitement en période hivernale (Gazave et al. 2001). Les variations qualitatives d'intensité de traitement (présence/absence) entraînent donc des variations des valeurs sélectives de ces allèles adaptatifs. Qu'en est-il des variations quantitatives de traitements entre années ?

L'EID nous a fourni les quantités d'OPs utilisées chaque année, depuis 1986 jusqu'à leur interdiction au niveau européen en 2007. Par ailleurs, les fréquences des différents allèles de résistance le long du transect étaient connues pour la période 1986 - 2002 (Guillemaud et al. 1998 ; Labbé et al. 2009). Lors de ma thèse j'ai complété ce jeu de données pour la période 2003 - 2012, ce qui a permis notamment d'étudier l'influence de l'arrêt des traitements sur la dynamique des allèles de résistance.

Grâce à ce jeu de données réunissant, sur une période de 27ans (1986 - 2012), les fréquences phénotypiques au locus *Ester* le long du transect et les quantités d'OPs appliquées annuellement, nous avons pu étudier trois questions : i) les variations quantitatives de la pression de sélection affectent-elles les compromis avantages-coûts des allèles adaptatifs ? ii) Les traitements insecticides sont-ils les seuls agents de sélection des allèles du locus *Ester* ? et iii) Les coûts sélectifs des allèles de résistance évoluent-ils en fonction de l'intensité de la pression de sélection ?

Pour répondre à ces trois questions et, de façon générale, mesurer le lien entre les variations des doses et celles des valeurs sélectives, nous avons développé un modèle de génétique des populations préexistant (Labbé et al. 2009). Son ajustement aux 994 fréquences phénotypiques réparties sur l'ensemble du transect sur la période 1986 - 2012 nous a permis de quantifier les coefficients de sélections, avantages (s) et coûts (c), associés aux différents allèles de résistance en relations avec les quantités d'OPs. Ce modèle explique 92.5% de la variance totale des données, avec une faible sur-dispersion ($od = 1.65$).

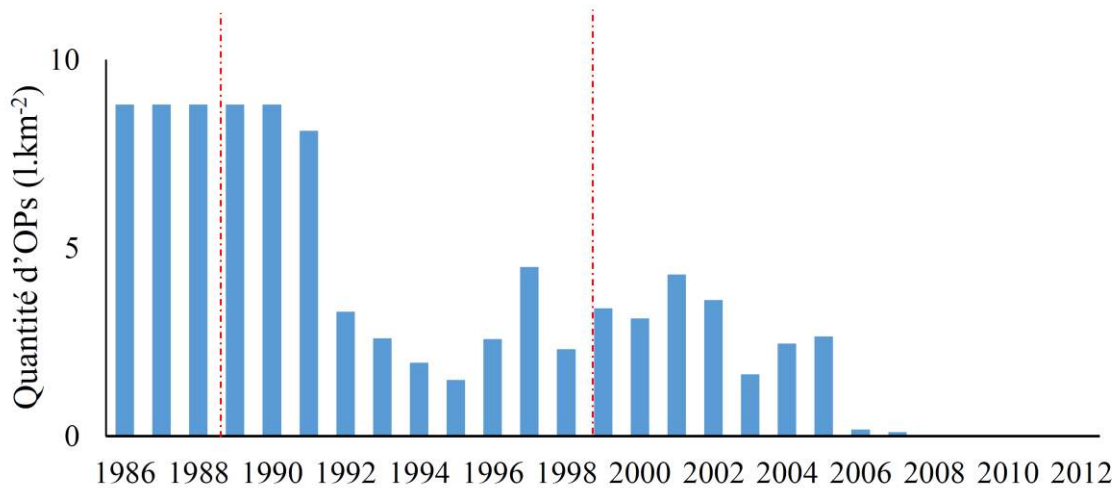

Figure 15 : Evolution de la quantité totale de traitements utilisée annuellement dans la zone traitée sur la période 1986 – 2012. Les trois régimes de traitements qui ont successivement été appliqués sont délimités par les lignes pointillées rouges.

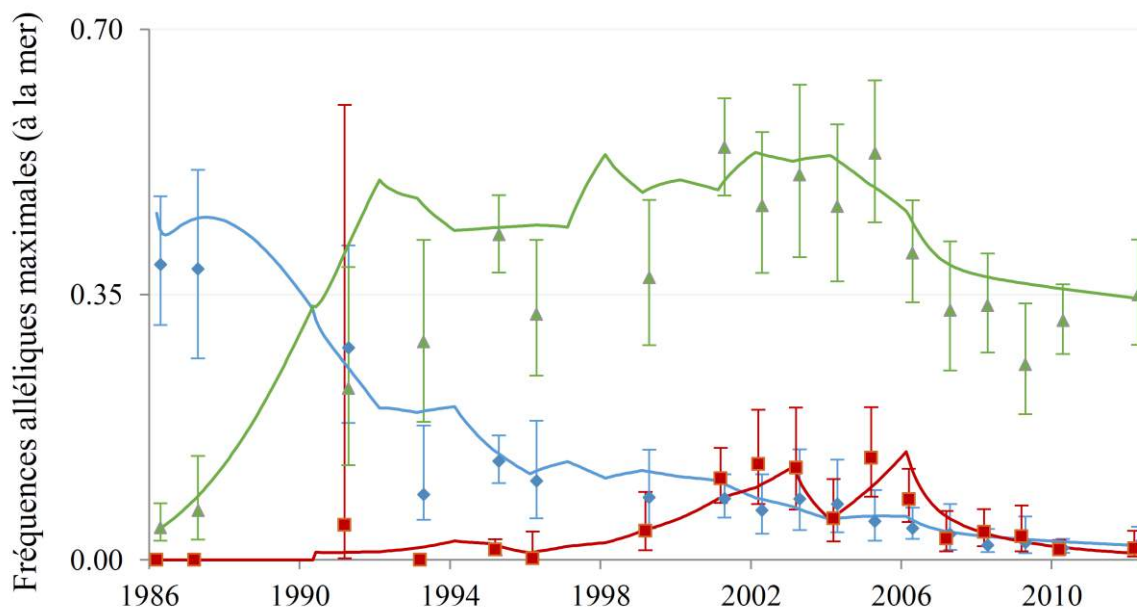

Figure 16 : Fréquence maximale des allèles de résistances du locus *Ester* sur la période 1986 – 2012. Les fréquences maximales de chaque allèle de résistance pour chaque année d'échantillonnage sont présentées avec les bornes associées : *Ester*¹ (losanges bleus), *Ester*² (carrés rouges) et *Ester*⁴ (triangles verts). Les lignes représentent les fréquences les plus vraisemblables estimées par le modèle de génétique des populations (voir texte).

Variations des quantités d'insecticides et dynamiques des allèles de résistance sur la période 1986 - 2012.

Pour répondre à ces questions et relier variations environnementales et variations de la valeur sélective, il a d'abord fallu définir des échelles cohérentes de variations. Nous disposons de fréquences alléliques estimées une fois par an, en période estivale, le long du transect ; les variations au cours d'une année des quantités d'OPs utilisées ont donc été négligées. De plus, la taille de la zone traitée est du même ordre (légèrement supérieure) que la capacité de dispersion des moustiques ; l'hétérogénéité des applications des traitements (répartition, quantité) à l'intérieur de la zone traitée n'a donc pas été prise en compte. Ainsi, c'est la quantité totale d'OPs utilisée sur l'ensemble de la zone traitée chaque année qui a été considérée pour étudier son influence sur la dynamique des allèles de résistance sur la période 1986 - 2012.

Trois régimes de traitements ont été successivement appliqués sur cette période (Fig. 15) : i) de 1986 à 1991, $\sim 9 \text{ l.km}^{-2}$ de temephos (OPs) étaient répandus dans la zone traitée sur une année ; ii) à partir de 1992, l'EID a utilisé des toxines bactériennes pour contrôler les populations de *Cx pipiens* (d'abord, *Bacillus sphaericus* (Bs) puis *Bacillus thuringiensis* var. *israelensis* (Bti)), et a diminué de moitié les quantités d'OPs utilisées ; iii) enfin, anticipant le bannissement des OPs, les doses ont été drastiquement réduites ($< 0.2 \text{ l.km}^{-2}$) en 2006 et 2007, avant leur abandon total après 2007. Nous disposons donc de plusieurs échelles de variations de la pression de sélection, variations larges lors des changements de régimes et variations d'amplitude beaucoup plus modérée au sein de chaque régime.

La fréquence des allèles de résistance au locus *Ester* a été inférée à partir des fréquences phénotypiques sous hypothèse de panmixie. Un cline géométrique a ensuite été ajusté aux fréquences phénotypiques le long du transect pour estimer la fréquence maximale des allèles de résistance (*i.e.* les fréquences à la mer) ; ces fréquences sont représentées sur la figure 16. Comme précédemment décrit, *Ester*¹ a été remplacé par *Ester*⁴ (Guillemaud et al. 1998 ; Labbé et al. 2009). Alors qu'une étude précédente prédisait qu'*Ester*⁴ serait à son tour remplacé par *Ester*², ce dernier allèle a toutefois atteint sa fréquence maximale en 2002 ; les fréquences alléliques sont ensuite restées stables jusqu'en 2005, malgré des variations interannuelles marquées (Fig. 16). A partir de 2005, soit deux ans avant l'arrêt des OPs, on observe une forte chute de la fréquence totale des allèles de résistance.

Table 6 : Estimations de divers paramètres par le modèle de génétique

	Paramètres (<i>SL</i>)	
s'_1	0.13 (0.08 – 0.18)	***
s'_2	0.08 (0.00 – 0.16)	***
s'_4	0.12 (0.09 – 0.14)	***
c_1	0.08 (0.07 – 0.10)	***
c_2	0.11 (0.08 – 0.17)	***
c_4	0.04 (0.03 – 0.05)	***
$t_{coût}$	261 (260 – 267)	***
c'_1	0.06 (0.02 – 0.10)	*
c'_2	0.07 (0.00 – 0.16)	ns
c'_4	0.04 (0.00 – 0.05)	ns

Pour chaque allèle de résistance i , les estimations, d'une part, de l'avantage sélectif lié à d'autres pressions de sélection que les traitements insecticides (s'_i) et, d'autre part, des coûts sélectifs avant (c_i) et après (c'_i) $t_{coût}$ générations sont présentées avec les bornes associées (*SL*). La significativité des paramètres a été testée par test des ratios de vraisemblances corrigés par la sur-dispersion entre (LRT_{od} ; ^{ns}, $p > 0.05$; *, $p < 0.05$; ***, $p < 0.001$).

Il apparaît donc que les faibles doses utilisées en 2006 et 2007 ($< 0.2 \text{ l.km}^{-2}$, Fig. 15) n'ont pas procuré aux allèles de résistance un avantage suffisant pour compenser le coût sélectif qui leur était associé. En revanche, au lieu de disparaître suite à l'arrêt des traitements après 2007, comme on pourrait s'y attendre lorsque les coûts surpassent les avantages, on observe que l'allèle *Ester^A* se maintient à une nouvelle fréquence d'équilibre (~ 0.35) dans les populations (Fig. 16). Deux hypothèses non-exclusives pourraient expliquer ce nouvel équilibre : i) il existe d'autres pressions de sélection que celles liées à la démoustication et ii) le coût sélectif des allèles de résistance a changé après l'arrêt des OPs.

L'arrêt des OPs révèle l'existence d'autres agents de sélection et une évolution du coût des allèles de résistance.

Nous avons testé l'hypothèse d'un maintien des allèles de résistance après à l'arrêt des OPs par d'autres sources de sélection que la pression insecticide de l'EID. Pour cela, l'avantage sélectif conféré par les allèles de résistance (s_i) a été séparé en deux coefficients estimés indépendamment : un avantage directement lié aux quantités d'OPs utilisées chaque année, s_{iT} , et un avantage quantifiant l'effet potentiel d'autres agent de sélections, s'_i : pour chaque allèle *Ester* de résistance i on a donc $s_i = s_{iT} + s'_i$. Tous les s'_i se sont révélés significativement > 0 (Tab. 6). De plus, on observe la permanence de clines de fréquences (bien que moins prononcés). Il semble donc que les autres sources qui avantagent les allèles de résistance ont une répartition similaire aux traitements de l'EID. Dans la région de Montpellier au moins deux facteurs ont une répartition de ce type : l'urbanisation et l'agriculture, toutes deux concentrées dans les plaines du sud du transect échantillonné. Comme les estérases sont des enzymes de détoxification généralistes, elles pourraient être avantageuses contre ces autres sources de pollutions, même si le lien reste à démontrer.

Pour déterminer si les coûts des allèles de résistance avaient évolué suite à l'arrêt des OPs, nous avons également laissé le modèle libre de réévaluer les coûts sélectifs après $t_{coût}$ générations ($t_{coût}$ étant également estimé). Seul le coût de *Ester^I* semble avoir significativement changé après $t_{coût} = 261$ générations soit vers 2006, date correspondant au quasi-abandon des OPs (Tab. 6).

Le fait que seul *Ester^I* ait pu s'ajuster à ces nouvelles conditions pourrait être dû à l'architecture des adaptations à ce locus. En effet, alors que la surproduction d'estérases est le résultat d'amplifications géniques pour *Ester²* et *Ester^A*, il s'agit d'une régulation transcriptomique pour *Ester^I* qui pourrait être moins contrainte que des amplifications.

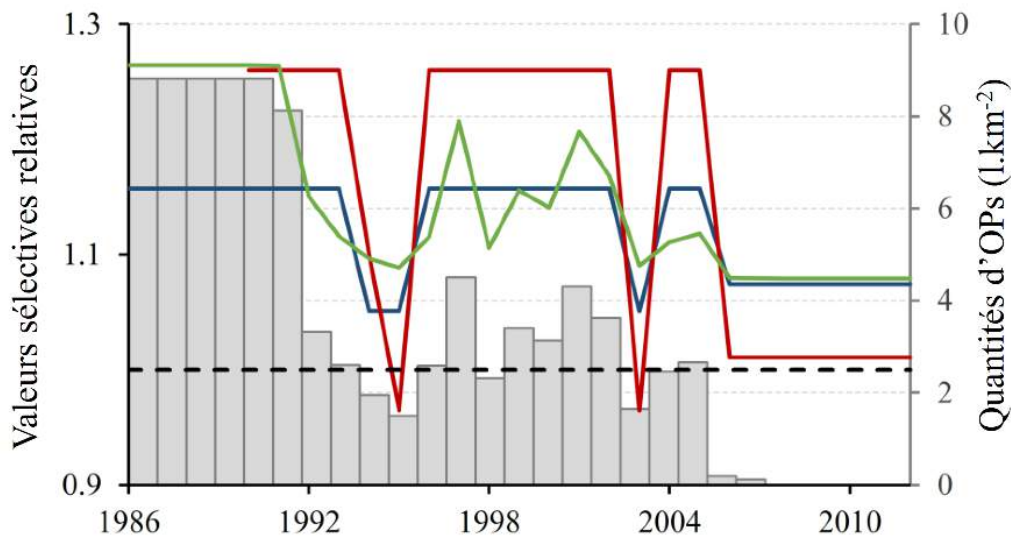

Figure 17 : Valeurs sélectives relatives des allèles du locus *Ester* en zone traitée sur la période 1986 à 2012. Les lignes représentent les valeurs sélectives estimées à partir du modèle (axe de gauche) pour chaque allèle de résistance (*Ester*¹ en bleu, *Ester*² en rouge et *Ester*⁴ en vert). La ligne pointillée représente la valeur sélective d'un allèle sensible ($w_s = 1$). Pour chaque année, la valeur sélective w_i de l'allèle de résistance i a été calculée comme : $1 + s_{iT} + s'_i - c_i$ avec s_{iT} , s'_i et c_i respectivement ses avantages (en fonction de la quantité d'OPs ou d'autres pressions de sélection) et son coût. L'histogramme représente la quantité totale d'OPs (l.km⁻², axe de droite) utilisée chaque année dans la zone traitée.

Il apparaît donc que de fortes variations des doses d'insecticides (ici leur retrait) affectent directement les compromis avantages-coûts de certains allèles de résistances. Quel est l'effet de plus faibles variations de doses sur la dynamique des allèles de résistances ?

Les valeurs sélectives des allèles de résistance dépendent de la dose d'insecticide : de faibles variations affectent-elles leur dynamique ?

Pour répondre à cette question, je me suis tout d'abord concentré sur la période 1995-2008 car tous les allèles de résistance sont installés dans les populations et les doses d'OPs utilisées varient dans une gamme réduite (entre 0 et 4 l.km⁻²). Il est apparu que les fréquences alléliques de l'année t étaient positivement corrélées à la quantité d'OPs utilisée l'année $t-1$ (le décalage étant dû aux dates d'échantillonnage par rapport aux périodes de traitement). La dose d'insecticide influence directement la dynamique des allèles de résistance de manière fine et rapide. Cependant, la force de la corrélation varie selon les allèles : les fréquences d'*Ester*² sont les plus fortement corrélées aux quantités d'OPs utilisées, alors que la corrélation n'était pas significative pour *Ester*¹.

A l'aide du modèle génétique, nous avons ensuite quantifié cette relation entre les variations de pressions de sélection et les variations de valeurs sélectives des différents allèles de résistance au locus *Ester*. Pour cela, la part de l'avantage directement lié aux quantités d'OPs utilisées chaque année, s_{IT} , a été définie comme étant une fonction de la quantité de traitements utilisée chaque année. Cela a permis de confirmer i) l'existence d'un lien direct entre valeur sélective et dose et ii) que ce lien est différent pour les différents allèles de résistance.

La conséquence directe de ces relations complexes entre dose et valeur sélective est que l'allèle de résistance conférant la valeur sélective la plus élevée dépend directement de l'intensité de traitement (Fig. 17). Ainsi, *Ester*¹ et *Ester*² présentent des caractéristiques similaires, du type "tout ou rien" : peu d'avantage pour des doses < 2 l.km⁻², avantage maximum au-delà. En revanche, l'avantage d'*Ester*⁴ augmente progressivement sur l'ensemble de la gamme (0 - 9 l.km⁻²). Ces différences ne sont donc pas expliquées par l'architecture génétique des différentes adaptations mais peut-être par des différences dans la nature des estérases codées par les différents allèles. Par ailleurs, *Ester*² présente le meilleur compromis pour des doses modérées à élevées, tandis que *Ester*⁴ et *Ester*¹ sont plus avantageux pour des doses faibles (Fig. 17). Plus surprenant, même de faibles variations d'intensité peuvent avoir de fortes conséquences sur la dynamique des allèles

adaptatifs : par exemple, il a suffi d'une réduction de l'ordre d' 1 l.km^{-2} entre 2002 et 2003 pour qu'*Ester*² passe du statut de meilleur compromis au pire (même moins bon qu'un sensible en zone traitée, Fig. 17).

Conclusion

Cette étude a montré que la dynamique des allèles de résistance dans la région montpelliéraine dépendait, non seulement, des changements quantitatifs de l'utilisation des OPs, mais également, de la présence d'autres sources de sélection et que leurs coûts pouvaient évoluer suite à des modifications d'intensité de la pression de sélection. En outre, la réponse aux variations d'intensité de la pression de sélection est rapide et finement ajustée.

Cette étude met en lumière, et de façon quantitative, à quel point la valeur sélective d'un allèle adaptatif est liée directement aux conditions environnementales. Sans une connaissance approfondie de ces relations entre dose et valeur sélective, notre capacité à prédire l'issue de la compétition entre allèles adaptatifs apparaît très limitée. La connaissance de ces relations apparaît d'autant plus primordiale que les pollutions dues aux activités anthropiques entraînent, en populations naturelles, une exposition chronique des organismes à de faibles doses de xénobiotiques, affectant très probablement leur évolution. Malheureusement, cela nécessite des études sur le long terme, donc difficiles à mettre en place et surtout à faire perdurer.

Long-term fitness-to-dose relations *in natura*

Pascal Milesi¹, Thomas Lenormand², Christophe Lagneau³, Mylène Weill¹, Pierrick Labbé^{1*}

1- Institut des Sciences de l'Evolution de Montpellier (UMR 5554, CNRS-UM-IRD-EPHE), Université de Montpellier, France.

2- CEFE UMR 5175, CNRS - Université de Montpellier - Université Paul-Valéry Montpellier - EPHE -1919 route de Mende, F-34293 Montpellier, CEDEX 5, France

3- Entente Interdépartementale pour la Démoustication du littoral méditerranéen, Montpellier, France

* Corresponding author

Key-words:

- insecticide resistance,
- adaptation dynamics,
- time-series,
- selective pressure variations,
- population genetics model.

Summary

Quantitatively link the ecological process and adaptation dynamics *in natura* remains a crucial challenge. If many studies have documented the strength, form and direction of selection as well as its variations in space and time, only a few have succeeded in linking these variations to their proximal causes. This is however a crucial step to understand how selective pressure variations affect adaptive allele dynamics in natural settings.

We used a long-term survey (~30 years) monitoring adaptation to insecticides of *Culex pipiens* mosquitoes in Montpellier area (France), in particular several resistance alleles of the *Ester* locus. We used a population genetic model which, in considering temporal and spatial variations of selective pressure, allowed assessing the quantitative relationships between variations in the proximal agent of selection (insecticide quantities sprayed) and in resistance alleles' fitness.

The response to variations in selective pressure was fast and finely tuned, and the different resistance alleles showed different fitness-to-dose relations. The analyses indeed revealed that even slight variations in insecticide doses could change the identity of the fittest resistance allele. The analyses also revealed that the selective cost of resistance alleles evolved after insecticide removal and that selective pressures other than insecticides used for mosquitoes control affected the resistance alleles' dynamics.

Corresponding author:

Pierrick Labbé (pierrick.labbe@univ-montp2.fr)

Institut des Sciences de l'Evolution de Montpellier (UMR 5554, CNRS-UM-IRD-EPHE),
Université de Montpellier, Place Eugene Bataillon, CC065, 34095 Montpellier, France.

Introduction

Studying how selective pressures shape the adaptive response dynamics of organisms *in natura* has been a crucial challenge for 150 years, and remains a challenge today [1–3]. A first difficulty is to measure fitness in the field. Natural selection has been extensively investigated at the phenotypic level, especially since the development of multivariate methods [4]. Many studies have documented the strength, form and direction of selection [5–7]; as well as their variations in space and time (reviewed in [3] and [8], respectively). The interpretation of these variations is hindered by a series of well-known issues [9–14], including the impact of drift, measurement error, trait plasticity. Another important difficulty is that natural selection can vary at different spatial and temporal scales. However, all variation is not relevant: for example variation of selection below generation time and dispersal distance are not necessarily relevant for adaptation. It thus requires measuring natural selection at the proper scale for the studied organism. Yet, measures are often taken at a finer grain (e.g. between life stages [15], seasons [16]; or years for longer lived species [17,18]). Finally, natural selection may favor phenotypes that can cope with rare (relative to the scale of observation) and extreme events that are difficult to properly sample [19]. Many of these perturbations are often central to ecosystems functioning (fire, flood, storms, etc.) and important to understand adaptation as well [20,21]. It thus requires repeated sampling, over sufficiently large geographical cover and time span.

Beyond all these issues inherent to measures of fitness in the field, a second major problem remains: linking selection to its causes is usually a bigger challenge than quantifying it [3,22]. Like finding a needle in a haystack, it is indeed often extremely difficult to precisely identify the *agent of selection*, let alone quantitatively relating its variation to fitness, as phenotypic and environmental variations are both complex and multidimensional. The agent of selection

affecting the variation of a particular adaptive trait has to be singled out among a large number of correlated and interdependent variables, acting on a similarly complex multivariate phenotype. Nevertheless, in many cases the agent of selection can be reasonably inferred from field data [17,23] (see also references in [2]) and further investigated using experimentations [23–26].

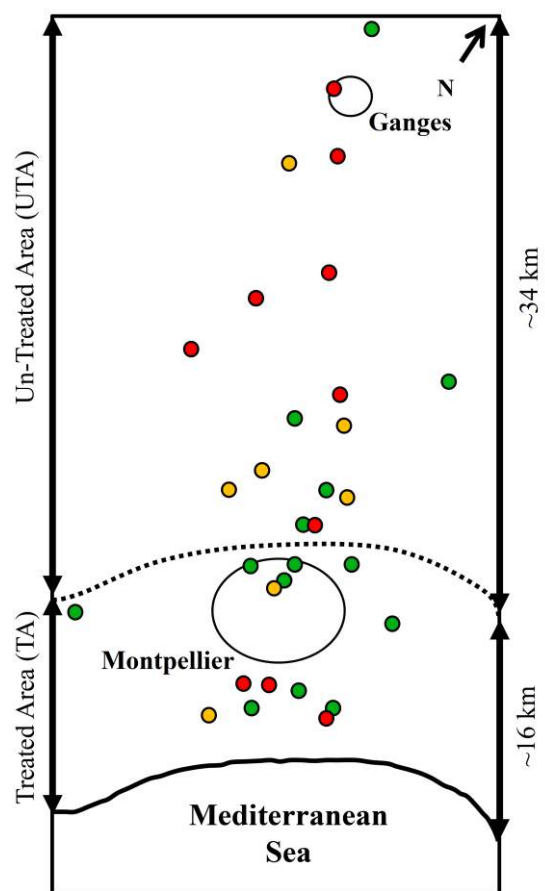

Figure 1: Sampling transect map.

Dots localize the different sampled populations over the period 1986-2012. Colors indicate the number of years of sampling for each locality (1 green; 2-4 yellow; > 4 red). The studied transect comprises two areas: a coastal strip treated with OPs (TA), and an un-treated area (UTA) inland; the approximate transition is represented by the dotted line. The main town in the TA and in the UTA is localized by black circles.

However, data assessing the quantitative link between environmental and fitness variations are usually not available, as fine-scale measures of well-identified selections through time and space are required. Useful situations to investigate fitness responses to environmental changes involve adaptations to human-induced environmental variation (e.g. insecticide resistance [27]; antibiotic resistance [28]; heavy metal tolerance [29]). In these cases, the agent of selection can be well identified and could, in principle, be quantified. Furthermore, the adaptive responses generally have simple genetic determinisms, and can thus be tracked in natural populations. However, even in these cases, the link between environmental variation and fitness remains mostly qualitative, semi-quantitative at best. For instance, even in best-known examples, the environmental variation is usually described in a binary fashion (e.g. polluted *vs* non polluted areas in the peppered moth [30]; mine *vs* pasture in *Holcus lanatus* [31]; treated *vs* non treated areas in insecticide resistance studies [32] and ignores the continuous quantitative variation in selection pressure (e.g. concentrations of coal smokes, heavy metals or pesticides). The aim of this paper is to go beyond this simplified description, and provide a quantitative explanation of the relation between the variations of environment (the agent of selection) and fitnesses in a natural setting.

To do so, we used insecticide resistance in *Culex pipiens* mosquitoes as a case study. Organophosphate insecticides (OPs) were used in Montpellier area (South of France) to control mosquito populations until 2007, when they were replaced by *Bacillus thuringiensis* var. *israelensis* (Bti) toxins due to new EU regulation [33]. In this area, resistance of *Culex pipiens* mosquitoes to OPs has been monitored for 40+ years, thereby constituting one of the best-documented cases of adaption to environmental modifications *in natura*.

Only the south coastal strip of the Montpellier area was treated, which resulted in antagonistic selective pressures between the Southern treated

area (hereafter, TA) and the Northern un-treated area (hereafter, UTA) (Fig.1). Three different resistance alleles were described segregating in natural populations at the carboxyl-esterase encoding *Ester* locus (*Ester*¹, *Ester*² and *Ester*⁴ [34]); as most newly arisen adaptations, they induce pleiotropic deleterious effects, *i.e.* a selective cost [35–39]. These alleles were thus selected for in the TA, as they allowed survival, and selected against in the UTA, due to these selective costs. Along a South-North transect, their frequencies thus followed a clinal distribution, which allowed quantifying the key parameters driving the long-term dynamics of *Ester* resistance alleles (e.g. migration, fitness coefficients, dominance [32,34,40,41], as well as their within-year variations in relation to seasons and OPs usage [32,42,43].

The continuous sampling of mosquito's populations along the transect provided us with a ~30 consecutive years dataset of *Ester* allele frequencies. Moreover, in this paper, we compiled and make use of the quantity of OPs used each year for mosquitoes control in the TA. This dataset allowed a quantitative description of the environment, both spatially and temporally. Using a population genetic model, we thus investigated how the variations in this insecticide quantity (*i.e.* selective pressure variations) have affected the dynamics of *Ester* resistance alleles over the 1986-2012 period, to quantitatively address the three following issues:

(i) Is the fittest resistance allele always the same at different insecticide doses? Three different resistance alleles segregate in Montpellier area; we investigated how environmental variations could affect the outcome of their competition. For each resistance allele, the selective advantage due to mosquito control was computed as a function of treatment intensity, which allowed establishing its specific fitness-to-dose response.

(ii) Did the adaptive alleles' cost changed through time, after accounting for variation in insecticide usage? Different studies showed that the selective cost inherent to a newly arisen adaptation could evolve with time [44–47]. This compensatory evolution can indeed depend on

the presence/absence of insecticide treatment. How treatment intensity variations could affect the metabolic costs of *Ester* resistance alleles is unknown and difficult to assess, and have thus so far been considered constant in space and time [32,41]. Here, we investigated this possibility using models allowing for cost evolution.

(iii) Were the insecticide treatments the only selective pressure driving the dynamic of *Ester* resistance alleles? As emphasized above, the evolution of a given trait is often shaped by multiple selective pressures. Esterases are generalist detoxification enzymes, so that other compounds than OPs could affect their dynamic. By quantifying the part of selective advantage due to mosquito control, we were able to test for and measure the effect of these alternative selective agents.

Results

The 1986-2012 dataset

Insecticide resistance: To estimate the allele frequencies along the surveyed transect (Fig. 1), 58 individuals per sampled population per year were phenotyped using starch-gel electrophoresis (S1 Table). The total dataset for the whole 1986-2012 period consists in 8519 analyzed individuals from 142 sampled populations, with an average of 8 sampled populations per year (Tab. 1). The numbers of individuals for each phenotype for the 1986 to 2002 samples were already published [34,51]. For samples from 2003 to 2012, these data are presented in S2 Table.

Insecticide treatments: The local mosquito control agency (EID) has been using OPs for nuisance control since 1969. The spatial distribution of treatments did not change significantly ([41], supplementary material; EID, pers. comm.). However, the quantities of OPs used each year in the treated area (TA) varied over the 1986-2012 period (Tab. 1). First, from 1986 to 1991, temephos (an OP insecticide) was the only insecticide used, with relatively large quantities sprayed, around 8 l.km⁻² (EID 1992; [34]). The precise information before 1990 is unfortunately missing: slight variations around

this dose probably occurred, but they were limited (EID 1992). Then, in 1992: EID began to use new bacterial toxins (first, *Bacillus sphaericus* (Bs) then *Bacillus thuringiensis* var. *israelensis* (Bti)), and temephos quantities were decreased by more than half; they varied between 1.5 and 4.5 l.km⁻², with a mean around 3 l.km⁻² (Tab. 1). Finally, temephos quantities were drastically decreased again in 2006 and 2007 (<0.2 l.km⁻²), before its complete withdrawal after 2007 due to new European legislation (Tab. 1). From there on, OPs insecticides were totally replaced by Bti.

Environmental variations affect *Ester* alleles dynamics

This unique dataset allowed a precise survey of the dynamics of *Ester* resistance alleles. Using a maximum likelihood approach, we inferred the observed allele frequencies in each sample for a given year, and fitted these data to a geometric cline for each allele (eq.1, Methods § “Allele frequencies and clines”, S3 Figure). It allowed describing the variations of the *Ester* alleles frequencies both in space and time. Using these clines, we computed the maximum resistance allele frequencies (MAFs, *i.e.* the frequencies at the sea) and the frequencies 20 km inland, as well as their associated support limits (Fig. 2): two main patterns can be observed, before and after OPs removal.

Resistance allele frequencies are correlated with OP quantities

During OPs use, and as shown before [34,41], *Ester*⁴ first replaced *Ester*¹, until the invasion of *Ester*² in the 1990th. In 2002 however, *Ester*² reached its maximal frequency. From there on, the *Ester* allele frequencies remained globally stable until 2005. There were however some marked interannual variations (Fig. 2). We investigated whether these allele frequency variations could result from OPs quantities variations. To analyze response to low amplitude selective pressure variations, we first focused on the 1995-2008 period, when the three resistant alleles were present in the studied area and OPs variation in the range 0.11 to 4.5 l.km⁻² (Tab. 1).

Table 1: Data collection from 1986 to 2012.

Year	86 ^a	87 ^a	...	90	91 ^a	92	93 ^a	94	95 ^a	96 ^a	97	98	99 ^b	00	01 ^b	02 ^b	03 ^c	04 ^c	05 ^c	06 ^c	07 ^c	08 ^c	09 ^c	10 ^c	12 ^c	Total
N_{pop}	10	3	-	-	7	-	2	-	10	7	-	-	8	-	12	9	8	8	9	8	8	7	4	13	9	142
N_i	354	125	-	-	217	-	110	-	1203	512	-	-	411	-	736	521	464	464	526	466	464	406	236	722	582	8519
T	8.82	8.82	...	8.82	8.12	3.31	2.60	1.95	1.49	2.58	4.50	2.31	3.40	3.13	4.30	3.62	1.64	2.46	2.65	0.18	0.11	0.00	0.00	0.00	0.00	

^a Data from [31]

^b Data from [51]

^c This study, see S1 table.

The number of populations collected (N_{pop}), the number of individuals analyzed (N_i) and the total OP quantity (T) used each year in the treated area are presented. From 1986 to 1989, treatment applications (i.e., size of the treated area and quantities used) were not significantly different from those of 1990 (EID 1992; [41]), so that we assigned the same OP quantity to those years where information was missing (italics). The distribution of the insecticide within the treated area did not change significantly between years from 1990 and 2005 ([41], this study, data not shown). After 2007, temephos was not used anymore, replaced by Bti, a toxin mix extracted from *Bacillus thuringiensis* var. *israelensis*.

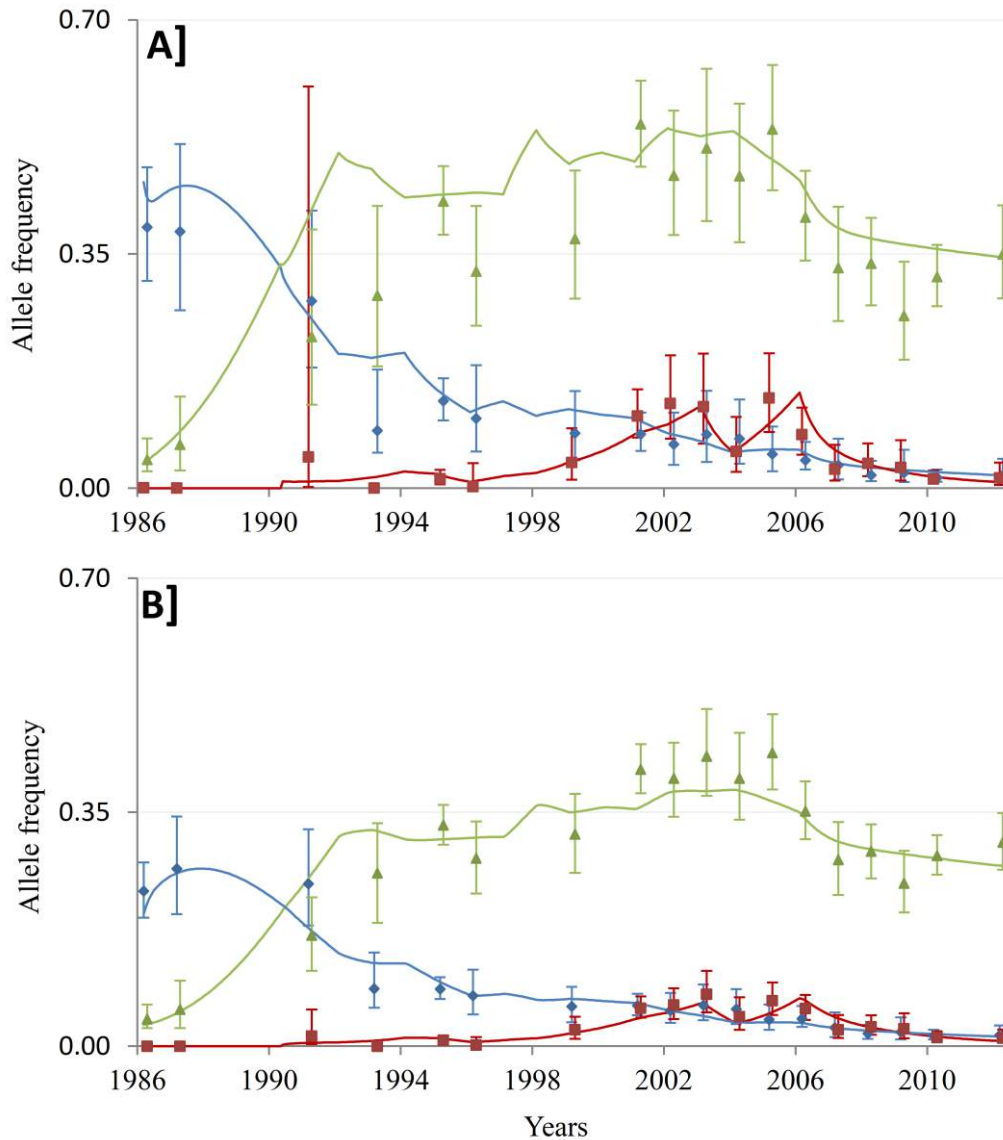

Figure 2: *Ester* resistance allele dynamics over the period 1986-2012.

The frequencies of the different resistance alleles and their support limits are presented for: *Ester*¹ (blue diamonds), *Ester*² (red squares) and *Ester*⁴ (green triangles). A: allele frequencies near the sea (MAFs); B: allele frequencies 20 km inland. Continuous lines represent the allele frequencies predicted by the complete model over the period 1986-2012. The vertical gray dotted line corresponds to the estimation of the date at which the model reestimated the cost of each resistance allele (t_{cost}).

Globally, it was found that *Ester* allele frequencies (resistance and susceptible) in a given year were significantly correlated with the OPs quantities used in the previous year (Fig. 3), but not with those used the same year (S4 Table). Considering the susceptible allele (*Ester*⁰) frequencies at the sea, a highly significant negative correlation was found (Pearson's coefficient correlation $r = -0.81$, $t = -4.16$, $df = 9$, $p < 0.01$,

Fig. 3A). However, the correlations were different when considering each resistance allele independently: while *Ester*² and *Ester*⁴ were correlated with OPs quantities ($r = 0.74$, $t = 3.33$, $df = 9$, $p < 0.01$ and $r = 0.70$, and $t = 2.95$, $df = 9$, $p < 0.05$, respectively, Fig. 3B), the correlation was not significant for *Ester*¹, despite a similar trend ($r = 0.37$, $t = 1.2$, $df = 9$, $p = 0.26$, Fig. 3B). When considering the whole dataset,

*Ester*¹ frequencies were nevertheless strongly impacted by the OPs reduction after 1991 (from 8.12 to 3.31 l.km⁻², Tab. 1 and Fig. 2). Note that the same correlations exist when the allele frequencies over the whole transect are considered, showing that the whole transect was affected by the inter-annual selective pressure variations and not only the coastal treated area (S5 Figure).

Resistance alleles frequencies dropped after OPs withdrawal, but they are reaching a new equilibrium

A major shift occurred around 2005: anticipating the 2007 European ban on OPs, EID dramatically reduced the quantities of OPs used, until complete withdrawal after 2007. As expected, the removal of the OPs insecticide had a dramatic effect on the dynamics of the *Ester* resistance alleles. After 2005, the MAFs dropped very rapidly, with a decrease from a frequency of 0.85 to 0.37 for the sum of the resistance allele frequencies between 2005 and 2010, before stabilizing again. OPs withdrawal

thus caused a decrease of 56 % of the amount of resistance allele's frequencies, highlighting the role of the strong selective cost they induced.

Considering now the whole sampling transect, all *Ester* allele frequencies followed a similar clinal distribution until 2005 ([41] and S3 Figure). After 2005, the global decrease of all resistance alleles resulted in a softening of these clines, as it was expected due to the spatial homogenization of the environment, before stabilizing again between 2010 and 2012 (Fig. 2 and S3 Figure). As a result, in 2012, *Ester*¹ and *Ester*² frequencies appeared homogeneous and low (around 0.01) over the entire transect (LRT_{od}, $F = 0.84$, $\square df = 2$, $p = 0.44$). By contrast, the clinal shape remained significant for *Ester*⁴ (LRT_{od}, $F = 14.9$, $\square df = 2$, $p < 0.001$) (S3 Figure). This allele remained relatively frequent over the whole transect, stabilizing around 0.35 close to the sea and 0.16 inland (S3 Figure).

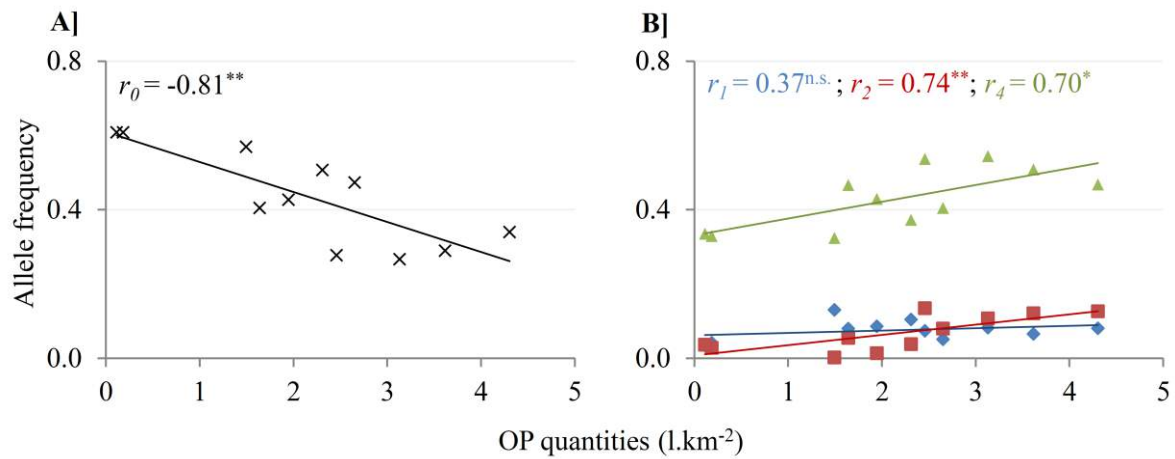

Figure 3: *Ester* allele frequencies versus insecticide quantities.

Data points represent the allele frequencies at the sea, inferred from phenotypic data. They are presented as a function of the OP quantity used the previous year. (A): for *Ester*⁰ (black crosses) and (B): for *Ester*¹ (blue diamonds), *Ester*² (red squares) and *Ester*⁴ (green triangles). Straight lines represent the linear regressions between the two factors. The correlation coefficient r_i (Pearson's product moment correlation) between f_i and the OP quantities is given, as well as the significance of this correlation (^{n.s.}, $p > 0.05$; *, $p < 0.05$; **, $p < 0.01$; ***, $p < 0.001$).

Quantifying the effects of environmental variations on fitness

In order to quantify the parameters influencing the allele dynamics at the *Ester* locus for the period 1986-2012, we used the same model as Labbé et al. [41], a deterministic stepping-stone model [32,40,42,54] of demes connected by migration. It implements three successive steps at each cycle (*i.e.* each generation): reproduction, selection and migration (see Methods § “Genetic model”).

Cost can be modified following OP withdrawal

One explanation for the persistence of resistance alleles after OPs withdrawal is that their costs may have evolved. To test this hypothesis, the model was allowed to fit different selective costs (c'_i , Tab. 2) after t_{cost} generations, this number of generations being also estimated by the model (see Methods § “Genetic model”, Tab. 2). The best fit indicated a significant cost reduction for the allele *Ester*¹ (from $c_1 = 0.08$ to $c'_1 = 0.06$, LRT_{od} , F -Test = 6, $\square df = 1$, $p = 0.02$) after $t_{cost} \approx 261$ generations (Tab. 2). This number of generation corresponds to year 2006, when the OPs quantities used were strongly reduced, in anticipation of their ban (Tab. 1 and Fig. 2). However, no significant change in the costs of *Ester*⁴ and *Ester*² was detected (Tab. 2).

Previous studies suggested that the level of amplification of some *Ester* resistance alleles could vary and adjust to selection pressures: a higher number of copies would result in higher resistance, but also in higher costs [37,56]. Both *Ester*² and *Ester*⁴ result from amplifications (while *Ester*¹ results from constitutive over-expression of a single copy); their levels of amplification were thus quantified before and after OPs removal by quantitative real-time PCR on genomic DNA (for details see S6 Appendix). Consistently with the model predictions, no change in amplification level was detected for both *Ester*² and *Ester*⁴ alleles (S6 Appendix).

Mosquito control treatments are not the only selective agent

In the model, the resistance allele selective advantages s_i were partitioned into a selective advantage s_{IT} due to OPs used for mosquito control (for which we know the doses that have been used along the years) and another advantage noted s'_i , to quantify the potential effects of other selective pressures (see Methods § “Genetic model”, eq.4). All the s'_i were estimated as significantly different from zero ($s'_1 = 0.13$, $s'_2 = 0.08$, $s'_4 = 0.12$; all $p < 0.001$; Tab. 2). Thus, the *Ester* resistance alleles conferred a selective advantage even after OPs removal, indicating that they are not only selected for by mosquito control treatments.

Fine fitness-to-dose responses shape the resistance allele dynamics

To quantify the fitness-to-dose responses of the different alleles, the selective advantage due to mosquito control (s_{IT}) was computed as a logistic function of the OPs quantities used each year t (T_t) over the period 1986-2012, adding two dose-response parameters for each allele (see Methods § “Genetic Model”, 3). This complete model fitted the data significantly better than the simplified model with constant s_{IT} (see Methods § “Tests and control for over-parametrization”; LRT_{od} , F -Test = 33, $\square df = 6$, $p < 0.001$).

Despite being highly significant, we checked whether the estimation of the dose-response parameters could have been driven by a couple of outlier samples. To rule out such over-parameterization, we analyzed the residuals of both the simplified and the complete models with regard to the OPs quantities (see Methods § “Tests and control for over-parametrization”). While the residuals of the simplified model appeared structured and correlated with OPs quantities ($r = 0.15$, $t = 2.7$, $df = 324$, $p = 0.007$), those of the complete model were not ($r = 0.09$, $t = 1.7$, $df = 324$, $p = 0.095$; S7 Figure). Together with the correlations illustrated on figure 3, this confirms that adding the dose-response parameters captured actual fitness responses to

Table 2: Complete genetic model.

Parameters		Estimate (SL)	F (Δdf)	
Initial conditions	h_1	0.55 (0.41 – 0.70)	19314 (1) ***	
	b_1	0.11 (0.07 – 0.15)	96 (1) ***	
	a_1	0.00 (0.00 – 0.00)	0 (1) n.s	
	h_4	0.04 (0.02 – 0.07)	90467 (1) ***	
	b_4	0.02 (0.00 – 0.08)	3 (1) n.s	
	a_4	0.00 (0.00 – 0.00)	0 (1) n.s	
<i>Ester</i> ² appearance		t_{app2}	55 (35 – 65)	8592 (1) ***
Evolution of Costs [#]		t_{cost}	261 (260 – 267)	15 (4) **
Selective Costs	<i>Before</i>	c_1	0.08 (0.07 – 0.10)	196 (1) ***
		c_2	0.11 (0.08 – 0.17)	67 (1) ***
		c_4	0.04 (0.03 – 0.05)	183 (1) ***
	<i>After</i> [#]	c'_1	0.06 (0.02 – 0.10)	6 (1) *
		c'_2	0.07 (0.00 – 0.16)	2 (1) n.s
		c'_4	0.04 (0.00 – 0.05)	0 (1) n.s
Selective Advantages	<i>Treatment</i>	s_{1T}	0.22 (0.19 – 0.26)	8 (3) *
		s_{2T}	0.32 (0.22 – 0.43)	72 (3) ***
		s_{4T}	0.21 (0.14 – 0.28)	77 (3) ***
	<i>Background</i> [#]	s'_1	0.13 (0.08 – 0.18)	325 (1) ***
		s'_2	0.08 (0.00 – 0.16)	25 (1) ***
		s'_4	0.12 (0.09 – 0.14)	217 (1) ***
Dose-response parameters [#]	d_1 / m_1	2.13 (1.96 – 2.39) / 80.0 (2.25 – 80)	8 (2) *	
	d_2 / m_2	1.95 (1.79 – 2.27) / 40.0 (2.30 – 40)	65 (2) ***	
	d_4 / m_4	3.66 (3.17 – 4.20) / 1.26 (1.12 – 2.1)	77 (2) ***	
Relative fitnesses ($w_1 : w_2 : w_4$)	TA	1.14 : 1.19 : 1.16		
	UTA	0.92 : 0.89 : 0.96		
	$\%TD$	92.5		
	Od	1.47		

The estimated value of the different parameters is given with its associated support limits (SL). The significance of each parameter was then tested by removing it, and comparing the likelihood of the resulting model to that of the complete one, using LRT_{od} (n.s. non-significant, * $p < 0.05$, ** $p < 0.01$, *** $p < 0.001$). The statistic of the LRT_{od} (F) and the difference of degree of freedom (Δdf) are also indicated for each parameter. The fitness of each resistance allele (w_i) before OPs removal and relatively to the susceptible ($w_0 = 1$) is also given, in both TA and UTA. Finally, the log-likelihood (L), the total deviance explained ($\%TD$) and the overdispersion (Od) of the complete model are indicated. Parameters with # correspond to the parameters additional to Labbé et al.'s model [41] (see Methods § “Genetic model”).

dose variations, and that this fit improvement was driven by the bulk of the data.

The parameter estimates indicate that the fitness-to-dose responses differed between the *Ester* resistance alleles (S8 Figure): their selective advantages were affected differently by the variations in OPs quantities, confirming the correlations observed earlier (Fig. 3 and S5 Figure). The advantage of all alleles was significantly and positively dependent on OPs quantities (*Ester¹*: LRT_{od} , F -test = 8, $df = 2$, $p = 0.021$; *Ester²*: F -test = 66, $df = 2$, $p < 0.001$ and *Ester⁴*: F -test = 78, $df = 2$, $p < 0.001$). However, the fitness-to-dose response was steep for *Ester¹* and *Ester²* (S8 Figure): they appeared proportionally affected by slight variations of treatment in the 0 to ~ 2 l.km⁻² range, but expressed their full advantage for higher quantities (S8 Figure). *Ester⁴* on the other hand was affected over the whole 0 to 9 l.km⁻² range,

but more smoothly than the two other alleles (S8 Figure).

Overall, this quantitative analysis suggested that, while being finely tuned to the quantitative changes in OPs quantities, the fitness of the various resistance alleles depends also on cost evolution and other sources of selection. The overall net effect is that the allele with the highest fitness in the TA differed depending on the treatment intensity (Fig. 4): *Ester²* fared better with moderate to high doses of OPs, while *Ester⁴* and *Ester¹* were more advantageous with low doses. However, in the untreated-area (UTA), thanks to a lower selective cost, *Ester⁴* was the fittest resistance allele (Tab. 2). After OPs removal, thanks to continuing secondary sources of selection, *Ester¹* and *Ester⁴* appeared to confer similar and higher fitnesses in the ex-TA (Fig. 4). In UTA, *Ester⁴* remained the fittest resistance allele, despite *Ester¹* selective cost reduction (Tab. 2).

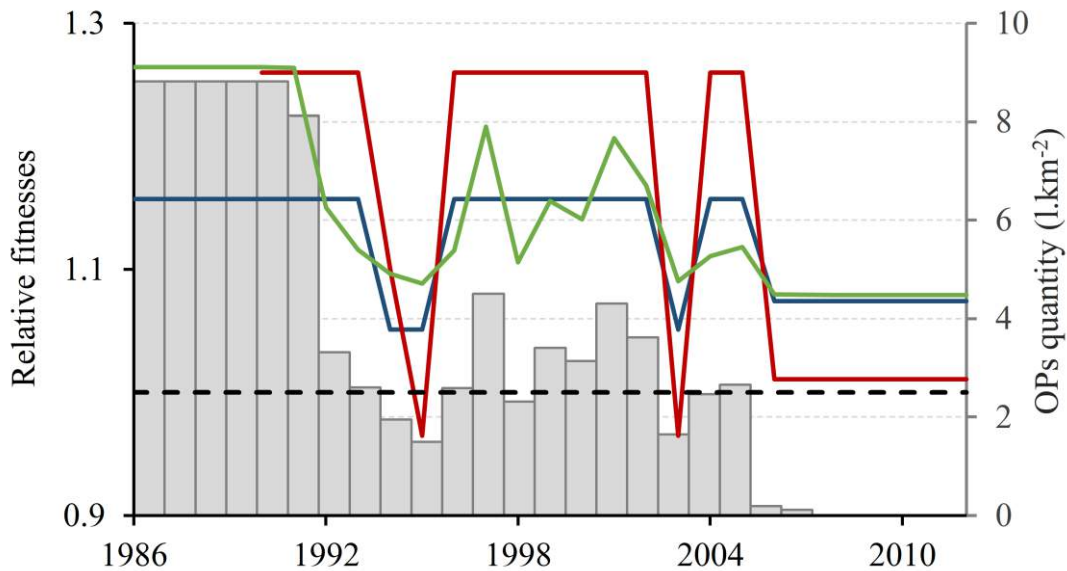

Figure 4: *Ester* allele's relative fitnesses in treated area over the 1986-2012 period.

Plain lines represent the relative fitness (left axis) in the insecticide treated area (TA) for each resistance allele (*Ester¹* in blue, *Ester²* in red and *Ester⁴* in green) estimated from the complete model (with treatment-dependent fitnesses). The dotted line represents the fitness of the susceptible allele (*Ester⁰* in black, $w_0 = 1$). For each year, the fitnesses are computed as: $I + s_{iT} + s'_i - c_i$ with s_{iT} , s'_i and c_i respectively the advantages (depending on the OPs quantity or on other selective pressures) and the cost of the allele i . The histogram represents the total OPs quantity (l.km⁻², right axis) used each year in the treated area over the 1986-2012 period.

Discussion

Resistance to OPs has been monitored for 40+ years in Montpellier area *Cx. pipiens* populations. Yearly sampling along a same transect provided a ~30 years time-series for *Ester* resistance allele frequencies. Moreover, the local mosquito control agency (EID) recorded the OPs quantities used each year during the same period. Combining both datasets for the 1986-2012 period, we investigated how the variations in OP quantities (*i.e.* selection intensity) affected the dynamics of the *Ester* resistance alleles (*i.e.* the adaptive alleles), more specifically addressing i) the evolution of the resistance allele selective costs, ii) the potential impacts of selective pressures other than the one caused by mosquito control, and iii) the effects of selective pressure variations on the outcome of adaptive allele competition.

We first had to quantitatively describe the environment at a scale consistent with the scale at which the allele frequencies variations were measured. Fortunately, the size of the treated area is only slightly larger than the scale of mosquito dispersal, so that the heterogeneous distribution of the selection intensities within the treated area (due to spatial variations in insecticide usage) could be neglected. We were also able to ignore the within-year variations, as they are not directly relevant to the long-term trend: while no insecticide treatment occurs from October to March-April (so that resistance alleles tend to decrease in frequency due to their cost [32,57]), it has been shown earlier that a selection-migration equilibrium was rapidly reached each year after a few rounds of treatments [32,41]. Similarly, we considered the total OPs quantity used in the TA over each sampling year (thereby neglecting the treatment precise timing). Spatial and temporal selective pressure's variations were thus both described quantitatively, at scales relevant to the long-term trends. Consistently with this environment description, we used *Ester* frequency data from only one season (early summer); fitness estimations inferred from these data must thus be considered as annual averages.

Adaptive responses are tuned to selective pressure variations

Confronting yearly OP usages to summer resistance-allele frequencies evidenced strong correlations: the allele frequencies of a given year were highly related to the OPs quantities used the previous year, and more so than to the same year quantities.

While they do not affect the long-term trends (see above), the seasonal OPs intensity variations are probably responsible for this delay. As stated above, in a year t most of the treatments were applied from June to August, on five to eight mosquito generations. Then, after one or two more generations, a single generation of mosquito females entered caves for overwintering until March-April, leading to one or two more generations before the beginning of the treatments of year $t+1$ [32,57]. Our samples were collected in late June of year t , *i.e.* after only one or two rounds of treatments, but only few generations (about three) after the end of the previous treatment campaign ($t-1$). Considering the long trend, and as we analyzed the total quantity of OPs used for each campaign (*i.e.* a dozen of rounds), the *Ester* frequencies in our June samples were thus more the result of the previous ($t-1$) than of the current (t) year of selection, thereby explaining the delayed correlations.

In conclusion, it clearly appeared that the yearly variations in insecticide treatment intensity affected the frequencies of the *Ester* alleles, confirming that the response to selection can be fast and finely tuned [32]. We then investigated how these variations quantitatively affected the fitness of *Ester* resistance alleles, and thus their evolutionary dynamics.

Long-term survey revealed that *Ester* evolution is more complex than anticipated

Using a migration-selection population genetic model with few parameters (and checked for over-parameterization, see S7 Figure), we were able to explain most of the total deviance (%TD

= 92.5), with a low over-dispersion ($od = 1.47$), of a long-term survey dataset composed on 994 phenotypic frequencies distributed over 27 years in a 50km transect.

This long-term survey covers a major environmental change: anticipating the ban of OPs by a new European Union regulation, EID drastically reduced OPs quantities after 2005, before stopping them definitively after 2007. From this date, *Ester* resistance allele's dynamics should have been determined only by their selective costs: resistance alleles were expected to disappear, replaced by the susceptible allele (the fittest in absence of treatments), as already observed in other situations of selection pressure removal [58–61]. In line with these predictions, OPs removal indeed resulted in a rapid drop in *Ester* resistance allele frequencies over the whole transect. Our yearly sampling allowed also quantifying the speed of this decrease to -51% in the three first years. This rapid change suggested that resistance management strategies based on temporal alternation of insecticides (see [49]) can be effective in natural populations, as long as resistance alleles remain costly. However, the following years showed that the Montpellier situation was actually more complex, and that both evolution and human activities can impede resistance management.

Selective costs allow resistance management, but they can evolve

A major threat to resistance management is indeed that the costs of resistant alleles can evolve too: cost reductions have been documented after selective pressure withdrawal in cultures of prokaryotes or protozoa [47,62,63], although examples in natural populations of metazoans remain scarce [64]. The present study is a new one, as the best model suggests a significant reduction of *Ester*¹ selective cost. Interestingly, this change is found concomitant with the OPs removal. This observation suggests that this compensatory evolution might directly involve change in expression of *Ester*¹ (rather than the occurrence of a modifier elsewhere in the genome). Meanwhile, the costs of

*Ester*² and *Ester*⁴ remained stable, a difference that could be due to the underlying mechanism of resistance: resistance results from a constitutive over-expression of esterases for *Ester*¹ (without variation in copy number), but is due to gene amplification of the esterase-encoding loci for *Ester*² and *Ester*⁴. Interestingly, *Ester*² and *Ester*⁴ amplification levels did not appear different before and after the OP removal (note however that sample size is limited for *Ester*², S6 Appendix). However, it is likely that adjusting protein expression by changes in regulatory regions (and thus the associated metabolic cost) is an easy route for cost compensation. As it turns out, this compensatory evolution seems less constrained when over-production results from gene up-regulation (*Ester*¹) than gene amplification (*Ester*² and *Ester*⁴). In any case, such reductions would slow the resistance allele disappearance and thus complicate resistance control.

Other human activities can prevent resistance elimination

Our study also revealed important observations for resistance management: from 2009 to 2012, instead of being further eliminated, the *Ester* resistance allele frequencies indeed remained relatively stable. While the frequencies of *Ester*¹ and *Ester*² were very low, *Ester*⁴ remained quite frequent over all the survey transect (S3 Figure). Accordingly, the model inferred that a significant part of the selective advantage of resistance alleles was not due to mosquito control (all s'_i parameters were significantly different from zero, Tab. 2). These results suggest that selective pressures other than OPs used for mosquito control act on resistance allele dynamics and allow their maintenance after OPs removal, thereby impeding resistance management.

Interestingly, *Ester*⁴ in 2012 presented a clinal distribution similar to that observed before OPs removal (S3 Figure). It thus seems that the distribution of the persisting selective pressures is similar to that of EID insecticide treatments, *i.e.* concentrated in the area closest to the sea. Two

anthropic perturbations show such a distribution in the area: urbanization and agriculture. *Cx. pipiens* habitat is composed of water bodies rich in organic matter and concentrating effluents from anthropic activities. Larvae are thus probably exposed to many residuals from agricultural or urban activities, so that elevated levels of detoxifying enzymes, such as esterases, could be advantageous. These peculiar preferences of *Cx. pipiens* could make it an interesting sentinel to detect chronic pollutions through insecticide resistance alleles. However, the exact sources of *Ester* allele selection remain elusive and could prove difficult to identify.

Different fitness-to-dose responses explain *Ester* resistance allele dynamics

The dynamics of the *Ester* resistance alleles after OP removal were thus consistent with both the evolution of cost and the persistence of a selective advantage due to background-environment, but how were these dynamics influenced before this removal? The complete model was implemented to quantify how the intensity of the selective pressure (*i.e.* the OP quantity) was affecting the relative fitness of the resistance alleles, and more particularly their selective advantage. We used a logistic function to model the fitness-to-dose relationship, allowing for possible non-linearity.

A previous study had shown that the dynamics of the different resistance alleles is due to their different selective advantages and costs [41]. The resistance allele *Ester*¹ was first replaced by *Ester*⁴, a more generalist allele (with the same advantage, but lower cost), and *Ester*² was later invading Montpellier area thanks to a higher advantage, and despite a relatively high cost. Everything being stable, *Ester*² was expected to replace *Ester*⁴ around 2007 [34,41](S9 Figure).

However, the present study showed that selective advantages are not fixed parameters, but varied with the quantity of insecticide used. Moreover, the three alleles showed different norms of reaction to variations in the selective pressure: while *Ester*⁴ showed a smooth relation

between dose and advantage, the other alleles rather display a more binary response, with full advantage over a threshold dose and none below (S8 Figure).

These differences are not the results of the genetic architecture underlying the resistance mechanisms, as *Ester*¹ and *Ester*² result from different mechanisms (over-expression *vs* gene amplification), but show similar and limited fitness-to-dose response. Differences are thus more probably due to the nature of the over-produced esterases (*i.e.* the sequences of the proteins differ between the various alleles), although further studies will be needed to explore the molecular causes of these differences.

Nevertheless, these differences in the shape of the fitness-to-dose relationships have important consequences, as variation in selection pressures can change the identity of the fittest allele: even within the small range of interannual OPs quantities, a change can occur from year to year (*e.g.* *Ester*⁴ is the fittest allele in 2003 with 1.64 l.km⁻² OPs, while *Ester*² is the fittest in 2004 with 2.46 l.km⁻², Fig. 4). Such relative fitness changes temporarily modify the direction of frequency changes among alleles. Labbé *et al.*'s study (2009), which considered only a qualitative description of the environment over the 1986-2002 period, anticipated *Ester*² invasion (S9 Figure). The different resistance allele's relative fitnesses were then estimated as 1.12 / 1.25 / 1.16 in TA and 0.92 / 0.88 / 0.96 in UTA, respectively for *Ester*¹, *Ester*² and *Ester*⁴. The mean relative fitnesses (computed from the fitnesses estimated each year over the 1986-2007 period) inferred by the complete model in the present study are consistent with these values (TA: 1.14 / 1.19 / 1.16 and UTA: 0.92 / 0.89 / 0.96, respectively, Tab. 2), emphasizing the robustness of the general approach. However, it appears that *Ester*⁴ (the least costly and the most generalist allele) won the competition in Montpellier area instead of *Ester*². This was entirely explained by the variations in the OPs selective pressure intensity, variations of low

OPs dose changed the fittest allele, which altered the *Ester* allele dynamics.

Fitness-to-dose responses associated with relatively large selection coefficients indeed allowed fast and finely-tuned responses to selective pressure variations. The resistance allele frequencies were thus adjusted over only a few generations (as seen in yearly variations of insecticide intensities [32]), and these adjustments were noticeable even for only slight variation of insecticide pressure (e.g. an increase of 0.2 l.km⁻² of OPs resulted in an increase of 8% of *Ester*² allele frequency between 2004 and 2005, Fig. 2). While these fitness-to-dose relationships and fast responses limit our ability to predict the outcome of the resistance allele competition without a sufficient knowledge of the environment variations, they also contribute to the maintenance of polymorphism in natural populations.

In a context where environmental pollution due to anthropogenic activities is increasing, organisms are chronically exposed to varying but generally low doses of xenobiotics. Understanding fitness-to-dose relationships in natural settings for these compounds thus appears of paramount importance. However, long-term surveys are mandatory for this task.

Material and methods

Ester resistance alleles in Montpellier area

Carboxyl-esterases (COE) catalyze the ester bond of many molecules, including OPs [48,49]. In *Culex pipiens*, COE-resistance is achieved through overproduction, due to up-regulation or gene amplification [34,50]. In Montpellier area, three different *Ester* resistance alleles were described: *Ester*¹ (up-regulation) *Ester*² and *Ester*⁴ (gene amplification).

As the various alleles can be easily identified by protein electrophoresis, their dynamics have been monitored since 1986 in Montpellier area, by sampling a similar transect in late-June, ear-

ly-July, until present [32,34,51; this study]. This *ca.* 50 km South-North transect extends from the Mediterranean sea inland (Fig. 1). Insecticide usage is variable over this transect, with a coastal treated area (TA), a seaside strip \approx 16km wide [41], and an un-treated area (UTA), more inland (Fig. 1). About ten larval *Cx. pipiens* populations have been collected almost each year along the sampling transect (localities changed, see Fig. 1). These larvae were reared to adulthood in the laboratory, and adults were stored in liquid nitrogen for further analyzes.

Insecticide treatments

In the coastal TA (Fig.1), the local mosquito control agency (Entente Interdépartementale pour la Démoustication, EID) regularly treated larval breeding sites with temephos (Abate®, Bayer), an OP insecticide, until 2007. EID provided us with the total quantities used per year from 1990 to 2007 (Tab. 1).

Phenotyping

The 1986-2002 phenotype dataset was already available [34,41,51]. It was extended by phenotyping 58 mosquitoes from each of the 74 populations from 2003 to 2012. The *Ester* phenotype of each mosquito was obtained using starch-gel electrophoresis (Tris–Malate–EDTA 7.4 buffer [52]). Overproduced esterases are dominant over non-overproduced esterases under our electrophoretic conditions, nomenclature and the correspondence between genotypes and observed phenotypes are given in (S1 Table).

Allele frequencies and clines

Allele frequencies and their support limits (equivalent to 95% confidence intervals) were estimated from phenotypic data, independently in each population and each year, using the maximum-likelihood approach developed by Lenormand et al. [32].

Following Lenormand et al. [53] a geometric cline of allele frequencies (p_i) was fitted by maximum likelihood (see below) to all samples

of each sampling year to estimate the maximum frequency (h_i) of each allele i . This cline was approximated by a negative exponential function:

$$p_i = h_i \cdot e^{-(a_i x^2 + b_i x)} \quad (\text{eq.1}),$$

where a_i and b_i describe the shape and the slope of the cline for allele i , and x was the distance to the sea.

Migration–selection model:

In order to quantify the parameters influencing the allele dynamics at the *Ester* locus, we used the same model as Labbé et al. [41]. This deterministic stepping-stone model [32,40,42,54] considers 35 2km-spaced demes connected by migration, and implements three successive steps at each cycle (*i.e.* each generation): reproduction, selection and migration. Following Lenormand et al. [32], we considered that there are 13 generations by year in *Cx. pipiens* from southern France, that is a total of 339 cycles for the period 1986-2012.

Reproduction: The allele frequencies in each generation were computed from the previous one assuming panmixia independently in each deme. Each deme was considered as an infinite population.

Selection: The fitness (w_{ij}) of a diploid genotype combining the *Ester* alleles i and j depended on the selective advantages (s_i and s_j) and costs (c_i and c_j) of each allele. We assumed co-dominance of advantages and of costs. w_{ij} was thus computed as:

$$w_{ij} = 1 + \gamma[s_i + 0.5(s_j - s_i)] - [c_i + 0.5(c_j - c_i)] \quad (\text{eq.2}),$$

where 1 was the fitness of a susceptible homozygote and γ a variable indicating whether the considered deme is in TA ($\gamma = 1$) or UTA ($\gamma = 0$). Both the resistance advantage s and the selective cost c impact fitness in TA, while only the latter plays a role in UTA.

The frequency of each genotype after selection was computed in each deme independently, as its frequency before selection times the ratio of its fitness over the mean fitness [41,42].

Migration: Migration between demes was computed as an approximately Gaussian dispersal

kernel with a parent-offspring distance standard deviation $\sigma = 6.6 \text{ km} \cdot \text{generation}^{-1/2}$ [40].

Initial conditions: As in Labbé et al. [41], the initial (*i.e.* in 1986) allele frequencies at the *Ester* locus were inferred using eq.1. As the *Ester*² allele was not yet present in 1986, we introduced it t_{app2} generations after 1986, at a frequency of 0.01 in all demes in the TA (t_{app2} is estimated in the model).

Parameters' estimation

The various parameters were estimated using a maximum-likelihood approach. Deterministic recursions generated the predicted frequency of each allele at any point in time and position on the transect, for a given set of parameter values. These predicted frequencies were then compared to the complete sample dataset. To this aim, we computed the log-likelihood L of observing all the data, which is proportional to:

$$L = \sum_t \sum_i \sum_j n_{ijt} \ln(f_{ijt}) \quad (\text{eq.3}),$$

with n_{ijt} and f_{ijt} the observed number (from phenotyping data) and the predicted frequency (from the models) of individuals with phenotype i in population j at time t , respectively. It was jointly maximized for all parameters of a given model over the whole dataset, using a simulated annealing algorithm [32,40–42,54].

For each parameter, the support-limits (SL) were computed as the minimum and maximum values it could take without significantly decreasing the likelihood of the model; SL are roughly equivalent to 95% confidence intervals. Over-dispersion was computed for each model as the ratio of residual deviance $D = -2L$ over the residual degrees of freedom (Δdf). The percentage of total deviance explained by a model was computed as $\%TD = (D_{max} - D_{model}) / (D_{max} - D_{min})$, with D_{max} and D_{min} respectively the maximal and the minimal deviance. Recursions and likelihood maximization algorithms were written and compiled using Lazarus v1.0.10 (<http://www.lazarus.freepascal.org/>).

Genetic model

The model developed by Labbé et al. [41] considered 13 parameters: two selection coeffi-

cients (s_i and c_i) for each resistance allele i , in addition to three initial allele frequency parameters (h_i , b_i , a_i) for $Ester^1$ and $Ester^4$ ($Ester^2$ was not yet present in 1986) and one parameter for the date of appearance of $Ester^2$ (t_{app2}) (Tab. 2). This model was then modified:

(1) to test for the evolution of the $Ester$ alleles selective costs (c'_i), the model was allowed to fit different selective costs after generation t_{cost} , a parameter estimated simultaneously with the others; from generation t_{cost} , c_i was replaced by c'_i in equation 2 (see Methods § "Migration-selection model).

(2) to estimate the impact of selective pressures other than the mosquito control insecticide, the selective advantage (s_i) was decomposed into two terms s_{iT} and s'_i : s_{iT} was the advantage due specifically to resistance to OPs used for mosquito control; s'_i was the selective advantage of the resistance alleles resulting from other sources of selection. It could thus remain > 0 even in absence of insecticide treatment.

3) to consider the quantitative variations of OP insecticides over the 1986-2012 period, the selective advantage of $Ester$ resistance alleles due to mosquito controls (s_{iT}) was computed as a function of the OP quantities used each year t (T_t).

To account for both points 2) and 3), the selective advantage s_i (equation 2), was computed as:

$$s_i = s_{iT} \cdot f(T_t) + s'_i \quad (\text{eq.4}),$$

We considered a flexible functional forms for $f(T_t)$, assuming that it was monotonically increasing (selection intensity should increase with insecticide dose). We used a logistic function: $f(T_t) = 1 - \frac{1}{1 + e^{(m_i \cdot (b_i + T_t))}}$

This sigmoid curve is centered at dose b_i , and has a maximum slope proportional to m_i . m_i and b_i parameters were fitted independently for each allele i and will be thereafter designated as the dose-response parameters. The model was con-

strained to accept only $m_i \cdot b_i$ couples for which $< 0 f(T_t) < 0.0001$; so that $f(T_t) \approx 0$ when no treatment was applied (*i.e.* when $T_t = 0$). Thus, the mosquito control resistance advantage varied from 0 at low doses to s_{iT} at high doses.

Tests and control for over-parameterization

Whether each parameter was significantly different from zero was tested using likelihood-ratio tests corrected for over-dispersion (LRT_{od}; [55]). The complete model involves 26 parameters. Although this is a limited number considering the dataset (994 phenotypic frequencies over 27 years along a 50 km transect, over 8500 individuals sampled), there is always a risk of over-parameterization. One way to check for over-parameterization is to control the structure of the model residuals: if they are randomly distributed, additional parameters would be superfluous.

We tested in particular whether the dose-response parameters could not result in over-parameterization. A simplified model was implemented; it considered only a qualitative description of the environment by modifying the selective advantage (s_i) as $s_i = s_{iT} + s'_i$. The over-parametrization risk was then assessed by comparing the correlations of the residuals of the simplified and the complete models with OPs quantities.

For the period when OPs were used, we calculated the simplified model's residuals ϵ_j for all data points j as: $\epsilon_j = p_{jobs} - p_{imod}$, where p_{jobs} is the allelic frequency estimated from phenotypic data and p_{imod} the allelic frequency estimated by the model. Correlations between ϵ_j and T_t were tested using Pearson's product-moments (*R software v.3.1.1* <http://www.R-project.org/>).

Acknowledgments

We are very grateful to N Pasteur for helpful comments on the manuscript, and to A Lezallie, C Triay, P Dupont-Guianvarch, P-Y Biba Nkouka, A Gouy, S Unal, P Makoundou and A Berthomieu for technical support.

Competing financial interests

The authors declare that they have no competing financial interest.

References

- Lewontin RC. The Genetic Basis of Evolutionary Change. New York: Columbia University Press; 1974.
- Endler JA. Natural selection in the wild. Princeton, N.J.: Princeton University Press; 1986.
- Siepielski AM, Dibattista JD, Carlson SM. It's about time: The temporal dynamics of phenotypic selection in the wild. *Ecol Lett.* 2009;12: 1261–1276.
- Lande R, Arnold SJ. The Measurement of Selection on Correlated Characters. *Evolution (N Y).* 1983;37: 1210–1226.
- Kingsolver JG, Hoekstra HE, Hoekstra JM, Berrigan D, Vignieri SN, Hill CE, et al. The strength of phenotypic selection in natural populations. *Am Nat.* 2001;157: 245–261.
- Conner JK. How strong is natural selection? *Trends Ecol Evol.* 2001;16: 215–217.
- Hereford J, Hansen TF, Houle D. Comparing strengths of directional selection: how strong is strong? *Evolution (N Y).* 2004;58: 2133–2143.
- Kawecki TJ, Ebert D. Conceptual issues in local adaptation. *Ecol Lett.* 2004;7: 1225–1241.
- Gallet R, Cooper TF, Elena SF, Lenormand T. Measuring selection coefficients below 10^{-3} : Method, Questions, and Prospects. *Genetics.* 2012;190: 175–186.
- Lenormand T, Rode N, Chevin LM, Rousset F. Valeur sélective : définitions enjeux et mesures *in press.* In: Lefèvre T, Thomas F, Raymond M, editors. *Biologie Evolutive.* 2nd ed. de boeck; 2015.
- Bell G. Selection. Oxford: Oxford Univ. Press.; 2008.
- Millstein RL. Distinguishing drift and selection empirically: “The great snail debate” of the 1950s. *J Hist Biol.* 2008;41: 339–367.
- Mitchell-olds AT, Shaw RG. Regression analysis of natural selection: statistical inference and biological interpretation. 1987;41: 1149–1161.
- Rausher MD. The Measurement of Selection on Quantitative Traits: Biases Due to Environmental Covariances between Traits and Fitness. *Evolution (N Y).* 1992;46: 616–626.
- Schluter D, Price TD, Rowe L. Conflicting Selection Pressures and Life History Trade-Offs. *Proc R Soc B Biol Sci.* 1991;246: 11–17.
- Benkman CW, Miller RE. Morphological Evolution in Response to Fluctuating Selection. *Evolution (N Y).* 1996;50: 2499–2504.
- Grant PR, Grant BR. Predicting Microevolutionary Responses to Directional Selection on Heritable Variation. *Evolution (N Y).* 1995;49: 241–251.
- Schemske DW, Horvitz CC. Temporal Variation in Selection on a Floral Character. *Evolution (N Y).* 1989;43: 461–465.
- Gutschick VP, BassiriRad H. Extreme events as shaping physiology, ecology, and evolution of plants: Toward a unified definition and evaluation of their consequences. *New Phytol.* 2003;160: 21–42.
- Karlin S, Lieberman U. Random temporal variation in selection intensities: case of large population size. *Theor Popul Biol.* 1974;6: 355–382.
- Grant BR, Grant PR. Evolution of Darwin's Finches Caused by a Rare Climatic Event. *Proc R Soc B Biol Sci.* 1993;251: 111–117.
- Caruso CM, Brook Peterson S, Ridley CE. Natural selection on floral traits of *Lobelia* (Lobeliaceae): spatial and temporal variation. *Am J Botany.* 2003;90: 1333–1340.
- Losos JB, Warheitt KI, Schoener TW. Adaptive differentiation following experimental island colonization in *Anolis lizards.* *Nature.* 1997;387: 70–73.

24. Reznick DN, Bryga H. Life-History Evolution in Guppies (*Poecilia reticulata*): 1. Phenotypic and genetic changes in an introduction experiment. *Evolution* (N Y). 1987;41: 1370–1385.
25. Rundle HD, Vamosi SM, Schluter D. Experimental test of predation's effect on divergent selection during character displacement in sticklebacks. *Proc Natl Acad Sci U S A*. 2003;100: 14943–14948.
26. Bradshaw WE, Zani P a, Holzapfel CM. Adaptation to temperate climates. *Evolution*. 2004;58: 1748–1762.
27. Whalon MEE, Mota-Sanchez D, Hollingworth RMM. Global pesticide resistance in arthropods. Whalon ME, Mota-Sanchez D, Hollingworth RM, editors. Office. Cambridge, MA: CABI publishing; 2008. p. 192.
28. Gonzales-Candels F, Comas I, Martinez J luiz, Galan JC, Baquero F. The evolution of antibiotic resistance. In: Tibayrenc M, editor. *Genetic and evolution of infectious diseases*. London, U.K.: Elsevier; 2011.
29. Janssens TKS, Roelofs D, van Straalen NM. Molecular mechanisms of heavy metal tolerance and evolution in invertebrates. *Insect Sci*. 2009;16: 3–18.
30. Cook LM, Mani GS, Varley ME. Postindustrial melanism in the peppered moth. *Science*. 1986;231: 611–613.
31. Macnair MR. Heavy metal tolerance in plants: A model evolutionary system. *Trends Ecol Evol*. 1987;2: 354–9.
32. Lenormand T, Bourguet D, Guillemaud T, Raymond M. Tracking the evolution of insecticide resistance in the mosquito *Culex pipiens*. *Nature*. 1999;400: 861–864.
33. European Commission 2007/393/EC. Commission decision of 6 June 2007 concerning the non-inclusion of diazinon in Annex I to Council Directive 91/414/EEC and the withdrawal of authorisations for plant protection products containing that substance. 2007/393/EC; 2007.
34. Guillemaud T, Lenormand T, Bourguet D, Chevillon C, Pasteur N, Raymond M. Evolution of resistance in *Culex pipiens* : Allele replacement and changing environment. *Evolution* (N Y). JSTOR; 1998;52: 443–453.
35. Carrière Y, Deland J-P, Roff DA, Vincent C. Life-history cost associated with the evolution of insecticide resistance. *Proc R Soc London B*. 1994;258: 35–40.
36. Chevillon C, Bourguet D, Rousset F, Pasteur N, Raymond M. Pleiotropy of adaptive changes in populations: comparisons among insecticide resistance genes in *Culex pipiens*. *Genet Res. Cambridge Univ Press*; 1997;68: 195–203.
37. Berticat C, Boquien G, Raymond M, Chevillon C. Insecticide resistance genes induce a mating competition cost in *Culex pipiens* mosquitoes. *Genet Res*. 2002;79: 41–47.
38. Bourguet D, Guillemaud T, Chevillon C, Raymond M. Fitness costs of insecticide resistance in natural breeding sites of the mosquito *Culex pipiens*. *Evolution* (N Y). Wiley Online Library; 2004;58: 128–135.
39. Duron O, Labbé P, Berticat C, Rousset F, Guillot S, Raymond M, et al. High *Wolbachia* density correlates with cost of infection for insecticide resistant *Culex pipiens* mosquitoes. *Evolution*. 2006;60: 303–314.
40. Lenormand T, Guillemaud T, Bourguet D, Raymond M. Evaluating gene flow using selected markers: a case study. *Genetics*. 1998;149: 1383–1392.
41. Labbé P, Sidos N, Raymond M, Lenormand T, Weill M. Resistance Gene Replacement in the mosquito *Culex pipiens*: fitness estimation from long-term cline series. *Genetics*. 2009;182: 303–12.
42. Lenormand T, Raymond M. Analysis of clines with variable selection and variable migration. *Am Nat*. 2000;155: 70–82.
43. Gazave E, Chevillon C, Lenormand T, Marquine M, Raymond M. Dissecting the cost of insecticide resistance genes during the overwintering period of the mosquito *Culex pipiens*. *Heredity* (Edinb). 2001;87: 441–448.
44. McKenzie JA. Measuring fitness and intergenic interactions: The evolution of resistance to diazinon in *Lucilia cuprina*. *Genetica*. 1993. pp. 227–237.
45. Cohan FM, King EC, Zawadzki P. Amelioration of the deleterious pleiotropic effects of an adaptive mutation in *Bacillus subtilis*. *Evolution* (N Y). 1994;48: 81–95.

46. Labbé P, Berticat C, Berthomieu A, Unal S, Bernard C, Weill M, et al. Forty years of erratic insecticide resistance evolution in the mosquito *Culex pipiens*. *PLoS Genet. Public Library of Science*; 2007;3: e205.
47. Andersson DI, Hughes D. Antibiotic resistance and its cost: is it possible to reverse resistance? *Nat Rev Microbiol. Nature Publishing Group*; 2010;8: 260–271.
48. Oakeshott JG, Devonshire AL, Claudianos C, Sutherland TD, Horne I, Campbell PM, et al. Comparing the organophosphorus and carbamate insecticide resistance mutations in cholin- and carboxyl-esterases. *Chem Biol Interact. 2005;157–158: 269–275*.
49. Labbé P, Alout H, Djogbénu D, Pasteur N, Weill M, Djogbénu L. Evolution of resistance to insecticide in disease vectors. In: Tibayrenc M, editor. *Genetics and evolution of infectious diseases*. London, U.K.: Elsevier; 2011. pp. 363–409.
50. Rooker S, Guillemaud T, Bergé J, Pasteur N, Raymond M. Coamplification of *esterase A* and *B* genes as a single unit in *Culex pipiens* mosquitoes. *Heredity*. 1996. pp. 555–561.
51. Labbé P, Lenormand T, Raymond M. On the worldwide spread of an insecticide resistance gene: A role for local selection. *J Evol Biol*. 2005;18: 1471–1484.
52. Pasteur N, Pasteur G, Bonhomme F, Britton-Davidian J. *Practical isozymes genetics*. Ltd. EH, editor. Chichester, U. K.; 1988.
53. Lenormand T, Guillemaud T, Bourguet D, Raymond M. Appearance and sweep of a gene duplication: Adaptive response and potential for new functions in the mosquito *Culex pipiens*. *Evolution (N Y)*. 1998;
54. Lenormand T, Raymond M. Resistance management: the stable zone strategy. *Proceeding R Soc London, B*. 1998;265: 1985–1990.
55. Anderson DR, Burnham KP, White GC. AIC model selection in overdispersed capture-recapture data. *Ecology*. 1994;75: 1780–1793.
56. Weill M, Berticat C, Raymond M, Chevillon C. Quantitative polymerase chain reaction to estimate the number of amplified esterase genes in insecticide-resistant mosquitoes. *Anal Biochem*. 2000;285: 267–270.
57. Raymond M, Berticat C, Weill M, Pasteur N, Chevillon C. Insecticide resistance in the mosquito *Culex pipiens*: what have we learned about adaptation? *Genetica*. 2001; 287–296.
58. Casimiro S, Coleman M, Hemingway J, Sharp B. Insecticide resistance in *Anopheles arabiensis* and *Anopheles gambiae* from Mozambique. *J Med Entomol*. 2006;43: 276–282.
59. Casimiro S, Coleman M, Mohloai P, Hemingway J, Sharp B. Insecticide resistance in *Anopheles funestus* (Diptera: Culicidae) from Mozambique. *J Med Entomol*. 2006;43: 267–275.
60. Sharp BL, Kleinschmidt I, Streat E, Maharaj R, Barnes KI, Durrheim DN, et al. Seven years of regional malaria control collaboration--Mozambique, South Africa, and Swaziland. *Am J Trop Med Hyg*. 2007;76: 42–47.
61. Parrella MP, Trumble JT. Decline of Resistance in *Liriomyza trifolii* (Diptera: Agromyzidae) in the absence of insecticide selection pressure. *J Econ Entomol*. 1989;82: 2–5.
62. Duncan AB, Fellous S, Kaltz O. Reverse evolution: selection against costly resistance in disease-free microcosm populations of *Paramecium caudatum*. *Evolution*. 2011;65: 3462–74.
63. Lenski RE. Experimental studies of pleiotropy and epistasis in *Escherichia coli*. I. variation in competitive fitness among mutants resistant to virus T4. *Evolution (N Y)*. 1988;42: 425–432.
64. McKenzie JA. *Ecological and evolutionary aspects of insecticide resistance*. Austin, Texas, USA: Academic Press; 1996.

Long-term fitness-to-dose relations *in natura*

Pascal Milesi¹, Thomas Lenormand², Christophe Lagneau³, Mylène Weill¹, Pierrick Labbé¹

Supplementary Files

S1 Table: Resistance mechanisms and nomenclature at the *Ester* locus.

Allele	Resistance mechanisms
<i>Ester</i> ⁰	-
<i>Ester</i> ¹	Up-regulation
<i>Ester</i> ²	Amplification
<i>Ester</i> ⁴	Amplification
Genotype	Phenotype
<i>Ester</i> ⁰ / <i>Ester</i> ⁰	[0]
<i>Ester</i> ⁰ / <i>Ester</i> ¹	}
<i>Ester</i> ¹ / <i>Ester</i> ¹	
<i>Ester</i> ⁰ / <i>Ester</i> ²	}
<i>Ester</i> ² / <i>Ester</i> ²	
<i>Ester</i> ⁰ / <i>Ester</i> ⁴	}
<i>Ester</i> ⁴ / <i>Ester</i> ⁴	
<i>Ester</i> ¹ / <i>Ester</i> ²	[12]
<i>Ester</i> ¹ / <i>Ester</i> ⁴	[14]
<i>Ester</i> ² / <i>Ester</i> ⁴	[24]

For the different *Ester* resistance alleles, the resistance mechanism associated is presented. Genotypes and the associated phenotypes (in starch-gel electrophoreses) are also indicated.

S2 Table: Ester phenotypes of individuals collected between 2003 and 2012.

Site	Km	2003								2004								2005							
		n	[0]	[1]	[2]	[4]	[12]	[14]	[24]	n	[0]	[1]	[2]	[4]	[12]	[14]	[24]	n	[0]	[1]	[2]	[4]	[12]	[14]	[24]
PérOLS	2.2	58	4	1	0	39	1	6	7	-	-	-	-	-	-	-	-	-	-	-	-	-	-	-	
Ch. gardée	2.5	-	-	-	-	-	-	-	-	-	-	-	-	-	-	-	-	-	-	-	-	-	-	-	
Parc expo	3.9	-	-	-	-	-	-	-	-	-	-	-	-	-	-	-	-	-	-	-	-	-	-	-	
Maurin	5.0	58	10	5	5	31	0	1	6	58	9	1	3	32	0	8	5	58	3	1	5	33	1	2	13
St-Jean	5	-	-	-	-	-	-	-	-	-	-	-	-	-	-	-	-	-	-	-	-	-	-	-	
Lattes	5.2	-	-	-	-	-	-	-	-	58	4	3	1	40	1	6	3	58	4	1	1	43	0	4	5
Malbosc	14	-	-	-	-	-	-	-	-	-	-	-	-	-	-	-	-	-	-	-	-	-	-	-	
Distill	18	-	-	-	-	-	-	-	-	58	24	0	2	29	0	1	2	58	13	5	7	26	0	2	5
Prades Plo	19	-	-	-	-	-	-	-	-	-	-	-	-	-	-	-	-	-	-	-	-	-	-	-	
Cuculles	26	58	33	1	3	20	0	0	1	58	14	2	5	31	2	3	1	55	14	6	1	29	1	1	3
Viols	30	58	19	3	1	33	0	2	0	58	21	5	-	29	0	2	1	58	30	1	0	27	0	0	0
SML	34	58	18	1	0	33	1	2	3	58	43	1	1	12	0	0	1	65	30	0	0	32	0	1	2
NDL	35	58	23	3	3	26	0	2	1	-	-	-	-	-	-	-	-	58	35	1	2	17	0	1	2
Worms	40	-	-	-	-	-	-	-	-	-	-	-	-	-	-	-	-	-	-	-	-	-	-	-	-
StBauzille	44	58	1	5	5	29	5	3	10	58	34	2	1	20	0	1	0	58	26	1	0	31	0	0	0
Ganges	49	58	29	3	2	24	0	0	0	58	22	0	3	30	0	2	1	58	36	3	0	18	0	0	1
Total		464	137	22	19	235	7	16	28	464	171	14	16	223	3	23	14	526	191	19	16	256	2	11	31

Site	Km	2006								2007								2008							
		n	[0]	[1]	[2]	[4]	[12]	[14]	[24]	n	[0]	[1]	[2]	[4]	[12]	[14]	[24]	n	[0]	[1]	[2]	[4]	[12]	[14]	[24]
PérOLS	2.2	-	-	-	-	-	-	-	-	58	14	0	6	38	0	0	0	58	14	1	1	39	0	2	1
Ch. gardée	2.5	-	-	-	-	-	-	-	-	-	-	-	-	-	-	-	-	-	-	-	-	-	-	-	
Parc expo	3.9	-	-	-	-	-	-	-	-	-	-	-	-	-	-	-	-	-	-	-	-	-	-	-	
Maurin	5.0	60	20	2	4	26	0	3	5	58	22	4	1	25	0	5	1	58	24	1	5	26	0	1	1
St-Jean	5	-	-	-	-	-	-	-	-	-	-	-	-	-	-	-	-	-	-	-	-	-	-	-	
Lattes	5.2	58	6	3	6	34	1	3	5	-	-	-	-	-	-	-	-	-	-	-	-	-	-	-	
Malbosc	14	-	-	-	-	-	-	-	-	-	-	-	-	-	-	-	-	-	-	-	-	-	-	-	
Distill	18	58	17	1	1	37	0	0	2	-	-	-	-	-	-	-	-	-	-	-	-	-	-	-	
Prades Plo	19	-	-	-	-	-	-	-	-	-	-	-	-	-	-	-	-	-	-	-	-	-	-	-	
Cuculles	26	58	24	4	1	23	1	2	3	58	31	3	2	21	0	0	1	58	35	0	2	18	1	0	2
Viols	30	-	-	-	-	-	-	-	-	58	33	1	0	23	0	0	1	58	31	2	2	23	0	0	0
SML	34	58	28	2	2	24	0	1	1	58	49	0	1	6	0	1	1	-	-	-	-	-	-	-	
NDL	35	58	28	3	4	22	0	1	0	58	34	2	0	22	0	0	0	58	35	3	0	20	0	0	0
Worms	40	-	-	-	-	-	-	-	-	-	-	-	-	-	-	-	-	-	-	-	-	-	-	-	
StBauzille	44	58	32	5	0	20	0	1	0	58	34	1	1	20	0	1	1	58	34	1	1	21	0	1	0
Ganges	49	58	33	2	0	19	1	1	2	58	37	2	3	16	0	0	0	58	38	2	1	16	0	0	1
Total		466	188	22	18	205	3	12	18	464	254	13	14	171	0	7	5	406	211	10	12	163	1	4	5

Site	Km	2009								2010								2012							
		N	[0]	[1]	[2]	[4]	[12]	[14]	[24]	n	[0]	[1]	[2]	[4]	[12]	[14]	[24]	n	[0]	[1]	[2]	[4]	[12]	[14]	[24]
PérOLS	2.2	-	-	-	-	-	-	-	58	17	3	0	36	0	2	0	116	43	1	0	70	1	1	0	
Ch. gardée	2.5	-	-	-	-	-	-	-	58	34	0	1	23	0	0	0	-	-	-	-	-	-	-	-	
Parc expo	3.9	-	-	-	-	-	-	-	56	18	1	1	36	0	0	0	-	-	-	-	-	-	-	-	
Maurin	5.0	60	23	1	4	29	0	2	57	26	1	2	25	0	3	0	-	-	-	-	-	-	-	-	
St-Jean	5	-	-	-	-	-	-	-	-	-	-	-	-	-	-	-	61	16	0	0	35	7	3	0	
Lattes	5.2	-	-	-	-	-	-	-	-	-	-	-	-	-	-	-	-	-	-	-	-	-	-	-	
Malbosc	14	-	-	-	-	-	-	-	56	25	0	0	29	0	2	0	-	-	-	-	-	-	-	-	
Distill	18	-	-	-	-	-	-	-	-	-	-	-	-	-	-	-	-	-	-	-	-	-	-	-	
Prades Plo	19	-	-	-	-	-	-	-	29	13	0	0	16	0	0	0	58	34	0	2	22	0	0	0	
Cuculles	26	58	36	1	1	18	0	2	85	52	0	2	30	0	1	0	58	36	0	2	20	0	0	0	
Viols	30	58	37	0	1	18	0	1	57	41	0	0	15	0	1	0	58	34	1	0	21	2	0	0	
SML	34	-	-	-	-	-	-	-	58	34	1	0	22	0	1	0	58	34	0	3	21	0	0	0	
NDL	35	-	-	-	-	-	-	-	56	30	0	0	26	0	0	0	57	35	0	0	21	0	1	0	
Worms	40	-	-	-	-	-	-	-	58	29	1	3	24	0	1	0	58	30	3	0	23	2	0	0	
StBauzille	44	-	-	-	-	-	-	-	37	24	1	1	11	0	0	0	-	-	-	-	-	-	-	-	
Ganges	49	60	34	1	2	22	0	1	57	34	2	0	19	0	2	0	58	36	0	0	22	0	0	0	
Total		236	130	3	8	87	0	6	722	377	10	10	312	0	13	0	582	298	5	7	255	12	5	0	

The name of the populations (*Site*), the distance from the sea in kilometers (*Km*), the total number of individuals phenotyped by population (*n*) and the total number of individuals of each phenotype [*x*], obtained using starch-gel electrophoresis, are presented. The different phenotypes are: [0] *Ester*⁰/*Ester*⁰ susceptible homozygous, [*i*] *Ester*⁰/*Ester*^{*i*} or *Ester*^{*i*}/*Ester*^{*i*}, [*ij*] *Ester*^{*i*}/*Ester*^{*j*}. A dash (-) means that the corresponding population was not collected during the corresponding year.

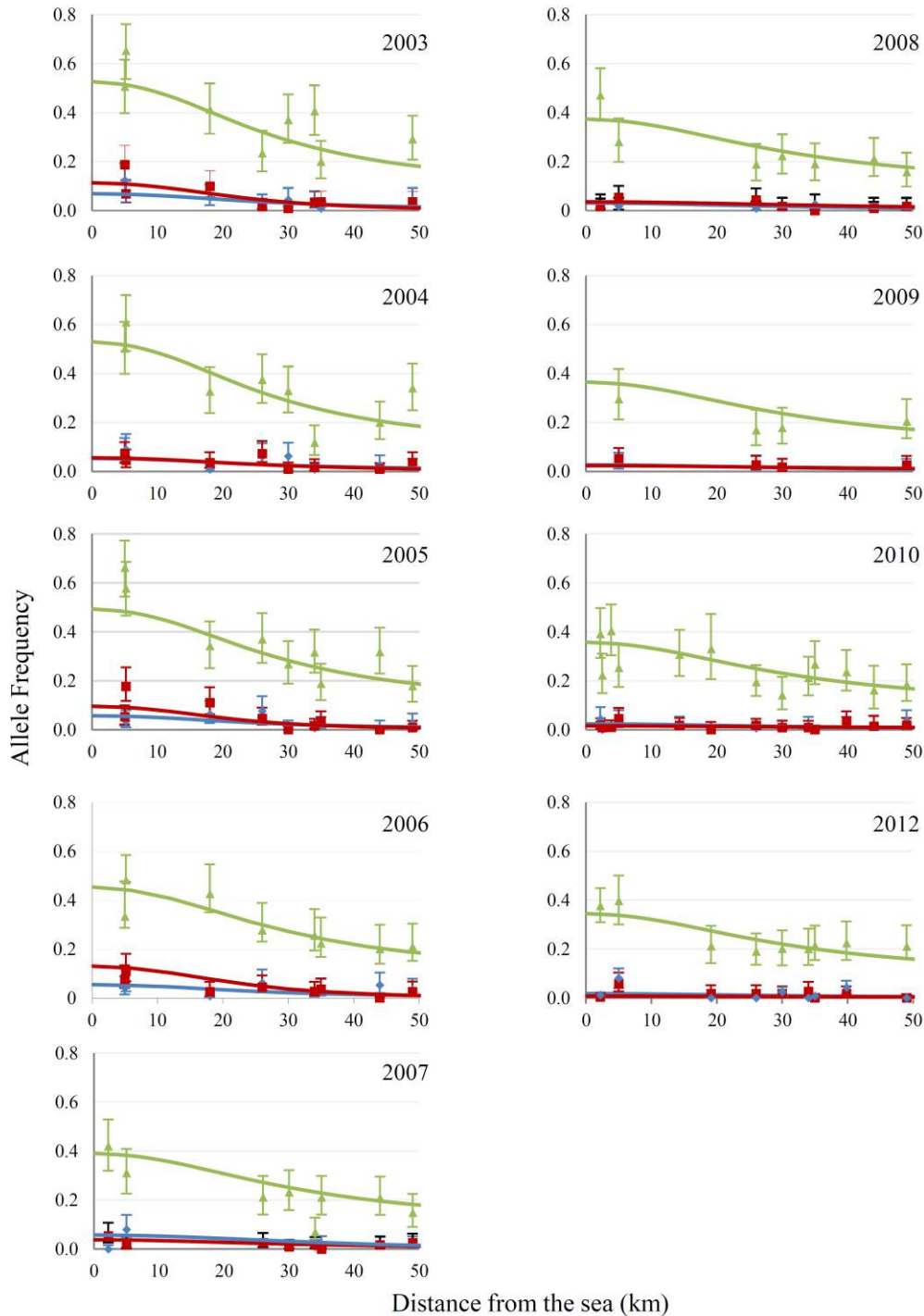

S3 Figure: Observed frequencies and geometric clines as a function of the distance from the sea (2003-2012) for the *Ester* resistance alleles. For the three *Ester* resistance alleles (*Ester*¹ in blue diamonds, *Ester*² in red squares and *Ester*⁴ in green triangles), dots represent the observed frequencies (with their support limits), and lines the associated geometric clines as a function of the distance from the sea (km).

S4 Table: Ester allele frequencies versus OP quantities of year *t* or *t-1*.

Year	Allele	<i>r</i>	Confidence Interval		<i>t</i>	<i>df</i>	<i>p</i>
<i>t</i>	<i>Ester</i> ⁰	-0.50	-0.86	0.19	-1.61	8	0.145 n.s.
	<i>Ester</i> ¹	0.36	-0.35	0.81	1.08	8	0.312 n.s.
	<i>Ester</i> ²	0.33	-0.38	0.79	0.98	8	0.358 n.s.
	<i>Ester</i> ⁴	0.44	-0.26	0.84	1.40	8	0.198 n.s.
<i>t-1</i>	<i>Ester</i> ⁰	-0.81	-0.95	-0.41	-4.16	9	0.002 **
	<i>Ester</i> ¹	0.37	-0.29	0.79	1.20	9	0.260 n.s.
	<i>Ester</i> ²	0.74	0.26	0.93	3.33	9	0.009 **
	<i>Ester</i> ⁴	0.70	0.17	0.92	2.95	9	0.016 *

The maximum allele frequencies (MAFs) were confronted to the OP quantities used the same year (*t*) or the previous year (*t-1*) over the 1995-2008 period. The Pearson's product moment correlation coefficient (*r*) and its confidence interval are presented for each *Ester* allele, with *Ester*⁰ the susceptible allele and the *Ester*¹, *Ester*² and *Ester*⁴, the resistant. For each correlation the value of the statistic (*t*), the degree of freedom (*df*) and the p-value (*p*) are given (n.s. *p* > 0.05, * *p* < 0.05, ** *p* < 0.01). For each allele, the highest correlation coefficient between year *t* or *t-1* is bolded and italicized.

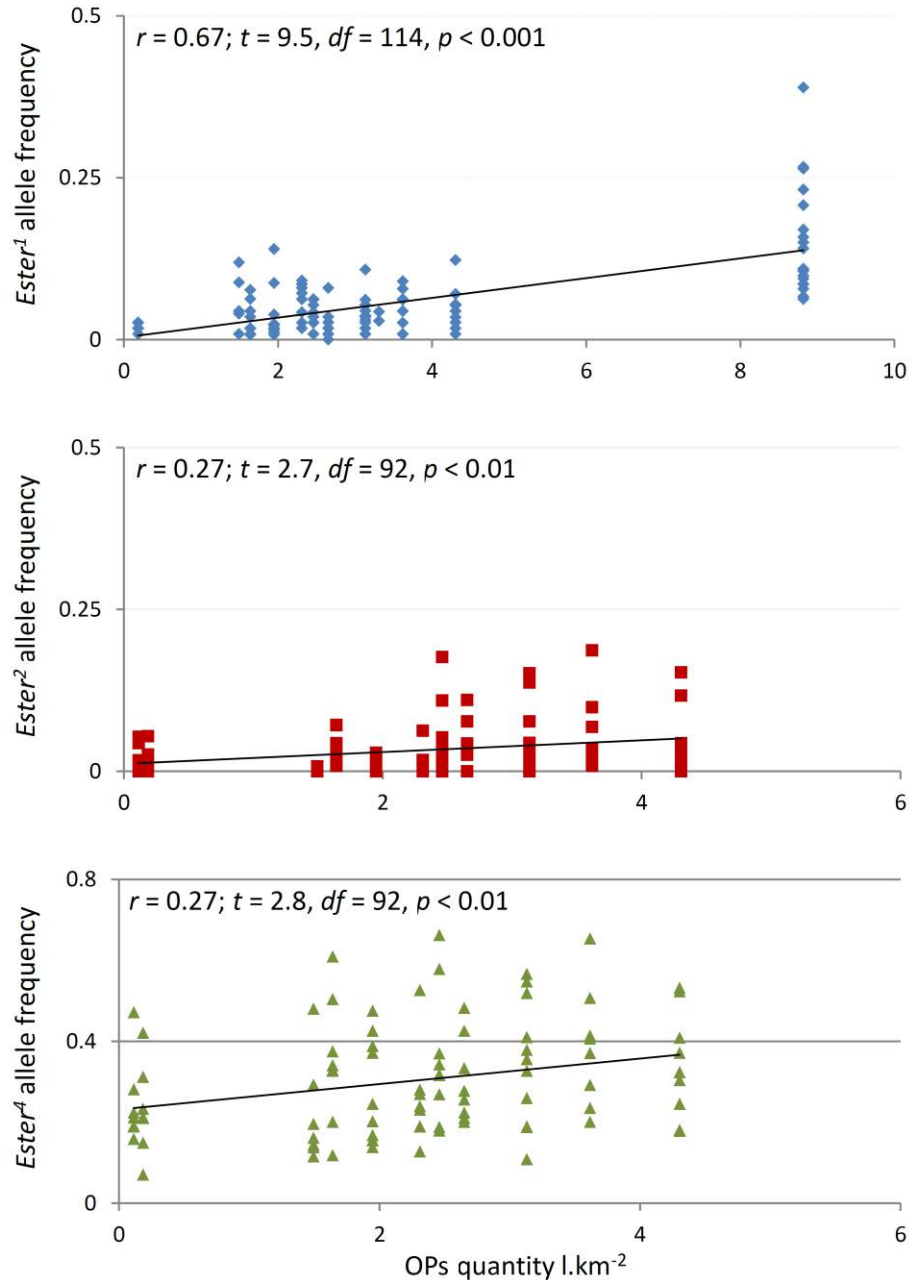

S5 Figure: *Ester* allele frequencies versus insecticide quantities over the whole sampling transect. The *Ester* resistance allele frequencies were computed from the observed phenotypic data over the whole transect. The treated period considered was 1986-2008 for *Ester*¹ (top), while only the 1993-2008 period was considered for *Ester*² and *Ester*⁴ (middle and bottom, respectively): *Ester*² was absent in the area before 1991, and *Ester*⁴ was just invading. The Pearson's product-moment correlation coefficient (r) and its significance are also indicated for each correlation. Solid lines represent the linear regressions between the two factors.

S6 Appendix. Evolution of copy numbers in *Ester* amplified allele

Copy numbers for the allele *Ester*² and *Ester*⁴ were measured at different dates (1992, 2005 and 2011 for *Ester*⁴, and 2001 and 2013 for *Ester*²) from mosquitoes sampled along the transect.

*Ester*² and *Ester*⁴ homozygous individuals were detected using the PCR diagnostic protocol developed by Berticat et al., 2000. Ten mosquitoes per year were analyzed for both *A* and *B* loci using qRT-PCR (Light Cycler 480 Roche®) as described in Weill et al. (2000). The allele copy number was computed as half the copy number of a homozygous individual. Differences between amplification levels were tested using the linear regression

$$N_c = E_{AB} + T + E_{AB} * T$$

with N_c the allele copy number, E_{AB} the type of esterase: *A* or *B*, T the date and $E_{AB} * T$ their interaction. Residuals of the model were checked for normality (Shapiro & Wilk, 1965) and for homoscedasticity (Breusch & Pagan, 1979). Results are presented below:

Years	N	<i>Est-A4</i>		<i>Est-B4</i>		<i>Ester</i> ⁴	
		$\mu_{Amp.}$	sd	$\mu_{Amp.}$	sd	μ_a	sd
1992	10	2.62	± 0.81	3.11	± 1.22	2.86	± 1.02
2005	10	3.37	± 1.39	3.12	± 1.08	3.25	± 1.22
2011	10	2.62	± 0.97	3.42	± 1.01	3.02	± 1.05
$\bar{\mu}_i$		2.87	± 1.11	3.22	± 1.07		

Years	N	<i>Est-A2</i>		<i>Est-B2</i>		<i>Ester</i> ²	
		$\mu_{Amp.}$	sd	$\mu_{Amp.}$	sd	μ_a	sd
2001	11	21.16	± 6.39	22.87	± 7.19	22.01	± 6.70
2013	3	25.86	± 3.96	28.43	± 4.41	27.15	± 4.00
μ_i		21.12	± 6.95	22.93	± 7.72		

The copy number of *Est-A* and *Est-B* were measured for different years for *Ester*⁴ (top) and *Ester*² (bottom). $\mu_{Amp.}$, μ_i , and μ_a , give respectively the mean of copy number for 1) the different years for each locus (*Est-A* or *Est-B*), 2) the overall mean by locus, and 3) the overall mean by year (considering *Est-A* and *Est-B* as a single locus). *sd* represents the standard deviation for all μ values. Differences between amplification levels were tested using linear regressions; none was significant ($p > 0.05$), either for *Ester*² or *Ester*⁴; either considering the year, or the loci, or their interaction.

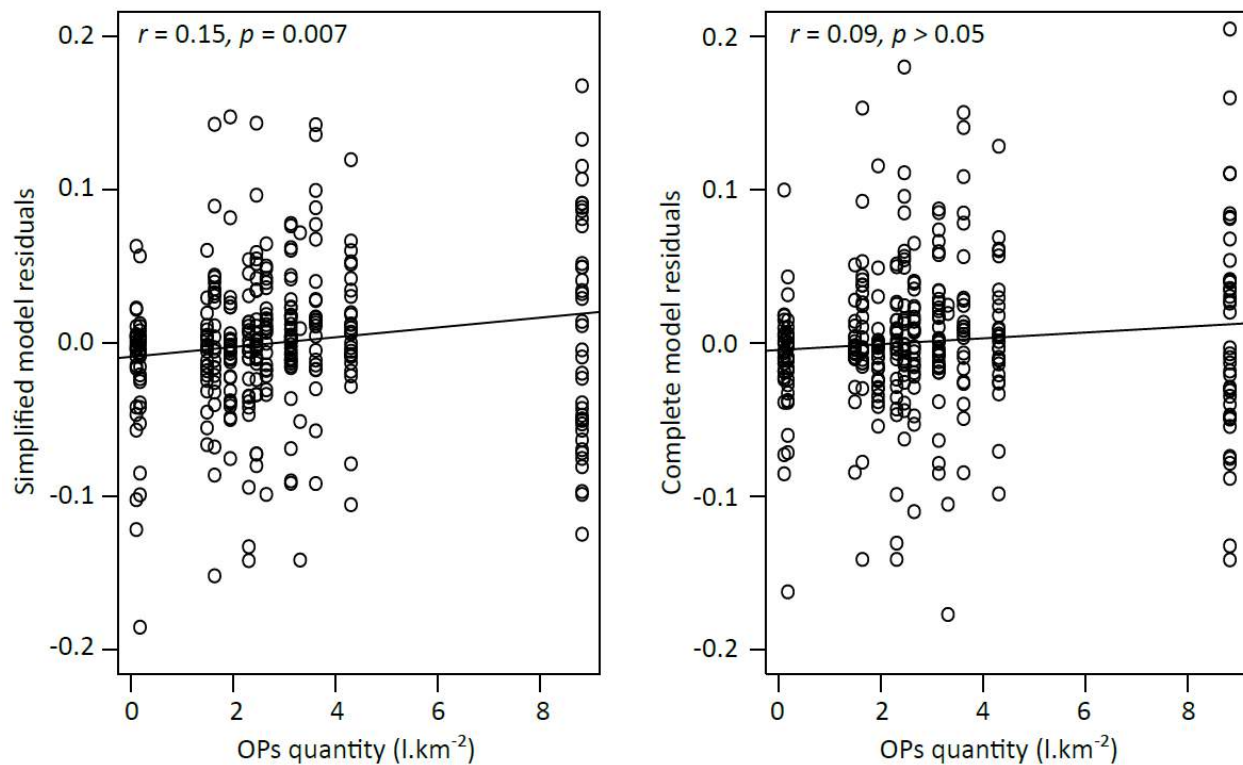

S7 Figure: The complete model is not over-parameterized. Residuals of the simplified model (left panel) and the complete one (right panel) are represented as a function of the OP quantities, each dot being one residual. Linear regressions between residuals and OP quantities are represented by solid lines. The correlation coefficient (r) and its significance (p) are indicated.

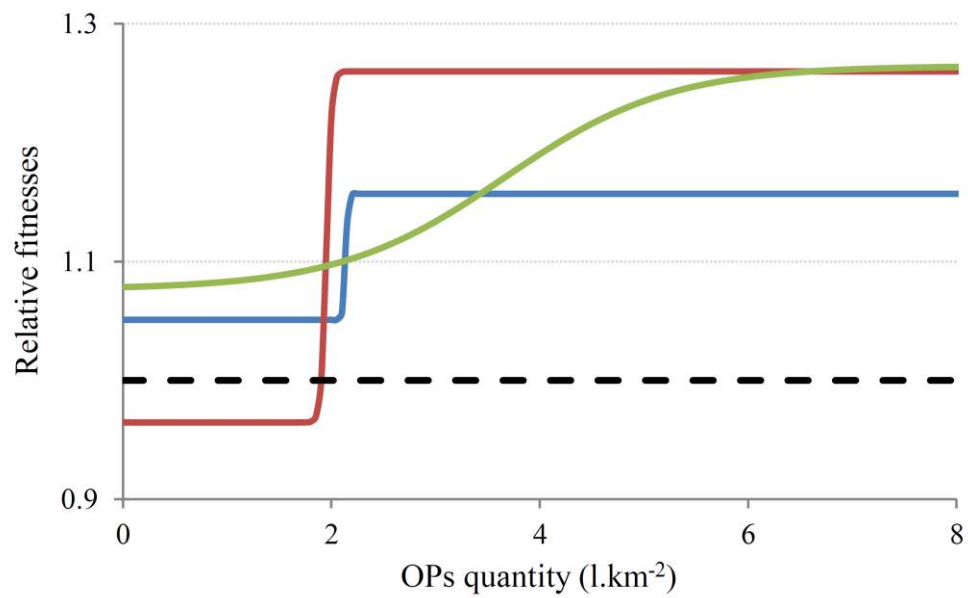

S8 Figure: Fitness-to-dose relationships. The relative fitnesses of the different *Ester* alleles are represented as a function of the OPs quantities (l.km⁻²), *Ester*⁰ (susceptible allele) dashed black line, *Ester*¹ blue line, *Ester*² red line and *Ester*⁴ green line.

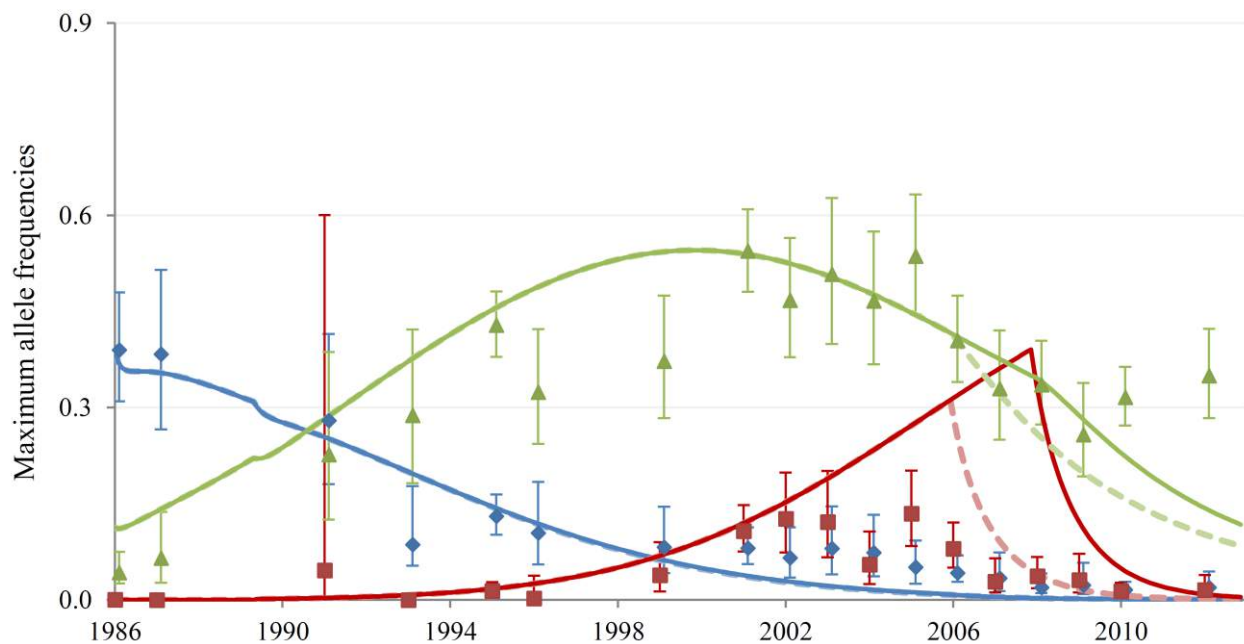

S9 Figure: Predictions from Labbé et al.'s model. The maximum allele frequencies (MAFs) estimated from field data (and their support limits) are presented as blue diamonds, red squares and green triangles for *Ester*¹, *Ester*² and *Ester*⁴ respectively. Lines represent the allele frequencies predicted by the model of Labbé et al. [41] for the period 1986-2012 considering an OPs stop in 2006 (dashed lines) or in 2008 (solid lines).

Chapitre 5 : Effet du retrait de la pression de sélection sur la dynamique d'allèles adaptatifs en populations naturelles : Etudes préliminaires.

Les OPs et CXs ont été utilisés dans la région montpelliéraine à partir des années 1970 pour des raisons principalement économiques (tourisme). Dans les DOM, et plus particulièrement à Mayotte et en Martinique, plusieurs espèces vectrices de différentes maladies sont présentes : *An. gambiae* pour le paludisme, *Ae. aegypti* ou *Ae. albopictus* pour les virus de la dengue, du chikungunya et du zika ou encore *Cx. quinquefasciatus* susceptible d'être vecteur de plusieurs filarioses et des virus de la vallée du rift ou du Nil occidental (Yébakima et al. 1995 ; Julvez et al. 1998 ; Sissoko et al. 2009). Le contrôle des populations de moustiques y représente donc un enjeu sanitaire capital.

Comme dans la région montpelliéraine, les OPs (temephos ou chlorpyrifos) ont été utilisés ; à partir de 1973 à Mayotte (Pocquet et al. 2013) et de 1991 en Martinique (Yébakima et al. 1995, 2004) pour contrôler les populations de *Cx. quinquefasciatus* (mais aussi des autres vecteurs). Des suivis de l'évolution de la résistance aux OPs ont été mis en place dans ces deux îles, dès 1990 en Martinique (Yébakima et al. 1995) et beaucoup plus récemment, à partir de 2011, à Mayotte (Pocquet et al. 2013). Dans les trois zones géographiques l'utilisation des OPs a sélectionné des allèles de résistance aux locus *ace-1* et *Ester*. Certains de ces allèles sont partagés : *Ester*² est présent dans les trois zones géographiques (Labbé et al. 2005), et les allèles du locus *ace-1*, R₂ et D₁, ont été observés en Martinique et à Mayotte (Chap. 2). Ces suivis ont également permis de décrire les patrons de la répartition spatiale de ces allèles ainsi que leur dynamique.

La dynamique au locus *Ester* dans la région montpelliéraine a été décrite au chapitre 4. Au locus *ace-1*, l'allèle de résistance mono-copie R₁ a rapidement été sélectionné (1979, Raymond et al. 1986), puis les allèles D₂ et D₃ ont envahi les populations au début des années 1990, avant de stagner autour de 20% (ces allèles sont sublétaux à l'état homozygote ; Labbé et al. 2007b). Comme pour les allèles *Ester*, la répartition des allèles de résistance *ace-1* est clinale : ils sont avantagés en zone traitée mais contre-sélectionnés en dehors, à cause de leur coût sélectif (Guillemaud et al. 1998 ; Lenormand et al. 1998b, 1999 ; Lenormand & Raymond 2000 ; Labbé et al. 2007b) (Chap. 4 : Fig. 14).

A Mayotte, la première campagne d'échantillonnage a eu lieu en 2011, juste après l'arrêt des traitements. Cette étude, à laquelle j'ai participé, avait pour but de faire un état des lieux de la résistance dans plusieurs îles de l'océan indien (Pocquet et al. 2013, Annexe 2).

L'échantillonnage de dix populations réparties dans toute l'île a montré i) que la résistance au locus *Ester* était élevée (forte fréquence de l'allèle *Ester*²), sans structure spatiale particulière, alors que ii) celle liée au locus *ace-1* était élevée mais structurée le long d'un gradient est/ouest. Comme dans la région montpelliéraine, cette structure spatiale semble résulter de la répartition des traitements insecticides plus intenses dans les zones les plus peuplées au nord et à l'est de l'île (Pocquet et al. 2013).

Enfin, en Martinique, deux campagnes d'échantillonnage ont été réalisées en 1990 et en 1999 (Yébakima et al. 1995, 2004). Elles ont permis de décrire un remplacement d'allèle puisque *Ester*^{B1} a envahi les populations au détriment d'*Ester*². Au locus *ace-1*, des méthodes indirectes (écarts à la panmixie) ont permis de proposer que l'allèle dupliqué D₁ avait remplacé l'allèle mono-copie local R₂ (Labbé et al. 2007a).

En 2007, la commercialisation des insecticides OPs et CXs a été interdite par une directive de la commission européenne (2007/393/EC). En Martinique et à Montpellier ces insecticides ont cessés d'être utilisés dès cette date, voire un peu avant (A. Yébakima et C. Lagneau, communications personnelles) ; une dérogation a été accordée à l'île de Mayotte où ils ont été utilisés au moins jusqu'à fin 2010 (Pocquet et al. 2013). Les allèles de résistance étant associés à un coût sélectif élevé, leur dynamique, après ce retrait de la pression de sélection, devrait être décroissante et proportionnelle à leur coût. Or, l'exemple montpelliérain de la résistance au locus *Ester* a montré que i) le coût sélectif de ces adaptations pouvait changer et ii) que des pressions de sélection différentes de celles utilisées pour le contrôle des vecteurs pouvaient affecter leur dynamique. Les suivis des allèles de résistance dans ces trois zones géographiques nous offrent la possibilité de comparer la dynamique des allèles de résistance aux locus *ace-1* et *Ester* après l'arrêt des traitements OPs à Montpellier, à Mayotte et en Martinique. Cette étude vise ainsi à mettre en évidence les tendances générales et les divergences liées aux contingences locales.

Matériels et Méthodes

Echantillonnage.

A Mayotte, les 10 mêmes populations qu'en 2011 ont été échantillonnées en 2013. En Martinique, des échantillons ont été récoltés au cours de 7 campagnes de prélèvements de 1990 à 2012, à raison de 5 à 10 localités par campagne. A Montpellier les populations ont été échantillonnées quasiment annuellement le long d'un même transect sur la période 1986 – 2012 (Chap. 4). Les individus, récoltés au stade larvaire, ont été soit conservés

directement en alcool, soit ramenés vivants au laboratoire pour y être élevés jusqu'au stade adulte puis conservés dans de l'azote liquide.

Phénotypage.

Pour les individus ayant été conservés en azote liquide, le phénotypage a été réalisé à l'aide de tests biochimiques : test TPP pour le locus *ace-1* (Bourguet et al. 1996a) et tests par électrophorèses sur gel d'amidon pour le locus *Ester* (Pasteur et al. 1981a). Ces tests n'étant pas réalisables sur des individus ayant été conservés en alcool, leur phénotypage a été réalisé grâce à des tests moléculaires. Pour chaque individu, l'ADN a été extrait d'après le protocole de Rogers & Bendich (1988). Le typage des individus aux locus *Ester* (*est-2* et *est-3*) et *ace-1* a été effectué par des tests PCR-RFLP spécifiques de chaque locus, respectivement, d'après les protocoles de Berticat et al. (2000) et Weill et al. (2004b).

Inférence des fréquences alléliques et représentation.

Pour mémoire, au locus *ace-1*, les tests disponibles ne permettent pas de discriminer tous les génotypes : tout génotype comprenant un allèle dupliqué (DD, DS, DR) apparaît comme un hétérozygote standard, RS. La fréquence totale des allèles D a donc été inférée à partir de l'excès d'hétérozygotes par rapport à l'attendu sous panmixie que sa présence dans une population entraîne (les allèles D qui co-ségrègent ne sont donc pas différenciables ; Lenormand et al. 1998a). Au locus *Ester*, les fréquences alléliques ont été inférées directement à partir des fréquences phénotypiques, sous hypothèse de panmixie (Lenormand et al. 1998a). La distribution spatiale des allèles de résistance dans la région montpelliéraine a été analysée dans une seule dimension, le long du transect d'échantillonnage (distance à la mer). Un cline géométrique descriptif a alors été ajusté aux données de fréquences alléliques (Lenormand et al. 1998b). Pour les îles de la Martinique et de Mayotte, la distribution des allèles de résistance a été analysée dans deux dimensions en tenant compte de la latitude et de la longitude auxquelles les échantillons ont été collectés. Pour mieux visualiser la distribution des fréquences alléliques, les prédictions d'un modèle descriptif, lissage "loess", de ces fréquences dans l'espace ont été reportées sur des fonds de carte de Mayotte et de la Martinique (Cleveland & Grosse 1991).

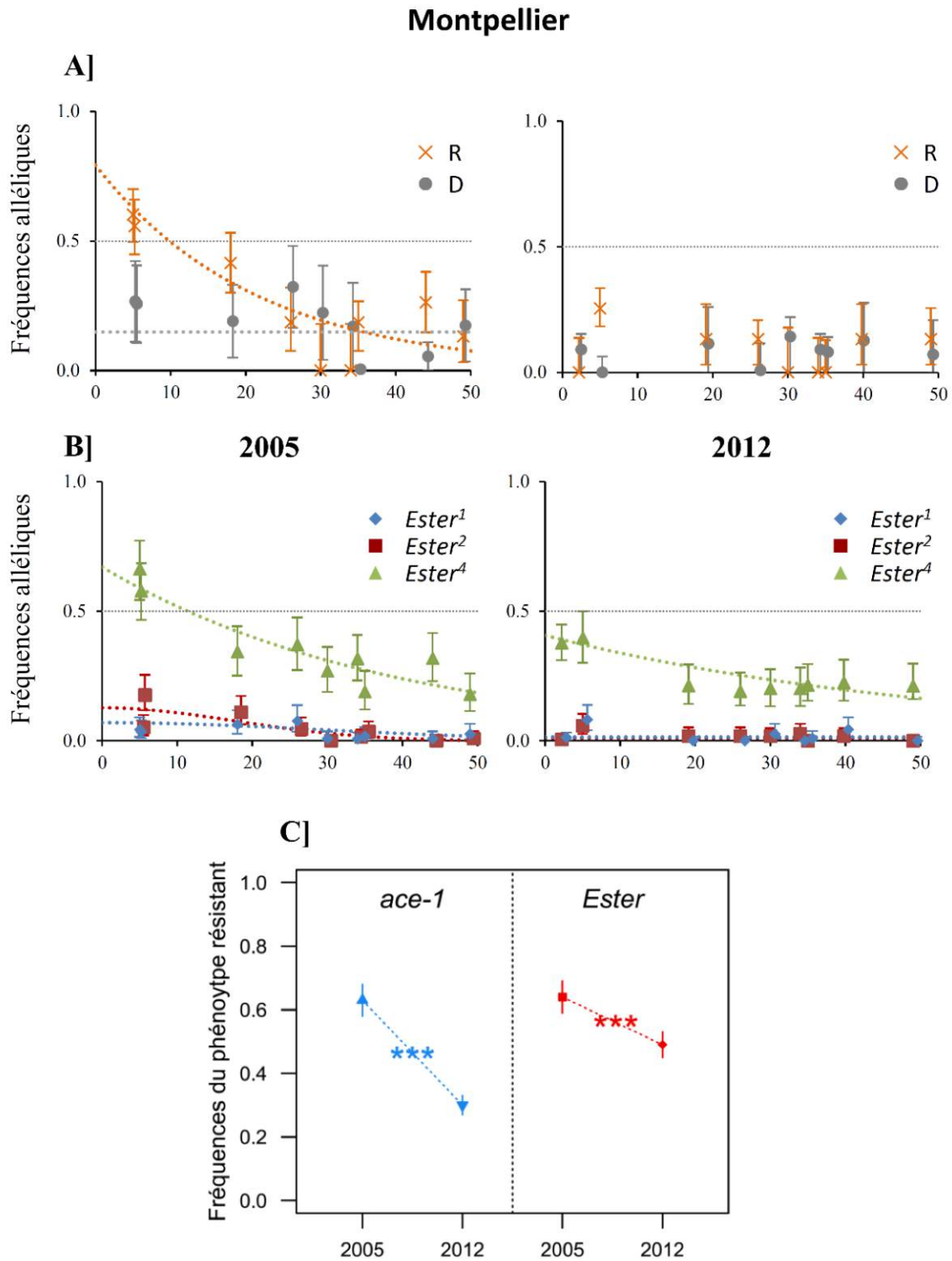

Figure 18 : Evolution dans l'espace et dans le temps de la fréquence des allèles de résistance aux locus *ace-1* et *Ester* dans la région montpelliéraine. Cette fréquence est présentée le long du transect d'échantillonnage pour les allèles des locus (A) *ace-1* et (B) *Ester* ; les lignes pointillées correspondent aux cliniques géométriques ajustés aux fréquences alléliques (sauf au locus *ace-1* en 2012, la faible fréquence des allèles de résistance et l'imprécision de leur estimation liée à la présence des allèles D n'ayant pas permis d'en estimer les paramètres). (C) Les fréquences moyennes des phénotypes résistants aux locus *ace-1* et *Ester* sont présentées pour les années 2005 et 2012.

Résultats et discussion

La nature de la réponse aux OPs explique la répartition spatiale et la dynamique temporelle des allèles de résistance

Evolution de la résistance à Montpellier

Dans le but d'étudier la dynamique des allèles de résistance sur la période couvrant l'arrêt des OPs, les jeux de données déjà publiés ont été complétés par le phénotypage des échantillons encadrant la date d'arrêt des traitements insecticides dans les différentes zones géographiques.

Dans la région montpelliéraine, nous avons montré que les fréquences des allèles de résistance du locus *Ester* diminuaient dès 2005, suite au quasi-abandon des traitements OPs, mais qu'elles atteignaient un nouvel équilibre entre 2010 et 2012 (Chap. 4). En conséquence, les échantillons récoltés sur la période 2005-2012 ont été phénotypés au locus *ace-1*.

Les fréquences alléliques estimées le long du transect en 2005 et 2012 pour les locus *ace-1* et *Ester* sont présentées sur la figure 18A et B. Avant l'arrêt des traitements OPs (2005), la distribution des allèles de résistance des locus *ace-1* et *Ester* était clinale ; après, on observe pour tous les allèles de résistance un aplatissement des clines de fréquences, ce qui traduit une homogénéisation de la pression de sélection le long du transect.

On observe également une diminution de la fréquence des allèles de résistance aux deux locus (Fig. 18A et B). Toutefois, ils n'ont pas été affectés de la même façon par l'arrêt des traitements : alors qu'en 2005 la fréquence moyenne des individus porteurs d'un allèle de résistance (ci-après les phénotypes résistants) était similaire entre les deux locus ($\chi^2 = 0.05$, $df = 1$, $p > 0.05$), cette fréquence, en 2012, est nettement supérieure au locus *Ester* ($\chi^2 = 41.4$, $df = 1$, $p < 0.001$; Fig. 18C). Ceci est essentiellement dû au maintien d'*Ester*⁴ en fréquence élevée (Fig. 18A et B), à cause de pressions de sélection autres que les insecticides utilisés pour le contrôle des moustiques (Chapitre 4). Comme, en revanche, les allèles de résistance du locus *ace-1* diminuent de manière continue depuis 2005 (données non présentées), on peut en déduire que ces pressions ne sont ni des OPs ni des CXs (issus par exemple de l'agriculture) mais proviennent d'une autre source, qui reste inconnue.

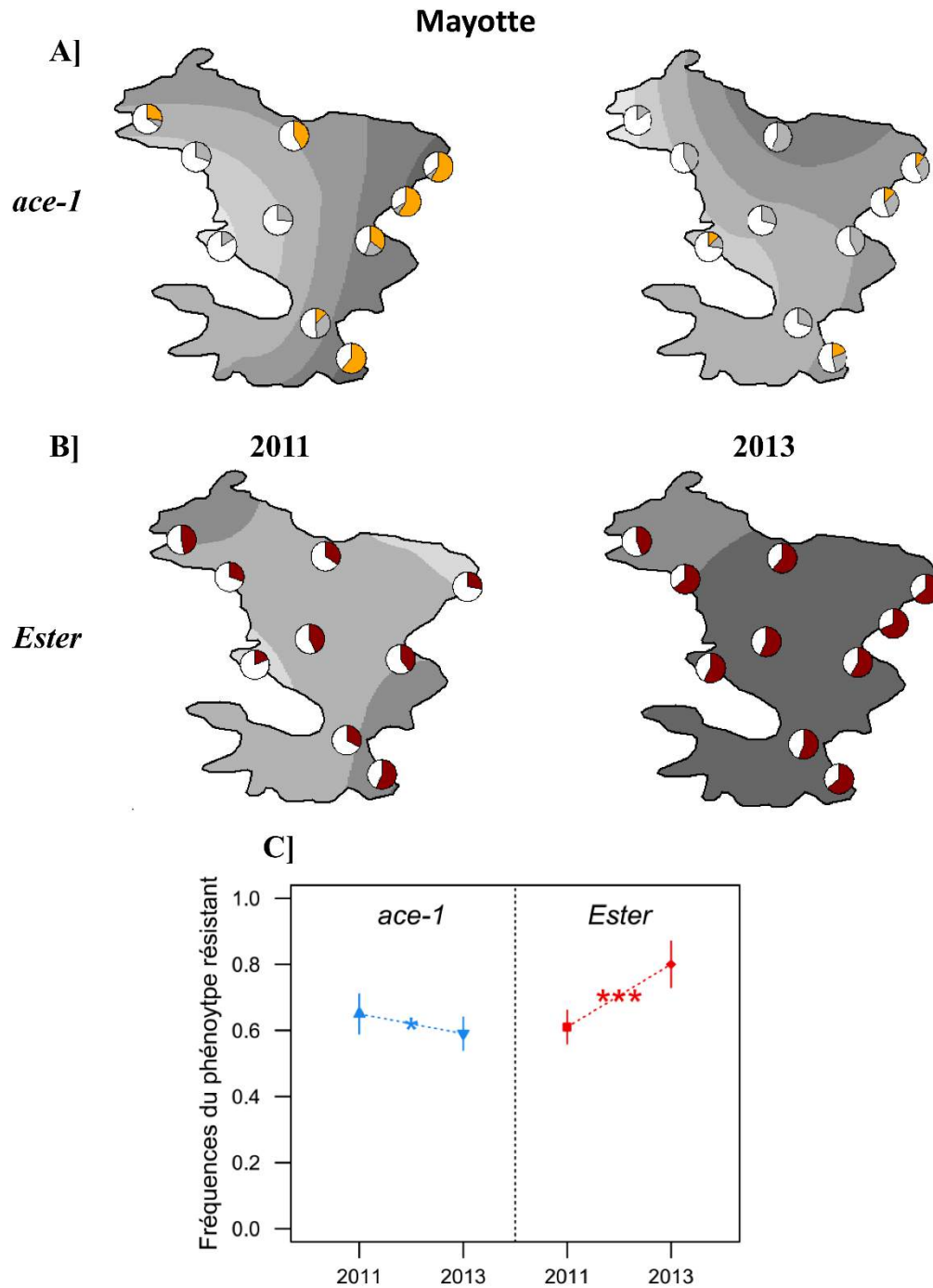

Figure 19 : Evolution dans l'espace et dans le temps de la fréquence des allèles de résistance aux locus *ace-1* et *Ester* à Mayotte. Les diagrammes circulaires représentent les fréquences des allèles des locus (A) *ace-1* (sensibles en blanc, D en gris et R en orange) et (B) *Ester* (sensibles en blanc, *Ester*² en rouge) dans chaque population échantillonnée en 2011 et 2013. (C) Les fréquences moyennes des phénotypes résistants aux locus *ace-1* et *Ester* sont également présentées pour les années 2011 et 2013.

Evolution de la résistance à Mayotte

A Mayotte, nous disposons des fréquences phénotypiques au locus *ace-1* et *Ester* juste après l'arrêt des traitements insecticides OPs en 2011 (Pocquet et al. 2013). Les fréquences alléliques estimées à partir de ces échantillons montrent que les allèles de résistance des locus *ace-1* et *Ester* sont distribués différemment à l'échelle de l'île (Fig. 19) : alors que la distribution de l'allèle *Ester*² est globalement homogène, les allèles du locus *ace-1* sont répartis selon un gradient est-ouest (Fig. 19A et B). On observe en outre que les fréquences des allèles D et R suivent des gradients opposés : R est majoritaire à l'Est, D à l'ouest (Fig. 19A). Ceci pourrait être expliqué par la répartition hétérogène des OPs par l'agence de démoustication locale : les traitements sont en effet moins intenses dans les zones les moins peuplées de l'île, au Sud et à l'Ouest (Pocquet et al. 2013). Or, comme nous l'avons démontré précédemment (Chap. 1 et 3), des pressions de sélection modérées avantagent les allèles D par rapport aux R. L'usage hétérogène des OPs semble donc entraîner ces réponses spatialisées au locus *ace-1*. A l'inverse, et comme à Montpellier, la répartition plus homogène de l'allèle *Ester*² pourrait être due à des sources de sélection autres que le contrôle des moustiques.

En 2013, soit deux ans après l'arrêt des traitements OPs, on assiste à une homogénéisation des fréquences des allèles de résistance aux deux locus (Fig. 19A et B), bien que la structure longitudinale au locus *ace-1* semble persister (Fig. 19A). Néanmoins, l'allèle D a remplacé l'allèle R dans l'ensemble des populations de l'île (Fig. 19A), ce qui est cohérent avec une baisse des pressions de sélection.

Les fréquences des phénotypes résistants aux deux locus étaient très proches en 2011 ($\chi^2 = 3.85$, $df = 1$, $p = 0.05$). Contrairement à la situation montpelliéraine, et contre toute attente, cette fréquence n'a que peu diminué au locus *ace-1*, ($\chi^2 = 4.4$, $df = 1$, $p = 0.04$) et a même fortement augmenté au locus *Ester* ($\chi^2 = 58.1$, $df = 1$, $p < 0.001$) (Fig. 19B et C). La dynamique de ces allèles de résistance, notamment au locus *ace-1*, ne permet pas d'exclure que l'utilisation des OPs ou des CXs se soit maintenue dans l'île. En effet, la commercialisation de ces molécules a fait localement l'objet d'une dérogation jusqu'en 2014 : si l'agence responsable de la démoustication semble avoir cessé de les utiliser fin 2010, ces composés étaient encore disponibles sur le marché. Une nouvelle campagne d'échantillonnage prévue début 2016 devrait permettre de clarifier la situation.

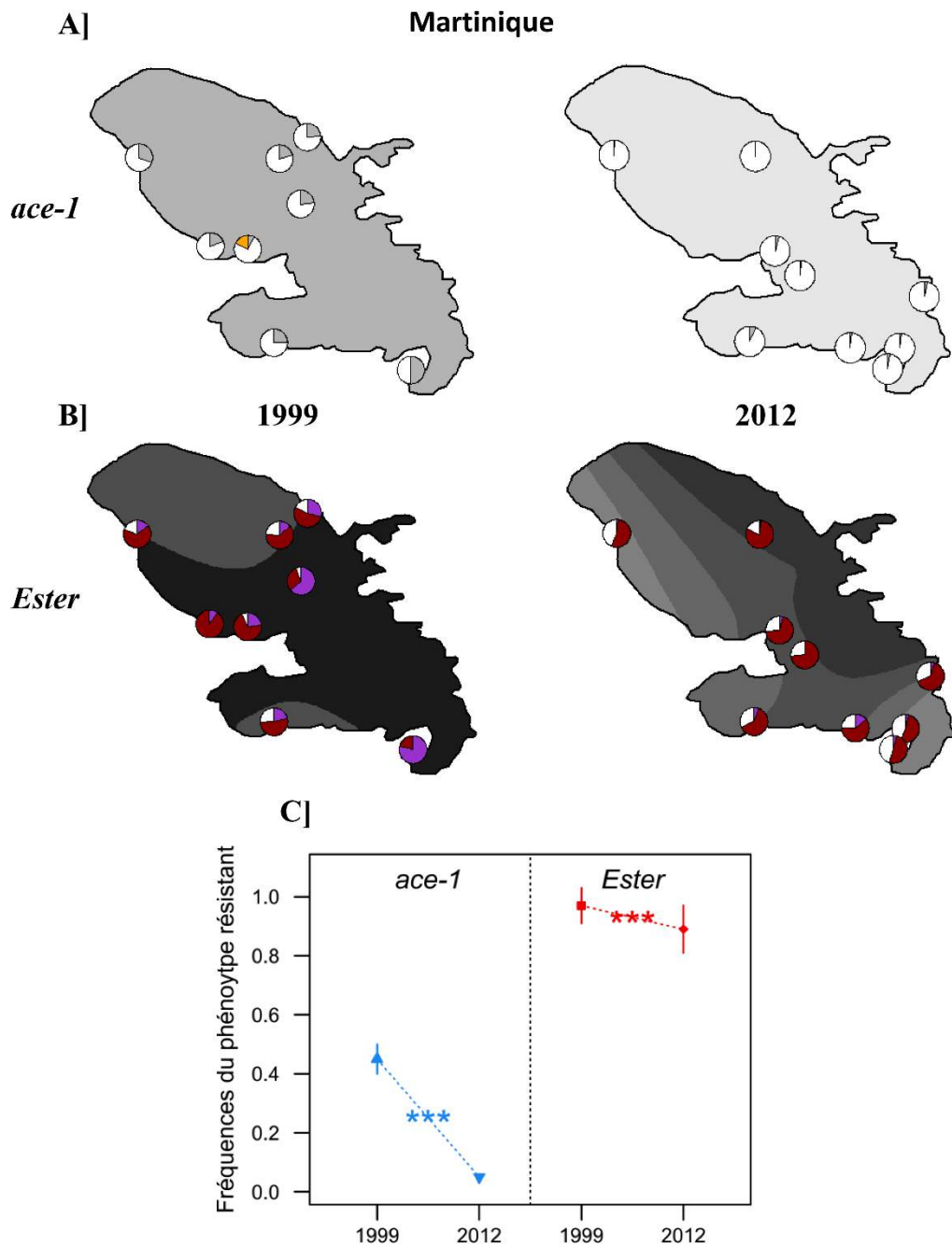

Figure 20 : Evolution dans l'espace et dans le temps de la fréquence des allèles de résistance aux locus *ace-1* et *Ester* en Martinique. Les diagrammes circulaires représentent les fréquences des allèles des locus (A) *ace-1* (sensibles en blanc, D en gris et R en orange) et (B) *Ester* (sensibles en blanc, *Ester*² en rouge et *Ester*^{B1} en violet) dans chaque population échantillonnée en 1999 et 2012. (C) Les fréquences moyennes des phénotypes résistants aux locus *ace-1* et *Ester* sont également présentées pour les années 1999 et 2012.

Evolution de la résistance en Martinique

Les échantillons récoltés en Martinique entre 1999 et 2012 n'ont pas pu être phénotypés en raison d'un ADN trop dégradé. Nous avons donc estimé les fréquences alléliques aux locus *ace-1* et *Ester* en 1999 à partir des données publiées dans Yébakima et al. 2004, que nous avons comparées avec celles estimées à partir des échantillons de 2012.

En 1999 (avant arrêt des OPs), la prévalence des allèles de résistance des locus *ace-1* et *Ester* dans les populations naturelles de Martinique était très différente : la fréquence moyenne du phénotype résistant au locus *ace-1* était d'environ 0.4, alors qu'elle était nettement plus élevée, ~ 0.97 , au locus *Ester* ($\chi^2 = 434$, $df = 1$, $p < 0.001$) (Fig. 20). Au locus *ace-1*, l'allèle D₁ (seul allèle détecté en Martinique jusqu'en 2003) semble avoir quasiment éliminé l'allèle R (Fig. 20A). Nous avons montré que i) cet allèle fait partie des rares qui ne sont pas sublétaux à l'état homozygote (Chap. 1 et 2), et ii) qu'il peut rapidement remplacer un allèle R en situation de pression de sélection modérée (Chap. 3). Le régime de traitement appliqué sur la période 1990-1999 semble donc avoir été effectivement modéré.

Au locus *Ester*, deux allèles de résistance ségrégeaient dans les populations, *Ester*^{B1} et *Ester*². Leurs distributions dans les populations étaient différentes, avec *Ester*^{B1} majoritaire dans les populations de l'est et *Ester*² dans les populations de l'ouest (Fig. 20B). Cette différence pourrait être due à des intensités de pression de sélection différentes, comme nous l'avons vu pour les allèles *Ester* de la région montpelliéraine. En 2012, l'allèle *Ester*^{B1} a quasiment disparu, alors qu'il semblait invasif sur la période 1990-1999 (Yébakima et al. 2004). En raison du manque d'échantillons entre 1999 et 2012, il est difficile de conclure quant à la raison de ce changement de dynamique. Cela pourrait être dû à l'abandon des OPs, mais un autre changement dans le régime de traitement ne peut être exclu. Seule l'acquisition des données de traitements (types d'insecticides et quantités utilisées) pourrait nous aider à conclure.

Toutefois, on observe, une dynamique très différente de la résistance aux locus *Ester* et *ace-1* suite à l'arrêt de l'utilisation des OPs et CXs pour la démoustication (Fig. 20C) : quasi-disparition de la résistance au locus *ace-1* ($\chi^2 = 181$, $df = 1$, $p < 0.001$) et faible diminution de la résistance au locus *Ester* ($\chi^2 = 43.7$, $df = 1$, $p < 0.001$) (Fig. 20). Là-encore, il semblerait que des pressions alternatives au contrôle des moustiques pourraient expliquer ces différences.

Conclusion

L'utilisation massive d'insecticides OPs a représenté une forte pression de sélection pour les populations de moustiques. Deux types de réponses ont été sélectionnés de manière récurrente et convergente dans les trois régions analysées : une réponse spécialiste au locus *ace-1* par mutation de la cible, et une réponse beaucoup plus généraliste par augmentation de la production d'enzymes de détoxification codées par le locus *Ester*. Cette différence de nature apparaît primordiale pour comprendre la dynamique de ces adaptations dans les populations naturelles. En effet, on observe généralement une réponse au locus *ace-1* beaucoup plus structurée, due à l'utilisation des OPs (répartition et quantité), alors que celle au locus *Ester* est plus homogène, probablement influencée par ailleurs par l'utilisation d'autres xénobiotiques.

En conséquence, malgré l'arrêt des traitements insecticides OPs, certains allèles du locus *Ester* se maintiennent dans les populations naturelles quand ceux du locus *ace-1* tendent à disparaître. *Cx. pipiens* est un moustique d'eaux « sales », stagnantes et très riches en matières organiques. Ses gîtes traditionnels sont les stations d'épurations, les fosses septiques, les caniveaux, les égouts ou encore les mares et fossés. Ces lieux sont généralement propices à la concentration des polluants. Son écologie en fait donc une espèce sentinelle pour la détection de ces pollutions. Ainsi le fait que l'arrêt de l'utilisation des OPs pour la démoustication n'ait pas entraîné la disparition des allèles de résistance au locus *ace-1* à Mayotte, contrairement aux deux autres régions étudiées, laisse supposer l'utilisation d'OPs et de CXs dans d'autres secteurs d'activités. Une étude récente a d'ailleurs montré que parmi les quatre espèces de moustiques vectrices présentes sur l'île, *Ae. aegypti*, *Ae. albopictus*, *An. gambiae* et *Cx. quinquefasciatus*, ce dernier est celui qui présente les niveaux de résistance les plus élevés, et ce, à une large gamme d'insecticides (Pocquet et al. 2014, Annexe 3).

Malgré les convergences observées, on observe toutefois des différences entre les zones géographiques. Au locus *ace-1*, l'allèle D₁ a remplacé l'allèle R en Martinique et à Mayotte, alors que les allèles D₂ et D₃ peinent dans la région de Montpellier. Le pur hasard, ici d'obtenir un allèle dupliqué non létal à l'état homozygote, joue donc un rôle important dans l'évolution à ce locus. Au locus *Ester*, ce n'est pas non plus toujours le même allèle qui se maintient après l'arrêt des OPs : *Ester*² reste fréquent à Mayotte et en Martinique alors qu'il est éliminé par *Ester*⁴ dans la région montpelliéraine. Les causes de ces différences sont probablement multiples, une part contingente liée aux allèles en

présence, mais aussi probablement un rôle de l'intensité des pressions de sélection alternatives au contrôle, bien que leurs parts respectives restent à explorer.

Discussion générale

Différentes adaptations, avec des architectures génétiques distinctes, ont été sélectionnées à deux locus majeur, *ace-1* et *Ester*, chez les moustiques, en réponse à l'utilisation des insecticides OPs et CXs pour contrôler leurs populations. Nous avons suivi leurs dynamiques dans différentes régions du monde présentant différentes histoires de traitement (types d'insecticides, quantités utilisées, fréquence et étendue des traitements...). J'ai utilisé ce modèle pour i) comprendre l'influence de l'architecture génétique de l'adaptation sur les compromis avantages-coûts, et ii) mesurer le rôle des variations de l'intensité des pressions de sélection sur l'évolution de ces compromis, et plus généralement sur l'évolution de cette adaptation.

Pour mémoire, les mutations au locus *ace-1* permettent la production d'AChE1 modifiée, une réponse spécifique aux OPs et CXs. On trouve principalement deux substitutions, F290V et G119S, et c'est le rôle de cette dernière dans l'adaptation aux insecticides, que j'ai étudié pendant ma thèse (elle est nettement plus fréquente et retrouvée chez plusieurs espèces de moustiques). Elle peut être retrouvée seule (allèle R), ou être impliquée dans une duplication hétérogène qui associe une copie sensible et une copie résistante (allèle D). La prévalence de chaque type d'allèle est différente entre espèces et au sein du complexe d'espèces *Cx. pipiens* : à ce jour, un seul allèle R et un seul allèle D ont été décrits chez *An. gambiae* alors que nous avons montré l'existence de quatre allèles R pour une trentaine d'allèles D chez *Cx. pipiens*.

Les mutations du locus *Ester* permettent, quant à elles, une réponse plus générale aux xénobiotiques, dont les OPs et CXs. Nos études comparées à Mayotte, en Martinique et à Montpellier ont d'ailleurs montré l'importance de cette différence de nature de l'adaptation : lors de l'arrêt des traitements, alors que les allèles du locus *ace-1* tendent à disparaître rapidement, on observe dans chaque région le maintien d'au moins un allèle *Ester* dans les populations, probablement parce qu'ils sont sélectionnés par d'autres composés.

Au locus *Ester*, rappelons que la résistance est liée à une surproduction des estérases qui peut résulter d'une mutation au niveau de la régulation (mutation qui reste à identifier), mais aussi d'une amplification des gènes qui les codent. A ce jour, un seul allèle de la première catégorie a été identifié chez *Cx. pipiens*, alors que sept allèles amplifiés ont été mis en évidence (il existe néanmoins des différences de séquence entre ces allèles amplifiés, mais leur rôle reste peu documenté ; Guillemaud et al. 1997 ; Raymond et al. 1998).

La valse des adaptations

Je marche seul ...

Les mutations ponctuelles qui affectent un ou quelques nucléotides (substitutions, insertions, délétions) génèrent la variabilité : c'est ce type de mutations qui permet de modifier une fonction préexistante. Dans le cas de nos allèles *ace-1* ou *Ester*, des substitutions ont modifié la protéine codée en changeant sa conformation (*ace-1^R*) ou sa régulation (*Ester^l*). Toutefois, ces mutations sont généralement associées à des coûts, qui peuvent générer des compromis irréductibles : c'est le cas de la mutation G119S qui, en permettant la résistance, réduit l'affinité pour le substrat naturel et diminue ainsi l'activité enzymatique. Si, parfois, des mutations sur d'autres locus peuvent compenser ces coûts (ex : estérases chez *Lucilia cuprina*, Clarke 1997, ou chez de nombreuses bactéries, Maisnier-Patin & Andersson 2004), c'est probablement moins aisé quand la mutation touche une protéine essentielle et très spécialisée comme l'AChE1 (impliquée dans la régulation de l'influx nerveux).

A l'inverse, les mutations de large ampleur comme les duplications de gènes ne changent pas la nature des protéines : elles affectent leur nombre (amplification) ou permettent l'association permanente d'allèles différents (duplications hétérogènes). Ces mutations peuvent se révéler avantageuses, comme le montre, entre autres, l'exemple des moustiques.

A la queue leu leu...

Les amplifications de gènes entraînent une augmentation de la quantité de protéine produite, et c'est cette augmentation qui les rend avantageuses. Ce type d'adaptation est fréquent, notamment dans les cas d'adaptation aux xénobiotiques (Hastings et al. 2000 ; Kondrashov 2012 ; Feyereisen et al. 2015). Toutefois, chez *Cx. pipiens*, tous les allèles de résistance *Ester* dont les conséquences phénotypiques ont été étudiées (soit en laboratoire, soit en populations naturelles) se sont révélés associés à des effets pléiotropes délétères en absence d'insecticide (Guillemaud et al. 1998 ; Lenormand et al. 1999 ; Weill et al. 2000 ; Raymond et al. 2001 ; Berticat et al. 2002, 2004 ; Bourguet et al. 2004 ; Duron et al. 2006 ; Labbé et al. 2009). L'origine des coûts associés à la surproduction d'estérases est probablement biochimique : elles peuvent représenter jusqu'à 12% de la quantité totale de protéines circulantes (Fournier et al. 1987), ce qui affecte probablement les équilibres de dosages géniques.

Dans la région montpelliéraine, nous avons montré que de faibles variations de pressions de sélection pouvaient fortement affecter la valeur sélective des allèles du locus *Ester*. Ainsi pour les trois allèles de résistance présents, *Ester*¹ (non amplifié), *Ester*² et *Ester*⁴ (amplifiés), nous avons mis en évidence que les compromis avantages-coûts étaient liés, de façons différentes, à la dose d'insecticide utilisée. En conséquence, de faibles variations d'intensités dans la pression de sélection ont pu avoir de grandes conséquences sur la trajectoire adaptative de ces adaptations, puisqu'elles ont suffi à changer l'identité de l'allèle le plus avantageux. Ainsi, les variations dans la répartition, la fréquence et l'intensité des traitements dans la région montpelliéraine sur la période 1992–2005 ont entraîné une situation de sélection balancée où l'allèle conférant la meilleure valeur sélective pouvait changer d'une année sur l'autre, maintenant le polymorphisme à ce locus. On a toutefois pu observer un remplacement de l'allèle non amplifié (*Ester*¹) par des allèles amplifiés (*Ester*² et *Ester*⁴). Les amplifications géniques pourraient permettre un ajustement plus fin du compromis avantages-coûts en fonction de la dose d'insecticide. En effet, le nombre de copies d'un même allèle peut varier fortement au sein des populations (ex: de 3 à 74 copies d'*Ester*² dans une population de *Cx. quinquefasciatus* collectée à Tahiti, Weill et al. 2000). Ce niveau d'amplification semble corrélé à la fois avec l'avantage conféré, mais aussi avec les coûts associés : plus le nombre de copies est élevé, plus le niveau de résistance et les effets délétères pléiotropes semblent importants. Par exemple, chez *Cx. quinquefasciatus*, le niveau d'amplification moyen d'*Ester*^{B1} a diminué d'un facteur deux en ~70 générations dans une souche où la pression de sélection avait été retirée (OPs) par rapport à la souche régulièrement exposée aux OPs (Weill et al. 2000).

Pourtant, nous n'avons pas mis en évidence de modification du nombre de copies pour les allèles *Ester*² et *Ester*⁴, et c'est même l'allèle *Ester*¹ qui semble s'ajuster le plus rapidement en réponse à l'arrêt des traitements, avec une diminution du coût associé. Ceci pourrait être dû à un manque de variabilité du nombre de copies dans les populations de la région, et / ou au fait que les variations de pressions de sélection soient trop rapides pour sélectionner différents niveaux d'amplifications. Quoi qu'il en soit, l'origine du lien entre dose et compromis avantages-coûts des allèles amplifiés reste donc à comprendre. Les populations mahoraises de *Cx. quinquefasciatus* pourraient en donner l'opportunité : l'allèle *Ester*² y est très fréquent et une analyse préliminaire par PCR quantitative que j'ai effectuée montre que le niveau d'amplification varie substantiellement (de 3 à 25 copies). Nous pourrions

donc tester directement le lien entre niveau d'amplification et compromis avantages-coûts en populations naturelles.

Partenaire particulier...

Les variations de pressions de sélection peuvent entraîner des situations de sélection balancée qui maintiennent le polymorphisme en favorisant tour à tour différents allèles, comme nous l'avons mis en évidence au locus *Ester* dans la région montpelliéraine. Toutefois ces mêmes variations peuvent également maintenir le polymorphisme en favorisant un génotype hétérozygote (*i.e.* superdominance marginale). C'est ce qui a été proposé, toujours dans la région montpelliéraine, pour le locus *ace-1* : à l'échelle du transect d'échantillonnage, les RR sont avantageux en zone traitée, les SS en zone non traitée, mais le génotype RS semble en moyenne le meilleur sur les deux zones (Labbé et al. 2007b). Dans de telles situations, une autre architecture génétique peut être avantageuse : les duplications de gènes hétérogènes. Ces duplications peuvent en effet permettre la fixation du phénotype hétérozygote, en annulant le fardeau de ségrégation qui leur est associé (Haldane 1954 ; Spofford 1969). Leur rôle dans l'adaptation a toutefois été largement ignoré en raison du manque d'exemples empiriques.

Ce type de duplications a pourtant été sélectionné plusieurs fois indépendamment au locus *ace-1* chez les moustiques : en réponse aux mêmes pressions de sélection (OPs et CXs), l'évolution du locus *ace-1* est parallèle chez *An. gambiae* et *Cx. pipiens* : mutation G119S, puis duplication hétérogène. Nous avons montré, chez ces deux espèces, que ces duplications permettent effectivement de fixer le phénotype hétérozygote : elles confèrent le même compromis évolutif, intermédiaire entre celui des allèles sensibles (pas de résistance ni de coût) et résistants standards (résistance et coûts élevés). Dans des situations où une substitution nucléotidique génère un compromis irréductible (elle est avantageuse parce qu'elle modifie la structure protéique, mais est coûteuse pour la même raison), les duplications hétérogènes apparaissent donc comme une alternative préférentielle.

Puisqu'elles génèrent un phénotype intermédiaire, ces duplications hétérogènes devraient, en conséquence, être favorisées par des pressions de sélection intermédiaire. Dans les populations naturelles, l'hétérogénéité environnementale due aux pratiques de traitement (type d'insecticides, répartition, fréquence, intensité) pourrait ainsi être à l'origine de nombreuses situations de pressions de sélection modérée, favorables à l'émergence de

situations de superdominance, au moins marginales sinon strictes, expliquant la sélection récurrente des duplications hétérogènes (d'autres exemples de duplications hétérogènes, à différents locus et chez différentes espèces, ont d'ailleurs été récemment décrits dans des études de résistances à des insecticides: *ace-1* chez *An. albimanus*, (Liebman et al. 2015), *rdl* chez *Drosophila melanogaster* (Remnant et al. 2013) et *kdr* chez *Aedes aegypti* (Martins et al. 2013); d'autres exemples sont moins clairs: *rdl* chez *Myzus persicae* (Anthony et al. 1998), *ace* chez *Tetranychus urticae* (Kwon et al. 2010), *ace-1* chez *Plutella xylostella*, (Sonoda et al. 2014). Nous avons testé cette hypothèse grâce à une étude d'évolution expérimentale. Elle démontre qu'il existe effectivement des situations de superdominance pour des doses d'insecticide intermédiaire : quand de nombreux SS meurent, les RS sont favorisés à cause du coût élevé des RR. Nous avons également montré que l'allèle D₁ envahit rapidement ces populations en situation de superdominance, au détriment des allèles R. Enfin, en modulant les avantages et les coûts sélectifs relatifs de ces allèles, nous avons montré que les fréquences à l'équilibre étaient finement dépendantes de ces deux facteurs. Il apparaît donc que de faibles variations de pressions de sélection peuvent changer l'issue de la trajectoire adaptative à ce locus, en permettant, d'une part, l'apparition de duplications hétérogènes, et en affectant, d'autre part, les probabilités de fixation des allèles mono-copie ou dupliqués.

De telles situations de sélection intermédiaire ne semblent pas rares à l'échelle mondiale. La prévalence des allèles *ace-1* dupliqués dans les populations naturelles de *Cx. pipiens* en est la preuve : grâce à un large échantillonnage, nous avons en effet décrit, à ce jour, 27 duplications hétérogènes (pour seulement 4 allèles résistants mono-copie), trouvées dans la quasi-totalité des populations où des phénomènes de résistance avaient été détectés. Ce nombre de duplications hétérogènes est toutefois très probablement sous-estimé : le protocole de détection de ces duplications à partir d'un échantillon d'une population naturelle nécessite en effet une série de croisements sur des souches de références, au cours desquels certains allèles peuvent être perdus, par dérive ou par sélection. Pour éviter cela, au cours de ma thèse, nous avons amélioré ce protocole, pour isoler plus rapidement les différents allèles et en conserver un maximum. Toutefois, ce protocole reste inapplicable de manière extensive, puisqu'il nécessite toujours des individus vivants.

Il ne permet pas non plus de détecter directement les individus porteurs d'un allèle dupliqué dans les populations naturelles pour en estimer les fréquences. Nous avons donc essayé de mettre au point d'autres méthodes de détection basées sur des tests moléculaires.

Les progrès réalisés dans la précision des estimations du nombre de copies par PCR quantitative, nous ont permis, chez *An. gambiae*, d'établir de façon relativement fiable le génotype d'individus directement à partir des populations naturelles. Mais un seul allèle dupliqué a été décrit chez cette espèce. Lorsque nous avons testé cette méthode chez *Cx. pipiens*, la variabilité de séquences des différents allèles du locus *ace-1* s'est révélée trop forte pour obtenir des estimations fiables : il a été impossible de trouver un couple d'amorces permettant d'amplifier les deux allèles dupliqués, D₂ et D₃, présents dans une même population de la région de Montpellier. Nous avons alors essayé d'estimer leurs fréquences en développant des marqueurs spécifiques (PCR-RFLP). Cependant, même en combinant trois tests PCR-RFLP différents, l'estimation est restée très imprécise, car des allèles sensibles mono-copies porteurs de séquences identiques ou très proches de celles des allèles dupliqués ségrégent en fréquence élevée dans les mêmes populations, générant de nombreux faux positifs.

Malgré tous ces écueils, nous avons tout de même réussi à isoler huit allèles dupliqués à partir de populations naturelles de *Cx. pipiens* et *Cx. quinquefasciatus*, pour en caractériser le phénotype. Nous avons d'abord essayé d'établir des souches présentant ces allèles à l'état homozygote, comme dans des études précédentes (Bourguet et al. 1996 ; Labbé et al. 2007, 2014). Toutefois, essayer de fixer des allèles sublétaux à l'état homozygote peut vite s'avérer infructueux... Nous avons donc développé des mesures de trait de vie réalisables à partir de souches comprenant un allèle dupliqué et l'allèle sensible de référence. Ces méthodes impliquent néanmoins un grand nombre de croisements et de nombreux tests moléculaires pour phénotyper les individus ; elles sont donc difficilement généralisables pour systématiser la caractérisation d'un grand nombre d'allèles. Nous avons alors développé un protocole d'évolution expérimentale mettant en compétition un allèle dupliqué avec l'allèle sensible de référence, chaque génération étant traitée avec un insecticide OPs. Nous avons validé la méthode grâce aux allèles déjà caractérisés par ailleurs : en six générations discrètes, on peut, aisément et de façon robuste, établir si l'allèle est sublétal ou non à l'état homozygote. Cette méthode présente en outre deux avantages majeurs : d'une part elle permet de prendre en compte l'intégralité du cycle de vie dans l'estimation du phénotype, d'autre part elle s'est avérée très économe en termes de temps (et d'argent ...), le phénotypage se faisant simplement par bioessais.

Ainsi, nous avons pu montrer que sur 10 allèles dupliqués, 8 sont sublétaux à l'état homozygote. De plus, l'origine de ce coût est à chaque fois différente puisque les allèles

complémentent entre eux. On a donc une estimation basse de 80% de duplications hétérogènes du locus *ace-1* présentant ce phénotype chez *Cx. pipiens*. Ce pourcentage est très probablement fortement sous-estimé : le protocole entraîne en effet un biais de détection en faveur des duplications les moins coûteuses qui risquent moins d'être perdues au cours de la fixation. Or cinq duplications ont été perdues pendant le processus d'isolation, très probablement éliminées par ces allèles plus favorables.

Le caractère sublétal de la majorité de ces duplications *ace-1* hétérogènes explique l'incroyable polymorphisme trouvé dans la majorité des populations naturelles de *Cx. pipiens* (jusqu'à six D différents). Elles sont avantageuses à l'état hétérozygote, que ce soit avec un allèle mono-copie, ou, comme nous l'avons démontré, avec un autre allèle dupliqué, même sublétal lui aussi à l'état homozygote. Leur faible fréquence initiale permet donc à ces allèles d'être dans un premier temps sélectionnés. En augmentant en fréquence, ils se retrouvent plus souvent à l'état homozygote ; cet état étant sublétal, ils atteignent rapidement un plateau. Ceci résulte en une situation de superdominance complexe : tout nouvel allèle dupliqué envahit, et plus il y a d'allèles dupliqués dans une population, plus leur fréquence globale dans la population augmente ; cependant la fréquence de chacun diminue.

Si la majorité des allèles dupliqués sont affectés par cette létalité homozygote, ce n'est pas le cas de tous : on trouve, dans le complexe *Cx. pipiens*, des duplications hétérogènes avec un coût réduit, similaires à celle caractérisée chez *An. gambiae*. Ces allèles semblent d'ailleurs se propager en populations naturelles : chez *Cx. quinquefasciatus*, D₁ a envahi la Martinique et a été retrouvé jusqu'à Mayotte (Chap. 2), et l'allèle dupliqué décrit chez *An. gambiae* semble avoir envahi l'Afrique de l'Ouest (Assogba et al. 2015 ; Djogbénou et al. 2008, 2009). Le polymorphisme observé pour les allèles dupliqués dans les populations du complexe *Cx. pipiens* pourrait donc n'être que transitoire.

L'origine des différences phénotypiques entre allèles dupliqués reste toutefois à déterminer. Bien que la duplication elle-même entraîne une perturbation du dosage génique au locus *ace-1*, nos études montrent que le caractère sublétal n'est probablement pas associé à ce locus: l'activité au locus *ace-1* est celle attendue pour un individu DD (le double d'un RS), y compris pour les allèles sublétaux. Au contraire, elle semble plutôt liée à des mutations délétères récessives, chaque fois différentes et embarquées dans l'amplicon, ou à des cassures de gènes aux bornes des duplications. Le séquençage de

l'allèle *ace-1* dupliqué chez *An. gambiae* a révélé un amplicon très grand, > 200 kb, comprenant 12 autres gènes (Assogba, Milesi et al. *in prep.*). Il existe donc de nombreuses opportunités de mutations délétères autour ou dans ces différents locus, dont un tel allèle dupliqué peinera à se débarrasser (la recombinaison est généralement réduite à cause de la duplication elle-même).

Etablir la structure de ces duplications dans le complexe *Cx. pipiens*, c'est-à-dire savoir si elles sont en tandem ou non, avec une syntenie conservée ou des inversions, dans quel ordre sont les copies, etc., pourrait nous aider à mieux en comprendre l'origine et les conséquences phénotypiques : la cassure est-elle systématiquement au même endroit ? Résultent-elles de crossing-over inégaux ou de glissements de réplifications ? Quelles sont les causes de sublétalement ?

Pour cela nous avons d'abord essayé de localiser les copies des duplications par marquage chromosomique (FISH). Si cela a été aisé pour *An. gambiae*, là encore la tâche s'est révélée plus complexe pour *Cx. pipiens* (que la duplication soit sublétalement ou non). En effet, les chromosomes polythènes, nécessaires à ce genre de marquage, ne sont localisés que dans quelques organes (glandes salivaires, tubes de Malpighi) et se forment surtout à un stade de développement précis (début L4), les rendant difficile à isoler. Mais plus encore, les télomères de ces chromosomes sont fusionnés, et de nombreux points de contacts existent entre zones non homologues d'un même chromosome (Naumenko et al. 2015). Ceci empêche un bon étalement et entraîne de nombreuses cassures sur les chromosomes empêchant le marquage. Jusque-là infructueuse, je persévère néanmoins pour développer cette approche, avec l'aide précieuse de Diego Ayala.

Compte tenu de l'expérience et des résultats acquis lors de l'analyse des séquences génomiques des souches d'*An. gambiae*, nous avons également tenté une approche par séquençage illumina de deux souches de laboratoire, du même taxon que le génome de référence (*Cx. quinquefasciatus*, JHB) : Slab, la souche sensible de référence et Ducos, la souche homozygote pour l'allèle dupliqué D₁. Malheureusement, ce génome de référence est très mal assemblé en raison des nombreux éléments répétés qu'il contient : à ce jour, il est fractionné en 3171 contigs avec un N₅₀ (*i.e.* ~ taille médiane) de 476 kb, soit à peine deux fois la taille de l'amplicon que nous avons identifié chez *An. gambiae*. Je compte commencer cette analyse très prochainement. La reconstruction de l'amplicon contenant le locus *ace-1* chez *Cx. pipiens* risque d'être nettement plus complexe que ce ne fut le cas

pour *An. gambiae*, dont le génome de référence (PEST) est totalement assemblé et extrêmement bien annoté. Si toutefois nous y parvenions, le séquençage de plusieurs souches portant des allèles dupliqués sublétaux serait bien sûr l'étape suivante.

Enfin, disposer de la séquence de l'amplicon contenant le locus *ace-1* pourrait nous permettre de mettre au point le test spécifique des allèles dupliqués tant désiré. En effet, si les points de cassures sont systématiquement les mêmes pour les différents allèles dupliqués, par exemple s'ils étaient dus à la présence d'un élément transposable (comme cela semble être le cas chez *An. gambiae*, Assogba, Milesi et al., *in prep.*), on pourrait développer un test moléculaire au niveau de la jonction des deux amplicons. Cela nous permettrait ainsi d'estimer précisément les fréquences des allèles dupliqués dans les populations naturelles (les techniques actuelles à partir des écarts à la panmixie restant trop imprécises), et donc d'étudier leur dynamique comme nous avons pu le faire au locus *Ester*. Cela nous permettrait de mesurer comment les variations quantitatives des pressions de sélection affectent la dynamique des allèles de ce locus, mais également de comparer l'influence de ces variations entre locus.

Conclusion générale

A partir de l'exemple de l'adaptation aux insecticides chez les moustiques, nous avons pu montrer que le polymorphisme du nombre de copies peut être avantageux, au même titre que les mutations ponctuelles. N'affectant pas le génome à la même échelle, ces différentes mutations sont soumises à des contraintes différentes, mais elles peuvent aussi être à l'origine de différentes innovations moléculaires. Ainsi, les modifications du dosage génique peuvent être avantageuses soit en modifiant l'intensité d'une fonction unique (amplification géniques), soit en permettant l'expression permanente et systématique de deux fonctions différentes (duplications hétérogènes). Ces différentes architectures génétiques sont le plus souvent associées à des effets pléiotropes délétères, car elles modifient la structure du génome et l'expression des gènes. Comme les mutations ponctuelles, elles sont donc associées à des compromis avantages-coûts, mais ces compromis présentent potentiellement une variation plus continue, plus subtile. Les variations de pressions de sélection, qu'elles soient qualitatives ou même quantitatives, y compris avec de faibles amplitudes, vont affecter l'évolution de ces adaptations en favorisant certains compromis au détriment des autres. Ainsi, la grande variabilité des réponses adaptatives aux variations de pressions de sélection rendue possible par ces différentes architectures génétiques, permet d'expliquer l'adéquation fine des phénotypes avec leur environnement.

Références

- Allison, A. C. 1956. The sickle-cell and haemoglobin C genes in some African populations. *Ann. Hum. Genet.* 21:67–89.
- Alout, H., A. Berthomieu, and C. Berticat. 2007a. Different amino-acid substitutions confer insecticide resistance through acetylcholinesterase 1 insensitivity in *Culex vishnui* and *Culex tritaeniorhynchus* (Diptera: Culicidae) mosquitoes from China. *J. Med. Entomol.* 44:463–469.
- Alout, H., A. Berthomieu, A. Hadjivassilis, and M. Weill. 2007b. A new amino-acid substitution in acetylcholinesterase 1 confers insecticide resistance to *Culex pipiens* mosquitoes from Cyprus. *Insect Biochem. Mol. Biol.* 37:41–47.
- Alout, H., L. Djogbénou, C. Berticat, F. Chandre, and M. Weill. 2008. Comparison of *Anopheles gambiae* and *Culex pipiens* acetylcholinesterase 1 biochemical properties. *Comp. Biochem. Physiol. B. Biochem. Mol. Biol.* 150:271–277.
- Alout, H., P. Labbé, N. Pasteur, and M. Weill. 2010. High incidence of *ace-1* duplicated haplotypes in resistant *Culex pipiens* mosquitoes from Algeria. *Insect Biochem. Mol. Biol.* 41:29–35.
- Anthony, N., T. Unruh, D. Ganser, and R. Ffrench-Constant. 1998. Duplication of the *Rdl* GABA receptor subunit gene in an insecticide-resistant aphid, *Myzus persicae*. *Mol. Gen. Genet.* 260:165–175.
- Assogba, B. S., L. S. Djogbénou, P. Milesi, A. Berthomieu, J. Perez, D. Ayala, F. Chandre, M. Makoutodé, P. Labbé, and M. Weill. 2015. An *ace-1* gene duplication resorbs the fitness cost associated with resistance in *Anopheles gambiae*, the main malaria mosquito. *Sci. Rep.* 5:14529
- Axelsson, E., A. Ratnakumar, M.-L. Arendt, K. Maqbool, M. T. Webster, M. Perloski, O. Liberg, J. M. Arnemo, A. Hedhammar, and K. Lindblad-Toh. 2013. The genomic signature of dog domestication reveals adaptation to a starch-rich diet. *Nature* 495:360–4.
- Belaousoff, S., and J. S. Shore. 1995. Floral Correlates and Fitness Consequences of Mating-System Variation in *Turnera ulmifolia*. *Evolution.* 49:545–556.
- Bell, G. 2008. *Selection*. Oxford: Oxford Univ. Press.
- Berticat, C., G. Boquien, M. Raymond, and C. Chevillon. 2002. Insecticide resistance genes induce a mating competition cost in *Culex pipiens* mosquitoes. *Genet. Res.* 79:41–47.
- Berticat, C., M.-P. Dubois, M. Marquine, C. Chevillon, M. Raymond. 2000. A molecular test to identify resistance alleles at the amplified esterase locus in the mosquito *Culex pipiens*. *Pest Manag. Sci.* 56:727–731.
- Berticat, C., O. Duron, D. Heyse, and M. Raymond. 2004. Insecticide resistance genes confer a predation cost on mosquitoes, *Culex pipiens*. *Genet. Res.* 83:189–196.
- Bourguet, D., T. Guillemaud, C. Chevillon, and M. Raymond. 2004. Fitness costs of insecticide resistance in natural breeding sites of the mosquito *Culex pipiens*. *Evolution.* 58:128–135.
- Bourguet, D., N. Pasteur, J. Bisset, and M. Raymond. 1996a. Determination of *ace-1* genotypes in single mosquitoes : toward an ecumenical biochemical test. *Pestic. Biochem. Physiol.* 55:122–128.
- Bourguet, D., M. Raymond, J. Bisset, N. Pasteur, and M. Arpagaus. 1996b. Duplication of the *ace-1* locus in *Culex pipiens* mosquitoes from the Caribbean. *Biochem. Genet.* 34:351–362.
- Bourguet, D., A. Roig, J. P. Toutant, and M. Arpagaus. 1997. Analysis of molecular forms and pharmacological properties of acetylcholinesterase in several mosquito species. *Neurochem. Int.* 31:65–72.
- Bradshaw, W. E., P. A. Zani, and C. M. Holzapfel. 2004. Adaptation to temperate climates. *Evolution* 58:1748–1762.
- Brown, C. J., K. M. Todd, and R. F. Rosenzweig. 1998. Multiple duplications of yeast hexose transport genes in response to selection in a glucose-limited environment. *Mol. Biol. Evol.* 15:931–942.
- Carrière, Y., J.-P. Deland, D. A. Roff, and C. Vincent. 1994. Life-history cost associated with the evolution of insecticide resistance. *Proc. R. Soc. London B* 258:35–40.
- Clarke, G. M. 1997. The genetic and molecular basis of developmental stability: The *Lucilia* story. *Trends Ecol. Evol.* 12:89–91.
- Cleveland, W. S., and E. Grosse. 1991. Computational methods for local regression. *Stat. Comput.* 1:47–62.
- Cook, L. M., R. L. H. Dennis, and G. S. Mani. 1999. Melanic morph frequency in the peppered moth in the Manchester area. *Proc. R. Soc. B Biol. Sci.* 266:293–297.

- Cook, L. M., G. S. Mani, and M. E. Varley. 1986. Postindustrial melanism in the peppered moth. *Science* 231:611–613.
- Cook, L. M., and I. J. Saccheri. 2013. The peppered moth and industrial melanism: evolution of a natural selection case study. *Heredity*. 110:207–12.
- Crow, J. F. 1948. Alternative hypotheses of hybrid vigor. *Genetics*. 33:477–487.
- Cui, F., M. Weill, A. Berthomieu, M. Raymond, and C.-L. Qiao. 2007. Characterization of novel esterases in insecticide-resistant mosquitoes. *Insect Biochem. Mol. Biol.* 37:1131–1137.
- Dehal, P., and J. L. Boore. 2005. Two rounds of whole genome duplication in the ancestral vertebrate. *PLoS Biol.* 3:e314.
- Demuth, J. P., T. De Bie, J. E. Stajich, N. Cristianini, and M. W. Hahn. 2006. The Evolution of Mammalian Gene Families. *PLoS One* 1:e85.
- Denver, D. R., P. C. Dolan, L. J. Wilhelm, W. Sung, J. I. Lucas-Lledó, D. K. Howe, S. C. Lewis, K. Okamoto, W. K. Thomas, M. Lynch, and C. F. Baer. 2009. A genome-wide view of *Caenorhabditis elegans* base-substitution mutation processes. *Proc. Natl. Acad. Sci. U. S. A.* 106:16310–16314.
- Diop, M., N. Moiroux, F. Chandre, H. Martin-Herrou, P. Milesi, O. Boussari, A. Porciani, S. Duchon, P. Labbé, C. Penetier. 2015. Behavioral cost & overdominance in *Anopheles gambiae*. *PLoS One*. 10(4): e0121755, 1-12.
- Djogbénu, L., F. Chandre, A. Berthomieu, R. Dabiré, A. Koffi, H. Alout, M. Weill. 2008. Evidence of introgression of the *ace-1^R* mutation and of the *ace-1* duplication in west African *Anopheles gambiae s.s.* *PLoS One* 3:e2172, 1–7.
- Djogbénu, L., P. Labbé, F. Chandre, N. Pasteur, M. Weill. 2009. *ace-1* duplication in *Anopheles gambiae*: a challenge for malaria control. *Malar. J.* 8:70.
- Djogbénu, L., V. Noel, and P. Agnew. 2010. Costs of insensitive acetylcholinesterase insecticide resistance for the malaria vector *Anopheles gambiae* homozygous for the G119S mutation. *Malar. J.* 9:12.
- Dobzhansky, T. 1952. Nature and origin of heterosis. Ames. Iowa.
- Duron, O., P. Labbé, C. Berticat, F. Rousset, S. Guillot, M. Raymond, and M. Weill. 2006. High *Wolbachia* density correlates with cost of infection for insecticide resistant *Culex pipiens* mosquitoes. *Evolution* 60:303–314.
- East, E. M. 1936. Heterosis. *Genetics* 4:375–397.
- East, E. M. 1908. Inbreeding in corn. Reports of the Connecticut Agricultural Experiment Station for Years 1907-1908. 419–428
- Emerson, J. J., M. Cardoso-Moreira, J. O. Borevitz, and M. Long. 2008. Natural selection shapes genome-wide patterns of copy-number polymorphism in *Drosophila melanogaster*. *Science* 320:1629–1631.
- Endler, J. A. 1986. Natural selection in the wild. Princeton University Press, Princeton, N.J.
- European Commission 2007/393/EC. 2007. Commission decision of 6 June 2007 concerning the non-inclusion of diazinon in Annex I to Council Directive 91/414/EEC and the withdrawal of authorisations for plant protection products containing that substance.
- Feyereisen, R., W. Dermauw, T. Van Leeuwen, and T. Van Leeuwen. 2015. Genotype to phenotype, the molecular and physiological dimensions of resistance in arthropods. *Pestic. Biochem. Physiol.* 121:61–77.
- Fisher, R. A. 1922. On the dominance ratio. *Proceeding R. Soc. Edimbg.* 42:321–341.
- Fisher, R. A. 1930. The genetical theory of natural selection. Clarendon Press, Oxford.
- Fournier, D., J. M. Bride, C. Mouchès, M. Raymond, M. Magnin, J. B. Bergé, N. Pasteur, and G. P. Georgiou. 1987. Biochemical characterization of the esterases A1 and B1 associated with organophosphate resistance in the *Culex pipiens* complex. *Pestic. Biochem. Physiol.* 27:211–217.
- Gallet, R., T. F. Cooper, S. F. Elena, and T. Lenormand. 2012. Measuring selection coefficients below 10⁻³: Method, Questions, and Prospects. *Genetics* 190:175–186.
- Galloway, L. F., and J. R. Etterson. 2007. Transgenerational Plasticity is adaptive in the wild. *Science*. 318:1134–1136.
- Gazave, E., C. Chevillon, T. Lenormand, M. Marquine, and M. Raymond. 2001. Dissecting the cost of insecticide resistance genes during the overwintering period of the mosquito *Culex pipiens*. *Heredity*. 87:441–448.

- Georghiou, G. P., R. L. Metcalf, and F. E. Gidgen. 1966. Carbamate-resistance in mosquitos. Selection of *Culex pipiens fatigans* Wiedemann (= *C. quinquefasciatus* Say) for resistance to Baygon. Bull. World Health Organ. 35:691–708.
- Geyer, C. J., S. Wagenius, and R. G. Shaw. 2007. Aster models for life history analysis. Biometrika 94:415–426.
- Gonzales-Candels, F., I. Comas, J. Luiz Martinez, J. C. Galan, and F. Baquero. 2011. The evolution of antibiotic resistance. in Genetic and evolution of infectious diseases. Ed. M. Tibayrenc, Elsevier, London, U.K.
- Grant, P. R., and B. R. Grant. 1995. Predicting microevolutionary responses to directional selection on heritable variation. Evolution. 49:241–251.
- Guillemaud, T., T. Lenormand, D. Bourguet, C. Chevillon, N. Pasteur, and M. Raymond. 1998. Evolution of resistance in *Culex pipiens* : Allele replacement and changing environment. Evolution. 52:443–453.
- Guillemaud, T., N. Makate, M. Raymond, B. Hirst, and A. Callaghan. 1997. Esterase gene amplification in *Culex pipiens*. Insect Mol. Biol. 6:319–327.
- Hahn, M. W. 2009. Distinguishing among evolutionary models for the maintenance of gene duplicates. J. Hered. 100:605–17.
- Haldane, J. B. S. 1949. Disease and evolution. Ric. Sci. Suppl. 19:68–76.
- Haldane, J. B. S. 1954. The biochemistry of genetics. George Allen and Unwin, London.
- Haldane, J. B. S. 1937. The effect of variation on fitness. Am. Nat. 71:337–349.
- Hastings, P., H. J. Bull, J. R. Klump, and S. M. Rosenberg. 2000. Adaptive amplification. cell 103:723–731.
- Hughes, M. K., and A. L. Hughes. 1993. Evolution of duplicate genes in a tetraploid animal, *Xenopus laevis*. Mol. Biol. Evol. 10:1360–1369.
- Hull, F. H. 1945. Recurrent selection for specific combining ability in corn. Agron. J. 37:134–145.
- Innan, H., and F. Kondrashov. 2010. The evolution of gene duplications: classifying and distinguishing between models. Nat. Rev. Genet. 11:97–108.
- Itsara, A., G. M. Cooper, C. Baker, S. Girirajan, J. Li, D. Absher, R. M. Krauss, R. M. Myers, P. M. Ridker, D. I. Chasman, H. Mefford, P. Ying, D. A. Nickerson, and E. E. Eichler. 2009. Population analysis of large copy number variants and hotspots of human genetic disease. Am. J. Hum. Genet. 84:148–161.
- Jaillon, O., J. Aury, F. Brunet, J. Petit, N. Stange-Thomann, E. Mauceli, L. Bouneau, C. Fischer, C. Ozouf-Costaz, A. Bernot, S. Nicaud, D. Jaffe, S. Fisher, G. Lutfalla, C. Dossat, B. Segurens, C. Dasilva, M. Salanoubat, M. Levy, N. Boudet, S. Castellano, V. Anthouard, C. Jubin, V. Castelli, M. Katinka, B. Vacherie, C. Biémont, Z. Skalli, L. Cattolico, J. Poulain, V. De Berardinis, C. Cruaud, S. Duprat, P. Brottier, J.-P. Coutanceau, J. Gouzy, G. Parra, G. Lardier, C. Chapple, K. J. McKernan, P. McEwan, S. Bosak, M. Kellis, J.-N. Volff, R. Guigó, M. C. Zody, J. Mesirov, K. Lindblad-Toh, B. Birren, C. Nusbaum, D. Kahn, M. Robinson-Rechavi, V. Laudet, V. Schachter, F. Quétier, W. Saurin, C. Scarpelli, P. Wincker, E. S. Lander, J. Weissenbach, and H. Roest Crollius. 2004. Genome duplication in the teleost fish *Tetraodon nigroviridis* reveals the early vertebrate proto-karyotype. Nature 431:946–957.
- Janssens, T. K. S., D. Roelofs, and N. M. van Straalen. 2009. Molecular mechanisms of heavy metal tolerance and evolution in invertebrates. Insect Sci. 16:3–18.
- Julvez, J., C. Ragavoodoo, a R. Gopaul, and J. Mouchet. 1998. Maladies humaines transmises par les culicidés dans les Îles du sud-ouest de l’Océan Indien. Bull Soc Pathol Exot 91:99–103.
- Katju, V., and U. Bergthorsson. 2013. Copy-number changes in evolution: rates, fitness effects and adaptive significance. Front. Genet. 4:273.
- Kawecki, T. J., and D. Ebert. 2004. Conceptual issues in local adaptation. Ecol. Lett. 7:1225–1241.
- Kondrashov, F. A. 2012. Gene duplication as a mechanism of genomic adaptation to a changing environment. Proc. R. Soc. B Biol. Sci. 5048–5057.
- Kondrashov, F. A., and A. S. Kondrashov. 2006. Role of selection in fixation of gene duplications. J. Theor. Biol. 239:141–151.
- Kwon, D. H., J. M. Clark, and S. H. Lee. 2010. Extensive gene duplication of acetylcholinesterase associated with organophosphate resistance in the two-spotted spider mite. Insect Mol. Biol. 19:195–204.

- Labbé, P., H. Alout, D. Djogbénu, N. Pasteur, M. Weill, L. Djogbénu, N. Pasteur, and M. Weill. 2011. Evolution of resistance to insecticide in disease vectors. *in* Genetics and evolution of infectious diseases. ed. M. Tibayrenc. Elsevier, London, U.K. Pp. 363–409
- Labbé, P., A. Berthomieu, C. Berticat, H. Alout, M. Raymond, T. Lenormand, and M. Weill. 2007a. Independent duplications of the acetylcholinesterase gene conferring insecticide resistance in the mosquito *Culex pipiens*. *Mol. Biol. Evol.* 24:1056–1067.
- Labbé, P., C. Berticat, A. Berthomieu, S. Unal, C. Bernard, M. Weill, and T. Lenormand. 2007b. Forty years of erratic insecticide resistance evolution in the mosquito *Culex pipiens*. *PLoS Genet.* 3:e205.
- Labbé, P., T. Lenormand, and M. Raymond. 2005. On the worldwide spread of an insecticide resistance gene: A role for local selection. *J. Evol. Biol.* 18:1471–1484.
- Labbé, P., P. Milesi, A. Yébakima, N. Pasteur, M. Weill, and T. Lenormand. 2014a. Gene-dosage effects on fitness in recent adaptive duplications: *ace-1* in the mosquito *Culex pipiens*. *Evolution.* 68:2092–2101.
- Labbé, P., N. Sidos, M. Raymond, T. Lenormand, N. Sidos, M. Weill, and T. Lenormand. 2009. Resistance gene replacement in the mosquito *Culex pipiens*: fitness estimation from long-term cline series. *Genetics* 182:303–12.
- Langley, C. H., K. Stevens, C. Cardeno, Y. C. G. Lee, D. R. Schrider, J. E. Pool, S. A. Langley, C. Suarez, R. B. Corbett-Detig, B. Kolaczkowski, S. Fang, P. M. Nista, A. K. Holloway, A. D. Kern, C. N. Dewey, Y. S. Song, M. W. Hahn, and D. J. Begun. 2012. Genomic variation in natural populations of *Drosophila melanogaster*. *Genetics* 192:533–598.
- Lenormand, T., D. Bourguet, T. Guillemaud, and M. Raymond. 1999. Tracking the evolution of insecticide resistance in the mosquito *Culex pipiens*. *Nature* 400:861–864.
- Lenormand, T., T. Guillemaud, D. Bourguet, and M. Raymond. 1998a. Appearance and sweep of a gene duplication: Adaptive response and potential for new functions in the mosquito *Culex pipiens*. *Evolution* 52:1705–1712.
- Lenormand, T., T. Guillemaud, D. Bourguet, and M. Raymond. 1998b. Evaluating gene flow using selected markers: a case study. *Genetics* 149:1383–1392.
- Lenormand, T., and M. Raymond. 2000. Analysis of clines with variable selection and variable migration. *Am. Nat.* 155:70–82.
- Lenormand, T., N. Rode, L. M. Chevin, and F. Rousset. 2015. Valeur sélective : définitions enjeux et mesures *in press.* *in* Biologie Evolutive , eds. T. Lefèvre, F. Thomas, and M. Raymond. de boeck.
- Lieberman, K. A., J. Pinto, J. Valle, M. Palomino, L. Vizcaino, W. Brogdon, and A. Lenhart. 2015. Novel mutations on the *ace-1* gene of the malaria vector *Anopheles albimanus* provide evidence for balancing selection in an area of high insecticide resistance in Peru. *Malar. J.* 14:1–10.
- Lipinski, K. J., J. C. Farslow, K. A. Fitzpatrick, M. Lynch, V. Katju, and U. Bergthorsson. 2011. High spontaneous rate of gene duplication in *Caenorhabditis elegans*. *Curr. Biol.* 21:306–310.
- Losos, J. B., K. I. Warheitt, and T. W. Schoener. 1997. Adaptive differentiation following experimental island colonization in *Anolis lizards*. *Nature* 387:70–73.
- Lupski, J. R. 2007. Genomic rearrangements and sporadic disease. *Nat. Genet.* 39:S43–7.
- Lynch, M., and J. S. Conery. 2000. The Evolutionary Fate and Consequences of Duplicate Genes. *Science.* 290:1151–1155.
- Lynch, M., and A. Force. 2000. The Probability of Duplicate Gene Preservation by Subfunctionalization. *Genetics* 154:459–473.
- Lynch, M., M. O’Hely, B. Walsh, and A. Force. 2001. The Probability of Preservation of a Newly Arisen Gene Duplicate. *Genetics* 159:1789–1804.
- Lynch, M., W. Sung, K. Morris, N. Coffey, C. R. Landry, E. B. Dopman, W. J. Dickinson, K. Okamoto, S. Kulkarni, D. L. Hartl, and W. K. Thomas. 2008. A genome-wide view of the spectrum of spontaneous mutations in yeast. *Proc. Natl. Acad. Sci. U. S. A.* 105:9272–7.
- Macnair, M. R. 1987. Heavy metal tolerance in plants: A model evolutionary system. *Trends Ecol. Evol.* 2:354–9.
- Maisnier-Patin, S., and D. I. Andersson. 2004. Adaptation to the deleterious effects of antimicrobial drug resistance mutations by compensatory evolution. *Res. Microbiol.* 155:360–369.
- Marchant, C. J. 1967. Evolution in *Spartina* (Gramineae): I. The history and morphology of the genus in Britain. *J. Linn. Soc. London, Bot.* 60:1–24.

- Maroni, G., J. Wise, J. E. Young, and E. Otto. 1987. Metallothionein gene duplications and metal tolerance in natural populations of *Drosophila melanogaster*. *Genetics* 117:739–744.
- Martins, A. J., L. P. Brito, J. Gerlinde, B. Linss, G. Bueno, R. Machado, R. V. Bruno, B. P. Lima, D. Valle, and A. A. Peixoto. 2013. Evidence for gene duplication in the voltage-gated sodium channel gene of *Aedes aegypti*. *Evol. Med. public Heal.* 2013:148–160.
- Mather, K. 1955. The Genetical Basis of Heterosis. *Proceeding R. Soc. London, B* 144:143–150.
- Mckenzie, J. A., and G. M. Clarke. 1988. Diazinon Resistance, fluctuating asymmetry and fitness in the Australian sheep blowfly, *Lucilia cuprina*. *Genetics* 120:213–220.
- McKenzie, J. A., J. M. Dearn, and M. J. Whitten. 1980. Genetic basis of resistance to diazinon in Victorian populations of the Australian sheep blowfly, *Lucilia cuprina*. *Aust J Biol Sci* 33:85–95.
- Millstein, R. L. 2008. Distinguishing drift and selection empirically: “The great snail debate” of the 1950s. *J. Hist. Biol.* 41:339–367.
- Mitchell-olds, A. T., and R. G. Shaw. 1987. Regression analysis of natural selection: statistical inference and biological interpretation. *41:1149–1161.*
- Mouchès, C., N. Pasteur, J. B. Bergé, O. Hyrien, M. Raymond, B. Robert de Saint Vincent, M. De Silvestri, and G. P. Georghiou. 1986. Amplification of an esterase gene is responsible for insecticide resistance in a California *Culex* mosquito. *Science.* 233:778–780.
- Nauen, R. 2007. Insecticide resistance in disease vectors of public health importance. *Pest. Man. Sci.* 63:628–633.
- Naumenko, A. N., V. a Timoshevskiy, N. a Kinney, A. a Kokhanenko, B. S. DeBruyn, D. D. Lovin, V. N. Stegnyy, D. W. Severson, I. V Sharakhov, and M. V Sharakhova. 2015. Mitotic-chromosome-based physical mapping of the *Culex quinquefasciatus* genome. *PLoS One* 10:e0115737.
- Ohno, S. 1970. *Evolution by gene duplication*. Springer-Verlag, Berlin.
- Orr, H. A. 1998. The population genetics of adaptation: the distribution of factors fixed during adaptive evolution. *Evolution.* 52:935–949.
- Osta, M. A., Z. J. Rizk, P. Labbé, M. Weill, and K. Knio. 2012. Insecticide resistance to organophosphates in *Culex pipiens* complex from Lebanon. *Parasites & vectors.* 5:132. 1-6
- Otto, S. P. P., and P. Yong. 2002. The evolution of gene duplicates. *Homol. Eff. Adv. Genet. Inc. Mol. Genet. Med.* 46:451–483.
- Pan, D., and L. Zhang. 2007. Quantifying the major mechanisms of recent gene duplications in the human and mouse genomes: a novel strategy to estimate gene duplication rates. *Genome Biol.* 8:R158.
- Parsons, P. A., and W. F. Bodmer. 1961. The evolution of overdominance: natural selection and heterozygote advantage. *Nature* 190:7–12.
- Pasteur, N., G. P. Georghiou, and A. Iseki. 1984. Variation in organophosphate resistance and esterase activity in *Culex quinquefasciatus* Say from California. *Genet. Sel. Evol.* 16:271–284.
- Pasteur, N., A. Iseki, and G. P. Georghiou. 1981a. Genetic and biochemical studies of the highly active esterases A and B associated with organophosphate resistance in mosquitoes of the *Culex pipiens* complex. *Biochem. Genet.* 19:909–919.
- Pasteur, N., G. Sinègre, and A. Gabinaud. 1981b. *Est-2* and *Est-3* polymorphism in *Culex pipiens* L. from southern France in relation to organophosphate resistance. *Biochem. Genet.* 19:499–508.
- Perry, G. H., N. J. Dominy, K. G. Claw, A. S. Lee, H. Fiegler, R. Redon, J. Werner, F. A. Villanea, J. L. Mountain, R. Misra, N. P. Carter, C. Lee, and A. C. Stone. 2007. Diet and the evolution of human amylase gene copy number variation. *Nat Genet* 39:1256–1260.
- Pocquet, N., F. Darriet, B. Zumbo, P. Milesi, J. Thiria, V. Bernard, C. Toty, P. Labbé, and F. Chandre. 2014. Insecticide resistance in disease vectors from Mayotte: an opportunity for integrated vector management. *Parasit. Vectors* 7:299.
- Pocquet, N., P. Milesi, P. Makoundou, S. Unal, B. Zumbo, C. Atyame, F. Darriet, J.-S. Dehecq, J. Thiria, A. Bheecarry, D. P. Iyaloo, M. Weill, F. Chandre, and P. Labbé. 2013. Multiple insecticide resistances in the disease vector *Culex p. quinquefasciatus* from Western Indian Ocean. *PLoS One* 8:e77855.
- Poirié, M., M. Raymond, and N. Pasteur. 1992. Identification of two distinct amplifications of the esterase B locus in *Culex pipiens* (L.) mosquitoes from Mediterranean countries. *Biochem. Genet.* 30:13–26.

- Proulx, S., and P. Phillips. 2006. Allelic divergence precedes and promotes gene duplication. *Evolution*. 60:881–892.
- Ranson, H., R. N’Guessan, J. Lines, N. Moiroux, Z. Nkuni, and V. Corbel. 2011. Pyrethroid resistance in African anopheline mosquitoes: What are the implications for malaria control? *Trends Parasitol.* 27:91–98.
- Rausher, M. D. 1992. The Measurement of Selection on Quantitative Traits : Biases Due to Environmental Covariances between Traits and Fitness. *Evolution*. 46:616–626.
- Raymond, M., C. Berticat, M. Weill, N. Pasteur, and C. Chevillon. 2001. Insecticide resistance in the mosquito *Culex pipiens*: what have we learned about adaptation? *Genetica* 287–296.
- Raymond, M., V. Beyssat-Arnaouty, N. Sivasubramanian, C. Mouchès, G. P. Georghiou, and N. Pasteur. 1989. Amplification of various esterase B responsible for organophosphate resistance in *Culex* mosquitoes. *Biochem. Genet.* 27:417–423.
- Raymond, M., C. Chevillon, T. Guillemaud, T. Lenormand, and N. Pasteur. 1998. An overview of the evolution of overproduced esterases in the mosquito *Culex pipiens*. *Philos. Trans. R. Soc. B* 353:1707–1711.
- Raymond, M., D. Fournier, J.-M. Bride, A. Cuany, J. Bergé, M. Magnin, and N. Pasteur. 1986. Identification of resistance mechanisms in *Culex pipiens* (Diptera: Culicidae) from southern France: insensitive acetylcholinesterase and detoxifying oxidases. *J. Econ. Entomol.* 79:1452–1458.
- Reams, A. B., E. Kofoid, M. Savageau, and J. R. Roth. 2010. Duplication frequency in a population of *Salmonella enterica* rapidly approaches steady state with or without recombination. *Genetics* 184:1077–1094.
- Remnant, E. J., R. T. Good, J. M. Schmidt, C. Lumb, C. Robin, P. J. Daborn, and P. Batterham. 2013. Gene duplication in the major insecticide target site, *Rdl*, in *Drosophila melanogaster*. *Proc. Natl. Acad. Sci. U. S. A.* 110:14705–10.
- Reznick, D. N., and H. Bryga. 1987. Life-History Evolution in Guppies (*Poecilia reticulata*): 1. Phenotypic and genetic changes in an introduction experiment. *Evolution*. 41:1370–1385.
- Roach, J. C., G. Glusman, a. F. a. Smit, C. D. Huff, R. Hubley, P. T. Shannon, L. Rowen, K. P. Pant, N. Goodman, M. Bamshad, J. Shendure, R. Drmanac, L. B. Jorde, L. Hood, and D. J. Galas. 2010. Analysis of Genetic Inheritance in a Family Quartet by Whole-Genome Sequencing. *Science*. 328:636–639.
- Rogers, S. O., and A. J. Bendich. 1988. Extraction of DNA from plant tissues. Pp. 1–10 *in* Plant Molecular Biology Manual. eds, S. B. Gelvin and R. A. Schilperoort. Kluwer Academic Publishers, Boston.
- Rooker, S., T. Guillemaud, J. Bergé, N. Pasteur, and M. Raymond. 1996. Coamplification of *esterase A* and *B* genes as a single unit in *Culex pipiens* mosquitoes. *Heredity*. 77:555–561.
- Rundle, H. D., S. M. Vamosi, and D. Schluter. 2003. Experimental test of predation’s effect on divergent selection during character displacement in sticklebacks. *Proc. Natl. Acad. Sci. U. S. A.* 100:14943–14948.
- Schrider, D. R., and M. W. Hahn. 2010. Gene copy-number polymorphism in nature. *Proc. Biol. Sci.* 277:3213–21.
- Schrider, D. R., D. Houle, M. Lynch, and M. W. Hahn. 2013. Rates and genomic consequences of spontaneous mutational events in *Drosophila melanogaster*. *Genetics* 194:937–54.
- Shaw, R. G., C. J. Geyer, S. Wagenius, H. H. Hangelbroek, and J. R. Etterson. 2008. Unifying Life History Analyses for Inference of Fitness and Population Growth. *Am. Nat.* 172:E35–E47.
- Shull, G. H. 1908. The Composition of a Field of Maize. *J. Hered.* 4:296–301.
- Siepielski, A. M., J. D. Dibattista, and S. M. Carlson. 2009. It’s about time: The temporal dynamics of phenotypic selection in the wild. *Ecol. Lett.* 12:1261–1276.
- Sissoko, D., C. Giry, P. Gabrie, A. Tarantola, F. Pettinelli, L. Collet, E. D’Ortenzio, P. Renault, and V. Pierre. 2009. Rift Valley fever, Mayotte, 2007–2008. *Emerg. Infect. Dis.* 15:568–70.
- Sonoda, S., X. Shi, D. Song, P. Liang, X. Gao, Y. Zhang, J. Li, Y. Liu, M. Li, M. Matsumura, S. Sanada-Morimura, C. Minakuchi, T. Tanaka, and T. Miyata. 2014. Duplication of acetylcholinesterase gene in diamondback moth strains with different sensitivities to acephate. *Insect Biochem. Mol. Biol.* 48:83–90.
- Spofford, J. B. 1969. Heterosis and the evolution of duplications. *Am. Nat.* 103:407–432.
- Turner, D. J., M. Miretti, D. Rajan, H. Fiegler, N. P. Carter, M. L. Blayney, S. Beck, and M. E. Hurles. 2008. Germline rates of de novo meiotic deletions and duplications causing several genomic disorders. *Nat. Genet.* 40:90–5.
- Wallace, B. 1968. Topics in population genetics. Norton. New Jersey.

- Weill, M., A. Berthomieu, C. Berticat, G. Lutfalla, V. Nègre, N. Pasteur, A. Philips, J.-P. Leonetti, P. Fort, and M. Raymond. 2004a. Insecticide resistance: A silent base prediction. *Curr. Biol.* 14(14):R552-553.
- Weill, M., C. Berticat, M. Raymond, and C. Chevillon. 2000. Quantitative polymerase chain reaction to estimate the number of amplified esterase genes in insecticide-resistant mosquitoes. *Anal. Biochem.* 285:267–270.
- Weill, M., G. Lutfalla, K. Mogensen, F. Chandre, A. Berthomieu, C. Berticat, N. Pasteur, A. Philips, P. Fort, and M. Raymond. 2003. Insecticide resistance in mosquito vectors. *Nature* 423:136–137.
- Weill, M., C. Malcolm, F. Chandre, K. Mogensen, A. Berthomieu, M. Marquine, and M. Raymond. 2004b. The unique mutation in *ace-1* giving high insecticide resistance is easily detectable in mosquito vectors. *Insect Mol. Biol.* 13:1–7.
- Weill, M., M. Marquine, A. Berthomieu, M. P. Dubois, C. Bernard, C. L. Qiao, and M. Raymond. 2001. Identification and characterization of novel organophosphate detoxifying esterase alleles in the Guangzhou area of China. *J. Am. Mosq. Control. Assoc.* 17(4):238-244.
- Whalon, M. E. E., D. Mota-Sanchez, and R. M. M. Hollingworth. 2008. Global pesticide resistance in arthropods. CABI publishing, Cambridge, MA.
- Williams, T. N., T. W. Mwangi, S. Wambua, N. D. Alexander, M. Kortok, R. W. Snow, and K. Marsh. 2005. Sick cell trait and the risk of *Plasmodium falciparum* malaria and other childhood diseases. *J. Infect. Dis.* 192:178–186.
- Yébakima, A., M. Marquine, J. Rosine, M.-M. Yp-Tcha, and N. Pasteur. 2004. Evolution of resistance under insecticide selection pressure in *Culex pipiens quinquefasciatus* (Diptera, Culicidae) from Martinique. *J. Med. Entomol.* 41:718–725.
- Yébakima, A., M. Raymond, M. Marquine, N. Pasteur, A. Yebakima, M. Raymond, M. Marquine, and N. Pasteur. 1995. Resistance to organophosphorous insecticides in *Culex pipiens quinquefasciatus* (Diptera: Culicidae) from Martinique. *J. Med. Entomol.* 32:77–82.
- Zhang, J. 2003. Evolution by gene duplication: an update. *Trends Ecol. Evol.* 18:292–298.

Communications scientifiques

Articles

- Milesi, P.**, Assogba, B. S., Atyame, C. M., Pocquet, N., Unal, S., Makoundou, P., Berthomieu, A., Weill, M., Labbé, P. Many independent heterogeneous gene duplications solve the resistance tradeoff in mosquitoes, but often at a cost. *In prep.*
- Assogba, B.S., **Milesi, P.**, et al. Recurrent segmental duplications encompassing the insecticide target *ace-1* in *Anopheles gambiae*: gene dosage effects on adaptive advantage. *In prep.*
- Milesi, P.**, Lenormand, T., Lagneau, C., Weill, M., Labbé, P. Long-term fitness-to-dose relations *in natura*. *Submitted.*
- Assogba, B. S., Djogbénu, L. S., **Milesi, P.**, Berthomieu, A., Perez, J., Ayala, D., Chandre, F., Makoutodé, M., Labbé, P., Weill, M. 2015. An *ace-1* gene duplication resorbs the fitness cost associated with resistance in *Anopheles gambiae*, the main malaria mosquito. *Sci. Rep.* 5:14529
- Diop, M. M., Moiroux, N., Chandre, F., Martin-Herrou, H., **Milesi, P.**, Boussari, O., Porciani, A., Duchon, S., Labbé, P., Penetier, C. (2015). Behavioral Cost & Overdominance in *Anopheles gambiae*. *PLoS ONE* 10(4):e0121755.
- Assogba, B. S., Djogbénu, L. S., Saizonou, J., **Milesi, P.**, Djossou, L., Djegbe, I., Oumbouke, W. A., Chandre, A., Baba-Moussa, L., Weill, M., Makoutodé, M. (2014). Phenotypic effects of concomitant insensitive acetylcholinesterase (*ace-1^R*) and knockdown resistance (*kdr^R*) in *Anopheles gambiae*: a hindrance for insecticide resistance management for malaria vector control. *Parasites & Vectors*, 7(1), 548.
- Pocquet, N., Darriet, F., Zumbo, B., **Milesi, P.**, Thiria, J., Bernard, V., Toty, C., Labbé, P., Chandre, F. (2014). Insecticide resistance in disease vectors from Mayotte: an opportunity for integrated vector management. *Parasites & Vectors*, 7(1), 299.
- Atyame, C. M., Labbé, P., Dumas, E., **Milesi, P.**, Charlat, S., Fort, P., & Weill, M. (2014). Wolbachia divergence and the evolution of cytoplasmic incompatibility in *Culex pipiens*. *PloS One*, 9(1), e87336.
- Labbé, P., **Milesi, P.**, Yébakima, A., Pasteur, N., Weill, M., & Lenormand, T. (2014). GENE-dosage effects on fitness in recent adaptive duplications: *ace-1* in the mosquito *Culex pipiens*. *Evolution; International Journal of Organic Evolution*, 68(7), 2092–101.
- Pocquet, N., **Milesi, P.**, Makoundou, P., Unal, S., Zumbo, B., Atyame, C., Darriet, F., Dehecq, J., Thiria, J., Bheecarry, A., Lyaloo, D. P., Weill, M., Chandre, F., Labbé, P. (2013). Multiple insecticide resistances in the disease vector *Culex p. quinquefasciatus* from Western Indian Ocean. *PloS One*, 8(10), e77855.
- Dumas, E., Atyame, C. M., **Milesi, P.**, Fonseca, D. M., Shaikovich, E. V., Unal, S., Makoundou, P., Weill, M., Duron, O. (2013). Population structure of Wolbachia and cytoplasmic introgression in a complex of mosquito species. *BMC Evolutionary Biology*, 13, 181.

Communications orales

- Milesi P.**, Weill, M., Lenormand, T., Labbé, P. (2015) Over-dominance and adaptive gene duplications. XVth ESEB Meeting (European Society for Evolutionary Biology), Lausanne, Switzerland.
- Milesi P.**, Lenormand T., Weill M., Labbé P. (09-2013) Duplication is easy. To make it right not so much... XIXth EMPSEB Meeting (European Meeting of PhD Students in Evolutionary Biology), Exeter, England.
- Milesi P.**, Lenormand T., Weill M., Labbé P. (08-2013) Rapid evolution of insecticide resistance genes in mosquito populations: a quantitative approach. XIVth ESEB Meeting (European Society for Evolutionary Biology), Lisbon, Portugal.
- Milesi P.**, Weill M., Labbé P. (09-2012) Rôle des duplications géniques dans l'adaptation aux insecticides chez le moustique *Culex pipiens*. 34th colloque du Petit Pois Dérivé, Avignon, France

Poster

- Milesi P.**, Lenormand T., Weill M., Labbé P. (09-2013) Duplication is easy. To make it right not so much... XVth ESEB Meeting (European Society for Evolutionary Biology), Lausanne, Switzerland.

Annexes

Annexe 1 : Behavioral cost & overdominance in *Anopheles gambiae*.

Diop, M. M., Moiroux, N., Chandre, F., Martin-Herrou, H., **Milesi, P.**, Boussari, O., Porciani, A., Duchon, S., Labbé, P., Penetier, C. (2015). *PLoS ONE* 10(4), e0121755.

Annexe 2 : Multiple insecticide resistances in the disease vector *Culex p. quinquefasciatus* from western Indian ocean.

Pocquet, N., **Milesi, P.**, Makoundou, P., Unal, S., Zumbo, B., Atyame, C., Darriet, F., Dehecq, J., Thiria, J., Bheecarry, A., Lyaloo, D. P., Weill, M., Chandre, F., Labbé, P. (2013). *PloS One*, 8(10), e77855.

Annexe 3 : Insecticide resistance in disease vectors from Mayotte: an opportunity for integrated vector management.

Pocquet, N., Darriet, F., Zumbo, B., **Milesi, P.**, Thiria, J., Bernard, V., Toty, C., Labbé, P., Chandre, F. (2014). *Parasites & Vectors*, 7(1), 299.

RESEARCH ARTICLE

Behavioral Cost & Overdominance in *Anopheles gambiae*

Malal M. Diop^{1,2}, Nicolas Moiroux³, Fabrice Chandre³, Hadrien Martin-Herrou³, Pascal Milesi⁴, Olayidé Boussari^{1,2}, Angélique Porciani^{1,2}, Stéphane Duchon³, Pierrick Labbé⁴, Cédric Pennetier^{1,2*}

1 MiVEGEC (UM1-UM2-CNRS 5290-IRD 224), Institut de Recherche pour le Développement (IRD), Cotonou, Bénin, **2** Centre de Recherche Entomologique de Cotonou, Cotonou, Bénin, **3** MiVEGEC (UM1-UM2-CNRS 5290-IRD 224), Institut de Recherche pour le Développement (IRD), Montpellier, France, **4** ISEM (CNRS 5554-UM2), Montpellier, France

* cedric.pennetier@ird.fr



OPEN ACCESS

Citation: Diop MM, Moiroux N, Chandre F, Martin-Herrou H, Milesi P, Boussari O, et al. (2015) Behavioral Cost & Overdominance in *Anopheles gambiae*. PLoS ONE 10(4): e0121755. doi:10.1371/journal.pone.0121755

Academic Editor: Claudio R. Lazzari, University of Tours, FRANCE

Received: September 11, 2014

Accepted: February 4, 2015

Published: April 1, 2015

Copyright: © 2015 Diop et al. This is an open access article distributed under the terms of the [Creative Commons Attribution License](https://creativecommons.org/licenses/by/4.0/), which permits unrestricted use, distribution, and reproduction in any medium, provided the original author and source are credited.

Data Availability Statement: All relevant data are within the paper and its Supporting Information files.

Funding: This work has been funded by Institut de Recherche pour le Développement (IRD). MMD is supported by an IRD PhD fellowship. The funders had no role in study design, data collection and analysis, decision to publish, or preparation of the manuscript.

Competing Interests: The authors have declared that no competing interests exist.

Abstract

In response to the widespread use of control strategies such as Insecticide Treated Nets (ITN), *Anopheles* mosquitoes have evolved various resistance mechanisms. *Kdr* is a mutation that provides physiological resistance to the pyrethroid insecticides family (PYR). In the present study, we investigated the effect of the *Kdr* mutation on the ability of female *An. gambiae* to locate and penetrate a 1cm-diameter hole in a piece of netting, either treated with insecticide or untreated, to reach a bait in a wind tunnel. *Kdr* homozygous, PYR-resistant mosquitoes were the least efficient at penetrating an untreated damaged net, with about 51% [39-63] success rate compared to 80% [70-90] and 78% [65-91] for homozygous susceptible and heterozygous respectively. This reduced efficiency, likely due to reduced host-seeking activity, as revealed by mosquito video-tracking, is evidence of a recessive behavioral cost of the mutation. *Kdr* heterozygous mosquitoes were the most efficient at penetrating nets treated with PYR insecticide, thus providing evidence for overdominance, the rarely-described case of heterozygote advantage conveyed by a single locus. The study also highlights the remarkable capacity of female mosquitoes, whether PYR-resistant or not, to locate holes in bed-nets.

Introduction

In an attempt to separate the hungry malaria mosquito female from its human host, a physical and chemical barrier was introduced: the PYR ITN [1,2]. The on-going extensive distribution of ITNs aims to reach universal coverage in endemic countries [2]. Because ITNs are so effective at killing mosquitoes, and because ITNs can only be treated with PYRs, specific responses have evolved in mosquito populations to confer either behavioral or physiological insecticide resistance to these chemicals [3-7]. The most widespread physiological PYR-resistance mechanism among mosquito vectors is the target-site L1014F mutation of the voltage-gated sodium channel gene, named *Kdr* mutation. The mutated form decreases the affinity between the PYR

molecule and the voltage-gated sodium channel, leading to a resistance phenotype that allows mosquito to survive contact with ITN [6,8]. The impact of this mutation on the host-seeking behavior of mosquito vectors has been largely overlooked. One especially important component of host-seeking behavior, particularly in the context of widespread ITN use, is the mosquitoes' ability to locate and penetrate weaknesses- i.e., holes- in damaged bed nets in order to reach the human host and be able to reproduce.

We thus investigated how genotype at the *Kdr* L1014F locus (hereafter indicated as SS = susceptible homozygotes; RR = resistant homozygotes; RS = heterozygotes) affected the ability of *An. gambiae* s.s. females to find a hole in a piece of net (either untreated or treated). Females sharing the same genetic background with only the *Kdr* locus altered [9] were individually video-tracked in a wind tunnel containing an attractive odor plume orientating the mosquitoes toward a guinea pig bait. The wind tunnel consisted of two chambers separated by a holed net (S1 Fig.). Trials were recorded as successful if the mosquito passed through the hole from the first chamber (C1) to the second chamber (C2) within a 60 min assay.

Results

A first, surprising result was that almost two-thirds of mosquitoes found the 1cm diameter hole that would have allowed them to reach their blood meal (overall success rate = 62.6%, $N = 376/601$, binomial 95% confidence interval CI [58.6–66.3]) in a mean time of 666.0s [588.8–742.5] (S2 Fig. panel F), regardless of the net treatment or the genotype. However, the *Kdr* genotype had a major effect on this success.

Cost of the homozygous resistant genotype for the *Kdr* locus

With an untreated holed net (UTN), the proportion of successful mosquitoes was significantly higher for both SS and RS genotypes compared to RR (binomial model odds ratios: $OR_{SS-RR} = 3.75$ [1.74–8.44], $p = 0.0009$; $OR_{RS-RR} = 3.23$ [1.36–8.23], $p = 0.0102$), while not differing significantly from each other ($OR_{RS-SS} = 1.16$ [0.43–3.01], $p = 0.75$) (Fig. 1A, left panel). The lower performance of the mutant homozygotes in the untreated net environment thus revealed a recessive behavioral cost of the *Kdr* mutation.

Analysis of behavioral traits from video tracks with untreated nets indicated that *An. gambiae* mosquitoes with the RR genotype spent less time flying than those with SS (Kruskal-Wallis rank sum test, $p = 0.0016$; Dunn's post tests, $p < 0.01$), and had fewer rates of contact with the holed net compared to both the SS and RS genotypes (Poisson model Contact Rate Ratio: $CRR_{RR-SS} = 0.261$ [0.245–0.278], $p < 0.0001$ and $CRR_{RR-RS} = 0.187$ [0.176–0.2], $p < 0.0001$) (S2 Fig.). This suggests less efficient host-seeking behavior of RR mosquitoes relative to the SS and RS types. RR mosquitoes mean flight speed was higher than that of either SS or RS mosquitoes (Kruskal-Wallis rank sum test, $p < 0.0001$; Dunn's post tests, $p < 0.01$) (S2 Fig.). Mosquito flight speed has been shown to be negatively correlated with attractive odor concentration [10–12], so that higher flight speed might be an indication of less efficient odor detection in RR compared with RS and SS mosquitoes. SS and RS mosquitoes showed similar rates of success in penetrating the net, despite significant differences in the various behavioral traits (S2 Fig. panels A and C).

Overdominance of *Kdr* mutation under PYR pressure

The behavior of the three *Kdr* different genotypes was then analyzed in presence of the two long lasting ITN recommended by the World Health Organization. One type (Olyset Net) has 1000mg/m² permethrin incorporated into it, whilst the other (PermaNet 2.0) is coated with 55mg/m² deltamethrin.

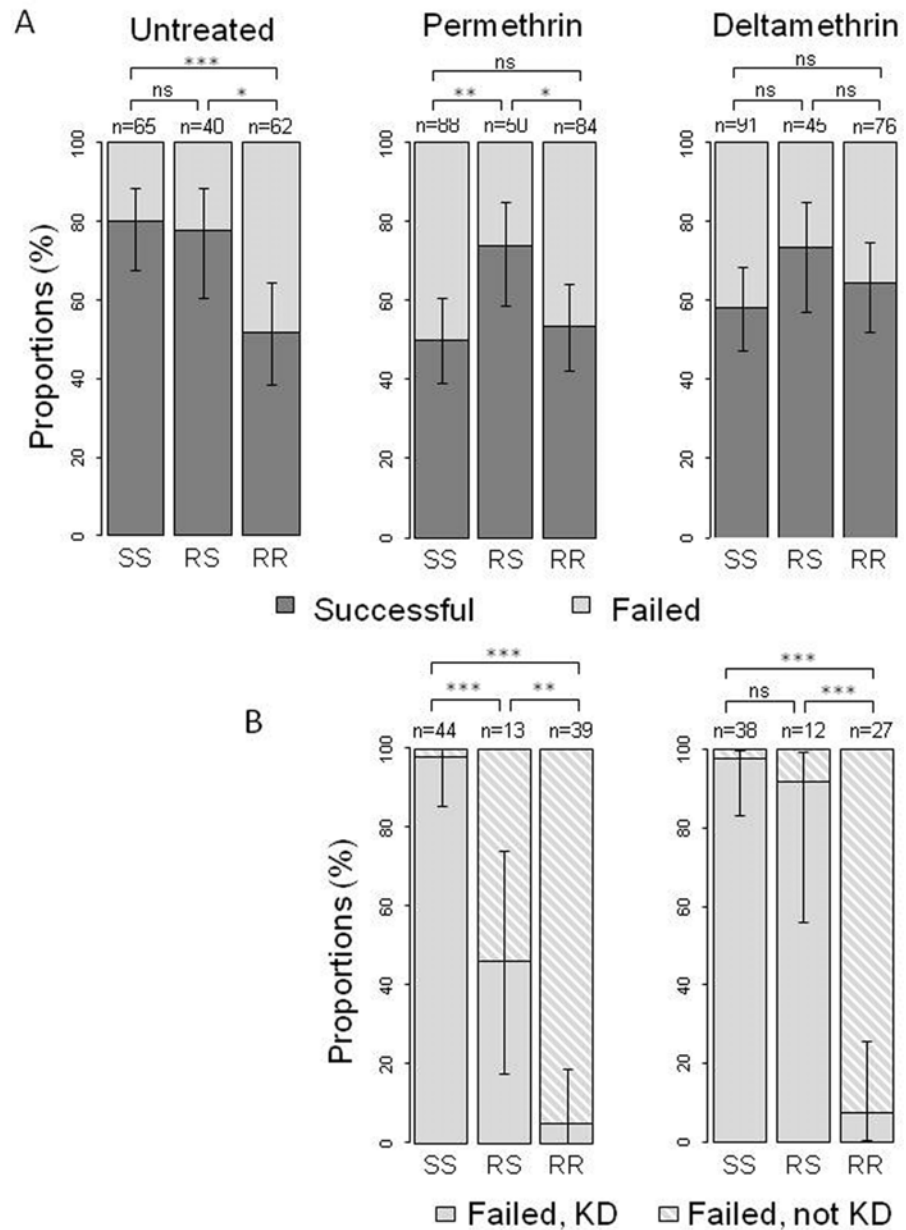

Fig 1. A- Proportions of Anopheles females of each *Kdr* genotype successfully penetrating a 1cm hole in (i) an untreated net, (ii) a permethrin-treated Olyset Net, and (iii) a deltamethrin-treated PermaNet 2.0. B- Proportions of knocked-down (KD) females among the failed when faced with ITN (permethrin-treated Olyset Net on the left, deltamethrin-treated PermaNet 2.0 on the right), for each *Kdr* genotype (untreated net is not presented since no mosquito from any strain presented the KD phenotype during those exposures). The number of mosquitoes tested for each genotype (SS, RS and RR: homozygous susceptible, heterozygous, and homozygous resistant for the *Kdr* mutation, respectively) is indicated. Error bars represent the 95% binomial confidence intervals for the different proportions. Significance of the different tests is indicated (^{NS} $p > 0.05$, * $p < 0.05$, ** $p < 0.01$, * $p < 0.001$).**

doi:10.1371/journal.pone.0121755.g001

Faced with the PermaNet 2.0 net, heterozygote mosquitoes tended to be more successful in finding the hole than either of the homozygotes (Fig. 1A, right panel), although these differences were not statistically significant ($OR_{RS-SS} = 1.97 [0.92-4.43]$, $p = 0.088$; $OR_{RS-RR} = 1.52 [0.68-3.49]$, $p = 0.315$). This trend was reinforced (Fig. 1A, centre panel) and differences were

significant when mosquitoes were faced with the Olyset Net (binomial regression, $OR_{RS-SS} = 2.85$ [1.36, 6.24], $p = 0.007$; $OR_{RS-RR} = 2.47$ [1.17–5.43], $p = 0.02$). Heterozygote mosquitoes were better able to penetrate the net than homozygous susceptible or resistant mosquitoes, regardless the net brand (when pooling data gathered with Olyset and PermaNet 2.0; $OR_{RS-SS} = 2.13$ [1.30, 3.49], $p = 0.0027$; $OR_{RS-RR} = 2.42$ [1.47, 4], $p = 0.0005$), supporting the heterozygote advantage hypothesis. There was no significant difference between homozygous susceptible or resistant mosquitoes regardless the ITN brand (Olyset: $OR_{RR-SS} = 1.15$ [0.63–2.11], $p = 0.64$; PermaNet 2.0: $OR_{RR-SS} = 1.30$ [0.70–2.45], $p = 0.41$) (Fig. 1A, center and right panels).

To further quantify this heterozygote advantage, we computed the proportion of success p_i as a proxy of the relative fitness (w_i) of each genotype i for each treatment, as $w_i = p_i/p_{SS}$ (thus $w_{SS} = 1$, as reference). Moreover, by decomposing the relative fitness as $w_{SS} = 1$, $w_{RS} = 1 + hs$ and $w_{RR} = 1 + s$, we were able to estimate selection (s) and dominance (h) coefficients in the different treatments. We confirmed that in the absence of PYR the R allele is deleterious ($s = -0.35$, 95% confidence interval [-0.18, -0.49]), and that this cost is recessive ($h = 0.09$ [0.01, 0.68]). However, R is advantageous in an environment with ITNs ($s = 0.07$ [0.001, 0.43] and 0.11 [0.001, 0.40] for Olyset and PermaNet 2.0, respectively). Furthermore, in ITN trials, we always found a dominance coefficient $h > 1$, confirming the observed heterozygote advantage, although quantifying this parameter precisely is more difficult: $h = 6.72$ [1.33, >100] and 2.42 [0.001, >100], for Olyset and PermaNet 2.0, respectively.

The better performances of the heterozygotes during the experiments are explained by two antagonistic forces of selection:

i. Benefit of R allele in presence of insecticide

SS females failed to find the hole because of the fast-acting knock-down (KD) effect of the PYR insecticides: 97.7% [85.3–99.9] (43/44) and 97.4% [83.2–99.9] (37/38) of the failed SS mosquitoes were KD with Olyset Net and PermaNet 2.0 respectively (Fig. 1B, multinomial model $OR_{PermaNet-Olyset} = 0.861$ [0.052–14.269], $p = 0.917$). By contrast, almost all of the unsuccessful RR mosquitoes had resisted the KD effect (KD 5.1% [0–18.6] (2/39) and 7.4% [0.04–25.7] (2/27) with Olyset Net and PermaNet 2.0, respectively) (Fig. 1B, $OR_{PermaNet-Olyset} = 1.483$ [0.196–11.242], $p = 0.703$). For heterozygotes, the result depended on the net: less than half of the failed RS were KD with permethrin-treated Olyset Net (46.2% [17.7–73.9], 6/13), while they were more affected by the deltamethrin-treated PermaNet 2.0 (91.7% [56.1–99.6], 11/12) (Fig. 1B, $OR_{PermaNet-Olyset} = 12.911$ [1.264–131.878], $p = 0.031$). This difference may be due to the difference in insecticide molecule, concentration and/or availability on the net fiber.

ii. Cost of RR in absence of insecticide.

Because of the cost carried by RR mosquitoes, SS and RS mosquitoes showed higher success rates in penetrating a 1cm hole in an untreated net (Fig. 1A). Moreover, the performance of RS and RR mosquitoes in finding the hole were not altered by the insecticides (binomial model, $p > 0.05$), while SS mosquitoes' success rate was indeed reduced by 30% [14.5–45.5] and 21.8% [6.8–36.7] with Olyset Net and PermaNet, respectively (binomial model, $OR_{UTN-Olyset} = 4$ [1.96–8.61], $p < 0.001$; $OR_{UTN-PermaNet} = 2.87$ [1.4–6.16], $p = 0.005$) (Fig. 1A).

Overall, the balance between the two antagonistic selection pressures, a negative influence of *Kdr* mutation on individuals' ability to find the hole on one hand, and the benefit for resistance to KD on the other, was most favorable to heterozygotes, providing evidence for an overdominant effect at the *Kdr* locus on this behavioral trait.

Discussion

Insecticide resistance mechanisms are adaptations selected by challenging environmental conditions. The *Kdr* mutation is an example of a specific amino acid change at a unique position of

the voltage-gated sodium channel that confers resistance to organochlorine and PYR insecticide classes in a major malaria vector in Africa, *Anopheles gambiae* s.l. [13]. PYR pressure can affect the mosquitoes at different stages of their life cycle: larva (contaminated breeding sites) and adult, both during resting (insecticide residual spraying) and host-seeking (ITN) periods. At these different stages, the *Kdr* mutation can allow survival, and thus reproduction, in presence of insecticides (selective advantages). However, it also imposes deleterious side-effects (selective costs), revealed in absence of insecticides. Conventional tests used to evaluate the insecticide effects on susceptible and resistant mosquitoes rely on forced and prolonged contact of the mosquitoes with the insecticide [14]. The results of these tests summarize the selection processes occurring at both the larval and adult stages of the mosquito's life and are meant to reflect the levels of resistance in the local mosquito population. Because of the higher resistance of the RR genotype, and if the mutation induces no fitness cost, prolonged insecticide selection in a population should lead to fixation of the *Kdr* mutation beyond the treated population [15]. However, as pointed out by Lynd et al. [16], there is a serious lack of evidence of *Kdr* mutation fixation in wild *Anopheles* populations, even in areas with high insecticide pressure (either from agriculture or from public health programs). Thus, they hypothesized that a fitness cost associated with the *Kdr* mutation explained the absence of fixation [16]. Such costs have been documented in *Culex quinquefasciatus* (through life history trait experiments) [17], however, none have been reported so far in *An. gambiae*. Interestingly, Lynd et al. [16] also suggested that the balance of advantages and costs could lead to overdominance, in which case the heterozygotes would be fitter than the SS and RR homozygotes [18–21].

Our study provides the first evidence of both a behavioural cost associated with the *Kdr* allele that conveys pyrethroid and DDT resistance in *An. gambiae*. Importantly, this evidence comes from an experimental set-up in which mosquito contacts with insecticide were unforced, and thus could be interrupted, similar to the situation in natural settings.

We first noted that the host-seeking performance was reduced in females homozygous for the resistance *Kdr* allele (RR) in the absence of insecticide. The RR females are less apt at finding the hole in the net to reach their blood meal. This is the first evidence of behavioral costs associated with this mutation. It suggests a deficiency in the nervous system of RR females. The voltage-gated sodium channel indeed plays a central role in message propagation in the nervous system. The *Kdr* mutation enhances closed-state inactivation of nerves, meaning that more stimulation is required before nerves fire and release acetylcholine into the synaptic cleft, relative to susceptible individuals [22]. Consequently, the *Kdr* mutation probably affects several behavior-related nervous pathways [23]. In *Kdr* resistant *Heliothis virescens* moths, pharmacological and biophysical properties of sodium channels were found to cause sluggish neural activity in the absence of PYR, and were characterized by decreased cellular and behavioral excitability of sodium channels [24]. Further physiological and behavioral investigations are underway to better understand the physiological processes underlying the behavioral changes we report here.

A second finding is that, while still partially resistant to the insecticide, the heterozygous females are not affected by the cost observed in RR females. This is evidence for heterosis, or hybrid vigor, in which the product of a cross is superior to either parent [25]. One of the modalities of heterosis is overdominance, the superior fitness of the heterozygous genotype over both homozygotes [26], though reports suggesting heterozygote advantage for single gene mutations are rare and controversial. Interestingly, the majority of the few examples came from the study of resistance to infectious diseases, such as the major histocompatibility complex in vertebrates; in insects, one of the best examples is the alcohol dehydrogenase (*Adh*) locus in *Drosophila melanogaster* [21]. Studying contemporaneous heterozygote advantage implies fulfillment of three criteria: i) identifying genes under selection, ii) establishing relative

fitness and iii) understanding the selection mechanism [21]. The present study fulfills these criteria and, thus, provides an unambiguous new example of overdominance. A single substitution in the gene encoding the voltage-gated sodium channel (*Kdr*) indeed provides heterozygotes with resistance to the KD effect of PYR higher than susceptible homozygotes SS, while imposing little cost, if any, as compared to the decreased host-seeking success seen in resistant homozygotes RR. Compared to the homozygotes, the RS genotype maintains a better balance between the antagonistic selective pressures to survive insecticide exposure while performing a complex behavior.

Interestingly, overdominance is favorable for the evolution of new resistance alleles in the form of heterozygote duplications (i.e. duplications in which the duplicates are different alleles [27–29]). An advantageous heterozygous genotype bears a segregation cost, as only half of two heterozygotes' progeny will bear this fitter genotype. A duplication associating both alleles on the same chromosome would allow this advantageous genotype to fix by eliminating this segregation cost. A similar heterosis situation is probably responsible for the selection of duplications of the *ace-1* gene (encoding the target of organophosphorous insecticides) in both *Cx. pipiens* and *An. gambiae* [30–33]. With one susceptible and one resistance allele in tandem on the same chromosome, individuals with the duplication have fitness similar to that of heterozygotes (resistance and reduced cost [29]); such duplication allows the fixation of this heterozygote advantage in a population [30]. The overdominance at the *Kdr* locus thus provides ground for similar evolution. Interestingly, a study of *An. gambiae* *Kdr* resistance by Pinto et al. [34] in Gabon showed a significant excess of the heterozygote genotype, which could be a sign of the presence of gene duplication for *Kdr*, as was shown in the case of *ace-1* [30,33,35].

In a more applied perspective, our work highlights the overall high performance of all genotypes in the trials: our results confirmed the remarkable ability of both susceptible and resistant mosquitoes to find the only way through a bednet. These observations are in agreement with previous experimental hut studies on the blood feeding rates of *An. gambiae* (see review [36]). The *Kdr* resistance currently at high frequencies across much of Africa is only one of the mechanisms conferring resistance to insecticides. The impact of such insecticide resistance mechanisms on behavior and/or infection by *Plasmodium spp.* is of crucial interest [9,37,38]. A multi-disciplinary approach is needed to study in depth the complex interactions among mosquito behavior, parasite infection and human-made insecticidal barriers, with the objective of designing innovative tools that can more specifically target resistant and infectious mosquitoes [39,40].

Our study highlights the importance of behavioral studies for developing a full understanding of the evolution of insecticide resistance and its impacts. By modulating host-seeking behavior, insecticide resistance can affect the vectorial capacity of female mosquitoes. Given the ability of heterozygous mosquitoes in particular to readily overcome the barrier of a damaged ITN, the effects of insecticide resistance on host choice and biting behavior remain to be investigated.

Experimental Procedures

Mosquito strains and rearing

PYR insecticides target the voltage-gated sodium channel on the insects' neurons. Non-synonymous mutations in this target site that cause resistance to insecticides are often referred to as knock-down resistance mutations (*Kdr*). These alleles confer the ability to survive prolonged exposure to insecticides without being 'knocked-down' [6]. The substitution of a leucine by a phenylalanine at codon 1014 (L1014F) is the most common sodium channel mutation, associated with PYR resistance in African malaria vectors [41].

Two strains of *An. gambiae* s.s. were used. One is the insecticide susceptible strain Kisumu (VectorBase, <http://www.vectorbase.org>, KISUMU1), isolated in Kenya in 1975. This strain is susceptible and homozygous (SS) for the L1014 codon. The second strain named Kdrkis is resistant to PYR and homozygous (RR) for the L1014F *Kdr* mutation. Kdrkis was obtained by introgression of the L1014F mutation into the Kisumu genome through repeated backcrosses [9]. Heterozygous individuals (RS) were obtained through more than 15 crosses of Kisumu SS females with Kdrkis RR males. The three genotypes thus share a common genetic background for most of their genome [9].

The genotype of both susceptible and resistant strains are confirmed every 3 months by PCR following standard operational procedures of a WHO collaborating centre. For the present study, Kisumu and KdrKis strains were checked by PCR (for the *Kdr* and *ace-1* mutations) before the beginning of the behavioral assays (July 2012) and after the end of the study (May 2013) confirming that both strains were respectively homozygous susceptible and resistant for *Kdr*.

The mosquitoes were reared at $27 \pm 1^\circ\text{C}$, 60–70% R.H. under 16:8h L:D photoperiod at the insectaries of the Institut de Recherche pour le Développement (IRD) in Montpellier, France. Adults were fed with a 10% glucose solution and received a blood meal twice a week. Gravid females laid eggs on cups placed inside mesh-covered cages. Eggs were dispensed into plastic trays containing de-ionized water. Larvae were kept in these trays and fed with TetraMin fish food. Pupae were removed daily and allowed to emerge inside 50x50x50cm cages. Adult females used to generate these lines were fed with rabbit blood.

Mosquitoes used in the experiments were 7–8 days old females that had never received a blood meal and were deprived of sugar the night before testing. The temperature of the experimental room was maintained at $27 \pm 1^\circ\text{C}$ and 60–70% R.H.

Experimental setup

Experiments were conducted in a wind tunnel (40x13x13cm), divided into two chambers of equal dimensions separated by a piece of netting (treated with insecticide or untreated) with a 1cm diameter hole in its center (HN) (S1 Fig.). Three types of holed nets were tested in this study: untreated polyester net, Olyset Net (incorporated with 1000mg/m² of permethrin), and PermaNet 2.0 (coated with 55mg/m² of deltamethrin). The chambers (C) were numbered 1 and 2, respectively. The tunnel was made of foam board with a white opaque Plexiglas floor and a removable transparent Plexiglas roof. The ends of the chambers were screened with untreated net (NS) prevented the mosquitoes from escaping. The airflow entered the tunnel *via* a 10 cm diameter circular opening covered with an untreated net screen that acted as a diaphragm to regulate airflow in the tunnel at $16 \pm 3 \text{ cm} \cdot \text{s}^{-1}$.

The tunnel was softly illuminated by 12 blue LEDs (450nm) from 83cm underneath. Illumination inside the tunnel was $186.66 \cdot 10^{-4} \text{ mW/cm}^{-2}$.

The tunnel was completed by a glass cage (GC; 60x26x26cm), which held the attractive guinea pig bait (able to move in a limited area in the upper part of the cage) and a fan aimed directly down the tunnel.

Mosquitoes were released individually for each trial. The trial was replicated for each genotype and treatment. In order to get enough replicates for the analysis of the performances, a minimum of 40 mosquitoes successfully passing through the piece of net was required. The number of replicates range from 40 to 91 depending of the treatment and genotype. Each mosquito was filmed during 60 min maximum using a Sony Digital HD Video Camera (HDR-XR550), placed 50cm above the tunnel. The camera was connected to a computer in an external room from where the assay was controlled in real-time. Recording was stopped when

the mosquito passed through the hole to chamber 2. MPEG-2 videos (PAL video: 720x576 pixels at 25 frames/s) were analyzed using Ethovision XT software (v.7, Noldus Information Technology, Wageningen, The Netherlands). During the trials, the mosquito was recorded as successful if it passed through the holed net to reach the upwind chamber and unsuccessful otherwise (i.e. it was still in the downwind chamber after the 60 min). Because ITN can induce a fast-acting effect known as Knock-down (KD), unsuccessful mosquitoes were recorded as KD if they were lying on their side or back with none of their tarsi in contact with the floor, or otherwise alive. Moreover, the following behavioral variables were measured in chamber 1 for the assay duration (60min or until the mosquito passed through the hole): (1) time spent on the walls (except the holed net) of chamber 1, (2) time spent on the holed net, (3) number of contacts with the holed net, (4) flight time, (5) mean flight speed, and (6) elapsed time before passing through the hole (if successful).

During the setting-up phase of each experiment, latex gloves were used to avoid any contamination with human skin odors. Mosquitoes were released individually from an opening (1cm diameter) at the downwind extremity of one of the tunnel walls. Cotton was used to plug the hole after releasing.

Statistical analysis

All statistical analyses were conducted using the software R version 3.0.2 [42] with the additional nnet, pgrmss and spaMM packages [43–45].

Performances

We analyzed the performance (i.e. probability of passing through the holed net) using a binomial logistic model with *Kdr* genotypes (SS, RS or RR), treatments of the holed net (untreated, Olyset Net or PermaNet) and interactions as explanatory variables. The model was written as follow:

$$\text{logit}(P(y = 1)) = \beta_0 + \beta_i^{\text{Genotype}} + \beta_k^{\text{Treatment}} + \beta_i^{\text{Genotype}} \times \beta_k^{\text{Treatment}}$$

, where $\beta_i^{\text{Genotype}}$ denotes the effect on the logit of classification in category *i* (SS, RS or RR) of Genotype and $\beta_k^{\text{Treatment}}$ denotes the effect of classification in category *k* (untreated, Olyset Net or PermaNet) of Treatment. Each combination of categories *i* and *k* of the explanatory variables was successively used as reference class to allow multiple comparisons among genotypes and treatments. Odds ratios and their 95% confidence intervals were computed. We calculated binomial confidence interval of the proportions of successful mosquitoes using Wilson's score method [46] with a continuity correction [47].

The selection parameters *h* (for dominance) and *s* (for selection) determine the proportion *p* of successful mosquitoes for the different genotypes in each trial, which are estimated by a binomial generalized linear model with predictor $\text{logit}(p) = a_g$ for the three genotypes *g* = SS, RS, RR. *h* and *s* are complex functions of the three a_g coefficients. For simplicity, we therefore randomly generated a_{RS} and a_{RR} values (100,000 such pairs in a uniform distribution), and for all such pairs we fitted a_{SS} and plotted the attained likelihood against the corresponding *h* or *s* values. The upper boundary of either cloud of points is the profile likelihood for either parameter, from which maximum likelihood estimates and likelihood ratio confidence intervals were computed.

A multinomial logistic model with 3 possible outcomes (successful, unsuccessful alive or unsuccessful KD) was used to compare the proportions of KD relative to the unsuccessful mosquitoes among genotypes and between insecticidal treatments (Olyset Net or PermaNet). The

multinomial model allowed us to take into account the proportion of successful mosquitoes in the analysis. Odds ratios and their 95% confidence interval were computed. We calculated multinomial confidence intervals for the proportions of KD using the method by Sison and Glaz [48] (R package "MultinomialCI").

Behavioral variables recorded using video analyses

The number of contacts with the holed untreated net per time unit was compared among genotypes using a Poisson model with the log of the video duration (i.e. the elapsed time before the mosquito passed through the hole and 60min for successful and unsuccessful mosquitoes, respectively) as an offset.

Proportion of flight time, mean flight speed, proportions of time spent on the holed net and on the walls of chamber 1 were not normally distributed and were therefore compared among genotypes using Kruskal-Wallis tests followed by Dunn's post-hoc tests [45,49].

For successful mosquitoes, the time needed to pass through the hole in the untreated net was also compared among genotypes using a Kruskal-Wallis tests followed by Dunn's post-hoc tests.

Ethical Considerations

The IRD lab where the experiments were run received the approval from the animal care and use committee named "Comité d'éthique pour l'expérimentation animale; Languedoc Roussillon" (CEEA-LR-1064 for guinea pigs and CEEA-LR-13002 for the rabbits).

Supporting Information

S1 Fig. Panel A. A wind tunnel to study the ability of malaria vector mosquitoes to pass through a holed net. C1: Chamber one (release chamber); C2: Chamber 2; GC: Glass cage receiving the guinea pig bait; RO: Release opening; NS: Net screens; HN: Holed net. Panel B. Photo of the experimental setup.

(TIF)

S2 Fig. Tukey's boxplots of (A) contact rates, (B) proportions of flight time, (C) flight speed, (D) proportion of time spent on the holed net, (E) proportions time spent on the tunnel walls, and (F) elapsed time before passing through the hole in *An. gambiae* of the three *kdr* genotypes faced with an untreated holed net. Whiskers indicate the most extreme data that is no more than 1.5 times the interquartile range. Outliers are not shown. ns: non significant, **: $p < 0.01$, ***: $p < 0.001$ according to (A) a Poisson model and (B, C, D, E, F) Dunn's post tests after a Kruskal-Wallis test.

(TIF)

Acknowledgments

The authors would like to thank François Rousset, Thierry Lefèvre, Claudio Lazzari, Michel Raymond and Adrian J F Luty for their help during the analysis and writing of the manuscript.

Author Contributions

Conceived and designed the experiments: MMD FC CP. Performed the experiments: MMD HMH SD. Analyzed the data: MMD NM PM OB AP PL CP. Contributed reagents/materials/analysis tools: NM FC PL CP. Wrote the paper: MMD NM FC PM AP PL CP.

References

1. Lehane MJ. *The Biology of Blood-Sucking in Insects*. Cambridge University Press; 2005.
2. WHO. *World Malaria Report 2013*. World Health Organization; 2013 p. 253. Report No.: ISBN 978 92 4 156469 4.
3. Moiroux N, Gomez MB, Pannetier C, Elanga E, Djenontin A, Chandre F, et al. Changes in *Anopheles funestus* biting behavior following universal coverage of long-lasting insecticidal nets in Benin. *J Infect Dis*. 2012; 206: 1622–1629. doi: [10.1093/infdis/jis565](https://doi.org/10.1093/infdis/jis565) PMID: [22966127](https://pubmed.ncbi.nlm.nih.gov/22966127/)
4. Lefevre T, Gouagna L-C, Dabire KR, Elguero E, Fontenille D, Renaud F, et al. Beyond nature and nurture: phenotypic plasticity in blood-feeding behavior of *Anopheles gambiae* s.s. when humans are not readily accessible. *Am J Trop Med Hyg*. 2009; 81: 1023–1029. doi: [10.4269/ajtmh.2009.09-0124](https://doi.org/10.4269/ajtmh.2009.09-0124) PMID: [19996432](https://pubmed.ncbi.nlm.nih.gov/19996432/)
5. Rivero A, Vézilier J, Weill M, Read AF, Gandon S. Insecticide control of vector-borne diseases: when is insecticide resistance a problem? Manchester M, editor. *PLoS Pathog*. 2010; 6: e1001000. doi: [10.1371/journal.ppat.1001000](https://doi.org/10.1371/journal.ppat.1001000) PMID: [20700451](https://pubmed.ncbi.nlm.nih.gov/20700451/)
6. Ranson H, N'Guessan R, Lines J, Moiroux N, Nkuni Z, Corbel V. Pyrethroid resistance in African anopheline mosquitoes: what are the implications for malaria control? *Trends Parasitol*. 2011; 27: 91–98. doi: [10.1016/j.pt.2010.08.004](https://doi.org/10.1016/j.pt.2010.08.004) PMID: [20843745](https://pubmed.ncbi.nlm.nih.gov/20843745/)
7. Gatton ML, Chitnis N, Churcher T, Donnelly MJ, Ghani AC, Godfray HCJ, et al. The importance of mosquito behavioural adaptations to malaria control in Africa. *Evolution*. 2013; 67: 1218–1230. doi: [10.1111/evo.12063](https://doi.org/10.1111/evo.12063) PMID: [23550770](https://pubmed.ncbi.nlm.nih.gov/23550770/)
8. Hougard J-M, Duchon S, Darriet F, Zaim M, Rogier C, Guillet P. Comparative performances, under laboratory conditions, of seven pyrethroid insecticides used for impregnation of mosquito nets. *Bull World Health Organ*. 2003; 81: 324–333. PMID: [12856050](https://pubmed.ncbi.nlm.nih.gov/12856050/)
9. Alout H, Ndam NT, Sandeu MM, Djégbé I, Chandre F, Dabiré RK, et al. Insecticide resistance alleles affect vector competence of *Anopheles gambiae* s.s. for *Plasmodium falciparum* field isolates. *Vontas J*, editor. *PLoS ONE*. 2013; 8: e63849. doi: [10.1371/journal.pone.0063849](https://doi.org/10.1371/journal.pone.0063849) PMID: [23704944](https://pubmed.ncbi.nlm.nih.gov/23704944/)
10. Beeuwkes J, Spitzen J, Spoor CW, Van Leeuwen JL, Takken W. 3-D flight behaviour of the malaria mosquito *Anopheles gambiae* ss inside an odour plume. *Proc Neth Entomol Soc Meet*. 2008; 19: 137–146.
11. Spitzen J, Spoor CW, Grieco F, ter Braak C, Beeuwkes J, van Brugge SP, et al. A 3D analysis of flight behavior of *Anopheles gambiae* sensu stricto malaria mosquitoes in response to human odor and heat. Dimopoulos G, editor. *PLoS ONE*. 2013; 8: e62995. doi: [10.1371/journal.pone.0062995](https://doi.org/10.1371/journal.pone.0062995) PMID: [23658792](https://pubmed.ncbi.nlm.nih.gov/23658792/)
12. Lacey ES, Cardé RT. Activation, orientation and landing of female *Culex quinquefasciatus* in response to carbon dioxide and odour from human feet: 3-D flight analysis in a wind tunnel. *Med Vet Entomol*. 2011; 25: 94–103. doi: [10.1007/s10158-005-0004-9](https://doi.org/10.1007/s10158-005-0004-9) PMID: [21118282](https://pubmed.ncbi.nlm.nih.gov/21118282/)
13. Raymond-Delpech V, Matsuda K, Sattelle BM, Rauh JJ, Sattelle DB. Ion channels: molecular targets of neuroactive insecticides. *Invert Neurosci*. 2005; 5: 119–133. PMID: [16172884](https://pubmed.ncbi.nlm.nih.gov/16172884/)
14. WHO. *Guidelines for laboratory and field-testing of long-lasting insecticidal nets*. World Health Organization; 2013 p. 89. Report No.: WHO/HTM/NTD/WHOPE/2013.3.
15. Chandre F, Darriet F, Duchon S, Finot L, Manguin S, Carnevale P, et al. Modifications of pyrethroid effects associated with *kdr* mutation in *Anopheles gambiae*. *Med Vet Entomol*. 2000; 14: 81–88. PMID: [10759316](https://pubmed.ncbi.nlm.nih.gov/10759316/)
16. Lynd A, Weetman D, Barbosa S, Egyir Yawson A, Mitchell S, Pinto J, et al. Field, genetic, and modeling approaches show strong positive selection acting upon an insecticide resistance mutation in *Anopheles gambiae* s.s. *Mol Biol Evol*. 2010; 27: 1117–1125. doi: [10.1093/molbev/msq002](https://doi.org/10.1093/molbev/msq002) PMID: [20056691](https://pubmed.ncbi.nlm.nih.gov/20056691/)
17. Berticat C, Bonnet J, Duchon S, Agnew P, Weill M, Corbel V. Costs and benefits of multiple resistance to insecticides for *Culex quinquefasciatus* mosquitoes. *BMC Evol Biol*. 2008; 8: 104. doi: [10.1186/1471-2148-8-104](https://doi.org/10.1186/1471-2148-8-104) PMID: [18397515](https://pubmed.ncbi.nlm.nih.gov/18397515/)
18. Fisher R. On the dominance ratio. *Proc R Soc Edin*. 1922; 321–241.
19. Asthana S, Schmidt S, Sunyaev S. A limited role for balancing selection. *Trends Genet TIG*. 2005; 21: 30–32. doi: [10.1016/j.tig.2004.11.001](https://doi.org/10.1016/j.tig.2004.11.001) PMID: [15680511](https://pubmed.ncbi.nlm.nih.gov/15680511/)
20. Andrés AM, Hubisz MJ, Indap A, Torgerson DG, Degenhardt JD, Boyko AR, et al. Targets of balancing selection in the human genome. *Mol Biol Evol*. 2009; 26: 2755–2764. doi: [10.1093/molbev/msp190](https://doi.org/10.1093/molbev/msp190) PMID: [19713326](https://pubmed.ncbi.nlm.nih.gov/19713326/)
21. Hedrick PW. What is the evidence for heterozygote advantage selection? *Trends Ecol Evol*. 2012; 27: 698–704. doi: [10.1016/j.tree.2012.08.012](https://doi.org/10.1016/j.tree.2012.08.012) PMID: [22975220](https://pubmed.ncbi.nlm.nih.gov/22975220/)

22. Vais H, Williamson MS, Goodson SJ, Devonshire AL, Warmke JW, Usherwood PN, et al. Activation of *Drosophila* sodium channels promotes modification by deltamethrin. Reductions in affinity caused by knock-down resistance mutations. *J Gen Physiol*. 2000; 115: 305–318. PMID: [10694259](#)
23. Ignell R, Sengul MS, Hill SR, Hansson BS. Odour coding and neural connections. Olfaction in vector-host interactions. Wageningen academics publisher.
24. Lee D, Park Y, Brown TM, Adams ME. Altered properties of neuronal sodium channels associated with genetic resistance to pyrethroids. *Mol Pharmacol*. 1999; 55: 584–593. PMID: [10051544](#)
25. Lippman ZB, Zamir D. Heterosis: revisiting the magic. *Trends Genet TIG*. 2007; 23: 60–66. doi: [10.1016/j.tig.2006.12.006](#) PMID: [17188398](#)
26. Haldane JBS. Disease and evolution. *Ric Sci Suppl*. 1949; 19: 68–76.
27. Haldane JBS. The causes of evolution. Harper. New York; 1932.
28. Spofford JB. Heterosis and the evolution of duplications. *Am Nat*. 1969; 103: 407–432.
29. Labbé P, Milesi P, Yébakima A, Pasteur N, Weill M, Lenormand T. Gene-dosage effects on fitness in recent adaptive duplications: *ace-1* in the mosquito *Culex pipiens*. *Evol Int J Org Evol*. 2014; doi: [10.1111/evo.12372](#)
30. Labbe P, Berthomieu A, Berticat C, Alout H, Raymond M, Lenormand T, et al. Independent duplications of the acetylcholinesterase Gene conferring insecticide resistance in the mosquito *Culex pipiens*. *Mol Biol Evol*. 2007; 24: 1056–1067. doi: [10.1093/molbev/msm025](#) PMID: [17283366](#)
31. Labbé P, Berticat C, Berthomieu A, Unal S, Bernard C, Weill M, et al. Forty years of erratic insecticide resistance evolution in the mosquito *Culex pipiens*. *PLoS Genet*. 2007; 3: e205. doi: [10.1371/journal.pgen.0030205](#) PMID: [18020711](#)
32. Djogbénou L, Chandre F, Berthomieu A, Dabiré R, Koffi A, Alout H, et al. Evidence of introgression of the *ace-1R* mutation and of the *ace-1* duplication in West African *Anopheles gambiae* s. s. Carter DA, editor. *PLoS ONE*. 2008; 3: e2172. doi: [10.1371/journal.pone.0002172](#) PMID: [18478097](#)
33. Djogbénou L, Labbé P, Chandre F, Pasteur N, Weill M. *Ace-1* duplication in *Anopheles gambiae*: a challenge for malaria control. *Malar J*. 2009; 8: 70. doi: [10.1186/1475-2875-8-70](#) PMID: [19374767](#)
34. Pinto J, Lynd A, Elissa N, Donnelly MJ, Costa C, Gentile G, et al. Co-occurrence of East and West African *kdr* mutations suggests high levels of resistance to pyrethroid insecticides in *Anopheles gambiae* from Libreville, Gabon. *Med Vet Entomol*. 2006; 20: 27–32. PMID: [16608487](#)
35. Lenormand T, Guillemaud T, Bourguet D, Raymond M. Evaluating gene flow using selected markers: a case study. *Genetics*. 1998; 149: 1383–1392. PMID: [9649528](#)
36. Strode C, Donegan S, Garner P, Enayati AA, Hemingway J. The impact of pyrethroid resistance on the efficacy of insecticide-treated bed nets against African Anopheline mosquitoes: systematic review and meta-analysis. *PLoS Med*. 2014; 11: e1001619. doi: [10.1371/journal.pmed.1001619](#) PMID: [24642791](#)
37. Alout H, Djègbè I, Chandre F, Djogbénou LS, Dabiré RK, Corbel V, et al. Insecticide exposure impacts vector-parasite interactions in insecticide-resistant malaria vectors. *Proc Biol Sci*. 2014; 281. doi: [10.1098/rspb.2014.0389](#)
38. Alout H, Yameogo B, Djogbénou LS, Chandre F, Dabiré RK, Corbel V, et al. Interplay between malaria infection and resistance to insecticides in vector mosquitoes. *J Infect Dis*. 2014; jiu276. doi: [10.1093/infdis/jiu276](#)
39. Hemingway J. The role of vector control in stopping the transmission of malaria: threats and opportunities. *Philos Trans R Soc Lond B Biol Sci*. 2014; 369: 20130431. doi: [10.1098/rstb.2013.0431](#) PMID: [24821917](#)
40. Vontas J, Moore S, Kleinschmidt I, Ranson H, Lindsay S, Lengeler C, et al. Framework for rapid assessment and adoption of new vector control tools. *Trends Parasitol*. 2014; 30: 191–204. doi: [10.1016/j.pt.2014.02.005](#) PMID: [24657042](#)
41. Martinez-Torres D, Chandre F, Williamson MS, Darriet F, Bergé JB, Devonshire AL, et al. Molecular characterization of pyrethroid knockdown resistance (*kdr*) in the major malaria vector *Anopheles gambiae* s.s. *Insect Mol Biol*. 1998; 7: 179–184. PMID: [9535162](#)
42. R Development Core Team. R: A Language and Environment for Statistical Computing. 3.02. Vienna, Austria: R Foundation for Statistical Computing;
43. Giraudoux P. *pgirmess*: Data analysis in ecology. R package version 158. 2011.
44. Croissant Y. Estimation of multinomial logit models in R: The *mlogit* Packages. R package version 02–4 Available: <http://cran.r-project.org/web/packages/mlogit/vignettes/mlogit.pdf>. 2012.
45. Dum O. Multiple Comparisons Using Rank Sums. *Technometrics*. 1964; 241–252.
46. Agresti A, Coull B. Approximate is better than “exact” for interval estimation of binomial proportions. *Am Stat*. 1998; 52: 119–126.

47. Yates F. Contingency table involving small numbers and the $\text{K}\chi^2$ test. *Suppl J R Stat Soc.* 1934; 1: 217–235.
48. Sison C, Glaz J. Simultaneous confidence intervals and sample size determination for multinomial proportions. *J Am Stat Assoc.* 1995; 90: 366–369.
49. Rousset F, Ferdy J-B. Testing environmental and genetic effects in the presence of spatial autocorrelation. *Ecography.* In press.

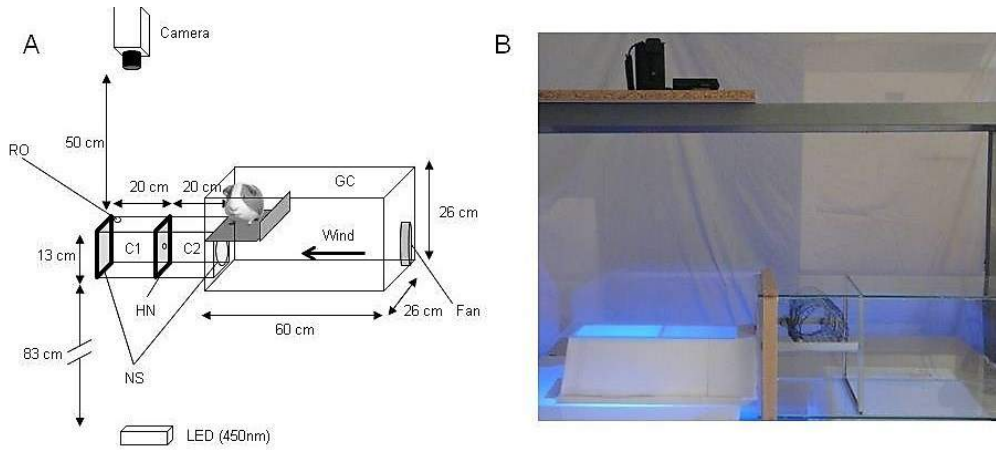

Fig. S1 : A wind tunnel to study the ability of malaria vector mosquitoes to pass through a holed net. C: Chamber one (release chamber); C2: Chamber 2; GC: Glass cage receiving the guinea pig bait; RO: Release opening; NS: Net screens; HN: Holed Net. Panel B. Photo of the experimental setup.

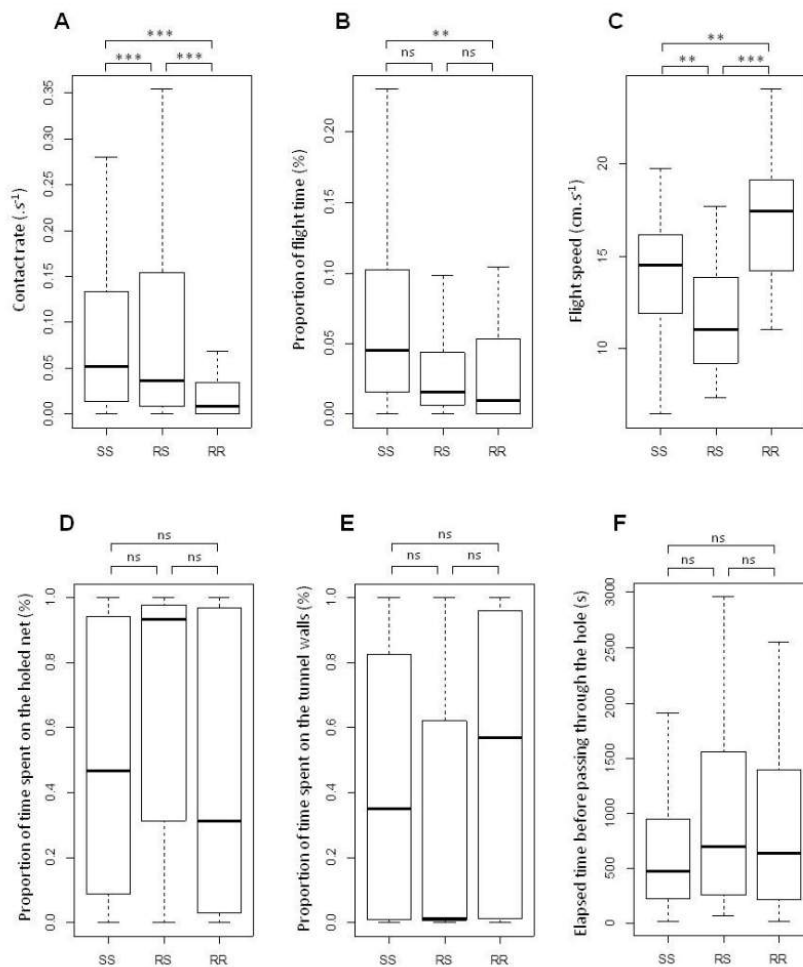

Fig. S2 : Tukey's boxplots of (A) contact rates, (B) proportions of flight time, (C) flight speed, (D) proportion of time spent on the holed net, (E) proportions time spent on the tunnel walls, and (F) elapsed time before passing through the hole in *An.gambiae* of the three *kdr* genotypes faced with an untreated holed net. Whiskers indicate the most extreme data that is no more than 1.5 times the interquartile range. Outliers are not shown. ns: non significant, **: $p < 0.01$, ***: $p < 0.001$ according to (A) a Poisson model and (B, C, D, E, F) Dunn's post tests after a Kruskal-Wallis test.

Multiple Insecticide Resistances in the Disease Vector *Culex p. quinquefasciatus* from Western Indian Ocean

Nicolas Pocquet¹, Pascal Milesi², Patrick Makoundou², Sandra Unal², Betty Zumbo³, Célestine Atyame², Frédéric Darriet¹, Jean-Sébastien Dehecq³, Julien Thiria⁴, Ambicadutt Bheecarry⁵, Diana P. Iyaloo⁵, Mylène Weill², Fabrice Chandre¹, Pierrick Labbé^{2*}

1 Institut de recherche pour le développement, Unité Mixte de Recherche MIVEGEC (IRD 224-CNRS 5290-UM1-UM2), Montpellier, France, **2** Université Montpellier 2, Institut des Sciences de l'Évolution de Montpellier (UMR 5554, CNRS-UM2-IRD), Montpellier, France, **3** Agence de Santé Océan Indien (ARS OI), St Denis, La Réunion Island, France, **4** DASS Nouvelle Calédonie, Santé Environnementale, Noumea, Territory of New Caledonia and Dependencies, Nouvelle Calédonie, **5** Vector Biology and Control Division, Ministry of Health and Quality of Life, Port Louis, Mauritius

Abstract

Several mosquito-borne diseases affect the Western Indian Ocean islands. *Culex pipiens quinquefasciatus* is one of these vectors and transmits filariasis, Rift Valley and West Nile viruses and the Japanese encephalitis. To limit the impact of these diseases on public health, considerable vector control efforts have been implemented since the 50s, mainly through the use of neurotoxic insecticides belonging to Organochlorines (OC), Organophosphates (OP) and pyrethroids (PYR) families. However, mosquito control failures have been reported on site, and they were probably due to the selection of resistant individuals in response to insecticide exposure. In this study, we used different approaches to establish a first regional assessment of the levels and mechanisms of resistance to various insecticides. Bioassays were used to evaluate resistance to various insecticides, enzyme activity was measured to assess the presence of metabolic resistances through elevated detoxification, and molecular identification of known resistance alleles was investigated to determine the frequency of target-site mutations. These complementary approaches showed that resistance to the most used insecticides families (OC, OP and PYR) is widespread at a regional scale. However, the distribution of the different resistance genes is quite heterogeneous among the islands, some being found at high frequencies everywhere, others being frequent in some islands and absent in others. Moreover, two resistance alleles displayed clinal distributions in Mayotte and La Réunion, probably as a result of a heterogeneous selection due to local treatment practices. These widespread and diverse resistance mechanisms reduce the capacity of resistance management through classical strategies (e.g. insecticide rotation). In case of a disease outbreak, it could undermine the efforts of the vector control services, as only few compounds could be used. It thus becomes urgent to find alternatives to control populations of *Cx. p. quinquefasciatus* in the Indian Ocean.

Citation: Pocquet N, Milesi P, Makoundou P, Unal S, Zumbo B, et al. (2013) Multiple Insecticide Resistances in the Disease Vector *Culex p. quinquefasciatus* from Western Indian Ocean. PLoS ONE 8(10): e77855. doi:10.1371/journal.pone.0077855

Editor: John Vontas, University of Crete, Greece

Received: June 21, 2013; **Accepted:** September 4, 2013; **Published:** October 21, 2013

Copyright: © 2013 Pocquet et al. This is an open-access article distributed under the terms of the Creative Commons Attribution License, which permits unrestricted use, distribution, and reproduction in any medium, provided the original author and source are credited.

Funding: This work was supported by ANSES (Agence nationale de sécurité sanitaire de l'alimentation, de l'environnement et du travail) convention IRD-ARS-ANSES 2009-CRD-38. The funders had no role in study design, data collection and analysis, decision to publish, or preparation of the manuscript.

Competing interests: The authors have declared that no competing interests exist.

* E-mail: pierrick.labbe@univ-montp2.fr

Introduction

Several vector-borne diseases, transmitted mainly by mosquitoes, have affected the Western Indian Ocean islands, i.e. the Comoros, the Mascarene Archipelago and Madagascar (Figure 1). The main ones are malaria transmitted by *Anopheles* species [1,2], dengue and chikungunya viruses transmitted by *Aedes* species [3-5], and several filariasis transmitted by *Culex pipiens quinquefasciatus* [6]. This last species is also suspected to transmit the Rift Valley fever virus in the western part of the Indian Ocean [7-9] and is the vector of the West Nile virus and Japanese encephalitis at a

worldwide scale [10]. Considerable efforts in vector control have therefore been carried out since the early 50s, in order to limit the impact of these diseases on public health [6,11].

In the western Indian Ocean islands, *Cx. p. quinquefasciatus* control was mainly implemented through the use of neurotoxic insecticides belonging to the Organochlorines (OC), the Organophosphates (OP) and the Pyrethroids (PYR) families [11-13]. The larvae of this species grow easily in breeding sites such as sewers or other wastewater collections [14], where in addition to insecticide treatments, they are also subject to a wide range of xenobiotics. In the field, mosquito control failures have been shown to result from resistant individuals, selected

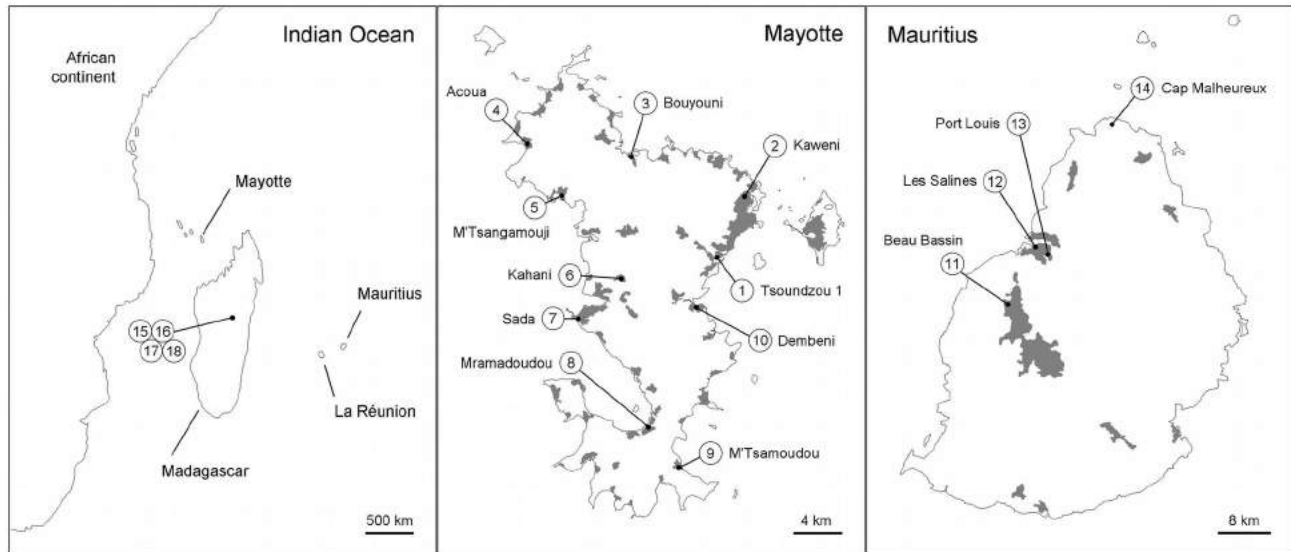

Figure 1. Sampled populations in the Indian Ocean. Samples from Mayotte are numbered from 1 to 10, samples from Mauritius are numbered from 11 to 14, and samples from Madagascar are numbered from 15 to 18. These numbers correspond to those of the samples in other tables and figures. The shaded areas correspond to urban areas.

doi: 10.1371/journal.pone.0077855.g001

in response to insecticide exposure. However, the xenobiotics used for other purposes than mosquito control are present in *Cx. p. quinquefasciatus* breeding sites and may also have a role in the development of resistance, as suggested for other mosquito vector species [15–18]. Despite such repeated failures in mosquito control, very few data on insecticide resistance in *Cx. p. quinquefasciatus* are available for the Indian Ocean, with the recent exception of La Réunion Island [12].

The two main insecticide resistance mechanisms in mosquitoes are enzymatic detoxification (i.e. metabolic resistance) and target site modification (review in [19,20]). The major classes of enzymes involved in metabolic resistance are cytochrome P450 oxidases, esterases and glutathione-S-transferases. All classes are involved in resistance to different insecticides families, but oxidases play a major role in resistance to PYR, while esterases are mainly involved in resistance to OP. One esterase allele in particular, encoded by the *Ester* locus and named *Ester*², is found all over the world in *Cx. pipiens* populations (in both *pipiens* and *quinquefasciatus* subspecies, [21]). Another class of enzymes -the DDT-dehydrochlorinases (DDTases)- is particularly involved in resistance to DDT (DichloroDiphenylTrichloroethane, an OC). The second common resistance mechanism is the insecticide target modification. There are only few targets for neurotoxic insecticides, the main ones being the axonic voltage-gated sodium channels (Na-channels), the synaptic acetylcholinesterase (AChE1), encoded by the *ace-1* gene, and the synaptic γ -aminobutyric acid receptor (GABA receptor), encoded by the *Rdl* gene. These different target proteins are highly constrained, and their variability limited, since they play a key role in the nervous system [22]. In *Cx. p.*

quinquefasciatus, the most common target modifications are the L1014F mutation (*kdr*^R allele) in the voltage-gated sodium channel gene, conferring resistance to PYR and DDT, the G119S *ace-1* mutation (*ace-1*^R allele), conferring resistance to OP and carbamates, and the A302S *Rdl* mutation (*Rdl*^R allele), conferring resistance to the OC dieldrin [12,23,24].

In this study, the resistance levels of *Cx. p. quinquefasciatus* to the three main insecticide families used in vector control (PYR, OP and OC) were evaluated for the first time in two of the western Indian Ocean islands. Resistance mechanisms were characterized in samples from ten populations distributed throughout Mayotte Island, four populations from Central Madagascar and four populations from Mauritius. Among them, the frequencies of four major resistance alleles were more particularly assessed: *kdr*^R, *ace-1*^R, *Ester*² and *Rdl*^R.

Mayotte is a small mountainous island, with a majority of coastal roads except for the two roads crossing from east to west. The Northeast is the most densely populated area (Figure 1). Consequently this area is the main target for insecticide use. Thanks to a sampling scheme covering the totality of Mayotte, we were more specifically able to assess the impact of the heterogeneity of selective pressure and the role of migration on the distribution of insecticide resistance to various insecticides.

Finally, comparisons between Mayotte, Madagascar, Mauritius and a previous study from La Réunion Island [12] allowed a first regional assessment of insecticide resistance in the major disease vector *Cx. p. quinquefasciatus* in the western Indian Ocean.

Materials and Methods

2.1: Mosquitoes samples and strains

None of the samples in any location were collected in protected areas, and these field studies did not involve endangered or protected species. No specific permission was required to collect mosquito larvae in public areas, and when collected on private land or in private residences, the owners or residents gave permission for the study to be conducted on their land or in their residences.

Cx. p. quinquefasciatus larvae were collected in ten localities of Mayotte in 2011 (Figure 1), in various types of breeding sites (latrines, sewer...). Larvae were reared to adults in the laboratory and a sample was stored in liquid nitrogen for later analyses. For the Tsoundzou I sample (number 1 in Figure 1), some of the remaining adults were used in biochemical assays (see below) while the rest was bred to establish a laboratory strain (TZ1), and was thus maintained for several generations. Preliminary bioassays were carried out on the first generation (TZ1-F1) to identify the presence of any resistance in the field sample. This strain was then split in four replicates, each selected with a different insecticide to which TZ1-F1 showed resistance, in order to identify the responsible mechanism(s): TZ1-per, TZ1-tem and TZ1-chlor were respectively selected with permethrin (PYR), temephos (OP) and chlorpyrifos (OP) for six generations, and TZ1-diel was selected with dieldrin (OC) for seven generations.

Eight other samples were collected in 2010 from two other Indian Ocean islands, Madagascar and Mauritius (Figure 1; samples described in [25]). Adults were kept in liquid nitrogen for later analyses. One sample -collected at Les Salines in Mauritius (number 12 in Figure 1)- was maintained in the laboratory to establish a laboratory strain. The first generation (MAU-F1) was tested using preliminary bioassays to identify the presence of any resistance in the field sample. This strain was then split in two replicates, each selected with a different insecticide to which MAU-F1 showed some resistance, in order to identify the responsible mechanism(s): MAU-per and MAU-chlor were thus respectively selected with permethrin (PYR) during eight generations (MAU-per) and with chlorpyrifos (OP) during nine generations (MAU-chlor).

Finally, two laboratory strains were used in this study. The strain Slab [26] was used as the susceptible reference strain. Slab is susceptible to all the insecticides tested in this study. The second strain, SGaba, shared the same genetic background as Slab but homozygous for the *Rdl^R* allele. This strain was established through eleven backcrosses of 200 females from Montpellier area (France) and carrying the *Rdl^R* allele on males from the Slab strain; at each generation, the progeny were selected using 0.025 ppm of dieldrin to kill the susceptible homozygotes. After these backcrosses, the individuals carrying *Rdl^R* were allowed to mate for three generations, their progeny being selected as above. Crosses between *Rdl^R* homozygotes allowed obtaining the SGaba strain.

2.2: Bioassays

Larval bioassays were performed as described by Raymond et al. [27], using ethanol solutions of permethrin (PYR), DDT (OC), temephos (OP), chlorpyrifos (OP) and dieldrin (OC) (all compounds were purchased from Dr Ehrenstorfer GmbH, Germany). They were conducted on sets of 20 early 4th-instar larvae placed in a cup with 99 ml of water. One milliliter of the tested insecticide solution was then added in each cup. Assays of four to thirteen doses in a minimum of two replicates per dose were performed for each insecticide. Similar tests were performed in presence of different synergists: (i) the 1,1-bis-(p-chlorophenyl) methyl carbinol (DMC, Dr Ehrenstorfer GmbH, Germany), a DDT dehydrochlorinases inhibitor (DDTases, [28,29]), (ii) the piperonyl butoxide (PBO, Dr Ehrenstorfer GmbH, Germany), an inhibitor of some P450 oxidases [30], and (iii) the S,S,S-tributyl-phosphorotrithioate (DEF, Dr Ehrenstorfer GmbH, Germany), an inhibitor of some esterases and some GST [31]. Larvae were exposed to classical sublethal doses of one synergist 4 hours before adding the insecticide (DMC: 2 mg.L⁻¹, PBO: 5 mg.L⁻¹, DEF: 0.08 g.L⁻¹). In all assays, larval mortality was recorded after 24 hours of insecticide exposure.

Mortality data were analyzed using the Probit software [32] based on Finney [33]. It allows testing the linearity of dose-mortality response and computing its slope and standard deviation. It also calculates the dose of insecticide necessary to kill 50 % of the tested sample (Lethal Concentration 50, or LC₅₀) and the associated confidence intervals. Finally, it allows the comparison of two dose-mortality lines and the resistance ratios calculation, or RR (= LC₅₀ of field sample / LC₅₀ of the reference strain) and the synergism ratios, or SR (= LC₅₀ in absence of synergist / LC₅₀ in presence of synergist) and their 95 % confidence interval.

2.3: Metabolic resistance

Biochemical tests were performed on single 2-5 days-old females reared from 1st-instar larvae from the TZ1 sample to evaluate the activity of the main families of detoxification enzymes. Protein activity was quantified in microplates using the method of Bradford [34], the quantity or activity of the different detoxifying enzymes being expressed per mg of protein present in the homogenate or quantity of molecules metabolized per minute, respectively. Cytochrome P450 monooxygenases (sometimes named Mixed Function Oxidases or MFO) were quantified indirectly by the peroxidase activity of the heme group with tetramethylbenzidine (note that all hemoproteins are thus quantified, not only MFO [35]), esterases by their ability to hydrolyze α -naphthyl and β -naphthyl acetates and GST by their ability to conjugate reduced glutathione and chlorodinitrobenzene [36].

Statistical comparisons of detoxification enzyme activity present in mosquitoes of the susceptible strain Slab and of the TZ1 sample were computed using Mann-Whitney tests with the Statistica software [37].

Over-produced esterases (*Ester* locus) were investigated in Mayotte samples using starch gel electrophoresis, according to Pasteur et al. [38]; thorax homogenates were used. Esterase activity was revealed using α - and β -naphthyl acetates (as

substrates) and Fast Garnett salts as dye. The esterases encoded by the different *Ester* alleles were identified by their electrophoretic mobility. For Mauritius and Madagascar samples, the *Ester* locus was studied by PCR as described by Berticat et al. [39], after total DNA extraction of single mosquitoes using a CTAB protocol [40].

Statistical analyses to compare the phenotypic frequencies at the *Ester* locus between samples were performed using the R software (<http://www.r-project.org/>) through a generalized linear model (GLM).

2.4: Analyses of target-site modifications

The frequencies of the various phenotypes associated to the presence/absence of susceptible/resistant acetylcholinesterase-1 (AChE1), encoded by the *ace-1* gene, were measured in Mayotte samples (except TZ1) using the TPP test described by Bourguet et al. [41]. For TZ1, Mauritius and Madagascar samples, the G119S mutation was investigated using the PCR-RFLP test described by Weill et al. [42], after total DNA extraction of single mosquitoes (CTAB protocol [40]). Both techniques provide the same information on the mosquito phenotypes ([RS] for heterozygotes, and [SS] or [RR] for susceptible and resistance allele homozygotes, respectively), so that their results are identical for a given individual. The choice on which method was used depended on whether the samples were conserved in liquid nitrogen (allowing the rapid TPP test on proteins) or in alcohol (where only the slower PCR test was usable).

For all samples from the different islands, genotyping of *kdr* and *Rdl* mutations was performed using a molecular test. Total DNA of single mosquitoes was extracted using the CTAB protocol [40]. The L1014F substitution causing resistance in the *kdr* gene was identified using the PASA method described in Martinez-Torres et al. [23]. The A302S substitution causing resistance in the *Rdl* gene was detected using the PCR-RFLP test described by Tantely et al. [12].

The frequency data from the *ace-1*, *kdr* and *Rdl* genes were analyzed using the Genepop software [43]. Hardy-Weinberg equilibrium was checked for each sample. Genotypic differentiation of the different Mayotte samples was computed by comparing each pair of samples with each locus. A p-value correction was applied using the sequential Bonferroni method to take multiple testing into account [44].

Results

3.1: High resistance levels and several resistance mechanisms were identified by bioassays and detoxification enzyme activities

Our first goal was to identify the different mechanisms of resistance present in Mayotte and in Mauritius. To this aim, we analyzed two strains through bioassays and biochemical assays. We used a strain derived from one sample collected in Tsoundzou I (Mayotte) and named TZ1, and another strain derived from a sample collected in Les Salines (Mauritius) and named MAU.

3.1.1: TZ1 strain from Mayotte. Bioassays carried out on the first generation of the TZ1 strain (TZ1-F1) revealed

resistance to the four tested insecticides when compared to the susceptible reference strain Slab, i.e. permethrin (PYR), chlorpyrifos and temephos (OP) and dieldrin (OC). Most assays suggested that the TZ1-F1 contained a mixture of susceptible and resistant individuals for the different insecticides tested (data not shown).

This heterogeneity was further investigated by analyzing (a) TZ1 field mosquitoes for the genes coding the target proteins of pyrethroids (*kdr* gene), organophosphates (*ace-1* gene) and cyclodienes (*Rdl* gene) that can be identified by biochemical or molecular tests, (b) the global activity of different detoxifying enzymes (MFO, esterases and GST) on single mosquitoes of the TZ1-F1 strain, and (c) by re-analyzing dose-mortality responses in sub-strains derived from TZ1-F1 after six or seven generations of selection with permethrin (TZ1-per), temephos (TZ1-tem), chlorpyrifos (TZ1-chlor) and dieldrin (TZ1-diel).

All analyzed mosquitoes from the TZ1 sample were homozygous for the *kdr^R* and the *Rdl^R* alleles (N = 35 and 34, respectively), and 31 individuals out of 35 carried the *ace-1^R* allele (either homozygous or heterozygous). The distributions of esterases and GST global activity among individuals from TZ1 were significantly shifted towards higher values ($p < 0.00005$) compared to the distributions for Slab mosquitoes (Figure 2). In contrast the global quantity of MFO was slightly lower for TZ1 than Slab ($p = 0.002$).

After six generations of permethrin selection of a replicate of TZ1-F1 (TZ1-per) resistance to this insecticide reached a resistance ratio (RR) of 199, compatible with previous studies [23]. Permethrin bioassays conducted with PBO did not show significant synergy effect ($p > 0.05$) between TZ1-per and Slab, suggesting that increased MFO detoxification was not involved in the observed permethrin resistance, in good agreement with the observed low global activity of MFO. In addition, TZ1-per displayed a strong cross-resistance to DDT (RR = 804; Table 1 and Figure S1B in supporting information), which was not synergized by DMC (a DDT-dehydrochlorinase inhibitor; Table 2), and which was thus probably due to the *kdr* mutation. These results indicated that permethrin resistance in TZ1 strains was probably mostly due to the presence of the resistant allele of the Na-channel gene (*kdr^R*), and that other resistance mechanisms (if present) had probably a very low frequency and a minor role.

Two subsets of TZ1-F1 were selected with temephos (TZ1-tem) and chlorpyrifos (TZ1-chlor) during 6 generations. In TZ1-tem, temephos resistance reached a relatively high level (RR = 86), and this resistance was synergized by DEF; however the DEF synergism ratio (SR) of Slab was higher than that of TZ1-tem (19 versus 9.9), and the temephos resistance observed in TZ1-tem could not be attributed to the increased esterase detoxification (Table 1 and Figure S1E in supporting information). In a manner similar to TZ1-chlor, chlorpyrifos resistance was particularly high (RR = 8070) but the addition of DEF yielded no effect (SR = 1.1 vs. SR = 275 for Slab; Table 1 and Figure S1F in supporting information), suggesting that detoxifying esterases were not involved in the observed resistance. These results were unexpected considering the high esterase activity observed in the TZ1 field sample with α -

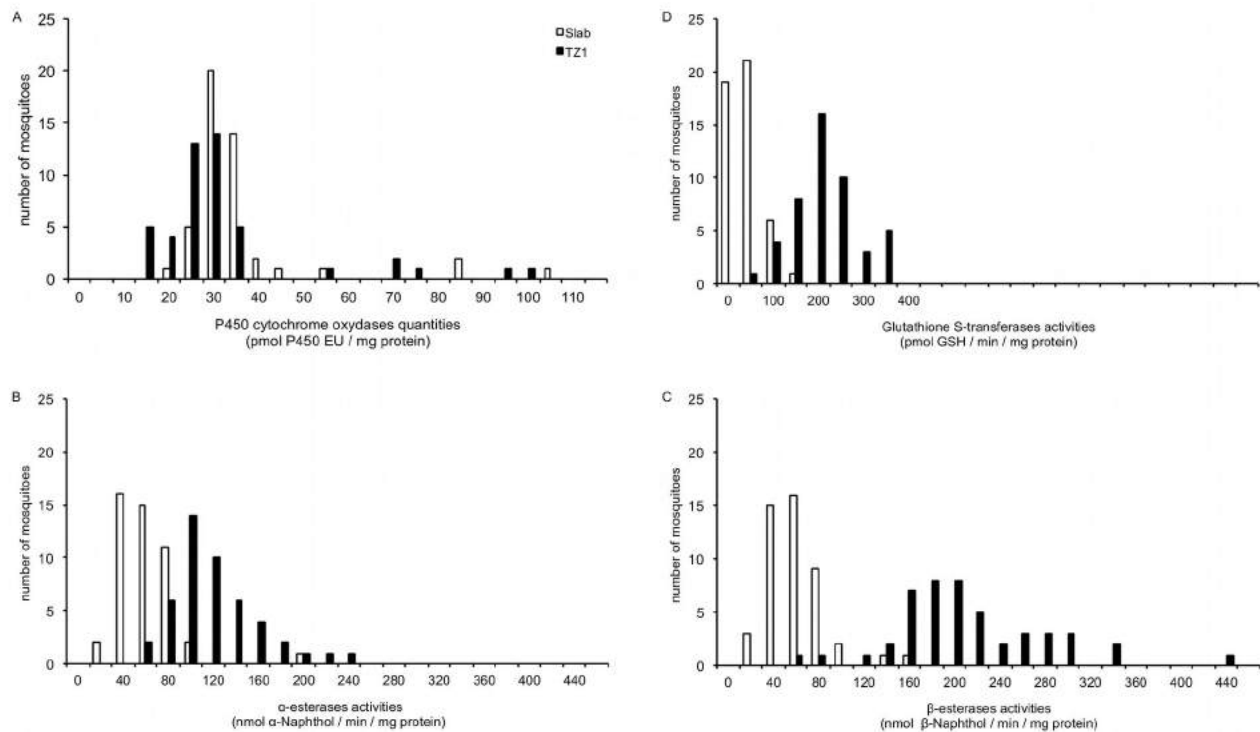

Figure 2. Comparison of detoxification enzymes quantities or activities in single mosquitoes of Slab and TZ1. A: The amount of cytochrome P450 oxidase is expressed in pmol of P450 Equivalent Unit per mg of protein for each mosquito. B and C: Activities of α and β -esterases are expressed as nmol of product formed (α or β -naphthol) per minute and per milligram of protein. D: GST activities are expressed in pmol of product formed per minute per milligram of protein.

doi: 10.1371/journal.pone.0077855.g002

and β -naphthyl acetates, two substrates known to be hydrolyzed by overproduced esterases involved in OP resistance [36]. It must be noted that *ace-1^R*, which confers a <10-fold resistance to temephos and a ~20-fold resistance to chlorpyrifos, was probably also selected in the TZ1-tem and TZ1-chlor substrains; this resistance is not synergized by DEF. However, detoxifying esterases and *ace-1^R* when associated in a same mosquito provide a resistance that is mostly additive [45]: the extremely high chlorpyrifos resistance recorded in the TZ1-chlor strain is thus particularly difficult to explain. Studies on a Tunisian strain [46] reported a ~10,000 fold resistance to chlorpyrifos that, as in TZ1-chlor, was not synergized by DEF.

Finally, a subset of TZ1-F1 was selected with dieldrin (TZ1-diel) during seven generations; resistance reached a high level (RR = 493 (419-574); Table 1). There is presently no known mechanism of dieldrin detoxification. To assess the level of resistance in a strain homozygous for the *Rdl^R* allele of the synaptic GABA in absence of other resistance genes, we established the SGaba strain, a strain carrying this allele and sharing the same genetic background as Slab. Bioassays were conducted on this strain with dieldrin: while Slab LC₅₀ was 9.5×10^{-4} (6.8×10^{-4} - 12.6×10^{-4}), SGaba LC₅₀ reached 0.25 (0.21-0.30), thus RR = 264 (166-437), which is coherent to a previous study of the *Rdl* mutation (RR = 196, 176-216; [47]). This is not very different from the resistance level displayed by

TZ1-diel, so that it is reasonable to assume that *Rdl^R*, which was fixed in this sample (N = 34, Table 2), explains most of this resistance.

3.1.2: MAU strain from Mauritius. Bioassays conducted on the first generation of the MAU strain (MAU-F1) showed moderate resistance to chlorpyrifos (OP) and dieldrin (OC) and a large resistance to permethrin (PYR). In the MAU field sample, no *ace-1^R* and *Rdl^R* allele was observed (N = 23 and 24, respectively) and *kdr^R* was found to be present in 8 of the 24 mosquitoes analyzed. The detoxifying enzyme activity was not studied in the MAU-F1 strain before it was split in substrains for selection with the different insecticides.

Resistance to permethrin reached a high level (RR = 641) in the MAU strain selected with permethrin for eight generations (MAU-per), compatible with previous studies [23]. As in Mayotte, MAU-per also presented a strong cross-resistance to DDT (RR = 605; Table 1), which was not synergized by the dehydrochlorinase synergist DMC. In addition, permethrin bioassays in presence of PBO synergist showed a significantly greater synergy in MAU-per than in Slab (SR = 15 and 2.8 respectively; Table 1 and Figure S1C in supporting information), indicating an increased detoxification by MFO in MAU-per. Thus, in Mauritius permethrin resistance involves both *kdr^R* and MFO.

Table 1. Resistance levels of TZ1 and MAU strains.

Insecticide	Strain	Linearity	LC ₅₀ (95% CI)	Slope (SD)	RR (95% CI)	SR (95% CI)
Permethrin	Slab	p = 0.02	1.0 x 10 ⁻³ (9.4 x 10 ⁻⁴ - 1.1 x 10 ⁻³)	6.21 (0.36)	-	-
	TZ1-per	p = 0.03	1.8 x 10 ⁻¹ (1.2 x 10 ⁻¹ - 2.5 x 10 ⁻¹)	2.01 (0.27)	199 (193 - 204)	-
	MAU-per	p < 10⁻²	5.7 x 10 ⁻¹ (3.8 x 10 ⁻¹ - 8.9 x 10 ⁻¹)	1.37 (0.16)	641 (546 - 754)	-
Permethrin + PBO	Slab	p < 10⁻²	3.4 x 10 ⁻⁴ (2.4 x 10 ⁻⁴ - 4.5 x 10 ⁻⁴)	3.80 (0.60)	-	2.8 (2.4 - 3.1)
	TZ1-per	p = 0.34	4.9 x 10 ⁻² (4.3 x 10 ⁻² - 5.6 x 10 ⁻²)	3.42 (0.36)	145 (119 - 178)	4.0 (3.1 - 5.0)
	MAU-per	p = 0.58	4.3 x 10 ⁻² (3.4 x 10 ⁻² - 5.2 x 10 ⁻²)	2.18 (0.23)	135 (107 - 171)	15 (11 - 23)
DDT	Slab	p = 0.68	7.1 x 10 ⁻³ (6.6 x 10 ⁻³ - 7.7 x 10 ⁻³)	6.68 (0.84)	-	-
	TZ1-per	p = 0.64	5.5 x 10 ⁰ (4.7 x 10 ⁰ - 6.4 x 10 ⁰)	3.20 (0.46)	804 (687 - 939)	-
	MAU-per	p = 0.28	3.9 x 10 ⁰ (3.1 x 10 ⁰ - 4.8 x 10 ⁰)	2.17 (0.23)	605 (486 - 748)	-
DDT + DMC	Slab	p = 0.07	1.8 x 10 ⁻² (1.5 x 10 ⁻² - 2.1 x 10 ⁻²)	3.88 (0.40)	-	0.4 (0.3 - 0.5)
	TZ1-per	p = 0.31	1.1 x 10 ¹ (9.1 x 10 ⁰ - 1.3 x 10 ¹)	2.13 (0.17)	615 (482 - 792)	0.5 (0.4 - 0.6)
	MAU-per	p = 0.25	2.6 x 10 ⁰ (2.0 x 10 ⁰ - 3.4 x 10 ⁰)	1.24 (0.11)	187 (131 - 270)	1.2 (0.8 - 1.6)
Temephos	Slab	p = 0.78	1.2 x 10 ⁻³ (1.1 x 10 ⁻³ - 1.2 x 10 ⁻³)	7.95 (0.45)	-	-
	TZ1-tem	p = 0.81	1.1 x 10 ⁻¹ (9.5 x 10 ⁻² - 1.3 x 10 ⁻¹)	5.47 (0.83)	86 (83 - 89)	-
Temephos + DEF	Slab	p = 0.06	7.0 x 10 ⁻⁵ (5.7 x 10 ⁻⁵ - 9.5 x 10 ⁻⁵)	2.07 (0.36)	-	19 (17 - 21)
	TZ1-tem	p = 0.74	1.2 x 10 ⁻² (1.0 x 10 ⁻² - 1.4 x 10 ⁻²)	3.63 (0.38)	193 (156 - 240)	9.9 (8.3 - 12)
Chlorpyrifos	Slab	p = 0.80	4.6 x 10 ⁻⁴ (4.5 x 10 ⁻⁴ - 4.8 x 10 ⁻⁴)	8.90 (0.46)	-	-
	TZ1-chlor	p = 0.24	3.9 x 10 ⁰ (3.0 x 10 ⁰ - 5.1 x 10 ⁰)	1.57 (0.16)	8070 (6949 - 9381)	-
	MAU-chlor	p = 0.13	3.5 x 10 ⁰ (2.2 x 10 ⁰ - 6.6 x 10 ⁰)	0.69 (0.11)	6024 (4870 - 7558)	-
Chlorpyrifos + DEF	Slab	p = 0.01	8.5 x 10 ⁻⁷ (3.9 x 10 ⁻⁷ - 1.5 x 10 ⁻⁶)	1.07 (0.14)	-	275 (217 - 349)
	TZ1-chlor	p = 0.18	3.5 x 10 ⁰ (2.8 x 10 ⁰ - 4.3 x 10 ⁰)	1.73 (0.18)	3.7 x 10 ⁶ (2.3 x 10 ⁶ - 6.5 x 10 ⁶)	1.1 (0.8 - 1.5)
Dieldrin	Slab	p = 0.17	1.1 x 10 ⁻³ (9.7 x 10 ⁻⁴ - 1.2 x 10 ⁻³)	3.87 (0.30)	-	-
	TZ1-diel	p = 0.79	5.3 x 10 ⁻¹ (4.8 x 10 ⁻¹ - 5.8 x 10 ⁻¹)	5.59 (0.74)	493 (419 - 574)	-

The resistance levels of TZ1 and MAU strains selected with permethrin, temephos, chlorpyrifos and dieldrin and the effect of synergist on these resistance levels are presented. p is the probability of linearity rejection (bold when significant), LC₅₀ is expressed in mg/l, SD is the standard deviation associated with the slope, RR is the resistant ratio, SR (LC₅₀ observed in absence of synergist/LC₅₀ observed in presence of synergist) is the synergism ratio and CI indicates the confidence intervals associated.

doi: 10.1371/journal.pone.0077855.t001

Even if only a low tolerance to chlorpyrifos was found in the MAU-F1 strain (RR = 5.2), selection with chlorpyrifos for nine generations has resulted in a sharp increase in resistance (RR = 6024 in MAU-chlor). Tests with synergists were not performed on this strain.

3.2: High heterogeneity of resistance genes in the Indian Ocean islands is revealed by biochemical and/or molecular identification tests

The polymorphism and distribution of four resistance genes were investigated, i.e. the three genes encoding target proteins (*kdr*, *ace-1* and *Rdl*, Table 2) and a gene encoding detoxifying esterases (*Ester*, Table 3), in samples collected from 10 populations in Mayotte, 4 populations in Mauritius, and 4 other populations in Madagascar (Figure 1). Three of these four genes were also studied in La Réunion [12].

The *kdr*^R mutation, identified using a PCR test, was observed in all the field samples of Mayotte where its frequency was high, ranging from 0.90 to 1 (mean frequency = 0.98 island-wide). In Mauritius, the resistance allele *kdr*^R was present in all samples and had frequencies ranging from 0.05 to 0.39 (mean frequency = 0.18). Finally in Madagascar, the *kdr*^R allele displayed frequencies ranging from 0.42 to 0.68 (mean frequency = 0.51). The distribution of *kdr* in La Réunion is

unfortunately unknown, but bioassays and PCR-tests showed that it was present in the island [12]. The *kdr*^R allele is thus widely distributed among the four islands where it can provide a strong resistance to PYR and DDT.

The *Rdl*^R mutation, identified using a PCR test, showed a more restricted distribution than *kdr*^R. It was observed in the nine studied samples collected in Mayotte. It was fixed in the TZ1 field sample and had frequencies ranging from 0.10 to 0.75 in the other Mayotte samples (mean frequency = 0.38, Table 2). Three samples (numbers 2, 6 and 10) showed a significant deficit of heterozygotes (p < 0.05), which was probably due to a Wahlund effect [48], i.e. a mixture of distinct sub-populations with reduced gene flow. The situation is quite similar to the one in La Réunion [12], where the frequency of *Rdl*^R ranged from 0.08 to 1 (mean frequency = 0.56). Finally, the *Rdl*^R allele was not found in any of the four field samples collected in Mauritius and was observed in a single mosquito (heterozygous) among the four studied samples from Madagascar.

The polymorphism of the *ace-1* gene can be detected indifferently through a molecular PCR-RFLP test or through a biochemical assay, TPP. Both tests were used in this study. In Mayotte, the TZ1 field sample was analyzed with the PCR-RFLP test and *ace-1*^R was found to have a frequency of 0.61. The nine other samples were investigated using the TPP test.

Table 2. Frequencies of *ace-1^R*, *kdr^R* and *Rdl^R* alleles in the Indian Ocean islands.

n°	Origin	Samples	<i>ace-1</i> locus				<i>kdr</i> locus				<i>Rdl</i> locus			
			N	<i>ace-1^R</i>	F _{is}	p	N	<i>kdr^R</i>	F _{is}	p	N	<i>Rdl^R</i>	F _{is}	p
1	Mayotte	Tsoundzou I	35	0.61	-0.13	0.34	35	1.00	-	-	34	1.00	-	-
2	Mayotte	Kaweni	47	0.61	-0.10	0.34	23	0.98	-	-	46	0.75	0.49	0.002
3	Mayotte	Bouyouni	52	0.41	0.10	0.84	57	1.00	-	-	58	0.42	-0.16	0.29
4	Mayotte	Acoua	58	0.32	-0.14	0.22	25	1.00	-	-	24	0.10	0.35	0.21
5	Mayotte	M'Tsangamouji	58	0.26	-0.34	0.006	48	1.00	-	-	56	0.16	0.21	0.13
6	Mayotte	Kahani	49	0.22	-0.28	0.048	56	0.99	-	-	58	0.28	0.46	<0.001
7	Mayotte	Sada	55	0.15	-0.16	0.28	20	1.00	-	-	23	0.26	0.12	0.61
8	Mayotte	Mramadoudou	54	0.38	-0.53	<0.001	0	-	-	-	0	-	-	-
9	Mayotte	M'Tsamoudou	57	0.61	0.02	0.66	50	1.00	-	-	57	0.10	0.30	0.07
10	Mayotte	Dembeni	57	0.46	-0.37	0.005	57	0.90	0.10	0.41	58	0.44	0.34	0.015
		<i>Total</i>	522	0.39	-0.08	0.08	371	0.98	0.14	0.10	414	0.38	0.47	<0.001
11	Mauritius	Beau Bassin	48	0	-	-	44	0.05	-0.02	1.00	43	0	-	-
12	Mauritius	Les Salines	23	0	-	-	24	0.35	-0.22	0.38	24	0	-	-
13	Mauritius	Port Louis	24	0	-	-	22	0.39	-0.04	1.00	24	0	-	-
14	Mauritius	Cap Malheureux	24	0	-	-	22	0.05	-0.16	0.66	24	0	-	-
		<i>Total</i>	119	0	-	-	112	0.18	0.03	0.75	115	0	-	-
15	Madagascar	Antananarivo 1	21	0	-	-	18	0.42	-0.23	0.62	22	0	-	-
16	Madagascar	Antananarivo 2	20	0	-	-	19	0.68	0.05	1.00	22	0.02	-	-
17	Madagascar	Itaosy 1	24	0	-	-	19	0.47	-0.03	1.00	24	0	-	-
18	Madagascar	Itaosy 2	24	0.02	-	-	18	0.44	-0.10	1.00	19	0	-	-
		<i>Total</i>	89	0.006	-	-	74	0.51	-0.05	0.81	87	0.006	-	-

The frequency of the resistant alleles for the *ace-1*, *kdr* and *Rdl* locus are presented for field samples of *Cx. p. quinquefasciatus* from Mayotte (samples 1 to 10), from Mauritius (samples 11 to 14) and from Madagascar (samples 15 to 18). F_{is} indicates deficit (F_{is} > 0) or excess (F_{is} < 0) of heterozygotes for each sample. p is the probability that observations deviate from the Hardy-Weinberg expectations (bold when significant) and N is the number of tested mosquitoes. NB: for *ace-1*, the frequencies have been computed as if only single copy alleles were present (see text).

doi: 10.1371/journal.pone.0077855.t002

The resistant allele *ace-1^R* was present throughout the island, with frequencies ranging from 0.15 to 0.61 (mean frequency = 0.39, Table 2). Among the ten Mayotte samples, four showed significant deviations from Hardy-Weinberg expectations due to an excess of heterozygotes (p < 0.05). Over all samples there was a close-to-significant excess of heterozygotes (p = 0.08). Such excesses of heterozygotes suggested the presence of duplicated haplotypes combining a susceptible and a resistant copy of the *ace-1* gene (allele *ace-1^D*) [49-51]. Such haplotypes have been identified in three samples of Mayotte by crossing experiments (as described in [50]) and are currently being further analyzed (unpublished data). The *ace-1* locus was analyzed by PCR test in the other islands. In the four samples from Mauritius, all individuals showed a susceptible genotype for *ace-1*, suggesting that the resistant allele is absent from the island or present at a very low frequency (N = 119). In Madagascar only one heterozygous individual (sample 18) was found among the four tested samples. In La Réunion, the frequency of *ace-1^R* ranged from 0 to 0.29 (mean frequency = 0.05) [12].

The *Ester* locus can also be analyzed indifferently by biochemical or molecular tests. Both tests only identify the presence or absence of a resistant *Ester* allele. In Mayotte only two phenotypes were found, [*Ester*⁰] corresponding to a susceptible homozygote, and [*Ester*²], corresponding to (*Ester*²/*Ester*²) and (*Ester*²/*Ester*⁰) genotypes. The [*Ester*²]

phenotype was found in all tested samples, with frequencies ranging from 0.34 to 0.81, and a mean frequency of 0.59. In Mauritius, the resistant phenotype [*Ester*²] was found in the four samples, with frequencies ranging from 0.63 to 0.88 (mean frequency = 0.76, Table 3). In Madagascar, the [*Ester*²] phenotype was found in the four studied samples at very high frequencies (from 0.86 to 1, mean frequency = 0.96). Finally in La Réunion, the frequency of the [*Ester*²] ranged from 0 to 0.88 (mean frequency = 0.18) [12].

3.3: Spatial distribution of resistance genes in Mayotte

Thanks to our sampling scheme all across the island, it was possible to analyze the distribution of the resistance alleles. Apart from the *kdr^R* allele, which was close to fixation all over the island, the resistance alleles analyzed here displayed structured distributions (Figure 3).

Analysis of the *Ester*² phenotype distribution did not show any particular pattern (Figure 3). Samples were statistically grouped according to their frequency as follows: two groups contained samples presenting no significant differences (samples 2, 3, 5 and 8, and samples 4, 6 and 10), although there was a significant difference between these two groups. Samples 7 and 9 were different from all other samples with, respectively, the lowest and the highest frequency of the island

Table 3. Frequencies of [*Ester^{R1}*] and [*Ester^{R2}*] phenotypes in the Indian Ocean islands.

n°	Origin	Samples	Esterase phenotypes		
			N	[<i>Ester^{R1}</i>]	[<i>Ester^{R2}</i>]
1	Mayotte	Tsoundzou I	0	-	-
2	Mayotte	Kaweni	53	0.53	0.47
3	Mayotte	Bouyouni	56	0.43	0.57
4	Mayotte	Acoua	58	0.28	0.72
5	Mayotte	M'Tsangamouji	58	0.48	0.52
6	Mayotte	Kahani	58	0.33	0.67
7	Mayotte	Sada	58	0.66	0.34
8	Mayotte	Mramadoudou	54	0.44	0.56
9	Mayotte	M'Tsamoudou	58	0.19	0.81
10	Mayotte	Dembeni	58	0.36	0.64
		<i>Total</i>	<i>511</i>	<i>0.41</i>	<i>0.59</i>
11	Mauritius	Beau Bassin	48	0.38	0.63
12	Mauritius	Les Salines	24	0.17	0.83
13	Mauritius	Port Louis	24	0.13	0.88
14	Mauritius	Cap Malheureux	24	0.17	0.83
		<i>Total</i>	<i>120</i>	<i>0.24</i>	<i>0.76</i>
15	Madagascar	Antananarivo 1	18	0	1.00
16	Madagascar	Antananarivo 2	21	0.14	0.86
17	Madagascar	Itaosy 1	19	0	1.00
18	Madagascar	Itaosy 2	16	0	1.00
		<i>Total</i>	<i>74</i>	<i>0.04</i>	<i>0.96</i>

Ester phenotype frequencies are presented for 10 samples of *Cx. p. quinquefasciatus* of Mayotte (samples 1 to 10), 4 samples from Mauritius (samples 11 to 14) and 4 samples from Madagascar (samples 15 to 18).

doi: 10.1371/journal.pone.0077855.t003

(0.34 and 0.81). However, these differences displayed no clinal pattern across the island.

Concerning *ace-1*, the resistant allele displayed a strong and heterogeneous spatial pattern, the average *ace-1^R* frequency decreased from east to west (Figure 3). Statistical analyses revealed four groups showing significant genotypic frequency differences. The first group, in the east of the island, was formed by samples 1, 2, 3, 9 and 10, with an average *ace-1^R* frequency of 0.54. The second and the third groups were formed by samples 3, 4, 8, 10 and samples 3, 4, 5, 6 and 8 with respective average *ace-1^R* frequencies of 0.39 and 0.32. The last group, formed by samples 5, 6, and 7, had an average *ace-1^R* frequency of 0.21. The four groups partially overlapped (leading to five frequency classes, see Figure 3) and *ace-1^R* frequency decreased as one moved away from Tsoundzou and Kaweni (samples 1 and 2, north-east) or from M'Tsamoudou (sample 9, south-east).

The *Rdl* alleles also displayed a marked variation in their spatial distribution over Mayotte (Figure 3). The resistant allele *Rdl^R* frequency seemed to decrease as one moved away from Tsoundzou (sample 1), as shown by the negative correlation between *Rdl^R* frequency and the distance from there (Pearson correlation: $r = -0.89$, $p = 0.001$). *Rdl^R* frequencies ranged from complete fixation in Tsoundzou I to 0.10 in samples 4 and 9, respectively the most eastern and the most southern collection sites on the island. Statistically homogeneous but overlapping

groups emerged as follows: sample 1 (Tsoundzou I), sample 2 (close to the north of Tsoundzou I), samples 3, 6, 7 and 10, samples 4, 5, 6 and 7 and samples 4, 5, 7 and 9, with respective *Rdl^R* average frequencies of 1, 0.75, 0.35, 0.20 and 0.16.

Discussion

In the Indian Ocean, the mosquito *Cx. p. quinquefasciatus* is an important vector of several diseases, including filariasis, Rift Valley fever and West Nile viruses, and the Japanese encephalitis. In this study we investigated its status of resistance to the most commonly used insecticides to control its population densities (including the diseases it transmits). So far, there is no available data for the western Indian Ocean islands, except for La Réunion [12]. We investigated Madagascar and two of the main archipelagos -the Comoros, Mayotte and the Mascarenes (Mauritius)- in order to build the first regional assessment of insecticide resistance for this important vector.

a): Resistance to a large variety of insecticides is widespread in the western Indian Ocean

In the western Indian Ocean, *Cx. p. quinquefasciatus* presents resistances and/or resistance mechanisms to all the main insecticide families used so far in vector control, i.e. PYR (permethrin), OP (chlorpyrifos, temephos) and OC (dieldrin, DDT). The most common resistance mechanism to PYR is the *kdr^R* mutation, which also confers resistance to DDT (OC); it was found through the whole region. In La Réunion and Mauritius, metabolic resistance due to an increased MFO detoxification was also present, but it was not found in Mayotte. The level of resistance to PYR in Mayotte and Mauritius is high, as expected from the presence of *kdr^R* in this species [23].

OP resistance through esterase overexpression, especially the *Ester^{R2}* allele, is widespread and found at high frequencies in all the sampled western Indian Ocean islands. The *ace-1^R* mutation is also present in the area, although is less common (ex. not found in Mauritius). Our knowledge of the resistance to chlorpyrifos conferred by these two resistance genes does not explain the high resistance to chlorpyrifos (OP) observed after the selection of Mayotte and Mauritius field samples (TZ1 and MAU, > 6,000 folds after selection). Such an extremely high resistance to this insecticide has only been reported in Tunisia (> 10,000 folds; [46,52]) where it involved a new gene (named G) associated with resistant *ace-1^R*. It is possible that this gene is present in Mayotte and Mauritius, and possibly in other Indian Ocean islands, but further studies are needed to confirm it. Finally, dieldrin (OC) resistance through the *Rdl^R* mutation has also been detected in some of the sampled islands, but not all.

In conclusion, in this study we used different and complementary approaches to describe the variety of resistance mechanisms in the Indian Ocean islands (bioassays, measures of enzyme activities, molecular identification of target-site mutations). Clearly, resistance to the most-used insecticides families is widespread at a regional

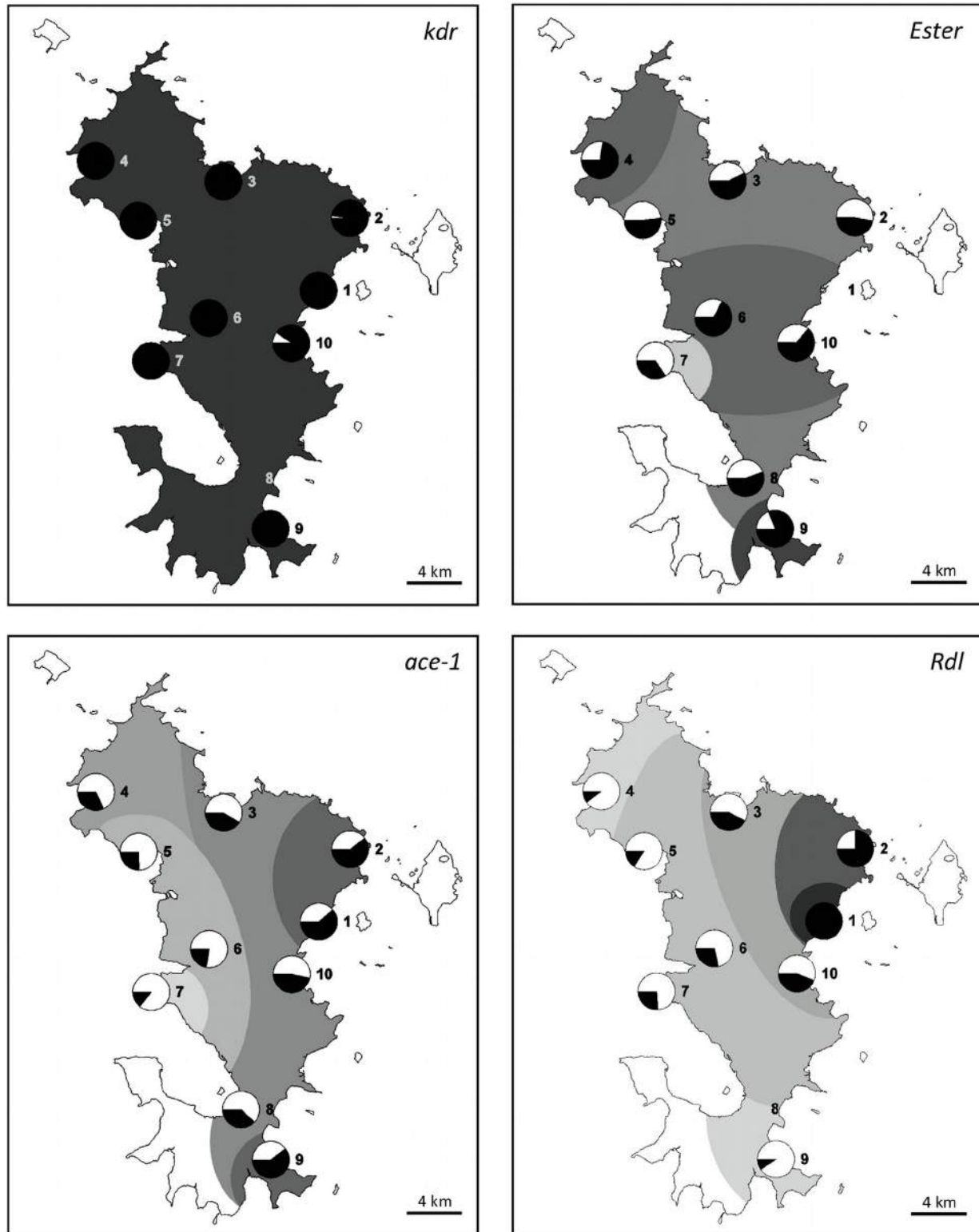

Figure 3. Geographic distribution of *kdr*, *Ester*, *ace-1* and *Rdl* resistant alleles in Mayotte. For each sample, the frequencies of resistant alleles (kdr^R , $ace-1^R$, Rdl^R) or phenotypes ($[Ester^2]$) are represented in black sectors in a circle. The shaded areas approximately correspond to the statistical groups observed (see text), with a scaled shade of gray ranging from 0 (white) to 1 (black) corresponding to the mean frequency of the corresponding group.

doi: 10.1371/journal.pone.0077855.g003

scale; however, the distribution of these resistance mechanisms is quite heterogeneous among the islands.

b): Regional heterogeneity of resistance is probably due to vector control practices

There are indeed important differences among the western Indian Ocean islands for the frequencies of the different resistance mechanisms present. This is particularly the case for the *kdr^R* allele: it is close to fixation in Mayotte (mean frequency = 0.98), but less frequent in Madagascar and Mauritius (0.51 and 0.18, respectively). In La Réunion, the *kdr^R* frequency is unknown, but the allele was found in a strain selected with permethrin and DDT was used in the island for malaria control [12]. These differences are probably related to the insecticides used in vector control: in Mayotte, DDT was used from 1973 to 1984 [11], and then replaced by deltamethrin (PYR). This insecticide is still used for indoor residual spraying (IRS) and deltamethrin-treated nets have recently been distributed in the island (Zumbo, pers. com.). Forty years of such intense selection pressure on the sodium channel gene, the common target of PYR and DDT, explain the near-fixation of this allele in this island. The lower *kdr^R* frequencies observed in Madagascar and Mauritius seems to indicate that the selection pressures on this gene, i.e. the intensities of PYR and DDT treatments, are certainly less important in these two islands. This seems surprising for Mauritius, as DDT has been continuously used from 1946 to 2011 for malaria control [13]. However, from 1990 on, the doses used could have been low enough to weaken the selection pressure intensity (ex. only 2 rounds per year of DDT spraying around the airport, [13]). The *kdr^R* distribution could also be structured (in Mauritius, *kdr^R* frequency ranged from 0.05 to 0.4, Table 2). Finally, *kdr^R* may also have been selected in La Réunion and Mauritius by reinforced vector control of *Aedes* species following chikungunya and dengue outbreaks [12,53].

Metabolic resistance to PYR is also contrasted between the islands, as MFO implication in resistance has been detected in Mauritius and La Réunion [12], but not in Mayotte (no available data for Madagascar). Considering the intensity of PYR used in Mayotte, the fact that no MFO-based metabolic resistance has been detected is surprising. One plausible explanation is that at the time of this study temephos (OP) was still intensively used in Mayotte (see below): temephos is bio-activated to temephos-oxon (the toxic form) by oxidases [54]; if the same oxidases are implicated in both temephos activation and permethrin resistance, it might thus be possible that the intense use of temephos in Mayotte could have led to a counter-selection of oxidases. Further studies are required to establish this point.

Heavy uses of OP insecticides have been documented in most of these islands: temephos was used for vector control in Mayotte from 1973 to the end of 2010 ([11]; Zumbo, pers. com.), until 2006 in La Réunion [12], and from 1975 to at least 2008 in Mauritius [13]; no information is available for Madagascar. In all four islands, *Ester^R* is present at high frequencies, with some samples reaching frequencies of 0.8 in Mayotte, 0.9 in Mauritius and up to 1 in Madagascar and La Réunion (Table 3 and [12]). It suggests a relatively early

spread of this resistance allele in the Indian Ocean, consistent with its highly invasive character [21,55], and appears a testimony of high OP selection pressure in all islands. However this selection may be due also to other OP and carbamates, for example those intended for agriculture and domestic usages.

Consequently, the more contrasted distribution of *ace-1* appears surprising. The *ace-1^R* allele is indeed only present in La Réunion and Mayotte (plus one heterozygote in Madagascar), and at much lower frequencies than *Ester^R* (Table 2 and [12]). The absence of *ace-1* in Mauritius is particularly puzzling: temephos is indeed used since 1975, many exchanges occur between the different Indian Ocean islands; furthermore all susceptible individuals tested (data not shown) displayed a 119 codon allowing the G119S mutation in one step [56]. One potential explanation is that, as *ace-1^R* provides low resistance to this OP (RR < 10, [27]), this limited advantage could, in certain treatment conditions, be unable to compensate its high fitness cost [57-61]. Another explanation for the discrepancies between *Ester^R* and *ace-1^R* frequencies could be that *Ester^R* would be selected by some other products (ex. agriculture), not necessarily used in vector control, and for which *ace-1* is not the target. Esterases are indeed generalist detoxifying enzymes, able to provide protection against a large array of xenobiotics, including other insecticide families (ex. most PYR; [62,63]). Another observation is that the frequency of the *ace-1* resistance allele is very different between La Réunion and Mayotte: it is much lower in the first than in the second island (from 0 to 0.29, mean = 0.05, and from 0.15 to 0.61, mean = 0.39, respectively, Table 2 and [12]). This may be due to the presence of *ace-1* duplications in Mayotte, which were not found in La Réunion [12]. These duplicated alleles have been shown to provide resistance while reducing its fitness cost [50]. Although their frequencies still need to be evaluated, they may partly explain why *ace-1* resistance is more frequent in Mayotte. An alternative but not exclusive explanation could be that *ace-1* is currently invading the Indian Ocean from the northwest, i.e. recent importation from Eastern Africa or local mutation [12], which would explain why it is more frequent in Mayotte than in La Réunion, and so far absent or quasi-absent in Mauritius and Madagascar. Only long-term studies documenting the dynamics of the different resistance genes could help solve this issue.

Finally, the *Rdl^R* allele conferring resistance to dieldrin exhibits a distribution very similar to that of *ace-1^R*: it is only found in Mayotte and La Réunion (and only one heterozygote in Madagascar) (Table 2 and [12]). Before being banned in France, dieldrin was the only insecticide targeting the GABA receptor used for vector control in these French overseas departments: it has been used in Mayotte from 1952 to 1958 [11], but never in La Réunion [12]. As the dieldrin half-life is 7 years in the soil [64], it is nevertheless unlikely that this legally-used dieldrin persisted in the environment to explain the current resistance. However, other insecticides, such as lindane and fipronil, target the GABA receptor [65] and are respectively used by veterinarians and against termites [12]. Traces of these compounds have been reported in La Réunion coastal waters, as well as traces of dieldrin, probably from illegal uses [12]. This could explain the selection of *Rdl^R*,

although the presence of an unknown source cannot be excluded.

c): Local gradients in resistance frequency reveal heterogeneous insecticide pressure

At a local scale, the distribution of *kdr^R*, *Rdl^R*, *ace-1^R* and *Ester²* were investigated in samples from 10 populations of *Cx. p. quinquefasciatus* throughout Mayotte. As a similar sampling scheme was performed in the previous study of La Réunion (except for *kdr*, [12]), we were able to compare the two islands and found that the distributions of resistance genes are particularly congruent.

Three of the genes present evidence of a strong structuration both in Mayotte and La Réunion, i.e. *Rdl^R*, *ace-1^R* and *Ester²* (Figure 3 in the present study and Figure 2 in [12]). No clear spatial pattern emerged for *Ester²*, either in La Réunion or in Mayotte (Figure 3): the gene was relatively frequent in both islands, with consequent variations between samples from different populations that probably reflect the heterogeneity of the selective agents in the environment. As discussed above, these selective agents may be the OP used in vector control, but also other xenobiotics, not used for vector control. Moreover, as *Ester²* can be relatively costly [57-61,66], the heterogeneity in its frequency distribution within an island could reflect a heterogeneity in the selective pressure intensity, i.e. the quantity of pesticide used.

Finally, both *Rdl^R* and *ace-1^R* showed gradient frequency distributions: in Mayotte both decreased from east to west, while they decreased from northwest to southeast in La Réunion; in both islands this gradient reflected the decreasing human population density gradient (Figure 3 in the present study and Figure 2 in [12]). While *ace-1^R* has been repetitively shown to be quite costly in absence of OP [57-61], few data exist on the potential cost of *Rdl^R* in absence of dieldrin, although it has been shown to usually decline in absence of the insecticide [67]. Their clinal distributions are thus probably the result of a more intense selection in the most populated areas associated with a decline due to their cost in less treated/less populated areas, with migration redistributing the different alleles [57]. Again, the source(s) of this selection is(are) not clearly identified for *Rdl^R*, while OPs or carbamates are the most probable cause for *ace-1^R*.

Conclusion

The status of *Cx. p. quinquefasciatus* insecticide resistance in the Western Indian Ocean is particularly worrying. Indeed, resistance mechanisms to all the most commonly used neurotoxic insecticide families (PYR, OC and OP) are found over the entire region. Both site mutations (*kdr^R*, *Rdl^R*, *ace-1^R*) of their main targets (respectively, sodium channels, GABA receptor and AChE1) and metabolic resistance mechanisms (*Ester²*, MFO) are present at a regional scale, sometimes close to fixation in the natural populations of this mosquito. Even more, a not yet identified mechanism providing extreme resistance to chlorpyrifos in mosquitoes carrying *ace-1^R*, and duplicated alleles of the locus *ace-1* are present. This type of multi-resistance is not uncommon and rather reflects the

situation of many areas across the world for several mosquito species [68-75].

This resistance diversity gravely reduces the capacity of its management. Classical strategies indeed consist in insecticide family rotation, which would be very difficult at this stage considering the variety of mechanisms already present. It is even more worrying as such strategies rely on the existence of resistance fitness costs: unfortunately, resistances with reduced cost have already appeared (ex. *ace-1* duplications) and different resistance mechanisms can act in synergy (ex. the presence of *kdr^R* largely limits the cost of *ace-1^R*; [61]). Moreover, large heterogeneities in the frequencies of the various resistance alleles were found, so that the control strategies should be precisely designed to adjust to the particular situation of each island.

In the case of *Cx. p. quinquefasciatus* in the Indian Ocean, the main risks are epidemics of Bancroftian filariasis [6,76,77] and the Rift Valley fever virus [7,9,78]. In case of an outbreak of either of these diseases, these already-established resistances could undermine the efforts of the vector control services. Temephos could still be used in emergency cases, but to do so the European legislation on this product should be changed, and the presence of resistance alleles could reduce its utility on a long-term basis.

In the meantime, alternative insecticides could also be potentially used to control an epidemic. Insect Growth Regulators (IGR) are efficient, but show very low persistence on *Cx. p. quinquefasciatus* at the currently used doses ([79,80]; Pocquet et al., unpublished data). *Bti* toxins (extracted from *Bacillus thuringiensis* var. *israelensis*) could be a serious alternative, however their residual efficiency is relatively short, particularly in tropical environments and polluted water ([81]; Pocquet et al., unpublished data).

Thus it becomes urgent to find alternatives to control populations of *Cx. p. quinquefasciatus* in the Indian Ocean. One of the most promising research paths is the development of Incompatible Insect Techniques (IIT). A first step in the development of these strategies has recently been performed: Atyame et al. [25] have introduced in a *Cx. p. quinquefasciatus* line a strain of *Wolbachia* incompatible with the strain present in the Indian Ocean. *Cx. p. quinquefasciatus* males of this new line could sterilize all females on most of the Indian Ocean islands. The development of such techniques would allow fighting effectively and specifically *Cx. p. quinquefasciatus* in this part of the world.

Supporting Information

Figure S1. Synergist effect on resistance levels of TZ1 and MAU strains selected to insecticides. Each graph shows the dose-mortality of Slab and one selected strain for one insecticide, with or without synergist. Panel A: effect of permethrin on Slab and TZ1-per, with or without PBO. Panel B: effect of DDT on Slab and TZ1-per, with or without DMC. Panel C: effect of permethrin on Slab and MAU-per, with or without PBO. Panel D: effect of DDT on Slab and MAU-per, with or without DMC. Panel E: effect of temephos on Slab and TZ1-

tem, with or without DEF. Panel F: effect of chlorpyrifos on Slab and TZ1-chlor, with or without DEF. (TIF)

Acknowledgements

We are very grateful to Nicole Pasteur for her valuable comments, discussions and help all along the manuscript preparation, Ohri Yamada for his support in the course of this study and Elodie Labbé for proofreading the manuscript. This study is the contribution no. 2013-124 of the Institut des

Sciences de l'Evolution of Montpellier (Unité Mixte de Recherche, CNRS-IRD-UM2 5554).

Author Contributions

Conceived and designed the experiments: NP FC PL MW. Performed the experiments: NP PL P. Milesi P. Makoundou SU FD. Analyzed the data: NP PL P. Milesi FC. Contributed reagents/materials/analysis tools: FD CA JSD AB DPI JT P. Milesi FC MW BZ. Wrote the manuscript: NP PL P. Milesi FC MW.

References

- Receveur MC, Roussin C, Vatan R, de Montéra AM, Sissoko D et al. (2004) Malaria in Mayotte: epidemiology, diagnostic, prevention and treatment. *Bull Soc Pathol Exot* 97: 265-267. PubMed: 17304748.
- Tchen J, Ouledi A, Lepere JF, Ferrandiz D, Yvin JL (2006) Epidemiology and prevention of malaria in the southwestern islands of the Indian Ocean. *Med Trop* 66: 295-301.
- Sissoko D, Ezzedine K, Giry C, Moendandzé A, Lernout T et al. (2010) Seroepidemiology of Dengue virus in Mayotte, Indian Ocean, 2006. *PLOS ONE* 5: e14141. doi:10.1371/journal.pone.0014141. PubMed: 21152441.
- Delatte H, Bagny L, Brengue C, Bouetard A, Paupy C et al. (2011) The invaders: phylogeography of dengue and chikungunya viruses *Aedes* vectors, on the South West Islands of the Indian Ocean. *Infect Genet Evol* 11: 1769-1781. doi:10.1016/j.meegid.2011.07.016. PubMed: 21827872.
- Renault P, Balleydier E, D'Ortenzio E, Bâville M, Filleul L (2012) Epidemiology of Chikungunya infection on Reunion Island, Mayotte, and neighboring countries. *Med Mal Infect* 42: 93-101. doi:10.1016/j.medmal.2011.12.002. PubMed: 22280563.
- Julvez J, Ragavoodoo C, Gopaul AR, Mouchet J (1998) Human diseases transmitted by Culicidae in southwest Indian Ocean islands. *Bull Soc Pathol Exot* 91: 99-103. PubMed: 9559180.
- Sissoko D, Giry C, Gabrie P, Tarantola A, Pettinelli F et al. (2009) Rift Valley fever, Mayotte, 2007-2008. *Emerg Infect Dis* 15: 568-570. doi:10.3201/eid1504.081045. PubMed: 19331733.
- Anyamba A, Linthicum KJ, Small JL, Collins KM, Tucker CJ et al. (2012) Climate teleconnections and recent patterns of human and animal disease outbreaks. *PLoS Negl Trop. Drosophila Inf Serv* 6: e1465.
- Cêtre-Sossah C, Zeller H, Grandadam M, Caro V, Pettinelli F et al. (2012) Genome analysis of Rift Valley fever virus, Mayotte. *Emerg Infect Dis* 18: 969-971. PubMed: 22608405.
- Richards SL, Lord CC, Pesko KN, Tabachnick WJ (2010) Environmental and biological factors influencing *Culex pipiens quinquefasciatus* (Diptera: Culicidae) vector competence for West Nile Virus. *Am J Trop Med Hyg* 83: 126-134. doi:10.4269/ajtmh.2010.09-0776. PubMed: 20595491.
- Robert V, Lagneau C (2009) Mission de conseil et d'appui à la mise en place de la lutte intégrée contre les vecteurs à Mayotte. IRD EID Méditerranée: 53.
- Tantely ML, Tortosa P, Alout H, Berticat C, Berthomieu A et al. (2010) Insecticide resistance in *Culex pipiens quinquefasciatus* and *Aedes albopictus* mosquitoes from La Reunion Island. *Insect Biochem Mol Biol* 40: 317-324. doi:10.1016/j.ibmb.2010.02.005. PubMed: 20188834.
- Ministry of Health and Quality of Life Mauritius, World Health Organization, University of California, San Francisco (2012) Eliminating Malaria, Case-study 4. *Prev Reintroduction Mauritius GENEVA*: 75.
- Vinogradova EB (2000) *Culex pipiens pipiens* mosquitoes: taxonomy, distribution, ecology, physiology, genetics, applied importance and control. Pensoft Publishers.
- Poupardin R, Reynaud S, Strode C, Ranson H, Vontas J et al. (2008) Cross-induction of detoxification genes by environmental xenobiotics and insecticides in the mosquito *Aedes aegypti*: Impact on larval tolerance to chemical insecticides. *Insect Biochem Mol Biol* 38: 540-551. doi:10.1016/j.ibmb.2008.01.004. PubMed: 18405832.
- Poupardin R, Riaz MA, Jones CM, Chandor-Proust A, Reynaud S et al. (2012) Do pollutants affect insecticide-driven gene selection in mosquitoes? Experimental evidence from transcriptomics. *Aquat Toxicol* 114-115: 49-57. doi:10.1016/j.aquatox.2012.02.001. PubMed: 22406618.
- Tene Fossog B, Kopya E, Ndo C, Menze-Djantio B, Costantini C et al. (2012) Water Quality and *Anopheles gambiae* Larval Tolerance to Pyrethroids in the Cities of Douala and Yaounde (Cameroon). *J Trop Med* 2012: 429817.
- Nkya TE, Akhouayri I, Kisinza W, David JP (2013) Impact of environment on mosquito response to pyrethroid insecticides: facts, evidences and prospects. *Insect Biochem Mol Biol* 43: 407-416. doi:10.1016/j.ibmb.2012.10.006. PubMed: 23123179.
- Hemingway J, Hawkes NJ, McCarron L, Ranson H (2004) The molecular basis of insecticide resistance in mosquitoes. *Insect Biochem Mol Biol* 34: 653-665. doi:10.1016/j.ibmb.2004.03.018. PubMed: 15242706.
- Labbé P, Alout H, Djogbéno L, Pasteur N, Weill M (2011). p. 14 -. Evolution of resistance to insecticide in disease vectors. Genetics and evolution of infectious disease. London: Elsevier. pp. 409.
- Labbe P, Lenormand T, Raymond M (2005) On the worldwide spread of an insecticide resistance gene: a role for local selection. *J Evol Biol* 18: 1471-1484. doi:10.1111/j.1420-9101.2005.00938.x. PubMed: 16313460.
- Ffrench-Constant RH, Pittendrigh B, Vaughan A, Anthony N (1998) Why are there so few resistance-associated mutations in insecticide target genes? *Philos Trans R Soc Lond B* 353: 1685-1693. doi:10.1098/rstb.1998.0319. PubMed: 10021768.
- Martinez-Torres D, Chevillon C, Brun-Barale A, Berge JB, Pasteur N et al. (1999) Voltage-dependent Na⁺ channels in pyrethroid-resistant *Culex pipiens* L mosquitoes. *Pestic Sci* 55: 1012-1020. doi:10.1002/(SICI)1096-9063(199910)55:10.
- Weill M, Lutfalla G, Mogensen K, Chandre F, Berthomieu A et al. (2003) Comparative genomics: Insecticide resistance in mosquito vectors. *Nature* 423: 136-137. doi:10.1038/423136a. PubMed: 12736674.
- Ayame CM, Pasteur N, Dumas E, Tortosa P, Tantely ML et al. (2011) Cytoplasmic incompatibility as a means of controlling *Culex pipiens quinquefasciatus* mosquito in the islands of the south-western Indian Ocean. *PLoS Negl Trop. Drosophila Inf Serv* 5: e1440.
- Georghiou GP, Metcalf RL, Giddey FE (1966) Carbamate-resistance in mosquitoes. Selection of *Culex pipiens fatigans* Wiedemann (= *C. quinquefasciatus* Say) for resistance to Baygon. *Bull World Health Organ* 35: 691-708. PubMed: 5297803.
- Raymond M, Fournier D, Bride JM, Cuany A, Berge J et al. (1986) Identification of resistance mechanisms in *Culex pipiens* (Diptera: Culicidae) from southern France: insensitive acetylcholinesterase and detoxifying oxidases. *J Econ Entomol* 79: 1452-1458. PubMed: 3805481.
- Perry AS, Mattson AM, Buckner AJ (1953) The mechanism of synergistic action of DMC with DDT against resistant house flies. *Biol Bull* 104: 426-438. doi:10.2307/1538495.
- Clark AG, Shamaan NA (1984) Evidence that DDT-dehydrochlorinase from the housefly is a glutathione S-transferase. *Pestic Biochem Physiol* 22: 249-261. doi:10.1016/0048-3575(84)90018-X.
- Perry AS, Buckner AJ (1970) Studies on microsomal cytochrome P-450 in resistant and susceptible houseflies. *Life Sci* 9: 335-350. doi:10.1016/0024-3205(70)90178-5. PubMed: 5463058.
- Metcalf RL (1967) Mode of action of insecticide synergists. *Annu Rev Entomol* 12: 229-256. doi:10.1146/annurev.en.12.010167.001305. PubMed: 5340719.
- Sakuma M (1998) Probit analysis of preference data. *Appl Entomol Zool* 33: 339-347.
- Finney DJ (1971). *robit Anal Camb*: 333.

34. Bradford MM (1976) Rapid and sensitive method for quantitation of microgram quantities of protein utilizing principle of protein-dye binding. *Anal Biochem* 72: 248-254. doi:10.1016/0003-2697(76)90527-3. PubMed: 942051.
35. Brogdon WG, McAllister JC, Vulule J (1997) Heme peroxidase activity measured in single mosquitoes identifies individuals expressing an elevated oxidase for insecticide resistance. *J Am Mosq Contr Assoc* 13: 233-237. PubMed: 9383763.
36. Hemingway J, WHO (1998) Techniques to detect insecticide resistance mechanisms (field and laboratory manual). Geneva: World Health Organization. WHO/CDS/CPC/MAL/98.6. 35 p
37. StatSoft (2011) STATISTICA (logiciel d'analyse des données), version 10.
38. Pasteur NP, Bonhomme G, Catalan F, Britton-Davidian JJ (1987) Manuel technique de génétique par électrophorèse des protéines; D Te. Paris: Lavoisier.
39. Berticat C, Dubois M-P, Marquine M, Chevillon C, Raymond M (2000) A molecular test to identify resistance alleles at the amplified esterase locus in the mosquito *Culex pipiens*. *Pest Manag Sci* 56: 727-731. doi: 10.1002/1526-4998(200009)56:9.
40. Rogers SOB, [(surname)] (1988) Extraction of DNA from plant tissues. Boston: Kluwer Academic Publisher.
41. Bourguet D, Pasteur N, Bisset J, Raymond M (1996) Determination of *ace-1* genotypes in single mosquitoes: toward an ecumenical biochemical test. *Pestic Biochem Physiol* 55: 122-128. doi:10.1006/pest.1996.0041. PubMed: 8980036.
42. Weill M, Malcolm C, Chandre F, Mogensen K, Berthomieu A et al. (2004) The unique mutation in *ace-1* giving high insecticide resistance is easily detectable in mosquito vectors. *Insect Mol Biol* 13: 1-7. doi: 10.1111/j.1365-2583.2004.00452.x. PubMed: 14728661.
43. Raymond M, Rousset F (1995) Genepop (Version-1.2) - Population-genetics software for exact tests and ecumenism. *J Hered* 86: 248-249.
44. Holm S (1979) A simple sequentially rejective multiple test procedure. *Scand J Stat* 6: 65-70.
45. Raymond M, Heckel DG, Scott JG (1989) Interactions between pesticide genes: model and experiment. *Genetics* 123: 543-551. PubMed: 2599366.
46. Pasteur N, Marquine M, Cheikh HB, Bernard C, Bourguet D (1999) A new mechanism conferring unprecedented high resistance to chlorpyrifos in *Culex pipiens* (Diptera: Culicidae). *J Med Entomol* 36: 794-802. PubMed: 10593083.
47. Pennell JT, Hoskins WM (1964) The monofactorial inheritance of resistance to dieldrin in larval and adult *Culex quinquefasciatus* Say. *Bull World Health Organ* 31: 669-677. PubMed: 14278004.
48. Ridley M (2004) Evolution: third edition. Blackwell Publishing. 751 pp.
49. Lenormand T, Guillemaud T, Bourguet D, Raymond M (1998) Evaluating gene flow using selected markers: a case study. *Genetics* 149: 1383-1392. PubMed: 9649528.
50. Labbé P, Berthomieu A, Berticat C, Alout H, Raymond M et al. (2007) Independent duplications of the acetylcholinesterase gene conferring insecticide resistance in the mosquito *Culex pipiens*. *Mol Biol Evol* 24: 1056-1067. doi:10.1093/molbev/msm025. PubMed: 17283366.
51. Djogbénou L, Labbé P, Chandre F, Pasteur N, Weill M (2009) *Ace-1* duplication in *Anopheles gambiae*: a challenge for malaria control. *Malar J* 8: 70. doi:10.1186/1475-2875-8-70. PubMed: 19374767.
52. Ben Cheikh H, Ben Ali-Haouas Z, Marquine M, Pasteur N (1998) Resistance to organophosphorus and pyrethroid insecticides in *Culex pipiens* (Diptera: Culicidae) from Tunisia. *J Med Entomol* 35: 251-260. PubMed: 9615543.
53. Ministry of Health and Quality of Life Mauritius (2009) Operational plan for the prevention and control of Chikungunya and Dengue in the Republic of Mauritius. Minist Health Quality Life Mauritius: 94.
54. Hardstone MC, Lazzaro BP, Scott JG (2009) The effect of three environmental conditions on the fitness of cytochrome P450 monooxygenase-mediated permethrin resistance in *Culex pipiens quinquefasciatus*. *BMC Evol Biol* 9: 42. doi:10.1186/1471-2148-9-42. PubMed: 19228410.
55. Raymond M, Callaghan A, Fort P, Pasteur N (1991) Worldwide migration of amplified insecticide resistance genes in mosquitoes. *Nature* 350: 151-153. doi:10.1038/350151a0. PubMed: 2005964.
56. Weill M, Berthomieu A, Berticat C, Lutfalla G, Nègre V et al. (2004) Insecticide resistance: a silent base prediction. *Curr Biol* 14: R552-R553. doi:10.1016/j.cub.2004.07.008. PubMed: 15268871.
57. Lenormand T, Bourguet D, Guillemaud T, Raymond M (1999) Tracking the evolution of insecticide resistance in the mosquito *Culex pipiens*. *Nature* 400: 861-864. doi:10.1038/23685. PubMed: 10476962.
58. Berticat C, Boquien G, Raymond M, Chevillon C (2002) Insecticide resistance genes induce a mating competition cost in *Culex pipiens* mosquitoes. *Genet Res* 79: 41-47. PubMed: 11974602.
59. Duron O, Labbé P, Berticat C, Rousset F, Guillot S et al. (2006) High *Wolbachia* density correlates with cost of infection for insecticide resistant *Culex pipiens* mosquitoes. *Evolution* 60: 303-314. doi: 10.1554/05-340.1. PubMed: 16610322.
60. Bourguet D, Guillemaud T, Chevillon C, Raymond M (2004) Fitness costs of insecticide resistance in natural breeding sites of the mosquito *Culex pipiens*. *Evolution* 58: 128-135. doi:10.1554/03-423. PubMed: 15058725.
61. Berticat C, Bonnet J, Duchon S, Agnew P, Weill M et al. (2008) Costs and benefits of multiple resistance to insecticides for *Culex quinquefasciatus* mosquitoes. *BMC Evol Biol* 8: 104. doi: 10.1186/1471-2148-8-104. PubMed: 18397515.
62. Oakeshott JG, Devonshire AL, Claudianos C, Sutherland TD, Horne I et al. (2005) Comparing the organophosphorus and carbamate insecticide resistance mutations in cholin- and carboxyl-esterases. *Chem Biol Interact* 157-158: 269-275. doi:10.1016/j.cbi.2005.10.041. PubMed: 16289012.
63. Hollingworth RM, Dong K (2008) The biochemical and molecular genetic basis of resistance to pesticides in arthropods. In: ME Whalon D Mota-Sanchez RM Hollingworth. *Global Pesticide Resistance in Arthropods*: CABI. p. 169.
64. Nash RG, Woolson EA (1967) Persistence of chlorinated hydrocarbon insecticides in soils. *Science* 157: 924-927. doi:10.1126/science.157.3791.924. PubMed: 17792829.
65. Tomlin C (2009) The Pesticide Manual: A World Compendium: BCPC.
66. Labbé P, Sidos N, Raymond M, Lenormand T (2009) Resistance gene replacement in the mosquito *Culex pipiens*: fitness estimation from long-term cline series. *Genetics* 182: 303-312. doi:10.1534/genetics.109.101444. PubMed: 19293141.
67. Ffrench-Constant RH, Anthony N, Aronstein K, Rocheleau T, Stilwell G (2000) Cycloidiene insecticide resistance: from molecular to population genetics. *Annu Rev Entomol* 45: 449-466. doi:10.1146/annurev.ento.45.1.449. PubMed: 10761585.
68. Liu HQ, Cupp EW, Micher KM, Guo AG, Liu NN (2004) Insecticide resistance and cross-resistance in Alabama and Florida strains of *Culex quinquefasciatus*. *J Med Entomol* 41: 408-413. doi: 10.1603/0022-2585-41.3.408. PubMed: 15185942.
69. Yebakima A, Marquine M, Rosine J, Yp Tcha MM, Pasteur N (2004) Evolution of resistance under insecticide selection pressure in *Culex pipiens quinquefasciatus* (Diptera, Culicidae) from Martinique. *J Med Entomol* 41: 718-725. doi:10.1603/0022-2585-41.4.718. PubMed: 15311466.
70. Corbel V, N'Guessan R, Brengues C, Chandre F, Djogbenou L et al. (2007) Multiple insecticide resistance mechanisms in *Anopheles gambiae* and *Culex quinquefasciatus* from Benin, West Africa. *Acta Trop* 101: 207-216. doi:10.1016/j.actatropica.2007.01.005. PubMed: 17359927.
71. Ranson H, Abdallah H, Badolo A, Guelbeogo WM, Kera-Hinzoumbé C et al. (2009) Insecticide resistance in *Anopheles gambiae*: data from the first year of a multi-country study highlight the extent of the problem. *Malar J* 8: 299. doi:10.1186/1475-2875-8-299. PubMed: 20015411.
72. Fonseca-Gonzalez I, Quinones ML, Lenhart A, Brogdon WG (2011) Insecticide resistance status of *Aedes aegypti* (L.) from Colombia. *Pest Manag Sci* 67: 430-437.
73. Jones CM, Machin C, Mohammed K, Majambere S, Ali AS et al. (2012) Insecticide resistance in *Culex quinquefasciatus* from Zanzibar: implications for vector control programmes. *Parasit Vectors* 5: 78. doi: 10.1186/1756-3305-5-78. PubMed: 22520274.
74. Namountougou M, Simard F, Baldet T, Diabaté A, Ouédraogo JB et al. (2012) Multiple insecticide resistance in *Anopheles gambiae* s.l. populations from Burkina Faso, West Africa. *PLOS ONE* 7: e48412. doi:10.1371/journal.pone.0048412. PubMed: 23189131.
75. Marcombe S, Mathieu RB, Pocquet N, Riaz MA, Poupardin R et al. (2012) Insecticide resistance in the dengue vector *Aedes aegypti* from Martinique: distribution, mechanisms and relations with environmental factors. *PLOS ONE* 7: e30989. doi:10.1371/journal.pone.0030989. PubMed: 22363529.
76. Sabatinelli G, Ranieri E, Gianzi FP, Papakay M, Cancrini G (1994) Role of *Culex quinquefasciatus* in the transmission of bancroftian filariasis in the Federal Islamic Republic of Comoros (Indian Ocean). *Parasite* 1: 71-76. PubMed: 9235195.
77. CNEV (2012) Circulation de *Wuchereria bancrofti* à Mayotte. Montpellier.
78. Sang R, Kioko E, Lutomia J, Warigia M, Ochieng C et al. (2010) Rift Valley fever virus epidemic in Kenya, 2006/2007: the entomologic

- investigations. *Am J Trop Med Hyg* 83: 28-37. doi:10.4269/ajtmh.2010.09-0734. PubMed: 20682903.
79. Jambulingam P, Sadanandane C, Boopathi Doss PS, Subramanian S, Zaim M (2008) Field evaluation of an insect growth regulator, pyriproxyfen. p. 0.5% GR against *Culex quinquefasciatus*, the vector of Bancroftian filariasis in Pondicherry, India. *Acta Trop* 107: 20-24.
80. Sadanandane C, Boopathi Doss PS, Jambulingam P (2012) Efficacy of three formulations of diflubenzuron, an insect growth regulator, against *Culex quinquefasciatus* Say, the vector of Bancroftian filariasis in India. *Indian J Med Res* 136: 783-791. PubMed: 23287125.
81. Marina CF, Bond JG, Muñoz J, Valle J, Chirino N et al. (2012) Spinosad: a biorational mosquito larvicide for use in car tires in southern Mexico. *Parasit Vectors* 5: 95. doi:10.1186/1756-3305-5-95. PubMed: 22608138.

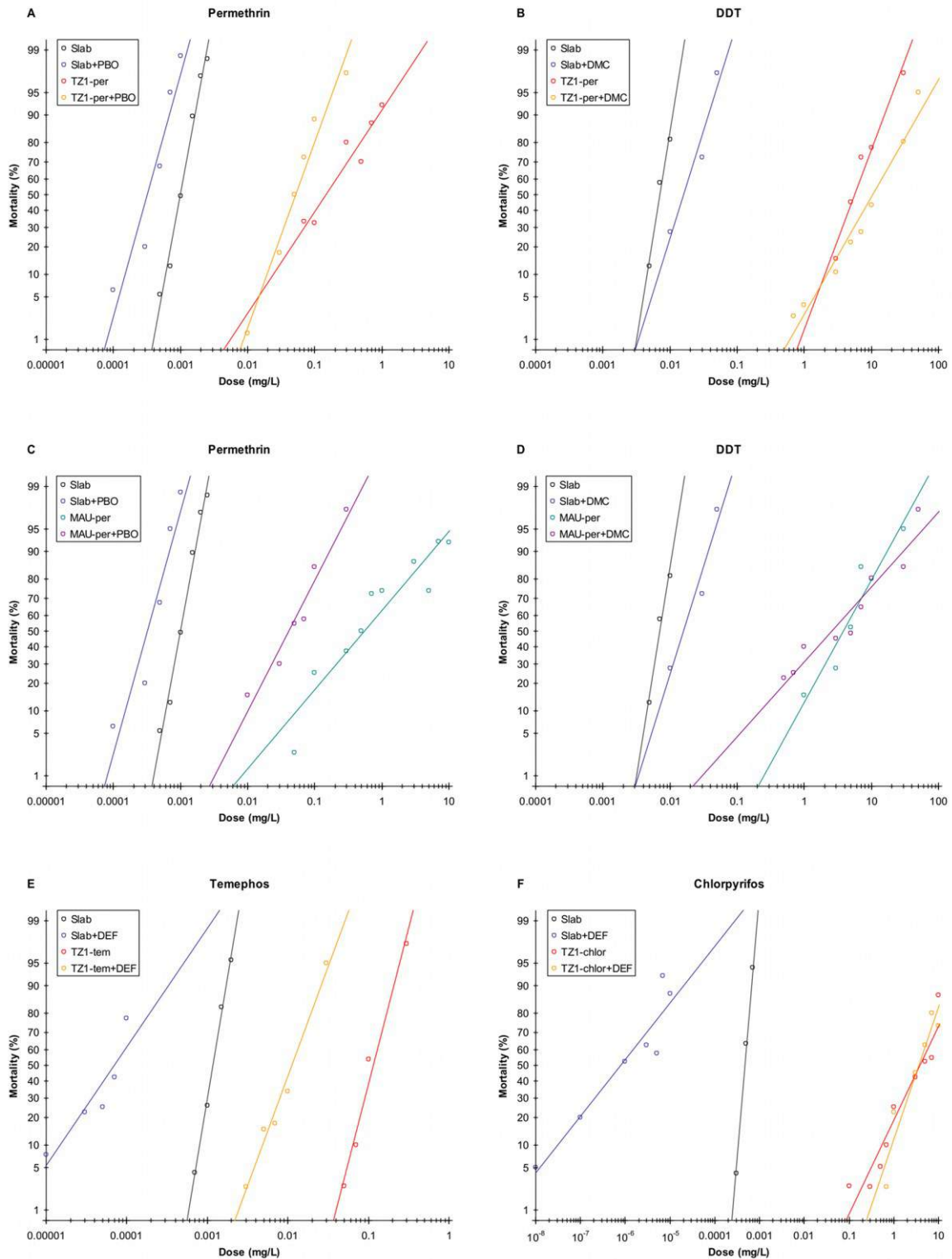

Synergist effect on resistance levels of TZ1 and MAU strains selected to insecticides. Each graph shows the dose-mortality of Slab and one selected strain for one insecticide, with or without synergist. Panel A: effect of permethrin on Slab and TZ1-per, with or without PBO. Panel B: effect of DDT on Slab and TZ1-per, with or without DMC. Panel C: effect of permethrin on Slab and MAU-per, with or without PBO. Panel D: effect of DDT on Slab and MAU-per, with or without DMC. Panel E: effect of temephos on Slab and TZ1-tem, with or without DEF. Panel F: effect of chlorpyrifos on Slab and TZ1-chlor, with or without DEF.

RESEARCH

Open Access

Insecticide resistance in disease vectors from Mayotte: an opportunity for integrated vector management

Nicolas Pocquet^{1*}, Frédéric Darriet¹, Betty Zumbo², Pascal Milesi³, Julien Thiria^{2,3,4}, Vincent Bernard¹, Céline Toty^{1,2}, Pierrick Labbé³ and Fabrice Chandre¹

Abstract

Background: Mayotte, a small island in the Indian Ocean, has been affected for many years by vector-borne diseases. Malaria, Bancroftian filariasis, dengue, chikungunya and Rift Valley fever have circulated or still circulate on the island. They are all transmitted by Culicidae mosquitoes. To limit the impact of these diseases on human health, vector control has been implemented for more than 60 years on Mayotte. In this study, we assessed the resistance levels of four major vector species (*Anopheles gambiae*, *Culex pipiens quinquefasciatus*, *Aedes aegypti* and *Aedes albopictus*) to two types of insecticides: i) the locally currently-used insecticides (organophosphates, pyrethroids) and ii) alternative molecules that are promising for vector control and come from different insecticide families (bacterial toxins or insect growth regulators). When some resistance was found to one of these insecticides, we characterized the mechanisms involved.

Methods: Larval and adult bioassays were used to evaluate the level of resistance. When resistance was found, we tested for the presence of metabolic resistance through detoxifying enzyme activity assays, or for target-site mutations through molecular identification of known resistance alleles.

Results: Resistance to currently-used insecticides varied greatly between the four vector species. While no resistance to any insecticides was found in the two *Aedes* species, bioassays confirmed multiple resistance in *Cx. p. quinquefasciatus* (temephos: ~ 20 fold and deltamethrin: only 10% mortality after 24 hours). In *An. gambiae*, resistance was scarce: only a moderate resistance to temephos was found (~5 fold). This resistance appears to be due only to carboxyl-esterase overexpression and not to target modification. Finally, and comfortingly, none of the four species showed resistance to any of the new insecticides.

Conclusions: The low resistance observed in Mayotte's main disease vectors is particularly interesting, because it leaves a range of tools useable by vector control services. Together with the relative isolation of the island (thus limited immigration of mosquitoes), it provides us with a unique place to implement an integrated vector management plan, including all the good practices learned from previous experiences.

Keywords: Insecticide resistance, Mosquito control, Resistance management, Integrated vector management

* Correspondence: nicolas.pocquet@ird.fr

¹Institut de Recherche pour le Développement, Unité Mixte de Recherche MIVEGEC (IRD 224-CNRS 5290-UM1-UM2), 911, avenue Agropolis, BP 64501 34394 Montpellier cedex 5, France

Full list of author information is available at the end of the article

Background

Mayotte is a French island located in the Indian Ocean, in the Comoros archipelago. For many years, this island has been heavily affected by vector-borne diseases. Historically, the two diseases that mainly plagued the island were Bancroftian filariasis, mostly transmitted by *Culex pipiens quinquefasciatus* [1-4], and malaria, transmitted by several anopheline species, including *Anopheles gambiae* s.s. [5,6]. Today, malaria is still present in Mayotte, although the number of cases has significantly decreased during the last two years [7]. Moreover, while the disease was considered eliminated from the island, some cases of Bancroftian filariasis were recently recorded [8].

In addition to these endemic diseases, a major dengue fever outbreak in 1943 [9] and a chikungunya outbreak in 2005 and 2006 have also affected Mayotte [10]. Both are due to arboviruses transmitted by *Aedes* species. However, while dengue was principally transmitted by *Aedes aegypti*, chikungunya main vector was *Ae. albopictus* [11]. This last species, observed for the first time on the island in 2001 [12], has since almost completely replaced *Ae. aegypti* [13], and certainly played the main role in the recently recorded cases of dengue and chikungunya [14]. Finally, new arboviruses recently started to circulate on the island, including the Rift Valley Fever virus [15].

To limit the impact of these diseases on people from Mayotte, many vector control programs have been implemented since the early 50s [16]. Most of the efforts were intended to control *Cx. p. quinquefasciatus* and *An. gambiae* populations, to prevent filariasis and malaria. They relied almost entirely on the use of chemical insecticides (from the organochlorines (OC), organophosphates (OP) and pyrethroids (PYR) families), through extensive applications on larval breeding sites, indoor residual spraying treatments (IRS) [3,5,9,16-18] and, more recently, long-lasting insecticide treated nets (LLIN). These vector control campaigns have had good results and greatly limited the impact of lymphatic filariasis and malaria in Mayotte [4,6]. Today however, several constraints could impede vector control. The first constraint is administrative, with a significant reduction of the number of insecticides available for vector control due to new European^a regulations [19]. All pesticide molecules had indeed to be re-examined in 2007 for marketing authorization, through a costly application filed by the producers; some unprofitable yet efficient molecules were not supported. There are also technical difficulties, due to the increasing role of *Ae. albopictus* as a major vector of arboviruses in Mayotte. Due to their preferences for confined larval breeding sites (natural, like tree holes, or artificial, like used tires) and their eggs resistant to desiccation [20,21], *Ae. albopictus* is particularly difficult to reach through conventional sprays of

insecticides. The third type of constraints is ecological: Mayotte is a small island with a specific ecosystem encompassing many endemic species, and as such must be protected from anthropic pollutions. The effects of insecticide treatments on non-target fauna and their potential accumulation in the food chain need to be taken into account and limited. Finally, the last and most important challenge come from evolutionary process: the long-term use of insecticides is known to select for resistance of the target insects, with the possible effect of rendering the available molecules ineffective for control [22].

However, in Mayotte, almost nothing was known on the resistance status of the various mosquito vectors, until a recent study on *Cx. p. quinquefasciatus* [23]. This study showed that many resistance mechanisms were present in this species, so that the lack of data for the other vectors became a major concern. In view of the history of insecticide treatments in the island, many resistance mechanisms could have been selected in the other species as well, and could prevent efficient vector control measures. There are indeed a large number of insecticide resistance mechanisms in mosquitoes, mainly through metabolic resistances or insecticide target modifications (review in: [24-26]). The usual way of overcoming resistance is to change the molecule used to restore efficient vector control. However, the number of new molecules available is continuously shrinking [27], and cross-resistance (i.e. the fact that one resistance mechanism is able to confer resistance to other molecule families) could lead to an additional reduction of alternatives [28].

All these constraints have to be considered to implement a rational and sustainable vector control plan. In this type of plan, it is clearly important to monitor the resistance levels to currently-used insecticides and to assay the few valuable and authorized molecules that could replace them in case of insecticide resistance development in the targeted vectors.

In this study, the four main mosquito vectors of the island (*Cx. p. quinquefasciatus*, *An. gambiae*, *Ae. aegypti* and *Ae. albopictus*) were thus investigated to determine their levels of resistance to the insecticides currently used in Mayotte: temephos (OP), *Bti* (bacterial toxins (BacT) extracted from *Bacillus thuringiensis* var *israelensis*), and deltamethrin (PYR). When resistance was found, the mechanisms involved were characterized through biochemical and molecular analyses. In addition, resistance to four candidate insecticides for vector control in Mayotte was also assayed: spinosad, an insecticide of bacterial origin (Spinosyns), and three insect growth regulators or IGRs, diflubenzuron, pyriproxyfen and methopren. The results are discussed in the light of the vector control strategies usable to prevent emergence and spread of resistance in the island vectors.

Methods

Mosquito samples and strains

Five laboratory strains were used in this study: *An. gambiae* KIS strain [29], *Cx. p. quinquefasciatus* SLAB strain [30], *Ae. aegypti* BORA strain [31] and *Ae. albopictus* PLP strain [32] were used as susceptible reference strains; the *An. gambiae* AcerKIS strain [33], homozygous for the G119S mutation of acetylcholinesterase [34], was used as the OP-resistant reference strain in this species.

Field larvae of *An. gambiae*, *Cx. p. quinquefasciatus*, *Ae. aegypti* and *Ae. albopictus* were collected in Mayotte between 2010 and 2011. Natural populations (Figure 1) were sampled from a garbage dump in Dzoumogné for *An. gambiae* (DZOU), an open sewer in Tsoundzou for *Cx. p. quinquefasciatus* (TZ1), several peri-domestic breeding sites in Petite Terre for *Ae. aegypti* (PT) and a stock of used tires in Kaweni for *Ae. albopictus* (KWI). The larvae of *An. gambiae* and *Cx. p. quinquefasciatus* were collected at early instars (1st or 2nd), reared in the laboratory to 3rd instar, and used for bioassays. The larvae of *Ae. aegypti* and *Ae. albopictus* were reared to adulthood in the laboratory. Mono-specific colonies of

Ae. aegypti and *Ae. albopictus* were established, and females were blood-fed to obtain F1 offsprings, which were used for bioassays (3rd-instar larvae). In *Cx. p. quinquefasciatus*, *Ae. aegypti* and *Ae. albopictus* samples, some of the field larvae were kept, reared, and the adults were bred in the laboratory to establish TZ1, PT and KWI colonies. These colonies were used for IGR bioassays. Due to technical difficulties for establishing an *An. gambiae* colony from field individuals, IGR bioassays were directly performed on field-collected larvae.

Finally, to overcome the difficulties to establishing an *An. gambiae* colony while remaining close to the original field population (as for the other species), the DZOU temephos resistance gene(s) were introgressed into the genome of the KIS strain, leading to the DZKIS strain. DZOU males were crossed with unmated females of the KIS strain and their progeny reared in the laboratory. Third-instar larvae were selected with temephos at a dose killing 80% of the individuals. Male survivors were backcrossed on females of the KIS strain and selected again. The following generations were then left to cross among themselves, 3rd-instar larvae being selected with temephos at each generation, until the resistance level had stopped increasing (10 generations). This protocol provided the DZKIS strain, containing mainly DZOU genome (the field population colony), and just enough KIS genome to be lab-adapted. It also resulted in a strain more homogeneous in terms of resistance.

Bioassays

Larval and adult bioassays were performed following WHO protocols [35,36]. Larval bioassays were carried out using ethanol solutions of the following active ingredients, temephos (OP), chlorpyrifos (OP), malathion (OP), propoxur (carbamate, or CM), spinosad (Spinosyns), diflubenzuron (IGR), pyriproxyfen (IGR) and methopren (IGR) (spinosad from Dow Agro Sciences, Indianapolis, USA; other products from Sigma-Aldrich, Germany), and using water solutions of *Bti* (BacT) formulation (Vectobac 12AS, 1200 ITU/mg). Larval bioassays were conducted on sets of 25 early 3rd-instar larvae placed in a cup with 99 ml of water. One ml of the tested insecticide solution was then added in each cup. Assays of four to nine doses in a minimum of two cups per dose were performed for each insecticide. Two replicates were performed for temephos, spinosad and *Bti*, and one or two replicates were performed for chlorpyrifos, malathion, propoxur and IGR insecticides (it results in 250 to 1500 mosquitoes assayed for each insecticide). In temephos, spinosad, chlorpyrifos, malathion, propoxur and *Bti* assays, larval mortality was recorded after 24 hours of insecticide exposure. For IGR assays, the total number of larvae in each cup was recorded after 24 hours and the number of emerging adults was recorded daily. Emergence Inhibition (EI) is calculated for each dose by subtracting the

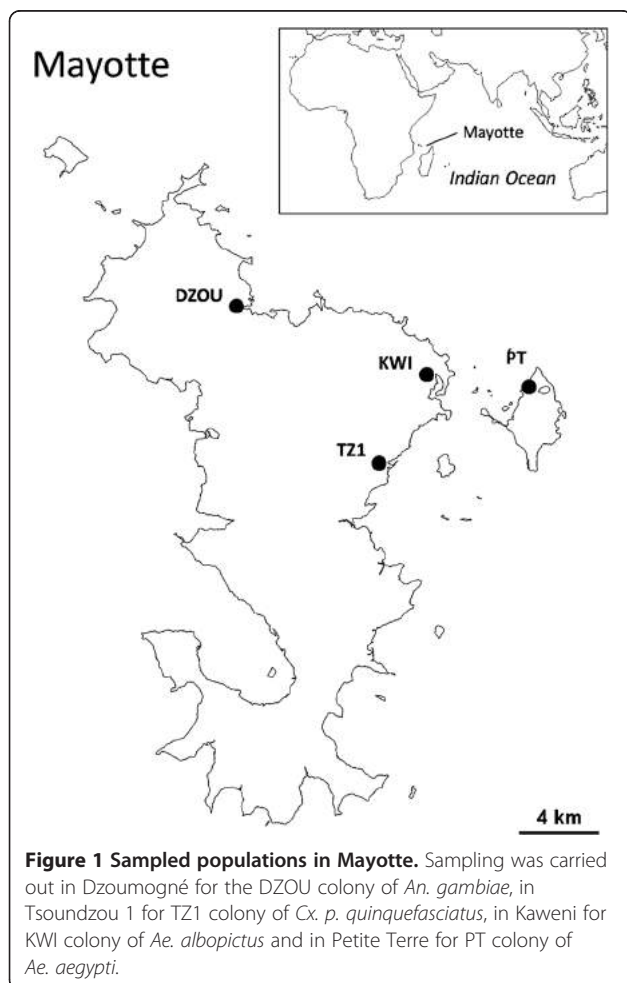

Figure 1 Sampled populations in Mayotte. Sampling was carried out in Dzoumogné for the DZOU colony of *An. gambiae*, in Tsoundzou 1 for TZ1 colony of *Cx. p. quinquefasciatus*, in Kaweni for KWI colony of *Ae. albopictus* and in Petite Terre for PT colony of *Ae. aegypti*.

number of emerged adults to the total number of larvae at the beginning of the test. Note that in such IGR tests, regular feeding of larvae is required, due to their duration (over 10 days). For *Aedes* and *Culex* larvae, 3 to 5 mg per cup of a mixture of dog and fish foods were added every day. For *Anopheles* larvae, 0.5 to 1.5 mg per cup of fish food were added on the surface. The quantity of food was decreased at the appearance of the first pupae, as some larvae were still feeding.

Adult bioassays were carried out using WHO test tubes. This device allows exposing sets of 25 adult females (2–5 days old) to a filter paper impregnated with deltamethrin at a dose of 0.05% (products from Sigma-Aldrich, Germany). This diagnostic dose kills 100% of individuals in a susceptible population [37]. Four sets of 25 females were exposed for 60 minutes to deltamethrin to evaluate its knockdown effect (KD) on each colony or strain. Mortality was recorded after 24 hours. Two replicates per colony/strain were performed.

The analyses of dose-mortality responses were performed using the R software [38]. The R script BioRssay was used; it is freely available on the website of the Institut des Sciences de l'Evolution de Montpellier [39]. This script computes the doses of insecticide killing 50% and 95% of the tested colony or strain (Lethal Concentration 50 and 95, or LC_{50} and LC_{95}) and the associated confidence intervals, using a script modified from Johnson *et al.* [40], which allows taking into account the heterogeneity of the data [41]. Mortality in controls is taken into account using the correction from the Abbott's formula [42]. A generalized linear model (GLM) with a binomial error and a probit link is then fitted to the data where the probit mortality is a function of the logarithm of the dose of insecticide for each colony/strain. The script also computes the slope and intercept of the regression for each colony/strain (and their standard errors), and tests for the linearity of the dose-mortality response (χ^2 test). Finally, it allows the comparison of two or more strains or colonies and calculates the resistance ratios, i.e. RR_{50} or RR_{95} ($=LC_{50}$ or LC_{95} of tested colony/ LC_{50} or LC_{95} of the reference strain, resp.) and their 95% confidence intervals. A RR in which the confidence interval does not include 1 was considered as statistically significant, so that the tested colony was significantly more resistant than the reference. Note, however, that even slight differences between colonies/strains can be statistically significant, due to the high number of mosquitoes tested. However, even a statistically significant $RR < 3$ is usually considered of limited biological significance (such RR can be obtained when comparing susceptible strains, e.g. [43]), and we applied this criterion here. The script then builds custom graphs and a summary text file with the different parameters and tests is provided.

The same script was used to calculate the Emergence Inhibition Concentrations for IGR insecticides (EIC_{50} and EIC_{95}) and the KnockDown Times for deltamethrin (KDT_{50} and KDT_{95}).

Metabolic resistance

Biochemical tests were performed on single 2–5 days-old females from the *An. gambiae* DZOU colony to evaluate the activity of the main families of detoxifying enzymes. Protein amount was quantified in microplates using the method of Bradford [44], the quantity or activity of the different detoxifying enzymes were expressed per mg of protein present in the homogenate or quantity of molecules metabolized per minute, respectively. Cytochrome P450 monooxygenases (named mixed function oxidases or MFO) were quantified indirectly by the peroxidase activity of the heme group with tetramethylbenzidine (note that all hemoproteins are thus quantified, not only MFO; [45]). Carboxyl-esterases (COE) were quantified indirectly by their ability to hydrolyze α -naphthyl and β -naphthyl acetate [46].

Statistical comparisons of detoxifying enzyme activities present in the *An. gambiae* susceptible strain KIS and the DZOU colony were computed using Mann–Whitney tests with the Statistica software [47].

Analyses of target-site modifications

Total DNA of single mosquitoes of the *An. gambiae* DZOU colony was extracted using the CTAB protocol [48]. The G119S mutation, carried by the *ace-1^R* allele of the acetylcholinesterase-1 gene (AChE1), was investigated using the PCR-RFLP test described by Weill *et al.* [49]. Two substitutions in the *kdr* gene are known to cause resistance to PYR in *An. gambiae*: L1014F and L1014S, respectively most often encountered in West Africa and East Africa. They were investigated using the multiplex-PCR described in Martinez-Torres *et al.* [50] and Ranson *et al.* [51], respectively. We thereafter called these two alleles *kdr^R*, indifferently. Only the L1014F mutation was found in *Culex quinquefasciatus* from Mayotte, where it was investigated in our precedent study [23], using the multiplex-PCR described in Martinez-Torres *et al.* [52]. The resistance allele was called *kdr^R* thereafter.

Results and discussion

No resistance observed in *Ae. aegypti* and *Ae. albopictus*

Larval bioassays revealed that colonies from field populations of *Ae. aegypti* and *Ae. albopictus* (PT and KWI, respectively) did not show biologically significant resistance to any of the tested larvicides (RR between 0.3 and 1.6, Figure 2 and Additional file 1). Similarly, adult bioassays to deltamethrin showed a complete susceptibility of these two species (over 97% mortality 24 hours after

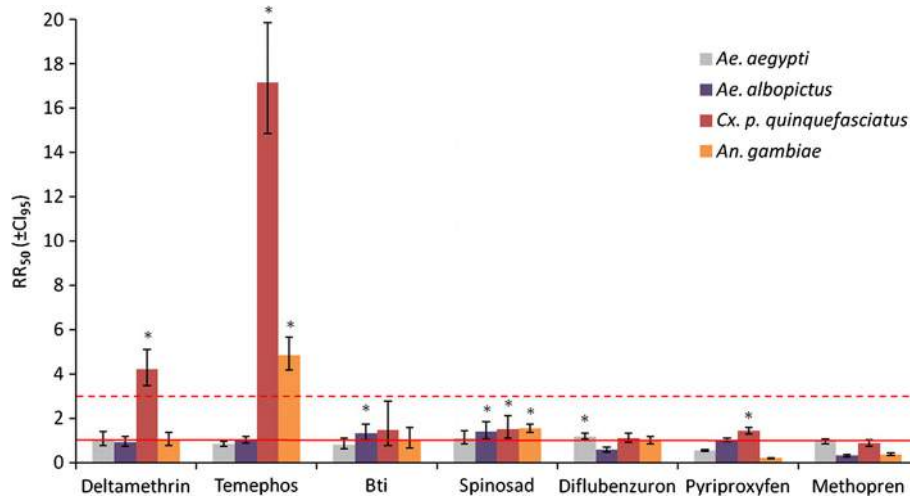

Figure 2 Insecticide resistance in vector mosquitoes from Mayotte. The resistance ratios (RR_{50} , i.e. the ratios of LC_{50} of the tested colonies over the LC_{50} of the susceptible reference strain), of colonies from field populations of *Ae. aegypti* (gray), *Ae. albopictus* (purple), *Cx. p. quinquefasciatus* (red) and *An. gambiae* (orange) to different tested insecticides are presented. The error bars represent the confidence interval of RR at 95%. The solid red line represents $RR = 1$ (i.e. a LC_{50} equal to that of the susceptible reference) and the dotted red line represents $RR = 3$ (resistance is considered of biological significance when above). RR significantly higher than 1 (i.e. when CI_{95} does not include 1) are indicated by a star.

exposure) and no increase of knockdown times was observed as compared to the susceptible reference strains (RR between 0.9 and 1, Figure 2 and Additional file 2).

The susceptibility of these two *Aedes* species to IGRs, Spinosad and *Bti* is not surprising because these insecticides have never been used on the island before 2011 ([16]; Belon, personal communication). Since 2011, *Bti* has been used by the vector control service of Mayotte as a larvicide, but not against *Aedes* species.

In contrast, temephos (larvicide) was used in Mayotte from 1973 to 2012 and deltamethrin (adulticide) has been used since 1984 ([16], Belon, personal communication), but no resistance was observed in either *Ae. aegypti* or *Ae. albopictus*. Several factors may explain the absence of resistance to deltamethrin and temephos in these two species. First, before the 2005–2006 chikungunya outbreak [10], these species were not targeted by vector control treatments. Since the epidemic, control against these two vectors is essentially based on social mobilization and physical destruction of breeding sites. Only few insecticide treatments have therefore been carried out specifically against *Aedes* species in Mayotte. Secondly, their main breeding sites are peri-domestic containers used for water storage and small water collections in peri-urban areas (coconut, dead leaves, used tires, etc. [20,21]). These soil-less breeding sites are little affected by environmental xenobiotic contamination (insecticides or pollutants) and difficult to reach by the vector-control teams. Thirdly, deltamethrin is used in Mayotte either in Indoor Residual Spraying (IRS), or on Long Lasting Insecticide-treated Nets (LLIN). These two

modes of treatment target adult female mosquitoes, but only indoors. *Ae. albopictus* and *Ae. aegypti* being diurnal and exophagous species [53,54], they are therefore not likely to be affected by LLINs, which protect people when sleeping. In addition, *Ae. albopictus* is an exophilic species [54], and although *Ae. aegypti* females can rest indoors, they do so preferentially on untreated surfaces [55,56], so that IRSs have little effect on these species. Overall, *Ae. albopictus* and *Ae. aegypti* are therefore likely to be subject to weak selection, which probably explains their complete susceptibility. This situation is radically different from that observed for some other French islands. For example, on the Martinique island, *Ae. aegypti* is the main target of vector control interventions, and this species presents strong levels of PYR resistance in this place [57]. A final remark concerning insensitive acetylcholinesterase target of OP and CM: it has been shown that, in these two *Aedes* species, the G119S mutation of this enzyme is highly unlikely, due to molecular constraints [58]. It was thus not surprising that this particular type of resistance was lacking, and it is unlikely to evolve in the future.

High levels of resistance in *Cx. p. quinquefasciatus*

The results for *Cx. p. quinquefasciatus* are in sharp contrast to those of the two *Aedes* species. Larval and adult bioassays on TZ1 colony indeed revealed strong resistance respectively to temephos ($RR_{50} = 17.2$, $RR_{95} = 18.9$; Figure 2 and Additional file 1) and to deltamethrin (10% of mortality after 24 hours and a strong decrease of knockdown effect: $RR_{50} = 4.2$, $RR_{95} = 4.9$; Figure 2 and

Additional file 2). However, no biologically significant resistance to any of the other tested insecticides has been identified in this colony (RR₅₀ between 0.9 and 1.5, Figure 2 and Additional file 1), even if TZ1 colony showed a low resistance at LC₉₅ to juvenile hormone analogs (pyriproxyfen and methopren, RR₉₅ = 4.9 and 4.1 respectively).

The resistance mechanisms of *Cx. p. quinquefasciatus* in Mayotte have been studied in depth recently (see [23]). Two mechanisms of resistance to OPs were found on the island. The first was an overexpression of esterases, encoded by the *Ester*² allele, and the second was a modification of the AChE1, due to the G119S mutation of the gene *ace-1*. Both were found at relatively high frequencies (0.59 for *Ester*² and 0.39 for *ace-1*^R; [23]). Similarly, the *kdr*^R allele, coding for a modification of the sodium channels allowing resistance to PYRs was found almost fixed on the entire island (*kdr*^R frequency = 0.98). Biochemical tests and bioassays with synergists did not reveal MFO involvement in PYR resistance [23]. The *kdr*^R allele thus appeared to be the main allele responsible for deltamethrin resistance, although the involvement of other metabolic resistance cannot be excluded. The low resistance to juvenile hormone analogues observed at the high doses could thus be due to the overproduction of esterases in this colony [23], as described in other insect species [59].

Cx. p. quinquefasciatus is the major vector of the Bancroftian filariasis, which has been plaguing Mayotte for many years [1,2,4]. Since the 50s, intense vector control efforts have been carried out against this species [16]. Many neurotoxic insecticides targeting AChE1 (OPs) and sodium channels (DDT followed by PYRs) have been used to control it [3,5,16-18]. These important selective pressures certainly explain the strong resistance to temephos and deltamethrin observed in the TZ1 colony. Such strong resistance to PYRs and OPs is not an isolated case in the Indian Ocean. Indeed, this species has been shown to also harbor major resistance mechanisms to PYR, OP and OC insecticides in Mauritius, Madagascar and La Réunion [23,32]).

The susceptibility of *Cx. p. quinquefasciatus* to *Bti* and spinosad and the low resistance to IGRs are probably related, similar to the *Aedes* species, in the fact that these insecticides have not been used in the past in Mayotte. They thus provide interesting alternatives to circumvent the high resistance to the insecticides classically used against *Culex*.

An original temephos resistance mechanism in *An. gambiae*

An. gambiae has always been the main target of insecticide-based vector control in Mayotte, as malaria has been endemic on the island for many years [5,9,16,17,60]. In the DZOU colony, a significant resistance to temephos (RR₅₀ =

4.8, RR₉₅ = 12.9; Figure 2 and Additional file 1) was observed but there was no biologically significant resistance to any of the other insecticides (RR between 0.2 and 2).

Whereas the absence of resistance is expected for the larvicides that have never been used in the island before 2011 (*Bti*, spinosad, IGRs), absence of resistance to the adulticide deltamethrin is particularly striking (over 99% mortality after 24 hours, and full susceptibility to knock-down effect, RR between 1 and 1.1, Figure 2 and Additional file 2). Surprisingly, PCR performed on *An. gambiae* adult mosquitoes of the DZOU colony did not show either any known *kdr* resistance mutation, neither the western (L1014F substitution: N = 31, all susceptible homozygous) nor the eastern (L1014S substitution: N = 28, all susceptible homozygous). Insecticides that target the sodium channel have indeed been used in Mayotte since the early 70s and are still currently used. DDT (OC) was first used in 1973, to be replaced by deltamethrin (PYR) in the early 80s [16]. In several cases, the development of *An. gambiae* s.s. insecticide resistance has been associated with selection pressures related to the control of agricultural pests [29,61,62], but in Mayotte there are no areas of intense agriculture. One hypothesis to explain the lack of *kdr*^R alleles is thus that the selection pressure coming only from public health is not enough to maintain these alleles at a detectable level in natural populations. Furthermore, Mayotte is a relatively isolated island and a second hypothesis is that no importation of a *kdr*^R resistance allele has yet taken place. The fact that so far no *kdr*^R mutation has been reported in *An. gambiae* populations from the closest islands, especially in Madagascar [24,63], gives support to this second hypothesis.

As temephos has been used since 1973 in the island [16,17], the resistance to this insecticide observed in the DZOU colony is more expected. To better understand the mechanism(s) involved, the DZOU colony was partly introgressed in the reference susceptible strain KIS and selected at each generation with temephos, thereby creating the DZKIS strain, which carries a mainly DZOU genome but is able to be maintained in the laboratory. The results of this introgression are presented Figure 3. DZKIS temephos resistance was significantly higher than in DZOU sample at LC₅₀ (RR₅₀ = 6.9 and 4.8, respectively; Additional file 3), but lower at LC₉₅ (RR₉₅ = 3.5 versus 12.9, respectively; Additional file 3). This observation was mainly due to an increase of the slope of the dose-mortality regression between DZOU and DZKIS (1.75 and 7.58 respectively), reflecting a greater genetic homogeneity in the selected strain (due to selection at each generation). Tests carried out on DZKIS with other insecticides that target the AChE1 (Additional file 3) did not show biologically significant cross-resistance to chlorpyrifos (OP, RR₅₀ = 1.2) and to malathion (OP, RR₅₀ = 2.2).

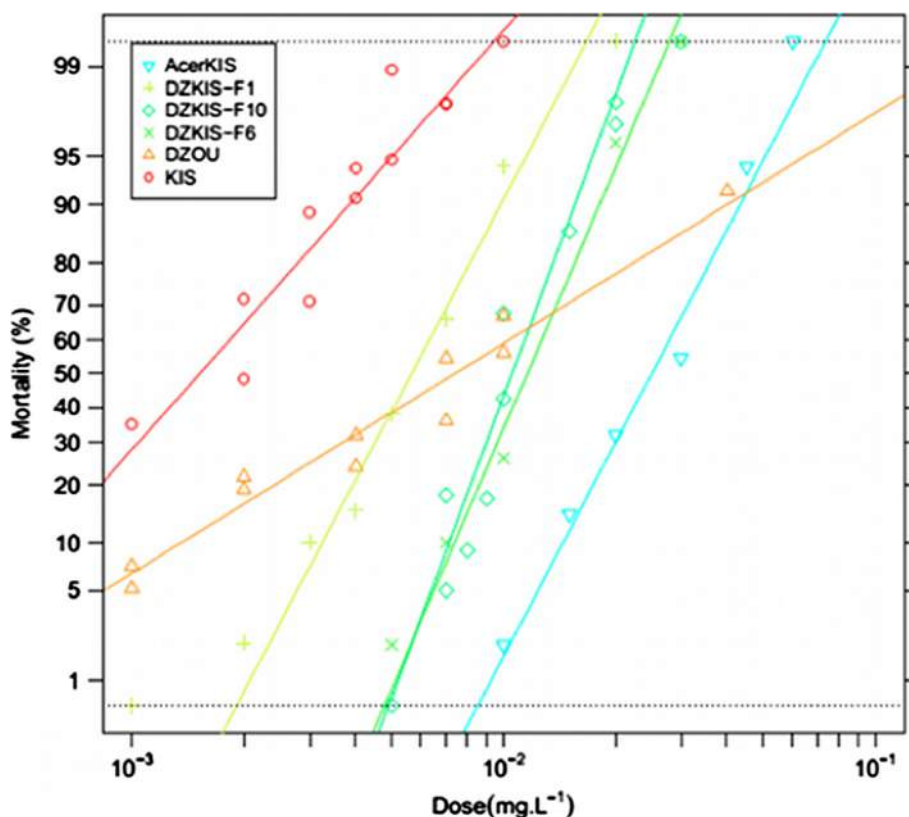

Figure 3 Temephos resistance in the DZKIS strain. The graph shows the evolution of the resistance level to temephos of the DZKIS strain in the 1st, 6th and 10th (i.e. the last) generations of selection. The dose-mortality of the DZOU original colony and of the KIS and AcerKIS reference strains (respectively susceptible and resistant to OPs through the G119S *ace-1* mutation) are also presented.

Moreover, the resistance levels of DZKIS were much lower than those of AcerKIS, the reference *ace-1^R* strain, for temephos (OP, RR₅₀ = 6.9 vs 16.4, respectively), malathion (OP, RR₅₀ = 2.2 vs 21.5, respectively) and propoxur (CM, RR₅₀ = 5.6 vs ≈ 10 000). These results thus exclude the presence of insensitive AChE1 associated with G119S mutation. The absence of the *ace-1^R* allele was confirmed by PCR performed on adult mosquitoes from the DZOU original sample (N = 30, all homozygous for *ace-1* susceptible alleles). The activity or quantity of detoxifying enzymes in adult mosquitoes was compared between the DZOU sample and the KIS strain. The activities of α- and β-esterases were significantly higher in DZOU than in KIS (respectively, 1.19 and 1.47 fold, Mann-Whitney test: p < 0.001; Figure 4B and C). In contrast, the global quantity of MFO was significantly lower for DZOU than for KIS (0.90 fold, Mann-Whitney test: p < 0.001; Figure 4A).

In view of these results, it seems that the temephos resistance observed in *An. gambiae* from Mayotte is mainly due to COE overexpression or overactivity. Resistance to OPs and to a lesser extent CMs by COEs is commonly encountered in insects [64], particularly in mosquito vectors, such as *Culex* species [65,66] or *Ae. aegypti* [57,67,68]. This

resistance mechanism usually confers a low level of resistance (about 10 fold, [26]), which is consistent with the resistance levels observed in DZOU and DZKIS (temephos and propoxur, 5 to 10 fold, Additional file 3). Although OP and CM resistance due to COE has already been reported in *An. gambiae*, it has so far always been found associated to the insensitive AChE1 [69,70], so that the situation in Mayotte is unique.

The DZOU colony breeding-site was a garbage dump, where a large variety of pollutants are present. This is a quite unexpected biotope for this species that usually prefers clean water collection. Such an environment, polluted by xenobiotics and organic matter, could have promoted the selection for an increase of COE expression, as it has been observed for other resistance mechanisms [71,72]. However, *An. gambiae* was also directly targeted by significant OP-based control in Mayotte [5,16]. The selective pressure generated by these treatments did not lead to the selection of the G119S *ace-1* mutation locally, and/or the allele was not imported, probably thanks to the island isolation (while it is extensively present in West Africa for example [33]). The contrast with *Cx. p. quinquefasciatus* is striking and will require more studies to be fully understood.

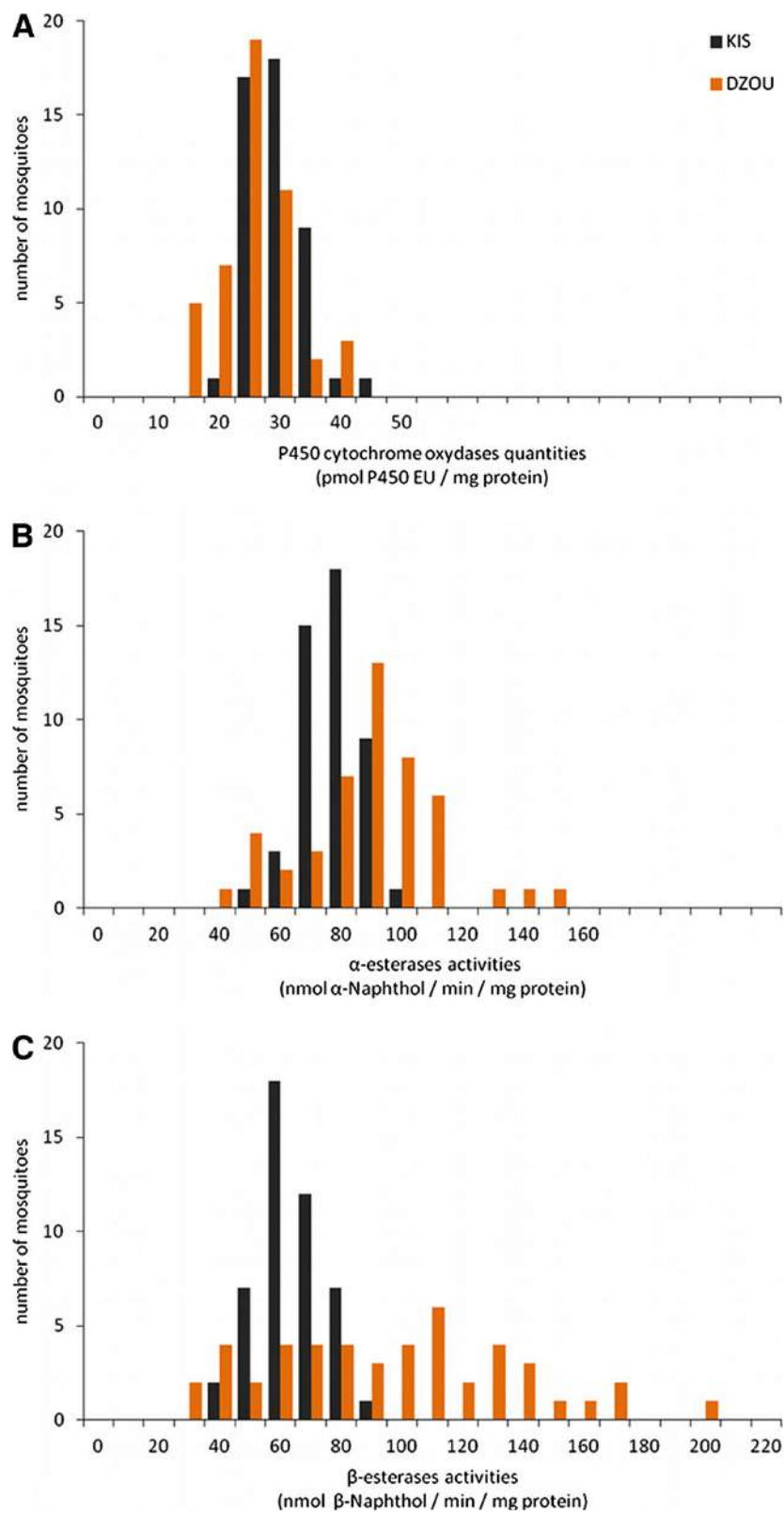

Figure 4 Comparison of detoxification enzyme quantities or activities in single mosquitoes of KIS and DZOU. The amount of cytochrome P450 oxidase (A) (MFO) is expressed in pmol of P450 Equivalent Unit per mg of protein for each mosquito. Activities of α (B) and β -esterases (C) (COE) are expressed as nmol of product formed (α or β -naphthol) per minute and per mg of protein.

Finally, while temephos treatments have certainly favored overexpressed COE selection in the DZOU colony, they might also explain the lower MFO expression in this strain compared to KIS. Indeed, some OP, such as temephos, are bio-activated in their oxon form (the toxic form) by some oxidases, and it has been shown in *Cx. p. quinquefasciatus* that MFO were counter-selected in an environment under temephos pressure [73].

Low resistance in disease vectors: an opportunity for Mayotte

In light of these results, the resistance status of vectors in Mayotte offers an unusual situation in the world of vector control. With the exception of temephos and deltamethrin resistances observed in *Cx. p. quinquefasciatus* and of the low temephos resistance in *An. gambiae*, the four main mosquito vector species were indeed susceptible to the majority of new tested insecticides (*Bti*, spinosad and two IGRs). Due to very different modes of action, resistance mechanisms to OPs and CM identified in *An. gambiae* and *Cx. p. quinquefasciatus*, including COEs, should not confer cross-resistance to these new insecticides (except, maybe, for juvenile hormone analogues, see above). Moreover, temephos has been recently abandoned from the arsenal of authorized insecticides for vector control in France due to European rules [19], and no other insecticides targeting AChE1 is presently authorized. As this resistance is costly in terms of fitness (e.g. [74,75]), they should thus disappear, and should not impact the future vector control efforts.

However, in order to preserve this positive situation, the usual vector control practices should be avoided. In particular, it is important to not use exclusively a single insecticide to control mosquitoes. *Bti* is currently the only larvicide used for vector control in Mayotte, thanks to its many advantages: this insecticide is highly specific, with little effect on non-target organisms [76], and it is a mixture of several synergistic toxins [77], thus limiting the risk of resistance development. Unfortunately, resistance has been described in a field population of *Cx. p. pipiens* from the United States [78] and resistance to separate *Bti* toxins in the laboratory were selected in *Ae. aegypti* [79] or *Cx. p. quinquefasciatus* [80]. Similarly, only deltamethrin is currently used for adulticides (IRS and LLINs). Its efficacy is preserved so far by the susceptibility of *An. gambiae*. However, this absence of resistance to PYRs should be carefully monitored, as it could rapidly spread through natural selection, following its appearance by mutation or importation [81]. Finally, even if other tested insecticides (spinosad and IGRs) are used less in vector control, examples of resistance to these compounds already exist in mosquitoes [78,82-84]. The exclusive use of any of those insecticides would

therefore lead to the rapid emergence and selection of resistance in mosquitoes from Mayotte.

To prevent the development of resistance in these disease vectors, various resistance management strategies can be used. One of the most efficient strategies is to alternatively use insecticides with different modes of action and for which no cross-resistance occur in target populations [26,27]. Such strategies require a large enough panel of molecules. This may be a problem since in Mayotte, as mentioned before, *Bti* is the only larvicide currently allowed for use in natural breeding sites with non-target fauna associated, and deltamethrin the only adulticide authorized. Moreover, alternatives would be necessary in case of emergence of resistance. Therefore, a change in the national, but also European, policies regarding pesticides agreement would be much welcome. Some molecules could be re-authorized to be used only in case of public-health threat for example. This may be the case for temephos, which is a handy, low-cost and relatively safe molecule [85]. Although low resistance to this insecticide was observed in Mayotte (*Anopheles* and *Culex*), the operational doses could remain mostly effective against these vectors [86]. This molecule could thus be used as a back-up in case of emergency. Again, it is important to stress that such back-up would not mean using a single molecule in less pressing periods, in which case emergencies would become the rule.

More generally, the absence of strong resistance in most vectors allows the local vector control programme to develop a preemptive and reasoned insecticide use strategy in order to prevent the risk of development of resistance. This is very positive as such strategies are most often only considered in dire circumstances, i.e. when resistance is installed and when they are thus the least effective. However, the fight against mosquito disease vectors in Mayotte should not be exclusively based on insecticides, but should rather follow an Integrated Vector Management strategy (IVM [87]). This strategy recommends the combination of several tools to manage vector populations: physical destruction of breeding sites, social mobilization of communities, entomological monitoring and rational use of insecticides by all those implementing any action [26,87]. A recent study compared 61 vector control interventions against dengue vectors and showed that interventions based on IVM were more effective than interventions based only on environmental management, biological control or chemical control alone [88]. IVM has already shown good results against *Ae. aegypti* in Singapore and Vietnam [89,90]. This strategy requires the collaboration of several health sectors (vector control services, epidemiologists, hospitals), but also of other sectors not directly related to health (local administration, urbanization development, immigration surveys, waste management, etc.). For example, most of the breeding sites of *Cx. p. quinquefasciatus* in

Mayotte are open sewers and latrines. Improving wastewater management and personal sanitation could greatly reduce the number of available breeding sites for this species. Similarly, the forthcoming closing of the garbage dump of Dzoumogné would limit the number of breeding sites for *An. gambiae* in this area.

Conclusion

Mayotte is an ideal territory to implement an IVM approach and to carefully anticipate vector control management. Indeed, the economic development of the island is now fast and many public works are ongoing. It would be relatively easy to integrate the concept of vector management in the land and city planning policies. Moreover, social mobilization is already used by the local vector control services and is continuously improved. Finally, the low levels of insecticide resistance observed in the main mosquito vectors of the island allow usage of most of the larvicide and adulticide tested here. Thus, only anticipated resistance management strategies and regular entomological surveys remain to be implemented. This unusual situation allows being relatively optimistic about the future of vector control in Mayotte.

Endnote

^aNB: Mayotte has recently become a French overseas administrative department and has to comply with Bio-cide Directive 98/8/EC.

Additional files

Additional file 1: Effects of larvicides on mosquito vectors from Mayotte. Resistance levels of DZOU, TZ1, PT and KWI colonies to temephos, *Bti*, spinosad, diflubenzuron, pyriproxyfen and methopren are compared to resistance levels of the reference strains KIS and AcerKIS, SLAB, BORA and PLP, respectively. For *An. gambiae*, additional tests with chlorpyrifos, malathion and propoxur are presented. N is the total number of tested larvae. The 50 and 95% lethal concentrations (LC_{50} and LC_{95}) and the 50 and 95% emergence inhibition concentrations (EIC_{50} and EIC_{95}) are expressed in mg/l, with their associated confidence intervals at 95% (CI_{95}). Finally, the corresponding resistant ratios (RR), i.e. the ratios of LC or EIC of the tested colony over the susceptible reference strain, are also indicated and presented in bold when significantly higher than 1 (i.e. when CI_{95} does not include 1).

Additional file 2: Effect of deltamethrin on adult vector mosquitoes from Mayotte. Short-term knockdown effect and mortality at 24 hours induced by deltamethrin on DZOU, TZ1, PT, KWI colonies and KIS, SLAB, BORA and PLP reference strains are presented. N is the total number of tested adult females. The 50 and 95% knockdown times (KDT_{50} and KDT_{95}) are expressed in minutes, with their associated confidence intervals at 95% (CI_{95}). Finally, the corresponding resistant ratios (RR), i.e. the ratios of KDT of the tested colony over the susceptible reference strain, are also indicated and presented in bold when significantly higher than 1 (i.e. when CI_{95} does not include 1).

Additional file 3: Effects of OP and CM larvicides on *Anopheles gambiae* from Mayotte. Resistance levels of the introgressed DZKIS strain are compared to resistance levels of the reference strains KIS and AcerKIS for three OP (temephos^a, chlorpyrifos, malathion) and one CM (propoxur) larvicides. N is the total number of tested larvae. The 50 and 95% lethal concentrations (LC_{50} and LC_{95}) are expressed in mg/l, with

their associated confidence intervals at 95% (CI_{95}). Finally, the corresponding resistant ratios (RR), i.e. the ratios of LC of the tested colony over the susceptible reference strain, are also indicated and presented in bold when significantly higher than 1 (i.e. when CI_{95} does not include 1).

Abbreviations

OC: Organochlorines; OP: Organophosphates; CM: Carbamate; PYR: Pyrethroids; BaCT: Bacterial toxins; *Bti*: *Bacillus thuringiensis* var *israelensis*; IGR: Insect growth regulator; LC: Lethal concentration; EI: Emergence inhibition; EIC: Emergence inhibition concentration; KD: Knockdown; KDT: Knockdown times; RR: Resistance ratio; GLM: Generalized linear model; MFO: Mixed function oxidases; COE: Carboxyl-esterases; AChE1: Acetylcholinesterase-1; IRS: Indoor residual spraying; LLIN: Long lasting insecticide-treated net; IVM: Integrated vector management.

Competing interests

The authors declare that they have no competing interest.

Authors' contributions

Conceived and designed the experiments: NP, FD, BZ, FC. Performed the experiments: NP, FD, VB, CT. Analyzed the data: NP, PM, PL, FC. Contributed to reagents, materials and analysis tools: BZ, JT, FC. Wrote the manuscript: NP, PL, FC. All authors read and approved the final version of the manuscript.

Acknowledgements

We are very grateful to Nicole Pasteur and Mylène Weill for their most valuable comments, discussions and help all along the manuscript preparation, and Ohri Yamada for his support in the course of this study. We also thank the "Agence régionale de santé" (ARS) of Mayotte and "Entente Interdépartementale pour la Démoustication en Méditerranée" (EID) for technical and human resources made available. We finally thank the two anonymous reviewers for their very helpful and detailed comments that substantially improved the manuscript.

Financial support

This study was financed by the "Agence nationale de sécurité sanitaire de l'alimentation, de l'environnement et du travail" (ANSES).

Author details

¹Institut de Recherche pour le Développement, Unité Mixte de Recherche MIVEGEC (IRD 224-CNRS 5290-UM1-UM2), 911, avenue Agropolis, BP 64501 34394 Montpellier cedex 5, France. ²Agence de Santé Océan Indien (ARS OI), St Denis, La Réunion Island, France. ³Institut des Sciences de l'Évolution de Montpellier (UMR 5554, CNRS-UM2-IRD), Université Montpellier 2, Montpellier, France. ⁴DASS Nouvelle Calédonie, Santé Environnementale, Nouméa, Nouvelle Calédonie.

Received: 25 February 2014 Accepted: 19 June 2014

Published: 1 July 2014

References

1. Grjebine A: *Rapport sommaire sur la première étude des moustiques vecteurs de la filariose des îles Pamandzi et Mayotte*. Paris: ORSTOM; 1956.
2. Brunhes J, Dandoy G: *Géographie de la filariose de bancroft dans les îles d'Anjouan et de Mayotte (archipel des Comores)*. *Cahier ORSTOM* 1978, **15**:3–15.
3. Blanchy S, Galtier J: *La filariose de Bancroft à Mayotte. Etat actuel de l'endémie filarienne et programme de lutte*. *Cahier ORSTOM* 1982, **20**:153–159.
4. Julvez J, Mouchet J: *Epidémiologie Historique de la filariose de bancroft dans les îles du sud-ouest de l'océan indien*. *Bull Soc Pathol Exot* 1994, **87**:194–201.
5. Galtier J, Blanchy S: *Le paludisme à Mayotte et son évolution de 1976 à 1981*. *Cahier ORSTOM* 1982, **20**:145–151.
6. Julvez J, Galtier J, Ali Halidi M, Henry M, Mouchet J: *Epidémiologie du paludisme et lutte antipaludique à Mayotte (archipel des Comores, Océan Indien)*. *Evolution de la situation de 1976 à 1986. Perspectives*. *Bull Soc Pathol Exot* 1987, **80**:505–519.
7. InVS: *Surveillance du paludisme à Mayotte: bilan 2012*. *Point Épidémiologique* 2013, **17**:1–2.

8. CNEV: Circulation de *Wuchereria bancrofti* à Mayotte? www.cnev.fr.
9. Julvez J, Ragavoodoo C, Gopaul AR, Mouchet J: **Maladies humaines transmises par les culicidés dans les îles du sud-ouest de l'Océan Indien.** *Bull Soc Pathol Exot* 1998, **91**:99–103.
10. Sissoko D, Malvy D, Giry C, Delmas G, Paquet C, Gabriele P, Pettinelli F, Sanquer MA, Pierre V: **Outbreak of Chikungunya fever in Mayotte, Comoros archipelago, 2005–2006.** *Trans R Soc Trop Med Hyg* 2008, **102**:780–786.
11. Vazeille M, Moutailler S, Coudrier D, Rousseau C, Khun H, Huerre M, Thiria J, Dehecq JS, Fontenille D, Schuffenecker I, Despres P, Failloux A-B: **Two Chikungunya isolates from the outbreak of La Reunion (Indian Ocean) exhibit different patterns of infection in the mosquito *Aedes albopictus*.** *PLoS ONE* 2007, **2**:e1168.
12. Girod R: **First record of *Aedes albopictus* in Mayotte Island.** *Comoros archipelago Parasite* 2004, **11**:74.
13. Bagny L, Arnoux S, Delatte H, Lajoie G, Fontenille D: **Spread of invasive *Aedes albopictus* and decline of resident *Aedes aegypti* in urban areas of Mayotte 2007–2010.** *Biol Invasions* 2012, **14**:1623–1633.
14. InVS: **Situation de la dengue et du chikungunya à Mayotte.** *Point Épidémiologique* 2012, **37**:1–2.
15. Sissoko D, Giry C, Gabriele P, Tarantola A, Pettinelli F, Collet L, D'Ortenzio E, Renault P, Pierre V: **Rift Valley fever, Mayotte, 2007–2008.** *Emerg Infect Dis* 2009, **15**:568–570.
16. Robert V, Lagneau C: **Mission de conseil et d'appui à la mise en place de la lutte intégrée contre les vecteurs à Mayotte.** IRD, EID Méditerranée: Montpellier, France; 2009.
17. Subra R, Hébrard G, Rabenirainy L: **Essai de lutte contre *Anopheles gambiae* s.l. et *Culex pipiens fatigans* Wiedemann, 1828, par les larvicides dans une zone d'endémie filarienne, (Mayotte, Archipel des Comores).** *Cahier ORSTOM* 1973, **11**:225–231.
18. Subra R: **Biology and control of *Culex pipiens quinquefasciatus* Say, 1823 (Diptera, Culicidae) with special reference to Africa.** *Insect Sci Applic* 1981, **1**:319–338.
19. European Parliament: **Directive 98/8/CE du parlement européen et du conseil du 16 février 1998 concernant la mise sur le marché des produits biocides.** *J Officiel Communautés Européennes* 1998, L123/1.
20. Bagny L, Delatte H, Elissa N, Quilici S, Fontenille D: ***Aedes* (Diptera: Culicidae) vectors of arboviruses in Mayotte (Indian Ocean): distribution area and larval habitats.** *J Med Entomol* 2009, **46**:198–207.
21. Bonizzoni M, Gasperi G, Chen X, James AA: **The invasive mosquito species *Aedes albopictus*: current knowledge and future perspectives.** *Trends Parasitol* 2013, **29**:460–468.
22. Hollingworth RM, Dong K: **The Biochemical and Molecular Genetic Basis of Resistance to Pesticides in Arthropods.** In *Global Pesticide Resistance in Arthropods*. Edited by Whalon ME, Mota-Sanchez D, Hollingworth RM. Cambridge, United Kingdom: CAB; 2008:40–89.
23. Pocquet N, Milesi P, Makoundou P, Unal S, Zumbo B, Atyame C, Darriet F, Dehecq J-S, Thiria J, Bheecarry A, Weill M, Chandre F, Labbé P: **Multiple insecticide resistances in the disease vector *Culex p. quinquefasciatus* from Western Indian Ocean.** *PLoS One* 2013, **8**:e77855.
24. Ranson H, N'Guessan R, Lines J, Moiroux N, Nkuni Z, Corbel V: **Pyrethroid resistance in African anopheline mosquitoes: what are the implications for malaria control?** *Trends Parasitol* 2011, **27**:91–98.
25. Vontas J, Kioulos E, Pavlidi N, Morou E, della Torre A, Ranson H: **Insecticide resistance in the major dengue vectors *Aedes albopictus* and *Aedes aegypti*.** *Pestic Biochem Physiol* 2012, **104**:126–131.
26. Labbé P, Alout H, Djogbénou L, Pasteur N, Weill M: **14 - Evolution of Resistance to Insecticide in Disease Vectors.** In *Genetics and Evolution of Infectious Disease*. London: Elsevier; 2011:363–409.
27. Nauen R: **Insecticide resistance in disease vectors of public health importance.** *Pest Manag Sci* 2007, **63**:628–633.
28. Whalon ME, Mota-sanchez D, Hollingworth RM: **Analysis of Global Pesticide Resistance in Arthropods.** In *Global Pesticide Resistance in Arthropods*. Edited by Whalon ME, Mota-Sanchez D, Hollingworth RM. Cambridge, United Kingdom: CAB; 2008:5–31.
29. Chandre F, Darriet F, Manga L, Akogbeto M, Faye O, Mouchet J, Guillet P: **Status of pyrethroid resistance in *Anopheles gambiae* sensu lato.** *Bull World Health Organ* 1999, **77**:230–234.
30. Georghiou GP, Metcalf RL, Gidgen FE: **Carbamate-resistance in mosquitos. Selection of *Culex pipiens fatigans* Wiedemann (=C. quinquefasciatus Say) for resistance to Baygon.** *Bull World Health Organ* 1966, **35**:691–708.
31. Brengues C, Hawkes NJ, Chandre F, McCarroll L, Duchon S, Guillet P, Manguin S, Morgan JC, Hemingway J: **Pyrethroid and DDT cross-resistance in *Aedes aegypti* is correlated with novel mutations in the voltage-gated sodium channel gene.** *Med Vet Entomol* 2003, **17**:87–94.
32. Tantely ML, Tortosa P, Alout H, Berticat C, Berthomieu A, Rutee A, Dehecq JS, Makoundou P, Labbé P, Pasteur N, Weill M: **Insecticide resistance in *Culex pipiens quinquefasciatus* and *Aedes albopictus* mosquitoes from La Reunion Island.** *Insect Biochem Mol Biol* 2010, **40**:317–324.
33. Djogbénou L, Weill M, Hougard JM, Raymond M, Akogbeto M, Chandre F: **Characterization of insensitive acetylcholinesterase (*ace-1^R*) in *Anopheles gambiae* (Diptera: Culicidae): resistance levels and dominance.** *J Med Entomol* 2007, **44**:805–810.
34. Weill M, Lutfalla G, Mogensen K, Chandre F, Berthomieu A, Berticat C, Pasteur N, Philips A, Fort P, Raymond M: **Comparative genomics: insecticide resistance in mosquito vectors.** *Nature* 2003, **423**:136–137.
35. WHO: **Guidelines for Laboratory and Field Testing of Mosquito Larvicides.** Geneva, Switzerland: World Health Organization; 2005.
36. WHO: **Guidelines for Testing Mosquito Adulticides for Indoor Residual Spraying and Treatment of Mosquito Nets.** Geneva, Switzerland: World Health Organization; 2006.
37. WHO: **Report of the WHO Informal Consultation Tests Procedures for Insecticide Resistance Monitoring in Malaria Vectors, Bio-efficacy and Persistence of Insecticides on Treated Surfaces.** Geneva: World Health Organization; 1998.
38. R Core Team: **R: a language and environment for statistical computing.** 2013.
39. Milesi P, Pocquet N, Labbé P: **BioRssay: a R script for bioassay analyses.** <http://www.isem.univ-montp2.fr/recherche/equipes/genomique-de-ladapation/personnel/labbe-pierrick/>.
40. Johnson RM, Dahlgren L, Siegfried BD, Ellis MD: **Acaricide, fungicide and drug interactions in honey bees (*Apis mellifera*).** *PLoS ONE* 2013, **8**:e54092.
41. Finney DJ: **Probit Analysis.** Cambridge: Cambridge University Press; 1971.
42. Abbott W: **A method of computing the effectiveness of an insecticide.** *J Econ Entomol* 1925, **18**:265–267.
43. Nielsen-Leroux C, Pasquier F, Charles JF, Sinegre G, Gaven B, Pasteur N: **Resistance to *Bacillus sphaericus* involves different mechanisms in *Culex pipiens* (Diptera:Culicidae) larvae.** *J Med Entomol* 1997, **34**:321–327.
44. Bradford MM: **Rapid and sensitive method for quantitation of microgram quantities of protein utilizing principle of protein-dye binding.** *Anal Biochem* 1976, **72**:248–254.
45. Brogdon WG, McAllister JC, Vulule J: **Heme peroxidase activity measured in single mosquitoes identifies individuals expressing an elevated oxidase for insecticide resistance.** *J Am Mosq Control Assoc* 1997, **13**:233–237.
46. Hemingway J: **Techniques to Detect Insecticide Resistance Mechanisms (Field and Laboratory Manual).** Geneva: World Health Organization; 1998.
47. StatSoft: **STATISTICA (Logiciel d'Analyse des Données), Version 10.** 2011.
48. Rogers SO, Bendich AJ: **Extraction of DNA from Plant Tissues.** Boston: Kluwer Academic Publisher; 1988.
49. Weill M, Malcolm C, Chandre F, Mogensen K, Berthomieu A, Marquine M, Raymond M: **The unique mutation in *ace-1* giving high insecticide resistance is easily detectable in mosquito vectors.** *Insect Mol Biol* 2004, **13**:1–7.
50. Martinez-Torres D, Chandre F, Williamson MS, Darriet F, Berge JB, Devonshire AL, Guillet P, Pasteur N, Pauron D: **Molecular characterization of pyrethroid knockdown resistance (*kdr*) in the major malaria vector *Anopheles gambiae* s.s.** *Insect Mol Biol* 1998, **7**:179–184.
51. Ranson H, Jensen B, Vulule JM, Wang X, Hemingway J, Collins FH: **Identification of a point mutation in the voltage-gated sodium channel gene of Kenyan *Anopheles gambiae* associated with resistance to DDT and pyrethroids.** *Insect Mol Biol* 2000, **9**:491–497.
52. Martinez-Torres D, Chevillon C, Brun-Barale A, Berge JB, Pasteur N, Pauron D: **Voltage-dependent Na⁺ channels in pyrethroid-resistant *Culex pipiens* L mosquitoes.** *Pesticide Science* 1999, **55**:1012–1020.
53. Corbet PS, Smith SM: **Diel periodicities of landing of nulliparous and parous *Aedes aegypti* (L.) at Dar es Salaam, Tanzania (Diptera, Culicidae).** *Bull Entomol Res* 1974, **64**:111–121.
54. Delatte H, Desvars A, Bouétard A, Bord S, Gimonneau G, Vourc'h G, Fontenille D: **Blood-feeding behavior of *Aedes albopictus*, a vector of Chikungunya on La Réunion.** *Vector Borne and Zoonotic Diseases* 2010, **10**:249–258.

55. Perich MJ, Davila G, Turner A, Garcia A, Nelson M: **Behavior of resting *Aedes aegypti* (Culicidae: Diptera) and its relation to ultra-low volume adulticide efficacy in Panama City, Panama.** *J Med Entomol* 2000, **37**:541–546.
56. Pates H, Curtis C: **Mosquito behavior and vector control.** *Annu Rev Entomol* 2005, **50**:53–70.
57. Marcombe S, Mathieu RB, Pocquet N, Riaz MA, Poupardin R, Selior S, Darriet F, Reynaud S, Yebakima A, Corbel V, David JP, Chandre F: **Insecticide resistance in the dengue vector *Aedes aegypti* from Martinique: distribution, mechanisms and relations with environmental factors.** *PLoS ONE* 2012, **7**:e30989.
58. Weill M, Berthomieu A, Berticat C, Lutfalla G, Negre V, Pasteur N, Philips A, Leonetti JP, Fort P, Raymond M: **Insecticide resistance: a silent base prediction.** *Curr Biol* 2004, **14**:R552–R553.
59. Mohandass SM, Arthur FH, Zhu KY, Throne JE: **Hydroprene: mode of action, current status in stored-product pest management, insect resistance, and future prospects.** *Crop Protection* 2006, **25**:902–909.
60. Quatresous I, Jeannel D, Sissoko D: **Épidémiologie du Paludisme à Mayotte: état des lieux 2003–2004 et Propositions.** Institut de veille sanitaire: Saint-Maurice; 2005.
61. Diabate A, Baldet T, Chandre F, Akogbeto M, Guiguemde TR, Darriet F, Brengues C, Guillet P, Hemingway J, Small GJ, Hougard JM: **The role of agricultural use of insecticides in resistance to pyrethroids in *Anopheles gambiae* s.l. in Burkina Faso.** *Am J Trop Med Hyg* 2002, **67**:617–622.
62. Yadouleton A, Martin T, Padonou G, Chandre F, Asidi A, Djogbenou L, Dabire R, Aikpon R, Boko M, Gliho I, Akogbeto M: **Cotton pest management practices and the selection of pyrethroid resistance in *Anopheles gambiae* population in northern Benin.** *Parasit Vectors* 2011, **4**:60.
63. Pinto J, Lynd A, Vicente JL, Santolamazza F, Randle NP, Gentile G, Moreno M, Simard F, Charlwood JD, Do Rosario VE, Caccone A, della Torre A, Donnelly MJ: **Multiple origins of knockdown resistance mutations in the afrotropical mosquito vector *Anopheles gambiae*.** *PLoS ONE* 2007, **2**:e1243.
64. Oakeshott JG, Devonshire AL, Claudianos C, Sutherland TD, Horne I, Campbell PM, Ollis DL, Russell RJ: **Comparing the organophosphorus and carbamate insecticide resistance mutations in cholin- and carboxyl-esterases.** *Chemico-Biological Interactions* 2005, **157–158**:269–275.
65. Pasteur N, Raymond M: **Insecticide resistance genes in mosquitoes: their mutations, migration, and selection in field populations.** *Journal of Heredity* 1996, **87**:444–449.
66. Liu Y, Zhang H, Qiao C, Lu X, Cui F: **Correlation between carboxylesterase alleles and insecticide resistance in *Culex pipiens* complex from China.** *Parasit Vectors* 2011, **4**:236.
67. Wirth M, Georghiou G: **Selection and characterization of temephos resistance in a population of *Aedes aegypti* from Tortola, British Virgin Islands.** *J Am Mosq Control Assoc* 1999, **15**:315–320.
68. Bisset JA, Marín R, Rodríguez MM, Severson DW, Ricardo Y, French L, Diaz M, Pérez O: **Insecticide resistance in two *Aedes aegypti* (Diptera: Culicidae) strains from Costa Rica.** *J Med Entomol* 2013, **50**:352–361.
69. Namountougou M, Simard F, Baldet T, Diabate A, Ouedraogo JB, Martin T, Dabire RK: **Multiple insecticide resistance in *Anopheles gambiae* s.l. populations from Burkina Faso, West Africa.** *PLoS ONE* 2012, **7**:e48412.
70. Koffi A, Alou L, Adja M, Koné M, Chandre F, N'Guessan R: **Update on resistance status of *Anopheles gambiae* s.s. to conventional insecticides at a previous WHOPES field site, “Yaokoffikro”, 6 years after the political crisis in Côte d'Ivoire.** *Parasit Vectors* 2012, **5**:68.
71. Tene Fossog B, Kopya E, Ndo C, Menze-Djantio B, Costantini C, Njiokou F, Awono-Ambene P, Antonio-Nkondjio C: **Water quality and *Anopheles gambiae* larval tolerance to pyrethroids in the cities of Douala and Yaounde (Cameroon).** *J Trop Med* 2012, **2012**:429817.
72. Nkya TE, Akhouayri I, Kisinza W, David JP: **Impact of environment on mosquito response to pyrethroid insecticides: facts, evidences and prospects.** *Insect Biochem Mol Biol* 2013, **43**:407–416.
73. Hardstone MC, Lazzaro BP, Scott JG: **The effect of three environmental conditions on the fitness of cytochrome P450 monooxygenase-mediated permethrin resistance in *Culex pipiens quinquefasciatus*.** *BMC Evolutionary Biology* 2009, **9**:42.
74. Berticat C, Boquien G, Raymond M, Chevillon C: **Insecticide resistance genes induce a mating competition cost in *Culex pipiens* mosquitoes.** *Genet Res* 2002, **79**:41–47.
75. Duron O, Labbé P, Berticat C, Rousset F, Guillot S, Raymond M, Weill M: **High *Wolbachia* density correlates with cost of infection for insecticide resistant *Culex pipiens* mosquitoes.** *Evolution* 2006, **60**:303–314.
76. Lacey LA: ***Bacillus thuringiensis* serovariety *israelensis* and *Bacillus sphaericus* for mosquito control.** *J Am Mosq Control Assoc* 2007, **23**:133–163.
77. Bravo A, Gill SS, Soberon M: **Mode of action of *Bacillus thuringiensis* Cry and Cyt toxins and their potential for insect control.** *Toxicon* 2007, **49**:423–435.
78. Paul A, Harrington LC, Zhang L, Scott JG: **Insecticide resistance in *Culex pipiens* from New York.** *J Am Mosq Control Assoc* 2005, **21**:305–309.
79. Paris M, Tetreau G, Laurent F, Lelu M, Despres L, David J-P: **Persistence of *Bacillus thuringiensis israelensis* (Bti) in the environment induces resistance to multiple Bti toxins in mosquitoes.** *Pest Manag Sci* 2011, **67**:122–128.
80. Wirth MC, Walton WE, Federici BA: **Inheritance patterns, dominance, stability, and allelism of insecticide resistance and cross-resistance in two colonies of *Culex quinquefasciatus* (Diptera: Culicidae) selected with Cry toxins from *Bacillus thuringiensis* subsp. *israelensis*.** *J Med Entomol* 2010, **47**:814–822.
81. Stump AD, Atieli FK, Vulule JM, Besansky NJ: **Dynamics of the pyrethroid knockdown resistance allele in western Kenyan populations of *Anopheles gambiae* in response to insecticide-treated bed net trials.** *Am J Trop Med Hyg* 2004, **70**:591–596.
82. Cornel A, Stanich M, McAbee R, Mulligan F: **High level methoprene resistance in the mosquito *Ochlerotatus nigromaculis* (Ludlow) in central California.** *Pest Manag Sci* 2002, **58**:791–798.
83. Kasai S, Shono T, Komagata O, Tsuda Y, Kobayashi M, Motoki M, Kashima I, Tanikawa T, Yoshida M, Tanaka I, Shinjo G, Hashimoto T, Ishikawa T, Takahashi T, Higa Y, Tomita T: **Insecticide resistance in potential vector mosquitoes for West Nile virus in Japan.** *J Med Entomol* 2007, **44**:822–829.
84. Su T, Cheng M-L: **Resistance development in *Culex quinquefasciatus* to spinosad: a preliminary report.** *J Am Mosq Control Assoc* 2012, **28**:263–267.
85. Tomlin CDS: *The pesticide Manual: a World Compendium.* Fifteenth edition. BCPC: Alton, England; 2009.
86. WHO: *Pesticides and their Application for the Control of Vectors and Pests of Public Health Importance.* Sixth edition. Geneva, Switzerland: World Health Organization; 2006.
87. Berg H, Mutero CM, Ichimori K: *Guidance on Policy-Making for Integrated Vector Management.* Geneva: World Health Organisation; 2012.
88. Erlanger T, Keiser J, Utzinger J: **Effect of dengue vector control interventions on entomological parameters in developing countries: a systematic review and meta-analysis.** *Med Vet Entomol* 2008, **22**:203–221.
89. Ooi E-E, Goh K-T, Gubler D: **Dengue prevention and 35 years of vector control in Singapore.** *Emerging infectious diseases* 2006, **12**:887–893.
90. Kay B, Vu S: **New strategy against *Aedes aegypti* in Vietnam.** *Lancet* 2005, **365**:613–617.

doi:10.1186/1756-3305-7-299

Cite this article as: Pocquet et al.: Insecticide resistance in disease vectors from Mayotte: an opportunity for integrated vector management. *Parasites & Vectors* 2014 **7**:299.

Submit your next manuscript to BioMed Central and take full advantage of:

- Convenient online submission
- Thorough peer review
- No space constraints or color figure charges
- Immediate publication on acceptance
- Inclusion in PubMed, CAS, Scopus and Google Scholar
- Research which is freely available for redistribution

Submit your manuscript at
www.biomedcentral.com/submit



AdditionalFile1: Effects of larvicides on mosquito vectors from Mayotte.

Species	Insecticide	Strain	N	LC ₅₀ / EIC ₅₀ (CI ₉₅)	LC ₉₅ / EIC ₉₅ (CI ₉₅)	Slope	RR ₅₀ (CI ₉₅)	RR ₉₅ (CI ₉₅)
<i>An. gambiae</i>	Temephos	KIS	1164	1.5x10 ⁻³ (1.2x10 ⁻³ – 1.8x10 ⁻³)	5.0x10 ⁻³ (4.1x10 ⁻³ – 6.7x10 ⁻³)	3.17	-	-
		DZOU	1080	7.4x10 ⁻³ (6.1x10 ⁻³ – 9.1x10 ⁻³)	6.4x10 ⁻² (4.1x10 ⁻² – 1.3x10 ⁻¹)	1.75	4.84 (4.16 - 5.64)	12.9 (7.68 - 21.6)
	<i>Bti</i>	KIS	900	1.9x10 ⁻¹ (1.4x10 ⁻¹ – 2.4x10 ⁻¹)	6.1x10 ⁻¹ (4.1x10 ⁻¹ – 1.87)	3.23	-	-
		DZOU	1000	1.9x10 ⁻¹ (1.7x10 ⁻¹ – 2.1x10 ⁻¹)	5.1x10 ⁻¹ (4.3x10 ⁻¹ – 6.7x10 ⁻¹)	3.9	1.02 (0.64 - 1.6)	0.83 (0.05 - 13.7)
	Spinosad	KIS	1289	3.2x10 ⁻³ (2.7x10 ⁻³ – 3.8x10 ⁻³)	1.7x10 ⁻² (1.3x10 ⁻² – 2.5x10 ⁻²)	2.27	-	-
		DZOU	1367	5.0x10 ⁻³ (3.7x10 ⁻³ – 6.5x10 ⁻³)	3.1x10 ⁻² (2.0x10 ⁻² – 6.1x10 ⁻²)	2.07	1.54 (1.37 - 1.73)	1.8 (1.31 - 2.48)
	Diflubenzuron	KIS	496	1.7x10 ⁻³ (1.5x10 ⁻³ – 2.0x10 ⁻³)	3.5x10 ⁻³ (2.9x10 ⁻³ – 4.9x10 ⁻³)	5.34	-	-
		DZOU	416	1.7x10 ⁻³ (6.9x10 ⁻⁴ – 2.7x10 ⁻³)	5.6x10 ⁻³ (3.2x10 ⁻³ – 3.81)	3.19	0.99 (0.84 - 1.16)	1.59 (0.99 - 2.55)
	Pyriproxyfen	KIS	595	5.1x10 ⁻⁵ (3.3x10 ⁻⁵ – 7.3x10 ⁻⁵)	5.5x10 ⁻⁴ (3.4x10 ⁻⁴ – 1.2x10 ⁻³)	1.6	-	-
		DZOU	507	9.9x10 ⁻⁶ (1.7x10 ⁻⁶ – 1.7x10 ⁻⁵)	1.2x10 ⁻⁴ (6.1x10 ⁻⁵ – 1.0x10 ⁻³)	1.54	0.19 (0.17 - 0.22)	0.21 (0.17 - 0.26)
	Methopren	KIS	285	1.9x10 ⁻³ (1.2x10 ⁻³ – 3.0x10 ⁻³)	1.5x10 ⁻² (7.5x10 ⁻³ – 5.7x10 ⁻²)	1.84	-	-
		DZOU	594	7.1x10 ⁻⁴ (3.6x10 ⁻⁴ – 1.2x10 ⁻³)	2.9x10 ⁻² (1.1x10 ⁻² – 1.8x10 ⁻¹)	1.02	0.38 (0.32 - 0.45)	1.95 (1.04 - 3.63)
<i>Cx. p. quinquefasciatus</i>	Temephos	SLAB	994	1.5x10 ⁻³ (1.3x10 ⁻³ – 1.7x10 ⁻³)	3.3x10 ⁻³ (2.7x10 ⁻³ – 4.8x10 ⁻³)	4.59	-	-
		TZI	1174	2.5x10 ⁻² (2.2x10 ⁻² – 2.8x10 ⁻²)	6.3x10 ⁻² (5.2x10 ⁻² – 8.4x10 ⁻²)	4.1	17.2 (14.9 - 19.9)	18.9 (12.8 - 28.1)
	<i>Bti</i>	SLAB	986	1.8x10 ⁻¹ (6.1x10 ⁻² – 2.5x10 ⁻¹)	6.6x10 ⁻¹ (4.7x10 ⁻¹ – 2.28)	2.94	-	-
		TZI	1302	2.7x10 ⁻¹ (2.4x10 ⁻¹ – 3.0x10 ⁻¹)	6.9x10 ⁻¹ (5.9x10 ⁻¹ – 8.7x10 ⁻¹)	3.97	1.46 (0.77 - 2.77)	1.04 (0.04 - 28)
	Spinosad	SLAB	994	6.8x10 ⁻² (5.9x10 ⁻² – 7.9x10 ⁻²)	2.7x10 ⁻¹ (2.1x10 ⁻¹ – 3.6x10 ⁻¹)	2.77	-	-
		TZI	1184	1.0x10 ⁻¹ (8.8x10 ⁻² – 1.2x10 ⁻¹)	4.5x10 ⁻¹ (3.4x10 ⁻¹ – 6.6x10 ⁻¹)	2.57	1.52 (1.11 - 2.09)	1.69 (0.37 - 7.77)
	Diflubenzuron	SLAB	244	2.2x10 ⁻³ (9.9x10 ⁻⁴ – 3.4x10 ⁻³)	6.6x10 ⁻³ (3.9x10 ⁻³ – 4.7x10 ⁻¹)	3.45	-	-
		TZI	1326	2.4x10 ⁻³ (1.2x10 ⁻³ – 3.3x10 ⁻³)	1.2x10 ⁻² (7.5x10 ⁻³ – 3.9x10 ⁻²)	2.44	1.11 (0.93 - 1.33)	1.75 (1.05 - 2.91)
	Pyriproxyfen	SLAB	697	1.9x10 ⁻⁵ (1.6x10 ⁻⁵ – 2.2x10 ⁻⁵)	6.3x10 ⁻⁵ (4.9x10 ⁻⁵ – 8.9x10 ⁻⁵)	3.18	-	-
		TZI	1495	2.7x10 ⁻⁵ (2.0x10 ⁻⁵ – 3.5x10 ⁻⁵)	3.1x10 ⁻⁴ (2.3x10 ⁻⁴ – 4.4x10 ⁻⁴)	1.57	1.43 (1.3 - 1.57)	4.88 (4.14 - 5.74)
	Methopren	SLAB	248	7.1x10 ⁻⁴ (4.0x10 ⁻⁴ – 1.2x10 ⁻³)	5.6x10 ⁻³ (2.8x10 ⁻³ – 2.8x10 ⁻²)	1.83	-	-
		TZI	895	6.2x10 ⁻⁴ (3.8x10 ⁻⁴ – 8.8x10 ⁻⁴)	2.3x10 ⁻² (1.4x10 ⁻² – 4.8x10 ⁻²)	1.05	0.87 (0.73 - 1.04)	4.06 (2.48 - 6.64)
<i>Ae. aegypti</i>	Temephos	BORA	998	4.2x10 ⁻³ (4.1x10 ⁻³ – 4.3x10 ⁻³)	6.1x10 ⁻³ (5.9x10 ⁻³ – 6.4x10 ⁻³)	10	-	-
		PT	978	3.5x10 ⁻³ (2.9x10 ⁻³ – 4.2x10 ⁻³)	6.4x10 ⁻³ (5.1x10 ⁻³ – 1.2x10 ⁻²)	6.46	0.84 (0.74 - 0.96)	1.04 (0.78 - 1.38)
	<i>Bti</i>	BORA	1200	1.0x10 ⁻¹ (9.3x10 ⁻² – 1.1x10 ⁻¹)	2.7x10 ⁻¹ (2.3x10 ⁻¹ – 3.3x10 ⁻¹)	3.91	-	-
		PT	1001	8.1x10 ⁻² (7.2x10 ⁻² – 9.0x10 ⁻²)	2.1x10 ⁻¹ (1.8x10 ⁻¹ – 2.7x10 ⁻¹)	4.04	0.81 (0.6 - 1.08)	0.78 (0.29 - 2.11)

	Spinosad	BORA	1187	5.5×10^{-2} (5.0×10^{-2} – 6.0×10^{-2})	1.2×10^{-1} (1.1×10^{-1} – 1.6×10^{-1})	4.61	-	-
		PT	787	6.0×10^{-2} (4.7×10^{-2} – 7.6×10^{-2})	1.2×10^{-1} (8.7×10^{-2} – 3.3×10^{-1})	5.58	1.09 (0.83 - 1.42)	0.94 (0.44 - 2.01)
	Diflubenzuron	BORA	1187	1.3×10^{-3} (7.3×10^{-4} – 1.9×10^{-3})	5.8×10^{-3} (3.2×10^{-3} – 8.2×10^{-2})	2.55	-	-
		PT	995	1.6×10^{-3} (1.2×10^{-3} – 1.9×10^{-3})	3.3×10^{-3} (2.6×10^{-3} – 5.9×10^{-3})	5.08	1.17 (1.05 - 1.31)	0.56 (0.42 - 0.74)
	Pyriproxyfen	BORA	594	6.8×10^{-5} (5.5×10^{-5} – 9.2×10^{-5})	1.8×10^{-4} (1.2×10^{-4} – 4.8×10^{-4})	3.84	-	-
		PT	1290	3.6×10^{-5} (2.8×10^{-5} – 5.1×10^{-5})	2.9×10^{-4} (1.6×10^{-4} – 9.4×10^{-4})	1.83	0.54 (0.49 - 0.59)	1.6 (1.23 - 2.07)
	Methopren	BORA	999	1.1×10^{-3} (7.2×10^{-4} – 1.5×10^{-3})	4.1×10^{-3} (2.4×10^{-3} – 1.5×10^{-2})	2.81	-	-
		PT	1195	1.0×10^{-3} (8.7×10^{-4} – 1.1×10^{-3})	3.5×10^{-3} (2.8×10^{-3} – 5.0×10^{-3})	2.99	0.94 (0.85 - 1.05)	0.87 (0.65 - 1.16)
<i>Ae. albopictus</i>	Temephos	PLP	1084	6.2×10^{-3} (5.8×10^{-3} – 6.7×10^{-3})	9.6×10^{-3} (8.4×10^{-3} – 1.2×10^{-2})	8.82	-	-
		KWI	1205	6.3×10^{-3} (6.0×10^{-3} – 6.6×10^{-3})	9.7×10^{-3} (8.8×10^{-3} – 1.1×10^{-2})	8.62	1.01 (0.88 - 1.16)	1.02 (0.71 - 1.47)
	<i>Bti</i>	PLP	1185	6.2×10^{-2} (5.6×10^{-2} – 6.7×10^{-2})	1.7×10^{-1} (1.5×10^{-1} – 2.0×10^{-1})	3.76	-	-
		KWI	1199	8.2×10^{-2} (7.2×10^{-2} – 9.2×10^{-2})	2.0×10^{-1} (1.7×10^{-1} – 2.5×10^{-1})	4.37	1.33 (1.02 - 1.74)	1.16 (0.58 - 2.31)
	Spinosad	PLP	1200	6.6×10^{-2} (5.9×10^{-2} – 7.2×10^{-2})	1.6×10^{-1} (1.4×10^{-1} – 1.9×10^{-1})	4.38	-	-
		KWI	992	9.2×10^{-2} (8.2×10^{-2} – 1.0×10^{-1})	2.5×10^{-1} (2.1×10^{-1} – 3.5×10^{-1})	3.73	1.4 (1.06 - 1.84)	1.63 (0.64 - 4.12)
	Diflubenzuron	PLP	372	2.6×10^{-3} (2.0×10^{-3} – 1.0×10^{-2})	5.9×10^{-3} (3.6×10^{-3} – 2.73)	4.62	-	-
		KWI	1000	1.5×10^{-3} (1.3×10^{-3} – 1.7×10^{-3})	3.2×10^{-3} (2.7×10^{-3} – 4.2×10^{-3})	5	0.57 (0.48 - 0.68)	0.53 (0.31 - 0.93)
	Pyriproxyfen	PLP	943	6.4×10^{-5} (5.0×10^{-5} – 9.0×10^{-5})	4.9×10^{-4} (2.6×10^{-4} – 1.7×10^{-3})	1.87	-	-
		KWI	1000	6.6×10^{-5} (5.3×10^{-5} – 8.4×10^{-5})	4.1×10^{-4} (2.4×10^{-4} – 1.1×10^{-3})	2.08	1.02 (0.95 - 1.1)	0.83 (0.63 - 1.1)
	Methopren	PLP	498	1.3×10^{-3} (7.8×10^{-4} – 2.6×10^{-3})	1.0×10^{-2} (4.0×10^{-3} – 1.14)	1.83	-	-
		KWI	498	4.0×10^{-4} (2.8×10^{-4} – 5.0×10^{-4})	2.9×10^{-3} (2.2×10^{-3} – 4.7×10^{-3})	1.89	0.3 (0.25 - 0.36)	0.28 (0.17 - 0.49)

Resistance levels of colonies from field populations (DZOU, TZ1, PT and KWI) to temephos, *Bti*, spinosad, diflubenzuron, pyriproxyfen and methopren are compared to resistance levels of the reference strains KIS and AcerKIS, SLAB, BORA and PLP, respectively. N is the total number of tested larvae. The 50 and 95% lethal concentrations (LC₅₀ and LC₉₅) and the 50 and 95% emergence inhibition concentrations (EIC₅₀ and EIC₉₅) are expressed in mg/l, with their associated confidence intervals at 95% (CI₉₅). Finally, the corresponding resistant ratios (RR), i.e. the ratios of LC or EIC of the tested colony over the susceptible reference strain, are also indicated and bolded when significantly higher than 1 (i.e. when CI₉₅ does not include 1).

Additional File 2: Effect of deltamethrin on adult vector mosquitoes from Mayotte.

Species	Strain/ colony	N	KDT ₅₀ (CI ₉₅)	KDT ₉₅ (CI ₉₅)	Slope	RR ₅₀ (CI ₉₅)	RR ₉₅ (CI ₉₅)	Mortality at 24H
<i>An. gambiae</i>	KIS	211	11 (10 - 11)	16 (15 - 17)	10.3	-	-	100%
	DZOU	191	11 (10 - 12)	17 (16 - 19)	8.19	1.01 (0.76 - 1.35)	1.11 (0.73 - 1.69)	99%
<i>Cx. p. quinquefasciatus</i>	SLAB	201	13 (13 - 14)	20 (19 - 21)	9.13	-	-	94%
	TZI	183	56 (54 - 57)	98 (92 - 106)	6.73	4.21 (3.46 - 5.11)	4.88 (3.47 - 6.85)	10%
<i>Ae. aegypti</i>	BORA	198	11 (11 - 11)	16 (15 - 16)	11	-	-	100%
	PT	201	11 (11 - 12)	16 (15 - 17)	11.59	1.03 (0.76 - 1.39)	1.01 (0.66 - 1.55)	100%
<i>Ae. albopictus</i>	PLP	195	14 (14 - 15)	22 (21 - 23)	8.93	-	-	95%
	KWI	202	13 (13 - 13)	19 (18 - 20)	10.62	0.92 (0.73 - 1.17)	0.86 (0.62 - 1.2)	97%

Short-term knockdown effect and mortality at 24 hours induced by deltamethrin on DZOU, TZI, PT and KWI colonies and KIS, SLAB, BORA and PLP reference strains are presented. N is the total number of tested adult females. The 50 and 95% knockdown times (KDT₅₀ and KDT₉₅) are expressed in minutes, with their associated confidence intervals at 95% (CI₉₅). Finally, the corresponding resistant ratios (RR), i.e. the ratios of KDT of the tested colony over the KDT of the susceptible reference strain, are also indicated and bolded when significantly higher than 1 (i.e. when CI₉₅ does not include 1).

Additional File 3: Effects of OP and CM larvicides on *Anopheles gambiae* from Mayotte.

Insecticide	Strain	N	LC ₅₀ (CI ₉₅)	LC ₉₅ (CI ₉₅)	Slope	RR ₅₀ (CI ₉₅)	RR ₉₅ (CI ₉₅)
Temephos	KIS	1164	1.5x10 ⁻³ (1.2x10 ⁻³ – 1.8x10 ⁻³)	5.0x10 ⁻³ (4.1x10 ⁻³ – 6.7x10 ⁻³)	3.17	-	-
	DZOU	1080	7.4x10 ⁻³ (6.1x10 ⁻³ – 9.1x10 ⁻³)	6.4x10 ⁻² (4.1x10 ⁻² – 1.3x10 ⁻¹)	1.75	4.84 (4.16 - 5.64)	12.9 (7.68 - 21.6)
	DZKIS	1106	1.1x10 ⁻² (9.6x10 ⁻³ – 1.2x10 ⁻²)	1.7x10 ⁻² (1.5x10 ⁻² – 2.3x10 ⁻²)	7.58	6.93 (5.84 - 8.21)	3.46 (2.47 - 4.85)
	AcerKIS	302	2.5x10 ⁻² (2.2x10 ⁻² – 2.9x10 ⁻²)	5.1x10 ⁻² (4.1x10 ⁻² – 7.3x10 ⁻²)	5.38	16.4 (12.2 - 22.2)	10.1 (5.29 - 19.2)
Chlorpyrifos	KIS	1199	7.2x10 ⁻⁴ (6.7x10 ⁻⁴ – 7.7x10 ⁻⁴)	1.4x10 ⁻³ (1.2x10 ⁻³ – 1.5x10 ⁻³)	6.06	-	-
	DZKIS	1041	8.7x10 ⁻⁴ (7.7x10 ⁻⁴ – 9.7x10 ⁻⁴)	1.7x10 ⁻³ (1.4x10 ⁻³ – 2.1x10 ⁻³)	5.83	1.21 (1.08 - 1.35)	1.24 (1.02 - 1.5)
Malathion	KIS	840	1.9x10 ⁻² (1.8x10 ⁻² – 2.2x10 ⁻²)	4.4x10 ⁻² (3.7x10 ⁻² – 6.0x10 ⁻²)	4.56	-	-
	DZKIS	492	4.3x10 ⁻² (3.6x10 ⁻² – 5.3x10 ⁻²)	6.8x10 ⁻² (5.5x10 ⁻² – 1.4x10 ⁻¹)	8.29	2.23 (1.69 - 2.95)	1.52 (0.74 - 3.11)
	AcerKIS	348	4.1x10 ⁻¹ (2.6x10 ⁻¹ – 6.4x10 ⁻¹)	1.51 (0.90 – 4.95)	2.93	21.5 (6.15 - 75.2)	33.9 (0.3 - 3766)
Propoxur	KIS	588	1.5x10 ⁻² (1.1x10 ⁻² – 1.8x10 ⁻²)	4.9x10 ⁻² (3.8x10 ⁻² – 7.1x10 ⁻²)	3.15	-	-
	DZKIS	841	8.1x10 ⁻² (7.6x10 ⁻² – 8.8x10 ⁻²)	1.2x10 ⁻¹ (1.1x10 ⁻¹ – 1.5x10 ⁻¹)	9.62	5.57 (4.07 - 7.62)	2.48 (1.23 - 4.99)
	AcerKIS	494	144 (129 – 159)	243 (209 – 317)	7.26	9872 (7511 - 12975)	4988 (3138 - 7927)

Resistance levels of the introgressed DZKIS strain are compared to resistance levels of the reference strains KIS and AcerKIS for three OP (temephos^a, chlorpyrifos, malathion) and one CM (propoxur) larvicides. N is the total number of tested larvae. The 50 and 95% lethal concentrations (LC₅₀ and LC₉₅) are expressed in mg/l, with their associated confidence intervals at 95% (CI₉₅). Finally, the corresponding resistant ratios (RR), i.e. the ratios of LC of the tested strain over the LC₅₀ of the susceptible reference strain, are also indicated and bolded when significantly higher than 1 (i.e. when CI₉₅ does not include 1).

^aDZOU results for temephos have been reported here from Additional File 1 for easier comparison.

Influence de l'architecture génétique et des variations environnementales sur l'adaptation: la résistance aux insecticides chez les moustiques

Les mutations sont à l'origine des nombreux "variants" présents dans les populations naturelles. Les variants adaptatifs sont propagés par sélection naturelle. Cependant, une mutation bénéfique sur un trait peut affecter négativement d'autres traits (coût sélectif): un compromis émerge alors entre les avantages et les coûts qu'elle induit. Cette thèse vise à comprendre comment des modifications de l'environnement peuvent affecter les compromis évolutifs de différents types de mutations adaptatives (substitutions, duplications hétérogènes, amplifications). Chez les moustiques, l'utilisation d'insecticides organophosphorés (OPs) et carbamates (CXs) a sélectionné trois réponses adaptatives majeures : une amplification de gènes au locus *Ester* (codant pour des enzymes détoxifiantes), une substitution au locus *ace-1* (codant pour la cible des insecticides), et des duplications associant une copie sensible et une copie résistante du locus *ace-1*. Un premier axe de ma thèse a été de mieux comprendre le rôle de ces duplications hétérogènes (qui associent deux copies divergentes d'un même gène) dans l'adaptation. En caractérisant leurs compromis évolutifs nous avons montré qu'elles confèrent un phénotype proche de celui d'hétérozygotes standards. Toutefois, l'étude de leur distribution mondiale et des analyses en laboratoire ont révélé que ces duplications, avantageuses à l'état hétérozygote, sont majoritairement sublétales à l'état homozygote. Le second axe de cette thèse a été l'étude de l'influence des variations de pression de sélection sur la dynamique des allèles adaptatifs. Une étude d'évolution expérimentale a montré que des pressions de sélection intermédiaires pouvaient générer des situations de superdominance au locus *ace-1*, favorables à la sélection de duplications hétérogènes. Par ailleurs, l'analyse d'échantillons montpelliérains récoltés sur une trentaine d'années nous a permis de relier quantitativement les variations de la pression de sélection et les variations de la valeur sélective des différents allèles du locus *Ester*. Enfin, l'étude de trois zones géographiques (Mayotte, Martinique, et Montpellier) a permis de montrer que les différentes adaptations ne répondaient pas de la même façon à une modification environnementale majeure liée au retrait de la pression de sélection (interdiction des OPs et CXs en 2007) : alors que les allèles de résistance du locus *ace-1* tendent à disparaître, ceux du locus *Ester* se maintiennent en fréquence non négligeable dans les populations naturelles.

Mots clés : *Résistance aux insecticides, compromis évolutifs, duplications de gènes, populations naturelles, biologie intégrative, génétique de l'adaptation*

Impact of genetic architecture and environmental variations on adaptation: insecticide resistance in mosquitoes

Mutations are the origin of the many "variants" present in natural populations. Adaptive variants are propagated by natural selection. However a mutation beneficial for a trait can negatively affect other traits (selective cost): a trade-off thus emerges between the benefits and the costs it induces. This PhD aimed at understanding how environmental changes could affect the evolutionary trade-offs of various types of adaptive mutations (substitutions, heterogeneous duplications, amplifications). In mosquitoes, organophosphate (OPs) and carbamates (CXs) insecticides usage has selected three major adaptive responses: gene amplifications at the *Ester* locus (encoding detoxifying enzymes), a substitution at the *ace-1* locus (encoding the target of the insecticides), and gene duplications pairing susceptible and resistance *ace-1* copies. The first axis of my PhD aimed at understanding the role of these heterogeneous duplications (combining two different copies of the same gene) in adaptation. Characterizing their evolutionary trade-offs, we showed that they confer a phenotype similar to standard heterozygotes. However, the study of their worldwide distribution and laboratory analyzes showed that these duplications, advantageous at the heterozygous state, are mostly sublethal when homozygous. The second axis of this PhD was the study of the impact of selection pressure variations on the dynamics of adaptive alleles. An experimental evolution study showed that intermediate selective pressures could generate overdominance situations at the *ace-1* locus, promoting the selection of heterogeneous duplications. Furthermore, analyzing Montpellier samples collected over a 27 years period allowed us establishing the quantitative relationship between selective pressure variations and fitness variations for the different *Ester* resistance alleles. Finally, by studying three different geographical areas (Mayotte and Martinique islands and Montpellier) we showed that the various adaptations were not responding similarly to a major environmental change resulting from the selection pressure withdrawal (OPs and CXs were banned in 2007): while the *ace-1* locus resistance alleles tended to disappear, those of the *Ester* locus remained at a significant frequency in natural populations.

Keywords: *Insecticide resistance, evolutionary trade-offs, gene duplications, natural populations, integrative biology, adaptation genetics*